

Congratulations on your selection of the 2008 Acura RL. We are certain you will be pleased with your purchase of one of the finest luxury vehicles in the world.

One of the best ways to enhance the enjoyment of your new vehicle is to read this manual. In it, you will learn how to operate its driving controls and convenience items. Afterwards, keep this owner's manual in your vehicle so you can refer to it at any time.

Several warranties protect your new vehicle. Read the warranty booklet thoroughly so you understand the coverages and are aware of your rights and responsibilities.

Maintaining your vehicle according to the maintenance minder shown in the instrument panel helps to keep your driving trouble-free while it preserves your investment. When your vehicle needs maintenance, keep in mind that your dealer's staff is specially trained in servicing the many systems unique to your vehicle. Your dealer is dedicated to your satisfaction and will be pleased to answer any questions and concerns.

As you read this manual, you will find information that is preceded by a **NOTICE** symbol. This information is intended to help you avoid damage to your vehicle, other property, or the environment.

# Introduction

---

## California Proposition 65 Warning

**WARNING:** This product contains or emits chemicals known to the State of California to cause cancer and birth defects or other reproductive harm.

## Event Data Recorders

**This vehicle is equipped with one or more devices commonly referred to as event data recorders. These devices record front seat belt use, front passenger seat occupancy, airbag deployment data, and the failure of any airbag system component.** This data belongs to the vehicle owner and may not be accessed by anyone else except as legally required or with the permission of the vehicle owner.

## Service Diagnostic Recorders

This vehicle is equipped with service-related devices that record information about powertrain performance. The data can be used to verify emissions law requirements and/or help technicians diagnose and solve service problems. It may also be combined with data from other sources for research purposes, but it remains confidential.

Your safety, and the safety of others, is very important. And operating this vehicle safely is an important responsibility.

To help you make informed decisions about safety, we have provided operating procedures and other information on labels and in this manual. This information alerts you to potential hazards that could hurt you or others.

Of course, it is not practical or possible to warn you about all the hazards associated with operating or maintaining your vehicle. You must use your own good judgement.

You will find this important safety information in a variety of forms, including:

- **Safety Labels** — on the vehicle.
- **Safety Messages** — preceded by a safety alert symbol  and one of three signal words: **DANGER**, **WARNING**, or **CAUTION**. These signal words mean:

 **DANGER**

You **WILL** be **KILLED** or **SERIOUSLY HURT** if you don't follow instructions.

 **WARNING**

You **CAN** be **KILLED** or **SERIOUSLY HURT** if you don't follow instructions.

 **CAUTION**

You **CAN** be **HURT** if you don't follow instructions.

- **Safety Headings** — such as Important Safety Reminders or Important Safety Precautions.
- **Safety Section** — such as Driver and Passenger Safety.
- **Instructions** — how to use this vehicle correctly and safely.

This entire book is filled with important safety information — please read it carefully.

### Owner's Identification Form

<b>Introduction</b> .....	<b>i</b>
<b>A Few Words About Safety</b> .....	<b>iii</b>
<b>Your Vehicle at a Glance</b> (main controls) .....	<b>4</b>
<b>Driver and Passenger Safety</b> (seat belts, SRS, and child protection) .....	<b>7</b>
<b>Instruments and Controls</b> (indicators, gauges, multi-information display, dashboard and steering column) .....	<b>59</b>
<b>Features</b> (climate control, audio, steering wheel, security, cruise control, HomeLink, and other convenience items) .....	<b>197</b>
<b>Before Driving</b> (fuel, vehicle break-in, and cargo loading) .....	<b>327</b>
<b>Driving</b> (engine and transmission operation) .....	<b>345</b>
<b>Maintenance</b> (minders, fluid checking, minor services, and vehicle storage).....	<b>385</b>
<b>Taking Care of the Unexpected</b> (flat tire, dead battery, overheating, fuses) .....	<b>431</b>
<b>Technical Information</b> (vehicle specifications, tires, and emissions controls) .....	<b>461</b>
<b>Warranty and Customer Relations</b> (U. S. and Canada only) (warranty and contact information) ...	<b>477</b>
<b>Authorized Manuals</b> (U. S. only) (how to order) .....	<b>481</b>
<b>Index</b> .....	<b>I</b>

### Service Information Summary (fluid capacities and tire pressures)





## **Contents**

A convenient reference to the sections in this manual.

## **Your Vehicle at a Glance**

A quick reference to the main controls in your vehicle.

## **Driver and Passenger Safety**

Important information about the proper use and care of your vehicle's seat belts, an overview of the supplemental restraint system, and valuable information on how to protect children with child restraints.

## **Instruments and Controls**

Explains the purpose of each instrument panel indicator and gauge, and how to use the controls on the dashboard and steering column.

## **Features**

How to operate the climate control system, the audio system, and other convenience features.

## **Before Driving**

What gasoline to use, how to break-in your new vehicle, and how to load luggage and other cargo.

## **Driving**

The proper way to start the engine, shift the transmission, and park; plus what you need to know if you're planning to tow a trailer.

## **Maintenance**

The maintenance minder shows you when you need to take your vehicle to the dealer for maintenance service. There is also a list of things to check and instructions on how to check them.

## **Taking Care of the Unexpected**

This section covers several problems motorists sometimes experience, and details how to handle them.

## **Technical Information**

ID numbers, dimensions, capacities, and technical information.

## **Warranty and Client Relations (U.S. and Canada only)**

A summary of the warranties covering your new vehicle, and how to contact us for any reason. Refer to your warranty manual for detailed information.

## **Authorized Manuals (U.S. only)**

How to order manuals and other technical literature.

## **Index**

## **Service Information Summary**

A summary of the information you need when you pull up to the fuel pump.

# Your Vehicle at a Glance

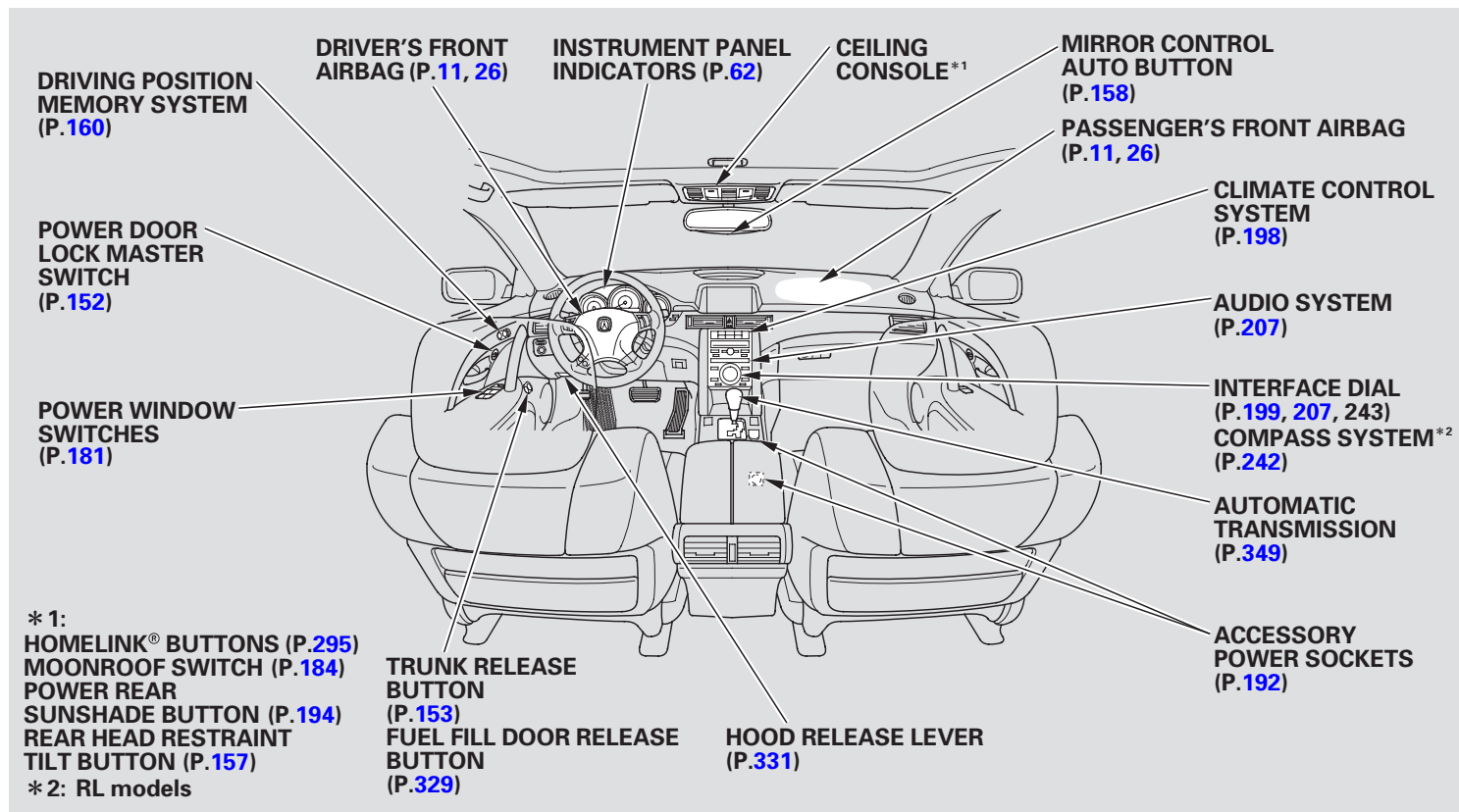

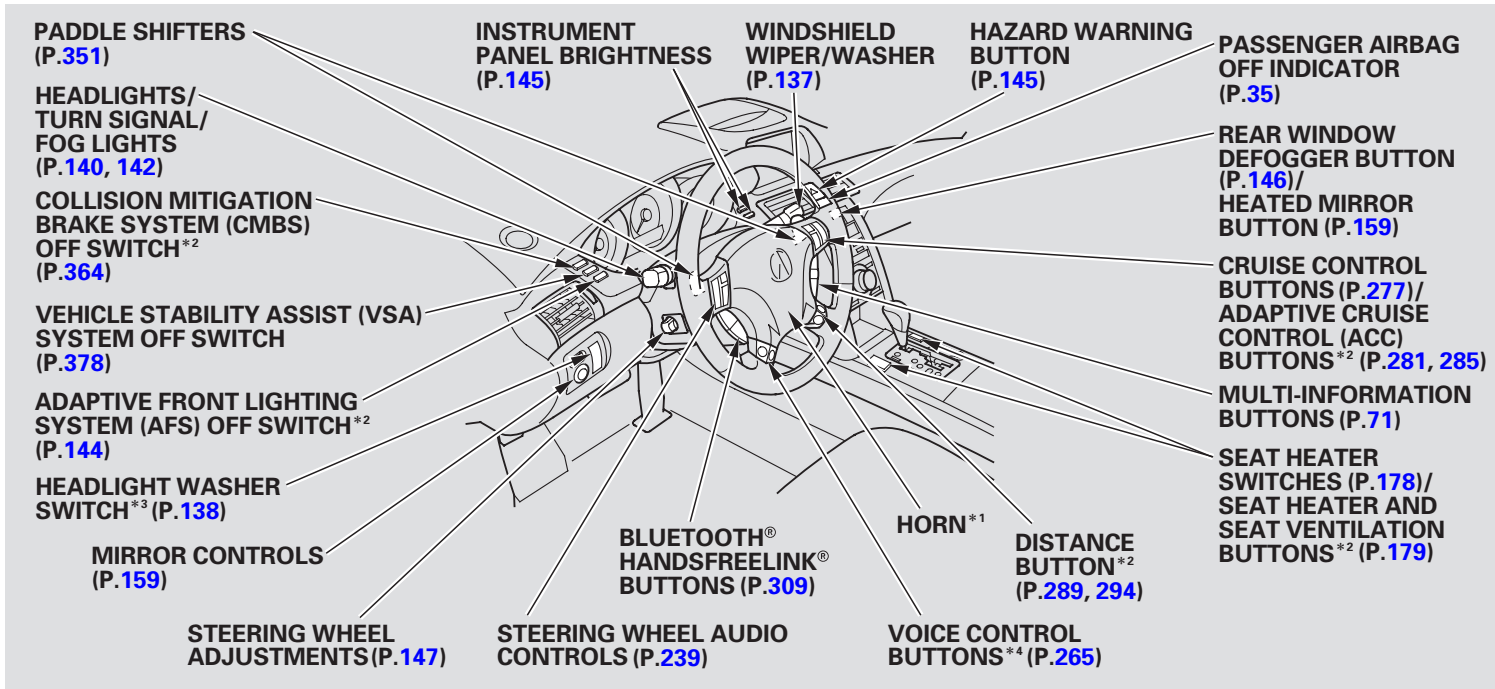

\* 1 : To use the horn, press the center pad of the steering wheel.

\* 2 : If equipped.

\* 3 : Canadian models only

\* 4 : Refer to the navigation system manual.



This section gives you important information about how to protect yourself and your passengers. It shows you how to use seat belts. It explains how your airbags work. And it tells you how to properly restrain infants and children in your vehicle.

- Important Safety Precautions ..... 8
- Your Vehicle’s Safety Features..... 9
- Protecting Adults and Teens..... 13
  - 1. Close and Lock the Doors ..... 13
  - 2. Adjust the Front Seats ..... 14
  - 3. Adjust the Seat-Backs ..... 15
  - 4. Adjust the Head Restraints .... 16
  - 5. Fasten and Position the Seat Belts ..... 17
  - 6. Maintain a Proper Sitting Position ..... 18
- Advice for Pregnant Women..... 19
- Additional Safety Precautions.... 20
- Additional Information About
  - Your Seat Belts ..... 21
  - Seat Belt System Components... 21

- Lap/Shoulder Belt..... 22
- Automatic Seat Belt
  - Tensioners..... 23
- Seat Belt E-pretensioners ..... 24
- Seat Belt Maintenance ..... 25
- Additional Information About
  - Your Airbags ..... 26
  - Airbag System Components..... 26
  - How Your Front Airbags Work..... 29
  - How Your Side Airbags Work.... 32
  - How Your Side Curtain Airbags Work..... 34
  - How the SRS Indicator Works... 34
  - How the Side Airbag Off Indicator Works ..... 35
  - How the Passenger Airbag Off Indicator Works ..... 35
  - Airbag Service ..... 36
  - Additional Safety Precautions.... 37
- Protecting Children – General Guidelines..... 38
  - All Children Must Be Restrained ..... 38
  - All Children Should Sit in a Back Seat ..... 39

- The Passenger’s Front Airbag Can Pose Serious Risks ..... 39
- If You Must Drive with Several Children ..... 41
- If a Child Requires Close Attention ..... 41
- Additional Safety Precautions.... 41
- Protecting Infants and Small Children ..... 43
- Protecting Infants..... 43
- Protecting Small Children ..... 44
- Selecting a Child Seat..... 45
- Installing a Child Seat ..... 46
  - With LATCH ..... 47
  - With a Lap/Shoulder Belt ..... 49
  - With a Tether ..... 51
- Protecting Larger Children ..... 52
- Checking Seat Belt Fit ..... 52
- Using a Booster Seat ..... 53
- When Can a Larger Child Sit in Front..... 54
  - Additional Safety Precautions.... 55
- Carbon Monoxide Hazard ..... 56
- Safety Labels ..... 57

## Important Safety Precautions

---

You'll find many safety recommendations throughout this section, and throughout this manual. The recommendations on this page are the ones we consider to be the most important.

### **Always Wear Your Seat Belt**

A seat belt is your best protection in all types of collisions. Airbags are designed to supplement seat belts, not replace them. So even though your vehicle is equipped with airbags, make sure you and your passengers always wear your seat belts, and wear them properly (see page 17 ).

### **Restrain All Children**

Children age 12 and under should ride properly restrained in a back seat, not the front seat. Infants and small children should be restrained in a child seat. Larger children should use a booster seat and a lap/shoulder belt until they can use the belt properly without a booster seat

(see pages 38 – 55 ).

### **Be Aware of Airbag Hazards**

While airbags can save lives, they can cause serious or fatal injuries to occupants who sit too close to them, or are not properly restrained. Infants, young children, and short adults are at the greatest risk. Be sure to follow all instructions and warnings in this manual.

### **Don't Drink and Drive**

Alcohol and driving don't mix. Even one drink can reduce your ability to respond to changing conditions, and your reaction time gets worse with every additional drink. So don't drink and drive, and don't let your friends drink and drive, either.

### **Control Your Speed**

Excessive speed is a major factor in crash injuries and deaths. Generally, the higher the speed, the greater the risk, but serious injuries can also occur at lower speeds. Never drive faster than is safe for current conditions, regardless of the maximum speed posted.

### **Keep Your Vehicle in Safe Condition**

Having a tire blowout or a mechanical failure can be extremely hazardous. To reduce the possibility of such problems, check your tire pressures and condition frequently, and perform all regularly scheduled maintenance (see page 387 ).

# Your Vehicle's Safety Features

Your vehicle is equipped with many features that work together to protect you and your passengers during a crash.

Some features do not require any action on your part. These include a strong steel framework that forms a safety cage around the passenger compartment; front and rear crush zones; a collapsible steering column; and tensioners that tighten the front seat belts in a crash.

However, you and your passengers can't take full advantage of these features unless you remain sitting in a proper position and ***always wear your seat belts***. In fact, some safety features can contribute to injuries if they are not used properly.

The following pages explain how you can take an active role in protecting yourself and your passengers.

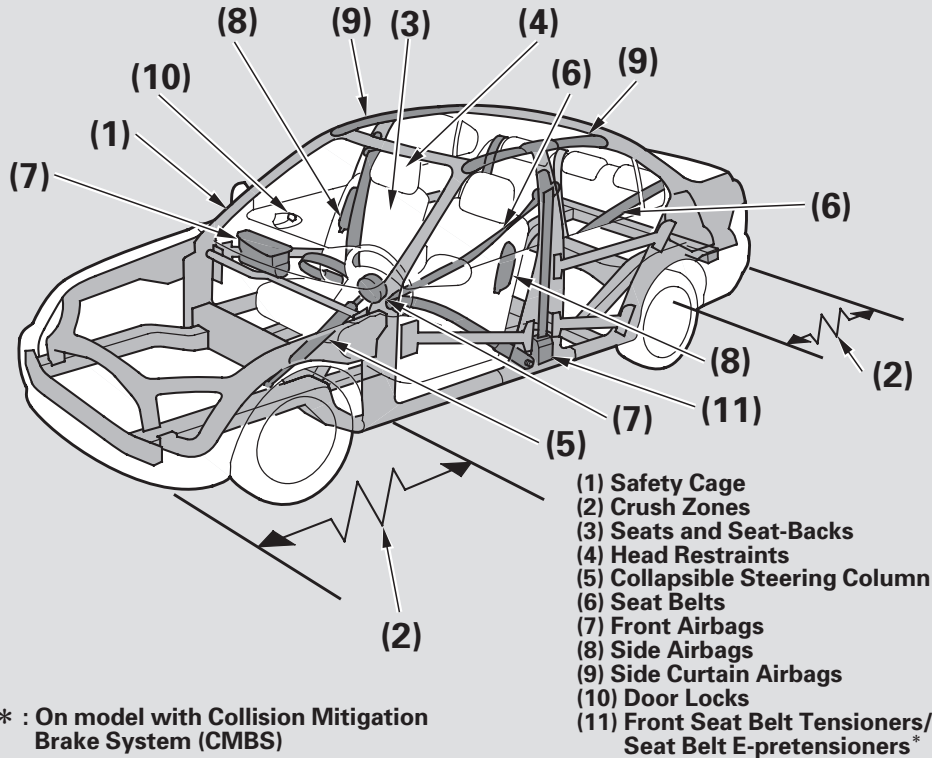



# Your Vehicle's Safety Features

---

## Seat Belts

Your vehicle is equipped with seat belts in all seating positions.

Your seat belt system also includes an indicator on the instrument panel and a beeper to remind you and your passengers to fasten your seat belts.

### *Why Wear Seat Belts*

Seat belts are the single most effective safety device for adults and larger children. (Infants and smaller children must be properly restrained in child seats.)

Not wearing a seat belt properly increases the chance of serious injury or death in a crash, even though your vehicle has airbags.

In addition, most states and all Canadian provinces require you to wear seat belts.

## **WARNING**

Not wearing a seat belt properly increases the chance of serious injury or death in a crash, even though your vehicle has airbags.

Be sure you and your passengers always wear seat belts and wear them properly.

When properly worn, seat belts:

- Keep you connected to the vehicle so you can take advantage of the vehicle's built-in safety features.
- Help protect you in almost every type of crash, including frontal, side, and rear impacts and rollovers.

- Help keep you from being thrown against the inside of the vehicle and against other occupants.
- Keep you from being thrown out of the vehicle.
- Help keep you in a good position should the airbags ever deploy. A good position reduces the risk of injury from an inflating airbag and allows you to get the best advantage from the airbag.

Of course, seat belts cannot completely protect you in every crash. But in most cases, seat belts can reduce your risk of serious injury.

### *What You Should Do:*

Always wear your seat belt, and make sure you wear it properly.

## Airbags

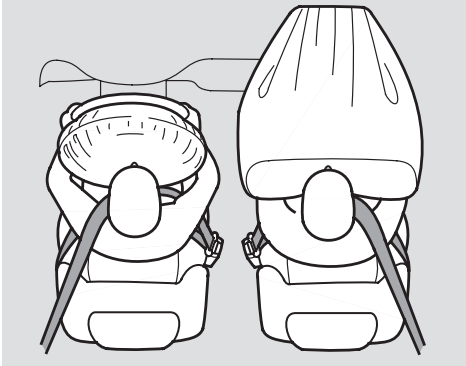

Your vehicle has a supplemental restraint system (SRS) with front airbags to help protect the heads and chests of the driver and a front seat passenger during a moderate to severe frontal collision (see page [29](#) for more information on how your front airbags work).

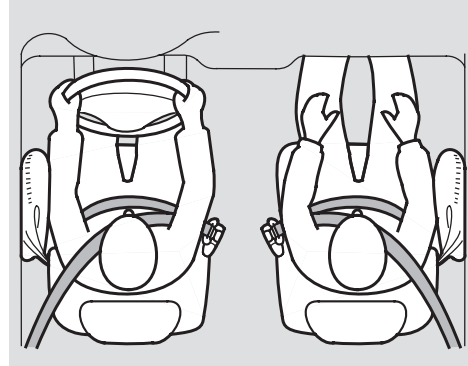

Your vehicle also has side airbags to help protect the upper torso of the driver or a front seat passenger during a moderate to severe side impact (see page [32](#) for more information on how your side airbags work).

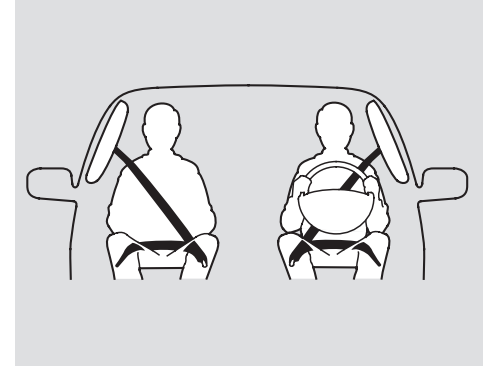

In addition, your vehicle has side curtain airbags to help protect the heads of the driver, front passenger, and passengers in the outer rear seating positions during a moderate to severe side impact (see page [34](#) for more information on how your side curtain airbags work).

*CONTINUED*

## Your Vehicle's Safety Features

---

The most important things you need to know about your airbags are:

- ***Airbags do not replace seat belts.*** They are designed to supplement the seat belts.
- ***Airbags offer no protection in rear impacts, or minor frontal or side collisions.***
- ***Airbags can pose serious hazards.*** To do their job, airbags must inflate with tremendous force. So while airbags help save lives, they can cause minor injuries or more serious or even fatal injuries if occupants are not properly restrained or sitting properly.

***What you should do:*** Always wear your seat belt properly, and sit upright and as far back from the steering wheel as possible while allowing full control of the vehicle. A front passenger should move their seat as far back from the dashboard as possible.

The rest of this section gives more detailed information about how you can maximize your safety.

Remember, however, that no safety system can prevent all injuries or deaths that can occur in a severe crash, even when seat belts are properly worn and the airbags deploy.

## Introduction

The following pages provide instructions on how to properly protect the driver, adult passengers, and teenage children who are large enough and mature enough to drive or ride in the front.

See pages 38 – 42 for important guidelines on how to properly protect infants, small children, and larger children who ride in your vehicle.

### 1. Close and Lock the Doors

After everyone has entered the vehicle, be sure the doors are closed and locked.

Your vehicle has door monitor indicators on the multi-information display to indicate when a specific door or the trunk is not tightly closed. You will see the appropriate indicator and the message for each condition.

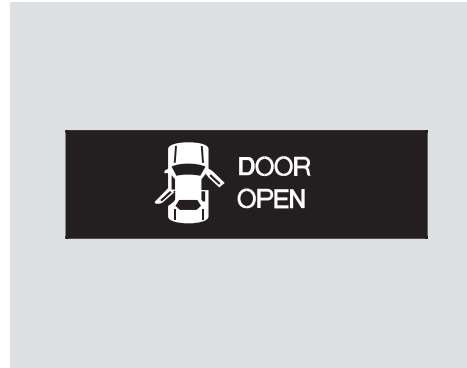

When one or more doors are not tightly closed, the “DOOR OPEN” indicator will stay on.



When the trunk is not tightly closed, the “TRUNK OPEN” indicator will stay on.

*CONTINUED*

## Protecting Adults and Teens



When both the trunk and one or more doors are not tightly closed, the “DOOR & TRUNK OPEN” indicator will stay on.

Locking the doors reduces the chance of someone being thrown out of the vehicle during a crash, and it helps prevent passengers from accidentally opening a door and falling out.

Locking the doors also helps prevent an outsider from unexpectedly opening a door when you come to a stop.

See page [152](#) for how to lock the doors.

### 2. Adjust the Front Seats

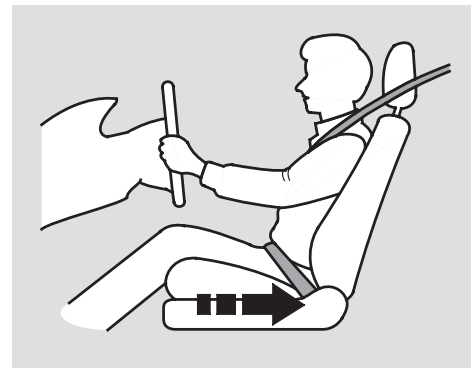

Adjust the driver’s seat as far to the rear as possible while allowing you to maintain full control of the vehicle. Have a front passenger adjust their seat as far to the rear as possible.

If you sit too close to the steering wheel or dashboard, you can be seriously injured by an inflating front airbag, or by striking the steering wheel or dashboard.

The National Highway Traffic Safety Administration and Transport Canada recommend that drivers allow at least 10 inches (25 cm) between the center of the steering wheel and the chest. In addition to adjusting the seat, you can adjust the steering wheel up and down, and in and out (see page 147).

If you cannot get far enough away from the steering wheel and still reach the controls, we recommend that you investigate whether some type of adaptive equipment may help.

### **⚠ WARNING**

Sitting too close to a front airbag can result in serious injury or death if the front airbags inflate.

Always sit as far back from the front airbags as possible.

See page 155 for how to adjust the front seats.

### 3. Adjust the Seat-Backs

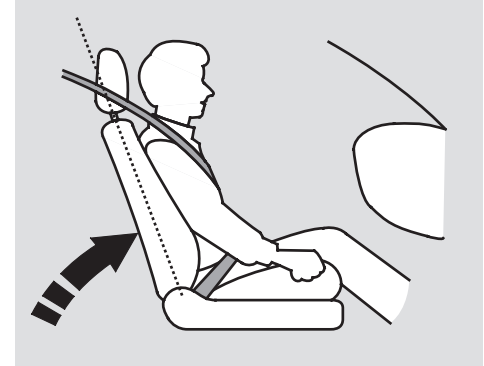

Adjust the driver's seat-back to a comfortable, upright position, leaving ample space between your chest and the airbag cover in the center of the steering wheel.

Passengers with adjustable seat-backs should also adjust their seat-back to a comfortable, upright position.

*CONTINUED*

## Protecting Adults and Teens

### **⚠️ WARNING**

Reclining the seat-back too far can result in serious injury or death in a crash.

Adjust the seat-back to an upright position, and sit well back in the seat.

Reclining a seat-back so that the shoulder part of the belt no longer rests against the occupant's chest reduces the protective capability of the belt. It also increases the chance of sliding under the belt in a crash and being seriously injured. The farther a seat-back is reclined, the greater the risk of injury.

See page [155](#) for how to adjust the seat-backs.

### 4. Adjust the Head Restraints

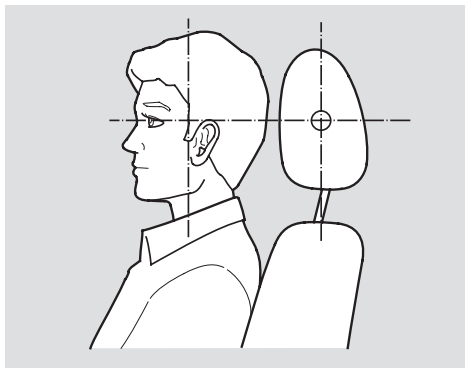

Adjust the driver's head restraint so the center of the back of your head rests against the center of the restraint.

Have passengers with adjustable head restraints adjust their restraints properly as well. Taller persons should adjust their restraint as high as possible.

### **⚠️ WARNING**

Improperly positioning head restraints reduces their effectiveness and you can be seriously injured in a crash.

Make sure head restraints are in place and positioned properly before driving.

Properly adjusted head restraints will help protect occupants from whiplash and other crash injuries.

See page [156](#) for how to adjust the head restraints.

### 5. Fasten and Position the Seat Belts

Insert the latch plate into the buckle, then tug on the belt to make sure the belt is securely latched. Check that the belt is not twisted, because a twisted belt can cause serious injuries in a crash.



Position the lap part of the belt as low as possible across your hips, then pull up on the shoulder part of the belt so the lap part fits snugly. This lets your strong pelvic bones take the force of a crash and reduces the chance of internal injuries.

If necessary, pull up on the belt again to remove any slack, then check that the belt rests across the center of your chest and over your shoulder.

This spreads the forces of a crash over the strongest bones in your upper body.

#### **WARNING**

Improperly positioning the seat belts can cause serious injury or death in a crash.

Make sure all seat belts are properly positioned before driving.

If the seat belt touches or crosses your neck, or if it crosses your arm instead of your shoulder, you need to adjust the seat belt anchor height.

*CONTINUED*



## Protecting Adults and Teens

---

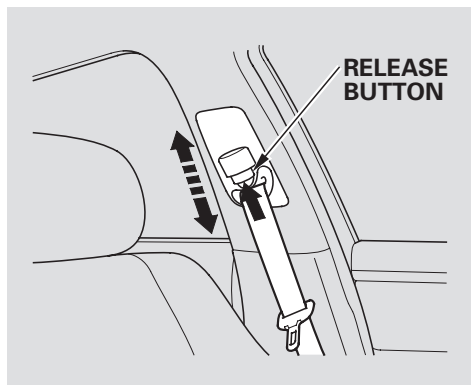

The front seats have adjustable seat belt anchors. To adjust the height of an anchor, press and hold the release buttons, and slide the anchor up or down as needed (it has four positions).

***Never place the shoulder portion of a lap/shoulder belt under your arm or behind your back.*** This could cause very serious injuries in a crash.

If a seat belt does not seem to work properly, it may not protect the occupant in a crash.

***No one should sit in a seat with an inoperative seat belt.*** Using a seat belt that is not working properly can result in serious injury or death. Have your dealer check the belt as soon as possible.

See page [21](#) for additional information about your seat belts and how to take care of them.

### **6. Maintain a Proper Sitting Position**

After all occupants have adjusted their seats and head restraints, and put on their seat belts, it is very important that they continue to sit upright, well back in their seats, with their feet on the floor, until the vehicle is parked and the engine is off.

Sitting improperly can increase the chance of injury during a crash. For example, if an occupant slouches, lies down, turns sideways, sits forward, leans forward or sideways, or puts one or both feet up, the chance of injury during a crash is greatly increased.

In addition, an occupant who is out of position in the front seat can be seriously or fatally injured in a crash by striking interior parts of the vehicle or being struck by an inflating front airbag.

**⚠ WARNING**

Sitting improperly or out of position can result in serious injury or death in a crash.

Always sit upright, well back in the seat, with your feet on the floor.

**Advice for Pregnant Women**



If you are pregnant, the best way to protect yourself and your unborn child when driving or riding in a vehicle is to always wear a seat belt, and keep the lap part of the belt as low as possible across the hips.

When driving, remember to sit upright and adjust the seat as far back as possible while allowing full control of the vehicle. When riding as a front passenger, adjust the seat as far back as possible.

This will reduce the risk of injuries to both you and your unborn child that can be caused by a crash or an inflating front airbag.

Each time you have a checkup, ask your doctor if it's okay for you to drive.

## Protecting Adults and Teens

---

### Additional Safety Precautions

- ***Two people should never use the same seat belt.*** If they do, they could be very seriously injured in a crash.
  - ***Do not put any accessories on seat belts.*** Devices intended to improve occupant comfort or reposition the shoulder part of a seat belt can reduce the protective capability of the belt and increase the chance of serious injury in a crash.
  - ***Do not place hard or sharp objects between yourself and a front airbag.*** Carrying hard or sharp objects on your lap, or driving with a pipe or other sharp object in your mouth, can result in injuries if your front airbag inflates.
- ***Keep your hands and arms away from the airbag covers.*** If your hands or arms are close to an airbag cover, they could be injured if the airbag inflates.
  - ***Do not attach or place objects on the front airbag covers.*** Objects on the covers marked “SRS AIRBAG” could interfere with the proper operation of the airbags or be propelled inside the vehicle and hurt someone if the airbags inflate.
  - ***Do not attach hard objects on or near a door.*** If a side airbag or a side curtain airbag inflates, a cup holder or other hard object attached on or near the door could be propelled inside the vehicle and hurt someone.

## Additional Information About Your Seat Belts

### Seat Belt System Components

Your seat belt system includes lap/shoulder belts in all five seating positions. The front seat belts are also equipped with automatic seat belt tensioners and, on models with collision mitigation brake system (CMBS), seat belt e-pretensioners.

This system uses the same sensors as the front airbags to monitor whether the front seat belts are latched or unlatched, and how much weight is on the front passenger's seat (see pages [31](#) and [32](#)).



The seat belt system includes an indicator on the instrument panel and a beeper to remind you and your passengers to fasten your seat belts.

This system monitors the front seat belts. If you turn the ignition switch to the ON (II) position before your seat belt is fastened, the beeper will sound and the indicator will flash. If your seat belt is not fastened before the beeper stops, the indicator will stop flashing but remain on.

If a front passenger does not fasten their seat belt, the indicator will come on about 6 seconds after the ignition switch is turned to the ON (II) position.

If either the driver or a front passenger does not fasten their seat belt while driving, the beeper will sound and the indicator will flash again at regular intervals.

You will also see a “FASTEN SEAT BELT” or “FASTEN PASSENGER SEAT BELT” message on the multi-information display (see page [79](#)).

When no one is sitting in the front passenger's seat, or a child or small adult is riding there, the indicator should not come on and the beeper should not sound.

*CONTINUED*

## Additional Information About Your Seat Belts

---

If the indicator comes on or the beeper sounds when the driver's seat belt is latched and there is no front seat passenger and no items on the front seat, something may be interfering with the monitoring system. Look for and remove:

- Any items under the front passenger's seat.
- Any object(s) hanging on the seat or in the seat-back pocket.
- Any object touching the rear of the seat-back.

If no obstructions are found, have your vehicle checked by a dealer.

### **Lap/Shoulder Belt**

The lap/shoulder belt goes over your shoulder, across your chest, and across your hips.

To fasten the belt, insert the latch plate into the buckle, then tug on the belt to make sure the buckle is latched (see page 17 for how to properly position the belt).

To unlock the belt, press the red PRESS button on the buckle. Guide the belt across your body so that it retracts completely. After exiting the vehicle, be sure the belt is out of the way and will not get closed in the door.

All seat belts have an emergency locking retractor. In normal driving, the retractor lets you move freely in your seat while it keeps some tension on the belt. During a collision or sudden stop, the retractor automatically locks the belt to help restrain your body.

## Additional Information About Your Seat Belts

The seat belts in all positions except the driver's have a lockable retractor that must be activated to secure a child seat (see page 49 ).

If the shoulder part of the belt is pulled all the way out, the lockable retractor will activate. The belt will retract, but it will not allow the passenger to move freely.

To deactivate the lockable retractor, unlatch the buckle and let the seat belt fully retract. To refasten the seat belt, pull it out only as far as needed.

### Automatic Seat Belt Tensioners

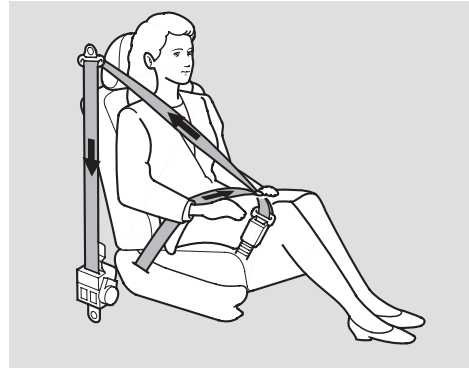

For added protection, the front seat belts are equipped with automatic seat belt tensioners. When activated, the tensioners immediately tighten the belts to help hold the driver and a front passenger in position.

The tensioners are designed to activate in any collision severe enough to cause the front airbags to deploy.

If a side airbag or side curtain airbag deploys during a side impact, the tensioner on that side of the vehicle will also deploy.

The tensioners can also be activated during a collision in which the front airbags *do not deploy*. In this case, the airbags would not be needed, but the additional restraint could be helpful.

When the tensioners are activated, the seat belts will remain tight until they are unbuckled.

## Additional Information About Your Seat Belts

---

### Seat Belt e-pretensioners

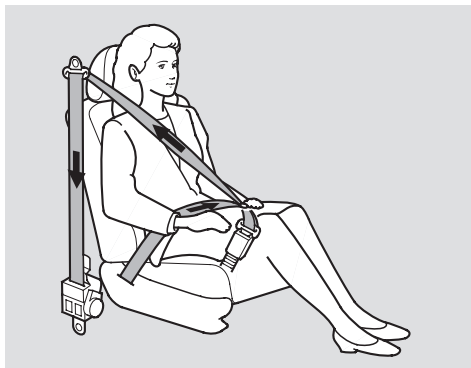

#### *On models with Collision Mitigation Brake System*

For added safety, the front seat belts are equipped with e-pretensioners that work in combination with the collision mitigation brake system (CMBS) (see page 361) and the brake pedal assist function (see page 358).

If your vehicle gets too close to the vehicle ahead of it in your lane, the driver's e-pretensioner slightly retracts the seat belt to alert the driver of the approaching vehicle. If a collision with the vehicle in front of you is likely, the e-pretensioners on both front seats retract the seat belts with enough force to properly restrain you and your front passenger. After they activate, the e-pretensioners release the retracted seat belts.

To get the full benefit of the e-pretensioners, you and your front passenger must sit normally in your seats and wear your seat belts properly (see page 17).

The e-pretensioners do not activate when the seat belts are not worn or when the vehicle stability assist (VSA) off indicator on the instrument panel is on.

If the automatic seat belt tensioners are activated by a collision, both front seat belts and all related components must be replaced (see page 25). If only the e-pretensioners were activated, no components need to be replaced.

In addition, the front passenger's e-pretensioner does not activate when the passenger's airbag is automatically turned off because the weight sensor detects a child in the front passenger's seat.

### Seat Belt Maintenance

For safety, you should check the condition of your seat belts regularly.

Pull each belt out fully, and look for frays, cuts, burns, and wear. Check that the latches work smoothly and the belts retract easily. If a belt does not retract easily, cleaning the belt may correct the problem (see page 415). Any belt that is not in good condition or working properly will not provide good protection and should be replaced as soon as possible.

Acura provides a limited warranty on seat belts. See your *Acura Warranty Information* booklet for details.

If a seat belt is worn during a crash, it must be replaced by the dealer. A belt that has been worn during a crash may not provide the same level of protection in a subsequent crash.

The dealer should also inspect the anchors for damage and replace them if needed. If the automatic seat belt tensioners activate during a crash, they must be replaced.

### WARNING

Not checking or maintaining seat belts can result in serious injury or death if the seat belts do not work properly when needed.

Check your seat belts regularly and have any problem corrected as soon as possible.



# Additional Information About Your Airbags

## Airbag System Components

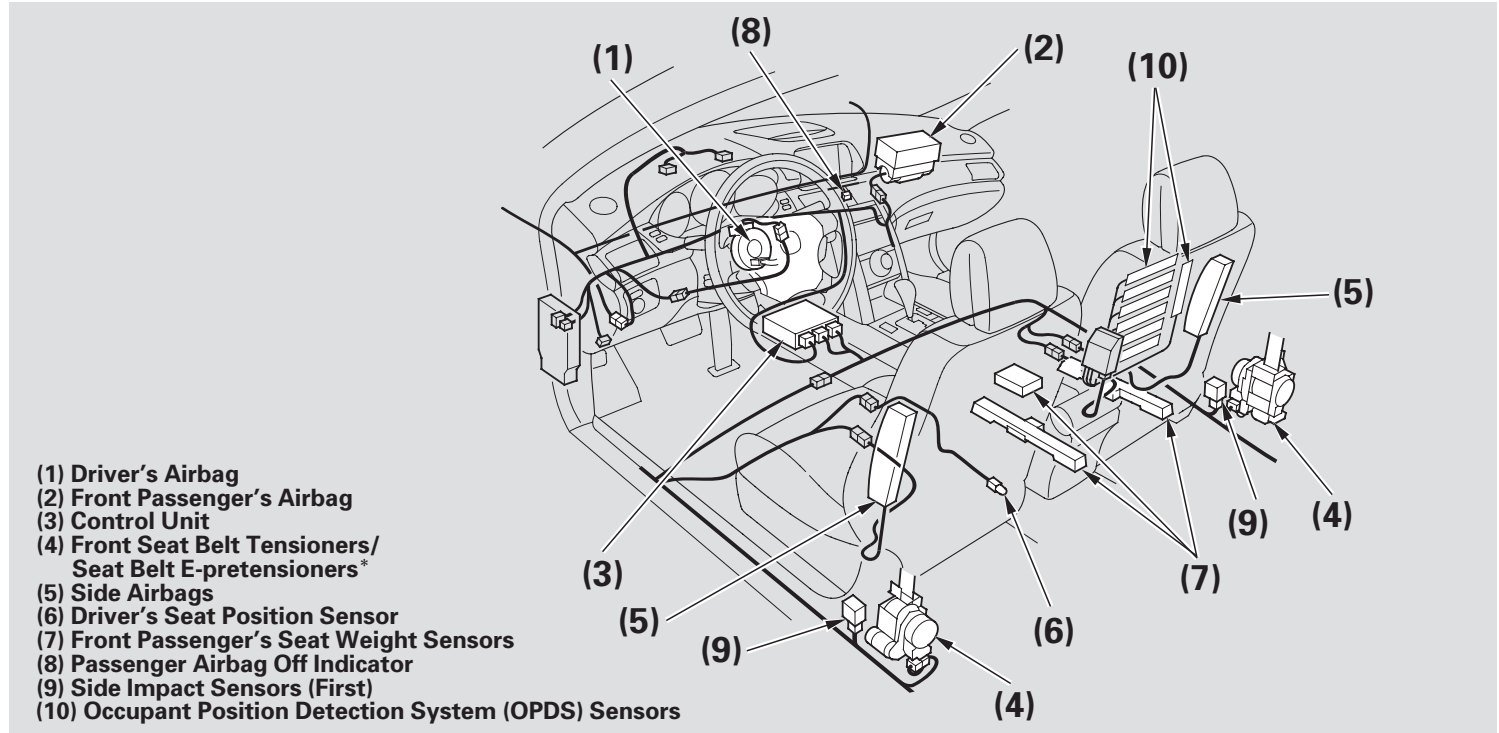

\* : On models with CMBS

## Additional Information About Your Airbags

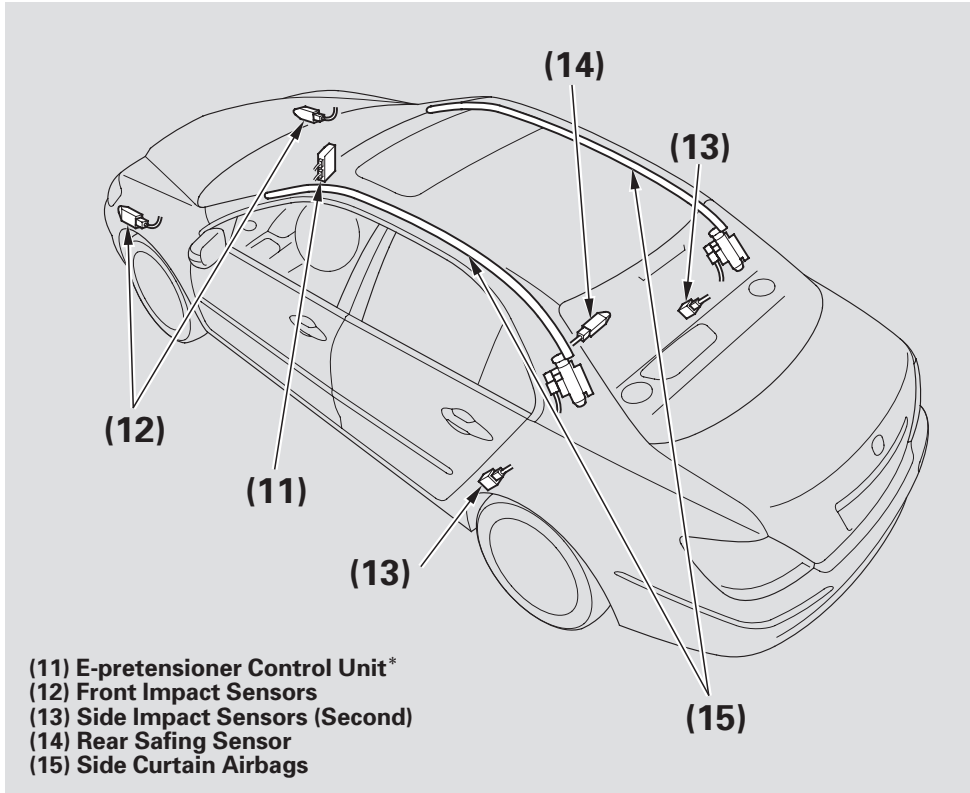

Your airbag system includes:

- Two SRS (supplemental restraint system) front airbags. The driver's airbag is stored in the center of the steering wheel; the front passenger's airbag is stored in the dashboard. Both are marked "SRS AIRBAG" (see page 29).
- Two side airbags, one for the driver and one for a front passenger. The airbags are stored in the outer edges of the seat-backs. Both are marked "SIDE AIRBAG" (see page 32).
- Two side curtain airbags, one for each side of the vehicle. The airbags are stored in the ceiling, above the side windows. The front and rear pillars are marked "SIDE CURTAIN AIRBAG" (see page 34).

CONTINUED

## Additional Information About Your Airbags

---

- On models with CMBS, front seat belt e-pretensioners (see page 24 ).
- Automatic front seat belt tensioners (see page 23 ).
- Sensors that can detect a moderate to severe front impact or side impact.
- Sensors that can detect whether a child is in the passenger's side airbag path and signal the control unit to turn the airbag off (see page 33 ).
- Sensors that can detect whether the driver's seat belt and the front passenger's seat belt are latched or unlatched (see page 21 ).
- A driver's seat position sensor that monitors the distance of the seat from the front airbag. If the seat is too far forward, the airbag will inflate with less force (see page 31 ).
- Weight sensors that monitor the weight on the front passenger's seat. If the weight is about 65 lbs (29 kg) or less (the weight of an infant or small child), the passenger's front airbag will be turned off (see page 31 ).
- A sophisticated electronic system that continually monitors and records information about the sensors, the control unit, the airbag activators, the seat belt tensioners, and driver and front passenger seat belt use when the ignition switch is in the ON (II) position.
- An indicator on the instrument panel that alerts you to a possible problem with your airbags, sensors, seat belt tensioners (see page 34 ), or, on models with CMBS, seat belt e-pretensioners (see page 24 ).
- An indicator on the instrument panel that alerts you that the passenger's side airbag has been turned off (see page 35 ).
- An indicator on the dashboard that alerts you that the passenger's front airbag has been turned off (see page 35 ).
- Emergency backup power in case your vehicle's electrical system is disconnected in a crash.

## Additional Information About Your Airbags

### How Your Front Airbags Work

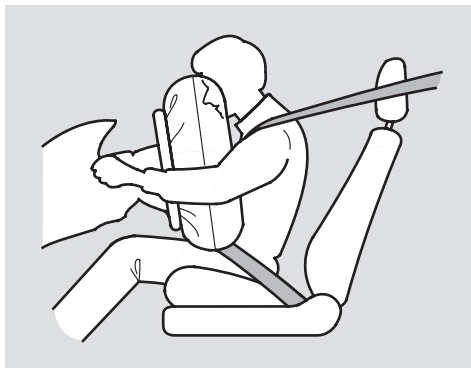

If you ever have a moderate to severe frontal collision, sensors will detect the vehicle's rapid deceleration.

If the rate of deceleration is high enough, the control unit will instantly inflate the driver's and front passenger's airbags, at the time and with the force needed.

During a frontal crash, your seat belt restrains your lower body and torso, and the front airbag helps protect your head and chest.

Although both airbags normally inflate within a split second of each other, it is possible for only one airbag to deploy.

This can happen if the severity of a collision is at the margin, or threshold, that determines whether or not the airbags will deploy. In such cases, the seat belt will provide sufficient protection, and the supplemental protection offered by the airbag would be minimal.

Only the driver's airbag will deploy if there is no passenger in the front seat, or if the advanced airbag system has turned the passenger's airbag off (see page 31).

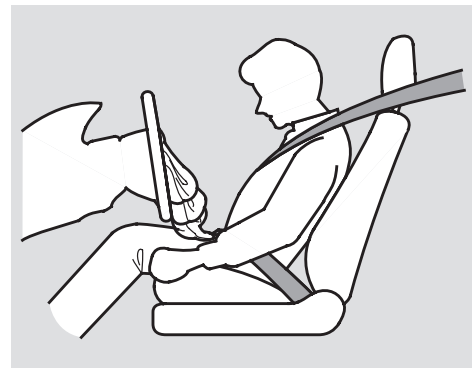

After inflating, the front airbags will immediately deflate, so they won't interfere with the driver's visibility, or the ability to steer or operate other controls.

The total time for inflation and deflation is one-tenth of a second, so fast that most occupants are not aware that the airbags deployed until they see them lying in their laps.

*CONTINUED*

## Additional Information About Your Airbags

---

After a crash, you may see what looks like smoke. This is actually powder from the airbag's surface. Although the powder is not harmful, people with respiratory problems may experience some temporary discomfort. If this occurs, get out of the vehicle as soon as it is safe to do so.

### ***Dual-Stage Airbags***

Your front airbags are dual-stage airbags. This means they have two inflation stages that can be ignited sequentially or simultaneously, depending on crash severity.

In a ***more severe*** crash, both stages will ignite simultaneously to provide the quickest and greatest protection.

In a ***less severe*** crash, one stage will ignite first, then the second stage will ignite a split second later. This provides longer airbag inflation time with a little less force.

### ***Dual-Threshold Airbags***

Your front airbags are also dual-threshold airbags. Airbags with this feature have two deployment thresholds that depend on whether sensors detect the occupant is wearing a seat belt or not.

If the occupant's belt is ***not latched***, the airbag will deploy at a slightly lower threshold, because the occupant would need extra protection.

If the occupant's belt is ***latched***, the airbag will inflate at a slightly higher threshold, when the airbag would be needed to supplement the protection provided by the seat belt.

## Additional Information About Your Airbags

### **Advanced Airbags**

Your front airbags are also advanced airbags. The main purpose of this feature is to help prevent airbag-caused injuries to short drivers and children who ride in front.

For both advanced airbags to work properly:

- Occupants must sit upright and wear their seat belts properly.
- Do not spill any liquids on or under the seats, cover the sensors, or put any objects or metal items under the front seats.
- Back-seat passengers should not put their feet under the front seats.

Failure to follow these instructions could damage the sensors or prevent them from working properly.

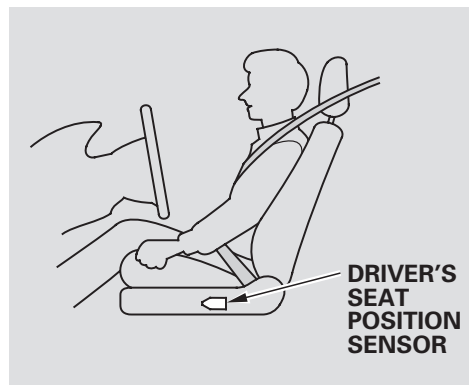

The driver's advanced front airbag system includes a seat position sensor under the seat. If the seat is too far forward, the airbag will inflate with less force, regardless of the severity of the impact.

If there is a problem with the sensor, the SRS indicator will come on, and the airbag will inflate in the normal manner regardless of the driver's seating position.

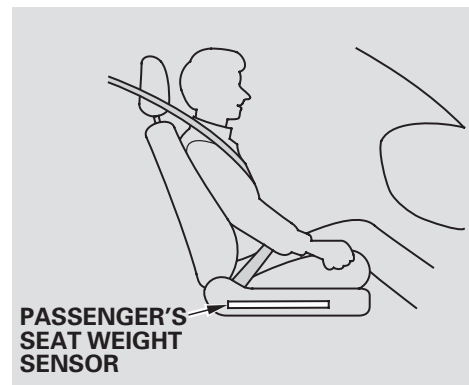

The passenger's advanced front airbag system has weight sensors under the seat. Although Acura does not encourage carrying an infant or small child in front, if the sensors detect the weight of an infant or small child (up to about 65 lbs or 29 kg), the system will automatically turn the passenger's front airbag off.

Be aware that objects placed on the passenger's seat can also cause the airbag to be turned off. *CONTINUED*

## Additional Information About Your Airbags

---

When the airbag is turned off, a “passenger airbag off” indicator in the center of the dashboard comes on (see page 35).

If the weight sensors detect there is no passenger in the front seat, the airbag will be off. However, the passenger airbag off indicator will not come on.

To ensure that the passenger’s advanced front airbag system will work properly, ***do not do anything that would increase or decrease the weight on the front passenger’s seat.*** This includes:

- A rear passenger pushing or pulling on the back of the front passenger’s seat.

- Moving the front seat forcibly back against cargo on the seat or floor behind it.
- Hanging heavy items on the front passenger seat, or placing heavy items in the seat-back pocket.

Also, make sure the floor mat behind the front passenger’s seat is hooked to the floor mat anchor (see page 416). If it is not, the mat may interfere with the proper operation of the sensors and operation of the seat.

### How Your Side Airbags Work

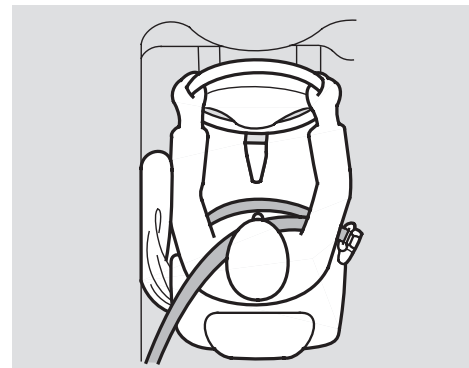

If you ever have a moderate to severe side impact, sensors will detect rapid acceleration and signal the control unit to instantly inflate either the driver’s or the passenger’s side airbag and activate the seat belt tensioner on the affected side.

## Additional Information About Your Airbags

Only one airbag will deploy during a side impact. If the impact is on the passenger's side, the passenger's side airbag will deploy even if there is no passenger.

To get the best protection from the side airbags, front seat occupants should wear their seat belts and sit upright and well back in their seats.

### ***Side Airbag Cutoff System***

Your vehicle has a side airbag cutoff system designed primarily to protect a child riding in the front passenger's seat.

Although Acura does not encourage children to ride in front, if the position sensors detect a child has leaned into the side airbag's deployment path, the airbag will shut off.

The side airbag may also shut off if a short adult leans sideways, or a larger adult slouches and leans sideways into the airbag's deployment path.

Objects placed on the front passenger seat can also cause the side airbag to be shut off.

If the side airbag off indicator comes on (see page 35), have the passenger sit upright. Once the passenger is out of the airbag's deployment path, the system will turn the airbag back on, and the indicator will go out.

There will be some delay between the moment the passenger moves into or out of the airbag deployment path and when the indicator comes on or goes off.

A front seat passenger should not use a cushion or other object as a backrest. It may prevent the cutoff system from working properly.



## Additional Information About Your Airbags

---

### How Your Side Curtain Airbags Work

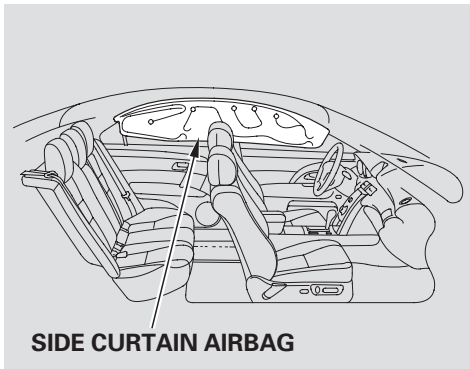

In a moderate to severe side impact, sensors will detect rapid acceleration and signal the control unit to instantly inflate the side curtain airbag and activate the seat belt tensioner on the driver's or the passenger's side of the vehicle.

If the impact is on the passenger's side, the passenger's side curtain airbag will inflate even if there are no occupants on that side of the vehicle.

To get the best protection from the side curtain airbags, occupants should wear their seat belts and sit upright and well back in their seats.

### How the SRS Indicator Works



The SRS indicator alerts you to a potential problem with your airbags, seat belt tensioners, and, on models with CMBS, seat belt e-pretensioners.

When you turn the ignition switch to the ON (II) position, this indicator comes on briefly then goes off. This tells you the system is working properly.

If the indicator comes on at any other time, or does not come on at all, you should have the system checked by your dealer. For example:

- If the SRS indicator does not come on after you turn the ignition switch to the ON (II) position.
- If the indicator stays on after the engine starts.
- If the indicator comes on or flashes on and off while you drive.

## Additional Information About Your Airbags

You will also see a “CHECK AIRBAG SYSTEM” message on the multi-information display (see page 78).

If you see any of these indications, the airbags and seat belt tensioners may not work properly when you need them.

### **⚠ WARNING**

Ignoring the SRS indicator can result in serious injury or death if the airbag systems or tensioners do not work properly.

Have your vehicle checked by a dealer as soon as possible if the SRS indicator alerts you to a possible problem.

### How the Side Airbag Off Indicator Works

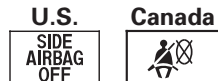

This indicator alerts you that the passenger’s side airbag has been automatically shut off. It does *not* mean there is a problem with your side airbags.

When you turn the ignition switch to the ON (II) position, the indicator should come on briefly and go out (see page 63). If it does not come on, stays on, or comes on while driving without a passenger in the front seat, you will also see a “PASSENGER SIDE AIRBAG OFF” message on the multi-information display. Have the system checked (see page 79).

### How the Passenger Airbag Off Indicator Works

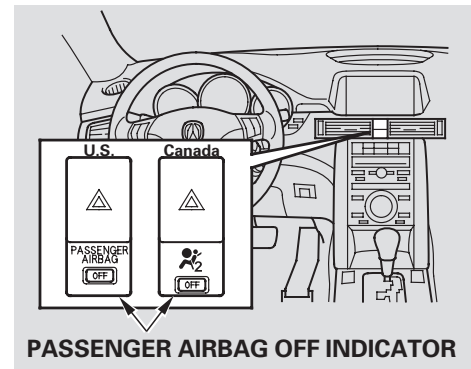

This indicator alerts you that the passenger’s front airbag has been shut off because weight sensors detect about 65 lbs (29 kg) or less (the weight of an infant or small child) on the front passenger’s seat. It does *not mean* there is a problem with the airbag.

CONTINUED

## Additional Information About Your Airbags

---

Be aware that objects placed on the front seat can cause the indicator to come on.

If no weight is detected in the front seat, the airbag will be automatically shut off. However, the indicator will not come on.

The passenger airbag off indicator may come on and off repeatedly if the total weight on the seat is near the airbag cutoff threshold.

If an adult or teenage passenger is riding in front, move the seat as far to the rear as possible, and have the passenger sit upright and wear the seat belt properly.

If the indicator comes on with no front seat passenger and no objects on the seat, or with an adult riding there, something may be interfering with the weight sensors. Look for and remove:

- Any items under the front passenger's seat.
- Any object hanging on the seat or in the seat-back pocket.
- Any object touching the rear of the seat-back.

If no obstructions are found, have your vehicle checked by a dealer as soon as possible.

### **Airbag Service**

Your airbag systems are virtually maintenance free, and there are no parts you can safely service. However, you must have your vehicle serviced if:

- ***An airbag ever inflates.*** Any airbag that has deployed must be replaced along with the control unit and other related parts. Any seat belt tensioner that activates must also be replaced.

Do not try to remove or replace any airbag by yourself. This must be done by an authorized dealer or a knowledgeable body shop.

## Additional Information About Your Airbags

- ***The SRS indicator alerts you to a problem.*** Take your vehicle to an authorized dealer as soon as possible. If you ignore this indication, your airbags may not operate properly.
- ***If your vehicle has a moderate to severe impact.*** Even if your airbags do not inflate, your dealer should inspect the driver's seat position sensor, the front passenger's weight sensors, the front seat belt tensioners, and all seat belts worn during a crash to make sure they are operating properly.

### Additional Safety Precautions

- ***Do not attempt to deactivate your airbags.*** Together, airbags and seat belts provide the best protection.
- ***Do not tamper with airbag components or wiring for any reason.*** Tampering could cause the airbags to deploy, possibly causing very serious injury.
- ***Do not remove or modify a front seat without consulting your dealer.*** This could make the driver's seat position sensor or the front passenger's weight sensors ineffective. If it is necessary to remove or modify a front seat to accommodate a person with disabilities, first contact Acura Client Services at 800-382-2238.

- ***Do not cover or replace front seat-back covers without consulting your dealer.*** Improperly replacing or covering front seat-back covers can prevent your side airbags from inflating during a side impact.
- ***Do not expose the front passenger's seat-back to liquid.*** If water or another liquid soaks into the seat-back, it can prevent the side airbag cutoff system from working properly.

## Protecting Children – General Guidelines



Children depend on adults to protect them. However, despite their best intentions, many adults do not know how to *properly* protect child passengers.

If you have children, or ever need to drive with a child in your vehicle, be sure to read this section. It begins with important general guidelines, then presents special information for infants, small children, and larger children.

### All Children Must Be Restrained

Each year, many children are injured or killed in vehicle crashes because they are either unrestrained or not properly restrained. In fact, vehicle accidents are the number one cause of the death of children ages 12 and under.

To reduce the number of child deaths and injuries, every state and Canadian province requires that infants and children be properly restrained when they ride in a vehicle.

***Infants and small children must be restrained in an approved child seat that is properly secured to the vehicle*** (see pages [43](#) – [51](#) ).

### **⚠ WARNING**

Children who are unrestrained or improperly restrained can be seriously injured or killed in a crash.

Any child too small for a seat belt should be properly restrained in a child seat. A larger child should be properly restrained with a seat belt and use a booster seat if necessary.

***Larger children must be restrained with a lap/shoulder belt and ride on a booster seat until the seat belt fits them properly*** (see pages [52](#) – [55](#) ).

### All Children Should Sit in a Back Seat

According to accident statistics, children of all ages and sizes are safer when they are restrained in a back seat.

The National Highway Traffic Safety Administration and Transport Canada recommend that all children aged 12 and under be properly restrained in a back seat. Some states have laws restricting where children may ride.

Children who ride in back are less likely to be injured by striking interior vehicle parts during a collision or hard braking. Also, children cannot be injured by an inflating front airbag when they ride in the back.

### The Passenger's Front Airbag Can Pose Serious Risks

Front airbags have been designed to help protect adults in a moderate to severe frontal collision. To do this, the passenger's front airbag is quite large, and it can inflate with enough force to cause very serious injuries.

Even though your vehicle has an advanced front airbag system that automatically turns the passenger's front airbag off (see page 35), please follow these guidelines:

#### *Infants*

***Never put a rear-facing child seat in the front seat of a vehicle equipped with a passenger's front airbag.*** If the airbag inflates, it can hit the back of the child seat with enough force to kill or very seriously injure an infant.

#### *Small Children*

***Placing a forward-facing child seat in the front seat of a vehicle equipped with a passenger's front airbag can be hazardous.*** If the vehicle seat is too far forward, or the child's head is thrown forward during a collision, an inflating front airbag can strike the child with enough force to kill or very seriously injure a small child.

#### *Larger Children*

***Children who have outgrown child seats are also at risk of being injured or killed by an inflating passenger's front airbag.*** Whenever possible, larger children should sit in the back seat, on a booster seat if needed, and be properly restrained with a seat belt (see page 52 for important information about protecting larger children).

CONTINUED

# Protecting Children – General Guidelines

To remind you of the passenger's front airbag hazards, and that children must be properly restrained in a back seat, your vehicle has warning labels on the dashboard (U.S. models) and on the front visors. Please read and follow the instructions on these labels.

## U.S. Models

### SUN VISORS



# AIRBAG WARNING

FLIP VISOR OVER



## DASHBOARD

This Vehicle is Equipped with  
Advanced Air Bags

### Even with Advanced Air Bags

Children can be killed or seriously injured by the air bag.  
The back seat is the safest place for children.  
Never put a rear-facing child seat in the front.  
Always use seat belts and child restraints.  
See owner's manual for more information about air bags.

To be removed by owner only.

## Canadian Models

### SUN VISORS

#### CAUTION

TO AVOID SERIOUS INJURY:

- FOR MAXIMUM SAFETY PROTECTION IN ALL TYPES OF CRASHES, YOU MUST ALWAYS WEAR YOUR SAFETY BELT.
- DO NOT INSTALL REARWARD-FACING CHILD SEATS IN ANY FRONT PASSENGER SEAT POSITION.
- DO NOT SIT OR LEAN UNNECESSARILY CLOSE TO THE AIR BAG.
- DO NOT PLACE ANY OBJECTS OVER THE AIR BAG OR BETWEEN THE AIR BAG AND YOURSELF.
- SEE THE OWNER'S MANUAL FOR FURTHER INFORMATION AND EXPLANATIONS.

#### PRÉCAUTION:

POUR ÉVITER DES BLESSURES GRAVES:

- POUR PROFITER D'UNE PROTECTION MAXIMALE LORS D'UNE COLLISION BOUCLEZ TOUJOURS VOTRE CEINTURE DE SÉCURITÉ.
- N'INSTALLEZ JAMAIS UN SIÈGE POUR ENFANTS FAISANT FACE À L'ARRIÈRE SUR LE SIÈGE DU PASSAGER AVANT.
- NE VOUS APPUYEZ PAS ET NE VOUS ASSEYEZ PAS PRES DU COUSSIN GONFLABLE.
- NE DEPOSEZ AUCUN OBJET SUR LE COUSSIN GONFLABLE OU ENTRE LE COUSSIN GONFLABLE ET VOUS.
- LISEZ LE GUIDE UTILISATEUR POUR DE PLUS AMPLES RENSEIGNEMENTS.

## If You Must Drive with Several Children

Your vehicle has a back seat where children can be properly restrained. If you ever have to carry a group of children, and a child must ride in front:

- Place the largest child in the front seat, provided the child is large enough to wear the lap/shoulder belt properly (see page 52).
- Move the vehicle seat as far to the rear as possible (see page 155).
- Have the child sit upright and well back in the seat (see page 18).
- Make sure the seat belt is properly positioned and secured (see page 17).

## If a Child Requires Close Attention

Many parents say they prefer to put an infant or a small child in the front passenger seat so they can watch the child, or because the child requires attention.

Placing a child in the front seat exposes the child to hazards in a frontal collision, and paying close attention to a child distracts the driver from the important tasks of driving, placing both of you at risk.

If a child requires close physical attention or frequent visual contact, we strongly recommend that another adult ride with the child in a back seat. The back seat is far safer for a child than the front.

## Additional Safety Precautions

- ***Never hold an infant or child on your lap.*** If you are not wearing a seat belt in a crash, you could be thrown forward and crush the child against the dashboard or a seat-back. If you are wearing a seat belt, the child can be torn from your arms and be seriously hurt or killed.
- ***Never put a seat belt over yourself and a child.*** During a crash, the belt could press deep into the child and cause serious or fatal injuries.
- ***Never let two children use the same seat belt.*** If they do, they could be very seriously injured in a crash.



## Protecting Children – General Guidelines

---

- **Use the childproof door locks to prevent children from opening the rear doors.** This can prevent children from accidentally falling out (see page [154](#) ).
- **Do not leave children alone in a vehicle.** Leaving children without adult supervision is illegal in most states and Canadian provinces, and can be very hazardous.

For example, infants and small children left in a vehicle on a hot day can die from heatstroke. A child left alone with the key in the ignition switch can accidentally set the vehicle in motion, possibly injuring themselves or others.

- **Make sure any unused seat belt that a child can reach is buckled, the lockable retractor is activated, and the belt is fully retracted and locked.** If a child wraps a loose seat belt around their neck, they can be seriously or fatally injured. (See pages [49](#) and [50](#) for how to activate and deactivate the lockable retractor.)

- **Lock all doors and the trunk when your vehicle is not in use.** Children who play in vehicles can accidentally get trapped inside. Teach your children not to play in or around vehicles. Know how to operate the emergency trunk opener and decide if your children should be shown how to use this feature (see page [154](#) ).
- **Keep vehicle keys/remote transmitters out of the reach of children.** Even very young children learn how to unlock vehicle doors, turn on the ignition switch, and open the trunk, which can lead to accidental injury or death.

## Protecting Infants



### ***Child Seat Type***

An infant must be properly restrained in a rear-facing, reclining child seat until the child reaches the seat maker's weight or height limit for the seat, and the child is at least one year old.

Only a rear-facing child seat provides proper support for a baby's head, neck, and back.

Two types of seats may be used: a seat designed exclusively for infants, or a convertible seat used in the rear-facing, reclining mode.

***Do not put a rear-facing child seat in a forward-facing position.*** If placed facing forward, an infant could be very seriously injured during a frontal collision.

### ***Rear-facing Child Seat Placement***

A rear-facing child seat can be placed in any seating position in the back seat, but not in the front. ***Never put a rear-facing child seat in the front seat.***

If the passenger's front airbag inflates, it can hit the back of the child seat with enough force to kill or seriously injure an infant.

When properly installed, a rear-facing child seat may prevent the driver or a front passenger from moving their seat as far back as recommended, or from locking their seat-back in the desired position.

It could also interfere with proper operation of the passenger's advanced front airbag system.

*CONTINUED*

## Protecting Infants and Small Children

---

In any of these situations, we strongly recommend that you install the child seat directly behind the front passenger's seat, move the seat as far forward as needed, and leave it unoccupied. Or, you may wish to get a smaller rear-facing child seat.

### **⚠ WARNING**

Placing a rear-facing child seat in the front seat can result in serious injury or death during a collision.

Always place a rear-facing child seat in the back seat, not the front.

### Protecting Small Children

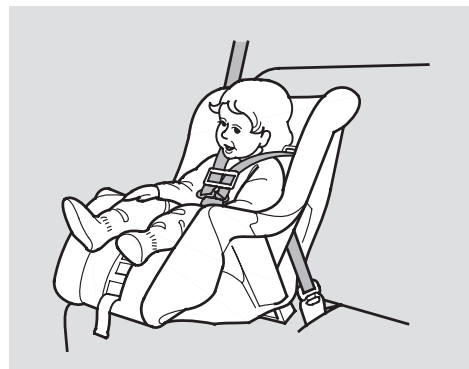

#### ***Child Seat Type***

A child who is at least 1 year old, and who fits within the child seat maker's weight and height limits, should be restrained in a forward-facing, upright child seat.

Of the different seats available, we recommend those that have a five-point harness system as shown.

We also recommend that a small child use the child seat until the child reaches the weight or height limit for the seat.

#### ***Child Seat Placement***

We strongly recommend placing a forward-facing child seat in a back seat, not the front.

***Placing a forward-facing child seat in the front seat of a vehicle equipped with a passenger's airbag can be hazardous.*** If the vehicle seat is too far forward, or the child's head is thrown forward during a collision, an inflating airbag can strike the child with enough force to cause very serious or fatal injuries.

Even with advanced front airbags that automatically turn the passenger's front airbag off (see page 31), a back seat is the safest place for a small child.

# Protecting Infants and Small Children, Selecting a Child Seat

If it is necessary to put a forward-facing child seat in the front, move the vehicle seat as far to the rear as possible, and be sure the child seat is firmly secured to the vehicle and the child is properly strapped in the seat.

## **WARNING**

Placing a forward-facing child seat in the front seat can result in serious injury or death if the front airbag inflates.

If you must place a forward-facing child seat in front, move the vehicle seat as far back as possible, and properly restrain the child.

## **Selecting a Child Seat**

When buying a child seat, you need to choose either a conventional child seat, or one designed for use with the lower anchors and tethers for children (LATCH) system.

Conventional child seats must be secured to a vehicle with a seat belt, whereas LATCH-compatible seats are secured by attaching the seat to hardware built into the two outer seating positions in the back seat.

Since LATCH-compatible child seats are easier to install and reduce the possibility of improper installation, we recommend selecting this style.

In seating positions and vehicles not equipped with LATCH, a LATCH-compatible child seat can be installed using a seat belt.

Whatever type of seat you choose, to provide proper protection, a child seat should meet three requirements:

- 1. The child seat should meet U.S. or Canadian Motor Vehicle Safety Standard 213.*** Look for FMVSS 213 or CMVSS 213 on the box.
- 2. The child seat should be of the proper type and size to fit the child.*** Rear-facing for infants, forward-facing for small children.

*CONTINUED*

## Selecting a Child Seat, Installing a Child Seat

---

### ***3. The child seat should fit the vehicle seating position (or positions) where it will be used.***

Before purchasing a conventional child seat, or using a previously purchased one, we recommend that you test the seat in the specific vehicle seating position or positions where the seat will be used.

### **Installing a Child Seat**

After selecting a proper child seat and a good place to install the seat, there are three main steps in installing the seat:

***1. Properly secure the child seat to the vehicle.*** All child seats must be secured to the vehicle with the lap part of a lap/shoulder belt or with the LATCH (lower anchors and tethers for children) system. A child whose seat is not properly secured to the vehicle can be endangered in a crash.

***2. Make sure the child seat is firmly secured.*** After installing a child seat, push and pull the seat forward and from side-to-side to verify that it is secure.

A child seat secured with a seat belt should be installed as firmly as possible. However, it does not need to be “rock solid.” Some side-to-side

movement can be expected and should not reduce the child seat’s effectiveness.

If the child seat is not secure, try installing it in a different seating position, or use a different style of child seat that can be firmly secured.

### ***3. Secure the child in the child seat.***

Make sure the child is properly strapped in the child seat according to the child seat maker’s instructions. A child who is not properly secured in a child seat can be seriously injured in a crash.

The following pages provide guidelines on how to properly install a child seat. A forward-facing child seat is used in all examples, but the instructions are the same for rear-facing child seats.

## Installing a Child Seat with LATCH

Your vehicle is equipped with LATCH (lower anchors and tethers for children) at the outer rear seats.

The lower anchors are located between the seat-back and seat bottom, and are to be used only with a child seat designed for use with LATCH.

The location of each lower anchor is indicated by a small button above the anchor point.

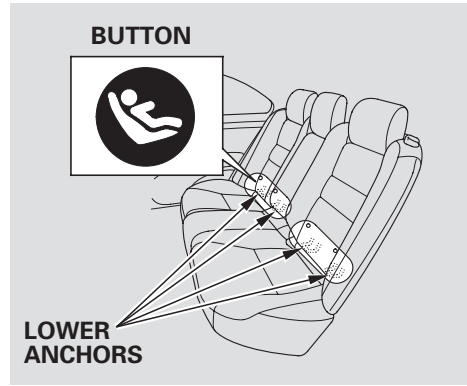

To install a LATCH-compatible child seat:

1. Move the seat belt buckle or tongue away from the lower anchors.
2. Make sure there are no objects near the anchors that could prevent a secure connection between the child seat and the anchors.

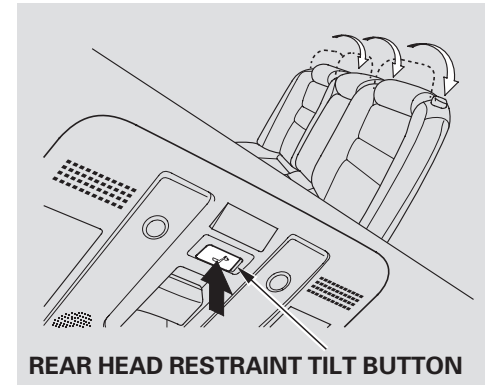

3. Push the rear head restraint tilt button on the ceiling console to pivot the head restraints down.

*CONTINUED*

## Installing a Child Seat

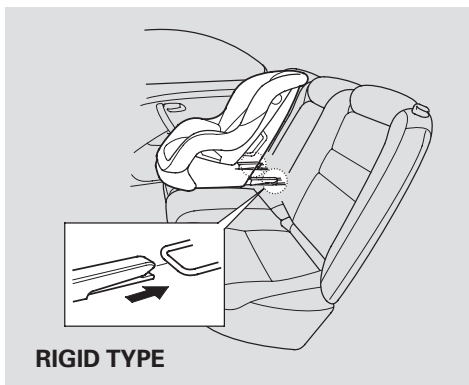

4. Place the child seat on the vehicle seat, then attach the seat to the lower anchors according to the child seat maker's instructions.

Some LATCH-compatible seats have a rigid-type connector as shown above.

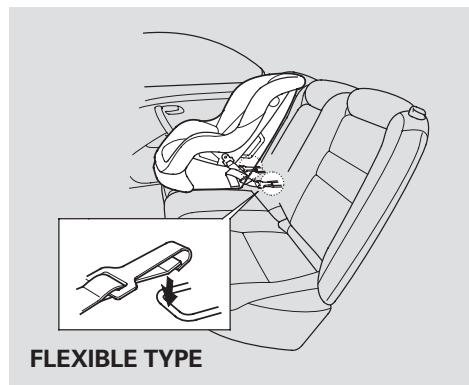

5. Whatever type you have, follow the child seat maker's instructions for adjusting or tightening the fit.

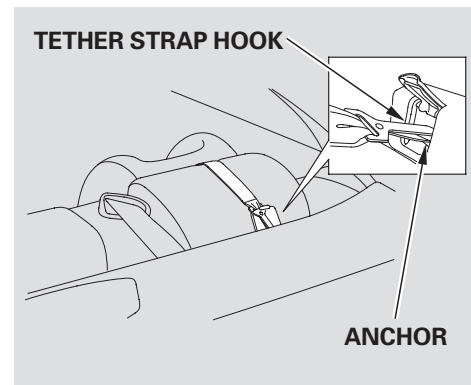

6. Route the tether strap over the head restraint, then attach the tether strap hook to the anchor, making sure the strap is not twisted.
7. Tighten the strap according to the seat maker's instructions.
8. Push and pull the child seat forward and from side-to-side to verify that it is secure.

### Installing a Child Seat with a Lap/Shoulder Belt

When not using the LATCH system, all child seats must be secured to the vehicle with the lap part of a lap/shoulder belt.

In addition, the lap/shoulder belts in all seating positions except the driver's have a lockable retractor that must be activated to secure a child seat.



1. With the child seat in the desired seating position, route the belt through the child seat according to the seat maker's instructions, then insert the latch plate into the buckle.

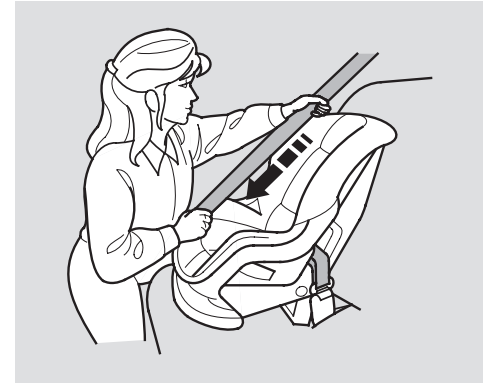

2. To activate the lockable retractor, slowly pull the shoulder part of the belt all the way out until it stops, then let the belt feed back into the retractor.
3. After the belt has retracted, tug on it. If the belt is locked, you will not be able to pull it out. If you can pull the belt out, it is not locked, and you will need to repeat these steps.

*CONTINUED*



## Installing a Child Seat

---



4. After confirming that the belt is locked, grab the shoulder part of the belt near the buckle, and pull up to remove any slack from the lap part of the belt. Remember, if the lap part of the belt is not tight, the child seat will not be secure.

To remove slack, it may help to put weight on the child seat, or push on the back of the seat while pulling up on the belt.

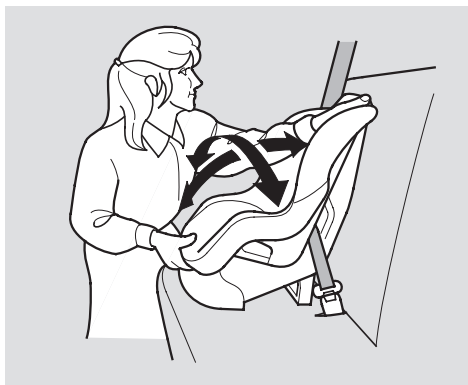

5. Push and pull the child seat forward and from side-to-side to verify that it is secure enough to stay upright during normal driving maneuvers. If the child seat is not secure, unlatch the belt, allow it to retract fully, then repeat these steps.

To deactivate the lockable retractor and remove a child seat, unlatch the buckle, unrout the seat belt, and let the belt fully retract.

## Installing a Child Seat with a Tether

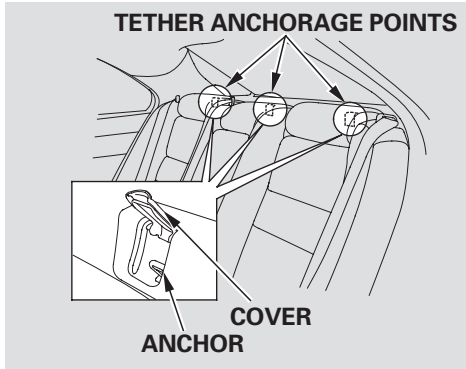

A child seat with a tether can be installed in any seating position in the back seat, using one of the anchorage points shown above.

Since a tether can provide additional security to the lap/shoulder belt installation, we recommend using a tether whenever one is required or available.

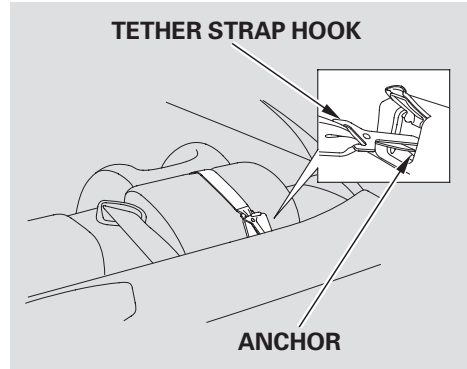

1. After properly securing the child seat with the lap/shoulder belt (see page 22 ), pivot the head restraint down (see page 156 ) and route the tether strap over the head restraint.

2. Lift the anchor cover, then attach the tether strap hook to the anchor, making sure the strap is not twisted.
3. Tighten the strap according to the seat maker's instructions.

## Protecting Larger Children

When a child reaches the recommended weight or height limit for a forward-facing child seat, the child should sit in a back seat on a booster seat and wear a lap/shoulder belt.

The following pages give instructions on how to check proper seat belt fit, what kind of booster seat to use if one is needed, and important precautions for a child who must sit in front.

### **⚠ WARNING**

Allowing a child age 12 or under to sit in front can result in injury or death if the passenger's front airbag inflates.

If a child must ride in front, move the vehicle seat as far back as possible, use a booster seat if needed, have the child sit up properly and wear the seat belt properly.

### Checking Seat Belt Fit

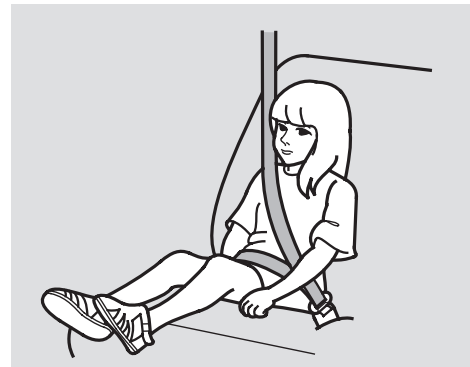

To determine if a lap/shoulder belt properly fits a child, have the child put on the seat belt, then ask yourself:

1. Does the child sit all the way back against the seat?
2. Do the child's knees bend comfortably over the edge of the seat?

3. Does the shoulder belt cross between the child's neck and arm?
4. Is the lap part of the belt as low as possible, touching the child's thighs?
5. Will the child be able to stay seated like this for the whole trip?

If you answer yes to all these questions, the child is ready to wear the lap/shoulder belt correctly. If you answer no to any question, the child needs to ride on a booster seat.

### Using a Booster Seat



A child who has outgrown a forward-facing child seat should ride in a back seat and use a booster seat until the lap/shoulder belt fits them properly without the booster.

Some states and Canadian provinces also require children to use a booster seat until they reach a given age or weight (e.g., 6 years or 60 lbs). Be sure to check current laws in the states or provinces where you intend

to drive.

Booster seats can be high-back or low-back. Whichever style you select, make sure the booster seat meets federal safety standards (see page 45) and that you follow the booster seat maker's instructions.

If a child who uses a booster seat must ride in front, move the vehicle seat as far back as possible and be sure the child is wearing the seat belt properly.

A child may continue using a booster seat until the tops of their ears are even with the top of the vehicle's or booster's seat-back. A child of this height should be tall enough to use the lap/shoulder belt without a booster seat.

## Protecting Larger Children

---

### **When Can a Larger Child Sit in Front**

The National Highway Traffic Safety Administration and Transport Canada recommend that all children age 12 and under be properly restrained in a back seat.

If the passenger's front airbag inflates in a moderate to severe frontal collision, the airbag can cause serious injuries to a child who is unrestrained, improperly restrained, sitting too close to the airbag, or out of position.

A side airbag also poses risks. If any part of a larger child's body is in the path of a deploying side airbag, the child could receive possibly serious injuries.

Of course, children vary widely. And while age may be one indicator of when a child can safely ride in front, there are other important factors you should consider.

### ***Physical Size***

Physically, a child must be large enough for the lap/shoulder belt to properly fit (see pages 17 and 52). If the seat belt does not fit properly, with or without the child sitting on a booster seat, the child should not sit in front.

### ***Maturity***

To safely ride in front, a child must be able to follow the rules, including sitting properly, and wearing the seat belt properly throughout a ride.

If you decide that a child can safely ride up front, be sure to:

- Carefully read the owner's manual, and make sure you understand all seat belt instructions and all safety information.
- Move the vehicle seat to the rear-most position.
- Have the child sit up straight, back against the seat, and feet on or near the floor.
- Check that the child's seat belt is properly and securely positioned.
- Supervise the child. Even mature children sometimes need to be reminded to fasten the seat belts or sit properly.

### Additional Safety Precautions

- ***Do not let a child wear a seat belt across the neck.*** This could result in serious neck injuries during a crash.
- ***Do not let a child put the shoulder part of a seat belt behind the back or under the arm.*** This could cause very serious injuries during a crash. It also increases the chance that the child will slide under the belt in a crash and be injured.
- ***Two children should never use the same seat belt.*** If they do, they could be very seriously injured in a crash.
- ***Do not put any accessories on a seat belt.*** Devices intended to improve a child's comfort or reposition the shoulder part of a seat belt can make the belt less effective and increase the chance of serious injury in a crash.

## Carbon Monoxide Hazard

---

Your vehicle's exhaust contains carbon monoxide gas. Carbon monoxide should not enter the vehicle in normal driving if you maintain your vehicle properly and follow the information on this page.

Have the exhaust system inspected for leaks whenever:

- The vehicle is raised for an oil change.
- You notice a change in the sound of the exhaust.
- The vehicle was in an accident that may have damaged the underside.

### **WARNING**

Carbon monoxide gas is toxic. Breathing it can cause unconsciousness and even kill you.

Avoid any enclosed areas or activities that expose you to carbon monoxide.

High levels of carbon monoxide can collect rapidly in enclosed areas, such as a garage. Do not run the engine with the garage door closed. Even with the door open, run the engine only long enough to move the vehicle out of the garage.

With the trunk open, airflow can pull exhaust gas into your vehicle's interior and create a hazardous condition. If you must drive with the trunk open, open all the windows and set the climate control system as shown below.

If you must sit in your parked vehicle with the engine running, even in an unconfined area, adjust the climate control system as follows:

1. Select the fresh air mode.
2. Select the  mode.
3. Turn the fan on high speed.
4. Set the temperature control to a comfortable setting.

These labels are in the locations shown. They warn you of potential hazards that could cause serious injury or death. Read these labels carefully.

If a label comes off or becomes hard to read (except for the U.S. dashboard label which may be removed by the owner), contact your dealer for a replacement.

### HOOD

#### U.S. models

SUPPLEMENTAL RESTRAINT SYSTEM (SRS)

This vehicle is equipped with front air bags, side air bags in the front seats, rear outboard head-curtain, and side curtain air bags. All SRS electrical wiring and components are color-coded. Tampering with, disconnecting or cutting these components or the SRS wiring can make the system inoperative and cause accidental deployment.

**▲ WARNING**

Accidental deployment can seriously hurt or kill you.  
Refer to Owner's Manual for more information.

#### Canadian models

SUPPLEMENTAL RESTRAINT SYSTEM (SRS)

This vehicle is equipped with front air bags, side air bags in the front seats, rear outboard head-curtain, and side curtain air bags. All SRS electrical wiring and components are color-coded. Tampering with, disconnecting or cutting these components or the SRS wiring can make the system inoperative and cause accidental deployment.

**▲ WARNING**

Accidental deployment can seriously hurt or kill you.  
Refer to Owner's Manual for more information.

SYSTEME DE RETENUE SUPPLEMENTAIRE (SRS)

Cet véhicule est équipé de dispositifs de retenue supplémentaires (airbags) à l'avant, à l'arrière et sur les côtés. Tous les composants électriques du système SRS sont colorés. Toute manipulation, déconnexion ou coupe de ces composants ou du système SRS peut rendre le système inopérant et causer un déploiement accidentaire.

**▲ ATTENTION**

Un déploiement accidentaire peut gravement blesser ou tuer le conducteur.  
Consultez le manuel des propriétaires du véhicule pour plus d'informations.

## DASHBOARD

*U.S. models only*

This Vehicle is Equipped with Advanced Air Bags

Even with Advanced Air Bags

Children can be killed or seriously injured by the air bag. The back seat is the safest place for children. Never put a rear-facing child seat in the front. Always use seat belts and child restraints. See owner's manual for more information about air bags.

To be removed by owner only.

## RADIATOR CAP

**▲ DANGER WARNING**  
危险 危险  
▶ NEVER OPEN WHEN HOT.  
▶ N'OUVREZ PAS QUAND CHAUD.  
▶ NICHT BEI HEISSEM MOTOR OFFENEN.  
▶ 高温时，请勿打开  
1.1

CONTINUED

Driver and Passenger Safety

2008 RL

57



# Safety Labels

## SUN VISORS

*U.S. models*



*Canadian models*

<p><b>CAUTION</b> TO AVOID SERIOUS INJURY:</p> <ul style="list-style-type: none"> <li>FOR MAXIMUM SAFETY PROTECTION IN ALL TYPES OF CRASHES, YOU MUST ALWAYS WEAR YOUR SAFETY BELT.</li> <li>DO NOT INSTALL REARWARD FACING CHILD SEATS IN ANY FRONT PASSENGER SEAT POSITION.</li> <li>DO NOT SIT OR LEAN UNNECESSARILY CLOSE TO THE AIR BAG.</li> <li>DO NOT PLACE ANY OBJECTS OVER THE AIR BAG OR BETWEEN THE AIR BAG AND YOURSELF.</li> <li>SEE THE OWNER'S MANUAL FOR FURTHER INFORMATION AND EXPLANATIONS.</li> </ul>	<p><b>PRÉCAUTION:</b> POUR ÉVITER DES BLESSURES GRAVES:</p> <p>POUR PROFITER D'UNE PROTECTION MAXIMALE LORS D'UNE COLLISION BOUCLEZ TOUJOURS VOTRE CEINTURE DE SÉCURITÉ.</p> <ul style="list-style-type: none"> <li>N'INSTALLEZ JAMAIS UN SIÈGE POUR ENFANTS FAISANT FACE À L'ARRIÈRE SUR LE SIÈGE DU PASSAGER AVANT.</li> <li>NE VOUS APPUYEZ PAS ET NE VOUS ASSEYEZ PAS PRÈS DU COUSSIN GONFLABLE.</li> <li>NE DÉPOSEZ AUCUN OBJET SUR LE COUSSIN GONFLABLE OU ENTRE LE COUSSIN GONFLABLE ET VOUS.</li> <li>LISEZ LE GUIDE UTILISATEUR POUR DE PLUS AMPLES RENSEIGNEMENTS.</li> </ul>
--	---

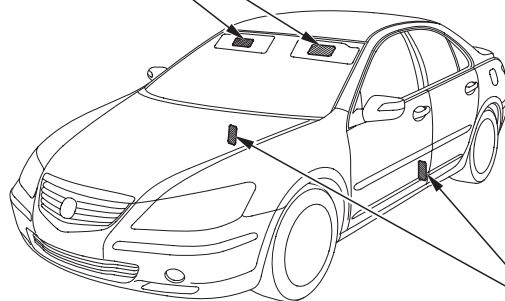

## DOORJAMBS

*U.S. models*

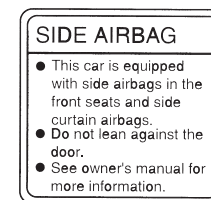

*Canadian models*

<p><b>SIDE AIRBAG</b></p> <ul style="list-style-type: none"> <li>This car is equipped with side airbags in the front seats and side curtain airbags.</li> <li>Do not lean against the door.</li> <li>See owner's manual for more information.</li> </ul>	<p><b>COUSSIN GONFLABLE LATÉRAL</b></p> <ul style="list-style-type: none"> <li>Cette automobile est équipée de coussins gonflables latéraux dans les sièges avant ainsi que de coussins gonflables latéraux de type rideau.</li> <li>Ne vous appuyez pas sur la porte.</li> <li>Consultez le Manuel du propriétaire pour en savoir plus.</li> </ul>
--	---

This section gives information about the controls and displays that contribute to the daily operation of your vehicle. All the essential controls are within easy reach.

Control Locations .....	60	Trunk.....	153
Instrument Panel .....	61	Emergency Trunk Opener .....	154
Instrument Panel Indicators.....	62	Childproof Door Locks .....	154
Gauges .....	70	Seats .....	155
Temperature Gauge .....	70	Mirrors.....	159
Fuel Gauge .....	70	Driving Position Memory	
Multi-Information Display .....	71	System.....	160
Controls Near the Steering		Keyless Access System.....	163
Wheel.....	136	Seat Heaters .....	178
Windshield Wipers and		Seat Heaters and Seat	
Washers .....	137	Ventilation .....	179
Turn Signals and Headlights.....	140	Power Windows .....	181
Fog Lights .....	142	Moonroof .....	184
Daytime Running Lights .....	142	Parking Brake .....	187
Automatic Lighting Off		Interior Convenience Items.....	188
Feature.....	142	Glove Box .....	189
Adaptive Front Lighting System		Beverage Holders.....	190
(AFS).....	143	Console Compartment .....	191
Hazard Warning Button.....	145	Sun Visors.....	192
Instrument Panel Brightness .....	145	Accessory Power Sockets.....	192
Rear Window Defogger .....	146	Rear Ashtrays .....	193
Steering Wheel Adjustments .....	147	Front Door Pockets.....	193
Keys and Locks.....	149	Power Rear Sunshade .....	194
Immobilizer System.....	150	Integrated Sunshades .....	195
Ignition Switch .....	151	Interior Lights .....	196
Door Locks .....	152		

# Control Locations

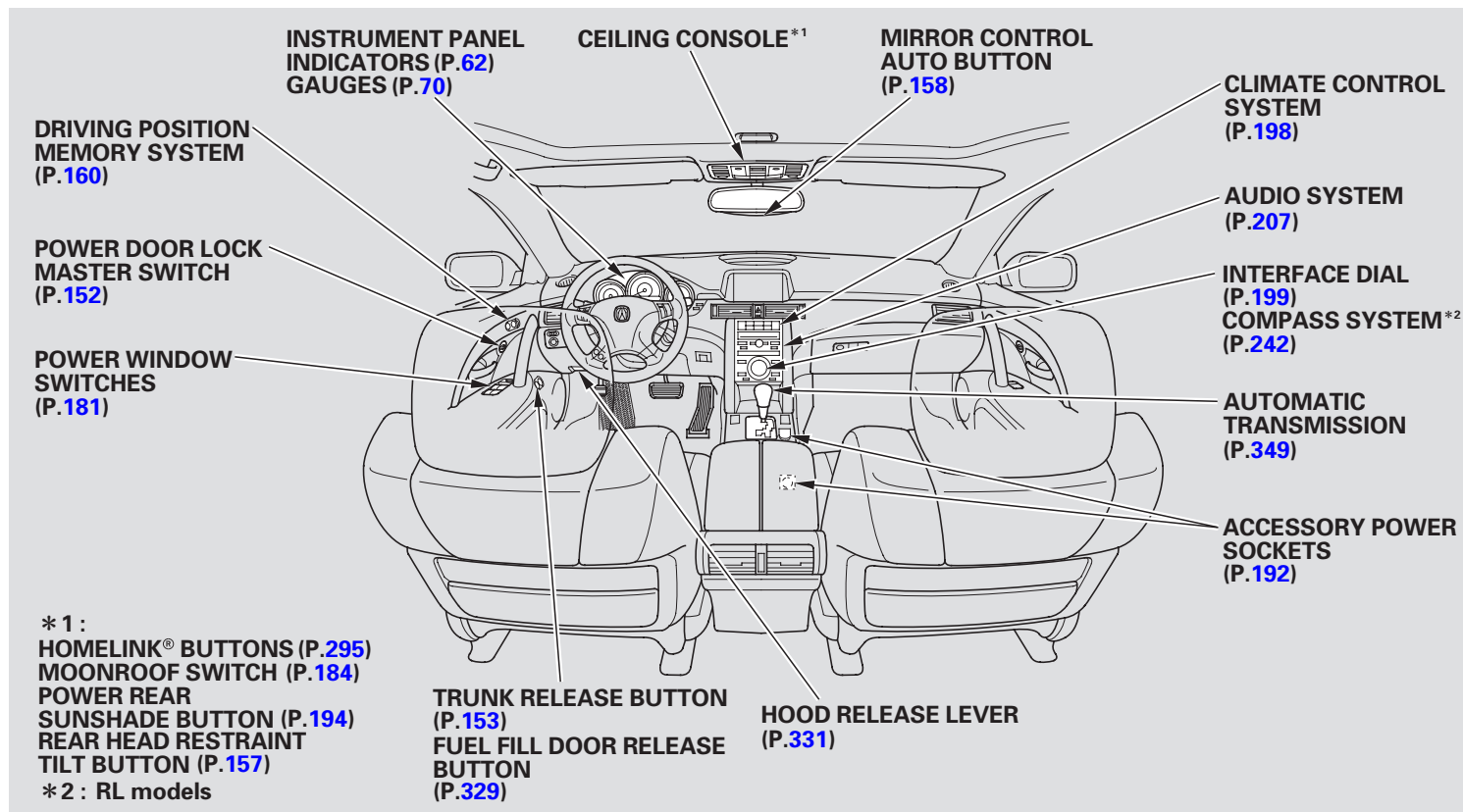

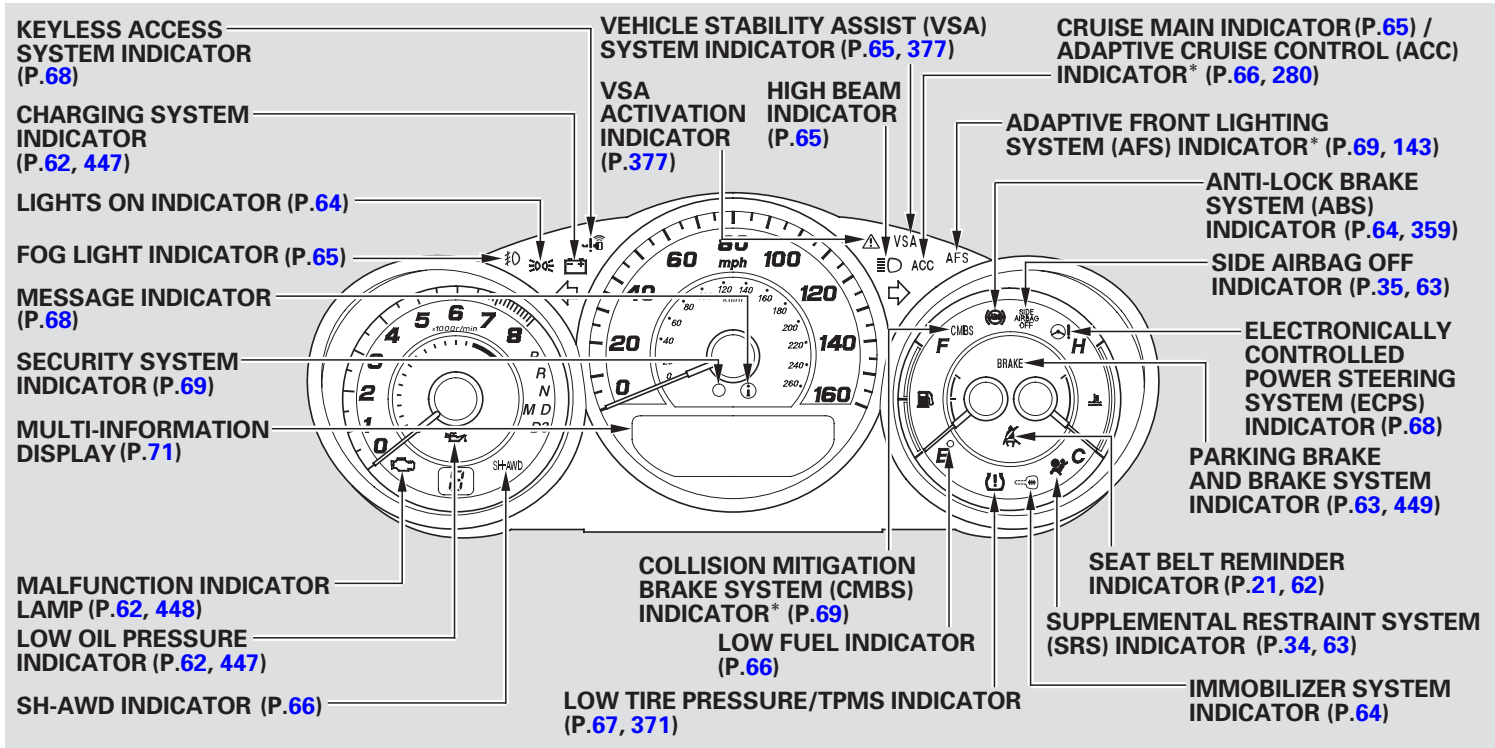

The U.S. instrument panel is shown. Differences for the Canadian models are noted in the text.

\* : If equipped.

## Instrument Panel Indicators

---

The instrument panel has many indicators to give you important information about your vehicle.



### Seat Belt Reminder Indicator

This indicator comes on when you turn the ignition switch to the ON (II) position. It reminds you and your passenger to fasten your seat belts. A beeper also sounds if you have not fastened your seat belt.

If you turn the ignition switch to the ON (II) position before fastening your belt, the beeper sounds and the indicator flashes. If you do not fasten your seat belt before the beeper stops, the indicator stops flashing but remains on.

If your front passenger does not fasten their seat belt, the indicator comes on about 6 seconds after the ignition switch is turned to the ON (II) position.

If either of you do not fasten your seat belt while driving, the beeper will sound and the indicator will flash again at regular intervals. For more information, see page 21 .

You will also see a “FASTEN SEAT BELT” or “FASTEN PASSENGER SEAT BELT” message on the multi-information display (see page 79 ).



### Low Oil Pressure Indicator

The engine can be severely damaged if this indicator flashes or stays on when the engine is running, or if a “CHECK ENGINE OIL LEVEL” message is on the multi-information display. For more information, see page 447 .



### Charging System Indicator

If this indicator comes on when the engine is running, the battery is not being charged, and you will also see a “CHECK CHARGING SYSTEM” message on the multi-information display. For more information, see page 447 .



### Malfunction Indicator Lamp

You will also see a “CHECK EMISSION SYSTEM” message on the multi-information display. For more information, see page 448 .

U.S.      Canada

**BRAKE**



## Parking Brake and Brake System Indicator

This indicator has two functions:

1. It comes on when you turn the ignition switch to the ON (II) position. It is a reminder to check the parking brake. Driving with the parking brake not fully released can damage the rear brakes, axles, and tires. If you drive without releasing the parking brake, a beeper will sound, and you will also see a “RELEASE PARKING BRAKE” message on the multi-information display (see page 78 ).
2. If it stays on after you have fully released the parking brake while the engine is running, or if it comes on while driving, it can indicate a problem in the brake

system. You will also see a “BRAKE FLUID LOW” or “CHECK BRAKE SYSTEM” message on the multi-information display. For more information, see page 449 .

U.S.      Canada



## Side Airbag Off Indicator

This indicator comes on when you turn the ignition switch to the ON (II) position. If it comes on at any other time, it indicates that the passenger’s side airbag has automatically shut off. You will also see a “PASSENGER SIDE AIRBAG OFF” message on the multi-information display (see page 79 ). For more information, see page 35 .





## Supplemental Restraint System Indicator

This indicator comes on briefly when you turn the ignition switch to the ON (II) position. If it comes on at any other time, it indicates a potential problem with your front airbags. This indicator will also alert you to a potential problem with your side airbags, passenger’s side airbag automatic cutoff system, side curtain airbags, automatic seat belt tensioners driver’s seat position sensor, the front passenger’s weight sensors, or, on models with ACC, seat belt e-pretensioners. You will also see a “CHECK AIRBAG SYSTEM” message on the multi-information display (see page 78 ). For more information, see page 35 .

## Instrument Panel Indicators



### Lights On Indicator

This indicator reminds you that the exterior lights are on. It comes on when the light switch is in either the  or  position. This indicator will also come on when the light switch is in AUTO and the lights turn on automatically. If you turn the ignition switch to the ACCESSORY (I) or the LOCK (0) position without turning off the light switch, this indicator will remain on. A reminder chime will also sound when you open the driver's door.



### Immobilizer System Indicator

This indicator comes on for a few seconds when you turn the ignition switch to the ON (II) position. It will then go off if you have a properly-coded remote. If it is not a properly-coded remote, the indicator will blink and the engine will not start (see page 150).

If you use the remote, this indicator blinks several times when you turn the ignition switch from ACCESSORY (I) to the LOCK (0) position.

If you use the built-in key, this indicator blinks several times when you turn the ignition switch from ON (II) to the ACCESSORY (I) position.



### Anti-lock Brake System (ABS) Indicator

This indicator normally comes on for a few seconds when you turn the ignition switch to the ON (II) position, and when the ignition switch is turned to the START (III) position. If this indicator comes on at any other time, there is a problem in the ABS. If this happens, take the vehicle to your dealer to have it checked. With this indicator on, your vehicle still has normal braking ability but no anti-lock function. You will also see a "CHECK ABS

SYSTEM" message on the multi-information display (see page 78). For more information, see page 359.



### Turn Signal and Hazard Warning Indicators

The left or right turn signal indicator blinks when you signal a lane change or turn. If the indicator does not blink or blinks rapidly, it usually means one of the turn signal bulbs is burned out (see page 410). Replace the bulb as soon as possible, since other drivers cannot see that you are signaling.

When you press the hazard warning button, both turn signals blink. All turn signals on the outside of the vehicle should flash.

## **Vehicle Stability Assist (VSA) System Indicator**

This indicator normally comes on for a few seconds when you turn the ignition switch to the ON (II) position.

If it comes on and stays on at any other time, or it does not come on when you turn the ignition switch to the ON (II) position, there is a problem with the VSA system. You will also see a “CHECK VSA SYSTEM” message on the multi-information display (see page 78). Take your vehicle to a dealer to have it checked. Without VSA, your vehicle still has normal driving ability, but will not have VSA traction and stability enhancement. For more information, see page 378.

## **VSA Activation Indicator**

This indicator has three functions:

1. It comes on as a reminder that you have turned off the vehicle stability assist (VSA) system.
2. It flashes when VSA is active (see page 377).
3. It comes on along with the VSA system indicator if there is a problem with the VSA system. You will also see a “CHECK VSA SYSTEM” message on the multi-information display (see page 78).

This indicator normally comes on for a few seconds when you turn the ignition switch to the ON (II) position. For more information, see page 378.

## **Fog Light Indicator**

This indicator comes on when you turn on the fog lights. For more information, see page 142.

## **High Beam Indicator**

This indicator comes on with the high beam headlights. For more information, see page 140.

This indicator also comes on with reduced brightness when the daytime running lights (DRL) are on (see page 142).

## **Cruise Main Indicator**

*On models without adaptive cruise control (ACC)*

This indicator comes on when you turn on the cruise control system by pressing the CRUISE button on the steering wheel (see page 277).



## Instrument Panel Indicators

**ACC**

### Adaptive Cruise Control (ACC) Indicator

*On models with adaptive cruise control (ACC)*

This indicator normally comes on for a few seconds when you turn the ignition switch to the ON (II) position.

When you push the ACC button on the steering wheel, this indicator comes on green. You will also see “ACC” on the multi-information display.

If the indicator comes on orange, there is a problem with the ACC system. You will also see a “CHECK ACC SYSTEM” message on the multi-information display (see page 79 ). Take your vehicle to your dealer to have it checked. For more information, see page 280 .

### Low Fuel Indicator

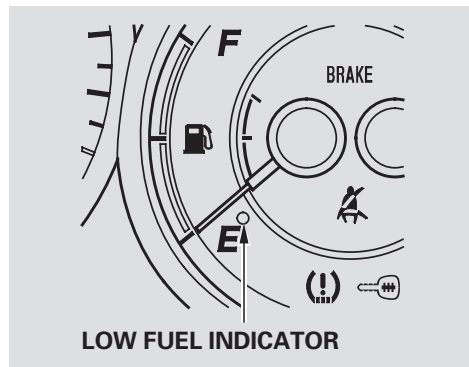

This indicator is in the fuel gauge. It comes on as a reminder that you must refuel soon. You will also see a “FUEL LOW” message on the multi-information display (see page 79 ). When the indicator comes on, there is about 2.69 U.S. gal (10.2 l) of fuel remaining in the tank before the needle reaches E. There is a small reserve of fuel remaining in the tank when the needle does reach E.

**SH-AWD**

### Super Handling-All Wheel Drive (SH-AWD) Indicator

This indicator normally comes on for a few seconds when you turn the ignition switch to the ON (II) position. If this indicator comes on at any other time, there is a problem in the SH-AWD system. You will also see a “CHECK SH-AWD SYSTEM” message on the multi-information display (see page 78 ). Take your vehicle to a dealer to have it checked. For more information, see page 356 . If the indicator blinks while driving, pull to the side of the road when it is safe, shift to Park, and let the engine idle until the indicator goes out. If it comes on while driving, it indicates the differential temperature is too high. You will also see a “SH-AWD DIFF TEMP. HIGH” message on the multi-information display (see page 78 ).

Pull to the side of the road when it is safe, shift to Park, and let the engine idle until the indicator goes out.

## NOTICE

*Continuing to drive with the SH-AWD indicator blinking may cause serious damage to the system.*



### Low Tire Pressure/ TPMS Indicator

This indicator normally comes on for a few seconds when you turn the ignition switch to the ON (II) position.

This indicator has two functions:

1. If it comes on while driving, it indicates that one or more of your vehicle's tires are significantly low on pressure.

You will also see a “CHECK TIRE PRESSURE” message on the multi-information display (see page [79](#) ).

Check the tire pressure monitor on the multi-information display and determine the cause (see page [373](#) ).

If this happens, pull to the side of the road when it is safe, check which tire has lost pressure on the multi-information display, and determine the cause. If it is because of a flat tire, have the flat tire repaired as soon as possible. If two or more tires are underinflated, call a professional towing service. For more information, see page [459](#) .

*If equipped*

Your vehicle has Michelin PAX tires. Repair or replacement of PAX tires must be done by an Acura dealer or an authorized Michelin PAX system dealer. For more information, see page [426](#) .

2. If this indicator begins to flash, there is a problem with the tire pressure monitoring system (TPMS). You will also see a “CHECK TPMS SYSTEM” message on the multi-information display. The indicator continues to flash for a while (approximately 1 minute), then stays on. If this happens, have your dealer check the system as soon as possible. For more information, see page [426](#) .

## Instrument Panel Indicators

---



### Electronically Controlled Power Steering System (ECPS) Indicator

This indicator normally comes on when you turn the ignition to the ON (II) position and goes off after the engine starts. If it comes on at any other time, there is a problem with the power steering system. You will also see a “CHECK POWER STEERING SYSTEM” message on the multi-information display (see page 78 ). If this happens, stop the vehicle in a safe place, and turn off the engine. Reset the system by restarting the engine, and watch this indicator. If it does not go off or comes back on again while driving, take the vehicle to your dealer to have it checked. With the indicator on, the ECPS is turned off, which could make the vehicle harder to steer.

The indicator comes on when you run the engine while the vehicle is not moving. To turn the indicator off,

restart the engine.



### Keyless Access System Indicator

This indicator normally comes on for a few seconds when you turn the ignition switch to the ON (II) position. If it comes on at any other time, it indicates that there is a problem with the system. You will also see a “CHECK KEYLESS ACCESS SYSTEM” message on the multi-information display (see page 79 ). For more information, see page 176 .



### Message Indicator

This indicator comes on when there is a system message on the multi-information display. Press the INFO button on the steering wheel (see page 71 ) to see the message (see page 78 ).

Most of the time, this indicator comes on along with other indicators in the instrument panel such as the seat belt reminder indicator, SRS indicator, VSA system indicator, etc.

AFS

## Adaptive Front Lighting System (AFS) Indicator

*If equipped*

This indicator normally comes on for a few seconds when you turn the ignition switch to the ON (II) position.

It comes on as a reminder that you have turned off the adaptive front lighting system (AFS).

This indicator blinks when there is a problem with the AFS system; you will also see a “CHECK ADAPTIVE FRONT LIGHTING SYSTEM” message on the multi-information display (see page 78). If this happens, stop the vehicle in a safe place, turn the ignition switch to the ACCESSORY (I) or the LOCK (0) position, and restart the engine. If the indicator does not go off or blinks again, take your vehicle to a dealer to have it checked. For more information, see page 143.

## Security System Indicator

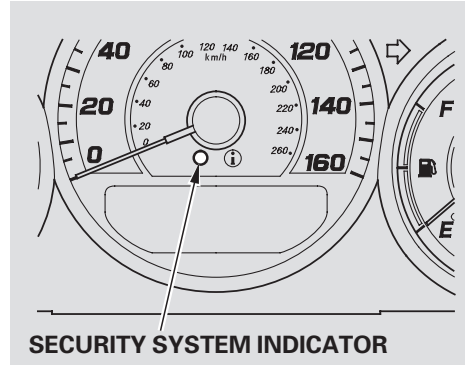

This indicator comes on when the security system is set. For more information, see page 276.

CMBS

## Collision Mitigation Brake System (CMBS) Indicator

*If equipped*

This indicator normally comes on for a few seconds when you turn the ignition switch to the ON (II) position. It also comes on as a

reminder that you have turned off the collision mitigation brake system (CMBS).

The CMBS indicator also comes on if dirt or other debris blocks the radar sensor in the front grille. You will also see a “CHECK CMBS RADAR SENSOR” message on the multi-information display. When you clean the radar sensor, the indicator should go off the next time you turn the ignition switch to the ON (II) position.

If the indicator comes on at any other time, there is a problem with the CMBS. You will also see a “CHECK CMBS SYSTEM” message on the multi-information display. If this happens, take your vehicle to a dealer, and have it checked. For more information, see page 365. When this indicator is on, the CMBS is not working.

# Gauges

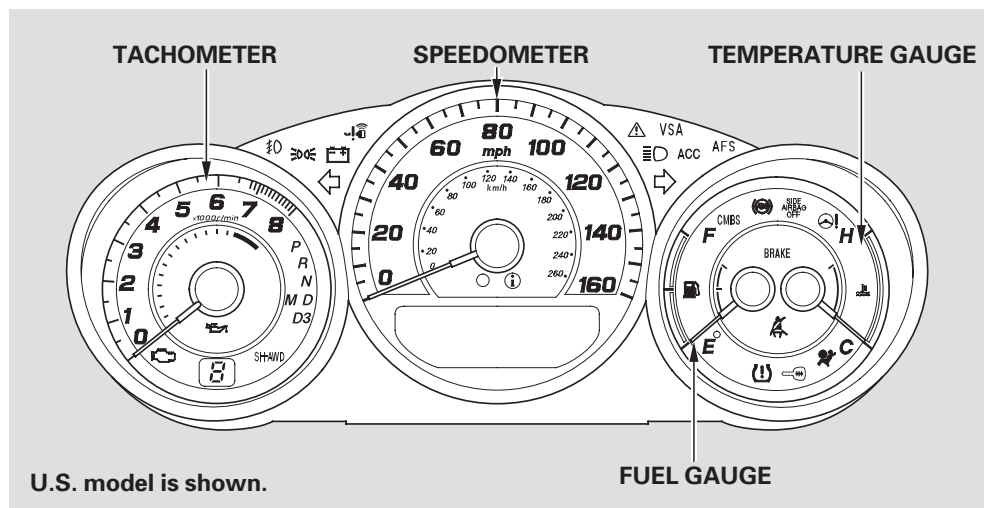

## Temperature Gauge

This shows the temperature of the engine's coolant. During normal operation, the pointer should rise from the bottom white mark to about the middle of the gauge. In severe driving conditions, such as very hot weather or a long period of uphill driving, the pointer may rise to the

upper end of the white section of the gauge. If it reaches the red (hot) mark, pull safely to the side of the road. For more information, see page 444.

## Fuel Gauge

This shows how much fuel you have. It may show slightly more or less than the actual amount. The needle returns to the bottom after you turn off the ignition.

### NOTICE

*Avoid driving with an extremely low fuel level. Running out of fuel could cause the engine to misfire, damaging the catalytic converter.*

The multi-information display in the instrument panel displays various information and messages when the ignition switch is in the ON (II) position. Some of the messages help you operate your vehicle more comfortably.

Others help to keep you aware of the periodic maintenance your vehicle needs for continued trouble-free driving.

When you open the driver's door, a "Welcome" message is shown on the multi-information display. When you turn the ignition switch from the ON (II) position to the ACCESSORY (I) position, a "Goodbye" message is shown on the display.

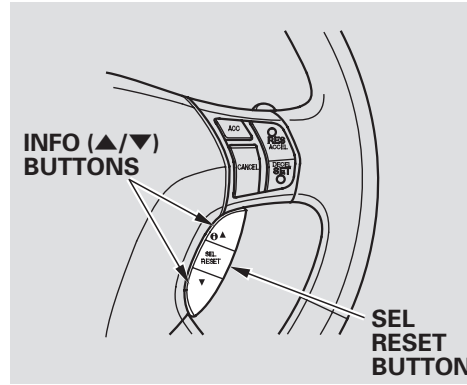

You can change the display and customize your vehicle control settings by pressing the SEL/RESET or INFO buttons on the right side of the steering wheel.

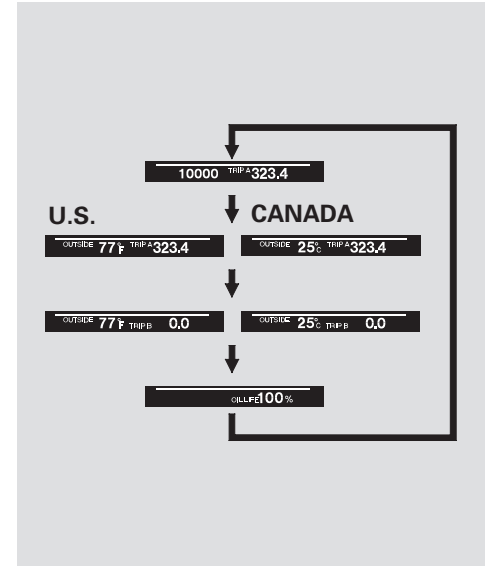

With the ignition switch in the ON (II) position, the lower part of the multi-information display changes as shown in the illustration, each time you press the SEL/RESET button.

# Multi-Information Display

## Odometer

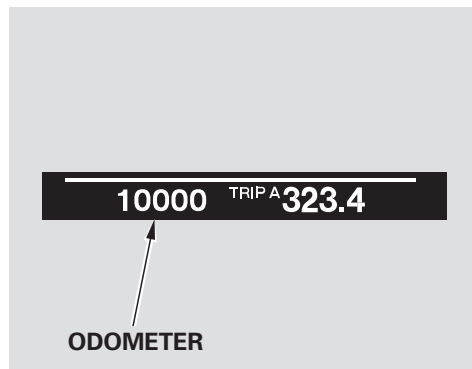

The odometer shows the total distance your vehicle has been driven. It measures miles in U.S. models and kilometers in Canadian models. It is illegal under U.S. federal law and Canadian provincial regulations to disconnect, reset, or alter the odometer with the intent to change the number of miles or kilometers indicated.

## Trip Meter

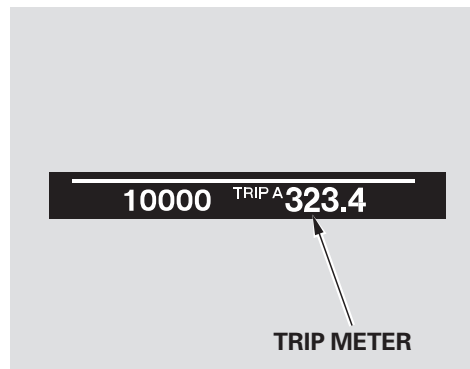

This meter shows the number of miles (U.S.) or kilometers (Canada) driven since you last reset it. There are two trip meters: Trip A and Trip B. Each trip meter works independently, so you can keep track of two different distances.

To reset a trip meter, display it, then press and hold the SEL/RESET button until the number resets to "0.0".

When you reset Trip A, average fuel economy A is reset at the same time. When you reset Trip B, average fuel economy B is reset.

In the customizing mode, you can set Trip A and average fuel economy A to reset at the same time when you refuel your vehicle (see page 100).

## Outside Temperature

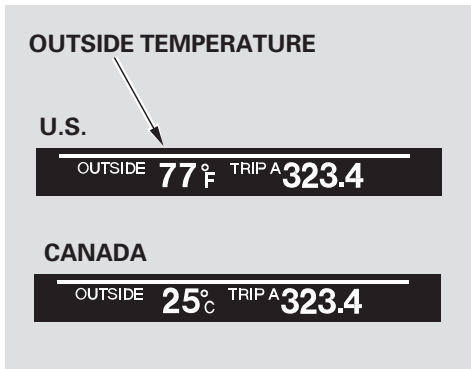

This shows the outside Fahrenheit temperature in U.S. models, and Centigrade temperature in Canadian models.

The temperature sensor is in the front bumper. The temperature reading can be affected by heat reflection from the road surface, engine heat, and the exhaust from surrounding traffic. This can cause an incorrect temperature reading when your vehicle speed is under 19 mph (30 km/h). When you start your trip, the sensor is not fully acclimatized, therefore it may take several minutes until the proper temperature is displayed.

You can adjust the outside temperature display (see page 97).

In certain weather conditions, temperature readings near freezing (32°F, 0°C) could mean that ice is forming on the road surface.

## Engine Oil Life

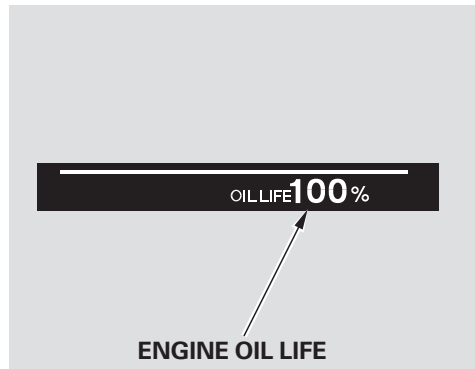

This shows the remaining life of the engine oil. It shows 100% after the engine oil is replaced and the display is reset. The engine oil life is calculated based on engine operating conditions and accumulated engine revolutions. For more information, see page 387.



# Multi-Information Display

## Normal Display Messages

With the ignition switch in the ON (II) position, the upper part of the display changes, as shown in the illustration, each time you press the ▼ button. If you press the ▲ button, the display returns to the previous message.

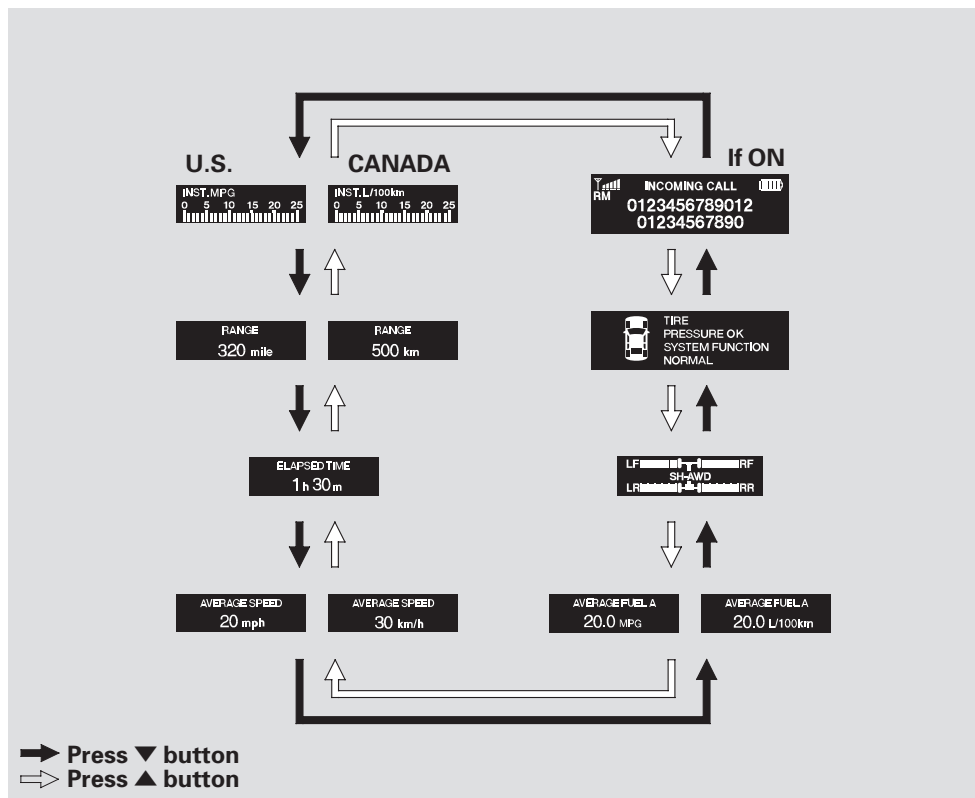

### Trip Computer

Along with the trip meter, the trip computer calculates these values:

- Instantaneous fuel mileage
- Range
- Elapsed Time
- Average Vehicle Speed
- Average Fuel Economy

### INST. MPG (U.S. models)/INST. L/100km (Canadian models)

This shows your current fuel mileage.

When you turn off the engine, INST. MPG or INST. L/100 km is also reset.

### RANGE

This shows the estimated distance you can travel on the fuel remaining in the fuel tank. This distance is estimated from the fuel economy you received over the last several miles (U.S.) or kilometers (Canada), so it will vary with changes in speed, traffic, etc.

When the battery is disconnected, or you refuel, RANGE is also reset.

### ELAPSED TIME

This shows the time passed traveled since you last reset it. When you turn the ignition switch to the ON (II) position, ELAPSED TIME is reset.

You can customize the ELAPSED TIME reset condition on the multi-information display (see page [101](#)).

### AVG. SPEED

This shows the average speed you are traveling in miles per hour (mph) for U.S. models or kilometers per hour (km/h) for Canadian models.

When you reset Trip A, AVG. SPEED is also reset.

### AVG. FUEL A/B

This shows your vehicle's average fuel economy in mpg (U.S. models) or liter/100 km (Canadian models) since you last reset the Trip A or Trip B.

You can customize the Trip A and AVG. FUEL A reset condition on the multi-information display (see page [99](#)).

The average fuel mileage will be reset when you reset the trip meter, or if the vehicle's battery goes dead or is disconnected.

# Multi-Information Display

## SH-AWD Torque Distribution Monitor

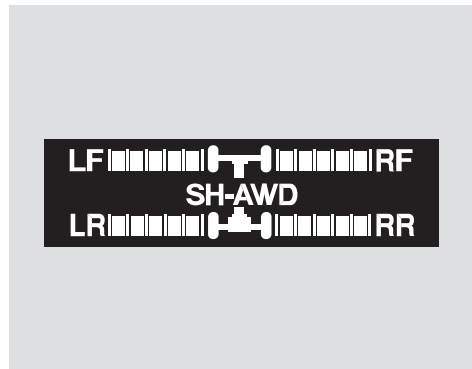

This monitor shows how much torque is being delivered to each wheel. For more information, see page [356](#).

## Tire Pressure Monitor

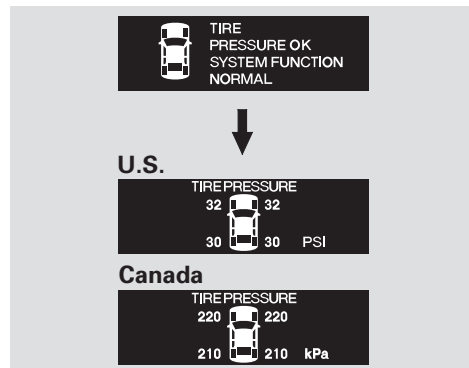

When the tire pressure monitor is shown on the multi-information display, press the SEL/RESET button. The display changes as shown. You can see the pressure of each tire in this monitor. If one or more tires are low, inflate them to the correct pressure. For more information, see page [371](#).

## Bluetooth® HandsFreeLink®



You can receive or make phone calls from your cell phone through your vehicle's Bluetooth® HandsFreeLink® (HFL) system without touching your cell phone.

To use the system, your cell phone and the HFL system must be linked. Not all cell phones are compatible with this system. Refer to page [308](#) for instructions on how to link your cell phone to the HFL and how to receive or make phone calls, or visit the [acura.com/handsfreelink](http://acura.com/handsfreelink) website.

### Maintenance Messages

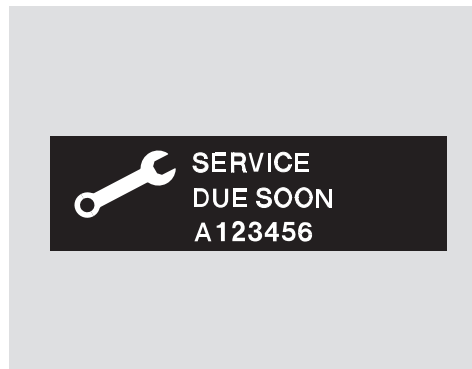

When the engine oil life reaches 15 %, the display shows “SERVICE DUE SOON” and the code for the maintenance items to be performed.

When the engine oil life reaches 5 %, the display shows “SERVICE DUE NOW” along with the same maintenance items.

Have your dealer do the indicated maintenance as soon as you see this message, and have them reset the display after completing the service.

If you do not perform the indicated maintenance or do not reset the display, the message changes to “SERVICE PAST DUE” when the engine oil life becomes 0 %.

These messages appear on the multi-information display each time you turn the ignition switch to the ON (II) position.

For details on engine oil life and maintenance messages, refer to page [386](#).

Also refer to page [386](#) for important maintenance safety precautions.

# Multi-Information Display

## Message Display









When a problem is detected with your vehicle, a message will be shown on the multi-information display.









If this happens, refer to the applicable pages of this owner's manual, and follow the instructions.

When there are several messages to be shown, the system switches the messages every 5 seconds.









The message is shown until you push the INFO (▲ or ▼) button. To see the message again, press the INFO (▲ or ▼) button, 5 seconds after the display disappears.







Here is a list of messages shown on the multi-information display:







 CHECK BRAKE BRAKE SYSTEM	See page 63, 449
 RELEASE PARKING BRAKE	
 BRAKE FLUID LOW	See page 449
 CHECK ENGINE OIL LEVEL	See page 62, 447
 CHECK EMISSION SYSTEM	See page 62, 448
 CHECK CHARGING SYSTEM	See page 62, 447
 CHECK STARTING SYSTEM	See page 348
 CHECK RADIATOR SYSTEM	See page 446

 CHECK ABS SYSTEM	See page 64, 359
 CHECK VSA SYSTEM	See page 65, 377
 CHECK ADAPTIVE FRONT LIGHTING SYSTEM	See page 69, 143
 CHECK POWER STEERING SYSTEM	See page 68
 CHECK SH-AWD SYSTEM	See page 66, 356
 SH-AWD DIFF TEMP. HIGH	
 CHECK TRANSMISSION	See page 349
 CHECK AIRBAG SYSTEM	See page 34, 63

# Multi-Information Display

 <b>DRL</b> CHECK DRL SYSTEM	See page <a href="#">142</a>
 <b>DRL</b> DRL OFF	
<b>U.S.</b>  PASSENGER SIDE AIRBAG OFF	See page <a href="#">35</a> , <a href="#">63</a>
<b>Canada</b>  PASSENGER SIDE AIRBAG OFF	
 CHECK KEYLESS ACCESS SYSTEM	See page <a href="#">176</a>
 KEYLESS REMOTE NOT DETECTED	See page <a href="#">174</a>
 KEYLESS REMOTE LOW BATTERY	See page <a href="#">175</a>
 WASHER FLUID LOW	See page <a href="#">404</a>





 <b>ACC</b> CHECK ACC SYSTEM	See page <a href="#">280</a>
 <b>CMBS</b> CHECK CMBS SYSTEM	See page <a href="#">364</a>
 <b>CMBS</b> CHECK CMBS RADAR SENSOR	See page <a href="#">69</a> , <a href="#">361</a>
 DOOR & TRUNK OPEN	See page <a href="#">13</a>
 <b>FASTEN SEAT BELT</b>	See page <a href="#">62</a>
 <b>FASTEN PASSENGER SEAT BELT</b>	See page <a href="#">62</a>
<b>TIGHTEN FUEL CAP</b>	See page <a href="#">331</a>
 <b>FUEL LOW</b>	See page <a href="#">66</a>

 SERVICE DUE NOW A123456	See page <a href="#">389</a>
 <b>TPMS</b> CHECK TPMS SYSTEM	See page <a href="#">375</a>
 SYSTEM FUNCTION ERROR	See page <a href="#">373</a>
 CHECK TIRE PRESSURE	See page <a href="#">67</a> , <a href="#">373</a>
 <b>PAX SYSTEM WARNING</b> RUN FLAT DRIVING MAX 50MPH	See page <a href="#">432</a>
 <b>PAX SYSTEM WARNING</b> RUN FLAT RANGE NEAR LIMIT CHECK TIRE SOON	See page <a href="#">433</a>
 <b>PAX SYSTEM WARNING</b> RUN FLAT LIMIT <b>STOP DRIVING</b>	See page <a href="#">434</a>

CONTINUED

## Multi-Information Display

---

 ACCESSORY (I) POSITION	See page <a href="#">151</a>
 RETURN IGNITION SWITCH TO LOCK (0) POSITION	
 ACCESSORY (I) POSITION	See page <a href="#">151</a>
 RETURN IGNITION SWITCH TO LOCK (0) POSITION	
 REMOVE KEY	

## Customized Settings

With the multi-information display and the INFO (▲/▼) and SEL/RESET buttons on the right side of the steering wheel, you can customize some vehicle control settings for “DRIVER 1” or “DRIVER 2”. If “DRIVER 1” or “DRIVER 2” is not displayed, customizing is not possible.

To have the driver’s ID detected, make sure your remote is linked to the system (see **Memory Position Link** on page 104 ). Then use your remote to unlock the doors (see **Keyless Access Setup** on page 108 ).

To change the settings, the ignition switch must be in the ON (II) position, and the vehicle must be stopped with the transmission in Park.

To enter the customizing mode, press and hold the INFO (▲/▼) button for more than 3 seconds while the multi-information display is in its normal mode.

If you turn the ignition switch to the ACCESSORY (I) or the LOCK (0) position, or move the shift lever out of Park, the display will change to the normal screen.

You cannot customize the settings under these conditions:

- When the keyless memory settings are off (see page 170 ).
- If you disconnect the battery, and then do not unlock the door.
- When the multi-information display does not show the driver’s ID.

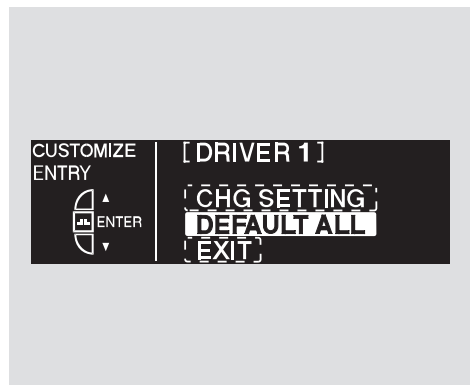

The first customizing menu is:

- CHG SETTING (see page 87 )
- DEFAULT ALL (see page 85 )

Refer to the following table for a brief summary of each customizable setting and its default. For more information, refer to the page number references in the table.

*CONTINUED*



# Multi-Information Display

CUSTOMIZE ENTRY	CUSTOMIZE GROUP	CUSTOMIZE MENU	Description	CUSTOMIZE SET UP	Page	
CHG SETTING (see page 87)	ACC SETUP (see page 89)	PRE-RUNNING CAR DETECT BEEP	Causes the system to beep when a vehicle ahead of you gets too close.	ON* <sup>1</sup>	90	
				OFF		
		ACC DISPLAY SPEED UNIT	Changes the ACC display speed unit.	MPH* <sup>2</sup>	previous setting	92
				km/h* <sup>3</sup>		
	METER SETUP (see page 94)	LANGUAGE SELECTION	LANGUAGE SELECTION	Changes the language used in the display.	ENGLISH* <sup>1</sup>	95
					FRENCH	
					SPANISH	
		ADJUST OUTSIDE TEMP. DISPLAY	Changes the outside temperature reading above or below its current reading.	-5°F ~ ±0°F* <sup>2</sup> ~ 5°F	97	
				-3°C ~ ±0°C* <sup>3</sup> ~ 3°C		
		TRIP A & AVG. FUEL RESET with REFUEL	Causes trip meter A and the average fuel economy to reset when you refuel.	ON	99	
			OFF* <sup>1</sup>			
	ELAPSED TIME RESET	Resets the elapsed time of your current trip.	IGN OFF* <sup>1</sup>	101		
			TRIP A			
			TRIP B			
POSITION SETUP (see page 103)	MEMORY POSITION LINK	MEMORY POSITION LINK	Changes the driver's seat, the steering wheel, and the outside mirror positions to your stored setting.	ON* <sup>1</sup>	104	
				OFF		
	AUTO TILT & TELESCOPIC	Moves the steering wheel fully in and out when the key is removed.	ON* <sup>1</sup>	106		
			OFF			

\* 1 : Default setting

\* 2 : Default setting for U.S. models

\* 3 : Default setting for Canadian model

# Multi-Information Display

CUSTOMIZE ENTRY	CUSTOMIZE GROUP	CUSTOMIZE MENU	Description	CUSTOMIZE SET UP	Page
CHG SETTING (see page 87)	KEYLESS ACCESS SETUP (see page 108)	DOOR UNLOCK MODE	Changes which doors unlock when you use the remote or grab the driver's doorhandle.	DRIVER DOOR*	109
				ALL DOORS	
		KEYLESS ACCESS LIGHT FLASH	Causes some exterior lights to blink twice when you unlock the doors by grabbing the driver's door handle.	ON* OFF	111
		KEYLESS ACCESS BEEP	Cause the beeper to sound twice when you unlock the doors by grabbing the driver's door handle.	ON* OFF	113
	LIGHTING SETUP (see page 115)	INTERIOR LIGHT DIMMING TIME	Changes how long (in seconds) the interior lights stay on after you close the doors.	60 SEC	116
				30 SEC*	
				15 SEC	
	HEADLIGHT AUTO OFF TIMER	Changes how long (in seconds) the exterior lights stay on after you close the driver's door.	60 SEC	118	
			30 SEC		0 SEC
			15 SEC*		
	AUTO LIGHT SENSITIVITY	Changes the light level that causes the headlights to come on. The headlight switch needs to be in the AUTO position.	MAX	120	
			HIGH		MIN
			MID*		
LOW					
DOOR/WINDOW SETUP (see page 122)	AUTO DOOR LOCK	Changes when the doors automatically lock.	SHIFT FROM P	123	
			WITH VEH SPD*		
			OFF		

\* : Default setting

CONTINUED

# Multi-Information Display

CUSTOMIZE ENTRY	CUSTOMIZE GROUP	CUSTOMIZE MENU	Description	CUSTOMIZE SET UP	Page
CHG SETTING (see page 87)	DOOR/WINDOW SETUP (see page 122)	AUTO DOOR UNLOCK	Changes when the doors automatically unlock.	SHIFT TO P*	125
				IGN OFF	
				OFF	
		DOOR LOCK MODE	Changes which doors unlock with the first push of the remote's unlock button.	DRIVER DOOR*	127
	KEYLESS LOCK ACKNOWLEDGMENT	The exterior lights flash each time you press the LOCK or UNLOCK button.	ON*	129	
			OFF		
	SECURITY RELOCK TIMER	Changes how long it takes (in seconds) for the doors to relock and the security system to set after you unlock the driver's door without opening it.	90 SEC	131	
			60 SEC		
			30 SEC*		
	WIPER SETUP (see page 133)	WIPER ACTION	Changes the wiper operation among two settings when the wiper switch is in the INT position.	INTERMITTENT	134
WITH VEH SPD*					
DEFAULT ALL (see page 85)		Changes all settings to the default.	SET	85	
			CANCEL		

\* : Default setting

If you want the settings as they were when the vehicle left the factory, select **DEFAULT ALL**, as described on this page.

If you want to change any vehicle control settings, select **CHG SETTING**, then press the **SEL/RESET** button.

Use the **INFO (▲/▼)** button on the steering wheel to select the settings and the **SEL/RESET** button to enter your selections.

## DEFAULT ALL

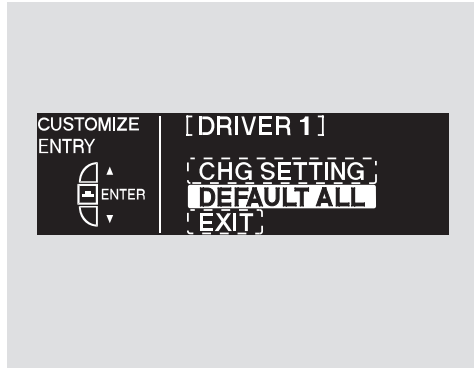

If you want to set the default settings, press the **INFO (▲/▼)** button to select **DEFAULT ALL**, then press the **SEL/RESET** button.

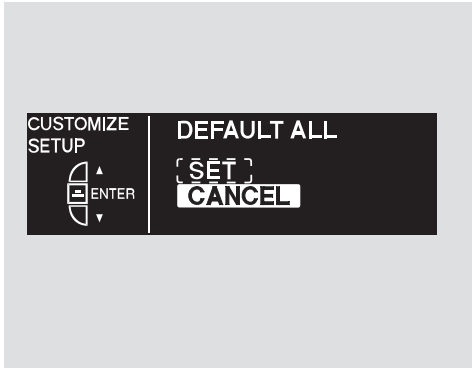

If you want to cancel **DEFAULT ALL**, select **CANCEL**, then press the **SEL/RESET** button. The screen goes back to **CUSTOMIZE ENTRY**.

*CONTINUED*

## Multi-Information Display

---

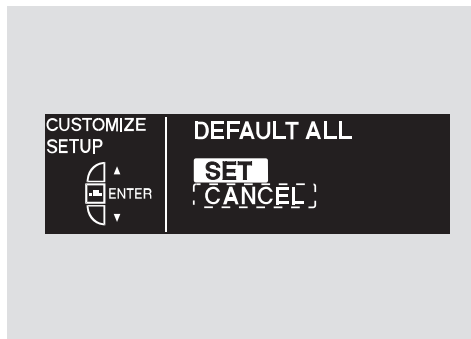

To set the default settings again, select **DEFAULT ALL**, and press the **SEL/RESET** button. Then select **SET**, and press the **SEL/RESET** button.

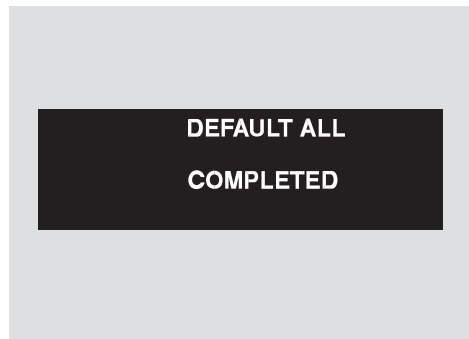

When **DEFAULT ALL** is set, you will see the above display for several seconds, then the screen returns to **CUSTOMIZE ENTRY**.

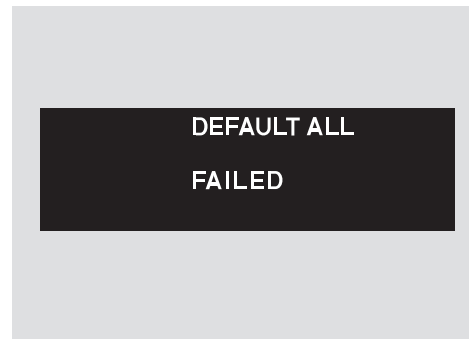

If **DEFAULT ALL** is not set, you will see the above display for several seconds, then the screen goes back to the normal message mode. Repeat the procedure to select **DEFAULT ALL**.

### CHG SETTING

You can customize some of the vehicle control settings to your preference. Here are the settings you can customize:

- ADAPTIVE CRUISE CONTROL SETUP
- METER SETUP
- POSITION SETUP
- KEYLESS ACCESS SETUP
- LIGHTING SETUP
- DOOR/WINDOW SETUP
- WIPER SETUP

While CHG SETTING in the CUSTOMIZE ENTRY is shown on the multi-information display, press the SEL/RESET button. The screen changes to ACC SETUP in the CUSTOMIZE GROUP.

Each time you press the INFO (▲/▼) button, the screen changes as shown on the next page. Press the INFO (▲/▼) button, until you see the setup you want to customize, then press the SEL/RESET button to enter your selection.

*CONTINUED*

# Multi-Information Display

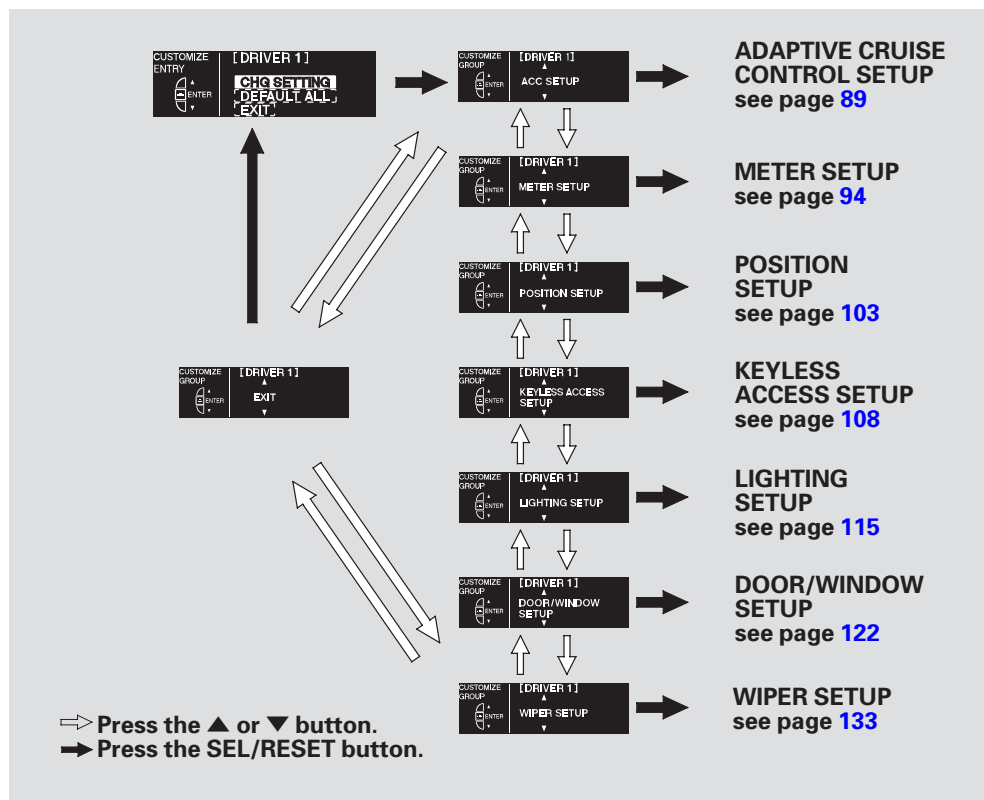

## Adaptive Cruise Control Setup

*If equipped*

Here are the two custom settings for adaptive cruise control (ACC):

- PRE-RUNNING CAR DETECT BEEP
- ACC DISPLAY SPEED UNIT

While the multi-information display is in the CUSTOMIZE GROUP screen, select ACC SETUP by pressing the INFO (▲/▼) button, then press the SEL/RESET button.

Each time you press the INFO (▲/▼) button, the display changes as shown in the illustration. Press the INFO (▲/▼) button until you see the setting you want to customize, then press the SEL/RESET button to enter your selection.

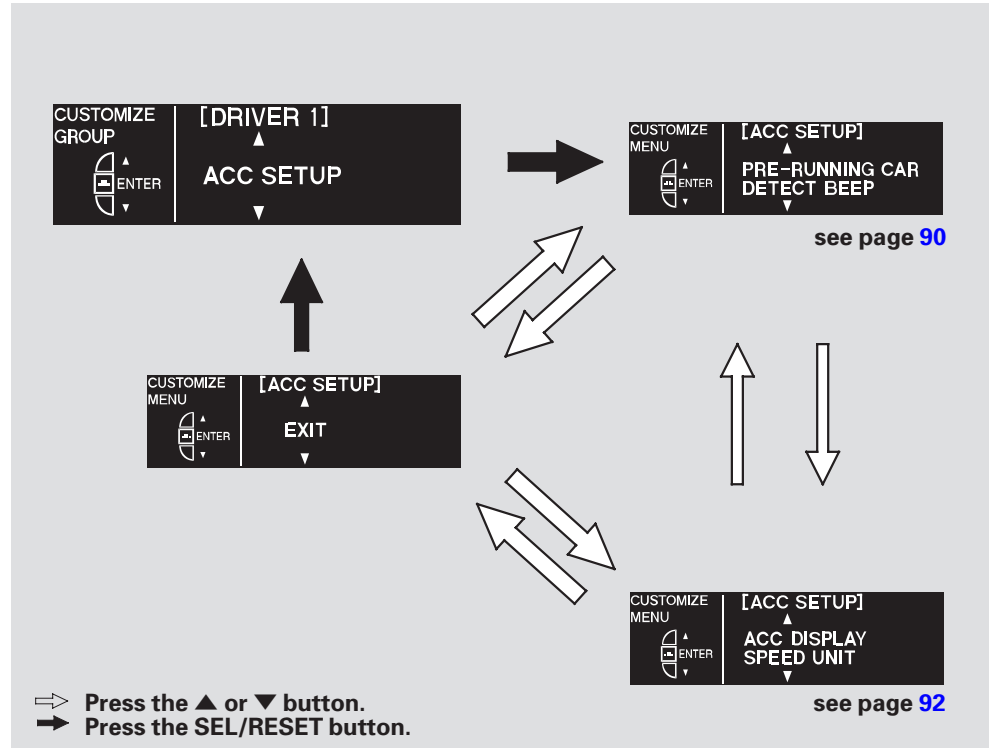

CONTINUED



## Multi-Information Display

### *Pre-Running Car Detect Beep*

When PRE-RUNNING CAR DETECT BEEP is set to ON, one beep sounds when the ACC detects a vehicle in front of you. You also hear a beep when that vehicle goes out of the range of your vehicle's radar sensor.



While the multi-information display is in the ACC SETUP of the CUSTOMIZE GROUP, press the SEL/RESET button. The screen changes to the above display.



Press the SEL/RESET button. The screen changes as shown above. Select ON or OFF by pressing the INFO (▲/▼) button, then press the SEL/RESET button to enter your selection.



When your choice is set, the display changes to the screen shown above for several seconds, and then goes back to CUSTOMIZE ENTRY.

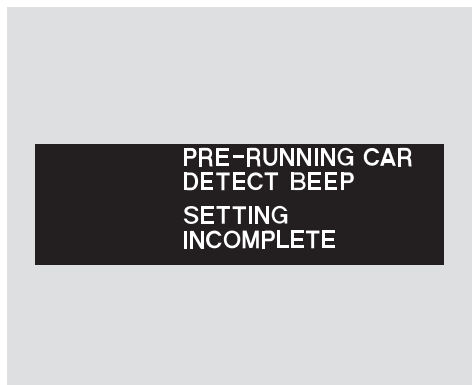

If your choice is not set, you will see the above display for several seconds, then the screen goes back to CUSTOMIZE SETUP. If this happens, you need to repeat the pre-running car detect beep setup.

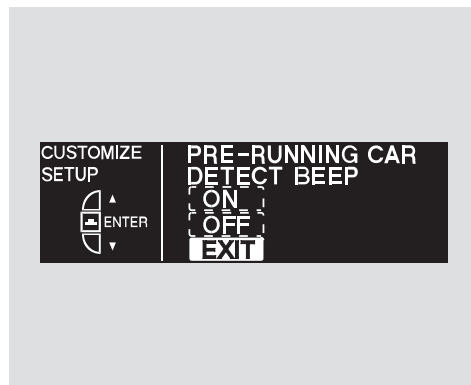

To exit PRE-RUNNING CAR DETECT BEEP without changing the current setting, select EXIT by pressing the INFO ( $\blacktriangle/\blacktriangledown$ ) button, then press the SEL/RESET button. The screen goes back to CUSTOMIZE MENU.

*CONTINUED*

## Multi-Information Display

### *Adaptive Cruise Control Display Speed Unit*

To change the unit of measurement from mph to km/h, do this:

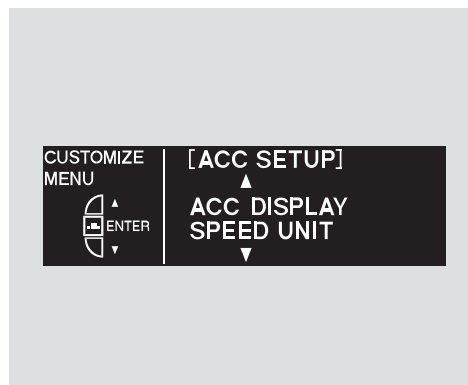

While the multi-information display is in the ACC SETUP of the CUSTOMIZE GROUP, press the SEL/RESET button. The screen changes to CUSTOMIZE MENU. Press the INFO (▲/▼) button until you see the above display.

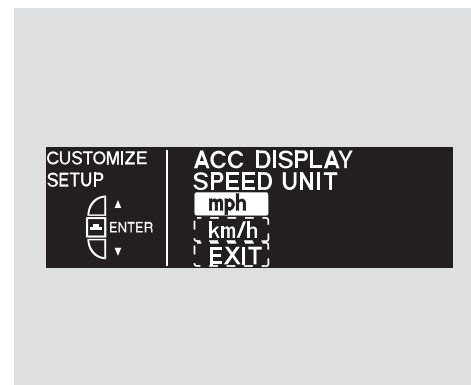

Press the SEL/RESET button. The screen changes as shown above. The highlighted unit, mph or km/h, is the current setting. To change the setting, press the INFO (▲/▼) button until the unit you want is highlighted, then press the SEL/RESET button.

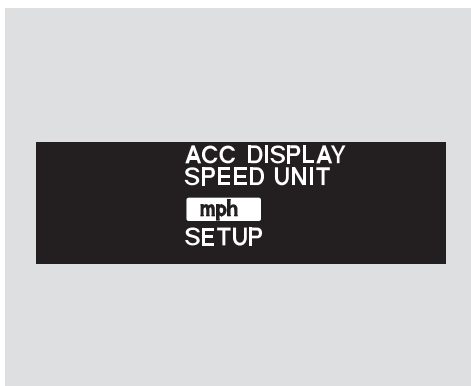

When your choice is set, you will see the above display for several seconds, then the screen goes back to CUSTOMIZE ENTRY.

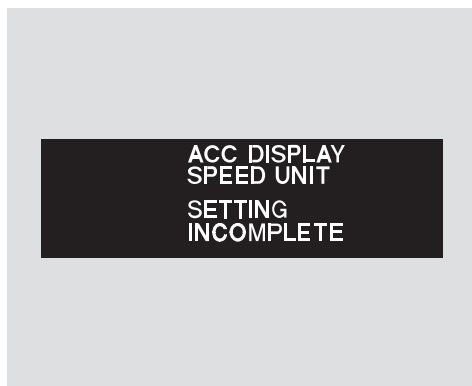

If your choice is not set, you will see the above display for several seconds, then the screen goes back to CUSTOMIZE SETUP. If this happens, you need to repeat the ACC display speed unit setup.

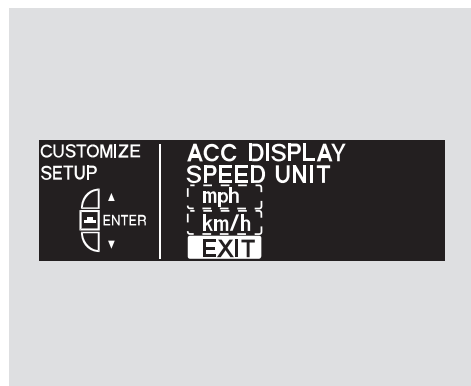

To exit ACC DISPLAY SPEED UNIT without changing the current setting, select EXIT by pressing the INFO ( $\blacktriangle/\blacktriangledown$ ) button, then press the SEL/RESET button. The screen goes back to CUSTOMIZE MENU.

# Multi-Information Display

## Meter Setup

Here are the four custom settings for the meter setup:

- LANGUAGE SELECTION
- ADJUST OUTSIDE TEMP. DISPLAY
- TRIP A & AVG. FUEL RESET with REFUEL
- ELAPSED TIME RESET

While METER SETUP is shown in the CUSTOMIZE GROUP of the multi-information display, press the SEL/RESET button.

Each time you press the INFO (▲/▼) button, the screen changes as shown in the illustration. Press the INFO (▲/▼) button until you see the setting you want to customize, then press the SEL/RESET button to enter your selection.

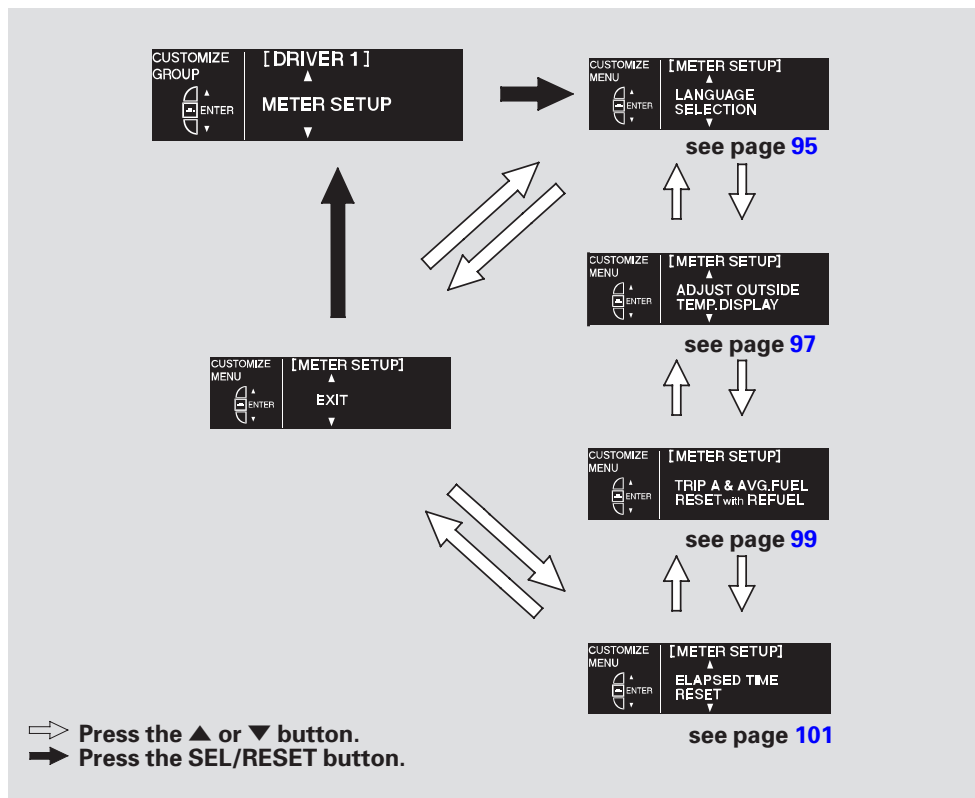

## Language Selection

There are three language selections you can make: English, French, and Spanish. To choose the language you want, follow these instructions:

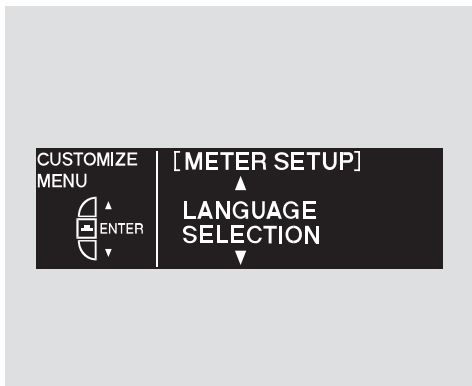

While METER SETUP is shown in the CUSTOMIZE GROUP of the multi-information display, press the SEL/RESET button. You will see the above display.

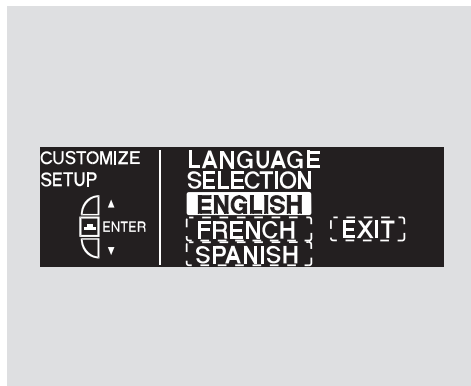

Select the desired language by pressing the INFO (▲/▼) button, then enter your selection by pressing the SEL/RESET button.

CONTINUED

## Multi-Information Display

---



When your choice is set, you will see the above display for several seconds, then the screen goes back to CUSTOMIZE ENTRY.

All messages on the multi-information display will be shown in the language you selected.



If your choice is not set, you will see the above display for several seconds, then screen goes back to CUSTOMIZE SETUP. If this happens, you need to repeat the language selection setup.

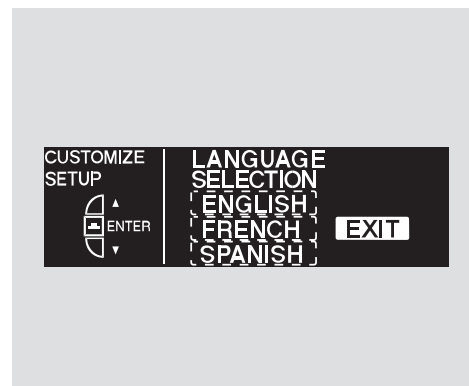

To exit LANGUAGE SELECTION without changing the current setting, select EXIT by pressing the INFO (▲/▼) button, then press the SEL/RESET button. The screen goes back to CUSTOMIZE MENU.

### ***Adjust Outside Temp. Display***

If you sometimes find that the temperature reading is a few degrees above or below the actual temperature, you can adjust it by following these instructions:

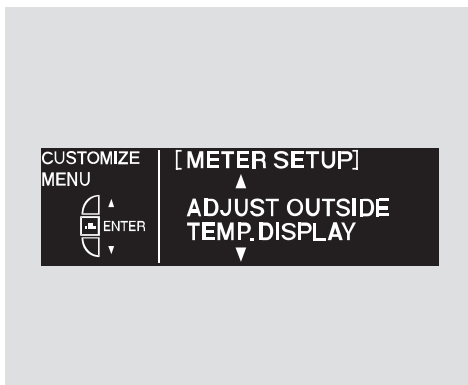

While the multi-information display is in the METER SETUP of the CUSTOMIZE GROUP, press the SEL/RESET button. The screen changes to CUSTOMIZE MENU. Press the INFO (▲/▼) button until you see the above display.

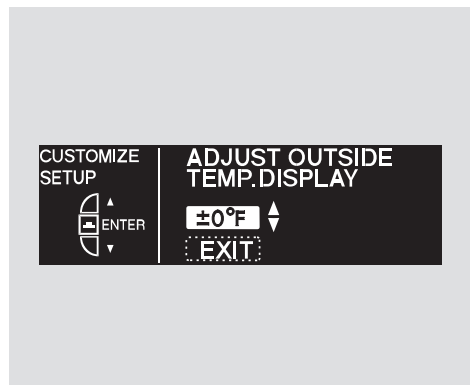

Press the SEL/RESET button. The screen changes as shown above. The highlighted number is the current setting above or below the outside temperature. Press the INFO (▲/▼) button repeatedly until the number you want appears, then press the SEL/RESET button to enter your selection.

*CONTINUED*



## Multi-Information Display

---

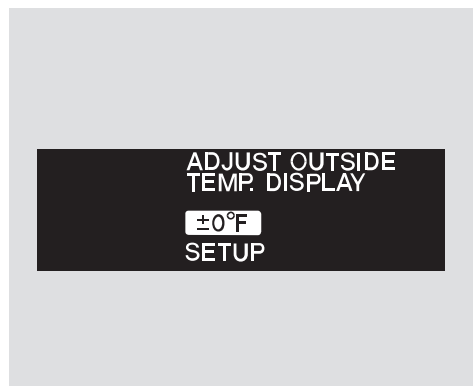

When your choice is set, you will see the above display for several seconds, then the screen goes back to CUSTOMIZE ENTRY.

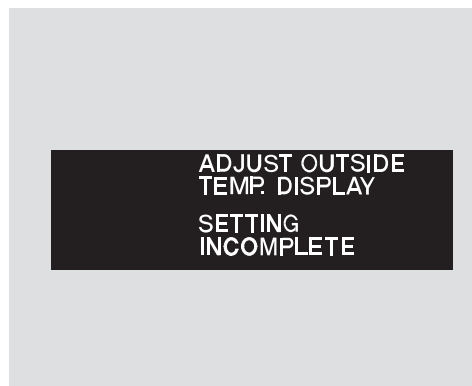

If your choice is not set, you will see the above display for several seconds, then the screen goes back to CUSTOMIZE SETUP. If this happens, you need to repeat the adjust outside air temperature display setup.

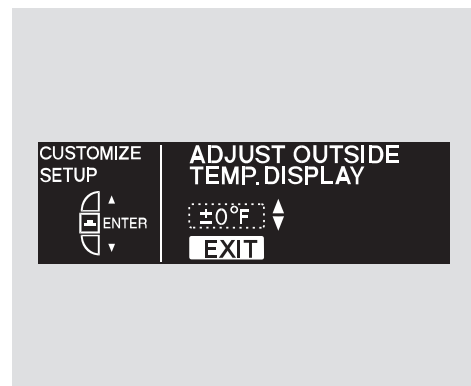

To exit ADJUST OUTSIDE TEMP. DISPLAY without changing the current setting, select EXIT by pressing the INFO (▲/▼) button, then press the SEL/RESET button. The screen goes back to CUSTOMIZE MENU.

### ***Trip A & Avg. Fuel Reset with Refuel***

To cause trip A and average fuel economy A to reset every time you refuel your vehicle, follow these instructions:

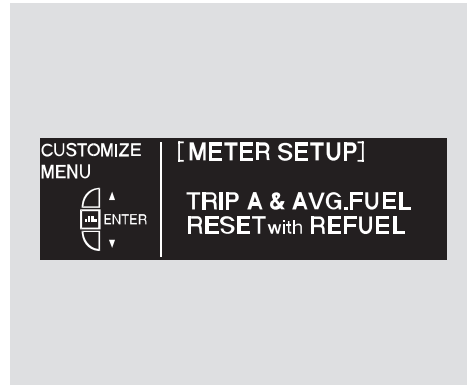

While METER SETUP is shown in the CUSTOMIZE GROUP of the multi-information display, press the SEL/RESET button. The screen changes to CUSTOMIZE MENU. Press the INFO (▲/▼) button until you see the above display.

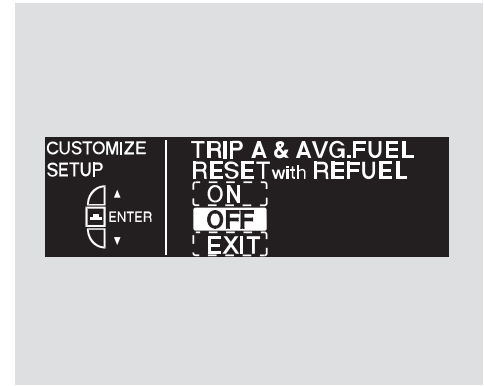

Press the SEL/RESET button. The screen changes as shown above. Select ON or OFF by pressing the INFO (▲/▼) button, then press the SEL/RESET button to enter your selection.

CONTINUED

## Multi-Information Display

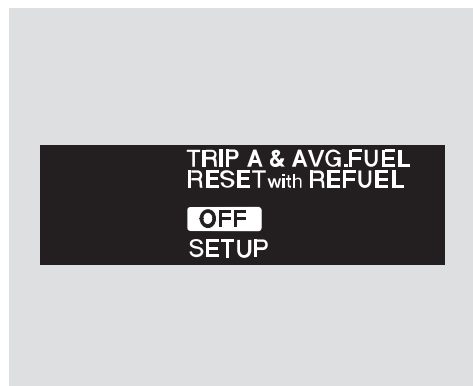

When your choice is set, you will see the above display for several seconds, then the screen goes back to CUSTOMIZE ENTRY.

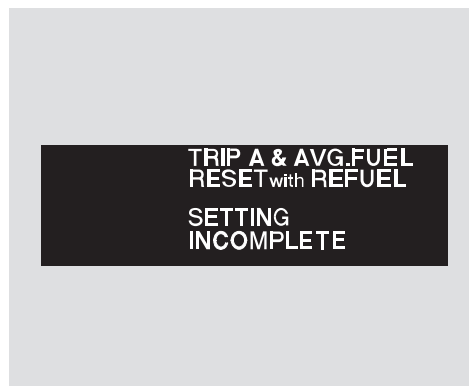

If your choice is not set, you will see the above display for several seconds, then the screen goes back to CUSTOMIZE SETUP. If this happens, you need to repeat the trip A and average fuel reset with refuel setup.

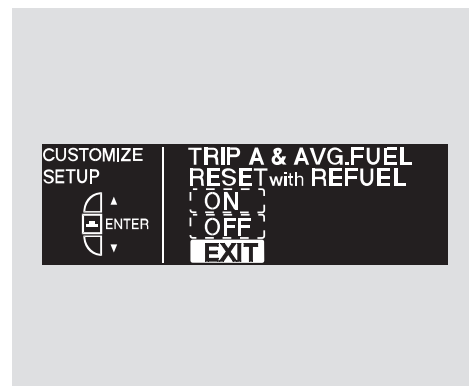

To exit TRIP A & AVG. FUEL RESET with REFUEL without changing the current setting, select EXIT by pressing the INFO (▲/▼) button, then press the SEL/RESET button. The screen goes back to CUSTOMIZE MENU.

### ***Elapsed Time Reset***

There are three elapsed time reset choices you can make:

**IGN OFF** — The elapsed time is reset when you turn the ignition switch to the LOCK (0) position.

**TRIP A** — The elapsed time is reset when the Trip A is reset.

**TRIP B** — The elapsed time is reset when the Trip B is reset.

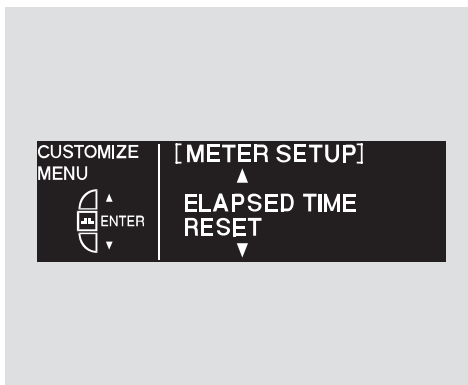

While METER SETUP is shown in the CUSTOMIZE GROUP of the multi-information display, press the SEL/RESET button. The screen changes to CUSTOMIZE MENU. Press the INFO (▲/▼) button until you see the above display.

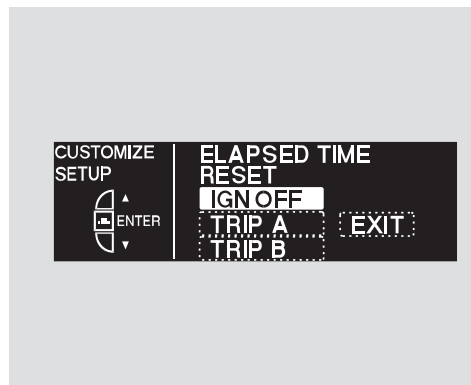

Press the SEL/RESET button. The screen changes as shown above. Select the desired setting by pressing the INFO (▲/▼) button, then press the SEL/RESET button to enter your selection.

CONTINUED

## Multi-Information Display



When your choice is set, you will see the above display for several seconds, then the screen goes back to CUSTOMIZE ENTRY.



If your choice is not set, you will see the above display for several seconds, then the screen goes back to CUSTOMIZE SETUP. If this happens, you need to repeat the elapsed time reset setup.

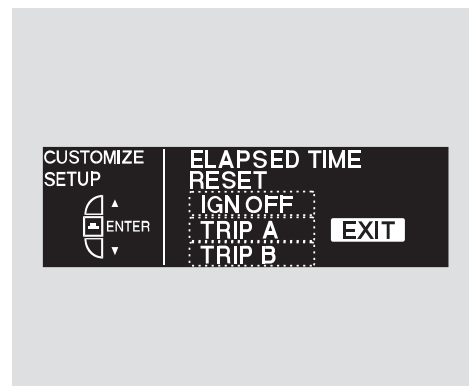

To exit ELAPSED TIME RESET without changing the current setting, select EXIT by pressing the INFO (▲/▼) button, then press the SEL/RESET button. The screen goes back to CUSTOMIZE MENU.

## Position Setup

There are two position setups you can make:

- MEMORY POSITION LINK
- AUTO TILT & TELESCOPIC

While the multi-information display is in the CUSTOMIZE GROUP screen, select POSITION SETUP by pressing the INFO (▲/▼) button, and then press the SEL/RESET button.

Each time you press the INFO (▲/▼) button, the screen changes as shown in the illustration. Press the INFO (▲/▼) button until you see the setting you want to customize, then press the SEL/RESET button to enter your selection.

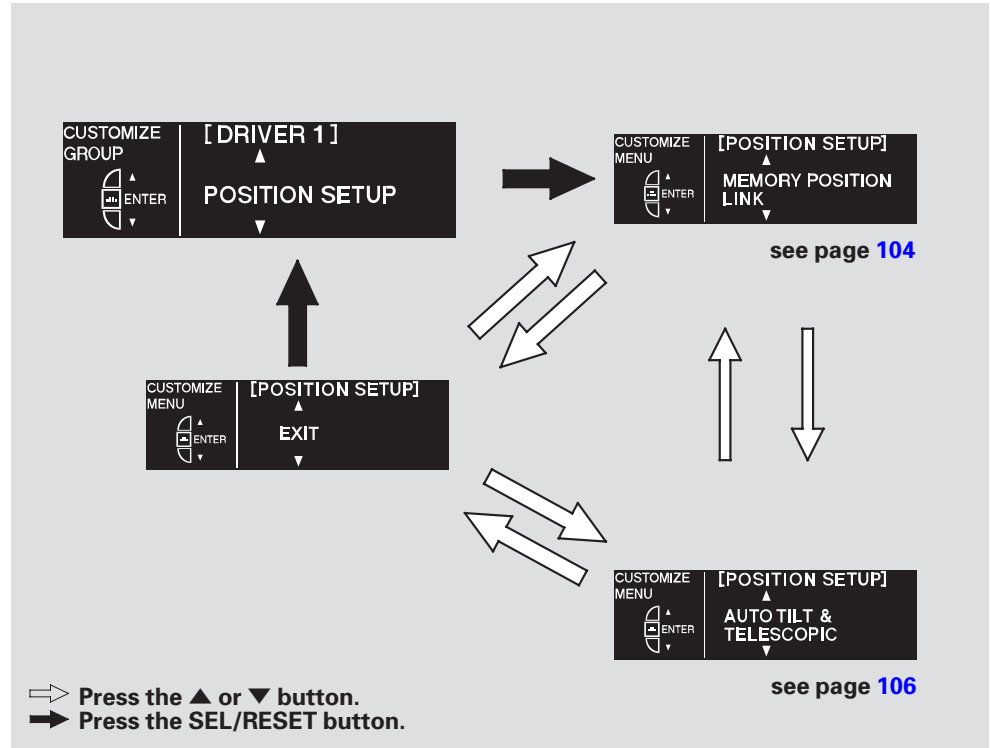

CONTINUED

## Multi-Information Display

### ***Memory Position Link***

When Memory Position Link is set to ON, the driver's seat, the steering wheel, and the outside mirror positions move to the positions stored in memory. To cause the memory to activate, open the driver's door with the remote, or grab the door handle while carrying the remote.

To set the seat memory position, see page 160. For information on using the remote, see page 170.

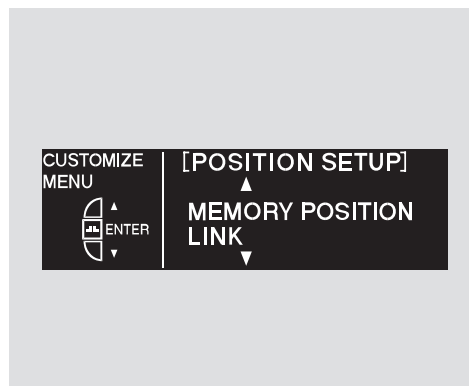

While the multi-information display is in the POSITION SETUP screen of the CUSTOMIZE GROUP, press the SEL/RESET button. The screen changes to the above display.

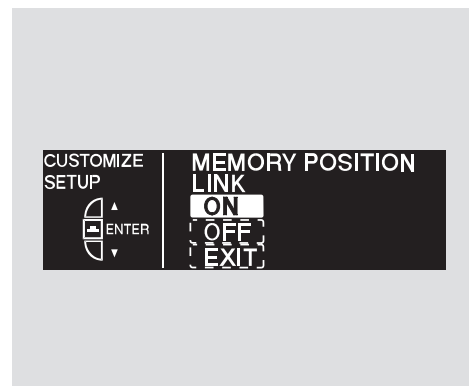

Press the SEL/RESET button. The screen changes as shown above. Select ON or OFF by pressing the INFO (▲/▼) button, then press the SEL/RESET button to enter your selection.

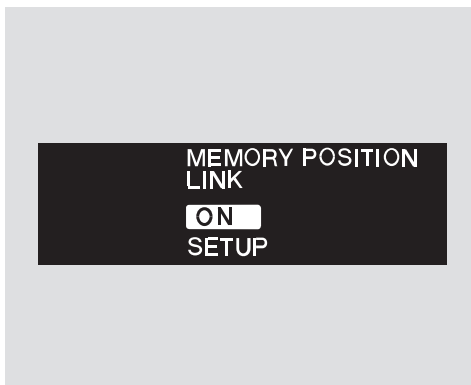

When your choice is set, you will see the above display for several seconds, then the screen goes back to CUSTOMIZE ENTRY.

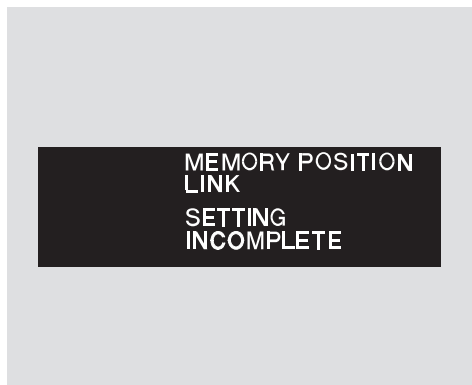

If your choice is not set, you will see the above display for several seconds, then the screen goes back to CUSTOMIZE SETUP. If this happens, you need to repeat the memory position link setup.

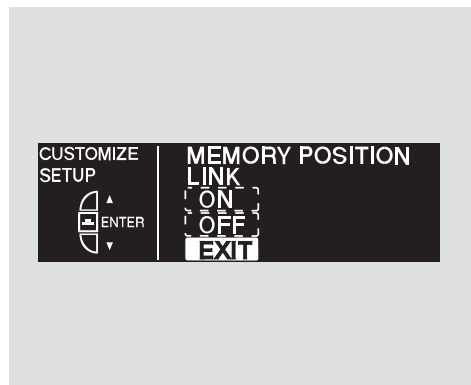

To exit MEMORY POSITION LINK without changing the current setting, select EXIT by pressing the INFO (▲/▼) button, then press the SEL/RESET button. The screen goes back to CUSTOMIZE MENU.

*CONTINUED*



## Multi-Information Display

### *Auto Tilt & Telescopic*

When AUTO TILT & TELESCOPIC is set to ON, the steering wheel automatically moves fully in and up when you turn the ignition switch to the LOCK (0) position and release it, or when you remove the built-in key from the ignition switch.

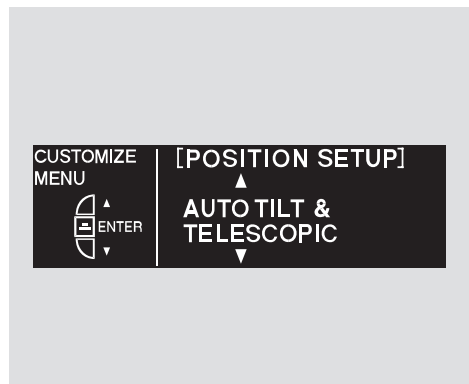

While the multi-information display is in the POSITION SETUP screen of the CUSTOMIZE GROUP, press the SEL/RESET button. The screen changes to CUSTOMIZE MENU. Press the INFO (▲/▼) button until you see the above display.

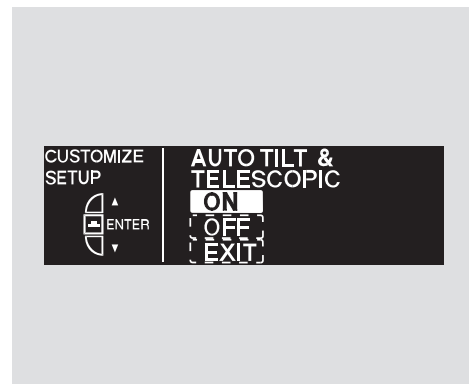

Press the SEL/RESET button. The screen changes as shown above. Select ON or OFF by pressing the INFO (▲/▼) button, then press the SEL/RESET button to enter your selection.

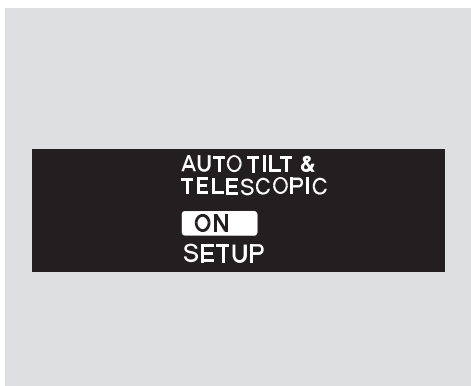

When your choice is set, you will see the above display for several seconds, then the screen goes back to CUSTOMIZE ENTRY.



If your choice is not set, you will see the above display for several seconds, then the screen goes back to CUSTOMIZE SETUP. If this happens, you need to repeat the auto tilt and telescopic setup.

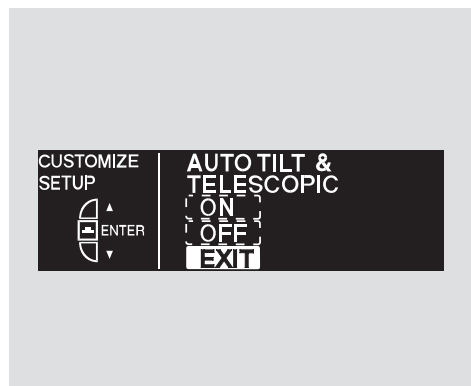

To exit AUTO TILT & TELESCOPIC without changing the current setting, select EXIT by pressing the INFO (▲/▼) button, then press the SEL/RESET button. The screen goes back to CUSTOMIZE MENU.

## Multi-Information Display

### KEYLESS ACCESS Setup

There are three settings in the keyless access setup:

- DOOR UNLOCK MODE
- KEYLESS ACCESS LIGHT FLASH
- KEYLESS ACCESS BEEP

While the multi-information display is in the CUSTOMIZE GROUP screen, select KEYLESS ACCESS SETUP by pressing the INFO (▲/▼) button, then press the SEL/RESET button.

Each time you press the INFO (▲/▼) button, the screen changes as shown in the illustration. Press the INFO (▲/▼) button, until you see the setting you want to customize, then press the SEL/RESET button to enter your selection.

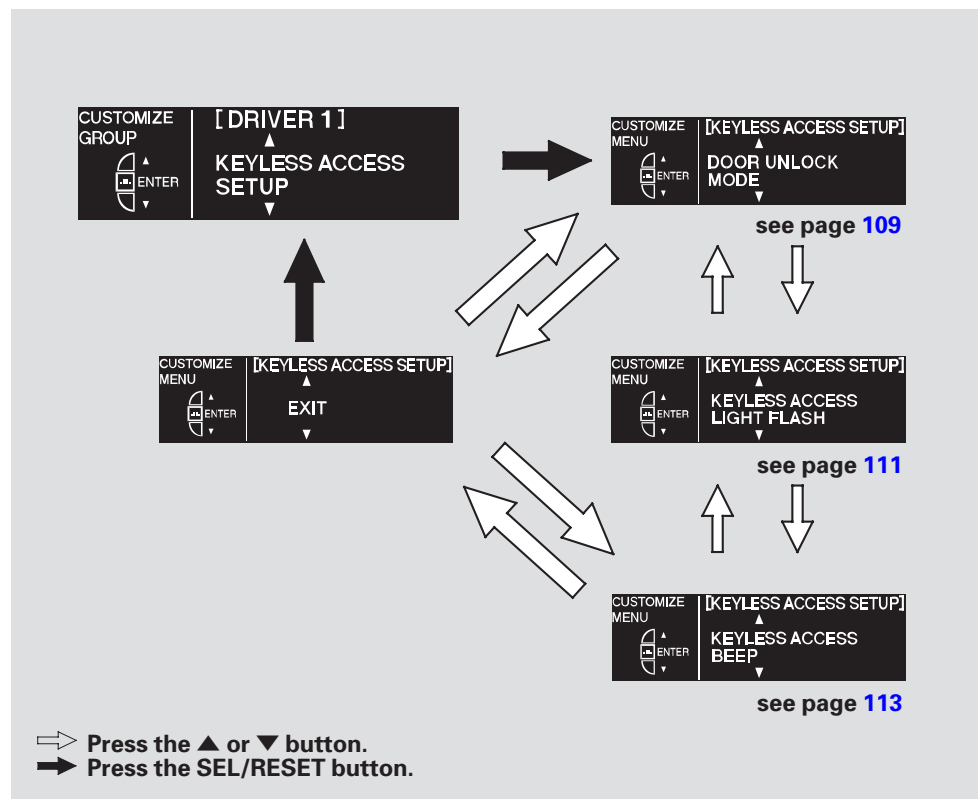

### ***Door Unlock Mode***

To select whether the driver's door or all doors unlock when you open the driver's door with the remote or by grabbing the door handle (while carrying the remote), follow these instructions:



While the multi-information display is in the KEYLESS ACCESS SETUP screen of the CUSTOMIZE GROUP, press the SEL/RESET button. The screen changes to the above display.



Press the SEL/RESET button. The screen changes as shown above. Select DRIVER DOOR ONLY or ALL DOORS by pressing the INFO (▲/▼) button, then press the SEL/RESET button to enter your selection.

*CONTINUED*

## Multi-Information Display

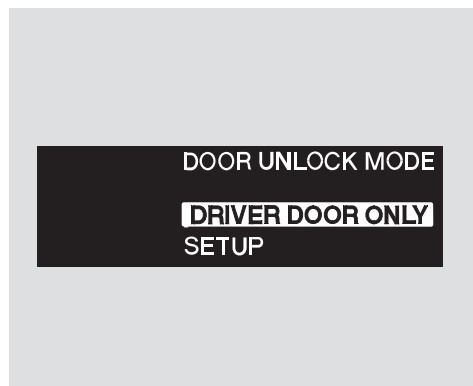

When your choice is set, you will see the above display for several seconds, then the screen goes back to CUSTOMIZE ENTRY.

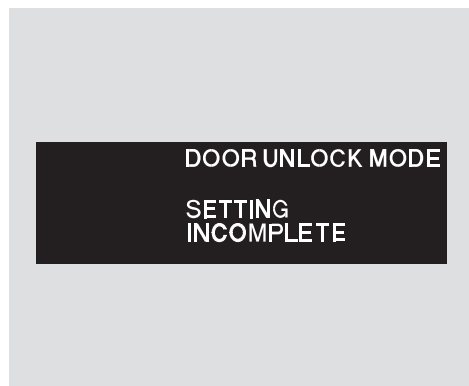

If your choice is not set, you will see the above display for several seconds, then the screen goes back to CUSTOMIZE SETUP. If this happens, you need to repeat the door unlock mode setup.



To exit DOOR UNLOCK MODE without changing the current setting, select EXIT by pressing the INFO (▲/▼) button, then press the SEL/RESET button. The screen goes back to CUSTOMIZE MENU.

### ***Keyless Access Light Flash***

When KEYLESS ACCESS LIGHT FLASH is set to ON, some exterior lights blink twice when you unlock the doors by grabbing the driver's door handle while carrying the remote.

The same exterior lights blink once when you lock the doors by touching the door lock sensor while carrying the remote.

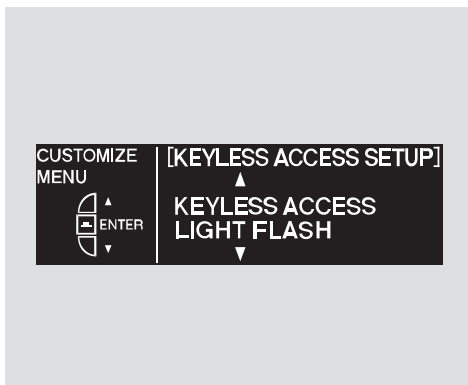

While the multi-information display is in the KEYLESS ACCESS SETUP screen of the CUSTOMIZE GROUP, press the SEL/RESET button. The screen changes to CUSTOMIZE MENU. Press the INFO (▲/▼) button until you see the above display.

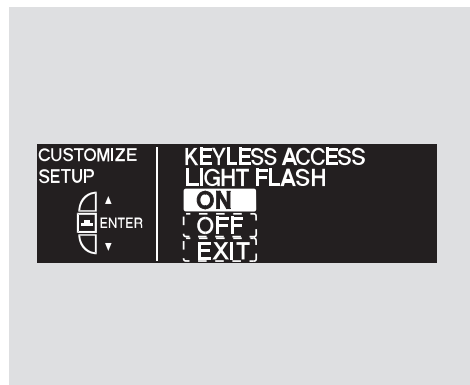

Press the SEL/RESET button. The screen changes as shown above. Select ON or OFF by pressing the INFO (▲/▼) button, then press the SEL/RESET button to enter your selection.

CONTINUED

## Multi-Information Display

---



When your choice is set, you will see the above display for several seconds, then the screen goes back to CUSTOMIZE ENTRY.



If your choice is not set, you will see the above display for several seconds, then the screen goes back to CUSTOMIZE SETUP. If this happens, you need to repeat the keyless access light flash setup.

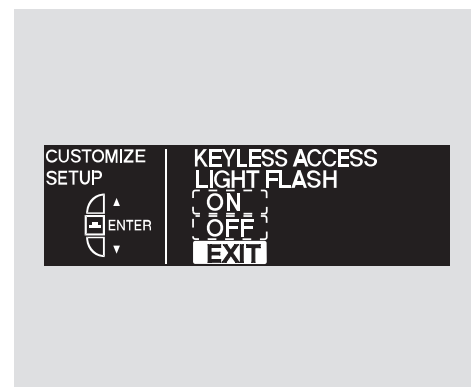

To exit KEYLESS ACCESS LIGHT FLASH without changing the current setting, select EXIT by pressing the INFO (▲/▼) button, then press the SEL/RESET button. The screen goes back to CUSTOMIZE MENU.

### **Keyless Access BEEP**

When KEYLESS ACCESS BEEP is set to ON, the beeper sounds twice when you unlock the doors by grabbing the drivers door handle while carrying the remote.

When you lock the doors by touching the door lock sensor while carrying the remote, the beeper sounds once.

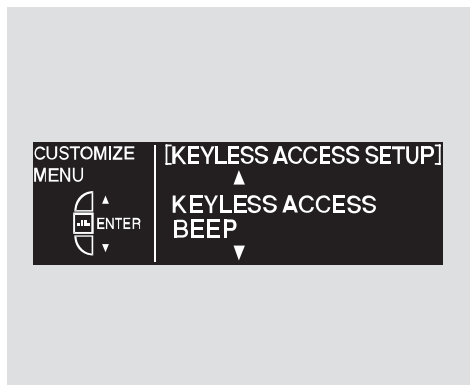

While the multi-information display is in the KEYLESS ACCESS SETUP screen of the CUSTOMIZE GROUP, press the SEL/RESET button. The screen changes to CUSTOMIZE MENU. Press the INFO (▲/▼) button until you see the above display.

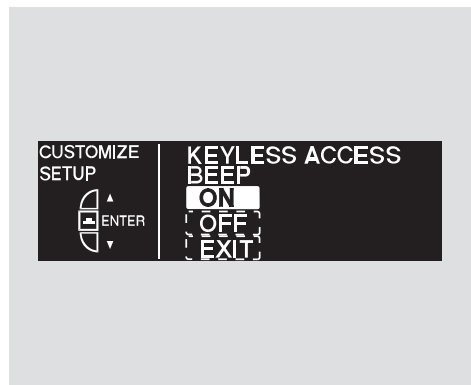

Press the SEL/RESET button. The screen changes as shown above. Select ON or OFF by pressing the INFO (▲/▼) button, then press the SEL/RESET button to enter your selection.

CONTINUED



## Multi-Information Display

---

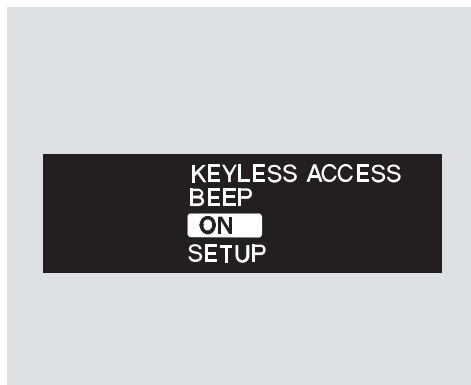

When your choice is set, you will see the above display for several seconds, then the screen goes back to CUSTOMIZE ENTRY.

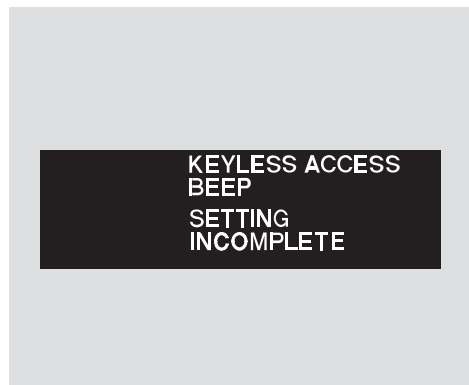

If your choice is not set, you will see the above display for several seconds, then the screen goes back to CUSTOMIZE SETUP. If this happens, you need to repeat the keyless access beep setup.

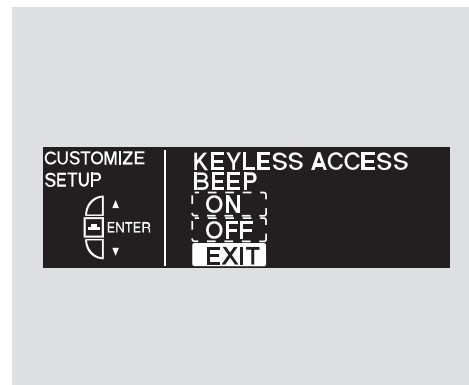

To exit KEYLESS ACCESS BEEP without changing the current setting, select EXIT by pressing the INFO (▲/▼) button, then press the SEL/RESET button. The screen goes back to CUSTOMIZE MENU.

## Lighting Setup

There are three settings in the lighting setup:

- INTERIOR LIGHT DIMMING TIME
- HEADLIGHT AUTO OFF TIMER
- AUTO LIGHT SENSITIVITY

While CUSTOMIZE GROUP is shown on the multi-information display, select LIGHTING SETUP by pressing the INFO (▲/▼) button, then press the SEL/RESET button.

Each time you press the INFO (▲/▼) button, the screen changes as shown in the illustration. Press the INFO (▲/▼) button, until you see the setting you want to customize, then press the SEL/RESET button to enter your selection.

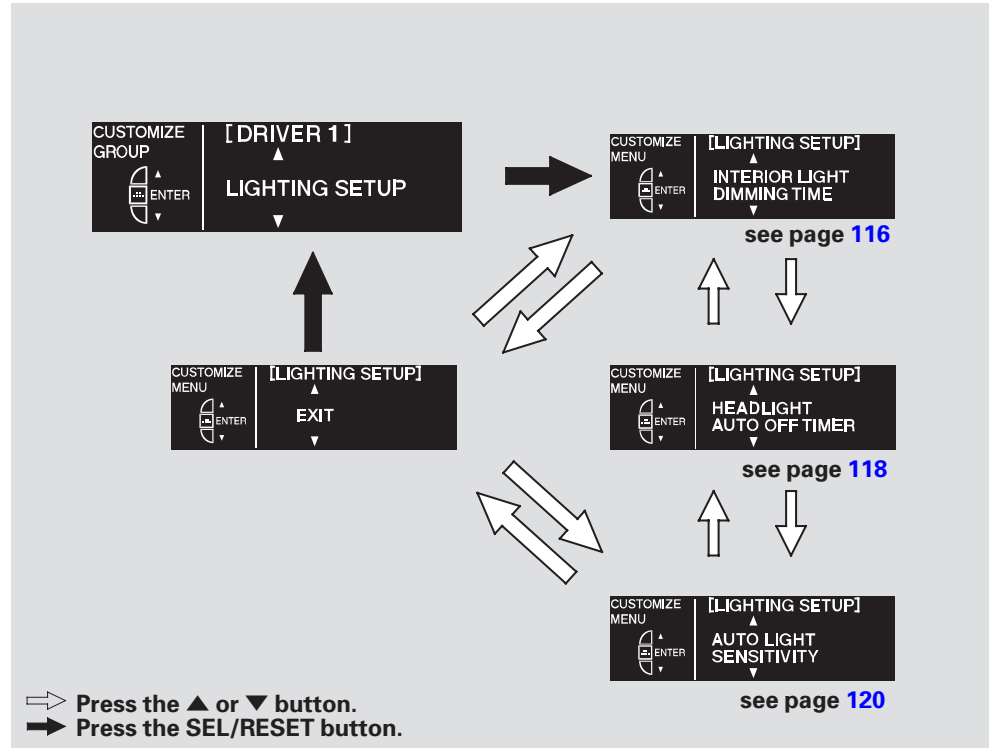

CONTINUED

## Multi-Information Display

### *Interior Light Dimming Time*

The interior lights fade out when you close all doors and the trunk. To change how long the lights stay on before they fade out, follow these instructions:

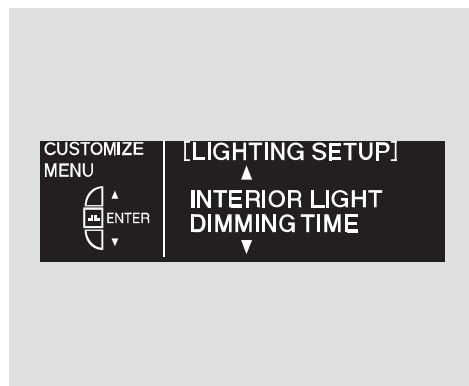

While LIGHTING SETUP is shown in the CUSTOMIZE GROUP of the multi-information display, press the SEL/RESET button. You will see the above display.

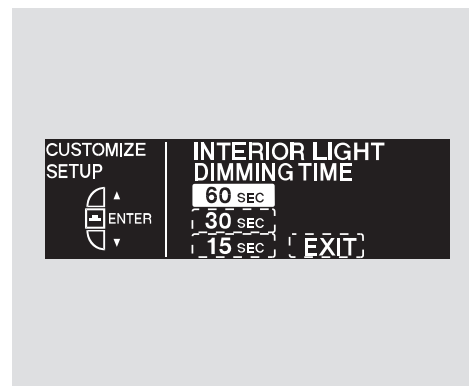

Press the SEL/RESET button. The screen changes as shown above. Select how long you want the lights to stay on before they fade out (60, 30, or 15 seconds) by pressing the INFO (▲/▼) button, then press the SEL/RESET button to enter your selection.



When your choice is set, you will see the above display for several seconds, then the screen goes back to CUSTOMIZE ENTRY.

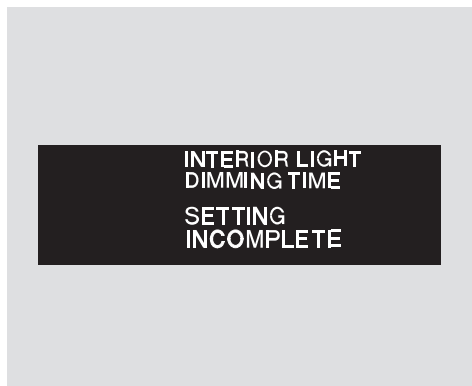

If your choice is not set, you will see the above display for several seconds, then the screen goes back to CUSTOMIZE SETUP. If this happens, you need to repeat the interior light dimming time setup.

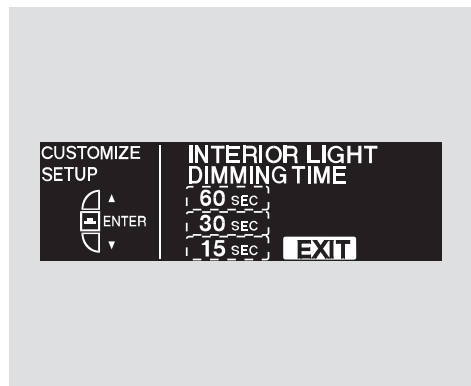

To exit INTERIOR LIGHT DIMMING TIME without changing the current setting, select EXIT by pressing the INFO (▲/▼) button, then press the SEL/RESET button. The screen goes back to CUSTOMIZE MENU.

CONTINUED

## Multi-Information Display

### *Headlight Auto Off Timer*

The headlights, parking lights, side marker lights, taillights, and license plate lights go off after the selected time when you close the driver's door and take the remote with you. To change how long the lights stay on before they go off, follow these instructions:



While the multi-information display is in the LIGHTING SETUP screen of the CUSTOMIZE GROUP, press the SEL/RESET button. The screen changes to CUSTOMIZE MENU. Press the INFO (▲/▼) button until you see the above display.

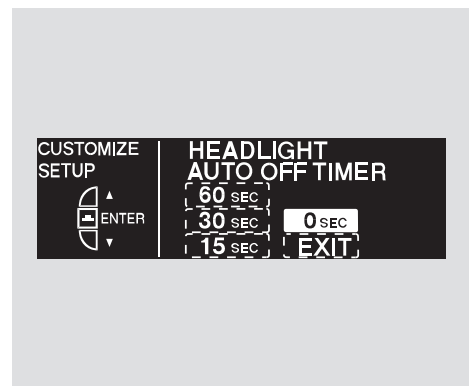

Press the SEL/RESET button. The screen changes as shown above. Select how long you want the lights to stay on before they go off (0, 15, 30, or 60 seconds) by pressing the INFO (▲/▼) button, then press the SEL/RESET button to enter your selection.



When your choice is set, you will see the above display for several seconds, then the screen goes back to CUSTOMIZE ENTRY.



If your choice is not set, you will see the above display for several seconds, then the screen goes back to CUSTOMIZE SETUP. If this happens, you need to repeat the headlight auto off timer setup.

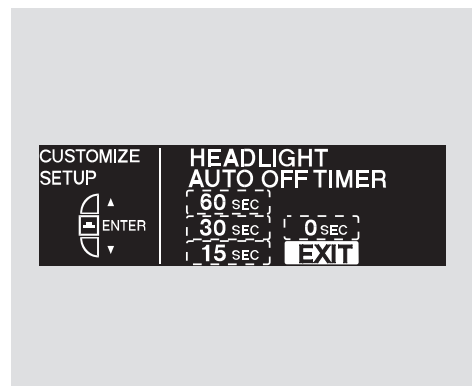

To exit HEADLIGHT AUTO OFF TIMER without changing the current setting, select EXIT by pressing the INFO ( $\blacktriangle/\blacktriangledown$ ) button, then press the SEL/RESET button. The screen goes back to CUSTOMIZE MENU.

*CONTINUED*

## Multi-Information Display

### *Auto Light Sensitivity*

The headlights automatically come on when the headlight switch is in the AUTO position and the ambient light reaches a changeable level. You can select the auto light sensitivity from the following five levels:

#### MAX —

The headlights come on when it is bright.

#### HIGH —

The headlights come on when it is somewhat bright.

#### MID —

The headlights come on when it is as bright as sunset or sunrise.

#### LOW —

The headlights come on when it is somewhat dark.

#### MIN —

The headlights come on when it is dark.



While LIGHTING SETUP is shown in the CUSTOMIZE GROUP of the multi-information display, press the SEL/RESET button. The screen changes to CUSTOMIZE MENU. Press the INFO (▲/▼) button until you see the above display.

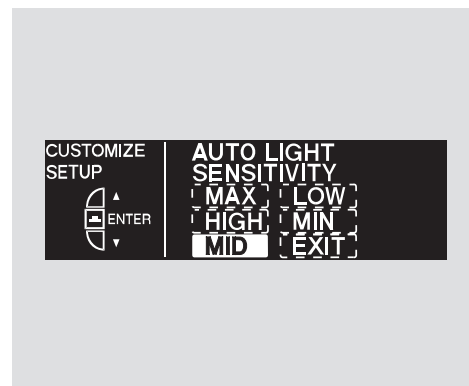

Press the SEL/RESET button. The screen changes as shown above. Select from five levels of sensitivity by pressing the INFO (▲/▼) button, then press the SEL/RESET button to enter your selection.

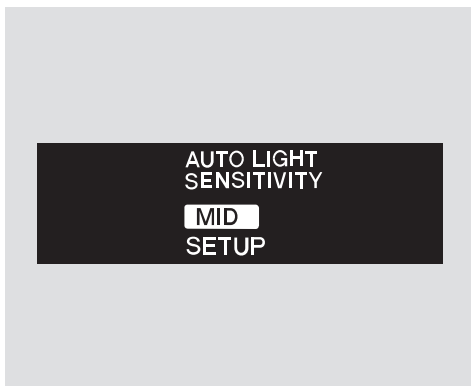

When your choice is set, you will see the above display for several seconds, then the screen goes back to CUSTOMIZE ENTRY.

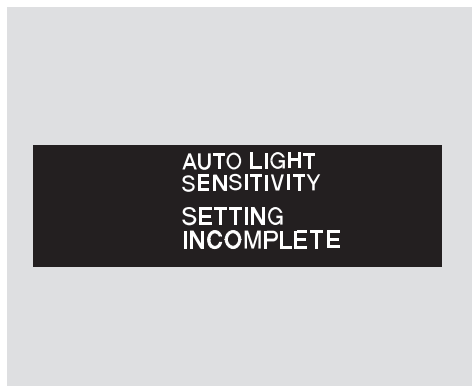

If your choice is not set, you will see the above display for several seconds, then the screen goes back to CUSTOMIZE SETUP. If this happens, you need to repeat the headlight auto light sensitivity setup.

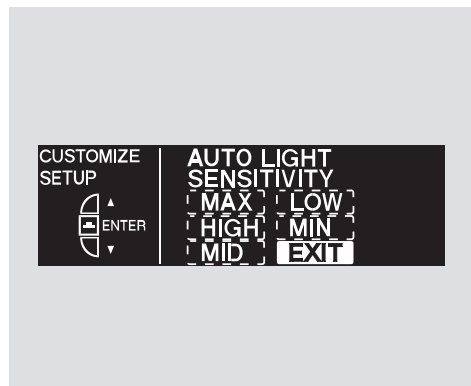

To exit AUTO LIGHT SENSITIVITY without changing the current setting, select EXIT by pressing the INFO (▲/▼) button, then press the SEL/RESET button. The screen goes back to CUSTOMIZE MENU.



# Multi-Information Display

## Door/Window Setup

There are five settings to choose from in the door/window setup:

- AUTO DOOR LOCK
- AUTO DOOR UNLOCK
- DOOR LOCK MODE
- KEYLESS LOCK ACKNOWLEDGMENT
- SECURITY RELOCK TIMER

While CUSTOMIZE GROUP is shown on the multi-information display, select DOOR/WINDOW SETUP by pressing the INFO (▲/▼) button, and then press the SEL/RESET button.

Each time you press the INFO (▲/▼) button, the screen changes as shown in the illustration. Press the INFO (▲/▼) button, until you see the setting you want to customize, then press the SEL/RESET button to enter your selection.

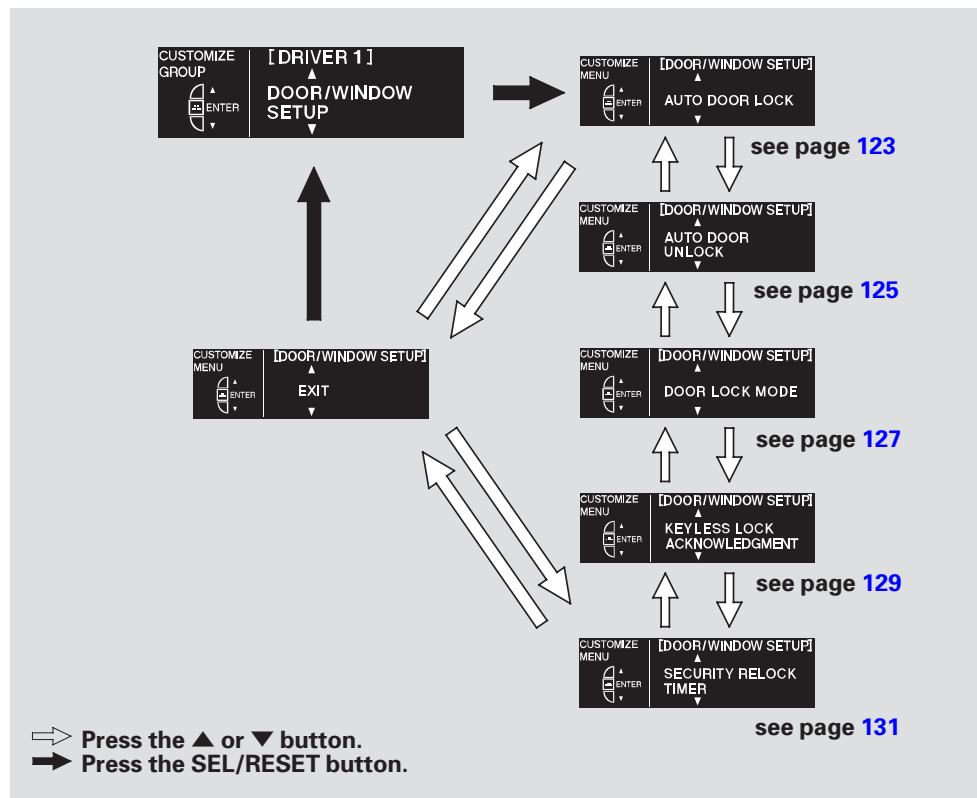

### ***Auto Door Lock***

There are three settings you can choose from:

#### **SHIFT FROM P —**

The doors lock whenever you move the shift lever out of Park.

#### **WITH VEH SPD —**

The doors lock when the vehicle speed reaches about 10 mph (about 15 km/h).

#### **OFF —**

The auto door lock is deactivated all the time.

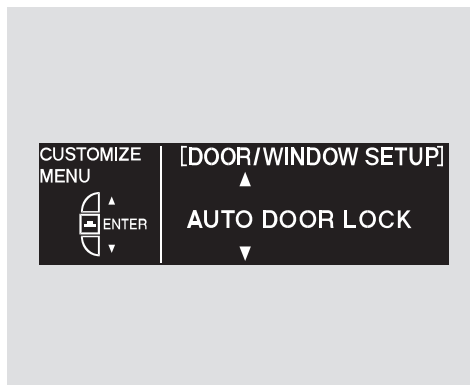

While DOOR/WINDOW SETUP is shown in the CUSTOMIZE GROUP of the multi-information display, press the SEL/RESET button. You will see the above display.

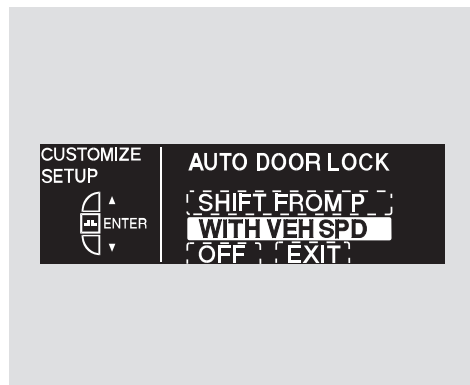

Press the SEL/RESET button. The screen changes as shown above. Select the desired setting by pressing the INFO ( $\blacktriangle/\blacktriangledown$ ) button, then press the SEL/RESET button to enter your selection.

CONTINUED

## Multi-Information Display

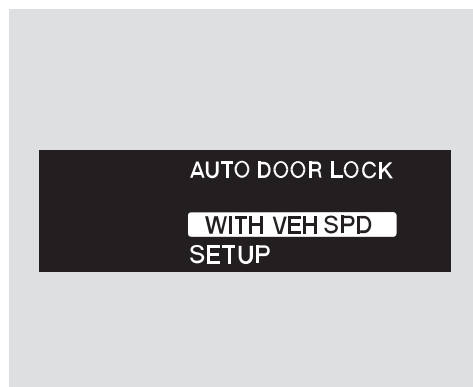

When your choice is set, you will see the above display for several seconds, then the screen goes back to CUSTOMIZE ENTRY.

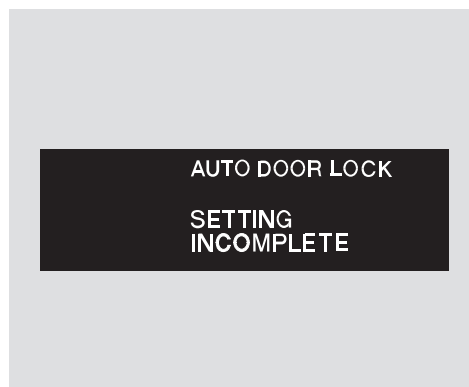

If your choice is not set, you will see the above display for several seconds, then the screen goes back to CUSTOMIZE SETUP. If this happens, you need to repeat the auto door lock setup.

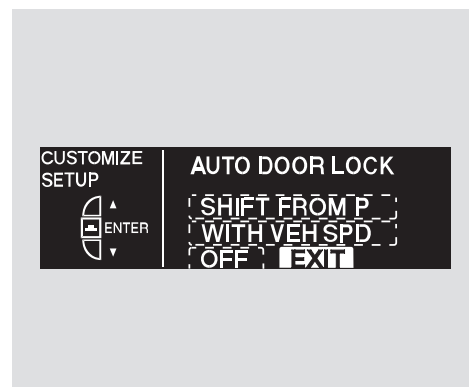

To exit AUTO DOOR LOCK without changing the current setting, select EXIT by pressing the INFO (▲/▼) button, then press the SEL/RESET button. The screen goes back to CUSTOMIZE MENU.

## Auto Door Unlock

There are three settings you can choose from:

**SHIFT TO P** – The driver’s door or all the doors, depending on the door lock mode setting ( see page 127 ), unlock when you move the shift lever to Park.

**IGN OFF** – The driver’s door or all the doors, depending on the door lock mode setting ( see page 127 ), unlock when you turn the ignition switch to the LOCK (0) position.

**OFF** – The auto door unlock is deactivated all the time.



While DOOR/WINDOW SETUP is shown in the CUSTOMIZE GROUP of the multi-information display, press the SEL/RESET button. The screen changes to CUSTOMIZE MENU. Press the INFO (▲/▼) button until you see the above display.

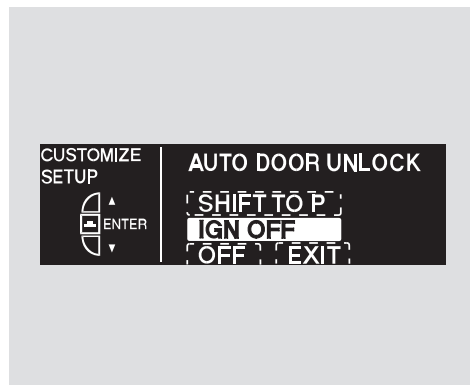

Press the SEL/RESET button. The screen changes as shown above. Select the desired setting by pressing the INFO (▲/▼) button, then press the SEL/RESET button to enter your selection.

CONTINUED

## Multi-Information Display



When your choice is set, you will see the above display for several seconds, then the screen goes back to CUSTOMIZE ENTRY.

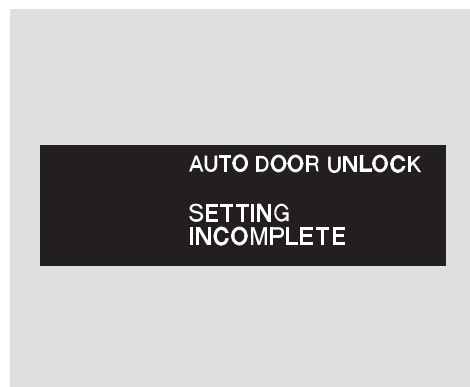

If your choice is not set, you will see the above display for several seconds, then the screen goes back to CUSTOMIZE SETUP. If this happens, you need to repeat the auto door unlock setup.

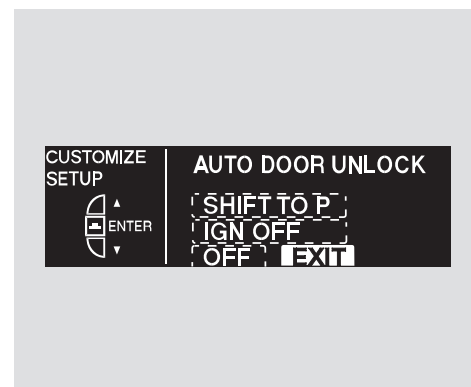

To exit AUTO DOOR UNLOCK without changing the current setting, select EXIT by pressing the INFO (▲/▼) button, then press the SEL/RESET button. The screen goes back to CUSTOMIZE MENU.

### ***Door Lock Mode***

To select whether the driver's door unlocks or all the doors unlock when you unlock the doors with the remote, follow these instructions.

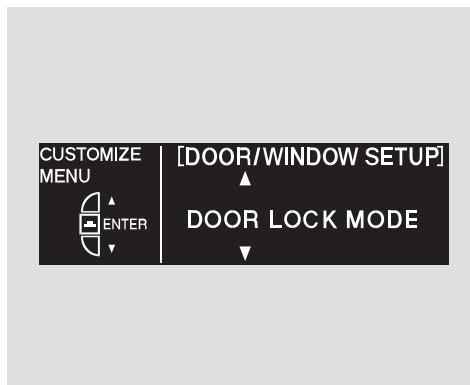

While the multi-information display is in the DOOR/WINDOW SETUP screen of the CUSTOMIZE GROUP, press the SEL/RESET button. The screen changes to CUSTOMIZE MENU. Press the INFO (▲/▼) button until you see above display.

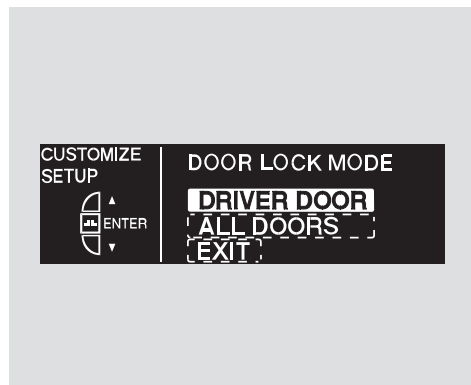

Press the SEL/RESET button. The screen changes as shown above. Select DRIVER DOOR or ALL DOORS by pressing the INFO (▲/▼) button, then press the SEL/RESET button to enter your selection.

*CONTINUED*

## Multi-Information Display

---

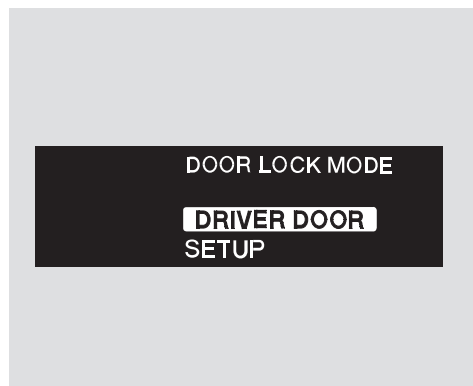

When your choice is set, you will see the above display for several seconds, then the screen goes back to CUSTOMIZE ENTRY.

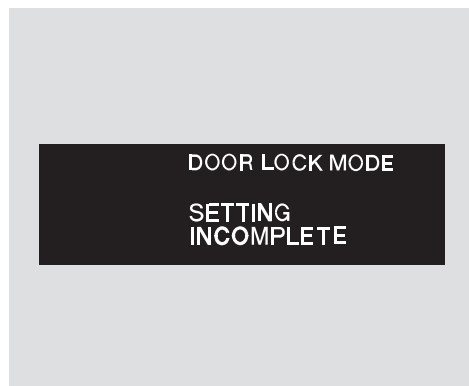

If your choice is not set, you will see the above display for several seconds, then the screen goes back to CUSTOMIZE SETUP. If this happens, you need to repeat the door lock mode setup.



To exit DOOR LOCK MODE without changing the current setting, select EXIT by pressing the INFO (▲/▼) button, and then press the SEL/RESET button. The screen goes back to CUSTOMIZE MENU.

### ***Keyless Lock Acknowledgment***

When you press the LOCK button on the remote to lock the doors and the trunk, and then press the button again within 5 seconds, a beeper sounds once and the exterior lights blink once to verify that the doors are locked and the security system is set.

When you press the UNLOCK button on the remote to unlock the doors, the exterior lights blink twice to verify that the doors are unlocked and the security system is turned off.

To turn this feature on or off, follow these instructions.



While the multi-information display is in the DOOR/WINDOW SETUP screen of the CUSTOMIZE GROUP, press the SEL/RESET button. The screen changes to CUSTOMIZE MENU. Press the INFO (▲/▼) button until you see the above display.

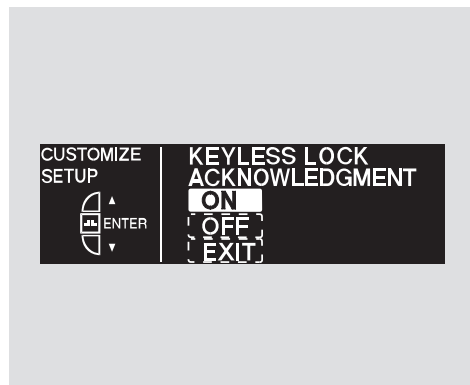

Press the SEL/RESET button. The screen changes as shown above. Select ON or OFF by pressing the INFO (▲/▼) button, then press the SEL/RESET button to enter your selection.

*CONTINUED*



## Multi-Information Display

---



When your choice is set, you will see the above display for several seconds, then the screen goes back to CUSTOMIZE ENTRY.

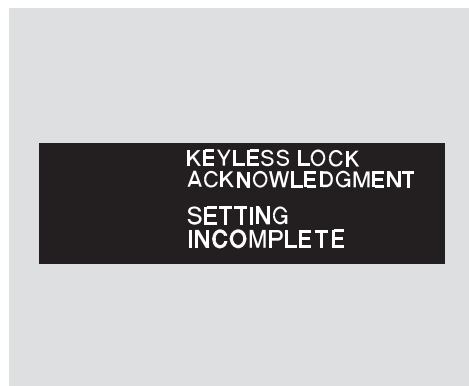

If your choice is not set, you will see the above display for several seconds, then the screen goes back to CUSTOMIZE SETUP. If this happens, you need to repeat the keyless lock acknowledgment setup.

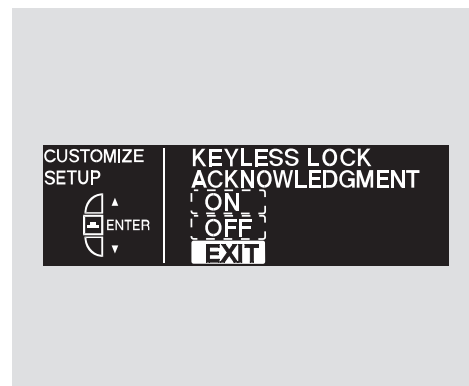

To exit KEYLESS LOCK ACKNOWLEDGMENT without changing the current setting, select EXIT by pressing the INFO (▲/▼) button, then press the SEL/RESET button. The screen goes back to CUSTOMIZE MENU.

### ***Security Relock Timer***

When you unlock the doors by pressing the UNLOCK button on the remote or by grabbing the driver's door handle while carrying the remote, but do not open any door the doors relock and the security system sets within 30 seconds. To change the relock time, follow these instructions:



While the multi-information display is in the DOOR/WINDOW SETUP screen of the CUSTOMIZE GROUP, press the SEL/RESET button. The screen changes to CUSTOMIZE MENU. Press the INFO (▲/▼) button until you see the above display.

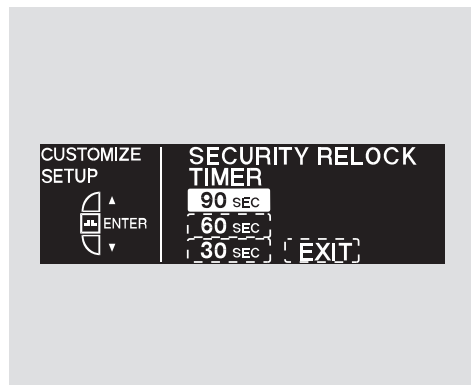

Press the SEL/RESET button. The screen changes as shown above. Select the relock time you want (90, 60, or 30 seconds) by pressing the INFO (▲/▼) button, then press the SEL/RESET button to enter your selection.

*CONTINUED*

## Multi-Information Display

---



When your choice is set, you will see the above display for several seconds, then the screen goes back to CUSTOMIZE ENTRY.

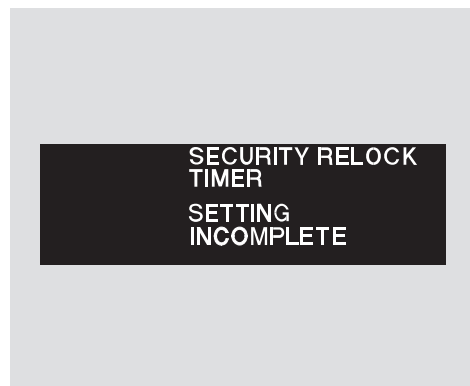

If your choice is not set, you will see the above display for several seconds, then the screen goes back to CUSTOMIZE SETUP. If this happens, you need to repeat the security relock timer setup.

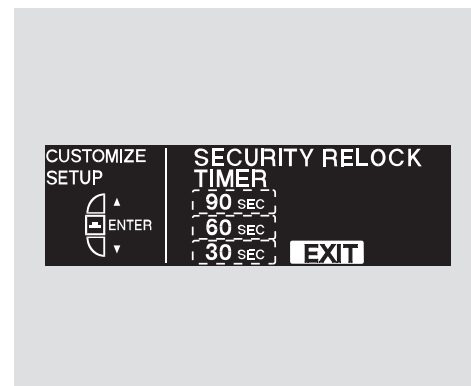

To exit SECURITY RELOCK TIMER without changing the current setting, select EXIT by pressing the INFO ( $\blacktriangle/\blacktriangledown$ ) button, then press the SEL/RESET button. The screen goes back to CUSTOMIZE MENU.

## Wiper Setup

The changeable setting under WIPER SETUP is called WIPER ACTION. To get into WIPER ACTION, do this:

While the multi-information display is in the CUSTOMIZE GROUP screen, select WIPER SETUP by pressing the INFO (▲/▼) button, then press the SEL/RESET button.

Each time you press the INFO (▲/▼) button, the screen changes as shown in the illustration. Press the INFO (▲/▼) button until you see WIPER ACTION, then press the SEL/RESET button to enter your selection.

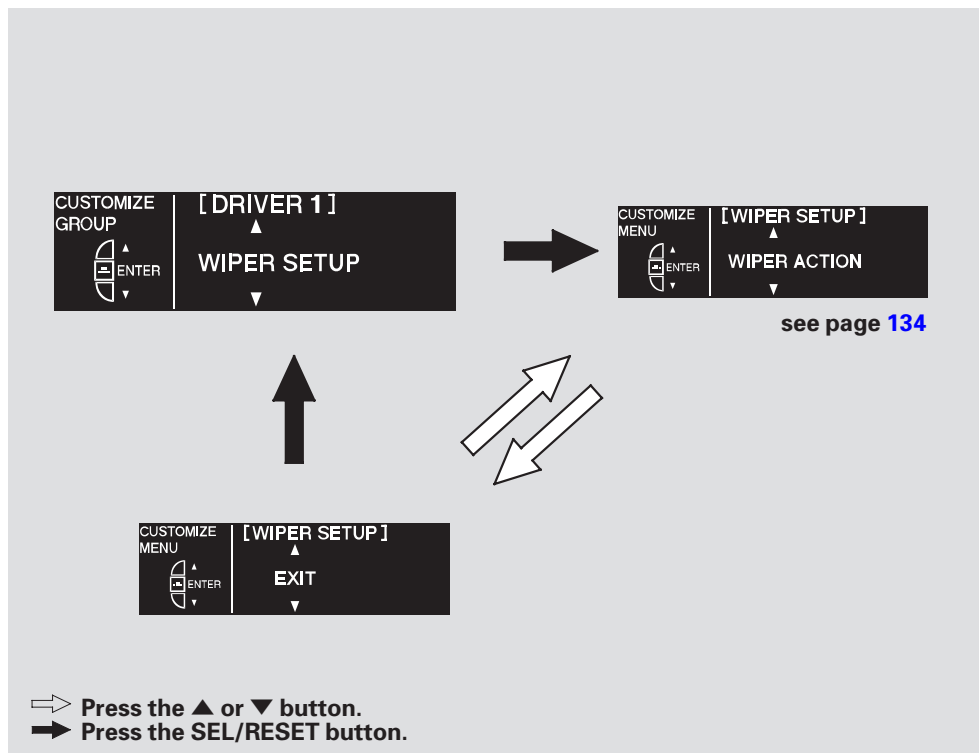

CONTINUED

## Multi-Information Display

### ***Wiper Action***

You can select from these two settings when the wiper switch is in the INT (intermittent) position:

**INTERMITTENT** – The intermittent operation varies according to the selection you make on the wiper lever's intermittent control ring.

**WITH VEH SPD** – The intermittent operation varies according to vehicle speed.



While the multi-information display is in the WIPER SETUP screen of the CUSTOMIZE GROUP, press the SEL/RESET button. The screen changes to the above display.

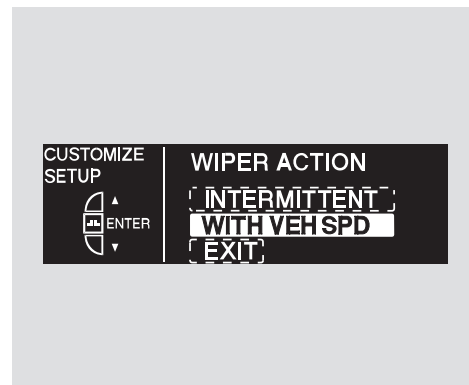

Press the SEL/RESET button. The screen changes as shown above. Select INTERMITTENT or WITH VEH SPD by pressing the INFO (▲/▼) button, then press the SEL/RESET button to enter your selection.



When your choice is set, you will see the above display for several seconds, then the screen goes back to CUSTOMIZE ENTRY.

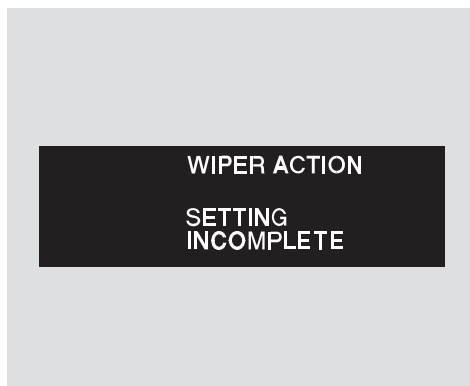

If your choice is not set, you will see the above display for several seconds, then the screen goes back to CUSTOMIZE SETUP. If this happens, you need to repeat the wiper action setup.

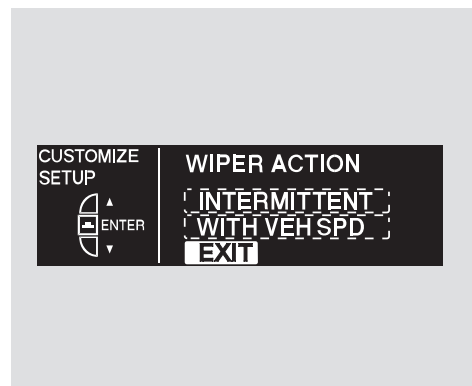

To exit WIPER ACTION without changing the current setting, select EXIT by pressing the INFO (▲/▼) button, then press the SEL/RESET button. The screen goes back to CUSTOMIZE MENU.

# Controls Near the Steering Wheel

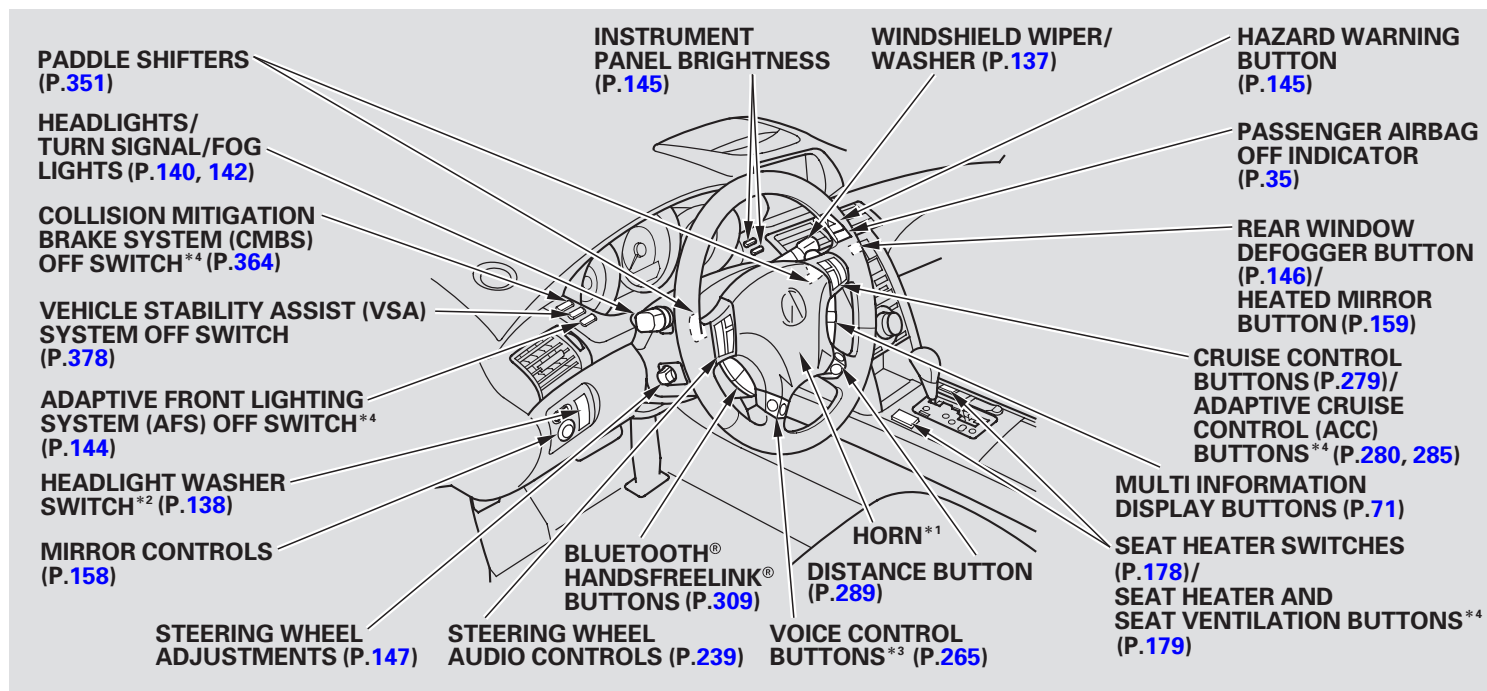

\* 1 : To use the horn, press the center pad of the steering wheel.

\* 2 : Canadian models only

\* 3 : On models with navigation system, refer to the navigation system manual.

\* 4 : If equipped.

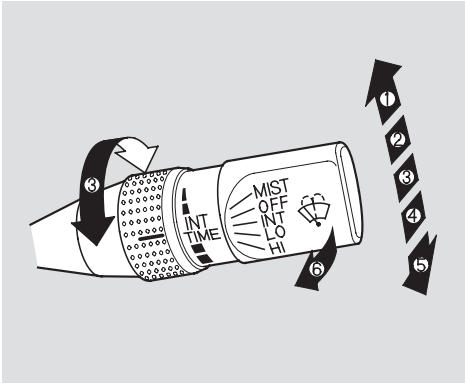

1. MIST
2. OFF
3. INT – Intermittent
4. LO – Low speed
5. HI – High speed
6. Windshield washers

Push the right lever up or down to select a position.

**MIST** – The wipers run at high speed until you release the lever.

**OFF** – The wipers are not activated.

**INT** – The length of the wipe interval is varied automatically according to vehicle speed.

To change the “WIPER ACTION” setting, see page [134](#).

If you turn it to the shortest delay, the wipers change to low speed operation when the vehicle speed exceeds 12 mph (20 km/h).

**LO** – The wipers run at low speed.

**HI** – The wipers run at high speed.

*CONTINUED*



## Windshield Wipers and Washers

---

**Windshield Washer** — Pull back and hold the wiper control lever. The washers spray until you release the lever. The wipers run at low speed, then complete one more sweep after you release the lever.

When you activate the windshield washer with the headlight turned on, the headlight washer will be activated under certain conditions. For more information, see **Headlight Washers** section in the next column.

### Headlight Washers Canadian models only

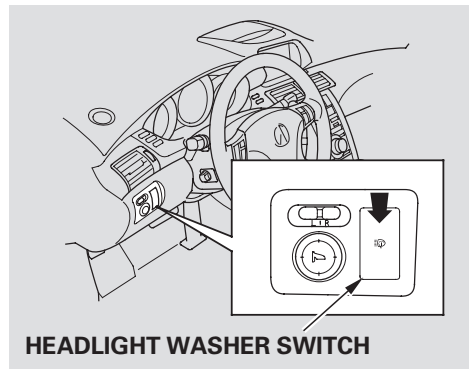

The headlight washers can be operated at any time by pressing the headlight washer button located next to the steering wheel column. The headlights must be turned on to use this button. In addition, the headlight washer operates without pressing the button, at the first time you turn on the windshield washers after you turn the ignition switch to the ON (II) position.

The headlight washers use the same fluid reservoir as the windshield washers.

## ***Wiper Arm Positions***

The windshield wiper arms have two parked positions: winter and summer. In the winter position, the arms sit slightly above the edge of the hood. This reduces the possibility of damage to the wiper arms or windshield wiper motor by a build-up of snow and ice.

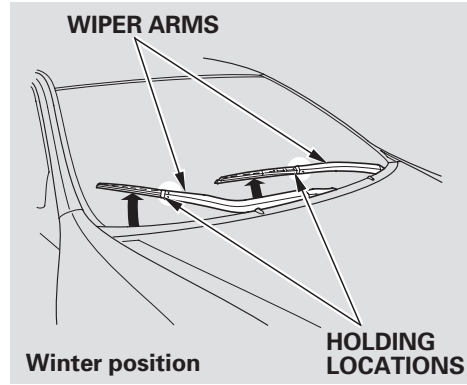

Adjust the wiper arms to the winter position by holding both arms as shown in the illustration at the same time. Pull on the arm, parallel to the windshield, until it locks in the higher position.

A heavy build-up of snow or ice on the wiper arms will cause them to automatically park in the winter position.

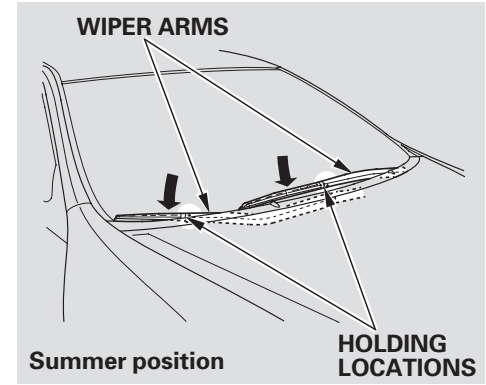

To return to the summer position, push the same area of both arms the other direction.

# Turn Signals and Headlights

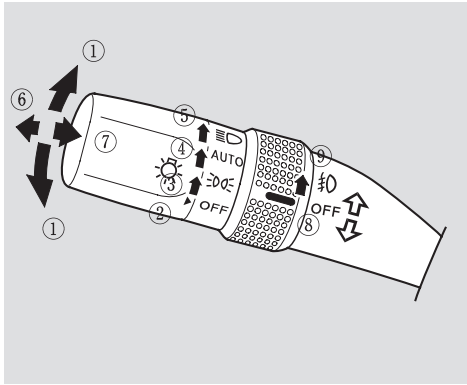



1. Turn signal
2. Off
3. Parking and indicator lights
4. AUTO
5. Headlights on
6. High beams
7. Flash high beams
8. Fog lights off
9. Fog lights on

**Turn Signal** – Push down on the lever to signal a left turn and up to signal a right turn. To signal a lane change, push lightly on the lever, and hold it. The lever will return to center when you release it or complete a turn.

**Headlights** – The rotating switch on the left lever controls the lights. Turning this switch to the “ ” position turns on the parking lights, taillights, instrument panel lights, side-marker lights, and rear license plate lights.

Turning the switch to the “ ” position turns on the headlights. If you leave the lights on with the ignition switch released after turned to the LOCK (0) position or when the built-in key is removed from the ignition switch, you will hear a reminder chime when you open the driver’s door.

When the light switch is in the “ ” or “ ” position, the lights on indicator comes on as a reminder. This indicator stays on if you leave the light switch on and turn the ignition switch to the ACCESSORY (I) or the LOCK (0) position.

**High Beams** – To switch from low beams to high beams, push the left lever forward until you hear a click. The blue high beam indicator will come on (see page 65 ). Pull it back to return to low beams. To flash the high beams, pull the lever back lightly, then release it. The high beams stay on as long as you hold the lever back.

**AUTO** – The automatic lighting feature turns on the headlights, all other exterior lights, and the instrument panel lights when it senses low ambient light.

To turn on automatic lighting, turn the light switch to **AUTO** at any time. The lights will come on automatically when the outside light level becomes low (at dusk, for example). The lights on indicator comes on as a reminder. The lights and indicator will turn off automatically when the system senses high ambient light.

The lights will remain on when you turn off the ignition switch. They will turn off automatically when you open and close the driver’s door. To turn them on again, either turn the ignition switch to the **ON (II)** position or turn the light switch to  .

Even with the automatic lighting feature turned on, we recommend that you turn on the lights manually when driving at night or in a dense fog, or when you enter dark areas such as long tunnels or parking facilities.

To change the “**AUTO LIGHT SENSITIVITY**” setting, see page [120](#) .

Do not leave the light switch in **AUTO** if you will not be driving the vehicle for an extended period (a week or more). You should also turn off the lights if you plan to leave the engine idling or off for a long time.

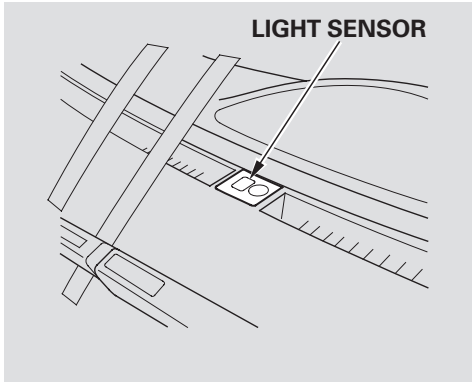

The automatic lighting feature is controlled by a sensor located on top of the dashboard. Do not cover this sensor or spill liquids on it.

# Turn Signals and Headlights

---

## Fog Lights

Turn the fog lights on and off by turning the switch next to the headlight switch.

You can use the fog lights only when the headlights are on low beam.

With the light switch in the AUTO position, you can also use the fog lights when the headlights turn on automatically. They will go off when the headlights turn off.

## Daytime Running Lights

With the headlight switch off, the high beam headlights come on with reduced brightness when you turn the ignition switch to the ON (II) position and release the parking brake. They remain on until you turn the ignition switch off, even if you set the parking brake.

The headlights revert to normal operation when you turn them on with the switch.



If you see a “CHECK DRL SYSTEM” message on the multi-information display, there is a problem with the daytime running light system. Take your vehicle to a dealer to have it checked.

When the multi-information display shows a “DRL OFF” message, the daytime running lights are off. Follow the procedure in the left column to turn them on.

## Automatic Lighting Off Feature

This feature turns off the headlights, all other exterior lights, and the instrument panel lights within 15 seconds after you turn the ignition switch to the LOCK (0) position and close the driver’s door.

To change the “HEADLIGHT AUTO OFF TIMER” setting, see page [118](#).

The automatic lighting off feature activates if you leave the headlight switch in the “ ” or “ ” position or if the lights are turned on by setting the switch in the “AUTO” position, turn the ignition switch to the LOCK (0) position, then open and close the driver’s door.

If you turn the ignition switch to the LOCK (0) position with the headlight switch on, but do not open the door and get out, the lights turn off after 10 minutes (3 minutes, if the switch is in the “AUTO” position).

The lights turn on again when you unlock or open the driver’s door. If you unlock the door, but do not open it within 15 seconds, the lights go off. With the driver’s door open, you will hear a lights-on reminder chime.

# Adaptive Front Lighting System (AFS)

## *If equipped*

The adaptive front lighting system (AFS) helps to improve visibility during nighttime driving. The AFS controls the aiming direction and lighting distribution of the low beams according to the amount of turn applied to the steering wheel during cornering or turning. Press the AFS OFF switch to turn the AFS on and off when the ignition switch is in the ON (II) position and the headlights are turned on.

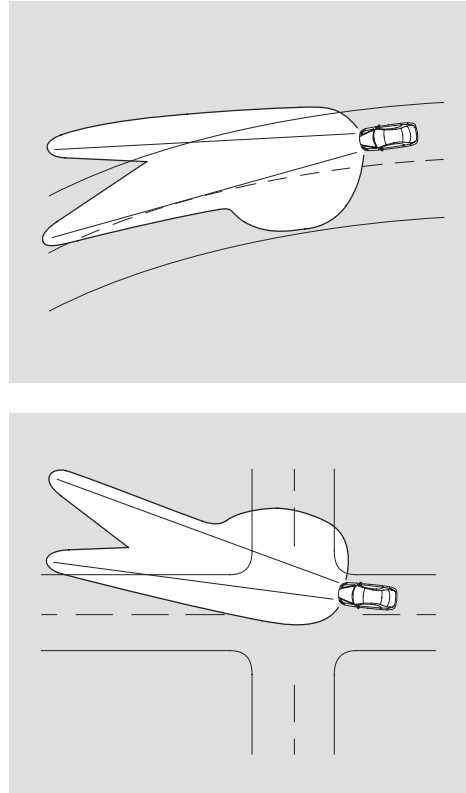

AFS

## AFS Indicator

If the AFS indicator comes on and starts blinking while driving, pull to the side of the road when it is safe, and turn off the engine. If the AFS indicator keeps blinking, or starts blinking again while driving after turning the ignition switch to the ON (II) position, the AFS is not working properly (see page 69). Have the AFS inspected by your dealer. Without AFS, your vehicle still has normal lighting ability to continue driving.

When the AFS indicator comes on, you will also see a “CHECK ADAPTIVE FRONT LIGHTING SYSTEM” message on the multi-information display (see page 78).

# Adaptive Front Lighting System (AFS)

---

## AFS Off Switch

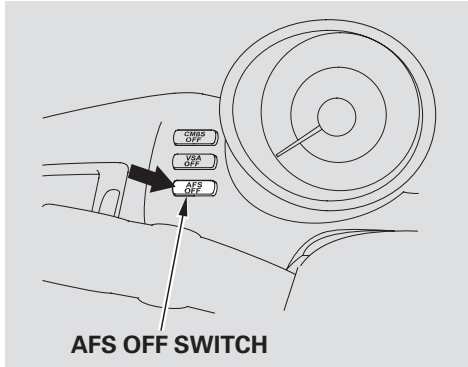

This switch is at the right side of the left vent. Press it to turn the AFS on and off. When AFS is off, the AFS indicator comes on as a reminder when you turn on the headlights.

When you turn the ignition switch to the ON (II) position, the AFS is turned on if it was on previously.

Here are some operating characteristics of the AFS:

- The system requires an initialization period. It does not begin to operate until you have driven the vehicle a short distance.
- At a stop, the right headlight turns right when you turn the steering wheel to the right. But the left headlight does not turn left when you turn the steering wheel to the left. This prevents the left headlight from pointing at oncoming traffic.
- AFS is turned off when the shift lever is in the R position.

## Automatic Headlight Adjusting System

The AFS works with the automatic headlight adjusting system to sense changes in vehicle height due to driving and loading conditions of passengers and luggage, and adjusts the vertical aim of the low beam headlights automatically to compensate for load.

If the headlights do not seem to be properly aimed, have the automatic headlight adjusting system inspected by your dealer.

# Hazard Warning Button, Instrument Panel Brightness

## Hazard Warning Button

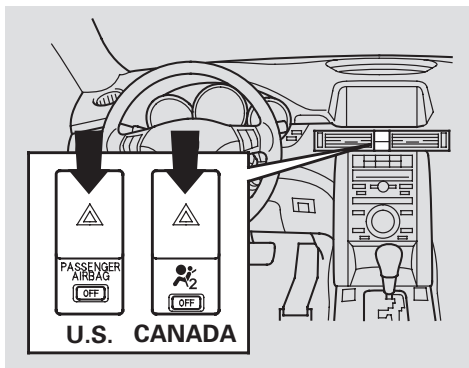

Push the button between the center vents to turn on the hazard warning lights (four-way flashers). This causes all four outside turn signals and both indicators in the instrument panel to flash. Use the hazard warning lights if you need to park in a dangerous area near heavy traffic, or if your vehicle is disabled.

## Instrument Panel Brightness

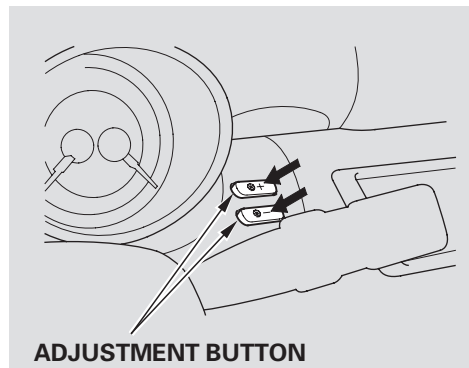

Adjust the brightness of the instrument panel by pressing the + or - button. Press the + button to increase the brightness and the - button to decrease it. You can adjust the brightness with the headlight switch on or off.

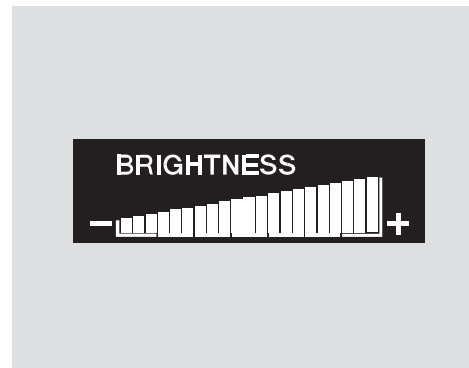

The level of brightness is shown on the multi-information display while you adjust it. It goes out 5 seconds after you finish adjusting.

*CONTINUED*



## Instrument Panel Brightness, Rear Window Defogger

---

To reduce glare at night, the instrument panel illumination dims when you turn the light switch to ☾☽ or ☾. To cancel the glare reduction function, set the brightness to the highest level, then press the + button. You will hear a beep when it is canceled.

### Rear Window Defogger

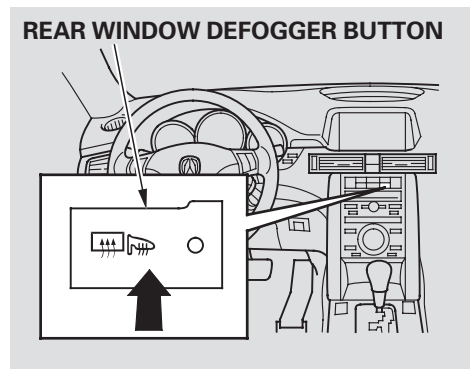

The rear window defogger clears fog, frost, and thin ice from the window. Push the defogger button to turn it on and off. Pushing this button also turns the mirror heaters on and off. The indicator in the button comes on to show the defogger is on. If you do not turn it off, the defogger will shut itself off after 5 to 40 minutes (depending on the ambient temperature). It also shuts off when you turn off the ignition switch. You

have to turn it on again when you restart the vehicle.

Make sure the rear window is clear and you have good visibility before starting to drive.

The defogger and antenna wires on the inside of the rear window can be accidentally damaged. When cleaning the glass, always wipe side to side.

Make any steering wheel adjustment before you start driving.

### **⚠ WARNING**

Adjusting the steering wheel position while driving may cause you to lose control of the vehicle and be seriously injured in a crash.

Adjust the steering wheel only when the vehicle is stopped.

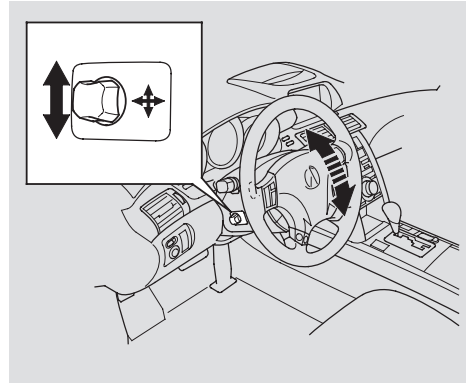

Move the steering wheel in, out, up, or down by pushing and holding the adjustment switch in that direction.

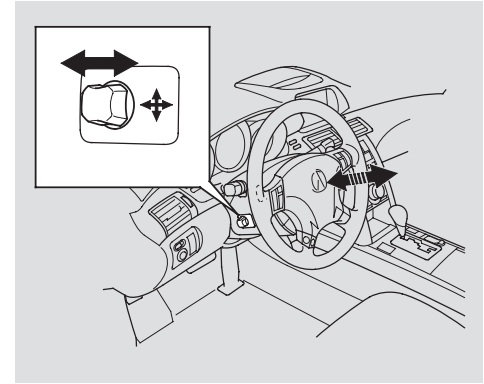

Release the switch when the steering wheel reaches the desired position. Make sure the steering wheel points towards your chest, not toward your face, and that you can see the instrument panel gauges and indicators.

*CONTINUED*

## Steering Wheel Adjustments

---

When you turn the ignition switch to the LOCK (0) position and release it, or remove the built-in key from the ignition switch, the steering wheel automatically moves fully in and up.

The steering wheel returns to its original position when you push the ignition switch or insert the built-in key back in the ignition switch.

Steering wheel movement is also controlled by the driving position memory system (see page [160](#)).

To change the “AUTO TILT & TELESCOPIC” setting, see page [106](#).

If your vehicle’s battery is disconnected or goes dead, or the fuse for the power tilt and telescopic steering wheel is removed, the power tilt and telescopic steering wheel system needs to be reset when you reconnect the battery or install the fuse.

Push the ignition switch for more than 1 second and release it, or insert the built-in key into the ignition switch, and remove it. The steering wheel automatically moves fully in and up to let you know the system is reset.

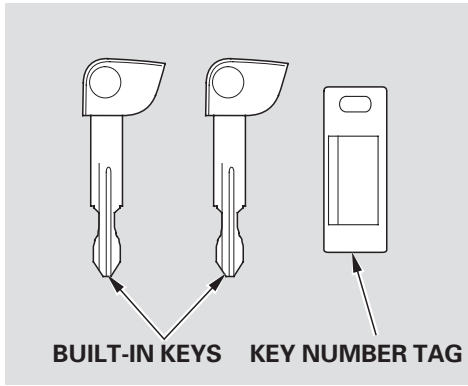

The built-in key (see page 177 ) fits all the locks on your vehicle.

You should have received a key number tag with your keys. You will need this key number if you ever have to get a lost key replaced. Use only Acura-approved key blanks.

These keys contain electronic circuits that are activated by the immobilizer system. They will not work to start the engine if the circuits are damaged.

- Protect the keys from direct sunlight, high temperature, and high humidity.
- Do not drop the keys or set heavy objects on them.
- Keep the keys away from liquids. If they get wet, dry them immediately with a soft cloth.

The keys do not contain batteries. Do not try to take them apart.

## Immobilizer System

---

The immobilizer system protects your vehicle from theft. If an improperly-coded key (or other device) is used, the engine will not start.

When you turn the ignition switch to the ON (II) position, the immobilizer system indicator should come on for a few seconds, then go out. If the indicator starts to blink, it means the system does not recognize the coding of the remote or built-in key. Turn the ignition switch to the LOCK (0) position, release the ignition switch and push it, or remove the built-in key, and reinsert it. Then turn the switch to the ON (II) position again.

The system may not recognize your key's coding if another immobilizer key or other metal object (i.e. key fob) is near the ignition switch when you turn the ignition switch to the ON (II) position.

If the system repeatedly does not recognize the coding of your remote or built-in key, contact your dealer.

Do not attempt to alter this system or add other devices to it. Electrical problems could result that may make your vehicle undrivable.

If you have lost your remote or built-in key and cannot start the engine, contact your dealer.

### **NOTICE**

*Always take the ignition key with you whenever you leave the vehicle alone.*

*As required by the FCC:*

*This device complies with Part 15 of the FCC rules. Operation is subject to the following two conditions: (1) This device may not cause harmful interference, and (2) this device must accept any interference received, including interference that may cause undesired operation.*

*Changes or modifications not expressly approved by the party responsible for compliance could void the user's authority to operate the equipment.*

*This device complies with Industry Canada Standard RSS-210.*

*Operation is subject to the following two conditions: (1) this device may not cause interference, and (2) this device must accept any interference that may cause undesired operation of the device.*

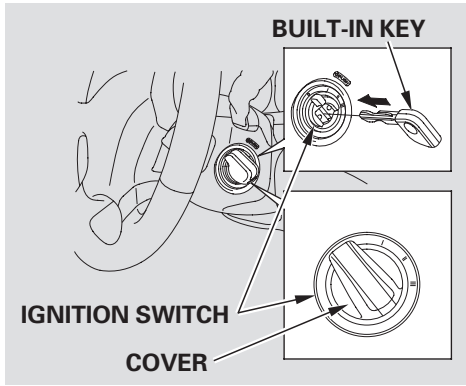

The ignition switch has four positions: LOCK (0), ACCESSORY (I), ON (II), and START (III).

To use the built-in key, you have to remove the cover (see page [177](#)).

**LOCK (0)** – You can insert or remove the built-in key only in this position. To turn the ignition switch to the LOCK (0) position, the shift lever must be in Park, and you must push the knob or built-in key in

slightly.

If the front wheels are turned, the anti-theft lock may make it difficult to turn the ignition switch. Firmly turn the steering wheel to the left or right as you turn the ignition switch.

**ACCESSORY (I)** – You can operate the audio system and the accessory power sockets in this position.

When you turn the ignition switch to the ACCESSORY (I) position, an “ACCESSORY (I) POSITION” message is shown on the multi-information display.

**ON (II)** – This is the normal ignition switch position when driving. Several of the indicators on the instrument panel come on as a test when you turn the ignition switch from the ACCESSORY (I) to the ON (II) position.

**START (III)** – Use this position only to start the engine. The switch returns to the ON (II) position when you let go of the ignition switch.

If you open the driver’s door and leave the key in the ignition switch, you will hear a reminder beeper, and a message appears on the multi-information display according to the ignition switch position. When the ignition switch is in the ACC (I) position, a “RETURN IGNITION SWITCH TO LOCK (0) POSITION” message is shown on the multi-information display. When the ignition switch is in the LOCK (0) position, a “REMOVE KEY” message is shown on the multi-information display.

The shift lever must be in Park before you turn the ignition switch knob to the LOCK (0) position or remove the built-in key from the ignition switch.

## Door Locks

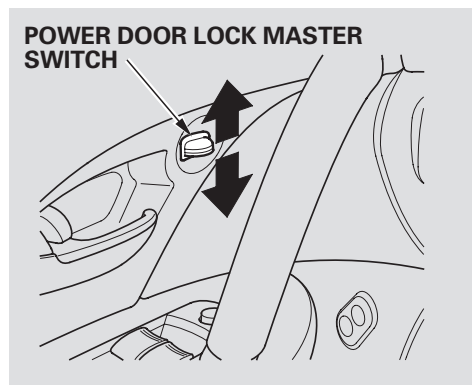

Each front door has a power door lock master switch. Either switch locks and unlocks all doors. Push the switch down to lock all doors and up to unlock them.

Each door has a lock tab above the inside door handle. Pull the tab to lock the door and push it to unlock. When you pull the tab on the driver's door, all the doors lock.

To lock any door when getting out of the vehicle, pull the lock tab and close the door.

All doors can be locked from the outside by using the built-in key in the driver's door. To unlock only the driver's door, insert the built-in key, turn it clockwise, and release it. The remaining doors unlock when you turn the built-in key a second time within a few seconds.

To change the "DOOR UNLOCK MODE" setting, see page [109](#).

When the vehicle speed reaches about 10 mph (about 15 km/h) or more, all the doors lock automatically.

To change the "AUTO DOOR LOCK" setting, see page [123](#).

When you shift to P after driving, the driver's door unlocks.

To change the "AUTO DOOR UNLOCK" setting, see page [125](#).

### ***Lockout Prevention***

With the driver's door open and the built-in key in the ignition, both master door lock switches are disabled. They are not disabled if the driver's door is closed. Pushing the switch down on the open front passenger's door will lock all doors. If you try to lock an open driver's door by pulling the lock tab rearward with the remote inside the vehicle and closing the driver's door, the driver's door will unlock.

## TRUNK RELEASE BUTTON

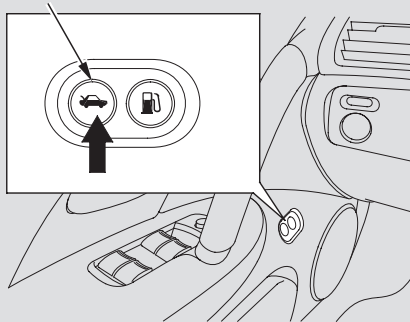

You can open the trunk in any of four ways:

- Press the trunk release button on the driver's door.
- Press and hold the trunk release button on the remote.
- If the doors are unlocked, press the trunk release switch on the trunk lid.

- If the doors are locked, press the trunk release switch on the trunk lid with the remote in keyless access operating range.

To close the trunk, press down on the trunk lid.

## TRUNK RELEASE HANDLE



If your vehicle's battery goes dead or is disconnected, you can open the trunk from the rear seat by pulling the trunk release handle. Reach the handle through the trunk pass-through.

Keep the trunk lid closed at all times while driving to avoid damaging the lid, and to prevent exhaust gas from getting into the interior. See **Carbon Monoxide Hazard** on page 56.

*CONTINUED*



# Trunk, Childproof Door Locks

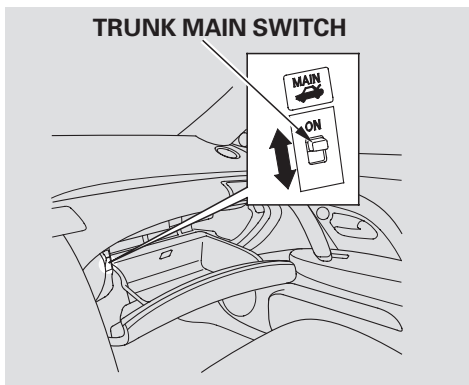

To protect items in the trunk, you can disable the trunk-release button on the driver's door, the trunk lid, and the remote. To do this, turn off the trunk main switch in the glove box, lock the glove box, and lock the trunk pass-through cover with the built-in key.

## Emergency Trunk Opener

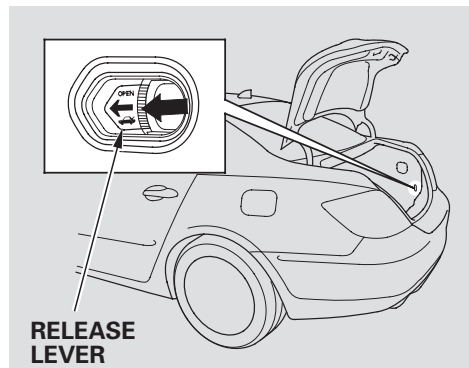

As a safety feature, your vehicle has a release lever on the right corner in the trunk so the trunk can be opened from the inside. To open the trunk, push the release lever to the left.

Parents should decide if their children should be shown how to use this feature.

For more information about child safety, see page [42](#).

## Childproof Door Locks

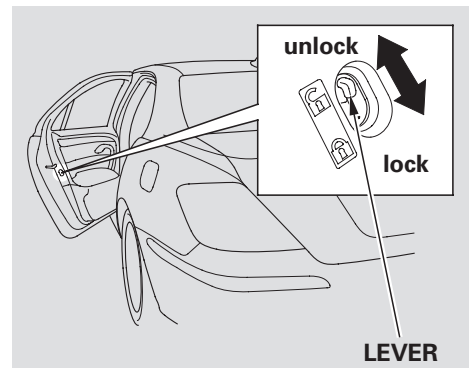

The childproof door locks are designed to prevent children seated in the rear from accidentally opening the rear doors. Each rear door has a lock lever near the edge. With the lever in the LOCK position, the door cannot be opened from the inside regardless of the position of the lock tab. To open the door, push the lock tab in, and use the outside door handle.

**Front Seat Power Adjustments**

See pages 14 – 17 for important safety information and warnings about how to properly position the seats and seat-backs.

The controls for the power adjustable front seats are on the outside edge of each seat bottom. You can adjust the seats with the ignition switch in any position. Make all seat adjustments before you start driving.

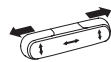
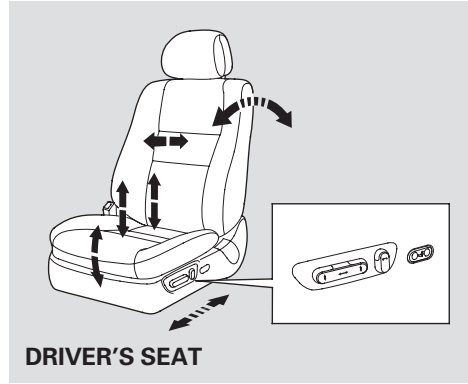

Moves the seat forward and backward.

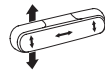

Moves the front of the seat up or down. (Driver's seat only)

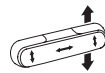

Raises or lowers the seat. (Driver's seat only)

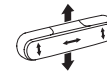
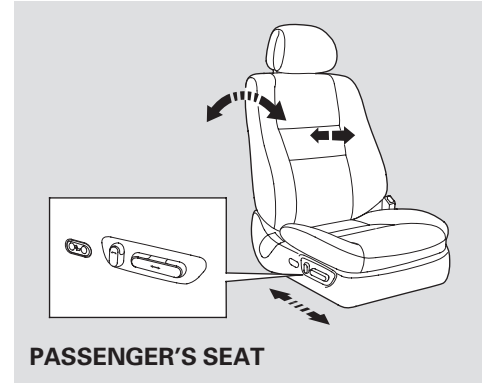

Moves the whole seat up and forward, or down and backward. The front of the seat also tilts up or down at the same time. (Driver's seat only)



Adjusts the seat-back angle forward or backward.



Increases or decreases the lumbar support.

# Seats

## Head Restraints

See page 16 for important safety information and a warning about improperly positioning head restraints.

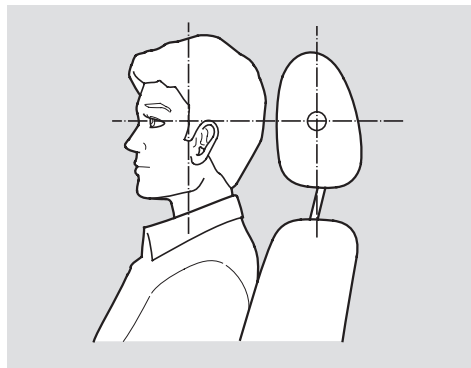

Your vehicle has adjustable head restraints on the front seats.

The head restraints help protect you and your passengers from whiplash and other injuries.

They are most effective when you adjust them so the center of the back of the occupant's head rests against the center of the restraint.

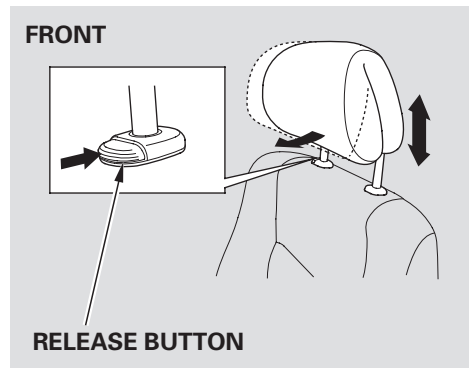

The head restraints adjust for height. The tilt of the front head restraints is also adjustable. You need both hands to adjust the restraint. Do not attempt to adjust it while driving.

To raise it, pull upward. To lower the restraint, push the release button sideways, and push the restraint down. To adjust the tilt, pivot the front head restraint to the desired position.

### **⚠ WARNING**

Failure to reinstall the head restraints can result in severe injury during a crash.

Always replace the head restraints before driving.

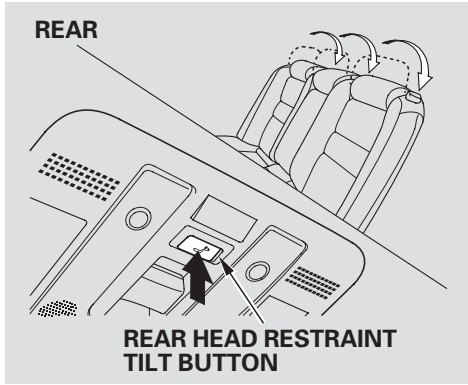

You can raise the rear head restraints by hand.

To lower the rear head restraints for better visibility, press the rear head restraint tilt button on the ceiling console with the ignition switch in the ON (II) position.

### Rear Seat Armrest

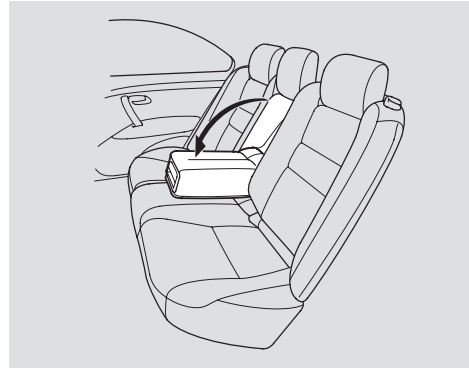

The rear seat armrest is in the center of the rear seat. Pivot it down to use it.

### Trunk Pass-through Cover

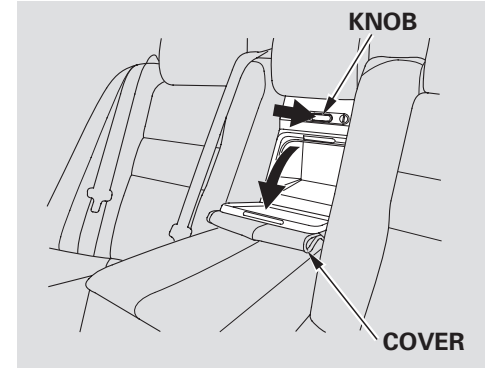

Open the cover by pushing the knob and pulling the cover down. To close the cover, swing it up, and push firmly on the top. Make sure it latches properly.

## Mirrors

---

Make sure all items in the trunk and those extending through the pass-through are secured.

For security, this cover can be locked and unlocked only with the built-in key. To lock the cover, insert the key, and turn it clockwise.

Never drive with this cover open and the trunk lid open.

See **Carbon Monoxide Hazard** on page [56](#).

Keep the inside and outside mirrors clean and adjusted for best visibility. Be sure to adjust the mirrors before you start driving.

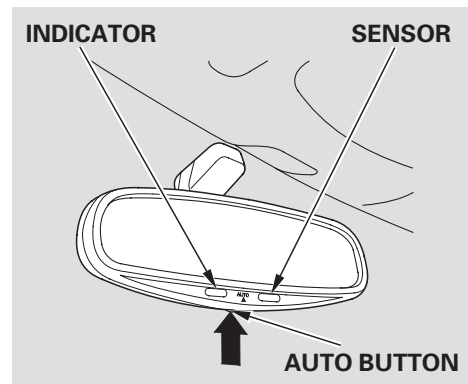

The inside mirror can automatically darken to reduce glare. To turn on this feature, press the button on the bottom of the mirror. The AUTO indicator comes on as a reminder. When it is on, the mirror darkens when it senses the headlights of a vehicle behind you, then returns to normal visibility when the lights are gone. Press the button again to turn off this feature.

## Adjusting the Power Mirrors

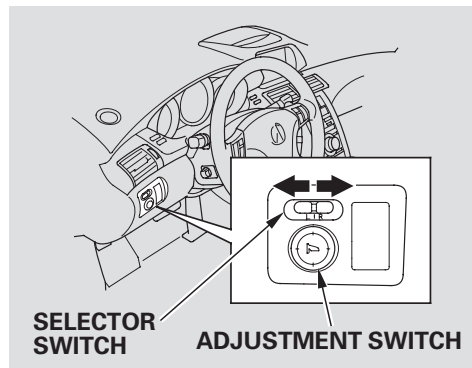

1. Move the selector switch to L (driver's side) or R (passenger's side).
2. Push the appropriate edge of the adjustment switch to move the mirror right, left, up, or down.

3. When you finish, move the selector switch to the center (off) position. This turns off the adjustment switch so you can't move a mirror out of position by accidentally bumping the switch.

Outside mirror positions can be stored in the driving position memory system (see page 160).

## Reverse Tilt Door Mirror

Depending on the position of the selector switch, the left or right side mirror will pivot downward slightly when you shift the transmission into reverse. In the left position, the left mirror pivots. In the right position, the right mirror pivots. This gives you a better view of that side of the vehicle while parallel parking. The mirror returns to its original position when you take the transmission out of reverse. To turn this feature off, leave the switch in the center position.

## Power Mirror Heaters

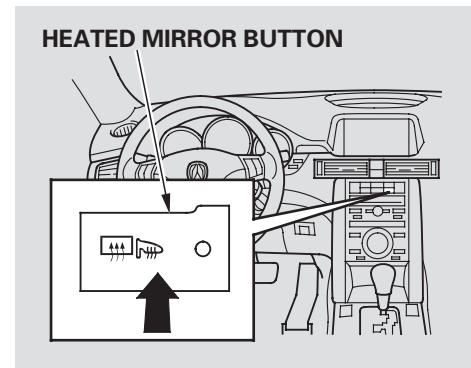

The outside mirrors are heated to remove fog and frost. With the ignition switch in the ON (II) position, turn on the heaters by pressing the button. The indicator in the button comes on as a reminder. Press the button again to turn the heaters off. Pressing this button also turns the rear window defogger on and off.

# Driving Position Memory System

Your vehicle has a memory feature for the steering wheel, driver's seat, and outside mirror positions.

Two seat, steering wheel, and outside mirror positions can be stored in separate memories. You select a memorized position by pushing the appropriate button.

## Storing a Driving Position in Memory

Store a driving position only when the vehicle is parked.

1. Turn the ignition switch to the ON (II) position. You cannot add a new driving position to the memory unless the ignition switch is in the ON (II) position. You can recall a memorized position with the ignition switch in any position.
2. Adjust the seat to a comfortable position (see page 155 ).  
Adjust the steering wheel to a comfortable position (see page 147 ).  
Adjust the outside mirrors for best visibility (see page 159 ).

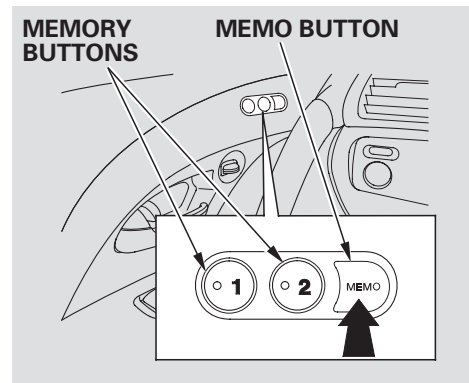

3. Press the MEMO button on the driver's door. You will hear a beep. The indicator in the memory buttons (1 and 2) will blink. Immediately press one of the memory buttons (1 or 2) until you hear two beeps. The indicator in the memory button will stay on. The current positions of the driver's seat, steering wheel, and outside mirrors are now stored.

To cancel the storing procedure after pressing the MEMO button:

- Do not press a memory button within 5 seconds.
- Readjust the seat or steering position.
- Readjust the outside mirror position.

Each memory button stores only one driving position. Storing a new position erases the previous setting stored in that button's memory.

All stored driving positions will be lost if your vehicle's battery goes dead or is disconnected.

## Selecting a Memorized Position

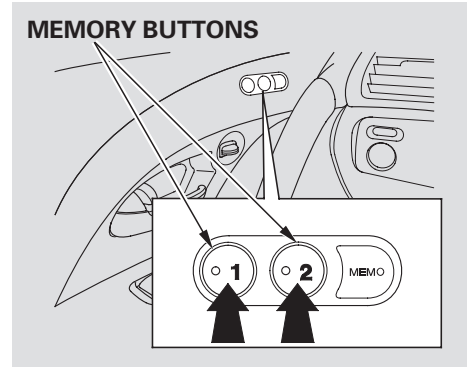

To select a memorized position, do this:

1. Make sure the shift lever is in Park.

2. Press the desired memory button (1 or 2) until you hear a beep.

The system will move the seat, steering wheel, and outside mirrors to the memorized positions. The indicator in the selected memory button will flash during movement. When the adjustments are complete, you will hear two beeps, and the indicator will remain on.

To change the “MEMORY POSITION LINK” setting, see page [104](#).

CONTINUED



## Driving Position Memory System

---

To stop the system's automatic adjustment, do any of the following:

- Press any button on the control panel: MEMO, 1, or 2.
- Push any of the adjustment switches for the seat or steering wheel.
- Shift out of Park.
- Adjust the outside mirrors.

If you select a memorized position without pushing the ignition switch knob or inserting the built-in key in the ignition switch, only the seat and outside mirrors will adjust. To get the system to also adjust the steering wheel, push and turn the ignition switch or insert the built-in key in the ignition switch. You will hear two beeps when it is complete.

You can use the adjustment switches to change the positions of the seat, steering wheel, or outside mirrors after they are in their memorized position. If you change the memorized position, the indicator in the memory button will go out. To keep this driving position for later use, you must store it in the driving position memory.

Your vehicle has a keyless access system. When you carry the remote with you, you can lock/unlock the door(s), unlock the trunk, and start the engine without using the built-in key.

The system may not work if:

- The battery of the remote is weak.
- There is strong electrical current nearby.
- You carry a cell phone, a laptop computer, or other electrical device near the remote.
- The remote is covered by metal.
- A vehicle is being operated with a transmitter nearby.
- When the remote battery is dead.
- When the vehicle battery is dead.

Make sure the driver always carries the remote/built-in key set.

Protect the remote and the built-in key from direct sunlight, high temperature, and high humidity.

Do not drop the remote or the built-in key, and do not set heavy objects on them.

Keep the remote and the built-in key away from liquids. If they get wet, dry them immediately with a soft cloth.

The built-in keys do not contain batteries.

Always keep the remote and the built-in key away from any magnetic material.

You should have received a key number tag with your built-in key. You will need this key number if you ever have to get a lost key replaced. Use only Acura-approved key blanks.

# Keyless Access System

## Keys

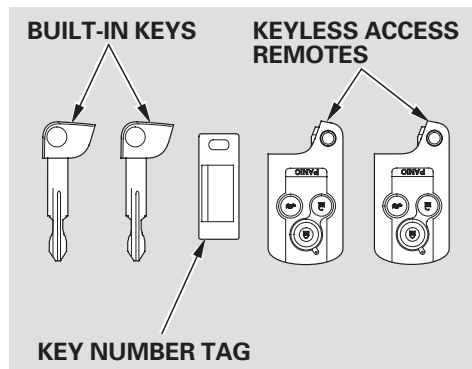

The following keys come with your vehicle. Refer to page 177 for how to separate the keys.

### *Built-in Key*

This key is used to lock/unlock the doors, glove box, trunk pass-through cover, and to start the engine (after you remove the ignition switch cover, see page 174).

### *Keyless Access Remote*

This remote is used to lock/unlock

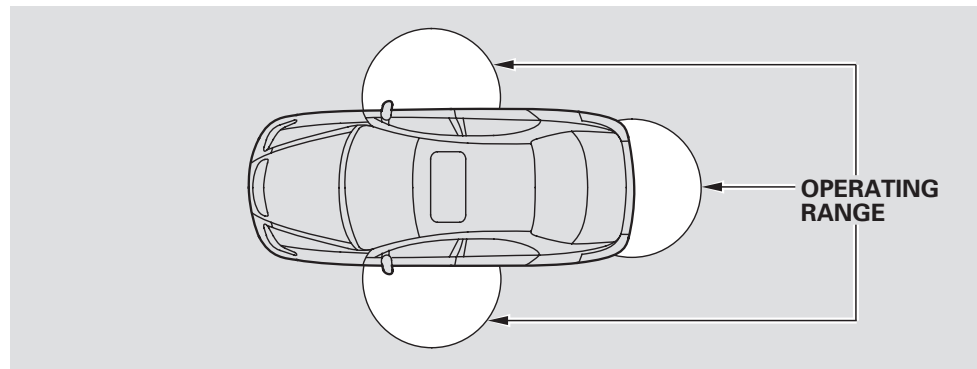

the doors and unlock the trunk. When you carry the remote, you can lock/unlock the doors, unlock the trunk, and start the engine without a key.

You can lock/unlock the doors within about 32 inches (about 80 cm) radius from the outside door handle. You can open the trunk within about 32 inches (about 80 cm) radius from the trunk release switch.

Anyone can lock/unlock a door or open the trunk if the remote is within the operating range of the door or the trunk.

The remote may not work if:

- It is too close to the vehicle.
- It is above or below the vehicle, even when it is within its operating range.

## Unlocking the Door(s)

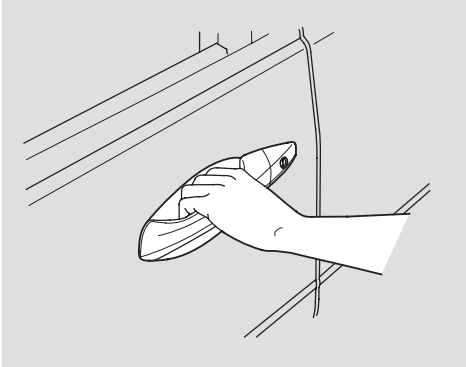

The handle of each front door has a sensor. That sensor works with the remote so you can automatically unlock/lock the door(s).

By default, only the driver's door unlocks when you grab its handle.

To change the “DOOR UNLOCK MODE” setting, see page [109](#).

All the doors unlock when you grab the handle of the front passenger's door.

When you unlock the door(s), some exterior lights blink twice and the system beeps twice.

To change the “KEYLESS ACCESS LIGHT FLASH” setting, see page [111](#).

To change the “KEYLESS ACCESS BEEP” setting, see page [113](#).

If you wear a glove while grabbing a front door handle, the door sensor may be slow to respond or may not respond by unlocking the doors.

If you do not open any of the doors within 30 seconds, they will automatically relock.

To change the “SECURITY RELOCK TIMER” setting, see page

[131](#).

If a remote is within operating range while you wash your vehicle or when it is raining heavily, the door sensors may respond by unlocking the doors.

The unlock sensors do not operate when:

- The remote is not within the operating range.
- The remote is too close to the vehicle.
- When the doors are unlocked.
- The remote battery is dead.
- The vehicle battery is dead.

# Keyless Access System

## Locking the Doors

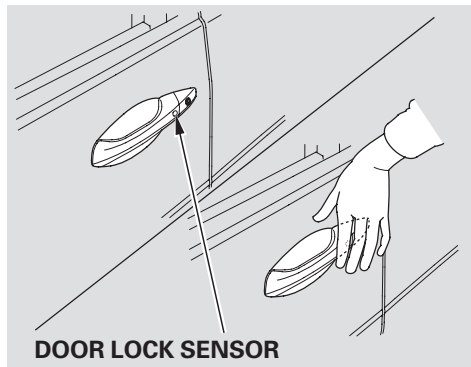

Each front door has a LOCK/UNLOCK feature.

When you touch the door lock sensor of the front door by hand, all the doors and the trunk will lock.

Before locking the doors, make sure the remote is not inside the vehicle.

When you lock the doors, some exterior lights blink once and the

system beeps once. When you cannot set the security system because the trunk or hood is open, no exterior light blinks and/or no beeper sounds.

To change the “KEYLESS ACCESS LIGHT FLASH” setting, see page [111](#).

To change the “KEYLESS ACCESS BEEP” setting, see page [113](#).

Within 2 seconds of touching the handle to lock the doors or locking the doors with remote, pull the handle to make sure the doors are actually locked. The door unlock sensors do not operate for about 2 seconds after the doors are locked.

If a remote is within operating range while you wash your vehicle or when it is raining heavily, the door sensors may respond by locking the doors.

If you touch the door lock sensor of the front door with your hand wearing a glove, the door sensor may delay to respond or not respond by locking the doors.

The lock sensors do not operate if:

- The remote is not within the operating range.
- The doors are open.
- The ignition switch is not in the LOCK (0) position.
- The built-in key is in the ignition switch.
- The remote is too close to the vehicle.
- The remote battery is dead.
- The vehicle battery is dead.

## ***Door Lock Prevention***

If you open a door, pull its lock tab, and shut it when the remote is inside the vehicle, the driver's door unlock. Make sure you carry the remote with you when you lock the doors.

## **Locking the Trunk**

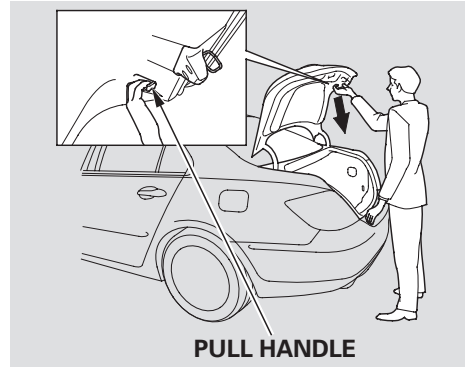

When you close the trunk with all doors locked, the trunk will lock.

When you unlock all the doors with the remote, built-in key or power door lock master switch, the trunk will unlock.

Use the pull handle when you close the trunk.

Before closing the trunk, make sure the remote is not in the trunk.

If you close the trunk when the remote is in it, the system beeps, and the trunk reopens.

# Keyless Access System

## Locking and Unlocking the Trunk

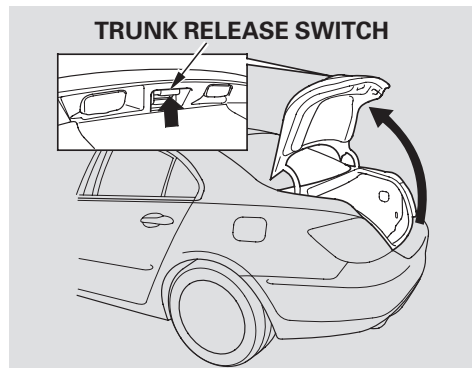

When the trunk is locked, you can open it in any of these ways:

- Press the trunk release button inside the vehicle.
- Press the trunk button on the remote.
- Pull the trunk release switch when carrying the remote (the system beeps once).

The trunk cannot be locked if:

- The remote is too close to the trunk lid.
- The remote is on the interior rear panel.
- The remote is too close to the seatback of the rear seat or the seat cushion.

Keep the trunk lid closed at all times while driving to avoid damaging the lid, and to prevent exhaust gas from getting into the interior. See **Carbon Monoxide Hazard** on page 56.

## Keyless Access Remote

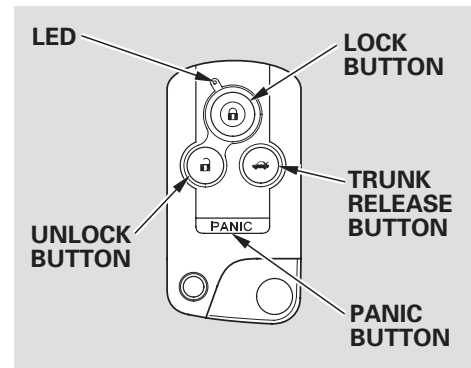

**LOCK** — Press this button once to lock all doors. Some exterior lights will flash. When you push the LOCK button twice within 5 seconds, you will hear a beep to verify that the doors are locked and the security system is set.

You cannot lock the doors if any door, the trunk, or the hood is not fully closed if the built-in key is in the ignition switch, or if the ignition switch is in any position except the LOCK (0) position.

When you cannot set the security system because the trunk or hood is open, no exterior light blinks and/or no beeper sounds.

**UNLOCK** — Press this button once to unlock the driver’s door. Press it twice to unlock the other doors. Some exterior lights will flash twice each time you press the button. The ceiling light (if the ceiling light switch is in the DOOR position) will come on when you press the UNLOCK button. If you do not open any doors within 30 seconds, the ceiling light fades out. If you relock the doors with the remote before 30 seconds have elapsed, the ceiling light will go off immediately.

To change the “DOOR LOCK MODE” setting, see page [127](#).

To change the “INTERIOR LIGHT DIMMING TIME,” see page [116](#).

If you unlock the doors with the remote, but do not open any doors within 30 seconds, the doors automatically relock and the security system sets.

To change the “SECURITY RELOCK TIMER” setting, see page [131](#).

To change the “KEYLESS LOCK ACKNOWLEDGMENT” setting, see page [129](#).

**TRUNK** — Press this button for about 1 second to open the trunk. You cannot open the trunk if the built-in key is in the ignition or the ignition switch is in any position except the LOCK (0) position. You cannot open the trunk with the remote if the trunk main switch is turned off.

**PANIC** — Press this button for about 2 seconds to attract attention: the horn will sound and the exterior lights will flash for about 30 seconds. To cancel panic mode, press any other button on the remote.



# Keyless Access System

## Keyless Memory Settings™

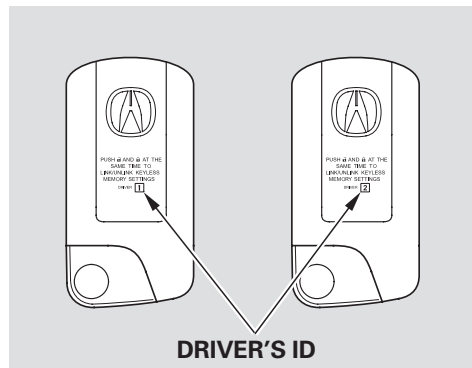

When you unlock the door with your remote, each remote activates the keyless memory settings related to that remote. The driver's ID (Driver 1 or Driver 2) is shown on the back of each remote.

Here are the settings activated with the remote;

- Driving position memory (see page 160 ).
- Customized settings (see page 81 ).
- Audio system settings (see page 207 ).
- Climate control settings (see page 199 ).

### *RL model*

- Compass system preferences (see page 242 ).

### *Except RL model*

- Navigation system preferences (see the navigation system manual).

To turn off this feature, press and hold the LOCK and UNLOCK buttons at the same time. The LED

in the remote will blink once. Then release the buttons. Doing this cancels the keyless memory settings for that remote and restores the default settings.

Some of them keep the same settings as they were set previously.

To turn the keyless memory settings back on, repeat this procedure. The LED will blink twice to indicate the feature has been turned on.

### ***Remote Transmitter Care***

- Avoid dropping or throwing the transmitter.
- Protect the transmitter from extreme temperature.
- Do not immerse the transmitter in any liquid.
- If you lose a transmitter, the replacement needs to be reprogrammed by your dealer.

## Replacing the Remote Battery

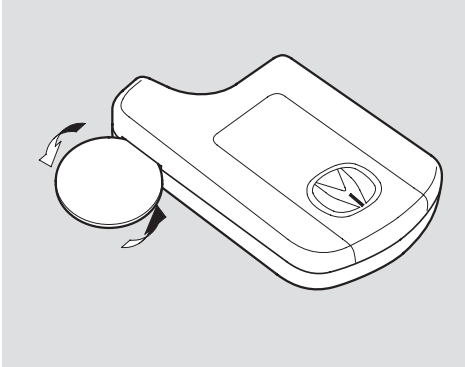

Replace the batteries if necessary.  
Battery type: CR2025

Remove the built-in key.

Remove the upper half by carefully prying on the edge with a coin.

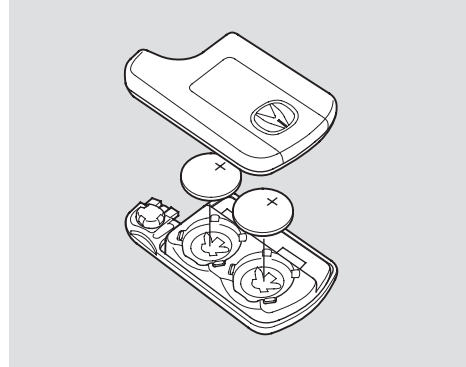

Replace the old batteries with new batteries. Place the batteries so the + side is facing up. Snap the two halves of the remote case back together.

An improperly disposed of battery can hurt the environment. Always confirm local regulations for battery disposal.

*As required by the FCC:*

*This device complies with Part 15 of the FCC rules. Operation is subject to the following two conditions: (1) This device may not cause harmful interference, and (2) this device must accept any interference received, including interference that may cause undesired operation.*

*Changes or modifications not expressly approved by the party responsible for compliance could void the user's authority to operate the equipment.*

*This device complies with Industry Canada Standard RSS-210.*

*Operation is subject to the following two conditions: (1) this device may not cause interference, and (2) this device must accept any interference that may cause undesired operation of the device.*

# Keyless Access System

---

## Ignition Switch Operating Range

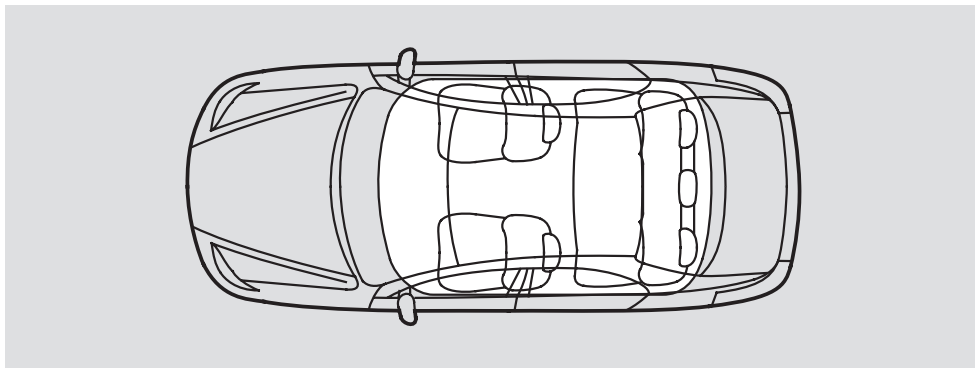

The engine may not run, and some malfunctions may occur, if the remote is:

- Outside the vehicle.
- On the dashboard.
- On the rear interior panel.
- In the glove box.
- In the door pockets.
- In the trunk, etc.

The engine may not start if the remote is subjected to strong radio waves.

Also, the engine may not start if the remote is too close to the windows.

### **NOTICE**

*Make sure you know where the remote is when you are inside the vehicle.*

*Remember that you can start the engine without using the built-in key when the remote is inside the vehicle.*

*Make sure you always carry the remote with you.*

## Ignition Switch

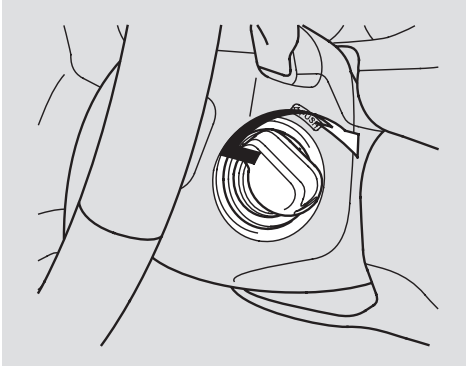

When you push the ignition switch, the remote and the vehicle recognize each other. After the recognition, the remote indicator flashes, and a beeper sounds once. After the beep, turn the ignition switch. When the remote is out of the operating range, the ignition switch is locked. If the ignition switch cannot be turned from the LOCK (0) position to the ACCESSORY (I) position after

the beep, the steering wheel is locked. To unlock the steering wheel, turn it right and left while turning the ignition switch at the same time. If the remote and the vehicle do not recognize each other, turn the ignition switch to the LOCK (0) position, remove the ignition switch cover, insert the built-in key, and turn the switch (see pages 151 and 174).

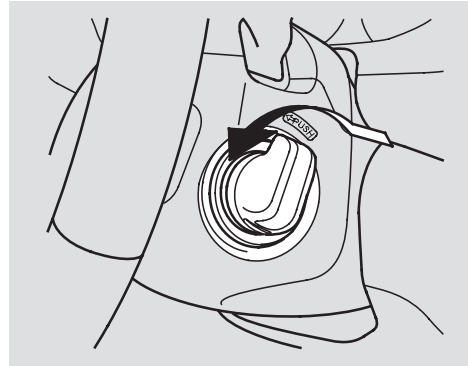

To turn the ignition switch to the LOCK (0) position, put the transmission in Park, press the switch in, and turn it to the LOCK (0) position. When the transmission is not in Park, you cannot turn the ignition switch to the LOCK (0) position.

Before leaving the vehicle, make sure the ignition switch is in the LOCK (0) position.

If you open the driver's door with the ignition switch in the ACCESSORY (I) position, a beeper will sound. You will also see a "RETURN IGNITION SWITCH TO LOCK (0) POSITION" message on the multi-information display.

*CONTINUED*

## Keyless Access System

Also, if you close the door when the ignition switch is not in the LOCK (0) position and the remote is not inside the vehicle, the keyless access alarm sounds outside the vehicle, a message appears on the multi-information display, and the beeper sounds if the ignition switch is in the ON (II) position.

When the beeper sounds after you close the driver's door outside the vehicle, check the position of the ignition switch and the location of the remote.

If the engine is running and you remove the remote from the vehicle, it will continue to run. But once turned to the LOCK (0) position, the engine will not restart until a remote is brought back into the vehicle.

### Removing the Ignition Switch Cover

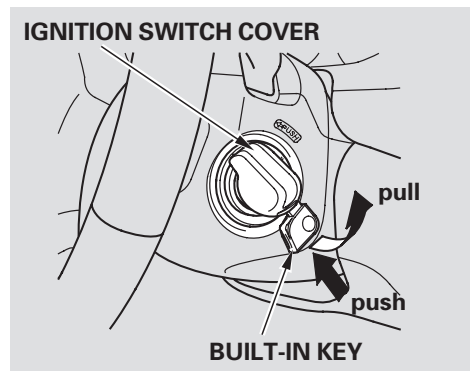

To remove the ignition switch cover, insert the built-in key (see page 177), then pull the cover out by pulling the built-in key while pushing it.

### Beeper and Message *Keyless Remote Not Detected*



When you are pressing the ignition switch, or when the ignition switch is in the ON (II) position, the beeper sounds if you take the remote out of the vehicle and close the door.

- The outside beeper sounds when the ignition switch is in the ACCESSORY (I) or the ON (II) position.
- When the ignition switch is in the ON (II) position, the multi-information display shows “KEYLESS REMOTE NOT DETECTED,” and the inside and outside beepers sound. The multi-information display message goes away when you bring the remote back inside the vehicle, and close the door or apply the parking brake.
- If the engine is running and you remove the remote from the vehicle, it will continue to run. Once turned to the LOCK (0) position, the engine will not restart until a remote is brought back into the vehicle.

The engine does not restart if you turn the ignition switch to the LOCK (0) position when the remote is outside the vehicle. Check where the remote is. Make sure that you carry the remote or built-in key with you when you operate the ignition switch.

If you pass the remote through an open window, the system does not respond. Also, even when the remote is inside the vehicle, the beeper may sound when the location of the remote is not detected due to surrounding conditions. It is not a failure. Make sure that you carry the remote with you.

## *Keyless Remote Low Battery*

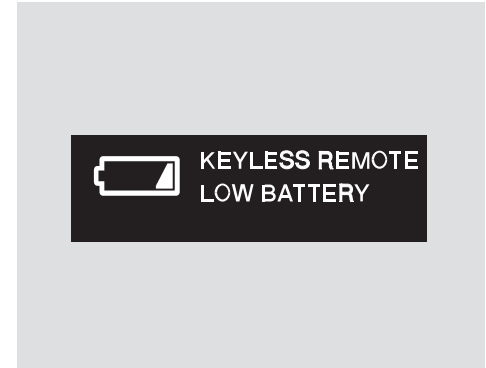

The batteries in the remote normally lasts about 2 years. To ensure maximum battery life, do not store the remote close to electrical devices such as computers or TVs. When the multi-information display shows “KEYLESS REMOTE LOW BATTERY,” replace the batteries as soon as possible (see page [171](#)).

*CONTINUED*

# Keyless Access System

---

## *Check Keyless Access System*

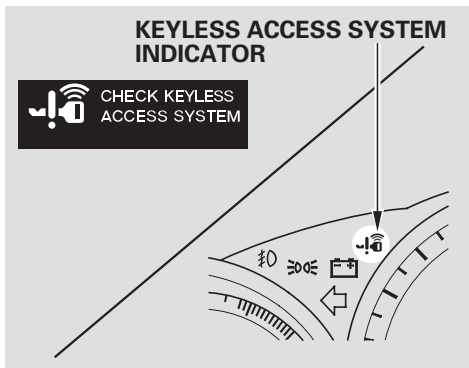

The indicator comes on for several seconds when you turn the ignition switch to the ON (II) position. Have your vehicle checked by your dealer if:

- The indicator stays on while you are driving.
- The indicator comes on with the ignition switch in the ON (II) position.
- The multi-information display shows “CHECK KEYLESS ACCESS SYSTEM.”

In this case, use the built-in key to lock/unlock the doors and start the engine.

## Built-in key and Remote

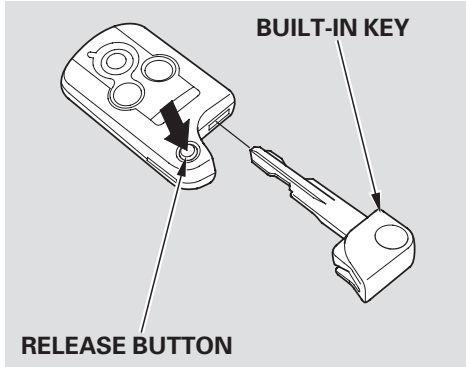

The built-in key can be inserted into the remote.

As shown above, keep inserting the built-in key until it is locked. To remove the built-in key, pull it out while you press the release button. To avoid damaging the remote and the built-in key, never pull on the built-in key unless you are pressing the release button.

The keyless access system uses electric current to identify the remote with the vehicle.

If you use medical equipment such as a cardiac pacemaker, ask your doctor if the electric current used by the remote will affect it.

## Valet Function

The trunk and glove box cannot be opened when you turn the trunk main switch off and lock the glove box and trunk pass-through cover with the built-in key. Also, the trunk cannot be opened by using the remote.



## Seat Heaters

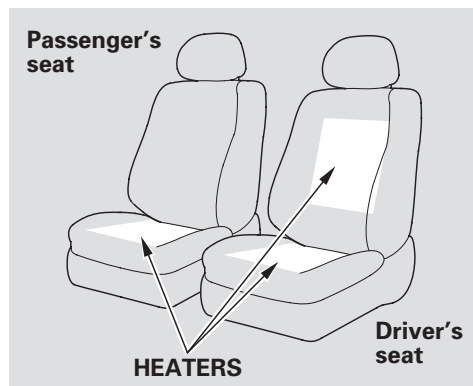

### *If equipped*

Both front seats are equipped with seat heaters. The passenger seat only has heaters in the seat bottom because of the side airbag cut off system.

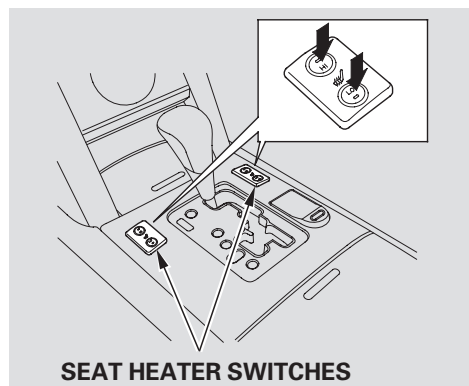

The ignition switch must be in the ON (II) position to use the heaters. Push the top of the switch, HI, to rapidly heat up the seat. After the seat reaches a comfortable temperature, select LO by pushing the bottom of the switch. This will keep the seat warm.

In the HI setting, the heater turns off when the seat gets warm, and turns back on after the seat's temperature drops.

In the LO setting, the heater runs continuously. It does not cycle with temperature changes.

Follow these precautions whenever you use the seat heaters:

- Use the HI setting only to heat the seats quickly, because it draws large amounts of current from the battery.
- If the engine is left idling for an extended period, do not use the seat heaters, even on the LO setting. It can weaken the battery, causing hard starting.

## Seat Heaters and Seat Ventilation (Canadian models)

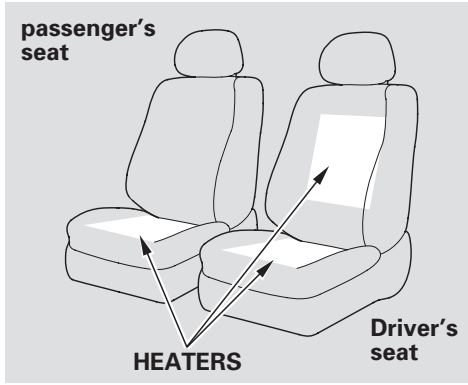

### *If equipped*

Both front seats are equipped with seat heaters and an air ventilation system. The passenger seat only has heaters in the seat bottom because of the side airbag system.

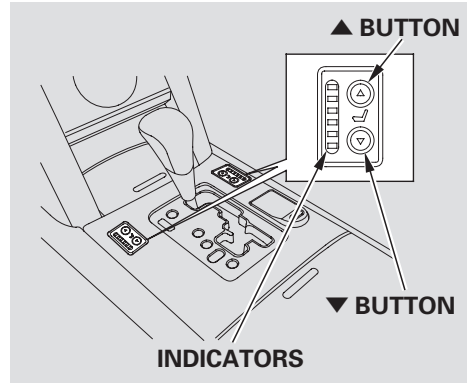

The ignition switch must be in the ON (II) position to use the heaters and the air ventilation system.

To use the heaters, press the ▲ button. The indicator (red) next to the button will come on. There are three settings in the heaters:  
HI – Three indicators on.  
MID – Two indicators on.  
LO – One indicator on.  
OFF – All indicators off.

When you press the ▲ button once, the heater is set to HI. After the seat reaches a comfortable temperature, select MID or LOW by pressing the ▼ button. This will keep the seat warm. To shut down the heater, press the ▼ button until the indicators go off.

In HI, when the seat gets warm, the heater will change to MID after about 5 minutes.

In MID, the heater will change to LOW after about 60 minutes.

In LOW, the heater runs continuously.

CONTINUED

## Seat Heaters and Seat Ventilation (Canadian models)

---

To ventilate the seat, press the ▼ button. The indicator (green) next to the button will come on. The air ventilation system has four settings:

HI – Three indicators on.  
MID – Two indicators on.  
LO – One indicator on.  
OFF – All indicators off.

When you press the ▼ button once, the system is set to HI. To change to the lower mode, press the ▲ button. To turn the air ventilation off, press the ▲ button until the indicators go off.

Follow these precautions whenever you use the seat heaters and the seat ventilation:

- Use the HI setting only to heat or to ventilate the seats quickly, because it draws large amounts of current from the battery.
- If the engine is left idling for an extended period, do not use the seat heaters or the seat ventilation, even on the LO setting. It can weaken the battery, causing hard starting.

Turn the ignition switch to the ON (II) position before operating any of the window switches. To open a window, push the switch down and hold it. To close the window, pull the switch up and hold it. Release the switch to stop the window.

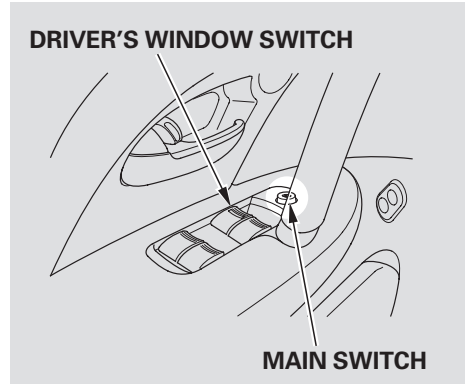

If the MAIN switch is pushed down (OFF), the passenger windows cannot be raised or lowered. Keep the MAIN switch off when you have children in the vehicle so they do not injure themselves by operating the windows unintentionally.

### **⚠ WARNING**

Closing a power window on someone's hands or fingers can cause serious injury.

Make sure your passengers are away from the windows before closing them.

*CONTINUED*

## Power Windows

---

**AUTO** – To open the window fully, push the window switch firmly down to the second detent, then release it. The window automatically goes down all the way. To stop the window from going all the way down, pull back on the window switch briefly.

To close the window fully, pull back the window switch firmly to the second detent, then release it. The window automatically goes all the way up. To stop the window from going all the way up, push down on the window switch briefly.

To open or close the window partially, push down or pull back on the window switch lightly to the first detent, and hold it. The window will stop when you release the switch.

All window switches also have the AUTO feature.

### **Auto Reverse**

If the window runs into any obstacle while it is closing automatically, it will reverse direction, and then stop. To close the window, remove the obstacle, then use the window switch again.

Auto reverse stops sensing when the window is almost closed. You should always check that all passengers and objects are away from the window before closing it.

The indicators in the switches come on when you turn the ignition switch to the ON (II) position.

The power windows have a key-off delay. You can still open and close the windows for up to 10 minutes after you turn off the ignition switch. The key-off delay cancels as soon as you open either front door. You must then turn the ignition switch to the ON (II) position for the power windows to operate.

## Opening the Windows and Moonroof with the Remote

You can open all of the windows and the moonroof from outside with the remote.

1. Press the UNLOCK button once to unlock the driver's door.
2. Press the UNLOCK button a second time, and hold it. All the doors unlock, and all four windows and moonroof start to open. To stop the windows and moonroof, release the button.
3. To open the windows and moonroof further, press the button again and hold it. If the windows and the moonroof stop before the desired position, repeat steps 1 and 2.

You cannot close the windows or the moonroof with the remote.

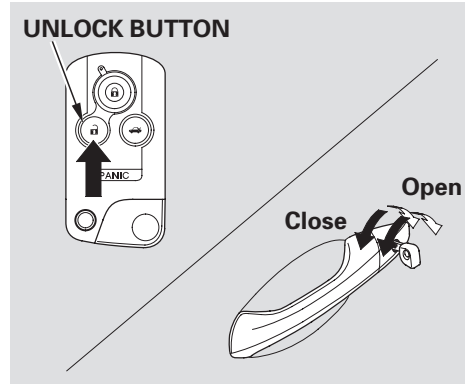

## Opening/Closing the Windows and Moonroof with the Built-in Key

You can open and close the windows and moonroof with the built-in key in the driver's door lock.

To open:

1. Insert the built-in key in the driver's door lock.

2. Turn the key clockwise, then release it.
3. Turn the built-in key clockwise again, and hold it. All four windows and the moonroof start to open. To stop the windows and moonroof, release the built-in key.
4. When the windows or moonroof stops before opening fully, to open the windows and moonroof further, turn and hold the key again (within 10 seconds).

CONTINUED

## Power Windows, Moonroof

---

To close:

1. Insert the built-in key in the driver's door lock.
2. Turn the key counterclockwise, then release it.
3. Turn the key counterclockwise again, and hold it. All four windows and the moonroof start to close. To stop the windows and the moonroof, release the key.
4. To close the windows and moonroof further, turn and hold the key again (within 10 seconds).

NOTE: If the windows and the moonroof stop before the desired position, repeat steps 2 and 3.

### Opening/Closing the Moonroof with the Ceiling Console Switch

Turn the ignition switch to the ON (II) position before operating the moonroof switch on the ceiling console. To open the moonroof, pull back the moonroof switch. To close the moonroof, push the moonroof switch forward. Release the switch to stop the moonroof.

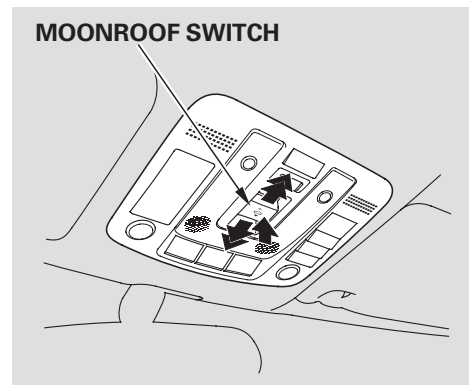

To open the moonroof fully, pull back the moonroof switch firmly. The moonroof opens all the way. To stop the moonroof from opening fully, push the switch briefly.

To tilt the moonroof, push the center of the moonroof switch straight up. To stop the moonroof from tilting fully open, push the moonroof switch forward.

To open or close the moonroof partially, pull back or push forward on the moonroof switch lightly to the first detent, and hold it. The moonroof will stop when you release the switch.

To close the moonroof fully, push the moonroof switch forward to the second detent, then release it. The moonroof closes all the way. To stop the moonroof from closing all the way, push the switch briefly.

## **WARNING**

Opening or closing the moonroof on someone's hands or fingers can cause serious injury.

Make sure all hands and fingers are clear of the moonroof before opening or closing it.



# Moonroof

---

## Auto Reverse

If the moonroof runs into any obstacle while it is closing automatically, it will reverse direction, and then stop. To close the moonroof, remove the obstacle, then use the moonroof switch again.

Auto reverse stops sensing when the moonroof is almost closed. You should always check that all passengers and objects are away from the moonroof before closing it.

The moonroof has a key-off delay. You can still open and close the moonroof for up to 10 minutes after you turn off the ignition switch. The key-off delay cancels as soon as you open either front door. You must then turn the ignition switch to the ON (II) position for the moonroof to operate.

### NOTICE

*If you try to open the moonroof in below-freezing temperatures, or when it is covered with snow or ice, you can damage the moonroof panel or its motor.*

## Operating the Moonroof with the Remote Transmitter or the Key

You can use the remote transmitter or the key to operate the moonroof from the outside. Refer to page [183](#) for details.

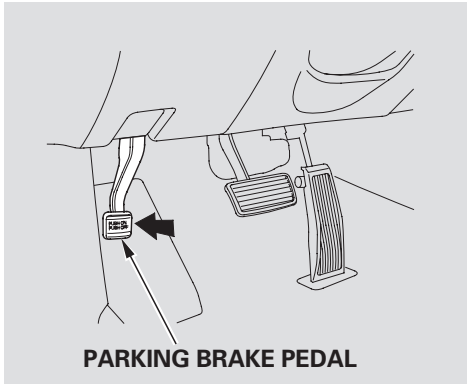

## NOTICE

*Driving the vehicle with the parking brake applied can damage the rear brakes, axles, and tires. A beeper will sound if the vehicle is put into gear with the parking brake on.*

To apply the parking brake, push the parking brake pedal down with your foot. To release the parking brake, push on the pedal again. The parking brake indicator on the instrument panel should go out when the parking brake is fully released with the engine running (see page [63](#)).

# Interior Convenience Items

---

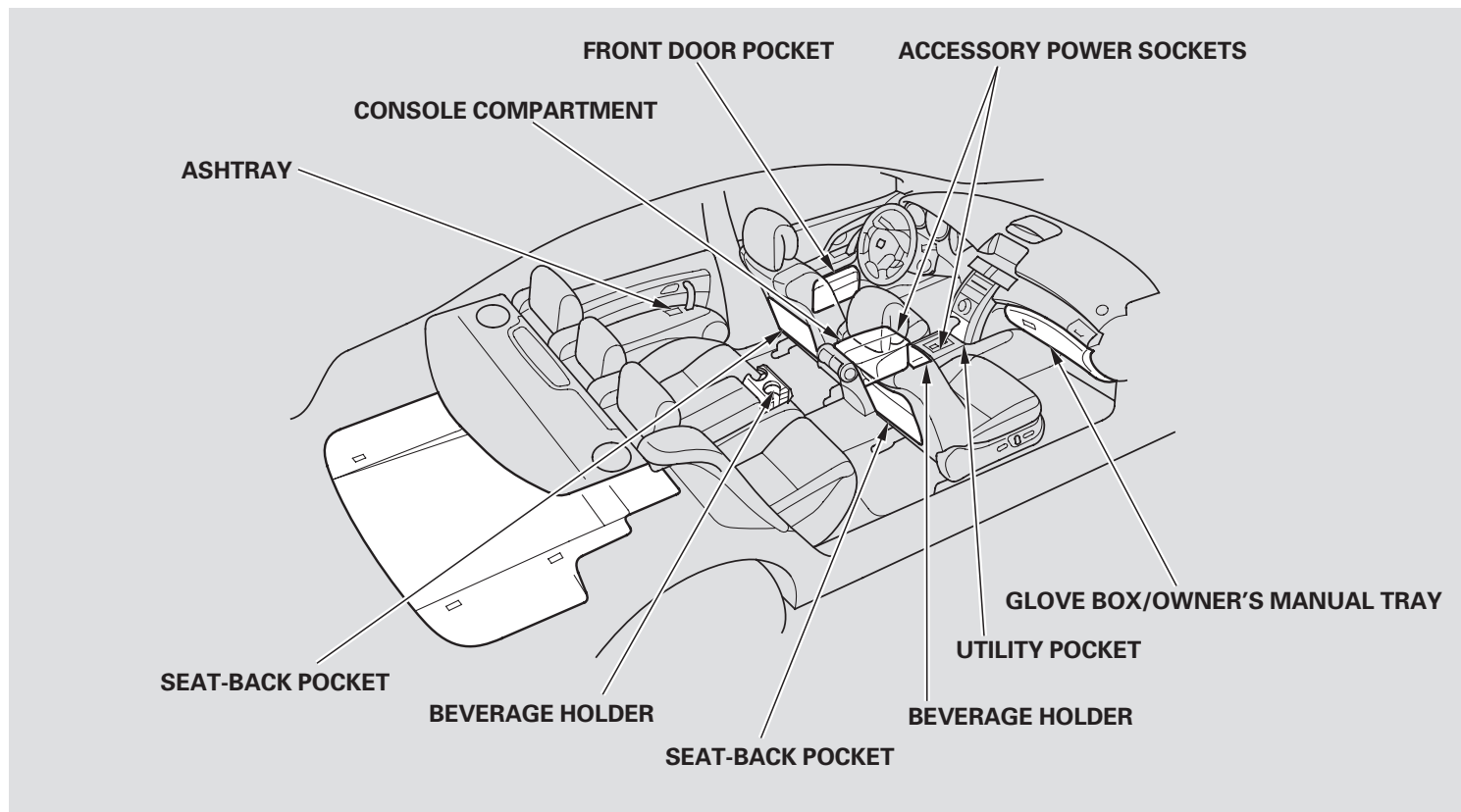

**Glove Box**

Open the glove box by pulling the handle. Close it with a firm push. Lock or unlock the glove box with the built-in key.

The glove box light comes on only when the parking lights are on.

**⚠ WARNING**

An open glove box can cause serious injury to your passenger in a crash, even if the passenger is wearing the seat belt.

Always keep the glove box closed while driving.

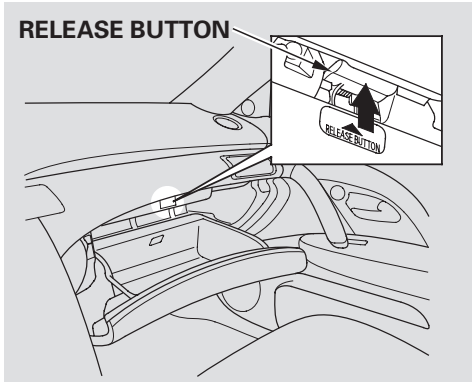

Your vehicle has an owner’s manual tray inside the glove box. To open the tray, push the release button up.

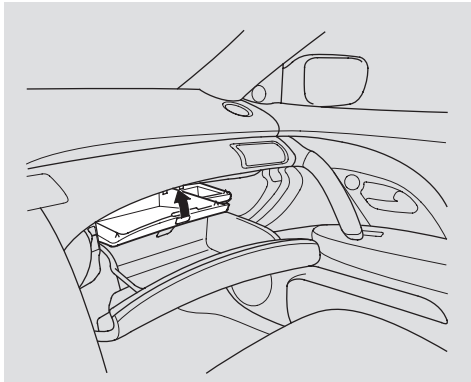

To close the tray, push it up.

## Interior Convenience Items

### Beverage Holders

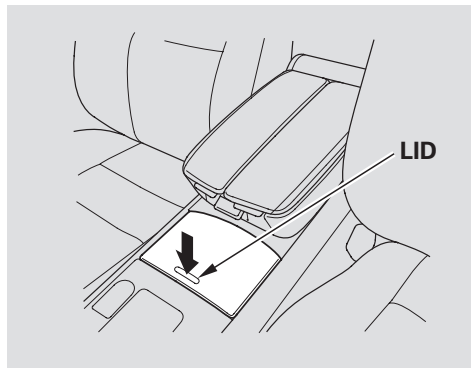

Be careful when you are using the beverage holders. A spilled liquid that is very hot can scald you or your passengers. Spilled liquids can damage the upholstery, carpeting, and electrical components in the interior.

To use the beverage holder, push the lid.

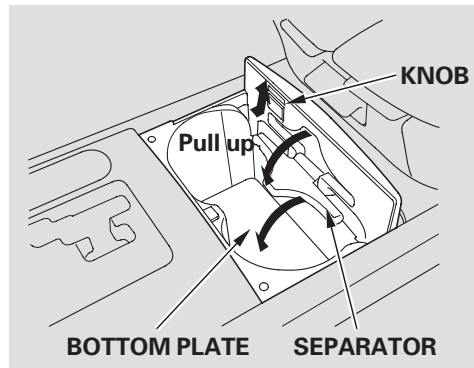

For a short container, put the bottom plate down, and pull up the knob to use the separator.

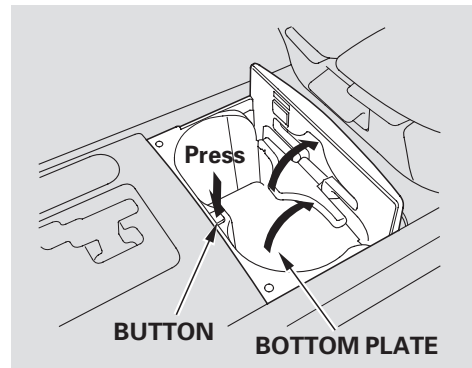

For a long container, press the button in the beverage holder to raise the bottom plate. Stand the separator up.

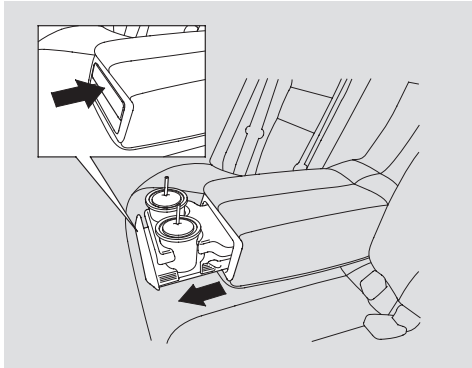

The rear beverage holder is in the rear seat armrest. Open the beverage holder by pushing the front of it.

**Console Compartment**

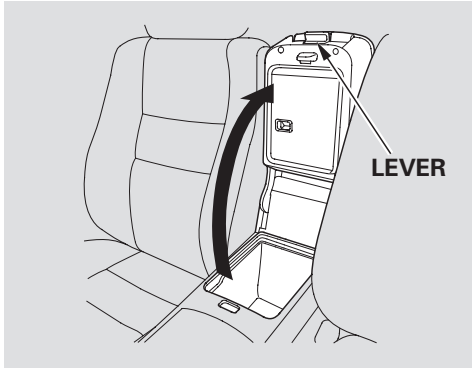

To open the console compartment, pull up on the lever and lift the armrest.

To close, lower the armrest, and push it down until it latches.

The console compartment light is on when the light switch is in the ☺ or ☹ position.

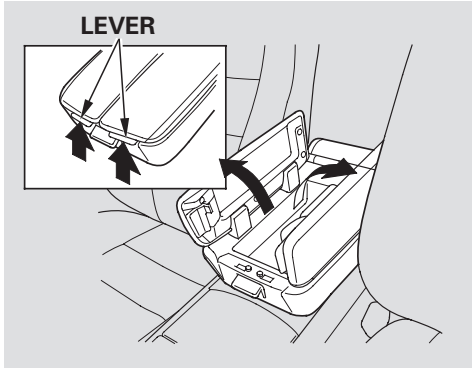

You can put small items in the tray located in the console compartment lid. To use the tray, pull up on the lever, and lift the armrest pad.

## Interior Convenience Items

---

### Sun Visors

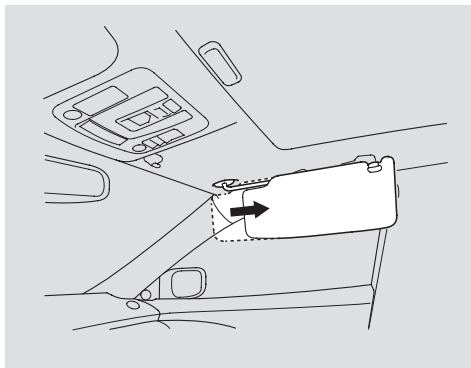

To use a sun visor, pull it down. You can also use a sun visor at the side window. Remove the support rod from the clip, and swing the sun visor toward the side window. You can extend the sun visor further by pulling it back.

Do not use the sun visor extension feature over the rear view mirror.

Make sure to slide a sun visor forward to set it to the normal length before flipping it back in place.

Make sure you put the sun visor back in place when you are getting into or out of the vehicle.

### Accessory Power Sockets

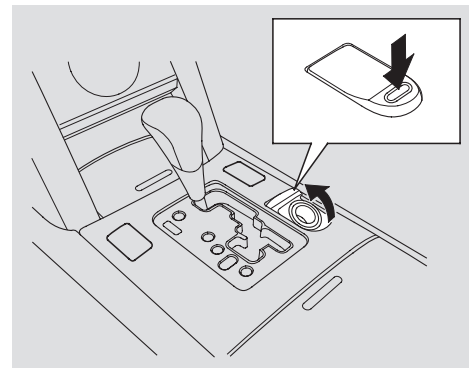

There are two accessory power sockets. One is located in the front of the center console. To use the power socket, push and release the lid, then push it forward until the socket comes to the proper position to use.

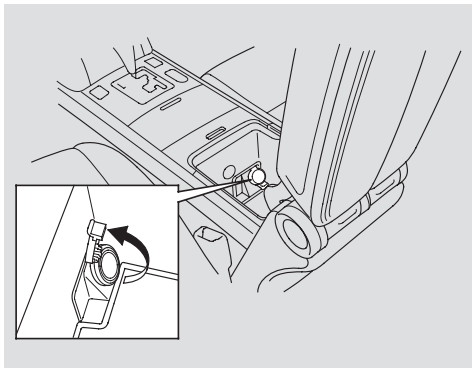

The other socket is under the armrest in the console compartment storage area. To use the power socket, pull up the cover.

These sockets are intended to supply power for 12 volt DC accessories that are rated 120 watts or less (10 amps).

They will not power an automotive type cigarette lighter element.

## Rear Ashtrays

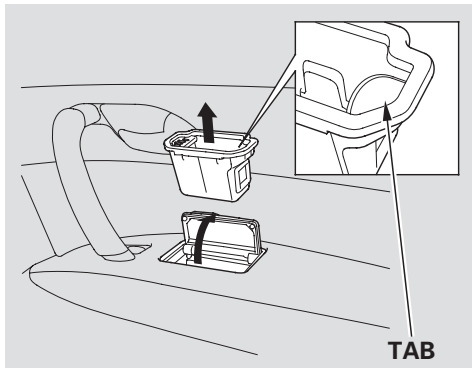

Small, rear ashtrays are located in the armrests of both rear doors. To open an ashtray, pivot the lid up.

To remove an ashtray for emptying, open the lid, then carefully pull the tab inside the ashtray straight up and out of the armrest.

The rear ashtray light is on when the light switch is in the ☺ or ☹ position.

## Front Door Pockets

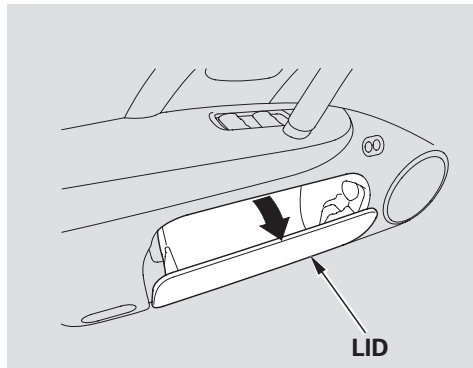

The interior of each front door has an extendable pocket for maps and other small, lightweight items. For safety, be sure both front door pockets are closed while driving.

When the light switch is in the ☺ or ☹ position, the front door pocket light is on.



## Interior Convenience Items

---

### Power Rear Sunshade

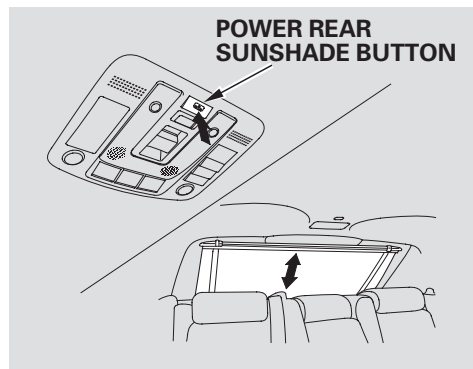

With the ignition switch in the ON (II) position, push the power rear sunshade button on the ceiling console to raise the rear sunshade. Push the button again to lower it.

When you shift to reverse, the sunshade goes down automatically. To use it again, shift to another position, and push the button to raise it.

If the sunshade stops while moving, check for and clear any obstacles, then push the button again.

**Integrated Sunshades**

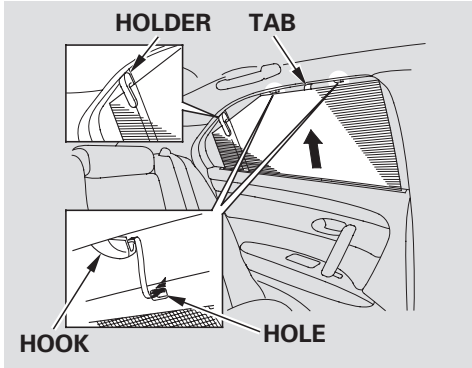

Each rear door has an integrated sunshade. To use a sunshade, hold the tab on the top, insert the sunshade into the holder, and pull the sunshade all the way up. Insert the holes on the sunshade into the hooks on the window frame.

The hooks are intended for use only by the sunshades. Do not hang any other items on the hooks, as that could interfere with proper operation of the side curtain airbags.

To prevent the integrated sunshades from being unhooked due to winds, leave the rear windows closed while driving.

# Interior Lights

## Ceiling Lights

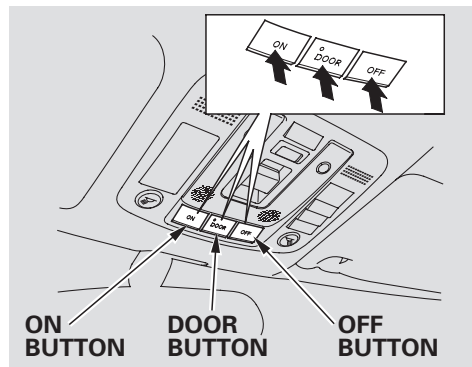

The front and rear of the ceiling have ceiling lights.

Push the ON button to turn on all the ceiling lights. Push the OFF button to turn them off.

After pushing the DOOR button, all the lights come on when you open any door, unlock the doors with the remote or built-in key, or turn the ignition switch from the ON (II) or the ACCESSORY (I) position to the LOCK (0) position. The indicator in the button comes on as a reminder.

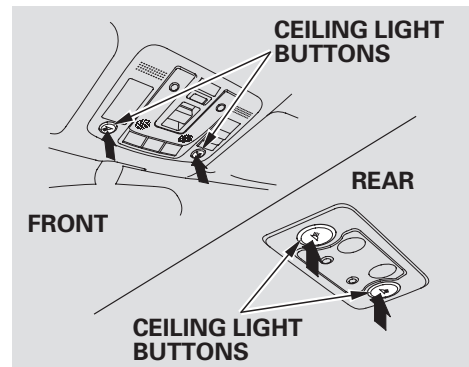

Push each ceiling light button to turn its light on and off.

To change the “INTERIOR LIGHT DIMMING TIME” setting, see page [116](#).

The climate control system in your vehicle provides a comfortable driving environment in all weather conditions.

The standard audio system has many features. This section describes those features and how to use them.

The climate control system and the audio system have a voice control feature.

Your vehicle has an anti-theft audio system that requires a code number to enable it.

The security system helps to discourage vandalism and theft of your vehicle.

Climate Control System.....	198
Audio System .....	207
Playing the AM/FM Radio.....	208
AM/FM Radio Frequencies....	212
AM/FM Radio Reception.....	212
Adjusting the Sound.....	214
Playing the XM® Satellite Radio .....	217
Operating the Disc Changer ....	223
Disc Changer Error Messages ....	234
Protecting Your Discs .....	235
Auxiliary Input Jack.....	238
Remote Audio Controls.....	239
Radio Theft Protection.....	241
Compass System.....	242
Voice Control Basics .....	265
Setting the Clock .....	274
Security System .....	276
Cruise Control.....	277
Adaptive Cruise Control (ACC)...	280
HomeLink® Universal Transceiver.....	295
AcuraLink .....	299
Bluetooth® HandsFreeLink® .....	308
Rearview Camera and Monitor ....	326

# Climate Control System

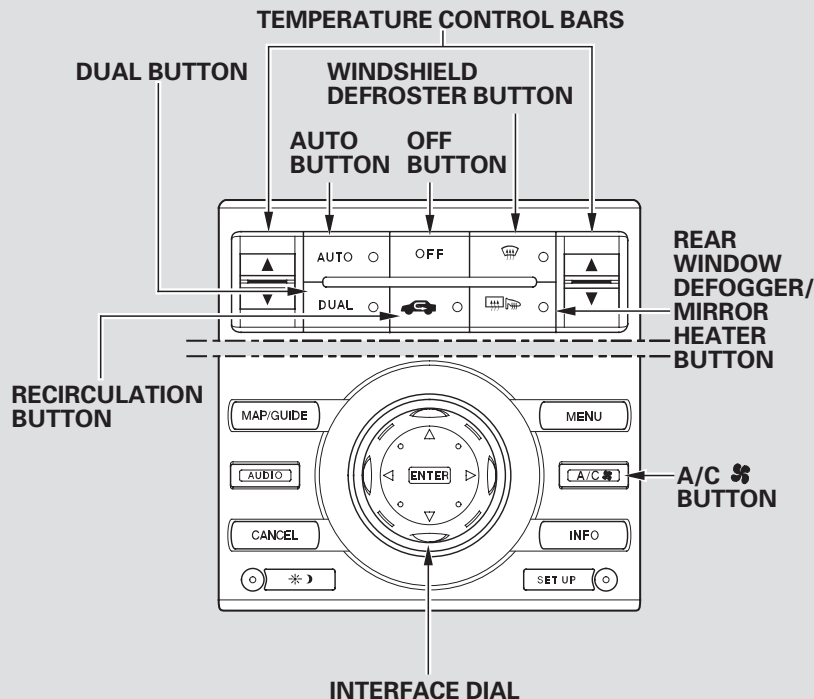
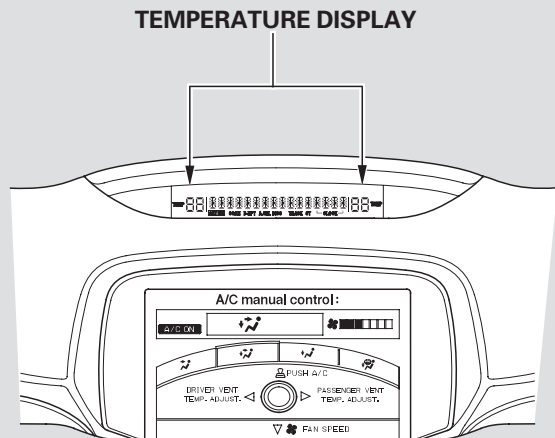

U.S. models  
(Technology package model is shown)

## Interface Dial

Many climate control functions can still be controlled by standard buttons, dials, and knobs, but some functions can only be accessed using the interface dial. The interface dial has two parts, a knob and a selector.

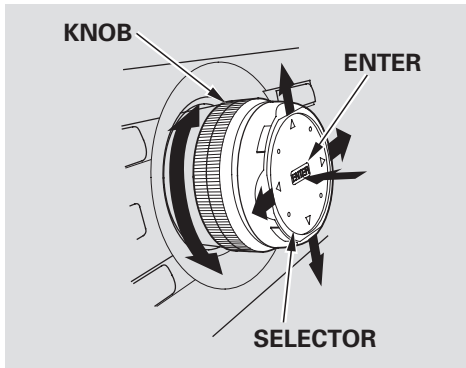

The knob turns left and right. Use it to make selections or adjustments to a list or menu on the screen.

The selector can be pushed left, right, up, down, and in. Use the selector to scroll through lists, to select menus, and to highlight menu items. When you make a selection, push the center of the selector (ENTER) to go to that selection.

## Personalization Setting

When you unlock the doors with your remote, the driver's ID (Driver 1 or Driver 2) is detected, and the climate control settings are turned to the respective mode automatically when the ignition is turned to the ON (II) position.

## Voice Control System

The climate control system can also be operated by voice control.

### *On models with navigation system*

See the Navi section in your Quick Start Guide for an overview of this system, and the Navigation System manual for complete details.

### *On models without navigation system*

Refer to Voice Control Basics for complete details (see page [265](#)).

# Climate Control System

## Fan Control

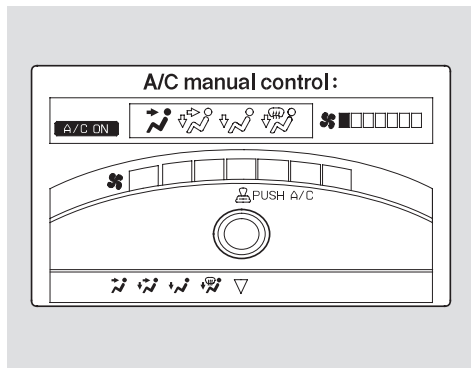

Press the A/C  button to view the climate control display, then turn the interface knob to increase or decrease the fan speed and airflow.

## Temperature Control Bars

To select the desired temperature, push the temperature control bar up or down.

To set the driver's and passenger's temperature separately, press the DUAL button. The indicator in the button will come on. The driver and passenger can each set the temperature to the desired setting.

To make the driver's and passenger's temperature the same, push the DUAL button again. The indicator in the button goes out, and the passenger's temperature is set to the driver's temperature.

## Air Conditioning (A/C)

Press the A/C  button to view the climate control display. Pushing ENTER on the interface selector turns the air conditioning on and off. You will see A/C ON or A/C OFF in the display.

When you turn the A/C off, the system cannot regulate the inside temperature if you set the temperature control below the outside temperature.

## Recirculation Button

When the indicator in the button is on, air from the vehicle's interior is sent throughout the system again. When the indicator is off, air is brought in from the outside of the vehicle (fresh air mode).

The outside air intakes for the climate control system are at the base of the windshield. Keep this area clear of leaves and other debris.

The system should be left in fresh air mode under almost all conditions. Keeping the system in recirculation mode, particularly with the A/C off, can cause the windows to fog up.

Switch to recirculation mode when driving through dusty or smoky conditions, then return to fresh air mode.

## Windshield Defroster Button

This button turns the windshield defrost on and off.

When you push this button, air flows from the defroster vents at the base of the windshield, and the system automatically switches to fresh air mode and turns on the A/C. When the indicator in the button is on, the passenger's temperature cannot be set separately from the driver's.

## Rear Window Defogger Button

This button turns the rear window defogger on and off (see page 146). Pushing this button also turns the power mirror heaters on and off.

## Mode Control

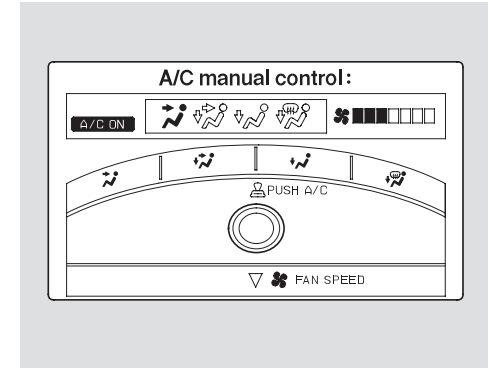

You can select the vents air flows from. Some air will flow from the dashboard corner and side vents in all modes.

Press the A/C  button to view the climate control display, then push the interface selector down. Select any of the modes by turning the interface knob.

*CONTINUED*



# Climate Control System

 Air flows from the center and corner vents in the dashboard.

 Airflow is divided between the vents in the dashboard and the floor vents.

 Air flows from the floor vents.

 Airflow is divided between the floor vents and defroster vents at the base of the windshield.

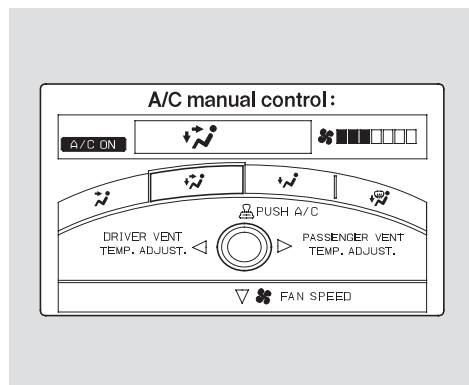

When  is selected, you can increase or decrease the temperature of airflow from the dashboard vent for the driver's side and the passenger's side without changing the temperature of airflow from the floor vent.

Push the interface selector right or left, then turn the interface knob to select the desired temperature.

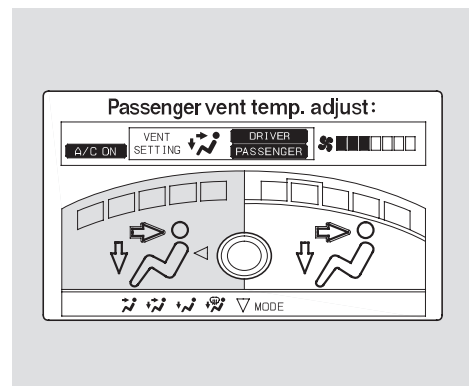
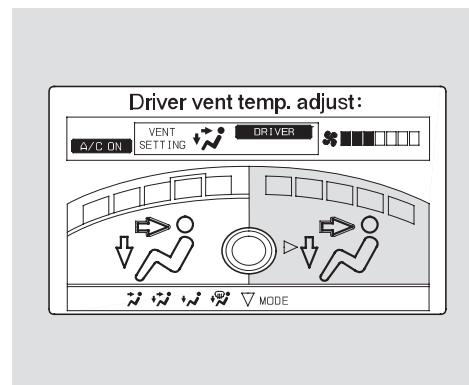

## Dual Button

You can set the temperature for the driver's side and the passenger's side separately when this button is pressed (indicator on). When the indicator in the DUAL button is off, you can adjust both sides to the same temperature with the driver's side temperature control bar.



## Ventilation

The flow-through ventilation system draws in outside air, circulates it through the interior, then exhausts it through vents near the rear window.

1. Set the temperature to the lower limit.
2. Make sure the A/C is off.
3. Select  and fresh air mode.
4. Set the fan to the desired speed.



## Using the Heater

The heater uses engine coolant to warm the air. If the engine is cold, it will be several minutes before you feel warm air coming from the system.

1. Press the A/C  button to view the climate control display.
2. Turn the interface knob to set the fan to the desired speed.
3. Push the interface selector down, then select  and fresh air mode.
4. Adjust the warmth of the air with the temperature control bars.

## Using the A/C

Air conditioning places an extra load on the engine. Watch the engine coolant temperature gauge (see page 70). If it moves near the red zone, turn off the A/C until the gauge reading returns to normal.

1. Press the A/C  button to view the climate control display.
2. Turn on the A/C by pushing ENTER on the interface selector. You will see A/C ON in the display.
3. Make sure the temperature is set to maximum cool.
4. Push the interface selector down, then select  by turning the interface knob.
5. If the outside air is humid, select recirculation mode. If the outside air is dry, select fresh air mode.
6. Push the interface selector down, then set the fan to the desired speed by turning the interface knob.

*If the interior is very warm, you can cool it down more rapidly by partially opening the windows, turning on the air conditioning, and setting the fan to maximum speed in fresh air mode.*

# Climate Control System

---

## Dehumidify the Interior



Air conditioning, as it cools, removes moisture from the air. When used in combination with the heater, it makes the interior warm and dry.

1. Switch the fan on.
2. Turn on the air conditioning.
3. Select  and fresh air mode.
4. Adjust the temperature to your preference.

This setting is suitable for all driving conditions whenever the outside temperature is above 32°F (0°C).



## To Defog and Defrost

To remove fog from the inside of the windows:

1. Set the fan to the desired speed, or high for faster defrosting.
2. Select . The system automatically switches to fresh air mode and turns on the A/C.
3. Adjust the temperature so the airflow feels warm.
4. Select  to help clear the rear window.
5. To increase airflow to the windshield, close the corner vents.

When you switch to another mode from , the A/C setting returns to the previous setting (on or off). Select A/C, then press ENTER on the interface selector to turn the A/C off if it is on.

## To Remove Exterior Frost or Ice From the Windows

1. Select . The system automatically switches to fresh air mode and turns on the A/C.
2. Select .
3. Set the fan and temperature controls to maximum level.

To clear the windshield faster, you can close the dashboard corner vents by rotating the wheel next to it. This sends more warm air to the windshield defroster vents. Once the windshield is clear, select the fresh air mode to avoid fogging the windows.

For your safety, make sure you have a clear view through all the windows before driving.

## Automatic Climate Control

The automatic climate control system adjusts the fan speed and airflow levels to maintain the interior temperature you select.

In AUTO mode, the vehicle's interior temperature is independently regulated for the driver and passenger. If the driver's side of the vehicle is getting too much sun, the system will adjust to a lower temperature.

1. Press the AUTO button.
2. Set the desired temperature with the temperature control bars.  
You will see AUTO in the display if the climate mode is selected.

The system automatically selects the proper mix of conditioned and/or heated air that will, as quickly as possible, raise or lower the interior temperature to your preference.

When you set the temperature to its lower or its upper limit, the system runs at full cooling or heating only. It does not regulate the interior temperature.

When you change the fan speed, the fan is taken out of AUTO mode and starts to run at the selected speed.

## Semi-automatic Operation

You can manually select various functions of the climate control system when it is in fully automatic mode. All other features remain automatically controlled. Making any manual selection causes the word AUTO in the display to go out.

## To Turn Everything Off

Press the OFF button. However, a lack of airflow can cause the windows to fog up. You should keep the fan on at all times so stale air and moisture do not build up in the interior and cause fogging.

## Climate Control Sensors

---

### Sunlight and Temperature Sensors

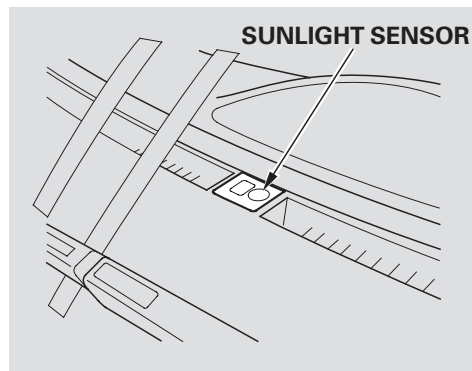

The climate control system has two sensors. A sunlight sensor is in the top of the dashboard, and a temperature sensor is next to the steering column. Do not cover the sensors or spill any liquid on them.

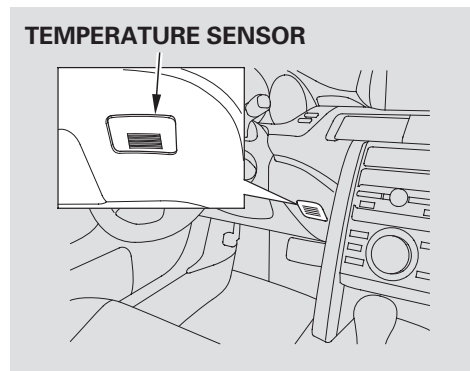

## Interface Dial

Most audio system functions can still be controlled by standard buttons, dials, and knobs, but some functions can only be accessed using the interface dial. The interface dial has two parts, a knob and a selector.

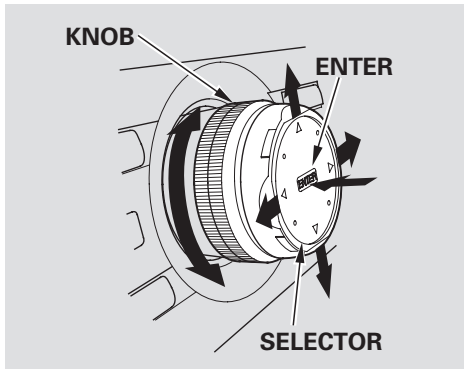

The knob turns left and right. Use it to make selections or adjustments to a list or menu on the screen.

The selector can be pushed left, right, up, down, and in. Use the selector to scroll through lists, to select menus, and to highlight menu items. When you make a selection, push the center of the selector (ENTER) to go to that selection.

## Personalization Setting

When you unlock the doors with your remote and turn the audio system on, the driver's ID (Driver 1 or Driver 2) is detected, and the radio preset memory (see page 210), the auto select preset memory (see page 211), and the volume and sound level settings (see page 214) are turned to the respective memorized mode automatically.

## Voice Control System

The audio system can also be operated by voice control.

*On models with navigation system*

See the Navi section in your Quick Start Guide for an overview of this system, and the Navigation System manual for complete details.

*On models without navigation system*

Refer to Voice Control Basics for complete details (see page 265).

# Audio System

## Playing the AM/FM Radio

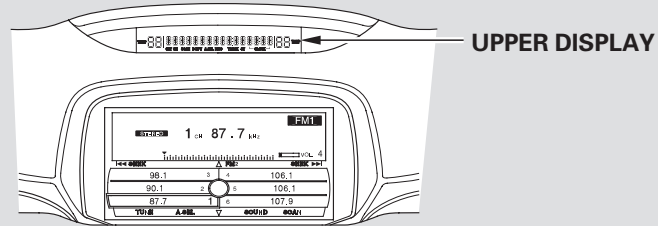

U.S. models (Technology package model is shown)

Canadian and Hawaiian models

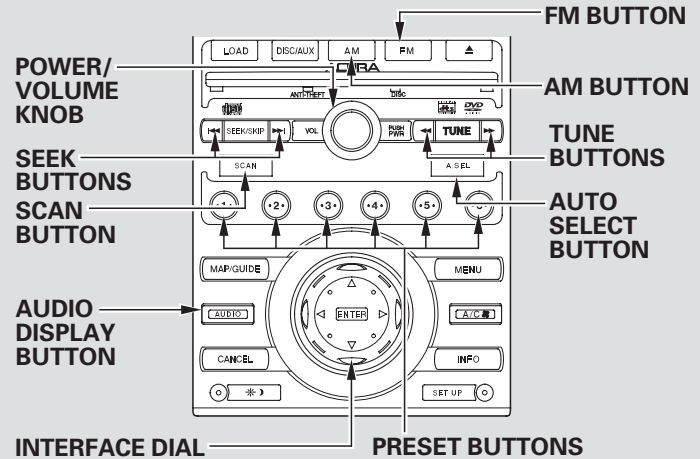
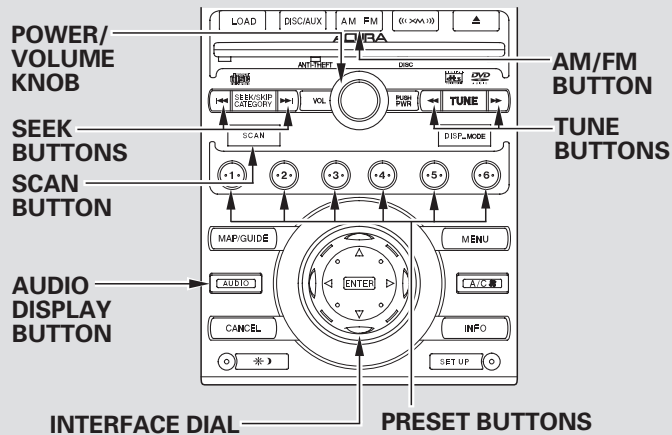

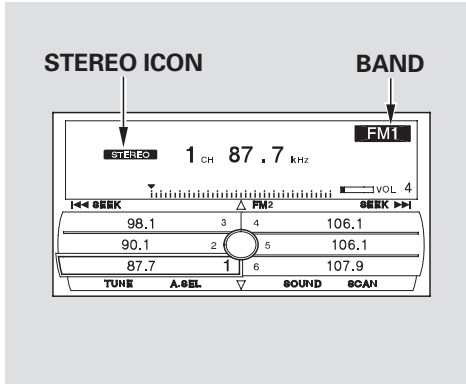

The ignition switch must be in the ACCESSORY (I) or the ON (II) position. Press the AUDIO button to view the audio control display. Turn the system on by pressing the power/volume knob or the AM/FM button (AM or FM button on Canadian and Hawaiian models). Adjust the volume by turning the power/volume knob.

The band and frequency that the radio was last tuned to are shown on the display. To change bands, press the AM/FM button (AM or FM button on Canadian and Hawaiian models). You can also change bands by pushing the interface selector up. Each time you push it up, the band will change to FM1, FM2, or AM. On the FM bands, STEREO will be shown on the navigation screen and ST on the upper display, if the station is broadcasting in stereo. Stereo reproduction on AM is not available.

### To Select a Station

You can use any of five methods to find radio stations on the selected band: **TUNE**, **SEEK**, **SCAN**, the preset buttons, and **AUTO SELECT**.

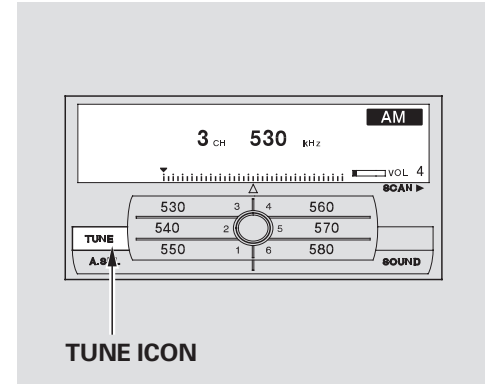

**TUNE** — Use the TUNE button to tune the radio to a desired frequency. Press the ►► button to tune to a higher frequency, or the ◀◀ button to tune to a lower frequency. To tune with the interface dial, push the selector down, and turn the knob to TUNE. Then press ENTER on the selector, and turn the knob to the desired frequency. To exit the TUNE mode, press ENTER on the selector.

*CONTINUED*



## Audio System

**SEEK** — The SEEK function searches up and down from the current frequency to find a station with a strong signal. To activate it, press the ◀◀ or ▶▶ SEEK button, then release it. You can also activate SEEK by pushing the interface selector to the right or left.

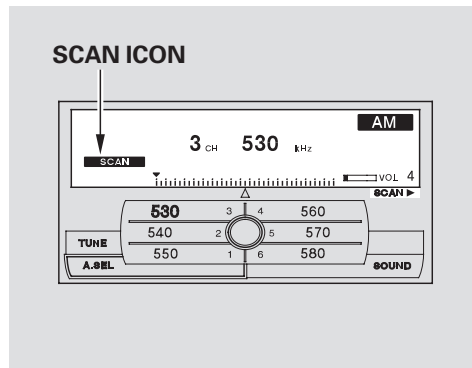

**SCAN** — The SCAN function samples all stations with strong signals on the selected band. To activate it, press the SCAN button, then release it.

To scan with the interface dial, push the selector down, and then push it to the right. You will see SCAN flashing on the screen and the upper display.

The system will scan for a station with a strong signal. When it finds one, it will stop and play that station for about 10 seconds. If you do nothing, the system will then scan for the next strong station and play it for 10 seconds. When it plays a station that you want to listen to, press the scan button again, or push the interface selector to the right again.

**Preset** — Each preset button or preset icon can store one frequency on AM and two frequencies on FM.

*To store a preset memory location:*

1. Select the desired band, AM or FM. FM1 and FM2 let you store two sets of FM frequencies with the preset buttons (on-screen icons).
2. Use the tune, seek, or scan function to tune the radio to a desired station.
3. Press the preset button, and hold it until you hear a beep. You can also store frequencies with the interface dial. Select the preset icon you want to store the frequency on, then press ENTER on the interface selector, and hold it for more than 2 seconds.
4. Repeat steps 1 through 3 to store a total of six stations on AM and twelve stations on FM.

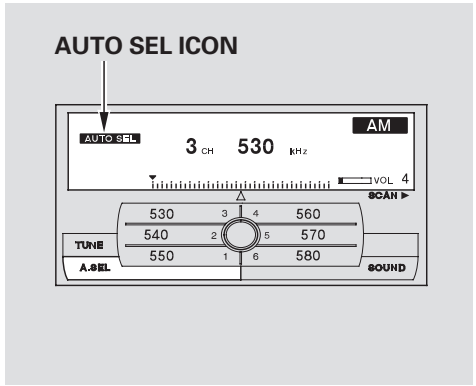

**AUTO SELECT** — If you are traveling far from home and can no longer receive your preset stations, you can use the auto select feature to find stations in the local area.

*U.S. models (except Hawaiian)*  
 Push the interface selector down to scroll down the screen, highlight A.SEL, then press ENTER on the interface selector. You will see A.SEL on the upper display and AUTO SEL on the screen, and the system goes into scan mode for several seconds.

*Canadian and Hawaiian models*  
 Press the A.SEL button. You will see A.SEL on the upper display AUTO SEL on the screen, and the system goes into scan mode for several seconds. The system stores the frequencies of six AM and twelve FM stations in the preset buttons.

You will see “0” displayed if auto select cannot find a strong station for every preset button. If you do not like the stations auto select has stored, you can store other frequencies on the preset buttons (icons) as previously described.

To turn off auto select, press ENTER on the interface selector (press the A.SEL button) again. This restores the presets you originally set.

# Audio System

---

## AM/FM Radio Frequencies

The radio can receive the complete AM and FM bands.

Those bands cover these frequencies:

AM band: 530 to 1,710 kHz

FM band: 87.7 to 107.9 MHz

Radio stations on the AM band are assigned frequencies at least 10 kHz apart (530, 540, 550). Stations on the FM band are assigned frequencies at least 0.2 MHz apart (87.9, 88.1, 88.3).

Stations must use these exact frequencies. It is fairly common for stations to round-off the frequency in their advertising, so your radio could display a frequency of 100.9 even though the announcer may identify the station as “FM101.”

## AM/FM Radio Reception

How well the radio receives stations is dependent on many factors, such as the distance from the station’s transmitter, nearby large objects, and atmospheric conditions.

A radio station’s signal gets weaker as you get farther away from its transmitter. If you are listening to an AM station, you will notice the sound volume becoming weaker, and the station drifting in and out. If you are listening to an FM station, you will see the stereo indicator flickering off and on as the signal weakens. Eventually, the stereo indicator will go off and the sound will fade completely as you get out of range of the station’s signal.

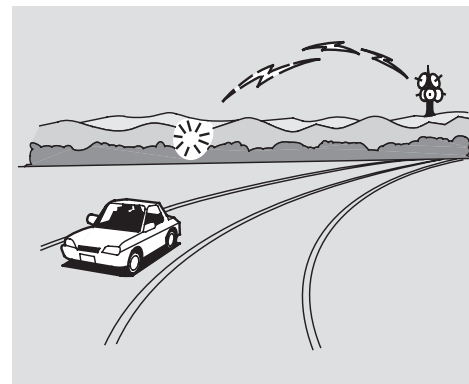

Driving very near the transmitter of a station that is broadcasting on a frequency close to the frequency of the station you are listening to can also affect your radio’s reception. You may temporarily hear both stations, or hear only the station you are close to.

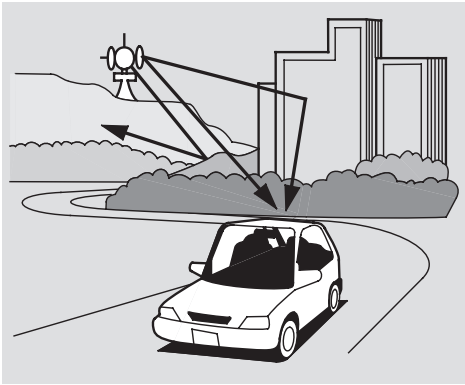

Radio signals, especially on the FM band, are deflected by large objects such as buildings and hills. Your radio then receives both the direct signal from the station's transmitter, and the deflected signal. This causes the sound to distort or flutter. This is a main cause of poor radio reception in city driving.



Radio reception can be affected by atmospheric conditions such as thunderstorms, high humidity, and even sunspots. You may be able to receive a distant radio station one day and not receive it the next day because of a change in conditions.

Electrical interference from passing vehicles and stationary sources can cause temporary reception problems.

*As required by the FCC:  
Changes or modifications not expressly  
approved by the party responsible for  
compliance could void the user's  
authority to operate the equipment.*

# Audio System

## Adjusting the Sound

BASS, TREBLE, BALANCE, and FADER are each adjustable. You can also adjust the strength of the sound coming from the center and subwoofer speakers. In addition, you can set the AudioPilot® and Centerpoint® features (when playing a CD-DA) to on or off.

To adjust them, press the AUDIO button, push the interface selector down, and turn the interface knob to SOUND. Then press ENTER on the selector.

Select the mode you want to adjust by pushing the interface selector up or down, or by turning the interface knob.

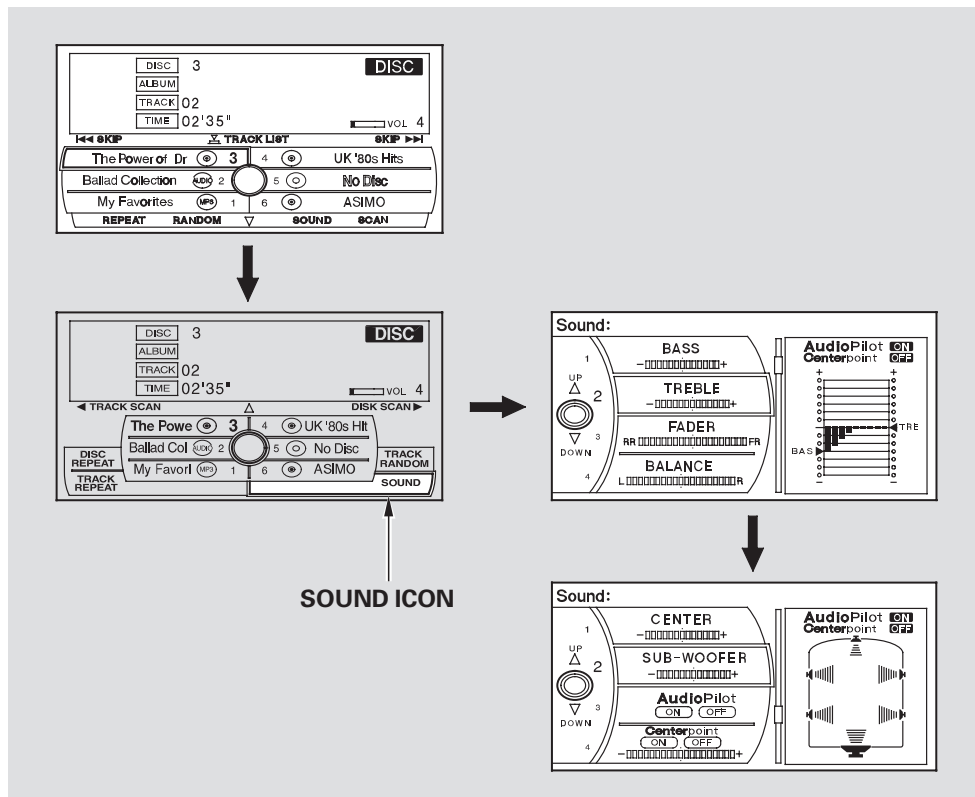

**BASS/TREBLE** — To adjust bass and treble, select BASS or TREBLE, and press ENTER on the interface selector. The current setting is shown on the display. Turn the interface knob to the desired level, and enter your selection by pressing ENTER on the interface selector.

**FADER/BALANCE** — These modes adjust the strength of the sound coming from each speaker. Fader adjusts the front-to-back strength, while balance adjusts the side-to-side strength. To adjust fader and balance, select FADER or BALANCE, then press ENTER on the interface selector. The current setting is shown on the screen. Turn the interface knob to the desired level, and enter your selection by pressing ENTER on the interface selector. To equalize the fader or balance, turn the interface knob until the marks on the sound grid come to the center of the adjustment bar.

**CENTER/SUBWOOFER** — To adjust the strength of the sound from the center or subwoofer speaker, select it and press ENTER on the interface selector. Turn the interface knob to the desired level, and enter your selection by pressing ENTER on the interface selector.

*CONTINUED*

## Audio System

---

**AudioPilot®** – Bose AudioPilot® digital processing monitors sound within the cabin, and helps compensate for unwanted ambient noise with no perceived change in audio volume.

To set this feature on or off, select AudioPilot, and press ENTER on the interface selector. Turn the interface knob to ON or OFF, and press ENTER on the interface selector. The ON or OFF indicator is shown on the screen.

**Centerpoint®** – Bose Centerpoint® signal processing processes stereo and matrix surround recordings to five independent channels, delivering a multi-channel surround sound experience, even from conventional stereo discs.

To set this feature on or off, select Centerpoint, and press ENTER on the interface selector. Turn the interface knob to ON or OFF, and press ENTER on the interface selector. The ON or OFF indicator is shown on the display.

**NOTE:** Centerpoint® is only available when listening to a CD (CD-DA).

AudioPilot® and Centerpoint® are registered trade marks of the Bose corporation.

## Playing the XM® Satellite Radio

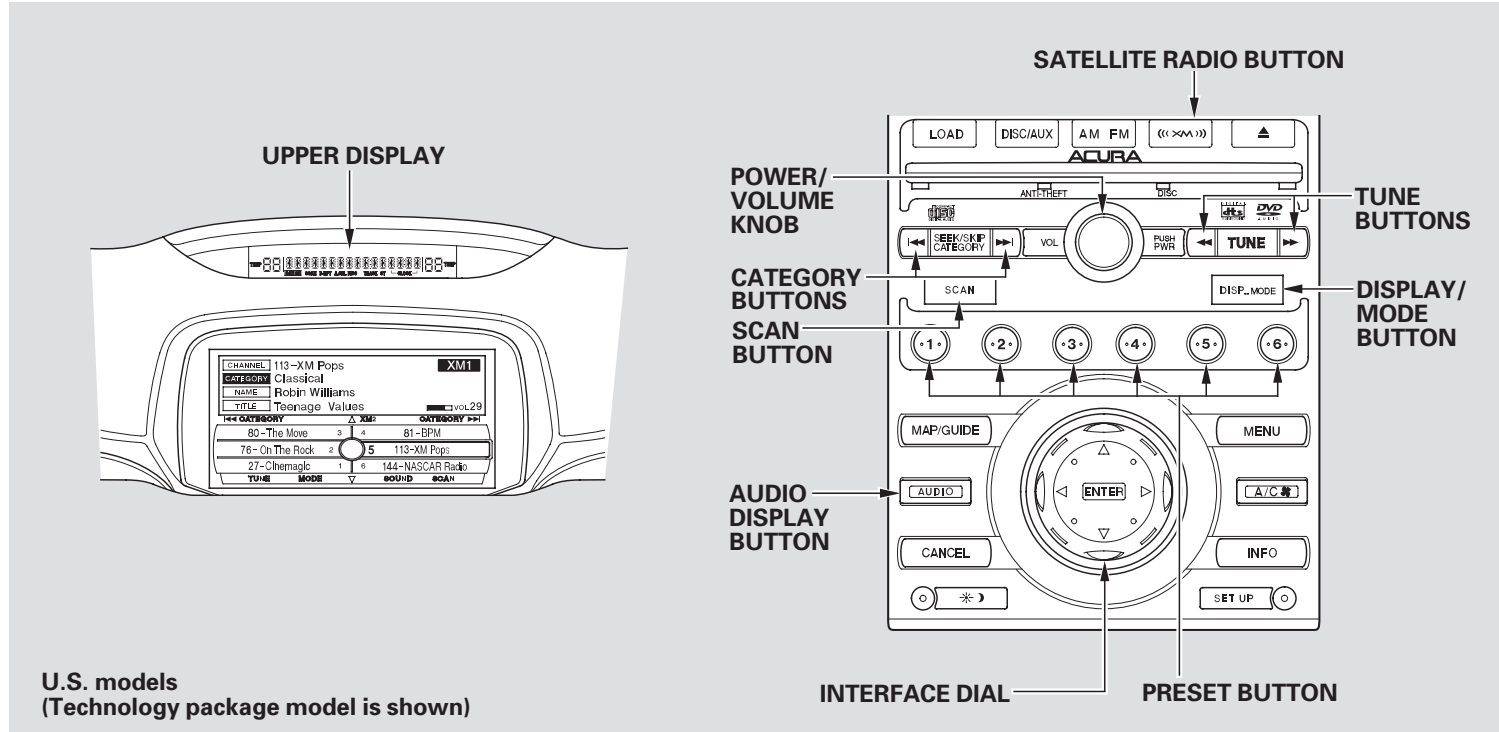

U.S. models  
(Technology package model is shown)

Features

CONTINUED



## Audio System

Your vehicle is capable of receiving XM<sup>®</sup> Satellite Radio anywhere in the United States, except Hawaii and Alaska.

XM<sup>®</sup> is a registered trade mark of XM Satellite Radio, Inc.

XM Satellite Radio receives signals from two satellites to produce clear, high-quality digital reception. It offers many channels in several categories. Along with a large selection of different types of music, XM Satellite Radio also allows you to view channel and category selections in the audio display.

To listen to XM satellite radio, turn the ignition switch to the ACCESSORY (I) or ON (II) position. Push the power/volume knob to turn on the audio system, and press the « XM » button. The last channel you listened to will show in the display. Adjust the volume by turning the power/volume knob.

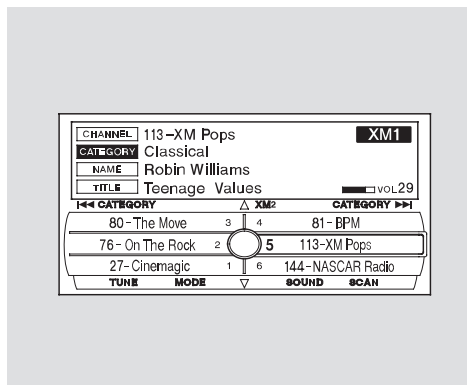

**MODE** — To switch between the category mode and channel mode, press and hold the DISP/MODE button until the mode changes. The CATEGORY or CHANNEL mode is displayed on the screen. To switch the mode with the interface dial, scroll down, select MODE, and press ENTER on the selector.

In the category mode, such as Jazz, Rock, Classical, etc., you can navigate through all of the channels within that category. In the channel mode, you can select all of the available channels.

You may experience periods when XM Satellite Radio does not transmit the artist's name and or the song title information. If this happens, there is nothing wrong with your system.

Push the AUDIO button to display XM information on the screen.

To change categories, press the CATEGORY button, or push the interface selector left or right.

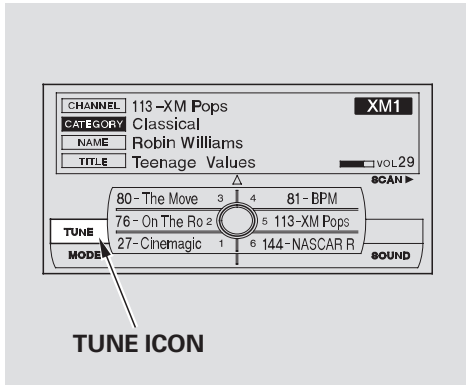

To change channels, press the **TUNE** button, or scroll down with the interface selector, select **TUNE**, and press **ENTER** on the selector. Then turn the interface knob to the desired channel. In the category mode, you can only select channels within that category.

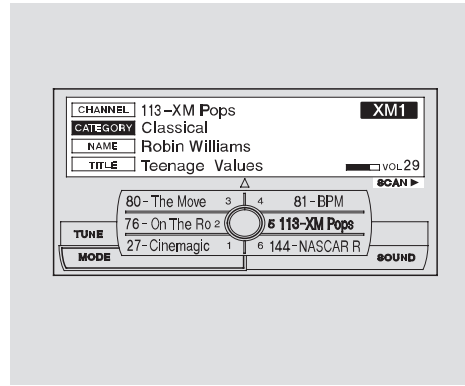

**SCAN** — The scan function gives you a sampling of all channels while in the channel mode. In the category mode, only the channels within that category are scanned. To activate **SCAN**, press the **SCAN** button. To scan with the interface dial, scroll down, and push interface selector to the right. You will see **SCAN** on the screen.

The system plays each channel in numerical order for a few seconds, then selects the next channel. When you hear a channel you want to continue listening to, press the **SCAN** button or push the interface selector to the right again.

*CONTINUED*

# Audio System

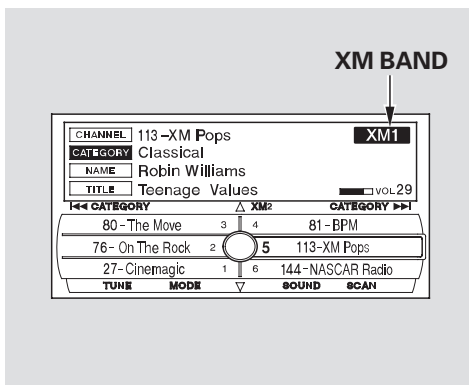

**Preset** — You can store up to 12 preset channels using the six preset buttons. Each button stores one channel from the XM1 band and one channel from the XM2 band.

To store a channel:

1. Press the «XM» button or scroll up by pushing the interface selector up. Either XM1 or XM2 will be shown on the display.

2. Use the TUNE or SCAN function to tune to a desired channel.

In category mode, only channels within that category can be selected. In channel mode, all channels can be selected.

3. Pick the preset button you want for that channel. Press and hold the button until you hear a beep.
4. Repeat steps 2 and 3 to store the first six channels.
5. Press the «XM» button or scroll up again. The other XM band will be shown. Store the next six channels using steps 2 and 3.

Once a channel is stored, press and release the proper preset button to tune to it.

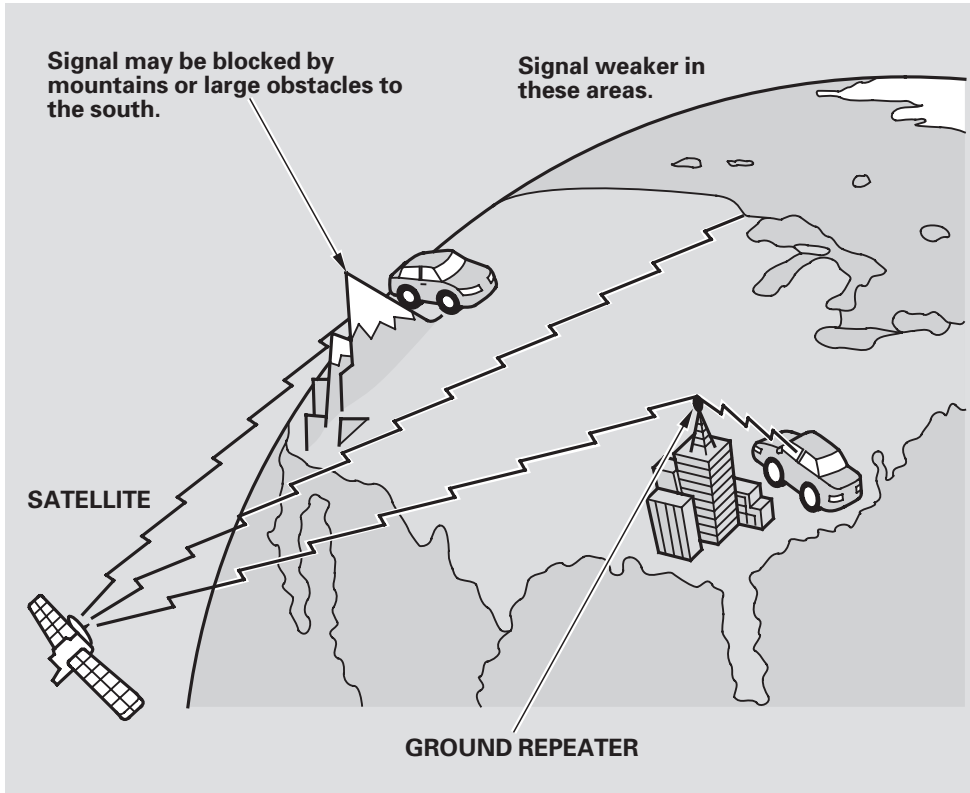

The XM satellites are in orbit over the equator; therefore, objects south of the vehicle may cause satellite reception interruptions. To help compensate for this, ground-based repeaters are placed in major metropolitan areas.

Satellite signals are more likely to be blocked by tall buildings and mountains the farther north you travel from the equator.

### ***Operation of RL model in Alaska***

Because XM is unavailable in Alaska, the XM hardware equipped with your vehicle cannot be operated.

CONTINUED

## Audio System

---

Depending on where you drive, you may experience reception problems. Interference can be caused by any of these conditions:

- Driving on the north side of an east/west mountain road.
- Driving on the north side of a large commercial truck on an east/west road.
- Driving in tunnels.
- Driving on a road beside a vertical wall, steep cliff, or hill to the south of you.
- Driving on the lower level of a multi-tiered road.
- Driving on a single lane road alongside dense trees taller than 50 ft. (15 m) to the south of you.

There may be other geographic situations that could affect satellite radio reception.

*As required by the FCC:  
Changes or modifications not expressly approved by the party responsible for compliance could void the user's authority to operate the equipment.*

### **Receiving XM Satellite Radio Service**

If your XM Radio service has expired or you purchased your vehicle from a previous owner, you can listen to a sampling of the broadcasts available on XM Satellite Radio. With the ignition switch in the ACCESSORY (I) or the ON (II) position, push the power/volume knob to turn on the audio system, and press the «» button. A variety of music types and styles will play.

If you decide to purchase XM Satellite Radio service, contact XM Radio at [www.xmradio.com](http://www.xmradio.com), or at 1-800-852-9696. You will need to give them your radio I.D. number and your credit card number. To get your

radio I.D. number, press the TUNE bar until “0” appears in the display. Your I.D. will appear in the display.

After you've registered with XM Radio, keep your audio system in the Satellite Radio mode while you wait for activation. This should take about 30 minutes.

While waiting for activation, make sure your vehicle remains in an open area with good reception. Once your audio system is activated, “category” or “CH” will appear in the display, and you'll be able to listen to XM Radio broadcasts. XM Radio will continue to send an activation signal to your vehicle for at least 12 hours from the activation request. If the service has not been activated after 36 hours, contact XM Radio.

## Operating the Disc Changer

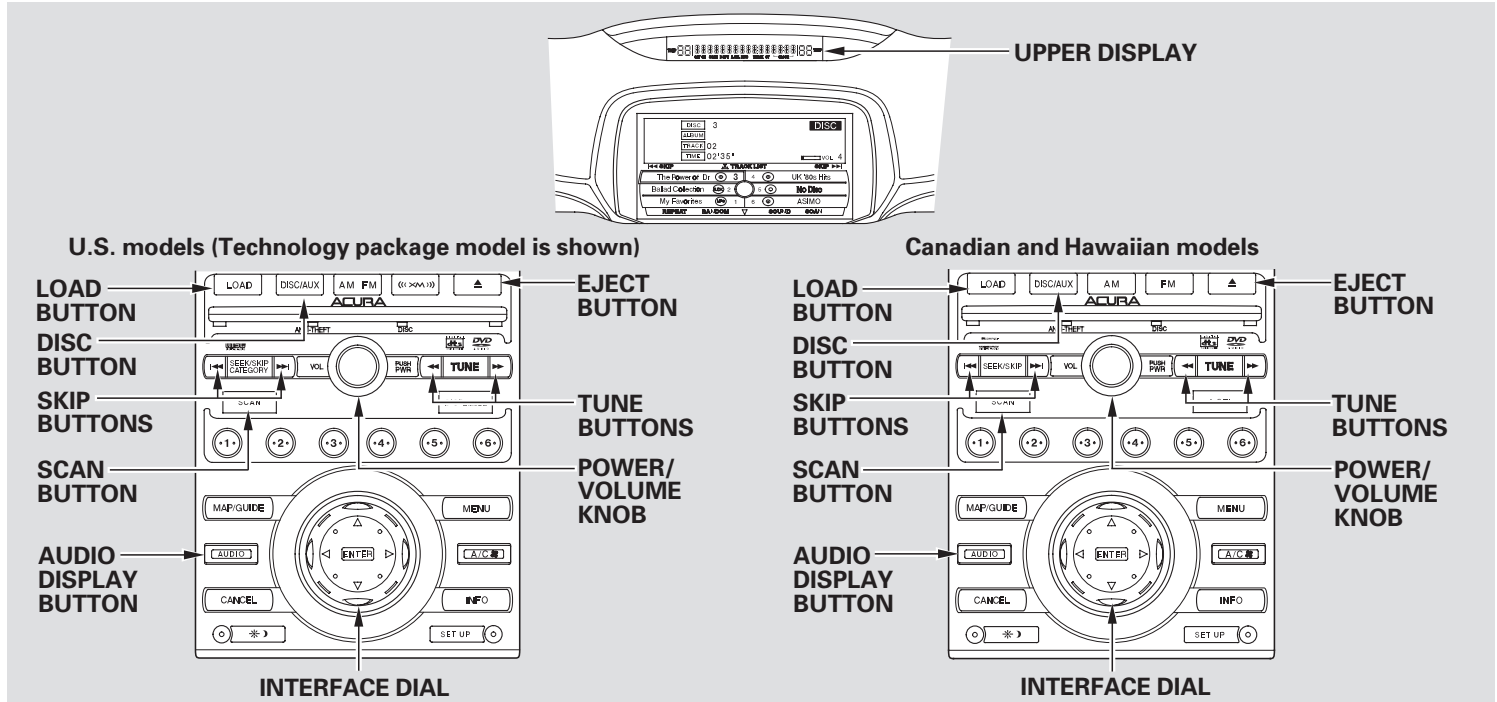

Features

CONTINUED

## Audio System

Your vehicle's audio system has an in-dash disc changer with the same controls used for the radio. To operate the disc changer, the ignition switch must be in the ACCESSORY (I) or the ON (II) position.

The disc changer can play these disc formats:

- CD (CD-DA)
- CD-R/RW
- DVD-A
- DTS™

The disc packages or jackets should have one of these marks.



The changer can also play MP3 or WMA format (see page [230](#) ).

DVD-A discs not meeting DVD verification standards may not be playable.

The changer cannot play DVD-V or DVD-R/RW formats.

Some CD-DA and CD-ROM mixed discs are not playable.

“DTS” and “DTS Digital Surround” are registered trademarks of Digital Theater Systems, Inc.

You cannot load and play 3-inch (8-cm) discs in this system.

### NOTICE

*Do not use discs with adhesive labels. The label can curl up and cause the disc to jam in the unit.*

## Loading Discs in the Changer

To load multiple discs in one operation:

1. Press and hold the LOAD button on the changer unit until you hear a beep. You will see “BUSY” on the upper display, and the disc load indicator turns red and starts blinking.
2. Insert the disc into the disc slot when the disc load indicator turns green and “LOAD” appears in the upper display at the same time. Insert it only halfway; the drive will pull it in the rest of the way. You will see “BUSY” on the upper display, and the disc load indicator turns red again and blinks as the disc is loaded.
3. When the disc load indicator turns green and “LOAD” appears on the upper display again, insert the next disc in the slot.

Do not try to insert a disc until “LOAD” appears. You could damage the audio unit.

4. Repeat steps 1 through 3 until all six positions are loaded. If you are not loading all six positions, press the LOAD button again after the last disc has loaded.

If you stop loading discs before all six positions are filled, the system will wait for 10 seconds, stop the load operation, and begin playing the last disc loaded.

To load a single disc:

1. Press and release the LOAD button on the changer unit. You will see “BUSY” on the upper display, and the disc load indicator turns red and starts blinking.

2. Insert a disc into the disc slot when the disc load indicator turns green, and “LOAD” appears on the upper display at the same time. Insert the disc only about halfway; the drive will pull it in the rest of the way. You will see the disc number blinking on the upper display, and the disc load indicator turns red again and blinks as the disc is loaded.

Do not try to insert a disc until “LOAD” appears. You could damage the audio unit.

3. You will see “DISC READ” on the upper display, then the system begins to play the disc.

*CONTINUED*



## Audio System

---

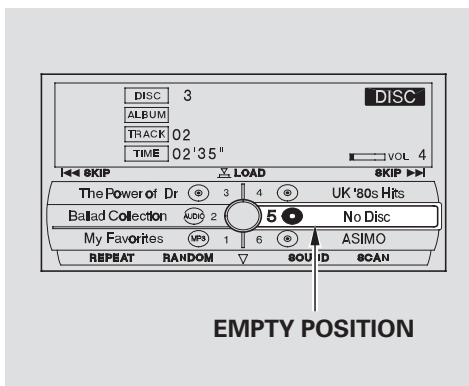

You can load a disc into an empty position while a disc is playing. Press the AUDIO button to view the audio control display. Select the empty position (“No Disc” is shown on the audio control display) by rotating the interface dial. Then press ENTER on the selector to enter your selection. The current disc stops playing and starts the loading sequence. The disc just loaded will play.

You can also select the empty position by pressing the appropriate preset button.

You can load a disc(s) in any mode (AM, FM, XM radio, or AUX) if you do not select an empty position.

You cannot select the empty position if there is no disc in the changer.

## To Play a Disc

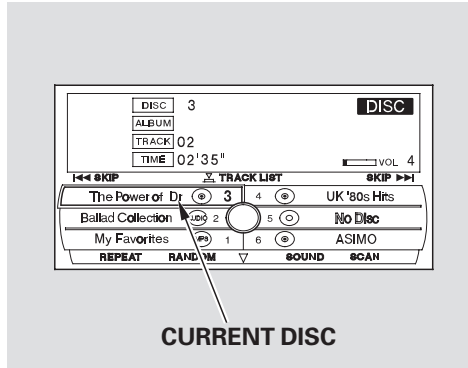

Select the changer by pressing the DISC/AUX button. The system will begin playing the last selected disc in the disc changer. You will see the current disc position highlighted.

To select a different disc, press the corresponding number on the preset buttons, or turn the interface knob to highlight the desired disc, then press ENTER on the interface selector.

When playing a CD (CD-DA) with CD-TEXT, the audio control display shows the disc number, album name, track number, and elapsed time. When playing a CD without this information, the number of the disc and track playing and the elapsed time are shown on the audio control display.

## To Change Tracks

Each time you press and release the ►► button or push the interface selector to the right, the player skips forward to the beginning of the next track. Press and release the ◄◄ button or push the interface selector to the left to skip backward to the beginning of the current track. Press the ◄◄ button or push the interface selector to the left again to skip to the previous track. To move rapidly within a track, press and hold the ◄◄ / ◄◄ or ►► / ►► button.

## To Choose a Track

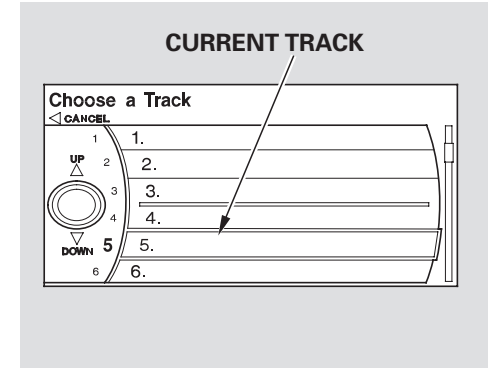

You can also choose a track directly from a track list. Press ENTER on the interface selector, and the track list screen will be shown. If there are no track names, track numbers are displayed. You will see the current track is highlighted. Turn the interface knob to select the desired track, then press ENTER on the interface selector.

CONTINUED

# Audio System

To exit the track list display, press the AUDIO button, or push the interface selector to the left.

## Track Scan

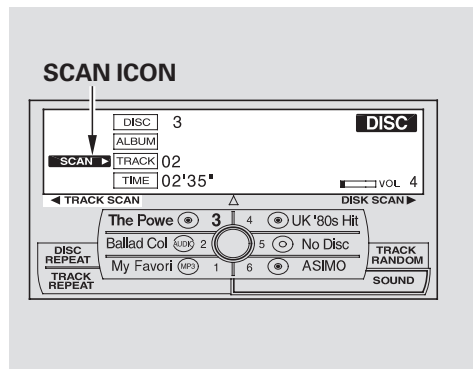

When you press the SCAN button or scroll down and push the interface selector to the left, the next track of the current track plays for about 10 seconds. You will see SCAN next to TRACK on the screen and SCAN on the upper display. To hear the rest of the track, press the SCAN button or

push the interface selector to the left again within 10 seconds.

If you don't, the system advances to the next track, plays about 10 seconds of it, and continues through the rest of the tracks the same way.

## Disc Scan

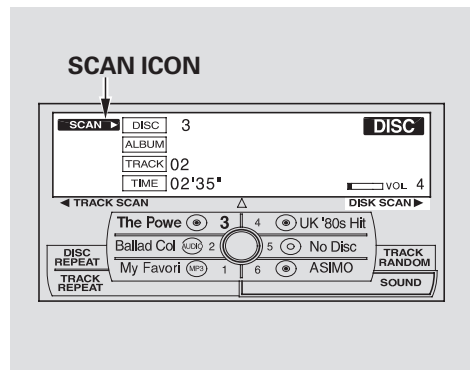

When you press and hold the SCAN button until you hear a beep or scroll down and push the interface selector to the right, the first track of the

current disc plays for about 10 seconds. You will see SCAN next to DISC on the screen and SCAN on the upper display. To hear the rest of the disc, press the SCAN button or push the interface selector to the right again within 10 seconds.

If you don't, the system advances to the next disc, plays about 10 seconds of it, and continues through the rest of the discs the same way. When the system reaches the last disc, DISC SCAN is canceled, and the disc plays normally.

## Track Repeat

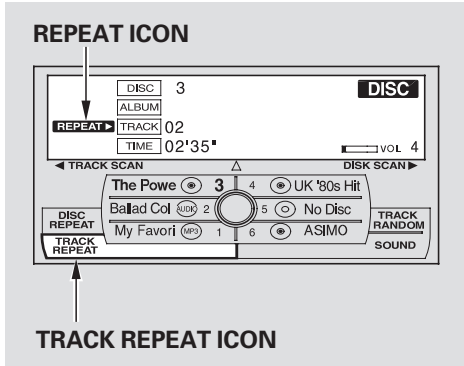

To replay the current track continuously, use the interface selector to scroll down, select **TRACK REPEAT**, and press **ENTER** on the interface selector. As a reminder, you will see **REPEAT** next to **TRACK** on the screen. To turn this feature off, highlight **TRACK REPEAT** (if not already highlighted), and press **ENTER** on the interface selector again.

## Disc Repeat

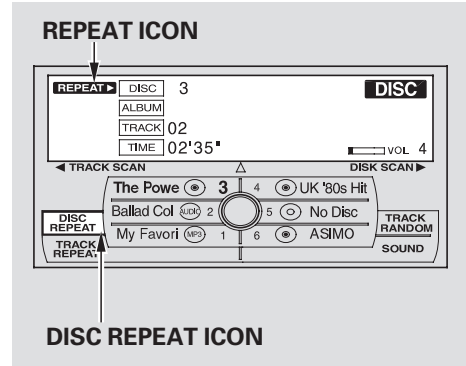

To replay the current disc continuously, use the interface selector to scroll down, select **DISC REPEAT**, and press **ENTER** on the interface selector. As a reminder, you will see **REPEAT** next to **DISC** on the screen. To turn this feature off, highlight **DISC REPEAT** (if not already highlighted), and press **ENTER** on the interface selector again.

## Random Play

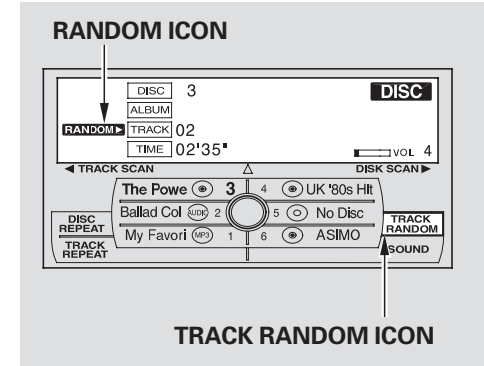

To play the tracks of the current disc in random order, use the interface selector to scroll down, select **TRACK RANDOM**, and press **ENTER** on the interface selector. As a reminder, you will see **RANDOM** next to **TRACK** on the screen. To turn this feature off, highlight **TRACK RANDOM** (if not already highlighted), and press **ENTER** on the interface selector again.

## Audio System

---

### To Pause a Disc

To pause a disc, press the corresponding number of the current disc on the preset buttons. To play the disc again, press the preset button again.

You can also pause a disc on the audio control display. Press the AUDIO button to view the display, select the corresponding number of the current disc on the preset icons by turning the interface knob, then press ENTER on the interface selector. To play the disc again, select the preset icon, then press ENTER again.

### To Stop Playing a Disc

If you turn the system off while a disc is playing, either with the power/volume knob or by turning off the ignition switch, the disc will stay in the drive. When you turn the system back on, the disc will begin playing where it left off.

To take the system out of disc mode, press the AM/FM (AM or FM on Canadian, and Hawaiian models), or DISC/AUX, or «>» button to switch to the radio, or satellite radio (U.S. models only), or auxiliary input while a disc is playing. When you return to disc mode by pressing the DISC/AUX button, play will continue at the same point that it left off.

### Playing a DVD-A Disc

You can play a DVD-A disc in the disc changer. The disc controls are same as previously described.

### Playing an MP3/WMA Disc

The changer plays MP3/WMA discs in recorded order. Maximum playable file layers are 8, and total playable tracks are 255. If your disc has a complex structure, the changer takes some time to read the disc before beginning play.

The specifications of the compatible MP3 file are:  
Sampling frequency: 32/44.1/48 kHz  
(MPEG1)  
24/22.05/16 kHz (MPEG2)  
Bit rate: 32/40/48/56/64/80/96/  
112/128/160/192/224/256/320 kbps  
(MPEG1)  
8/16/24/32/40/48/56/64/80/96/  
112/128/160 kbps (MPEG2)  
Compatible with variable bit rate and multi-session

The specifications of the compatible WMA file are:  
Sampling frequency: 32/44.1/48 kHz  
Bit rate: 48/64/80/96/128/160/192 kbps  
Compatible with variable bit rate and multi-session

To play an MP3/WMA disc, use the disc controls previously described, along with the following information.

## ***Name Display Function***

*U.S. models except Hawaiian*

Each time you press the DISP/MODE button while playing a CD (CD-DA), the center display changes from album name, to track name, to artist name, and then to normal display. If the disc was not recorded with CD-TEXT, "NO INFO" will be shown on the center display.

When playing a CD compressed in MP3/WMA format, the display changes from folder name, to file name, to track tag, to artist tag, to album tag, and then to normal display each time you press the DISP/MODE button. If the disc was not recorded with this information, "NO INFO" will be shown on the center display.

If the title is too long, it will not show all at once. Press and hold the DISP/MODE button, and the rest of the title will show on the center display.

You will also see the album and track name (CD-TEXT), or the folder and file name (MP3/WMA) under these conditions:

- When you insert a disc, and the system begins to play.
- Each time a new track, file, or folder plays.

*CONTINUED*

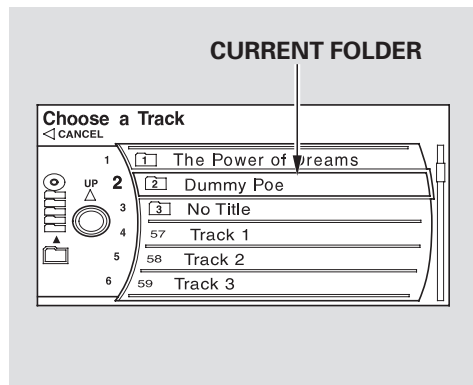

To enter the FOLDER LIST, press ENTER on the selector, select a folder by turning the interface knob, then press ENTER on the selector. If you want to move to the parent folder, push the selector up. If there are no folder names, “No Title” is displayed. You will see the current folder highlighted.

## Folder Repeat (MP3/WMA Mode)

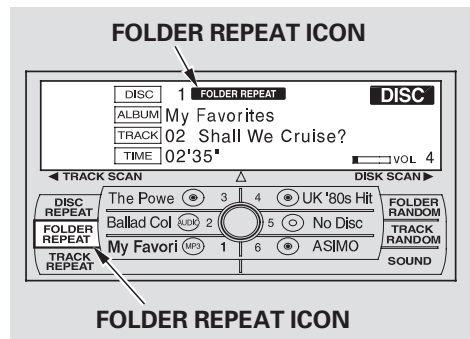

To replay the current folder continuously, use the interface selector to scroll down, select FOLDER REPEAT with the interface knob, and press ENTER on the interface selector. As a reminder, you will see FOLDER REPEAT next to the disc number on the screen. To turn this feature off, highlight FOLDER REPEAT (if not already highlighted), and press ENTER on the selector again.

## Folder Random (MP3/WMA Mode)

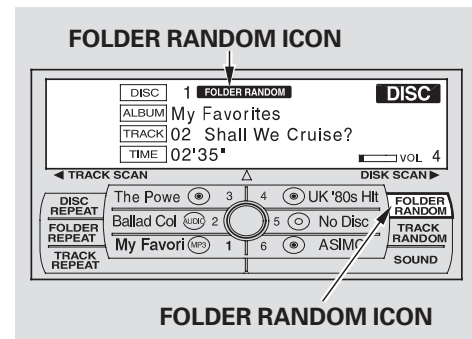

To play the tracks of the current folder in random order, use the interface selector to scroll down, select FOLDER RANDOM with the interface knob, and press ENTER on the interface selector. As a reminder, you will see FOLDER RANDOM next to the disc number on the screen. To turn this feature off, highlight FOLDER RANDOM (if not already highlighted), and press ENTER on the selector again.

## Removing Discs from the Changer

To remove the disc that is currently playing, press and release the eject (  ) button. You will see “EJECT” on the upper display. When you remove the disc from the slot, the system begins the load sequence so you can load another disc in that position. If you do not load another disc within 10 seconds, the system selects the previous mode [AM, FM1, FM2, or XM Radio (U.S. models except Hawaiian)].

If you do not remove the disc from the slot, the system will reload the disc after 10 seconds and put the disc changer in pause mode. To begin playing the disc, press the DISC/AUX button.

To remove a different disc from the changer, first select it by pressing the corresponding number on the preset button or turning the interface knob, and pressing ENTER on the interface selector. When that disc begins playing, press the eject button.

When you press the eject button while listening to the radio, or with the audio system turned off, the disc that was last selected is ejected. After that disc is ejected, pressing the eject button again will eject the next disc in numerical order. By doing this six times, you can remove all the discs from the changer.

You can also eject discs when the ignition switch is off:

To eject one disc, press and release the eject button.

To eject all discs, press and hold the eject button.



## Disc Changer Error Messages

---

The chart on the right explains the error messages you may see in the display while playing a disc.

If you see an error message in the display while playing a disc, press the eject button. After ejecting the disc, check it for damage or deformation. If there is no damage, insert the disc again.

The audio system will try to play the disc. If there is still a problem, the error message will reappear. Press the eject button, and pull out the disc.

Insert a different disc. If the new disc plays, there is a problem with the first disc. If the error message cycle repeats and you cannot clear it, take your vehicle to a dealer.

Error Message	Cause	Solution
DISC	FOCUS Error	Press the disc eject button, and remove the disc(s). Check for an error indication. For more information, see page 235. Insert the disc(s) again. If the code does not disappear or the disc(s) cannot be removed, consult your dealer.
ERROR	Mechanical Error	Press the disc eject button, and remove the disc(s). Check for an error indication. For more information, see page 235. Insert the disc(s) again. If the code does not disappear or the disc(s) cannot be removed, consult your dealer.
HOT	High Temperature	Will disappear when the temperature returns to normal.

### General Information

- When using CD-R or CD-RW discs, use only high quality discs labeled for audio use.
- When recording a CD-R or CD-RW, the recording must be closed for it to be used by the disc changer.
- Play only standard, round, 5-inch (12 cm) discs. Smaller or odd-shaped discs may jam in the drive or cause other problems.
- Handle your discs properly to prevent damage and skipping.

### Protecting Discs

When a disc is not being played, store it in its case to protect it from dust and other contamination. To prevent warpage, keep discs out of direct sunlight and extreme heat.

To clean a disc, use a clean soft cloth. Wipe across the disc from the center to the outside edge.

A new disc may be rough on the inner and outer edges. The small plastic pieces causing this roughness can flake off and fall on the recording surface of the disc, causing skipping or other problems. Remove these pieces by rubbing the inner and outer edges with the side of a pencil or pen.

Never try to insert foreign objects in the disc changer.

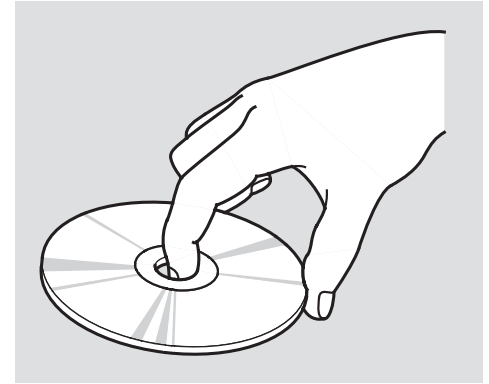

Handle a disc by its edges; never touch either surface. Do not place stabilizer rings or labels on the disc. These, along with contamination from finger prints, liquids, and felt-tip pens, can cause the disc to not play properly, or possibly jam in the drive.

# Protecting Your Discs

## Additional Information of Recommended Discs

The in-dash disc player/changer has a sophisticated and delicate mechanism. If you insert a damaged disc as indicated in this section, it may become stuck inside and damage the audio unit.

Examples of these discs are shown to the right:

### 1. Bubbled, wrinkled, labelled, and excessively thick discs

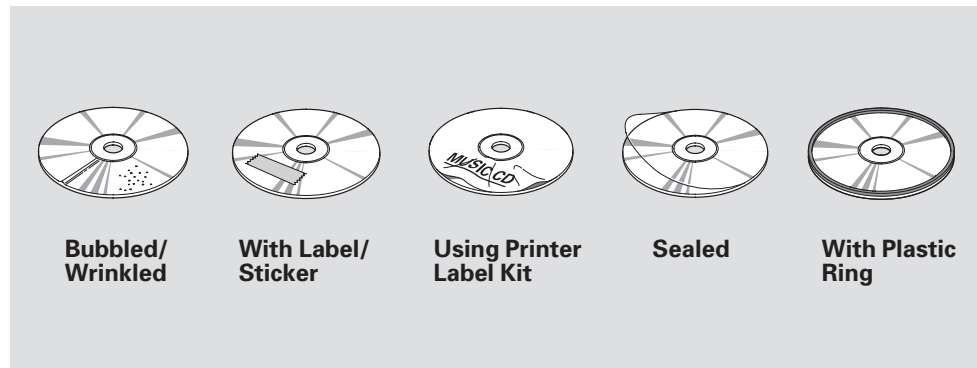

### 2. Damaged discs

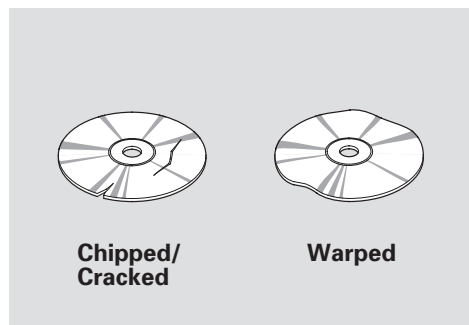

### 3. Poor quality discs

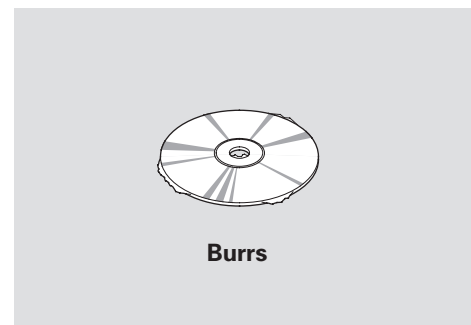

## 4. Small, irregular shaped discs

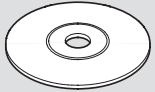

**3-inch (8-cm) CD**

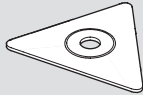

**Triangle Shape**

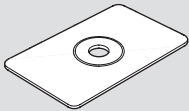

**Can Shape**

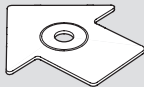

**Arrow Shape**

## 5. Discs with scratches, dirty discs

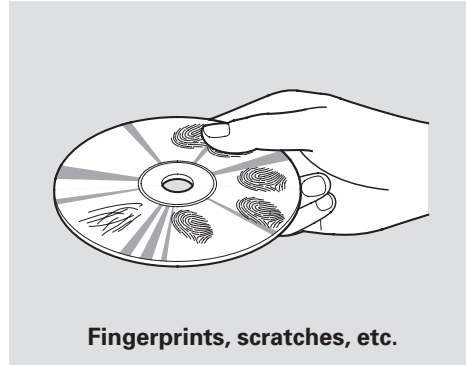

**Fingerprints, scratches, etc.**

- CD-R or CD-RW may not play due to the recording conditions.
- Scratches and fingerprints on the discs may cause the sound to skip.

- Recommended discs are printed with the following logo.



- Audio unit may not play the following formats.



## Auxiliary Input Jack

---

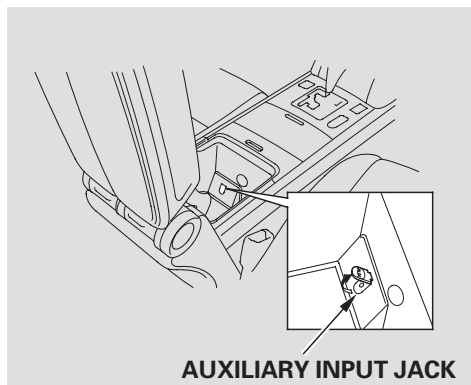

The auxiliary input jack is in the console compartment (see page 191). The system will accept auxiliary input from standard audio accessories using a standard 1/8-inch miniplug.

Connect a compatible audio unit to the jack, then select it by pressing DISC/AUX button.

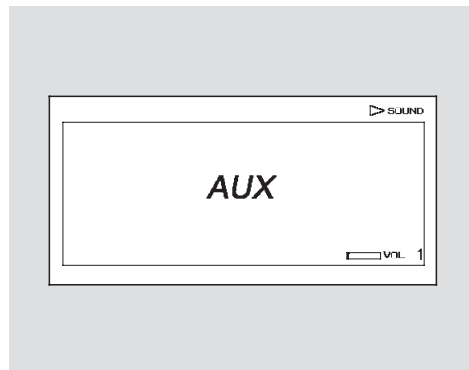

When a compatible audio unit is selected, you will see "AUX" on the display.

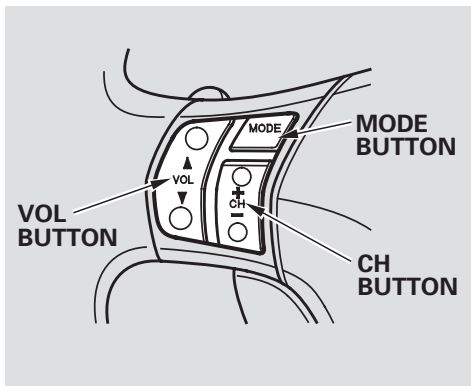

Three controls for the audio system are mounted in the steering wheel hub. These let you control basic functions without removing your hand from the wheel.

The VOL button adjusts the volume up (▲) or down (▼). Press the top or bottom of the button, hold it until the desired volume is reached, then release it.

The MODE button changes the mode. Pressing the button repeatedly selects FM1, FM2, AM, XM Satellite Radio (U.S. models except Hawaiian), or a disc (if a disc is loaded).

If you are listening to the radio, use the CH button to change stations. Each time you press the top (+) of the button, the system goes to the next preset station on the band you are listening to. Press the bottom (-) to go back to the previous station.

To activate the seek function, press and hold the top (+) or bottom (-) of the CH button until you hear a beep. The system searches up or down from the current frequency to find a station with a strong signal.

If you are playing a disc, the system skips to the beginning of the next track/file (in MP3/WMA mode) each time you press the top (+) of the CH button. Press the bottom (-) to return to the beginning of the current track/file. Press it again to return to the previous track/file.

To select a different disc (folder in MP3/WMA mode), press and hold the top (+) or bottom (-) of the CH button until you hear a beep.

*CONTINUED*

## Remote Audio Controls

---

*On U.S. models except Hawaiian*

If you are listening to XM Satellite Radio, use the CH button to change channels. Each time you press the top (+) of the button, the system goes to the next preset channel. Press the bottom (–) to go back to the previous preset channel.

To select a different channel of the category you are listening to, press and hold the top (+) or bottom (–) of the CH button until you hear a beep.

Your vehicle's audio system may disable itself if it is disconnected from electrical power for any reason. To make it work again, you must enter a specific five-digit code with the preset buttons. Because there are hundreds of number combinations possible from the five digits, making the system work without knowing the exact code is nearly impossible.

You should have received a radio code card that lists your audio system's code and serial numbers. It is best to store this card in a safe place at home. In addition, you should write the audio system's serial number in this owner's manual.

If you lose the card, you must obtain the code number from your dealer. To do this, you will need the audio system's serial number.

If your vehicle's battery is disconnected or goes dead, or the radio fuse is removed, the audio system will disable itself. If this happens, you will see "ENTER CODE" in the upper display the next time you turn on the system. Use the preset buttons to enter the code. The code is located on the radio code card included in your owner's manual kit. When it is entered correctly, the radio will start playing.

If you make a mistake entering the code, do not start over; complete the five-digit sequence, then enter the correct code. You have 10 tries to enter the correct code.

If the code card is lost, your dealer can access your code with your radio's serial number. To access the serial number, turn the radio on. It must display "ENTER CODE", then turn the radio off. Push and hold the preset 1 and preset 6 buttons, then

push the power/volume knob. The serial number will appear in two sets of four digits.

The system will retain your AM and FM presets even if power is disconnected.



## Compass System (U.S. model without navigation system)

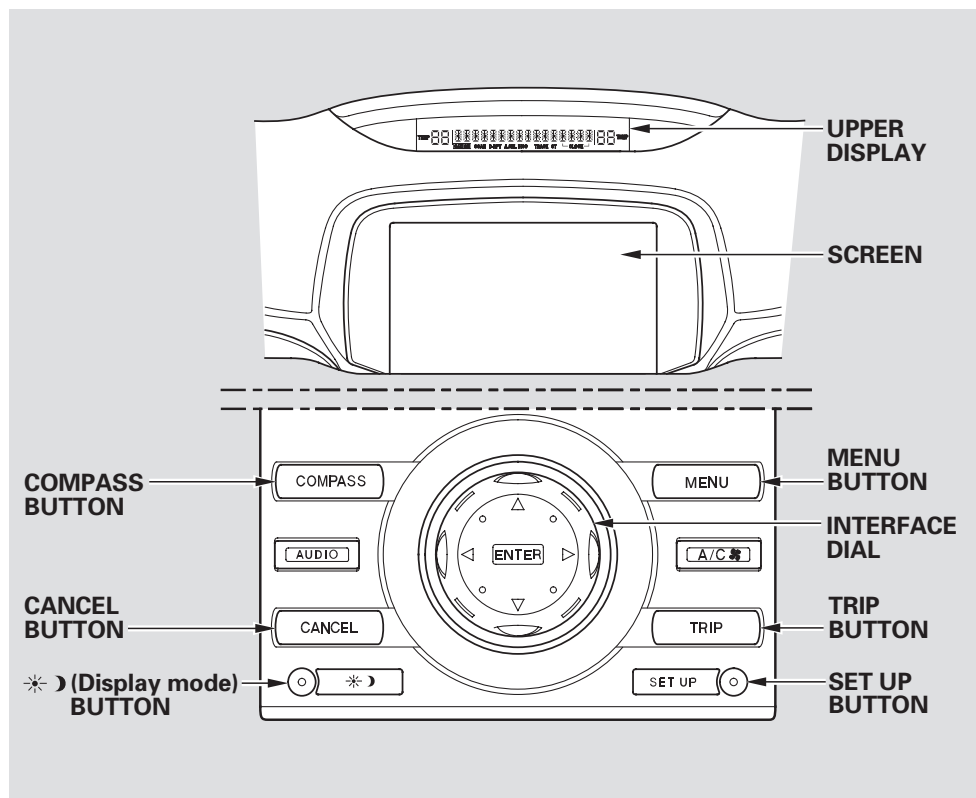

The compass system in your vehicle contains several convenient features, including a direction and elevation finder, a calendar reminder for important events, a calculator, and a trip computer to help you track your mileage and fuel economy.

### System Controls

The controls for the compass system are on the center console panel. These controls are also used to operate the climate control system (see page 198) and the audio system (see page 208).

#### *Compass Button*

Press this button to display the **Compass** screen (see page 247).

#### *Menu Button*

Press this button to display the **Main Menu** screen (see page 248) for the trip computer, calendar, calculator, and voice command Help.

# Compass System (U.S. model without navigation system)

## **Trip Button**

Press this button to display the **Trip Computer** screen (see page 249).

## **Set Up Button**

Press the button to display the set up screen (see page 254) to change and update information in the system.

## **☀ ☾ (Display Mode) Button**

This button switches the display between day mode, night mode, and off (see page 258).

## **Cancel Button**

Press this button to cancel the current screen and return to the previous screen.

## **Interface Dial**

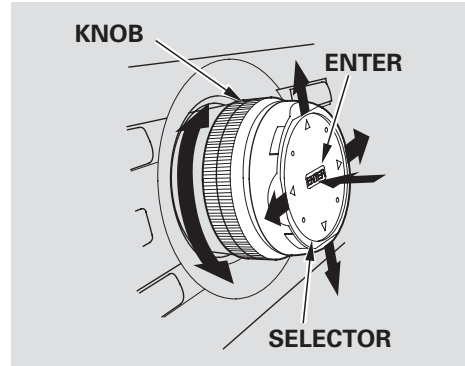

Most functions of the compass system can be accessed with the interface dial. The interface dial has two parts: a knob and a selector.

The knob turns left and right. Use it to make selections or adjustments to a list or menu on the screen.

The selector can be pushed left, right, up, down, and in. Use the selector to scroll through lists, to

select menus, and to highlight menu items. When you make a selection, push the center of the selector in (ENTER) to go to that selection.

In almost all cases, you can enter a selection into the system by pushing in on the interface selector.

## **Screen**

All selections and instructions are displayed on the screen.

Clean the screen with a soft damp cloth. You may use a mild cleanser intended for use on liquid crystal displays (LCDs). Harsher chemicals may damage the screen.

## **Upper Display**

Shows the radio band, frequency, volume, the climate control status, and the time.

## Compass System (U.S. model without navigation system)

### System Start-up

Throughout the compass system section, the icon “” is used to indicate features that are dependent on the “Driver number” as displayed on the multi-information display “Welcome” display.

When you turn the ignition switch to the ON (II) position, the compass system boots up within a few seconds.

The first screen to appear is the compass system globe screen. The screen then changes to the disclaimer screen:

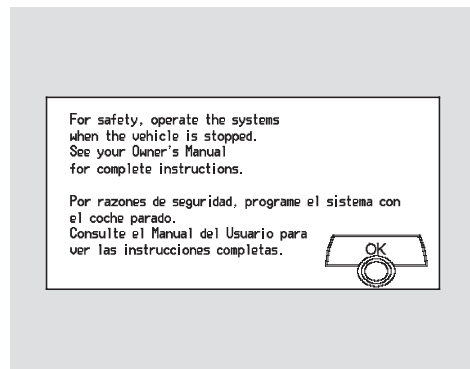

### NOTE:

- The **OK** button does not appear immediately. It appears after the system is loaded. The OK command cannot be activated by voice.

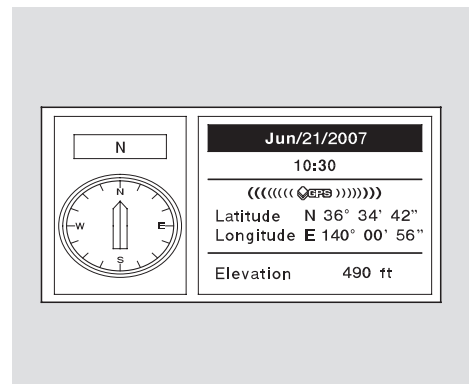

Please read the disclaimer carefully before you continue. To go to the compass screen, select OK by pushing in the interface selector.

## Compass System (U.S. model without navigation system)

If you do not push in on the **interface selector**, the screen will go dark after 30 seconds. To return to the disclaimer screen, press any compass or voice control button.

**NOTE:** If you do not select **OK**, and then enter the Set up or Trip computer screens, some items are not available, and will show up as darkened buttons (grayed out).



If any calendar reminders were previously entered, the calendar reminder screen is displayed next.

The calendar reminder screen remains displayed until you select **OK**, **Remind Later** or press the **CANCEL** button.

If you select **OK**, the reminder will not show up again. If you wish to have the reminder show up again later in the day, select **Remind Later** and push in on the interface selector.

If you press the **CANCEL** button, the message will be displayed the next time you start the vehicle.

**NOTE:** The system will display the current message and any older or previously unread messages, with the newest message listed first.

## Compass System (U.S. model without navigation system)

---

### Keyless Memory Settings™

The vehicle “senses” the driver number, based on which keyless remote is used to unlock the vehicle. If two drivers with remotes approach the vehicle at the same time, the welcome display and related settings are based on which remote the vehicle sensed first “senses.”

**NOTE:** If both remotes come within range simultaneously, the “Welcome” display may be unpredictable.

The compass system uses the driver number (as recognized by the multi-information display) to personalize the compass system. For example, if Driver 1 unlocks the vehicle, the “Driver 1” personal address book and other navigation settings are automatically loaded when the vehicle is started. There is no way to change from one driver’s settings to another while driving.

When the keyless access remote is deliberately “unlinked,” (as when giving the key to a valet) the multi-information display will display “Welcome.” Then the following occurs:

- The calendar feature is not selectable (buttons grayed out).
- Setup values (like volume, brightness, etc.) can be changed but are not remembered the next time you restart the vehicle.

For information on “linking” and “unlinking” the keyless access remotes, see page [170](#).

# Compass System (U.S. model without navigation system)

## The Compass Screen

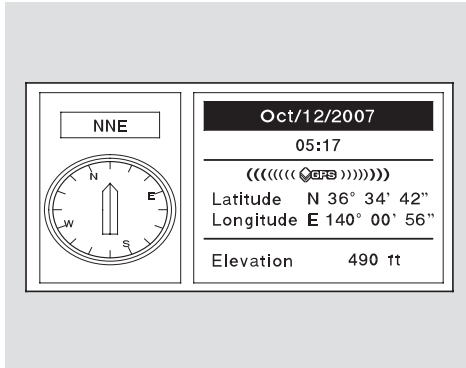

You can see the current latitude, longitude, and elevation at any time when you press the COMPASS button or say “Display map guide.” The date and time is also displayed.

**NOTE:** If the battery is disconnected or the fuse for the compass system is removed, the system may require GPS initialization (see page [260](#) ).

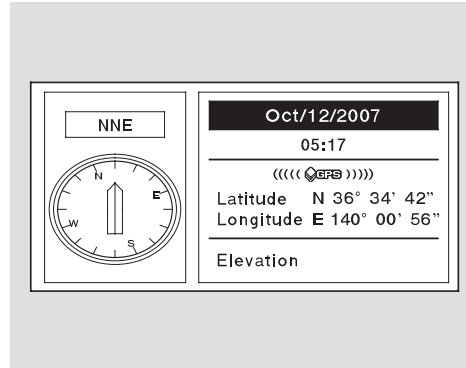

If the system does not receive the elevation information, the display shows only current latitude and longitude.

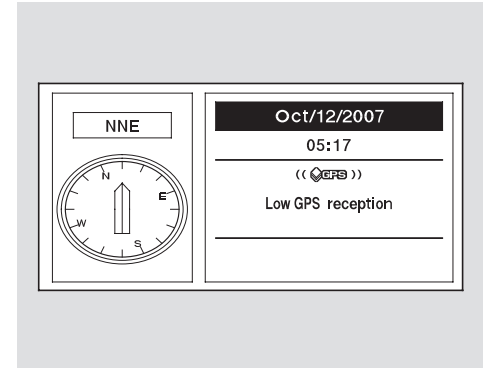

If the GPS reception is low, the display shows a “Low GPS reception” message.

# Compass System (U.S. model without navigation system)

## Main Menu

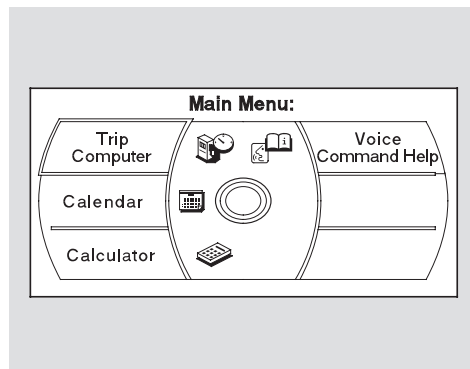

When you say “Display menu” or press the MENU button, the display changes to the **Main menu** screen. To select a menu item, turn the interface knob to highlight the item, then press the interface selector.

**NOTE:** If some items appear grayed out and cannot be selected, the vehicle does not sense the driver’s ID of the remote (see page 170).

## Voice Command Help

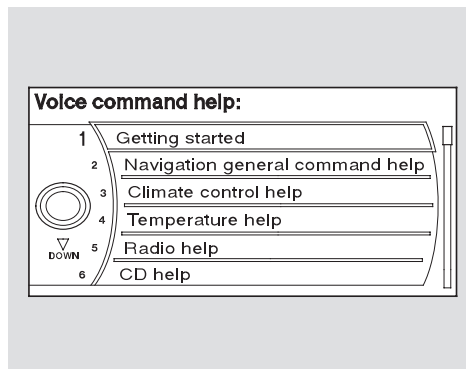

The voice command help screen displays several topics that help you to understand your vehicle’s voice control system. To go to the voice command help screen, say or select “Voice command help.” Then select a topic by saying either the topic name or its line number.

## Getting started:

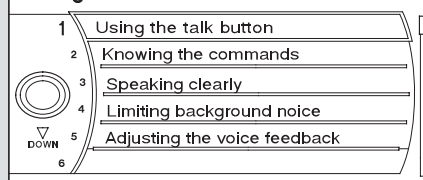

To use the voice command tutorial, say or select “Getting started.” The display changes to the Getting started screen.

Select the line number of the tutorial you want to view, and the tutorial will automatically be read out. To stop the system from reading the tutorial, move the interface knob to the right.

# Compass System (U.S. model without navigation system)

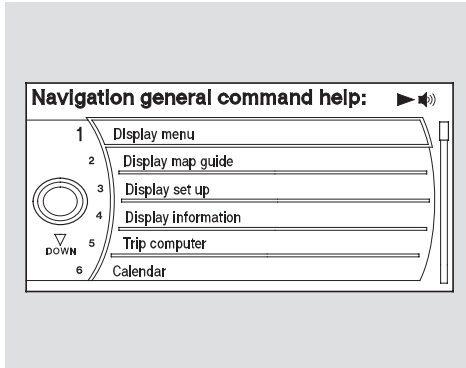

When you make a selection (such as Navigation general command help), you will see the help commands that can be used with the voice control. To have the system read the list, say “Read list,” or select  by moving the interface selector to the right, and the system will read the list to you.

For a listing of all voice commands, see *Voice Command Index* on page 268.

## *Trip Computer*

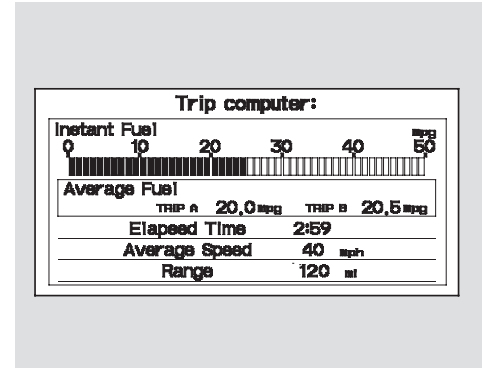

The **trip computer** screens display the trip information from the multi-information display in the gauge assembly.

To go to the trip computer, say “Trip Computer,” select Trip computer from the main menu, or press the TRIP button on the center console panel.

*CONTINUED*



## Compass System (U.S. model without navigation system)

### *MPG*

Shows the instantaneous fuel economy in miles per gallon.

### *Instant Fuel*

Shows you the current fuel economy in miles per gallon.

### *Average Fuel*

Shows you the average fuel economy in miles per gallon since the display was last reset.

### *Elapsed Time*

Shows the elapsed time that the ignition has been on since the display was last reset.

### *Average Speed*

Shows you the average speed in miles per hour since the display was last reset.

### *Range*

Shows the estimated distance you can travel on the fuel remaining in the tank. This distance is estimated from the average fuel economy over the last several miles, so it will vary with changes in speed, traffic, etc.

### *Resetting the Display*

The average fuel, average speed, and elapsed time meters can be reset automatically.

### **NOTE:**

- The “Average Fuel” and “MPG” may vary from actual fuel consumed. These values are estimates only.
- The “Range” value is approximate, and may vary from actual range.

### *Calendar*

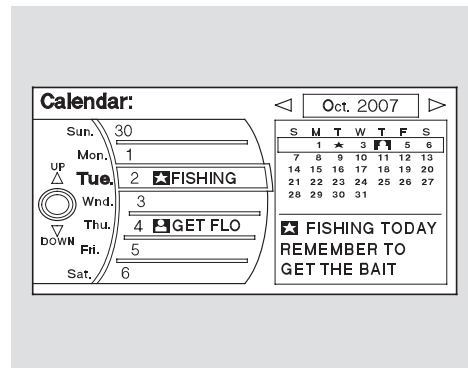

The calendar feature allows you to enter events and be reminded of them in the future. When you say “Calendar” or select the **Calendar** on the **Main Menu** screen, the display changes to the **calendar** screen.

Dates with an icon indicate there is a schedule entry for that date.

You can scroll through the calendar day by day by turning the interface knob, or select the day by voice. When you push the interface selector up or down, you can also scroll through the calendar week by week. When you say “Next month” or “Previous month,” or when you push the interface selector to the right or left, the system displays the next or previous month.

## Entering Your Schedule

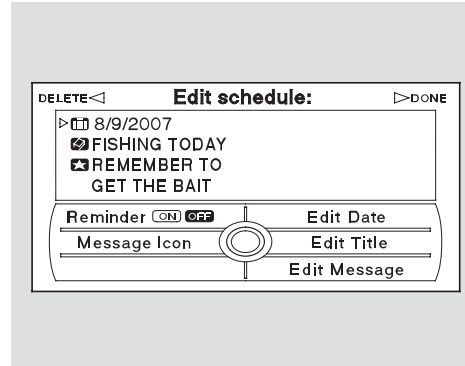

Set your schedule by selecting the day on the calendar, and the display changes to the **Edit schedule** screen.

## Reminder

The default for the reminder is **ON**. This allows the system to remind you of the calendar item the next time you start the vehicle. See *System Start-up* on page 244.

## Title

Say or select “**Edit title**,” then enter the name of your title using the interface selector. Once you enter the title, say or select “**Done**.” The title will be displayed on the specified date of the Calendar screen.

## Message

Say or select “**Edit message**,” and the system will show the Enter Message screen. You can enter a message on two lines. Use  to change the line. Once you have entered the message, say or select “Done.” The message will be displayed on the specified date of the calendar screen.

*CONTINUED*

## Compass System (U.S. model without navigation system)

### *Message Icon*

Say or select “**Message icon**,” and the system displays a list of icons you can select to help identify the type of message you entered. The message icon you choose will be displayed alongside the specified date on the calendar screen.

### *Delete*

From the **calendar** screen, select the date of the schedule you wish to remove. To remove the schedule, say or select “**Delete**.”

### *Done*

Once you have finished entering the schedule, say or select “**Done**.” The **calendar** screen is redisplayed and a category icon appears.

### **NOTE:**

- You can only enter one message per day.
- To re-activate a previous message, turn the reminder setting from **OFF** to **ON**. If it is not turned on, the reminder will not be displayed when you start vehicle.
- For more information, refer to System Start-up on page [244](#) .

### *Edit Date*

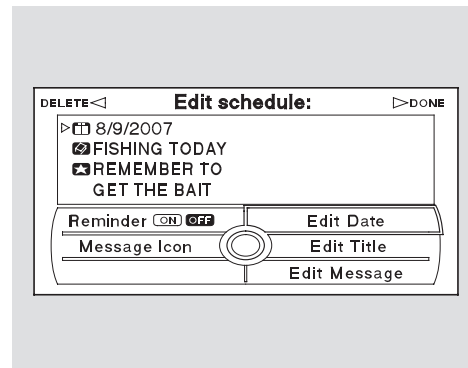

This allows you to move your calendar entry to a different date. If you say or select “**Edit date**,” the **calendar** screen is displayed with existing entries grayed out. Select a new day and the **edit schedule** screen is redisplayed with the new date.

# Compass System (U.S. model without navigation system)

## Calculator

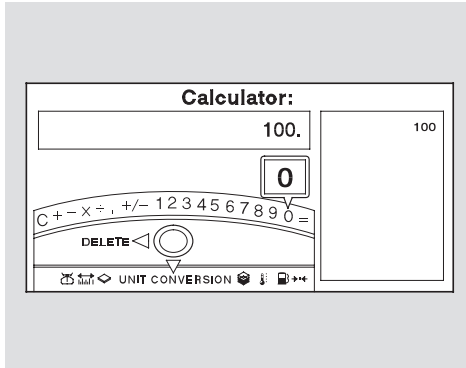

When you say or select “Calculator,” the display changes to the **Calculator** screen.

Enter the digits and operation symbols with the interface selector.

## Convert

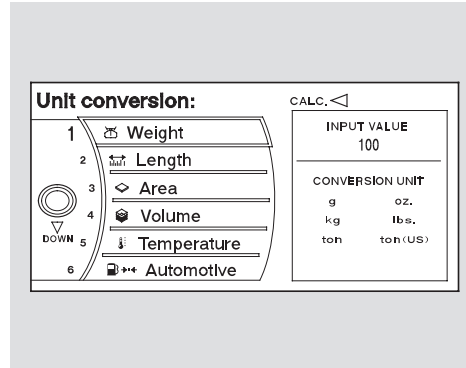

Use the interface selector to control the calculator, and calculator “conversion” feature.

To convert a unit of measurement, do this:

1. Enter a numeric value to be converted (for example, 100).
2. Push the interface selector down to select Unit conversion. The screen above appears.

3. Turn the interface knob until the conversion you want is highlighted (weight, for example), then push the selector in to select it. The screen for that conversion type appears (see illustration in step 4).

CONTINUED

## Compass System (U.S. model without navigation system)

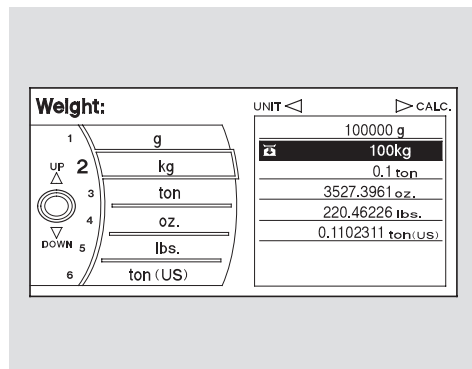

4. Turn the interface knob until the unit you want to convert from is highlighted (kilogram, for example), then push the selector in to select it as it the example above.

### System Set-up

The set-up functions consist of three different screens that allow you to change and update information in the system. To display the **set up screen**, say "Set up" or press the SET UP button, and then select an item. To select more setup items, say "More," or select MORE at the top right corner of the screen.

### First Set up Screen

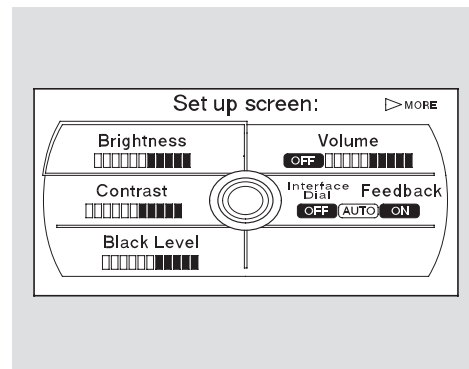

The first setup screen allows you to change the system's brightness, contrast, black level, volume, and interface dial feedback. To select a setup item, turn the interface knob until it is highlighted, then push the interface selector in to select it.

## Compass System (U.S. model without navigation system)

### Brightness

There are 11 possible brightness settings. To change the brightness, say “Brightness up” or “Brightness down.” You can also select **Brightness** and change the setting by turning the interface knob.

***Tip:** If you are having trouble viewing the screen in bright lighting conditions, try increasing the brightness.*

### Contrast

There are 11 possible contrast settings. To adjust the contrast, say “Contrast up” or “Contrast down.” You can also select **Contrast** and change the setting by turning the interface knob. Changes to the display are very subtle – this is normal.

### Black Level

There are 11 possible black level settings. To change the black level, say “Black level up” or “Black level down.” You can also select **Black Level** and change the setting by turning the Interface knob. Changes to the display are very subtle – this is normal.

**NOTE:** You can have separate daytime and nighttime settings for brightness, contrast, and black level. Adjust each setting when the display is in either daytime or nighttime mode. Use the Display mode button (see page 243 ) to select daytime or nighttime mode.

### Volume

To adjust the volume of the system voice, do one of these actions:

- Say “Volume up” or “Volume down.”
- Select **Volume**, then change the setting by turning the interface knob.
- Select volume off.

**NOTE:** If you turn the volume off, you will not hear voice command confirmations.

CONTINUED

## Compass System (U.S. model without navigation system)

### Interface Dial Feedback

Changing this setting allows you to control when (and if) the system will read the current selection you choose with the interface dial. This feature can minimize the need to look at the screen while operating the dial. The three settings are explained in the following table. The factory default setting is **AUTO**.

Setting	Feedback Level
On	The system always reads what you select.
Auto (default)	The system reads your selection only while the vehicle is moving.
No	The system does not read your selection.

### Second Set up Screen

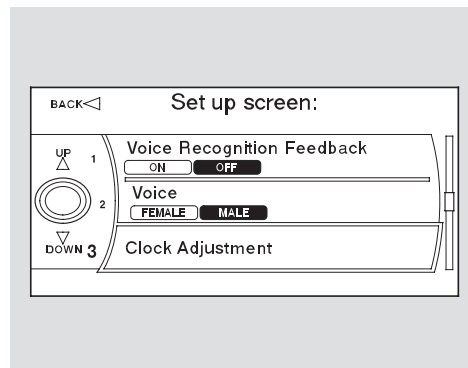

The second setup screen allows you to change the system's voice recognition feedback, voice gender, and clock settings. To select a setup item, turn the interface knob until it is highlighted, then push the interface selector in to select it.

To view the second setup screen, say "More," or move the interface selector to the right to select MORE. To go back to the first setup screen,

say "Backward," or move the interface selector to the left to select BACK.

# Compass System (U.S. model without navigation system)

## Voice Recognition Feedback

Allows you to turn voice control system prompts **ON** or **OFF**. To select ON or OFF, turn the interface knob to the right or left, then press the interface selector. When **OFF**, you will not hear the voice control system confirmations or prompts.

## Voice

Allows you to select the guidance voice: **MALE** or **FEMALE**. To select MALE or FEMALE, turn the interface knob to the right or left, then press the interface selector.

## Clock Adjustment

You can adjust the clock of your system. When the battery is disconnected or the fuse for the compass system is removed, you need to reset the time. See page [274](#) for more information on setting the clock.

## Third Set up Screen

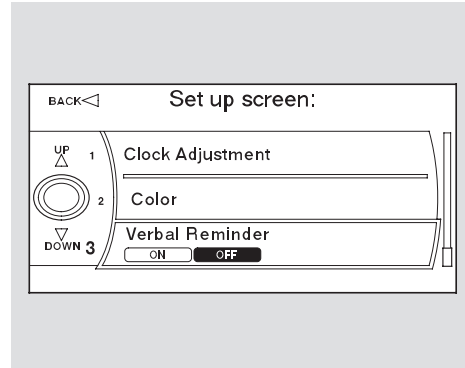

The third setup screen allows you to change the system's screen color and verbal reminders. To select a setup item, turn the interface knob until it is highlighted, then push the interface selector in to select it.

To view the third setup screen, move the interface selector down. To return to the first setup screen, say "Backward," or move the interface selector to the left to select BACK.

## Color

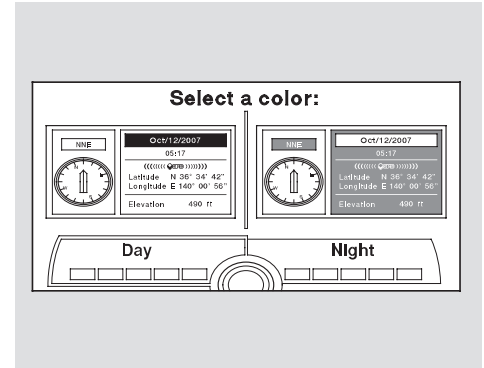

To view the Select a color screen, say "Color," or select COLOR on the screen. You can choose from one of five colors for the day and night display modes.

CONTINUED



## Compass System (U.S. model without navigation system)

---

To change the color, select Day or night by turning the interface knob to the right or left. Press the interface selector, then turn the interface knob to select desired color. Press the interface selector to enter your choice.

### NOTE:

- Choose silver metal (factory default) as the **Day** color to obtain the best display contrast.
- Choose black metal (factory default) as the **Night** color to obtain the best display contrast.

### *Verbal Reminder*

This function allows you to turn **ON** or **OFF** verbal reminders. Examples of these reminders include:

- Driving with the parking brake on
- Driving with the trunk or a door open
- A reminder to fasten the driver's and front passenger's seat belts

To select ON or OFF, turn the interface knob to the right or left, then press the interface selector.

### Setting Display Mode

Pressing the  (Display mode) button allows you to switch display modes.

Each time you turn the ignition switch to the ACCESSORY (I) position, the display mode is in auto. The screen changes between day and night modes when you turn the headlights on and off.

To override the auto mode, select either day or night mode. This can be useful if you want to use the headlights during the day. Be aware that using day mode at night will make the screen extremely bright.

# Compass System (U.S. model without navigation system)

## System Initialization

If for any reason, you lose power to the compass system (the battery was disconnected), the system needs to be initialized before you can use it.

Initialization requires this:

- Entry of the compass system 4-digit security code to “unlock” the system.
- GPS initialization. This may not be needed depending on how long the system was without power.

## Entering the Security Code

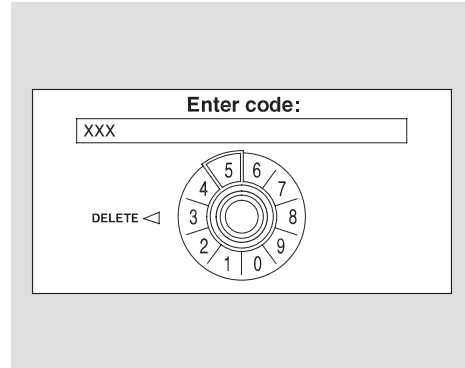

If the battery goes dead or is disconnected for any reason, you will have to enter a security code into both the audio system and the compass system before you can use it again.

When you purchased the vehicle, you should have received two cards that have the audio and compass system's security codes and serial numbers. Keep these cards in a safe

place in case you need the codes. If you lose the cards, you must obtain the security codes from your dealer.

Enter the four-digit compass system security code. If you have entered it correctly, the display changes to the **Disclaimer screen**. You have ten chances to enter the correct code. If all ten are incorrect, turn the ignition to OFF, then back to ON (II) to have ten more chances to enter the correct code.

To enter the code, turn the interface knob to select the number, then press the interface selector to enter it. Keep doing the same procedure to enter all four correct numbers. If you need to delete the number you entered mistakenly, move the interface selector to the right.

*CONTINUED*

## Compass System (U.S. model without navigation system)

---

Follow the instructions in the audio system section to enter the 5-digit audio code (see page 241). The system voice will not operate if the audio code is not entered

### *GPS initialization*

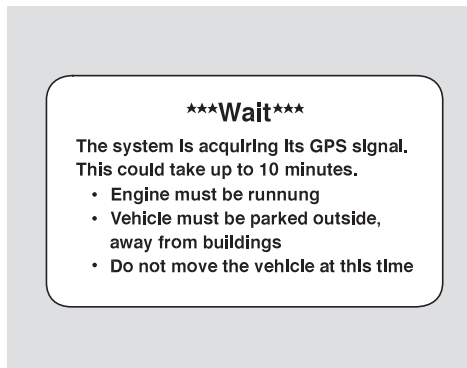

Depending on the length of time the battery was disconnected, your system may require GPS initialization. If it does, the above screen appears. Follow the instructions on the screen.

If this procedure is not necessary the system proceeds directly to the **Compass screen** (see page 247). During initialization, the system searches for all available GPS satellites, and obtains their orbital information. During this procedure the vehicle should be out in the open with a clear view of the sky.

# Compass System (U.S. model without navigation system)

Navigation system is unable to acquire a proper GPS signal.

- Move vehicle to another location
- Turn the ignition switch off
- Disconnect the battery for 30 minutes to clear the GPS receiver's memory
- Reconnect the battery and follow the screen prompts

If within ten minutes the system fails to locate a sufficient number of satellites to locate your position, the screen above appears. Follow the instructions on the screen.

After 30 minutes with this screen displayed, turn off the engine and restart the vehicle. If you now see the **Disclaimer screen**, the GPS initialization is complete.

## NOTE:

- The average acquiring time is less than 10 minutes, but it can take as long as 45 minutes.
- If the system is still unable to acquire a signal, follow the instructions on the screen, or contact your local dealer for assistance.

## License notice

You have acquired a device (“DEVICE”) that includes software licensed by ALPINE ELECTRONICS, INC., from an affiliate of Microsoft Corporation (collectively “MS”). Those installed software products of MS origin, as well as associated media, printed materials, and “online” or electronic documentation (“SOFTWARE”) are protected by international intellectual property laws and treaties. The SOFTWARE is licensed, not sold. All rights reserved.

CONTINUED

## Compass System (U.S. model without navigation system)

---

IF YOU DO NOT AGREE TO THIS END USER LICENSE AGREEMENT (“EULA”), DO NOT USE THE DEVICE OR COPY THE SOFTWARE. INSTEAD, PROMPTLY CONTACT ALPINE ELECTRONICS, INC., FOR INSTRUCTIONS ON RETURN OF THE UNUSED DEVICE(S) FOR A REFUND. ANY USE OF THE SOFTWARE, INCLUDING BUT NOT LIMITED TO USE ON THE DEVICE, WILL CONSTITUTE YOUR AGREEMENT TO THIS EULA (OR RATIFICATION OF ANY PREVIOUS CONSENT).

**GRANT OF SOFTWARE LICENSE.** This EULA grants you the following license;

You may use the SOFTWARE only on the DEVICE.

NOT FAULT TOLERANT. THE SOFTWARE IS NOT FAULT TOLERANT. ALPINE ELECTRONICS, INC., HAS INDEPENDENTLY DETERMINED HOW TO USE THE SOFTWARE IN THE DEVICE, AND MS HAS RELIED UPON ALPINE ELECTRONICS, INC., TO CONDUCT SUFFICIENT TESTING TO DETERMINE THAT THE SOFTWARE IS SUITABLE FOR SUCH USE.

NO WARRANTIES FOR THE SOFTWARE. THE SOFTWARE is provided “AS IS” and with all faults. THE ENTIRE RISK AS TO SATISFACTORY QUALITY, PERFORMANCE, ACCURACY, AND EFFORT (INCLUDING LACK OF NEGLIGENCE) IS WITH YOU. ALSO, THERE IS NO WARRANTY AGAINST INTERFERENCE WITH YOUR ENJOYMENT OF THE SOFTWARE OR AGAINST INFRINGEMENT. IF YOU HAVE RECEIVED ANY WARRANTIES REGARDING THE DEVICE OR THE SOFTWARE, THOSE WARRANTIES DO NOT ORIGINATE FROM, AND ARE NOT BINDING ON, MS.

## Compass System (U.S. model without navigation system)

No Liability for Certain Damages, EXCEPT AS PROHIBITED BY LAW, MS SHALL HAVE NO LIABILITY FOR ANY INDIRECT, SPECIAL, CONSEQUENTIAL OR INCIDENTAL DAMAGES ARISING FROM OR IN CONNECTION WITH THE USE OR PERFORMANCE OF THE SOFTWARE. THIS LIMITATION SHALL APPLY EVEN IF ANY REMEDY FAILS OF ITS ESSENTIAL PURPOSE. IN NO EVENT SHALL MS BE LIABLE FOR ANY AMOUNT IN EXCESS OF U.S.TWO HUNDRED FIFTY DOLLARS (U.S.\$250.00).

Limitations, on Reverse Engineering, Decompilation, and Disassembly. You may not reverse engineer, decompile, or disassemble the SOFTWARE, except and only to the extent that such activity is expressly permitted by applicable law not withstanding this limitation.

Additional Software/Services. The SOFTWARE may permit ALPINE ELECTRONICS, INC., MS, Microsoft Corporation or their affiliates to provide or make available to you SOFTWARE updates, supplements, add-on components, or Internet- based services components of the SOFTWARE after the date you obtain your initial copy of the SOFTWARE (“Supplemental Components”).

- If ALPINE ELECTRONICS, INC., provides or makes available to you Supplemental Components and no other EULA terms are provided along with the Supplemental Components, then the terms of this EULA shall apply.
- If MS, Microsoft Corporation or their affiliates make available Supplemental Components, and no other EULA terms are provided, then the terms of this EULA shall apply, except that the MS, Microsoft Corporation or affiliate entity providing the Supplemental Component(s) shall be the licensor of the Supplemental Component(s).

CONTINUED

## Compass System (U.S. model without navigation system)

---

ALPINE ELECTRONICS, INC., MS, Microsoft Corporation and their affiliates reserve the right to discontinue any Internet-based services provided to you or made available to you through the use of the SOFTWARE.

**RECOVERY MEDIA.** If SOFTWARE is provided by ALPINE ELECTRONICS, INC., on separate media and labeled “Recovery Media” you may use the Recovery Media solely to restore or reinstall the SOFTWARE originally installed on the DEVICE.

**SOFTWARE TRANSFER ALLOWED BUT WITH RESTRICTIONS.** You may permanently transfer rights under this EULA only as part of a permanent sale or transfer of the Device, and only if the recipient agrees to this EULA. If the SOFTWARE is an upgrade, any transfer must also include all prior versions of the SOFTWARE.

**EXPORT RESTRICTIONS.** You acknowledge that SOFTWARE is of US-origin. You agree to comply with all applicable international and national laws that apply to the SOFTWARE, including the U.S. Export Administration Regulations, as well as end-user, end-use and country destination restrictions issued by U.S. and other governments. For additional information on exporting the SOFTWARE, see <http://www.microsoft.com/exporting/>.

# Compass System (U.S. model without navigation system)

## Voice Control Basics

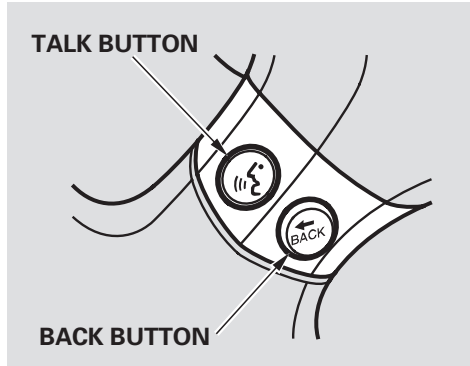

**NOTE:** For models with navigation system, refer to the navigation system manual.

Your vehicle has a voice control system that allows hands-free operation of the audio system, the climate control system and some functions of the compass system. The voice control system uses the TALK and BACK buttons on the steering wheel and a microphone

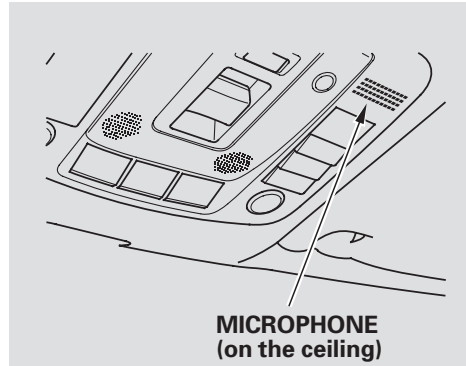

near the map light on the ceiling.

**NOTE:** While using the voice control system, all of the speakers are muted.

## *Talk Button*

This button activates the voice control system. Press it when you want to give a voice command. See *Voice Command Index* on page 268 for a list of voice commands.

## *Back Button*

This button has the same function as the CANCEL button on the center console (see page 243 ). When you press it, the display returns to the previous screen. When the previous screen appears, the system replays the last prompt. This button can be used to cancel an audio, climate control, or compass system voice command up to one second after the command confirmation.



## Compass System (U.S. model without navigation system)

---

### Using the Voice Control System

You should use the voice control system as much as possible, and consider manual entry using the **interface dial** as a “back-up” method of entry.

Most of the system’s functions can be controlled by voice commands activated with the **Talk** button. To control your compass system by voice:

- Press and release the **Talk** button.
- Wait for the beep.
- Give a voice command.

Once the microphone picks up your command, the system changes the display in response to the command and prompts you for the next command. Using the **Talk** button, answer the prompts as required.

If the system does not understand a command or you wait too long to give a command, it responds with “Pardon,” “Please repeat,” or “Would you say again.” If the system cannot perform a command or the command is not appropriate for the screen you are on, it sounds a beep.

Anytime you are not sure of what voice commands are available on a screen, you can always say “Help” at any screen. The system can then read the list of commands to you.

When you speak a command, the system generally either repeats the command as a confirmation or asks you for further information. If you do not wish to hear this feedback, you can turn it off. See the **Voice Recognition Feedback** setting in Setup.

If you hear a prompt such as “Please use the interface dial to...” or “Please choose an area with the interface dial.” the system is asking for input that cannot be done by voice.

## Compass System (U.S. model without navigation system)

### Improving Voice Recognition

To achieve optimum voice recognition, the following guidelines should be followed:

**NOTE:** Make sure the correct screen is displayed for the voice command that you are using. See Voice Command Index on page [268](#).

- Close the windows and the moonroof.
- The fan speed will be automatically adjusted to low.
- Make sure the airflow from the A/C vents does not interfere with the system microphone in the ceiling console. Place your hand over the microphone; if you feel any airflow, adjust the vents.
- After pressing the **Talk** button, wait for the beep, then give a voice command.
- Give a voice command in a clear, natural speaking voice without pausing between words.
- If the system cannot recognize your command because of background noise, speak louder.
- If the microphone picks up voices other than yours, the system may not interpret your voice commands correctly.
- If you speak a command with something in your mouth, or your voice is either too high or too husky, the system may misinterpret your voice commands.
- If you are still having trouble with the voice control system, refer to **Voice Command Help** on the main menu screen.

## Compass System (U.S. model without navigation system)

---

### **Voice Command Index**

The voice control system needs appropriate voice commands for controlling the climate control, the audio system, and the compass system.

### ***Global Commands***

The system accepts these commands on any screen.

*Help* (reads list of the commands for the displayed screen)

*Set up* (displays set up screen)

*Display map guide* (displays the compass screen)

*Display menu* (displays the main menu)

*Information* (displays the *trip computer* screen)

*Trip Computer*

*Backward* (to previous screen, same as CANCEL or BACK button)

*Cancel* (cancels current activity)

*What time is it?*

*Calendar*

*Calculator*

*Repeat voice*

*Voice command help*

The voice command help option on the main menu lists many of the following controls. To avoid distraction while you are driving, the system can read the commands for you.

The commands are accessible at any time while driving and can be read to you so that you do not need to memorize all of them.

### ***Climate Control Commands***

The system accepts these climate control commands on most screens.

*Climate control full automatic* (controls temperature to 72 degrees F)

*Climate control automatic* (controls temperature to your selection)

*Climate control off*

*Air conditioner on*

*Air conditioner off*

*Air conditioner\**

*Climate control defrost on*

*Climate control defrost off*

*Climate control defrost\**

*Rear defrost on*

*Rear defrost off*

*Rear defrost\**

# Compass System (U.S. model without navigation system)

*Climate control fresh air*  
*Climate control recirculate*  
*Climate control vent*  
*Climate control bi-level* (vent and floor)  
*Climate control floor*  
*Climate control floor and defrost*  
*Fan speed up*  
*Fan speed down*  
*Fan speed #* (# : 1–7) (for best voice control, keep fan speed at 1 or 2)

\* Repeating these commands switches (toggles) the function between On and Off.

*Temperature Commands*  
The system accepts these commands on most screens.  
*Temperature # degrees* (# : 57 to 87 degrees F)  
*Temperature up*  
*Temperature down*  
*Temperature max hot* (displays HI)  
*Temperature max cold* (displays LO)  
*Temperature balance*  
*Temperature dual mode on*  
*Temperature dual mode off*  
*Temperature dual mode\**  
*Drive temperature # degrees* (# : 57 to 87 degrees F)  
*Passenger temperature # degrees* (# : 57 to 87 degrees F)  
*Drive vent temperature adjustment*  
*Passenger vent temperature adjustment*  
*Vent temperature up*  
*Vent temperature down*  
*Vent temperature max*  
*Vent temperature minimum*  
*Vent temperature normal*

\* Repeating these commands switches (toggles) the function between On and Off.

**NOTE:** The commands for vent temperature settings are available on the climate control screen.

CONTINUED

## Compass System (U.S. model without navigation system)

---

### **Audio System Commands**

The system accepts these audio system commands on most screens.

#### *Radio Commands*

To control the radio system, say one of the following commands:

*Audio on*

*Audio off*

*Audio\**

*Radio on (or Radio play)*

*Radio off*

*Radio\**

*Radio select FM1*

*Radio select FM2*

*Radio select AM*

*Radio # FM (# : frequency.*

Example *Radio 95.5 FM)*

*Radio # AM (# : frequency.*

Example *Radio 1020 AM)*

*Radio seek up*

*Radio seek down*

*Radio next station (same as Radio seek)*

*Radio preset # (# : 1–6)*

*Radio FM preset # (# : 1–6)*

*Radio FM1 preset # (# : 1–6)*

*Radio FM2 preset # (# : 1–6)*

*Radio AM preset # (# : 1–6)*

*Radio auto select\**

*Radio scan\**

\* Repeating these commands switches (toggles) the function between On and Off.

### *CD Commands*

The system accepts these commands on most screens.

*CD play*

*CD play disc # (# : 1–6)*

*CD play track # (# : 1–30)*

*CD play disc # 1 track # 2 (# 1: 1–6, # 2: 1–30)*

*CD skip forward*

*CD skip back*

*CD play next disc*

*CD play previous disc*

*CD track random\**

*CD track repeat\**

*CD disc repeat\**

*CD track scan\**

*CD disk scan\**

*CD normal play* (resumes “Play” from these commands: “CD track random,” “CD track repeat,” and “CD disc repeat”)

*CD track list*

*CD folder random\**

*CD folder repeat\**

*CD folder scan\**

*CD folder list*

# Compass System (U.S. model without navigation system)

\* Repeating these commands switches (toggles) the function between On and Off.

## ***DVD Commands***

The system accepts these commands on most screens.

*DVD play*

*DVD play disc # (# : 1–6)*

*DVD play track # (# : 1–30)*

*DVD play disc # 1 track # 2 (# 1: 1–6, # 2: 1–30)*

*DVD skip forward*

*DVD skip back*

*DVD play next disc*

*DVD play previous disc*

*DVD track random\**

*DVD track repeat\**

*DVD disc repeat\**

*DVD track scan\**

*DVD disc scan\**

*DVD normal play* (resumes “Play”

from these commands: “DVD track random,” “DVD track repeat,” “DVD disc repeat,” “DVD folder random,” and “DVD folder repeat”)

*DVD track list*

*DVD folder random*

*DVD folder repeat*

*DVD folder list*

\* Repeating these commands switches (toggles) the function between On and Off.

CONTINUED

## Compass System (U.S. model without navigation system)

---

### *MP3/WMA Commands*

The system accepts these commands on most screens.

*MP3 play*

*MP3 play disc # (# : 1–6)*

*MP3 play track # (# : 1–30)*

*MP3 play disc # 1 track # 2 (# 1: 1–6, # 2: 1–30)*

*MP3 skip forward*

*MP3 skip back*

*MP3 play next disc*

*MP3 play previous disc*

*MP3 track random\**

*MP3 track repeat\**

*MP3 disc repeat\**

*MP3 track scan\**

*MP3 disc scan\**

*MP3 normal play* (resumes “Play”

from these commands: “MP3 track random,” “MP3 track repeat,” “MP3 disc repeat,” “MP3 folder random,” and “MP3 folder repeat”)

*MP3 track list*

*MP3 folder random\**

*MP3 folder repeat\**

*MP3 folder list*

*WMA play*

*WMA play disc # (# : 1–6)*

*WMA play track # (# : 1–30)*

*WMA play disc # 1 track # 2 (# 1: 1–6, # 2: 1–30)*

*WMA skip forward*

*WMA skip back*

*WMA play next disc*

*WMA play previous disc*

*WMA track random\**

*WMA track repeat\**

*WMA disc repeat\**

*WMA track scan\**

*WMA disc scan\**

*WMA normal play* (resumes “Play” from these commands: “WMA track random,” “WMA track repeat,” “WMA disc repeat,” “WMA folder random,” and “WMA folder repeat”)

*WMA track list*

*WMA folder random\**

*WMA folder repeat\**

*WMA folder list*

- \* Repeating these commands switches (toggles) the function between On and Off.

### ***Main Menu Screen Commands***

These are additional commands not found on the **Voice Commands Help** screen. Follow the voice prompts.

*Voice command help* (the system reads and lists all of the commands)

*Calendar*

*Calculator*

*Trip computer*

## ***Set up Screen Commands***

The system accepts these commands on the first setup screen. (For the second and third setup screens, simply say what is written on the screen, and follow the voice prompts)

*Brightness up*

*Brightness down*

*Brightness minimum/min.*

*Brightness maximum/max.*

*Contrast up*

*Contrast down*

*Contrast minimum/min*

*Contrast maximum/max*

*Black level up*

*Black level down*

*Black level minimum/min*

*Black level maximum/max*

*Volume up*

*Volume down*

*Volume minimum/min.*

*Volume maximum/max.*

*Volume Off*

*Interface Dial feedback off*

*Interface Dial feedback auto*

*Interface Dial feedback on*

## ***On-Screen Commands***

The system accepts over 100 on-screen commands. The only commands that must be chosen by the interface dial are listed below.

*Next*

*Previous*

*Return*

*OK*

*Delete*



# Compass System (U.S. model without navigation system)

## Setting the Clock

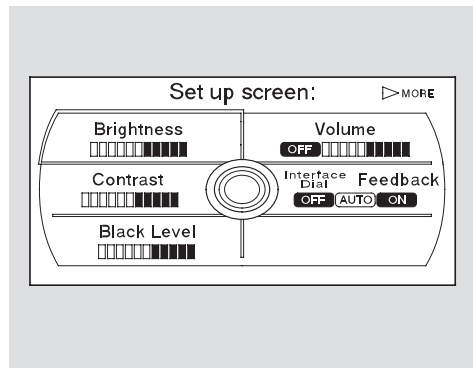

To set the clock, the ignition switch must be in the ACCESSORY (I) or ON (II) position, and either or both remotes must be linked.

Say “Set up” or press the SET UP button on the center console to display the Set up screen. Then move the interface dial to the right.

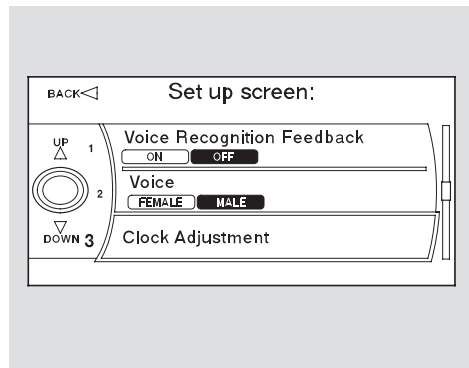

Select the **Clock Adjustment** by turning the interface knob to the right, then press the center of the interface selector.

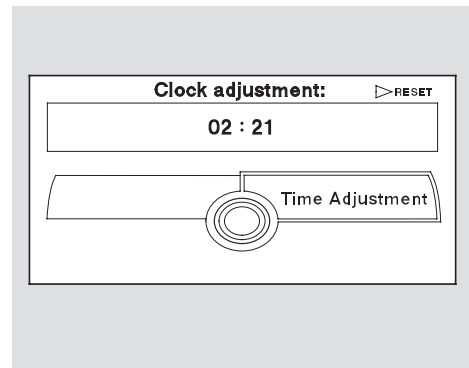

Select the **Time Adjustment**, then press the center of the interface selector. The display changes to the **Time Adjustment** screen for HOUR.

# Compass System (U.S. model without navigation system)

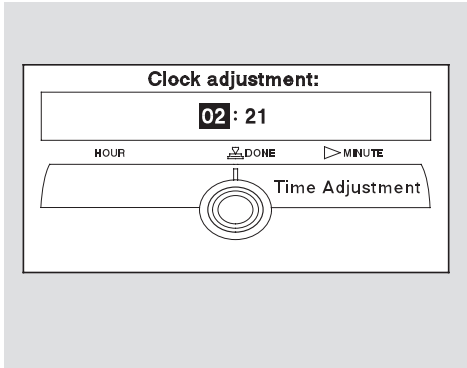

To adjust the hour, turn the interface knob, then press the center of the interface selector.

To adjust the minute, turn the interface knob to the right to display the adjustment screen for MINUTE.

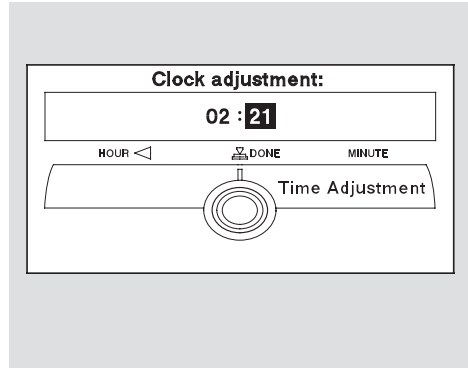

Turn the interface knob to adjust the minute.

Press the center of the interface selector to enter the time. The screen will return to the **Clock adjustment** screen (see page [274](#)).

## Security System

The security system helps to protect your vehicle and valuables from theft. The horn sounds and a combination of headlights, parking/side marker lights, and taillights flash if someone attempts to break into your vehicle or remove the radio. This alarm continues for 2 minutes, then the system resets. To reset an alarming system before the 2 minutes have elapsed, unlock either front door with the remote or the built-in key.

The security system automatically sets 15 seconds after you lock the doors, close the hood, and close the trunk. For the system to activate, you must lock the doors from the outside with the remote, built-in key, lock tab, or door lock switch. The security system indicator on the instrument panel starts blinking immediately to show you the system is setting itself.

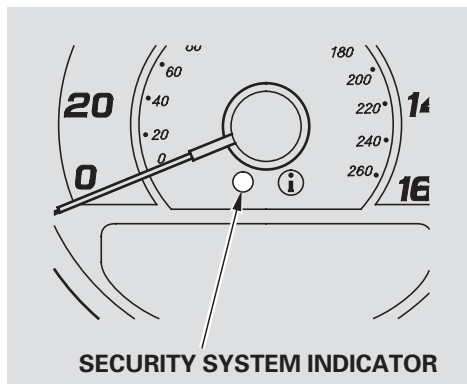

Once the security system is set, opening any door or the hood without using the built-in key or the remote will cause it to sound. It also sounds if the radio is removed from the dashboard or the audio system wiring is cut.

With the system set, you can still open the trunk with the remote without triggering the alarm. The alarm will sound if the trunk lock is forced, or the trunk is opened with the trunk release button on the driver's door or the emergency trunk opener.

The security system will not set if the hood, trunk, or any door is not fully closed. If the system will not set, check the Door and Trunk Open monitor on the instrument panel (see page 13) to see if the doors and trunk are fully closed. Since it is not part of the monitor display, manually check the hood.

Do not attempt to alter this system or add other devices to it.

Cruise control allows you to maintain a set speed above 25 mph (40 km/h) without keeping your foot on the accelerator pedal. It should be used for cruising on straight, open highways. It is not recommended for city driving, winding roads, slippery roads, heavy rain, or bad weather.

## **⚠ WARNING**

Improper use of the cruise control can lead to a crash.

Use the cruise control only when traveling on open highways in good weather.

## Using Cruise Control

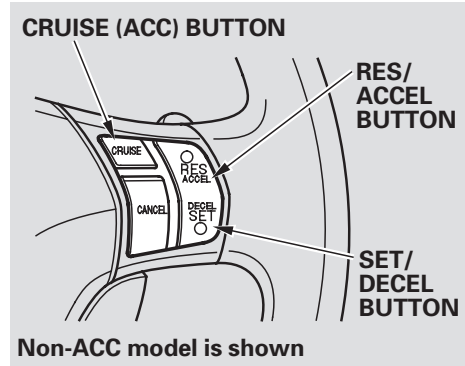

1. Push in the CRUISE button or the ACC button (models with adaptive cruise control) on the steering wheel. The CRUISE MAIN or green ACC indicator (models with ACC) indicator on the instrument panel comes on.

*On models with adaptive cruise control*

To switch from ACC to cruise control, press the distance button

on the steering wheel, and hold it for 1 second (see page 294).

2. Accelerate to the desired cruising speed above 25 mph (40 km/h).
3. Press and release the SET/DECEL button on the steering wheel. The CRUISE CONTROL icon appears on the multi-information display to show the system is now activated.

When cruise control is on while driving, the SH-AWD torque distribution monitor and the tire pressure monitor are not shown on the multi-information display.

*CONTINUED*

## Cruise Control

---

Cruise control may not hold the set speed when you are going up and down hills. If your speed increases going down a hill, use the brakes to slow down. This will cancel cruise control. On models with adaptive cruise control (ACC), this also causes the cruise control icon on the multi-information display to go off and the cruise mode icon to come on. To resume the set speed, press the RES/ACCEL button. The CRUISE CONTROL icon on the multi-information display will come back on.

When climbing a steep hill, the automatic transmission may downshift to hold the set speed.

### Changing the Set Speed

You can increase the set cruising speed in any of these ways:

- Press and hold the RES/ACCEL button. When you reach the desired cruising speed, release the button.
- Push on the accelerator pedal. Accelerate to the desired cruising speed, then press the SET/DECEL button.
- To increase your speed in very small amounts, tap the RES/ACCEL button. Each time you do this, the vehicle speeds up about 1 mph (1.6 km/h).

You can decrease the set cruising speed in any of these ways:

- Press and hold the SET/DECEL button. Release the button when you reach the desired speed.
- To slow down in very small amounts, tap the SET/DECEL button. Each time you do this, your vehicle will slow down about 1 mph (1.6 km/h).
- Tap the brake pedal lightly with your foot. The CRUISE CONTROL indicator or ACC indicator on the instrument panel and the CRUISE CONTROL icon on the multi-information display will go out. When the vehicle slows to the desired speed, press the SET/DECEL button.

Even with cruise control on, you can still use the accelerator pedal to speed up for passing. After completing the pass, take your foot off the accelerator pedal. The vehicle will return to the set cruising speed.

Resting your foot on the brake pedal causes cruise control to cancel.

## Canceling Cruise Control

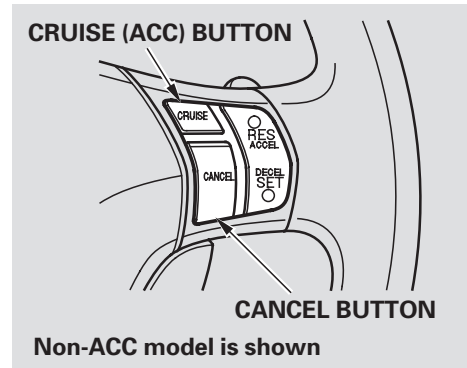

You can cancel cruise control in any of these ways:

- Tap the brake pedal.
- Push the CANCEL button on the steering wheel.
- Push the CRUISE (ACC) button.

## Resuming the Set Speed

When you push the CANCEL button or tap the brake pedal, the system remembers the previously set speed. To return to that speed, accelerate to above 25 mph (40 km/h), then press and release the RES/ACCEL button. The CRUISE CONTROL (ACC (green)) indicator comes on. The vehicle accelerates to the same speed as before.

Pressing the CRUISE (ACC) button turns the system completely off and erases the previous cruising speed.

# Adaptive Cruise Control (ACC)

## ACC Components

*If equipped*

Adaptive cruise control (ACC) consists of a radar sensor in the front grille, the ACC buttons on the steering wheel, and the ACC functions of the multi-information display.

The radar sensor for ACC is shared with the collision mitigation brake system (CMBS). For more information on the radar sensor, see page 362. For more information on CMBS, see page 361.

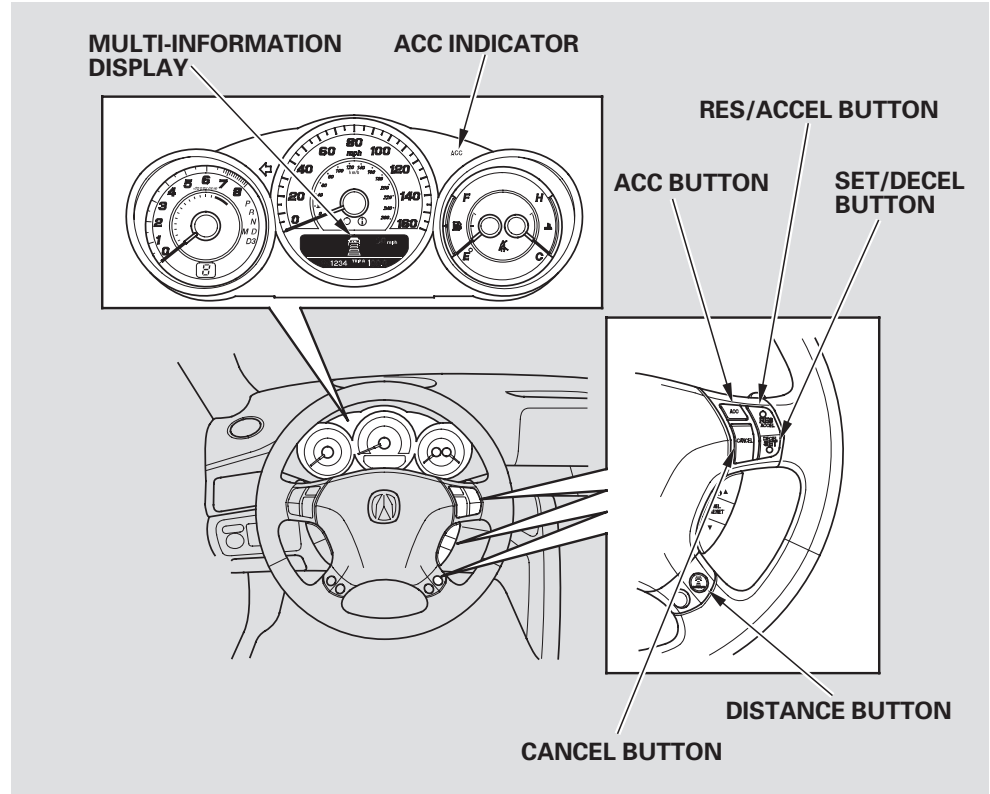

## Overview

Adaptive cruise control (ACC) allows you to maintain a set speed and keep the vehicle ahead of you and your vehicle at a safe distance without having to use the accelerator pedal or the brake pedal.

When the vehicle ahead of you slows down or speeds up, ACC senses the change in distance and compensates by accelerating or braking your vehicle to reach the cruising speed you previously set. The distance between vehicles is based on your speed: the faster you go, the longer the distance will be; the slower you go, the shorter it will be.

If the vehicle ahead of you slows down suddenly or another vehicle cuts in front of your vehicle, ACC alerts you by sounding a beeper and displaying a message on the multi-information display.

The ACC radar sensor in the front grille can detect and monitor the distance of a vehicle up to 328 feet (100 meters) ahead of your vehicle. For more information on the radar sensor, see page [362](#).

## Important Safety Precautions

As with any system, there are limits to ACC. Inappropriate use of ACC can result in a serious accident. Use the brake pedal whenever necessary, and always keep a safe distance between your vehicle and other vehicles.

Do not use ACC under these conditions:

- In poor visibility.
- In heavy traffic.
- When you must slow down and speed up repeatedly.
- On winding roads.
- When you enter a toll gate, interchange, service area, parking area, etc. In these areas, there is no vehicle ahead of you, but ACC would still try to accelerate to your set speed.
- In bad weather (rain, fog, snow, etc.)
- On a slippery road (for example a road covered with ice or snow).

*CONTINUED*



# Adaptive Cruise Control (ACC)

## ⚠ WARNING

Improper use of ACC can lead to a crash.

Use ACC only when traveling on open highways in good weather.

## Operating Characteristics

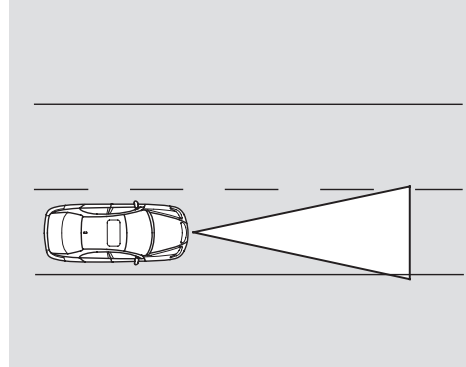

*When there is no vehicle ahead within ACC range  
Your vehicle will maintain a set cruising speed.*

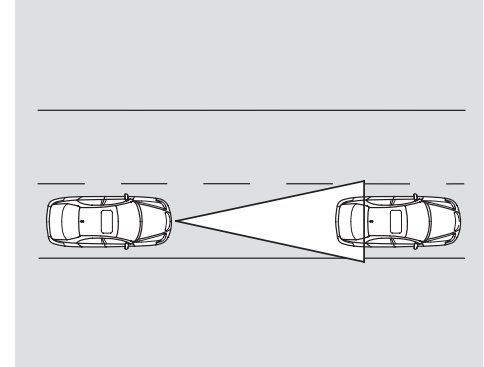

*When a vehicle ahead is within ACC range and going slower than your set speed  
If the vehicle ahead of you is going slower than your set speed, your vehicle will slow down to the speed of that vehicle. Your vehicle will then follow at a constant distance until the vehicle ahead changes speed again.*

If the vehicle ahead of you slows down abruptly, or if another vehicle cuts in front of you, a beeper sounds and a message appears on the multi-information display to warn you.

In the case, decelerate your vehicle by pressing the brake pedal, and keep an appropriate distance from the vehicle ahead.

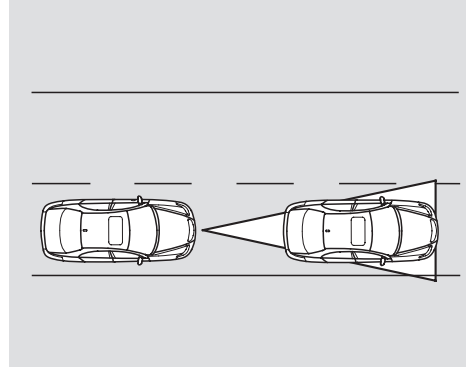

*When a vehicle ahead is within ACC range and going at a steady speed*  
Your vehicle follows the vehicle ahead of it, keeping a constant distance. ACC will not keep your vehicle at a constant distance if the vehicle ahead of you goes out of range of your set speed.

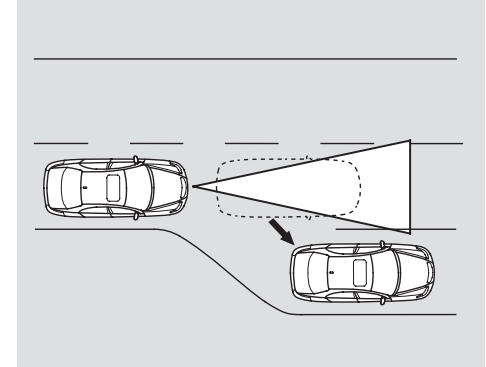

If the vehicle ahead of you slows down and changes lanes, ACC no longer tracks it. Your vehicle will then return to your set speed.

## Adaptive Cruise Control (ACC)

---

### Limitations

- ACC does not work below 25 mph (40 km/h). It cannot bring your vehicle to a complete stop.
  - ACC will not sound a beeper or display a message on the multi-information display to warn you of vehicles going slower than 13 mph (20 km/h) or vehicles that are parked. In these cases, it is up to you to maintain a safe distance by using the brake pedal.
  - ACC may not recognize motorcycles or other small vehicles ahead of your vehicle.
- ACC may react to vehicles beside you or even building beside you by momentarily applying the brakes or sounding a beeper under conditions such as a sudden curve or narrowing of the road, an abrupt movement of the steering wheel, or if you are in an unusual position within your lane.

## Using the ACC

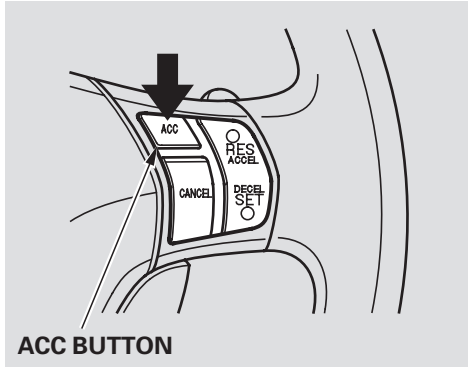

1. Push the ACC button on the steering wheel. The ACC indicator on the instrument panel comes on, and "ACC" is shown on the multi-information display.
2. Accelerate to the desired speed above 25 mph (40 km/h).

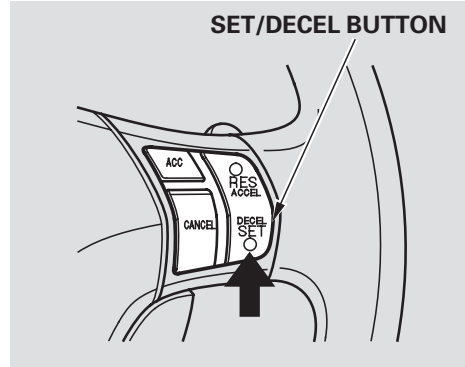

3. Press and release the SET/DECEL button on the steering wheel.  
If you press the SET/DECEL button when the vehicle speed is below 25 mph (40 km/h), you will hear three beeps. This means ACC is not activated, and you cannot set your speed.



When your speed reaches 25 mph (40 km/h), ACC goes into wait mode, and "ACC STANDBY" is shown on the multi-information display.

*CONTINUED*

# Adaptive Cruise Control (ACC)

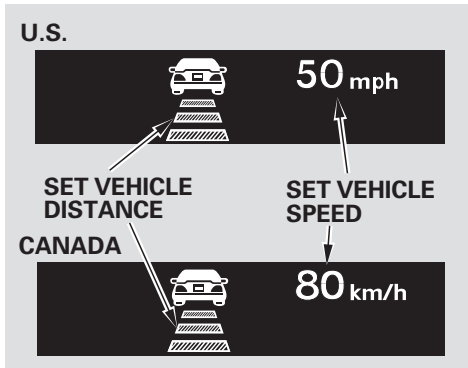

When the speed is set, it is shown along with a vehicle icon and distance bars on the multi-information display. Refer to page 289 for how to set and change the set distance between your vehicle and the vehicle ahead of you.

To change the speed unit measurement from mph to km/h, see page 92 .

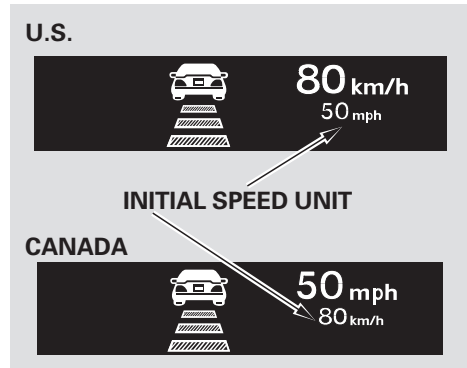

If you change the speed unit measurement from the factory default setting, the initial speed unit measurement is shown under the current unit.

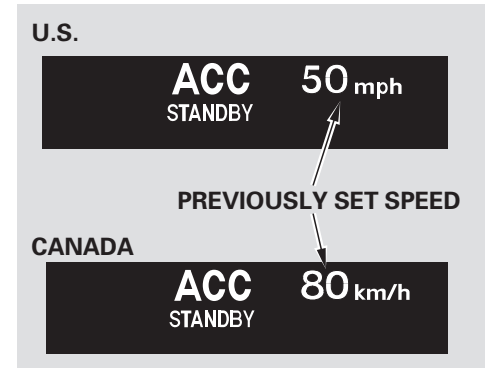

If you cancel ACC by pressing the CANCEL button or by tapping the brake pedal, the previously set cruising speed is shown on the multi-information display. To store this speed as your new cruising speed, press and release the RES/ACCEL button.

## Increasing the Set Speed

The set speed can be increased using the RES/ACCEL button or the accelerator pedal.

To increase the set speed with the RES/ACCEL button, do this:

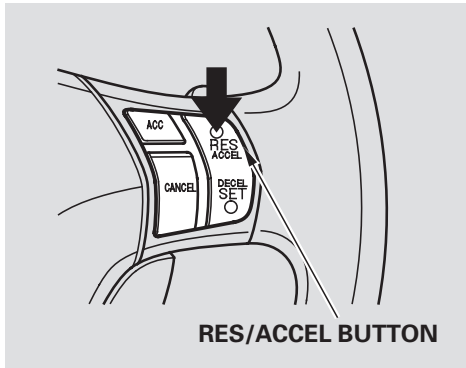

Press and hold the RES/ACCEL button. The vehicle will accelerate. When you reach the speed you want, release the button.

To increase your speed in small

amounts, tap the RES/ACCEL button repeatedly. Each time you do this, your vehicle will speed up about 1 mph (1 km/h).

While the vehicle accelerates to the set speed, the set speed on the multi-information display will flash.

If a vehicle ahead of you is driving at a slower speed than the speed you want to set, your vehicle will not accelerate; it will keep some distance between your vehicles.

To increase the set speed with the accelerator pedal, do this:

Press the accelerator pedal to increase to the speed you want, then press the SET/DECEL button. The set speed will be shown on the multi-information display. If you do not press the SET/DECEL button, your vehicle will return to the previously set speed.

The ACC beeper will not sound while you press the accelerator pedal, no matter how close you get to the vehicle ahead of you.

# Adaptive Cruise Control (ACC)

## Decreasing the Set Speed

The set speed can be decreased using the SET/DECEL button or the brake pedal.

To decrease the set speed with the SET/DECEL button, do this:

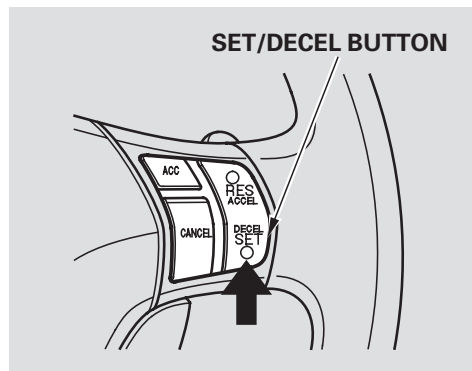

Press and hold the SET/DECEL button. Release the button when you reach the speed you want.

To slow down in small amounts, tap the SET/DECEL button repeatedly.

Each time you do this, your vehicle slows down about 1 mph (1 km/h).

The set cruising speed will be shown on the multi-information display.

On a steep downhill, the vehicle speed may exceed the set cruising speed.

To decrease the set speed with the brake pedal, do this:

Tap the brake pedal. When the vehicle slows down to the speed you want, press the SET/DECEL button. The set speed will be shown on the multi-information display. If you use the brake pedal to decrease speed, and then press the RES/ACCEL button, your vehicle will return to the previously set speed.

## Detecting a Vehicle Ahead of You

U.S.



CANADA



When the system detects a vehicle ahead of you, a beeper sounds once and a solid-line vehicle icon appears on the multi-information display.

U.S.



CANADA



When that vehicle changes lanes or goes out of ACC range, a beeper sounds once. If there is no vehicle ahead of you within ACC range, a dotted-line vehicle icon will be on the multi-information display. To set the ACC beeper on or off, see page [90](#).

## Changing Vehicle Distance

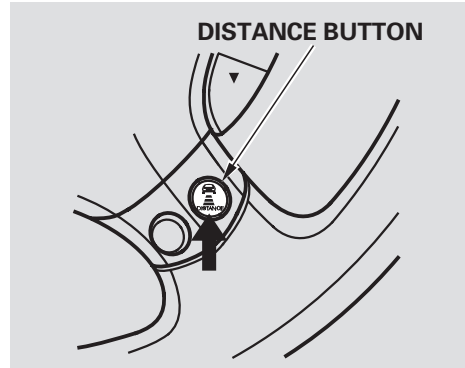

With ACC on, the distance between your vehicle and the vehicle ahead of you is controlled and maintained. You can change this distance to one of three ranges: long, middle, or short.

To change the range, press the DISTANCE button. Each time you press the button, the range changes from Long, to Middle, and then to Short.

The higher your vehicle speed is, the longer the distance between the vehicle in front will be set as shown below.

Speed	50 mph (80 Km/h)	65 mph (104 Km/h)
Vehicle Distance		
Long	154 feet 47 meters	200 feet 61 meters
Middle	111 feet 34 meters	173 feet 42 meters
Short	85 feet 26 meters	101 feet 31 meters

Features

CONTINUED



# Adaptive Cruise Control (ACC)

The distance you select is also shown on the multi-information display.

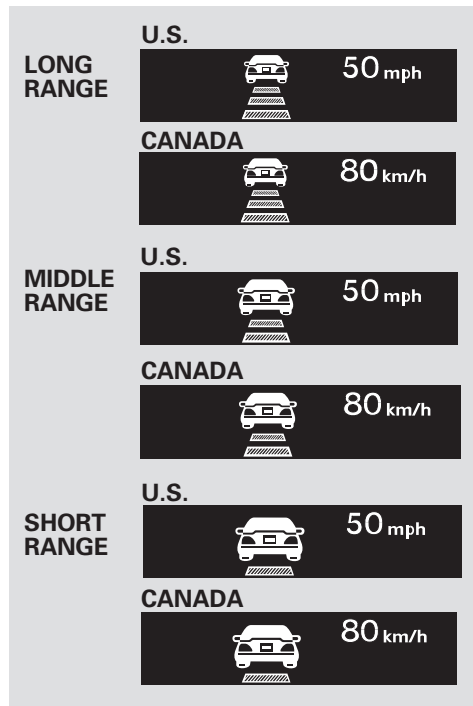

## Canceling the ACC

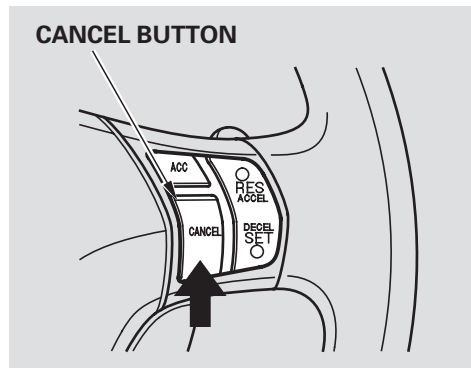

ACC is canceled whenever you do any of these actions:

- Push the CANCEL button on the steering wheel.
- Tap the brake pedal.
- Press the ACC button. The ACC indicator in the instrument panel goes off.

When you push the CANCEL button or tap the brake pedal to cancel ACC, the set cruising speed stays in memory. When you turn on ACC again, the speed is shown on the multi-information display. To return to that speed, accelerate to over 25 mph (40 km/h), then press the RES/ACCEL button.

If you cancel ACC by pressing the ACC button, the previously set cruising speed is erased from memory.

## Automatic ACC Cancellation

When ACC is automatically cancelled, the beeper sounds three times, and an ACC OFF message appears on the multi-information display for 3 seconds.

Any of these conditions may cause ACC to cancel:

- The vehicle speed decreases below 22 mph (35 km/h).
- Poor weather (rain, fog, snow, etc.)
- When the radar sensor in the front grille gets dirty.
- The vehicle ahead of you cannot be detected.
- An abnormal tire condition is detected, or the tires are skidding.

- Driving on a mountainous road, or driving off road for extended periods.
- Abrupt steering wheel movement.
- When the ABS or VSA is activated.
- When the VSA indicator comes on.

If ACC is cancelled by any of these conditions, wait until the condition improves, then press the RES/ACCEL button to restore ACC. When you do this, the vehicle will resume its set cruising speed.

If you turn the ignition switch to the ACCESSORY (I) or LOCK (0) position after ACC was automatically cancelled, the set speed is erased, and you must enter it again (see page 285).

## ACC Indicator

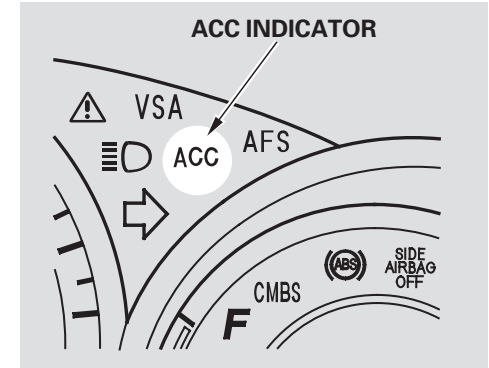

This indicator normally comes on for a few seconds when you turn the ignition switch to the ON (II) position. If it comes on at any other time, there is a problem in the ACC system. If this happens, take the vehicle to your dealer to have it checked.





The ACC system cannot be used while this indicator is on.

# Adaptive Cruise Control (ACC)





---



## Messages on the Multi-Information Display

The multi-information display shows various messages related to ACC. For a description of each ACC message you may see, refer to the chart on this and the following page.

Message	Description
	ACC is on.
	ACC is on and in standby mode. A cruising speed can be set by pressing the SET/DECEL button.
<p><b>U.S.</b></p>  <p><b>CANADA</b></p> 	ACC is in standby mode, and the previously set cruising speed is in memory. The previously set speed can be resumed by pressing the RES/ACCEL button.

# Adaptive Cruise Control (ACC)

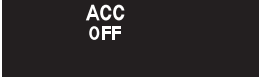
Message	Description
<p><b>U.S.</b></p>  <p><b>CANADA</b></p> 	<p>ACC detects a vehicle ahead of you.</p> <p>You will hear a beep when the vehicle moves out of the ACC radar sensor's range.</p>
<p><b>U.S.</b></p>  <p><b>CANADA</b></p> 	<p>ACC does not detect a vehicle ahead of you.</p> <p>You will hear a beep when ACC detects a vehicle ahead of you.</p>
	<p>ACC has automatically cancelled because its radar sensor in the front grill is dirty.</p> <p>You will hear three beeps.</p>

Message	Description
	<p>ACC has automatically cancelled because of bad weather or other conditions.</p> <p>You will hear three beeps.</p>
	<p>Apply the brakes immediately. Your vehicle is too close to the vehicle ahead of it.</p> <p>You will hear a continuous beep.</p>
	<p>ACC needs to be checked.</p> <p>Have your vehicle checked by a dealer.</p>

# Adaptive Cruise Control (ACC)

## Switching to Cruise Control

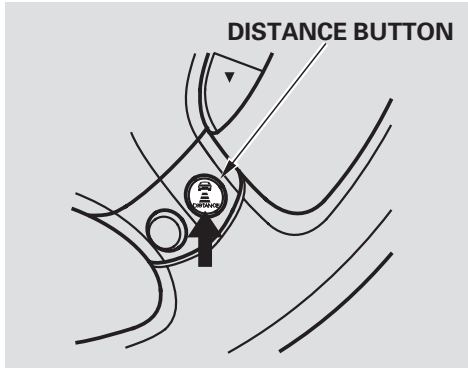

To switch from ACC to cruise control, press the distance button on the steering wheel, and hold it for 1 second.

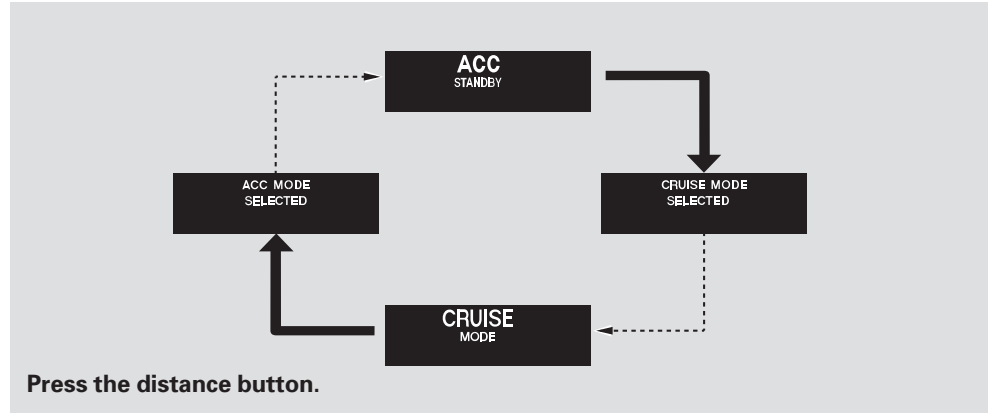

When you press the button, you will see CRUISE MODE SELECTED on the multi-information display for 2 seconds. To switch back to ACC, press and hold the distance button again for 1 second.

When the cruise control is selected, ACC does not sound a beeper or display a message on the multi-information display. Make sure to keep a safe distance from the vehicle ahead of you.

Always be aware which mode is selected.

The HomeLink® Universal Transceiver built into your vehicle can be programmed to operate up to three remote controlled devices around your home, such as garage doors, lighting, or home security systems.

## General Safety Information

Before programming your HomeLink to operate a garage door opener, confirm that the opener has an external entrapment protection system, such as an “electronic eye,” or other safety and reverse stop features.

If your garage door was manufactured before April 1, 1982, you may not be able to program HomeLink to operate it. These units do not have safety features that cause the motor to stop and reverse it if an obstacle is detected during closing, increasing the risk of injury. Do not use HomeLink with any

garage door opener that lacks safety stop and reverse features.

Units manufactured between April 1, 1982 and January 1, 1993 may be equipped with safety stop and reverse features. If your unit does not have an external entrapment protection system, an easy test to confirm the function and performance of the safety stop and reverse feature is to lay a  $2 \times 4$  under the closing door. The door should stop and reverse upon contacting the piece of wood. As an additional safety feature, garage door openers manufactured after January 1, 1993 are required to have external entrapment protection systems, such as an electronic eye, which detect an object obstructing the door.

## Important Safety Precautions

Refer to the safety information that came with your garage door opener

to test that the safety features are functioning properly. If you do not have this information, contact the manufacturer of the equipment. Before programming HomeLink to a garage door or gate opener, make sure that people and objects are out of the way of the device to prevent potential injury or damage. When programming a garage door opener, park just outside the garage.

## Training HomeLink

**Before you begin** — If you just received your vehicle and have not trained any of the buttons in HomeLink before, you should erase any previously learned codes before training the first button. To do this, press and hold the two outside buttons on the HomeLink transceiver for about 20 seconds, until the red indicator flashes. Release the buttons, then proceed to step 1.

CONTINUED

# HomeLink® Universal Transceiver

If you are training the second or third buttons, go directly to step 1.

1. Hold the end of the garage door opener remote transmitter 1 to 3 inches from HomeLink. Make sure you are not blocking your view of the red indicator in HomeLink.

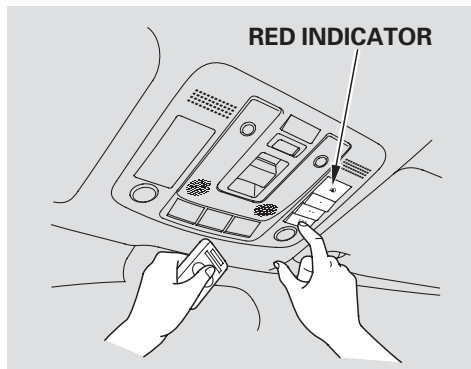

2. Press and hold the remote transmitter button and one of the HomeLink buttons at the same time.

- If the red indicator in HomeLink begins to flash slowly at first, then rapidly, release both buttons, and go to step 4.
  - If the red indicator in HomeLink continues to flash slowly (does not flash rapidly), your remote transmitter may stop transmitting after a short time. Go to step 3.
3. Press and hold the remote transmitter button and one of the HomeLink buttons at the same time. While continuing to hold the HomeLink button, press and release the remote transmitter button every 2 seconds.
    - If the red indicator in HomeLink begins to flash slowly at first, then rapidly, release both buttons, and go to step 4.

- If the red indicator in HomeLink continues to flash slowly (does not begin to flash rapidly), repeat steps 1 thru 3.
4. Test the HomeLink button by pushing it for about 1 second.
    - If the button works, programming is complete.
    - If the button does not work go to step 5.
  5. Push and hold the HomeLink button and watch the red indicator on HomeLink.
    - If the indicator stays on, press the HomeLink button again; the remotely controlled device should operate.
    - If the indicator flashes rapidly for 2 seconds then stays on, you have a rolling code transmitter: go to “Training with a Rolling Code System” (see page [297](#)).

- Repeat these steps to train the other two HomeLink buttons to operate any other compatible remotely controlled devices around your home (lighting, automatic gate, security system, etc.).

## Training With a Rolling Code System

For security purposes, newer garage door opening systems use a “rolling” or variable code. Information from the remote control and the garage door opener is needed before HomeLink can operate the garage door opener.

The “Training HomeLink” procedure trains HomeLink to the proper garage door opener code. The following procedure synchronizes HomeLink to the garage door opener so it sends and receives the correct codes.

- Make sure you have properly completed the “Training HomeLink” procedure.
- Find the “learn” button on your garage door opener unit. The location will vary, depending on the manufacturer.

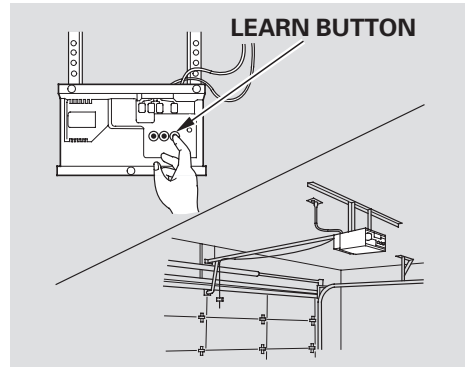

- Press the learn button on the garage door opener unit until the indicator next to the button comes on. The indicator may blink, or come on and stay on. You then

have approximately 30 seconds to complete the following steps.

- Press and hold the button on HomeLink for 3 to 4 seconds.
- Press the HomeLink button again for about 1 second. It should operate the garage door.



# HomeLink® Universal Transceiver

---

## Erasing Codes

To erase the codes stored in all three buttons, press and hold the two outside buttons until the red indicator begins to flash, then release the buttons.

You should erase all three codes before selling the vehicle.

## Retraining a Button

If you want to retrain a programmed button for a new device, you do not have to erase all button memory. You can replace the existing memory code using this procedure:

1. Press and hold the HomeLink button to be trained until the HomeLink indicator begins to flash slowly.
  - If a rolling code transmitter was previously programmed, the indicator will flash rapidly for 2 seconds, and then stay on for about 23 seconds.

- If a standard transmitter was programmed, the indicator will stay on for about 25 seconds.

2. Once the HomeLink indicator begins to flash slowly, continue to hold the HomeLink button, and follow steps 2 thru 5 under “Training HomeLink” (see page 295).

## Client Assistance

If you have problems with training the HomeLink Universal Transceiver, or would like information on home products that can be operated by HomeLink, call (800) 355-3515. On the Internet, go to [www.homelink.com](http://www.homelink.com).

HomeLink® is a registered trademark of Johnson Controls, Inc.

*As required by the FCC:*

*This device complies with Part 15 of the FCC rules. Operation is subject to the following two conditions: (1) This device may not cause harmful interference, and (2) this device must accept any interference received, including interference that may cause undesired operation.*

*Changes or modifications not expressly approved by the party responsible for compliance could void the user's authority to operate the equipment.*

*This device complies with Industry Canada Standard RSS-210. Operation is subject to the following two conditions: (1) this device may not cause interference, and (2) this device must accept any interference that may cause undesired operation of the device.*

*RL Technology Package and RL CMBS/  
PAX models*

AcuraLink enhances your ownership experience by providing a direct communication link between your vehicle and the Acura Server. Working through the XM radio satellite, AcuraLink works in conjunction with the navigation system, Bluetooth® HandsFreeLink® (HFL), and audio system in your vehicle. It displays and receives several kinds of messages, including:

- Operating tips and information on your vehicle's features.
- Important recall and safety information.
- Maintenance information to keep your vehicle in top condition.
- Diagnostic information to provide information about any problems with your vehicle.

### Interface Dial

Most AcuraLink functions are controlled by the interface dial. The interface dial has two parts, a knob and a selector.

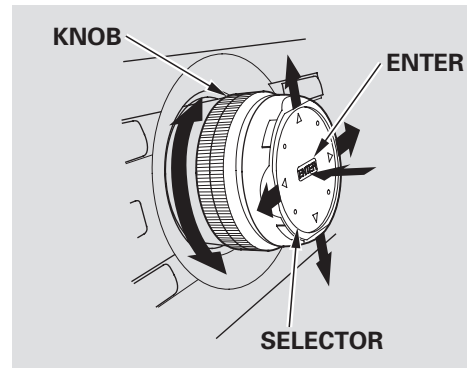

The knob turns left and right. Use it to make selections or adjustments to a list or menu on the screen.

The selector can be pushed left, right, up, down, and in. Use the selector to scroll through lists, to select menus, and to highlight menu items. When you make a selection, push the center of the selector (ENTER) to go to that selection.

## Reading Messages

If you have new messages, an envelope icon appears in the top right corner of the navigation screen.

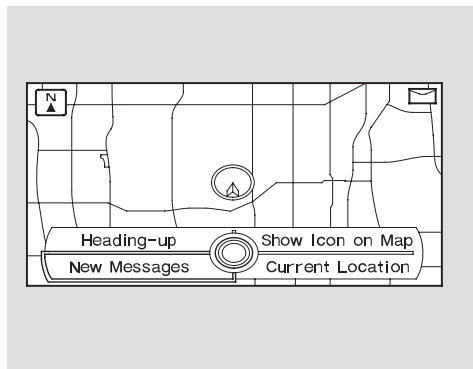

To open a message:

- Press ENTER on the interface selector, then select New Message from the navigation system map menu. If there is more than one message, stored in the system, you will see a list of message titles.

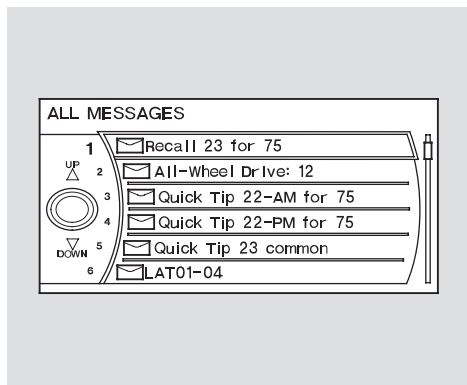

- Scroll up or down, and select the message you want to read by pressing ENTER on the interface selector.

To view previously read messages, press the INFO button, select MESSAGES, then select the category you want to review.

Unread messages have a closed envelope icon next to them. The icon disappears when it has already been read.

**NOTE:** Only Diagnostic Info messages overlay the navigation screen while driving. They indicate if your vehicle has a problem that may need immediate attention (see page [306](#)).

After purchasing your vehicle, messages may not appear immediately. Your dealer has to register the vehicle identification before you can receive messages. This can take several days to process.

## Deleting Messages

**NOTE:** Diagnostic info and recall/campaign messages can only be deleted by your dealer.

To delete a single message:

- Press the INFO button to bring up the Information screen.
- Scroll to the Messages option, then select it by pressing ENTER on the interface selector.
- Select the message category for the message you want to delete.
- Use the interface knob to scroll up or down to the message title you want to delete, and select it by pressing ENTER on the interface selector.
- Scroll to Delete with the interface knob, and select it by pressing ENTER on the interface selector.

To delete all messages:

**NOTE:** The Delete All Messages command does not apply to Diagnostic Info and Recall messages. They can only be deleted by your dealer.

- Press the SETUP button to view the setup screen.
- Select MORE by pushing the interface selector to the right.
- Use the interface knob to scroll to the AcuraLink/Messages button, and select it by pressing ENTER on the interface selector.
- Scroll to the Delete Messages option, and select it by pressing ENTER on the interface selector.
- Scroll to the category with the messages you want to delete, and select the category by pressing ENTER on the interface selector.

## Message Options

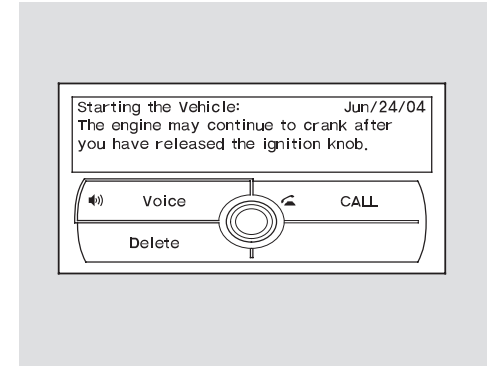

When you open a message, you can read a summary of it, and then choose one of several options. If an option is not available for a message, that button will not be highlighted.

*CONTINUED*

**Delete** — Select this button to delete the current message.

**Voice** — Select this button to hear a voice read the entire message. This gives you more information than the screen can display at one time. When you select the Voice button, it changes to a Stop Reading button. Select the button again to stop the voice.

**Call** — Select this button to call a phone number embedded in the message. When you select **Call**, the Bluetooth® HandsFreeLink® (HFL) dials the number for you. To make a call, your Bluetooth® compatible phone must be paired to the vehicle's HandsFreeLink system, powered on, and located within the vehicle (see page 308).

**Find Nearest Acura Dealer** — Select this button to find the nearest Acura dealer using the navigation

system.

**Call Your Acura Dealer** — Select this button to call the Acura dealer you purchased your vehicle from. AcuraLink also directs you to this dealer so you can schedule a maintenance appointment or receive information about a message. If your assigned servicing dealer changes, AcuraLink will be updated to call that dealer.

**More Info** — Select this button to get more information about the current diagnostic message. To use this option, your cell phone must be paired to the HFL. In addition, the paired phone must have a compatible data service and be set up with the AcuraLink system to make a data connection. Access the [acura.com/handsfreelink](http://acura.com/handsfreelink) website to find out which data services are currently compatible with AcuraLink.

## Message Preferences

To set your AcuraLink preferences (the types of messages you want to receive, if any), visit the Owner Link website at [www.owners.acura.com](http://www.owners.acura.com), and choose what you would like to receive. If you do not have internet access, call Acura Client Services at (800) 382-2238; they can set your message preferences for you.

**AcuraLink/Message Screen**

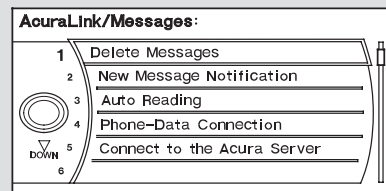
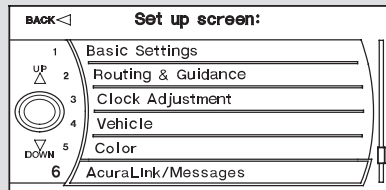

To access the following functions, press the SETUP button, push the interface selector to the right to select MORE, then rotate the interface knob to select AcuraLink/ Messages.

**Delete Messages** — Select this button to delete all stored messages within a category, except for diagnostic info and recall campaign messages. These messages can only be deleted by a certified technician after the recall is done or the problem is corrected, or through a broadcast message from Acura.

**New Message Notification** — Select ON if you want to be notified of new messages (envelope icon appears on the navigation screen). Select OFF if you do not want to be notified of new messages (envelope icon does not appear on the navigation screen).

Messages can still be accessed using the INFO menu. If you would like to stop receiving messages, visit the OwnerLink website at [www.owners.acura.com](http://www.owners.acura.com) to change your messaging preferences.

**Auto Reading** — Select ON to have the system automatically read each message to you. Select OFF to manually select the Voice button when you want a message read to you.

**Phone-Data Connection** — Select this button to begin the process required to connect to Acura. This is used to access the most recent diagnostic information when a problem occurs.

CONTINUED

## Connect to the Acura Server —

The default setting is prompt. When a diagnostic info message appears, and you select the Check Now button, the system will prompt you before connecting to the Acura server. If you do not wish to connect at that time, select No at the prompt, and you will see the information from the onboard database. The “Auto” setting will remove the prompt when you select the Check Now button and will automatically connect to the Acura server. This setting only applies when you have a Bluetooth® enabled phone that is paired with the HFL and you have completed the Phone-Data Connection setup.

**NOTE:** For the Phone Data Connection button to be active, you need a Bluetooth® compatible and enabled cellphone paired to the Bluetooth® HandsFreeLink® (HFL). To complete the data connection setup, the paired phone must have a compatible data service.

## Message Categories

There are six message categories in AcuraLink: Quick Tips, Feature Guides, Maintenance Minders, Recalls/Campaigns, Diagnostic Info, and Dealer Appointment Reminders. The system can store up to 256 messages.

Message categories can be added, revised, or deleted through broadcast messages from Acura.

## Quick Tips

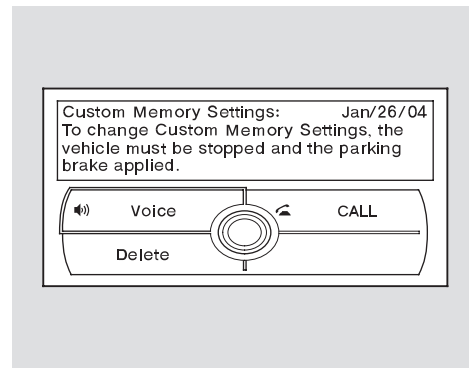

These messages, based on updated vehicle information and comments from other RL owners, supplement your Owner's Manual and Quick Start Guide. They provide you with relevant information for a safe and enjoyable ownership experience. For additional information, call Acura Client Services directly through the HFL.

## Feature Guide

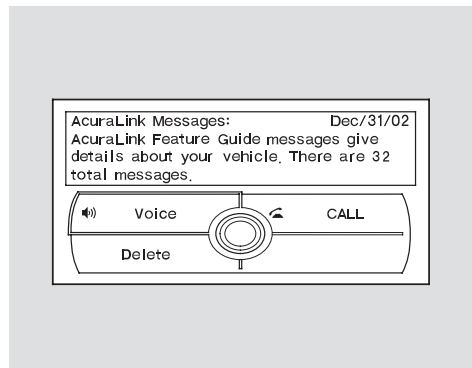

During the first 90 days of ownership, one of up to 32 different messages appears each day. These messages help you to use and understand the technological features of your vehicle.

## Maintenance Minder

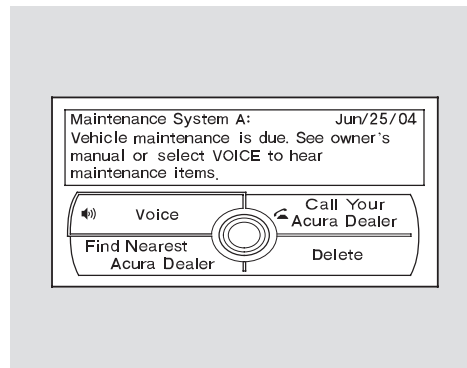

These messages provide detailed information about the service needed for your vehicle. When a maintenance message appears on the multi-information display, a list of needed maintenance items is provided through in an AcuraLink message. These messages tell you the exact maintenance needed, helping you to avoid unnecessary maintenance costs.

You can then use the message options to call your dealer for an appointment or to find the nearest dealer.



## Recall/Campaigns

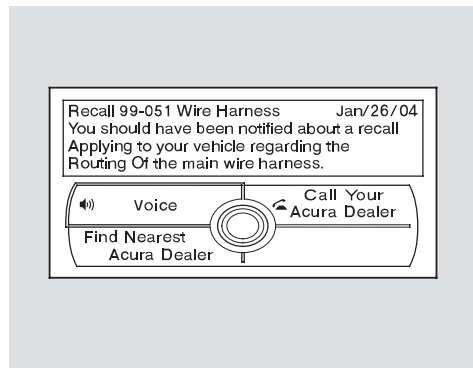

If your vehicle is affected by a recall or other important safety information, a letter will be mailed to you about the issue and how to fix it. If you don't get your vehicle fixed, you will also receive a reminder message through AcuraLink. You can then use the message options to call your dealer for an appointment or to find the nearest dealer.

## Diagnostic Info

When an indicator comes on or a message is displayed on the multi-information display (MID), AcuraLink can provide information about the cause of indicator or message and the recommended action to take. This helps you handle the problem as it occurs, preventing or limiting costly repairs.

The AcuraLink system cannot determine some mechanical problems (such as squeaks or rattles) that are not triggered by the diagnostic indicator monitors.

For more information on the instrument panel indicators, see page [61](#).

When an indicator comes on or a message is displayed on the MID, AcuraLink immediately notifies you with the message, "An indicator is on. AcuraLink can help you decide what

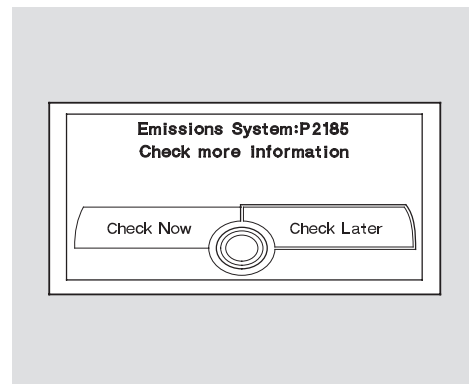

to do." If you do not want the information right away, select the Check Later option. If you want the information now, select the Check Now option. (If the navigation screen is not active, you must select OK from the navigation disclaimer screen before you can check the information.)

Depending on the severity of the problem, the message will let you know if you should see your dealer immediately or if you can wait a while.

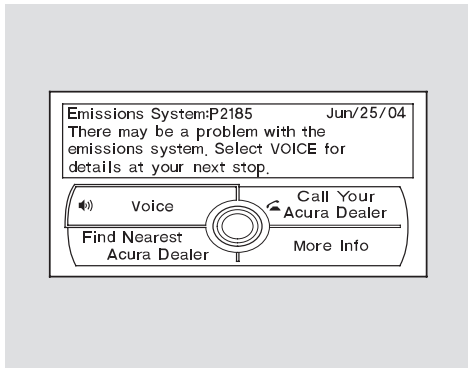

You can then use message options to call your dealer for an appointment, to find the nearest dealer, or to find out more information about the issue.

When you select the More Info option, if the HFL is connected to a cellular data service, AcuraLink gathers more information about the problem, and sends it to Acura. There, the information is analyzed and returned to the vehicle with the most accurate repair information.

**NOTE:** There may not be any additional information, depending on the time elapsed since the previous time you retrieved the information from the Acura server.

## Dealer Appointment Reminder



When you make an appointment through the Owner's Link Online Scheduling Service, you can be reminded in advance about that appointment through AcuraLink. If you need to reschedule, you can call your dealer directly with the HFL.

The timing of your reminder is based on your reminder preference established on Owner Link.

*CONTINUED*

*As required by the FCC:*

*This device complies with Part 15 of the FCC rules. Operation is subject to the following two conditions: (1) This device may not cause harmful interference, and (2) this device must accept any interference received, including interference that may cause undesired operation.*

*Changes or modifications not expressly approved by the party responsible for compliance could void the user's authority to operate the equipment.*

*This device complies with Industry Canada Standard RSS-210.*

*Operation is subject to the following two conditions: (1) this device may not cause interference, and (2) this device must accept any interference that may cause undesired operation of the device.*

### **Bluetooth® HandsFreeLink®**

Your vehicle is equipped with the Bluetooth® HandsFreeLink® (HFL). HFL uses Bluetooth® technology as a wireless link between it and your Bluetooth® compatible cellphone. When you are in your vehicle and your phone is linked to the HFL, you'll enjoy hands-free phone use. The HFL is available in both English and French (Canadian models only). To change the language, see page [324](#).

Here are the main features of the HFL. Instructions for using the HFL begin on page [309](#).

### **Voice Control**

HFL recognizes simple voice commands, such as phone numbers and names. It uses these commands to automatically dial, receive, and store numbers. For more information on voice control, see Using Voice Control on page [311](#).

### **Bluetooth® Wireless Technology**

Bluetooth® is a registered trademark of Bluetooth SIG, Inc. Bluetooth is the wireless technology that links your phone to the HFL. The HFL uses a Class 2 Bluetooth, which means the maximum range between your phone and vehicle is 30 feet (10 meters).

To use the HFL, your phone must have approved Bluetooth capability along with the Hands Free Profile. This type of phone is available through many phone makers and cellular carriers. You can also find an approved phone by visiting [www.acura.com/handsfreelink](http://www.acura.com/handsfreelink) ( In Canada, visit [www.acura.ca](http://www.acura.ca).) or by calling the Hands Free Link® client support at (888) 528-7876.

## Incoming/Outgoing Calls

With a linked phone, the HFL allows you to send and receive calls in your vehicle without holding the phone.

## Phonebook

The HFL can store up to 50 names and phone numbers in its phonebook. With a linked phone, you can then automatically dial any name or number in the phonebook.

Here are the main components of the HFL system:

## Microphone

The HFL microphone is on the ceiling console. The microphone is shared with the navigation system (if equipped).

## Audio System

When the HFL is in use, the sound comes through the vehicle's front audio system speakers. If the audio system is in use while operating either of the HFL buttons or making a call, the HFL over-rides the audio system. To change the volume level, use the audio system volume knob, or the steering wheel volume controls.

## HFL Buttons

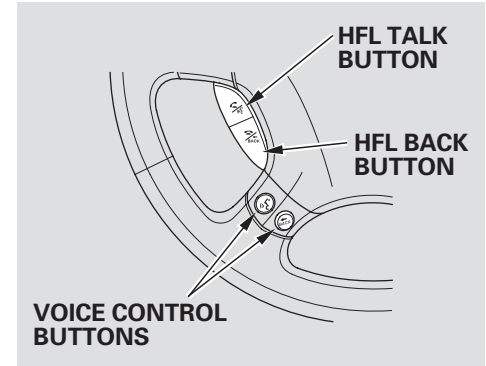

To operate the HFL, use the HFL Talk and Back buttons on the left side of the steering wheel. Below the HFL buttons is another set of voice control buttons for the navigation, climate control, and audio systems.

CONTINUED

Here is the function of each HFL button:

**HFL Talk:** This button is used before you give a command, to answer incoming calls, and to confirm system information.

**HFL Back:** This button is used to end a call, go back to the previous voice control command, and to cancel an operation.

## Multi-Information Display

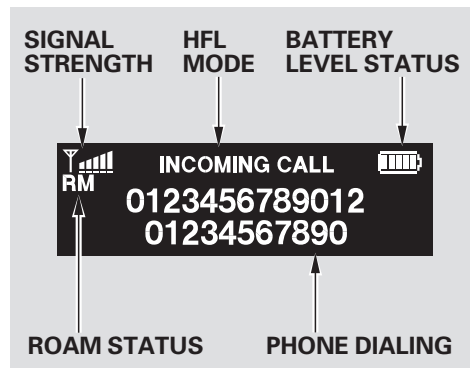

When you are operating the HFL, or when you manually select HFL on the multi-information display, you will see this information on the screen:

- **Signal Strength\*** — Indicates the network signal strength of the current phone. Five bars equals full strength.
- **ROAM Status\*** — Indicates your phone is roaming.
- **Battery Level Status\*** — Indicates the power currently remaining in your phone's battery. Five bars equals full battery strength.
- **HFL Mode** — Indicates when you are dialing and receiving calls.
- **Phone Dialing** — Indicates the number you entered or the number of the incoming call.

\* : Some phones do not send this information to the HFL.

With the HFL system activated, you will also see “HF LINK” on the upper display.

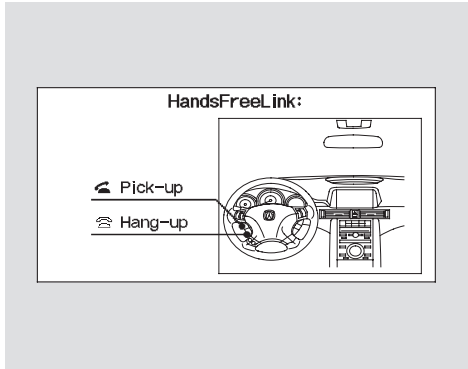

When you are dialing or receiving calls with the audio system in use, you will see the HFL screen on the navigation display.

## How to Use the HFL

The HFL is operated by the HFL Talk and Back buttons on the left side of the steering wheel. The next few pages provide instructions for all basic features of the HFL.

**NOTE:** All phones may not operate identically, and some may cause inconsistent operation of the HFL.

## Using Voice Control

Here are some guidelines for using voice control:

- To enter a command, press the Talk button. Then, after the beep, say your command in a clear, natural tone.
- For best system operation, set the climate control fan speed to low, and direct the center vents away from the microphone in the ceiling.
- If the HFL does not recognize a command, its response is, “Pardon.” If it doesn’t recognize the command a second time, its response is, “Please repeat.” If it doesn’t recognize the command a third time, it plays the Help prompt.

CONTINUED

- To hear a list of available options at any time, press the Talk button, wait for the beep, and say, “Hands free link help.”
  - Many commands can be spoken together. For example, you can say, “Dial 123-456-7891.”
  - To enter a string of numbers in a Call or Dial command, you can say them all at once, or you can separate them in blocks of 3, 4, 7, 10, or 11.
  - To skip a voice prompt, press the Talk button while the HFL is speaking. The HFL will then begin listening for your next command.
- To go back one step in a command process, say, “Go back,” or press the Back button.  
If nothing is said while the HFL is listening for a command, the HFL will time out and stop its voice recognition. The next time you press the Talk button, the HFL begins listening from the point at which it timed out.
  - To end a command sequence at any time, press and hold the Back button, or press and release the Talk button, wait for the beep, and say, “Cancel.” The next time you press the Talk button, the HFL begins from its main menu.
- When you finish a command sequence, the HFL goes back to its main menu. For example, when you store the name, “Eric,” the HFL response is, “Eric has been stored.” The next time you press the Talk button, you will be at the main menu.

### Setting Up the System

The voice of the HFL can be set to male or female (U.S. models only). Also, the incoming notification can be set to a ring tone, a prompt, or no notification.

*To set up the system, do this:*

1. Press and release the Talk button. After the beep, say “System.” The HFL response is, “System options are setup and clear.”
2. Press and release the Talk button. After the beep, say “Setup.” The HFL response is “Would you like male or female prompts?”
3. Press and release the Talk button. After the beep, say “Male” or “Female,” depending on the system voice you want. The HFL response is, “Male (Female) prompts have been selected. Would you like an audible notification of an incoming call?”

4. Press and release the Talk button. If you say “Yes” after the beep, the HFL system response is, “Would you like the notification to be a ring tone or a prompt?” If you say “No” after the beep, the HFL system returns to its main menu. Saying “No” will result in no ring tone or prompt playback during an incoming call. The audio system will be mute, and a message will be displayed.
5. Press and release the Talk button. After the beep, say “Ring tone” or “Prompt.” The HFL system response is “A ring tone will be used.” or “An incoming call prompt will be used.” If you choose “Ring tone,” you will hear a ring tone through the audio speakers to announce an incoming call. If you choose “Prompt,” you will hear this message to announce an incoming call: “You have an incoming call.”

6. The HFL response continues “A security option is available to lock the hands free system. Each time the vehicle is turned on, a passcode would be required to use this system. Would you like this security option turned on?”
7. Press and release the Talk button. If you say “No” after the beep, the HFL system response is, “Security will not be used. The system setup is complete.”

If you say “Yes,” you can set your passcode. Refer to the setting procedure in the next column.



## Setting Your Passcode

The HFL will accept a numeric, four-digit passcode that you can use for security purposes.

*To set your passcode, do this:*

1. Follow the system setup procedure as described previously.
2. Press and release the Talk button. After the beep, say “Yes.”
3. The HFL response is “What is the four-digit number you would like to set as your passcode?”
4. Press and release the Talk button. After the beep, say the four-digit passcode you want to use. For example, say “1, 2, 3, 4.” The HFL response is “1, 2, 3, 4. Is this correct?”

5. Press and release the Talk button. After the beep, say “Yes.” The HFL response is “Security is on. Each time the vehicle is turned on, the passcode will be required to use the system. The system setup is complete. Returning to the main menu.”

6. Press and release the Talk button. If you say “No.” after the beep, the HFL response is “Security will not be used. The system setup is complete.”

*To enter your passcode, do this:*

Once a passcode is set, you can lock the HFL so it only operates after the passcode is entered.

1. The HFL will prompt you for your passcode each time the ignition switch is turned to the ON (II) position and you press the Talk button. You will only be asked for the passcode once per ignition

cycle. If the passcode is set, its response is “The system is locked. What is the four-digit passcode?”

2. Press and release the Talk button. After the beep, say your four-digit passcode. For example, say “1, 2, 3, 4.”

3. If the passcode is correct, the HFL response is “Main menu.” If the passcode is not correct, the HFL response is “1,2,3,4 is incorrect. Please try again.” Go back to the step 2.

If you forget your passcode and you cannot activate the HFL, consult your dealer to cancel the passcode.

## Pairing Your Phone

Your Bluetooth® compatible phone with HandsFree Profile must be paired to the HFL before you can make and receive hands-free calls.

### NOTE:

- HFL does not allow you to pair your phone if the vehicle is moving.
- For pairing, your phone must be in its Discovery mode.
- Up to six phones can be paired to the HFL.
- The following procedure works for most phones. If you cannot pair your phone to the HFL with this procedure, refer to your phone's operating manual, visit [www.acura.com/handsfreelink](http://www.acura.com/handsfreelink), call the Hands Free Link® client support at (888) 528-7876, or call your phone retailer.
- During the pairing process, turn off any previously paired phones before pairing a new phone.

1. With your phone on and the ignition in the ACCESSORY (I) or ON (II) position, press and release the Talk button. After the beep, say "Phone setup." The HFL response is "Phone setup options are status, pair, edit, delete, and list."
2. Press and release the Talk button. After the beep, say "Pair." The HFL response is "The pairing process requires operation of your mobile phone. For safety, only perform this function while the vehicle is stopped. State a four-digit code for pairing. Note this code. It will be requested by the phone."

CONTINUED

3. Press and release the Talk button.  
After the beep, say the four-digit code you want to use. For example, say “1, 2, 3, 4.” The HFL response is, “1, 2, 3, 4. Is this correct?”

4. Press and release the Talk button.  
After the beep, say “Yes.” The HFL system response is “Searching for a Bluetooth phone. Make sure the phone you are trying to pair is in discovery mode.”

**NOTE:** Steps 5 and 6 show a common way to get your phone into its Discovery mode. If these steps do not work on your phone, refer to the phone’s operating manual.

5. Follow the prompts on your phone to get it into its Discovery mode. The phone will search for the HFL. When it comes up, select HandsFreeLink from the list of options displayed on your phone.

6. When asked by the phone, enter the four-digit code from step 3 into your phone. The HFL response is “A new phone has been found. What would you like to name this phone?”

7. Press and release the Talk button.  
After the beep, say the name you want to use. For example, say “Eric’s phone.” The HFL response is “Eric’s phone has been successfully paired. Returning to the main menu.”

8. If you want to pair another phone, repeat steps 1 through 7.

*On vehicles with navigation system*  
Once the pairing process is completed, AcuraLink may display a connection confirmation screen. This screen is used to create a data connection between your cell phone and the AcuraLink system. You can choose to set up the data connection now, or do it later. If you want to do it now, exit the HFL menu by pressing the HFL Back button one or more times.

*To rename a paired phone, do this:*

1. Press and release the Talk button. After the beep, say “Phone setup.” The HFL response is “Phone setup options are status, pair, edit, delete, and list.”
2. Press and release the Talk button. After the beep, say “Edit.” The HFL response is “Which phone would you like to edit?”
3. Press and release the Talk button. After the beep, say the name of the phone you want to rename. For example, say “Eric’s phone.” The HFL response is “What is the new name for Eric’s phone?”
4. Press and release the Talk button. After the beep, say the new name of the phone. For example, say “Lisa’s phone.” The HFL response is, “The name has been changed. Returning to the main menu.”

*To delete a paired phone, do this:*

1. Press and release the Talk button. After the beep, say “Phone setup.” The HFL response is, “Phone setup options are status, pair, edit, delete, and list.”
2. Press and release the Talk button. After the beep, say “Delete.” The HFL response is, “Which phone would you like to delete?”
3. Press and release the Talk button. After the beep, say the name of the phone you want to delete. For example say “Eric’s phone.” The HFL response is “Would you like to delete Eric’s phone?”

4. Press and release the Talk button. After the beep, say “Yes.” The HFL response is “Preparing to delete Eric’s phone.” Say “OK” to continue. Otherwise, say “Go back,” or “Cancel.”
5. Press and release the Talk button. If you say “OK” after the beep, the HFL response is “The phone has been deleted. Returning to the main menu.” If you say “Go back,” or “Cancel,” the phone will not be deleted.

CONTINUED

*To list all paired phones, do this:*

1. Press and release the Talk button. After the beep, say “Phone setup.” The HFL response is “Phone setup options are status, pair, edit, delete, and list.”
2. Press and release the Talk button. After the beep, say “List.” The HFL responds by listing the name of each paired phone. When all phones paired to the system have been read, the HFL response is “The entire list has been read. Returning to the main menu.”

*To find out the status of the phone being used, do this:*

1. Press and release the Talk button. After the beep, say “Phone setup.” The HFL response is “Phone setup options are status, pair, edit, delete, and list.”
2. Press and release the Talk button. After the beep, say “Status.” An example of the HFL response is, “Eric’s phone is linked. Battery strength is three bars. Signal strength is five bars, and the phone is roaming. Returning to the main menu.”

*To change from the currently linked phone to another paired phone, do this:*

1. Press and release the Talk button. After the beep, say “Next phone.” The HFL response is “Searching for the next phone.” The HFL then disconnects the linked phone and searches for another paired phone. If no other phones are found, the first phone remains linked.

**Making a Call**

You can make calls using any phone number, or by using a name in the HFL phonebook. You can also redial the last number called. During a call, the HFL allows you to talk up to 30 minutes after you remove the key from the ignition switch.

*To make a call using a phone number, do this:*

1. With your phone on and the ignition in the ACCESSORY (I) or ON (II) position, press and release the Talk button. After the beep, say “Call” or “Dial.” The HFL response is, “What name or number would you like to call/dial?”
2. Press and release the Talk button. After the beep, say the number you want to call. For example, say “123 456 7891.” The HFL response is “123 456 7891. Say call, dial, or continue to add numbers.”

3. Press and release the Talk button. After the beep, say “Call” or “Dial.” The HFL response is “Calling” or “Dialing.” Once connected, you will hear the person you called through the audio speakers. To change the volume, use the audio system volume knob, or the steering wheel volume controls.

4. To end the call, press the Back button.

*To make a call using a name in the HFL phonebook, do this:*

1. With your phone on and the ignition in the ACCESSORY (I) or ON (II) position, press and release the Talk button. After the beep, say “Call” or “Dial.” The HFL response is “What name or number would you like to call/dial?”
2. Press and release the Talk button. After the beep, say the name you

want to call. For example, say “Eric.” The HFL response is “Would you like to call Eric?”

3. Press and release the Talk button. After the beep, say “Yes.” The HFL response is “Calling” or “Dialing.” Once connected, you will hear the person you called through the audio speakers. To change the volume, use the audio system volume knob.

4. To end the call, press the Back button.

To redial the last number called by the phone, press and release the Talk button. After the beep, say “Redial.” The HFL response is, “Redialing.” Once connected, you will hear the person you called through the audio speakers. To change the volume, use the audio system volume knob, or the steering wheel volume controls.

## **Sending Numbers or Names During a Call**

The HFL allows you to send numbers or names during a call. This is useful when you call a menu-driven phone system. You can also program account numbers into the HFL phonebook for easy retrieval during menu-driven calls.

*To send a number during a call, do this:*

1. Press and release the Talk button. After the beep, say “Send.” The HFL response is, “What name or number would you like to send?”
2. Press and release the Talk button. After the beep, say the number you want to send. For example, say “1, 2, 3.” The HFL response is “1, 2, 3. Say send, or continue to add numbers.”

3. Press and release the Talk button. After the beep, say “Send.” The dial tones will be sent, and the call will continue.

*To send a name during a call, do this:*

1. Press and release the Talk button. After the beep, say “Send.” The HFL response is “What name or number would you like to send?”
2. Press and release the Talk button. After the beep, say the name you want to send. For example, say “Account number.” The HFL response is “Would you like to send account number?”
3. Press and release the Talk button. After the beep, say “Send.” The dial tones will be sent, and the call will continue.

## **Receiving a Call**

If you receive a call when you are not on the phone, the HFL interrupts the audio system (if it is on), and plays the incoming call notification, if activated. To answer the call, press the Talk button and begin speaking. If you don’t want to answer the call, press the Back button.

If your phone has Call Waiting, and you receive a call when you are on the phone, press and release the Talk button to answer it. When you do this, the original call is placed on hold. To return to the original call, press the Talk button again. If you don’t want to answer the new call, disregard it, and continue with your original call. If you want to hang up the original call and answer the new call, press the Back button.

**Transferring a Call**

During a call, you can transfer it from the HFL to your phone, or from your phone to the HFL.

*To transfer a call from the HFL to your phone, do this:*

1. Press and release the Talk button. After the beep, say “Transfer.” The audio switches from the HFL to the phone.

*To transfer a call from your phone to the HFL, do this:*

2. Press and release the Talk button. After the beep, say “Transfer.” The audio switches from your phone to the HFL.

**Muting a Call**

During a call, you can mute or unmute your voice to the person you are talking to.

*To mute your voice, do this:*

1. Press and release the Talk button. After the beep, say “Mute.” The HFL response is, “Mute is active.”

*To unmute your voice, do this:*

2. Press and release the Talk button. After the beep, say “Mute.” The HFL response is, “Mute is canceled.”

**Setting up the Phonebook**

The HFL phonebook can store up to 50 names with their associated numbers. These can be any types of numbers. For example, you can store a phone number and use it to make a call, or you can store an account number and use it during a call to a menu-driven phone system.

*To add a name, do this:*

1. Press and release the Talk button. After the beep, say “Phonebook.” The HFL response is “Phonebook options are store, edit, delete, receive contact, and list.”
2. Press and release the Talk button. After the beep, say “Store.” The HFL response is, “What name would you like to store?”
3. Press and release the Talk button. After the beep, say the name you would like to store. For example, say “Eric” or say “account number.” The HFL response is “What is the number for Eric,” or “What is the number for account number?”
4. Press and release the Talk button. After the beep, say the number. For example, say “123 456 7891.” The HFL response is “123 456 7891.”

CONTINUED



5. Press and release the Talk button. After the beep, say “Enter.” The HFL response is “Eric (or account number) has been stored. Returning to the main menu.”

*To edit the number of a name, do this:*

1. Press and release the Talk button. After the beep, say “Phonebook.” The HFL response is “Phonebook options are store, edit, delete, receive contact, and list.”
2. Press and release the Talk button. After the beep, say “Edit.” The HFL response is, “What name would you like to edit?”
3. Press and release the Talk button. After the beep, say the name you would like to edit. For example, say “Eric.” The HFL response is “What is the new number for Eric?”

4. Press and release the Talk button. After the beep, say the new number for Eric. For example, say “987 654 3219.” The HFL response is, “987 654 3219.”

5. Press and release the Talk button. After the beep, say “Enter.” The HFL response is “The number has been changed. Returning to the main menu.”

*To delete a name, do this:*

1. Press and release the Talk button. After the beep, say “Phonebook.” The HFL response is, “The Phonebook options are store, edit, delete, receive contact, and list.”
2. Press and release the Talk button. After the beep, say “Delete.” The HFL response is, “What name would you like to delete?”

3. Press and release the Talk button. After the beep, say the name you would like to delete. For example, say “Eric.” The HFL response is “Would you like to delete Eric?”

4. Press and release the Talk button. After the beep, say “Yes.” The HFL response is, “The name has been deleted. Returning to the main menu.”

*To list all names in the phonebook, do this:*

1. Press and release the Talk button. After the beep, say “Phonebook.” The HFL response is, “The Phonebook options are store, edit, delete, receive contact, and list.”

2. Press and release the Talk button. After the beep, say “List.” The HFL responds by listing the names in the phonebook. When the end of the list is reached, the HFL response is, “The entire list has been read. Returning to the main menu.”

*To call a name from the phonebook list, do this:*

1. Press and release the Talk button. After the beep, say “Phonebook.” The HFL response is “Phonebook options are store, edit, delete, receive contact, and list.”
2. Press and release the Talk button. After the beep, say “List.” The HFL responds by listing the names in the phonebook. When it says the name you want to call, for example, Eric, press the Talk button, and then say “Call.” The HFL response is, “Would you like to call Eric?”

3. Press and release the Talk button. After the beep, say “Yes.” The HFL response is “Calling.” Once connected, you will hear the person you called through the audio speakers. To change the volume, use the audio system volume knob, or the steering wheel volume controls.

### **Clearing the System**

This operation clears the HFL of your passcode, your paired phones, and all names in the HFL phonebook. Clearing is recommended before you sell your vehicle.

*To clear the system, do this:*

1. Press and release the Talk button. After the beep, say “System.” The HFL response is, “System options are setup and clear.”

2. Press and release the Talk button. After the beep, say “Clear.” The HFL response is, “This process will clear all paired phones, clear all entries in the phonebook, and clear the passcode. Is this what you would like to do?”
3. Press and release the Talk button. After the beep, say “Yes.” The HFL response is “Preparing to clear all paired phones, all phonebook entries, and the passcode. This may take up to 2 minutes to complete.” Press and release the Talk button. After the beep, say “OK” to proceed, or say “Go back” or “Cancel.”
4. If you said “OK,” after a short period of time, the HFL response is, “System has been cleared. Returning to the main menu.”

## Changing Language Canadian models only

*To change from English to French, do this:*

1. Press and release the Talk button. After the beep, say “Change language.” The HFL response is “English or French?”
2. Press and release the Talk button. After the beep, say “Français.” The HFL response is “Vous avez sélectionné Français. Les noms enregistrés en mode Anglais ne seront pas accessible en mode Français. Voulez-vous continuer?”
3. Press and release the Talk button. After the beep, say “Oui.” If there are no paired phones without French name tags, the HFL response is “La langue a été changée. Retour au menu principal.”

If there are paired phones without French name tags, the HFL response is “Pour que le système identifie les téléphones qui ont été jumelés dans une autre langue, les noms des téléphones doivent être ré-enregistrés.”

**NOTE:** If there are paired phones without French name tags, the following prompts will continue.

4. The HFL response is, for example, “Quel est le nom Français pour <Paul’s phone>?” Press and release the Talk button. After the beep, say “Téléphone de Paul.” The HFL response is, “Quel est le nom Français pour <Pat’s phone>?” Press and release the Talk button. Say “Téléphone de Pat.” After all paired phones missing a French name tag are re-recorded, the HFL will prompt, “Retour au menu principal.”

*To change from French to English, do this:*

1. Press and release the Talk button. After the beep, say “Changer Langue.” The HFL response is, “Anglais ou Français?”
2. Press and release the Talk button. After the beep, say “English.” The HFL response is, “You have selected English. Name tags that were stored while in French mode will not be accessible in English mode. Would you like to continue?”
3. Press and release the Talk button. After the beep, say “Yes.” If there are no paired phones without English name tags, the HFL response is “The language has been changed. Returning to the main menu.”

If there are paired phones without English name tags, the HFL response is “The language has been changed. For the system to identify phones that were paired while in another language, the phone names need to be re-recorded.”

**NOTE:** If there are paired phones without English name tags, the following prompts will continue.

4. The HFL says, for example, “What is the English name for <Téléphone de Paul>?” Press and release the Talk button. After the beep, say “Paul’s phone.” The HFL response is “What is the English name for <Téléphone de Pat>?” Press and release the Talk button. After the beep, say “Pat’s phone.” After all paired phones missing an English name tag are re-recorded, the HFL will say “Returning to the main menu.”

### HFL Limitations

When using voice control, the HFL call is placed on hold, or the HFL stops its voice recognition. To operate the HFL again, press the Talk button. Then after the beep, say the appropriate command.

In addition, you cannot use the HFL while using AcuraLink.

*As required by the FCC:*

*This device complies with Part 15 of the FCC rules. Operation is subject to the following two conditions: (1) This device may not cause harmful interference, and (2) this device must accept any interference received, including interference that may cause undesired operation.*

*Changes or modifications not expressly approved by the party responsible for compliance could void the user’s authority to operate the equipment.*

*This device complies with Industry Canada Standard RSS-210. Operation is subject to the following two conditions: (1) this device may not cause interference, and (2) this device must accept any interference that may cause undesired operation of the device.*

## Rearview Camera and Monitor

---

*On models with navigation system*

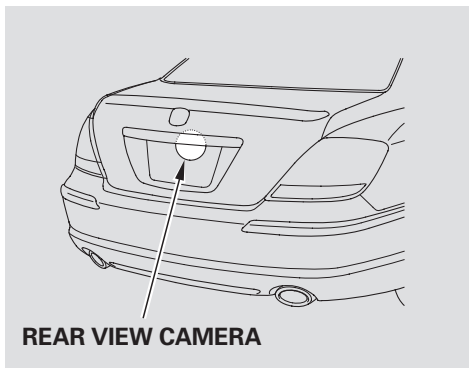

Whenever you shift to reverse (R) with the ignition switch in the ON (II) position, the rear view is shown on the navigation system screen.

For the best picture, always keep the rearview camera clean, and do not cover the camera lens. To avoid scratching the lens when you clean it, use a moist, soft cloth.

Since the rearview camera display area is limited, you should always back up slowly and carefully, and look behind you for obstacles.

Before you begin driving your vehicle, you should know what gasoline to use and how to check the levels of important fluids. You also need to know how to properly store luggage or packages. The information in this section will help you. If you plan to add any accessories to your vehicle, please read the information in this section first.

Break-in Period .....	328
Fuel Recommendation .....	328
Service Station Procedures .....	329
Refueling .....	329
Tighten Fuel Cap Message .....	331
Opening and Closing the Hood .....	331
Oil Check .....	333
Engine Coolant Check .....	333
Fuel Economy .....	334
Accessories and Modifications ....	337
Carrying Cargo .....	339

## Break-in Period, Fuel Recommendation

---

### Break-in Period

Help assure your vehicle's future reliability and performance by paying extra attention to how you drive during the first 600 miles (1,000 km). During this period:

- Avoid full-throttle starts and rapid acceleration.
- Avoid hard braking for the first 200 miles (300 km).
- Do not change the oil until the scheduled maintenance time.
- Do not tow a trailer.

You should also follow these recommendations with an overhauled or exchanged engine, or when the brakes are replaced.

### Fuel Recommendation

Your vehicle is designed to operate on premium unleaded gasoline with a pump octane of 91 or higher. If this octane grade is unavailable, regular unleaded gasoline with a pump octane of 87 or higher may be used temporarily. The use of regular unleaded gasoline can cause metallic knocking noises in the engine and will result in decreased engine performance. The long-term use of regular-grade gasoline can lead to engine damage.

We recommend quality gasolines containing detergent additives that help prevent fuel system and engine deposits.

In addition, in order to maintain good performance, fuel economy, and emissions control, we strongly recommend, in areas where it is available, the use of gasoline that does NOT contain manganese-based fuel additives such as MMT. Use of gasoline with these additives may adversely affect performance, and cause the malfunction indicator lamp on your instrument panel to come on. If this happens, contact your authorized dealer for service.

Some gasoline today is blended with oxygenates such as ethanol or MTBE. Your vehicle is designed to operate on oxygenated gasoline containing up to 10% ethanol by volume and up to 15% MTBE by volume. Do not use gasoline containing methanol.

If you notice any undesirable operating symptoms, try another service station or switch to another brand of gasoline.

For further important fuel-related information, please refer to your **Quick Start Guide**.

## Refueling

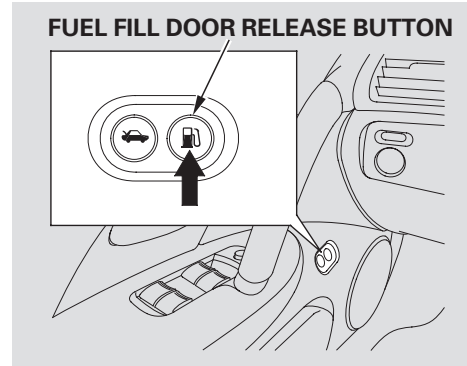

1. Park with the driver's side closest to the service station pump.
2. Open the fuel fill door by pressing the button in the driver's door. (To open the fuel fill door manually, see page [450](#).)

## **⚠ WARNING**

Gasoline is highly flammable and explosive. You can be burned or seriously injured when handling fuel.

- Stop the engine, and keep heat, sparks, and flames away.
- Handle fuel only outdoors.
- Wipe up spills immediately.

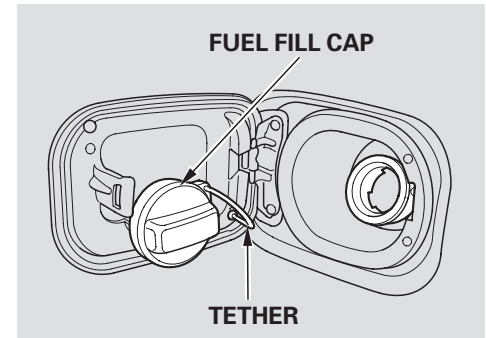

*CONTINUED*



## Service Station Procedures

---

3. Remove the fuel fill cap slowly.

You may hear a hissing sound as pressure inside the tank escapes. Place the cap in the holder on the fuel fill door.

4. Stop filling the tank after the fuel nozzle automatically clicks off. Do not try to “top off” the tank. Leave some room for the fuel to expand with temperature changes.

*If the fuel nozzle keeps clicking off even though the tank is not full, there may be a problem with your vehicle’s fuel vapor recovery system. The system helps keep fuel vapor from going into the atmosphere. Try filling at another pump. If this does not fix the problem, consult your dealer.*

5. Screw the fuel fill cap back on until it clicks at least once. If you do not properly tighten the cap, you will see a “TIGHTEN FUEL CAP” message on the multi-information display (see right column on this page), and the malfunction indicator lamp may also come on (see page [448](#)).

6. Push the fuel fill door closed until it latches.

### Tighten Fuel Cap Message



TIGHTEN  
FUEL CAP

Your vehicle's on board diagnostic system will detect a loose or missing fuel fill cap as an evaporative system leak. The first time a leak is detected a "TIGHTEN FUEL CAP" message appears on the multi-information display. Turn the engine off, and confirm the fuel fill cap is installed. If it is, loosen it, then retighten it until it clicks at least once. The message should go off after several days of normal driving once you tighten or

replace the fuel fill cap. To scroll to another message, press the INFO button. The "TIGHTEN FUEL CAP" message will appear each time you restart the engine until the system turns the message off.

If the system still detects a leak in the vehicle's evaporative emissions system, the malfunction indicator lamp (MIL) comes on. If the fuel fill cap was not already tightened, turn the engine off, and check or retighten the fuel fill cap until it clicks at least once. The MIL should go off after several days of normal driving once the cap is tightened or replaced. If the MIL does not go off, have your vehicle inspected by a dealer. For more information, see page 448 .

### Opening and Closing the Hood



1. Park the vehicle, and set the parking brake. Pull the hood release lever located under the lower left corner of the dashboard. The hood will pop up slightly.

*CONTINUED*

## Service Station Procedures

---

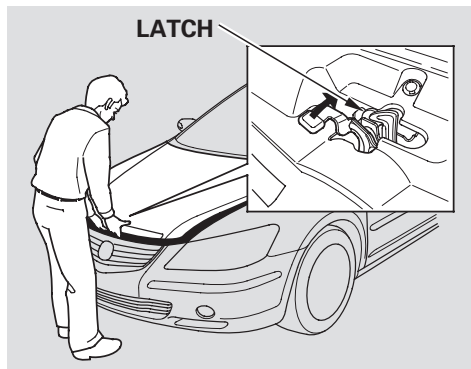

2. Reach between the hood and the front bumper with your finger. Slide the latch handle up.

If the hood latch handle moves stiffly, or if you can open the hood without lifting the handle, the mechanism should be cleaned and lubricated.

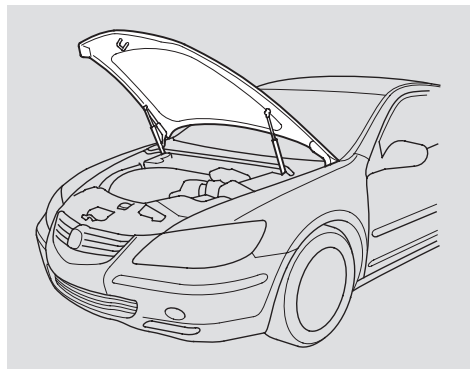

3. Lift the hood up most of the way. The hydraulic supports will lift it up the rest of the way and hold it up.

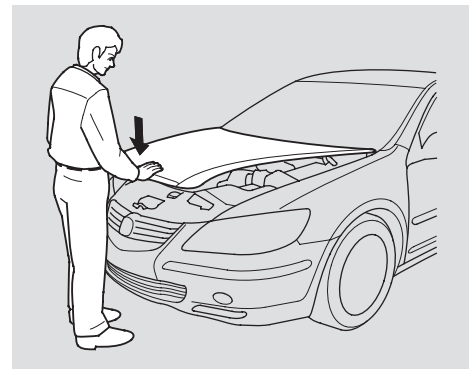

To close the hood, lower the hood to about a foot (30 cm) above the fender, then firmly press down on the front edge of the hood. Make sure it is securely latched.

## Oil Check

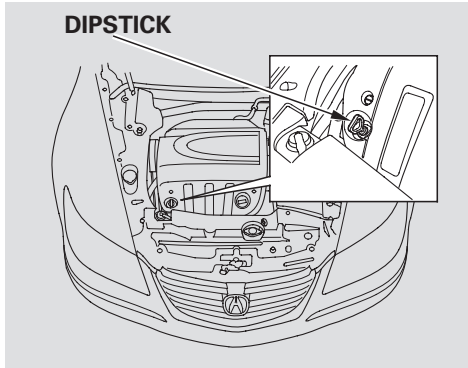

Wait a few minutes after turning the engine off before you check the oil.

1. Remove the dipstick (orange loop).
2. Wipe the dipstick with a clean cloth or paper towel.
3. Insert the dipstick all the way back into its hole.

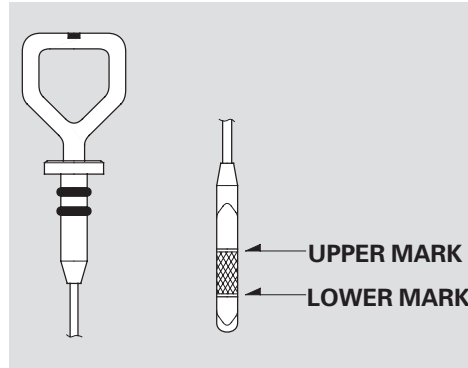

4. Remove the dipstick again, and check the level. It should be between the upper and lower marks.

If it is near or below the lower mark, see **Adding Engine Oil** on page [399](#).

## Engine Coolant Check

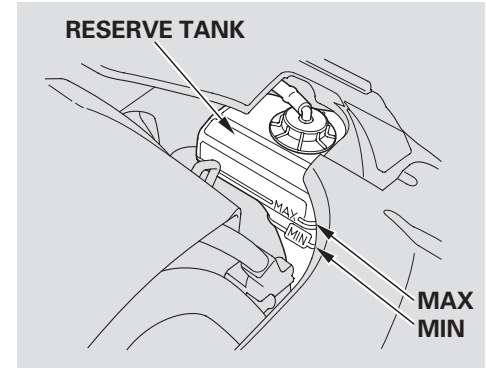

Look at the coolant level in the radiator reserve tank. Make sure it is between the MAX and MIN lines. If it is below the MIN line, see **Adding Engine Coolant** on page [402](#).

Refer to **Owner's Maintenance Checks** on page [394](#) for information about checking other items on your vehicle.

# Fuel Economy

## Actual Mileage and EPA Fuel Economy Estimates Comparison.

Fuel economy is not a fixed number. It varies based on driving conditions, driving habits and vehicle condition. Therefore, it is not possible for one set of estimates to predict fuel economy precisely for all drivers in all environments.

The EPA fuel economy estimates shown in the example to the right are a useful tool for comparison when buying a vehicle. EPA estimates include:

**City MPG** — Represents urban driving in a vehicle in light traffic. A range of miles per gallon achieved is also provided.

**Highway MPG** — Represents a mixture of rural and interstate driving, in a warmed-up vehicle, typical of longer trips in free-flowing traffic. A range of miles per gallon

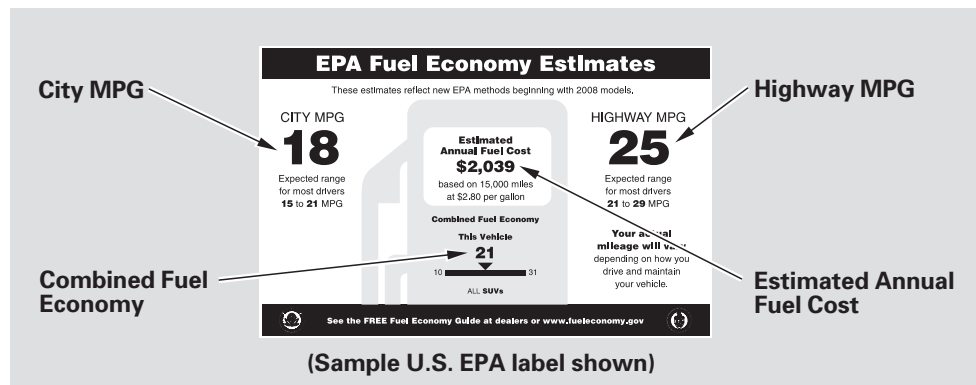

achieved is also provided.

**Combined Fuel Economy** — Represents a combination of city and highway driving. The scale represents the range of combined fuel economy for other vehicles in the class.

**Estimated Annual Fuel Cost** — Provides an estimated annual fuel cost, based on 15,000 miles (20,000 km) per year multiplied by the cost per gallon (based on EPA fuel cost data) divided by the combined fuel economy.

For more information on fuel economy ratings and factors that affect fuel economy, visit [www.fueleconomy.gov](http://www.fueleconomy.gov) (Canada: Visit [www.vehicles.gc.ca](http://www.vehicles.gc.ca))

## Fuel Economy Factors

The following factors can lower your vehicle's fuel economy:

- Aggressive driving (hard acceleration and braking)
- Excessive idling, accelerating and braking in stop-and-go traffic
- Cold engine operation (engines are more efficient when warmed up)
- Driving with a heavy load or the air conditioner running
- Improperly inflated tires

## Improving Fuel Economy

### *Vehicle Maintenance*

A properly maintained vehicle maximizes fuel economy. Poor maintenance can significantly reduce fuel economy. Always maintain your vehicle according to the maintenance messages displayed on the multi-information display (see **Owner's Maintenance Checks** on page 394 ). For example:

- **Use the recommended viscosity motor oil, displaying the API Certification Seal (see page 399).**
- **Maintain proper tire inflation** — An under-inflated tire increases “rolling resistance,” which reduces fuel economy.
- **Avoid carrying excess weight in your vehicle** — It puts a heavier load on the engine, increasing fuel consumption.
- **Keep your vehicle clean** — In particular, a build-up of snow or mud on your vehicle's underside adds weight and rolling resistance. Frequent cleaning helps your fuel economy.

### *Drive Efficiently*

- **Drive moderately** — Rapid acceleration, abrupt cornering, and hard braking increase fuel consumption.

- **Observe the speed limit** — Aerodynamic drag has a big effect on fuel mileage at speeds above 45 mph (75 km/h). Reduce your speed and you reduce the drag. Trailers, car top carriers, roof racks and bike racks are also big contributors to increased drag.
- **Always drive in the highest gear possible** — If your vehicle has a manual transmission, you can boost your fuel economy by up shifting as early as possible.
- **Avoid excessive idling** — Idling results in 0 miles per gallon.

# Fuel Economy

- **Minimize the use of the air conditioning system** – The A/C puts an extra load on the engine which makes it use more fuel. Use the fresh-air ventilation when possible.
- **Plan and combine trips** – Combine several short trips into one. A warmed-up engine is more fuel efficient than a cold one.

## Calculating Fuel Economy

### *Measuring Techniques*

Direct calculation is the recommended source of information about your actual fuel economy. Using frequency of fill-ups or taking fuel gauge readings are NOT accurate measures of fuel economy. Fuel economy may improve over the first several thousand miles.

### *Checking Your Fuel Economy*

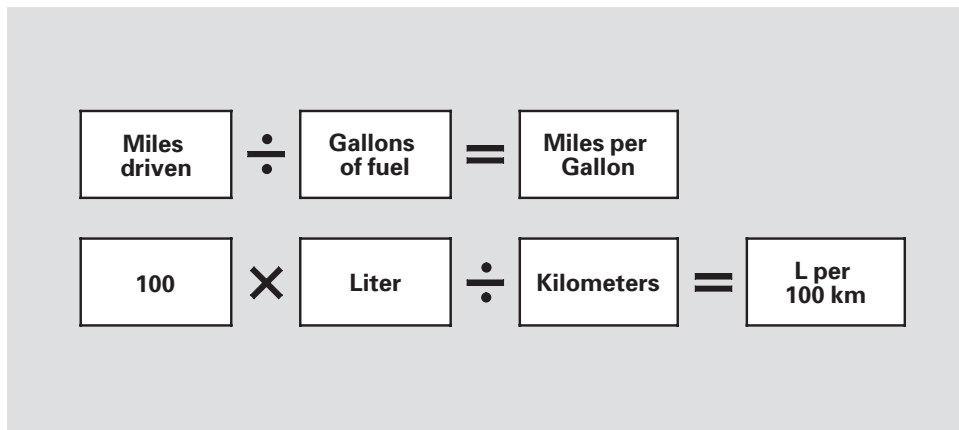

- 1) Fill the fuel tank until the nozzle automatically clicks off.
- 2) Reset trip counter to zero.
- 3) Record the total gallons (liters) needed to refill.
- 4) Follow one of the simple calculations above.

Modifying your vehicle, or installing some non-Acura accessories, can make your vehicle unsafe. Before you make any modifications or add any accessories, be sure to read the following information.

### Accessories

Your dealer has Acura accessories that allow you to personalize your vehicle. These accessories have been designed and approved for your vehicle, and are covered by warranty.

Although non-Acura accessories may fit on your vehicle, they may not meet factory specifications, and could adversely affect your vehicle's handling and stability.

### WARNING

Improper accessories or modifications can affect your vehicle's handling, stability, and performance, and cause a crash in which you can be hurt or killed.

Follow all instructions in this owner's manual regarding accessories and modifications.

When properly installed, cellular phones, alarms, two-way radios, and low-powered audio systems should not interfere with your vehicle's computer controlled systems, such as your airbags, anti-lock brakes, and tire pressure monitoring system.

Before installing any accessory:

- Make sure the accessory does not obscure any lights, or interfere with proper vehicle operation or performance.
- Be sure electronic accessories do not overload electrical circuits (see page 451 ) or interfere with the proper operation of your vehicle.
- Before installing any electronic accessory, have the installer contact your dealer. If possible, have your dealer inspect the final installation.
- Do not install accessories on the side pillars or across the rear windows. Accessories installed in these areas may interfere with proper operation of the side curtain airbags.



## Accessories and Modifications

---

### Modifying Your Vehicle

Removing parts from your vehicle, or replacing components with non-Acura components could seriously affect your vehicle's handling, stability, and reliability.

Here are some examples:

- Lowering the vehicle with a non-Acura suspension kit that significantly reduces ground clearance can allow the undercarriage to hit speed bumps or other raised objects, which could cause the airbags to deploy.
- Raising your vehicle with a non-Acura suspension kit can affect the handling and stability.
- Non-Acura wheels, because they are a universal design, can cause excessive stress on suspension components and will not be compatible with the tire pressure monitoring system (TPMS).

- Larger or smaller wheels and tires can interfere with the operation of your vehicle's anti-lock brakes and other systems.
- Modifying your steering wheel or any other part of your vehicle's safety systems could make the systems ineffective.

If you plan to modify your vehicle, consult your dealer.

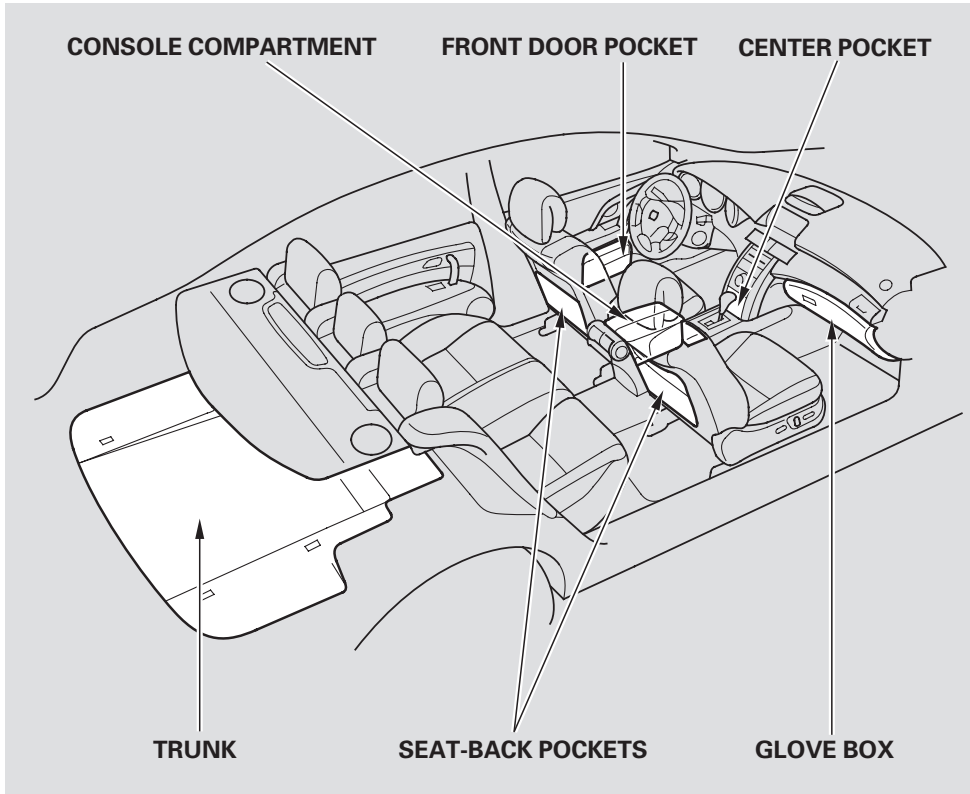

Your vehicle has several convenient storage areas:

- Glove box
- Front door and seat-back pockets
- Console compartment
- Center pocket
- Trunk

In addition, the trunk pass-through allows you to carry longer items.

However, carrying too much cargo, or improperly storing it, can affect your vehicle's handling, stability, stopping distance, and tires, and make it unsafe. Before carrying any type of cargo, be sure to read the following pages.

# Carrying Cargo

## Load Limits

The maximum load for your vehicle is 850 lbs (385 kg) for U.S. vehicles, and 395 kg for Canadian vehicles.

See Tire And Loading Information label attached to the driver's doorjamb.

## Label Example

TIRE AND LOADING INFORMATION			
SEATING CAPACITY    †TOTAL 5 †FRONT 2 †REAR 3			
The combined weight of occupants and cargo should never exceed 385kg or 850lbs.			
TIRE	SIZE	COLD TIRE PRESSURE	SEE OWNER'S
FRONT	XXXX/XXXXX XXX	XXXKPA, XXPSI	MANUAL FOR ADDITIONAL INFORMATION
REAR	XXXX/XXXXX XXX	XXXKPA, XXPSI	
SPARE	XXXX/XXXXX XXX	XXXKPA, XXPSI	

This figure includes the total weight of all occupants, cargo, and accessories, and the tongue load if you are towing a trailer.



## ⚠ WARNING

Overloading or improper loading can affect handling and stability and cause a crash in which you can be hurt or killed.

Follow all load limits and other loading guidelines in this manual.

## Steps for Determining Correct Load Limit –

- (1) Locate the statement “The combined weight of occupants and cargo should never exceed XXX kg or XXX lbs.” on your vehicle's placard.
- (2) Determine the combined weight of the driver and passenger that will be riding in your vehicle.
- (3) Subtract the combined weight of the driver and passengers from XXX kg or XXX lbs.
- (4) The resulting figure equals the available amount of cargo and luggage load capacity. For example, if the “XXX” amount equals 1,400 lbs. and there will be five 150 lb. passengers in your vehicle, the amount of available cargo and luggage load capacity is 650 lbs.  
(1,400 – 750 (5 × 150) = 650 lbs.)
- (5) Determine the combined weight of luggage and cargo being loaded on the vehicle. That weight may not safely exceed the available cargo and luggage load capacity calculated in Step 4.
- (6) If your vehicle will be towing a trailer, load from your trailer will be transferred to your vehicle. Consult this manual to determine how this reduces the available cargo and luggage load capacity of your vehicle.

<p>Example 1</p>	 <p><b>Max Load (850 lbs)</b>      <b>Passenger Weight (150 lbs x 2 = 300 lbs)</b>      <b>Cargo Weight (550 lbs)</b></p>
<p>Example 2</p>	 <p><b>Max Load (850 lbs)</b>      <b>Passenger Weight (150 lbs x 4 = 600 lbs)</b>      <b>Cargo Weight (250 lbs)</b></p>
<p>Example 3</p>	 <p><b>Max Load (850 lbs)</b>      <b>Passenger Weight (150 lbs x 5 = 750 lbs)</b>      <b>Cargo Weight (100 lbs)</b></p>

In addition, the total weight of the vehicle, all occupants, accessories, cargo, and trailer tongue load must not exceed the Gross Vehicle Weight Rating (GVWR) or the Gross Axle Weight Rating (GAWR). Both are on a label on the driver's doorjamb.

## Carrying Cargo

---

### Carrying Items in the Passenger Compartment

- Store or secure all items that could be thrown around and hurt someone during a crash.
- Do not put any items on top of the rear shelf. They can block your view and be thrown around the vehicle during a crash.
- Be sure items placed on the floor behind the front seats cannot roll under the seats and interfere with the pedals or seat operation.
- Keep the glove box closed while driving. If it is open, a passenger could injure their knees during a crash or sudden stop.

### Carrying Cargo in the Trunk or on a Roof Rack

- Distribute cargo evenly on the floor of the trunk, placing the heaviest items on the bottom and as far forward as possible.
  - If you carry large items that prevent you from closing the trunk lid, exhaust gas can enter the passenger area. To avoid the possibility of **carbon monoxide poisoning**, follow the instructions on page [56](#) .
  - If you carry any items on a roof rack, be sure the total weight of the rack and the items does not exceed the maximum allowable weight. Please contact your dealer for further information.
- If you carry any items extending through the trunk pass-through, tie down or secure all items that could be thrown around the vehicle and hurt someone during a crash or sudden stop.

## Cargo Hooks

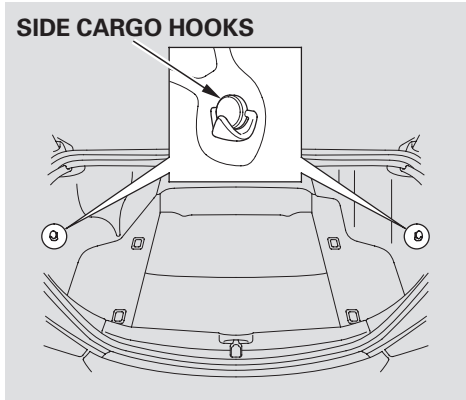

There are hooks on the floor and both sides of the trunk. They can be used to install the cargo net for securing items. The side cargo hooks are designed to hold light items (maximum load: 6 lbs or 3 kgs for each hook). Heavy objects may damage the side hooks.

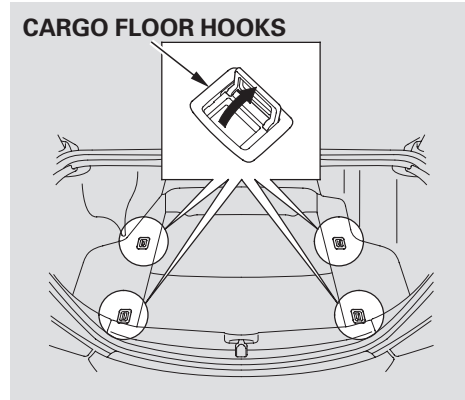

The cargo floor hooks can also be used to tie down and secure items on the floor.



This section gives you tips on starting the engine under various conditions, and how to operate the automatic transmission. It also includes important information on parking your vehicle, the braking system, the Super handling-all wheel drive (SH-AWD) system, the vehicle stability assist (VSA) system, the tire pressure monitoring system (TPMS), the collision mitigation brake system (CMBS), and facts you need if you are planning to tow a trailer.

Preparing to Drive .....	346
Starting the Engine.....	347
Check Starting System Message.....	348
Automatic Transmission.....	349
Super Handling-All Wheel Drive (SH-AWD) System .....	356
Parking.....	357
Braking System.....	358
Anti-lock Brakes (ABS) .....	359
Collision Mitigation Brake System (CMBS) .....	361
Tire Pressure Monitoring System (TPMS) ....	371
Vehicle Stability Assist (VSA) System.....	377
Towing a Trailer .....	379
Towing Your Vehicle .....	384



## Preparing to Drive

---

You should do the following checks and adjustments before you drive your vehicle.

1. Make sure all windows, mirrors, and outside lights are clean and unobstructed. Remove frost, snow, or ice.
2. Check that the hood is fully closed.
3. Visually check the tires. If a tire looks low, use a gauge to check its pressure (see page [420](#) ).
4. Check that any items you may be carrying are stored properly or fastened down securely.
5. Check the seat adjustment (see page [155](#) ).
6. Check the adjustment of the inside and outside mirrors (see page [159](#) ).
7. Check the steering wheel adjustment (see page [147](#) ).
8. Make sure the doors and the trunk are securely closed and locked.
9. Fasten your seat belt. Check that your passengers have fastened their seat belts (see page [17](#) ).
10. When you start the engine, check the gauges and indicators in the instrument panel, and the messages on the multi-information display (see pages [61](#) , [70](#) and [78](#) ).

Your vehicle's starting system has an auto control mode. When you turn the ignition switch to the START (III) position, this feature keeps the engine's starter motor running until the engine starts. Follow these instructions to start the engine:

1. Apply the parking brake.
2. In cold weather, turn off all electrical accessories to reduce the drain on the battery.
3. Make sure the shift lever is in Park. Press on the brake pedal.
4. Without touching the accelerator pedal, turn the ignition switch to the START (III) position, then release the ignition switch. You do not need to hold the ignition switch in the START (III) position to start the engine. Depending on the outside temperature, the starter motor runs for about 6 to 9

seconds until the engine starts.

If you hold the ignition switch in the START (III) position for more than 7 seconds, the starter motor, depending on the outside temperature, runs for about 10 to 25 seconds until the engine starts.

If the engine does not start, wait at least 10 seconds before trying again.

## NOTICE

*The immobilizer system protects your vehicle from theft. If an improperly-coded key (or other device) is used, the engine's fuel system is disabled. For more information, see page 150.*

5. If the engine does not start within 15 seconds, or starts but stalls right away, repeat step 4 with the accelerator pedal pressed halfway down. If the engine starts, release pressure on the accelerator pedal so the engine does not race.
6. If the engine fails to start, press the accelerator pedal all the way down, and hold it there while starting to clear flooding. If the engine still does not start, return to step 5.

## NOTICE

*The engine is harder to start in cold weather. Also, the thinner air found at altitudes above 8,000 feet (2,400 meters) adds to this problem.*

## Starting the Engine

---

### Check Starting System Message



If there is a problem with the starting system, you will see a “CHECK STARTING SYSTEM” message on the multi-information display when the ignition switch is turned to the ON (II) position. You will also see this message when the auto control mode of the starting system has a problem.

If this message is on, the ignition switch has to be held in the START (III) position manually until the engine starts. The ignition switch can be held in that position up to 15 seconds.

Even though you may be able to start the engine manually without the auto control mode of the starting system, have your dealer inspect your vehicle.

## Shift Lever Position Indicators

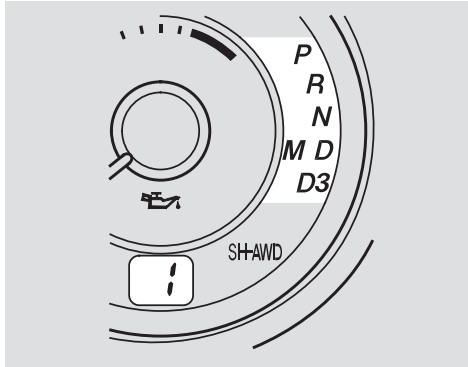

These indicators on the instrument panel show which position the shift lever is in. In the Sequential SportShift Mode, the “M” indicator next to the “D” indicator comes on, and the illuminated number under the low oil pressure indicator shows you the gear you have selected.

The “D” indicator comes on for a few seconds when you turn the ignition switch to the ON (II) position. If it flashes while driving (in any shift position), it indicates a possible problem in the transmission.

If the malfunction indicator lamp comes on along with the “D” indicator, there is a problem with the automatic transmission control system. Avoid rapid acceleration, and have the transmission checked by your dealer as soon as possible.

When the “D” indicator warns of a possible problem with the transmission, you will see a “CHECK TRANSMISSION” message on the multi-information display (see page [78](#)).

## Shifting

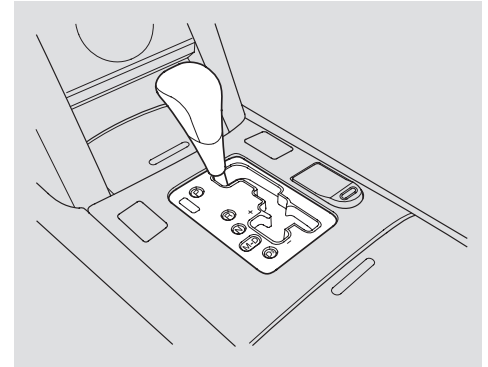

To shift from Park to any position, press firmly on the brake pedal and slide the lever along the guide on the console. You cannot shift out of Park when the ignition switch is in the LOCK (0) or the ACCESSORY (I) position.

*CONTINUED*

# Automatic Transmission

---

To shift from:	Do this:
P to R	Press the brake pedal, then move the shift lever.
R to N N to D D to D <sub>3</sub> D <sub>3</sub> to D D to N N to R R to P	Move the lever.

**Park (P)** – This position mechanically locks the transmission. Use Park whenever you are turning off or starting the engine. To shift out of Park, you must press on the brake pedal and have your foot off the accelerator pedal. Move the shift lever to the right to shift out of Park.

If you have done all of the above and still cannot move the lever out of Park, see **Shift Lock Release** on page [354](#).

To avoid transmission damage, come to a complete stop before shifting into Park. The shift lever must be in Park before you can turn the ignition switch to the LOCK (0) position, or remove the built-in key from the ignition switch.

**Reverse (R)** – Press the brake pedal to shift from Park to reverse. To shift from neutral to reverse, come to a complete stop and then shift.

Your vehicle has a reverse lockout so you cannot accidentally shift to reverse from neutral or any other driving position when the vehicle speed exceeds 5–6 mph (8–10 km/h).

If you cannot shift to reverse when the vehicle is stopped, press the brake pedal, slowly shift to neutral, and then shift to reverse.

If there is a problem in the reverse lockout system, or your vehicle's battery is disconnected or goes dead, you cannot shift to reverse. (Refer to **Shift Lock Release** on page [354](#)).

**Neutral (N)** – Use neutral if you need to restart a stalled engine, or if it is necessary to stop briefly with the engine idling. Shift to the Park position if you need to leave your vehicle for any reason. Press on the brake pedal when you are moving the shift lever from neutral to another gear.

**Drive (D)** – Use this position for your normal driving. The transmission automatically selects a suitable gear (1 through 5) for your speed and acceleration. You may notice the transmission shifting up at higher engine speeds when the engine is cold. This helps the engine warm up faster.

## Sequential SportShift Mode

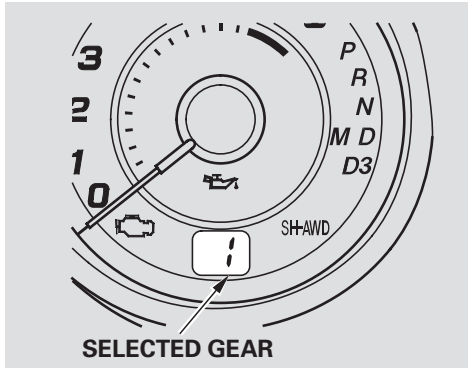

With the shift lever in “D” position, you can select the Sequential SportShift mode to shift gears much like a manual transmission, but without a clutch pedal.

When you move the shift lever from “D” to “M” position, the display shows the selected gear.

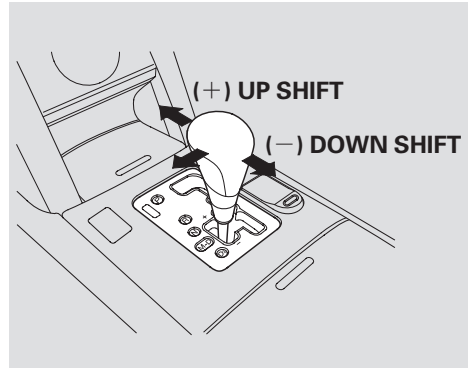

To enter the Sequential SportShift mode, move the shift lever further to the driver’s side. To return to “D,” move the shift lever to the passenger’s side.

In Sequential SportShift mode, each time you push forward on the shift lever, the transmission shifts to a higher gear. Pull back on the lever to downshift. The number of the gear selected is displayed on the instrument panel.

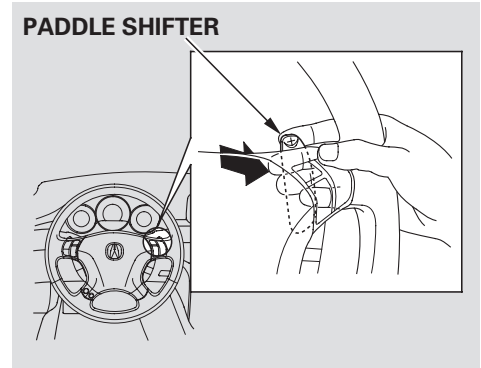

While in the Sequential SportShift mode, you can also shift up or down using the + (right side) or – (left side) paddle shifters on the right and left side of the steering wheel.

For up shift, press the right side (+) paddle shifter.

For down shift, press the left side (-) paddle shifter.

*CONTINUED*

## Automatic Transmission

---

When you accelerate away from a stop, the transmission starts in first gear. You have to manually upshift between first and fifth gears. Make sure you upshift before the engine speed reaches the tachometer's red zone.

The transmission remains in the selected gear (5, 4, 3, 2, or 1). There is no automatic downshift when you push the accelerator pedal to the floor.

The transmission may automatically downshift from the higher gear to the lower gear under these conditions:

### Driving on level roads and downhill

To shift from	Speed range
4 → 3	under 17 mph (27 km/h)
5 → 4	under 38 mph (60 km/h)

### Driving uphill

To shift from	Speed range
4 → 3	under 41 mph (65 km/h)
5 → 4	under 47 mph (75 km/h)

Downshifting gives you more power when climbing, and provides engine braking when going down a steep hill.

The transmission also shifts automatically as the vehicle comes to a complete stop. It downshifts to first gear when the vehicle speed is under 8 mph (13 km/h).

If you try to manually downshift at a speed that would cause the engine to exceed the redline in a lower gear, the transmission does not downshift. The gear indicator will flash the number of the lower gear several times, then return to the higher gear.

If the vehicle speed slows to below the redline of the selected lower gear position while the indicator is flashing, the transmission downshifts, and the display shows the selected lower gear.

The table shows the speed ranges for upshifting and downshifting.

To shift from	Speed range
1 → 2	over 0 mph (0 km/h)
2 → 3	over 8 mph (13 km/h)
3 → 4	over 17 mph (27 km/h)
4 → 5	over 37 mph (60 km/h)

To shift from	Speed range
3 → 2	under 56 mph (90 km/h)
4 → 3	under 93 mph (150 km/h)
5 → 4	under 130 mph (209 km/h)

### ***Starting in Second Gear***

When you are in Sequential SportShift mode, and the vehicle is stopped, push forward on the shift lever to shift to second gear. You will see “2” in the display. Starting out in second gear will help to reduce wheelspin in deep snow or on a slippery surface.

If you start out in second gear, the transmission will be fixed in that gear.

The transmission will not automatically downshift to first gear even when the vehicle speed is under 8 mph (13 km/h). You need to shift down to first gear manually.

CONTINUED



## Automatic Transmission

---

**Drive (D3)** – This position is similar to D, except only the first three gears are selected. Use D3 when towing a trailer in hilly terrain, or to provide engine braking when going down a steep hill. D3 can also keep the transmission from cycling between third, fourth, and fifth gears in stop-and-go driving.

For faster acceleration when in D3 or D, you can get the transmission to automatically downshift by pushing the accelerator pedal to the floor. The transmission will shift down one, two, or three gears, depending on your speed.

### **Engine Speed Limiter**

If you exceed the maximum speed for the gear you are in, the engine speed will enter into the tachometer's red zone. If this occurs, you may feel the engine cut in and out. This is caused by a limiter in the engine's computer controls. The engine will run normally when you reduce the rpm below the red zone.

Before downshifting, make sure the engine will not go into the tachometer's red zone.

### **Shift Lock Release**

This allows you to move the shift lever out of Park if the normal method of pushing on the brake pedal does not work.

1. Set the parking brake.
2. Make sure the ignition switch is in the LOCK (0) position.

To release the reverse lockout, make sure the ignition switch is in the ACCESSORY (I) position.

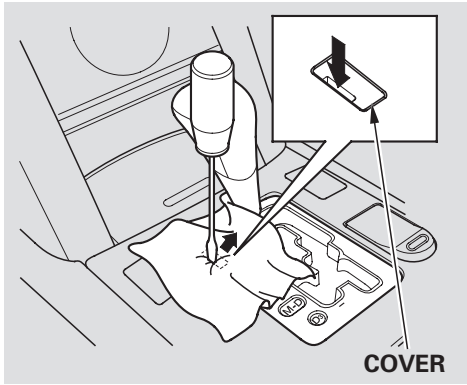

3. Put a cloth on the edge of the shift lock release slot cover next to the shift lever. Use a small flat-tipped screwdriver or a metal fingernail file to remove the cover. Carefully pry on the edge of the cover.

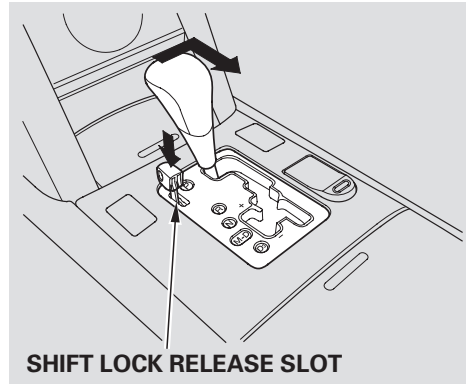

4. Insert a built-in key into the shift lock release slot.
5. Push down on the built-in key, and move the shift lever out of Park to neutral.

To release the reverse lockout, move the shift lever from neutral to reverse, then to Park.

6. Remove the built-in key from the shift lock release slot, then reinstall the cover. Make sure the notch on the cover is on the driver's side. Press the brake pedal, and restart the engine.

If you need to use the shift lock release, it means your vehicle is developing a problem. Have the vehicle checked by a dealer.

## Super Handling-All Wheel Drive (SH-AWD) System

---

The super handling-all wheel drive (SH-AWD) system is a full time all-wheel-drive system that automatically controls and transfers varying amounts of engine torque to all wheels independently, according to the driving conditions.

While the SH-AWD system helps to enhance the vehicle's driving stability in all situations, it is still your responsibility to drive and corner at reasonable speeds and to leave a sufficient margin of safety.

### SH-AWD Torque Distribution Monitor

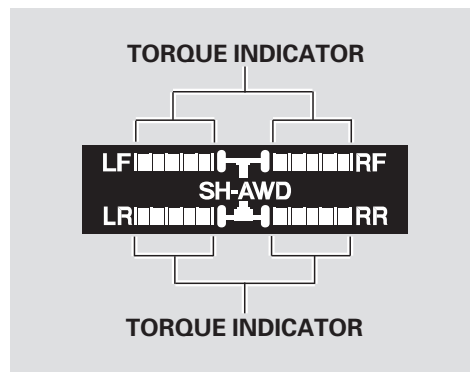

The SH-AWD torque distribution monitor on the multi-information display shows you the amount of torque being sent to the wheels. Each wheel: right front (RF), left front (LF), right rear (RR), and left rear (LR), has its own torque indicator.

Each torque indicator is displayed as a bar graph divided into 5 segments. The number of segments represents the amount of torque distributed to each wheel.

When cruise control is on while driving, the torque distribution monitor is not shown.

When there is only a slight change in torque distribution while driving, such as cruising on level roads at the same speed, the torque distribution monitor may stop displaying the amount of torque. This is not a system problem. The monitor will show the amount if the system senses any change in torque distribution.

## Super Handling-All Wheel Drive (SH-AWD) System, Parking

If the SH-AWD indicator on the instrument panel stays on, and the multi-information display shows an SH-AWD message, there is a problem with the system. Your vehicle still has normal front-wheel drive with vehicle stability assist (VSA), but does not have the advantages of SH-AWD. Have your vehicle checked by a dealer as soon as possible.

### Parking

Always use the parking brake when you park your vehicle. Make sure the parking brake is set firmly or your vehicle may roll if it is on an incline.

Set the parking brake before you put the transmission in Park. This keeps the vehicle from moving and putting pressure on the parking mechanism in the transmission.

### Parking Tips

- Make sure the moonroof and the windows are closed.
- Turn off the lights.
- Place any packages, valuables, etc., in the trunk or take them with you.
- Lock the doors.

- Never park over dry leaves, tall grass, or other flammable materials. The hot three way catalytic converter could cause these materials to catch on fire.
- If the vehicle is facing uphill, turn the front wheels away from the curb.
- If the vehicle is facing downhill, turn the front wheels toward the curb.
- Check the indicator on the instrument panel to verify that the security system is set.
- Make sure the parking brake is fully released before driving away. Driving with the parking brake partially set can overheat or damage the rear brakes.

# Braking System

---

Your vehicle is equipped with disc brakes at all four wheels. A power assist helps reduce the effort needed on the brake pedal. The brake pedal assist function increases the force you apply to the brake pedal during an emergency stop. When the brake pedal assist is activated, the e-pretensioners (if equipped) tighten front seat belts (see page 24 ). The anti-lock brake system (ABS) helps you retain steering control when braking very hard (see page 359 ).

Resting your foot on the pedal keeps the brakes applied lightly, builds up heat, and reduces their effectiveness and reduces brake pad life. In addition, fuel economy can be reduced. It also keeps your brake lights on all the time, confusing drivers behind you.

Constant application of the brakes when going down a long hill builds up heat and reduces their effectiveness. Use the engine to assist the brakes by taking your foot off the accelerator and downshifting to a lower gear.

Check the brakes after driving through deep water. Apply the brakes moderately to see if they feel normal. If not, apply them gently and frequently until they do. Be extra cautious in your driving.

## **Braking System Design**

The hydraulic system that operates the brakes has two separate circuits. Each circuit works diagonally across the vehicle (the left-front brake is connected with the right-rear brake, etc.). If one circuit should develop a problem, you will still have braking at two wheels.

## **Brake Pad Wear Indicators**

If the brake pads need replacing, you will hear a distinctive, metallic screeching sound when you apply the brake pedal. If you do not have the brake pads replaced, they will screech all the time. It is normal for the brakes to occasionally squeal or squeak when you apply them.

The anti-lock brake system (ABS) helps prevent the wheels from locking up, and helps you retain steering control by pumping the brakes rapidly, much faster than a person can do it.

The electronic brake distribution (EBD) system, which is part of the ABS, also balances the front-to-rear braking distribution according to vehicle loading.

*You should never pump the brake pedal.* Let the ABS work for you by always keeping firm, steady pressure on the brake pedal. This is sometimes referred to as “stomp and steer.”

You will feel a pulsation in the brake pedal when the ABS activates, and you may hear some noise. This is normal: it is the ABS rapidly pumping the brakes. On dry pavement, you will need to press on the brake pedal very hard before the ABS activates. However, you may feel the ABS activate immediately if you are trying to stop on snow or ice.



### ABS Indicator

If this indicator comes on, the anti-lock function of the braking system has shut down. The brakes still work like a conventional system, but without anti-lock. You should have your dealer inspect your vehicle as soon as possible.

When the ABS indicator comes on, you will also see a “CHECK ABS SYSTEM” message on the multi-information display.

CONTINUED

## Anti-lock Brakes (ABS)

---

If the ABS indicator and the brake system indicator come on together, and the parking brake is fully released, the EBD system may also be shut down.

Test your brakes as instructed on page 449 . If the brakes feel normal, drive slowly and have your vehicle repaired by your dealer as soon as possible. Avoid sudden hard braking which could cause the rear wheels to lock up and possibly lead to a loss of control.

The VSA indicator will come on along with the ABS indicator.

**Important Safety Reminders**  
**ABS does not reduce the time or distance it takes to stop the vehicle.** It only helps with steering control during braking.

**ABS will not prevent a skid that results from changing direction abruptly,** such as trying to take a corner too fast or making a sudden lane change. Always drive at a safe speed for the road and weather conditions.

**ABS cannot prevent the loss of stability.** Always steer moderately when you are braking hard. Severe or sharp steering wheel movement can still cause your vehicle to veer into oncoming traffic or off the road.

**A vehicle with ABS may require a longer distance to stop** on loose or uneven surfaces, such as gravel or snow, than a vehicle without anti-lock.

# Collision Mitigation Brake System (CMBS)

## Overview

### *If equipped*

The collision mitigation brake system (CMBS) can assist you when there is a possibility of your vehicle hitting the vehicle in front of you. It is designed to reduce the speed of your vehicle before an unavoidable collision occurs and, if possible, to alert you to a potential collision while there is time to prevent it. Here is a brief description of what the CMBS can do:

- When your speed is above 10 mph (15 km/h), the CMBS radar sensor in the front grille can sense a vehicle ahead of you. When your vehicle gets too close to the vehicle ahead of you, the system may activate a warning beep, causing automatic application of the brakes, and causing the e-pretensioners to tighten the front seat belts (see page [24](#)).

- The CMBS does not activate if the speed difference between your vehicles is less than 10 mph (15 km/h). CMBS may also not activate if you turn the steering wheel to avoid the collision.

When the CMBS activates, the brake lights also come on.

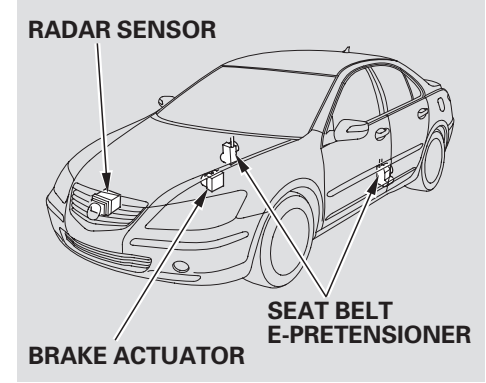

The CMBS consists of a radar sensor in the front grille, a brake actuator in the engine compartment, an indicator on the instrument panel, seat belt e-pretensioners on the front seats, and an on/off switch on the dashboard.



# Collision Mitigation Brake System (CMBS)

## Radar Sensor

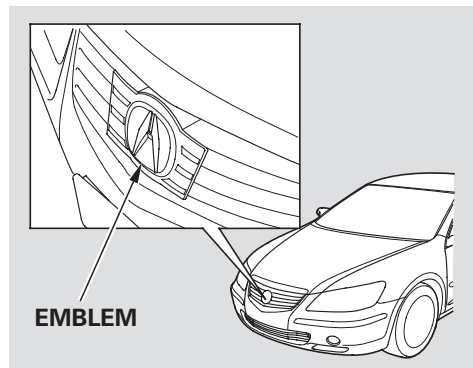

The radar sensor is located behind the Acura emblem in the front grille. If the emblem is covered with mud, dirt, dead leaves, wet snow, etc., or if you put a sticker on it, the CMBS will automatically shut off, and the CMBS indicator on the instrument panel will come on. You will also see a CHECK CMBS RADAR SENSOR message on the multi-information display for about 5 seconds.

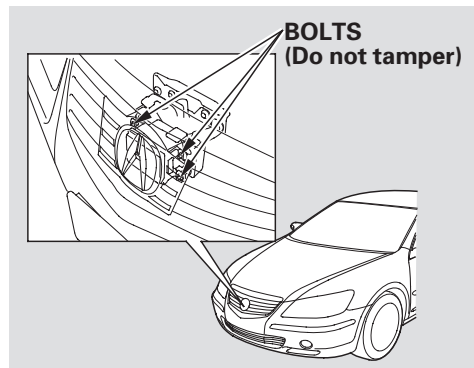

Always keep the emblem clean. If it gets dirty, clean it with water or a mild detergent. Never use chemical solvents or polishing powder.

There are three bolts on the sides of the radar sensor. Do not tamper with these bolts, or you may cause the system to malfunction.

Do not allow anything to impact the radar sensor or the emblem. If either of these parts receives a strong impact, turn off the system by pressing the CMBS off switch, and have your vehicle checked by a dealer. If the front grille ever needs to be repaired, consult a dealer first.

If the front emblem or the radar sensor ever needs to be removed, take your vehicle to a dealer.

## NOTICE

*When the CMBS is on, the radar sensor constantly scans for vehicles ahead of you. This means that driving on a road with a few or no vehicles could cause a CHECK CMBS RADAR SENSOR message to appear on the multi-information display. This is normal and not a cause for concern.*

The radar sensor may not always scan as intended. Here are two examples:

- Your vehicle is tilted because of a heavy load in the rear or from modifications to the suspension. Do not overload your vehicle (see Carrying Cargo on page 339 ), and do not make any modifications to the suspension (see Accessories and Modifications on page 337 ).
- The tires are not correctly maintained. Always make sure the tire pressures are correct (see page 419 ), and that the tires are the correct size and in good condition (see Tires on page 419 ).

# Collision Mitigation Brake System (CMBS)

## Collision Alarm

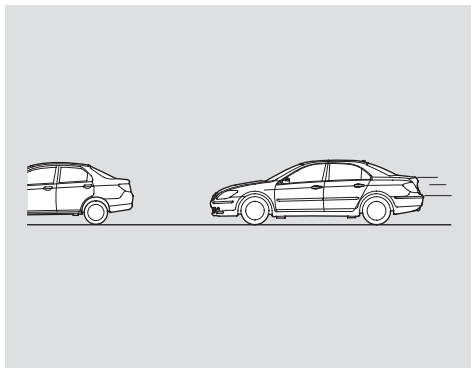

If the system senses a likely collision with a vehicle or object ahead of you, it alerts you with an audible and a visual alarm.



The audible alarm is a constant beeping sound; the visual alert is an amber colored BRAKE message that flashes on the multi-information display. If these alarms come on, take the appropriate means to prevent a collision (apply the brakes, change lanes, etc.).

## CMBS OFF Switch

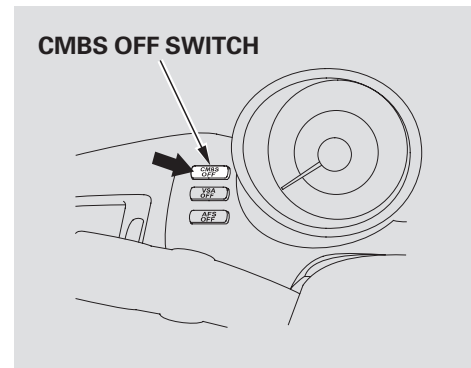

To turn the CMBS off, press the CMBS OFF switch on the dashboard for about 1 second. When you do this, a beeper sounds, a CMBS indicator on the instrument panel comes on, and a CMBS OFF message appears on the multi-information display. To turn the system back on, press the switch again for about 1 second.

When you turn the ignition switch to the ON (II) position, the CMBS is turned on if it was on previously.

### **Automatic Shut Off**

Any of the conditions below can cause the CMBS to shut off. When the system shuts off, the CMBS indicator in the instrument panel comes on, and a CHECK CMBS SYSTEM message appears on the multi-information display for about 5 seconds.

- An abnormal tire condition is detected (wrong tire size, flat tire, etc.).
- Extended off-road or mountainous driving.
- Driving your vehicle with the parking brake applied.
- Driving your vehicle in bad weather (rain, fog, snow, etc.).
- A dirty emblem on the front grille.

The CMBS will automatically recover when these conditions are improved.

# Collision Mitigation Brake System (CMBS)

## CMBS Indicator

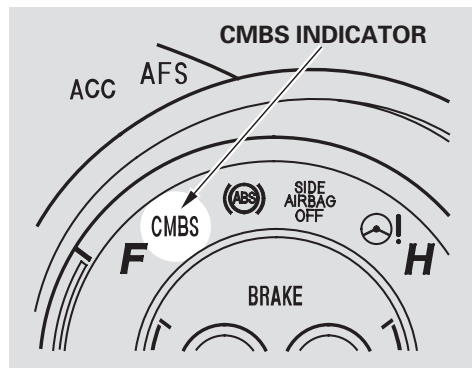

This indicator comes on for several seconds when you turn the ignition switch to the ON (II) position. It also comes on and stays on when you turn the CMBS off by pressing the CMBS OFF switch.

To turn the CMBS back on, make sure the vehicle is stopped and the ignition switch is in the ON (II) position, then press the CMBS OFF switch for about 1 second.

The CMBS indicator normally comes on under these conditions:

- When you manually turn off the system.
  - When the system shuts off automatically.
  - When you drive in bad weather (rain, snow, fog, etc.).
  - If anything covers the front grille (dirt, mud, dry leaves, wet snow, etc.).
- When the VSA system indicator comes on (see page 377 ).
  - When you turn the ignition switch to the ON (II) position, the CMBS indicator should come on for a few seconds, then go off. If the indicator comes on at any other time and a CHECK CMBS SYSTEM message appears on the multi-information display, there is a problem with the CMBS. You can still drive your vehicle, but CMBS will not be operating. Have your vehicle checked by a dealer.

# Collision Mitigation Brake System (CMBS)

## Limitations

The CMBS may not activate under some conditions. Here are a few examples:

- The distance between your vehicle and the vehicle ahead of you is too short.
- A vehicle cuts in front of you at a slow speed.

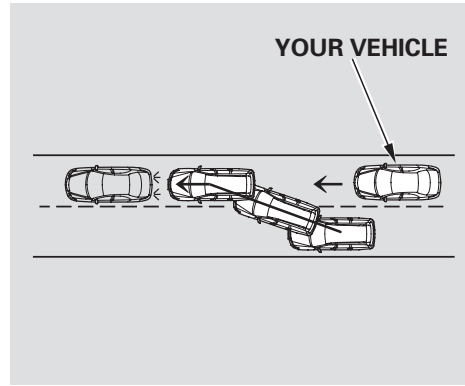

- A vehicle cuts in front of you and brakes suddenly.
- When you accelerate rapidly and approach the vehicle ahead of you at high speed.
- Immediately after you drive off.

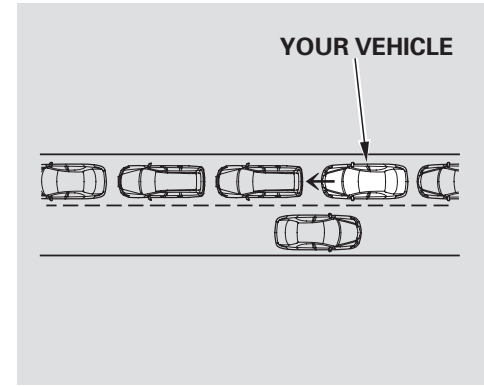

- Driving in heavy, stop-and-go traffic.
- The vehicle ahead of you is a motorcycle or other small vehicle.

CONTINUED

## Collision Mitigation Brake System (CMBS)

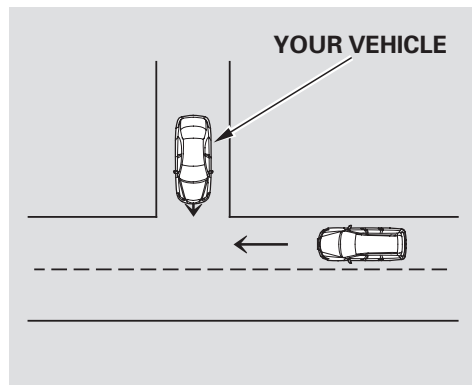

- A vehicle suddenly crosses in front of you.

### NOTICE

*The CMBS is not designed to detect pedestrians.*

Even with little or no chance of a collision, the CMBS may activate under these conditions:

- When you change lanes quickly, then overtake the vehicle ahead of you.

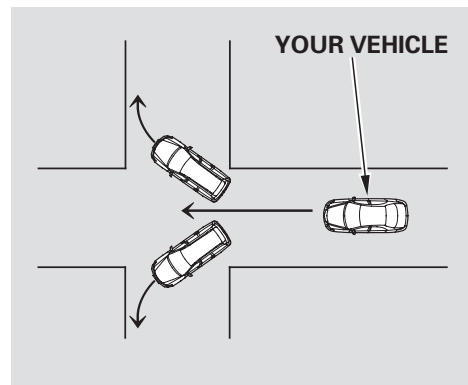

- When you approach or pass a vehicle ahead of you that is turning left or right in an intersection.

# Collision Mitigation Brake System (CMBS)

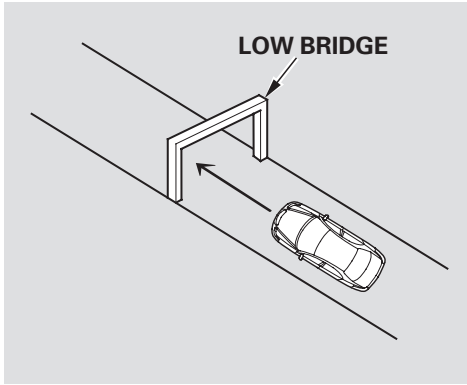

- When you pass a low bridge at high speed.
- When you go over a sharp-edged speed bump at high speed.
- When you go over areas of construction on the road surface.

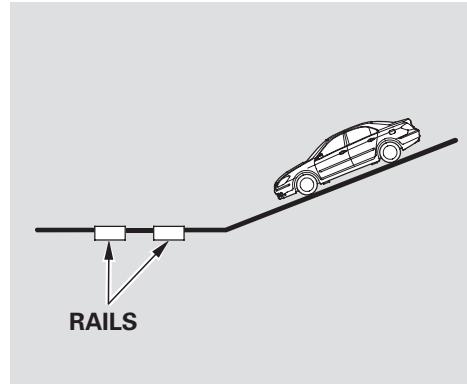

- When you approach train tracks at the bottom of a hill and you do not apply the brakes.

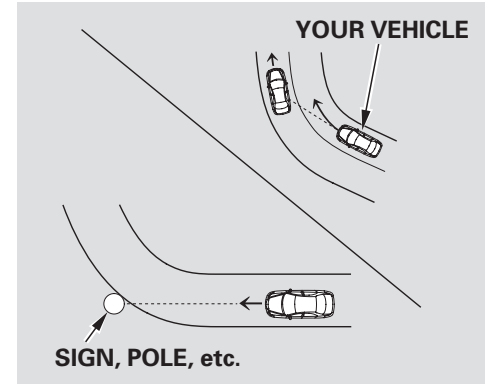

Because of the road condition (curved, winding, etc.) or the state of your vehicle (turning angle, lane position, etc.), CMBS can sometimes mistake a stationary object (light pole, traffic sign, etc.) as a vehicle ahead of you and temporarily operate. This is normal.



# Collision Mitigation Brake System (CMBS)

---

## **Important Safety Reminder**

The main purpose of the CMBS is to reduce the severity of injuries caused by an unavoidable collision. While the CMBS may help to alert you and minimize the severity of a collision, it may not activate in every dangerous situation.

Even with the CMBS, it is still your responsibility to operate the brake pedal and steering wheel appropriately, according to the driving conditions.

*As required by the FCC:*

*This device complies with Part 15 of the FCC rules. Operation is subject to the following two conditions: (1) This device may not cause harmful interference, and (2) this device must accept any interference received, including interference that may cause undesired operation.*

*Changes or modifications not expressly approved by the party responsible for compliance could void the user's authority to operate the equipment.*

*This device complies with Industry Canada Standard RSS-210.*

*Operation is subject to the following two conditions: (1) this device may not cause interference, and (2) this device must accept any interference that may cause undesired operation of the device.*

## Tire Pressure Monitoring System (TPMS)

Your vehicle is equipped with a tire pressure monitoring system (TPMS) that turns on every time you start the engine and monitors the pressure in your tires while driving.

Each tire has its own pressure sensor. If the air pressure of a tire becomes significantly low, the sensor in that tire immediately sends a signal that causes the low tire pressure/TPMS indicator in the instrumental panel and the appropriate tire position indicator on the tire pressure monitor on the multi-information display (see page [373](#)) to come on.



### Low Tire Pressure/ TPMS Indicator

When the low tire pressure/TPMS indicator is on, one or more of your tires is significantly underinflated. The multi-information display also shows a “CHECK TIRE PRESSURE” message (see page [373](#)). You should stop and check your tires as soon as possible, and inflate them to the proper pressure as indicated on the vehicle’s tire information placard.

Driving on a significantly underinflated tire causes the tire to overheat and can lead to tire failure. Under-inflation also reduces fuel efficiency and tire tread life, and may affect the vehicle’s handling and stopping ability.

Because tire pressure varies by temperature and other conditions, the low tire pressure/TPMS indicator may come on unexpectedly.

For example, if you check and fill your tires in a warm area, then drive in extremely cold weather, the tire pressure will be lower than measured and could be underinflated and cause the low tire pressure/TPMS indicator to come on. Or, if you check and adjust your tire pressure in cooler conditions, and drive into extremely hot conditions, the tire may become overinflated. However, the low tire pressure/TPMS indicator will not come on if the tires are overinflated.

Refer to page [419](#) for tire inflation guidelines.

If there is a problem with the TPMS, this indicator begins to flash. It stops flashing after approximately 1 minute, then stays on. You will also see a “CHECK TPMS SYSTEM” message on the multi-information display (see page [375](#)).

*CONTINUED*

## Tire Pressure Monitoring System (TPMS)

---

Although your tire pressure is monitored, you must manually check the tire pressures monthly.

Each tire, including the spare, should be checked monthly when the vehicle is cold, and set to the recommended inflation pressure as specified on the vehicle placard and in the owner's manual (see page 419).

If you think you can safely drive a short distance to a service station, proceed slowly to the station, then inflate the tire to the recommended pressure.

If the tire is flat, or if the tire pressure is too low to continue driving, replace the tire with the compact spare tire (see page 375).

### Changing a Tire with TPMS

If you have a flat tire, the low tire pressure/TPMS and tire monitor indicators will come on. Replace the indicated flat tire with the compact spare tire (see page 436).

After the flat tire is replaced with the spare tire, the low tire pressure/TPMS indicator stays on while driving. After several miles (kilometers) driving, this indicator begins to flash, then stays on again. You will also see a "CHECK TPMS SYSTEM" message on the multi-information display. This is normal; the system cannot monitor the spare tire pressure. Manually check the spare tire pressure to be sure it is correct.

This indicator and the warning message on the multi-information display will go off, after several miles (kilometers) driving, when the spare tire is replaced with the specified

regular tire equipped with the tire pressure monitor sensor.

Never use a puncture-repairing agent in a flat tire. If used, you will have to replace the tire pressure sensor. Have the flat tire repaired by your dealer as soon as possible.

Each wheel is equipped with a tire pressure sensor mounted inside the tire behind the valve stem. You must use TPMS specific wheels. It is recommended that you always have your tires serviced by your dealer or a qualified technician.

## Tire Pressure Monitor



When all tire pressures are normal, the multi-information display will show “TIRE PRESSURE OK SYSTEM FUNCTION NORMAL.”

When any of the tires has low pressure, the multi-information display shows a “TIRE PRESSURE ERROR SYSTEM FUNCTION NORMAL” message (see page 76 ).

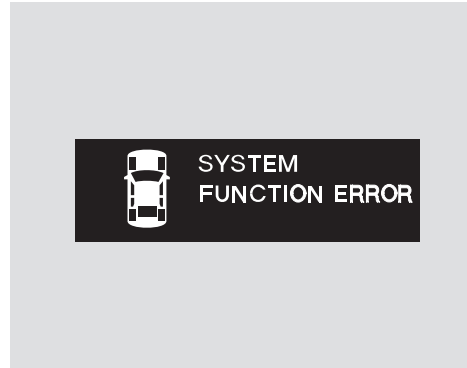

If there is a system error with the TPMS, the multi-information display shows a “SYSTEM FUNCTION ERROR” message (see page 79 ), and the tire pressure readings will not be displayed. You will also see a “CHECK TPMS SYSTEM” message on the multi-information display (see page 375 ).

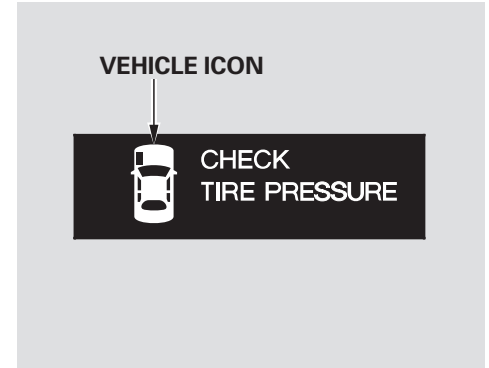

If any of the tires have low pressure, the multi-information display will show a “CHECK TIRE PRESSURE” message. You will also see one or more low pressure tire positions blinking in the display (see page 79 ).

*CONTINUED*

# Tire Pressure Monitoring System (TPMS)

If the low tire pressure/TPMS indicator and the low tire position on the low tire pressure monitor do not go out after inflating the tires to the specified values, have your dealer check the system as soon as possible.

## *Tire Pressure Readings*

### U.S.



When the TPMS is functioning normally, you can see the tire pressure readings of each tire in psi (U.S. models) or kPa (Canadian models) by pressing the SEL/RESET button while the multi-information display shows the tire pressure monitor.

### CANADA



If one or more tires have low pressure, the low tire pressure/TPMS indicator on the instrument panel also comes on (see page [371](#)).

When cruise control is on while driving, the pressure reading cannot be checked by the tire pressure monitor on the multi-information display.

# Tire Pressure Monitoring System (TPMS)

It is possible that the pressures shown on the multi-information display and the pressures you manually measure are slightly different.

If the difference is significant or you cannot make the low tire pressure/TPMS indicator and message on the multi-information display go out after inflating the tires to the specified values, have your dealer check the system as soon as possible.

## Check TPMS System Message



If there is a problem with the TPMS, the multi-information display shows a “CHECK TPMS SYSTEM” message.

Also, the low tire pressure/TPMS indicator begins to flash (see page [67](#) ).

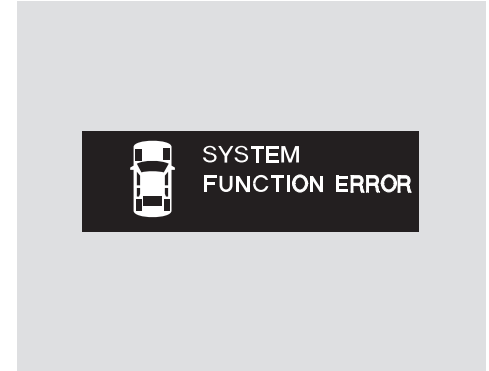

If you see this message, the tire pressure monitor shows a “SYSTEM FUNCTION ERROR” message. The system may not be able to detect or signal low tire pressure as intended. Also, the tire pressure readings will not be displayed. Have your vehicle checked by a dealer as soon as possible.

*CONTINUED*

## Tire Pressure Monitoring System (TPMS)

---

If the low tire pressure/TPMS indicator comes on, or the multi-information display shows a “CHECK TPMS SYSTEM” message, the VSA system automatically turns on even when the VSA system is turned off by pressing the VSA OFF switch (see page 378). If this happens, you cannot turn the VSA system off by pressing the VSA OFF switch again.

When you restart the vehicle with the compact spare tire, the TPMS system message will also be displayed on the multi-information display after several miles (kilometers) driving.

*As required by the FCC:*

*This device complies with Part 15 of the FCC rules. Operation is subject to the following two conditions: (1) This device may not cause harmful interference, and (2) this device must accept any interference received, including interference that may cause undesired operation.*

*Changes or modifications not expressly approved by the party responsible for compliance could void the user’s authority to operate the equipment.*

*This device complies with Industry Canada Standard RSS-210.*

*Operation is subject to the following two conditions: (1) this device may not cause interference, and (2) this device must accept any interference that may cause undesired operation of the device.*

The vehicle stability assist (VSA) system helps to stabilize the vehicle during cornering if the vehicle turns more or less than desired. It also assists you in maintaining traction while accelerating on loose or slippery road surfaces. It does this by regulating the engine's output and by selectively applying the brakes.

When VSA activates, you may notice that the engine does not respond to the accelerator in the same way it does at other times. There may also be some noise from the VSA hydraulic system. You will also see the VSA activation indicator blink.

The VSA system cannot enhance the vehicle's driving stability in all situations and does not control your vehicle's entire braking system. It is still your responsibility to drive and corner at reasonable speeds and to leave a sufficient margin of safety.



## VSA Activation Indicator

When VSA activates, you will see the VSA activation indicator blink (see page 65 ).



## VSA System Indicator

If this indicator comes on while driving, pull to the side of the road when it is safe, and turn off the engine. Reset the system by restarting the engine. If the VSA system indicator stays on or comes back on while driving, have the VSA system inspected by your dealer.

If the indicator does not come on when the ignition switch is turned to the ON (II) position, there may be a problem with the VSA system. Have your dealer inspect your vehicle as soon as possible (see page 65 ).

When the VSA system indicator comes on, you will also see a "CHECK VSA SYSTEM" message on the multi-information display.

Without VSA, your vehicle still has normal braking and cornering ability, but it does not have VSA traction and stability enhancement.

If the low tire pressure/TPMS indicator comes on (see page 371), or the multi-information display shows a "CHECK TPMS SYSTEM" message with the indicator flashing (see page 375 ), the VSA system automatically turns on even when the VSA system is turned off with the VSA OFF switch. In this case, you cannot turn the VSA system off by pressing the VSA OFF switch again.



# Vehicle Stability Assist (VSA) System

## VSA Off Switch

In certain unusual conditions when your vehicle gets stuck in shallow mud or fresh snow, it may be easier to free it with the VSA temporarily switched off. When the VSA system is off, the traction control system is also off. You should only attempt to free your vehicle with the VSA off if you are not able to free it when the VSA is on.

Immediately after freeing your vehicle, be sure to switch the VSA on again. We do not recommend driving your vehicle with the VSA and traction control systems switched off.

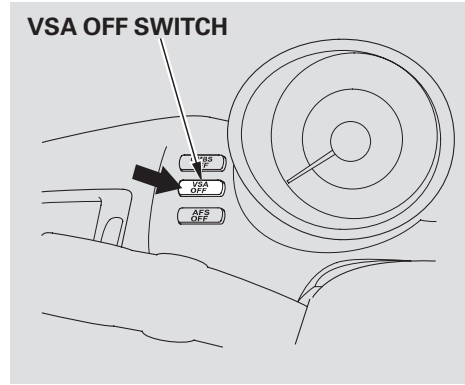

This switch is at the right side of the left vent. Press it to turn VSA on and off.

When VSA is off, the VSA activation indicator comes on as a reminder.

VSA is turned on every time you start the engine, even if you turned it off the last time you drove the vehicle.

## VSA and Tire Sizes

Driving with varying tire or wheel sizes may cause the VSA to malfunction. When replacing tires, make sure they are of the same size and type as your original tires (see page [423](#)).

If you install winter tires, make sure they are the same size as those that were originally supplied with your vehicle. Exercise the same caution during winter driving as you would if your vehicle was not equipped with VSA.

Your vehicle has been designed primarily to carry passengers and their cargo. You can also use it to tow a trailer if you carefully observe the load limits, use the proper equipment, and follow the guidelines in this section.

## **⚠ WARNING**

Exceeding any load limit or improperly loading your vehicle and trailer can cause a crash in which you can be seriously hurt or killed.

Check the loading of your vehicle and trailer carefully before starting to drive.

## Load Limits

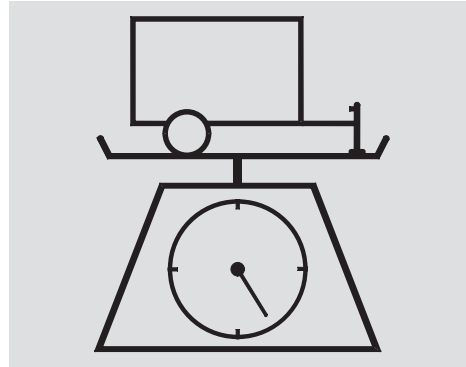

- **Total Trailer Weight:** The maximum allowable weight of the trailer and everything in or on it must not exceed 1,000 lbs (450 kg). Towing a load that is too heavy can seriously affect your vehicle's handling and performance. It can also damage the engine and drivetrain.

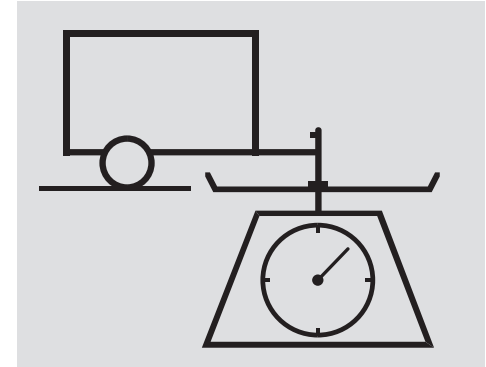

- **Tongue Load:** The weight that the tongue of a fully-loaded trailer puts on the hitch should be approximately 10 percent of the trailer weight. Too much tongue load reduces front-tire traction and steering control. Too little tongue load can make the trailer unstable and cause it to sway.

*CONTINUED*

## Towing a Trailer

---

To achieve a proper tongue load, start by loading 60 % of the load toward the front of the trailer and 40 % toward the rear, then re-adjust the load as needed.

- **Gross Vehicle Weight Rating (GVWR):**

The maximum allowable weight of the vehicle, all occupants, all accessories, all cargo, and the tongue load is: 4,980 lbs (2,260 kg)

- **Gross Axle Weight Rating (GAWR):**

The maximum allowable weight of the vehicle axles are: 2,680 lbs (1,215 kg) on the front axle, and 2,380 lbs (1,080 kg) on the rear axle.

### **Checking Loads**

The best way to confirm that all loads are within limits is to check them at a public scale. For public scales in your area, check your local phone book, or contact your trailer dealer or rental agency for assistance.

If you cannot get to a public scale, you can estimate the total trailer weight by adding the weight of your trailer (as quoted by the manufacturer) with everything in or on the trailer.

If you normally pull the same load each time you tow a trailer, you can use a suitable scale or a special tongue load gauge to check the tongue load the first time you set up a towing combination (a fully loaded vehicle and trailer), then recheck the tongue load whenever the conditions change.

### **Towing Equipment and Accessories**

Towing generally requires a variety of supplemental equipment, depending on the size of your trailer, how much load you are towing, and where you tow. To ensure the best quality, we recommend that you purchase Acura equipment whenever possible.

Discuss your needs with your trailer sales or rental agency, and follow the guidelines in the rest of this section. Also make sure that all equipment is properly installed and maintained, and that it meets federal, state, province, and local regulations.

### **Hitches**

Any hitch used on your vehicle must be properly bolted to the underbody.

## ***Safety Chains***

Always use safety chains when you tow a trailer. Make sure the chains are secured to the trailer and hitch, and that they cross under the tongue and can catch the trailer if it becomes unhitched. Leave enough slack to allow the trailer to turn corners easily, but do not let the chains drag on the ground.

## ***Trailer Brakes***

Acura recommends that any trailer having a total weight of 1,000 lbs (450 kg) or more be equipped with its own electric or surge-type brakes.

If you choose electric brakes, be sure they are electronically actuated. Do not attempt to tap into your vehicle's hydraulic system. No matter how successful it may seem, any attempt to attach trailer brakes to your vehicle's hydraulic system will lower braking effectiveness and create a potential hazard.

See your trailer dealer or rental agency for more information on installing electric brakes.

## ***Trailer Lights***

Trailer lights and equipment must comply with federal, state/province, and local regulations. Check with your local trailer sales or rental agencies for the requirements in the area where you plan to tow, and use only equipment designed for your vehicle.

Since lighting and wiring vary by trailer type and brand, you should have a qualified technician install a suitable connector between the vehicle and the trailer. Improper equipment or installation can cause damage to your vehicle's electrical system and affect your vehicle warranty.

*CONTINUED*

# Towing a Trailer

---

## *Additional Towing Equipment*

Many states and Canadian provinces require special outside mirrors when towing a trailer. Even if they don't, you should install special mirrors if you cannot clearly see behind you, or if the trailer creates a blind spot.

Ask your trailer sales or rental agency if any other items are recommended or required for your towing situation.

## **Pre-Tow Checklist**

When preparing to tow, and before driving away, be sure to check the following:

- The vehicle has been properly serviced, and the suspension and the cooling system are in good operating condition.
- The trailer has been properly serviced and is in good condition, and the lights and brakes on the trailer are working properly.
- All weights and loads are within limits.
- The hitch, safety chains, and any other attachments are secure.
- All items in or on the trailer are properly secured and cannot shift while you drive.

- Your vehicle tires and spare are properly inflated, and the trailer tires and spare are inflated as recommended by the trailer maker.

## Driving Safely With a Trailer

The added weight, length, and height of a trailer will affect your vehicle's handling and performance, so driving with a trailer requires some special driving skills and techniques.

For your safety and the safety of others, take time to practice driving maneuvers before heading for the open road, and follow the guidelines below.

### *Towing Speeds and Gears*

Drive slower than normal in all driving situations, and obey posted speed limits for vehicles with trailers. Use D position when towing a trailer on level roads. D3 is the proper shift lever position to use when towing a trailer in hilly terrain. (See “*Driving on Hills*” on the next page for additional gear information.)

When driving uphill and downhill, use the Sequential SportShift mode to provide the proper engine power and engine braking on each gear. Select fourth, third, second, or first gear; depending on the vehicle speeds and road condition. Do not use fifth gear. The recommended speed range for each gear position is shown in the table.

Gear position	Speed range
1	0 – 19 mph (0 – 30 km/h)
2	19 – 31 mph (30 – 50 km/h)
3	31 – 41 mph (50 – 65 km/h)
4	over 41 mph (over 65 km/h)

### *Making Turns and Braking*

Make turns more slowly and wider than normal. The trailer tracks a smaller arc than your vehicle, and it can hit or run over something the vehicle misses. Allow more time and distance for braking. Do not brake or turn suddenly as this could cause the trailer to jackknife or turn over.

CONTINUED

## Towing a Trailer, Towing Your Vehicle

---

### ***Driving on Hills***

When climbing hills, closely watch your temperature gauge. If it nears the red (Hot) mark, turn the air conditioning off, reduce speed and, if necessary, pull to the side of the road to let the engine cool.

If the automatic transmission shifts frequently while going up a hill, shift to D3.

If you must stop when facing uphill, use the foot brake or parking brake. Do not try to hold the vehicle in place by pressing on the accelerator, as this can cause the automatic transmission to overheat.

When driving down hills, reduce your speed, and shift down to second gear. Do not “ride” the brakes, and remember, it will take longer to slow down and stop when towing a trailer.

### ***Handling Crosswinds and Buffeting***

Crosswinds and air turbulence caused by passing trucks can disrupt your steering and cause the trailer to sway. When being passed by a large vehicle, keep a constant speed, and steer straight ahead. Do not try to make quick steering or braking corrections.

### ***Backing Up***

Always drive slowly and have someone guide you when backing up. Grip the *bottom* of the steering wheel; turn the wheel to the left to get the trailer to move to the left, and turn the wheel right to move the trailer to the right.

### ***Parking***

Follow all normal precautions when parking, including firmly setting the parking brake and putting the transmission in Park. Also, place wheel chocks at each of the trailer’s tires.

### **Towing Your Vehicle**

Your vehicle is not designed to be towed behind a motor home. If your vehicle needs to be towed in an emergency, see page [459](#).

This section explains why it is important to keep your vehicle well maintained and how to follow basic maintenance safety precautions.

This section also includes instructions on how to read the maintenance minder messages on the multi-information display, and instructions for simple maintenance tasks you may want to take care of yourself.

If you have the skills and tools to perform more complex maintenance tasks on your vehicle, you may want to purchase the service manual. See page 481 for information on how to obtain a copy, or see your dealer.

- Maintenance Safety..... 386
- Maintenance Minder..... 387
- Fluid Locations..... 397
- Engine Compartment Covers..... 398
- Adding Engine Oil ..... 399
- Changing the Engine Oil and Filter..... 400
- Engine Coolant..... 402
- Windshield Washers ..... 404
- Automatic Transmission Fluid.... 404
- Brake Fluid..... 406
- Power Steering Fluid..... 406
- Timing Belt..... 407
- Lights ..... 408
- Dust and Pollen Filter ..... 415
- Cleaning the Seat Belts..... 415
- Floor Mats ..... 416
- Wiper Blades..... 417
- Wheels ..... 419
- Tires ..... 419
- Checking the Battery ..... 427
- Vehicle Storage..... 429



# Maintenance Safety

---

All service items not detailed in this section should be performed by a certified technician or other qualified mechanic.

## Important Safety Precautions

To eliminate potential hazards, read the instructions before you begin, and make sure you have the tools and skills required.

- Make sure your vehicle is parked on level ground, the parking brake is set, and the engine is off.
- To clean parts, use a commercially available degreaser or parts cleaner, not gasoline.
- To reduce the possibility of fire or explosion, keep cigarettes, sparks, and flames away from the battery and all fuel-related parts.
- Wear eye protection and protective clothing when working with the battery or compressed air.

## WARNING

Improperly maintaining this vehicle, or failing to correct a problem before driving can cause a crash in which you can be seriously hurt or killed.

Always follow the inspection and maintenance recommendations and schedules in this owner's manual.

## Potential Vehicle Hazards

- **Carbon Monoxide poison from engine exhaust.** Be sure there is adequate ventilation whenever you operate the engine.
- **Burns from hot parts.** Let the engine and exhaust system cool down before touching any parts.

- **Injury from moving parts.** Do not run the engine unless instructed to do so.

## WARNING

Failure to properly follow maintenance instructions and precautions can cause you to be seriously hurt or killed.

Always follow the procedures and precautions in this owner's manual.

Some of the most important safety precautions are given here. However, we cannot warn you of every conceivable hazard that can arise in performing maintenance. Only you can decide whether or not you should perform a given task.

One of the most convenient and important features of the multi-information display on your vehicle is the maintenance minder.

Based on engine operating conditions and accumulated engine revolutions, the onboard computer in your vehicle calculates the remaining engine oil life.

The system also displays the code for other scheduled maintenance items needing service.

## Engine Oil Life Display

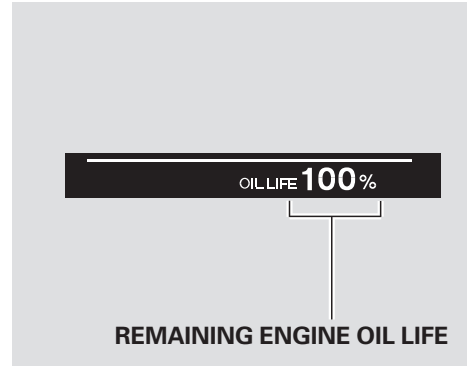

To see the remaining engine oil life displayed on the lower right corner on the multi-information display as a percentage, turn the ignition switch to the ON (II) position, and press the SEL/RESET button on the steering wheel repeatedly until the engine oil life appears (see page 73).

The remaining engine oil life is displayed according to the table shown below.

Calculated Engine Oil Life (%)	Displayed Engine Oil Life (%)
100% – 91%	100%
90% – 81%	90%
80% – 71%	80%
70% – 61%	70%
60% – 51%	60%
50% – 41%	50%
40% – 31%	40%
30% – 21%	30%
20% – 16%	20%
15% – 11%	15%
10% – 6%	10%
5% – 1%	5%
0%	0%

CONTINUED

## Maintenance Minder

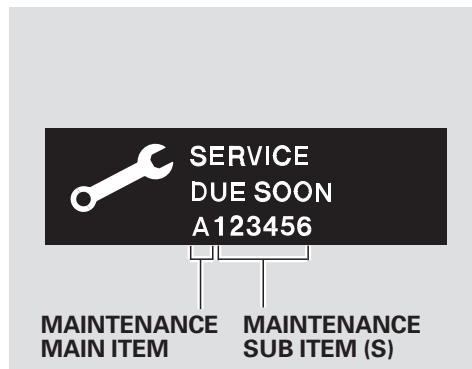

When the remaining engine oil life is 15 to 6 percent, the multi-information display shows a “SERVICE DUE SOON” message along with the maintenance schedule code indicating the main and sub items required at the time of the oil change. Refer to page [395](#) and [396](#) for a complete list of the maintenance main items and sub items.

The message will be canceled if the ▼ or ▲ button on the steering wheel is pressed. Press the ▼ or ▲ button to see the message again.

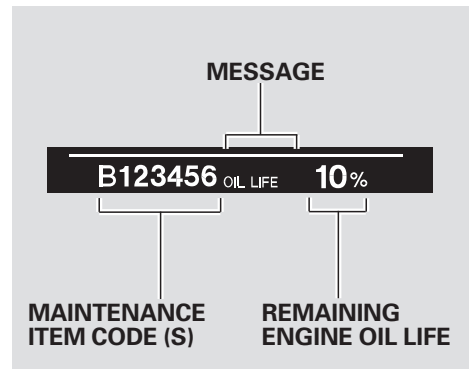

Press the SEL/RESET button on the steering wheel repeatedly to select the engine oil life. The message “OIL LIFE” along with the percentage of oil life remaining and the maintenance item code(s), appear on the lower part of the multi-information display.

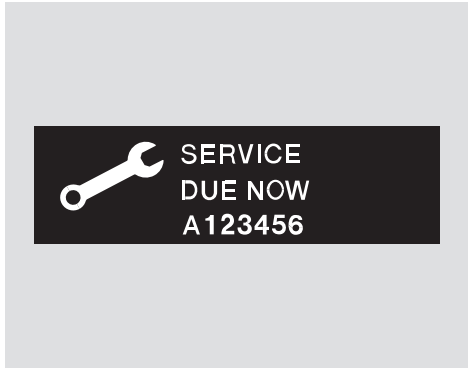

When the remaining engine oil life is 1 to 5 percent, the multi-information display shows a “SERVICE DUE NOW” message with the maintenance items. When you see this message have the indicated maintenance performed as soon as possible.

The message will be canceled if the ▼ or ▲ button on the steering wheel is pressed. Press the ▼ or ▲ button to see the message again.



Press the SEL/RESET button on the steering wheel repeatedly to select the engine oil life. The message “SERVICE OIL LIFE”, along with “5%”, and the maintenance item code(s) are displayed on the lower part of the multi-information display when the calculated engine oil life is 1 to 5 percent (see page [387](#)).

CONTINUED

## Maintenance Minder

The maintenance item code or codes indicate the main and sub items required at the time of the oil change (see page 395 ).

Your dealer will reset the display after completing the required maintenance service. You will see “OIL LIFE 100%” on the display the next time you turn the ignition switch to the ON (II) position.

If maintenance service is done by someone other than your dealer, reset the maintenance minder as follows:

1. Turn the ignition switch to the ON (II) position.
2. If the oil life minder is not displayed, press the SEL/RESET button on the steering wheel repeatedly until it is.

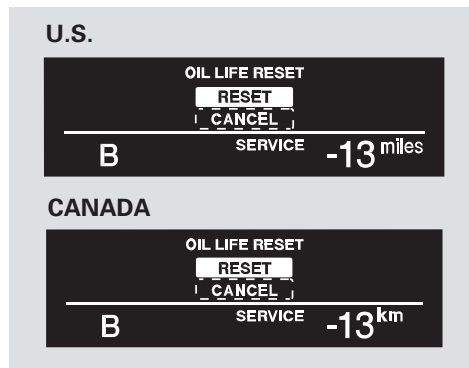

3. Press and hold the SEL/RESET button on the steering wheel for more than 10 seconds. The remaining engine oil life reset mode will be shown on the multi-information display.

- To reset the engine oil life, press the ▼ or ▲ button on the steering wheel to select RESET on the display, and press the SEL/RESET button.

- To cancel resetting the oil life, press the ▲ or ▼ button on the steering wheel to select CANCEL on the display, and press the SEL/RESET button.

If you do not complete the reset procedure within 30 seconds after selecting the reset mode, the mode will be canceled automatically.



If the indicated maintenance service is not done and the remaining engine oil life reaches 0 %, the multi-information display will show the message “SERVICE PAST DUE” and the maintenance item code(s). This message is displayed when the total mileage is less than 10 miles (for U.S. models) or 10 km (for Canadian models) after the engine oil life became 0 %.

Immediately have the service performed, and make sure to reset the oil life minder as previously described.

The message will be canceled if the ▼ or ▲ button on the steering wheel is pressed. Press the ▼ or ▲ button to see the message again.

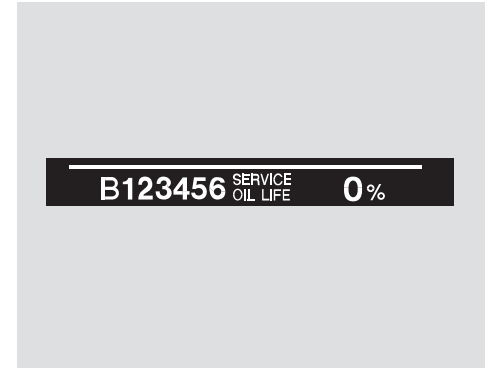

Press the SEL/RESET button on the steering wheel repeatedly to select the engine oil life minder. The message “SERVICE OIL LIFE”, along with “0%”, and the maintenance item code are displayed on the lower part of the multi-information display when the calculated engine oil life is 0 percent.

*CONTINUED*

## Maintenance Minder

And also, the percentage “0” keeps blinking on the display.

This particular message is displayed when the mileage after the engine oil life became 0 % reaches 10 miles (for U.S. models)/10 km (for Canadian models).

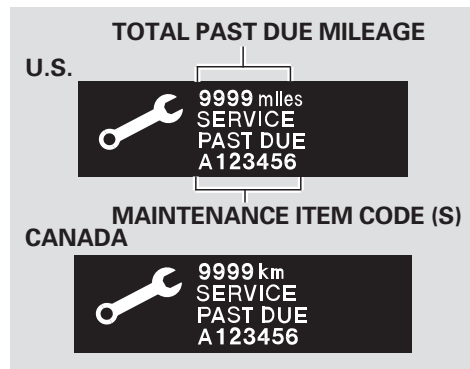

If the indicated required service is not done and the remaining engine oil life becomes 0 %, the multi-information display will show a “SERVICE PAST DUE” message, the total mileage after the remaining oil life became 0 %, and the maintenance item code (s).

This message is displayed when you drive over 10 miles (for U.S. models) or 10 km (for Canadian models) after seeing the 0 % message.

Immediately have the service performed, and make sure to reset the display as previously described.

The maximum total mileage shown with this message is “9999 mile” (for U.S. models) or “9999 km” (for Canadian models).

The message will be canceled if the ▼ or ▲ button on the steering wheel is pressed. Press the ▼ or ▲ button to see the message again.

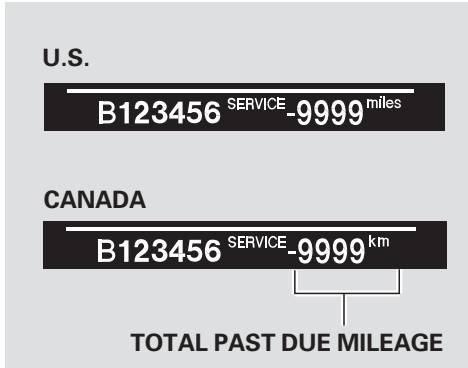

When you press the SEL/RESET button to select the engine oil life minder, the message “SERVICE”, along with the maintenance item code and the total negative mileage after the oil life became 0 percent, will be displayed on the lower part of the multi-information display.

This particular message is displayed when you drive over 10 miles (for U.S. models) or 10 km (for Canadian models) after seeing 0 %.

The maximum total negative mileage is “-9999 mile” (for U.S. models) or “-9999 km” (for Canadian models).

## Important Maintenance Precautions

If you have the required service performed but do not reset the display, or reset the display without performing the service, the system will not show the proper maintenance intervals. This can lead to serious mechanical problems because you will no longer have an accurate record of when maintenance is needed.

Your authorized Acura dealer knows your vehicle best and can provide competent, efficient service.

CONTINUED



## Maintenance Minder

---

Your authorized dealer knows your vehicle best and can provide competent, efficient service. However, service at a dealer is not mandatory to keep your warranties in effect. Maintenance may be done by any qualified service facility or person who is skilled in this type of automotive service. Keep all receipts as proof of completion, and have the person who does the work fill out your Maintenance Journal or Canadian Maintenance Log. Check your warranty booklet for more information.

We recommend the use of Acura parts and fluids whenever you have maintenance done. These are manufactured to the same high quality standards as the original components, so you can be confident of their performance and durability.

U.S. Vehicles:

**Maintenance, replacement, or repair of emissions control devices and systems may be done by any automotive repair establishment or individual using parts that are “certified” to EPA standards.**

According to state and federal regulations, failure to perform maintenance on the items marked with # will not void your emissions warranties. However, Acura recommends that all maintenance services be performed in accordance with the intervals indicated by the Multi-Information Display.

### **Owner’s Maintenance Checks**

You should check the following items at the specified intervals. If you are unsure of how to perform any check, turn to the appropriate page listed.

- Engine oil level — Check every time you fill the fuel tank. See page [333](#).
- Engine coolant level — Check the radiator reserve tank every time you fill the fuel tank. See page [333](#).
- Automatic transmission — Check the fluid level monthly. See page [404](#).
- Brakes — Check the fluid level monthly. See page [406](#).
- Tires — Check the tire pressure monthly. Examine the tread for wear and foreign objects. See page [421](#).
- Lights — Check the operation of the headlights, parking lights, taillights, high-mount brake light, and license plate lights monthly. See page [408](#).

Symbol	Maintenance Main Items
A	<ul style="list-style-type: none"> <li>● Replace engine oil*1</li> </ul>
B	<ul style="list-style-type: none"> <li>● Replace engine oil and oil filter</li> <li>● Inspect front and rear brakes</li> <li>● Check parking brake adjustment</li> <li>● Inspect these items:                             <ul style="list-style-type: none"> <li>● Tie rod ends, steering gear box, and boots</li> <li>● Suspension components</li> <li>● Driveshaft boots</li> <li>● Brake hoses and line (including ABS)</li> <li>● All fluid levels and condition of fluids</li> <li>● Exhaust system#</li> <li>● Fuel lines and connections#</li> </ul> </li> </ul>

\* 1 : If the message “SERVICE DUE NOW” does not appear more than 12 months after the display is reset, change the engine oil every year.

# : See information on maintenance and emissions warranty on page 394 .

NOTE: ● Independent of the maintenance messages in the Multi-Information Display, replace the brake fluid every 3 years.  
 ● Inspect idle speed every 160,000 miles (256,000 km).  
 ● Adjust the valves during services A, B, 1, 2, or 3 only if they are noisy.

CONTINUED

# Maintenance Minder

Symbol	Maintenance Sub Items
1	<ul style="list-style-type: none"> <li>• Rotate tires</li> </ul>
2	<ul style="list-style-type: none"> <li>• Replace air cleaner element If you drive in dusty conditions, replace every 15,000 miles (24,000 km).</li> <li>• Replace dust and pollen filter If you drive primarily in urban areas that have high concentrations of soot in the air from industry and from diesel-powered vehicles, replace every 15,000 miles (24,000 km).</li> <li>• Inspect drive belt</li> </ul>
3	<ul style="list-style-type: none"> <li>• Replace transmission and transfer fluid Driving in mountainous areas at very low vehicle speeds or trailer towing results in higher transmission and transfer temperatures. This requires transmission and transfer fluid changes more frequently than recommended by the Maintenance Minder. If you regularly drive your vehicle under these conditions, have the transmission and transfer fluid changed at 60,000 miles (100,000 km), then every 30,000 miles (48,000 km).</li> </ul>
4	<ul style="list-style-type: none"> <li>• Replace spark plugs</li> <li>• Replace timing belt and inspect water pump If you drive regularly in very high temperatures (over 110°F, 43°C), or in very low temperatures (under -20°F, -29°C), replace every 60,000 mile (U.S.)/ 100,000 km (Canada)</li> <li>• Inspect valve clearance</li> </ul>
5	<ul style="list-style-type: none"> <li>• Replace engine coolant</li> </ul>

Symbol	Maintenance Sub Items
6	<ul style="list-style-type: none"> <li>• Replace rear differential fluid Driving in mountainous areas at very low vehicle speeds or trailer towing results in higher level of mechanical (shear) stress to fluid This requires differential fluid changes more frequently than recommended by the Maintenance Minder. If you regularly drive your vehicle under these conditions, have the differential fluid changed at 7,500 miles (12,000 km), then every 15,000 miles (24,000 km).</li> </ul>

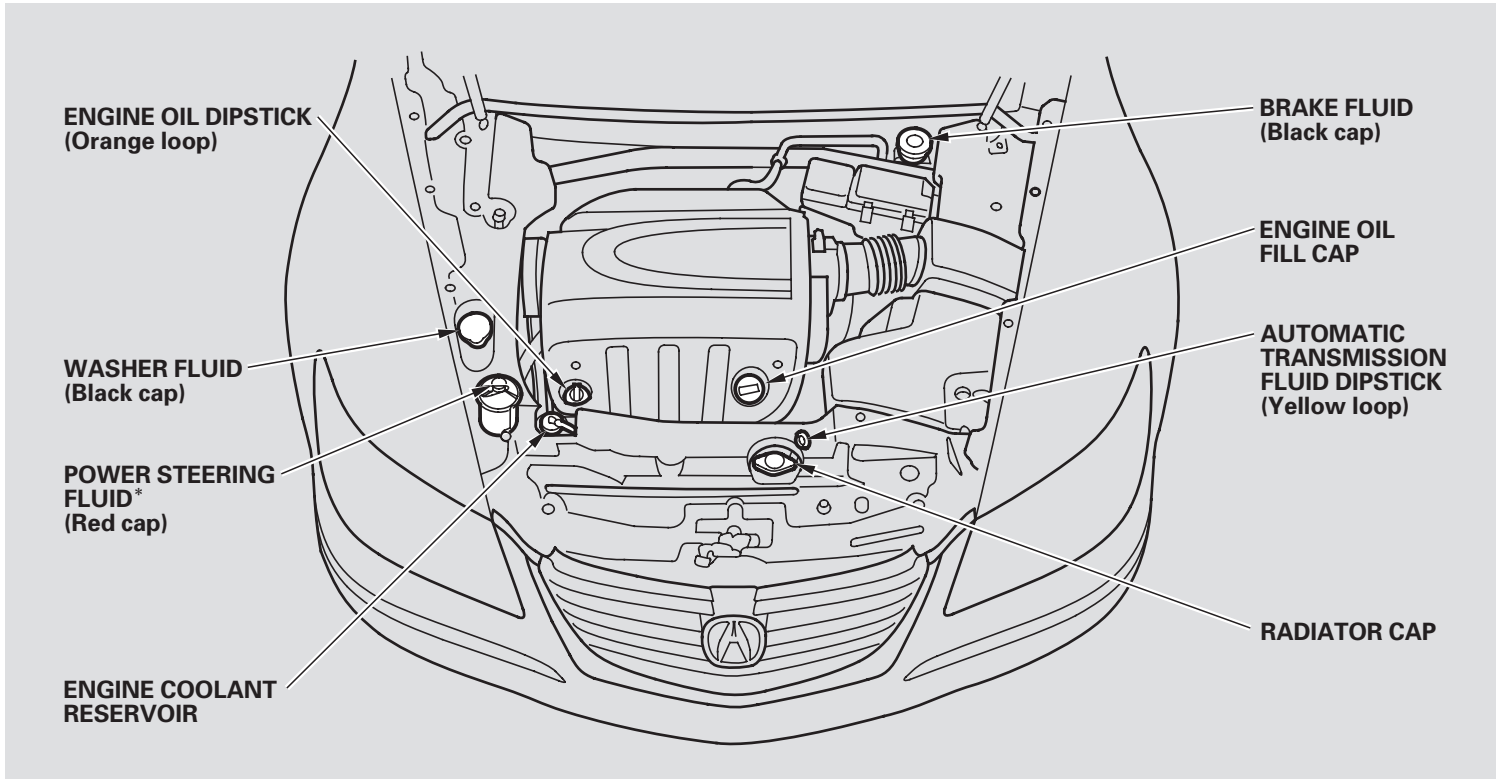

\*: The power steering fluid reservoir is located under the right compartment cover.

## Engine Compartment Covers

The component parts in the engine compartment are protected by several covers. You may need to remove the covers when you perform some simple maintenance work.

All of the covers are secured by holding clips.

To remove the front bulkhead cover, remove the holding clips with a flat-tip screwdriver.

To remove the left or right engine compartment cover, remove the holding clips by loosening the pins in the center of the fastener.

To remove the battery cover, turn the knob of the fastener (see page [428](#)).

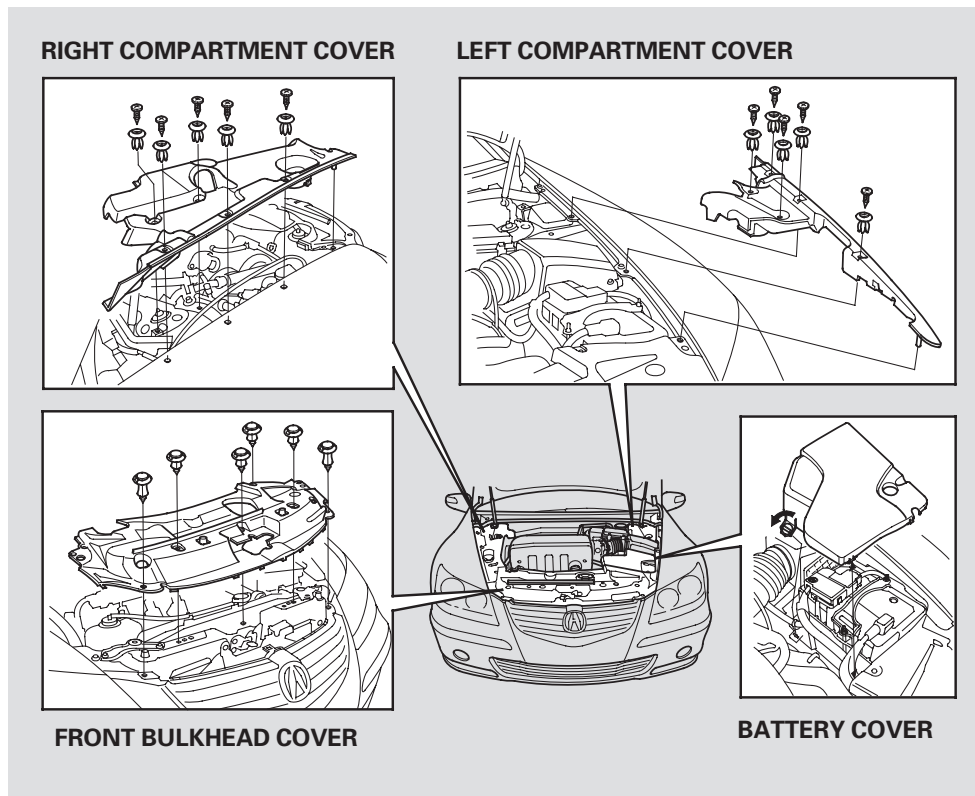

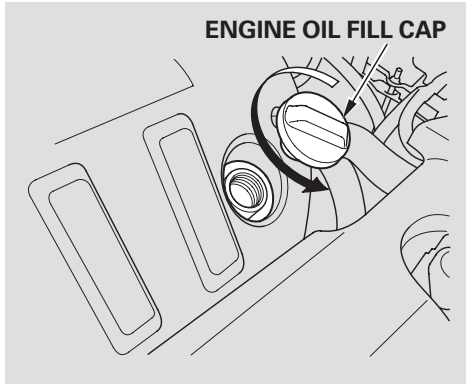

Unscrew and remove the engine oil fill cap on top of the valve cover. Pour in the oil slowly and carefully so you do not spill any. Clean up any spills immediately. Spilled oil could damage components in the engine compartment.

Install the engine oil fill cap, and tighten it securely. Wait a few minutes, and recheck the oil level. Do not fill above the upper mark; you could damage the engine.

## Recommended Engine Oil

Oil is a major contributor to your engine's performance and longevity. Always use a premium-grade 5W-20 detergent oil displaying the API Certification Seal. This seal indicates the oil is energy conserving, and that it meets the American Petroleum Institute's latest requirements.

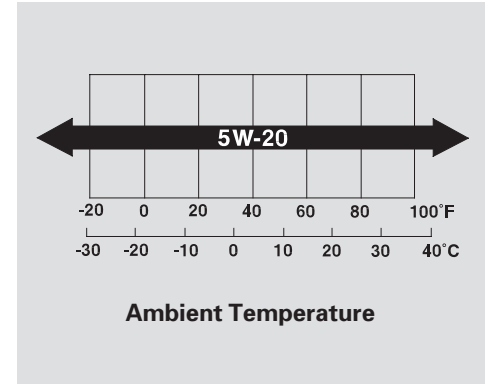

Honda Motor Oil is the preferred 5W-20 lubricant for your vehicle. It is highly recommended that you use Honda Motor Oil in your vehicle for optimum engine protection. Make sure the API Certification Seal says "For Gasoline Engines." The oil viscosity or weight is provided on the container's label. 5W-20 oil is formulated for year-round protection of your vehicle to improve cold weather starting and fuel economy. *CONTINUED*

# Adding Engine Oil, Changing the Engine Oil and Filter

---

## Synthetic Oil

You may use a synthetic motor oil if it meets the same requirements given for a conventional motor oil, it displays the API certification seal, and it is the proper weight. You must follow the oil and filter change intervals shown on the maintenance minder display.

## Engine Oil Additives

Your vehicle does not require any oil additives. Additives may adversely affect the engine or transmission performance and durability.

## Changing the Engine Oil and Filter

Always change the oil and filter according to the maintenance messages shown on the multi-information display. The oil and filter collect contaminants that can damage your engine if they are not removed regularly.

Changing the oil and filter requires special tools and access from underneath the vehicle. The vehicle should be raised on a service station-type hydraulic lift for this service. Unless you have the knowledge and proper equipment, you should have this maintenance done by a skilled mechanic.

1. Run the engine until it reaches normal operating temperature, then shut it off.

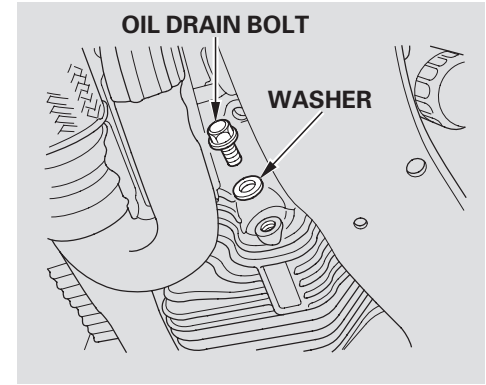

2. Open the hood, and remove the engine oil fill cap. Remove the oil drain bolt and washer from the bottom of the engine. Drain the oil into an appropriate container.

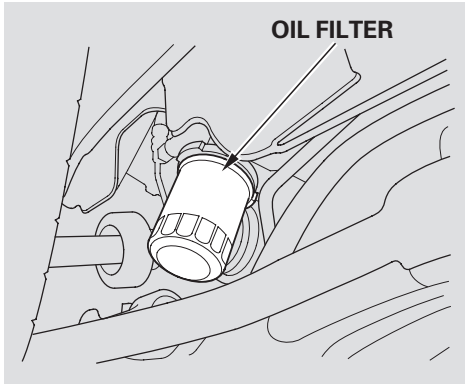

3. Remove the oil filter, and let the remaining oil drain. A special wrench (available from your dealer) is required.

Make sure the oil filter gasket is not stuck to the engine block. If it is, remove it before installing a new oil filter.

4. Install a new oil filter according to the instructions that come with it.

5. Put a new washer on the drain bolt, then reinstall the drain bolt. Tighten the drain bolt to:  
29 lbf·ft (39 N·m , 4.0 kgf·m)
6. Refill the engine with the recommended oil.  
Engine oil change capacity (including filter):  
4.5 US qt (4.3 ℓ)
7. Replace the engine oil fill cap. Start the engine. The oil pressure indicator should go out within 5 seconds. If it does not, turn off the engine, and check your work.
8. Let the engine run for several minutes, then check the drain bolt and oil filter for leaks.
9. Turn off the engine and let it sit for several minutes, then check the oil level on the dipstick. If necessary, add more oil.

## NOTICE

*Improper disposal of engine oil can be harmful to the environment. If you change your own oil, please dispose of the used oil properly. Put it in a sealed container, and take it to a recycling center. Do not discard it in a trash bin or dump it on the ground.*



# Engine Coolant

## Adding Engine Coolant



If the coolant level in the reserve tank is at or below the MIN line, add coolant to bring it up to the MAX line. Inspect the cooling system for leaks.

Always use Honda Long-life Antifreeze/Coolant Type 2. This coolant is pre-mixed with 50 percent antifreeze and 50 percent water. Never add straight antifreeze or plain water.

If Honda antifreeze/coolant is not available, you may use another major-brand non-silicate coolant as a temporary replacement. Make sure it is a high-quality coolant recommended for aluminum engines. Continued use of any non-Honda coolant can result in corrosion, causing the cooling system to malfunction or fail. Have the cooling system flushed and refilled with Honda antifreeze/coolant as soon as possible.

If the reserve tank is completely empty, you should also check the coolant level in the radiator.

### **WARNING**

Removing the radiator cap while the engine is hot can cause the coolant to spray out, seriously scalding you.

Always let the engine and radiator cool down before removing the radiator cap.

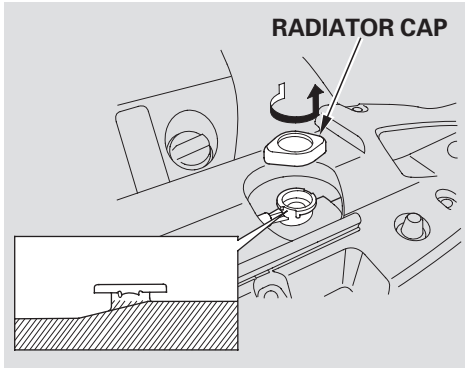

1. When the radiator and engine are cool, relieve any pressure in the cooling system by turning the radiator cap counterclockwise, without pressing down.
2. Remove the radiator cap by pushing down and turning counterclockwise.

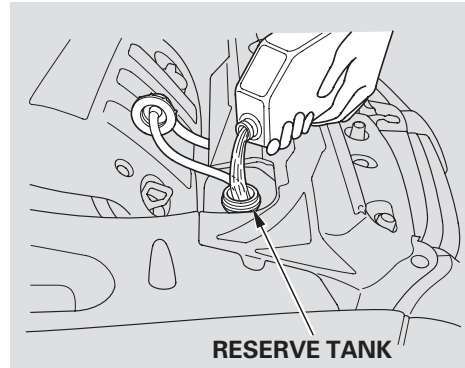

3. The coolant level should be up to the base of the filler neck. Add coolant if it is low.

Pour the coolant slowly and carefully so you do not spill any. Clean up any spill immediately; it could damage components in the engine compartment.

4. Put the radiator cap back on, and tighten it fully.
5. Pour coolant into the reserve tank. Fill it to halfway between the MAX and MIN marks. Put the cap back on the reserve tank.

Do not add any rust inhibitors or other additives to your vehicle's cooling system. They may not be compatible with the coolant or engine components.

# Windshield Washers, Automatic Transmission Fluid

## Windshield Washers

Check the fluid level in the windshield washer reservoir at least monthly during normal use.

If the washer fluid is low, a “WASHER FLUID LOW” message appears on the multi-information display.

Fill the reservoir with a good-quality windshield washer fluid. This increases the cleaning capability and prevents freezing in cold weather. When you refill the reservoir, clean the edges of the windshield wiper blades with windshield washer fluid on a clean cloth. This will help to condition them.

**NOTICE:** *Do not use engine antifreeze or a vinegar/water solution in the windshield washer reservoir. Antifreeze can damage your vehicle’s paint, while a vinegar/water solution can damage the windshield washer pump. Use only commercially-available windshield washer fluid.*

## Automatic Transmission Fluid

Check the fluid level with the engine at normal operating temperature.

1. Park the vehicle on level ground. Start the engine, let it run until the radiator fan comes on, then shut off the engine. For accurate results, wait about 60 seconds (but no longer than 90 seconds) before doing step 2.

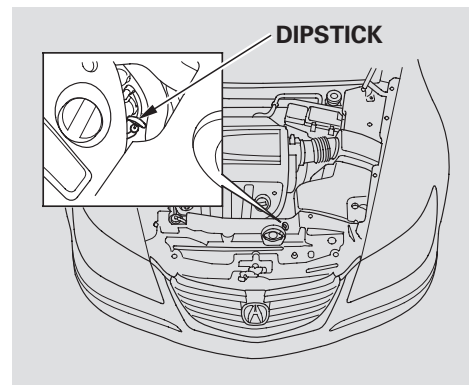

2. Remove the dipstick (yellow loop) from the transmission, and wipe it with a clean cloth.

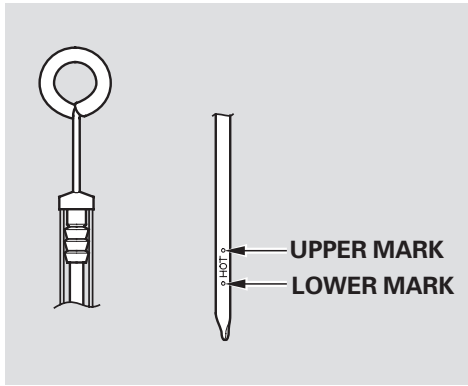

3. Insert the dipstick all the way into the transmission as shown.
4. Remove the dipstick and check the fluid level. It should be between the upper and lower marks.
5. If the level is below the lower mark, add fluid into the dipstick hole to bring it to the level between the upper and lower marks.

Pour the fluid slowly and carefully so you do not spill any. Clean up any spill immediately; it could damage components in the engine compartment.

Always use Honda ATF-Z1 (automatic transmission fluid).

## NOTICE

*Use only Honda Genuine ATF-Z1 (Automatic Transmission Fluid). Do not mix with other transmission fluids. Using transmission fluid other than Honda Genuine ATF-Z1 may cause deterioration in transmission operation and durability, and could result in damage to the transmission. Damage resulting from the use of transmission fluid other than Honda Genuine ATF-Z1 is not covered by the Honda new vehicle warranty.*

6. Insert the dipstick all the way back into the transmission securely as shown in the illustration.

The transmission should be drained and refilled with new fluid when this service is shown by a maintenance message on the multi-information display.

If you are not sure how to add fluid, contact your dealer.

## Brake Fluid, Power Steering Fluid

---

### Brake Fluid

Check the brake fluid level in the reservoirs monthly.

Replace the brake fluid every 3 years, independent of mileage.

Always use Honda Heavy Duty Brake Fluid DOT 3. If it is not available, you should use only DOT 3 or DOT 4 fluid, from a sealed container, as a temporary replacement.

Using any non-Honda brake fluid can cause corrosion and decrease the life of the system. Have the brake system flushed and refilled with Honda Heavy Duty Brake Fluid DOT 3 as soon as possible.

Brake fluid marked DOT 5 is not compatible with your vehicle's braking system and can cause extensive damage.

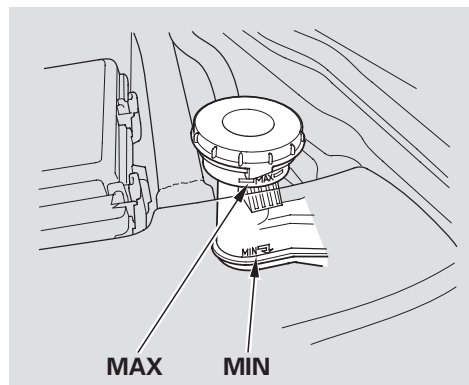

The fluid level should be between the MIN and MAX marks on the side of the reservoir. If the level is at or below the MIN mark, your brake system needs attention. Have the brake system inspected for leaks or worn brake pads.

### Power Steering Fluid

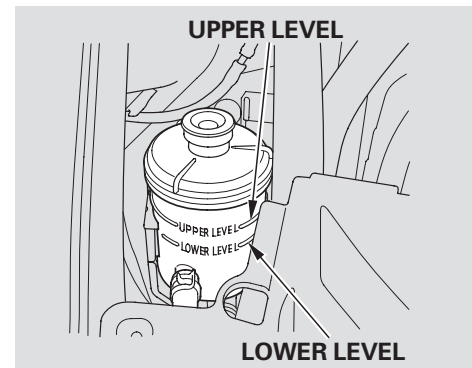

After removing the right engine compartment cover (see page [398](#)), check the level on the side of the reservoir when the engine is cold. The fluid should be between the UPPER LEVEL and LOWER LEVEL. If not, add power steering fluid to the UPPER LEVEL mark.

Pour the fluid slowly and carefully so you do not spill any. Clean up any spill immediately; it could damage components in the engine compartment.

Always use Honda Power Steering Fluid. You may use another power steering fluid as an emergency replacement, but have the power steering system flushed and refilled with Honda PSF as soon as possible.

A low power steering fluid level can indicate a leak in the system. Check the fluid level frequently, and have the system inspected as soon as possible.

### NOTICE

*Turning the steering wheel to full left or right lock and holding it there can damage the power steering pump.*

### Timing Belt

The timing belt should be replaced at the intervals shown on the maintenance minder. Replace the belt at 60,000 miles (100,000 km) if you regularly drive your vehicle in one or more of these conditions:

- In very high temperatures (over 110°F, 43°C).
- In very low temperatures (under -20°F, -29°C).
- If you frequently tow a trailer.

# Lights

---

## Headlight Aiming

Your vehicle is equipped with an automatic headlight adjusting system that adjusts the vertical angle of the headlights automatically.

Refer to page [144](#) for more information.

The headlights were properly aimed when your vehicle was new. If you regularly carry heavy items in the trunk or pull a trailer (if applicable), readjustment may be required.

Adjustments should be done by your dealer or other qualified technician.

The low beam headlight bulbs are a type of high voltage discharge tube. High voltage can remain in the circuit even with the light switch off and the key removed. Because of this, you should not attempt to examine or change a low beam headlight bulb yourself. If a low beam headlight bulb fails, take the vehicle to your dealer to have it replaced.

## Replacing a Headlight/Daytime Running Light Bulb

Your vehicle has halogen high beam headlight bulbs which are also used for the daytime running light.

Handle it by its base and protect the glass from contact with your skin or hard objects. If you touch the glass, clean it with denatured alcohol and a clean cloth.

### NOTICE

*Halogen bulbs get very hot when lit. Oil, perspiration, or a scratch on the glass can cause the bulb to overheat and shatter.*

1. Remove the left or right side engine compartment cover from the side you are working on by carefully pulling the cover out (see page 398 ).

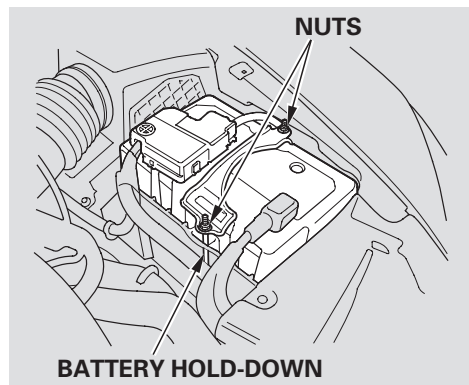

If you are replacing the bulb on the driver's side, remove the battery cover (see page 428 ), then remove the battery hold-down by removing the two nuts with a 10 mm wrench. Then carefully slide the battery toward the engine to access the bulb.

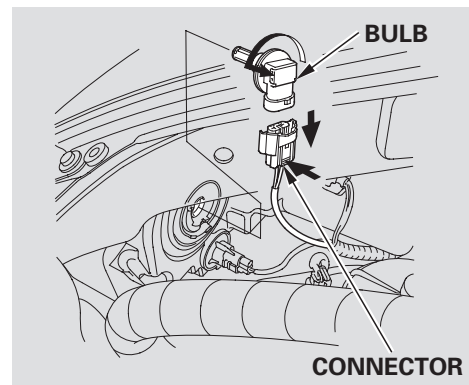

2. Remove the electrical connector from the bulb by pushing on the tab and pulling the connector down.
3. Remove the bulb by turning it one-quarter turn counterclockwise.

*CONTINUED*



# Lights

4. Insert the new bulb into the hole, and turn it one-quarter turn clockwise to lock it in place.
5. Push the electrical connector back onto the bulb. Make sure it is on all the way.
6. Turn on the headlights to test the new bulb.
7. (Driver's side)  
Reinstall the battery in the reverse order of removal, and reinstall the cover on the battery.
8. Reinstall the engine compartment side cover.

## Replacing a Front Turn Signal/ Front Parking Light Bulb

1. Remove the left or right side engine compartment cover from the side you are working on by carefully pulling the cover out (see page [398](#)).

If you are replacing a driver's side bulb, slide the battery toward the engine to get more clearance (see page [428](#)).

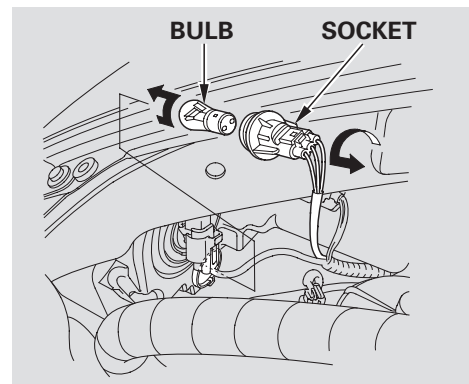

2. Remove the socket from the headlight assembly by turning it one-quarter turn counterclockwise.
3. Push the bulb in slightly, and turn it counterclockwise.

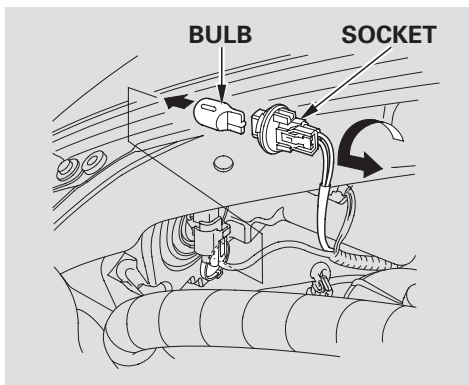

*On model without adaptive front lighting system*

Pull the bulb straight out of its socket.

4. Install the new bulb into the socket.
5. Insert the socket back into the headlight assembly. Turn it clockwise to lock it in place.
6. Turn on the lights to make sure the new bulb is working.
7. (Driver's side)  
Reinstall the battery and the battery cover.
8. Reinstall the engine compartment side cover.

## Replacing a Front Position/Side Marker Light Bulb

1. Remove the left or right side engine compartment cover (see page 398).

If you are replacing a driver's side bulb, slide the battery toward the engine to get more clearance (see page 428).

2. (Passenger's side)  
Use a flat-tipped screwdriver to remove the holding clip from the windshield washer reservoir.

CONTINUED

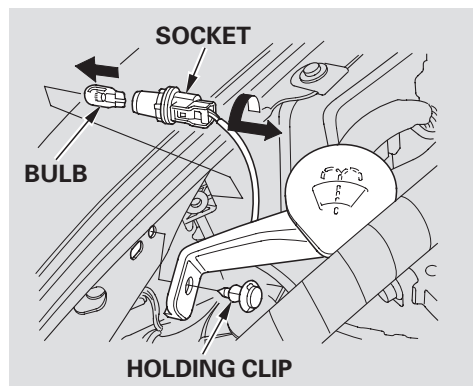

3. Remove the socket from the headlight assembly by turning it one-quarter turn counterclockwise.
4. Pull the bulb straight out of its socket.

5. Install the new bulb into the socket.
6. Insert the socket back into the headlight assembly. Turn it clockwise to lock it in place.
7. Turn on the lights to make sure the new bulb is working.
8. (Driver's side)  
Reinstall the battery and the battery cover.  
  
(Passenger's side)  
Reinstall the windshield washer reservoir.
9. Reinstall the engine compartment side cover.

## Replacing a Fog Light Bulb

Your vehicle uses halogen light bulbs. When replacing a bulb, handle it by its plastic case, and protect the glass from contact with your skin or hard objects. If you touch the glass, clean it with denatured alcohol and a clean cloth.

### NOTICE

*Halogen bulbs get very hot when lit. Oil, perspiration, or a scratch on the glass can cause the bulb to overheat and shatter.*

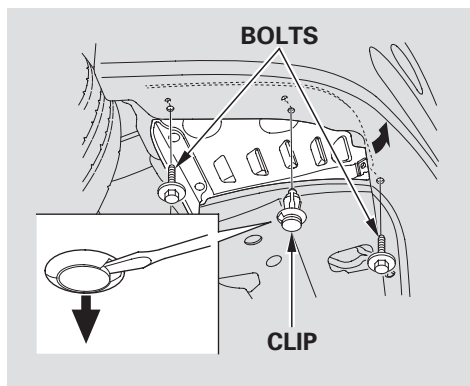

1. Use a Phillips-head screwdriver to remove the two undercover bolts, and remove the holding clip with a flat-tipped screwdriver.
2. Carefully push up the side undercover into the bumper.

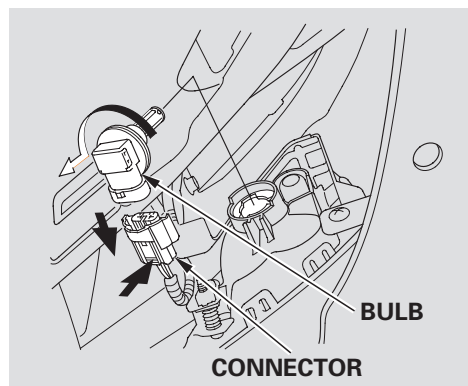

3. Remove the electrical connector from the bulb by pushing on the tab and pulling the connector down.
4. Remove the bulb by turning it one-quarter turn counterclockwise.

5. Insert the new bulb into the hole, and turn it one-quarter turn clockwise to lock it in place.
6. Push the electrical connector back onto the bulb. Make sure it is on all the way.
7. Turn on the fog lights to test the new bulb.
8. Reinstall the two undercover bolts on the side undercover and tighten them securely. Put the holding clip back on the side undercover and push on the center until it locks (the center is flush with the head).

# Lights

## Replacing Rear Bulbs

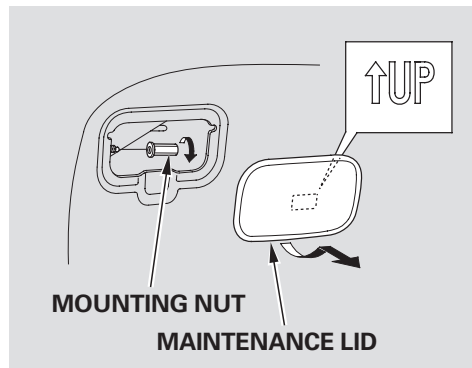

1. Open the trunk lid, and remove the left or right maintenance lid.
2. Remove the mounting nut with an 8 mm wrench.

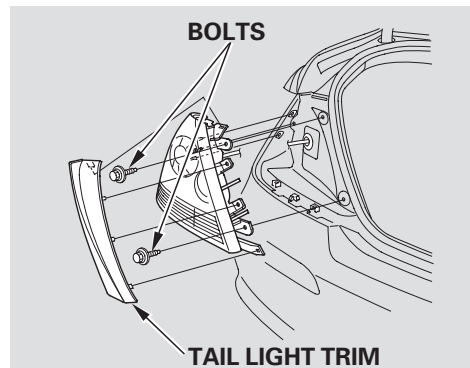

3. Carefully pry in the top or bottom edge of the trim with a small flat-tipped screwdriver, and pull the trim straight back.
4. Remove the two mounting bolts with an 8 mm wrench.
5. Pull the taillight assembly straight back out of the body.

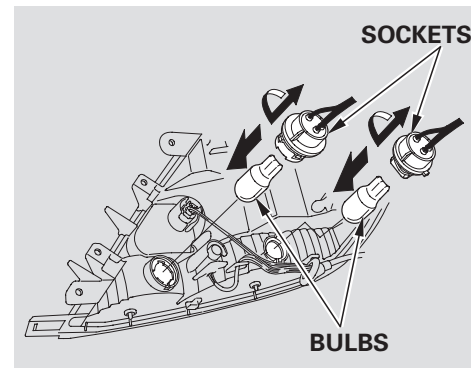

6. Determine which of the two bulbs is burned out: turn signal or back-up light.
7. Remove the socket by turning it one-quarter turn counterclockwise.
8. Remove the burned out bulb by pulling it straight out of its socket.

## Lights, Dust and Pollen Filter, Cleaning the Seat Belts

9. Install the new bulb in the socket by pushing it straight in the socket until it bottoms.
10. Reinstall the socket into the light assembly. Turn it clockwise to lock it in place.
11. Test the lights to make sure the new bulb is working.
12. When reinstalling the taillight assembly, align and pop the snap fasteners in place. Tighten the two mounting bolts and reinstall the trim in place.
13. Tighten the mounting nut securely, and reinstall the maintenance lid.

### Dust and Pollen Filter

This filter removes the dust and pollen that is brought in from the outside through the climate control system.

Have your dealer replace the filter when this service is indicated by a maintenance message on the multi-information display. It should be replaced every 15,000 miles (24,000 km) if you drive primarily in urban areas that have high concentrations of soot in the air, or if the flow from the climate control system becomes less than usual.

### Cleaning the Seat Belts

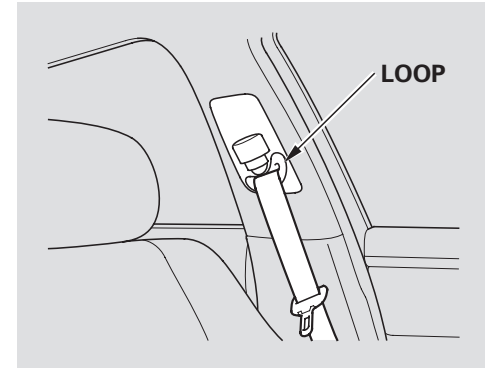

If your seat belts get dirty, use a soft brush with a mixture of mild soap and warm water to clean them. Do not use bleach, dye, or cleaning solvents. Let the belts air-dry before you use the vehicle. Dirt build-up in the loops of the seat belt anchors can cause the belts to retract slowly. Wipe the insides of the loops with a clean cloth dampened in mild soap and warm water or isopropyl alcohol.

## Floor Mats

### DRIVER'S SIDE FLOOR MAT

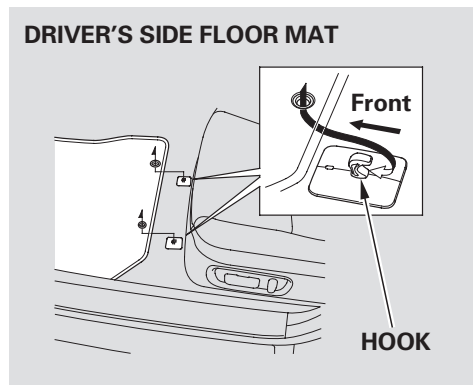

The floor mats that came with your vehicle hook over the floor mat anchors. This keeps the floor mats from sliding forward, possibly interfering with the pedals, or backwards, making the front passenger's weight sensors ineffective.

If you remove a floor mat, make sure to re-anchor it when you put it back in your vehicle.

### FRONT PASSENGER'S SIDE FLOOR MAT

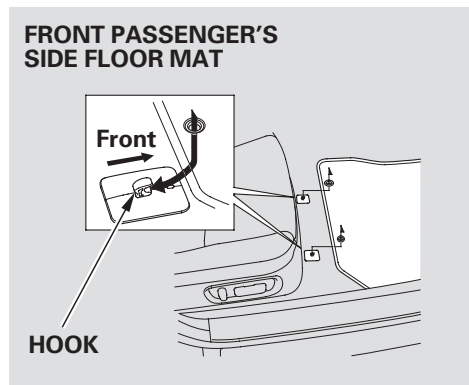

If you use a non-Acura floor mat, make sure it fits properly and that it can be used with the floor mat anchors. Do not put additional floor mats on top of the anchored mats.

### REAR PASSENGER'S FLOOR MAT



Make sure the rear floor mats are properly hooked to the floor mat anchors. Your vehicle is equipped with front passenger's seat weight sensors. If the rear passenger's floor mat is on the seat rail of the front passenger's seat, the sensors will detect the decreased weight on the seat, and they may not work properly.

Check the condition of the wiper blades at least every 6 months. Replace them if you find signs of cracking in the rubber, areas that are getting hard, or if they leave streaks and unwiped areas when used.

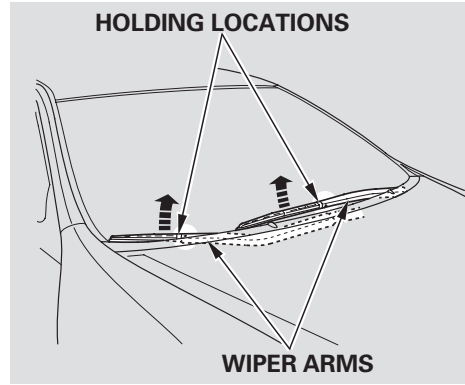

1. Adjust the windshield wiper arms to the winter position by holding both wiper arms as shown in the illustration at the same time (see page 139). Raise the wiper arms off the windshield.

## NOTICE

*Do not open the hood when the wiper arms are raised, or you will damage the hood and the wiper arms.*

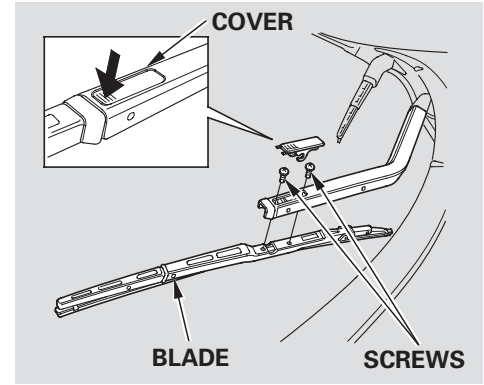

2. Push the end of the cover on the blade assembly until the other end is pivoted out, and remove the cover.
3. Disconnect the blade assembly from the wiper arm by removing the two screws from the arm.

CONTINUED



# Wiper Blades

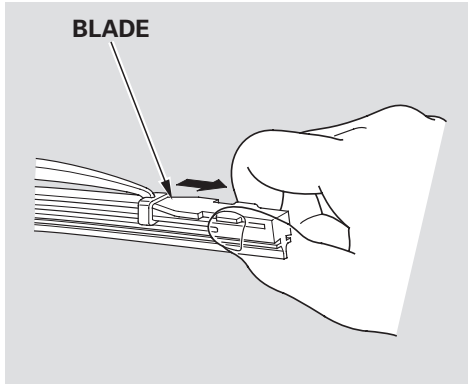

4. Remove the blade from its holder by grabbing the tabbed end of the blade. Pull up firmly until the tabs come out of the holder.

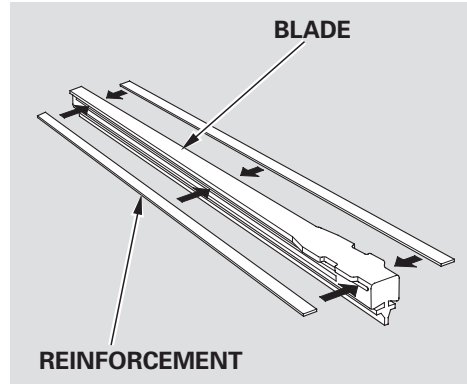

5. Examine the new wiper blades. If they have no plastic or metal reinforcement along the back edge, remove the metal reinforcement strips from the old wiper blade, and install them in the slots along the edge of the new blade.

6. Slide the new wiper blade into the holder until the tabs lock.
7. Reinstall the blade assembly to the wiper arm and tighten the two screws securely. Reinstall the cover by pushing it in.
8. Set the wiper arms back on the windshield. Adjust the windshield wipers to their previously parked position.

**Wheels**

Clean the wheels as you would the rest of the exterior. Wash them with the same solution, and rinse them thoroughly.

Aluminum alloy wheels have a protective clear-coat that keeps the aluminum from corroding and tarnishing. Cleaning the wheels with harsh chemicals (including some commercial wheel cleaners) or a stiff brush can damage the clear-coat. To clean the wheels, use a mild detergent and a soft brush or sponge.

**Tires**

To safely operate your vehicle, your tires must be the proper type and size, in good condition with adequate tread, and correctly inflated.

The following pages give more detailed information on how to take care of your tires and what to do when they need to be replaced.

**▲ WARNING**

Using tires that are excessively worn or improperly inflated can cause a crash in which you can be seriously hurt or killed.

Follow all instructions in this owner’s manual regarding tire inflation and maintenance.

**Inflation Guidelines**

Keeping the tires properly inflated provides the best combination of handling, tread life, and riding comfort.

- Underinflated tires wear unevenly, adversely affect handling and fuel economy, and are more likely to fail from being overheated.
- Overinflated tires can make your vehicle ride more harshly, are more prone to damage from road hazards, and wear unevenly.

The tire pressure monitoring system (TPMS) will warn you when a tire pressure is low. See page 371 for information on the TPMS.

*CONTINUED*

# Tires

---

Even though your vehicle is equipped with TPMS, we recommend that you visually check your tires every day. If you think a tire might be low, check it immediately with a tire gauge.

Use a gauge to measure the air pressure in each tire at least once a month. Even tires that are in good condition may lose one to two psi (10 to 20 kPa, 0.1 to 0.2 kgf/cm<sup>2</sup>) per month. Remember to check the spare tire at the same time.

Check the pressure in the tires when they are cold. This means the vehicle has been parked for at least three hours, or driven less than 1 mile (1.6 km).

Add or release air, if needed, to match the recommended cold tire pressures on page [421](#).

If you check the pressure when the tires are hot [driven for several miles (kilometers)], you will see readings 4 to 6 psi (30 to 40 kPa, 0.3 to 0.4 kgf/cm<sup>2</sup>) higher than the cold reading. This is normal; do not release air to match the cold pressure. The tires will be underinflated.

You should get your own tire pressure gauge and use it whenever you check your tire pressures. This will make it easier for you to tell if a pressure loss is due to a tire problem and not due to a variation between gauges.

While tubeless tires have some ability to self-seal if they are punctured, you should look closely for punctures if a tire starts losing pressure.

## Recommended Tire Pressures

The following charts show the recommended cold tire pressures for most normal and high-speed driving conditions.

Tire Size/Type	Cold Tire Pressure
P245/50R17 98V	Front 32 psi (220 kPa , 2.2 kgf/cm <sup>2</sup> )
	Rear 30 psi (210 kPa , 2.1 kgf/cm <sup>2</sup> )
Compact Spare T155/70D17 110M	60 psi (420 kPa , 4.2 kgf/cm <sup>2</sup> )

*On models with the Michelin PAX system*

Tire Size	Cold Tire Pressure for Normal Driving
245-680R460A 102V	Front: 32 psi (220 kPa , 2.2 kgf/cm <sup>2</sup> ) Rear: 30 psi (210 kPa , 2.1 kgf/cm <sup>2</sup> )

For convenience, the recommended tire sizes and cold tire pressures are on a label on the driver's doorjamb.

For additional technical information about your tires, see page [466](#).

## Tire Inspection

Every time you check inflation, you should also examine the tires for damage, foreign objects, and wear.

You should look for:

- Bumps or bulges in the tread or side of the tire. Replace the tire if you find either of these conditions.
- Cuts, splits, or cracks in the side of the tire. Replace the tire if you can see fabric or cord.
- Excessive tread wear.

CONTINUED

# Tires

---

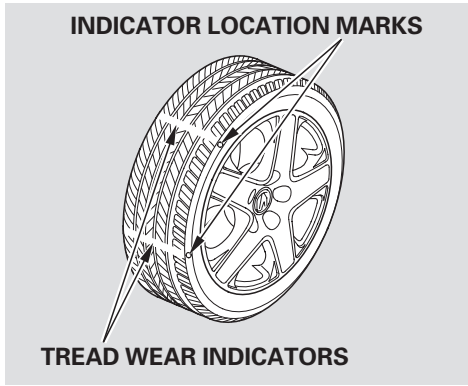

Your tires have wear indicators molded into the tread. When the tread wears down, you will see a 1/2 inch (12.7 mm) wide band across the tread. This shows there is less than 1/16 inch (1.6 mm) of tread left on the tire.

A tire this worn gives very little traction on wet roads. You should replace the tire if you can see three or more tread wear indicators.

## Tire Service Life

The service life of your tires is dependent on many factors, including, but not limited to, driving habits, road conditions, vehicle loading, inflation pressure, maintenance history, speed, and environmental conditions (even when the tires are not in use).

In addition to your regular inspections and inflation pressure maintenance, it is recommended that you have annual inspections performed once the tires reach five years old. It is also recommended that all tires, including the spare, be removed from service after 10 years from the date of manufacture, regardless of their condition or state of wear.

The last four digits of the TIN (tire identification number) are found on the sidewall of the tire and indicate the date of manufacture (See **Tire Labeling** on page 468 ).

## Tire Maintenance

In addition to proper inflation, correct wheel alignment helps to decrease tire wear. If you find a tire is worn unevenly, have your dealer check the wheel alignment.

Have your dealer check the tires if you feel a consistent vibration while driving. A tire should always be rebalanced if it is removed from the wheel. When you have new tires installed, make sure they are balanced. This increases riding comfort and tire life. For best results, have the installer perform a dynamic balance.

### NOTICE

*Improper wheel weights can damage your vehicle's aluminum wheels. Use only Acura wheel weights for balancing.*

## Tire Rotation

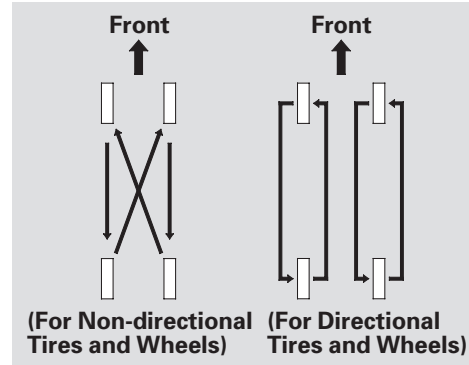

To help increase tire life and distribute wear more evenly, rotate the tires according to the maintenance messages displayed on the multi-information display. Move the tires to the positions shown in the illustration each time they are rotated. If you purchase directional tires, rotate only front-to-back.

When the tires are rotated, make sure the air pressures are checked.

## Replacing Tires and Wheels

Replace your tires with radial tires of the same size, load range, speed rating, and maximum cold tire pressure rating (as shown on the tire's sidewall).

Mixing radial and bias-ply tires on your vehicle can reduce braking ability, traction, and steering accuracy. Using tires of a different size or construction can cause the ABS and vehicle stability assist system (VSA) to work inconsistently.

*Vehicles without the Michelin PAX System*

Your vehicle is not designed for Michelin PAX system wheels or tires. Use only the wheels and tires designated in this owner's manual. Never mix conventional wheels or tires with PAX system wheels or tires.

# Tires

---

It is best to replace all four tires at the same time. If that is not possible or necessary, replace the two front tires or two rear tires as a pair. Replacing just one tire can seriously affect your vehicle's handling.

If you ever need to replace a wheel, make sure the wheel's specifications match those of the original wheel that came on your vehicle. Replacement wheels are available at your Acura dealer.

## WARNING

Installing improper tires on your vehicle can affect handling and stability. This can cause a crash in which you can be seriously hurt or killed.

Always use the size and type of tires recommended in this owner's manual.

## Wheels and Tires

Wheels:  
17 x 8.0J AL (TPMS)

*On models with the Michelin PAX system*  
235 — 460A (TPMS)

Tires:  
P245/50R17 98V

*On models with the Michelin PAX system*  
245-680R460A 102V

See page [466](#) for DOT tire quality grading information, and page [468](#) for tire size explanation.

## Winter Driving

Tires marked “M + S” or “All Season” on the sidewall have an all-weather tread design suitable for most winter driving conditions.

For the best performance in snowy or icy conditions, you should install snow tires or tire chains. They may be required by local laws under certain conditions.

## *Snow Tires*

If you mount snow tires on your vehicle, make sure they are radial tires of the same size and load range as the original tires. Mount snow tires on all four wheels. The traction provided by snow tires on dry roads may be lower than your original tires. Check with the tire dealer for maximum speed recommendations.

There are no snow tires compatible with the PAX system.

**Tire Chains**

Mount tire chains on your tires when required by driving conditions or local laws. Install them only on the front tires.

Because your vehicle has limited tire clearance, Acura strongly recommends using the chain listed below, made by Security Chain Company (SCC).

Cable-type: SCC Radial Chain  
CH2612T

Tire chains cannot be used with a flat front tire. If a front tire goes flat when a tire chain is installed on it, remove the chain, and follow the precautions described under Michelin PAX System (see page [426](#)).

When installing cables, follow the manufacturer's instructions, and mount them as tight as you can. Make sure they are not contacting the brake lines or suspension. Drive slowly with them installed. If you hear them coming into contact with the body or chassis, stop and investigate. Remove them as soon as you begin driving on cleared roads.

**⚠ WARNING**

Using the wrong chains, or not properly installing chains, can damage the brake lines and cause a crash in which you can be seriously injured or killed.

Follow all instructions in this owner's manual regarding the selection and use of tire chains.

**NOTICE**

*Traction devices that are the wrong size or improperly installed can damage your vehicle's brake lines, suspension, body, and wheels. Stop driving if they are hitting any part of the vehicle.*



# Tires

---

## **Michelin® PAX System™**

*If equipped*

Your vehicle is equipped with the Michelin PAX system which, together with the tire pressure monitoring system (TPMS), enables you to continue driving even if one or more of your tires loses its pressure.

The tires and wheels on your vehicle are specially designed for the PAX system, and the PAX system is specifically designed and fine-tuned for your vehicle.

Because of these reasons, use only the wheels and tires designated in this owner's manual. Never mix PAX system wheels or tires with conventional wheels or tires.

There are no snow tires compatible with the PAX system, and not all tire chains are suitable for use on the PAX system tires.

If you mount snow chains on your tires, use the chains recommended by Acura (see page [425](#)).

Do not replace the PAX system tires and wheels with conventional tires and wheels. Doing so would disable the PAX system and the tire pressure monitoring system (TPMS), and may void your new vehicle warranty.

## ***Important Precautions***

- Never use a tire repair agent in a PAX system tire, and never repair a PAX system tire by yourself. Repair or replacement must be done by an Acura dealer or an authorized Michelin PAX system dealer.
- If you must continue driving with a flat tire, follow all the procedures and precautions described on page [432](#).

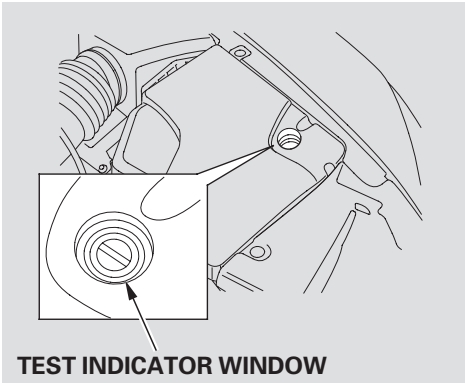

Check the condition of the battery monthly by looking at the test indicator window. The label on the battery explains the test indicator's colors. To see the label, remove the battery cover (see page [428](#) ).

Check the terminals for corrosion (a white or yellowish powder). To remove it, cover the terminals with a solution of baking soda and water. It will bubble up and turn brown. When this stops, wash it off with plain water. Dry off the battery with a cloth or paper towel. Coat the terminals with grease to help prevent future corrosion.

If additional battery maintenance is needed, see your dealer or a qualified technician.

**WARNING:** Battery posts, terminals, and related accessories contain lead and lead compounds. **Wash your hands after handling.**

If you need to connect the battery to a charger, disconnect both cables to prevent damaging your vehicle's electrical system. Always disconnect the negative (–) cable first, and reconnect it last.

### **⚠ WARNING**

The battery gives off explosive hydrogen gas during normal operation.

A spark or flame can cause the battery to explode with enough force to kill or seriously hurt you.

Wear protective clothing and a face shield, or have a skilled technician do the battery maintenance.

*CONTINUED*

## Checking the Battery

If your vehicle's battery is disconnected or goes dead, all stored driving positions will be lost. To store the driving positions again, see the storing procedure on page 160 .

### *On vehicles with navigation system*

The navigation system will also disable itself. The next time you turn on the ignition switch, the system will require you to enter a PIN before it can be used. Refer to the navigation system manual.

### *On vehicles without navigation system*

The compass System will also disable itself. The next time you turn on the ignition switch, the system will require you to enter a PIN before it can be used. Enter the four-digit anti-theft security code (see page 259 ). You will also need reset the clock according to the instruction of setting the clock (see page 274 ).

If your vehicle's battery is disconnected or goes dead, the audio system may disable itself. The next time you turn on the radio you will see "ENTER CODE" in the frequency display. Use the preset buttons to enter the code (see page 241 ).

If your vehicle's battery is disconnected or goes dead, the power tilt and telescopic steering wheel system will be disabled. The system needs to be reset after reconnecting the battery (see page 148 ).

## Removing the Battery Cover

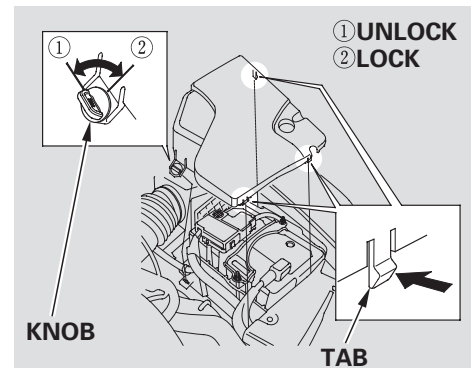

1. Turn the knob of the battery cover to UNLOCK as shown in the illustration.

2. Push the tabs and remove the cover by pulling it up carefully.
3. To reinstall the cover, put the tabs of the cover back to the original position properly.
4. Turn the knob of the cover to LOCK position as shown in the illustration.

If you need to park your vehicle for an extended period (more than 1 month), there are several things you should do to prepare it for storage. Proper preparation helps prevent deterioration and makes it easier to get your vehicle back on the road. If possible, store your vehicle indoors.

- Fill the fuel tank.
- Wash and dry the exterior completely.
- Clean the interior. Make sure the carpeting, floor mats, etc., are completely dry.
- Leave the parking brake off. Put the transmission in Park.

- Block the rear wheels.
- If the vehicle is to be stored for a longer period, it should be supported on jackstands so the tires are off the ground.
- Leave one window open slightly (if the vehicle is being stored indoors).
- Disconnect the battery.
- Support the front wiper blade arms with a folded towel or rag so they do not touch the windshield.
- To minimize sticking, apply a silicone spray lubricant to all door and trunk seals. Also, apply a vehicle body wax to the painted surfaces that mate with the door and trunk seals.

*CONTINUED*

## Vehicle Storage

---

- Cover the vehicle with a “breathable” cover, one made from a porous material such as cotton. Non-porous materials, such as plastic sheeting, trap moisture, which can damage the paint.
- If possible, periodically run the engine until it reaches full operating temperature (the cooling fans cycle on and off twice). Preferably, do this once a month.

This section covers the more common problems that motorists experience with their vehicles. It gives you information about how to safely evaluate the problem and what to do to correct it. If the problem has stranded you on the side of the road, you may be able to get going again. If not, you will also find instructions on getting your vehicle towed.

Driving with a Flat Tire .....	432
Compact Spare Tire.....	435
Changing a Flat Tire .....	436
If the Engine Won't Start.....	440
Jump Starting .....	441
If the Engine Overheats .....	444
Low Oil Pressure Indicator .....	447
Charging System Indicator.....	447
Malfunction Indicator Lamp .....	448
Brake System Indicator .....	449
Opening the Fuel Fill Door	
Manually .....	450
Fuses .....	451
Fuse Locations.....	456
Emergency Towing .....	459
If Your Vehicle Gets Stuck.....	459

## Driving With a Flat Tire

### Michelin® PAX System™

*If equipped*

Your vehicle is equipped with the Michelin PAX system. Since each Michelin PAX system tire has an inner support ring that allows it to continue running without air, it may be difficult to immediately judge from its appearance if a tire is punctured. Your vehicle is also equipped with a tire pressure monitoring system (TPMS), and this system may be your first detection of a flat tire.



The TPMS monitors the air pressure of all four tires whenever the ignition switch is in the ON (II) position. It will immediately sense if a tire starts to lose its pressure, and give you warning with the low tire pressure/TPMS indicator in the instrument panel and a “CHECK TIRE PRESSURE” message on the multi-information display. If the indicator and the warning message do not come on again after you inflate the tire to its correct air pressure (see



page 421 ), it was probably a natural loss of the air pressure and you can continue driving as before.

If the indicator and the message come on again, you probably have a flat tire. In this case, you will see a “PAX SYSTEM WARNING” message on the multi-information display.

With the PAX system tires, you can drive up to about 125 miles (200 km) even if one or more of your tires are punctured. This allows you to drive to the nearest Acura dealer or authorized Michelin PAX system dealer to have the tire(s) repaired.

If you get a flat tire, never try to repair it yourself, and never replace a flat tire with a compact spare tire.

Follow the instructions shown on the multi-information display, and drive very carefully.



The above message shows that you are driving your vehicle on a flat tire, and should observe the “RUN FLAT DRIVING” speed limit of 50 mph (80 km/h). Drive to your nearest Acura dealer or authorized Michelin PAX system dealer, or call the PAX help hotline at 1-877-PAXTIRE (1-877-729-8473).



If the display changes to the above message, it means that “RUN FLAT DRIVING” is nearing the limit, and you have to stop driving soon. Take your vehicle to the nearest Acura dealer or authorized Michelin PAX system dealer as soon as possible.

*CONTINUED*



## Driving With a Flat Tire

---



If you see the above message on the multi-information display, you have reached the limit of run flat driving, and you should stop driving immediately. Be aware that if you continue to drive, the noise and vibration level from the tire will increase significantly, and the tire may no longer be repairable.

Call a professional towing service who can transport your vehicle on flat-bed equipment. Never tow your

vehicle behind another vehicle with a rope or chain. Flat-bed equipment is the only way to transport your vehicle.

### Important Safety Precautions

Although your vehicle is capable of run flat driving, you should always observe the following:

- Do not drive faster than 50 mph (80 km/h).
- Drive carefully. Your vehicle may handle differently from when the tires are properly inflated, especially when cornering.
- In its run flat mode, a PAX system tire is somewhat noisier than when it is fully inflated, this is normal.

- Stop driving immediately when you see a “RUN FLAT LIMIT STOP DRIVING” message on the multi-information display. Continuous driving after this message will make it impossible to repair the tire.

If you cannot find an Acura dealer or an authorized Michelin PAX system dealer where you are driving, call the PAX help hotline at 1-877-PAXTIRE (1-877-729-8473).

Use the compact spare tire as a temporary replacement only. Get your regular tire repaired or replaced, and put it back on your vehicle as soon as you can.

Check the inflation pressure of the compact spare tire every time you check the other tires. It should be inflated to:

60 psi (420 kPa , 4.2 kgf/cm<sup>2</sup>)

Follow these precautions:

- Never exceed 50 mph (80 km/h).
- This tire gives a harsher ride and less traction on some road surfaces. Use greater caution while driving.
- Do not mount snow chains on the compact spare tire.
- Do not use your compact spare tire on another vehicle unless it is the same make and model.
- After the flat tire is replaced with the spare tire, the low tire pressure/TPMS indicator stays on. After several miles (kilometers) driving with the spare, this indicator begins to flash, then stays on again. You will also see a “CHECK TPMS SYSTEM” message on the multi-information display (see page [375](#) ).

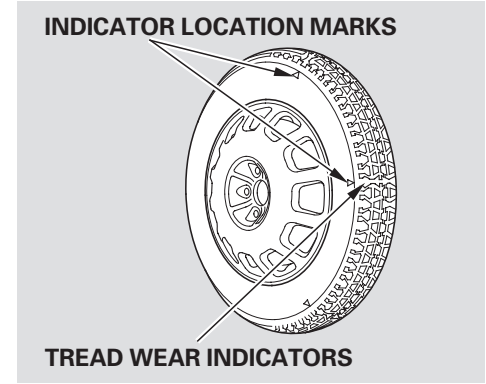

Replace the tire when you can see the tread wear indicator bars. The replacement should be the same size and design tire, mounted on the same wheel. The spare tire is not designed to be mounted on a regular wheel, and the spare wheel is not designed for mounting a regular tire.

## Changing a Flat Tire

### *Models without Michelin PAX System*

If you have a flat tire while driving, stop in a safe place to change it. Drive slowly along the shoulder until you get to an exit or an area to stop that is far away from the traffic lanes.

### **⚠ WARNING**

The vehicle can easily roll off the jack, seriously injuring anyone underneath.

Follow the directions for changing a tire exactly, and never get under the vehicle when it is supported only by the jack.

1. Park the vehicle on firm, level, and non-slippery ground. Put the transmission in Park. Apply the parking brake. If you are towing a trailer, unhitch it.
2. Turn on the hazard warning lights, and turn the ignition switch to the LOCK (0) position. Have all passengers get out of the vehicle while you change the tire.

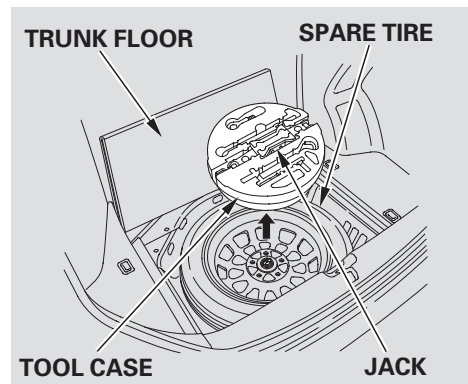

3. Open the trunk, and fold the trunk floor forward.
4. Take the tool case out of the spare tire.
5. Unscrew the wing bolt, and remove the spacer cone. Then take the spare tire out of its well.



6. Loosen each wheel nut 1/2 turn with the wheel nut wrench.

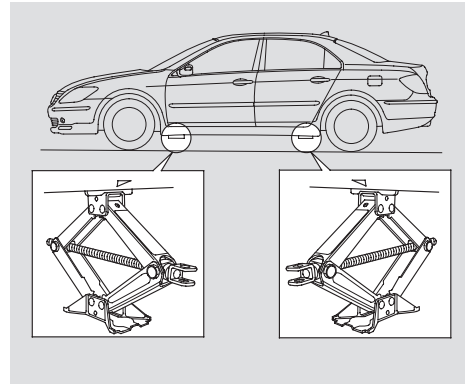

7. Place the jack under the jacking point nearest the tire you need to change. It is pointed to by a  $\Delta$  mark molded into the underside of the body. Turn the end bracket clockwise until the top of the jack contacts the jacking point. Make sure the jacking point tab is resting in the jack notch.

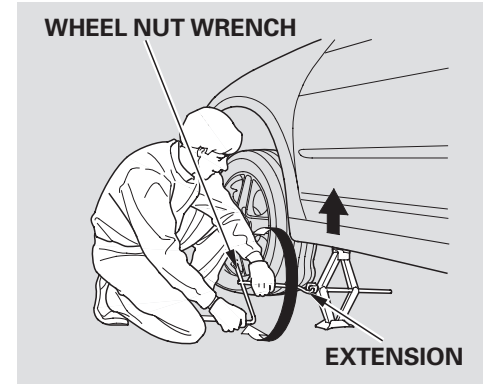

8. Use the extension and the wheel nut wrench as shown to raise the vehicle until the flat tire is off the ground.
9. Remove the wheel nuts, then remove the flat tire. Temporarily place the flat tire on the ground with the outside surface of the wheel facing up. You could scratch the wheel if you put it face down.

CONTINUED

## Changing a Flat Tire

---

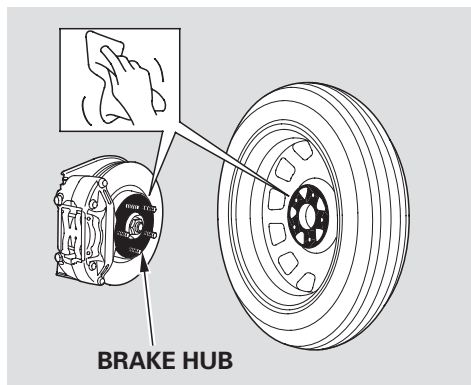

10. Before mounting the spare tire, wipe any dirt off the mounting surface of the wheel and hub with a clean cloth. Wipe the hub carefully; it may be hot from driving.

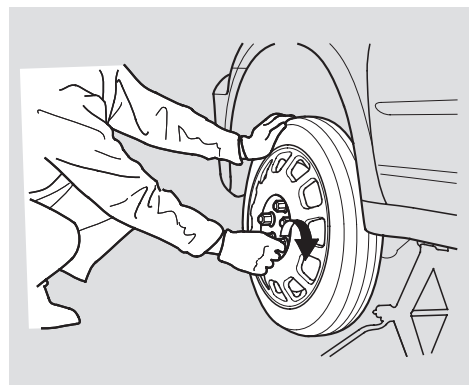

11. Put on the spare tire. Put the wheel nuts back on finger-tight, then tighten them in a crisscross pattern with the wheel nut wrench until the wheel is firmly against the hub. Do not try to tighten the wheel nuts fully.

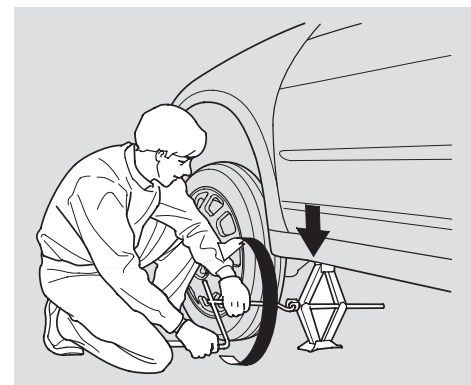

12. Lower the vehicle to the ground, and remove the jack.

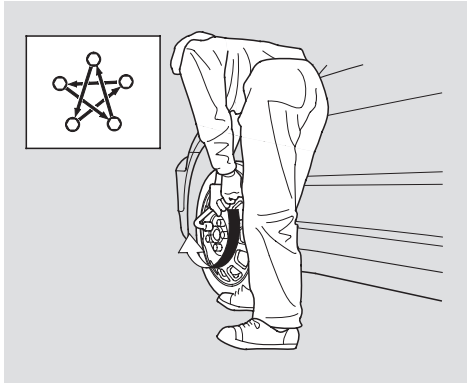

13. Tighten the wheel nuts securely in the same crisscross pattern. Have the wheel nut torque checked at the nearest automotive service facility.  
Tighten the wheel nuts to:  
94 lbf·ft (127 N·m , 13 kgf·m)

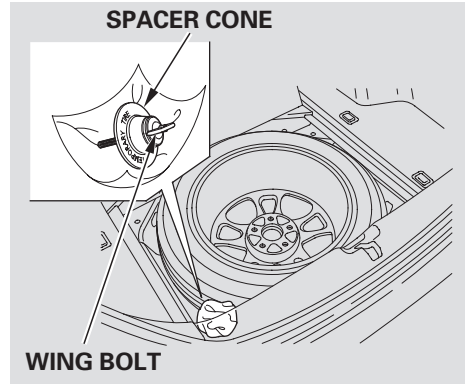

14. Place the flat tire face down in the spare tire well.
15. Wrap the spacer cone and spare tire wing bolt with cloth or paper, and store them in the spare tire well.

16. Store the jack and tools in the tool case. Place the tool case in the flat tire.

### **⚠ WARNING**

Loose items can fly around the interior in a crash and could seriously injure the occupants.

Store the wheel, jack, and tools securely before driving.

17. Lower the trunk floor, then close the trunk lid.
18. Refer to **Changing a Tire with TPMS** (see page 372).

## If the Engine Won't Start

---

Diagnosing why the engine won't start falls into two areas, depending on what you hear when you turn the ignition switch to the START (III) position:

- You hear nothing, or almost nothing. The engine's starter motor does not operate at all, or operates very slowly.
- You can hear the starter motor operating normally, or the starter motor sounds like it is spinning faster than normal, but the engine does not start up and run.

### **Nothing Happens or the Starter Motor Operates Very Slowly**

When you turn the ignition switch to the START (III) position, you do not hear the normal noise of the engine trying to start. You may hear a clicking sound, a series of clicks, or nothing at all.

Check these things:

- Make sure the remote is with you, inside the vehicle.
- Check the transmission interlock. The transmission must be in Park or neutral or the starter will not operate.
- Turn the ignition switch to the ON (II) position. Turn on the headlights, and check their brightness. If the headlights are very dim or do not come on at all, the battery is discharged. See **Jump Starting** on page [441](#) .

- Turn the ignition switch to the START (III) position. If the headlights do not dim, check the condition of the fuses. If the fuses are OK, there is probably something wrong with the electrical circuit for the ignition switch or starter motor. You will need a qualified technician to determine the problem. See **Emergency Towing** on page [459](#) .

If the headlights dim noticeably or go out when you try to start the engine, either the battery is discharged or the connections are corroded. Check the condition of the battery and terminal connections (see page [427](#) ). You can then try jump starting the vehicle from a booster battery (see page [441](#) ).

## The Starter Operates Normally

In this case, the starter motor's speed sounds normal, or even faster than normal, when you turn the ignition switch to the START (III) position, but the engine does not run.

- Are you using the proper starting procedure? Refer to **Starting the Engine** on page 347 .
- Are you using a properly coded built-in key or remote? An improperly coded built-in key or remote will cause the immobilizer system indicator in the instrument panel to blink rapidly (see page 64).
- Do you have fuel? Check the fuel gauge; the low fuel indicator may not be working.

- There may be an electrical problem, such as no power to the fuel pump. Check all the fuses (see page 453 ).

If you find nothing wrong, you will need a qualified technician to find the problem. See **Emergency Towing** on page 459 .

## Jump Starting

Although this seems like a simple procedure, you should take several precautions.

### **WARNING**

A battery can explode if you do not follow the correct procedure, seriously injuring anyone nearby.

Keep all sparks, open flames, and smoking materials away from the battery.

You cannot start your vehicle by pushing or pulling it.



## Jump Starting

### *To Jump Start Your Vehicle:*

1. Open the hood, and check the physical condition of the battery. In very cold weather, check the condition of the electrolyte. If it seems slushy or frozen, do not try jump starting until it thaws.

### **NOTICE**

*If a battery sits in extreme cold, the electrolyte inside can freeze. Attempting to jump start with a frozen battery can cause it to rupture.*

2. Turn off all the electrical accessories: heater, A/C, climate control, stereo system, lights, etc. Put the transmission in Park, and set the parking brake.

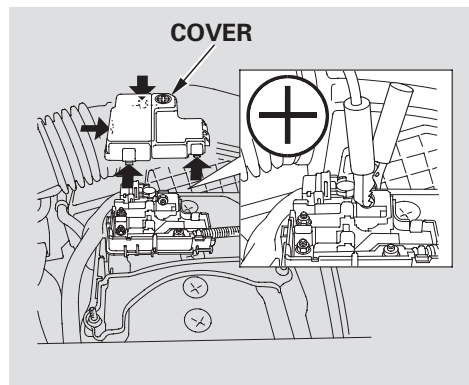

3. Remove the battery cover (see page 428), then remove the secondary under-hood fuse box cover from the positive (+) terminal on the battery.

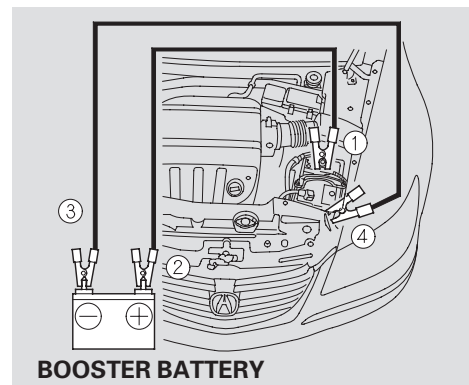

The numbers in the illustration show you the order to connect the jumper cables.

4. Connect one jumper cable to the positive (+) terminal on your vehicle's battery. Connect the other end to the positive (+) terminal on the booster battery.

## NOTICE

*Connecting the jumper cable to the secondary under-hood fuse box causes the fuses blown.*

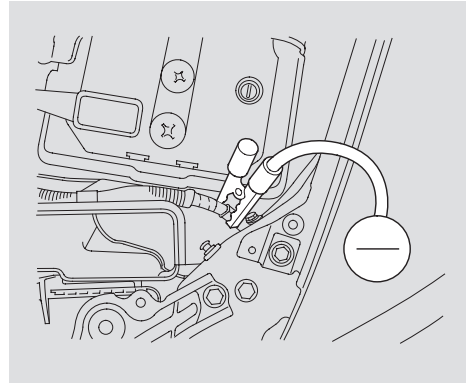

5. Connect the second jumper cable to the negative (–) terminal on the booster battery. Connect the other end to the grounding point as shown. Do not connect this jumper cable to any other part of the engine.
6. If the booster battery is in another vehicle, have an assistant start that vehicle and run it at a fast idle.

7. Start your vehicle. If the starter motor still operates slowly, check that the jumper cables have good metal-to-metal contact.
8. Once your vehicle is running, disconnect the negative cable from your vehicle, then from the booster battery. Disconnect the positive cable from your vehicle, then from the booster battery.
9. Reinstall the secondary under-hood fuse box cover over the positive (+) terminal of the battery, then reinstall the battery cover.

Keep the ends of the jumper cables away from each other and any metal on the vehicle until everything is disconnected. Otherwise, you may cause an electrical short.

## If the Engine Overheats

---

The pointer of the vehicle's temperature gauge should stay in the midrange. If it climbs to the red mark, you should determine the reason (hot day, driving up a steep hill, etc.).

If your vehicle overheats, you should take immediate action. The only indication may be the temperature gauge climbing to or above the red mark. Or you may see steam or spray coming from under the hood.

### NOTICE

*Driving with the temperature gauge pointer at the red mark can cause serious damage to the engine.*

### WARNING

Steam and spray from an overheated engine can seriously scald you.

Do not open the hood if steam is coming out.

1. Safely pull to the side of the road. Put the transmission in Park, and set the parking brake. Turn off all accessories, and turn on the hazard warning lights.
2. If you see steam and/or spray coming from under the hood, turn off the engine. Wait until you see no more signs of steam or spray, then open the hood.
3. If you do not see steam or spray, leave the engine running and watch the temperature gauge. If the high heat is due to overloading, the engine should start to cool down almost immediately. If it does, wait until the temperature gauge comes down to the midpoint, then continue driving.
4. If the temperature gauge stays at the red mark, turn off the engine.
5. Look for any obvious coolant leaks, such as a split radiator hose. Everything is still extremely hot, so use caution. If you find a leak, it must be repaired before you continue driving (see **Emergency Towing** on page [459](#)).

6. If you do not find an obvious leak, check the coolant level in the radiator reserve tank. Add coolant if the level is below the MIN mark.
7. If there was no coolant in the reserve tank, you may need to add coolant to the radiator. Let the engine cool down until the pointer reaches the middle of the temperature gauge, or lower, before checking the radiator.
8. Using gloves or a large heavy cloth, turn the radiator cap counterclockwise, without pushing down, to the first stop. After the pressure releases, push down on the cap, and turn it until it comes off.
9. Start the engine, and set the interior temperature to maximum (climate control to FULL AUTO at “”). Add coolant to the radiator up to the base of the filler neck. If you do not have the proper coolant mixture available, you can add plain water. Remember to have the cooling system drained and refilled with the proper mixture as soon as you can.
10. Put the radiator cap back on tightly. Run the engine, and check the temperature gauge. If it goes back to the red mark, the engine needs repair (see **Emergency Towing** on page 459).
11. If the temperature stays normal, check the coolant level in the radiator reserve tank. If it has gone down, add coolant to the MAX mark. Put the cap back on tightly.

### **WARNING**

Removing the radiator cap while the engine is hot can cause the coolant to spray out, seriously scalding you.

Always let the engine and radiator cool down before removing the radiator cap.

## If the Engine Overheats

---

### Check Radiator System

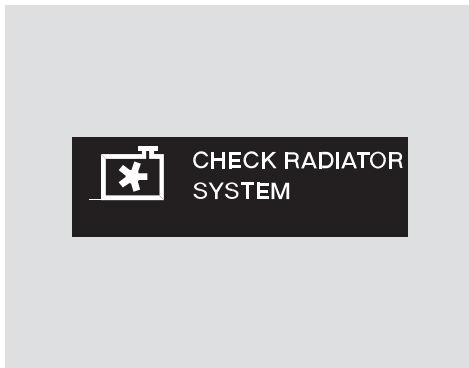

If there is a problem with the radiator system, you will see a “CHECK RADIATOR SYSTEM” on the multi-information display.

If you see this message, the engine has probably overheated. You should take your vehicle to a dealer, and have it repaired as soon as possible.

You can still drive your vehicle even if this message appears on the multi-information display, however you should check the temperature gauge while driving.

If you notice the temperature gauge climbing to or above the red mark, Safely pull to the side of the road. Follow the instructions on pages [444](#) and [445](#).

## Low Oil Pressure Indicator, Charging System Indicator

### Low Oil Pressure Indicator



This indicator should never come on when the engine is running. If it starts flashing or stays on, or if you see a “CHECK ENGINE OIL LEVEL” message on the multi-information display, the oil pressure has dropped very low or lost pressure. Serious engine damage is possible, and you should take immediate action.

#### NOTICE

*Running the engine with low oil pressure can cause serious mechanical damage almost immediately. Turn off the engine as soon as you can safely get the vehicle stopped.*

1. Safely pull off the road and shut off the engine. Turn on the hazard warning lights.
2. Let the vehicle sit for a minute. Open the hood, and check the oil level (see page [333](#)). An engine very low on oil can lose pressure during cornering and other driving maneuvers.
3. If necessary, add oil to bring the level back to the full mark on the dipstick (see page [399](#)).
4. Start the engine, and watch the oil pressure indicator. If it does not go out within 10 seconds, turn off the engine. There is a mechanical problem that needs to be repaired before you can continue driving (see **Emergency Towing** on page [459](#)).

### Charging System Indicator



If the charging system indicator comes on brightly when the engine is running, or if you see a “CHECK CHARGING SYSTEM” message on the multi-information display, the battery is not being charged.

Immediately turn off all electrical accessories. Try not to use other electrically operated controls such as the power windows. Keep the engine running; starting the engine will discharge the battery rapidly.

Go to a dealer or a service station where you can get technical assistance.

## Malfunction Indicator Lamp

---



If this indicator comes on while driving, or if you see a “CHECK EMISSION SYSTEM” message on the multi-information display, it means one of the engine’s emissions control systems may have a problem. Even though you may feel no difference in your vehicle’s performance, it can reduce your fuel economy and cause increased emissions. Continued operation may cause serious damage.

If you have recently refueled your vehicle, the indicator coming on could be due to a loose or missing fuel fill cap. You will also see a “TIGHTEN FUEL CAP” message on the multi-information display. Tighten the cap until it clicks at least once (see page [331](#) ). Tightening the cap will not turn the indicator off immediately; it can take several days of normal driving.

If the indicator comes on repeatedly, even though it may go off as you continue driving, have the vehicle checked by your dealer as soon as possible.

### NOTICE

*If you keep driving with the malfunction indicator lamp on, you can damage your vehicle’s emissions controls and engine. Those repairs may not be covered by your vehicle’s warranties.*

### Readiness Code

Your vehicle has certain “readiness codes” that are part of the on-board diagnostics for the emissions systems. In some states, part of the emissions testing is to make sure these codes are set. If they are not set, the test cannot be completed.

If the battery in your vehicle has been disconnected or gone dead, these codes may be erased. It can take several days of driving under various conditions to set the codes again.

To check if they are set, turn the ignition switch to the ON (II) position, without starting the engine. The malfunction indicator lamp will come on for 20 seconds. If it then goes off, the readiness codes are set. If it blinks five times, the readiness codes are not set. If possible, do not take your vehicle for an emissions test until the readiness codes are set. Refer to **Emissions Testing** for more information (see page [475](#) ).



The brake system indicator normally comes on when you turn the ignition switch to the ON (II) position and as a reminder to check the parking brake. If you do not release the parking brake, the indicator will stay on, and you will see a “RELEASE PARKING BRAKE” message on the multi-information display.

If the brake system indicator comes on while driving, the brake fluid level is probably low. You will see a “BRAKE FLUID LOW” message on the multi-information display. Press lightly on the brake pedal to see if it feels normal. If it does, check the brake fluid level the next time you stop at a service station (see page [406](#)).

If the fluid level is low, take your vehicle to a dealer, and have the brake system inspected for leaks or worn brake pads.

However, if the brake pedal does not feel normal, you should take immediate action. A problem in one part of the system’s dual circuit design will still give you braking at two wheels. You will feel the brake pedal go down much farther before the vehicle begins to slow down, and you will have to press harder on the pedal.

You will also see a “CHECK BRAKE SYSTEM” message on the multi-information display.

Slow down by shifting to a lower gear, and pull to the side of the road when it is safe. Because of the long distance needed to stop, it is hazardous to drive the vehicle. You should have it towed and repaired as soon as possible (see **Emergency Towing** on page [459](#)).

CONTINUED



## Brake System Indicator, Opening the Fuel Fill Door Manually

---

If you must drive the vehicle a short distance in this condition, drive slowly and carefully.

If the ABS indicator and the VSA system indicator come on with the brake system indicator, have your vehicle inspected by your dealer immediately.

### Opening the Fuel Fill Door Manually

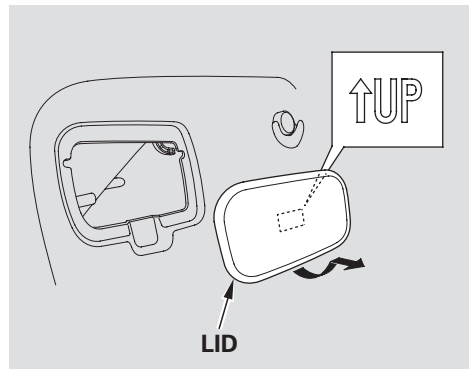

If the fuel fill door release button does not work, use the release lever inside the left maintenance lid in the trunk.

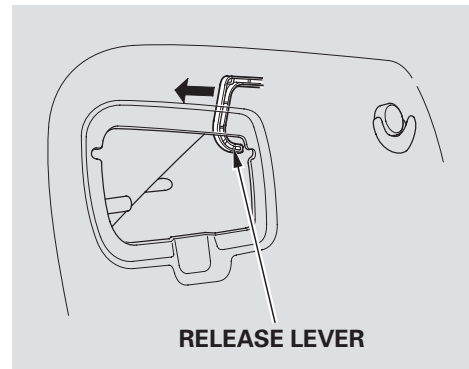

To open the fuel fill door, pull the release lever rearward.

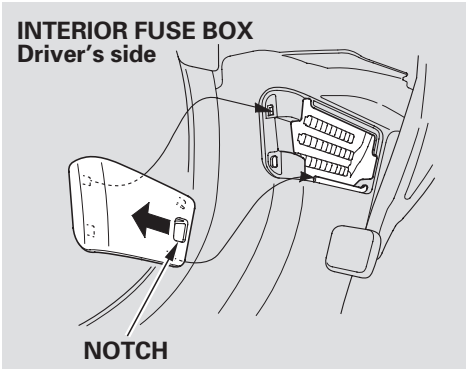

The fuses are located in five fuse boxes. The interior fuse boxes are located under the dashboard on the driver's and passenger's side.

To remove the fuse box lid, put your finger in the notch on the lid, pull it toward you, and take it out of its hinges.

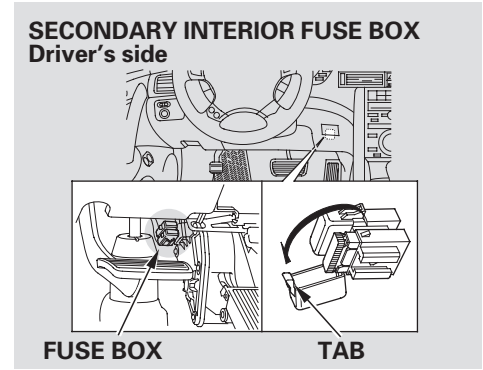
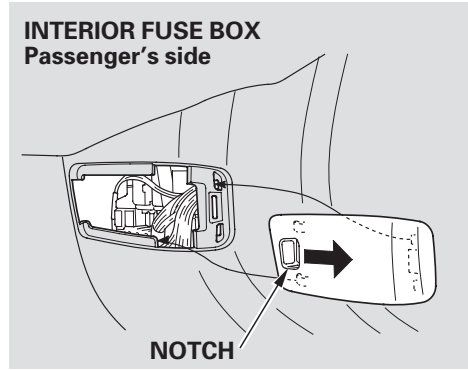

To open the secondary fuse box lid, push the tab in the direction as shown in the illustration.

*CONTINUED*

# Fuses

---

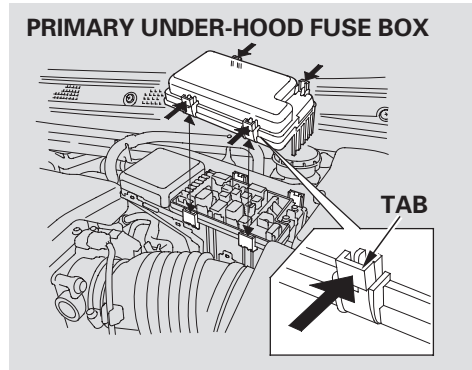

The primary under-hood fuse box is in the engine compartment on the driver's side. To open it, push the tabs as shown.

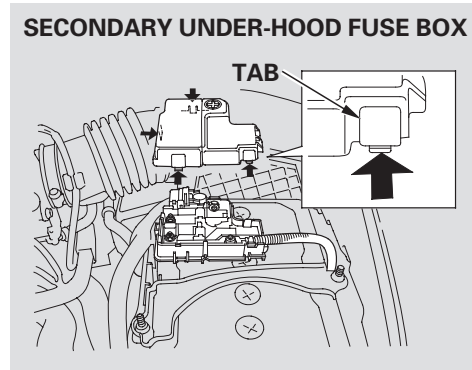

The secondary under-hood fuse box is on the battery. To open it, push the tabs as shown.

To check the fuse box, remove the battery cover first (see page [428](#)).

## Checking and Replacing Fuses

If something electrical in your vehicle stops working, the first thing you should check for is a blown fuse. Determine from the chart on pages [456](#), [457](#), and [458](#), or the diagram on the fuse box lid, which fuse or fuses control that device. Check those fuses first, but check all the fuses before deciding that a blown fuse is the cause. Replace any blown fuses, and check if the device works.

1. Turn the ignition switch to the LOCK (0) position. Make sure the headlights and all other accessories are off.
2. Remove the cover from the fuse box.

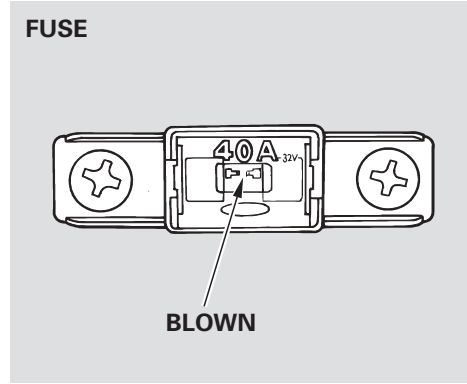

3. Check each of the large fuses in the under-hood fuse box by looking through the top at the wire inside. Removing these fuses requires a Phillips-head screwdriver.

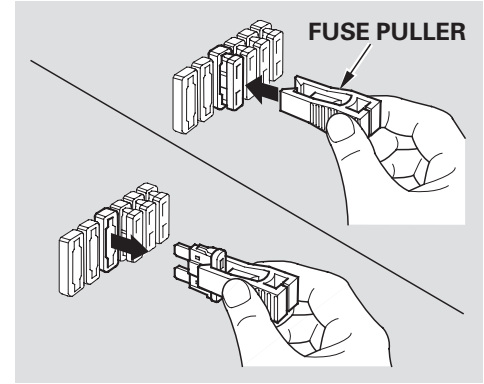

4. Check the smaller fuses in the under-hood fuse box and all the fuses in the interior fuse boxes by pulling out each fuse with the fuse puller. The fuse puller is inside the primary under-hood fuse box.

CONTINUED

# Fuses

---

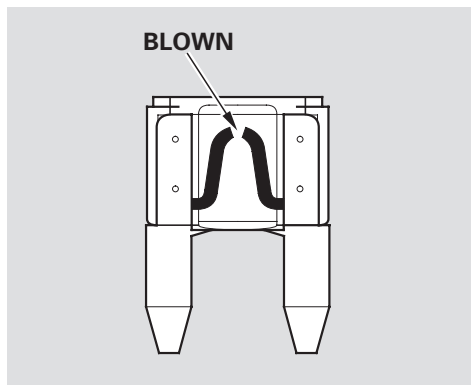

5. Look for a blown wire inside the fuse. If it is blown, replace it with one of the spare fuses of the same rating or lower.

If you cannot drive the vehicle without fixing the problem, and you do not have a spare fuse, take a fuse of the same rating or a lower rating from one of the other circuits with the fuse puller provided in the underhood fuse box. Make sure you can do without that circuit temporarily (such as the accessory power socket or radio).

If you replace the blown fuse with a spare fuse that has a lower rating, it might blow out again. This does not indicate anything wrong. Replace the fuse with one of the correct rating as soon as you can.

## NOTICE

*Replacing a fuse with one that has a higher rating greatly increases the chances of damaging the electrical system. If you do not have a replacement fuse with the proper rating for the circuit, install one with a lower rating.*

6. If the replacement fuse of the same rating blows in a short time, there is probably a serious electrical problem with your vehicle. Leave the blown fuse in that circuit, and have your vehicle checked by a qualified technician.

If the fuse for the driving position memory system is removed, all stored driving positions will be lost. To store the driving positions again, see page [160](#).

*On vehicles with navigation system*

If the navigation system fuse is removed, the navigation system will disable itself. The next time you turn on the ignition switch, the system will require you to enter a PIN before it can be used. Refer to the navigation system manual.

*On vehicles without navigation system*

If the compass system fuse is removed, the compass system will disable itself. The next time you turn on the ignition switch, the system will require you to enter a PIN before it can be used. Enter the four-digit anti-theft security code (see page [259](#)). You will also need reset the clock according to the instruction of the clock setting (see

page [274](#)).

If the radio fuse is removed, the audio system will disable itself. The next time you turn on the audio system you will see “ENTER CODE” in the frequency display. Use the preset buttons to enter the five-digit code (see page [241](#)).

If the fuse for the power tilt telescopic steering is removed, the system will be disabled. The system needs to be reset after reinstalling the fuse (see page [148](#)).

# Fuse Locations

## PRIMARY UNDER-HOOD FUSE BOX

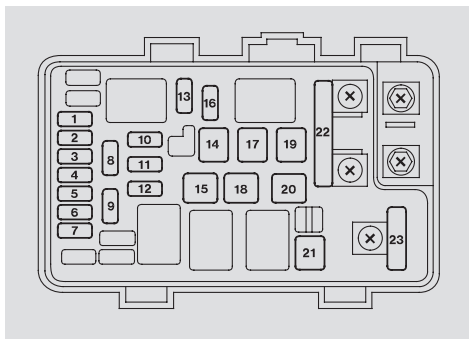

## SECONDARY UNDER-HOOD FUSE BOX

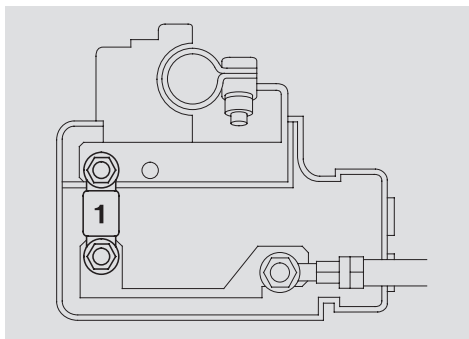

No.	Amps.	Circuits Protected
1	15 A	Left headlight low beam
2	30 A	Rear defroster coil
3	10 A	Left headlight high beam
4	15 A	Small light
5	10 A	Right headlight high beam
6	15 A	Right headlight low beam
7	7.5 A	Back-up
8	15 A	FI ECU
9	30 A	Wiper
10	30 A	Headlight washer*
11	20 A	Fog lights
12	7.5 A	MG clutch
13	15 A	Horn, Stop
14	40 A	Rear defroster

No.	Amps.	Circuits Protected
15	40 A	Back-up, ACC
16	15 A	Hazard
17	30 A	ABS/VSA motor
18	40 A	ABS/VSA
19	40 A	Drive by wire, LAF heater
20	(40 A)	Option
21	40 A	Heater motor
	40 A	Passenger's fuse box
22	70 A	Battery
	120 A	Battery
23	50 A	IG main
	50 A	Power window

\* : On Canadian models

No.	Amps.	Circuits Protected
1	50 A	Radiator fan

## INTERIOR FUSE BOX

Driver's side

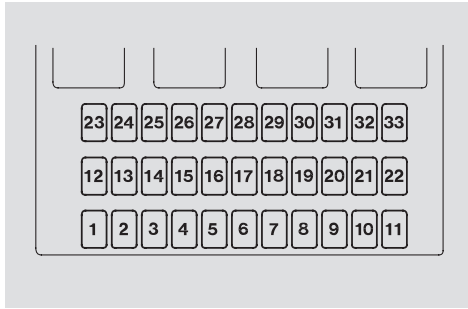

## SECONDARY INTERIOR FUSE BOX

Driver's side

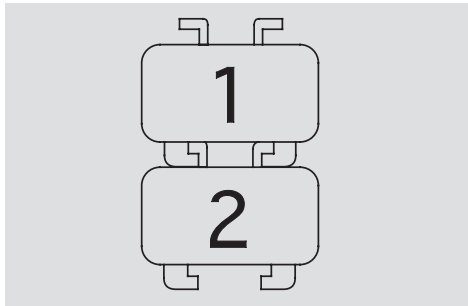

No.	Amps.	Circuits Protected
1	15 A	Drive by Wire
2	15 A	Ignition coil
3	10 A	Daytime running light
4	15 A	LAF heater
5	7.5 A	Radio
6	7.5 A	Interior light
7	10 A	Back-up
8	20 A	Door lock
9	20 A	Accessory socket
10	7.5 A	Occupant position detection system
11	7.5 A	Wiper
12	7.5 A	Tire pressure monitoring system
13	20 A	Passenger's power seat reclining
14	20 A	Driver's power seat sliding
15	10 A	Power lumbar support
16	20 A	Driver's power seat reclining

No.	Amps.	Circuits Protected
1	7.5 A	Starter diag.
2	7.5 A	Starter signal

No.	Amps.	Circuits Protected
17	20 A	Passenger's power seat sliding
18	15 A	ACG
19	20 A	Fuel Pump
20	15 A	IGN SOL
21	10 A	Meter
22	10 A	SRS
23	7.5 A	IGP (PGM-FI ECU)
24	20 A	Left rear power window
25	20 A	ETS (telescopic)
26	20 A	ETS (tilt)
27	30 A	Driver's power window
28	20 A	Moonroof
29	7.5 A	Adaptive Front Lighting System
30	7.5 A	Air Conditioner
31	7.5 A	e-pretensioner
32	10 A	ACC
33	(7.5 A)	Option



# Fuse Locations

## INTERIOR FUSE BOX

Passenger's side

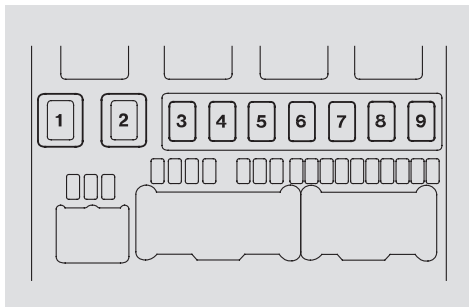

No.	Amps.	Circuits Protected
1	30 A	SH-AWD
2	30 A	Premium amplifier
3	30 A	Passenger's power window
4	30 A	Driver's automatic seat belt tensioner/e-pretensioner
5	20 A	Right rear power window

No.	Amps.	Circuits Protected
6	20 A	Heated seats
7	7.5 A	Interior lights
8	30 A	Passenger's automatic seat belt tensioner/e-pretensioner
9	7.5 A	Air conditioner

# Emergency Towing, If Your Vehicle Gets Stuck

## Emergency Towing

If your vehicle needs to be towed, call a professional towing service or organization. Never tow your vehicle with just a rope or chain. It is very dangerous.

**The only way you can safely tow your vehicle is with flat-bed equipment.** The operator will load your vehicle on the back of a truck. Any other method of towing will damage the drive system. When you contact the towing agency, inform them a flat-bed is required.

### NOTICE

*Towing with only two tires on the ground will damage parts of the all-wheel-drive system. Your vehicle should be transported on a flat-bed truck or trailer.*

## If Your Vehicle Gets Stuck

If your vehicle gets stuck in sand, mud, or snow, call a towing service to pull it out (see the previous column).

For very short distances, such as freeing the vehicle, you can use the detachable towing hook that mounts on the anchor in the front bumper.

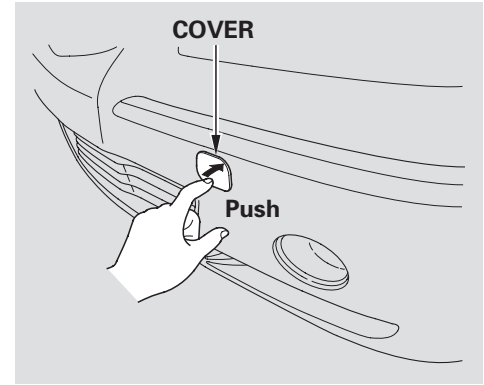

To use the towing hook:

1. Remove the cover from the front bumper by pushing the right corner edge of the cover with a finger until the cover comes out as shown in the illustration.

CONTINUED

## If Your Vehicle Gets Stuck

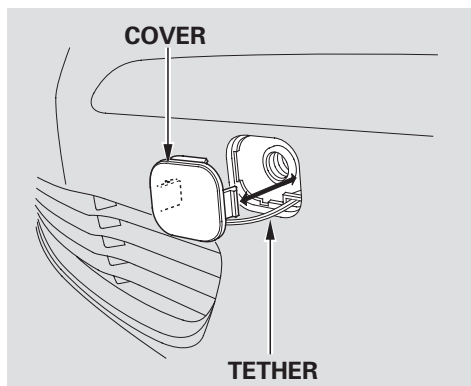

The cover is attached to the bumper with a tether.

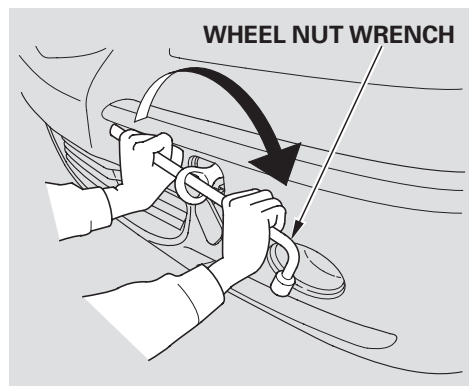

2. Remove the towing hook and wheel nut wrench from the tool case in the spare tire.
3. Screw the towing hook into the hole, and tighten it with the wheel nut wrench.

### NOTICE

*To avoid damage to your vehicle, use the towing hook for straight, flat ground towing only. Do not tow at an angle. The tow hook should not be used to tow the vehicle onto a flat bed. Do not use it as a tie down.*

The diagrams in this section give you the dimensions and capacities of your vehicle, and the location of identification numbers. It also includes information you should know about your vehicle’s tires and emissions control systems.

- Identification Numbers..... 462
- Specifications ..... 464
- DOT Tire Quality Grading  
    (U.S. Vehicles) ..... 466
- Treadwear ..... 466
- Traction..... 466
- Temperature ..... 467
- Tire Labeling ..... 468
- Tire Pressure Monitoring System  
    (TPMS) – Required Federal  
    Explanation..... 470

- Emissions Controls..... 472
- The Clean Air Act..... 472
- Crankcase Emissions Control  
        System..... 472
- Evaporative Emissions Control  
        System..... 472
- Onboard Refueling Vapor  
        Recovery ..... 472
- Exhaust Emissions Controls .... 473
- PGM-FI System ..... 473
- Ignition Timing Control  
            System..... 473
- Exhaust Gas Recirculation  
            (EGR) System..... 473
- Three Way Catalytic  
            Converter..... 473
- Replacement Parts..... 473
- Three Way Catalytic  
        Converters ..... 474
- Emissions Testing ..... 475

## Identification Numbers

---

Your vehicle has several identifying numbers in various places.

The vehicle identification number (VIN) is the 17-digit number your dealer uses to register your vehicle for warranty purposes. It is also necessary for licensing and insuring your vehicle. The easiest place to find the VIN is on a plate fastened to the top of the dashboard. You can see it by looking through the windshield on the driver's side. It is also on the certification label attached to the driver's doorjamb, and is stamped on the engine compartment bulkhead. The VIN is also provided in bar code on the certification label.

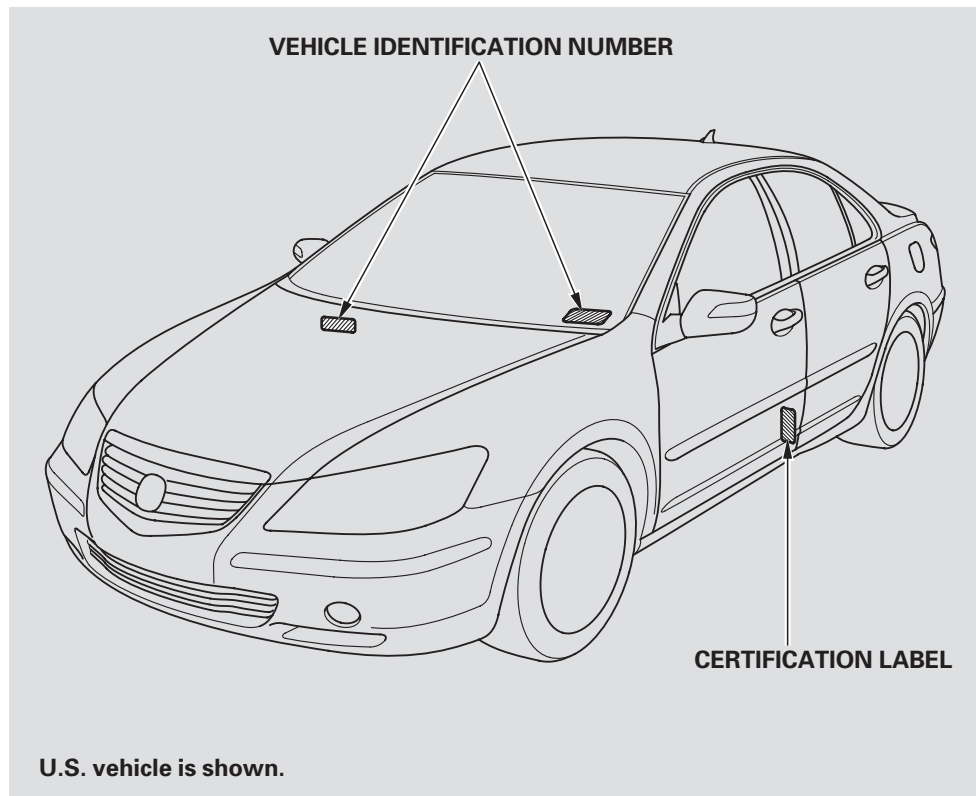

The engine number is stamped into the engine block. It is on the front left, below the valve cover.

The transmission number is on a label on top of the transmission.

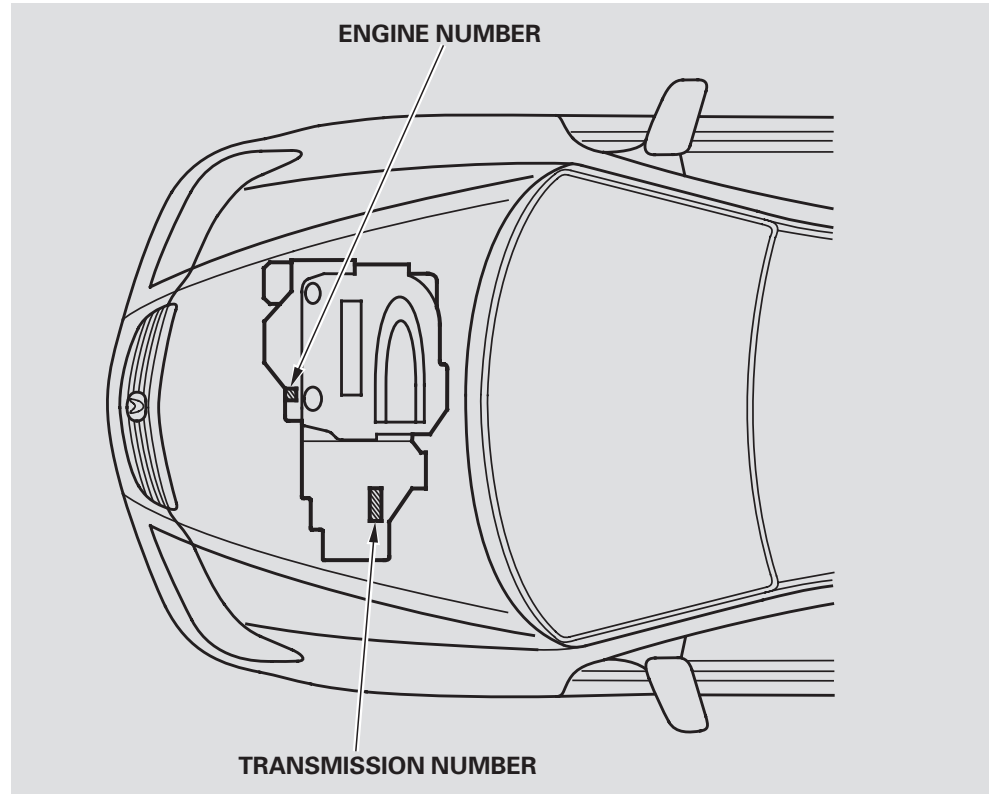

# Specifications

## Dimensions

Length		193.6 in (4,917 mm)
Width		72.7 in (1,847 mm)
Height		57.1 in (1,451 mm)
Wheelbase		110.2 in (2,800 mm)
Track	Front	62.0 in (1,576 mm)
	Rear	62.4 in (1,585 mm)

## Weights

Gross vehicle weight rating	See the certification label attached to the driver's doorjamb.
-----------------------------	--

## Seating Capacities

Total	5
Front	2
Rear	3

## Air Conditioning

Refrigerant type	HFC-134a (R-134a)
Charge quantity	15.8 – 17.60 oz (450 – 500 g)
Lubricant type	ND-OIL8

## Capacities

Fuel tank		Approx. 19.4 US gal (73 ℓ)
Engine coolant	Change* <sup>1</sup> Total	1.59 US gal (6.0 ℓ) 2.27 US gal (8.6 ℓ)
Engine oil	Change* <sup>2</sup> Including filter Without filter Total	4.5 US qt (4.3 ℓ) 4.2 US qt (4.0 ℓ) 5.3 US qt (5.0 ℓ)
Automatic transmission fluid	Change Total	2.9 US qt (2.7 ℓ) 7.6 US qt (7.2 ℓ)
Rear differential fluid		
SH-AWD differential case	Change Total	0.77 US qt (0.73 ℓ) 0.79 US qt (0.75 ℓ)
SH-AWD clutch case	Change Total	2.8 US qt (2.7 ℓ) 3.3 US qt (3.1 ℓ)
Transfer assembly fluid	Change Total	0.45 US qt (0.43 ℓ) 0.48 US qt (0.45 ℓ)
Windshield washer reservoir	U.S. vehicles Canadian vehicles	2.6 US qt (2.5 ℓ) 6.9 US qt (6.5 ℓ)

\* 1 : Including the coolant in the reserve tank and that remaining in the engine

Reserve tank capacity:  
0.16 US gal (0.58 ℓ)

\* 2 : Excluding the oil remaining in the engine

## Lights

Headlights* <sup>1</sup> (High Beam)	12 V — 60 W (HB3)
Front turn signal/parking lights	12 V — 24/2.2 CP (Amber) 12 V — 21 W (Amber)* <sup>2</sup>
Front side marker	12 V — 3 CP (5W)
Rear turn signal lights	12 V — 21 W (Amber)
Back-up light	12 V — 21 W
Fog lights	12 V — 55 W (H11)
License plate lights	12 V — 5 W
Ceiling lights	Front 12 V — 8 W Rear 12 V — 8 W
Vanity mirror lights	12 V — 2 W
Door courtesy lights	12 V — 2 CP
Trunk light	12 V — 5 W

\* 1 : Low beam headlight bulbs are a type of high voltage discharge tube (D2S).

\* 2 : On model without adaptive front lighting system

## Battery

Capacity	12 V — 55 AH/5 HR 12 V — 72 AH/20 HR
----------	---

## Fuses

Interior	See page <a href="#">453</a> and <a href="#">454</a> or the fuse label attached to the inside of each fuse box cover.
Under-hood	See page <a href="#">452</a> or the fuse box cover.

## Engine

Type	SOHC VTEC V-6 gasoline engine
Bore x Stroke	3.54 x 3.58 in (89 x 93 mm)
Displacement	212 cu-in (3,471 cm <sup>3</sup> )
Compression ratio	11.0 : 1
Spark plugs	NGK: IZFR6K11 DENSO: SKJ20DR-M11

## Alignment

Toe-in	Front	0.00 in (0.0 mm)
	Rear	0.08 in (2.0 mm)
Camber	Front	—0°8'
	Rear	—1°15'
Caster	Front	2°10'

## Tires

Size	Front/Rear	P245/50R17 98V 245-680R460A 102V * <sup>1</sup>
	Spare	T155/70D17 110M
Pressure	Front	32 psi (220 kPa , 2.2 kgf/cm <sup>2</sup> )
	Rear	30 psi (210 kPa , 2.1 kgf/cm <sup>2</sup> )
	Spare	60 psi (420 kPa , 4.2 kgf/cm <sup>2</sup> ) * <sup>2</sup>

\* 1 : Michelin PAX system model

\* 2 : If equipped



## DOT Tire Quality Grading (U.S. Vehicles)

---

The tires on your vehicle meet all U.S. Federal Safety Requirements. All tires are also graded for treadwear, traction, and temperature performance according to Department of Transportation (DOT) standards. The following explains these gradings.

### **Uniform Tire Quality Grading**

Quality grades can be found where applicable on the tire sidewall between tread shoulder and maximum section width. For example:

**Treadwear 200**

**Traction AA**

**Temperature A**

All passenger car tires must conform to Federal Safety Requirements in addition to these grades.

### **Treadwear**

The treadwear grade is a comparative rating based on the wear rate of the tire when tested under controlled conditions on a specified government test course. For example, a tire graded 150 would wear one and one-half (1 1/2) times as well on the government course as a tire graded 100. The relative performance of tires depends upon the actual conditions of their use, however, and may depart significantly from the norm due to variations in driving habits, service practices and differences in road characteristics and climate.

### **Traction**

The traction grades, from highest to lowest, are AA, A, B, and C. Those grades represent the tire's ability to stop on wet pavement as measured under controlled conditions on specified government test surfaces of asphalt and concrete. A tire marked C may have poor traction performance.

Warning: The traction grade assigned to this tire is based on straight-ahead braking traction tests, and does not include acceleration, cornering, hydroplaning, or peak traction characteristics.

### **Temperature**

The temperature grades are A (the highest), B, and C, representing the tire's resistance to the generation of heat and its ability to dissipate heat when tested under controlled conditions on a specified indoor laboratory test wheel. Sustained high temperature can cause the material of the tire to degenerate and reduce tire life, and excessive temperature can lead to sudden tire failure. The grade C corresponds to a level of performance which all passenger car tires must meet under the Federal Motor Vehicle Safety Standard No. 109. Grades B and A represent higher levels of performance on the laboratory test wheel than the minimum required by law.

**Warning:** The temperature grade for this tire is established for a tire that is properly inflated and not overloaded. Excessive speed, underinflation, or excessive loading, either separately or in combination, can cause heat buildup and possible tire failure.

# Tire Labeling

The tires that came on your vehicle have a number of markings. Those you should be aware of are described below.

## TIRE LABELING EXAMPLE

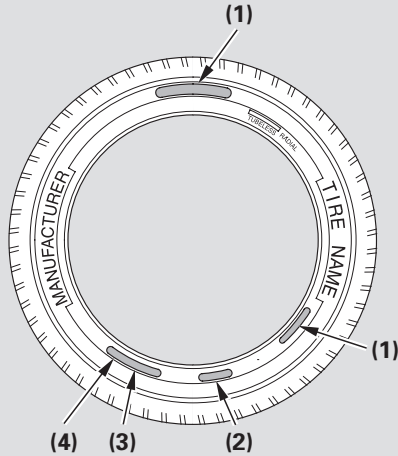

- (1) Tire Size
- (2) Tire Identification Number (TIN)
- (3) Maximum Tire Pressure
- (4) Maximum Tire Load

### **Tire Size**

Whenever tires are replaced, they should be replaced with tires of the same size. Following is an example of tire size with an explanation of what each component means.

P245/50R17 98V

- P — Vehicle type (P indicates passenger vehicle).
- 245 — Tire width in millimeters.
- 50 — Aspect ratio (the tire's section height as a percentage of its width).
- R — Tire construction code (R indicates radial).
- 17 — Rim diameter in inches.

- 98 — Load index (a numerical code associated with the maximum load the tire can carry).
- V — Speed symbol (an alphabetical code indicating the maximum speed rating).

### **Tire Identification Number (TIN)**

The tire identification number (TIN) is a group of numbers and letters that look like the following example. TIN is located on the sidewall of the tire.

DOT B97R FW6X 2202

- DOT — This indicates that the tire meets all requirements of the U.S. Department of Transportation.
- B97R — Manufacturer's identification mark.

FW6X — Tire type code.

2202 — Date of manufacture.

└─── Year  
└─── Week

### **Maximum Tire Pressure**

Max Press — The maximum air pressure the tire can hold.

### **Maximum Tire Load**

Max Load — The maximum load the tire can carry at maximum air pressure.

### **PAX System™ Tire Labeling**

*If equipped*

The PAX system tires have different markings from conventional tire markings. Following is an example of PAX system tire size with an explanation of what each component means.

245-680R460A 102V

245 — Tire width in millimeters.

680 — Outside diameter of the tire in millimeters.

R — Tire construction code (R indicates radial)

460 — Nominal diameter at the rim seat in millimeters.

A — Symmetric

102 — Load index (a numerical code associated with the maximum load the tire can carry).

V — Speed symbol (an alphabetical code indicating the maximum speed rating).

## Tire Pressure Monitoring System (TPMS) – Required Federal Explanation

---

Each tire, including the spare (if provided), should be checked monthly when cold and inflated to the inflation pressure recommended by the vehicle manufacturer on the vehicle placard or tire inflation pressure label.

(If your vehicle has tires of a different size than the size indicated on the vehicle placard or tire inflation pressure label, you should determine the proper tire inflation pressure for those tires.)

As an added safety feature, your vehicle has been equipped with a tire pressure monitoring system (TPMS) that illuminates a low tire pressure telltale



when one or more of your tires is significantly under-inflated.

Accordingly, when the low tire pressure telltale illuminates, you should stop and check your tires as soon as possible, and inflate them to the proper pressure.

Driving on a significantly under-inflated tire causes the tire to overheat and can lead to tire failure. Under-inflation also reduces fuel efficiency and tire tread life, and may affect the vehicle's handling and stopping ability.

Please note that the TPMS is not a substitute for proper tire maintenance, and it is the driver's responsibility to maintain correct tire pressure, even if under-inflation has not reached the level to trigger illumination of the TPMS low tire pressure telltale.

## Tire Pressure Monitoring System (TPMS) – Required Federal Explanation

---

Your vehicle has also been equipped with a TPMS malfunction indicator to indicate when the system is not operating properly. The TPMS malfunction indicator is combined with the low tire pressure telltale. When the system detects a malfunction, the telltale will flash for approximately one minute and then remain continuously illuminated. This sequence will continue upon subsequent vehicle start-ups as long as the malfunction exists.

When the malfunction indicator is illuminated, the system may not be able to detect or signal low tire pressure as intended.

TPMS malfunctions may occur for a variety of reasons, including the installation of replacement or alternate tires or wheels on the vehicle that prevent the TPMS from functioning properly.

Always check the TPMS malfunction telltale after replacing one or more tires or wheels on your vehicle to ensure that the replacement or alternate tires and wheels allow the TPMS to continue to function properly.

## Emissions Controls

---

The burning of gasoline in your vehicle's engine produces several by-products. Some of these are carbon monoxide (CO), oxides of nitrogen (NO<sub>x</sub>), and hydrocarbons (HC). Gasoline evaporating from the tank also produces hydrocarbons. Controlling the production of NO<sub>x</sub>, CO, and HC is important to the environment. Under certain conditions of sunlight and climate, NO<sub>x</sub> and HC react to form photochemical "smog." Carbon monoxide does not contribute to smog creation, but it is a poisonous gas.

### **The Clean Air Act**

The United States Clean Air Act\* sets standards for automobile emissions. It also requires that automobile manufacturers explain to owners how their emissions controls work and what to do to maintain them. This section summarizes how the emissions controls work. Scheduled maintenance is on pages [374](#) and [394](#).

\* In Canada, Acura vehicles comply with the Canadian emission requirements, as specified in an agreement with Environment Canada, at the time they are manufactured.

### **Crankcase Emissions Control System**

Your vehicle has a positive crankcase ventilation system. This keeps gasses that build up in the engine's crankcase from going into the atmosphere. The positive

crankcase ventilation valve routes them from the crankcase back to the intake manifold. They are then drawn into the engine and burned.

### **Evaporative Emissions Control System**

As gasoline evaporates in the fuel tank, an evaporative emissions control canister filled with charcoal adsorbs the vapor. It is stored in this canister while the engine is off. After the engine is started and warmed up, the vapor is drawn into the engine and burned during driving.

### **Onboard Refueling Vapor Recovery**

The onboard refueling vapor recovery (ORVR) system captures the fuel vapors during refueling. The vapors are adsorbed in a canister filled with activated carbon. While driving, the fuel vapors are drawn into the engine and burned off.

## **Exhaust Emissions Controls**

The exhaust emissions controls include four systems: PGM-FI, ignition timing control, exhaust gas recirculation, and three way catalytic converter. These four systems work together to control the engine's combustion and minimize the amount of HC, CO, and NOx that come out the tailpipe. The exhaust emissions control systems are separate from the crankcase and evaporative emissions control systems.

### ***PGM-FI System***

The PGM-FI system uses sequential multiport fuel injection. It has three subsystems: air intake, engine control, and fuel control. The powertrain control module (PCM) uses various sensors to determine how much air is going into the engine. It then controls how much fuel to inject under all operating conditions.

### ***Ignition Timing Control System***

This system constantly adjusts the ignition timing, reducing the amount of HC, CO, and NOx produced.

### ***Exhaust Gas Recirculation (EGR) System***

The exhaust gas recirculation (EGR) system takes some of the exhaust gas and routes it back into the intake manifold. Adding exhaust gas to the air/fuel mixture reduces the amount of NOx produced when the fuel is burned.

### ***Three Way Catalytic Converter***

The three way catalytic converters are in the exhaust system. Through chemical reactions, they convert HC, CO, and NOx in the engine's exhaust to carbon dioxide (CO<sub>2</sub>), nitrogen (N<sub>2</sub>), and water vapor.

## **Replacement Parts**

The emissions control systems are designed and certified to work together in reducing emissions to levels that comply with the Clean Air Act. To make sure the emissions remain low, you should use only new Acura replacement parts or their equivalent for repairs. Using lower quality parts may increase the emissions from your vehicle.

The emissions control systems are covered by warranties separate from the rest of your vehicle. Read your warranty manual for more information.



## Three Way Catalytic Converters

---

The three way catalytic converters contain precious metals that serve as catalysts, promoting chemical reactions to convert the exhaust gasses without affecting the metals. The catalytic converters are referred to as three-way catalysts, since they act on HC, CO, and NOx. Replacement units must be original Acura parts or their equivalent.

The three way catalytic converters must operate at a high temperature for the chemical reactions to take place. They can set on fire any combustible materials that come near them. Park your vehicle away from high grass, dry leaves, or other flammables.

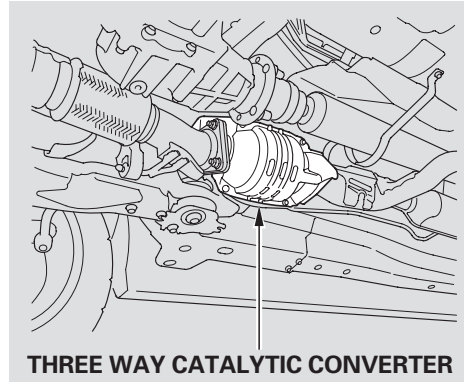

**THREE WAY CATALYTIC CONVERTER**

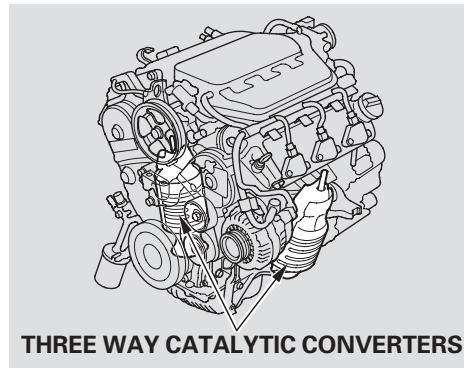

**THREE WAY CATALYTIC CONVERTERS**

A defective three way catalytic converter contributes to air pollution, and can impair your engine's performance. Follow these guidelines to protect your vehicle's three way catalytic converters.

- Always use unleaded gasoline. Even a small amount of leaded gasoline can contaminate the catalyst metals, making the three way catalytic converters ineffective.
- Keep the engine well maintained.
- Have your vehicle diagnosed and repaired if it is misfiring, back-firing, stalling, or otherwise not running properly.

## Testing of Readiness Codes

If you take your vehicle for an emissions test shortly after the battery has been disconnected or gone dead, it may not pass the test. This is because of certain “readiness codes” that must be set in the on-board diagnostics for the emissions systems. These codes are erased when the battery is disconnected, and set again only after several days of driving under a variety of conditions.

If the testing facility determines that the readiness codes are not set, you will be requested to return at a later date to complete the test. If you must get the vehicle retested within the next two or three days, you can condition the vehicle for retesting by doing the following.

1. Make sure the gas tank is nearly, but not completely, full (around 3/4).
2. Make sure the vehicle has been parked with the engine off for 6 hours or more.
3. Make sure the ambient temperature is between 40° and 95° F.

4. Without touching the accelerator pedal, start the engine, and let it idle for 20 seconds.
5. Keep the vehicle in Park. Increase the engine speed to 2,000 rpm, and hold it there until the temperature gauge rises to at least 1/4 of the scale (about 3 minutes).
6. Without touching the accelerator pedal and let the engine idle for 20 seconds.

*CONTINUED*

## Emissions Testing

---

7. Select a nearby lightly traveled major highway where you can maintain a speed of 50 to 60 mph for at least 20 minutes. Drive on the highway in D. Do not use the cruise control. When traffic allows, drive for 90 seconds without moving the accelerator pedal. (Vehicle speed may vary slightly; this is okay.) If you cannot do this for a continuous 90 seconds because of traffic conditions, drive for at least 30 seconds, then repeat it two more times (for a total of 90 seconds).

8. Then drive in city/suburban traffic for at least 10 minutes. When traffic conditions allow, let the vehicle coast for several seconds without using the accelerator pedal or the brake pedal.
9. Stop the vehicle, turn off the ignition switch, and leave it off for 30 minutes.

If the testing facility determines the readiness codes are still not set, see your dealer.

Client Service Information ..... 478  
Warranty Coverages ..... 479  
Reporting Safety Defects  
    (U.S. Vehicles) ..... 480  
Authorized Manuals..... 481

## Client Service Information

---

Acura dealership personnel are trained professionals. They should be able to answer all your questions. If you encounter a problem that your dealership does not solve to your satisfaction, please discuss it with the dealership's management. The service manager or general manager can help. Almost all problems are solved in this way.

If you are dissatisfied with the decision made by the dealership's management, contact the Acura Client Services Office.

U.S. Owners:  
American Honda Motor Co., Inc.  
Acura Client Services  
Mail Stop 500-2N-7E  
1919 Torrance Blvd.  
Torrance, CA 90501-2746

Tel: (800) 382-2238

Canadian Owners:  
**CLIENT RELATIONS**  
**RELATIONS AVEC LA CLIENTÈLE**

Honda Canada Inc.  
715 Milner Avenue  
Toronto, ON  
M1B 2K8

Tel: 1-888-9-ACURA-9  
Fax: Toll-free 1-877-939-0909  
Toronto (416) 287-4776

In Puerto Rico and the U.S. Virgin Islands:  
Vortex Motor Corp.  
Bella International  
P.O. Box 190816  
San Juan, PR 00919-0816

Tel: (787) 620-7546

When you call or write, please give us this information:

- Vehicle identification number (see page [462](#) )
- Name and address of the dealer who services your vehicle
- Date of purchase
- Mileage on your vehicle
- Your name, address, and telephone number
- A detailed description of the problem
- Name of the dealer who sold the vehicle to you

### U.S. Owners

Your new vehicle is covered by these warranties:

***New Vehicle Limited Warranty*** — covers your new vehicle, except for the battery, emissions control systems, and accessories, against defects in materials and workmanship.

***Emissions Control Systems Defects Warranty and Emissions Performance Warranty*** — these two warranties cover your vehicle's emissions control systems. Time, mileage, and coverage are conditional. Please read your warranty booklet for exact information.

***Original Equipment Battery Limited Warranty*** — this warranty gives up to 100 % credit toward a replacement battery.

***Seat Belt Limited Warranty*** — a seat belt that fails to function properly is covered by a limited warranty. Please read your warranty booklet for details.

***Rust Perforation Limited Warranty*** — all exterior body panels are covered for rust-through from the inside for the specified time period with no mileage limit.

***Accessory Limited Warranty*** — Acura accessories are covered under this warranty. Time and mileage limits depend on the type of accessory and other factors. Please read your warranty manual for details.

***Replacement Parts Limited Warranty*** — covers all Acura replacement parts against defects in materials and workmanship.

***Replacement Battery Limited Warranty*** — provides prorated coverage for a replacement battery purchased from your dealer.

***Replacement Muffler Lifetime Limited Warranty*** — provides coverage for as long as the purchaser of the muffler owns the vehicle.

Restrictions and exclusions apply to all these warranties. Please read the 2008 Acura warranty information booklet that came with your vehicle for precise information on warranty coverages. Your vehicle's original tires are covered by their manufacturer. Tire warranty information is in a separate booklet.

### Canadian Owners

Please refer to the 2008 warranty manual that came with your vehicle.

## Reporting Safety Defects (U.S. Vehicles)

---

If you believe that your vehicle has a defect which could cause a crash or could cause injury or death, you should immediately inform the National Highway Traffic Safety Administration (NHTSA), in addition to notifying American Honda Motor Co., Inc.

If NHTSA receives similar complaints, it may open an investigation, and if it finds that a safety defect exists in a group of vehicles, it may order a recall and remedy campaign. However, NHTSA cannot become involved in individual problems between you, your dealer, or American Honda Motor Co., Inc.

To contact NHTSA, you may call the Vehicle Safety Hotline toll-free at 1-888-327-4236 (TTY: 1-800-424-9153); go to <http://www.safercar.gov>; or write to: Administrator, NHTSA, 400 Seventh Street, SW., Washington, DC 20590. You can also obtain other information about motor vehicle safety from <http://www.safercar.gov>.

## Purchasing Factory Authorized Manuals (U.S. only)

The publications shown below can be purchased from Helm Incorporated. You can order by phone or online:

- Call Helm Inc. at 1-800-782-4356 (credit card orders only)
- Go online at [www.helminc.com](http://www.helminc.com)

If you are interested in other years or models, contact Helm Inc. at 1-800-782-4356.

Publication Form Number	Form Description
61SJA03	2005-2008 Acura RL Service Manual
61SJA03EL	2005-2008 Acura RL Electrical Troubleshooting Manual
61SJA30	2005 Model Series Acura RL Body Repair Manual
31SJA630	2008 Acura RL Owner's Manual
31SJA810	2008 Acura RL Navigation System Manual
31SJAM30	2008 Acura RL Maintenance Journal
31SJAQ30	2008 Acura RL Quick Start Guide
ACU-R	Order Form for Previous Years Indicate Year and Model Desired

## Service Manual:

Covers maintenance and recommended procedures for repair to engine and chassis components. It is written for the journeyman mechanic, but it is simple enough for most mechanically inclined owners to understand.

## Electrical Troubleshooting Manual:

Complements the Service Manual by providing in-depth troubleshooting information for each electrical circuit in your vehicle.

## Body Repair Manual:

Describes the procedures involved in the replacement of damaged body parts.





**A**

Accessories..... 337

ACCESSORY (Ignition Switch Position) ..... 151

Accessory Power Sockets..... 192

AcuraLink ..... 299

Adaptive Cruise Control (ACC)  
Indicator..... 280  
Operation ..... 282

Adaptive Front Lighting System (AFS) ..... 143

Additives, Engine Oil..... 399

Airbag (SRS) ..... 11, 27

Air Conditioning..... 198

Air Pressure, Tires ..... 421

Alcohol in Gasoline..... 328

Antifreeze ..... 402

Anti-lock Brakes (ABS)  
Indicator..... 64, 359  
Operation ..... 359

Anti-theft, Audio System..... 241

Anti-theft Steering Column  
Lock..... 151

Ashtrays..... 193

Audio System ..... 207

Auto Control Mode, Starting  
Engine ..... 347

Automatic Climate Control..... 205

Automatic Lighting..... 141

Automatic Seat Belt Tensioners... 23

Automatic Speed Control..... 277

Automatic Transmission..... 349  
Capacity, Fluid ..... 464  
Checking Fluid Level ..... 404  
Shifting..... 349  
Shift Lever Position  
Indicators..... 349  
Shift Lever Positions ..... 349  
Shift Lock Release..... 354

Auxiliary Input Jack..... 238

**B**

Battery  
Charging System  
Indicator..... 62, 447  
Jump Starting ..... 441  
Maintenance..... 427  
Cover ..... 428  
Specifications ..... 465

Before Driving ..... 327

Belts, Seat ..... 10, 21

Beverage Holders ..... 190

Bluetooth® HandsFreeLink® ..... 308

Booster Seats ..... 53

Brakes  
Anti-lock Brake System (ABS) ..... 359  
Break-in, New Linings ..... 328  
Fluid ..... 406  
Parking..... 187  
System Indicator..... 63, 449  
Wear Indicators ..... 358

Braking System..... 358

Break-in, New Vehicle ..... 328

Brightness Control,  
Instruments ..... 145

Brights, Headlights ..... 140

CONTINUED

# Index

---

Bulb Replacement	
Back-up Lights .....	414
Fog Lights .....	412
Front Position Lights .....	411
Front Side Marker Lights.....	411
Headlights .....	408
Specifications .....	465
Turn Signal Lights.....	411
Built-in-key.....	164
Bulbs, Halogen.....	408

## C

Capacities Chart.....	464
Carbon Monoxide Hazard .....	56
Cargo, How to Carry .....	339
CAUTION, Explanation of .....	iii
CD Care .....	235
CD Error Message .....	234
CD Changer.....	223
Ceiling Lights.....	196
Certification Label.....	462
Chains, Tires .....	425
Changing a Flat Tire .....	436
Changing Oil	
How to.....	400

When to.....	387
Charging System Indicator.....	447
Checklist, Before Driving.....	346
Child Safety .....	38
Booster Seats .....	53
Child Seats.....	45
Important Safety Reminders.....	38
Infants .....	43
Larger Children .....	52
LATCH.....	47
Risks with Airbags.....	39
Small Children.....	44
Tethers.....	51
Where Should a Child Sit?.....	39
Child Seats.....	44
LATCH.....	47
Tether Anchorage Points .....	51
Childproof Door Locks .....	154
Cleaning	
Seat Belts .....	415
Client Service Office .....	478
Climate Control System.....	198
Clock, Setting the .....	274
CO in the Exhaust .....	472
Cold Weather, Starting in .....	347

Collision Mitigation Brake System (CMBS)	
Indicator.....	366
Operation .....	361
Compact Spare Tire.....	435
Compass System.....	242
Console Compartment .....	191
Consumer Information.....	478
Controls, Instruments and.....	59
Coolant	
Adding.....	402
Checking.....	333
Proper Solution .....	402
Temperature Gauge .....	70
Crankcase Emissions Control System.....	472
Cruise Control Indicator .....	65
Cruise Control Operation .....	277
Cup Holders.....	190

Customize Settings..... 81  
 ACC Setup ..... 89  
 Door/Window Setup ..... 122  
 KEYLESS ACCESS Setup ..... 108  
 Lighting Setup..... 115  
 Meter Setup..... 94  
 Position Setup ..... 103  
 Setting to Default..... 85  
 Wiper Setup..... 133

**D**

DANGER, Explanation of..... iii  
 Dashboard ..... 4, 60  
 Daytime Running Lights..... 142  
 Indicator ..... 65  
 Dead Battery ..... 440  
 Defects, Reporting Safety..... 480  
 Defogger, Rear Window ..... 146  
 Defrosting the Windows..... 204  
 Differential Fluid ..... 464  
 Dimensions..... 464  
 Dimming the Headlights ..... 140  
 Dipstick  
 Automatic Transmission..... 404  
 Engine Oil..... 333

Directional Signals..... 140  
 Disc Brake Wear Indicators..... 358  
 Disposal of Used Oil..... 401  
 Doors  
 Locking and Unlocking..... 152  
 Lockout Prevention ..... 152  
 Monitor Indicator ..... 13, 79  
 Power Door Locks..... 152  
 DOT Tire Quality Grading\* ..... 466  
 Driver and Passenger Safety..... 7  
 Driver's ID ..... 81  
 Driving ..... 345  
 Economy ..... 336  
 Driving Position Memory  
 System..... 160  
 Dust and Pollen Filter ..... 415

**E**

Economy, Fuel ..... 334  
 Emergencies..... 431  
 Battery, Jump Starting ..... 441  
 Brake System Indicator ..... 449  
 Changing a Flat Tire ..... 436  
 Charging System Indicator ..... 447  
 Checking the Fuses..... 453

Hazard Warning Flashers ..... 145  
 Jump Starting ..... 441  
 Low Oil Pressure Indicator ..... 447  
 Malfunction Indicator Lamp .... 448  
 Opening the Fuel Fill Door  
 Manually ..... 450  
 Overheated Engine ..... 444  
 Towing ..... 459  
 Emergency Brake..... 187  
 Emergency Flashers ..... 145  
 Emergency Towing ..... 459  
 Emergency Trunk Opener ..... 154  
 Emissions Controls..... 472  
 Emissions Testing ..... 475

CONTINUED

# Index

Engine	
Check Starting System .....	348
Compartment Covers .....	398
Coolant Temperature Gauge .....	70
If It Won't Start .....	440
Malfunction Indicator	
Lamp .....	62, 448
Oil life .....	387
Oil Pressure Indicator .....	62, 447
Oil, What Kind to Use .....	399
Overheating .....	444
Specifications .....	465
Speed Limiter .....	354
Starting .....	347
Engine Speed Limiter .....	354
Ethanol in Gasoline .....	328
Evaporative Emissions Controls ..	472
Exhaust Fumes .....	56
Exhaust Gas Recirculation	
System .....	473
Expectant Mothers, Use of Seat	
Belts by .....	19

## F

Fan, Interior .....	200
---------------------	-----

Features .....	197
Filling the Fuel Tank .....	329
Filters	
Dust and Pollen .....	415
Oil .....	400
Flashers, Hazard Warning .....	145
Flat Tire, Changing a .....	436
Floor Mats .....	416
Fluids	
Automatic Transmission .....	404
Brake .....	406
Power Steering .....	406
Windshield Washer .....	404
Fog Lights .....	142
Four-way Flashers .....	145
Front Airbags .....	11, 29
Front Seat .....	155
Adjusting .....	155
Heaters .....	178
Airbags .....	11, 29
Air Ventilation .....	179
Fuel .....	328
Fill Door and Cap .....	329
Gauge .....	70
Low Fuel Indicator .....	66
Octane Requirement .....	328

Opening the Fuel Fill Door	
Manually .....	450
Oxygenated .....	329
Tank, Refueling .....	329
Tighten Fuel Cap .....	330
Fuses, Checking the .....	453

## G

Gas Mileage Improving .....	335
Gasoline .....	328
Gauge .....	70
Low Fuel Indicator .....	66
Octane Requirement .....	328
Tank, Refueling .....	329
Gas Station Procedures .....	329
Gauges .....	70
Engine Coolant Temperature .....	70
Fuel .....	70
GAWR (Gross Axle Weight	
Rating) .....	380
Gearshift Lever Positions .....	349
Glove Box .....	189
GPS initialization .....	260
GVWR (Gross Vehicle Weight	
Rating) .....	380

**H**

Halogen Headlight Bulbs..... 408  
HandsFreeLink®, Bluetooth® ..... 308  
Hazard Warning Flashers..... 145  
Headlights  
Adaptive Front Lighting System  
(AFS)..... 143  
Aiming..... 408  
Automatic Lighting ..... 141  
Daytime Running Lights ..... 142  
High Beam Indicator ..... 65  
Lights On Indicator ..... 64  
Low Beams, Turning on ..... 140  
Reminder Chime..... 140  
Replacing Halogen Bulbs ..... 408  
High beams, Turning on..... 140  
Washer\*\* ..... 138  
Head Restraints ..... 156  
Heated Mirror ..... 159  
Heater, Seat ..... 178  
High Altitude, Starting at..... 347  
HomeLink® Universal  
Transceiver..... 295  
Hood, Opening the ..... 331  
Horn ..... 5, 136

**I**

Identification Number, Vehicle... 462  
Ignition  
Keys..... 149  
Switch..... 151  
Timing Control System..... 473  
Immobilizer System..... 150  
Important Safety Precautions ..... 8  
Indicators ..... 62  
ABS (Anti-lock Brake  
System) ..... 64, 359  
Adaptive Front lighting  
System (AFS)..... 69, 143  
Brake (Parking and Brake  
System) ..... 63, 449  
Charging System ..... 62, 447  
Collision Mitigation Brake  
System (CMBS)..... 69, 365  
Cruise Control..... 66  
Electronically Controlled Power  
Steering System (ECPS)..... 68  
Fog Light ..... 65  
High Beam..... 64  
Key (Immobilizer System) ..... 64  
Keyless Access System ..... 68, 176

Lights On..... 64  
Low Fuel ..... 66  
Low Oil Pressure ..... 62, 447  
Low Tire Pressure/TPMS  
Indicator..... 67, 371  
Malfunction (MIL) ..... 62, 448  
Message..... 68  
Seat Belt Reminder ..... 21, 62  
Security System ..... 69, 276  
SH-AWD ..... 66  
Side Airbag Off ..... 63  
SRS ..... 63  
Turn Signal and Hazard  
Warning ..... 64  
VSA (Vehicle Stability Assist) ... 65  
VSA (Vehicle Stability Assist)  
Activation..... 65, 377  
Indicators, Instrument Panel..... 61  
Infant Restraint ..... 43  
Infant Seats..... 43  
Tether Anchorage Points ..... 51  
Inflation, Proper Tire ..... 419  
Inside Mirror ..... 158  
Inspection, Tire ..... 422

CONTINUED

# Index

---

Instrument Panel .....	61
Instrument Panel Brightness .....	145
Interface Dial .....	199, 207, 299
Interior Lights .....	196
Introduction .....	i

## J

Jacking up the Vehicle .....	437
Jack, Tire .....	436
Jump Starting .....	441

## K

Keys.....	149
Keyless Access System.....	163
Keyless Access Remote.....	164
Keyless Memory Settings .....	170

## L

Label, Certification.....	462
Lane Change, Signaling.....	140
Lap/Shoulder Belts .....	22
Lights On Indicator .....	64

Lights	
Bulb Replacement .....	408
Indicator.....	61
Position .....	140
Turn Signal.....	140
Load Limit .....	379
LOCK (Ignition Key Position) ....	151

Locks	
Anti-theft Steering Column .....	151
Childproof Door.....	154
Fuel Fill Door .....	329
Glove Box .....	189
Power Door .....	152
Trunk .....	153
Trunk Pass-through Cover.....	157
Low Coolant Level.....	333
Low Fuel Indicator .....	66
Low Oil Pressure Indicator ....	62, 447
Lubricant Specifications Chart ....	464
Luggage, Storing .....	339

## M

Maintenance.....	385
Main Items .....	395
Minder.....	387

Owner's Maintenance	
Checks .....	394
Safety.....	386
Sub Items.....	396
Malfunction Indicator Lamp ..	62, 448
Memory, Driving Position .....	160
Message Display.....	78
Message Indicator .....	68
Meters, Gauges.....	70
Methanol in Gasoline .....	328
Mirrors, Adjusting .....	159
Modifications.....	337
Modifying Your Vehicle.....	338
Moonroof .....	183-186
MP3 .....	230
Multi-Information Display .....	71

## N

Neutral Gear Position.....	350
New Vehicle Break-in .....	328
NOTICE, Explanation of.....	i
Numbers, Identification.....	462

**O**

Octane Requirement, Gasoline.... 328  
 Odometer..... 72  
 Odometer, Trip ..... 72  
 Oil  
   Change, How to ..... 400  
   Change, When to ..... 387  
   Checking Engine ..... 333  
   Life, Engine ..... 387  
   Pressure Indicator ..... 62, 447  
   Selecting Proper Viscosity  
     Chart ..... 399  
 ON (Ignition Switch Position)..... 151  
 Onboard Refueling Vapor  
   Recovery ..... 472  
 Outside Mirrors ..... 158  
 Outside Temperature Indicator .... 73  
 Overheating, Engine ..... 444  
 Owner’s Maintenance Checks .... 394  
 Oxygenated Fuels..... 328

**P**

Paddle Shifters..... 351  
 Panel Brightness Control ..... 145

Park Gear Position..... 350  
 Parking..... 357  
 Parking Brake ..... 187  
 Parking Brake and Brake  
   System Indicator..... 63, 449  
 Parking Over Things that Burn... 474  
 PAX System..... 426  
 PGM-FI System..... 473  
 Power Door Locks..... 152  
 Power Socket Locations..... 192  
 Power Windows ..... 181  
 Pregnancy, Using Seat Belts ..... 19  
 Protecting Adults and Teens..... 13  
   Additional Safety Precautions... 20  
   Advice for Pregnant Women..... 19  
 Protecting Children ..... 38  
   Protecting Infants..... 43  
   Protecting Larger Children ..... 52  
   Protecting Small Children ..... 44  
   Using Child Seats with  
     Tethers..... 51  
   Using LATCH ..... 47

**R**

Radiator Overheating..... 444

Radio/CD Sound System..... 207  
 Readiness Codes..... 448  
 Rear Lights, Bulb Replacement.. 414  
 Rear View Mirror..... 158  
 Rear Window Defogger ..... 146  
 Reclining the Seat Backs ..... 155  
 Reminder Indicators..... 62  
 Remote ..... 163  
 Replacement Information  
   Engine Oil and Filter ..... 400  
   Fuses ..... 451  
   Light Bulbs..... 408  
   Schedule ..... 387  
   Tires ..... 419  
   Wiper Blades..... 417  
 Replacing Seat Belts After a  
   Crash..... 25  
 Reserve Tank, Engine Coolant .... 333  
 Restraint, Child ..... 38  
 Reverse Gear Position..... 350  
 Reverse Tilt Door Mirror ..... 159  
 Rearview Camera..... 326  
 Roof Rack ..... 342  
 Rotation, Tire ..... 423

CONTINUED



# Index

S	
Safety Belts.....	10, 21
Safety Defects, Reporting* .....	480
Safety Features .....	9
Airbags.....	11
Seat Belts .....	10
Safety Labels, Location of .....	57
Safety Messages .....	iii
Satellite Digital Radio* .....	217
Seat Belts .....	10, 21
Additional Information.....	21
Automatic Seat Belt	
Tensioners.....	23
Cleaning .....	415
e-pretensioner .....	24
Lap/Shoulder Belt.....	17, 22
Maintenance.....	25
Reminder Indicator and	
Beeper.....	21, 62
System Components.....	21
Use During Pregnancy.....	19
Seat Heaters .....	178
Seat Position Memory .....	160
Seat Ventilation** .....	179
Seats, Adjusting the.....	155
Security System .....	276
Sequential Sports Shift Mode .....	351
Paddle Shifters.....	351
Serial Number .....	462
Service Intervals .....	387
Service Manual, Purchasing* .....	481
Service Station Procedures .....	329
Super Handling-All Wheel Drive	
(SH-AWD) .....	356
Torque Distribution Monitor ...	356
Indicator .....	66
Shift Lever Position Indicators ...	349
Shift Lock Release.....	354
Side Airbags .....	11, 32
How the Side Airbag off	
Indicator Works .....	35
How Your Side Airbags Work....	32
Side Curtain Airbags .....	11, 34
How Your Side Curtain	
Airbags Work.....	34
Side Marker Lights, Bulb	
Replacement in .....	411
Signaling Turns.....	140
Snow Tires.....	424
Sound System.....	207
Spare Tire	
Inflating.....	435
Specifications .....	465
Specification Charts .....	464
Speed Limiter .....	354
Spotlights .....	196
SRS, Additional Information.....	26
Additional Safety Precautions....	37
How the SRS Indicator Works...	34
How Your Airbags	
Work .....	29, 32, 34
SRS Components .....	26
SRS Service.....	36
SRS Indicator.....	34, 63
START (Ignition Switch	
Position) .....	151
Starting the Engine.....	347
Auto Control Mode.....	347
In Cold Weather at High	
Altitude .....	347
With a Dead Battery .....	441
Steam Coming from Engine .....	444
Steering Wheel	
Adjustments .....	147
Anti-theft Column Lock .....	151
Position Memory .....	160

Steering Wheel Buttons/  
Switches ..... 136

Stereo Sound System ..... 207

Storing Your Vehicle ..... 429

Sun Visors..... 192

Supplemental Restraint  
System..... 11, 26

    Servicing ..... 36

    SRS Indicator..... 34, 63

    System Components..... 26

Synthetic Oil..... 400

**T**

Taking Care of the Unexpected .. 431

Technical Descriptions

    DOT Tire Quality Grading ..... 466

    Emissions Control Systems..... 472

    Three Way Catalytic  
    Converters..... 474

Temperature Gauge ..... 70

Temperature, Inside Sensor..... 206

Temperature, Outside..... 73

Tether Anchorage Points ..... 51

Three Way Catalytic  
Converters..... 474

Tilt/Telescopic Steering  
Wheel ..... 147

Timing Belt..... 407

Tire Chains ..... 424

Tire, How to Change a Flat ..... 436

Tire Pressure Monitoring System  
(TPMS) ..... 372, 470

    Monitoring Tire Pressure  
    Reading..... 419

    TPMS System Warning ..... 371

Tires ..... 419

    Air Pressure ..... 421

    Chains ..... 424

    Checking Wear ..... 421

    Compact Spare ..... 435

    DOT Tire Quality Grading ..... 466

    Inflation..... 419

    Inspection ..... 421

    Labeling ..... 468, 469

    Low Tire Pressure  
    Indicator..... 67, 371

    Michelin PAX System ..... 426

    Pressure Monitor..... 373

    Pressure Monitor System..... 371

    Replacing ..... 423

    Rotating..... 422

    Snow ..... 424

    Specifications ..... 465

Tools, Tire Changing ..... 436

Torque Distribution Monitor  
(SH-AWD) ..... 356

Towing

    A Trailer..... 379

    Equipment and Accessories..... 380

    Weight Limit ..... 379

TPMS (Tire Pressure Monitoring  
System) ..... 371

    Required Federal  
    Explanation..... 470

    Warning Message..... 375

Trailer Loading ..... 379

Trailer Towing Tips..... 382

Transmission

    Checking Fluid Level,  
    Automatic ..... 404

    Fluid Selection..... 405

    Identification Number..... 462

    Shifting the Automatic..... 349

Treadwear ..... 422, 435

Trip Meter ..... 72

CONTINUED

# Index

---

Trunk.....	153
Emergency Opener .....	154
Opening the.....	153
Open Monitor Indicator .....	13, 79
Turn Signals .....	140

## U

Unexpected, Taking Care of the .....	431
Uniform Tire Quality Grading .....	466
Unleaded Gasoline.....	328
Used Oil, How to Dispose of .....	401

## V

Vehicle Capacity Load .....	340
Vehicle Dimensions.....	464
Vehicle Identification Number.....	462
Vehicle Stability Assist (VSA) System.....	377
VSA Activation Indicator ....	65, 377
VSA Off Switch.....	378
VSA System Indicator .....	65, 377
Vehicle Storage.....	429
VIN .....	462

Viscosity, Oil.....	399
Voice Control System.....	265

## W

WARNING, Explanation of .....	iii
Warning Labels, Location of .....	57
Warranty Coverages .....	479
Washer, Windshield Checking the Fluid Level .....	404
Operation.....	137
Wheels Adjusting the Steering .....	147
Alignment and Balance.....	423
Compact Spare .....	435
Nut Wrench.....	437
Windows Auto Reverse.....	182
Operating the Power .....	181
Rear, Defogger .....	146
Windshield Cleaning .....	137
Defroster .....	201
Washers.....	137
Wipers, Windshield Changing Blades.....	417

Operation.....	137
Summer/Winter Position .....	139
WMA .....	230
Worn Tires .....	421
Wrecker, Emergency Towing.....	459

## X

XM Satellite Radio* .....	217
---------------------------	-----

\* : U.S. only  
\*\* : Canada only

2008 RL

2008 RL

2008 RL

## Service Information Summary

---

### **Gasoline:**

Premium unleaded gasoline, pump octane number of 91 or higher.

### **Fuel Tank Capacity:**

19.4 US gal (73 ℓ)

### **Recommended Engine Oil:**

API Premium grade 5W-20 detergent oil (see page [399](#)).

Oil change capacity (including filter):

4.5 US qt (4.3 ℓ)

### **Automatic Transmission Fluid:**

Honda ATF-Z1 (Automatic Transmission Fluid) (see page [404](#)).

### **Rear Differential Fluid:**

Honda ATF-Z1 (Automatic Transmission Fluid) preferred, or a DEXRON® III ATF as a temporary replacement.

Capacity:

SH-AWD differential case

0.77 US qt (0.73 ℓ)

SH-AWD clutch case

2.8 US qt (2.7 ℓ)

### **Transfer Assembly Fluid:**

SAE 90 or SAE 80W-90 viscosity hypoid gear oil, API service classified GL4 or GL5 only.

### **Power Steering Fluid:**

Honda Power Steering Fluid preferred, or another brand of power steering fluid as a temporary replacement. Do not use ATF (see page [406](#)).

### **Brake Fluid:**

Honda Heavy Duty Brake Fluid DOT 3 preferred, or a DOT 3 or DOT 4 brake fluid as a temporary replacement (see page [406](#)).

### **Tire Pressure (measured cold):**

Front:

32 psi (220 kPa , 2.2 kgf/cm<sup>2</sup>)

Rear:

30 psi (210 kPa , 2.1 kgf/cm<sup>2</sup>)

### **Spare Tire Pressure:**

60 psi (420 kPa , 4.2 kgf/cm<sup>2</sup>)

## Owner's Identification

---

OWNER \_\_\_\_\_  
\_\_\_\_\_

ADDRESS \_\_\_\_\_

STREET

\_\_\_\_\_ CITY

STATE/PROVINCE

ZIP CODE/  
POSTAL CODE

V. I. N. \_\_\_\_\_

DELIVERY DATE \_\_\_\_\_

(Date sold to original retail purchaser)

DEALER NAME \_\_\_\_\_ DEALER NO. \_\_\_\_\_

ADDRESS \_\_\_\_\_

STREET

\_\_\_\_\_ CITY

STATE/PROVINCE

ZIP CODE/  
POSTAL CODE

OWNER'S SIGNATURE \_\_\_\_\_

DEALER'S SIGNATURE \_\_\_\_\_

This owner's manual should be considered a permanent part of the vehicle and should remain with the vehicle when it is sold.

This owner's manual covers all models of the Acura RL. You may find descriptions of equipment and features that are not on your particular model.

The information and specifications included in this publication were in effect at the time of approval for printing. Honda Motor Co., Ltd. reserves the right, however, to discontinue or change specifications or design at any time without notice and without incurring any obligation whatsoever.