

Congratulations! Your selection of a 2008 Acura TSX was a wise investment. It will give you years of driving pleasure.

One of the best ways to enhance the enjoyment of your new vehicle is to read this manual. In it, you will learn how to operate its driving controls and convenience items. Afterwards, keep this owner's manual in your vehicle so you can refer to it at any time.

Several warranties protect your new vehicle. Read the warranty booklet thoroughly so you understand the coverages and are aware of your rights and responsibilities.

Maintaining your vehicle according to the maintenance minder shown in the instrument panel helps to keep your driving trouble-free while it preserves your investment. When your vehicle needs maintenance, keep in mind that your dealer's staff is specially trained in servicing the many systems unique to your vehicle. Your dealer is dedicated to your satisfaction and will be pleased to answer any questions and concerns.

As you read this manual, you will find information that is preceded by a **NOTICE** symbol. This information is intended to help you avoid damage to your vehicle, other property, or the environment.

Introduction

California Proposition 65 Warning

WARNING: This product contains or emits chemicals known to the State of California to cause cancer and birth defects or other reproductive harm.

Event Data Recorders

This vehicle is equipped with one or more devices commonly referred to as event data recorders. These devices record front seat belt use, front passenger seat occupancy, airbag deployment data, and the failure of any airbag system component. This data belongs to the vehicle owner and may not be accessed by anyone else except as legally required or with the permission of the vehicle owner.

Service Diagnostic Recorders

This vehicle is equipped with service-related devices that record information about powertrain performance. The data can be used to verify emissions law requirements and/or help technicians diagnose and solve service problems. It may also be combined with data from other sources for research purposes, but it remains confidential.

Your safety, and the safety of others, is very important. And operating this vehicle safely is an important responsibility.

To help you make informed decisions about safety, we have provided operating procedures and other information on labels and in this manual. This information alerts you to potential hazards that could hurt you or others.

Of course, it is not practical or possible to warn you about all the hazards associated with operating or maintaining your vehicle. You must use your own good judgement.

You will find this important safety information in a variety of forms, including:

- **Safety Labels** — on the vehicle.
- **Safety Messages** — preceded by a safety alert symbol  and one of three signal words: **DANGER**, **WARNING**, or **CAUTION**. These signal words mean:

 **DANGER**

You **WILL** be **KILLED** or **SERIOUSLY HURT** if you don't follow instructions.

 **WARNING**

You **CAN** be **KILLED** or **SERIOUSLY HURT** if you don't follow instructions.

 **CAUTION**

You **CAN** be **HURT** if you don't follow instructions.

- **Safety Headings** — such as Important Safety Reminders or Important Safety Precautions.
- **Safety Section** — such as Driver and Passenger Safety.
- **Instructions** — how to use this vehicle correctly and safely.

This entire book is filled with important safety information — please read it carefully.

Owner's Identification Form

| | |
|---|------------|
| Introduction | i |
| A Few Words About Safety | iii |
| Your Vehicle at a Glance (main controls) | 3 |
| Driver and Passenger Safety (seat belts, SRS, and child protection) | 5 |
| Instruments and Controls (indicators, gauges, multi-information display, dashboard and steering column) | 59 |
| Features (climate control, audio, steering wheel, security, cruise control, HomeLink [®] , and other convenience items) | 159 |
| Before Driving (fuel, vehicle break-in, and cargo loading) | 231 |
| Driving (engine and transmission operation) | 247 |
| Maintenance (minder, fluid checking, minor services, and vehicle storage)..... | 277 |
| Taking Care of the Unexpected (flat tire, dead battery, overheating, and fuses) | 323 |
| Technical Information (vehicle specifications, tires, and emissions controls) | 347 |
| Warranty and Customer Relations (U. S. and Canada only) (warranty and contact information) ... | 365 |
| Authorized Manuals (U. S. only) (how to order) | 369 |
| Index | I |

Service Information Summary (fluid capacities and tire pressures)

Overview of Contents

Contents

A convenient reference to the sections in this manual.

Your Vehicle at a Glance

A quick reference to the main controls in your vehicle.

Driver and Passenger Safety

Important information about the proper use and care of your vehicle's seat belts, an overview of the supplemental restraint system, and valuable information on how to protect children with child restraints.

Instruments and Controls

Explains the purpose of each instrument panel indicator and gauge, the multi-information display, and how to use the controls on the dashboard and steering column.

Features

How to operate the climate control system, the audio system, and other

convenience features.

Before Driving

What gasoline to use, how to break-in your new vehicle, and how to load luggage and other cargo.

Driving

The proper way to start the engine, shift the transmission, and park; plus what you need to know if you're planning to tow a trailer.

Maintenance

The maintenance minder shows you when you need to take your vehicle to the dealer for maintenance service. There is also a list of things to check and instructions on how to check them.

Taking Care of the Unexpected

This section covers several problems motorists sometimes experience, and details how to handle them.

Technical Information

ID numbers, dimensions, capacities, and technical information.

Warranty and Client Relations (U.S. and Canada only)

A summary of the warranties covering your new vehicle, and how to contact us for any reason. Refer to your warranty manual for detailed information.

Authorized Manuals (U.S. only)

How to order manuals and other technical literature.

Index

Service Information Summary

A summary of the information you need when you pull up to the fuel pump.

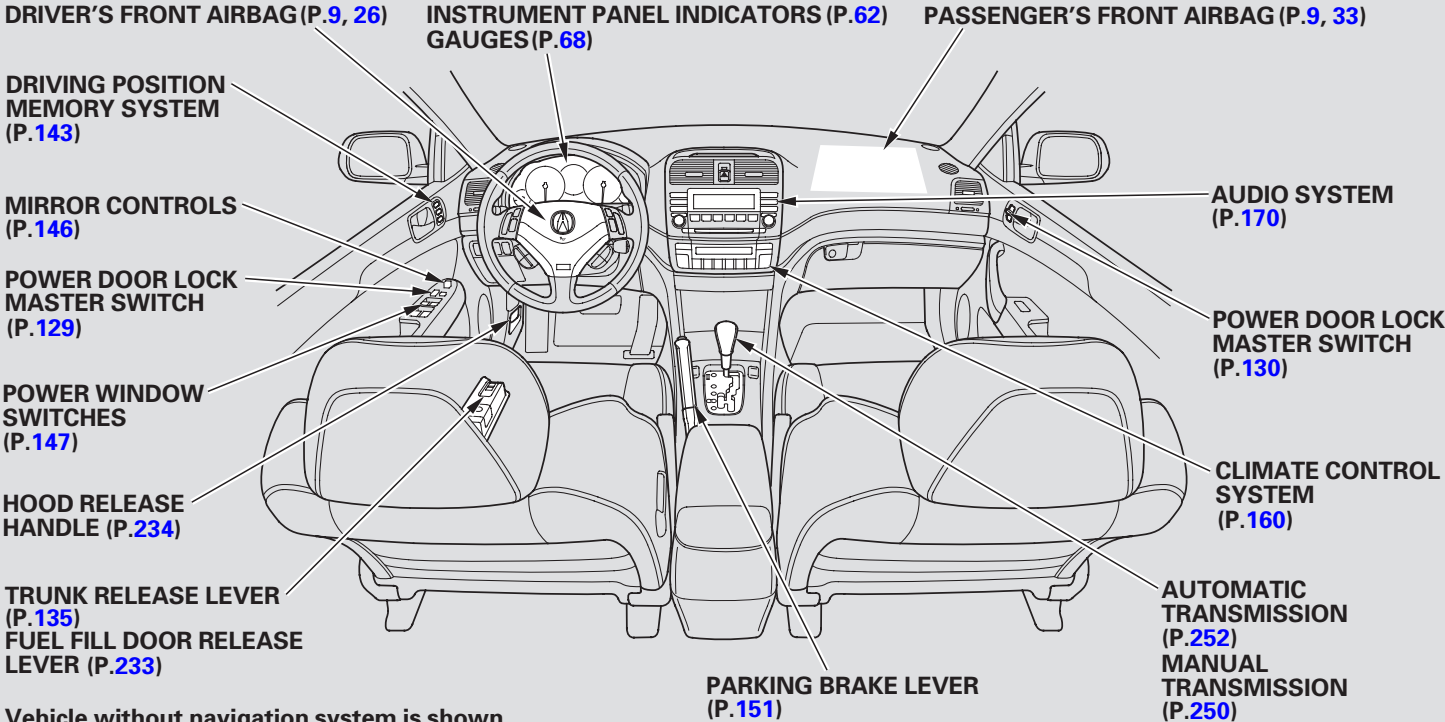

Vehicle without navigation system is shown.

CONTINUED

Your Vehicle at a Glance

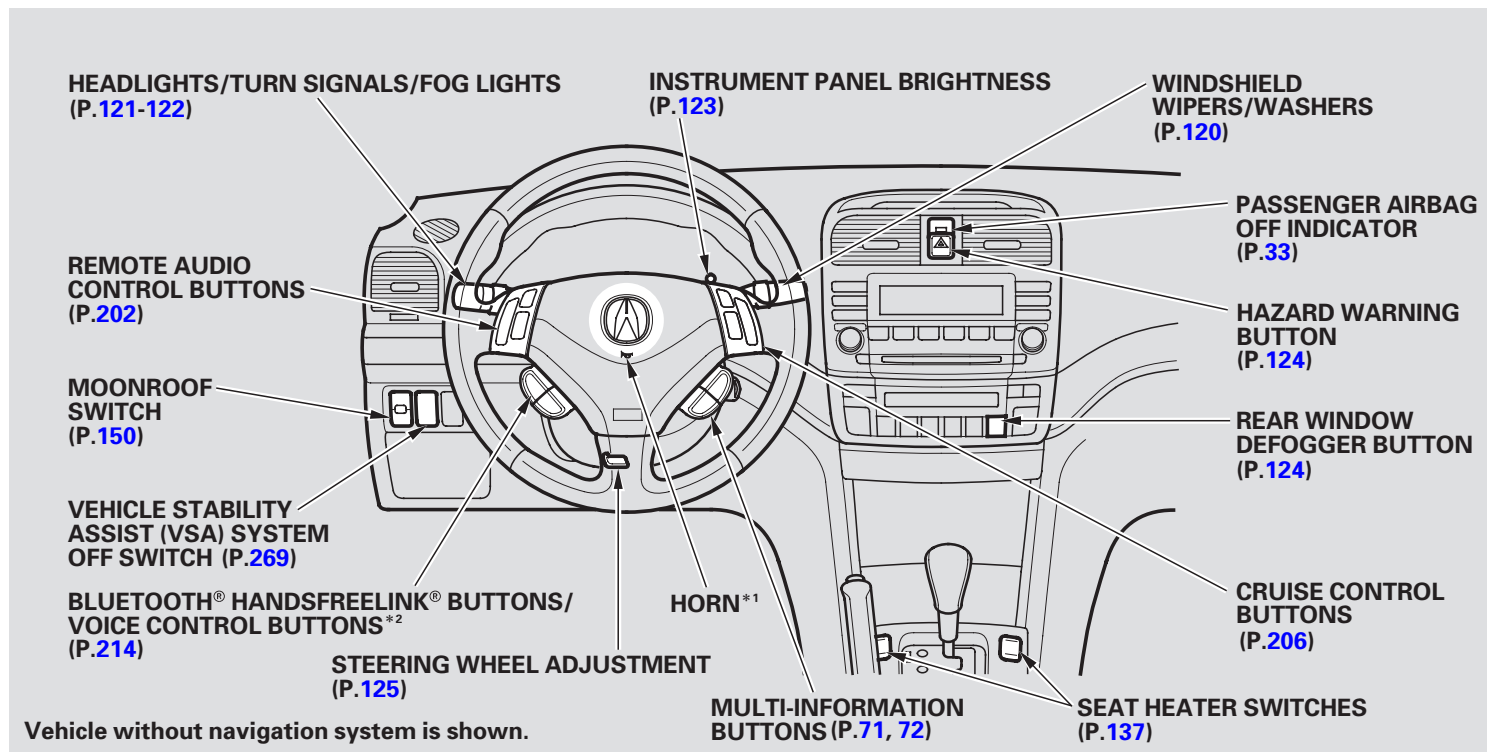

* 1 : To use the horn, press the pad around the “Acura” logo.

* 2 : Only on vehicles equipped with navigation system. Refer to the navigation system manual.

This section gives you important information about how to protect yourself and your passengers. It shows you how to use seat belts. It explains how your airbags work. And it tells you how to properly restrain infants and children in your vehicle.

- Important Safety Precautions 6
- Your Vehicle’s Safety Features..... 7
 - Seat Belts 8
 - Airbags..... 9
- Protecting Adults and Teens..... 11
 1. Close and Lock the Doors..... 11
 2. Adjust the Front Seats 12
 3. Adjust the Seat-Backs 13
 4. Adjust the Head Restraints 14
 5. Fasten and Position the Seat Belts 15
 6. Maintain a Proper Sitting Position 16
- Advice for Pregnant Women..... 17
- Additional Safety Precautions.... 18
- Additional Information About
 - Your Seat Belts 19
 - Seat Belt System Components... 19

- Lap/Shoulder Belt..... 20
- Automatic Seat Belt
 - Tensioners..... 21
- Seat Belt Maintenance 22
- Additional Information About
 - Your Airbags 23
 - Airbag System Components..... 23
 - How Your Front Airbags Work..... 26
 - How Your Side Airbags Work.... 30
 - How Your Side Curtain Airbags Work..... 31
 - How the SRS Indicator Works... 32
 - How the Side Airbag Off Indicator Works 32
 - How the Passenger Airbag Off Indicator Works 33
 - Airbag Service 34
 - Additional Safety Precautions.... 35
- Protecting Children – General Guidelines..... 36
 - All Children Must Be Restrained 36
 - All Children Should Sit in a Back Seat 37

- The Passenger’s Front Airbag Can Pose Serious Risks 37
- If You Must Drive with Several Children 39
 - If a Child Requires Close Attention 39
 - Additional Safety Precautions... 40
- Protecting Infants and Small Children..... 41
 - Protecting Infants..... 41
 - Protecting Small Children 42
- Selecting Child Seats..... 44
- Installing a Child Seat 45
 - Installing a Child Seat with LATCH 46
 - with a Lap/Shoulder Belt 48
 - with a Tether 49
- Protecting Larger Children 51
 - Checking Seat Belt Fit 51
 - Using a Booster Seat 52
 - When Can a Larger Child Sit in Front 53
 - Additional Safety Precautions.... 54
- Carbon Monoxide Hazard 55
- Safety Labels 56

Important Safety Precautions

You'll find many safety recommendations throughout this section, and throughout this manual. The recommendations on this page are the ones we consider to be the most important.

Always Wear Your Seat Belt

A seat belt is your best protection in all types of collisions. Airbags are designed to supplement seat belts, not replace them. So even though your vehicle is equipped with airbags, make sure you and your passengers always wear your seat belts, and wear them properly (see page 15).

Restrain All Children

Children age 12 and under should ride properly restrained in a back seat, not the front seat. Infants and small children should be restrained in a child seat. Larger children should use a booster seat and a lap/shoulder belt until they can use the belt properly without a booster seat (see pages 36 – 54).

Be Aware of Airbag Hazards

While airbags can save lives, they can cause serious or fatal injuries to occupants who sit too close to them, or are not properly restrained. Infants, young children, and short adults are at the greatest risk. Be sure to follow all instructions and warnings in this manual.

Don't Drink and Drive

Alcohol and driving don't mix. Even one drink can reduce your ability to respond to changing conditions, and your reaction time gets worse with

every additional drink. So don't drink and drive, and don't let your friends drink and drive, either.

Control Your Speed

Excessive speed is a major factor in crash injuries and deaths. Generally, the higher the speed, the greater the risk, but serious injuries can also occur at lower speeds. Never drive faster than is safe for current conditions, regardless of the maximum speed posted.

Keep Your Vehicle in Safe Condition

Having a tire blowout or a mechanical failure can be extremely hazardous. To reduce the possibility of such problems, check your tire pressures and condition frequently, and perform all regularly scheduled maintenance (see page 280).

Your Vehicle's Safety Features

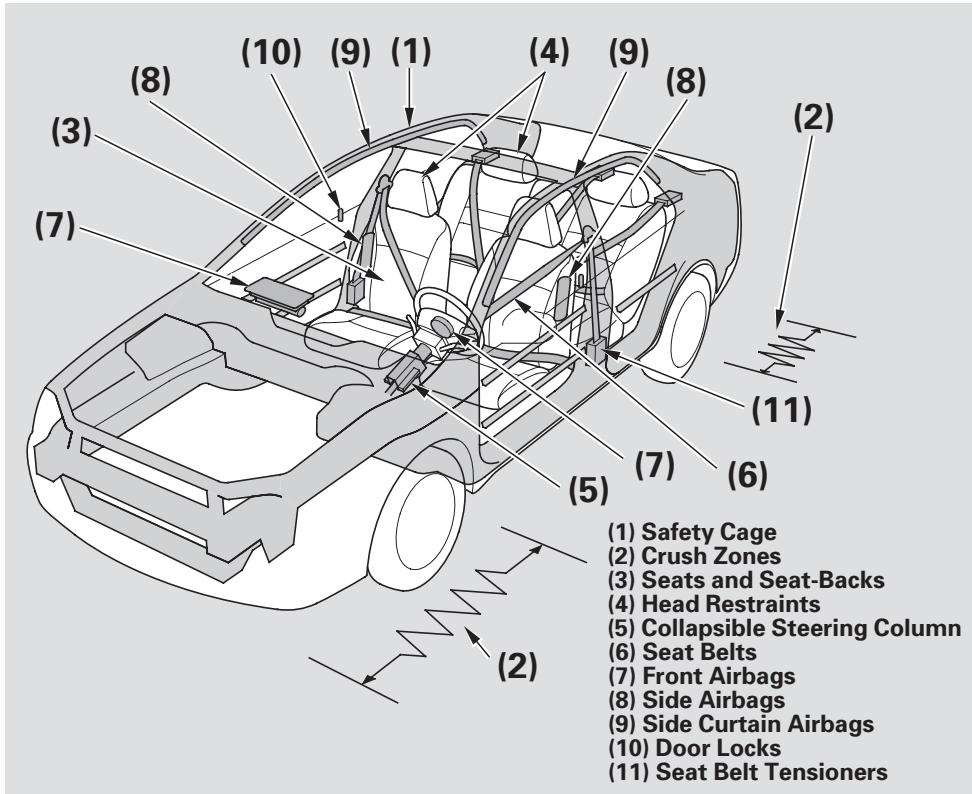

Your vehicle is equipped with many features that work together to protect you and your passengers during a crash.

Some features do not require any action on your part. These include a strong steel framework that forms a safety cage around the passenger compartment, front and rear crush zones, a collapsible steering column, and tensioners that tighten the front seat belts in a crash.

However, you and your passengers can't take full advantage of these features unless you remain sitting in a proper position and ***always wear your seat belts***. In fact, some safety features can contribute to injuries if they are not used properly.

The following pages explain how you can take an active role in protecting yourself and your passengers.

Your Vehicle's Safety Features

Seat Belts

Your vehicle is equipped with seat belts in all seating positions.

Your seat belt system also includes an indicator on the instrument panel and a beeper to remind you and your passengers to fasten your seat belts.

Why Wear Seat Belts

Seat belts are the single most effective safety device for adults and larger children. (Infants and smaller children must be properly restrained in child seats.)

Not wearing a seat belt properly increases the chance of serious injury or death in a crash, even though your vehicle has airbags.

In addition, most states and all Canadian provinces require you to wear seat belts.

WARNING

Not wearing a seat belt properly increases the chance of serious injury or death in a crash, even though your vehicle has airbags.

Be sure you and your passengers always wear seat belts and wear them properly.

When properly worn, seat belts:

- Keep you connected to the vehicle so you can take advantage of the vehicle's built-in safety features.
- Help protect you in almost every type of crash, including frontal, side, and rear impacts and rollovers.

- Help keep you from being thrown against the inside of the vehicle and against other occupants.
- Keep you from being thrown out of the vehicle.
- Help keep you in a good position should the airbags ever deploy. A good position reduces the risk of injury from an inflating airbag and allows you to get the best advantage from the airbag.

Of course, seat belts cannot completely protect you in every crash. But in most cases, seat belts can reduce your risk of serious injury.

What You Should Do:

Always wear your seat belt, and make sure you wear it properly.

Airbags

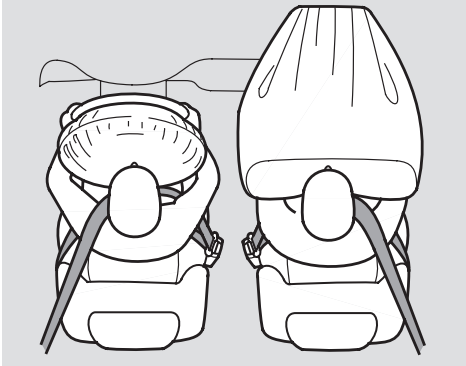

Your vehicle has a supplemental restraint system (SRS) with front airbags to help protect the heads and chests of the driver and a front seat passenger during a moderate to severe frontal collision (see page [26](#) for more information on how your front airbags work).

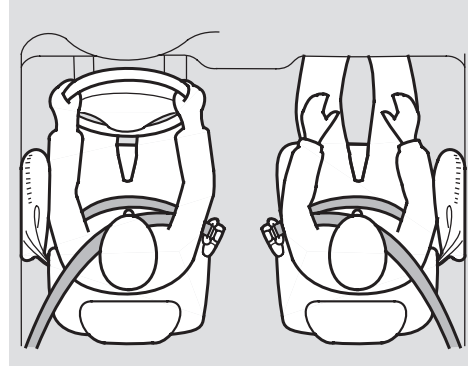

Your vehicle also has side airbags to help protect the upper torso of the driver or a front seat passenger during a moderate to severe side impact (see page [30](#) for more information on how your side airbags work).

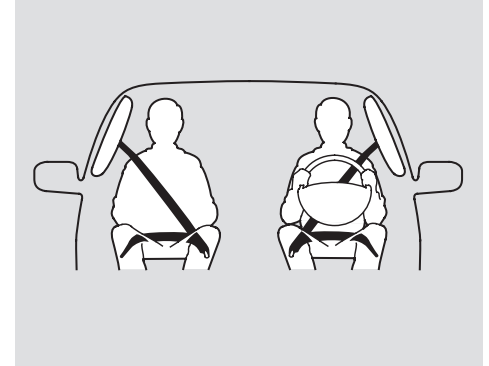

In addition, your vehicle has side curtain airbags to help protect the heads of the driver, front passenger, and passengers in the outer rear seating positions during a moderate to severe side impact (see page [31](#) for more information on how your side curtain airbags work).

CONTINUED

Your Vehicle's Safety Features

The most important things you need to know about your airbags are:

- ***Airbags do not replace seat belts.*** They are designed to supplement the seat belts.
- ***Airbags offer no protection in rear impacts, or minor frontal or side collisions.***
- ***Airbags can pose serious hazards.*** To do their job, airbags must inflate with tremendous force. So while airbags help save lives, they can cause minor injuries or more serious or even fatal injuries if occupants are not properly restrained or sitting properly.

What you should do: Always wear your seat belt properly, and sit upright and as far back from the steering wheel as possible while allowing full control of the vehicle. A front passenger should move their seat as far back from the dashboard as possible.

The rest of this section gives more detailed information about how you can maximize your safety.

Remember, however, that no safety system can prevent all injuries or deaths that can occur in a severe crash, even when seat belts are properly worn and the airbags deploy.

Introduction

The following pages provide instructions on how to properly protect the driver, adult passengers and teenage children who are large enough and mature enough to drive or ride in the front seat.

See pages [36](#) – [43](#) for important guidelines on how to properly protect infants, small children, and larger children who ride in your vehicle.

1. Close and Lock the Doors

After everyone has entered the vehicle, be sure the doors are closed and locked.

Your vehicle has a door and trunk open monitor on the multi-information display to indicate when a specific door or the trunk is not tightly closed. You will see the appropriate light/lights and the message for each condition.

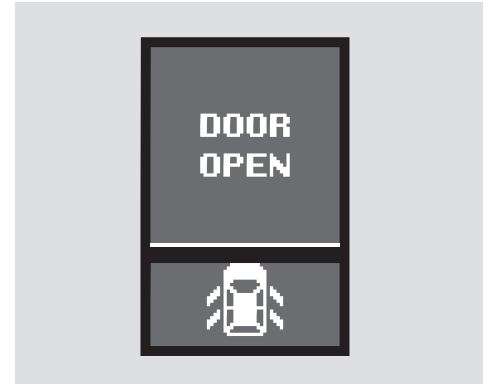

When one or more doors are not tightly closed, the “DOOR OPEN” message will come on.

CONTINUED

Protecting Adults and Teens

Locking the doors reduces the chance of someone being thrown out of the vehicle during a crash, and it helps prevent passengers from accidentally opening a door and falling out.

Locking the doors also helps prevent an outsider from unexpectedly opening a door when you come to a stop.

See page [129](#) for how to lock the doors.

2. Adjust the Front Seats

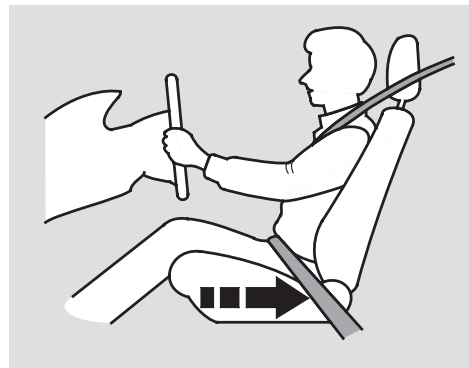

Adjust the driver's seat as far to the rear as possible while allowing you to maintain full control of the vehicle. Have a front passenger adjust their seat as far to the rear as possible.

If you sit too close to the steering wheel or dashboard, you can be seriously injured by an inflating front airbag, or by striking the steering wheel or dashboard.

The National Highway Traffic Safety Administration and Transport Canada recommend that drivers allow at least 10 inches (25 cm) between the center of the steering wheel and the chest. In addition to adjusting the seat, you can adjust the steering wheel up and down, and in and out (see page [125](#)).

If you cannot get far enough away from the steering wheel and still reach the controls, we recommend that you investigate whether some type of adaptive equipment may help.

⚠ WARNING

Sitting too close to a front airbag can result in serious injury or death if the front airbags inflate.

Always sit as far back from the front airbags as possible.

See page [138](#) for how to adjust the front seats.

3. Adjust the Seat-Backs

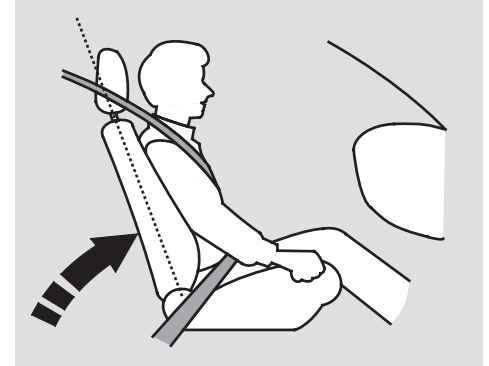

Adjust the driver's seat-back to a comfortable, upright position, leaving ample space between your chest and the airbag cover in the center of the steering wheel.

Passengers with adjustable seat-backs should also adjust their seat-back to a comfortable, upright position.

CONTINUED

Protecting Adults and Teens

⚠️ WARNING

Reclining the seat-back too far can result in serious injury or death in a crash.

Adjust the seat-back to an upright position, and sit well back in the seat.

Reclining a seat-back so that the shoulder part of the belt no longer rests against the occupant's chest reduces the protective capability of the belt. It also increases the chance of sliding under the belt in a crash and being seriously injured. The farther a seat-back is reclined, the greater the risk of injury.

See page [138](#) for how to adjust the seat-backs.

4. Adjust the Head Restraints

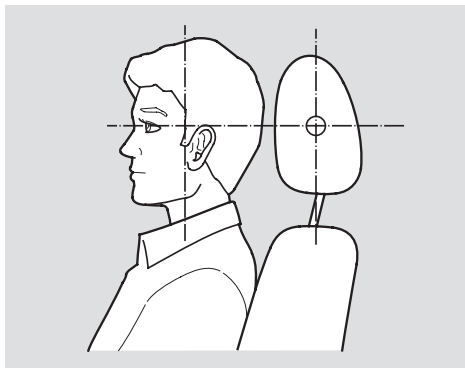

Adjust the driver's head restraint so the center of the back of your head rests against the center of the restraint.

Have passengers adjust their head restraints properly as well. Taller persons should adjust their restraint as high as possible.

⚠️ WARNING

Improperly positioning head restraints reduces their effectiveness and you can be seriously injured in a crash.

Make sure head restraints are in place and positioned properly before driving.

Properly adjusted head restraints will help protect occupants from whiplash and other crash injuries.

See page [139](#) for how to adjust the head restraints.

5. Fasten and Position the Seat Belts

Insert the latch plate into the buckle, then tug on the belt to make sure the belt is securely latched. Check that the belt is not twisted, because a twisted belt can cause serious injuries in a crash.



Position the lap part of the belt as low as possible across your hips, then pull up on the shoulder part of the belt so the lap part fits snugly. This lets your strong pelvic bones take the force of a crash and reduces the chance of internal injuries.

If necessary, pull up on the belt again to remove any slack, then check that the belt rests across the center of your chest and over your shoulder.

This spreads the forces of a crash over the strongest bones in your upper body.

WARNING

Improperly positioning the seat belts can cause serious injury or death in a crash.

Make sure all seat belts are properly positioned before driving.

If the seat belt touches or crosses your neck, or if it crosses your arm instead of your shoulder, you need to adjust the seat belt anchor height.

CONTINUED

Protecting Adults and Teens

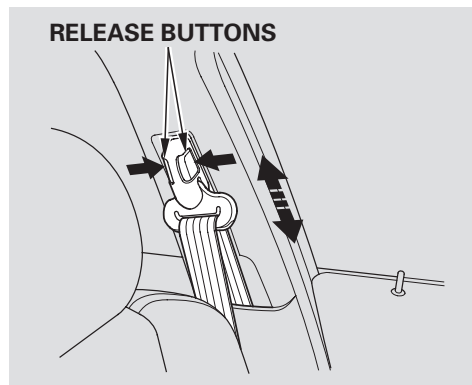

The front seats have adjustable seat belt anchors. To adjust the height of an anchor, press and hold the release buttons, and slide the anchor up or down as needed (it has four positions).

Never place the shoulder portion of a lap/shoulder belt under your arm or behind your back. This could cause very serious injuries in a crash.

If a seat belt does not seem to work properly, it may not protect the occupant in a crash.

No one should sit in a seat with an inoperative seat belt. Using a seat belt that is not working properly can result in serious injury or death. Have your dealer check the belt as soon as possible.

See page 19 for additional information about your seat belts and how to take care of them.

6. Maintain a Proper Sitting Position

After all occupants have adjusted their seats and head restraints, and put on their seat belts, it is very important that they continue to sit upright, well back in their seats, with their feet on the floor, until the vehicle is parked and the engine is off.

Sitting improperly can increase the chance of injury during a crash. For example, if an occupant slouches, lies down, turns sideways, sits forward, leans forward or sideways, or puts one or both feet up, the chance of injury during a crash is greatly increased.

In addition, an occupant who is out of position in the front seat can be seriously or fatally injured in a crash by striking interior parts of the vehicle or being struck by an inflating front airbag.

⚠ WARNING

Sitting improperly or out of position can result in serious injury or death in a crash.

Always sit upright, well back in the seat, with your feet on the floor.

Advice for Pregnant Women



If you are pregnant, the best way to protect yourself and your unborn child when driving or riding in a vehicle is to always wear a seat belt, and keep the lap part of the belt as low as possible across the hips.

When driving, remember to sit upright and adjust the seat as far back as possible while allowing full control of the vehicle. When riding as a front passenger, adjust the seat as far back as possible.

This will reduce the risk of injuries to both you and your unborn child that can be caused by a crash or an inflating front airbag.

Each time you have a checkup, ask your doctor if it's okay for you to drive.

Protecting Adults and Teens

Additional Safety Precautions

- ***Two people should never use the same seat belt.*** If they do, they could be very seriously injured in a crash.
- ***Do not put any accessories on seat belts.*** Devices intended to improve occupant comfort or reposition the shoulder part of a seat belt can reduce the protective capability of the belt and increase the chance of serious injury in a crash.
- ***Do not place hard or sharp objects between yourself and a front airbag.*** Carrying hard or sharp objects on your lap, or driving with a pipe or other sharp object in your mouth, can result in injuries if your front airbag inflates.
- ***Keep your hands and arms away from the airbag covers.*** If your hands or arms are close to an airbag cover, they could be injured if the airbag inflates.
- ***Do not attach or place objects on the front airbag covers.*** Objects on the covers marked “SRS AIRBAG” could interfere with the proper operation of the airbags or be propelled inside the vehicle and hurt someone if the airbags inflate.
- ***Do not attach hard objects on or near a door.*** If a side airbag or a side curtain airbag inflates, a cup holder or other hard object attached on or near the door could be propelled inside the vehicle and hurt someone.

Seat Belt System Components

Your seat belt system includes lap/shoulder belts in all five seating positions. The front seat belts are also equipped with automatic seat belt tensioners.

This system uses the same sensors as the front airbags to monitor whether the front seat belts are latched or unlatched, and how much weight is on the front passenger's seat (see pages [28](#) and [29](#)).



The seat belt system includes an indicator on the instrument panel and a beeper to remind you and your passengers to fasten your seat belts.

If you turn the ignition switch to the ON (II) position before your seat belt is fastened, the beeper will sound and the indicator will flash. If your seat belt is not fastened before the beeper stops, the indicator will stop flashing but remain on.

If a front passenger does not fasten their seat belt, the indicator will come on about 6 seconds after the ignition switch is turned to the ON (II) position.

If either the driver or a front passenger does not fasten their seat belt while driving, the beeper will sound and the indicator will flash again at regular intervals.

You will also see a “FASTEN SEAT BELT” or “FASTEN PASSENGER SEAT BELT” message on the multi-information display (see page [78](#)).

When no one is sitting in the front passenger's seat, or a child or small adult is riding there, the indicator should not come on and the beeper should not sound.

CONTINUED

Additional Information About Your Seat Belts

If the indicator comes on or the beeper sounds when the driver's seat belt is latched and there is no front seat passenger and no items on the front seat, something may be interfering with the monitoring system. Look for and remove:

- Any items under the front passenger's seat.
- Any object(s) hanging on the seat or in the seat-back pocket.
- Any objects, such as a folded-down back seat, that are touching the rear of the seat-back.

If no obstructions are found, have your vehicle checked by a dealer.

Lap/Shoulder Belt

The lap/shoulder belt goes over your shoulder, across your chest, and across your hips.

To fasten the belt, insert the latch plate into the buckle, then tug on the belt to make sure the buckle is latched (see page 15 for how to properly position the belt).

To unlock the belt, press the red PRESS button on the buckle. Guide the belt across your body so that it retracts completely. After exiting the vehicle, be sure the belt is out of the way and will not get closed in the door.

All seat belts have an emergency locking retractor. In normal driving, the retractor lets you move freely in your seat while it keeps some tension on the belt. During a collision or sudden stop, the retractor automatically locks the belt to help restrain your body.

The seat belts in all positions except the driver's have a lockable retractor that must be activated to secure a child seat (see page 48).

Additional Information About Your Seat Belts

If the shoulder part of the belt is pulled all the way out, the lockable retractor will activate. The belt will retract, but it will not allow the passenger to move freely.

To deactivate the lockable retractor, unlatch the buckle and let the seat belt fully retract. To refasten the seat belt, pull it out only as far as needed.

Automatic Seat Belt Tensioners

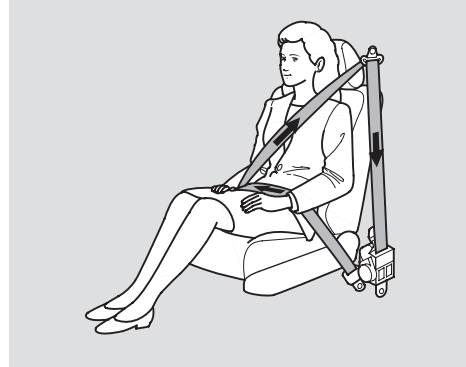

For added protection, the front seat belts are equipped with automatic seat belt tensioners. When activated, the tensioners immediately tighten the belts to help hold the driver and a front passenger in position.

The tensioners are designed to activate in any collision severe enough to cause the front airbags to deploy.

If a side airbag or side curtain airbag deploys during a side impact, the tensioner on that side of the vehicle will also deploy.

The tensioners can also be activated during a collision in which the front airbags *do not deploy*. In this case, the airbags would not be needed, but the additional restraint could be helpful.

When the tensioners are activated, the seat belts will remain tight until they are unbuckled.

Additional Information About Your Seat Belts

Seat Belt Maintenance

For safety, you should check the condition of your seat belts regularly.

Pull each belt out fully, and look for frays, cuts, burns, and wear. Check that the latches work smoothly and the belts retract easily. If a belt does not retract easily, cleaning the belt may correct the problem (see page 310). Any belt that is not in good condition or working properly will not provide good protection and should be replaced as soon as possible.

Acura provides a limited warranty on seat belts. See your *Acura Warranty Information* booklet for details.

If a seat belt is worn during a crash, it must be replaced by your dealer. A belt that has been worn during a crash may not provide the same level of protection in a subsequent crash.

The dealer should also inspect the anchors for damage and replace them if needed. If the automatic seat belt tensioners activate during a crash, they must be replaced.

WARNING

Not checking or maintaining seat belts can result in serious injury or death if the seat belts do not work properly when needed.

Check your seat belts regularly and have any problem corrected as soon as possible.

Additional Information About Your Airbags

Airbag System Components

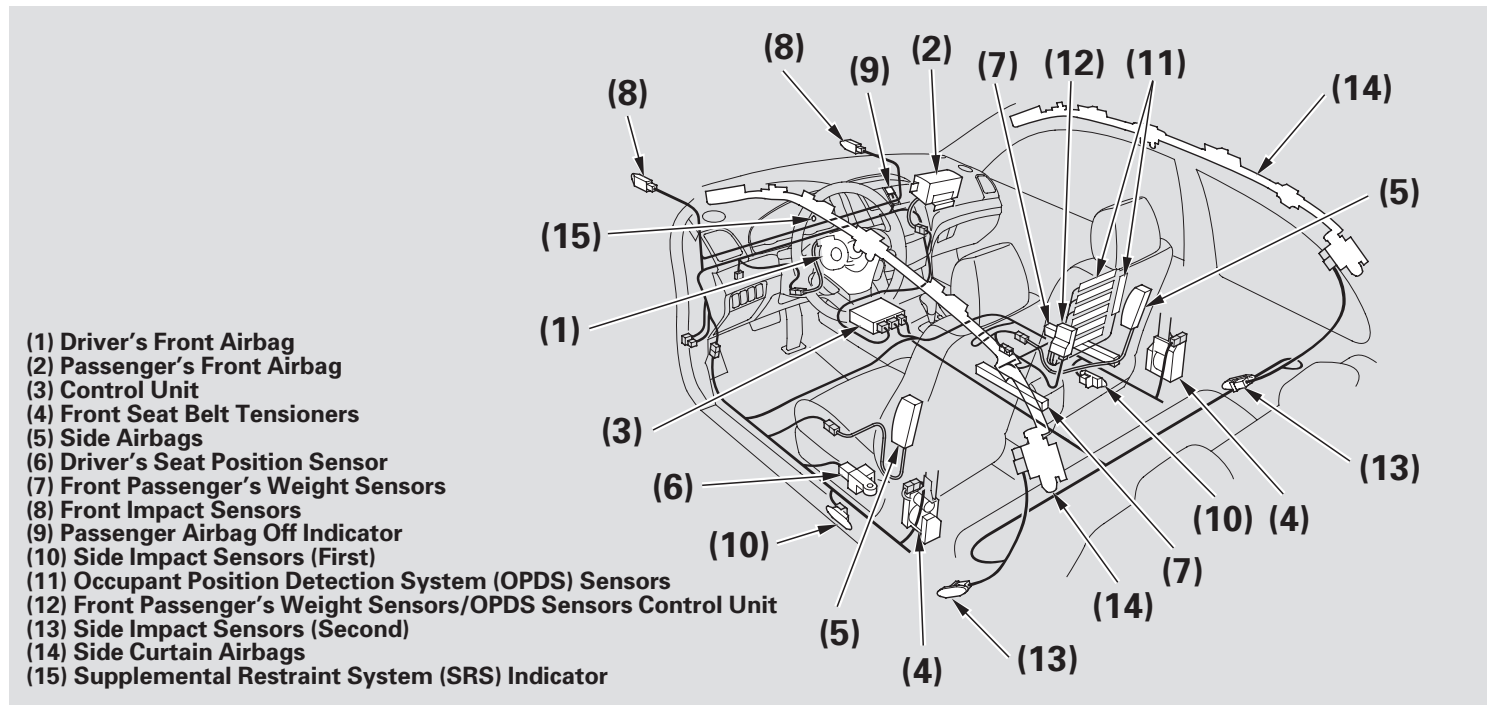

CONTINUED

Additional Information About Your Airbags

Your airbag system includes:

- Two SRS (supplemental restraint system) front airbags. The driver's airbag is stored in the center of the steering wheel; the front passenger's airbag is stored in the dashboard. Both are marked "SRS AIRBAG" (see page 26).
- Two side airbags, one for the driver and one for a front passenger. The airbags are stored in the outer edges of the seat-backs. Both are marked "SIDE AIRBAG" (see page 30).
- Two side curtain airbags, one for each side of the vehicle. The airbags are stored in the ceiling, above the side windows. The front and rear pillars are marked "SIDE CURTAIN AIRBAG" (see page 31).
- Automatic front seat belt tensioners (see page 21).
- Sensors that can detect a moderate to severe frontal or side impact.
- Sensors that can detect whether a child is in the passenger's side airbag path and signal the control unit to turn the airbag off (see page 30).
- Sensors that can detect whether the driver's seat belt and the front passenger's seat belt are latched or unlatched (see page 19).
- A driver's seat position sensor that monitors the distance of the seat from the front airbag. If the seat is too far forward, the airbag will inflate with less force (see page 28).

- Weight sensors that monitor the weight on the front passenger's seat. If the weight is about 65 lbs (29 kg) or less (the weight of an infant or small child), the passenger's front airbag will be turned off (see page 28).
- A sophisticated electronic system that continually monitors and records information about the sensors, the control unit, the airbag activators, the seat belt tensioners, and driver and front passenger seat belt use when the ignition switch is in the ON (II) position.
- An indicator on the instrument panel that alerts you to a possible problem with your airbags, sensors, or seat belt tensioners (see page 32).
- An indicator on the instrument panel that alerts you that the passenger's side airbag has been turned off (see page 32).
- An indicator on the dashboard that alerts you that the passenger's front airbag has been turned off (see page 33).
- Emergency backup power in case your vehicle's electrical system is disconnected in a crash.

Additional Information About Your Airbags

How Your Front Airbags Work

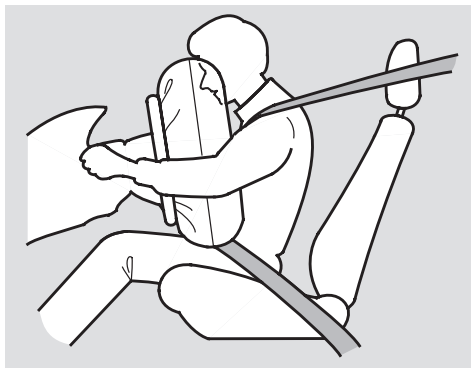

If you ever have a moderate to severe frontal collision, sensors will detect the vehicle's rapid deceleration.

If the rate of deceleration is high enough, the control unit will instantly inflate the driver's and front passenger's airbags, at the time and with the force needed.

During a frontal crash, your seat belt restrains your lower body and torso, and the front airbag helps protect your head and chest.

Although both airbags normally inflate within a split second of each other, it is possible for only one airbag to deploy.

This can happen if the severity of a collision is at the margin, or threshold, that determines whether or not the airbags will deploy. In such cases, the seat belt will provide sufficient protection, and the supplemental protection offered by the airbag would be minimal.

Only the driver's airbag will deploy if there is no passenger in the front seat, or if the advanced airbag system has turned the passenger's airbag off (see page [28](#)).

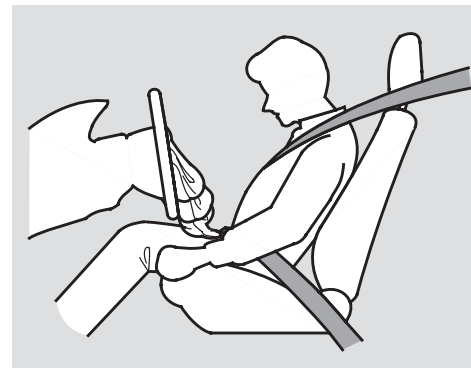

After inflating, the front airbags immediately deflate, so they won't interfere with the driver's visibility, or the ability to steer or operate other controls.

Additional Information About Your Airbags

The total time for inflation and deflation is one-tenth of a second, so fast that most occupants are not aware that the airbags deployed until they see them lying in their laps.

After a crash, you may see what looks like smoke. This is actually powder from the airbag's surface. Although the powder is not harmful, people with respiratory problems may experience some temporary discomfort. If this occurs, get out of the vehicle as soon as it is safe to do so.

Dual-Stage Airbags

Your front airbags are dual-stage airbags. This means they have two inflation stages that can be ignited sequentially or simultaneously, depending on crash severity.

In a ***more severe*** crash, both stages will ignite simultaneously to provide the quickest and greatest protection.

In a ***less severe*** crash, one stage will ignite first, then the second stage will ignite a split second later. This provides longer airbag inflation time with a little less force.

Dual-Threshold Airbags

Your front airbags are also dual-threshold airbags. Airbags with this feature have two deployment thresholds that depend on whether sensors detect the occupant is wearing a seat belt or not.

If the occupant's belt is ***not latched***, the airbag will deploy at a slightly lower threshold, because the occupant would need extra protection.

If the occupant's belt is ***latched***, the airbag will inflate at a slightly higher threshold, when the airbag would be needed to supplement the protection provided by the seat belt.

CONTINUED

Additional Information About Your Airbags

Advanced Airbags

Your front airbags are also advanced airbags. The main purpose of this feature is to help prevent airbag-caused injuries to short drivers and children who ride in front.

For both advanced airbags to work properly:

- Occupants must sit upright and wear their seat belts properly.
- Do not spill any liquids on or under the seats, cover the sensors, or put any objects or metal items under the front seats.
- Back-seat passengers should not put their feet under the front seats.

Failure to follow these instructions could damage the sensors or prevent them from working properly.

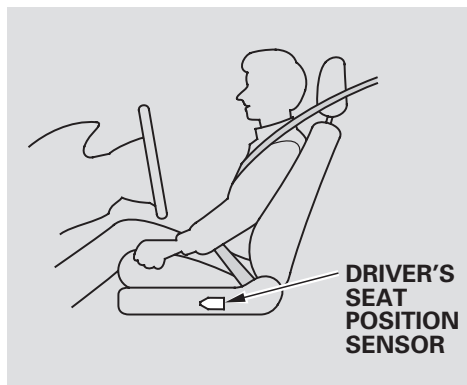

The driver's advanced front airbag system includes a seat position sensor under the seat. If the seat is too far forward, the airbag will inflate with less force, regardless of the severity of the impact.

If there is a problem with the sensor, the SRS indicator will come on, and the airbag will inflate in the normal manner regardless of the driver's seating position.

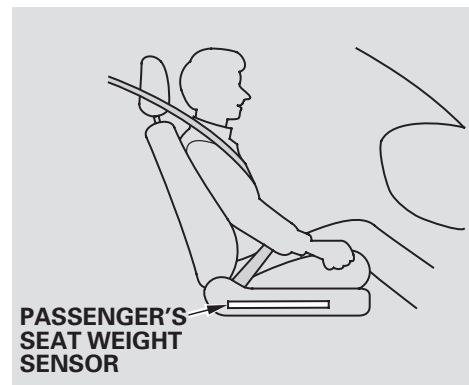

The passenger's advanced front airbag system has weight sensors under the seat. Although Acura does not encourage carrying an infant or small child in front, if the sensors detect the weight of an infant or small child (up to about 65 lbs or 29 kg), the system will automatically turn the passenger's front airbag off.

Be aware that objects placed on the passenger's seat can also cause the airbag to be turned off.

When the airbag is turned off, a "passenger airbag off" indicator in the center of the dashboard comes on (see page 33).

If the weight sensors detect there is no passenger in the front seat, the airbag will be off. However, the passenger airbag off indicator will not come on.

To ensure that the passenger's advanced front airbag system will work properly, ***do not do anything that would increase or decrease the weight on the front passenger's seat.*** This includes:

- A rear passenger pushing or pulling on the back of the front passenger's seat.
- Moving the front seat forcibly back against cargo on the seat or floor behind it.
- Hanging heavy items on the front passenger seat, or placing heavy items in the seat-back pocket.
- Moving the front seat or seat-back forcibly back against the folded rear seat.

Also, make sure the floor mat behind the front passenger's seat is hooked to the floor mat anchor (see page 310). If it is not, the mat may interfere with the proper operation of the sensors and operation of the seat.

Additional Information About Your Airbags

How Your Side Airbags Work

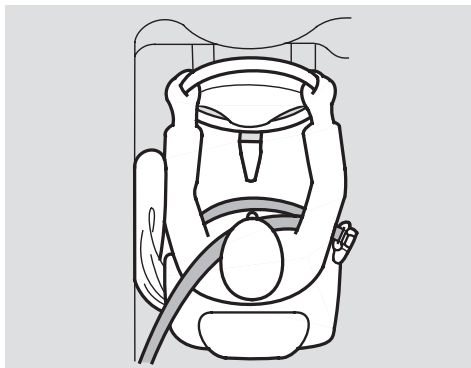

If you ever have a moderate to severe side impact, sensors will detect rapid acceleration and signal the control unit to instantly inflate either the driver's or the passenger's side airbag and activate the seat belt tensioner on the affected side.

Only one airbag will deploy during a side impact. If the impact is on the passenger's side, the passenger's side airbag will deploy even if there is no passenger.

To get the best protection from the side airbags, front seat occupants should wear their seat belts and sit upright and well back in their seats.

Side Airbag Cutoff System

Your vehicle has a side airbag cutoff system designed primarily to protect a child riding in the front passenger's seat.

Although Acura does not encourage children to ride in front, if the position sensors detect a child has leaned into the side airbag's deployment path, the airbag will shut off.

The side airbag may also shut off if a short adult leans sideways, or a larger adult slouches and leans sideways into the airbag's deployment path.

Objects placed on the front passenger seat can also cause the side airbag to be shut off.

Additional Information About Your Airbags

If the side airbag off indicator comes on (see page 32), have the passenger sit upright. Once the passenger is out of the airbag's deployment path, the system will turn the airbag back on, and the indicator will go out.

There will be some delay between the moment the passenger moves into or out of the airbag deployment path and when the indicator comes on or goes off.

A front seat passenger should not use a cushion or other object as a backrest. It may prevent the cutoff system from working properly.

How Your Side Curtain Airbags Work

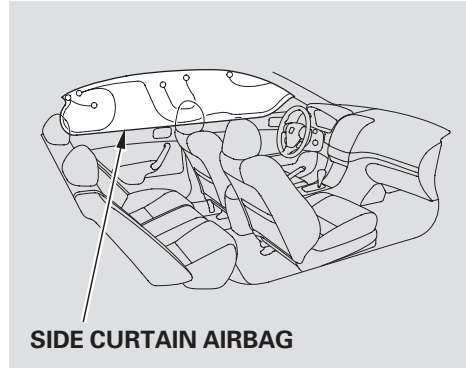

In a moderate to severe side impact, sensors will detect rapid acceleration and signal the control unit to instantly inflate the side curtain airbag and activate the seat belt tensioner on the driver's or the passenger's side of the vehicle.

If the impact is on the passenger's side, the passenger's side curtain airbag will inflate even if there are no occupants on that side of the vehicle.

To get the best protection from the side curtain airbags, occupants should wear their seat belts and sit upright and well back in their seats.

Additional Information About Your Airbags

How the SRS Indicator Works



The SRS indicator alerts you to a potential problem with your airbags or seat belt tensioners.

When you turn the ignition switch to the ON (II) position, this indicator comes on for several seconds then goes off. This tells you the system is working properly.

If the indicator comes on at any other time, or does not come on at all, you should have the system checked by your dealer. For example:

- If the SRS indicator does not come on after you turn the ignition switch to the ON (II) position.
- If the indicator stays on after the engine starts.
- If the indicator comes on or flashes on and off while you drive.

You will also see a “CHECK AIRBAG SYSTEM” message on the multi-information display (see page 83).

If you see any of these indications, the airbags and seat belt tensioners may not work properly when you need them.

WARNING

Ignoring the SRS indicator can result in serious injury or death if the airbag systems or tensioners do not work properly.

Have your vehicle checked by a dealer as soon as possible if the SRS indicator alerts you to a possible problem.

How the Side Airbag Off Indicator Works

U.S.



Canada



This indicator alerts you that the passenger’s side airbag has been automatically shut off. It does *not* mean there is a problem with your side airbags.

When you turn the ignition switch to the ON (II) position, the indicator should come on for several seconds and then go off (see page 64). If it doesn’t come on, stays on, or comes on while driving without a passenger in the front seat, have the system checked.

You will also see a “PASSENGER SIDE AIRBAG OFF” message on the multi-information display (see page 82).

How the Passenger Airbag Off Indicator Works

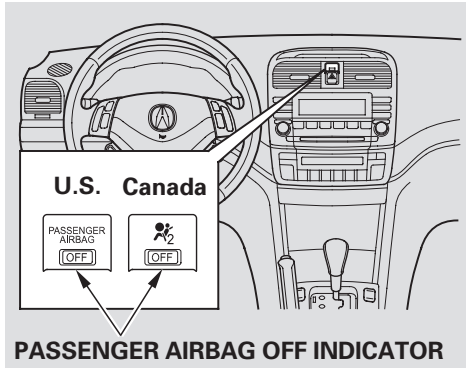

This indicator alerts you that the passenger's front airbag has been shut off because weight sensors detect about 65 lbs (29 kg) or less (the weight of an infant or small child) on the front passenger's seat. It does **not mean** there is a problem with the airbag.

Be aware that objects placed on the front seat can cause the indicator to come on.

If the weight sensors detect there is no passenger in the front seat, the airbag will be off. However, the passenger airbag off indicator will not come on.

The passenger airbag off indicator may come on and off repeatedly if the total weight on the seat is near the airbag cutoff threshold.

If an adult or teenage passenger is riding in front, move the seat as far to the rear as possible, and have the passenger sit upright and wear the seat belt properly.

If the indicator comes on with no front seat passenger and no objects on the seat, or with an adult riding there, something may be interfering with the weight sensors. Look for and remove:

- Any items under the front passenger's seat.
- Any object hanging on the seat or in the seat-back pocket.
- Any object, such as a folded-down back seat, that is touching the rear of the seat-back.

If no obstructions are found, have your vehicle checked by a dealer as soon as possible.

Additional Information About Your Airbags

Airbag Service

Your airbag systems are virtually maintenance free, and there are no parts you can safely service.

However, you must have your vehicle serviced if:

- ***An airbag ever inflates.*** Any airbag that has deployed must be replaced along with the control unit and other related parts. Any seat belt tensioner that activates must also be replaced.

Do not try to remove or replace any airbag by yourself. This must be done by an authorized dealer or a knowledgeable body shop.

- ***The SRS indicator alerts you to a problem.*** Take your vehicle to an authorized dealer as soon as possible. If you ignore this indication, your airbags may not operate properly.

- ***If your vehicle has a moderate to severe impact.*** Even if your airbags do not inflate, your dealer should inspect the driver's seat position sensor, the front passenger's weight sensors, the front seat belt tensioners, and all seat belts worn during a crash to make sure they are operating properly.

Additional Safety Precautions

- ***Do not attempt to deactivate your airbags.*** Together, airbags and seat belts provide the best protection.
- ***Do not tamper with airbag components or wiring for any reason.*** Tampering could cause the airbags to deploy, possibly causing very serious injury.
- ***Do not expose the front passenger's seat-back to liquid.*** If water or another liquid soaks into a seat-back, it can prevent the side airbag cutoff system from working properly.
- ***Do not cover or replace front seat-back covers without consulting your dealer.*** Improperly replacing or covering front seat-back covers can prevent your side airbags from inflating during a side impact.
- ***Do not remove or modify a front seat without consulting your dealer.*** This could make the driver's seat position sensor or the front passenger's weight sensors ineffective. If it is necessary to remove or modify a front seat to accommodate a person with disabilities, first contact Acura Client Services at 800-382-2238.

Protecting Children – General Guidelines



Children depend on adults to protect them. However, despite their best intentions, many adults do not know how to *properly* protect child passengers.

If you have children, or ever need to drive with a child in your vehicle, be sure to read this section. It begins with important general guidelines, then presents special information for infants, small children, and larger children.

All Children Must Be Restrained

Each year, many children are injured or killed in vehicle crashes because they are either unrestrained or not properly restrained. In fact, vehicle accidents are the number one cause of the death of children ages 12 and under.

To reduce the number of child deaths and injuries, every state and Canadian province requires that infants and children be properly restrained when they ride in a vehicle.

Infants and small children must be restrained in an approved child seat that is properly secured to the vehicle (see pages 41 – 50).

⚠ WARNING

Children who are unrestrained or improperly restrained can be seriously injured or killed in a crash.

Any child too small for a seat belt should be properly restrained in a child seat. A larger child should be properly restrained with a seat belt and use a booster seat if necessary.

Larger children must be restrained with a lap/shoulder belt and ride on a booster seat until the seat belt fits them properly (see pages 51 – 54).

All Children Should Sit in a Back Seat

According to accident statistics, children of all ages and sizes are safer when they are restrained in a back seat. The National Highway Traffic Safety Administration and Transport Canada recommend that all children aged 12 and under be properly restrained in a back seat. Some states have laws restricting where children may ride.

Children who ride in back are less likely to be injured by striking interior vehicle parts during a collision or hard braking. Also, children cannot be injured by an inflating front airbag when they ride in the back.

The Passenger's Front Airbag Can Pose Serious Risks

Front airbags have been designed to help protect adults in a moderate to severe frontal collision. To do this, the passenger's front airbag is quite large, and it can inflate with enough force to cause very serious injuries.

Even though your vehicle has an advanced front airbag system that automatically turns the passenger's front airbag off (see page 33), please follow these guidelines:

Infants

Never put a rear-facing child seat in the front seat of a vehicle equipped with a passenger's front airbag. If the airbag inflates, it can hit the back of the child seat with enough force to kill or very seriously injure an infant.

Small Children

Placing a forward-facing child seat in the front seat of a vehicle equipped with a passenger's front airbag can be hazardous. If the vehicle seat is too far forward, or the child's head is thrown forward during a collision, an inflating front airbag can strike the child with enough force to kill or very seriously injure a small child.

Larger Children

Children who have outgrown child seats are also at risk of being injured or killed by an inflating passenger's front airbag. Whenever possible, larger children should sit in the back seat, on a booster seat if needed, and be properly restrained with a seat belt (see page 51 for important information about protecting larger children).

CONTINUED

Protecting Children – General Guidelines

To remind you of the passenger's front airbag hazards, and that children must be properly restrained in a back seat, your vehicle has warning labels on the dashboard (U.S. models) and on the front visors. Please read and follow the instructions on these labels.

U.S. Models

SUN VISORS



Canadian Models

SUN VISORS

CAUTION

TO AVOID SERIOUS INJURY:

- FOR MAXIMUM SAFETY PROTECTION IN ALL TYPES OF CRASHES, YOU MUST ALWAYS WEAR YOUR SAFETY BELT.
- DO NOT INSTALL REARWARD-FACING CHILD SEATS IN ANY FRONT PASSENGER SEAT POSITION.
- DO NOT SIT OR LEAN UNNECESSARILY CLOSE TO THE AIR BAG.
- DO NOT PLACE ANY OBJECTS OVER THE AIR BAG OR BETWEEN THE AIR BAG AND YOURSELF.
- SEE THE OWNER'S MANUAL FOR FURTHER INFORMATION AND EXPLANATIONS.

PRECAUTIONS:

POUR EVITER DES BLESSURES GRAVES:

- POUR PROFITER D'UNE PROTECTION MAXIMALE LORS D'UNE COLLISION BOUCLEZ TOUJOURS VOTRE CEINTURE DE SECURITE.
- N'INSTALLEZ JAMAIS UN SIEGE POUR ENFANTS FAISANT FACE A L'ARRIERE SUR LE SIEGE DU PASSAGER AVANT.
- NE VOUS APPUYEZ PAS ET NE VOUS ASSOYEZ PAS PRES DU COUSSIN GONFLABLE.
- NE DEPOSEZ AUCUN OBJET SUR LE COUSSIN GONFLABLE OU ENTRE LE COUSSIN GONFLABLE ET VOUS.
- LISEZ LE GUIDE UTILISATEUR POUR DE PLUS AMPLES RENSEIGNEMENTS.

DASHBOARD

This Vehicle is Equipped with
Advanced Air Bags

Even with Advanced Air Bags

Children can be killed or seriously injured by the air bag.

The back seat is the safest place for children.

Never put a rear-facing child seat in the front.

Always use seat belts and child restraints.

See owner's manual for more information about air bags.

To be removed by owner only.

If You Must Drive with Several Children

Your vehicle has a back seat where children can be properly restrained. If you ever have to carry a group of children, and a child must ride in front:

- Place the largest child in the front seat, provided the child is large enough to wear the lap/shoulder belt properly (see page 51).
- Move the vehicle seat as far to the rear as possible (see page 12).
- Have the child sit upright and well back in the seat (see page 16).
- Make sure the seat belt is properly positioned and secured (see page 15).

If a Child Requires Close Attention

Many parents say they prefer to put an infant or a small child in the front passenger seat so they can watch the child, or because the child requires attention.

Placing a child in the front seat exposes the child to hazards in a frontal collision, and paying close attention to a child distracts the driver from the important tasks of driving, placing both of you at risk.

If a child requires close physical attention or frequent visual contact, we strongly recommend that another adult ride with the child in a back seat. The back seat is far safer for a child than the front.

Protecting Children – General Guidelines

Additional Safety Precautions

- **Never hold an infant or child on your lap.** If you are not wearing a seat belt in a crash, you could be thrown forward and crush the child against the dashboard or a seat-back. If you are wearing a seat belt, the child can be torn from your arms and be seriously hurt or killed.
- **Never put a seat belt over yourself and a child.** During a crash, the belt could press deep into the child and cause serious or fatal injuries.
- **Never let two children use the same seat belt.** If they do, they could be very seriously injured in a crash.
- **Use the childproof door locks to prevent children from opening the rear doors.** This can prevent children from accidentally falling out (see page [130](#)).

- **Make sure any unused seat belt that a child can reach is buckled, the lockable retractor is activated, and the belt is fully retracted and locked.** If a child wraps a loose seat belt around their neck, they can be seriously or fatally injured. (See pages [48](#) and [49](#) for how to activate and deactivate the lockable retractor.)

- **Do not leave children alone in a vehicle.** Leaving children without adult supervision is illegal in most states and Canadian provinces, and can be very hazardous.

For example, infants and small children left in a vehicle on a hot day can die from heatstroke. A child left alone with the key in the ignition switch can accidentally set the vehicle in motion, possibly injuring themselves or others.

- **Lock all doors and the trunk when your vehicle is not in use.** Children who play in vehicles can accidentally get trapped inside. Teach your children not to play in or around vehicles. Know how to operate the emergency trunk opener and decide if your children should be shown how to use this feature (see page [136](#)).
- **Keep vehicle keys and remote transmitters out of the reach of children.** Even very young children learn how to unlock vehicle doors, turn on the ignition switch, and open the trunk, which can lead to accidental injury or death.

Protecting Infants

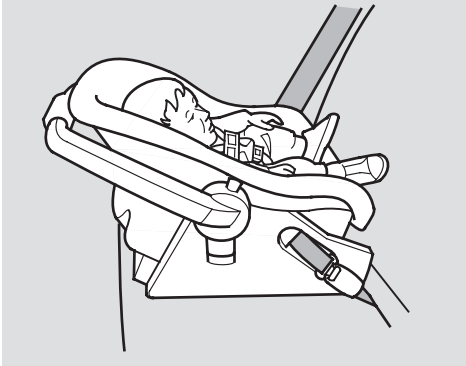

Child Seat Type

An infant must be properly restrained in a rear-facing, reclining child seat until the child reaches the seat maker's weight or height limit for the seat, and the child is at least one year old.

Only a rear-facing child seat provides proper support for a baby's head, neck, and back.

Two types of seats may be used: a seat designed exclusively for infants, or a convertible seat used in the rear-facing, reclining mode.

Do not put a rear-facing child seat in a forward-facing position. If placed facing forward, an infant could be very seriously injured during a frontal collision.

Rear-facing Child Seat Placement

A rear-facing child seat can be placed in any seating position in the back seat, but not in the front. ***Never put a rear-facing child seat in the front seat.***

If the passenger's front airbag inflates, it can hit the back of the child seat with enough force to kill or seriously injure an infant.

When properly installed, a rear-facing child seat may prevent the driver or a front passenger from moving their seat as far back as recommended, or from locking their seat-back in the desired position.

It can also interfere with proper operation of the passenger's advanced front airbag system.

CONTINUED

Protecting Infants and Small Children

In any of these situations, we strongly recommend that you install the child seat directly behind the front passenger's seat, move the seat as far forward as needed, and leave it unoccupied. Or, you may wish to get a smaller rear-facing child seat.

⚠ WARNING

Placing a rear-facing child seat in the front seat can result in serious injury or death during a collision.

Always place a rear-facing child seat in the back seat, not the front.

Protecting Small Children

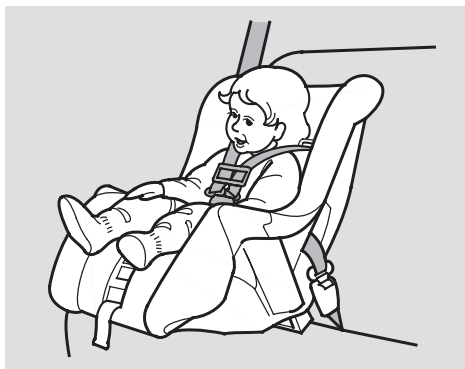

Child Seat Type

A child who is at least one year old, and who fits within the child seat maker's weight and height limits, should be restrained in a forward-facing, upright child seat.

Of the different seats available, we recommend those that have a five-point harness system as shown.

We also recommend that a small child use the child seat until the child reaches the weight or height limit for the seat.

Child Seat Placement

We strongly recommend placing a forward-facing child seat in a back seat, not the front.

Placing a forward-facing child seat in the front seat of a vehicle equipped with a passenger's airbag can be hazardous. If the vehicle seat is too far forward, or the child's head is thrown forward during a collision, an inflating airbag can strike the child with enough force to cause very serious or fatal injuries.

Even with advanced front airbags, which can automatically turn the passenger's front airbag off (see page 33), a back seat is the safest place for a small child.

If it is necessary to put a forward-facing child seat in the front, move the vehicle seat as far to the rear as possible, and be sure the child seat is firmly secured to the vehicle and the child is properly strapped in the seat.

⚠ WARNING

Placing a forward-facing child seat in the front seat can result in serious injury or death if the front airbag inflates.

If you must place a forward-facing child seat in front, move the vehicle seat as far back as possible, and properly restrain the child.

Selecting Child Seats

When buying a child seat, you need to choose either a conventional child seat, or one designed for use with the lower anchors and tethers for children (LATCH) system.

Conventional child seats must be secured to a vehicle with a seat belt, whereas LATCH-compatible seats are secured by attaching the seat to hardware built into the two outer seating positions in the back seat.

Since LATCH-compatible child seats are easier to install and reduce the possibility of improper installation, we recommend selecting this style.

In seating positions and vehicles not equipped with LATCH, a LATCH-compatible child seat can be installed using a seat belt.

Whatever type of seat you choose, to provide proper protection, a child seat should meet three requirements:

- 1. The child seat should meet U.S. or Canadian Motor Vehicle Safety Standard 213.*** Look for FMVSS 213 or CMVSS 213 on the box.
- 2. The child seat should be of the proper type and size to fit the child.*** Rear-facing for infants, forward-facing for small children.
- 3. The child seat should fit the vehicle seating position (or positions) where it will be used.***

Before purchasing a conventional child seat, or using a previously purchased one, we recommend that you test the seat in the specific vehicle seating position or positions where the seat will be used.

After selecting a proper child seat and a good place to install the seat, there are three main steps in installing the seat:

1. Properly secure the child seat to the vehicle. All child seats must be secured to the vehicle with the lap part of a lap/shoulder belt or with the LATCH (lower anchors and tethers for children) system. A child whose seat is not properly secured to the vehicle can be endangered in a crash.

2. Make sure the child seat is firmly secured. After installing a child seat, push and pull the seat forward and from side-to-side to verify that it is secure.

A child seat secured with a seat belt should be installed as firmly as possible. However, it does not need to be “rock solid.” Some side-to-side movement can be expected and should not reduce the child seat’s effectiveness.

If the child seat is not secure, try installing it in a different seating position, or use a different style of child seat that can be firmly secured.

3. Secure the child in the child seat.

Make sure the child is properly strapped in the child seat according to the child seat maker’s instructions. A child who is not properly secured in a child seat can be seriously injured in a crash.

The following pages provide guidelines on how to properly install a child seat. A forward-facing child seat is used in all examples, but the instructions are the same for rear-facing child seats.

Installing a Child Seat

Installing a Child Seat with LATCH

Your vehicle is equipped with LATCH (lower anchors and tethers for children) at the outer rear seats.

The lower anchors are located between the seat-back and seat bottom, and are to be used only with a child seat designed for use with LATCH.

The location of each lower anchor is indicated by a small button above the anchor point.

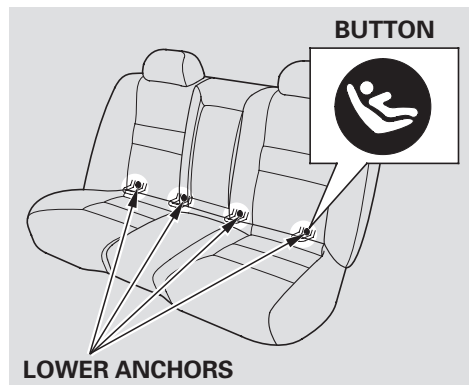

To install a LATCH-compatible child seat:

1. Move the seat belt buckle or tongue away from the lower anchors.
2. Make sure there are no objects near the anchors that could prevent a secure connection between the child seat and the anchors.

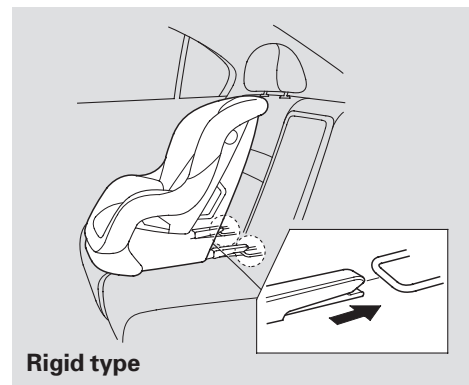

3. Place the child seat on the vehicle seat, then attach the seat to the lower anchors according to the child seat maker's instructions.

Some LATCH-compatible seats have a rigid-type connector as shown above.

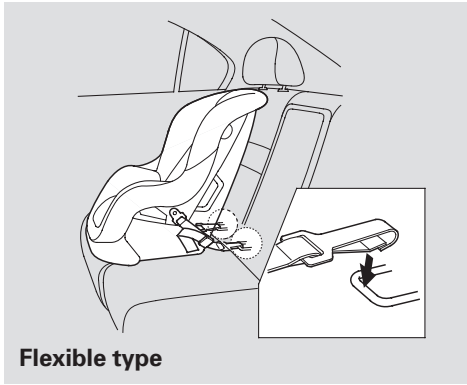

Flexible type

Other LATCH-compatible seats have a flexible-type connector as shown above.

4. Whatever type you have, follow the child seat maker's instructions for adjusting or tightening the fit.

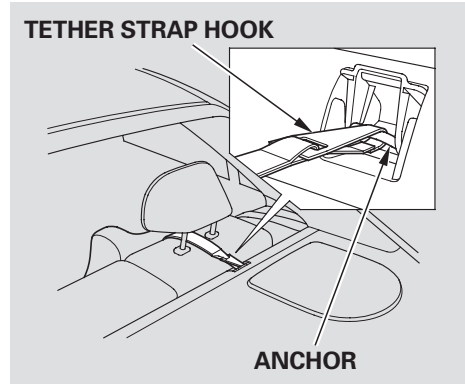

5. Lift the head restraint (see page [139](#)), then route the tether strap through the legs of the head restraint and over the seat-back, making sure the strap is not twisted.

If the tether strap is too long and cannot be tightened firmly, find a route where the strap can be tightened securely.

6. Attach the tether strap hook to the tether anchor, then tighten the strap as instructed by the child seat maker.
7. Push and pull the child seat forward and from side-to-side to verify that it is secure.

Installing a Child Seat

Installing a Child Seat with a Lap/Shoulder Belt

When not using the LATCH system, all child seats must be secured to the vehicle with the lap part of a lap/shoulder belt.

In addition, the lap/shoulder belts in all seating positions except the driver's have a lockable retractor that must be activated to secure a child seat.



1. With the child seat in the desired seating position, route the belt through the child seat according to the seat maker's instructions, then insert the latch plate into the buckle.



2. To activate the lockable retractor, slowly pull the shoulder part of the belt all the way out until it stops, then let the belt feed back into the retractor.
3. After the belt has retracted, tug on it. If the belt is locked, you will not be able to pull it out. If you can pull the belt out, it is not locked, and you will need to repeat these steps.

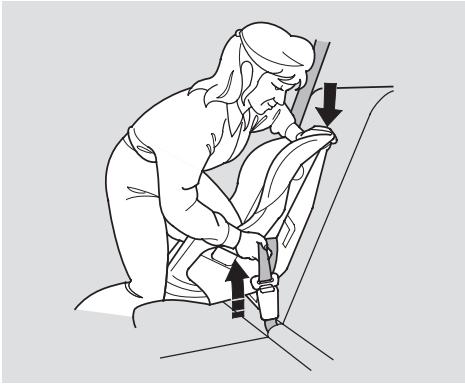

4. After confirming that the belt is locked, grab the shoulder part of the belt near the buckle, and pull up to remove any slack from the lap part of the belt. Remember, if the lap part of the belt is not tight, the child seat will not be secure.

To remove slack, it may help to put weight on the child seat, or push on the back of the seat while pulling up on the belt.

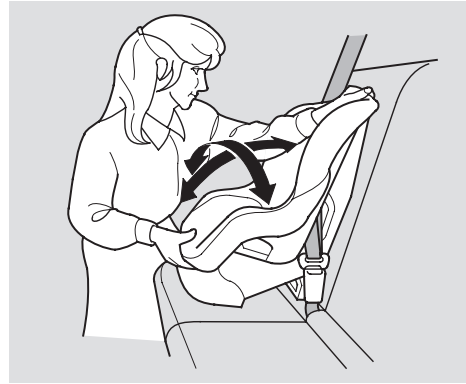

5. Push and pull the child seat forward and from side-to-side to verify that it is secure enough to stay upright during normal driving maneuvers. If the child seat is not secure, unlatch the belt, allow it to retract fully, then repeat these steps.

To deactivate the lockable retractor and remove a child seat, unlatch the buckle, unroute the seat belt, and let the belt fully retract.

Installing a Child Seat with a Tether

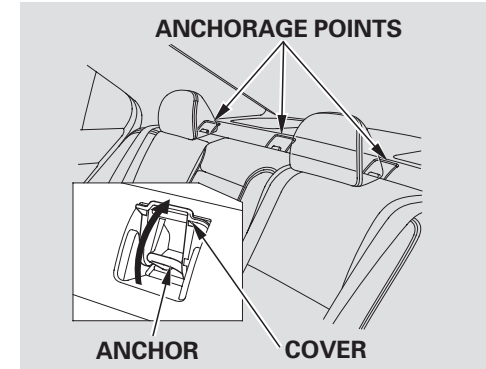

A child seat with a tether can be installed in any seating position in the back seat, using one of the anchorage points shown above.

Since a tether can provide additional security to the lap/shoulder belt installation, we recommend using a tether whenever one is required or available.

CONTINUED

Installing a Child Seat

Using an Outer Anchor

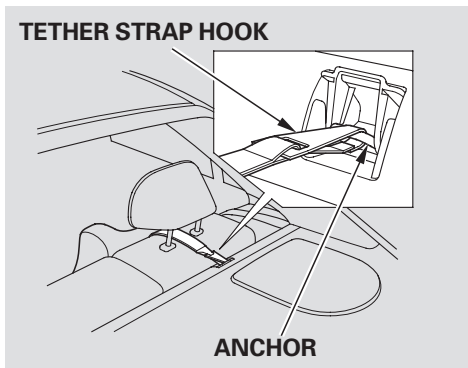

1. After properly securing the child seat (see page 48), lift the head restraint, then route the tether strap over the seat-back and through the head restraint legs.

If the tether strap is too long and cannot be tightened firmly, find a route where the strap can be tightened securely.

2. Lift the anchor cover, then attach the tether strap hook to the anchor, making sure the strap is not twisted.
3. Tighten the strap according to the seat maker's instructions.

Using the Center Anchor

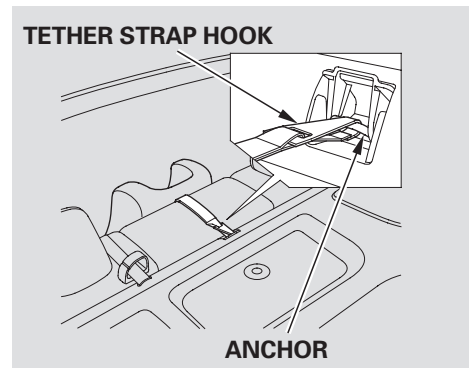

1. After properly securing the child seat (see page 48), route the tether strap over the seat-back.
2. Follow steps 2 and 3 from the previous column.

When a child reaches the recommended weight or height limit for a forward-facing child seat, the child should sit in a back seat on a booster seat and wear a lap/shoulder belt.

The following pages give instructions on how to check proper seat belt fit, what kind of booster seat to use if one is needed, and important precautions for a child who must sit in front.

⚠ WARNING

Allowing a child age 12 or under to sit in front can result in injury or death if the passenger's front airbag inflates.

If a child must ride in front, move the vehicle seat as far back as possible, use a booster seat if needed, have the child sit up properly and wear the seat belt properly.

Checking Seat Belt Fit



To determine if a lap/shoulder belt properly fits a child, have the child put on the seat belt, then ask yourself:

1. Does the child sit all the way back against the seat?
2. Do the child's knees bend comfortably over the edge of the seat?

CONTINUED

Protecting Larger Children

3. Does the shoulder belt cross between the child's neck and arm?
4. Is the lap part of the belt as low as possible, touching the child's thighs?
5. Will the child be able to stay seated like this for the whole trip?

If you answer yes to all these questions, the child is ready to wear the lap/shoulder belt correctly. If you answer no to any question, the child needs to ride on a booster seat.

Using a Booster Seat



A child who has outgrown a forward-facing child seat should ride in a back seat and use a booster seat until the lap/shoulder belt fits them properly without the booster.

Some states and Canadian provinces also require children to use a booster seat until they reach a given age or weight (e.g., 6 years or 60 lbs). Be sure to check current laws in the states or provinces where you intend to drive.

Booster seats can be high-back or low-back. Whichever style you select, make sure the booster seat meets federal safety standards (see page [44](#)) and that you follow the booster seat maker's instructions.

If a child who uses a booster seat must ride in front, move the vehicle seat as far back as possible and be sure the child is wearing the seat belt properly.

A child may continue using a booster seat until the tops of their ears are even with the top of the vehicle's or booster's seat-back. A child of this height should be tall enough to use the lap/shoulder belt without a booster seat.

When Can a Larger Child Sit in Front

The National Highway Traffic Safety Administration and Transport Canada recommend that all children age 12 and under be properly restrained in a back seat.

If the passenger's front airbag inflates in a moderate to severe frontal collision, the airbag can cause serious injuries to a child who is unrestrained, improperly restrained, sitting too close to the airbag, or out of position.

A side airbag also poses risks. If any part of a larger child's body is in the path of a deploying side airbag, the child could receive possibly serious injuries.

Of course, children vary widely. And while age may be one indicator of when a child can safely ride in front, there are other important factors you should consider.

Physical Size

Physically, a child must be large enough for the lap/shoulder belt to properly fit (see pages 15 and 51). If the seat belt does not fit properly, with or without the child sitting on a booster seat, the child should not sit in front.

Maturity

To safely ride in front, a child must be able to follow the rules, including sitting properly, and wearing the seat belt properly throughout a ride.

CONTINUED

Protecting Larger Children

If you decide that a child can safely ride up front, be sure to:

- Carefully read the owner's manual, and make sure you understand all seat belt instructions and all safety information.
- Move the vehicle seat to the rear-most position.
- Have the child sit up straight, back against the seat, and feet on or near the floor.
- Check that the child's seat belt is properly positioned and secured.
- Supervise the child. Even mature children sometimes need to be reminded to fasten the seat belts or sit properly.

Additional Safety Precautions

- ***Do not let a child wear a seat belt across the neck.*** This could result in serious neck injuries during a crash.
 - ***Do not let a child put the shoulder part of a seat belt behind the back or under the arm.*** This could cause very serious injuries during a crash. It also increases the chance that the child will slide under the belt in a crash and be injured.
 - ***Two children should never use the same seat belt.*** If they do, they could be very seriously injured in a crash.
- ***Do not put any accessories on a seat belt.*** Devices intended to improve a child's comfort or reposition the shoulder part of a seat belt can make the belt less effective and increase the chance of serious injury in a crash.

Your vehicle's exhaust contains carbon monoxide gas. Carbon monoxide should not enter the vehicle in normal driving if you maintain your vehicle properly and follow the information on this page.

Have the exhaust system inspected for leaks whenever:

- The vehicle is raised for an oil change.
- You notice a change in the sound of the exhaust.
- The vehicle was in an accident that may have damaged the underside.

WARNING

Carbon monoxide gas is toxic. Breathing it can cause unconsciousness and even kill you.

Avoid any enclosed areas or activities that expose you to carbon monoxide.

High levels of carbon monoxide can collect rapidly in enclosed areas, such as a garage. Do not run the engine with the garage door closed. Even with the door open, run the engine only long enough to move the vehicle out of the garage.

With the trunk open, airflow can pull exhaust gas into your vehicle's interior and create a hazardous condition. If you must drive with the trunk open, open all the windows and set the climate control system as shown below.

If you must sit in your parked vehicle with the engine running, even in an unconfined area, adjust the climate control system as follows:

1. Select the fresh air mode.
2. Select the  mode.
3. Set the fan speed to high.
4. Set the temperature control to a comfortable setting.

Safety Labels

These labels are in the locations shown. They warn you of potential hazards that could cause serious injury or death. Read these labels carefully.

If a label comes off or becomes hard to read (except for the U.S. dashboard label which may be removed by the owner), contact your dealer for a replacement.

RADIATOR CAP



DASHBOARD

U.S. models only

This Vehicle is Equipped with
Advanced Air Bags

Even with Advanced Air Bags

Children can be killed or seriously injured by the air bag. The back seat is the safest place for children. Never put a rear-facing child seat in the front. Always use seat belts and child restraints. See owner's manual for more information about air bags.

To be removed by owner only.

HOOD

U.S. models

SUPPLEMENTAL RESTRAINT SYSTEM (SRS)
This vehicle is equipped with front air bags, side air bags in the front seats, front (driver) and side curtain air bags. All SRS warning and indicator lights are colored yellow.

Warning with flashing or using not equipped or the SRS warning will cause the system to operate or cause accidental deployment.

▲ WARNING

Accidental deployment can seriously hurt or kill you. See Service Manual instructions carefully.

Canadian models

SUPPLEMENTAL RESTRAINT SYSTEM (SRS)
This vehicle is equipped with front air bags, side air bags in the front seats, front (driver) and side curtain air bags. All SRS warning and indicator lights are colored yellow. Warning with flashing or using not equipped or the SRS warning will cause the system to operate or cause accidental deployment.

▲ WARNING

Accidental deployment can seriously hurt or kill you. See Service Manual instructions carefully.

SYSTÈME DE RETENUE SUPPLÉMENTAIRE (SRS)
Ce véhicule est équipé de ceintures de sécurité portables, de ceintures portables latérales, de ceintures portables latérales de type bébé, de ceintures de protection de tête et de ceintures de protection de tête. Les voyants et les dispositifs du système SRS sont jaunes.

Une mise en garde avec clignotement ou utilisation du système SRS sans être équipé peut causer le système à fonctionner ou à déclencher accidentellement.

▲ ATTENTION

Un déploiement accidentel peut entraîner des blessures graves ou la mort. Consultez les instructions de manuel de référence attentivement.

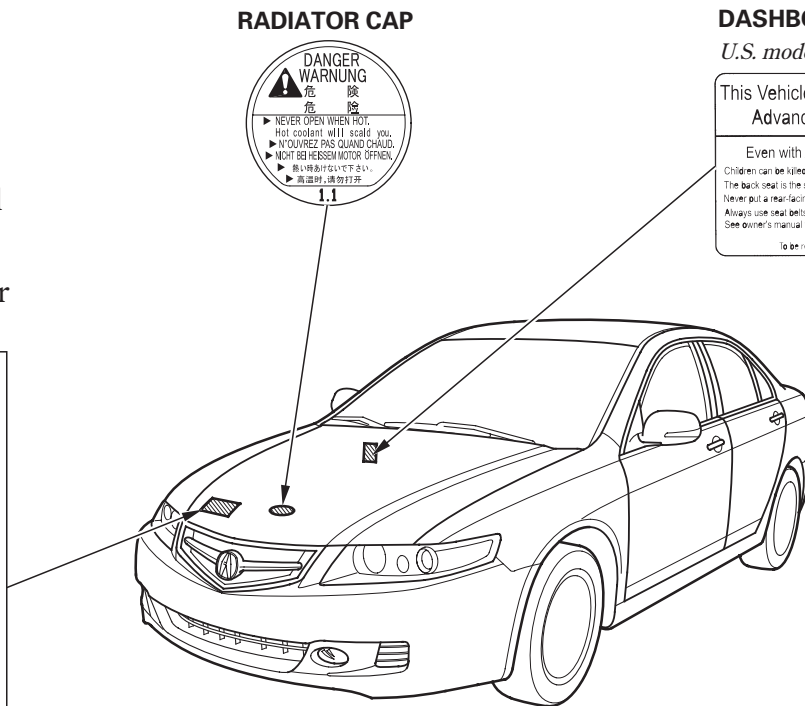

SUN VISORS

U.S. models



Canadian models

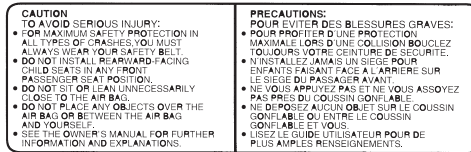

DOORJAMBS

U.S. models

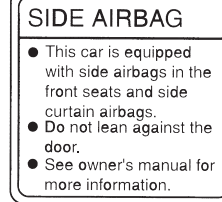

Canadian models

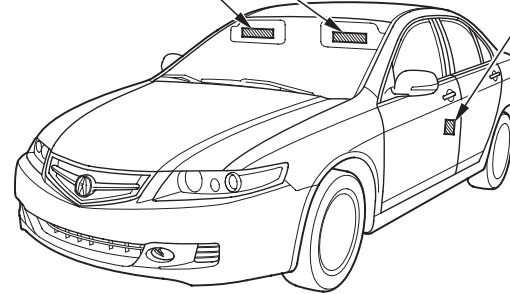
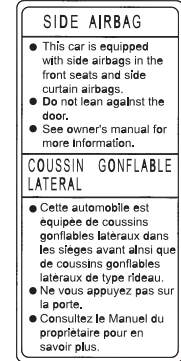

This section gives information about the controls and displays that contribute to the daily operation of your vehicle. All the essential controls are within easy reach.

| | | | |
|-----------------------------------|-----|---------------------------------|-----|
| Control Locations | 60 | Trunk Main Switch..... | 136 |
| Instrument Panel | 61 | Seat Heaters | 137 |
| Instrument Panel Indicators..... | 62 | Seats | 138 |
| Gauges | 68 | Power Seat Adjustment | 138 |
| Multi-Information Display | 69 | Driver's Lumbar Support..... | 139 |
| Controls Near the Steering | | Head Restraints | 139 |
| Wheel..... | 119 | Folding Rear Seat | 141 |
| Windshield Wipers and | | Driving Position Memory | |
| Washers | 120 | System..... | 143 |
| Turn Signals and Headlights..... | 121 | Mirrors..... | 145 |
| Fog Lights | 122 | Adjusting the Power Mirrors ... | 146 |
| Automatic Lighting Off | | Power Mirror Heaters..... | 146 |
| Feature..... | 122 | Power Windows | 147 |
| Daytime Running Lights..... | 122 | Moonroof | 150 |
| Instrument Panel Brightness | 123 | Parking Brake | 151 |
| Hazard Warning Button..... | 124 | Sun Visor..... | 152 |
| Rear Window Defogger | 124 | Vanity Mirror | 152 |
| Steering Wheel Adjustment | 125 | Interior Lights..... | 153 |
| Keys and Locks..... | 126 | Interior Convenience Items..... | 155 |
| Immobilizer System..... | 127 | Beverage Holders..... | 156 |
| Ignition Switch | 128 | Accessory Power Sockets..... | 156 |
| Door Locks | 129 | Console Compartment | 157 |
| Childproof Door Locks | 130 | Sunglasses Holder | 158 |
| Remote Transmitter | 131 | Glove Box | 158 |
| Trunk..... | 135 | | |
| Emergency Trunk Opener | 136 | | |

Control Locations

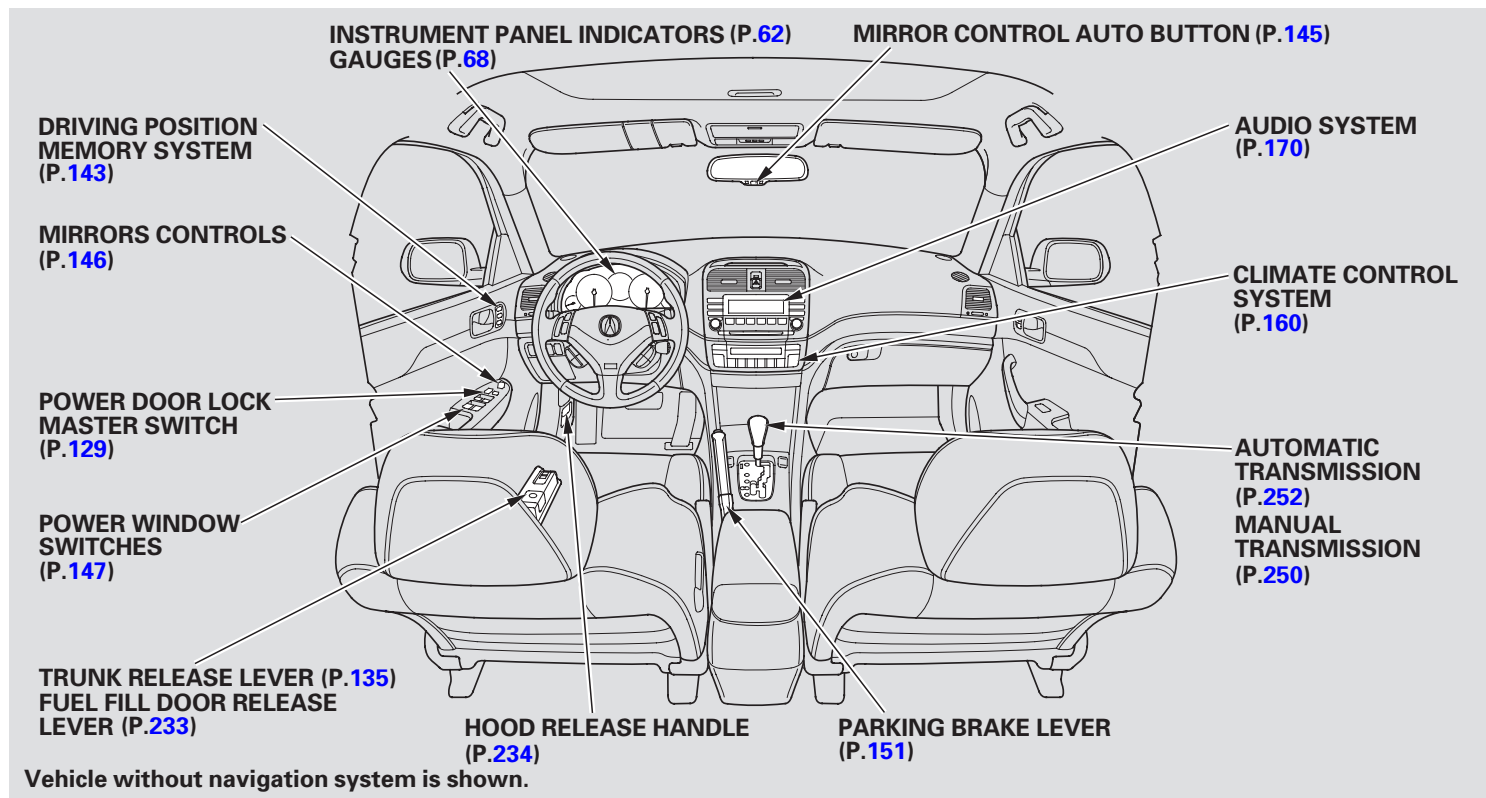

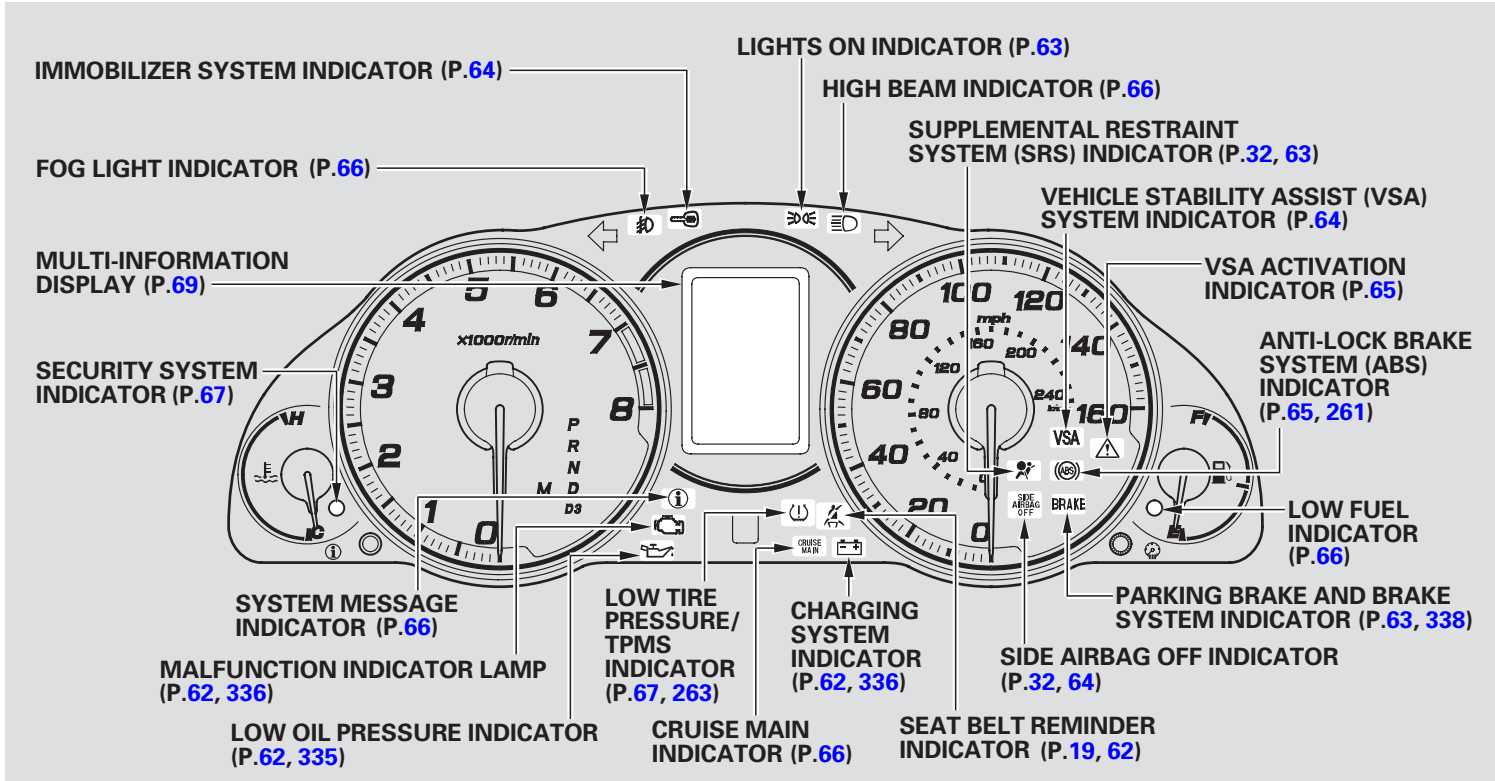

The U.S. instrument panel is shown. Differences for the Canadian models are noted in the text.

Instrument Panel Indicators

The instrument panel has many indicators to give you important information about your vehicle.



Seat Belt Reminder Indicator

This indicator comes on when you turn the ignition switch to the ON (II) position. It reminds you and your passengers to fasten your seat belts. A beeper also sounds if you and your front passenger have not fastened your seat belts.

If you turn the ignition switch to the ON (II) position before fastening your seat belts, the beeper sounds, and the indicator flashes. If you do not fasten your seat belts before the beeper stops, the indicator stops flashing but remains on.

If your front passenger does not fasten their seat belt, the indicator comes on about 6 seconds after the ignition switch is turned to the ON (II) position.

If either of you do not fasten your seat belt while driving, the beeper will sound and the indicator will flash again at regular intervals. For more information, see page 19.

You will also see a “FASTEN SEAT BELT” or “FASTEN PASSENGER SEAT BELT” message on the multi-information display (see page 78).



Malfunction Indicator Lamp

You will also see a “CHECK EMISSION SYSTEM” message on the multi-information display (see page 84). For more information, see page 336.



Low Oil Pressure Indicator

The engine can be severely damaged if this indicator flashes or stays on when the engine is running. For more information, see page 335. You will also see a “CHECK ENGINE OIL LEVEL” message on the multi-information display (see page 82).



Charging System Indicator

If this indicator comes on when the engine is running, the battery is not being charged, and you will also see a “CHECK CHARGING SYSTEM” message on the multi-information display (see page 84). For more information, see page 336.

U.S. Canada

BRAKE



Parking Brake and Brake System Indicator

This indicator has two functions:



1. It comes on when you turn the ignition switch to the ON (II) position. It is a reminder to check the parking brake. Driving with the parking brake not fully released can damage the rear brakes, axles, and tires.

If you drive without releasing the parking brake, a beeper will sound, and you will also see a “RELEASE PARKING BRAKE” message on the multi-information display (see page 78).

2. If it stays on after you have fully released the parking brake while the engine is running, or if it comes on while driving, it can indicate a problem in the brake system. You will also see a “BRAKE FLUID LOW” or “CHECK BRAKE SYSTEM” message on the multi-information display (see pages 79 , 84). For more information, see page 338 .



Lights On Indicator

This indicator reminds you that the exterior lights are on. It comes on when the light switch is in either the  or  position. If you turn the ignition switch to the ACCESSORY (I) or the LOCK (0) position without turning off the light switch, this indicator will remain on. A reminder chime will also sound when you open the driver’s door and remove the key from the ignition switch.



Supplemental Restraint System (SRS) Indicator

This indicator comes on for several seconds when you turn the ignition switch to the ON (II) position. If it comes on at any other time, it indicates a potential problem with your front airbags. This indicator will also alert you to a potential problem with your side airbags, passenger’s side airbag automatic cutoff system, automatic seat belt tensioners, side curtain airbags, driver’s seat position sensor, and the front passenger’s weight sensors. You will also see a “CHECK AIRBAG SYSTEM” message on the multi-information display (see page 83). For more information, see page 32 .

Instrument Panel Indicators



This indicator comes on when you turn the ignition switch to the ON (II) position. If it comes on at any other time, it indicates that the passenger's side airbag has automatically shut off. You will also see a "PASSENGER SIDE AIRBAG OFF" message on the multi-information display (see page [82](#)). For more information, see page [32](#) .



Immobilizer System Indicator

This indicator comes on for a few seconds when you turn the ignition switch to the ON (II) position. It will then go off if you have a properly-coded ignition key. If it is not a properly-coded key, the indicator will blink and the engine will not start (see page [127](#)).

This indicator also blinks several times when you turn the ignition switch from the ON (II) position to the ACCESSORY (I) or LOCK (0) position.



Vehicle Stability Assist (VSA) System Indicator

This indicator normally comes on for a few seconds when you turn the ignition switch to the ON (II) position.

If it comes on and stays on at any other time, or it does not come on when you turn the ignition switch to the ON (II) position, there is a problem with the VSA system. You will also see a "CHECK VSA SYSTEM" message on the multi-information display (see page [82](#)). Take your vehicle to a dealer to have it checked. Without VSA, your vehicle still has normal driving ability, but will not have VSA traction and stability enhancement. For more information, see page [268](#) .



VSA Activation Indicator

This indicator has three functions:

1. It comes on as a reminder that you have turned off the vehicle stability assist (VSA) system.
2. It flashes when VSA is active (see page [268](#)).
3. It comes on along with the VSA system indicator if there is a problem with the VSA system. You will also see a “CHECK VSA SYSTEM” message on the multi-information display (see page [82](#)).

This indicator normally comes on for a few seconds when you turn the ignition switch to the ON (II) position. For more information, see page [268](#) .



Turn Signal and Hazard Warning Indicators

The left or right turn signal indicator blinks when you signal a lane change or turn. If an indicator does not blink or blinks rapidly, it usually means one of the turn signal bulbs is burned out (see pages [304](#) and [306](#)). Replace the bulb as soon as possible, since other drivers cannot see that you are signaling.

When you press the hazard warning button, both turn signals blink. All turn signals on the outside of the vehicle should flash.



Anti-lock Brake System (ABS) Indicator

This indicator normally comes on for a few seconds when you turn the ignition switch to the ON (II) position. If this indicator comes on at any other time, there is a problem in the ABS. If this happens, take the vehicle to your dealer to have it checked. With this indicator on, your vehicle still has normal braking ability but no anti-lock function. You will also see a “CHECK ABS SYSTEM” message on the multi-information display (see page [83](#)). For more information, see page [261](#) .

Instrument Panel Indicators



High Beam Indicator

This indicator comes on with the high beam headlights. For more information, see page [121](#).

On Canadian models, this indicator comes on with reduced brightness when the daytime running lights (DRL) are on (see page [122](#)).



Fog Light Indicator

This indicator comes on when you turn on the fog lights. For more information, see page [122](#).



Cruise Main Indicator

This indicator comes on when you turn on the cruise control system by pressing the CRUISE button on the steering wheel (see page [206](#)).

Low Fuel Indicator

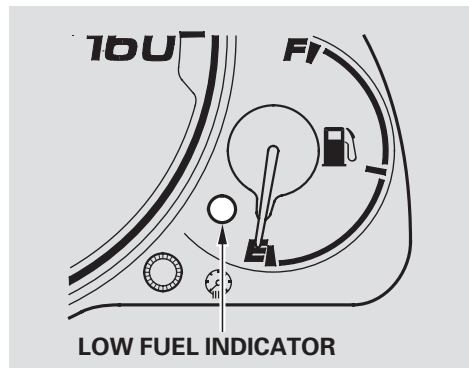

This indicator is in the fuel gauge. It comes on as a reminder that you must refuel soon. You will also see a “FUEL LOW” message on the multi-information display (see page [81](#)). When the indicator comes on, there is about 2.3 U.S. gal (8.6 ℓ) of fuel remaining in the tank before the needle reaches E.



System Message Indicator

This indicator comes on when there is a system message on the multi-information display. Press the INFO button on the steering wheel (see page [71](#)) to see the message (see page [75](#)).

Most of the time, this indicator comes on along with other indicators in the instrument panel such as the seat belt reminder indicator, SRS indicator, VSA system indicator, etc.

Security System Indicator

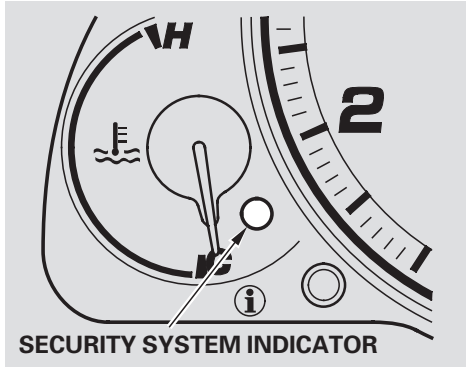

This indicator comes on when the security system is set. For more information, see page [205](#) .



Low Tire Pressure/ TPMS Indicator

This indicator normally comes on for a few seconds when you turn the ignition switch to the ON (II) position.

This indicator has two functions:

1. If it comes on while driving, it indicates that one or more of your vehicle's tires are significantly low on pressure.

You will also see a “CHECK TIRE PRESSURE” message on the multi-information display (see page [265](#)).

You may see one or more of the low pressure tire positions displayed along with this message.

Check the tire pressure monitor on the multi-information display and determine the cause (see page [265](#)).

If this happens, pull to the side of the road when it is safe, check which tire has lost pressure on the multi-information display, and determine the cause. If it is because of a flat tire, have the flat tire repaired as soon as possible. If two or more tires are underinflated, call a professional towing service. For more information, see page [345](#) .

2. If this indicator begins to flash, there is a problem with the tire pressure monitoring system (TPMS). You will also see a “CHECK TPMS SYSTEM” message on the multi-information display. The indicator continues to flash for a while (approximately 1 minute), then stays on. If this happens, have your dealer check the system as soon as possible. For more information, see page [267](#) .

Gauges

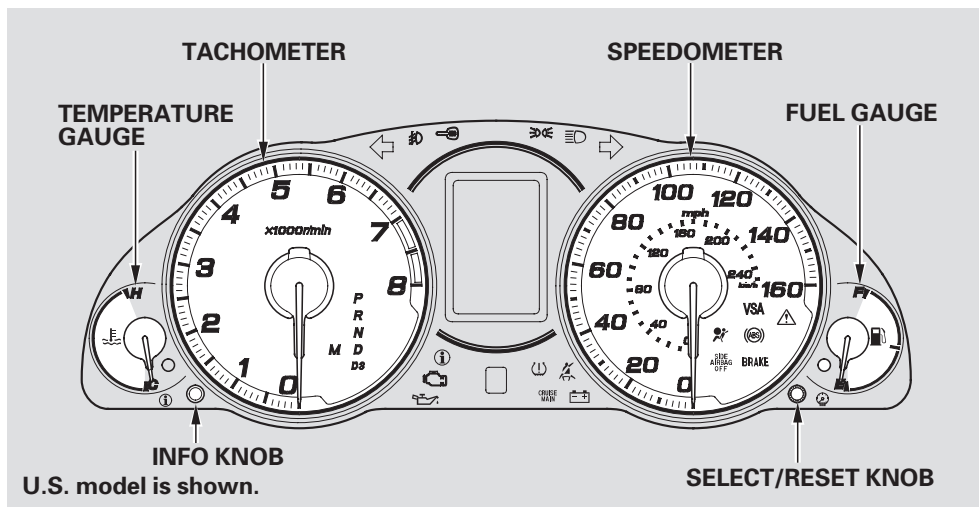

Temperature Gauge

This shows the temperature of the engine's coolant. During normal operation, the pointer should rise to about the middle of the gauge. In severe driving conditions, such as very hot weather or a long period of uphill driving, the pointer may rise to the upper zone. If it reaches the red

(Hot) mark, pull safely to the side of the road. See page 333 for instructions and precautions on checking the engine's cooling system.

Fuel Gauge

This shows how much fuel you have. It may show slightly more or less than the actual amount. The needle returns to the bottom after you turn off the ignition.

NOTICE

Avoid driving with an extremely low fuel level. Running out of fuel could cause the engine to misfire, damaging the catalytic converter.

The multi-information display in the instrument panel displays various information and messages when the ignition switch is in the ON (II) position. Some of the messages help you operate your vehicle more comfortably.

Others help to keep you aware of the periodic maintenance your vehicle needs for continued trouble-free driving.

There are three types of messages; normal display messages, engine oil life and maintenance messages, and system messages.

You can also customize some vehicle control settings to your liking with the multi-information display and the two buttons on the steering wheel (see page [86](#)).

Normal Display Messages



When you unlock and open the driver's door with the remote transmitter, the display shows "Welcome Driver 1" or "Welcome Driver 2" depending on which remote transmitter you use. The driver's "ID" is detected by the transmitter. For more information about driver's "ID", see page [132](#) .



If you use the key to unlock the driver's door, the display only shows "Welcome." This means the system cannot recognize either "Driver 1" or "Driver 2." In this case, you cannot use the customized settings on the multi-information display (see page [86](#)).

When you turn the ignition switch to the ACCESSORY (I) position, the display shows "Goodbye."

CONTINUED

Multi-Information Display

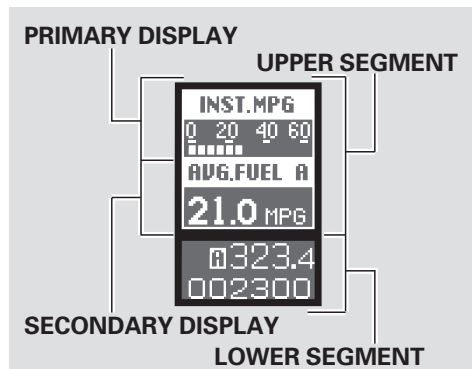

The multi-information display consists of two segments; an upper segment and a lower segment.

In normal display mode, the upper segment displays trip computer. The lower segment displays the odometer, Trip A/B, outside temperature, and engine oil life and maintenance message.

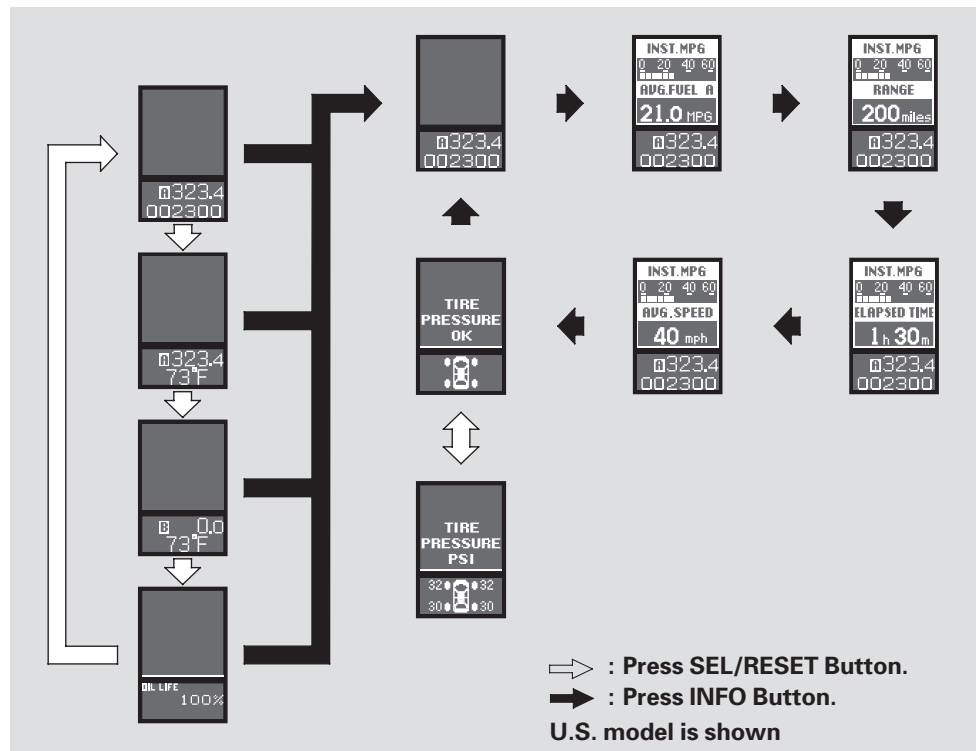

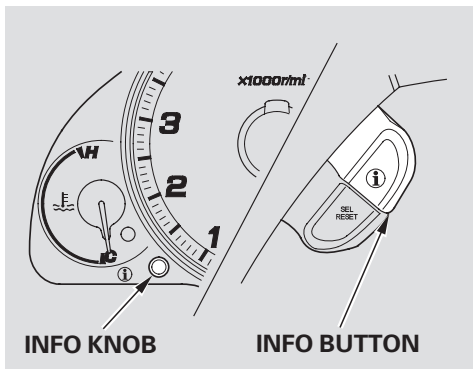

The upper segment is divided into two displays; primary and secondary. After you turn the ignition switch to the ON (II) position, press the INFO button on the steering wheel or the INFO knob in the instrument panel. What you last selected appears on the secondary display of the trip computer. Pressing the INFO button/knob repeatedly changes the display as shown in the example on the previous page.

The primary display always shows its default setting, “INST. MPG” (U.S. models) or “INST. L/100 km” (Canadian models) even if you press the INFO button. It only changes the secondary display. You can customize this setting to your liking (see page 102).

Messages in the trip computer include:

- INST. MPG (U.S. models)/ INST.L/100 km (Canadian models): Your vehicle’s current fuel mileage.
- AVG. FUEL A/AVG. FUEL B: Your vehicle’s average fuel economy since you last reset the Trip A or Trip B. When you select Trip B in the lower segment by pressing the SEL/RESET button on the steering wheel or select/reset knob in the instrument panel, the AVG. FUEL B appears in the secondary display.
- RANGE: The estimated distance you can travel on the fuel remaining in the tank. This distance is estimated from the fuel economy you received over the last several miles, so it will vary with changes in speed, traffic, etc.
- ELAPSED TIME: The time traveled since you last reset the trip computer. When you turn the ignition switch to the ON (II) position, ELAPSED TIME is reset.
- AVG. SPEED: The average speed you are traveling.
- TIRE PRESSURE MONITOR: You can see the pressure of each tire in this monitor. If the tire pressure is low on one or more tires, inflate them to the correct pressure. For more information, see page 264 .

CONTINUED

Multi-Information Display

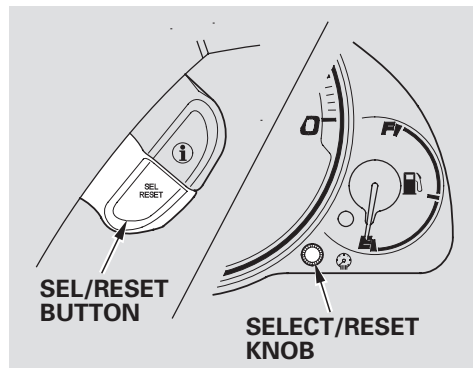

In the lower segment, each time you press the SEL/RESET button on the steering wheel, the display changes from “Trip A/Odometer” to “Trip A/ Outside Temperature” to “Trip B/ Outside Temperature” to “Engine Oil Life,” and then back to the “Trip A/Odometer” as shown on page [70](#).

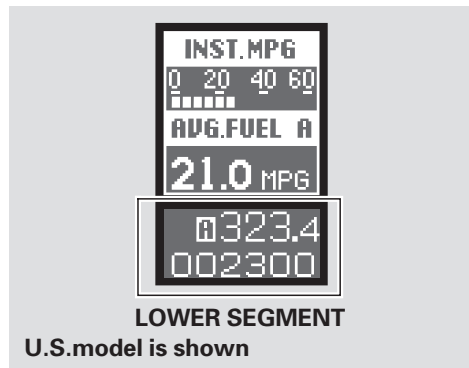

You can also change the display by pushing the select/reset knob in the instrument panel.

When you turn the ignition switch to the ON (II) position, what you last selected is displayed.

Trip Meter

While a trip meter is displayed, you can change the display between “Trip A” and “Trip B” by pressing the SEL/RESET button on the steering wheel, or the select/reset knob in the instrument panel.

To reset a trip meter, display it, and press and hold the SEL/RESET button or select/reset knob until the number resets to “0.0.” When you reset “Trip B”, “AVG. FUEL B” is also reset. If you reset “Trip A”, “AVG. FUEL A” and “AVG. SPEED” will be reset at the same time.

Outside Temperature

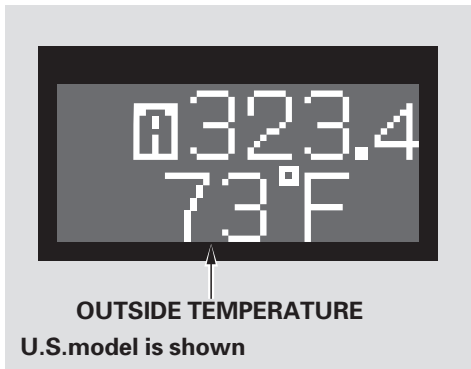

This shows the outside Fahrenheit temperature in U.S. models, and Centigrade temperature in Canadian models.

The temperature sensor is in the front bumper. The temperature reading can be affected by heat reflection from the road surface, engine heat, and the exhaust from surrounding traffic. This can cause an incorrect temperature reading when your vehicle speed is under 19 mph (30 km/h). When you start your trip, the sensor is not fully acclimatized, therefore it may take several minutes until the proper temperature is displayed.

In certain weather conditions, temperature readings near freezing (32°F, 0°C) could mean that ice is forming on the road surface.

You can adjust the outside temperature display (see page [96](#)).

Engine Oil Life

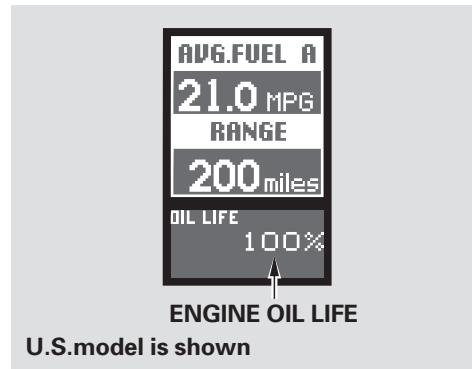

This shows the remaining life of the engine oil. It shows 100% after the engine oil is replaced and the display is reset. The engine oil life is calculated based on engine operating conditions and accumulated engine revolutions. For more information, see page [280](#).

Multi-Information Display

Maintenance Messages

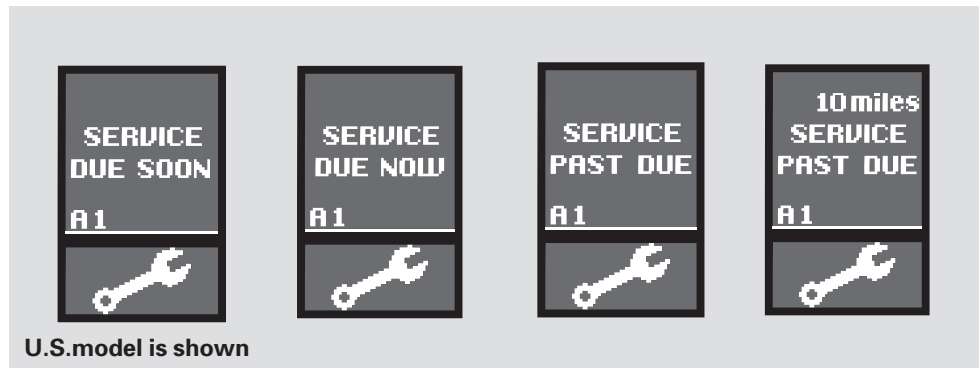

When the engine oil life reaches 15 %, the display shows “SERVICE DUE SOON” and the code for the maintenance items to be performed.

When the engine oil life reaches 5 %, the display shows “SERVICE DUE NOW” along with the same maintenance items.

Have your dealer do the indicated maintenance as soon as you see this message, and have them reset the display after completing the service.

If you do not perform the indicated maintenance or do not reset the display, the message changes to “SERVICE PAST DUE” when the engine oil life becomes 0 %.

These messages appear on the multi-information display each time you turn the ignition switch to the ON (II) position.

For more information about Maintenance Messages, see “**Maintenance Minder**” on page [280](#) .

Also refer to page [278](#) for important maintenance safety precautions.

System Messages

If there is a problem with your vehicle, for example, the engine oil level is low or a door is not fully closed, the multi-information display will show you the problem. It does this by interrupting the current display with one or more messages.

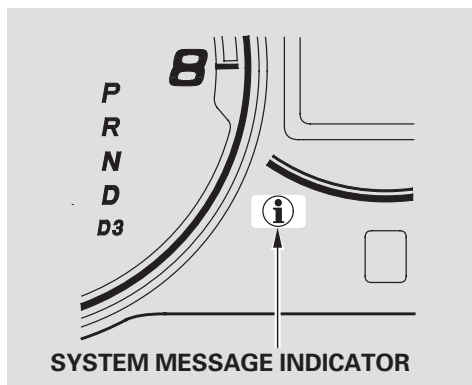















The system message(s) triggers the appropriate indicator(s) on the instrument panel, including the system message indicator, to come on. The system message indicator does not go off until the problem(s) is corrected.







When there are several warnings to be shown, the system switches the messages every 5 seconds. The message is shown until you push the INFO button. To see the message again, press the INFO button, 5 seconds after the display disappears.





CONTINUED

Multi-Information Display

Here is a table which shows the possible multi-information display messages and where to find further information on each message.

| | | | | |
|---|---|----------------|---|----------------|
|  |  | See page 78 |  | See page 79 |
|  |  | See page 78 |  | See page 80 |
|  |  | See page 78 |  | See page 81 |
|  | | See page 79 |  | See page 81 |
|  |  | See page 79 |  | See page 81 |

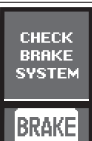
| | |
|---|----------------|
|   | See page 82 |
|   | See page 82 |
|  | See page 82 |
|  | See page 83 |
|  | See page 83 |

| | |
|---|----------------|
|  | See page 83 |
|  | See page 84 |
|  | See page 84 |
|   | See page 84 |
|  | See page 85 |

| | |
|---|-----------------|
|  | See page 122 |
|---|-----------------|

CONTINUED

Multi-Information Display

Fasten Seat Belt

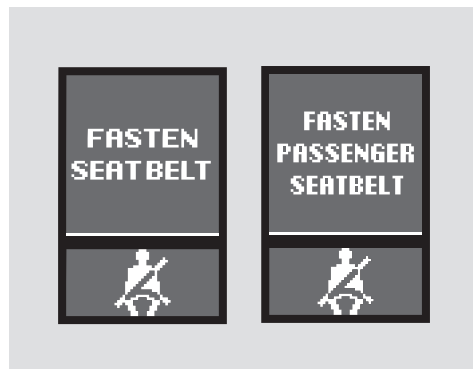

In addition to the seat belt reminder indicator in the instrument panel, the multi-information display interrupts the current display and shows “FASTEN SEAT BELT” or “FASTEN PASSENGER SEAT BELT” if either the driver or a front passenger does not fasten their seat belt while driving. This message remains displayed while the vehicle is moving until you or your passenger’s seat belts are fastened.

Door and Trunk Open

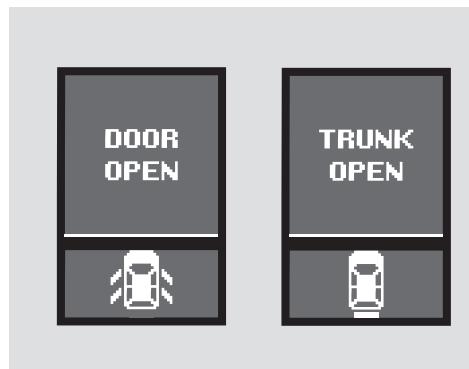

If the trunk or any door is not closed tightly, the display reminds you to close the open trunk or the door(s) before you start driving.

Release Parking Lever

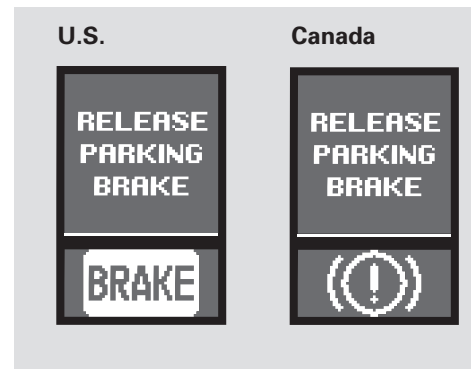

If you start driving without releasing the parking brake, the multi-information display interrupts the current display and shows “RELEASE PARKING BRAKE.” This message continues, and a chime sounds, until you release the parking brake, or the vehicle speed slows down to less than 1.8 mph (3 km/h).

Remove Key

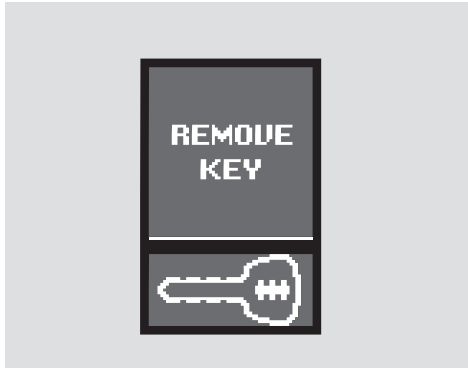

If you leave the key in the ignition switch in the LOCK (0) or ACCESSORY (I) position and open the driver's door, you will see "REMOVE KEY" on the display and hear a reminder beeper.

Brake Fluid Low

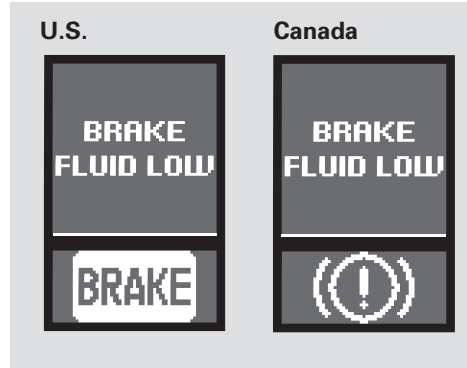

If the brake fluid level is at or below the MIN mark on the side of the brake fluid reservoir in the engine compartment, you will see "BRAKE FLUID LOW." If you see this message, have the brake system checked by your dealer (see page 300).

Tighten Fuel Cap



If the fuel fill cap is missing or not tightened properly, you will see "TIGHTEN FUEL CAP." Make sure the fuel cap is installed and tightened at least one click.

CONTINUED

Multi-Information Display

Your vehicle's on board diagnostic system will detect a loose or missing fuel fill cap as an evaporative system leak. The first time a leak is detected a "TIGHTEN FUEL CAP" message appears on the multi-information display. Turn the engine off, and confirm the fuel fill cap is installed. If it is, loosen it, then retighten it until it clicks at least once. The message should go off after several days of normal driving once you tighten or replace the fuel fill cap. To scroll to another message, press the INFO button. The "TIGHTEN FUEL CAP" message will appear each time you restart the engine until the system turns the message off.

If the system still detects a leak in the vehicle's evaporative emissions system, the malfunction indicator lamp (MIL) comes on. If the fuel fill cap was not already tightened, turn the engine off, and check or retighten the fuel fill cap until it clicks at least once. The MIL should go off after several days of normal driving once the cap is tightened or replaced. If the MIL does not go off, have your vehicle inspected by a dealer. For more information, see page [336](#).

Check TPMS System

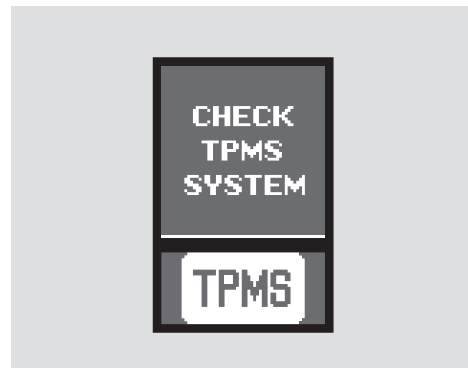

If there is a problem in the tire pressure monitoring system (TPMS), you will see "CHECK TPMS SYSTEM" on the multi-information display. If you see this message, the TPMS is not monitoring tire pressures. Have the TPMS checked by your dealer as soon as possible (see page [267](#)). Also, the low tire pressure/TPMS indicator begins to flash (see page [67](#)).

Check Tire Pressure



If one or more of your vehicle tires are low on pressure, you will see a “CHECK TIRE PRESSURE” message on the display. See page [265](#) for more information on the tire pressure monitoring system (TPMS).

Fuel Low

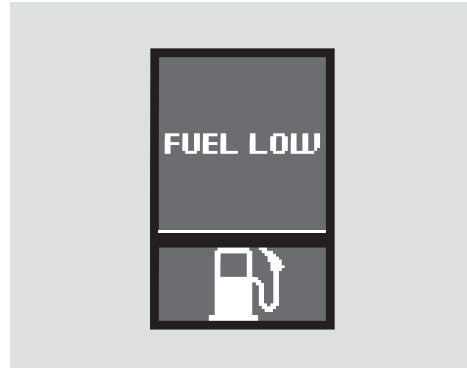

If the level of the fuel in the tank gets low, you will see “FUEL LOW” on the multi-information display, and you must refuel soon. The low fuel indicator on the instrument panel will also come on.

Washer Fluid Low



Canadian models only
If the fluid level in the windshield washer reservoir gets low, you will see “WASHER FLUID LOW” on the multi-information display.

CONTINUED

Multi-Information Display

Passenger Side Airbag Off

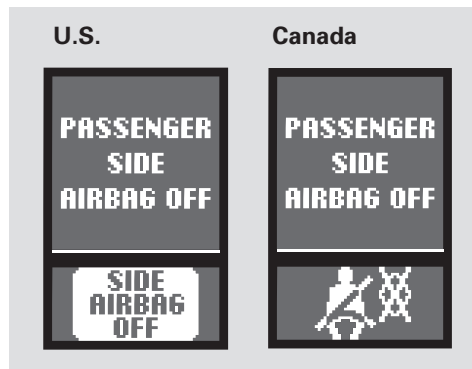

If the passenger's side airbag has automatically shut off, you will see "PASSENGER SIDE AIRBAG OFF" on the multi-information display. See [page 32](#) for more information.

Check VSA System

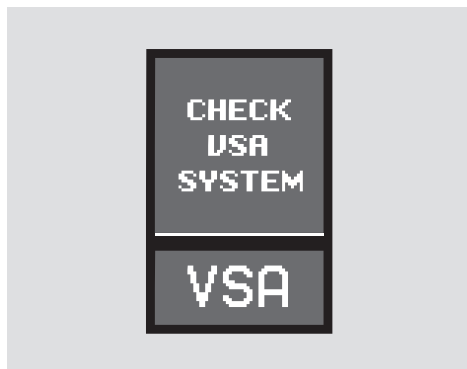

If there is a problem with the vehicle stability assist (VSA) system, you will see "CHECK VSA SYSTEM" on the multi-information display. If you see this message, have the VSA system checked by your dealer (see [page 268](#)).

Check Engine Oil Level

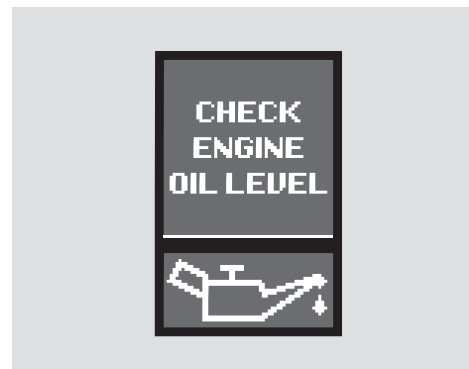

If the engine oil is very low or has lost pressure, you will see "CHECK ENGINE OIL LEVEL" on the multi-information display. You will also see the low oil pressure indicator in the instrument panel flashing or staying on. If you see this message, you should take immediate action since serious engine damage is possible. Follow the procedure on [page 335](#).

Check Transmission



Automatic transmission:
If there is a problem with the automatic transmission, you will see “CHECK TRANSMISSION” on the multi-information display. Avoid rapid acceleration, and have the transmission checked by a dealer as soon as possible.

Check ABS System

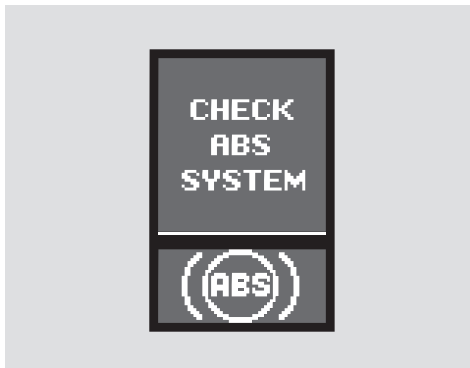

If there is a problem in the anti-lock brake system (ABS), you will see “CHECK ABS SYSTEM” on the multi-information display. If you see this message, have your vehicle checked by a dealer (see page [261](#)).

Check Airbag System



If there is a problem with your front airbags, side airbags, passenger’s side airbag automatic cutoff system, automatic seat belt tensioners, side curtain airbags, driver’s seat position sensor, or the front passenger’s weight sensors, you will see “CHECK AIRBAG SYSTEM” on the multi-information display. Take your vehicle to a dealer as soon as possible (see page [32](#)).

CONTINUED

Multi-Information Display

Check Charging System

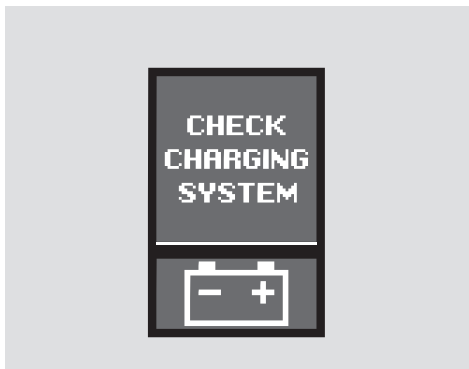

If you see “CHECK CHARGING SYSTEM” on the multi-information display, it means the battery is not being charged. See page [336](#) for more information.

Check Emission System

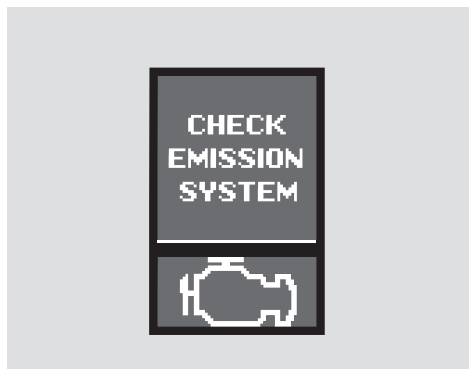

If you see “CHECK EMISSION SYSTEM” on the multi-information display, it means one of the engine’s emission systems may have a problem. Have your vehicle checked by your dealer (see page [336](#)).

Check Brake System

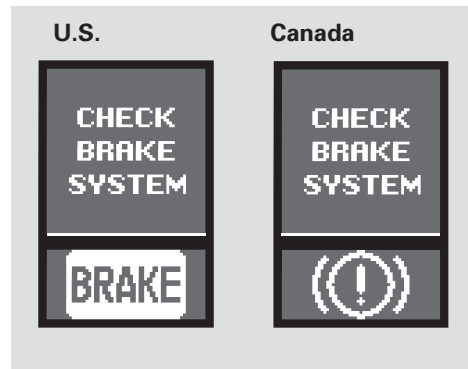

If there is a problem with the brake system, you will see “CHECK BRAKE SYSTEM” on the multi-information display. The parking brake and brake system indicator in the instrument panel will also come on. See page [338](#) for more information.

Check DRL System



Canadian models only
If there is a problem in the high beam headlight's circuit, you will see "CHECK DRL SYSTEM" on the multi-information display. If you see this message, have your vehicle checked by your dealer.

Cruise Control

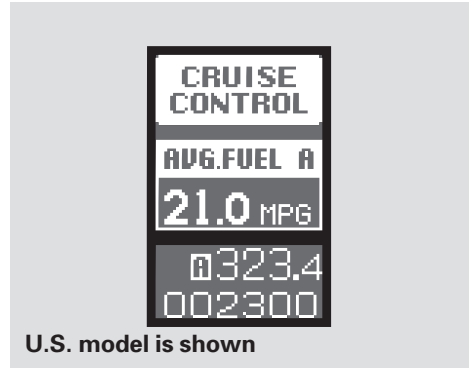

This message comes on when you set the cruise control. The Cruise Control indicator in the instrument panel will also come on. See page [206](#) for information on cruise control operation.

Bluetooth® HandsFreeLink®



You can receive or make phone calls from your cell phone through your vehicle's Bluetooth® HandsFreeLink® (HFL) system without touching your cell phone.

CONTINUED

Multi-Information Display

To use the system, your cell phone and the HFL system must be linked. Not all cell phones are compatible with this system. Refer to page 219 for instructions on how to link your cell phone to the HFL and how to receive or make phone calls, or visit the acura.com/handsfreelink website.

Customized Settings

With the ignition switch in the ON (II) position, press and hold the INFO button for more than 3 seconds. “CUSTOMIZE ENTRY” appears on the multi-information display.

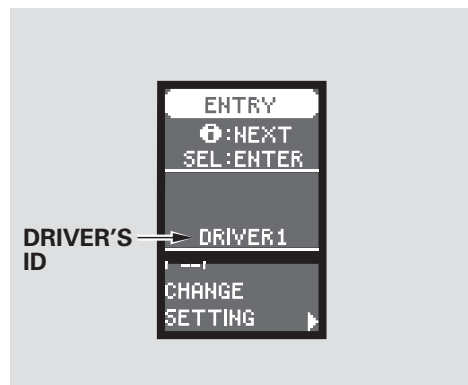

You can customize some vehicle control settings for “DRIVER 1” and “DRIVER 2” separately.

To have the driver’s ID detected, make sure you use your transmitter to unlock the driver’s door.

If you use the key to unlock the driver’s door, the system cannot recognize either “DRIVER 1” or “DRIVER 2.” In this case, when you try to enter the customizing mode,



“DRIVER UNKNOWN CUSTOMIZE IMPOSSIBLE” will be displayed, and you cannot customize some of the settings. Refer to the table on page 88 to see what settings you can customize.

If you use your remote transmitter to unlock the driver’s door, and the system fails to recognize either “DRIVER 1” or “DRIVER 2” see page 132 to link your transmitter to your vehicle.

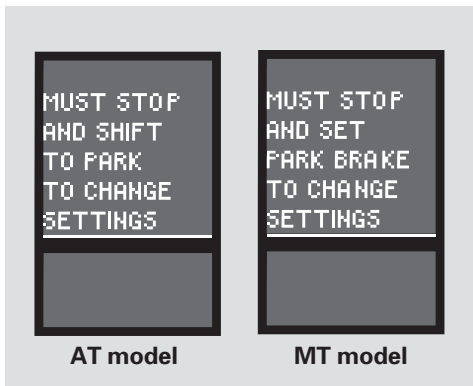

To change the settings, stop the vehicle, and make sure to set the parking brake and put the transmission in Park (A/T) or neutral (M/T). If you try to enter the customizing mode while the vehicle is moving, the above message appears and you cannot change the settings.

The first customizing menu is:

- CHANGE SETTING
- DEFAULT ALL

Every time you press the INFO button, the display cycles from “CHANGE SETTING,” “DEFAULT ALL,” “EXIT” and then back to “CHANGE SETTING.” Press the SEL/RESET button to enter your selection.

If you want the settings as they were when the vehicle left the factory, select “DEFAULT ALL,” as described on page 90 .

If you want to change any vehicle control settings, select “CHANGE SETTING,” and follow the instructions on page 92 .

If you do not make any changes, select “EXIT,” the display returns to normal display.

You can also use the select/reset knob in the instrument panel. Turn the knob to select a setting and press it to enter your selection.

CONTINUED

Multi-Information Display

| Customize Entry | Customize Group | Customize Menu | Description | Customize Setup | Page |
|---------------------------|------------------------|--|---|---------------------|------|
| CHG SETTING (P.92) | METER SETUP (P.93) | LANGUAGE SELECTION | Changes the language used in the display. | ENGLISH* | 94 |
| | | | | FRENCH | |
| | | | | SPANISH | |
| | | ADJUST OUTSIDE TEMP. DISPLAY | Changes the outside temperature reading above or below its current reading. | -5°F ~ ±0°F* ~ +5°F | 96 |
| | | | | -3°C ~ ±0°C* ~ +3°C | |
| | | TRIP A & AVG. FUEL RESET with REFUEL | Causes trip meter A and the average fuel economy to reset when you refuel. | ON | 98 |
| | | | | OFF* | |
| | | ELAP. TIME RESET CONDITION | Resets the elapsed time of your current trip. | IGN RESET* | 100 |
| | | | | TRIP A RESET | |
| | | | | TRIP B RESET | |
| | PRIMARY DISP SELECTION | Changes the trip computer's main display from its default setting. | INST. FUEL* | 102 | |
| | | | AVG. FUEL | | |
| | | | RANGE | | |
| | | | ELAPSED TIME | | |
| AVG. SPEED | | | | | |
| POSITION SETUP (P.104) | MEMORY POSITION LINK | Causes the driver's seat position to be stored in memory. | ON* | 104 | |
| | | | OFF | | |

* : Default setting

| Customize Entry | Customize Group | Customize Menu | Description | Customize Setup | Page |
|--------------------------|--|---|---|---------------------------|------|
| CHG SETTING (P.92) | LIGHTING SETUP (P.106) | INTERIOR LIGHT DIMMING TIME | Changes how long (in seconds) the interior lights stay on after you close the doors. | 15 sec | 106 |
| | | | | 30 sec* | |
| | | | | 60 sec | |
| | HEADLIGHT AUTO OFF TIMER | Changes how long (in seconds) the exterior lights stay on after you close the driver's door. | 0 sec | 108 | |
| | | | 15 sec* | | |
| | | | 30 sec | | |
| | | | 60 sec | | |
| | DOOR · WINDOW SETUP (P.110) | DOOR LOCK MODE | Changes which doors unlock with the remote transmitter when the button is pushed one time. | DRIVER DOOR* ALL DOORS | 111 |
| | | KEYLESS LOCK ACKNOWLEDGEMENT | The exterior lights flash each time you press the LOCK or UNLOCK button. A horn will also sound when you press the LOCK button twice. | ON* | 113 |
| | | | | OFF | |
| SECURITY RELOCK TIMER | Changes how long it takes (in seconds) for the doors to relock and the security system to set after you unlock but do not open the door. | 30 sec* | 115 | | |
| | | 60 sec | | | |
| | | 90 sec | | | |
| WIPER SETUP (P.117) | FRONT WIPER ACTION | Changes the windshield wiper operation between two settings when the wiper switch is in the INT position. | WITH VEH SPD* | 117 | |
| | | | INTERMITTENT | | |

* : Default setting

Multi-Information Display

DEFAULT ALL

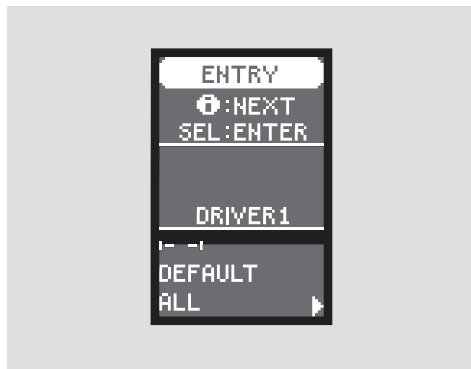

If you want to set the customizable vehicle control settings to the default setting, press the INFO button on the steering wheel until “DEFAULT ALL” is displayed.

Press the SEL/RESET button to enter “DEFAULT ALL.” You can change the display between “CANCEL,” “OK” and “EXIT” each time you press the INFO button.

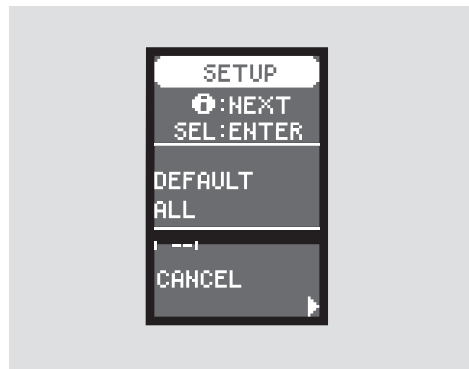

If you want to cancel “DEFAULT ALL,” press the SEL/RESET button while “CANCEL” is shown. The display goes back to “CUSTOMIZE ENTRY.”



To set the default settings, press the INFO button until the display changes as shown above. Press the SEL/RESET button to select “DEFAULT ALL.”



When “DEFAULT ALL” is completed successfully, you will see the above display for several seconds, and the display will return to “CUSTOMIZE ENTRY.”

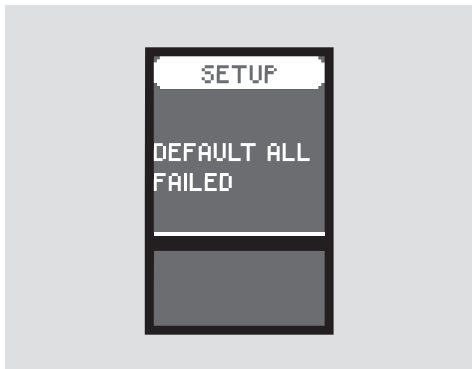

If “DEFAULT ALL” is not completed successfully, you will see the above display for several seconds, then the display goes back to “CUSTOMIZE ENTRY.” Repeat the procedure to select “DEFAULT ALL.”



To exit “DEFAULT ALL,” press the INFO button until you see “EXIT,” then press the SEL/RESET button.

Multi-Information Display

Change Setting

You can customize some of the vehicle control settings to your preference. Here are the settings you can customize:

- METER SETUP
- POSITION SETUP
- LIGHTING SETUP
- DOOR · WINDOW SETUP
- WIPER SETUP

While the multi-information display is showing “CHANGE SETTING,” press the SEL/RESET button. The display will start showing the initial “CUSTOMIZE GROUP.” Each time you press the INFO button, the display changes as shown in the next column. Press the INFO button until you see the setup you want to customize, and press the SEL/RESET button to enter your selection.

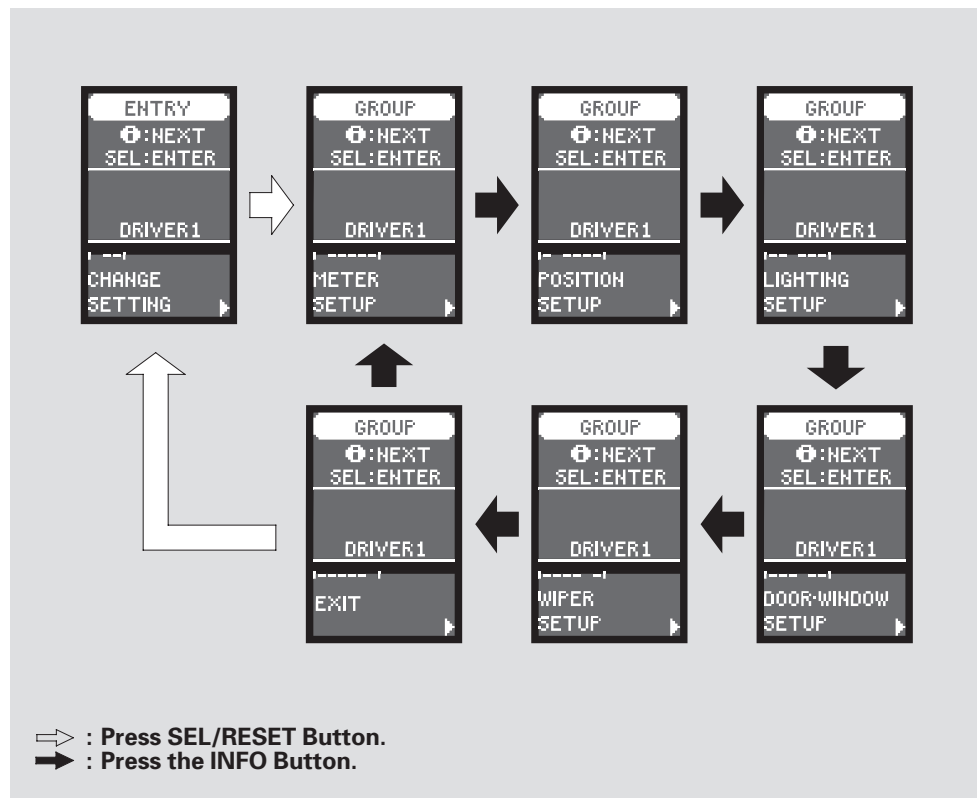

Meter Setup

There are five custom settings in the Meter Setup:

- LANGUAGE SELECTION
- ADJUST OUTSIDE TEMP. DISPLAY
- TRIP A & AVG. FUEL RESET WITH REFUEL
- ELAP. TIME RESET CONDITION
- PRIMARY DISP SELECTION

While “METER SETUP” is displayed, press the SEL/RESET button on the steering wheel. Then, press the INFO button repeatedly. Each time you press the INFO button, the display changes as shown.

To customize a setting, press the INFO button repeatedly until you see the setting you want to customize, and press the SEL/RESET button. Then follow the procedures described on the following pages.

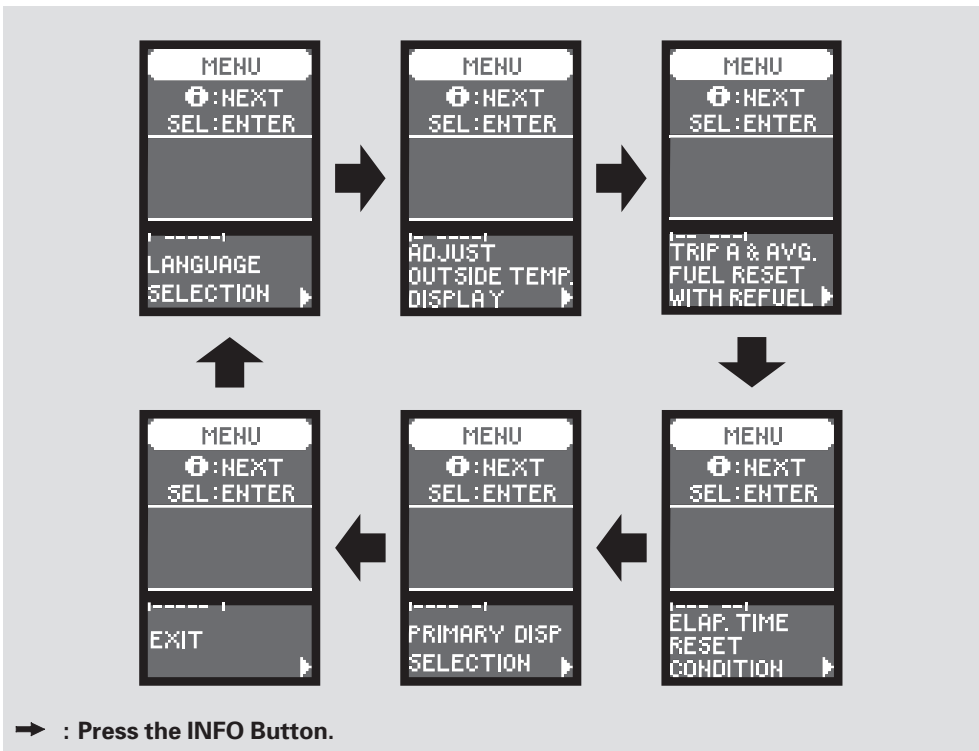

CONTINUED

Multi-Information Display

Language Selection



While the multi-information display is showing “METER SETUP,” press the SEL/RESET button on the steering wheel. The display changes to “LANGUAGE SELECTION.” Press the SEL/RESET button again to enter the language selection mode.

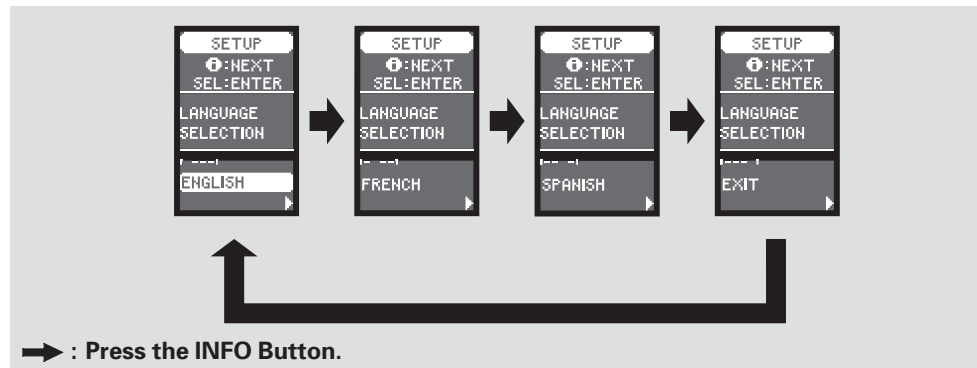

There are three selectable languages, English, French, and Spanish. Each time you press the INFO button, the display changes as shown.

Select the language you want by pressing the INFO button, and press the SEL/RESET button to enter your selection.



When language selection is successfully completed, the display changes to the screen shown above for several seconds, then goes back to "CUSTOMIZE MENU."

All messages on the multi-information display will be shown in the language you selected.

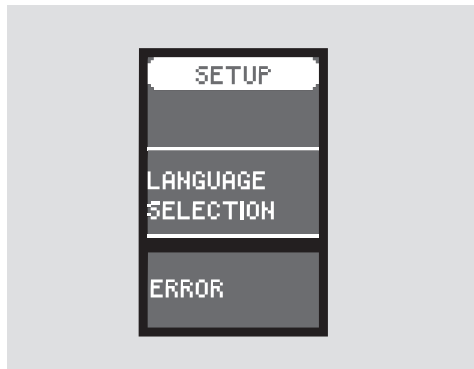

If you fail to select a language properly, you will see the above display for several seconds, then the display goes back to "CUSTOMIZE MENU." Repeat the setup.



To exit "LANGUAGE SELECTION," press the INFO button repeatedly until you see "EXIT," then press the SEL/RESET button. The display goes back to "CUSTOMIZE MENU."

CONTINUED

Multi-Information Display

Adjust Outside Temp. Display

If you find that the temperature reading is always a few degrees below or above the actual temperature, adjust it as described on the following columns.

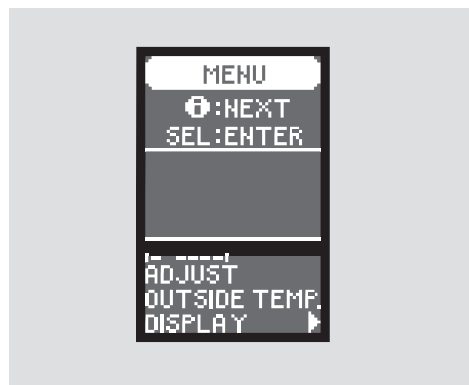

While the multi-information display shows “METER SETUP,” press the SEL/RESET button on the steering wheel. The display changes to the “CUSTOMIZE MENU.” Press the INFO button once, and you will see “ADJUST OUTSIDE TEMP. DISPLAY” as shown above.

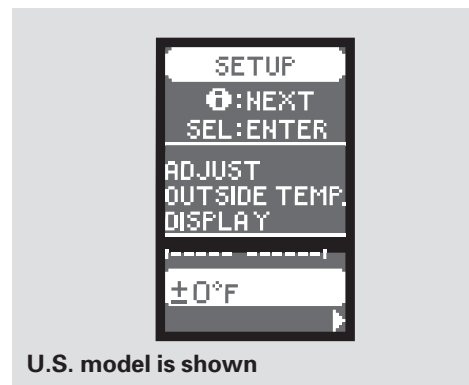

Press the SEL/RESET button. The display changes as shown above. The highlighted number is the current adjustment above or below the outside temperature. Press the INFO button repeatedly until the appropriate number appears, then press the SEL/RESET button to enter your selection.

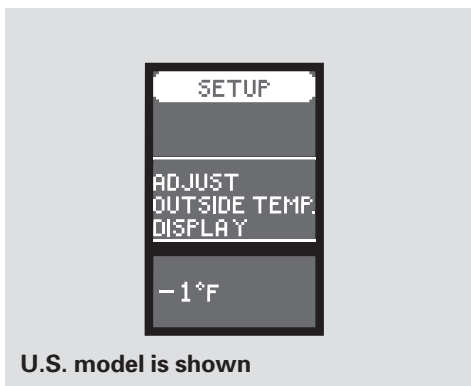

When your selection is successfully entered, you will see the above display for several seconds, and then the display goes back to "CUSTOMIZE MENU."

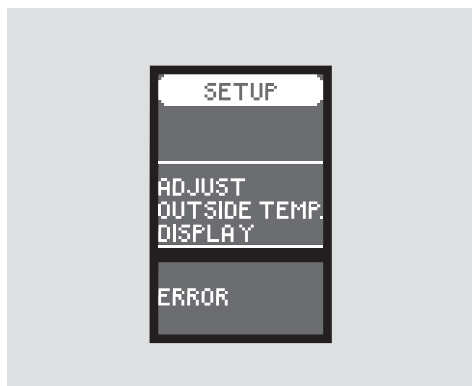

If you fail to enter the desired adjustment properly, you will see the above display for several seconds, then the display goes back to "CUSTOMIZE MENU." Repeat the adjustment.

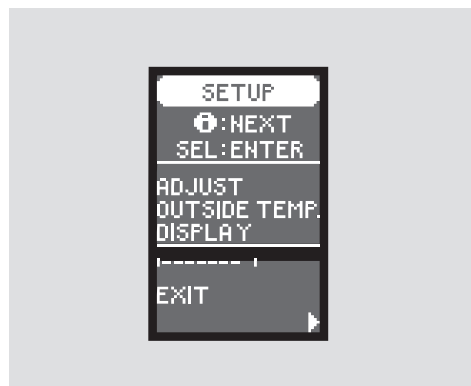

To exit "ADJUST OUTSIDE TEMP. DISPLAY," press the INFO button until you see "EXIT," and press the SEL/RESET button. The display goes back to "CUSTOMIZE MENU."

CONTINUED

Multi-Information Display

Trip A & Avg. Fuel Reset with Refuel

To set “Trip A” and “AVG. FUEL A” to reset every time you refuel your vehicle, follow the procedure described from the next column.



While the multi-information display shows “METER SETUP” press the SEL/RESET button on the steering wheel. The display changes to “CUSTOMIZE MENU.” Press the INFO button repeatedly until you see “TRIP A & AVG. FUEL RESET WITH REFUEL” in the lower segment as shown above.



Press the SEL/RESET button. The display changes as shown above. The lower segment changes between “ON” and “OFF” each time you press the INFO button. Enter your selection by pressing the SEL/RESET button.



When your selection is successfully entered, you will see the above display for several seconds, and then the display goes back to "CUSTOMIZE MENU."



If you fail to enter your selection, you will see the above display for several seconds, then the display goes back to "CUSTOMIZE MENU." Repeat the setup.



To exit "TRIP A & AVG. FUEL WITH REFUEL," press the INFO button until you see "EXIT," and press the SEL/RESET button. The display goes back to "CUSTOMIZE MENU."

CONTINUED

Multi-Information Display

Elap. Time Reset Condition

“ELAPSED TIME” is the driving time since you last reset the trip computer. You can customize the condition of when to reset the “ELAPSED TIME”.



While the multi-information display shows “METER SETUP,” press the SEL/RESET button on the steering wheel. The display changes to the “CUSTOMIZE MENU.” Press the INFO button repeatedly until you see “ELAP. TIME RESET CONDITION” in the lower segment as shown above.



Press the SEL/RESET button. The display changes as shown above. The lower segment changes between “IGN RESET,” “TRIP A RESET” and “TRIP B RESET” each time you press the INFO button. Enter your selection by pressing the SEL/RESET button.



When your selection is successfully entered, you will see the above display for several seconds, and then the display goes back to “CUSTOMIZE MENU.”



If you fail to enter your selection, you will see the above display for several seconds, then the display goes back to “CUSTOMIZE MENU.” Repeat the setup.



To exit “ELAP. TIME RESET CONDITION,” press the INFO button until you see “EXIT,” and press the SEL/RESET button. The display goes back to “CUSTOMIZE MENU.”

CONTINUED

Multi-Information Display

Primary Display Selection

When you turn the ignition switch to the ON (II) position, the primary display of the trip computer always shows “INST. MPG” (U.S. models) or “INST. L/100 km” (Canadian models) in default setting. You can customize this setting to your liking in following procedure.

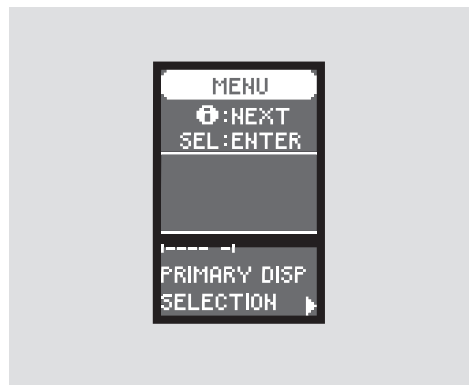

While the multi-information display shows “METER SETUP,” press the SEL/RESET button on the steering wheel. Press the INFO button until you see “PRIMARY DISP SELECTION” as shown above.



Press the SEL/RESET button. The display changes as shown above. The lower segment changes from “INST. FUEL,” to “AVG. FUEL,” to “RANGE,” to “ELAPSED TIME,” then to “AVG. SPEED” each time you press the INFO button. Enter your selection by pressing the SEL/RESET button.

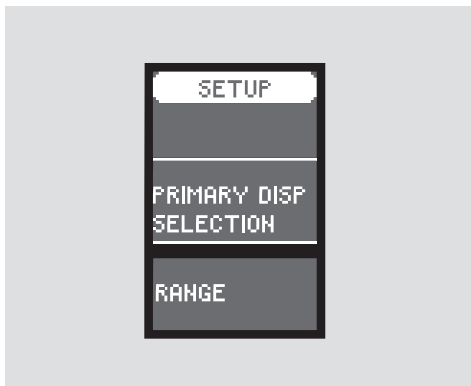

When your selection is successfully entered, you will see the above display for several seconds, and then the display goes back to "CUSTOMIZE MENU."

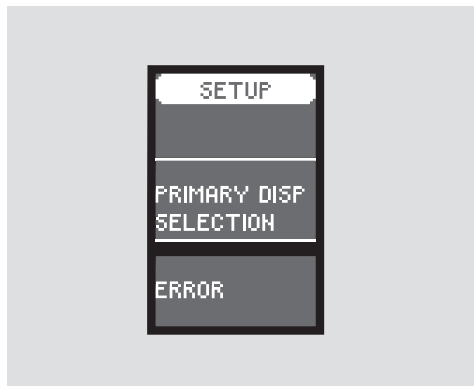

If you fail to enter your selection, you will see the above display for several seconds, then the display goes back to "CUSTOMIZE MENU." Repeat the setup.



To exit "PRIMARY DISP SELECTION," press the INFO button until you see "EXIT," and press the SEL/RESET button. The display goes back to "CUSTOMIZE MENU."

Multi-Information Display

Position Setup

If “MEMORY POSITION LINK” is “ON,” the driver’s seat moves to the position stored in the memory when you open the driver’s door, using the remote transmitter.

Refer to page 143 for setting the seat position memory. Also refer to page 132 for remote transmitter use.

Memory Position Link

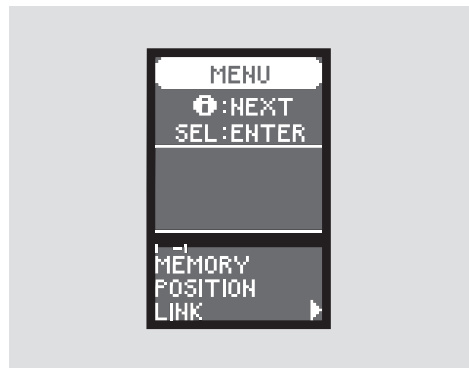

While the multi-information display shows “POSITION SETUP,” press the SEL/RESET button on the steering wheel. The display changes to “MEMORY POSITION LINK” as shown above.



Press the SEL/RESET button. The display changes as shown above.

Select “ON” or “OFF” by pressing the INFO button, and enter your selection by pressing the SEL/RESET button.

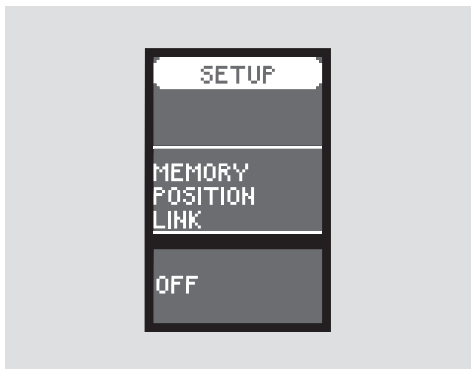

When your selection is entered, you will see the above display for several seconds, then the display goes back to “CUSTOMIZE MENU.”

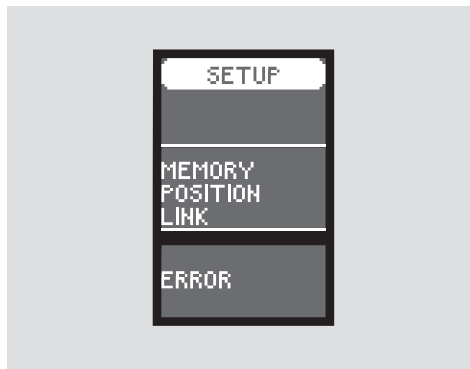

If you fail to enter your selection, you will see the above display for several seconds, and the display goes back to “CUSTOMIZE MENU.” Repeat the setup.



To exit “MEMORY POSITION LINK,” press the INFO button until you see “EXIT,” then press the SEL/RESET button. The display goes back to “CUSTOMIZE MENU.”

Multi-Information Display

Lighting Setup

There are two custom settings in the Lighting Setup:

- INTERIOR LIGHT DIMMING TIME
- HEADLIGHT AUTO OFF TIMER

While the “LIGHTING SETUP” is displayed, press the SEL/RESET button on the steering wheel. Each time you press the INFO button, the display changes between “INTERIOR LIGHT DIMMING TIME” and “HEADLIGHT AUTO OFF TIMER.” To make your selection, press the SEL/RESET button.

Interior Light Dimming Time

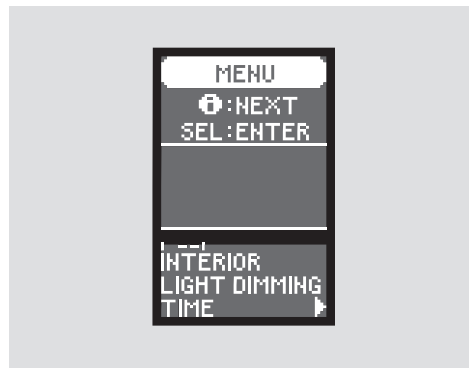

The interior lights fade out when you close all doors. You can change the time that the interior lights fade out.

While the multi-information display shows “LIGHTING SETUP,” press the SEL/RESET button on the steering wheel. The display changes to “INTERIOR LIGHT DIMMING TIME” as shown above.



Press the SEL/RESET button. The display changes as shown above.

Each time you press the INFO button, the highlighted number changes from “15 sec,” to “30 sec,” and then to “60 sec.” To make your selection, press the SEL/RESET button.



When your selection is entered, you will see the above display for several seconds, and then the display goes back to “CUSTOMIZE MENU.”



If you fail to enter your selection, you will see the above display for several seconds, and the display goes back to “CUSTOMIZE MENU.” Repeat the setup.



To exit “INTERIOR LIGHT DIMMING TIME,” press the INFO button until you see “EXIT,” then press the SEL/RESET button. The display goes back to “CUSTOMIZE MENU.”

CONTINUED

Multi-Information Display

Headlight Auto Off Timer

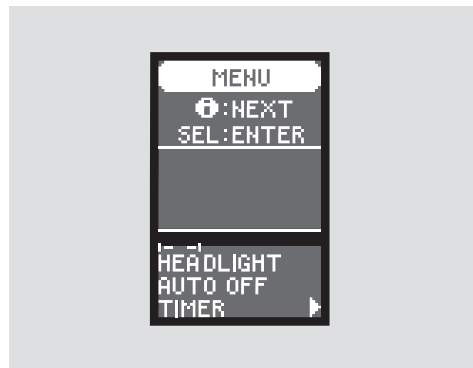

While the multi-information display shows “LIGHTING SETUP,” press the SEL/RESET button on the steering wheel. Then press the INFO button to display “HEADLIGHT AUTO OFF TIMER” as shown above.



Press the SEL/RESET button. The display changes as shown above.

Each time you press the INFO button, the highlighted number changes from “0 sec,” to “15 sec,” to “30 sec,” and then to “60 sec.”



Press the INFO button repeatedly until the desired time appears, then press the SEL/RESET button to enter your selection.

When your selection is entered, you will see the above display for several seconds, and then the display goes back to “CUSTOMIZE MENU.”

The headlights, parking lights, taillights, and license plate lights turn off after the selected time when you remove the key from the ignition switch and close the driver's door.



If you fail to enter your selection, you will see the above display for several seconds, then the display goes back to "CUSTOMIZE MENU." Repeat the setup.



To exit "HEADLIGHT AUTO OFF TIMER," press the INFO button until you see "EXIT," then press the SEL/RESET button. The display goes back to "CUSTOMIZE MENU."

Multi-Information Display

Door · Window Setup

There are three custom settings in the Door · Window Setup:

- DOOR LOCK MODE
- KEYLESS LOCK ACKNOWLEDGEMENT
- SECURITY RELOCK TIMER

While the multi-information display shows “DOOR · WINDOW SETUP,” press the SEL/RESET button on the steering wheel. Each time you press the INFO button, the display changes as shown in the next column.

To customize a setting, press the INFO button repeatedly until you see the setting you want to customize, and press the SEL/RESET button. Then follow the procedures described on the following pages.

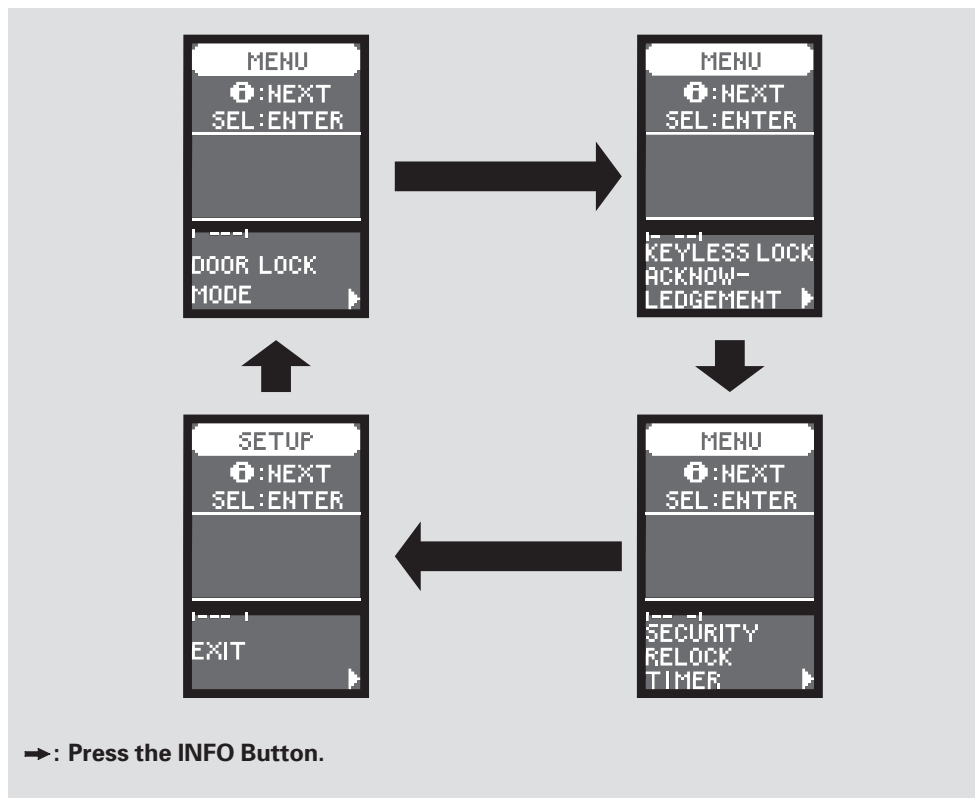

Door Lock Mode

In default setting, if you push the UNLOCK button once on the remote transmitter or turn the key clockwise in the driver's door lock, only the driver's door unlocks.

You can select whether only the driver's door unlocks or all the doors unlock in "DOOR LOCK MODE."



While the multi-information display is showing "DOOR · WINDOW SETUP," press the SEL/RESET button on the steering wheel. The display changes to "DOOR LOCK MODE" as shown above.



Press the SEL/RESET button. The display changes as shown above.

Select "DRIVER DOOR" or "ALL DOORS" by pressing the INFO button, and enter your selection by pressing the SEL/RESET button.

CONTINUED

Multi-Information Display



When your selection is successfully entered, you will see the above display for several seconds, and then the display goes back to "CUSTOMIZE MENU."



If you fail to enter your selection, you will see the above display for several seconds, then the display goes back to "CUSTOMIZE MENU." Repeat the setup.



To exit "DOOR LOCK MODE," press the INFO button until you see "EXIT," then press the SEL/RESET button. The display goes back to "CUSTOMIZE MENU."

Keyless Lock Acknowledgement

When you push the LOCK button on the remote transmitter, the door and trunk locks are set, some of the exterior lights flash, and a beeper sounds. If you push the LOCK button (with the security system set) again within 5 seconds, the horn sounds to let you know the security system is working. You can customize the Keyless Lock settings so that the exterior lights do not flash and/or the acknowledgement beeper does not sound.

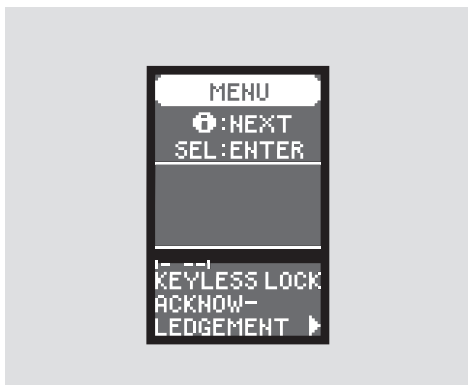

While the multi-information display shows “DOOR·WINDOW SETUP,” press the SEL/RESET button on the steering wheel. Then press the INFO button repeatedly until you see “KEYLESS LOCK ACKNOWLEDGEMENT” as shown above.



Press SEL/RESET button, then press the INFO button.

Each time you press the INFO button, the display changes to “ON,” to “OFF,” then to “EXIT.”

Select “ON” or “OFF” by pressing the INFO button, and enter your selection by pressing the SEL/RESET button.

CONTINUED

Multi-Information Display



When your selection is entered, you will see the above display for several seconds, and then the display changes to “CUSTOMIZE MENU.”



If you fail to enter your selection, you will see the above display for several seconds, and the display goes back to “CUSTOMIZE MENU.” Repeat the setup.



To exit “KEYLESS LOCK ACKNOWLEDGEMENT,” press the INFO button until you see “EXIT,” then press the SEL/RESET button. The display goes back to “CUSTOMIZE MENU.”

Security Relock Timer

If you unlock the doors with the remote transmitter, but do not open any of the doors within 30 seconds, the doors automatically relock and the security system sets.

You can change this relock time from 30 seconds to 60 or 90 seconds.



While the multi-information display shows “DOOR WINDOW SETUP,” press the SEL/RESET button on the steering wheel. Then press the INFO button repeatedly until you see “SECURITY RELOCK TIMER” as shown above.



Press the SEL/RESET button, then press the INFO button.

Each time you press the INFO button, the time changes from “30 sec,” to “60 sec,” and then to “90 sec.”

CONTINUED

Multi-Information Display



Select the desired relock time by pressing the INFO button, and enter your selection by pressing the SEL/RESET button.

When your selection is entered, you will see the above display for several seconds, and then the display goes back to "CUSTOMIZE MENU."



If you fail to enter your selection, you will see the above display for several seconds, and the display goes back to "CUSTOMIZE MENU." Repeat the setup.



To exit "SECURITY RELOCK TIMER," press the INFO button until you see "EXIT," then press the SEL/RESET button. The display goes back to "CUSTOMIZE MENU."

Wiper Setup

When “WIPER SETUP” is shown on the multi-information display, the action of the windshield wipers can be changed. To do this, refer to the following procedure.

Front Wiper Action



With “WIPER SETUP” shown on the multi-information display, press the SEL/RESET button on the steering wheel. The display changes to “FRONT WIPER ACTION” as shown above.

Press the SEL/RESET button, then press the INFO button.



Each time you press the INFO button, the display changes from “WITH VEH SPD,” to “INTERMITTENT,” and then to “EXIT.”

Press the INFO button to select “WITH VEH SPD” or “INTERMITTENT,” and enter your selection by pressing the SEL/RESET button.

CONTINUED

Multi-Information Display



If you set the front wiper action to “WITH VEH SPD,” the front wipers run intermittently and the wiper interval is varied automatically according to the vehicle’s speed when the wiper switch is in the “INT” position. If you set it to “INTERMITTENT,” the wipers run at regular intervals.

When your selection is entered, you will see the above display for several



seconds, and then the display goes back to “CUSTOMIZE MENU.”

If you fail to enter your selection, you will see the above display for several seconds, and the display goes back to “CUSTOMIZE MENU.” Repeat the setup.



To exit “FRONT WIPER ACTION,” press the INFO button until you see “EXIT,” then press the SEL/RESET button. The display goes back to “CUSTOMIZE MENU.”

Controls Near the Steering Wheel

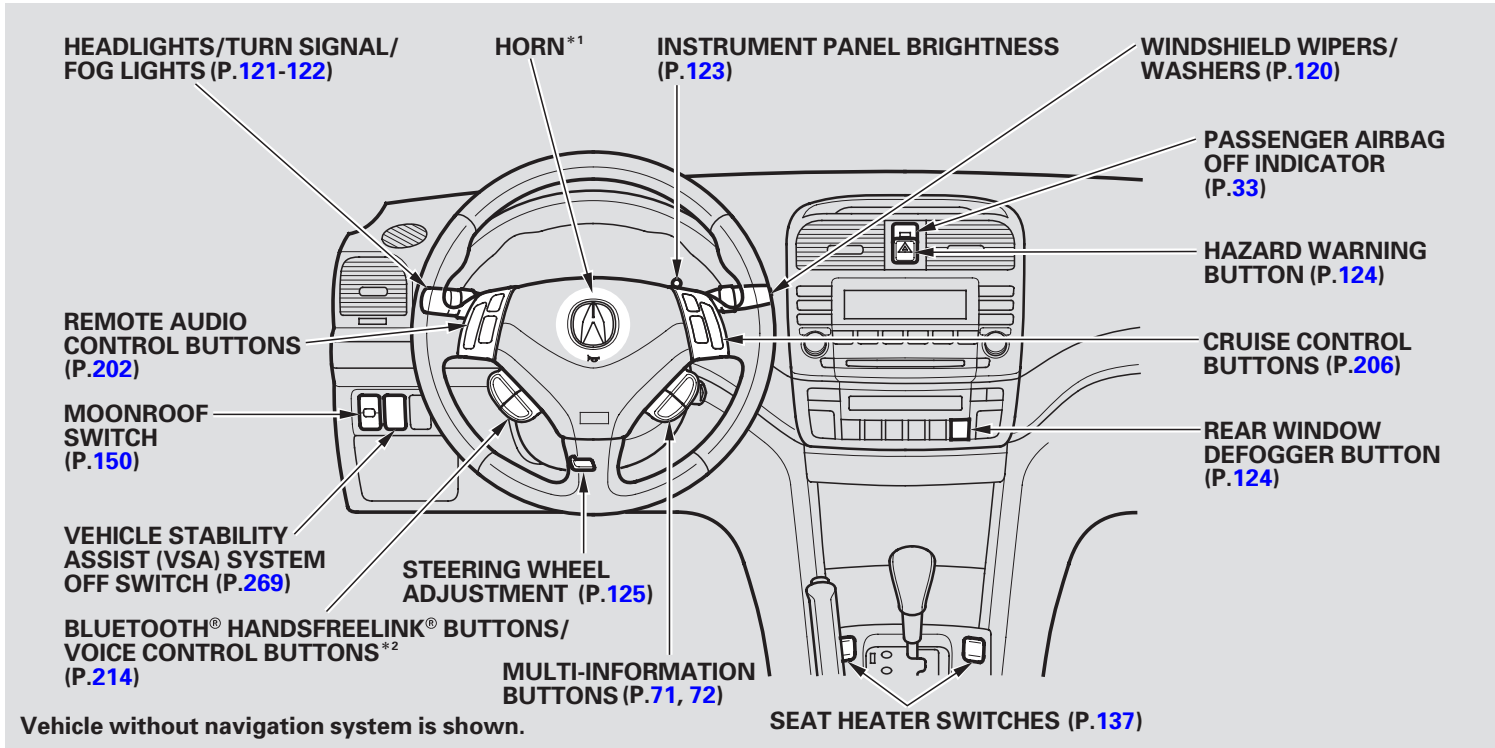

* 1 : To use the horn, press the pad around the “Acura” logo.

* 2 : Only on vehicles equipped with navigation system. Refer to the navigation system manual.

Windshield Wipers and Washers

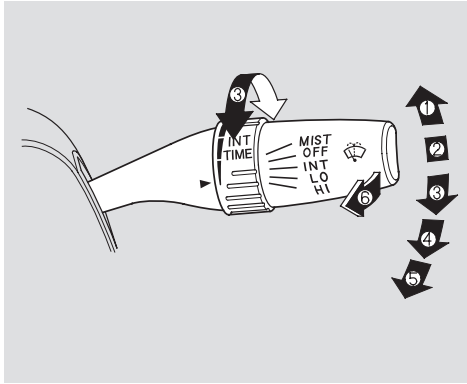

1. MIST
2. OFF
3. INT – Intermittent
4. LO – Low speed
5. HI – High speed
6. Windshield washers

Push the right lever up or down to select a position.

MIST – The wipers run at high speed until you release the lever.

OFF – The wipers are not activated.

INT – The length of the wiper interval is varied automatically according to the vehicle's speed. Vary the delay by turning the INT TIME ring. If you turn it to the shortest delay, the wiper speed will increase to low speed operation when the vehicle speed exceeds 12 mph (20 km/h).

To change the “FRONT WIPER ACTION” setting, see page [117](#).

LO – The wipers run at low speed.

HI – The wipers run at high speed.

Windshield Washer – Pull the wiper control lever toward you, and hold it. The washers spray until you release the lever. The wipers run at low speed, then complete one more sweep after you release the lever.

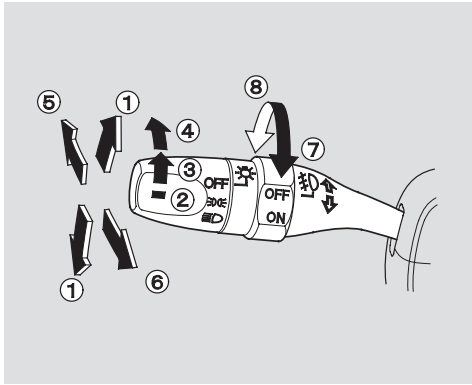



- 1. Turn signal
- 2. Off
- 3. Parking and indicator lights
- 4. Headlights
- 5. High beams
- 6. Flash high beams
- 7. Fog lights off
- 8. Fog lights on

Turn Signal – Push down on the left lever to signal a left turn and up to signal a right turn. To signal a lane change, push lightly on the lever in the proper direction and hold it. The lever will return to center when you release it or complete a turn.

Headlights – Turning the switch on the left lever to the “” position turns on the parking lights, taillights, instrument panel lights, side-marker lights, and rear license plate lights.

Turning the switch to the “” position turns on the headlights.

When the light switch is in the “” or the “” position, the Lights On indicator comes on as a reminder. This indicator stays on if you leave the light switch on and turn the ignition switch to the ACCESSORY (I) or LOCK (0) position.

If you leave the lights on with the key removed from the ignition switch, you will hear a reminder chime when you open the driver’s door.

CONTINUED

Headlights, Automatic Lighting Off Feature, Daytime Running Lights

High Beams – To switch from low beams to high beams, push the left lever forward until you hear a click. The high beam indicator will come on (see page 66). Pull it back to return to low beams. To flash the high beams, pull the lever back lightly, then release it. The high beams will stay on as long as you hold the lever back.

Fog Lights



Turn the fog lights on and off by turning the switch next to the headlight switch.

You can use the fog lights only when the headlights are on low beam. They will go off when you turn the headlights off or onto high beam.

Automatic Lighting Off Feature

This feature turns off the headlights, parking lights, taillights, and license plate lights within 15 seconds of removing the key from the ignition switch and closing the driver's door.

You can change this 15 second timer to 0, 30, or 60 seconds (see page 108).

This feature activates if you leave the headlight switch in the  or  position, remove the key, then open and close the driver's door.

If you remove the key from the ignition switch with the headlight switch on, but do not open the door, the lights will turn off after 10 minutes.

The lights will turn on again when you unlock or open the driver's door. If you unlock the door, but do not open it within 15 seconds, the lights will go off. With the driver's door open, you will hear a lights on reminder chime.

Daytime Running Lights (Canadian Models)

With the headlight switch in the off or  position, the high beam headlights and the high beam indicator come on with reduced brightness when you turn the ignition switch to the ON (II) position and release the parking brake. They remain on until you turn the ignition switch off, even if you set the parking brake.

Daytime Running Lights, Instrument Panel Brightness

The headlights revert to normal operation when you turn them on with the switch.

If you see a “CHECK DRL SYSTEM” message on the multi-information display, there is a problem in the high beam headlight’s circuit. Take your vehicle to a dealer to have it checked.

When the multi-information display shows a “DRL OFF” message, the daytime running lights are off. Follow the procedure in the previous page to turn them on.

Instrument Panel Brightness

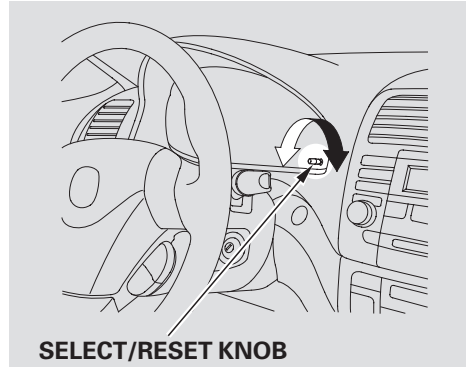

The select/reset knob on the instrument panel controls the brightness of the instrument panel lights. Turn the knob to adjust the brightness.

U.S. model is shown

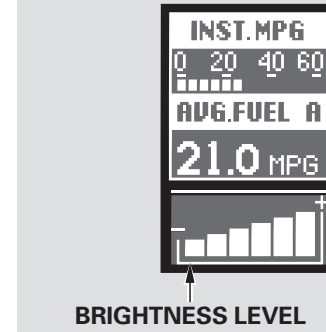

The level of brightness is shown on the multi-information display while you adjust it. It goes out 5 seconds after you finish adjusting.

To reduce glare at night, the instrument panel illumination dims when you turn the light switch to ☰ or ☷. Turning the select/reset knob fully to the right until you hear a click will cancel the reduced brightness.

Hazard Warning Button, Rear Window Defogger

Hazard Warning Button

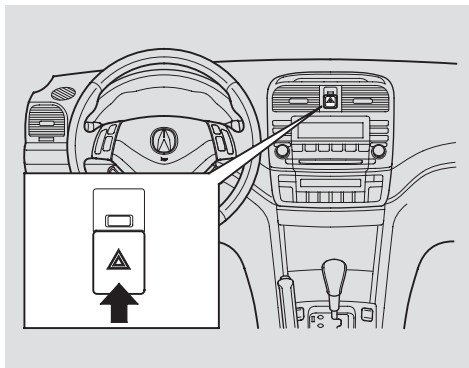

Push the button between the center vents to turn on the hazard warning lights (four-way flashers). This causes all four outside turn signal lights and both turn signal indicators in the instrument panel to flash. Use the hazard warning lights if you need to park in a dangerous area near heavy traffic, or if your vehicle is disabled.

Rear Window Defogger

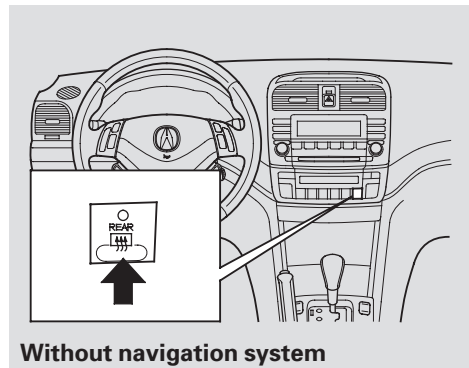

Without navigation system

The rear window defogger will clear fog, frost, and thin ice from the window. Push the defogger button to turn it on and off. The indicator above the button comes on to show the defogger is on. If you do not turn it off, the defogger will shut itself off after about 35 minutes. It also shuts off when you turn off the ignition switch. You have to turn the defogger on again when you restart the vehicle.

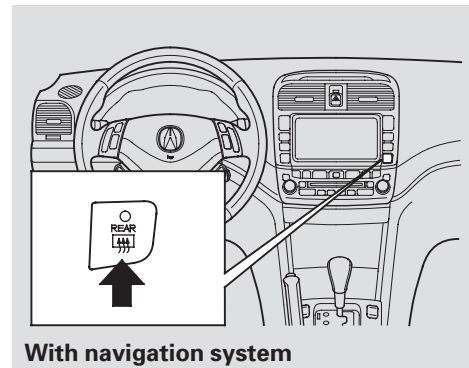

With navigation system

Make sure the rear window is clear and you have good visibility before starting to drive.

The defogger and antenna wires on the inside of the rear window can be accidentally damaged. When cleaning the glass, always wipe side-to-side.

Make any steering wheel adjustment before you start driving.

⚠ WARNING

Adjusting the steering wheel position while driving may cause you to lose control of the vehicle and be seriously injured in a crash.

Adjust the steering wheel only when the vehicle is stopped.

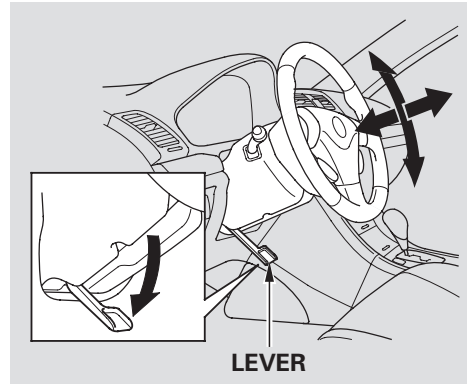

1. Push the lever under the steering column all the way down.
2. Move the steering wheel so it points toward your chest, not toward your face. Make sure you can see the instrument panel gauges and indicators.

3. Push the lever up to lock the steering wheel in position.
4. Make sure you have securely locked the steering wheel in place by trying to move it up, down, in, and out.

Keys and Locks

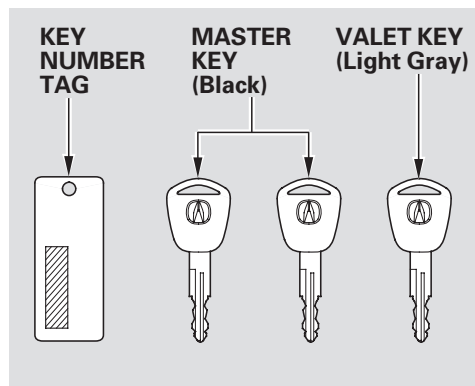

The master key fits all the locks on your vehicle. The valet key works only in the ignition and the door locks. You can keep the trunk release lever, rear seat trunk access, and glove box locked when you leave your vehicle and the valet key at a parking facility.

You should have received a key number tag with your keys. You will need this key number if you ever have to get a lost key replaced. Use only Acura-approved key blanks.

These keys contain electronic circuits that are activated by the immobilizer system. They will not work to start the engine if the circuits are damaged.

- Protect the keys from direct sunlight, high temperature, and high humidity.

- Do not drop the keys or set heavy objects on them.
- Keep the keys away from liquids. If they get wet, dry them immediately with a soft cloth.

The keys do not contain batteries. Do not try to take them apart.

The immobilizer system protects your vehicle from theft. If an improperly-coded key (or other device) is used, the engine will not start.

When you turn the ignition switch to the ON (II) position, the immobilizer system indicator should come on for a few seconds, then go off. If the indicator starts to blink, it means the system does not recognize the coding of the key. Turn the ignition switch to the LOCK (0) position, remove the key, reinsert it, and turn the ignition switch to the ON (II) position again.

The system may not recognize your key's coding if another immobilizer key or other metal object (i.e. key fob) is near the ignition switch when you insert the key.

If the system repeatedly does not recognize the coding of your key, contact your dealer.

Do not attempt to alter this system or add other devices to it. Electrical problems could result that may make your vehicle undrivable.

If you lose your key and you cannot start the engine, contact your dealer.

NOTICE

Always take the ignition key with you whenever you leave the vehicle alone.

As required by the FCC:

This device complies with Part 15 of the FCC rules. Operation is subject to the following two conditions: (1) This device may not cause harmful interference, and (2) this device must accept any interference received, including interference that may cause undesired operation.

Changes or modifications not expressly approved by the party responsible for compliance could void the user's authority to operate the equipment.

This device complies with Industry Canada Standard RSS-210. Operation is subject to the following two conditions: (1) this device may not cause interference, and (2) this device must accept any interference that may cause undesired operation of the device.

Ignition Switch

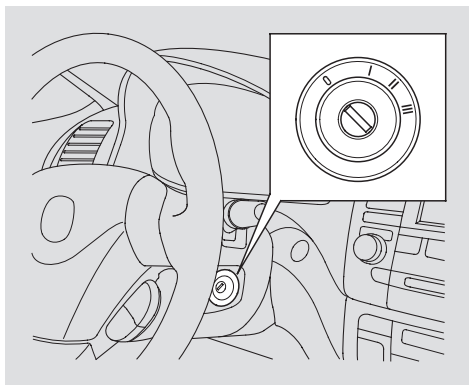

The ignition switch has four positions: LOCK (0), ACCESSORY (I), ON (II), and START (III).

LOCK (0) – You can insert or remove the key only in this position. To turn the key, you must push the key in slightly. If your vehicle has an automatic transmission, the shift lever must also be in Park.

If the front wheels are turned, the anti-theft lock may make it difficult to turn the key. Firmly turn the steering wheel to the left or right as you turn the key.

ACCESSORY (I) – You can operate the audio system and the accessory power sockets in this position.

ON (II) – This is the normal key position when driving. Several of the indicators on the instrument panel come on as a test when you turn the ignition switch from the ACCESSORY (I) to the ON (II) position.

START (III) – Use this position only to start the engine. The switch returns to the ON (II) position when you let go of the key.

You will hear a reminder beeper if you leave the key in the ignition

switch in the LOCK (0) or the ACCESSORY (I) position and open the driver's door. Remove the key to turn off the beeper.

You will also see a “REMOVE KEY” message on the multi-information display (see page 79).

If your vehicle has an automatic transmission, the shift lever must be in Park before you can remove the key from the ignition switch.

⚠ WARNING

Removing the key from the ignition switch while driving locks the steering. This can cause you to lose control of the vehicle.

Remove the key from the ignition switch only when parked.

LOCK TAB

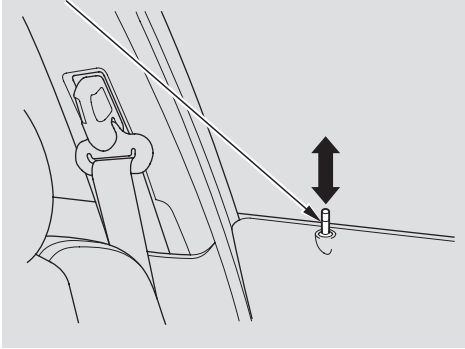

Each door has a lock tab on the top. Push the tab down to lock the door and pull it up to unlock.

To lock the passenger's door when getting out of the vehicle, push the lock tab down and close the door. To lock the driver's door, remove the key from the ignition switch and push the lock tab down or push the top of the master switch, then close the door.

All doors can be locked from the outside by using the key in the driver's door. To unlock only the driver's door or all doors (depending on the "DOOR LOCK MODE" setting), insert the key, turn the key, and release it. The remaining doors unlock when you turn the key a second time within a few seconds. To change this setting, see page [111](#).

You can open or close the windows by using the key in the driver's door (see page [149](#)).

Power Door Locks

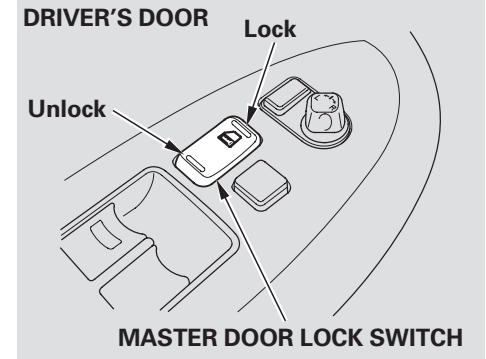

Each front door has a master door lock switch. Either switch locks and unlocks all doors. On the driver's door, push the top of the master door lock switch to lock all doors. Push the bottom to unlock them.

CONTINUED

Door Locks, Childproof Door Locks

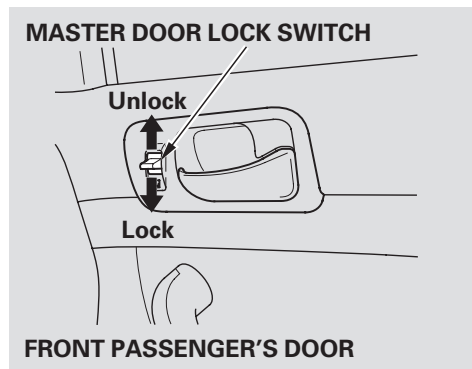

On the front passenger's door, push the master door lock switch down to lock the all doors, and up to unlock them.

Lockout Prevention

With the driver's door open and the key in the ignition, both master door lock switches are disabled. If you try to lock an open driver's door by pushing in the lock tab, all doors will unlock when you close the driver's door.

Childproof Door Locks

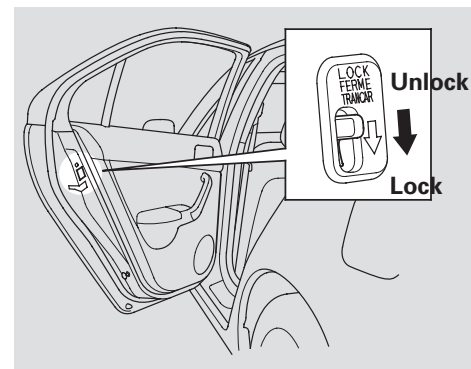

The childproof door locks are designed to prevent children seated in the rear from accidentally opening the rear doors. Each rear door has a lock lever near the edge. With the lever in the LOCK position, the door cannot be opened from inside regardless of the position of the lock tab. To open the door, pull the lock tab up, and use the outside door handle.

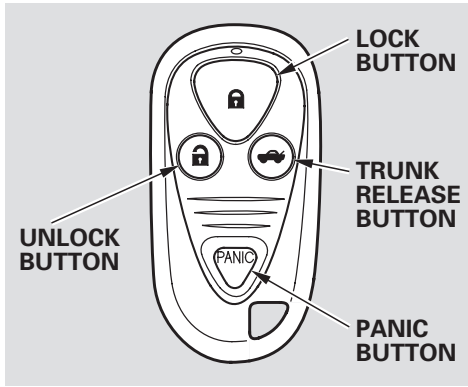

When the key is in the ignition switch, the functions of each button are disabled.

LOCK – Press this button once to lock all doors. Some exterior lights will flash. When you push LOCK twice within 5 seconds, you will hear a horn (depending on the “KEYLESS LOCK ACKNOWLEDGEMENT” setting) to verify that the doors are locked and the security system has set. The Lock button will not work

this way if any door is not fully closed.

To change the “KEYLESS LOCK ACKNOWLEDGEMENT” setting, see page [113](#).

You can open and close all power windows from outside the vehicle with the key. With the remote transmitter, you can open the windows. Refer to Power Windows on page [149](#).

UNLOCK – Press this button once to unlock the driver’s door or all the doors (depending on the “DOOR LOCK MODE” setting). Press it twice to unlock the other doors. Some exterior lights will flash twice each time you press the button. The ceiling light (if the ceiling light switch is in the Door Activated position) will come on when you press the UNLOCK button. If you do not open any doors within 30 seconds (or whatever setting the “INTERIOR LIGHT DIMMING TIME” is set to), the light fades out. If you relock the doors with the remote transmitter before 30 seconds have elapsed, the light will go off immediately.

To change the “DOOR LOCK MODE” setting, see page [111](#).

CONTINUED

Remote Transmitter

To change the “INTERIOR LIGHT DIMMING TIME,” see page [106](#).

If you unlock the doors with the remote transmitter, but do not open any doors within 30 seconds, the doors automatically relock and the security system sets. To change this setting, refer to “SECURITY RELOCK TIMER” on page [115](#).

PANIC — Press this button for about 1 second to attract attention; the horn will sound and the exterior lights will flash for about 30 seconds. To cancel panic mode, press any other button on the remote transmitter, or turn the ignition switch to the ON (II) position.

TRUNK — Press this button for about 1 second to open the trunk. You cannot open the trunk if the key is in the ignition switch.

Linking Your Remote Transmitter

1. Standing outside the vehicle with all the doors shut, push the lock and unlock buttons at the same time until the LED on the remote transmitter blinks 2 times.
2. Open and shut the driver’s door.
3. Use the remote transmitter to lock and unlock the driver’s door.
4. Verify that the remote transmitter is in the linked mode. Turn the ignition switch to the ON (II) position. The MID display should read “Welcome Driver 1” or “Welcome Driver 2”, depending on which remote you just linked (the remote number is on the back of the remote transmitter).

If the MID display only reads “Welcome Driver” once the ignition switch is turned to the ON (II) position, the link from the remote transmitter to the vehicle has failed. Repeat the procedure. If the link still fails, see your dealer.

Recalling a Memorized Driving Position

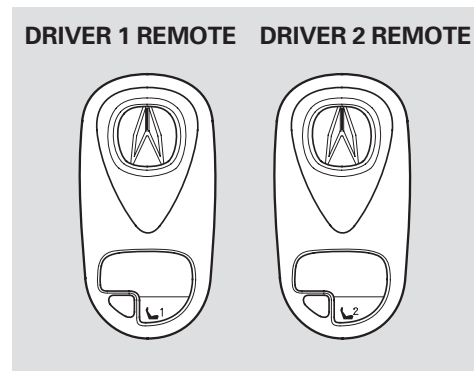

Each remote transmitter also activates the Driving Position Memory System and changes the “MEMORY POSITION LINK” setting according to that remote (see page [143](#)).

When you open the driver's door after unlocking it with the remote transmitter, you will hear a beep (depending on the "KEYLESS LOCK ACKNOWLEDGEMENT" setting see page 113). The driver's seat will move to the positions stored in the memory location corresponding to the remote in use. You will hear two beeps when the seat stops moving.

Any of these actions will stop the system's automatic seat adjustment:

- Pressing either memory button or the MEMO button on the driver's door.
- Pressing any of the seat adjustment switches.
- Shifting out of Park (A/T), or into reverse (M/T).

The driving position memory activated (Driver 1, Driver 2) is shown on the back of each transmitter. Make sure you store your desired driving position in the memory that is activated by the transmitter you normally carry.

You can turn off this system activation. Press and hold the LOCK and UNLOCK buttons at the same time. The LED in the remote transmitter will blink twice. Then release the buttons. Doing this also cancels the "MEMORY POSITION LINK" setting for that remote and restores the default settings.

To turn it back on, repeat this procedure. The LED will come on for 1 second to indicate the feature has been turned on.

Remote Transmitter Care

- Avoid dropping or throwing the transmitter.
- Protect the transmitter from extreme temperature.
- Do not immerse the transmitter in any liquid.
- If you lose a transmitter, the replacement needs to be reprogrammed by your dealer.

Replacing the Transmitter Battery

If it takes several pushes on the button to lock or unlock the doors, replace the battery as soon as possible.

Battery type: CR2025

CONTINUED

Remote Transmitter

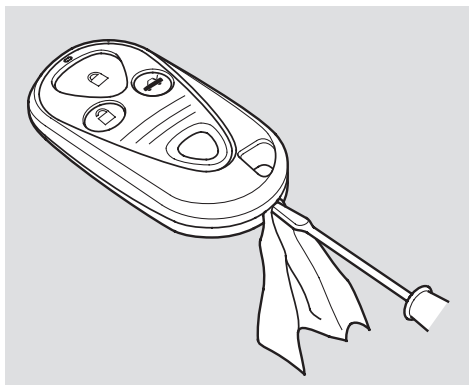

To replace the battery:

1. Place a cloth on the edge of the transmitter, and remove the upper half by carefully prying on the edge with a small flat-tip screwdriver.

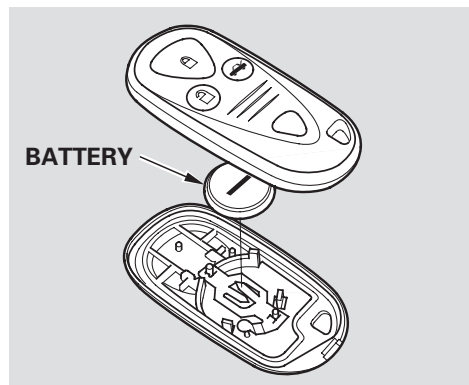

2. Remove the old battery and note the polarity. Make sure the polarity of the new battery is the same (– side facing up), then insert it in the transmitter.

An improperly disposed of battery can hurt the environment. Always confirm local regulations for battery disposal.

3. Snap the two halves of the transmitter case back together.

As required by the FCC:

This device complies with Part 15 of the FCC rules. Operation is subject to the following two conditions: (1) This device may not cause harmful interference, and (2) this device must accept any interference received, including interference that may cause undesired operation.

Changes or modifications not expressly approved by the party responsible for compliance could void the user's authority to operate the equipment.

This device complies with Industry Canada Standard RSS-210.

Operation is subject to the following two conditions: (1) this device may not cause interference, and (2) this device must accept any interference that may cause undesired operation of the device.

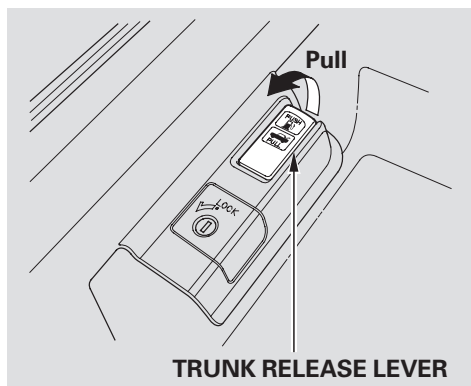

You can open the trunk in any of three ways:

- Pull up on the trunk release lever to the left of the driver's seat.
- Press and hold the trunk release button on the remote transmitter.
- If the doors are unlocked, press the trunk release switch on the trunk lid.

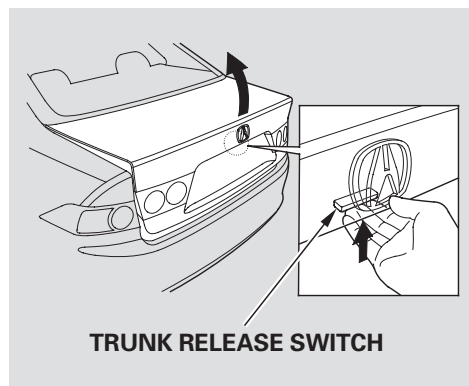

To close the trunk, press down on the trunk lid.

See page [243](#) for cargo loading and weight limit information. Keep the trunk lid closed at all times while driving to avoid damaging the lid, and to prevent exhaust gas from getting into the interior. See **Carbon Monoxide Hazard** on page [55](#).

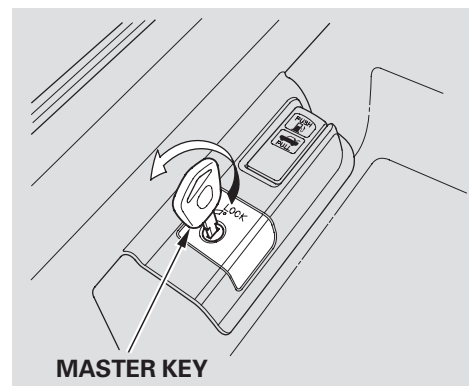

To protect items in the trunk when you need to give the key to someone else:

1. Lock the trunk release lever with the master key. Also make sure the rear seat is not folded down (see page [141](#)).
2. Give the person the valet key.

Trunk

Emergency Trunk Opener

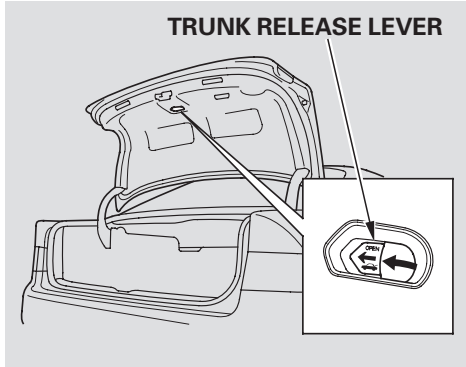

As a safety feature, your vehicle has a release lever on the trunk latch so the trunk can be opened from the inside.

To open the trunk, push the release lever to the left.

Parents should decide if their children should be shown how to use this feature.

For more information about child safety, see page [40](#).

Trunk Main Switch

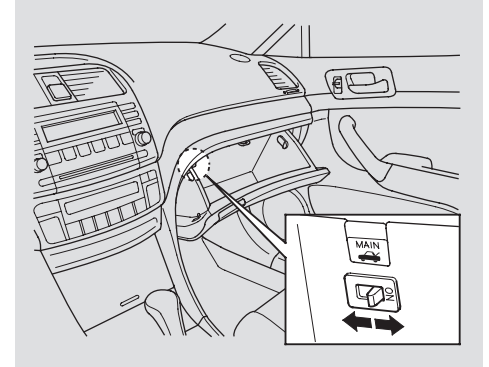

To protect items in the trunk, you can disable the trunk-release switch on the trunk lid by turning off the trunk main switch in the glove box and locking the glove box. Make sure the rear seat is not folded down.

If you need to give the key to someone else, give them the valet key.

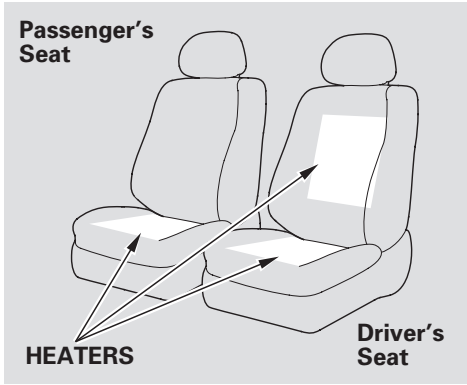

Both front seats are equipped with seat heaters. The passenger seat is only heated in the seat bottom because of the side airbag cutoff system.

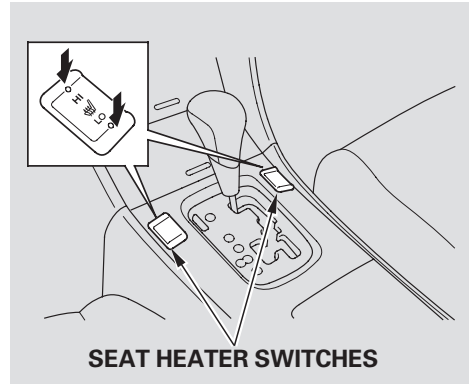

The ignition switch must be in the ON (II) position to use them. Push the front of the switch, HI, to rapidly heat up the seat. After the seat reaches a comfortable temperature, select LO by pushing the back of the switch. This will keep the seat warm.

In the HI setting, the heater turns off when the seat gets warm, and turns back on after the seat's temperature drops.

In the LO setting, the heater runs continuously. It does not cycle with temperature changes.

Follow these precautions whenever you use the seat heaters:

- Use the HI setting only to heat the seats quickly, because it draws large amounts of current from the battery.
- If the engine is left idling for an extended period, do not use the seat heaters even on the LO setting. It can weaken the battery, causing hard starting.

Seats

Power Seat Adjustment

See pages 12 – 14 for important safety information and warnings about how to properly position seats and seat-backs.

The controls for the power adjustable front seats are on the outside edge of each seat bottom. You can adjust the seats with the ignition switch in any position. Make all seat adjustments before you start driving.

Moving the long horizontal switch adjusts the seat bottom in several directions. The seat bottom adjusts in the direction you move the switch. The short vertical switch adjusts the seat back angle.

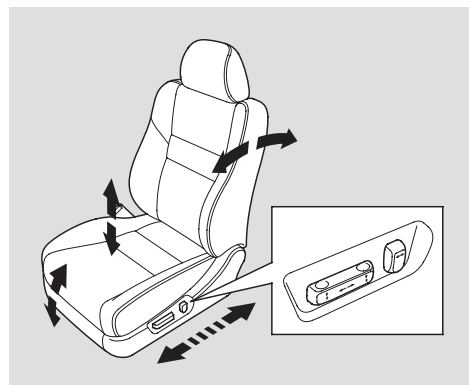

Moves the seat forward and backward.

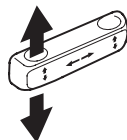

Driver's seat only:
Moves the front of the seat up or down.

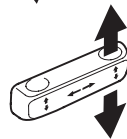

Driver's seat only:
Raises or lowers the seat.

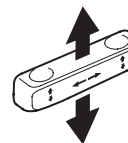

Driver's seat only:
Moves the whole seat up and forward, or down and backward. The front of the seat also tilts up or down at the same time.



Adjusts the seat-back angle forward or backward.

Driver's Lumbar Support



To change the lumbar support, move the lever on the right side of the seat-back forward or backward. Keep moving the lever forward or backward until you find a suitable position.

Head Restraints

See page 14 for important safety information and a warning about improperly positioning head restraints.

Your vehicle has adjustable head restraints on the front seats and on the outside positions of the rear seat.

The head restraints help protect you and your passengers from whiplash and other injuries.

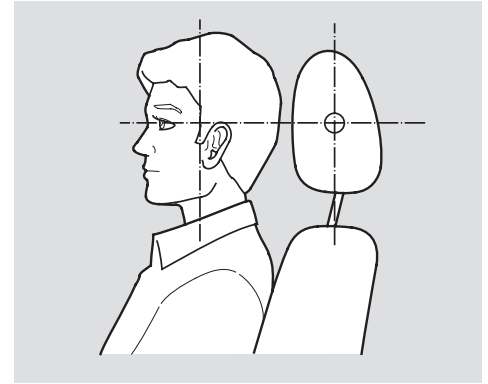

They are most effective when you adjust them so the center of the back of the occupant's head rests against the center of the restraint.

CONTINUED

Seats

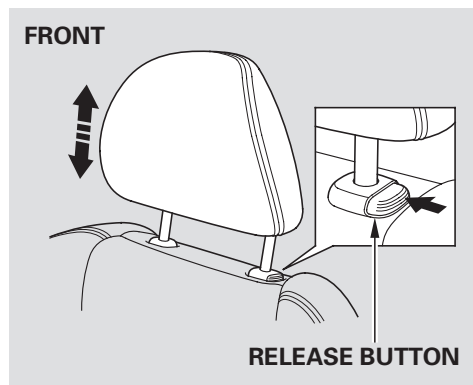

The head restraints adjust for height. You need both hands to adjust the restraint. Do not attempt to adjust it while driving. To raise it, pull upward. To lower the restraint, push the release button sideways, and push the restraint down.

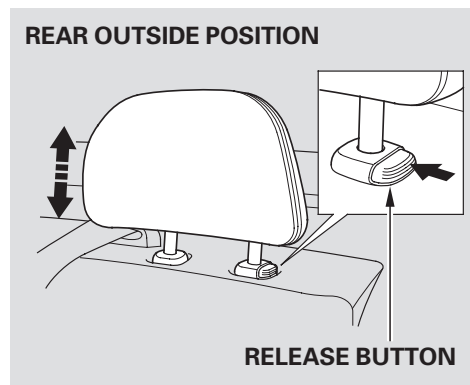

Removing the Head Restraint

To remove a head restraint for cleaning or repair, pull it up as far as it will go. Push the release button and pull the restraint out of the seat-back.

When reinstalling a head restraint, put the legs back in place. Then adjust it to the appropriate height while pressing the release button.

Make sure the head restraint locks in position when you reinstall it.

⚠ WARNING

Failure to reinstall the head restraints can result in severe injury during a crash.

Always replace the head restraints before driving.

Folding Rear Seat

The back of the rear seat folds down to give you direct access to the trunk. Each side folds down separately. With only half the seat folded, you can still carry a passenger in the back seat. The seat-back can be released from inside the vehicle or inside the trunk.

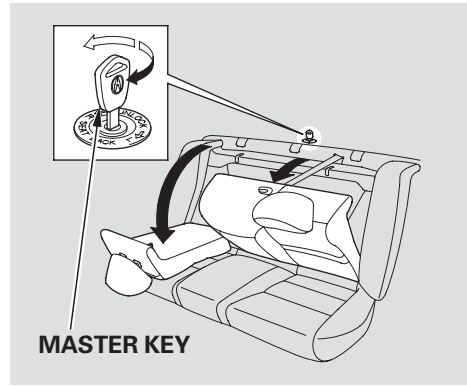

To fold down either side of the seat-back from inside the vehicle, insert the master key in the lock on the rear shelf. To fold down the driver's side, turn the key clockwise, pull down the top of the seat-back, then release the key. To fold down the passenger's side, turn the key counterclockwise and perform the same procedure.

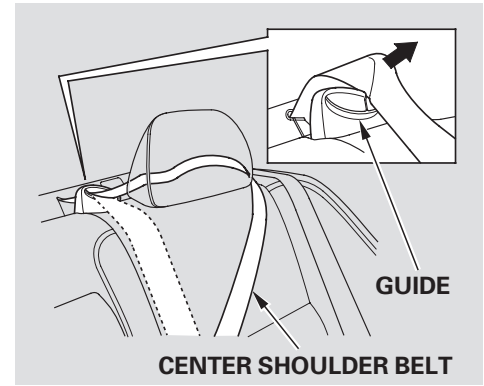

When storing cargo, you can move the rear center shoulder belt out of the way by removing the belt from the guide.

CONTINUED

Seats

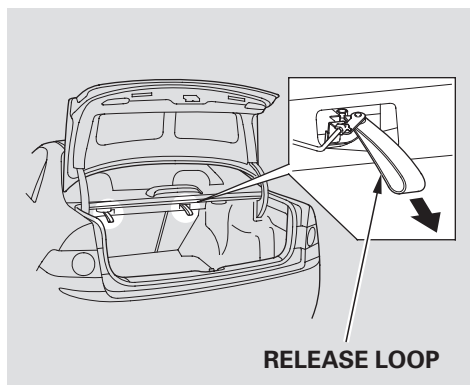

To release the seat-back from inside the trunk, pull the release loop under the trunk panel.

Push the seat-back down, then let go of the release.

To lock the seat-back upright, push it firmly against the trunk panel. Make sure it is latched in place by pulling on the top of the seat.

Make sure that the folded seat-back does not press against the front passenger's seat, as this could cause the weight sensors to work improperly.

Make sure all rear shoulder belts are positioned in front of the rear seat-back, and the center shoulder belt is re-positioned in the guide whenever the seat-back is in its upright position. Be sure there are no twists in any shoulder belt.

Do not put any heavy items on the seat-back when it is folded down.

Make sure all items in the trunk, or items extending through the opening into the back seat, are secured. Loose items can fly forward and cause injury if you have to brake hard. See **Carrying Cargo** on page [240](#).

Never drive with the seat-back folded down and the trunk lid open. See **Carbon Monoxide Hazard** on page [55](#).

Driving Position Memory System

Your vehicle has a memory feature for the driver's seat position.

Two seat positions can be stored in separate memories. You select a memorized position by pushing the appropriate button or appropriate remote transmitter (Driver 1 or Driver 2).

This setting can be linked or unlinked with the remote transmitter. To customize the setting "MEMORY POSITION LINK", see page 104 .

Storing a Driving Position in Memory

Store a driving position only when the vehicle is parked.

1. Turn the ignition switch to the ON (II) position. You cannot add a new driving position to the memory unless the ignition switch is in the ON (II) position. You can recall a memorized position with the ignition switch in any position.
2. Adjust the seat to a comfortable position (see page 138).

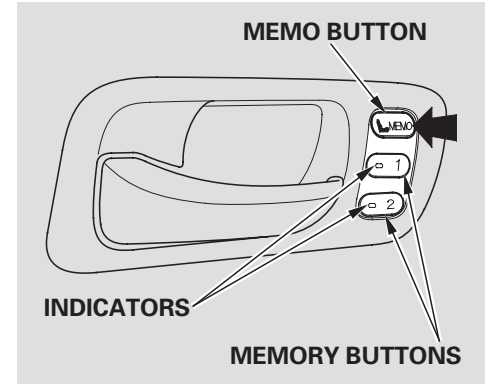

3. Press and release the MEMO button on the driver's door. You will hear a beep. Then, both indicators in the memory buttons will start to blink. Press and hold one of the memory buttons (1 or 2) within 5 seconds after you press the MEMO button. When the system completes storing a new driving position, you hear two beeps. The indicator in the stored memory button will come on.

CONTINUED

Driving Position Memory System

Doing any of the following after pressing the MEMO button will cancel the storing procedure.

- Not pressing a memory button within 5 seconds.
- Pressing the MEMO button again within 5 seconds.
- Readjusting the seat position.

Each memory button stores only one driving position. Storing a new position erases the previous setting stored in that button's memory. If you want to add a new position while retaining the current one, use the other memory button.

All stored driving positions will be lost if your vehicle's battery goes dead or is disconnected.

Selecting a Memorized Position

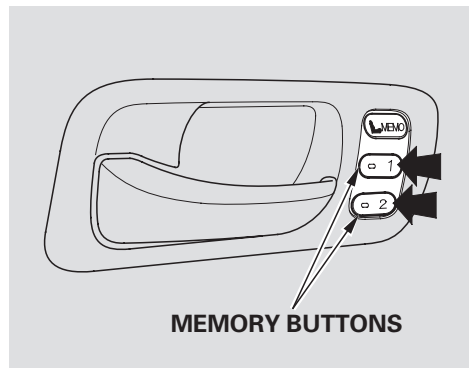

To select a memorized position, do this:

1. Make sure the parking brake is set (M/T) or the shift lever is in Park (A/T).
2. Press the desired memory button (1 or 2) until you hear a beep.

The system will move the driver's seat to the memorized position. The indicator in the selected memory button will flash during movement. When the adjustment is complete, you will hear two beeps, and the indicator will stay on.

Notes for vehicles with M/T

- You cannot select a memorized position if the transmission is in reverse. Shift to another gear, then select a position.
- If the parking brake is not set, you must press and hold the memory button until the adjustment is complete.

Any of these actions will stop the system's automatic seat adjustment:

- Pressing either memory button or the MEMO button on the driver's door.
- Pressing any of the seat adjustment switches.
- Shifting out of Park (A/T), or into reverse (M/T).

If desired, you can use the adjustment switches to change the seat position after it is in its memorized position. If you change the memorized position, the indicator in the memory button will go out. To keep this seat position for later use, you must store it in the driver's seat position memory.

Mirrors

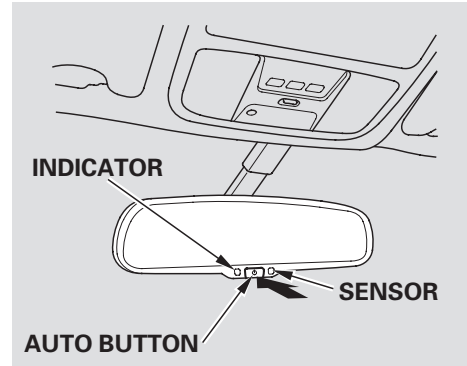

Keep the inside and outside mirrors clean and adjusted for best visibility. Be sure to adjust the mirrors before you start driving.

The inside mirror can automatically darken to reduce glare. To turn on this feature, press the button on the bottom of the mirror. The AUTO indicator comes on as a reminder. When it is on, the mirror darkens when it senses the headlights of a vehicle behind you, then returns to normal visibility when the lights are gone. Press the button again to turn off this feature.

Mirrors

Adjusting the Power Mirrors

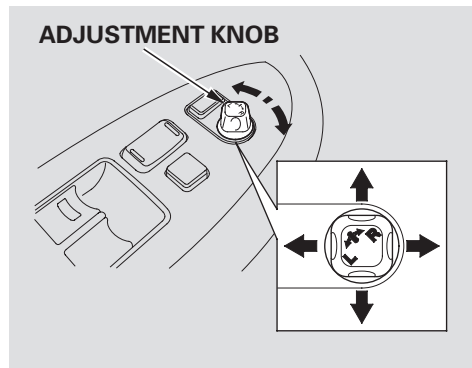

1. Turn the ignition switch to the ON (II) position.
2. Turn the adjustment knob to L (driver's side) or R (passenger's side).

3. Push or pull the adjustment knob right, left, up, or down to move the mirror.
4. When you finish, turn the adjustment knob to the center (off) position. This turns off the adjustment knob to keep your settings.

Power Mirror Heaters

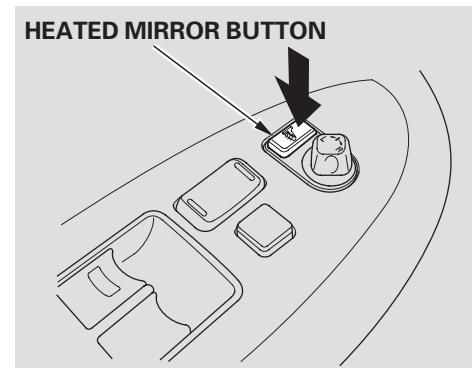

The outside mirrors are heated to remove fog and frost. With the ignition switch in the ON (II) position, turn on the heaters by pressing the button. The indicator in the button comes on as a reminder. Press the button again to turn the heaters off.

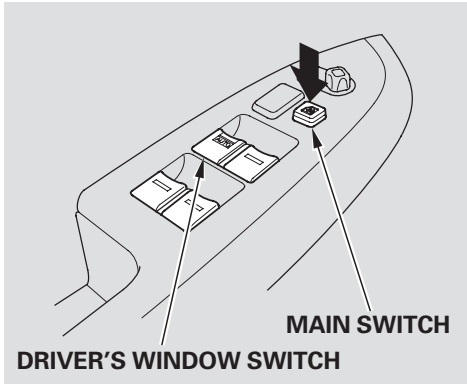

Turn the ignition switch to the ON (II) position before operating any of the window switches. To open a window, push the switch down and hold it. To close the window, pull the switch up and hold it. Release the switch to stop the window.

⚠ WARNING

Closing a power window on someone's hands or fingers can cause serious injury.

Make sure your passengers are away from the windows before closing them.

If the MAIN switch is pushed down (OFF), the passenger windows cannot be raised or lowered. Keep the MAIN switch off when you have children in the vehicle so they do not injure themselves by operating the windows unintentionally.

AUTO – To open the driver's window, push the window switch firmly down, then release it. To stop the window from going all the way down, pull back on the window switch briefly.

To close the driver's window fully, pull back the window switch firmly, then release it. To stop the window from going all the way up, push down on the window switch briefly.

To open or close the driver's window partially, push down or pull back on the window switch lightly and hold it. The window will stop when you release the switch.

CONTINUED

Power Windows

AUTO REVERSE — If the driver's window senses any obstacle while it is closing automatically, it will reverse direction, and then stop. To close the window, remove the obstacle, then use the window switch again.

Auto reverse stops sensing when the window is almost closed. You should always check that all passengers and objects are away from the window before closing it.

If your vehicle's battery is disconnected or goes dead, or the driver's window fuse is removed, the AUTO function may be disabled. If this happens, the power window system will need to be reset after reconnecting the battery or installing the fuse.

1. Start the engine. Push down and hold the driver's window switch until the window is fully open.
2. Pull and hold the driver's window switch to close the window completely, then hold the switch for about 2 seconds.

If the power windows do not operate properly after resetting, have your vehicle checked by your dealer.

The power window system has a key-off delay function. The windows will still operate for up to 10 minutes after you turn off the ignition switch. Opening either front door cancels the delay function. You must turn the ignition switch to the ON (II) position again before you can raise or lower the windows.

Opening the Windows with the Remote Transmitter

You can open all of the windows from the outside with the remote transmitter.

1. Press the UNLOCK button once to unlock the driver's door (depending on the "DOOR LOCK MODE" setting).
2. Press the UNLOCK button a second time, and hold it. The passenger's doors unlock, and all four windows start to open. To stop the windows, release the button.
3. To open the windows further, press the button again (within 10 seconds).

You cannot close the windows with the remote transmitter.

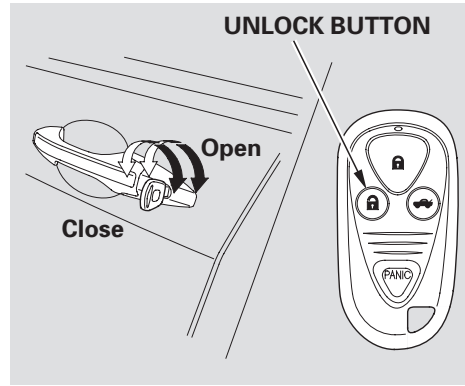

Opening/Closing the Windows with the Key

You can open and close the windows with the key in the driver's door lock.

To open:

1. Insert the key in the driver's door lock.
2. Turn the key clockwise, then release it.

3. Turn the key clockwise again, and hold it. All four windows start to open. To stop the windows, release the key.

4. To open the windows further, turn and hold the key again (within 10 seconds).

To close:

1. Insert the key in the driver's door lock.
2. Turn the key counterclockwise, then release it.
3. Turn the key counterclockwise again, and hold it. All four windows start to close. To stop the windows, release the key.
4. To close the windows further, turn and hold the key again (within 10 seconds).

Moonroof

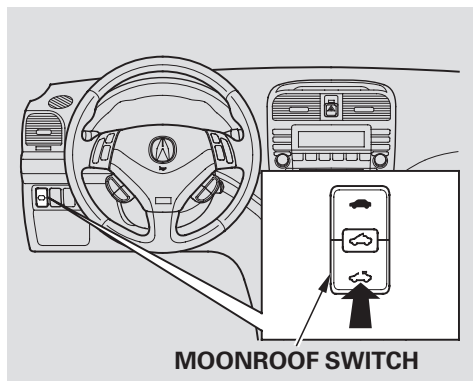

The moonroof has two positions: it can be tilted up in the back for ventilation, or it can be slid back into the roof. Use the switch under the left dashboard vent to operate the moonroof. The ignition switch must be in the ON (II) position.

To tilt up the back of the moonroof, press and hold the center button (☀️). To close the moonroof, press and hold the upper part of the switch (🌙). To open the moonroof, press and hold the lower part of the switch (🚗). Release the switch when the moonroof gets to the desired position. Make sure everyone's hands are away from the moonroof before opening or closing it.

⚠️ WARNING

Opening or closing the moonroof on someone's hands or fingers can cause serious injury.

Make sure all hands and fingers are clear of the moonroof before opening or closing it.

The moonroof has a key-off delay function. You can still open and close the moonroof for up to 10 minutes after you turn off the ignition switch. The key-off delay function cancels as soon as you open either front door. You must then turn the ignition switch to the ON (II) position to operate the moonroof.

NOTICE

If you try to open the moonroof in below-freezing temperatures, or when it is covered with snow or ice, you can damage the moonroof panel or motor.

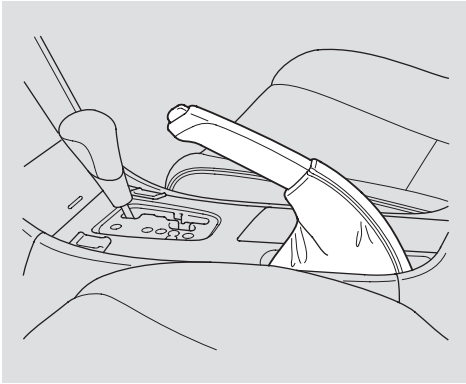

To apply the parking brake, pull the lever up fully. To release it, pull up slightly, push the button, and lower the lever. The parking brake indicator on the instrument panel should go out when the parking brake is fully released (see page 63).

If you drive without releasing the parking brake, a beeper will sound, and you will also see a “RELEASE PARKING BRAKE” message on the multi-information display (see page 78).

NOTICE

Driving the vehicle with the parking brake applied can damage the rear brakes and hubs. A beeper will sound if the vehicle is put into gear with the parking brake on.

Sun Visor, Vanity Mirror

Sun Visor

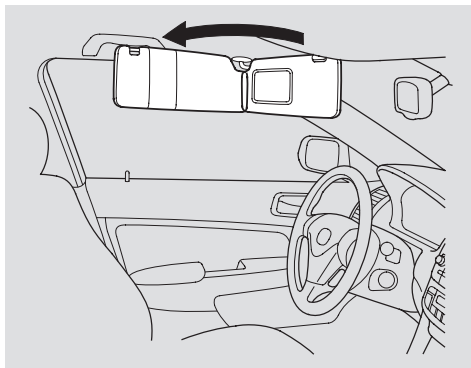

To use the sun visor, pull it down. You can also use the sun visor at the side window. Remove the support rod from the clip and swing the sun visor toward the side window.

Vanity Mirror

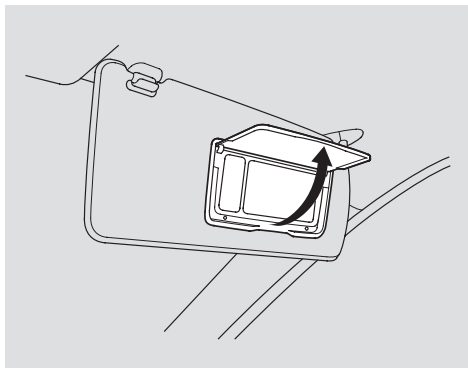

To use the vanity mirror on the back of the sun visor, pull up the cover.

The lights come on when you pull up the cover.

Ceiling Light

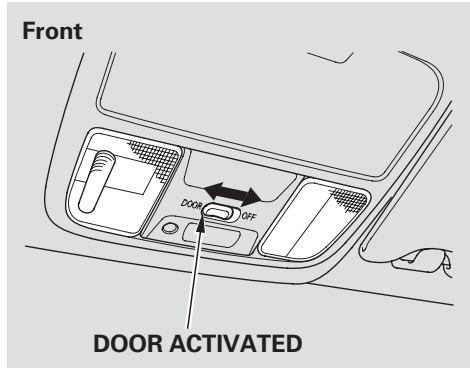

The front ceiling lights have a two-position switch. In the Door Activated position, the lights come on when you open any door. In the OFF position, the lights do not come on.

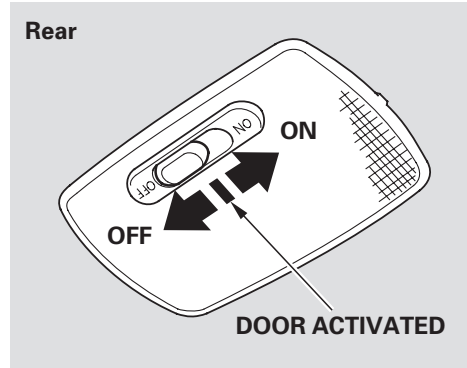

The rear ceiling light has a three-position switch. In the OFF position, the light does not come on. In the Door Activated position, the ceiling light comes on when you open any door. After all doors are closed tightly, the light fades out in about 30 seconds. In the ON position, the ceiling light stays on continuously.

In the Door Activated position, both ceiling lights, come on when you:

- Open any door.
- Remove the key from the ignition switch.
- Unlock the doors with the key, lock tab on the driver's door, master door lock switch, or remote transmitter.

After all doors are closed tightly, the light dims slightly, then fades out in about 30 seconds.

If you leave any door open without the key in the ignition switch, the ceiling light will go off after 3 minutes.

To change the “INTERIOR LIGHT DIMMING TIME,” see page [106](#).

Turn on the front ceiling lights by pushing the lens. Push the lens again to turn if off. You can use these lights at all times.

Interior Lights

Courtesy Light

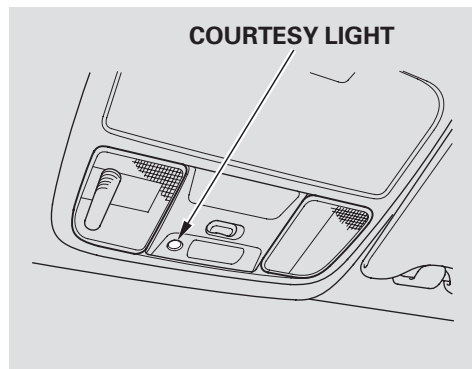

The courtesy light between the spotlights comes on when you turn the parking lights on. To adjust its brightness, turn the select/reset knob on the instrument panel.

Individual Interior Lights

The courtesy lights in the front doors and around the ignition switch come on when you open any door, remove key from the ignition switch, or unlock the driver's door.

After all doors are closed tightly, the light dims slightly, then fades out in about 30 seconds.

To change the "INTERIOR LIGHT DIMMING TIME," see page [106](#).

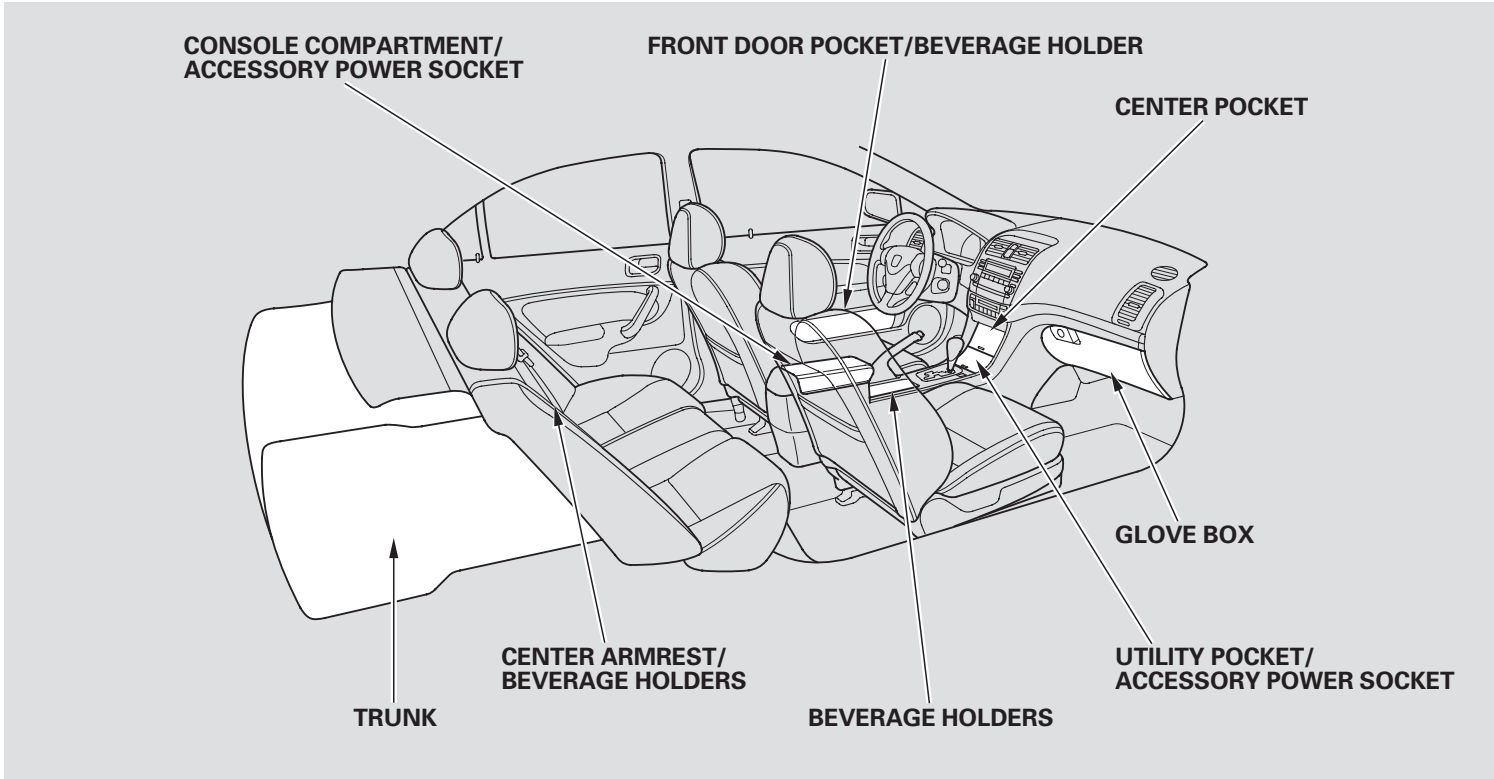

CONTINUED

Interior Convenience Items

Beverage Holders

Be careful when you are using the beverage holders. A spilled liquid that is very hot can scald you or your passengers. Liquid can also spill from the door pocket beverage holders when you close the doors. Use only resealable containers in the door pockets.

Spilled liquids can damage the upholstery, carpeting, and electrical components in the interior.

Accessory Power Sockets

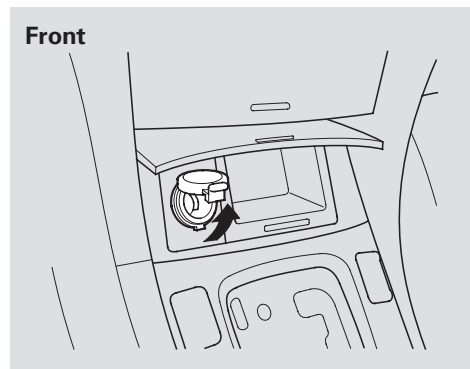

To use the accessory power socket, pull up the cover. The ignition switch must be in the ACCESSORY (I) or ON (II) position.

These sockets are intended to supply power for 12 volt DC accessories that are rated 120 watts or less (10 amps).

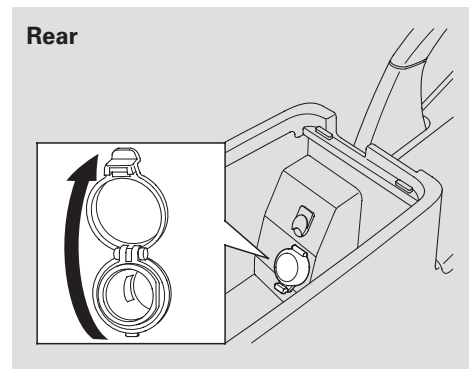

None of the sockets will power an automotive type cigarette lighter element. When both sockets are being used, the combined power rating of the accessories should be 120 watts or less (10 amps).

Console Compartment

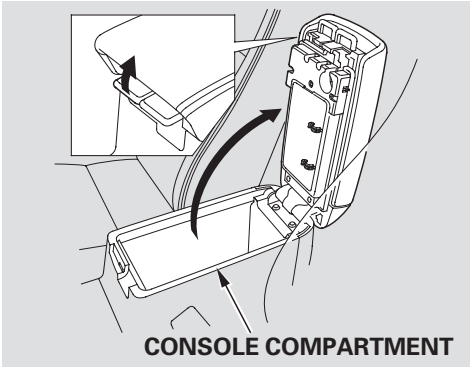

To open the console compartment, pull up on the right lever and lift the armrest.

To close, lower the armrest, and push it down until it latches.

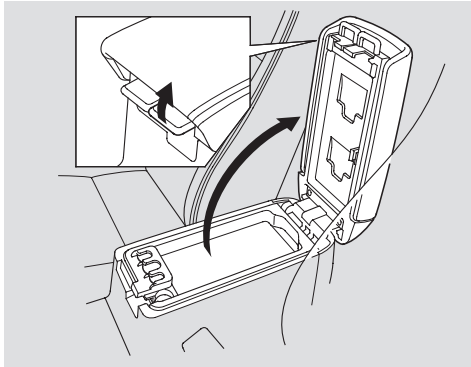

You can put small items in the tray located in the console compartment lid. To use the tray, pull up on the left lever and lift up the armrest.

The tray in the console compartment has a coin holder.

Interior Convenience Items

Sunglasses Holder

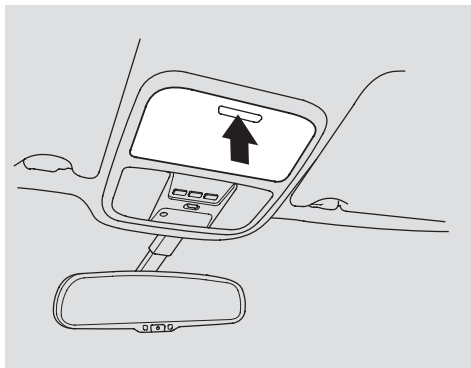

To open the sunglasses holder, push on the front edge. Make sure the holder is closed while you are driving.

Glove Box

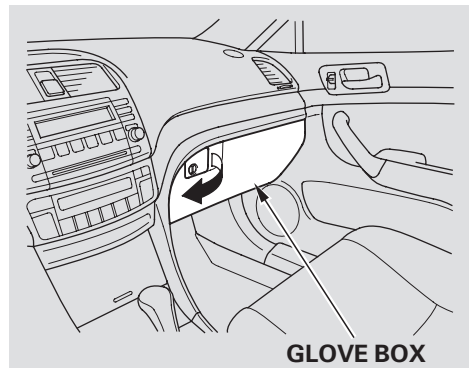

Open the glove box by pulling the handle to the left. Close it with a firm push. Lock or unlock the glove box with the master key.

The glove box light comes on when the parking lights are on.

⚠ WARNING

An open glove box can cause serious injury to your passenger in a crash, even if the passenger is wearing the seat belt.

Always keep the glove box closed while driving.

The climate control system in your vehicle provides a comfortable driving environment in all weather conditions.

The standard audio system has many features. This section describes those features and how to use them.

Your vehicle has an anti-theft audio system that requires a code number to enable it.

The security system helps to discourage vandalism and theft of your vehicle.

| | |
|--|-----|
| Climate Control System..... | 160 |
| Automatic Operation..... | 162 |
| Semi-automatic Operation..... | 163 |
| Dual Temperature Control..... | 167 |
| Climate Control Sensors..... | 169 |
| Playing the AM/FM Radio..... | 170 |
| Adjusting the Sound..... | 175 |
| AM/FM Radio Reception..... | 177 |
| Playing the XM® Satellite Radio | 179 |
| Auxiliary Input Jack..... | 184 |
| Playing Discs..... | 185 |
| CD Player Error Messages | 193 |
| Protecting your CDs..... | 194 |
| Playing a Tape..... | 197 |
| Steering Wheel Controls | 202 |
| Radio Theft Protection..... | 203 |
| Setting the Clock | 204 |
| Security System | 205 |
| Cruise Control..... | 206 |
| HomeLink® Universal Transceiver..... | 209 |
| Bluetooth® HandsFreeLink® | 213 |

Climate Control System

Without navigation system

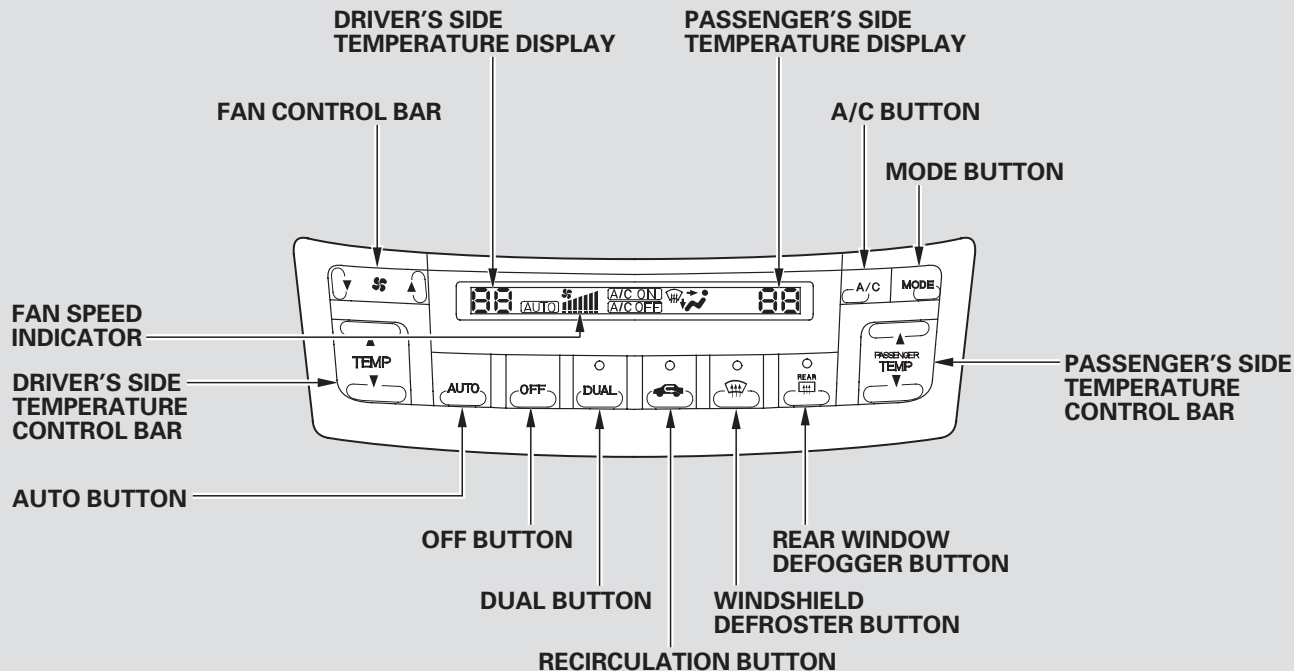

With navigation system

DRIVER'S SIDE
TEMPERATURE DISPLAY

PASSENGER'S SIDE
TEMPERATURE DISPLAY

A/C ICONS

DRIVER'S SIDE
TEMPERATURE
CONTROL BAR

PASSENGER'S SIDE
TEMPERATURE
CONTROL BAR

AUTO BUTTON

RECIRCULATION BUTTON

OFF BUTTON

WINDSHIELD
DEFROSTER BUTTON

DUAL BUTTON

REAR WINDOW
DEFOGGER BUTTON

A/C BUTTON

MODE ICONS

FAN CONTROL ICONS

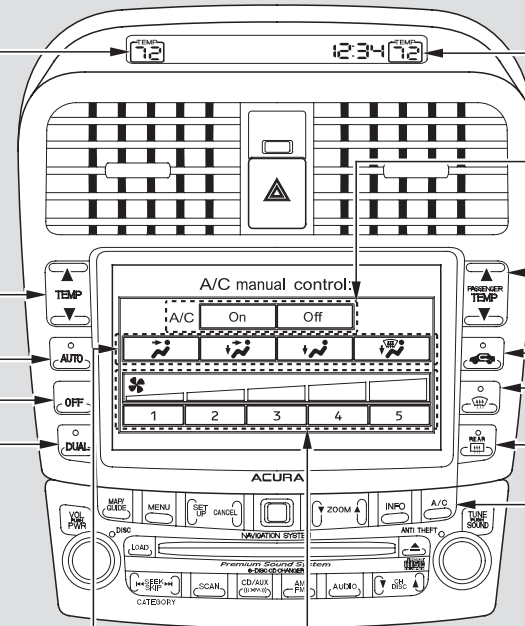

CONTINUED

Climate Control System

Proper use of the climate control system can make the interior dry and comfortable, and keep the windows clear for best visibility.

For the climate control system to provide heating and cooling, the engine must be running.

You can adjust the temperatures of the driver's side and the passenger's side independently (see page [167](#)).

Voice Control System

On vehicles with navigation system

The climate control system for your vehicle can also be operated using the voice control system. See the Navigation section in your Quick Start Guide for an overview of this system and the Navigation System manual for complete details.

Automatic Operation

The automatic climate control system adjusts the fan speed and airflow levels to maintain the interior temperature you select.

In AUTO mode, the vehicle's interior temperature is independently regulated for the driver and passenger. If the driver's side of the vehicle is getting too much sun, the system will adjust to a lower temperature.

On vehicles with navigation system

1. Press the AUTO button. The indicator in the button comes on.

On vehicles without navigation system

Press the AUTO button. You will see AUTO in the display.

2. Set the desired temperature by pushing ▲ or ▼ on the driver's side temperature control bar. The selected temperature will show in the upper display.

When you push the passenger's side temperature control bar, the indicator in the DUAL button comes on and the driver's side and passenger's side temperature can be controlled independently (see page 167).

The system automatically selects the proper mix of conditioned and/or heated air that will, as quickly as possible, raise or lower the interior temperature to your preference.

When you set the temperature to its lowest limit (**Lo**) or its highest limit (**Hi**), the system runs at full cooling or heating only. It does not regulate the interior temperature.

In cold weather, the fan will not come on automatically until the heater starts to develop warm air.

Semi-automatic Operation

You can manually select various functions of the climate control system when it is in the AUTO mode. All other features remain automatically controlled.

On vehicles without navigation system
Making any manual selection causes the word AUTO in the display to go out.

On vehicles with navigation system
Press the A/C button to view the A/C manual control display. Making any manual selection causes the indicator in the AUTO button to turn off.

Climate Control System

Fan Control

On vehicles without navigation system

Select the fan speed by pressing the fan control bar (▲ or ▼). The fan speed is represented by vertical bars in the display.

On vehicles with navigation system

Press the A/C button to view the A/C manual control display. Touch the fan control icons to the desired speed.

Temperature Control

To adjust the desired temperature, push ▲ or ▼ on the temperature control bar.

Dual Button

Press the DUAL button to select dual temperature control mode (see page [167](#)). The indicator in the DUAL button comes on.

When you press the DUAL button again (indicator turns off), both sides adjust to the driver's side temperature.

Air Conditioning (A/C) Button/Icons

On vehicles without navigation system
Press the A/C button to turn the air conditioning on and off. You will see A/C ON or A/C OFF in the display.

On vehicles with navigation system

Press the A/C button to view the A/C manual control display. Touching ON or OFF icon in the display turns the air conditioning on and off.

When you turn the A/C off, the system cannot regulate the inside temperature if you set the temperature control below the outside temperature.

Recirculation Button

When the indicator in the button is on, air from the vehicle's interior is sent throughout the system again. When the indicator is off, air is brought in from the outside of the vehicle (fresh air mode).

The outside air intakes for the climate control system are at the base of the windshield. Keep this area clear of leaves and other debris.

The system should be left in fresh air mode under almost all conditions. Keeping the system in recirculation mode, particularly with the A/C off, can cause the windows to fog up.

Switch to recirculation mode when driving through dusty or smoky conditions, then return to fresh air mode.

Windshield Defroster Button

This button turns the windshield defrost on and off.

When you push this button, air flows from the defroster vents at the base of the windshield, and the system automatically switches to fresh air mode and turns on the A/C. When the indicator in the button is on, the passenger's temperature cannot be set separately from the driver's.

Rear Window Defogger Button REAR

This button turns the rear window defogger off and on (see page [124](#)).

Climate Control System

Mode Control

Use the mode control buttons or icons to select the vents the air flows from. Some air flows from the dashboard corner vents in all modes.

On vehicles with navigation system

Press the A/C button to view the A/C manual control display, then touch any of the mode icons on the display.

 Air flows from the center and corner vents in the dashboard.

 Airflow is divided between the vents in the dashboard and the floor vents.

 Air flows from the floor vents.

 Airflow is divided between the floor vents and the defroster vents at the base of the windshield.

To Turn Everything Off

If you press the OFF button, the climate control system shuts off completely.

- Keep the system off for short periods only.
- To keep stale air and mustiness from collecting, you should have the fan running at all times.

On vehicles with navigation system

When the climate control system is turned off, the temperature in the upper display will also turn off.

Your vehicle has two temperature control bars, one for the driver, and one for the passenger.

The driver's side and the passenger's side can be controlled independently by adjusting these bars when the green indicator in the DUAL button is lit.

Temperature Control Bars

To set the driver's side temperature to a different value than the passenger's, press the DUAL button, then press the temperature control bars (▲ or ▼ side) on the driver's side. To set the passenger's side to a different value than the driver's, press the temperature control bars (▲ or ▼ side) on the passenger's side. You can adjust the passenger's side without pressing the DUAL button first.

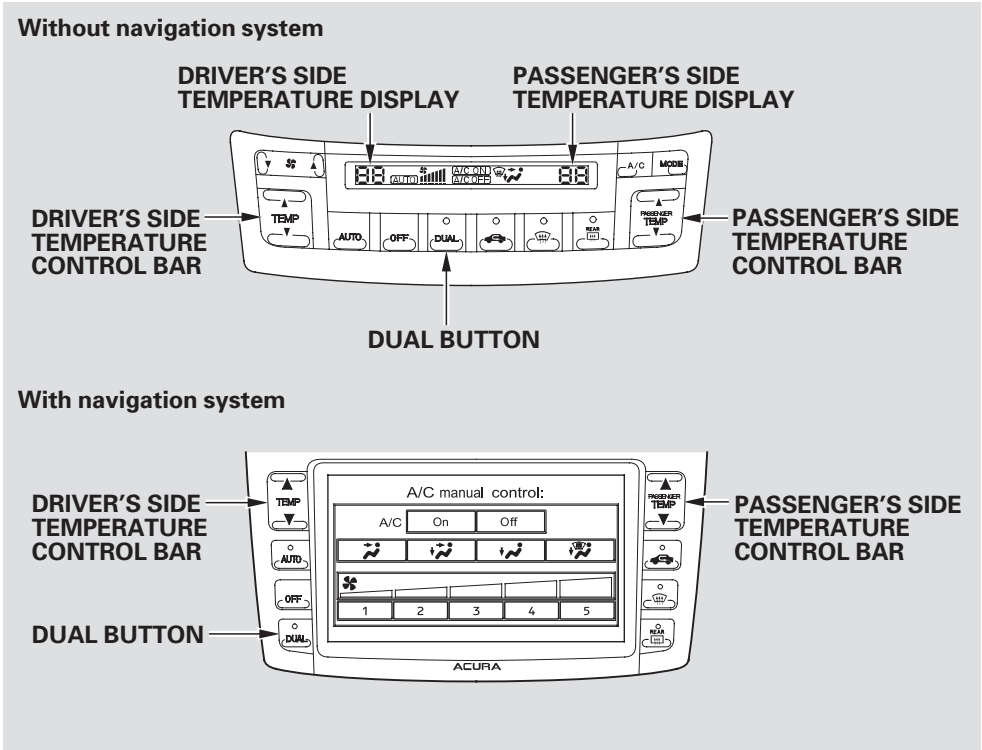



Features

CONTINUED

Dual Temperature Control

When you set the temperature to its lower or upper limit, it is displayed as

Hi or **Lo**.

Push **AUTO** or . The selected temperatures appear in the upper display. For vehicles with navigation system when the indicator in the **DUAL** button is off, you can adjust both sides to the same temperature by adjusting the driver's side temperature control bar ( or  side).

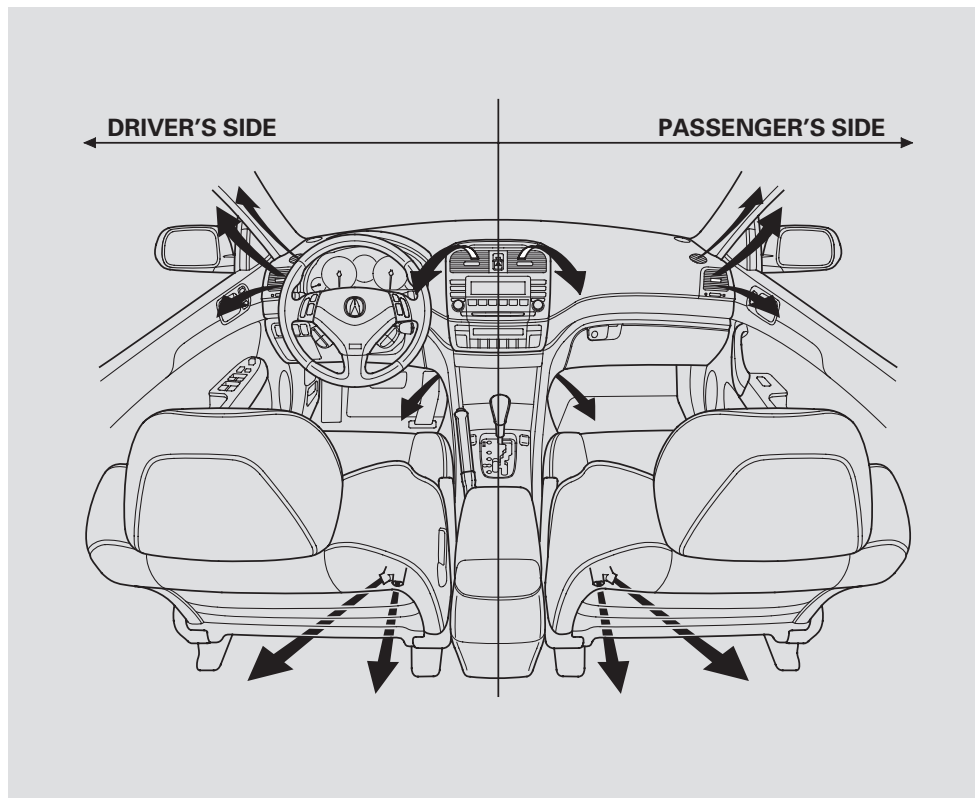

Sunlight Sensor/Temperature Sensor

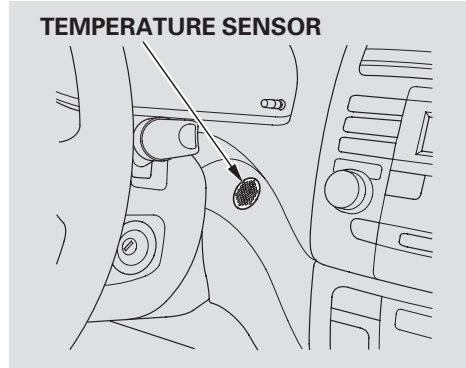
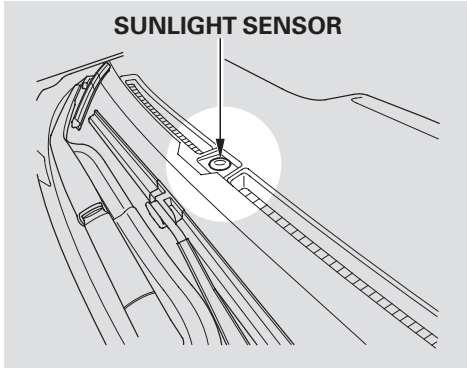

The climate control system has two sensors. A sunlight sensor is in the top of the dashboard, and a temperature sensor is next to the steering column. Do not cover the sensors or spill any liquid on them.

Playing the AM/FM Radio

Without navigation system

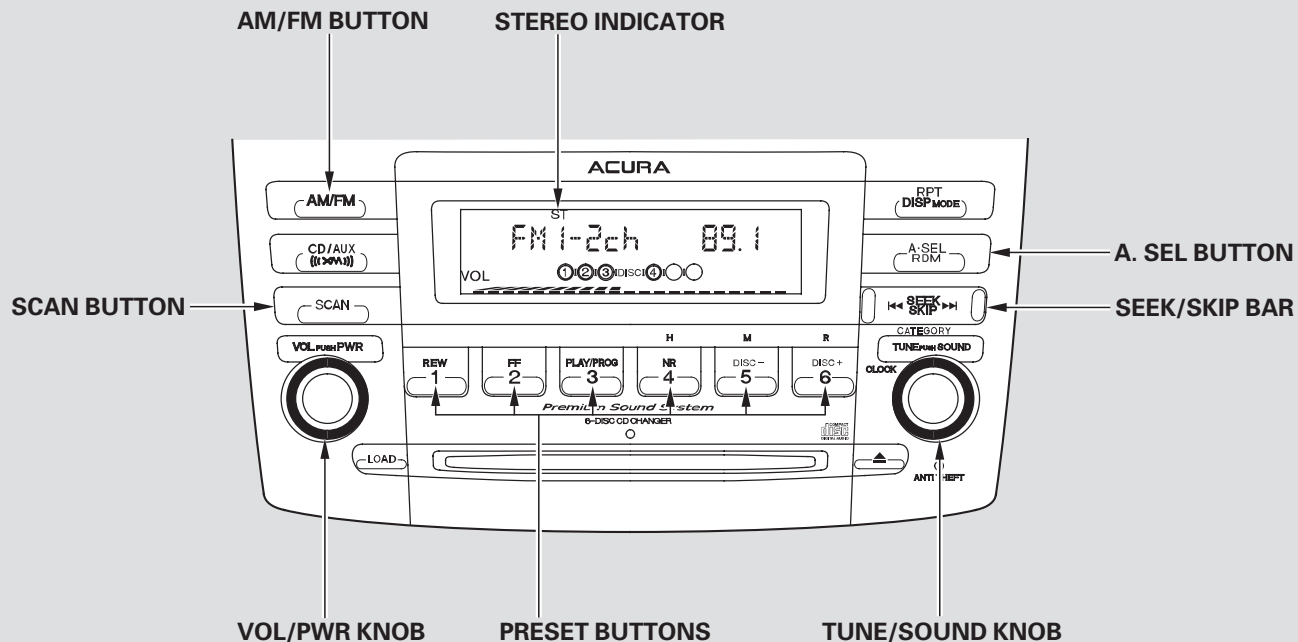

U.S. model is shown.

With navigation system

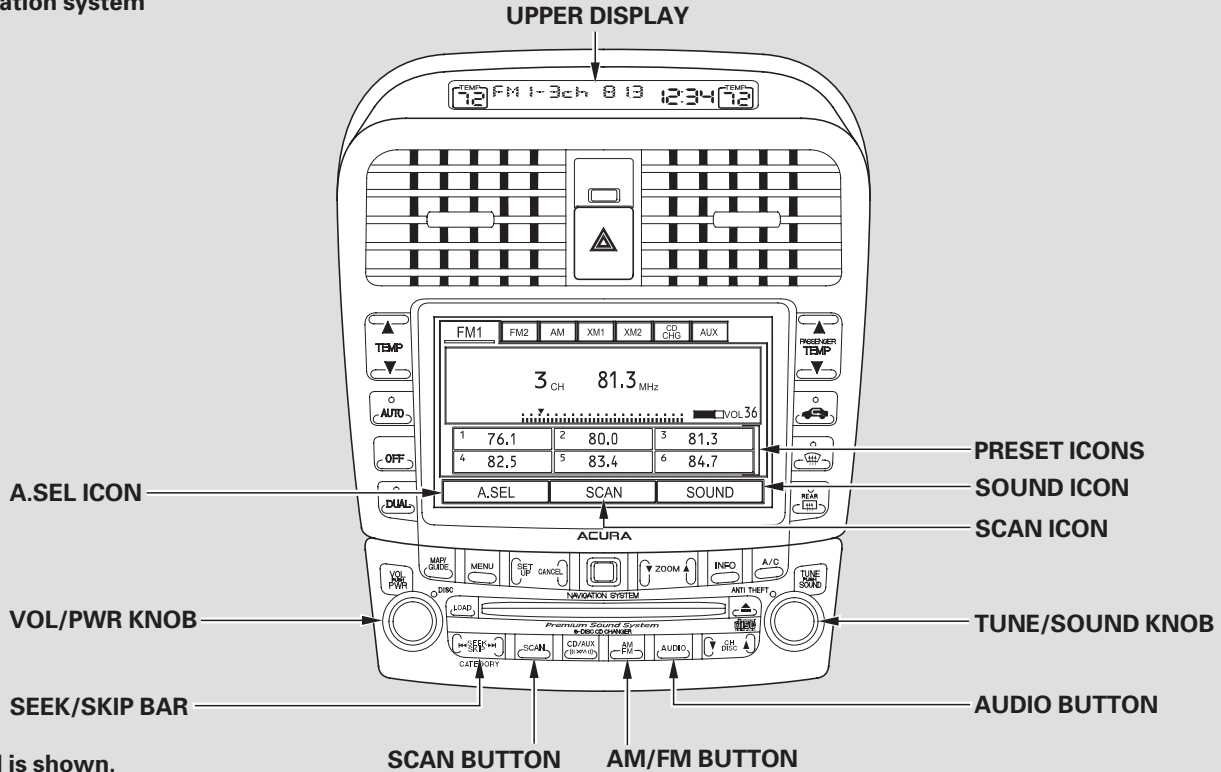

U.S. model is shown.

Playing the AM/FM Radio

Voice Control System

On vehicles with navigation system

The audio system for your vehicle can also be operated using the voice control system. See the Navi section in your Quick Start Guide for an overview of this system, and the Navigation System manual for complete details.

To Play the AM/FM Radio

The ignition switch must be in the ACCESSORY (I) or the ON (II) position. Turn the system on by pushing the VOL/PWR knob or the AM/FM button. Adjust the volume by turning the same knob.

On vehicles with navigation system

Pushing the AUDIO button will also turn on the system.

The band and frequency that the radio was last tuned to is displayed. To change bands, press the FM/AM button. On the FM band, ST will be displayed if the station is broadcasting in stereo. Stereo reproduction on AM is not available.

On U.S. models

XM satellite radio information is available on page [179](#).

To Select a Station

You can use any of five methods to find radio stations on the selected band: TUNE, SEEK, SCAN, the preset buttons or icons, and AUTO SELECT.

TUNE — Use the TUNE/SOUND knob to tune the radio to a desired frequency. Turn the knob right to tune to a higher frequency, and turn the knob left to tune to a lower frequency.

SEEK — The SEEK function searches up and down from the current frequency to find a station with a strong signal. To activate it, press the **◀◀** or **▶▶** side of the SEEK/SKIP bar, then release it.

On vehicles with navigation system

To use the SCAN, preset and A.SEL function, press the AUDIO button to view these icons.

SCAN — The SCAN function samples all stations with strong signals on the selected band. To activate it, press the SCAN button, or touch the SCAN icon (models with navigation system), then release it. You will see SCAN in the display. The system will scan for a station with a strong signal. When it finds one, it will stop and play that station for about 5 seconds.

If you do nothing, the system will then scan for the next strong station and play it for 5 seconds. When it plays a station you want to listen to, press the SCAN button or touch the SCAN icon again.

Preset — Each preset button or icon can store one frequency on AM, and two frequencies on FM.

1. Select the desired band, AM or FM. FM1 and FM2 let you store two frequencies with each preset button or icon.
2. Use the TUNE, SEEK, or SCAN function to tune the radio to a desired station.

3. Pick the preset number (1 – 6) you want for that station. Press the button or icon and hold it until you hear a beep.
4. Repeat steps 1 through 3 to store a total of six stations on AM and twelve stations on FM.

The preset frequencies may be lost if your vehicle's battery goes dead, is disconnected, or the radio fuse is removed.

CONTINUED

Playing the AM/FM Radio

AUTO SELECT – If you are traveling far from home and can no longer receive your preset stations, you can use the auto select feature to find stations in the local area.

Press the A. SEL button or touch the A. SEL icon. A. SEL will appear in the display, and the system will go into scan mode for several seconds. It stores the frequencies of six AM, and twelve FM stations in the preset buttons (1 – 6) or icons. You will see a “0” displayed after pressing a preset button or icon if Auto Select cannot find a strong station for every preset button or icon.

If you do not like the stations Auto Select has stored, you can store other frequencies on the preset buttons or icons. Use the TUNE, SEEK, or SCAN function to find stations, then store them in the preset buttons or icons as described previously.

To turn off Auto Select, press the A.SEL button or touch the A.SEL icon. This restores the presets you originally set.

Bass, Treble, Balance, and Fader are each adjustable.

Balance/Fader – These two modes adjust the strength of the sound coming from each speaker. BAL adjusts the side-to-side strength, while FAD adjusts the front-to-back strength.

Treble/Bass – Use the TRE/BAS modes to adjust the tone to your liking.

On vehicles without navigation system
You select which of these you want to adjust by pressing the TUNE/SOUND knob. The mode changes from BASS to TREBLE to FADER to BALANCE, and then back to the selected audio mode, each time you press the knob. Turn the knob to adjust the setting to your liking. When the level reaches the center, you will see “ [” in the display.

The system will automatically return the display to the selected audio mode about 5 seconds after you stop adjusting a mode.

On vehicles with navigation system

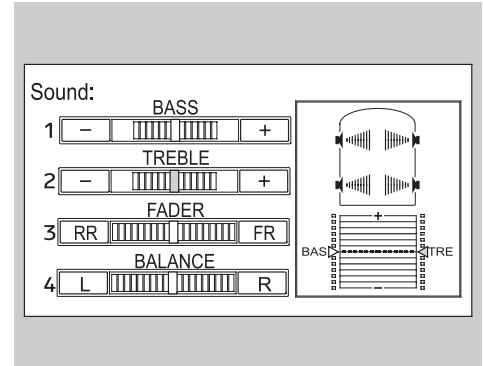

If you want to adjust the sound while the radio or CD is playing, push the AUDIO button and then push the TUNE/SOUND knob or touch the SOUND icon in the display. The current setting is shown on the display.

CONTINUED

Adjusting the Sound

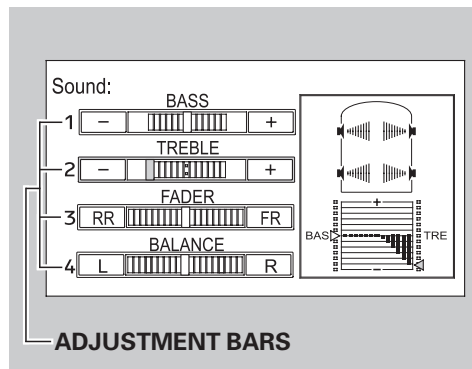

You select which of these you want to adjust by pressing the TUNE/SOUND knob. The mode changes from BASS to TREBLE to FADER to BALANCE, and then back to the selected audio mode, each time you press the button. You can also select the mode by touching the adjustment bar on the display directly.

To adjust the TREBLE and BASS, touch + or - on each side of the TREBLE or BASS adjustment bar. The adjustment bar shows you the current setting.

The Left/Right BALANCE adjusts the side-to-side strength, while Front/Rear FADER adjust the front-to-back strength. To adjust the Left/Right BALANCE, touch the “L” or “R” icon. To adjust the Front/Rear FADER, touch the “FR” or “RR” icon.

The system will automatically return the display to the selected audio mode about 5 seconds after you stop adjusting a mode.

Radio Frequencies

The radio can receive the complete AM and FM bands.

Those bands cover these frequencies:

AM band: 530 to 1,710 kHz

FM band: 87.7 to 107.9 MHz

Radio stations on the AM band are assigned frequencies at least 10 kHz apart (530, 540, 550). Stations on the FM band are assigned frequencies at least 0.2 MHz apart (87.9, 88.1, 88.3).

Stations must use these exact frequencies. It is fairly common for stations to round-off the frequency in their advertising, so your radio could display a frequency of 100.9 even though the announcer may identify the station as “FM101.”

Radio Reception

How well the radio receives stations is dependent on many factors, such as the distance from the station’s transmitter, nearby large objects, and atmospheric conditions.

A radio station’s signal gets weaker as you get farther away from its transmitter. If you are listening to an AM station, you will notice the sound volume becoming weaker, and the station drifting in and out. If you are listening to an FM station, you will see the stereo indicator flickering off and on as the signal weakens. Eventually, the stereo indicator will go off and the sound will fade completely as you get out of range of the station’s signal.

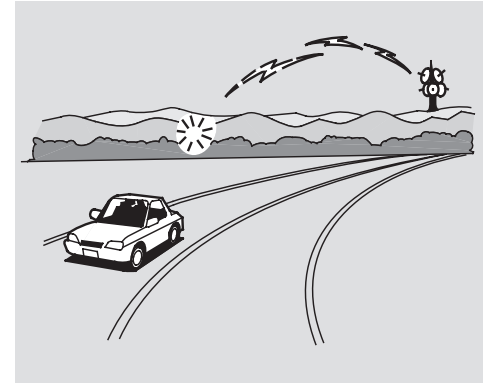

Driving very near the transmitter of a station that is broadcasting on a frequency close to the frequency of the station you are listening to can also affect your radio’s reception. You may temporarily hear both stations, or hear only the station you are close to.

CONTINUED

AM/FM Radio Reception

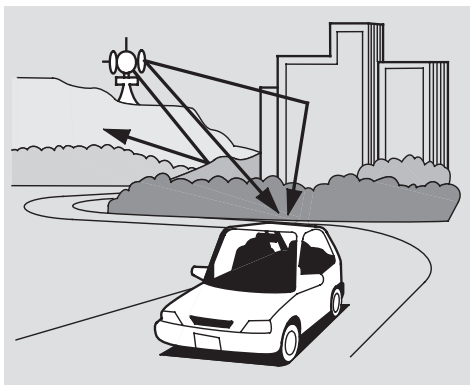

Radio signals, especially on the FM band, are deflected by large objects such as buildings and hills. Your radio then receives both the direct signal from the station's transmitter, and the deflected signal. This causes the sound to distort or flutter. This is a main cause of poor radio reception in city driving.



Radio reception can be affected by atmospheric conditions such as thunderstorms, high humidity, and even sunspots. You may be able to receive a distant radio station one day and not receive it the next day because of a change in conditions.

Electrical interference from passing vehicles and stationary sources can cause temporary reception problems.

*As required by the FCC:
Changes or modifications not expressly
approved by the party responsible for
compliance could void the user's
authority to operate the equipment.*

Playing the XM® Satellite Radio (U.S. Models)

Satellite Digital Radio

U.S. Models only

Your vehicle is capable of receiving XM® Satellite Radio anywhere in the United States, except Hawaii and Alaska.

XM® is a registered trade mark of XM Satellite Radio, Inc.

XM Satellite Radio receives signals from two satellites to produce clear, high-quality digital reception. It offers many channels in several categories. Along with a large selection of different types of music, XM Satellite Radio also allows you to view channel and category selections in the audio display.

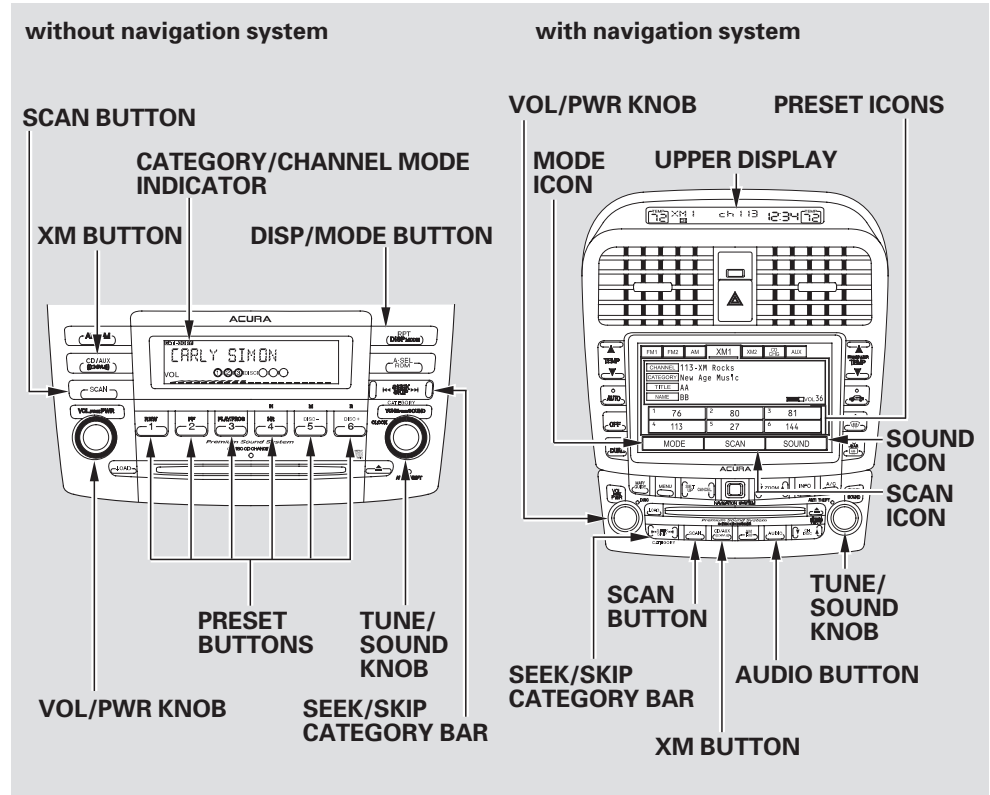

Features

Playing the XM® Satellite Radio (U.S. Models)

Operating the XM Radio

To listen to the XM satellite Radio, turn the ignition switch to the ACCESSORY (I) or ON (II) position. Push the VOL/PWR knob to turn on the audio system, and press the XM button. Adjust the volume turning the VOL/PWR knob. The last channel you listened to will show in the display.

On vehicles with navigation system

To operate the XM Radio, Press the AUDIO button to view the XM Radio control display.

MODE — To switch between the category mode and channel mode, press and hold the DISP/MODE button until the mode changes. On models with navigation system, touch the MODE icon on the display. In channel mode, you can select all of the available channels. In category mode, such as Jazz, Rock, Classical, etc., you can select all of the channels within that category.

On vehicles without navigation system

DISP — Each time you press and release the DISP/MODE button, the display changes in the following sequence: Channel name, category, artist name, and music title.

To Select a Channel

When in the satellite radio mode, you can use any of four methods to find channels: TUNE, SEEK/SKIP (CATEGORY), SCAN, and the preset buttons.

TUNE — Turn the TUNE knob to change channel selections. Turn the knob right for higher numbered channels and left for lower numbered channels. In the category mode, you can only select channels within that category.

SEEK/SKIP (CATEGORY) —

Press either side of the CATEGORY bar (◀◀ or ▶▶) to select another category.

SCAN — The scan function gives you a sampling of all channels while in the channel mode. In the category mode, only the channels within that category are scanned. To activate scan, press the SCAN button or touch the SCAN icon on the screen. The system plays each channel in numerical order for a few seconds, then selects the next channel. When you hear a channel you want to listen to, press the button or touch the icon again.

Preset — You can store up to 12 preset channels using each side of the preset button or preset icons on the screen. Each side of the button stores one channel from the XM1 band and one channel from the XM2 band.

To store a channel:

1. Press the XM button. Either XM1 or XM2 will show in the display.
2. Use the tune, seek, or scan function to tune to a desired channel.

In category mode, only channels within that category can be selected. In channel mode, all channels can be selected.

3. Pick a preset number (icon) you want for that channel. Press and hold the button (icon) until you hear a beep.
4. Repeat steps 2 and 3 to store the first six channels.
5. Press the XM button again or touch the other XM icon (XM1 or XM2) on the audio display. Store the next six channels using steps 2 and 3.

Once a channel is stored, press and release the proper side of the preset button (icon) to tune to it.

CONTINUED

Playing the XM® Satellite Radio (U.S. Models)

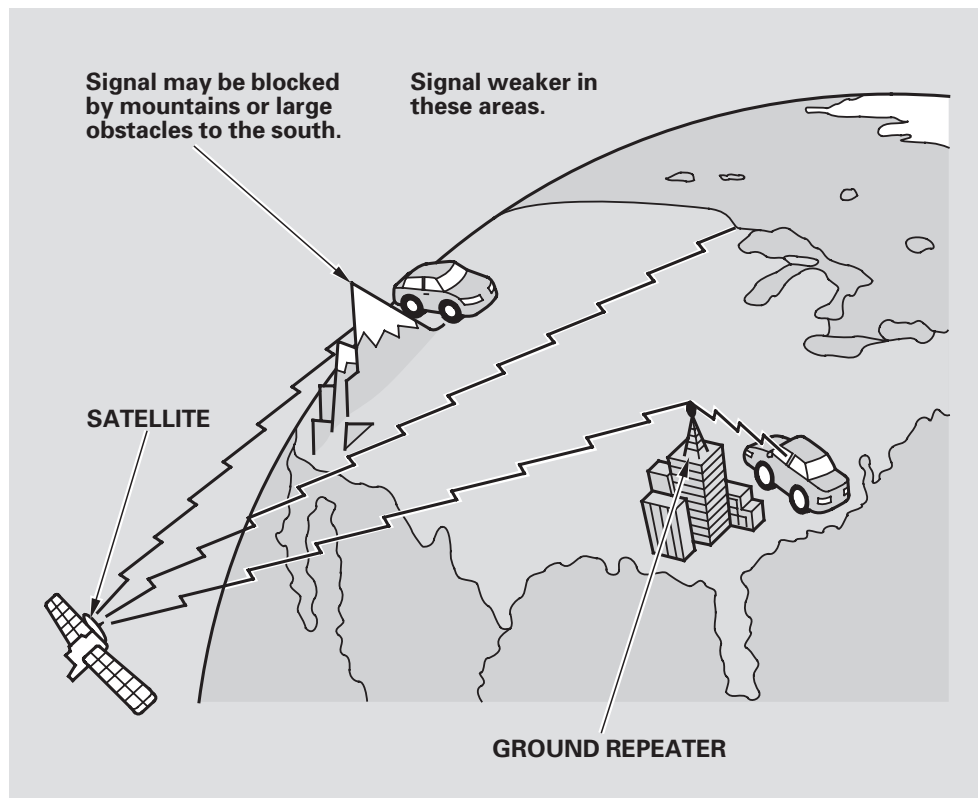

Satellite Radio Signals

Satellite radio receives signals from two satellites to produce clear, high-quality digital reception. It offers many channels in several categories. Along with a large selection of different types of music, satellite radio also allows you to view channel and category selections in the audio display.

The XM satellites are in orbit over the equator; therefore, objects south of the vehicle may cause satellite reception interruptions. To help compensate for this, ground-based repeaters are placed in major metropolitan areas. Satellite signals are more likely to be blocked by tall buildings and mountains the farther north you travel from the equator.

Depending on where you drive, you may experience reception problems. Interference can be caused by any of these conditions:

- Driving on the north side of an east/west mountain road.
- Driving on the north side of a large commercial truck on an east/west road.
- Driving in tunnels.
- Driving on a road beside a vertical wall, steep cliff, or hill to the south of you.
- Driving on the lower level of a multi-tiered road.
- Driving on a single lane road alongside dense trees taller than 50 ft. (15 m) to the south of you.

There may be other geographic situations that could affect satellite radio reception.

*As required by the FCC:
Changes or modifications not expressly approved by the party responsible for compliance could void the user's authority to operate the equipment.*

Receiving Satellite Radio Service

If your XM Radio service has expired or you purchased your vehicle from a previous owner, you can listen to a sampling of the broadcasts available on XM Satellite Radio. With the ignition switch in the ACCESSORY (I) or ON (II) position, push the VOL/PWR knob to turn on the audio system and press the CD/AUX XM button. A variety of music types and styles will play.

If you decide to purchase XM satellite radio service, contact XM Radio at www.xmradio.com, or at 1-800-852-9696. You will need to give them your radio I.D. number and your credit card number.

To get your XM Satellite radio ID number:

Turn the TUNE knob until “0” appears in the display. Your I.D. will appear in the display.

After you have registered with XM Radio, keep your audio system in the SAT Radio mode while you await activation. This should take about 30 minutes.

While awaiting activation, make sure your vehicle remains in an open area with good reception. Once your audio system is activated, “category” or “CH” will appear on the display and you will be able to listen to XM Radio broadcasts. XM Radio will continue to send an activation signal to your vehicle for at least 12 hours from activation request. If the service has not been activated after 36 hours, contact XM Radio.

Auxiliary Input Jack

Auxiliary Input Jack

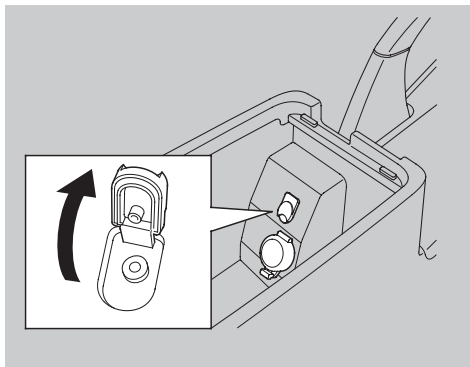

Your audio system will accept auxiliary inputs from a portable cassette player, MP3 player, etc.

To use the jack, turn down the volume of the portable unit, and pivot the input jack cover up, then plug in a mini-jack cable between the portable unit and the jack. You will see AUX in the display and the system automatically switches to AUX mode. To adjust the volume, turn the VOL/PWR knob.

To take the system out of AUX mode, press the AM/FM, or CD/AUX or CD/AUX/XM (U.S. models only) button. To return to AUX mode while the jack is connected, press the CD/AUX or CD/AUX/XM button.

Without navigation system

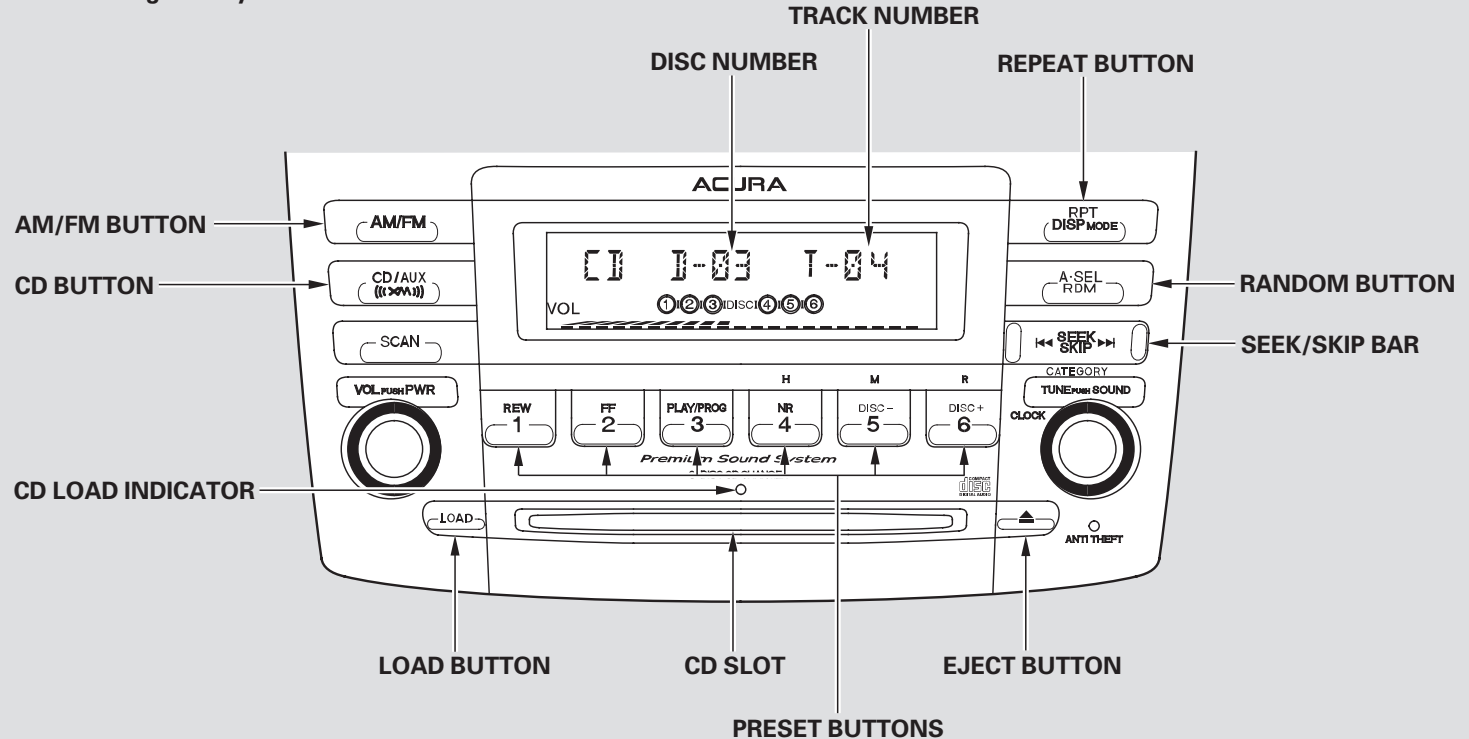

U.S. model is shown.

Features

Playing Discs

With navigation system

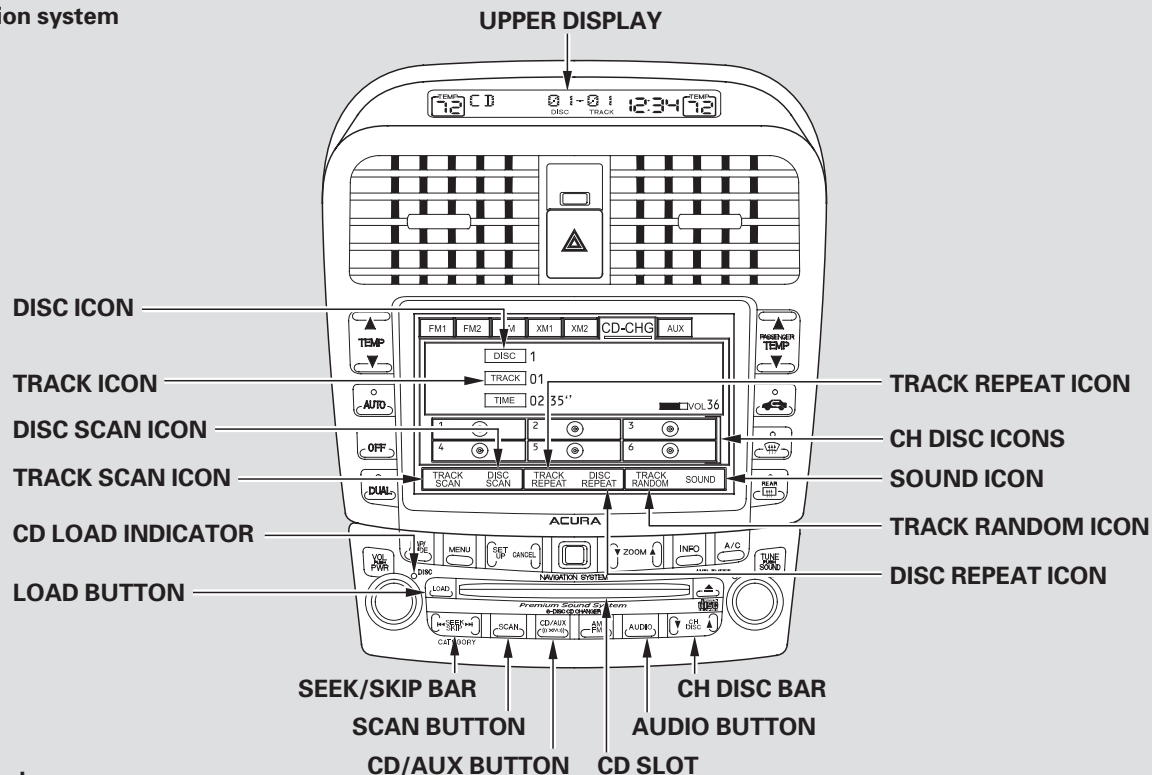

U.S. model is shown.

Operating the CD Changer

Your audio system has an in-dash CD changer that holds up to six CDs, providing several hours of continuous entertainment. You operate this CD changer with the same controls used for the radio. To load CDs or operate the CD changer, the ignition switch must be in the ACCESSORY (I) or ON (II) position.

NOTICE

Do not use CDs with adhesive labels. The label can curl up and cause the CD to jam in the unit.

For best results when using CD-R or CD-RW discs, use only high quality discs labeled for audio use. When recording a CD-R or CD-RW, the recording must be closed in order for the disc to be played by the CD player.

Loading CDs in the Changer

To load multiple discs in one operation:

1. Press the LOAD button until you hear a beep and see “LOAD” on the display.

To load only one CD, press and release the LOAD button.
2. The disc number for an empty position is highlighted and the red light starts blinking.
3. Insert the disc into the CD slot when the green CD load indicator comes on. Insert it only about halfway; the drive will pull it in the rest of the way. You will see “BUSY” on the display as the CD load indicator turns red and blinks as the CD is loaded.

You cannot load and play 3-inch (8-cm) discs in this system.

4. When the CD load indicator turns green and “LOAD” appears on the display again, insert the next CD in the slot.

Do not try to insert a disc until “LOAD” appears. You could damage the audio unit.
5. Repeat steps 1 through 3 until all six positions are loaded. If you are not loading all six positions, the system begins playing the last CD loaded.

CONTINUED

Playing Discs

If you are not loading CDs into all six positions, press the LOAD button again after the last CD has loaded. The system will begin playing the last CD loaded.

If you stop loading discs before all six positions are filled, the system will wait for 15 seconds, stop the load operation, and begin playing the last disc loaded.

You can also load a CD into an empty position while a CD is playing. Select the empty position (the disc number indicator is not highlighted) and press the appropriate preset button or touch a disc icon. The current CD stops playing and starts the loading sequence. The CD just loaded will play.

To Play a CD

Select the CD changer by pressing the CD button. You will see “CD” on the display. The system will begin playing the last selected CD in the CD changer. You will see the disc and track numbers displayed.

When that CD ends, the next CD in the CD changer is loaded and played. After the last CD finishes, the system returns to the first CD.

To select a different disc, press an appropriate preset button (1–6) or use the Preset 5 (DISC –) to select the previous disc or Preset 6 (DISC +) to select the next disc in sequence. On vehicles with navigation system, touch the appropriate disc icon or press the ▲ or ▼ side of the CH/DISC bar. If you select an empty position in the CD changer, the system will try to load the CD in the next available slot.

SEEK/SKIP — Each time you press and release the ►►| side of the SEEK/SKIP bar, the system skips forward to the beginning of the next track. Press and release the |◄◄ side of the bar to skip backward to the beginning of the current track. Press it again to skip to the beginning of the previous track.

To move rapidly within a track, press and hold the |◄◄ or ►►| side of the SEEK/SKIP bar.

On vehicles without navigation system
The available CD functions are described as follows.

REPEAT — To activate the repeat feature, press and release the RPT button. You will see RPT on the display as a reminder. The system continuously replays the current track. Press the RPT button again to turn it off. Pressing either of the SKIP bar also turns off the repeat feature.

DISC REPEAT — Press and hold the RPT button to continuously replay the current CD. You will see D-RPT on the display as a reminder. Press the button again to turn it off.

RANDOM — The RANDOM function plays the tracks within a CD in random order, rather than in the order they are recorded on the CD. To activate it, press the RDM button. You will see RDM on the display as a reminder. The system will then

select and play tracks randomly. This continues until you deactivate RANDOM by pressing the RDM button again.

SCAN — The SCAN function samples all the tracks on the selected disc in the order they are recorded on the CD. To activate it, press and release the SCAN button. You will see SCAN on the display as a reminder. The system will then play the first track for approximately 10 seconds. If you do nothing, the system will then play the following tracks for 10 seconds each. When it plays a track that you want to continue listening to, press the SCAN button again.

CONTINUED

Playing Discs

DISC SCAN – This feature, when activated, samples the first track of all the discs in the CD changer in the order they are stored. To activate the DISC SCAN feature, press and hold the SCAN button. You will see D-SCAN on the display as a reminder. The system will then play the first track of the first CD for approximately 10 seconds. If you do nothing, the system will then play the next CD's first track. When it plays a disc that you want to continue listening to, press the SCAN button again.

On vehicles with navigation system
Press the AUDIO button to view the available CD control icons on the display. The icon functions are described as follows.

TRACK SCAN – This function samples all the tracks on the selected disc in the order they are recorded on the CD. To activate it, touch the TRACK SCAN icon or press and release the SCAN button. You will see SCAN on the left side of TRACK icon on the display as a reminder. SCAN also appears on the upper display. The system will then play the first track for approximately 10 seconds. If you do nothing, the system will then play the following tracks for 10 seconds each. When it plays a track that you want to continue listening to, touch the TRACK SCAN icon or press the SCAN button again.

DISC SCAN – This function samples the first track of all the discs in the CD changer in the order they are stored. To activate it, touch the DISC SCAN icon or press and hold the SCAN button. You will see SCAN on the left side of the DISC icon on the display as a reminder. D-SCAN also appears on the upper display. The system will then play the first track of the first CD for approximately 10 seconds. If you do nothing, the system will then play the next CD's first track. When it plays a disc that you want to continue listening to, touch the DISC SCAN icon or press the SCAN button again.

TRACK REPEAT – Touch the TRACK REPEAT icon to continuously replay a track. You will see REPEAT on the left side of the TRACK icon on the display as a reminder. RPT also appears on the upper display. Press the icon again to turn it off.

DISC REPEAT – Touch the DISC REPEAT icon to continuously replay the current CD. You will see REPEAT on the left side of the DISC icon. D-RPT also appears on the upper display. Press the icon again to turn it off.

TRACK RANDOM – The TRACK RANDOM function plays the tracks within a CD in random order, rather than in the order they are recorded on the CD. To activate it, press the TRACK RANDOM icon. You will see RANDOM on the left side of the TRACK icon on the display as a reminder. The system will then select and play tracks randomly. This continues until you deactivate TRACK RANDOM by touching the TRACK RANDOM icon again.

Playing Discs

To Stop Playing a CD

If you turn off the system while a CD is playing, either by pushing the VOL/PWR knob or by turning off the ignition, the CD will stay in the drive. When you turn the system back on, it will begin at the same disc and track.

To take the system out of CD mode, press the AM/FM or CD/AUX, or CD/AUX/XM button to switch to the radio or satellite radio (U.S. models only), or optional tape player (if a tape is loaded) while a CD is playing. When you return to CD mode by pressing the CD/AUX or CD/AUX/XM button, play will continue at the same point that it left off.

Removing CDs from the Changer

To remove the disc that is currently playing, press and release the eject () button. You will see EJECT in the display. When you remove the disc from the slot, the system begins the load sequence so you can load another disc in that position. If you do not load another CD within 15 seconds, the system selects the previous mode [AM, FM1, FM2, or XM Radio (U.S. models)].

If you do not remove the CD from the slot, the system will reload the CD after 15 seconds and put the CD changer in pause mode. To begin playing the CD, press the CD button.

To remove a different CD from the changer, first select it with the appropriate preset button, or the appropriate icon or CH/DISC bar. When that CD begins playing, press the eject button.

After that disc is ejected, pressing the eject button again will eject the next disc in numerical order. By doing this six times, you can remove all the CDs from the changer.

If you press the eject button while listening to the radio, or with the audio system turned off, the disc that was last selected is ejected.

In any mode, if you press the eject button and hold it until you hear a beep, the system will eject all of the discs in the changer.

You can also eject discs when the ignition switch is off by pressing the eject button. The disc that was last selected is ejected first. You can eject up to 5 discs, one at a time.

The chart on the right explains the error messages you may see in the display while playing a disc.

If you see an error message in the display while playing a disc, press the eject button. After ejecting the disc, check it for damage or deformation. If there is no damage, insert the disc again.

For the additional information of the damaged discs, see page 195 .

The audio system will try to play the disc. If there is still a problem, the error message will reappear. Press the eject button, and pull out the disc.

Insert a different disc. If the new disc plays, there is a problem with the first disc. If the error message cycle repeats and you cannot clear it, take your vehicle to a dealer.

| Error Message | Cause | Solution |
|---|---------------------------------|---|
| HEAT ERROR | High Temperature | Will disappear when the temperature returns to normal. |
| FORMAT | Track/File format not supported | Current track will be skipped. The next supported track or file plays automatically. |
| BAD DISC PLEASE CHECK OWNER'S MANUAL PUSH EJECT | Mechanical Error | Press the EJECT button and pull out the disc(s). Check the disc for serious damage, signs of deformation, excessive scratches, and/or dirt (see page 195). Insert the disc again. If the code does not disappear, or the disc(s) cannot be removed, consult your dealer, Do not try to force the disc out the player. |
| BAD DISC PLEASE CHECK OWNER'S MANUAL | Servo Error | |

Protecting Your CDs

General Information

- When using CD-R discs, use only high quality CDs labeled for audio use.
- When recording a CD-R, the recording must be closed for it to be used by the system.
- Play only standard round CDs. Odd-shaped CDs may jam in the drive or cause other problems.
- Handle your CDs properly to prevent damage and skipping. See this page.

Protecting CDs

When a CD is not being played, store it in its case to protect it from dust and other contamination. To prevent warpage, keep CDs out of direct sunlight and extreme heat.

To clean a CD, use a clean soft cloth. Wipe across the CD from the center to the outside edge.

A new CD may be rough on the inner and outer edges. The small plastic pieces causing this roughness can flake off and fall on the recording surface of the CD, causing skipping or other problems. Remove these pieces by rubbing the inner and outer edges with the side of a pencil or pen.

Never try to insert foreign objects in the CD player or the magazine.

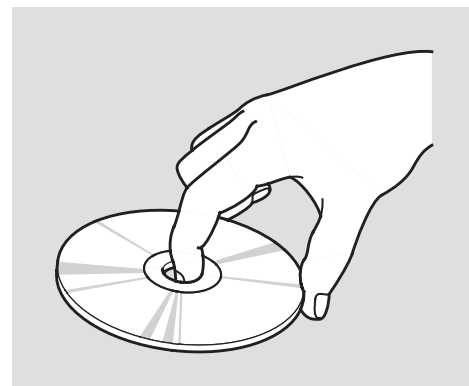

Handle a CD by its edges; never touch either surface. Do not place stabilizer rings or labels on the CD. These, along with contamination from fingerprints, liquids, and felt-tip pens, can cause the CD to not play properly or possibly jam in the drive.

Additional Information of Recommended CDs

The in-dash CD player/changer has a sophisticated and delicate mechanism. If you insert a damaged CD as indicated below, it may become stuck inside and damage the audio unit.

Examples of these CDs are shown to the right:

1. Bubbled, wrinkled, labelled, and excessively thick CDs

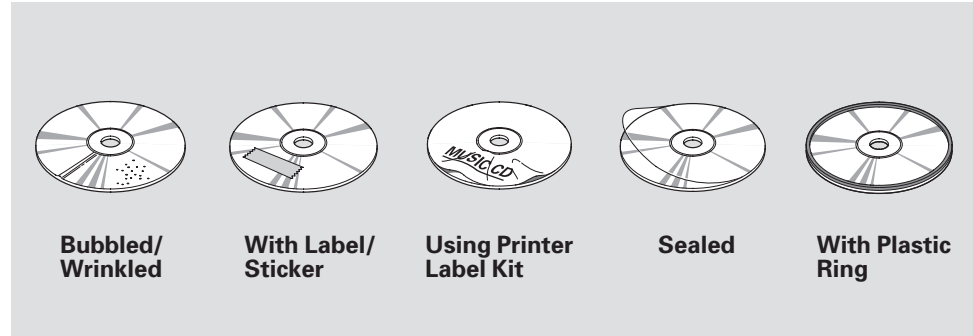

2. Damaged CDs

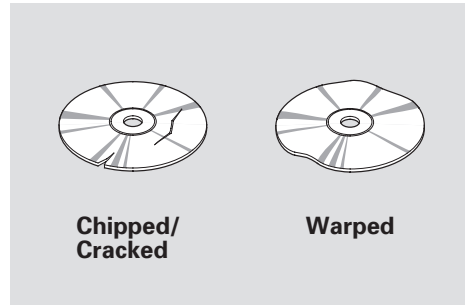

3. Poor quality CDs

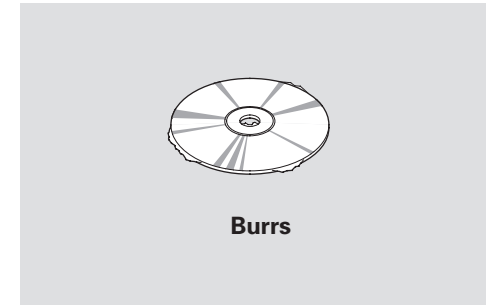

CONTINUED

Protecting Your CDs

4. Small, irregular shaped CDs

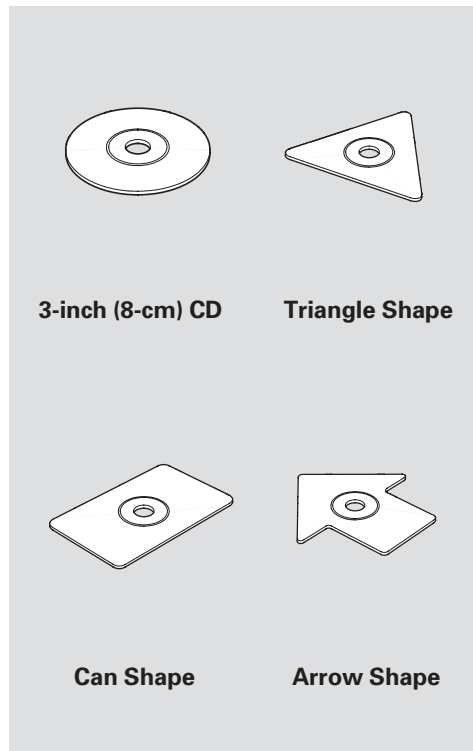

5. CDs with scratches, dirty CDs

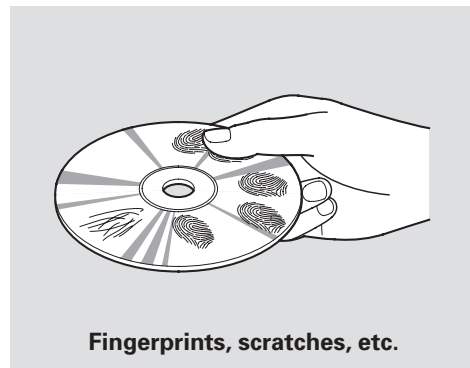

- CD-R or CD-RW may not play due to the recording conditions.
- Scratches and fingerprints on the CDs may cause the sound to skip.

- Recommended CDs are printed with the following logo.



Without navigation system

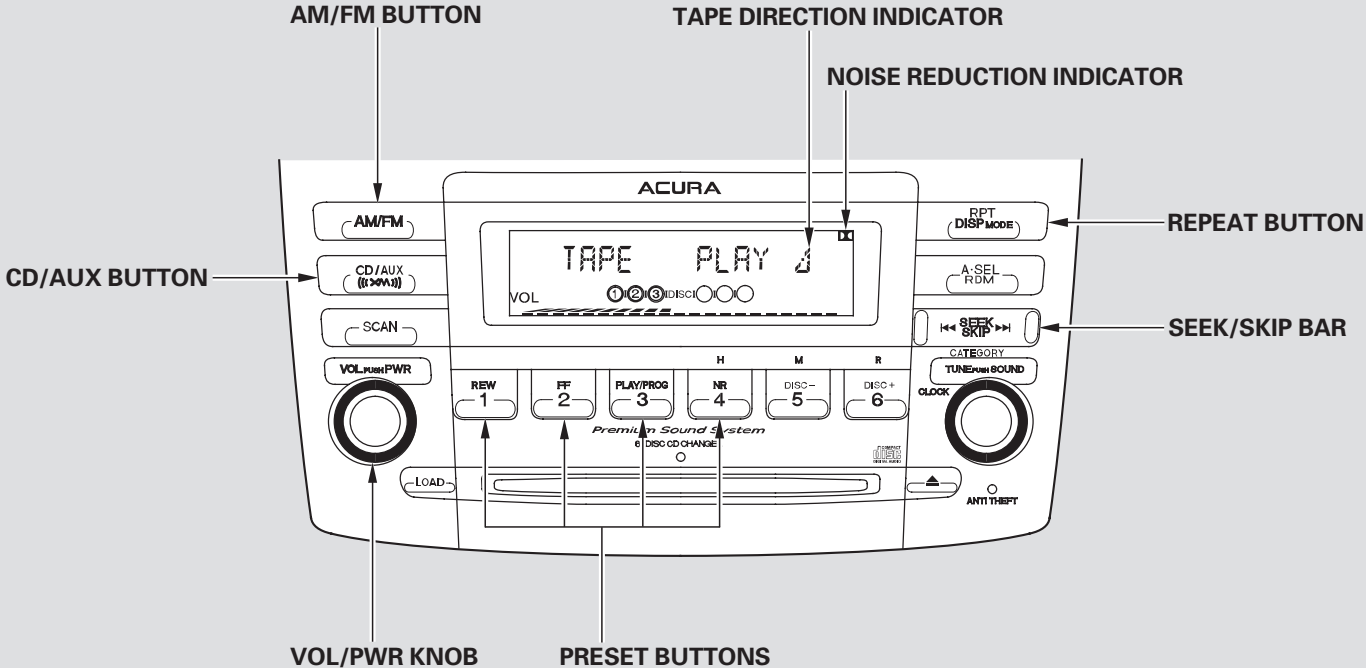

U.S. model is shown.

Playing a Tape (Optional)

With Navigation System

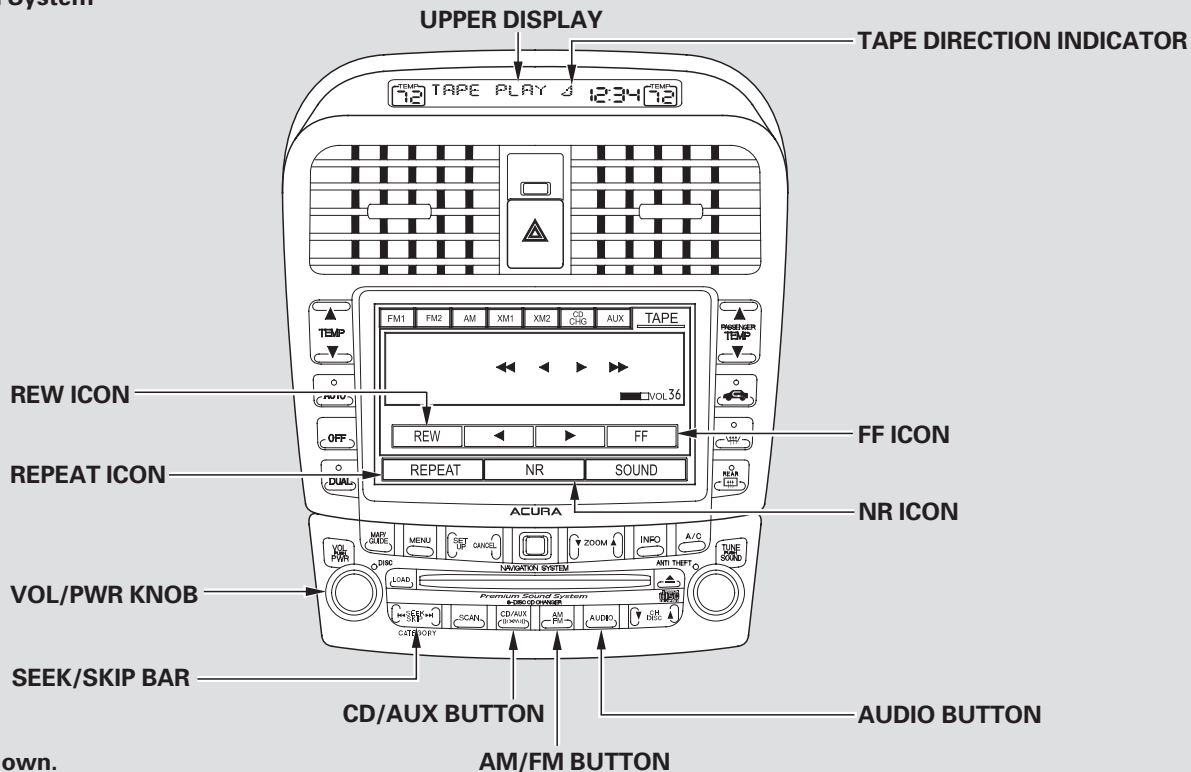

U.S. model is shown.

To Play a Tape

The ignition switch must be in the ACCESSORY (I) or ON (II) position. Make sure the open side of the tape is facing right, then insert the tape most of the way into the slot. The system will pull the tape in the rest of the way, and begin to play it.

The tape direction indicator will light to show you which side of the tape is playing. The ▲ indicates the side you inserted upward is now playing. If you want to play the other side, press the Preset 3 (PLAY/PROG) or press the AUDIO button and touch either ◀ or ▶ icon. When the player reaches the end of the tape, it will automatically reverse direction and play the other side.

Dolby* noise reduction turns on when you insert a tape. The □□ indicator will light in the display. If the tape was not recorded in Dolby, turn it off by pressing the Preset 4 (NR) or touching the NR icon. Dolby remains off until you press the preset button or the icon again.

*Dolby noise reduction manufactured under license from Dolby laboratories licensing Corporation. “Dolby” and the double-D symbol are trademarks of the Dolby Laboratories Licensing Corporation.

To Stop Playing a Tape

If you turn the system off while a tape is playing, either with the VOL/PWR knob or by turning off the ignition, the cassette will remain in the drive. When you turn the system back on, the tape will begin playing where it left off.

To switch to the radio or CD player while a tape is playing, press the AM/FM, or CD/AUX button or CD/AUX XM button. To change back to the tape player, push the CD/AUX button or CD/AUX XM button.

Playing a Tape (Optional)

Tape Search Functions

SKIP — Each time you press and release the ►► side of the SEEK/SKIP bar, the player skips forward to the beginning of the next track. On vehicles without navigation system, you will see FF in the display. Press and release the ◄◄ side of the SKIP bar to skip backward to the beginning of the current track. On vehicles without navigation system, you will see REW in the display.

On vehicles without navigation system

FF/REW — To rewind the tape, push the Preset 1 (REW). You will see REW in the display. To fast forward the tape, push the Preset 2 (FF). You will see FF displayed. Press the Preset 1, 2, or 3 (PLAY/PRG) to take the system out of rewind or fast forward.

REPEAT — Press the RPT button to continuously play a track or passage. You will see RPT displayed. The track will repeat until you press the RPT button again.

On vehicles with navigation system
Press the AUDIO button to view the available tape control icons on the display. The icon functions are described as follows.

FF/REW — To rewind the tape, touch the REW icon. To fast forward the tape, touch the FF icon. Press either ◄ or ► icon to take the system out of fast forward or rewind.

REPEAT — Touch the REPEAT icon to continuously replay a track. You will see REPEAT displayed. The track will repeat until you touch the REPEAT icon again.

NOTE: The skip and repeat functions use silent periods on the tape to find the end of a song or passage. These features may not work if there is almost no gap between selections, a high noise level, or a silent period in the middle of a selection.

If you see the error message “*TAPE ERR*” on the display, press the tape eject button to remove the tape from the unit. Make sure the tape is not damaged. If the tape will not eject or the error message stays on after the tape ejects, take your vehicle to your dealer.

Caring for the Tape and Player

The tape player picks up dirt and oxides from the tape. This contamination builds up over time and causes the sound quality to degrade. To prevent this, you should clean the player after every 30 hours of use.

If you do not clean the tape player regularly, it may eventually become impossible to remove the contamination with a normal cleaning kit. Your dealer has a cleaning kit available.

Use 100-minute or shorter tapes. Tapes longer than that may break or jam in the drive.

If the tape is loose, tighten it by turning the hub with a pencil or your finger. If the label is peeling off, remove it or it could cause the tape to jam in the player. Never try to insert a warped or damaged tape in the player.

Store tapes in their cases to protect them from dust and moisture. Never place tapes where they will be exposed to direct sunlight, high heat, or high humidity. If a tape is exposed to extreme heat or cold, let it reach a moderate temperature before inserting it into the player.

Never try to insert foreign objects into the tape player.

Steering Wheel Controls

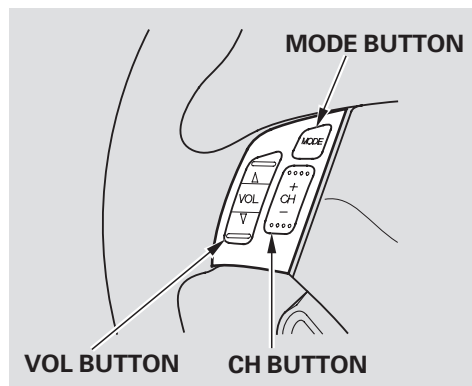

Three controls for the audio system are mounted in the steering wheel hub. These let you control basic functions without removing your hand from the wheel.

The VOL button adjusts the volume up (▲) or down (▼). Press the top or bottom of the button, hold it until the desired volume is reached, then release it.

The MODE button changes the mode. Pressing the button repeatedly selects FM1, FM2, AM, CD (if a CD is loaded), or a tape (if equipped). On models with satellite radio system, you can also select XM1 and XM2.

If you are listening to the radio, use the CH button to change stations. Each time you press the top (+) of the button, the system goes to the next preset station on the band you are listening to. Press the bottom (–) to go back to the previous station.

If you are playing a CD, the system skips to the beginning of the next track each time you press the top (+) of the CH button. Press the bottom (–) to return to the beginning of the current track. Press it twice to return to the previous track. You will see the disc and track numbers on the display.

If you are playing a tape in the optional tape player, press the top (+) of the CH button to advance to the next selection. Press the bottom (–) to go back to the previous selection. The system senses a silent period, then resumes playing.

Your vehicle's audio system will disable itself if it is disconnected from electrical power for any reason. To make it work again, you must enter a specific digit code using the preset buttons (icon on vehicle's with navigation system). Because there are hundreds of number combinations possible from specific digits, making the system work without knowing the exact code is nearly impossible.

You should have received a card that lists your audio system code number and serial number. It is best to store this card in a safe place at home. In addition, you should write the audio system's serial number in this owner's manual.

If you lose the card, you must obtain the code number from a dealer. To do this, you will need the system's serial number.

If your vehicle's battery is disconnected or goes dead, the audio system will disable itself. If this happens, you will see "CODE" on the frequency display the next time you turn on the system. Use the preset buttons (icons on vehicles with navigation system) to enter the five-digit code. The code is on the radio code card included in your owner's manual kit. When it is entered correctly, the radio will start playing.

If you make a mistake entering the code, do not start over; complete the five-digit sequence, then enter the correct code. You have 10 tries to enter the correct code. If you are unsuccessful in 10 attempts, you must then leave the system on for 1 hour before trying again.

If the code card is lost, a dealer can access your code with your radio's serial number. To access the serial number, turn the radio on. It must display "CODE", then turn the radio off. Push the preset 1, preset 6, and power buttons at the same time, then quickly release.

You will have to store your favorite stations on each side of the preset buttons (1 – 6) after the system begins working. Your original settings were lost when power was disconnected.

Setting the Clock

On vehicles without navigation system
If your vehicle's battery is disconnected or goes dead, you may need to set the clock.

To set or change the time, press and hold the TUNE/SOUND knob until you hear a beep. The displayed time begins to blink. Press on the H button (Preset 4) until the numbers advance to the desired time. Change the minutes by pressing the M button (Preset 5) until the numbers advance to the desired time. When you are finished, press the TUNE/SOUND knob again to set the time.

You can quickly set the time to the nearest hour. If the time displayed is before the half hour, press and hold the TUNE/SOUND knob, then press the R button (Preset 6) to set the time back to the previous hour.

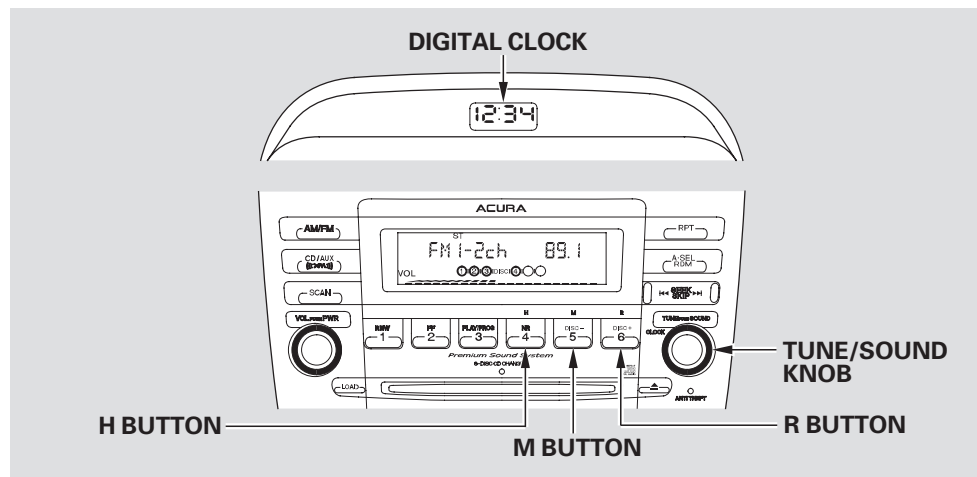

If the time displayed is after the half hour, the same procedure sets the time forward to the beginning of the next hour.

For example:

- 1:06 would RESET to 1:00.
- 1:52 would RESET to 2:00.

On vehicles with navigation system
The upper display shows the time when the ignition switch is in the ACCESSORY (I) or ON (II) position. The navigation system receives signals from the Global Positioning System (GPS), and the displayed time is updated automatically by the GPS. Refer to the navigation system owner's manual to set up the time.

The security system helps to protect your vehicle and valuables from theft. The horn sounds and a combination of headlights, parking lights, side marker lights and taillights flash if someone attempts to break into your vehicle or remove the radio. This alarm continues for 2 minutes, then the system resets. To reset an alarming system before the 2 minutes have elapsed, unlock the driver's door with the key or use the remote transmitter.

The security system automatically sets 15 seconds (depending on the "SECURITY RELOCK TIMER" setting) after you lock the doors, hood, and trunk. For the system to activate, you must lock the doors from the outside with the key, lock tab, door lock switch, or remote transmitter. The security system indicator in the instrument panel starts blinking immediately to show you the system is setting itself.

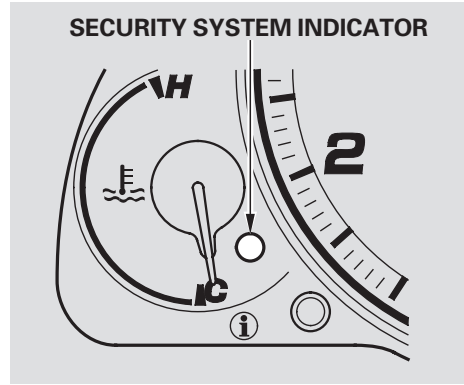

Once the security system is set, opening any door (without using the key or the remote transmitter), the hood, or the trunk will cause it to sound. It also sounds if the radio is removed from the dashboard or the wiring is cut.

With the system set, you can still open the trunk with the remote transmitter without triggering the alarm. The alarm will sound if the trunk lock is forced, or the trunk is opened with the trunk release handle or the emergency trunk opener.

The security system will not set if the hood, trunk, or any door is not fully closed. Before you leave the vehicle, make sure the doors, trunk, and hood are securely closed.

NOTE: To see if the system is set after you exit the vehicle, press the LOCK button on the remote transmitter within 5 seconds. If the system is set, the horn will beep once.

Do not attempt to alter this system or add other devices to it.

Cruise Control

Cruise control allows you to maintain a set speed above 25 mph (40 km/h) without keeping your foot on the accelerator pedal. It should be used for cruising on straight, open highways. It is not recommended for city driving, winding roads, slippery roads, heavy rain, or bad weather.

⚠ WARNING

Improper use of the cruise control can lead to a crash.

Use the cruise control only when traveling on open highways in good weather.

Using Cruise Control

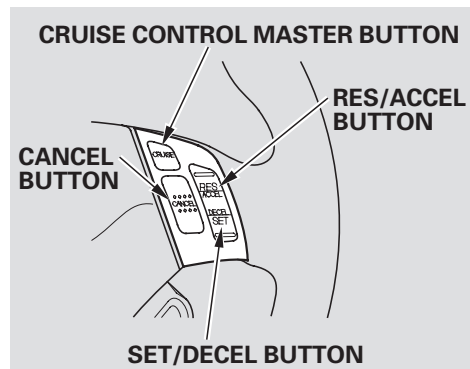

1. Push the cruise control master button on the steering wheel. The CRUISE MAIN indicator in the instrument panel comes on.
2. Accelerate to the desired cruising speed above 25 mph (40 km/h).

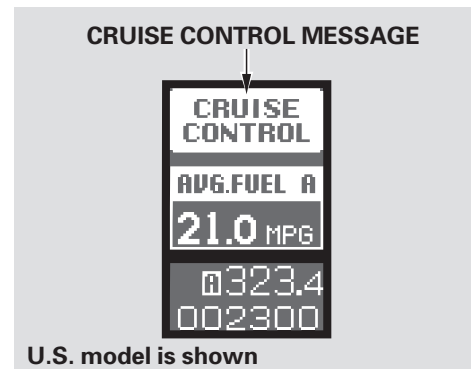

3. Press and release the SET/DECEL button on the steering wheel. The "CRUISE CONTROL" message appears on the multi-information display to show the system is now activated.

Cruise control may not hold the set speed when you are going up and down hills. If your speed increases going down a hill, use the brakes to slow down. This will cancel cruise control. To resume the set speed, press the RES/ACCEL button. The “CRUISE CONTROL” message on the multi-information display will come back on.

Changing the Set Speed

You can increase the set cruising speed in any of these ways:

- Press and hold the RES/ACCEL button. When you reach the desired cruising speed, release the button.

- Push on the accelerator pedal. Accelerate to the desired cruising speed and press the SET/DECEL button.
- To increase the speed in very small amounts, tap the RES/ACCEL button. Each time you do this, your vehicle will speed up about 1 mph (1.6 km/h).

You can decrease the set cruising speed in any of these ways:

- Press and hold the SET/DECEL button. Release the button when you reach the desired speed.
- To slow down in very small amounts, tap the SET/DECEL button repeatedly. Each time you do this, your vehicle will slow down about 1 mph (1.6 km/h).

- Tap the brake or clutch pedal lightly with your foot. The “CRUISE CONTROL” message on the multi-information display goes out. When the vehicle slows to the desired speed, press the SET/DECEL button.

Even with cruise control turned on, you can still use the accelerator pedal to speed up for passing. After completing the pass, take your foot off the accelerator pedal. The vehicle will return to the set cruising speed.

Resting your foot on the brake or clutch pedal causes cruise control to cancel.

Cruise Control

Canceling Cruise Control

You can cancel cruise control in any of these ways:

- Tap the brake or clutch pedal.
- Push the CANCEL button on the steering wheel.
- Push the cruise control master button.

Resuming the Set Speed

When you push the CANCEL button, or tap the brake or clutch pedal, the system remembers the previously set cruising speed. To return to that speed, accelerate to above 25 mph (40 km/h) then press and release the RES/ACCEL button. The “CRUISE CONTROL” message on the multi-information display comes on, and the vehicle accelerates to the same cruising speed as before.

Pressing the cruise control master button turns the system off and erases the previous cruising speed.

The HomeLink® Universal Transceiver built into your vehicle can be programmed to operate up to three remote controlled devices around your home, such as garage doors, lighting, or home security systems.

General Safety Information

Before programming your HomeLink to operate a garage door opener, confirm that the opener has an external entrapment protection system, such as an “electronic eye,” or other safety and reverse stop features.

If your garage door was manufactured before April 1, 1982, you may not be able to program HomeLink to operate it. These units do not have safety features that cause the motor to stop and reverse it if an obstacle is detected during closing, increasing the risk of injury. Do not use HomeLink with any

garage door opener that lacks safety stop and reverse features.

Units manufactured between April 1, 1982 and January 1, 1993 may be equipped with safety stop and reverse features. If your unit does not have an external entrapment protection system, an easy test to confirm the function and performance of the safety stop and reverse feature is to lay a 2×4 under the closing door. The door should stop and reverse upon contacting the piece of wood. As an additional safety feature, garage door openers manufactured after January 1, 1993 are required to have external entrapment protection systems, such as an electronic eye, which detect an object obstructing the door.

Important Safety Precautions

Refer to the safety information that came with your garage door opener

to test that the safety features are functioning properly. If you do not have this information, contact the manufacturer of the equipment. Before programming HomeLink to a garage door or gate opener, make sure that people and objects are out of the way of the device to prevent potential injury or damage. When programming a garage door opener, park just outside the garage.

Training HomeLink

Before you begin — If you just received your vehicle and have not trained any of the buttons in HomeLink before, you should erase any previously learned codes before training the first button. To do this, press and hold the two outside buttons on the HomeLink transceiver for about 20 seconds, until the red indicator flashes. Release the buttons, then proceed to step 1.

CONTINUED

HomeLink® Universal Transceiver

If you are training the second or third buttons, go directly to step 1.

1. Hold the end of the garage door opener remote transmitter 1 to 3 inches from HomeLink. Make sure you are not blocking your view of the red indicator in HomeLink.

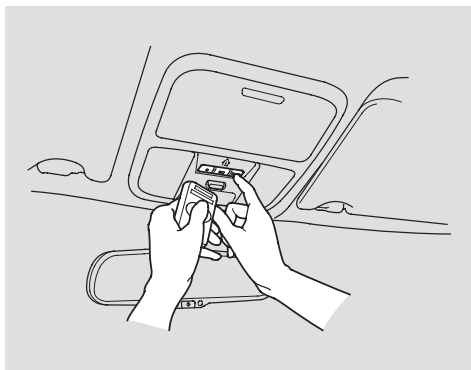

2. Press and hold the remote transmitter button and one of the HomeLink buttons at the same time.

- If the red indicator in HomeLink begins to flash slowly at first, then rapidly, release both buttons, and go to step 4.
 - If the red indicator in HomeLink continues to flash slowly (does not flash rapidly), your remote transmitter may stop transmitting after a short time. Go to step 3.
3. Press and hold the remote transmitter button and one of the HomeLink buttons at the same time. While continuing to hold the HomeLink button, press and release the remote transmitter button every 2 seconds.
 - If the red indicator in HomeLink begins to flash slowly at first, then rapidly, release both buttons, and go to step 4.
 - If the red indicator in HomeLink continues to flash slowly (does not begin to flash rapidly), repeat steps 1 thru 3.

4. Test the HomeLink button by pushing it for about 1 second.
 - If the button works, programming is complete.
 - If the button does not work go to step 5.
5. Push and hold the HomeLink button and watch the red indicator on HomeLink.
 - If the indicator stays on, press the HomeLink button again; the remotely controlled device should operate.
 - If the indicator flashes rapidly for 2 seconds then stays on, you have a rolling code transmitter: go to “Training with a Rolling Code System” (see page [211](#)).

- Repeat these steps to train the other two HomeLink buttons to operate any other compatible remotely controlled devices around your home (lighting, automatic gate, security system, etc.).

Training With a Rolling Code System

For security purposes, newer garage door opening systems use a “rolling” or variable code. Information from the remote control and the garage door opener is needed before HomeLink can operate the garage door opener.

The “Training HomeLink” procedure trains HomeLink to the proper garage door opener code. The following procedure synchronizes HomeLink to the garage door opener so it sends and receives the correct codes.

- Make sure you have properly completed the “Training HomeLink” procedure.
- Find the “learn” button on your garage door opener unit. The location will vary, depending on the manufacturer.

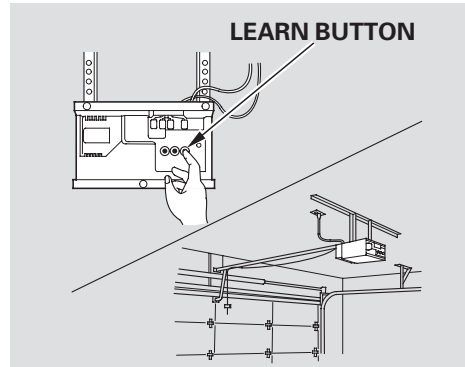

- Press the learn button on the garage door opener unit until the indicator next to the button comes on. The indicator may blink, or come on and stay on. You then

have approximately 30 seconds to complete the following steps.

- Press and hold the button on HomeLink for 3 to 4 seconds.
- Press the HomeLink button again for about 1 second. It should operate the garage door.

HomeLink® Universal Transceiver

Erasing Codes

To erase the codes stored in all three buttons, press and hold the two outside buttons until the red indicator begins to flash, then release the buttons.

You should erase all three codes before selling the vehicle.

Retraining a Button

If you want to retrain a programmed button for a new device, you do not have to erase all button memory. You can replace the existing memory code using this procedure:

1. Press and hold the HomeLink button to be trained until the HomeLink indicator begins to flash slowly.
 - If a rolling code transmitter was previously programmed, the indicator will flash rapidly for 2 seconds, and then stay on for about 23 seconds.

- If a standard transmitter was programmed, the indicator will stay on for about 25 seconds.

2. Once the HomeLink indicator begins to flash slowly, continue to hold the HomeLink button, and follow steps 2 thru 5 under “Training HomeLink” (see page 209).

Client Assistance

If you have problems with training the HomeLink Universal Transceiver, or would like information on home products that can be operated by HomeLink, call (800) 355-3515. On the Internet, go to www.homelink.com.

HomeLink® is a registered trademark of Johnson Controls, Inc.

As required by the FCC:

This device complies with Part 15 of the FCC rules. Operation is subject to the following two conditions: (1) This device may not cause harmful interference, and (2) this device must accept any interference received, including interference that may cause undesired operation.

Changes or modifications not expressly approved by the party responsible for compliance could void the user's authority to operate the equipment.

This device complies with Industry Canada Standard RSS-210. Operation is subject to the following two conditions: (1) this device may not cause interference, and (2) this device must accept any interference that may cause undesired operation of the device.

Your vehicle is equipped with the Bluetooth® HandsFreeLink® (HFL). HFL uses Bluetooth® technology as a wireless link between it and your Bluetooth® compatible cellphone. When you are in your vehicle and your phone is linked to the HFL, you'll enjoy hands-free phone use. The HFL is available in both English and French (Canadian models only). To change the language, see page [228](#).

Here are the main features of the HFL. Instructions for using the HFL begin on page [223](#).

Voice Control

HFL recognizes simple voice commands, such as phone numbers and names. It uses these commands to automatically dial, receive, and store numbers. For more information on voice control, see Using Voice Control on page [216](#).

Bluetooth® Wireless Technology

Bluetooth® is a registered trademark of Bluetooth SIG, Inc.

Bluetooth is the wireless technology that links your phone to the HFL. The HFL uses a Class 2 Bluetooth, which means the maximum range between your phone and vehicle is 30 feet (10 meters).

To use the HFL, your phone must have approved Bluetooth capability along with the Hands Free Profile. This type of phone is available through many phone makers and cellular carriers. You can also find an approved phone by visiting www.acura.com/handsfreelink (In Canada, visit www.acura.ca) or by calling the Hands Free Link® client support at (888) 528-7876.

Incoming/Outgoing Calls

With a linked phone, the HFL allows you to send and receive calls in your vehicle without holding the phone.

Phonebook

The HFL can store up to 50 names and phone numbers in its phonebook. With a linked phone, you can then automatically dial any name or number in the phonebook.

Microphone

The HFL microphone is on the ceiling, between the front map lights and the console buttons. On models with navigation system, the microphone is shared with the navigation system.

Audio System

When the HFL is in use, the sound comes through the vehicle's front audio system speakers. If the audio system is in use while operating either of the HFL buttons or making a call, the HFL over-rides the audio system. To change the volume level, use the audio system volume knob, or the steering wheel volume controls.

HFL Buttons

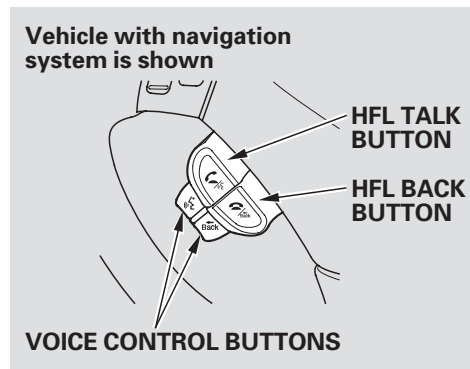

To operate the HFL, use the HFL Talk and Back buttons on the left side of the steering wheel. Below the HFL buttons is another set of voice control buttons for the navigation, climate control, and audio systems.

The HFL buttons are used as follows:

HFL Talk: This button is used before you give a command, to answer incoming calls, and to confirm system information.

Press and release the button, then wait for a beep before giving a command.

HFL Back: This button is used to end a call, go back to the previous voice control command, and to cancel an operation.

Multi-Information Display

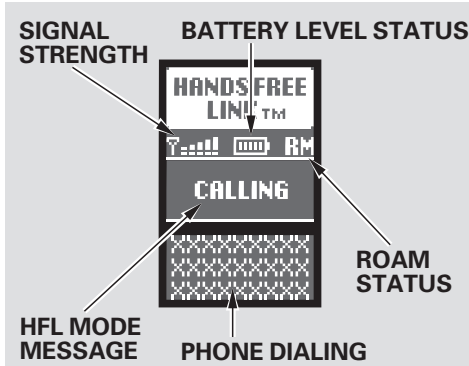

When you are operating the HFL, or when you manually select HFL on the multi-information display, you will see this information on the screen:

- Signal Strength* – Indicates the network signal strength of the current phone. Five bars equals full strength.
- ROAM Status* – Indicates your phone is roaming.
- Battery Level Status* – Indicates the power currently remaining in your phone’s battery. Five bars equals full battery strength.
- HFL Mode – Indicates when you are dialing and receiving calls.
- Phone Dialing – Indicates the number you entered or the number of the incoming call.

* : Some phones do not send this information to the HFL.

How to Use the HFL

The HFL is operated by the HFL Talk and Back buttons on the left side of the steering wheel. The next few pages provide instructions for all basic features of the HFL.

NOTE: All phones may not operate identically, and some may cause inconsistent operation of the HFL.

Using Voice Control

Here are some guidelines for using voice control:

- To enter a command, press and release the Talk button. Then, after the beep, say your command in a clear, natural tone.
 - Close the windows and the moonroof.
 - Adjust the airflow from both the dashboard and side vents so they do not blow against the microphone on the ceiling.
 - After pressing the Talk button, wait for the beep, then give a voice command.
- Give a voice command in a clear natural speaking voice without pausing between words or numbers. If the system cannot recognize your command because of the background noise, speak louder.
 - If the microphone picks up voices other than yours, the system may not interpret your voice commands correctly.
 - If the HFL does not recognize a command, its response is, "Pardon." If it doesn't recognize the command a second time, its response is, "Please repeat." If it doesn't recognize the command a third time, it plays the Help prompt.
- To hear a list of available options at any time, press the Talk button, wait for the beep, and say, "Hands free link help."
 - Many commands can be spoken together. For example, you can say, "Dial 123-456-7891."
 - To enter a string of numbers in a Call or Dial command, you can say them all at once, or you can separate them in blocks of 3, 4, 7, 10, or 11.
 - To skip a voice prompt, press the Talk button while the HFL is speaking. The HFL will then begin listening for your next command.

- To go back one step in a command process, say, “Go back,” or press the Back button.
If nothing is said while the HFL is listening for a command, the HFL will time out and stop its voice recognition. The next time you press the Talk button, the HFL begins listening from the point at which it timed out.
- To end a command sequence at any time, press and hold the Back button, or press and release the Talk button, wait for the beep, and say, “Cancel.” The next time you press the Talk button, the HFL begins from its main menu.

- When you finish a command sequence, the HFL goes back to its main menu. For example, when you store the name, “Eric,” the HFL response is, “Eric has been stored.” The next time you press the Talk button, you will be at the main menu.

Setting Up the System

The voice of the HFL can be set to male or female (U.S. models only). Also, the incoming notification can be set to a ring tone, a prompt, or no notification.

To set up the system, do this:

1. Press and release the Talk button.
After the beep, say “System.” The HFL response is, “System options are setup and clear.”

2. Press and release the Talk button.
After the beep, say “Setup.” The HFL response is “Would you like male or female prompts?”
3. Press and release the Talk button.
After the beep, say “Male” or “Female,” depending on the system voice you want. The HFL response is, “Male (Female) prompts have been selected. Would you like an audible notification of an incoming call?”

CONTINUED

4. Press and release the Talk button. If you say “Yes” after the beep, the HFL system response is, “Would you like the notification to be a ring tone or a prompt?” If you say “No” after the beep, the HFL system returns to its main menu. Saying “No” will result in no ring tone or prompt playback during an incoming call. The audio system will be mute, and a message will be displayed.
5. Press and release the Talk button. After the beep, say “Ring tone” or “Prompt.” The HFT system response is “A ring tone will be used.” or “An incoming call prompt will be used.” If you choose “Ring tone,” you will hear a ring tone through the audio speakers to announce an incoming call. If you choose “Prompt,” you will hear this message to announce an incoming call: “You have an incoming call.”

6. The HFL response continues “A security option is available to lock the HFL system. Each time the vehicle is turned on, a passcode would be required to use this system. Would you like this security option turned on?” If you say “Yes,” you can set your passcode. Refer to the setting procedure in the next column.

Setting Your Passcode

The HFL will accept a numeric, four-digit passcode that you can use for security purposes.

To set your passcode, do this:

1. Follow the system setup procedure as described previously.
2. Press and release the Talk button. After the beep, say “Yes.”
3. The HFL response is “What is the four-digit number you would like to set as your passcode?”
4. Press and release the Talk button. After the beep, say the four-digit passcode you want to use. For example, say “1, 2, 3, 4.” The HFL response is “1, 2, 3, 4. Is this correct?”

5. Press and release the Talk button. After the beep, say “Yes.” The HFL response is “Security is on. Each time the vehicle is turned on, the passcode will be required to use the system. The system setup is complete. Returning to the main menu.”
6. Press and release the Talk button. If you say “No” after the beep, the HFL system response is, “Security will not be used. The system setup is complete.”

To enter your passcode, do this;

Once a passcode is set, you can lock the HFL so it only operates after the passcode is entered.

1. The HFL will prompt you for your passcode each time the ignition switch is turned to the ON (II) position and you press the Talk button. You will only be asked for the passcode once per ignition

cycle. If the passcode is set, its response is “The system is locked. What is the four-digit passcode?”

2. Press and release the Talk button. After the beep, say your four-digit passcode. For example, say “1, 2, 3, 4.”
3. If the passcode is correct, the HFL response is “Main menu.” If the passcode is not correct, the HFL response is “1,2,3,4 is incorrect. Please try again.” Go back to the step 2.

If you forget your passcode and you cannot activate the HFL, consult your dealer to cancel the passcode.

Pairing Your Phone

Your Bluetooth® compatible phone with HandsFree Profile must be paired to the HFL before you can make and receive hands-free calls.

NOTE:

- HFL does not allow you to pair your phone if the vehicle is moving.
- For pairing, your phone must be in its Discovery mode.
- Up to six phones can be paired to the HFL.
- The following procedure works for most phones. If you cannot pair your phone to the HFL with this procedure, refer to your phone’s operating manual, visit www.acura.com/handsfreelink, call the Hands Free Link® client support at (888) 528-7876, or call your phone retailer.
- During the pairing process, turn off any previously paired phones before pairing a new phone.

CONTINUED

1. With your phone on and the ignition in the ACCESSORY (I) or ON (II) position, press and release the Talk button. After the beep, say “Phone setup.” The HFL response is “Phone setup options are status, pair, edit, delete, and list.”
2. Press and release the Talk button. After the beep, say “Pair.” The HFL response is “The pairing process requires operation of your mobile phone. For safety, only perform this function while the vehicle is stopped. State a four-digit code for pairing. Note this code. It will be requested by the phone.”
3. Press and release the Talk button. After the beep, say the four-digit code you want to use. For example, say “1, 2, 3, 4.” The HFL response is, “1, 2, 3, 4. Is this correct?”
4. Press and release the Talk button. After the beep, say “Yes.” The HFL response is “Searching for a Bluetooth phone.”
NOTE: Steps 5 and 6 show a common way to get your phone into its Discovery mode. If these steps do not work on your phone, refer to the phone’s operating manual.
5. Follow the prompts on your phone to get it into its Discovery mode. The phone will search for the HFL. When it comes up, select HandsFreeLink from the list of options displayed on your phone.
6. When asked by the phone, enter the four-digit code from step 3 into your phone. The HFL response is “A new phone has been found. What would you like to name this phone?”
7. Press and release the Talk button. After the beep, say the name you want to use. For example, say “Eric’s phone.” The HFL response is “Eric’s phone has been successfully paired. Returning to the main menu.”
8. If you want to pair another phone, repeat steps 1 through 7.

To rename a paired phone, do this:

1. Press and release the Talk button. After the beep, say “Phone setup.” The HFL response is “Phone setup options are status, pair, edit, delete, and list.”
2. Press and release the Talk button. After the beep, say “Edit.” The HFL response is “Which phone would you like to edit?”
3. Press and release the Talk button. After the beep, say the name of the phone you want to rename. For example, say “Eric’s phone.” The HFL response is “What is the new name for Eric’s phone?”
4. Press and release the Talk button. After the beep, say the new name of the phone. For example, say “Lisa’s phone.” The HFL response is, “The name has been changed. Returning to the main menu.”

To delete a paired phone, do this:

1. Press and release the Talk button. After the beep, say “Phone setup.” The HFL response is, “Phone setup options are status, pair, edit, delete, and list.”
2. Press and release the Talk button. After the beep, say “Delete.” The HFL response is, “Which phone would you like to delete?”
3. Press and release the Talk button. After the beep, say the name of the phone you want to delete. For example say “Eric’s phone.” The HFL response is “Would you like to delete Eric’s phone?”

4. Press and release the Talk button. After the beep, say “Yes.” The HFL response is “Preparing to delete Eric’s phone.” Say “OK” to continue. Otherwise, say “Go back,” or “Cancel.”
5. Press and release the Talk button. If you say “OK” after the beep, the HFL response is “The phone has been deleted. Returning to the main menu.” If you say “Go back,” or “Cancel,” the phone will not be deleted.

CONTINUED

To list all paired phones, do this:

1. Press and release the Talk button.
After the beep, say “Phone setup.”
The HFL response is “Phone setup options are status, pair, edit, delete, and list.”
2. Press and release the Talk button.
After the beep, say “List.” The HFL responds by listing the name of each paired phone. When all phones paired to the system have been read, the HFL response is “The entire list has been read. Returning to the main menu.”

To find out the status of the phone being used, do this:

1. Press and release the Talk button.
After the beep, say “Phone setup.”
The HFL response is “Phone setup options are status, pair, edit, delete, and list.”
2. Press and release the Talk button.
After the beep, say “Status.” An example of the HFL response is, “Eric’s phone is linked. Battery strength is three bars. Signal strength is five bars, and the phone is roaming. Returning to the main menu.”

To change from the currently linked phone to another paired phone, do this:

1. Press and release the Talk button.
After the beep, say “Next phone.”
The HFL response is “Searching for the next phone.” The HFL then disconnects the linked phone and searches for another paired phone. If no other phones are found, the first phone remains linked.

Making a Call

You can make calls using any phone number, or by using a name in the HFL phonebook. You can also redial the last number called. During a call, the HFL allows you to talk up to 30 minutes after you remove the key from the ignition switch.

To make a call using a phone number, do this:

1. With your phone on and the ignition in the ACCESSORY (I) or ON (II) position, press and release the Talk button. After the beep, say “Call” or “Dial.” The HFL response is, “What name or number would you like to call/dial?”
2. Press and release the Talk button. After the beep, say the number you want to call. For example, say “123 456 7891.” The HFL response is “123 456 7891. Say call, dial, or continue to add numbers.”

On vehicles with navigation system

You can also make a call directly from the list shown on the navigation display.

3. Press and release the Talk button. After the beep, say “Call” or “Dial.” The HFL response is “Calling” or “Dialing.” Once connected, you will hear the person you called through the audio speakers. To change the volume, use the audio system volume knob, or the steering wheel volume controls.
4. To end the call, press the Back button.

To make a call using a name in the HFL phonebook, do this:

1. With your phone on and the ignition in the ACCESSORY (I) or ON (II) position, press and release the Talk button. After the beep, say “Call” or “Dial.” The HFL response is “What name or number would you like to call/dial?”
2. Press and release the Talk button. After the beep, say the name you want to call. For example, say “Eric.” The HFL response is “Would you like to call Eric?”
3. Press and release the Talk button. After the beep, say “Yes.” The HFL response is “Calling” or “Dialing.” Once connected, you will hear the person you called through the audio speakers. To change the volume, use the audio system volume knob.

CONTINUED

4. To end the call, press the Back button.

To redial the last number called by the phone, press and release the Talk button. After the beep, say “Redial.” The HFL response is, “Redialing.” Once connected, you will hear the person you called through the audio speakers. To change the volume, use the audio system volume knob, or the steering wheel volume controls.

Sending Numbers or Names During a Call

The HFL allows you to send numbers or names during a call. This is useful when you call a menu-driven phone system. You can also program account numbers into the HFL phonebook for easy retrieval during menu-driven calls.

To send a number during a call, do this:

1. Press and release the Talk button. After the beep, say “Send.” The HFL response is, “What name or number would you like to send?”
2. Press and release the Talk button. After the beep, say the number you want to send. For example, say “1, 2, 3.” The HFL response is “1, 2, 3. Say send, or continue to add numbers.”

3. Press and release the Talk button. After the beep, say “Send.” The dial tones will be sent, and the call will continue.

To send a name during a call, do this:

1. Press and release the Talk button. After the beep, say “Send.” The HFL response is “What name or number would you like to send?”
2. Press and release the Talk button. After the beep, say the name you want to send. For example, say “Account number.” The HFL response is “Would you like to send account number?”
3. Press and release the Talk button. After the beep, say “Send.” The dial tones will be sent, and the call will continue.

Receiving a Call

If you receive a call when you are not on the phone, the HFL interrupts the audio system (if it is on), and plays the incoming call notification, if activated. To answer the call, press the Talk button and begin speaking. If you don't want to answer the call, press the Back button.

If your phone has Call Waiting, and you receive a call when you are on the phone, press and release the Talk button to answer it. When you do this, the original call is placed on hold. To return to the original call, press the Talk button again. If you don't want to answer the new call, disregard it, and continue with your original call. If you want to hang up the original call and answer the new call, press the Back button.

Transferring a Call

During a call, you can transfer it from the HFL to your phone, or from your phone to the HFL.

To transfer a call from the HFL to your phone, do this:

Press and release the Talk button. After the beep, say "Transfer." The audio switches from the HFL to the phone.

To transfer a call from your phone to the HFL, do this:

Press and release the Talk button. After the beep, say "Transfer." The audio switches from your phone to the HFL.

Muting a Call

During a call, you can mute or unmute your voice to the person you are talking to.

To mute your voice, do this:

1. Press and release the Talk button. After the beep, say "Mute." The HFL response is, "Mute is active."

To unmute your voice, do this:

2. Press and release the Talk button. After the beep, say "Mute." The HFL response is, "Mute is canceled."

Setting up the Phonebook

The HFL phonebook can store up to 50 names with their associated numbers. These can be any types of numbers. For example, you can store a phone number and use it to make a call, or you can store an account number and use it during a call to a menu-driven phone system.

CONTINUED

To add a name, do this:

1. Press and release the Talk button.
After the beep, say “Phonebook.”
The HFL response is “Phonebook options are store, edit, delete, and list.”
2. Press and release the Talk button.
After the beep, say “Store.” The HFL response is, “What name would you like to store?”
3. Press and release the Talk button.
After the beep, say the name you would like to store. For example, say “Eric” or say “account number.”
The HFL response is “What is the number for Eric,” or “What is the number for account number?”
4. Press and release the Talk button.
After the beep, say the number.
For example, say “123 456 7891.”
The HFL response is “123 456 7891.”

5. Press and release the Talk button.
After the beep, say “Enter.” The HFL response is “Eric (or account number) has been stored.”
Returning to the main menu.”

To edit the number of a name, do this:

1. Press and release the Talk button.
After the beep, say “Phonebook.”
The HFL response is “Phonebook options are store, edit, delete, and list.”
2. Press and release the Talk button.
After the beep, say “Edit.” The HFL response is, “What name would you like to edit?”
3. Press and release the Talk button.
After the beep, say the name you would like to edit. For example, say “Eric.” The HFL response is “What is the new number for Eric?”

4. Press and release the Talk button.
After the beep, say the new number for Eric. For example, say “987 654 3219.” The HFL response is, “987 654 3219.”

5. Press and release the Talk button.
After the beep, say “Enter.” The HFL response is “The number has been changed. Returning to the main menu.”

To delete a name, do this:

1. Press and release the Talk button.
After the beep, say “Phonebook.”
The HFL response is, “The Phonebook options are store, edit, delete, and list.”
2. Press and release the Talk button.
After the beep, say “Delete.” The HFL response is, “What name would you like to delete?”

3. Press and release the Talk button. After the beep, say the name you would like to delete. For example, say “Eric.” The HFL response is “Do you want to delete Eric?”
4. Press and release the Talk button. After the beep, say “Yes.” The HFL response is, “The name has been deleted. Returning to the main menu.”

To list all names in the phonebook, do this:

1. Press and release the Talk button. After the beep, say “Phonebook.” The HFL response is, “The Phonebook options are store, edit, delete, and list.”

2. Press and release the Talk button. After the beep, say “List.” The HFL responds by listing the names in the phonebook. When the end of the list is reached, the HFL response is, “The entire list has been read. Returning to the main menu.”

To call a name from the phonebook list, do this:

1. Press and release the Talk button. After the beep, say “Phonebook.” The HFL response is “Phonebook options are store, edit, delete, and list.”
2. Press and release the Talk button. After the beep, say “List.” The HFL responds by listing the names in the phonebook. When it says the name you want to call, for example, Eric, press the Talk button, and then say “Call.” The HFL response is, “Would you like to call Eric?”

3. Press and release the Talk button. After the beep, say “Yes.” The HFL response is “Calling.” Once connected, you will hear the person you called through the audio speakers. To change the volume, use the audio system volume knob, or the steering wheel volume controls.

Clearing the System

This operation clears the HFL of your passcode, your paired phones, and all names in the HFL phonebook. Clearing is recommended before you sell your vehicle.

To clear the system, do this:

1. Press and release the Talk button. After the beep, say “System.” The HFL response is, “System options are setup and clear.”

CONTINUED

2. Press and release the Talk button. After the beep, say “Clear.” The HFL response is, “This process will clear all paired phones, clear all entries in the phonebook, and clear the passcode. Is this what you would like to do?”
3. Press and release the Talk button. After the beep, say “Yes.” The HFL response is “Preparing to clear all paired phones, all phonebook entries, and the passcode. This may take up to 2 minutes to complete.” Press and release the Talk button. After the beep, say “OK” to proceed, or say “Go back” or “Cancel.”
4. If you said “OK,” after a short period of time, the HFL response is, “System has been cleared. Returning to the main menu.”

Changing Language (Canadian Models Only)

To change from English to French, do this:

1. Press and release the Talk button. After the beep, say “Change language.” The HFL response is “English or French?”
2. Press and release the Talk button. After the beep, say “French.” The HFL response is “Vous avez sélectionné Français. Les noms enregistrés en mode Anglais ne seront pas accessible en mode Français. Voulez-vous continuer?”

3. Press and release the Talk button. After the beep, say “Oui.” If there are no paired phones without French name tags, the HFL response is “La langue a été changée. Retour au menu principal.”

NOTE: If there are paired phones without French name tags, the following prompts will continue.

If there are paired phones without French name tags, the HFL response is “Pour que le système identifie les téléphones qui ont été jumelés dans une autre langue, les noms des téléphones doivent être ré-enregistrés.”

4. The HFL response is, for example, “Quel est le nom Français pour <Paul’s phone>?” Press and release the Talk button. After the beep, say “Téléphone de Paul.” The HFL response is, “Quel est le nom Français pour <Pat’s phone>?” Press and release the Talk button. Say “Téléphone de Pat.” After all paired phones missing a French name tag are re-recorded, the HFL will prompt, “Retour au menu principal.”

To change from French to English, do this:

1. Press and release the Talk button. After the beep, say “Changer Langue.” The HFL response is, “Anglais ou Français?”
2. Press and release the Talk button. After the beep, say “Anglais.” The HFL response is, “You have selected English. Name tags that were stored while in French mode will not be accessible in English mode. Would you like to continue?”

3. Press and release the Talk button. After the beep, say “Yes.” If there are no paired phones without English name tags, the HFL response is “The language has been changed. Returning to the main menu.”

NOTE: If there are paired phones without English name tags, the following prompts will continue.

If there are paired phones without English name tags, the HFL response is “The language has been changed. For the system to identify phones that were paired while in another language, the phone names need to be re-recorded.”

CONTINUED

4. The HFL says, for example, “What is the English name for <Téléphone de Paul>?” Press and release the Talk button. After the beep, say “Paul’s phone.” The HFL response is “What is the English name for <Téléphone de Pat>?” Press and release the Talk button. After the beep, say “Pat’s phone.” After all paired phones missing an English name tag are re-recorded, the HFL will say “Returning to the main menu.”

As required by the FCC: This device complies with Part 15 of the FCC rules. Operation is subject to the following two conditions: (1) This device may not cause harmful interference, and (2) this device must accept any interference received, including interference that may cause undesired operation.

Changes or modifications not expressly approved by the party responsible for compliance could void the user’s authority to operate the equipment.

This device complies with Industry Canada Standard RSS-210. Operation is subject to the following two conditions: (1) this device may not cause interference, and (2) this device must accept any interference that may cause undesired operation of the device.

Before you begin driving your vehicle, you should know what gasoline to use and how to check the levels of important fluids. You also need to know how to properly store luggage or packages. The information in this section will help you. If you plan to add any accessories to your vehicle, please read the information in this section first.

| | |
|--------------------------------------|-----|
| Break-in Period | 232 |
| Fuel Recommendation | 232 |
| Service Station Procedure | 233 |
| Refueling..... | 233 |
| Opening and Closing the Hood..... | 234 |
| Oil Check..... | 236 |
| Engine Coolant Check | 236 |
| Fuel Economy | 237 |
| Accessories and Modifications | 240 |
| Carrying Cargo | 242 |

Break-in Period, Fuel Recommendation

Break-in Period

Help assure your vehicle's future reliability and performance by paying extra attention to how you drive during the first 600 miles (1,000 km). During this period:

- Avoid full-throttle starts and rapid acceleration.
- Do not change the oil until the scheduled maintenance time.
- Avoid hard braking for the first 200 miles (300 km).
- Do not tow a trailer.

You should also follow these recommendations with an overhauled or exchanged engine, or when the brakes are replaced.

Fuel Recommendation

Your vehicle is designed to operate on premium unleaded gasoline with a pump octane number of 91 or higher. Use of a lower octane gasoline can cause occasional metallic knocking noises in the engine and will result in decreased engine performance. Use of a gasoline with a pump octane number less than 87 can lead to engine damage.

On vehicles with manual transmission

You may hear a knocking noise from the engine if you drive the vehicle at low engine speed (below about 1,000 rpm) in a higher gear. To stop this, raise the engine speed by shifting to a lower gear.

We recommend quality gasoline containing detergent additives that help prevent fuel system and engine deposits.

In addition, in order to maintain good performance, fuel economy, and emissions control, we strongly

recommend, in areas where it is available, the use of gasoline that does NOT contain manganese-based fuel additives such as MMT.

Use of gasoline with these additives may adversely affect performance, and cause the malfunction indicator lamp on your instrument panel to come on. If this happens, contact your authorized dealer for service.

Some gasoline today is blended with oxygenates such as ethanol or MTBE. Your vehicle is designed to operate on oxygenated gasoline containing up to 10 % ethanol by volume and up to 15 % MTBE by volume. Do not use gasoline containing methanol.

If you notice any undesirable operating symptoms, try another service station or switch to another brand of gasoline.

For further important fuel-related information, please refer to your **Quick Start Guide**.

Refueling

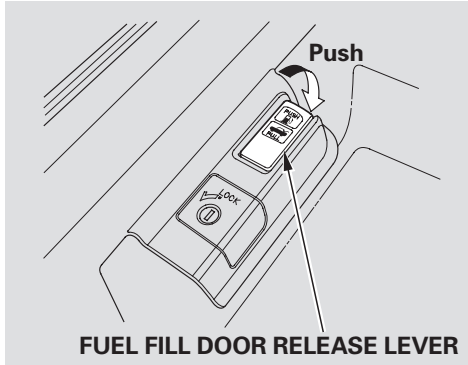

1. Park with the driver's side closest to the gas pump.
2. To open the fuel fill door, push down on the lever located to the left of the driver's seat.

⚠ WARNING

Gasoline is highly flammable and explosive. You can be burned or seriously injured when handling fuel.

- Stop the engine, and keep heat, sparks, and flame away.
- Handle fuel only outdoors.
- Wipe up spills immediately.

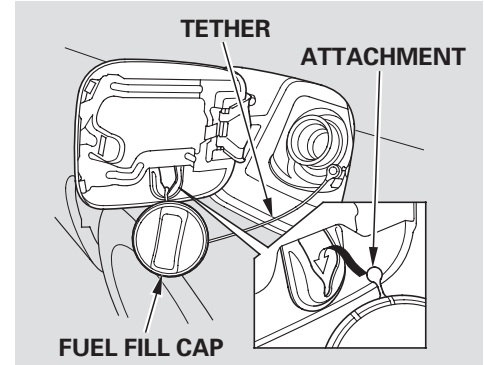

3. Remove the fuel fill cap slowly. You may hear a hissing sound as pressure inside the tank escapes. The fuel fill cap is attached to the fuel filler with a tether. Put the attachment on the fuel fill cap into the slit on the fuel fill door.

CONTINUED

Service Station Procedure

4. Stop filling the tank after the fuel nozzle automatically clicks off. Do not try to “top off” the tank. Leave some room for the fuel to expand with temperature changes.

If the fuel nozzle keeps clicking off even though the tank is not full, there may be a problem with your vehicle’s fuel vapor recovery system. The system helps keep fuel vapor from going into the atmosphere. Try filling at another pump. If this does not fix the problem, consult your dealer.

5. Screw the fuel fill cap back on until it clicks at least once. If you do not properly tighten the cap, the malfunction indicator lamp may come on (see page 336). You will also see a “TIGHTEN FUEL CAP” message on the multi-information display.
6. Push the fuel fill door closed until it latches.

Opening and Closing the Hood



To Open the Hood:

1. Park the vehicle, and set the parking brake. Pull the hood release handle located under the lower left corner of the dashboard. The hood will pop up slightly.

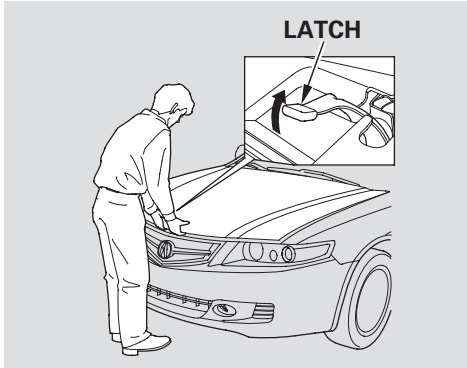

- Put your fingers under the front edge of the hood near the center. Slide your hand to the left until you feel the hood latch handle. Push this handle up to release it. Lift the hood.

If the hood latch handle moves stiffly, or if you can open the hood without lifting the handle, the mechanism should be cleaned and lubricated.

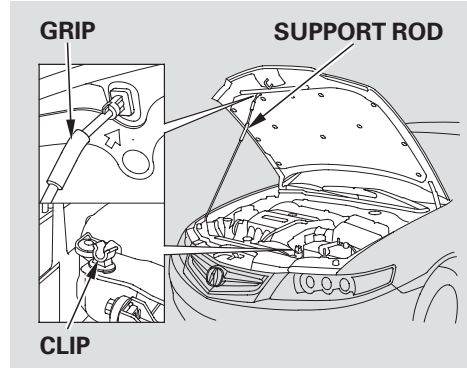

- Pull the support rod out of its clip by holding the grip, and insert the end into the designated hole in the hood.

To Close the Hood:

Lift it up slightly to remove the support rod from the hole. Put the support rod back into its holding clip. Lower the hood to about a foot (30 cm) above the fender, then let it drop. Make sure it is securely latched.

Service Station Procedure

Oil Check

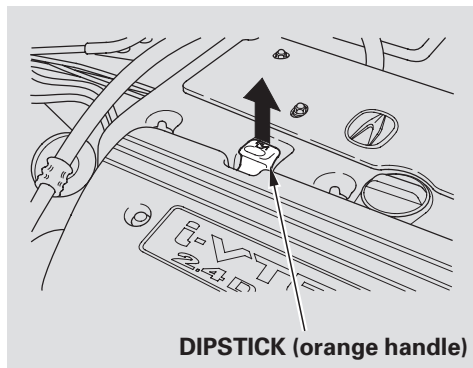

Park the vehicle on a level surface. Wait a few minutes after turning the engine off before you check the oil.

1. Remove the dipstick (orange handle).
2. Wipe the dipstick with a clean cloth or paper towel.
3. Insert the dipstick all the way back into its hole.

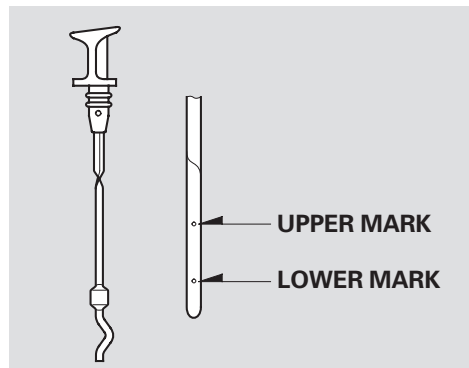

4. Remove the dipstick again, and check the level. It should be between the upper and lower marks.

If it is near or below the lower mark, see **Adding Engine Oil** on page [291](#).

Engine Coolant Check

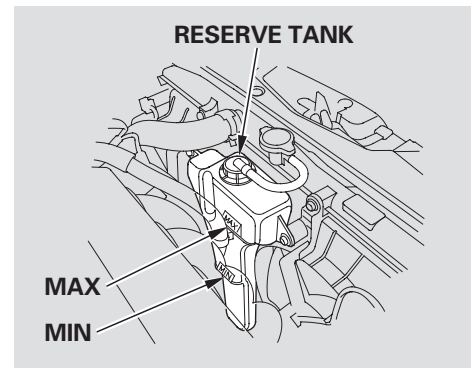

Look at the coolant level in the radiator reserve tank. Make sure it is between the MAX and MIN lines. If it is below the MIN line, see **Adding Engine Coolant** on page [295](#) for information on adding the proper coolant.

Refer to **Owner's Maintenance Checks** on page [288](#) for information about checking other items on your vehicle.

Actual Mileage and EPA Fuel Economy Estimates Comparison. Fuel economy is not a fixed number. It varies based on driving conditions, driving habits and vehicle condition. Therefore, it is not possible for one set of estimates to predict fuel economy precisely for all drivers in all environments.

The EPA fuel economy estimates shown in the example to the right are a useful tool for comparison when buying a vehicle. EPA estimates include:

City MPG — Represents urban driving in a vehicle in light traffic. A range of miles per gallon achieved is also provided.

Highway MPG — Represents a mixture of rural and interstate driving, in a warmed-up vehicle, typical of longer trips in free-flowing traffic. A range of miles per gallon

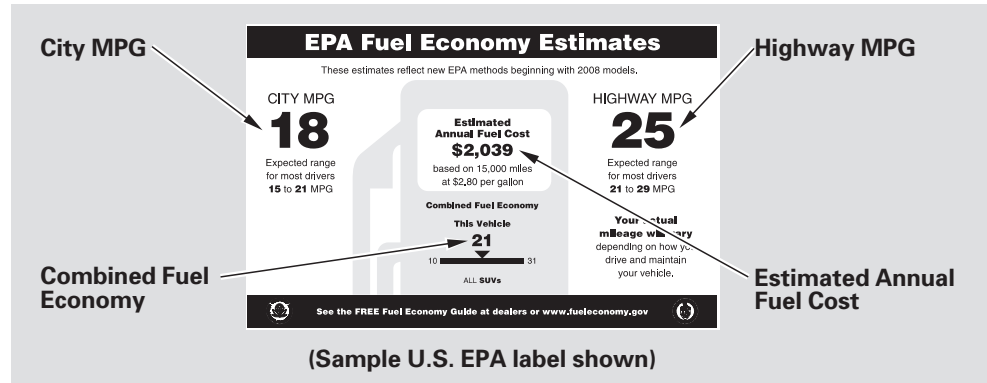

achieved is also provided.

Combined Fuel Economy — Represents a combination of city and highway driving. The scale represents the range of combined fuel economy for other vehicles in the class.

Estimated Annual Fuel Cost — Provides an estimated annual fuel cost, based on 15,000 miles (20,000 km) per year multiplied by the cost per gallon (based on EPA fuel cost data) divided by the combined fuel economy.

For more information on fuel economy ratings and factors that affect fuel economy, visit www.fueleconomy.gov (Canada: Visit www.vehicles.gc.ca)

Fuel Economy

Fuel Economy Factors

The following factors can lower your vehicle's fuel economy:

- Aggressive driving (hard acceleration and braking)
- Excessive idling, accelerating and braking in stop-and-go traffic
- Cold engine operation (engines are more efficient when warmed up)
- Driving with a heavy load or the air conditioner running
- Improperly inflated tires

Improving Fuel Economy

Vehicle Maintenance

A properly maintained vehicle maximizes fuel economy. Poor maintenance can significantly reduce fuel economy. Always maintain your vehicle according to the maintenance messages displayed on the multi-information display (see **Owner's Maintenance Checks** on page 288). For example:

- **Use the recommended viscosity motor oil, displaying the API Certification Seal (see page 291).**
- **Maintain proper tire inflation** — An under-inflated tire increases “rolling resistance,” which reduces fuel economy.
- **Avoid carrying excess weight in your vehicle** — It puts a heavier load on the engine, increasing fuel consumption.
- **Keep your vehicle clean** — In particular, a build-up of snow or mud on your vehicle's underside adds weight and rolling resistance. Frequent cleaning helps your fuel economy.

Drive Efficiently

- **Drive moderately** — Rapid acceleration, abrupt cornering, and hard braking increase fuel consumption.

- **Observe the speed limit** — Aerodynamic drag has a big effect on fuel mileage at speeds above 45 mph (75 km/h). Reduce your speed and you reduce the drag. Trailers, car top carriers, roof racks and bike racks are also big contributors to increased drag.
- **Always drive in the highest gear possible** — If your vehicle has a manual transmission, you can boost your fuel economy by up shifting as early as possible.
- **Avoid excessive idling** — Idling results in 0 miles per gallon.
- **Minimize the use of the air conditioning system** — The A/C puts an extra load on the engine which makes it use more fuel. Use the fresh-air ventilation when possible.
- **Plan and combine trips** — Combine several short trips into one. A warmed-up engine is more fuel efficient than a cold one.

Calculating Fuel Economy

Measuring Techniques

Direct calculation is the recommended source of information about your actual fuel economy. Using frequency of fill-ups or taking fuel gauge readings are NOT accurate measures of fuel economy. Fuel economy may improve over the first several thousand miles.

Checking Your Fuel Economy

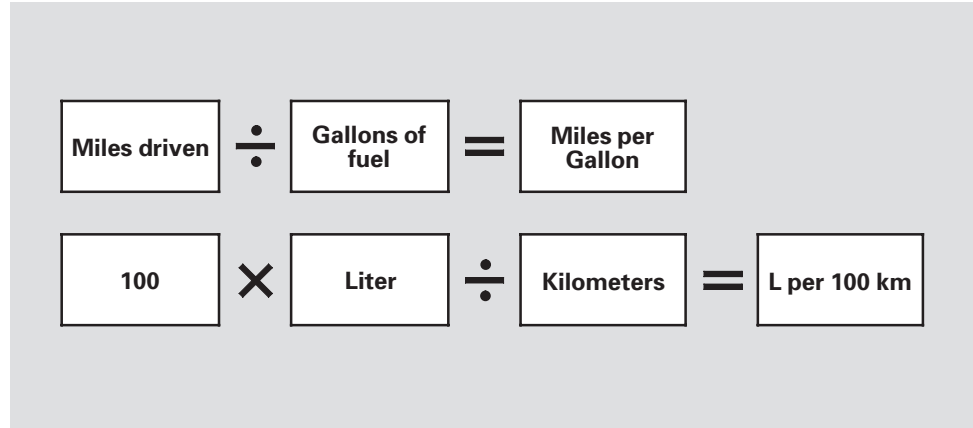

Before Driving

- 1) Fill the fuel tank until the nozzle automatically clicks off.
- 2) Reset trip counter to zero.
- 3) Record the total gallons (liters) needed to refill.
- 4) Follow one of the simple calculations above.

Accessories and Modifications

Modifying your vehicle, or installing some non-Acura accessories, can make your vehicle unsafe. Before you make any modifications or add any accessories, be sure to read the following information.

Accessories

Your dealer has Acura accessories that allow you to personalize your vehicle. These accessories have been designed and approved for your vehicle, and are covered by warranty.

Although non-Acura accessories may fit on your vehicle, they may not meet factory specifications, and could adversely affect your vehicle's handling and stability.

WARNING

Improper accessories or modifications can affect your vehicle's handling, stability, and performance, and cause a crash in which you can be hurt or killed.

Follow all instructions in this owner's manual regarding accessories and modifications.

When properly installed, cellular phones, alarms, two-way radios, and low-powered audio systems should not interfere with your vehicle's computer controlled systems, such as your airbags, anti-lock brakes, and tire pressure monitoring system.

Before installing any accessory:

- Make sure the accessory does not obscure any lights, or interfere with proper vehicle operation or performance.
- Be sure electronic accessories do not overload electrical circuits (see page [340](#)) or interfere with proper operation of your vehicle.
- Before installing any electronic accessory, have the installer contact your dealer for assistance. If possible, have your dealer inspect the final installation.
- Do not install accessories on the side pillars or across the rear windows. Accessories installed in these areas may interfere with proper operation of the side curtain airbags.

Modifying Your Vehicle

Removing parts from your vehicle, or replacing components with non-Acura components could seriously affect your vehicle's handling, stability, and reliability.

Some examples are:

- Lowering the vehicle with a non-Acura suspension kit that significantly reduces ground clearance can allow the undercarriage to hit speed bumps or other raised objects, which could cause the airbags to deploy.
- Raising your vehicle with a non-Acura suspension kit can affect the handling and stability.
- Non-Acura wheels, because they are a universal design, can cause excessive stress on suspension components and will not be compatible with the tire pressure monitoring system (TPMS).

- Larger or smaller wheels and tires can interfere with the operation of your vehicle's anti-lock brakes and other systems.
- Modifying your steering wheel or any other part of your vehicle's safety systems could make the systems ineffective.

If you plan to modify your vehicle, consult your dealer.

Carrying Cargo

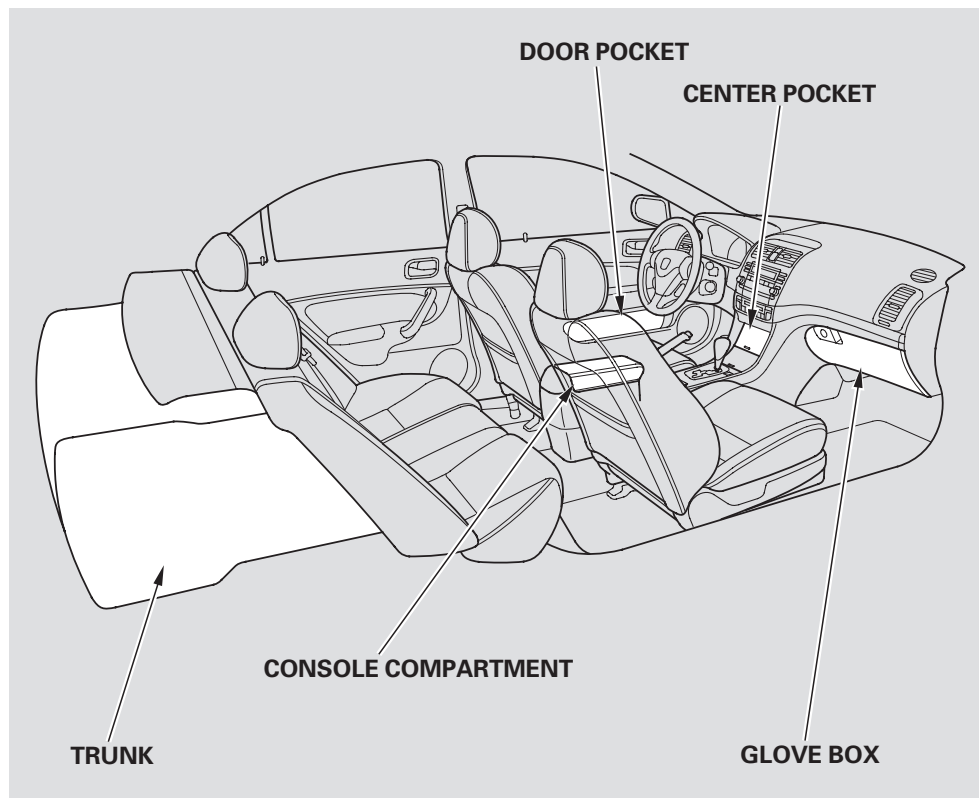

Your vehicle has several convenient storage areas:

- Glove box
- Door pockets
- Trunk, including the back seats when folded down
- Center pocket
- Console compartment

However, carrying too much cargo, or improperly storing it, can affect your vehicle's handling, stability, stopping distance, and tires, and make it unsafe. Before carrying any type of cargo, be sure to read the following pages.

Load Limits

The maximum load for your vehicle is 850 lbs (385 kg) for U.S. vehicles, and 395 kg for Canadian vehicles.

See Tire And Loading Information label attached to the driver's doorjamb.

Label Example

| TIRE AND LOADING INFORMATION | | | |
|---|---------------|--------------------|---|
| SEATING CAPACITY | | TOTAL X | FRONT X REAR X |
| The combined weight of occupants and cargo should never exceed XXXkg or XXXXlbs | | | |
| TIRE | SIZE | COLD TIRE PRESSURE | SEE OWNER'S MANUAL FOR ADDITIONAL INFORMATION |
| FRONT | XXXX/XXXX XXX | XXXKPA, XXPSI | |
| REAR | XXXX/XXXX XXX | XXXKPA, XXPSI | |
| SPARE | XXXX/XXXX XXX | XXXKPA, XXPSI | |

This figure includes the total weight of all occupants, cargo, and accessories, and the tongue load if you are towing a trailer.

⚠ WARNING

Overloading or improper loading can affect handling and stability and cause a crash in which you can be hurt or killed.

Follow all load limits and other loading guidelines in this manual.

Steps for Determining Correct Load Limit –

- (1) Locate the statement “The combined weight of occupants and cargo should never exceed XXX kg or XXX lbs.” on your vehicle’s placard.
- (2) Determine the combined weight of the driver and passengers that will be riding in your vehicle.
- (3) Subtract the combined weight of the driver and passengers from XXX kg or XXX lbs.
- (4) The resulting figure equals the available amount of cargo and luggage load capacity. For example, if the “XXX” amount equals 1,400 lbs. and there will be five 150 lb. passengers in your vehicle, the amount of available cargo and luggage load capacity is 650 lbs.
(1,400 – 750 (5 × 150) = 650 lbs.)









CONTINUED

Carrying Cargo

(5) Determine the combined weight of luggage and cargo being loaded on the vehicle. That weight may not safely exceed the available cargo and luggage load capacity calculated in Step 4.

(6) If your vehicle will be towing a trailer, load from your trailer will be transferred to your vehicle. Consult this manual to determine how this reduces the available cargo and luggage load capacity of your vehicle.

In addition, the total weight of the vehicle, all occupants, accessories, cargo, and trailer tongue load must not exceed the Gross Vehicle Weight Rating (GVWR) or the Gross Axle Weight Rating (GAWR). Both are on a label on the driver's doorjamb.

| | | | | | |
|------------------|--|--------|---|---|---|
| <p>Example 1</p> |  Max Load (850 lbs) | \geq |  Passenger Weight (150 lbs x 2 = 300 lbs) | + |  Cargo Weight (550 lbs) |
| <p>Example 2</p> |  Max Load (850 lbs) | \geq |  Passenger Weight (150 lbs x 4 = 600 lbs) | + |  Cargo Weight (250 lbs) |
| <p>Example 3</p> |  Max Load (850 lbs) | \geq |  Passenger Weight (150 lbs x 5 = 750 lbs) | + |  Cargo Weight (100 lbs) |

Carrying Cargo in the Trunk

- Distribute cargo evenly on the floor of the trunk, placing the heaviest items on the bottom and as far forward as possible. Tie down items that could be thrown about the vehicle during a crash or sudden stop.
- If you fold down the back seat, tie down items that could be thrown about the vehicle during a crash or sudden stop.

- If you carry large items that prevent you from closing the trunk lid, exhaust gas can enter the passenger area. To avoid the possibility of **carbon monoxide poisoning**, follow the instructions on page 55 .

Carrying Items in the Passenger Compartment

- Store or secure all items that could be thrown around and hurt someone during a crash.
- Be sure items placed on the floor behind the front seats cannot roll underneath and interfere with the proper operation of the seats, the sensors under the seats, or the driver's ability to operate the pedals.
- Keep the glove box closed while driving. If it is open, a passenger could injure their knees during a crash or sudden stop.
- Do not put any items on top of the rear shelf. They can block your view and be thrown around the vehicle during a crash.

This section gives you tips on starting the engine under various conditions, and how to operate the manual and automatic transmissions. It also includes important information on parking your vehicle, the braking system, the vehicle stability assist (VSA) system, the tire pressure monitoring system (TPMS), and facts you need if you are planning to tow a trailer.

| | |
|---|-----|
| Preparing to Drive | 248 |
| Starting the Engine..... | 249 |
| Manual Transmission..... | 250 |
| Automatic Transmission..... | 252 |
| Parking..... | 259 |
| Braking System..... | 260 |
| Anti-lock Brakes (ABS) | 261 |
| Tire Pressure Monitoring System (TPMS) | 263 |
| Vehicle Stability Assist (VSA) System..... | 268 |
| Towing a Trailer | 270 |

Preparing to Drive

You should do these checks and adjustments before you drive your vehicle:

1. Make sure all windows, mirrors, and outside lights are clean and unobstructed. Remove frost, snow, or ice.
2. Check that the hood is fully closed.
3. Check that the trunk is fully closed.
4. Visually check the tires. If a tire looks low, use a gauge to check its pressure.
5. Check that any items you may be carrying are stored properly or fastened down securely.
6. Check the seat adjustment (see page [138](#)).
7. Check the adjustment of the inside and outside mirrors (see pages [145](#) and [146](#)).
8. Check the steering wheel adjustment (see page [125](#)).
9. Make sure the doors are securely closed and locked.
10. Fasten your seat belt. Check that your passengers have fastened their seat belts (see page [15](#)).
11. When you start the engine, check the gauges and indicators in the instrument panel, and the messages on the multi-information display (see pages [61](#) , [68](#) and [76](#)).

1. Apply the parking brake.
2. In cold weather, turn off all electrical accessories to reduce the drain on the battery.
3. *Manual transmission:*
Push the clutch pedal down all the way.

Automatic transmission:

Make sure the shift lever is in Park. Press on the brake pedal.

4. Without touching the accelerator pedal, turn the ignition key to the START (III) position. Do not hold the key in the START (III) position for more than 15 seconds at a time. If the engine does not start right away, pause for at least 10 seconds before trying again.

NOTICE

The immobilizer system protects your vehicle from theft. If an improperly-coded key (or other device) is used, the engine's fuel system is disabled. For more information, see page [127](#).

5. If the engine does not start within 15 seconds, or starts but stalls right away, repeat step 4 with the accelerator pedal pressed halfway down. If the engine starts, release pressure on the accelerator pedal so the engine does not race.

6. If the engine fails to start, press the accelerator pedal all the way down and hold it there while starting to clear flooding. Return to step 5 if the engine does not start.

NOTICE

The engine is harder to start in cold weather. Also, the thinner air found at altitudes above 8,000 feet (2,400 meters) adds to this problem.

Manual Transmission

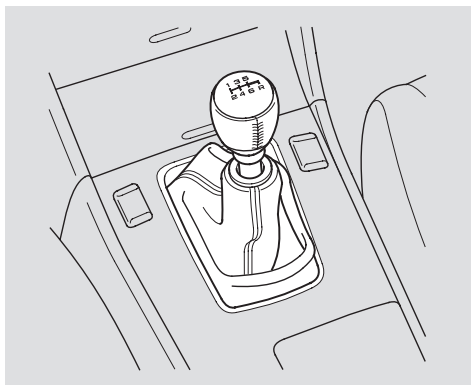

The manual transmission is synchronized in all forward gears for smooth operation. When shifting up or down, make sure you push the clutch pedal down all the way, shift to the next gear, and let the pedal up gradually. When you are not shifting, do not rest your foot on the clutch pedal. This can cause your clutch to wear out faster.

Come to a full stop before you shift into reverse. You can damage the transmission by trying to shift into reverse with the vehicle moving. Push down the clutch pedal, and pause for a few seconds before shifting into reverse, or shift into one of the forward gears for a moment. This stops the gears so they won't "grind."

When slowing down, you can get extra braking from the engine by shifting to a lower gear. This extra braking can help you maintain a safe speed and prevent your brakes from overheating while going down a steep hill. Before downshifting, make sure the engine speed will not go into the tachometer's red zone in the lower gear. Downshift one gear at a time.

⚠ WARNING

Rapid slowing or speeding up can cause loss of control on slippery surfaces. If you crash, you can be injured.

Use extra care when driving on slippery surfaces.

Recommended Shift Points

Drive in the highest gear that lets the engine run and accelerate smoothly. This will give you good fuel economy and effective emissions control. The following shift points are recommended:

| Shift up | Normal acceleration |
|------------|---------------------|
| 1st to 2nd | 12 mph (19 km/h) |
| 2nd to 3rd | 23 mph (37 km/h) |
| 3rd to 4th | 34 mph (54 km/h) |
| 4th to 5th | 45 mph (72 km/h) |
| 5th to 6th | 56 mph (90 km/h) |

Engine Speed Limiter

If you exceed the maximum speed for the gear you are in, the engine speed will enter into the tachometer's red zone. If this occurs, you may feel the engine cut in and out. This is caused by a limiter in the engine's computer controls. The engine will run normally when you reduce the rpm below the red zone.

The engine speed limiter only works when you upshift; engine speed is not limited during downshifts. Before downshifting, make sure the engine will not go into the tachometer's red zone.

Reverse Lockout

The 6-speed manual transmission has an electric lockout so you cannot accidentally shift from fifth to reverse instead of sixth while the vehicle is moving. If you cannot shift to reverse when the vehicle is stopped:

1. Apply the parking brake, and turn the ignition key to the ACCESSORY (I) or the LOCK (0) position.
2. Press the clutch pedal, and shift to reverse.
3. With the clutch pedal still pressed, start the engine.

If you need to use this procedure to shift to reverse, your vehicle may be developing a problem. Have the vehicle checked by your dealer.

Automatic Transmission

Shift Lever Position Indicators

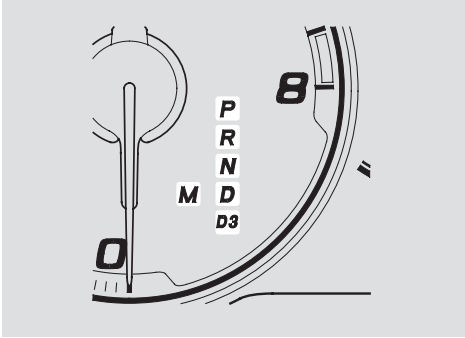

These indicators in the tachometer show which position the shift lever is in.

The “D” indicator comes on for a few seconds when you turn the ignition switch to the ON (II) position. If it flashes while driving (in any shift position), it indicates a possible problem in the transmission.

If the malfunction indicator lamp comes on along with the “D” indicator, there is a problem with the automatic transmission control system. Avoid rapid acceleration, and have the transmission checked by your dealer as soon as possible.

When the “D” indicator warns of a possible problem with the transmission, you will see a “CHECK TRANSMISSION” message on the multi-information display (see page [83](#)).

Shifting

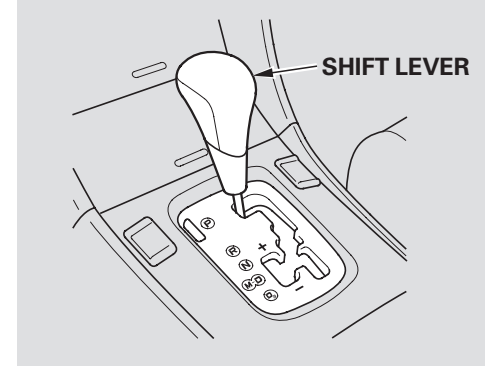

To shift from any position, move the shift lever. You cannot shift out of Park when the ignition switch is in the LOCK (0) or the ACCESSORY (I) position.

| To shift from: | Do this: |
|--|---|
| P to R | Press the brake pedal and move the lever. |
| R to P N to R D ₃ to D D to N D to D ₃ N to D R to N | Move the lever. |

Park (P) — This position mechanically locks the transmission. Use Park whenever you are turning off or starting the engine. To shift out of Park, you must press on the brake pedal and have your foot off the accelerator pedal. Move the shift lever to the right to shift out of Park.

If you have done all of the above and still cannot move the lever out of Park, see **Shift Lock Release** on page 257.

To avoid transmission damage, come to a complete stop before shifting into Park. The shift lever must be in Park before you can remove the key from the ignition switch.

Reverse (R) — Press the brake pedal, and move the shift lever from Park to reverse. To shift from reverse to neutral, come to a complete stop, and then shift.

Your vehicle has a reverse lockout so you cannot accidentally shift to reverse from neutral or any other driving position when the vehicle speed exceeds 5–6 mph (8–10 km/h).

If you cannot shift to reverse when the vehicle is stopped, press the brake pedal, slowly shift to neutral, and then shift to reverse.

If there is a problem in the reverse lockout system, or your vehicle's

battery is disconnected or goes dead, you cannot shift to reverse. (Refer to **Shift Lock Release** on page 257).

Neutral (N) — Use neutral if you need to restart a stalled engine, or if it is necessary to stop briefly with the engine idling. Shift to the Park position if you need to leave your vehicle and apply the parking brake. Press on the brake pedal when you are moving the shift lever from neutral to another gear.

Drive (D) — Use this position for your normal driving. The transmission automatically selects a suitable gear for the vehicle speed and acceleration. You may notice the transmission shifting up at higher speeds when the engine is cold. This helps the engine warm up faster.

CONTINUED

Automatic Transmission

Drive (D3) — This position is similar to D, except only the first three gears are selected instead of all five. Use D3 when towing a trailer in hilly terrain, or to provide engine braking when going down a steep hill. D3 can also keep the transmission from cycling between third and fourth gears in stop-and-go driving.

Sequential SportShift Mode — With the shift lever in “D” position, you can select the Sequential SportShift mode to shift gears; much like a manual transmission, but without a clutch pedal.

To enter the Sequential SportShift mode, move the shift lever further to the driver’s side. To return to “D,” move the shift lever to the passenger’s side.

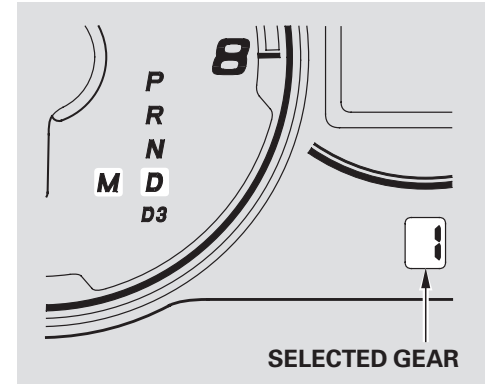

When you move the shift lever from “D” to “M” position, the display shows the selected gear.

In Sequential SportShift mode, each time you push forward on the shift lever, the transmission shifts to a higher gear. Pull back on the lever to downshift. The number of the gear selected is displayed on the instrument panel.

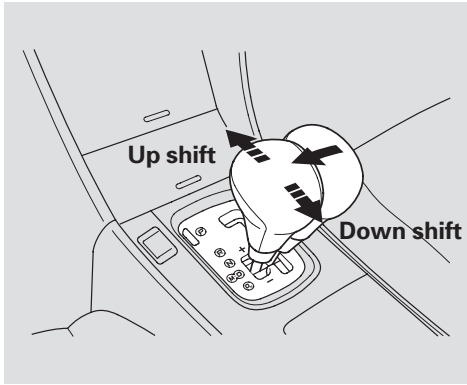

When you accelerate away from a stop, the transmission will be in first gear. The transmission will not automatically upshift. Watch the tachometer and upshift manually before the engine reaches the redline.

The transmission remains in the selected gear (5, 4, 3, 2, or 1). There is no automatic downshift when you push the accelerator pedal to the floor.

The transmission may automatically downshift from the higher gear to the lower gear under the following conditions:

- The vehicle speeds drops below
 - 5 → 4: 33 mph (52 km/h)
 - 4 → 3: 20 mph (32 km/h)
- If you drive uphill between
 - 5 → 4: 45–33 mph (72–52 km/h)
 - 4 → 3: 33–20 mph (52–32 km/h)
 - 3 → 2: 20–10 mph (32–16 km/h)
- If you press the brake pedal as you drive downhill.

Downshifting gives you more power when climbing, and provides engine braking when going down a steep hill.

The transmission will also shift automatically as the vehicle comes to a complete stop. It will downshift to first gear when the vehicle speed is under 6 mph (10 km/h).

If you try to manually downshift at a speed that would cause the engine to exceed the redline in a lower gear, the transmission will not downshift. The gear indicator will flash the number of the lower gear several times, then return to the higher gear.

If the vehicle speed slows to below the redline of the selected lower gear position while the indicator is flashing, the transmission will downshift and the display will show the selected lower gear.

CONTINUED

Automatic Transmission

The table shows the speed ranges for upshifting and downshifting.

| To shift from | Speed range |
|---------------|--------------------------|
| 1 → 2 | over 0 mph (0 km/h) |
| 2 → 3 | over 6 mph (10 km/h) |
| 3 → 4 | over 20 mph (32 km/h) |
| 4 → 5 | over 33 mph (52 km/h) |

| To shift from | Speed range |
|---------------|-----------------------------|
| 2 → 1 | under 31 mph (50 km/h) |
| 3 → 2 | under 69 mph (110 km/h) |
| 4 → 3 | under 88 mph (140 km/h) |
| 5 → 4 | under 131 mph (210 km/h) |

Starting in Second Gear

When you are in Sequential SportShift mode, and the vehicle is stopped, push forward on the shift lever to shift to second gear. You will see “2” in the display. Starting out in second gear will help to reduce wheelspin in deep snow or on a slippery surface.

If you start out in second gear, the transmission will be fixed in that gear.

The transmission will not automatically downshift to first gear even when the vehicle speed is under 6 mph (10 km/h). You need to shift down to first gear manually.

Engine Speed Limiter

If you exceed the maximum speed for the gear you are in, the engine speed will enter into the tachometer's red zone. If this occurs, you may feel the engine cut in and out. This is caused by a limiter in the engine's computer controls. The engine will run normally when you reduce the rpm below the red zone.

Before downshifting, make sure the engine will not go into the tachometer's red zone.

Shift Lock Release

This allows you to move the shift lever out of Park if the normal method of pushing on the brake pedal does not work. This procedure is also used to release the reverse lockout.

1. Set the parking brake.
2. Remove the key from the ignition switch.

To release the reverse lockout, make sure the ignition switch is in the ACCESSORY (I) position.

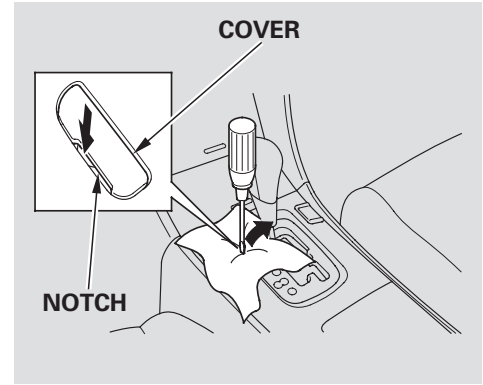

3. Put a cloth on the notch of the shift lock release slot cover. Using a small flat-tipped screwdriver or a metal fingernail file, carefully pry on the notch of the cover to remove it.

CONTINUED

Automatic Transmission

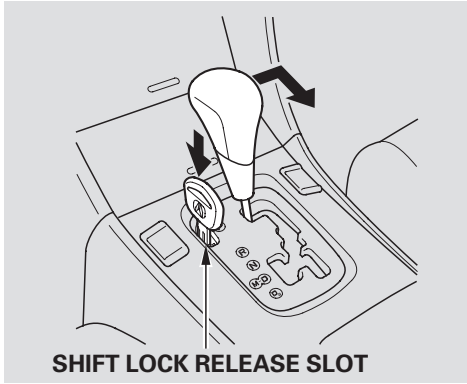

4. Insert the key in the shift lock release slot.
5. Push down on the key while you move the shift lever out of Park to neutral.

To release the reverse lockout, move the shift lever from neutral to reverse, then to Park.

6. Remove the key from the shift lock release slot, then reinstall the cover. Make sure the notch on the cover is on the driver's side. Press the brake pedal, and restart the engine.

If you need to use the shift lock release, it means your vehicle is developing a problem. Have it checked by your dealer.

Always use the parking brake when you park your vehicle. Make sure the parking brake is set firmly, or your vehicle may roll if it is parked on an incline.

If your vehicle has an automatic transmission, set the parking brake before you put the transmission in Park. This keeps the vehicle from moving and putting pressure on the parking mechanism in the transmission.

If your vehicle has a manual transmission, put it in first gear.

Parking Tips

- Make sure the moonroof and the windows are closed.
- Turn off the lights.
- Place any packages, valuables, etc., in the trunk or take them with you.
- Lock the doors with the key or the remote transmitter. Check the indicator on the instrument panel to verify that the security system is set.
- Never park over dry leaves, tall grass, or other flammable materials. The hot three way catalytic converter could cause these materials to catch on fire.

- If the vehicle is facing uphill, turn the front wheels away from the curb. If your vehicle has a manual transmission, put it in first gear.
- If the vehicle is facing downhill, turn the front wheels toward the curb. If your vehicle has a manual transmission, put it in reverse gear.
- Make sure the parking brake is fully released before driving away. Driving with the parking brake partially set can overheat or damage the rear brakes.

Braking System

Your vehicle is equipped with disc brakes at all four wheels. A power assist helps reduce the effort needed on the brake pedal. The anti-lock brake system (ABS) helps you retain steering control when braking very hard.

Resting your foot on the pedal keeps the brakes applied lightly, builds up heat, increases wear, and reduces their effectiveness. It also keeps your brake lights on all the time, confusing drivers behind you.

Constant application of the brakes when going down a long hill builds up heat and reduces their effectiveness. Use the engine to assist the brakes by taking your foot off the accelerator and downshifting to a lower gear.

Check the brakes after driving through deep water. Apply the brakes moderately to see if they feel normal. If not, apply them gently and frequently until they do. Be extra cautious and alert in your driving.

Braking System Design

The hydraulic system that operates the brakes has two separate circuits. Each circuit works diagonally across the vehicle (the left-front brake is connected with the right-rear brake, etc.). If one circuit should develop a problem, you will still have braking at two wheels.

Brake Pad Wear Indicators

All four brakes have audible brake wear indicators.

If the brake pads need replacing, you will hear a distinctive, metallic screeching sound when you apply the brake pedal. If you do not have the brake pads replaced, they will screech all the time. It is normal for the brakes to occasionally squeal or squeak when you apply them.

The anti-lock brake system (ABS) helps prevent the wheels from locking up, and helps you retain steering control by pumping the brakes rapidly, much faster than a person can do it.

The electronic brake distribution (EBD) system, which is part of the ABS, also balances the front-to-rear braking distribution according to vehicle loading.

You should never pump the brake pedal. Let the ABS work for you by always keeping firm, steady pressure on the brake pedal. This is sometimes referred to as “stomp and steer.”

You will feel a pulsation in the brake pedal when the ABS activates, and you may hear some noise. This is normal: it is the ABS rapidly pumping the brakes. On dry pavement, you will need to press on the brake pedal very hard before the ABS activates. However, you may feel the ABS activate immediately if you are trying to stop on snow or ice.



ABS Indicator

If this indicator comes on, the anti-lock function of the braking system has shut down. The brakes still work like a conventional system, but without anti-lock. You should have your dealer inspect your vehicle as soon as possible.

When the ABS indicator comes on, you will also see a “CHECK ABS SYSTEM” message on the multi-information display.

If the ABS indicator and the brake system indicator come on together, and the parking brake is fully released, the EBD system may also be shut down.

CONTINUED

Anti-lock Brakes (ABS)

Test your brakes as instructed on page 338 . If the brakes feel normal, drive slowly and have your vehicle repaired by your dealer as soon as possible. Avoid sudden hard braking which could cause the rear wheels to lock up and possibly lead to a loss of control.

The VSA indicator will come on along with the ABS indicator.

Important Safety Reminders
ABS does not reduce the time or distance it takes to stop the vehicle. It only helps with the steering control during braking.

ABS will not prevent a skid that results from changing direction abruptly, such as trying to take a corner too fast or making a sudden lane change. Always drive at a safe speed for the road and weather conditions.

ABS cannot prevent a loss of stability. Always steer moderately when you are braking hard. Severe or sharp steering wheel movement can still cause your vehicle to veer into oncoming traffic or off the road.

A vehicle with ABS may require a longer distance to stop on loose or uneven surfaces, such as gravel or snow, than a vehicle without anti-lock.

Tire Pressure Monitoring System (TPMS)

Your vehicle is equipped with a tire pressure monitoring system (TPMS) that turns on every time you start the engine and monitors the pressure in your tires while driving.

Each tire has its own pressure sensor. If the air pressure of a tire becomes significantly low, the sensor in that tire immediately sends a signal that causes the low tire pressure/TPMS indicator in the instrument panel to come on. If this happens, you will see which tire is losing pressure on the multi-information display along with a “CHECK TIRE PRESSURE” message.



Low Tire Pressure/ TPMS Indicator

When the low tire pressure/TPMS indicator is on, one or more of your tires is significantly underinflated. You should stop and check your tires as soon as possible, and inflate them to the proper pressure as indicated on the vehicle’s tire information placard.

It is possible that the pressures shown on the multi-information display and the pressures you manually measure are slightly different.

If the difference is significant or you cannot make the low tire pressure/TPMS indicator and message on the multi-information display go out after inflating the tires to the specified values, have your dealer check the system as soon as possible.

If you think you can safely drive a short distance to a service station, proceed slowly to the station, then inflate the tire to the recommended pressure.

If the tire is flat, or if the tire pressure is too low to continue driving, replace the tire with the compact spare tire (see page 324).

Driving on a significantly underinflated tire causes the tire to overheat and can lead to tire failure. Under-inflation also reduces fuel efficiency and tire tread life, and may affect the vehicle’s handling and stopping ability.

Because tire pressure varies by temperature and other conditions, the low tire pressure/TPMS indicator may come on unexpectedly.

CONTINUED

Tire Pressure Monitoring System (TPMS)

For example, if you check and fill your tires in a warm area, then drive in extremely cold weather, the tire pressure will be lower than measured and could be underinflated and cause the low tire pressure/TPMS indicator to come on. Or, if you check and adjust your tire pressure in cooler conditions, and drive into extremely hot conditions, the tires may become overinflated. However, the low tire pressure/TPMS indicator will not come on if the tires are overinflated.

Refer to page [314](#) for tire inflation guidelines.

If there is a problem with the TPMS, this indicator begins to flash. It stops flashing after approximately 1 minute, then stays on. You will also see a “CHECK TPMS SYSTEM” message on the multi-information display (see page [267](#)).

Although your tire pressure is monitored, you must manually check the tire pressures monthly.

Each tire, including the spare, should be checked monthly when the vehicle is cold, and set to the recommended inflation pressure as specified on the vehicle placard and in the owner’s manual (see page [315](#)).

Tire Pressure Monitor

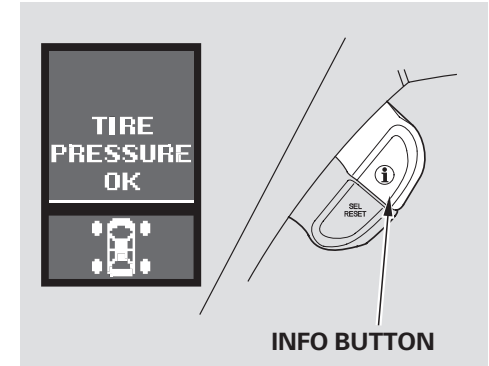

To display the tire pressure monitor, press the INFO button until it appears on the multi-information display.

When all tire pressures are normal, the tire pressure monitor will show a “TIRE PRESSURE OK” message.

Tire Pressure Monitoring System (TPMS)

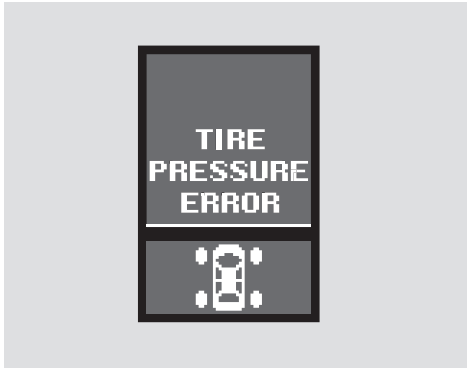

When any of the tires have low pressure, the tire pressure monitor shows a “TIRE PRESSURE ERROR” message.



When any of the tires have low pressure, the low tire pressure/TPMS indicator on the instrument panel comes on, and the multi-information display also interrupts the current display and shows a “CHECK TIRE PRESSURE” message. You can see one or more of the low pressure tire positions highlighted in the display along with this message.

Tire Pressure Readings

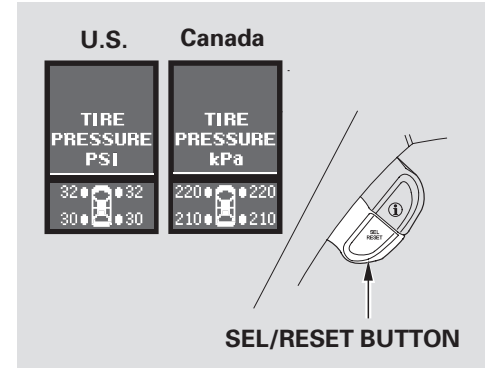

When the TPMS is functioning normally, you can see the tire pressure readings of each tire in psi (U.S. models) or kPa (Canadian models) by pressing the SEL/RESET button while the multi-information display shows the tire pressure monitor.

CONTINUED

Tire Pressure Monitoring System (TPMS)

It is possible that the pressures shown on the multi-information display and the pressures you manually measure are slightly different.

If the difference is significant or you cannot make the low tire pressure/TPMS indicator and message on the multi-information display go out after inflating the tires to the specified values, have your dealer check the system as soon as possible.

Changing a Tire with TPMS

If you have a flat tire, the low tire pressure/TPMS indicator and tire monitor indicator will come on.

Replace the indicated flat tire with the compact spare tire (see page 324).

After the flat tire is replaced with the spare tire, the low tire pressure/TPMS indicator stays on while driving. After several miles (kilometers) driving, this indicator begins to flash, then stays on again. You will also see a “CHECK TPMS SYSTEM” message on the multi-information display. This is normal; the system cannot monitor the spare tire pressure. Manually check the spare tire pressure to be sure it is correct.

This indicator and the warning message on the multi-information display will go off, after several miles (kilometers) driving, when the spare

tire is replaced with the specified regular tire equipped with the tire pressure monitor sensor.

Each wheel is equipped with a tire pressure sensor mounted inside the tire behind the valve stem. You must use TPMS specific wheels. It is recommended that you always have your tires serviced by your dealer or a qualified technician.

Never use a puncture-repairing agent in a flat tire. If used, you will have to replace the tire pressure sensor. Have the flat tire repaired by your dealer as soon as possible.

Tire Pressure Monitoring System (TPMS)

Check TPMS System Message

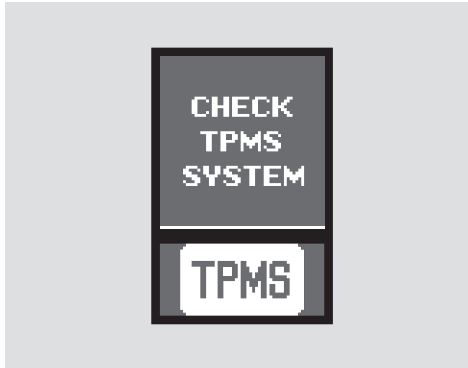

If there is a problem with the TPMS, you will see the above message on the multi-information display.

If you see this message, the system is off and is not monitoring the tire pressures. Have the system checked by your dealer as soon as possible.

Also, the low tire pressure/TPMS indicator begins to flash, then stays on (see page 67).

When you restart the vehicle with the compact spare tire, the TPMS system message will also be displayed on the multi-information display after several miles (kilometers) driving.

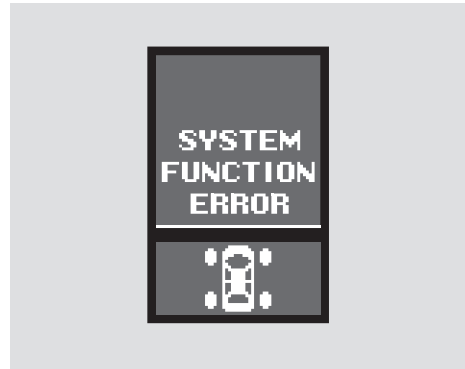

If you see this message, the tire pressure monitor shows a "SYSTEM FUNCTION ERROR" message. The system may not be able to detect or signal low tire pressure as intended. Also, the tire pressure readings will not be displayed. Have your vehicle

checked by a dealer as soon as possible.

As required by the FCC:

This device complies with Part 15 of the FCC rules. Operation is subject to the following two conditions: (1) This device may not cause harmful interference, and (2) this device must accept any interference received, including interference that may cause undesired operation.

Changes or modifications not expressly approved by the party responsible for compliance could void the user's authority to operate the equipment.

This device complies with Industry Canada Standard RSS-210.

Operation is subject to the following two conditions: (1) this device may not cause interference, and (2) this device must accept any interference that may cause undesired operation of the device.

Vehicle Stability Assist (VSA) System

The vehicle stability assist (VSA) system helps to stabilize the vehicle during cornering if the vehicle turns more or less than desired. It also assists you in maintaining traction while accelerating on loose or slippery road surfaces. It does this by regulating the engine's output and by selectively applying the brakes.

When VSA activates, you may notice that the engine does not respond to the accelerator in the same way it does at other times. You will also see the VSA activation indicator blink.

The VSA system cannot enhance the vehicle's driving stability in all situations and does not control your vehicle's entire braking system. It is still your responsibility to drive and corner at reasonable speeds and to leave a sufficient margin of safety.



VSA Activation Indicator

When VSA activates, you will see the VSA activation indicator blink (see page 65).



Vehicle Stability Assist (VSA) System Indicator

If this indicator comes on while driving, pull to the side of the road when it is safe, and turn off the engine. Reset the system by restarting the engine. If the VSA system indicator stays on or comes back on while driving, have the VSA system inspected by your dealer.

If the indicator does not come on when the ignition switch is turned to the ON (II) position, there may be a problem with the VSA system. Have your dealer inspect your vehicle as soon as possible.

When the VSA system indicator comes on, you will also see a "CHECK VSA SYSTEM" message on the multi-information display.

Without VSA, your vehicle will have normal braking and cornering ability, but it will not have VSA traction and stability enhancement.

VSA Off Switch

In certain unusual conditions when your vehicle gets stuck in shallow mud or fresh snow, it may be easier to free it with the VSA temporarily switched off. When the VSA system is off, the traction control system is also off. You should only attempt to free your vehicle with the VSA off if you are not able to free it when the VSA is on.

Immediately after freeing your vehicle, be sure to switch the VSA on again. We do not recommend driving your vehicle with the VSA and traction control systems switched off.

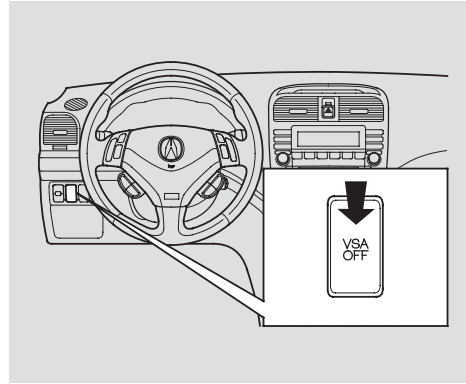

This switch is under the left vent. Press it to turn the vehicle stability assist system on and off.

When VSA is off, the VSA activation indicator comes on as a reminder.

VSA is turned on every time you start the engine, even if you turned it off the last time you drove the vehicle.

VSA and Tire Sizes

Driving with varying tire or wheel sizes may cause the VSA to malfunction. When replacing tires, make sure they are of the same size and type as your original tires (see page [318](#)).

If you install winter tires, make sure they are the same size as those that were originally supplied with your vehicle. Exercise the same caution during winter driving as you would if your vehicle was not equipped with VSA.

Towing a Trailer

Your vehicle has been designed primarily to carry passengers and their cargo. You can also use it to tow a trailer if you carefully observe the load limits, use the proper equipment, and follow the guidelines in this section.

⚠ WARNING

Exceeding any load limit or improperly loading your vehicle and trailer can cause a crash in which you can be seriously hurt or killed.

Check the loading of your vehicle and trailer carefully before starting to drive.

Load Limits

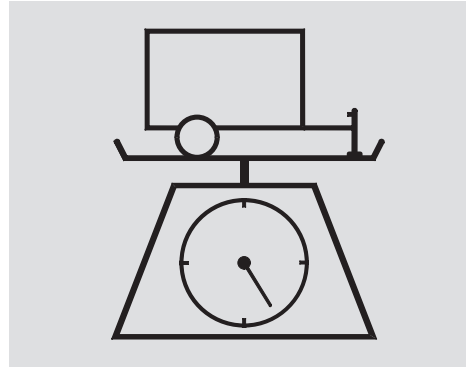

Total Trailer Weight: The maximum allowable weight of the trailer and everything in or on it must not exceed 1,000 lbs (450 kg). Towing a load that is too heavy can seriously affect your vehicle's handling and performance. It can also damage the engine and drivetrain.

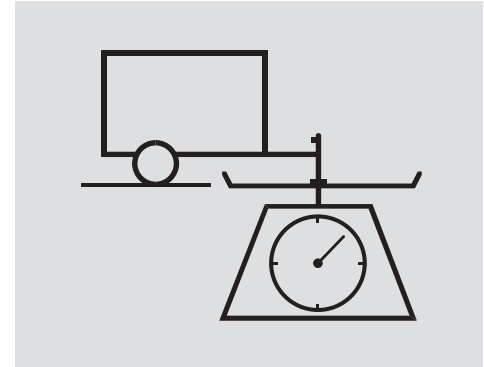

Tongue Load: The weight that the tongue of a fully-loaded trailer puts on the hitch should be approximately 10 % of the total trailer weight. Too much tongue load reduces front-tire traction and steering control. Too little tongue load can make the trailer unstable and cause it to sway.

To achieve a proper tongue load, start by loading 60 % of the load toward the front of the trailer and 40 % toward the rear, then re-adjust the load as needed.

- **Gross Vehicle Weight Rating (GVWR):**

The maximum allowable weight of the vehicle, all occupants, all accessories, all cargo, and the tongue load is:

4,300 lbs (1,950 kg)

- **Gross Axle Weight Rating (GAWR):**

The maximum allowable weight of the vehicle axles is:

2,335 lbs (1,060 kg)
on the front axle
2,030 lbs (920 kg)
on the rear axle

Checking Loads

The best way to confirm that vehicle and trailer weights are within limits is to have them checked at a public scale.

Using a suitable scale or a special tongue load gauge, check the tongue load the first time you set up a towing combination (a fully-loaded vehicle and trailer), then recheck the tongue load whenever the conditions change.

Towing a Trailer

Towing Equipment and Accessories

Towing generally requires a variety of supplemental equipment, depending on the size of your trailer, how much load you are towing, and where you tow. To ensure the best quality, we recommend that you purchase Acura equipment whenever possible.

Discuss your needs with your trailer sales or rental agency, and follow the guidelines in the rest of this section. Also make sure that all equipment is properly installed and maintained, and that it meets federal, state, province, and local regulations.

Hitches

Any hitch used on your vehicle must be properly bolted to the underbody.

Safety Chains

Always use safety chains when you tow a trailer. Make sure the chains are secured to the trailer and hitch, and that they cross under the tongue and can catch the trailer if it becomes unhitched. Leave enough slack to allow the trailer to turn corners easily, but do not let the chains drag on the ground.

Trailer Brakes

Acura recommends that any trailer having a total weight of 1,000 lbs (450 kg) or more be equipped with its own electric or surge-type brakes.

If you choose electric brakes, be sure they are electronically actuated. Do not attempt to tap into your vehicle's hydraulic system. No matter how successful it may seem, any attempt to attach trailer brakes to your vehicle's hydraulic system will lower braking effectiveness and create a potential hazard.

See your trailer dealer or rental agency for more information on installing electric brakes.

Trailer Lights

Trailer lights and equipment must comply with federal, state, province, and local regulations. Check with local trailer sales or rental agencies for requirements for the areas where you plan to tow, and use only equipment designed for your vehicle.

Since lighting and wiring vary by trailer type and brand, you should have a qualified technician install a suitable connector between the vehicle and the trailer. Improper equipment or installation can cause damage to your vehicle's electrical system and affect your vehicle warranty.

Additional Towing Equipment

Many states and Canadian provinces require special outside mirrors when towing a trailer. Even if they don't, you should install special mirrors if you cannot clearly see behind you, or if the trailer creates a blind spot.

Ask your trailer sales or rental agency if any other items are recommended or required for your towing situation.

Towing a Trailer

Pre-Tow Checklist

When preparing to tow, and before driving away, be sure to check the following:

- The vehicle has been properly serviced, and the suspension, cooling system, and lights are in good operating condition.
- The trailer has been properly serviced and is in good condition.
- All weights and loads are within limits (see pages 270 and 271).
- The hitch, safety chains, and any other attachments are secure.
- All items in or on the trailer are properly secured and cannot shift while you drive.

- The lights and brakes on your vehicle and the trailer are working properly.
- Your vehicle tires and spare are properly inflated (see page 315), and the trailer tires and spare are inflated as recommended by the trailer maker.

Handling Crosswinds and Buffeting

Crosswinds and air turbulence caused by passing trucks can disrupt your steering and cause the trailer to sway. When being passed by a large vehicle, keep a constant speed, and steer straight ahead. Do not try to make quick steering or braking corrections.

Backing Up

Always drive slowly and have someone guide you when backing up. Grip the *bottom* of the steering wheel; then turn the wheel to the left to get the trailer to move to the left, and turn the wheel right to move the trailer to the right.

Parking

Follow all normal precautions when parking, including firmly setting the parking brake and putting the transmission in Park (automatic) or in first or reverse (manual). Also, place wheel chocks at each of the trailer's tires.

Driving Safely With a Trailer

The added weight, length, and height of a trailer will affect your vehicle's handling and performance, so driving with a trailer requires some special driving skills and techniques.

For your safety and the safety of others, take time to practice driving maneuvers before heading for the open road, and follow the guidelines below.

Towing Speeds and Gears

Drive slower than normal in all driving situations, and obey posted speed limits for vehicles with trailers. If you have an automatic transmission, use D position when towing a trailer on level roads. D3 is the proper shift lever position to use when towing a trailer in hilly terrain. (See "***Driving on Hills***" in the next column for additional gear information.)

Making Turns and Braking

Make turns more slowly and wider than normal. The trailer tracks a smaller arc than your vehicle, and it can hit or run over something the vehicle misses. Allow more time and distance for braking. Do not brake or turn suddenly as this could cause the trailer to jackknife or turn over.

Driving on Hills

When climbing hills, closely watch your temperature gauge. If it nears the red (Hot) mark, turn the air conditioning off, reduce speed and, if necessary, pull to the side of the road to let the engine cool.

If the automatic transmission shifts frequently while going up a hill, shift to D3.

If you must stop when facing uphill, use the foot brake or parking brake. Do not try to hold the vehicle in place by pressing on the accelerator, as this can cause the automatic transmission to overheat.

When driving down hills, reduce your speed, and shift down to second gear. Do not "ride" the brakes, and remember, it will take longer to slow down and stop when towing a trailer.

This section explains why it is important to keep your vehicle well maintained and how to follow basic maintenance safety precautions.

This section also includes instructions on how to read the maintenance messages on the multi-information display and instructions for simple maintenance tasks you may want to take care of yourself.

If you have the skills and tools to perform more complex maintenance tasks on your vehicle, you may want to purchase the service manual. See page 369 for information on how to obtain a copy, or see your dealer.

- Maintenance Safety 278
- Maintenance Minder 280
- Fluid Locations..... 290
- Adding Engine Oil 291
- Changing the Engine Oil and Filter 293
- Engine Coolant..... 295
- Windshield Washers 296
- Transmission Fluid..... 297
 - Automatic Transmission..... 297
 - Manual Transmission 299
- Brake and Clutch Fluid..... 300
- Power Steering Fluid..... 301
- Lights 302
- Seat Belts 310
- Floor Mats 310
- Dust and Pollen Filter 311
- Wiper Blades 312
- Wheels 314
- Tires 314
- Checking the Battery 320
- Vehicle Storage 321

Maintenance Safety

All service items not detailed in this section should be performed by a certified technician or other qualified mechanic.

Important Safety Precautions

To eliminate potential hazards, read the instructions before you begin, and make sure you have the tools and skills required.

- Make sure your vehicle is parked on level ground, the parking brake is set, and the engine is off.
- To clean parts, use a commercially available degreaser or parts cleaner, not gasoline.
- To reduce the possibility of fire or explosion, keep cigarettes, sparks, and flames away from the battery and all fuel-related parts.
- Wear eye protection and protective clothing when working near the battery or when using compressed air.

WARNING

Improperly maintaining this vehicle, or failing to correct a problem before driving can cause a crash in which you can be seriously hurt or killed.

Always follow the inspection and maintenance recommendations and schedules in this owner's manual.

Potential Vehicle Hazards

- **Carbon Monoxide poison from engine exhaust.** Be sure there is adequate ventilation whenever you operate the engine.
- **Burns from hot parts.** Let the engine and exhaust system cool down before touching any parts.
- **Injury from moving parts.** Do not run the engine unless instructed to do so.

WARNING

Failure to properly follow maintenance instructions and precautions can cause you to be seriously hurt or killed.

Always follow the procedures and precautions in this owner's manual.

Some of the most important safety precautions are given here. However, we cannot warn you of every conceivable hazard that can arise in performing maintenance. Only you can decide whether or not you should perform a given task.

Maintenance Minder

Your vehicle displays engine oil life and maintenance service items on the multi-information display to show you when you should have your dealer perform engine oil replacement and indicated maintenance service.

Based on the engine operating conditions and accumulated engine revolutions, the onboard computer in your vehicle calculates the remaining engine oil life and displays it as a percentage.

Engine Oil Life Display

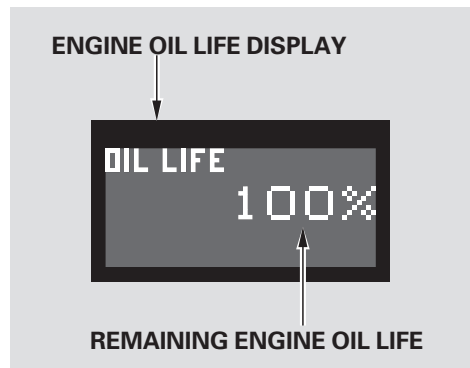

To see the current engine oil life displayed on the lower segment of the multi-information display, turn the ignition switch to the ON (II) position, and press the SEL/RESET button on the steering wheel repeatedly until engine oil life is displayed.

The remaining engine oil life is shown on the display according to this table:

| Calculated Engine Oil Life (%) | Displayed Engine Oil Life (%) |
|--------------------------------|-------------------------------|
| 100% – 91% | 100% |
| 90% – 81% | 90% |
| 80% – 71% | 80% |
| 70% – 61% | 70% |
| 60% – 51% | 60% |
| 50% – 41% | 50% |
| 40% – 31% | 40% |
| 30% – 21% | 30% |
| 20% – 16% | 20% |
| 15% – 11% | 15% |
| 10% – 6% | 10% |
| 5% – 1% | 5% |
| 0% | 0% |

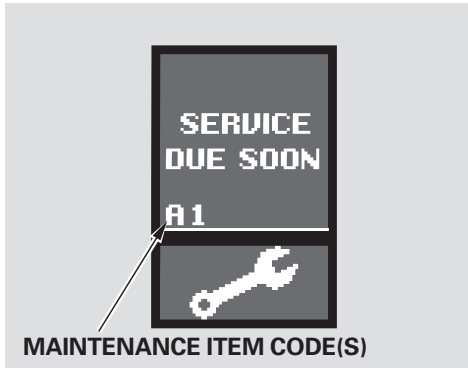

When the remaining engine oil life is 15 to 6 %, the multi-information display shows a “SERVICE DUE SOON” message along with the maintenance item code (s) indicating the main and sub items required at the time of the oil change. Refer to page 289 for a complete list of the maintenance main items and sub items.

To cancel the message, press the INFO button on the steering wheel.

When the message appears, the system message indicator also comes on (see page 75). Even after you press the INFO button to cancel the message, the indicator continues to stay on until you have the service performed.

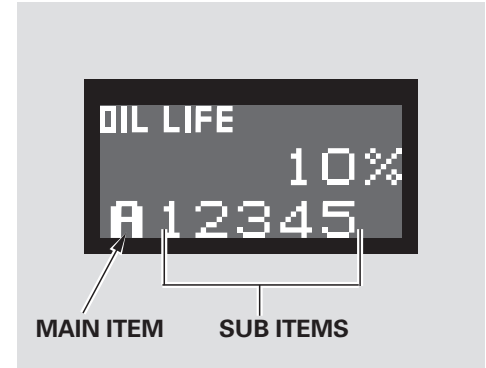

After the message on the multi-information display is canceled by pressing the INFO button, the engine oil life display will appear in the lower segment. You will see the percentage of the remaining engine oil life and the maintenance item code(s) displayed.

CONTINUED

Maintenance Minder

To cancel the engine oil life display, press the SEL/RESET button to return to the previous display.

The message appears on the multi-information display each time you turn the ignition switch to the ON (II) position. After canceling the message, the engine oil life display will appear in the lower segment. This continues until you have the indicated maintenance done by your dealer.

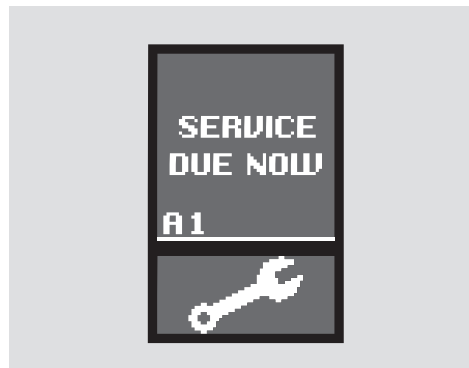

When the remaining oil life is 5 to 1%, the multi-information display shows a “SERVICE DUE NOW” message. The display also shows the same maintenance items that were previously shown with “SERVICE DUE SOON.” Make sure you have the indicated maintenance performed as soon as possible.

After have the service is performed, make sure to reset the display as described on page [283](#).

To cancel the message, press the INFO button on the steering wheel. To see the message again, wait for an interval for more than 5 seconds, and then press the INFO button.

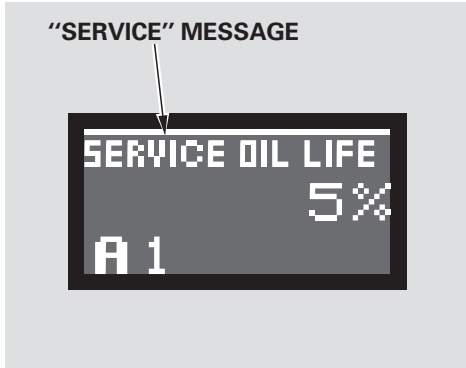

After the message on the multi-information display is canceled by pressing the INFO button, the engine oil life display will appear in the lower segment. You will see a "SERVICE" message along with the percentage of the remaining engine oil life and the maintenance item code(s) displayed. To cancel the engine oil life display, press the SEL/RESET button to return to the previous display.

Your dealer will reset the display after completing the required maintenance service. You will see "OIL LIFE 100 %" on the lower segment of the multi-information display and the maintenance item code(s) erased the next time you turn the ignition switch to the ON (II) position.

If maintenance service is done by someone other than your dealer, reset the maintenance minder as follows:

1. Turn the ignition switch to the ON (II) position.
2. If the engine oil life display is not displayed, press the SEL/RESET button on the steering wheel repeatedly until it comes back.

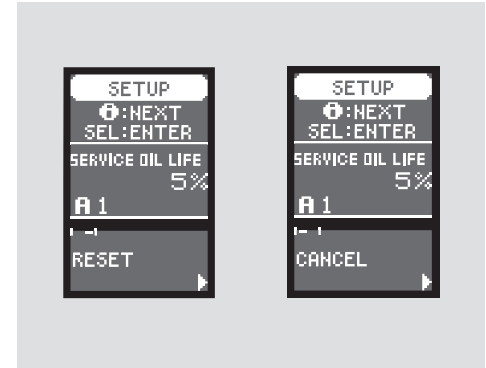

3. Press and hold the SEL/RESET button on the steering wheel for more than 10 seconds. The remaining engine oil life reset mode will be shown on the multi-information display.

- To reset the engine oil life, press the INFO button on the steering wheel to select "RESET" on the display, and press the SEL/RESET button. *CONTINUED*

Maintenance Minder

- To cancel resetting the oil life, press the INFO button on the steering wheel to select “CANCEL” on the display, and press the SEL/RESET button.

If you do not complete the reset procedure within 30 seconds after selecting the reset mode, the mode will be canceled automatically.

If you have the required service performed but do not reset the display, or reset the display without performing the service, the system will not show the proper maintenance intervals. This can lead to serious mechanical problems because you will no longer have an accurate record of when maintenance is needed.

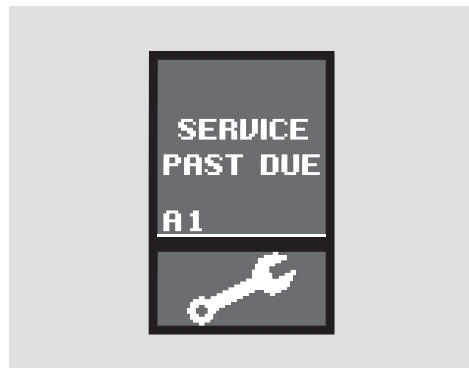

If the indicated maintenance service is not done and the remaining engine oil life reaches 0 %, the multi-information display will show the message “SERVICE PAST DUE” and the maintenance item code(s). This message is displayed when the total mileage is less than 10 miles (for U.S. models) or 10 km (for Canadian models) after the engine oil life became 0 %.

Immediately have the service performed, and make sure to reset the display as previously described.

To cancel the message, press the INFO button on the steering wheel. To see the message again, wait for an interval for more than 5 seconds, and then press the INFO button.



After the message on the multi-information display is canceled by pressing the INFO button, the engine oil life display will appear in the lower segment. You will see a “SERVICE” message along with the percentage “0%” and the maintenance item code (s) displayed.

Also, the percentage “0 %” keeps blinking on the display.

This particular message is displayed when the mileage is less than 10 miles (for U.S. models) or 10 km (for Canadian models) after the engine oil life became 0 %.

To cancel the engine oil life display, press the SEL/RESET button to return to the previous display.

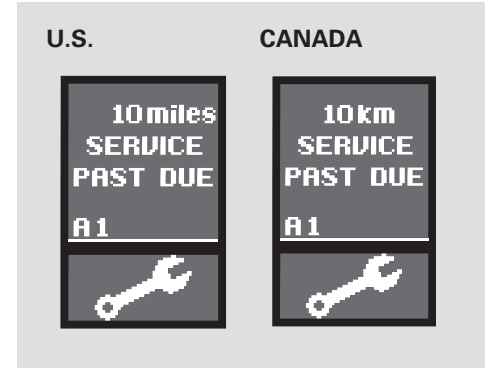

If the indicated required service is not done and the remaining engine oil life becomes 0 %, the multi-information display will show a “SERVICE PAST DUE” message, the total mileage after the remaining oil life became 0 %, and the maintenance item code (s).

CONTINUED

Maintenance Minder

This message is displayed when you drive over 10 miles (for U.S. models) or 10 km (for Canadian models) after seeing the 0 % message.

Immediately have the service performed, and make sure to reset the display as previously described.

To cancel the message, press the INFO button on the steering wheel. To see the message again, wait for an interval of more than 5 seconds, and then press the INFO button.

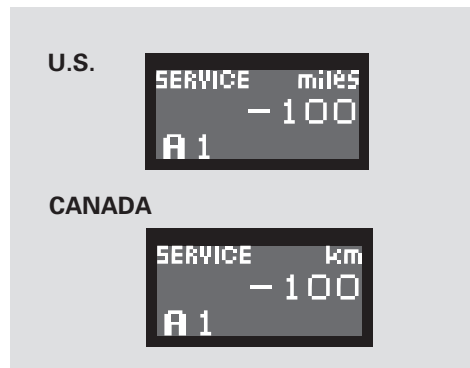

After the message on the multi-information display is canceled by pressing the INFO button, the engine oil life display will appear in the lower segment. You will see a "SERVICE" message along with the maintenance item code(s), and the total negative mileage after the oil life becomes 0 % is displayed.

Also, the total negative mileage keeps blinking on the display.

This particular message is displayed when you drive over 10 miles (for U.S. models) or 10 km (for Canadian models) after seeing the 0 % message.

To cancel the engine oil life display, press the SEL/RESET button to return to the previous display.

Important Maintenance Precautions

If you have the required service done but do not reset the display, or reset the display without doing the service, the system will not show the proper maintenance intervals. This can lead to serious mechanical problems because you will no longer have an accurate record of when maintenance is needed.

Your authorized dealer knows your vehicle best and can provide competent, efficient service. However, service at a dealer is not mandatory to keep your warranties in effect. Maintenance may be done by any qualified service facility or person who is skilled in this type of automotive service. Keep all receipts as proof of completion, and have the person who does the work fill out your Maintenance Journal or Canadian Maintenance Log. Check your warranty booklet for more information.

We recommend the use of Acura parts and fluids whenever you have maintenance done. These are manufactured to the same high quality standards as the original components, so you can be confident of their performance and durability.

U.S. Vehicles:

Maintenance, replacement, or repair of emissions control devices and systems may be done by any automotive repair establishment or individual using parts that are “certified” to EPA standards.

According to state and federal regulations, failure to perform maintenance on the items marked with # will not void your emissions warranties. However, all maintenance services should be performed in accordance with the intervals indicated by the information display.

Maintenance Minder

Owner's Maintenance Checks

You should check the following items at the specified intervals. If you are unsure of how to perform any check, turn to the appropriate page listed.

- Engine oil level — Check every time you fill the fuel tank. See page [236](#).
- Engine coolant level — Check the radiator reserve tank every time you fill the fuel tank. See page [236](#).
- Automatic transmission — Check the fluid level monthly. See pages [297](#) — [298](#).
- Brakes — Check the fluid level monthly. See page [300](#).
- Tires — Check the tire pressure monthly. Examine the tread for wear and foreign objects. See page [316](#).

- Lights — Check the operation of the headlights, parking lights, taillights, high-mount brake light, and license plate lights monthly. See page [302](#).

| Symbol | Maintenance Main Items |
|--------|---|
| A | <ul style="list-style-type: none"> ● Replace engine oil*¹ |
| B | <ul style="list-style-type: none"> ● Replace engine oil*¹ and oil filter ● Inspect front and rear brakes ● Check parking brake adjustment ● Inspect these items: <ul style="list-style-type: none"> ● Tie rod ends, steering gearbox, and boots ● Suspension components ● Driveshaft boots ● Brake hoses and line (including ABS) ● All fluid levels and condition of fluids ● Exhaust system[#] ● Fuel lines and connections[#] |

| Symbol | Maintenance Sub Items |
|--------|--|
| 1 | <ul style="list-style-type: none"> ● Rotate tires |
| 2 | <ul style="list-style-type: none"> ● Replace air cleaner element If you drive in dusty conditions, replace every 15,000 miles (24,000 km). ● Replace dust and pollen filter If you drive primarily in urban areas that have high concentrations of soot in the air from industry and from diesel-powered vehicles, replace every 15,000 miles (24,000 km). ● Inspect drive belt |
| 3 | <ul style="list-style-type: none"> ● Replace transmission fluid Driving in mountainous areas at very low vehicle speeds or trailer towing results in higher transmission and transfer temperatures. This requires transmission and transfer fluid changes more frequently than recommended by the maintenance minder. If you regularly drive your vehicle under these conditions, have the transmission and transfer fluid changed at 60,000 miles (100,000 km), then every 30,000 miles (48,000 km). (For A/T only.) |
| 4 | <ul style="list-style-type: none"> ● Replace spark plugs ● Inspect valve clearance |
| 5 | <ul style="list-style-type: none"> ● Replace engine coolant |

* 1 : If the message “SERVICE DUE NOW” does not appear more than 12 months after the display is reset, change the engine oil every year.

: See information on maintenance and emissions warranty, last column, page [287](#).

NOTE: ● Independent of the maintenance messages in the multi-information display, replace the brake fluid every 3 years.
 ● Inspect idle speed every 160,000 miles (256,000 km).
 ● Adjust the valves during services A, B, 1, 2, or 3 only if they are noisy.

Fluid Locations

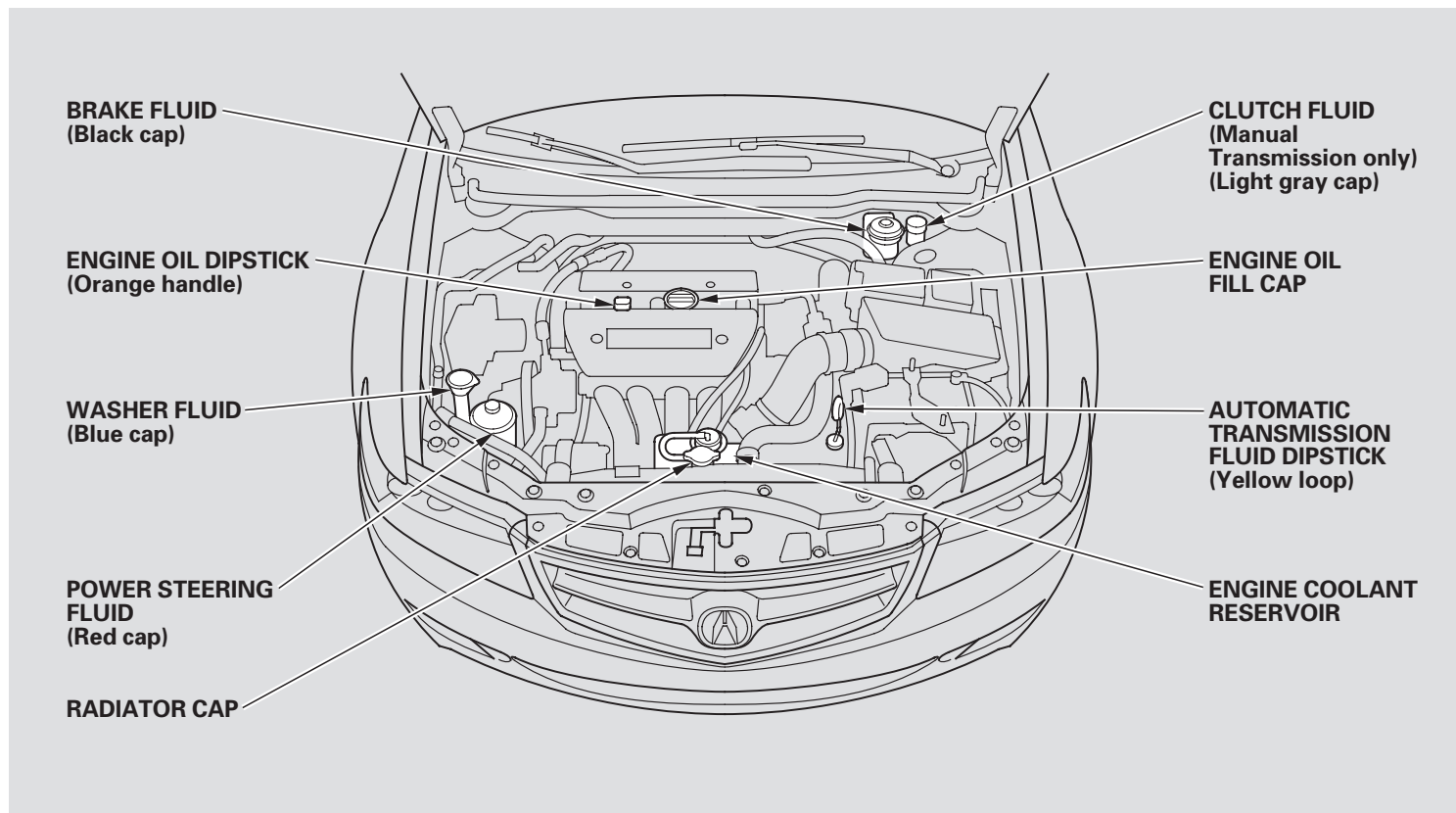

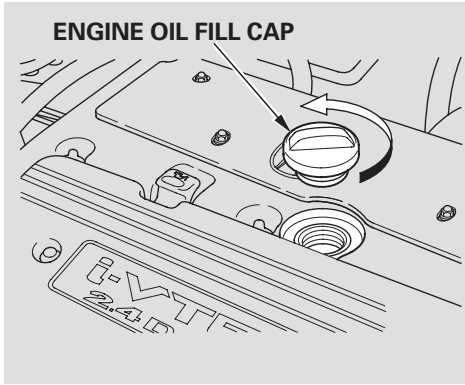

Unscrew and remove the engine oil fill cap on top of the valve cover. Pour in the oil slowly and carefully so you do not spill any. Clean up any spills immediately. Spilled oil could damage components in the engine compartment.

Reinstall the engine oil fill cap, and tighten it securely. Wait a few minutes, and recheck the oil level on the engine oil dipstick. Do not fill above the upper mark; you could damage the engine.

Recommended Engine Oil

Oil is a major contributor to your engine's performance and longevity. Always use a premium-grade detergent oil displaying the API Certification Seal. This seal indicates the oil is energy conserving and that it meets the American Petroleum Institute's latest requirements. It is highly recommended that you use Honda Motor Oil in your vehicle for as long as you own it.

CONTINUED

Adding Engine Oil



API CERTIFICATION SEAL

Make sure the API Certification Seal says "For Gasoline Engines."

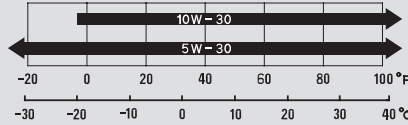

Ambient Temperature

An oil with a viscosity of 5W-30 is preferred for improved fuel economy and year-round protection in your vehicle. You may use a 10W-30 oil if the temperature in your area never goes below 0°F (-20°C).

Synthetic Oil

You may use a synthetic motor oil if it meets the same requirements given for a conventional motor oil: it displays the API Certification Seal and it is the proper weight. You must follow the oil and filter change intervals shown on the multi-information display.

Engine Oil Additives

Your vehicle does not require any oil additives. Additives may adversely affect the engine or transmission performance and durability.

Changing the Engine Oil and Filter

Always change the oil and filter according to the maintenance messages shown on the multi-information display. The oil and filter collect contaminants that can damage your engine if they are not removed regularly.

Changing the oil and filter requires special tools and access from underneath the vehicle. The vehicle should be raised on a service station-type hydraulic lift for this service. Unless you have the knowledge and proper equipment, you should have this maintenance done by a skilled technician.

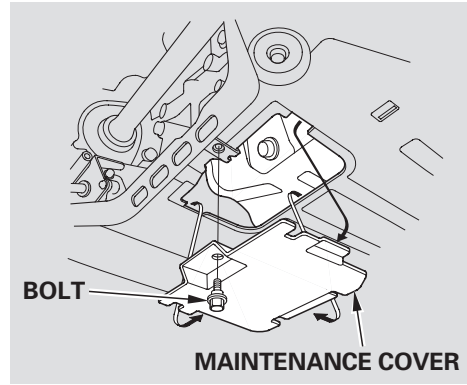

1. Run the engine until it reaches normal operating temperature, then shut it off.
2. Open the hood and remove the engine oil fill cap.
3. Remove the bolt located on the underside of the body with a wrench, then remove the maintenance cover.

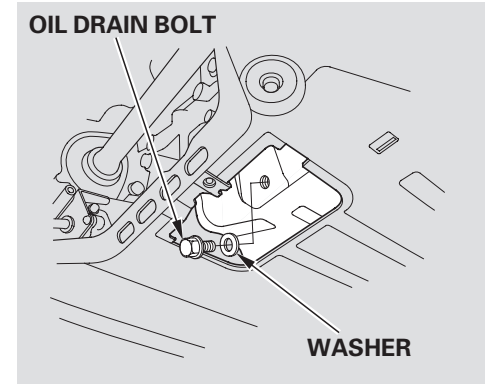

4. Remove the oil drain bolt and washer from the bottom of the engine. Drain the oil into an appropriate container.
5. Remove the oil filter and let the remaining oil drain. A special wrench (available from your dealer) is required.

CONTINUED

Changing the Engine Oil and Filter

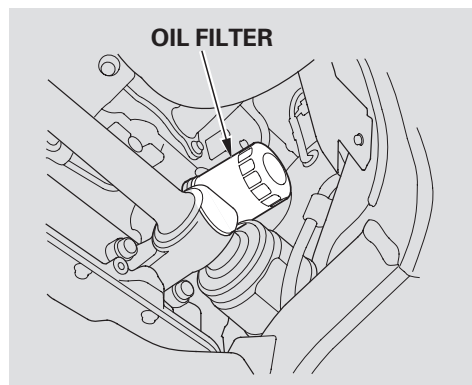

6. Check the oil filter to make sure its gasket did not stick to the filter base. A stuck gasket could cause an oil leak.
7. Install a new oil filter according to the instructions that come with it. Make sure to clean off any dirt and dust on the connecting surface of a new oil filter.

8. Put a new washer on the drain bolt, then reinstall the drain bolt. Tighten it to:
33 lbf·ft (45 N·m , 4.6 kgf·m)

9. Refill the engine with the recommended oil.

Engine oil change capacity
(including filter):
4.4 US qt (4.2 ℓ)

10. Replace the engine oil fill cap. Start the engine. The oil pressure indicator should go out within 5 seconds. If it does not, turn off the engine, and check your work.
11. Let the engine run for several minutes, then check the drain bolt and oil filter for leaks.

12. Turn off the engine, let it sit for several minutes, then check the oil level on the dipstick. If necessary, add more oil.

13. Install the maintenance cover and tighten the bolt securely.

NOTICE

Improper disposal of engine oil can be harmful to the environment. If you change your own oil, please dispose of the used oil properly. Put it in a sealed container and take it to a recycling center. Do not discard it in a trash bin or dump it on the ground.

Adding Engine Coolant

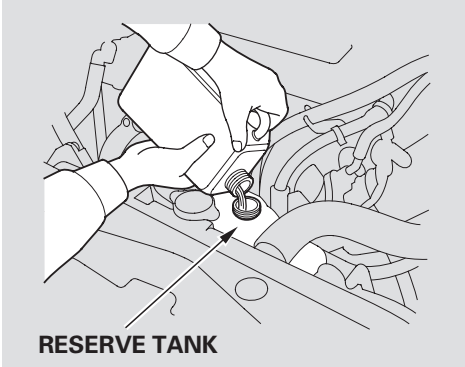

If the coolant level in the reserve tank is at or below the MIN line, add coolant to bring it up to the MAX line. Inspect the cooling system for leaks.

Always use Honda Long-Life Antifreeze/Coolant Type 2. This coolant is pre-mixed with 50 % antifreeze and 50 % water. Never add straight antifreeze or plain water.

If Honda antifreeze/coolant is not available, you may use another major-brand non-silicate coolant as a temporary replacement. Make sure it is a high-quality coolant recommended for aluminum engines. Continued use of any non-Honda coolant can result in corrosion, causing the cooling system to malfunction or fail. Have the cooling system flushed and refilled with Honda antifreeze/coolant as soon as possible.

If the reserve tank is completely empty, you should also check the coolant level in the radiator.

⚠ WARNING

Removing the radiator cap while the engine is hot can cause the coolant to spray out, seriously scalding you.

Always let the engine and radiator cool down before removing the radiator cap.

CONTINUED

Engine Coolant, Windshield Washers

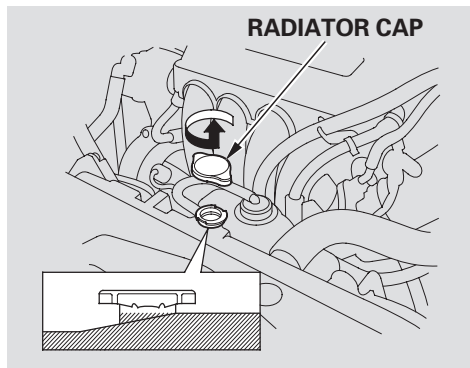

1. Make sure the engine and radiator are cool.
2. Relieve any pressure in the cooling system by turning the radiator cap counterclockwise, without pressing down.
3. Remove the radiator cap by pushing down and turning counterclockwise.

4. The coolant level should be up to the base of the filler neck. Add coolant if it is low.

Pour the coolant slowly and carefully so you do not spill any. Clean up any spill immediately; it could damage components in the engine compartment.

5. Put the radiator cap back on, and tighten it fully.
6. Pour coolant into the reserve tank. Fill it to halfway between the MAX and MIN marks. Put the cap back on the reserve tank.

Do not add any rust inhibitors or other additives to your vehicle's cooling system. They may not be compatible with the coolant or engine components.

Windshield Washers

Check the fluid level in the windshield washer reservoir at least monthly during normal use.

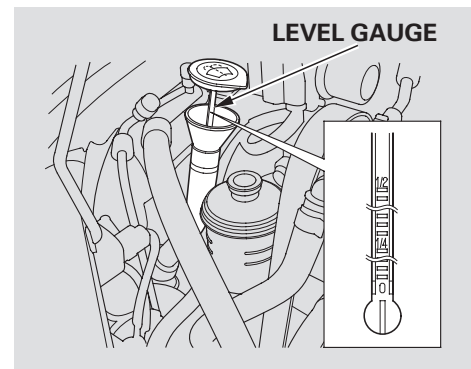

Check the reservoir's fluid level by removing the cap and looking at the level gauge attached to the cap.

Canadian models only

If the washer fluid is low, a “WASHER FLUID LOW” message appears on the multi-information display.

Fill the reservoir with a good-quality windshield washer fluid. This increases the cleaning capability and prevents freezing in cold weather.

When you refill the reservoir, clean the edges of the windshield wiper blades with windshield washer fluid on a clean cloth. This will help to condition the blade edges.

NOTICE

Do not use engine antifreeze or a vinegar/water solution in the windshield washer reservoir. Antifreeze can damage your vehicle’s paint, while a vinegar/water solution can damage the windshield washer pump. Use only commercially-available windshield washer fluid.

Automatic Transmission

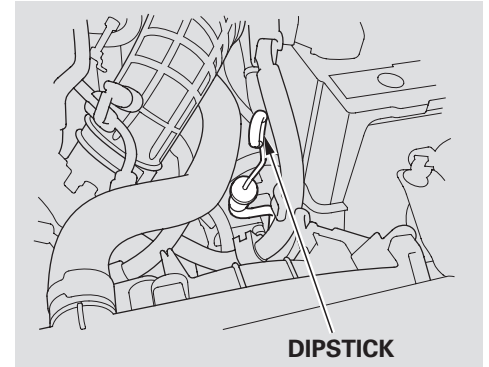

Check the fluid level with the engine at normal operating temperature.

1. Park the vehicle on level ground. Start the engine, let it run until the radiator fan comes on, then shut off the engine. For accurate results, wait about 60 seconds (but no longer than 90 seconds) before doing step 2.

CONTINUED

Transmission Fluid

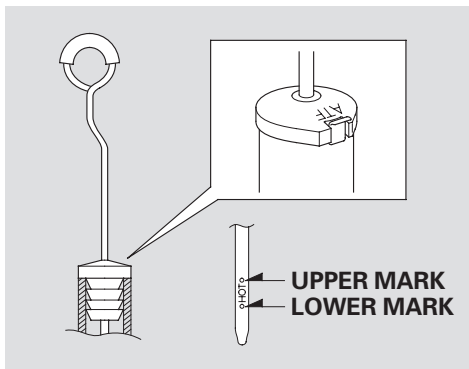

2. Remove the dipstick (yellow loop) from the transmission, and wipe it with a clean cloth.
3. Insert the dipstick all the way back into the transmission securely as shown in the illustration.

Make sure the rubber cap on the dipstick fits in the dipstick guide and that you push the dipstick in all the way.

4. Remove the dipstick and check the fluid level. It should be between the upper and lower marks.
5. If the level is below the lower mark, add fluid into the dipstick hole to bring it to the level between the upper and lower marks.

Pour the fluid slowly and carefully so you do not spill any. Clean up any spill immediately; it could damage components in the engine compartment.

Always use Honda ATF-Z1 (automatic transmission fluid).

NOTICE

Use only Honda Genuine ATF-Z1 (Automatic Transmission Fluid). Do not mix with other transmission fluids. Using transmission fluid other than Honda Genuine ATF-Z1 may cause deterioration in transmission operation and durability, and could result in damage to the transmission. Damage resulting from the use of transmission fluid other than Honda Genuine ATF-Z1 is not covered by the Honda new vehicle warranty.

6. Insert the dipstick all the way back into the transmission securely as shown in the illustration.

If you are not sure how to add fluid, contact your dealer.

Manual Transmission

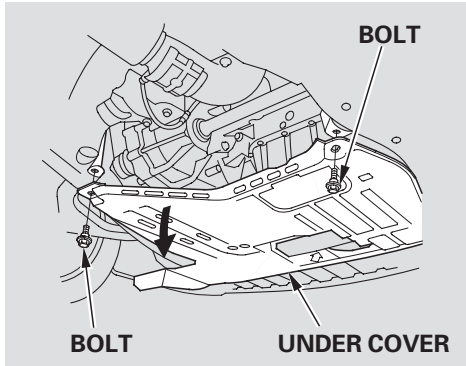

To check the transmission fluid level, remove the two bolts, then pull the left part of the under cover down.

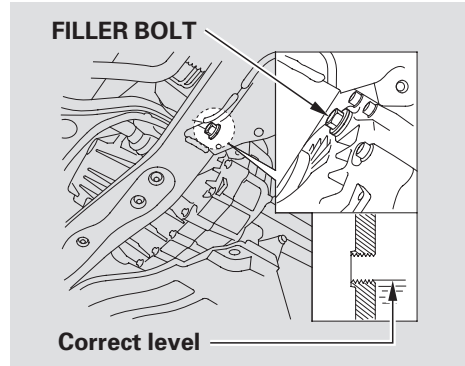

Check the fluid level with the transmission at normal operating temperature and the vehicle sitting on level ground. Remove the transmission filler bolt, and carefully feel inside the bolt hole with your finger. The fluid level should be up to the edge of the bolt hole. If it is not, add Honda Manual Transmission Fluid (MTF) until it starts to run out of the hole. Reinstall the filler bolt, and tighten it securely.

After checking and adding the fluid, put the under cover back in place and tighten the bolts securely.

If Honda MTF is not available, you may use an SAE 10W-30 or 10W-40 viscosity motor oil with the API Certification seal that says "FOR GASOLINE ENGINES" as a temporary replacement. However, motor oil does not contain the proper additives, and continued use can cause stiffer shifting. Replace as soon as it is convenient.

If you are not sure how to add fluid, contact your dealer.

Brake and Clutch Fluid

Check the fluid level in the reservoirs monthly. There are up to two reservoirs, depending on the model. They are:

- Brake fluid reservoir (all models)
- Clutch fluid reservoir (manual transmission models only)

Replace the brake fluid every 3 years, independent of mileage.

Always use Honda Heavy Duty Brake Fluid DOT 3. If it is not available, you should use only DOT 3 or DOT 4 fluid, from a sealed container, as a temporary replacement.

Using any non-Honda brake fluid can cause corrosion and decrease the life of the system. Have the brake system flushed and refilled with Honda Heavy Duty Brake Fluid DOT 3 as soon as possible.

Brake fluid marked DOT 5 is not compatible with your vehicle's braking system and can cause extensive damage.

Brake Fluid

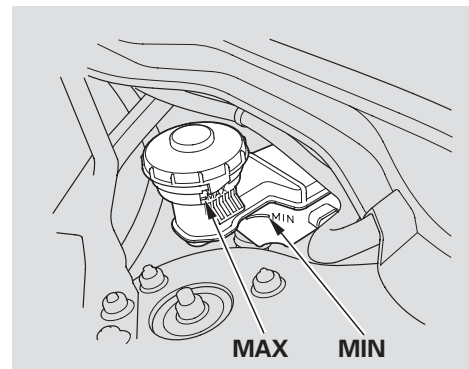

The fluid level should be between the MIN and MAX marks on the side of the reservoir. If the level is at or below the MIN mark, your brake system needs attention. Have the brake system inspected for leaks or worn brake pads.

Clutch Fluid

Manual Transmission only

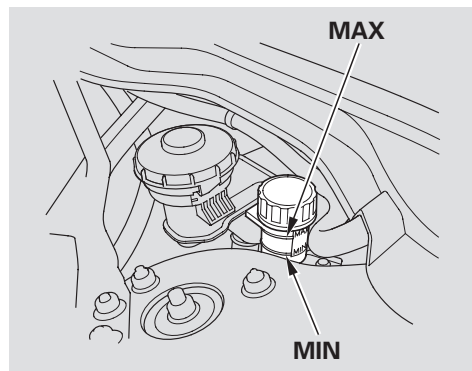

The fluid level should be between the MIN and MAX marks on the side of the reservoir. If it is not, add brake fluid to bring it up to that level. Use the same fluid specified for the brake system.

A low fluid level can indicate a leak in the clutch system. Have this system inspected as soon as possible.

Power Steering Fluid

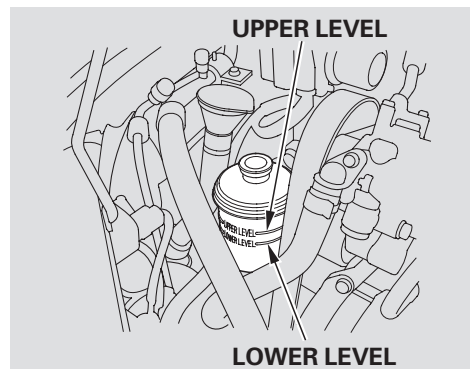

Check the level on the side of the reservoir when the engine is cold. The fluid should be between the UPPER LEVEL and LOWER LEVEL. If not, add power steering fluid to the UPPER LEVEL.

Pour the fluid slowly and carefully so you do not spill any. Clean up any spill immediately; it could damage components in the engine compartment.

Always use Honda Power Steering Fluid. You may use another power steering fluid as an emergency replacement, but have the power steering system flushed and refilled with Honda PSF as soon as possible.

A low power steering fluid level can indicate a leak in the system. Check the fluid level frequently, and have the system inspected as soon as possible.

NOTICE

Turning the steering wheel to full left or right lock and holding it there can damage the power steering pump.

Lights

Headlight Aiming

The headlights were properly aimed when your vehicle was new. If you regularly carry heavy items in the trunk or pull a trailer, readjustment may be required. Adjustments should be done by your dealer or other qualified technician.

Low Beam Headlight Bulb Replacement

The low beam headlight bulbs are a type of high voltage discharge tube. High voltage can remain in the circuit even with the light switch off and the key removed. Because of this, you should not attempt to examine or change a low beam headlight bulb yourself. If a low beam headlight bulb fails, take the vehicle to your dealer to have it replaced.

Replacing a High Beam Headlight Bulb

Your vehicle has halogen headlight bulbs, one on each side. When replacing a bulb, handle it by its steel base and protect the glass from contact with your skin or hard objects. If you touch the glass, clean it with denatured alcohol and a clean cloth.

NOTICE

Halogen headlight bulbs get very hot when lit. Oil, perspiration, or a scratch on the glass can cause the bulb to overheat and shatter.

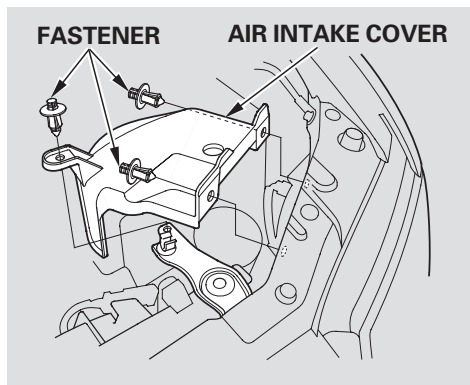

1. Open the hood. To change a bulb on the driver's side, undo the three fasteners and remove the air intake cover.

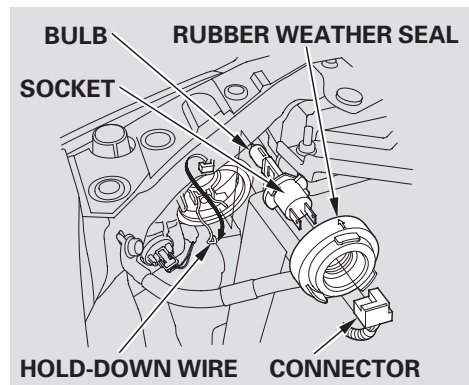

2. Remove the electrical connector from the bulb by pulling the connector straight back.
3. Remove the rubber weather seal by pulling on the tab.

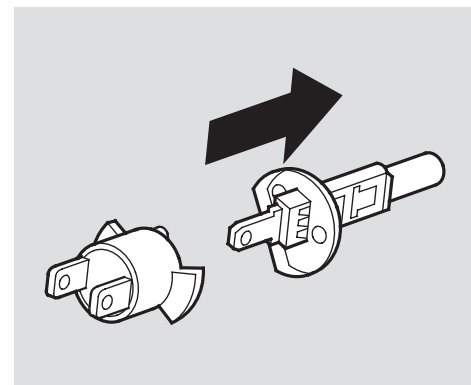

4. Unclip the end of the hold-down wire from its slot. Pivot it out of the way, and remove the bulb socket.
5. Pull the burned out bulb straight out of its socket. Push the new bulb straight into the socket until it bottoms.

CONTINUED

Lights

6. Insert the socket back into the headlight assembly. Make sure the bulb is installed correctly by looking through the headlight lens. Pivot the hold-down wire back in place, and clip the end into the slot.
7. Install the rubber weather seal over the back of the headlight assembly. Make sure it is right side up; it is marked with an arrow.
8. Push the electrical connector onto the socket. Make sure it is connected securely.
9. Turn on the headlights to test the new bulb.
10. On the driver's side, reinstall the air intake cover. Reinstall the three fasteners and secure them by pushing on the heads until they lock.

Replacing the Turn Signal Light Bulb

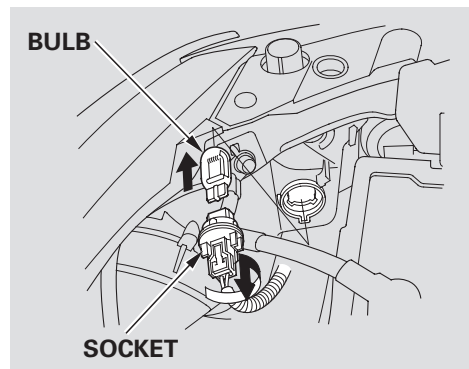

1. Open the hood.
2. Remove the socket from the headlight assembly by turning it one-quarter turn counterclockwise.

3. Pull the bulb straight out of its socket. Push the new bulb straight into the socket until it bottoms.
4. Insert the socket back into the headlight assembly. Turn it clockwise to lock it in place.
5. Turn on the lights to test the new bulb.

Replacing a Front Side Marker/ Front Parking Light Bulb

1. To change the bulb on the driver's side, start the engine, turn the steering wheel all the way to the right, then turn off the engine. To change the bulb on the passenger's side, turn the steering wheel to the left.

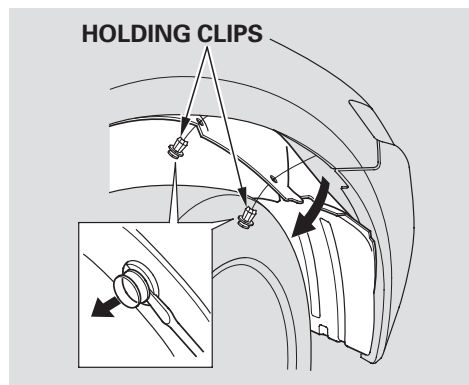

2. Use a flat-tipped screwdriver to remove the two holding clips from the inner fender.
3. Pull the inner fender cover away from the fender and bumper.
4. Remove the socket from the headlight assembly by turning it one-quarter turn counterclockwise.

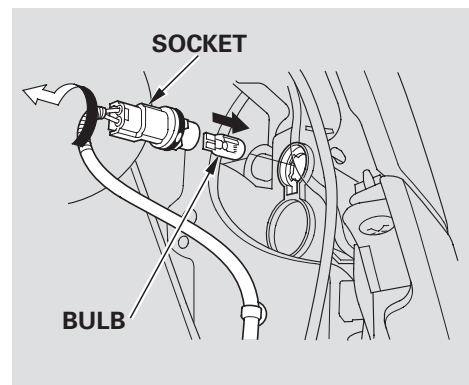

5. Pull the bulb straight out of its socket. Push the new bulb straight into the socket until it bottoms.

CONTINUED

Lights

6. Insert the socket back into the headlight assembly. Turn it clockwise to lock it in place.
7. Turn on the lights to test the new bulb.
8. Put the inner fender cover in place. Install and lock each holding clip by pushing on the center.

Replacing Rear Bulbs (In Fenders)

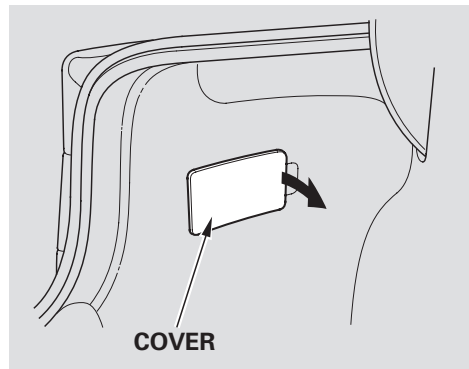

1. Open the trunk.
2. Remove the light assembly cover by pulling its outside edge.
3. Remove the socket by turning it one-quarter turn counterclockwise, and pull the bulb straight out of its socket.

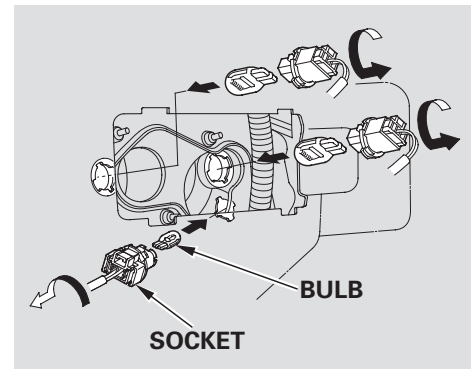

4. Push a new bulb straight into the socket until it bottoms, and reinstall the socket into the light assembly by turning it clockwise until it locks.
5. Test the new bulb to make sure it works.
6. Reinstall the light assembly cover.

Replacing Rear Bulbs (in Trunk Lid)

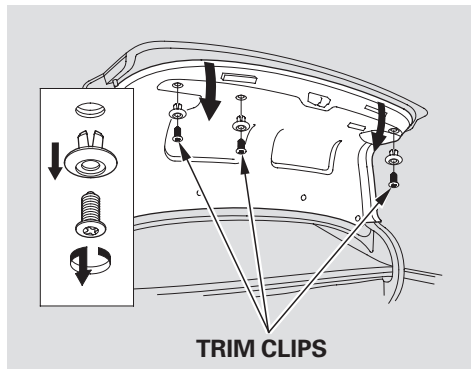

1. Open the trunk.
2. To replace a bulb on the right side, remove the trim clip. For the left side, remove the two trim clips.
3. Pull the lining back carefully.

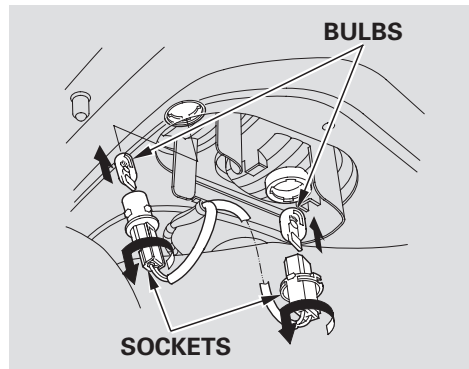

4. Determine which of the two bulbs is burned out: taillight or back-up light.
5. Remove the socket by turning it one-quarter turn counterclockwise.
6. Pull the bulb straight out of its socket. Push the new bulb straight into the socket until it bottoms.

7. Insert the socket back into the light assembly. Turn it clockwise to lock it in place.
8. Turn on the lights to test the new bulb.
9. Reinstall the trunk lid trim. Make sure it is installed under the edge of the trunk lid seal.
10. Press the trim clips back into their holes.

Lights

Replacing a High-mount Brake Light Bulb

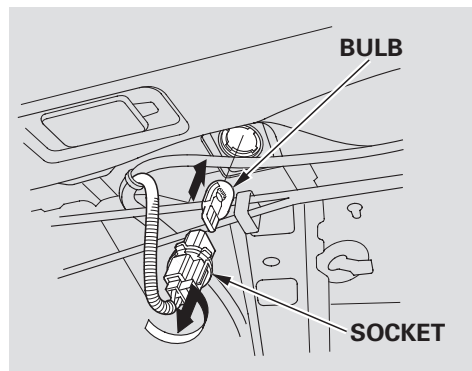

1. Open the trunk, and remove the socket from the light assembly by turning it one-quarter turn counter-clockwise.
2. Remove the burned-out bulb by pulling it straight out of the socket.
3. Install the new bulb and reinstall the socket. Make sure the new bulb is working.

Side Turn Signal Light

Each outside mirror has side turn signal lights. The lights should be replaced by your dealer.

Rear License Plate Bulb

The license plate has two lights above it. The bulbs should be replaced by your dealer.

Replacing a Fog Light Bulb

Your vehicle uses halogen light bulbs. When replacing a bulb, handle it by its plastic case, and protect the glass from contact with your skin or hard objects. If you touch the glass, clean it with denatured alcohol and a clean cloth.

NOTICE

Halogen bulbs get very hot when lit. Oil, perspiration, or a scratch on the glass can cause the bulb to overheat and shatter.

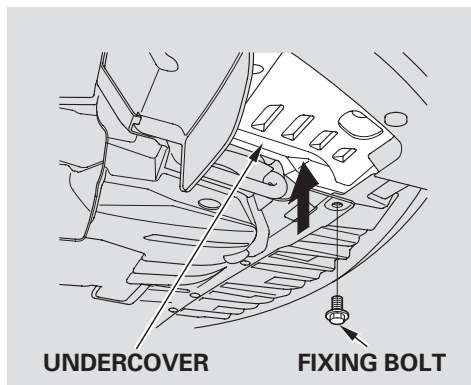

1. Remove the undercover fixing bolt located under the front bumper.
2. Push up the undercover.

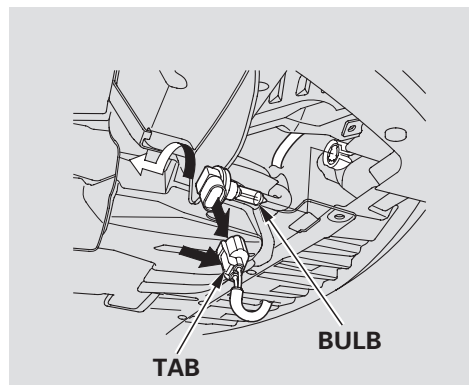

3. Remove the electrical connector from the bulb by pushing on the tab and pulling the connector down.
4. Remove the bulb from the fog light assembly by turning it one-quarter turn counterclockwise.

5. Install the new bulb into the hole and turn it one-quarter turn clockwise to lock it in place.
6. Push the electrical connector back onto the bulb. Make sure it is on all the way.
7. Turn on the fog lights to test the new bulb.
8. Put the undercover in place. Reinstall the fixing bolt and tighten it securely.

Seat Belts, Floor Mats

Seat Belts

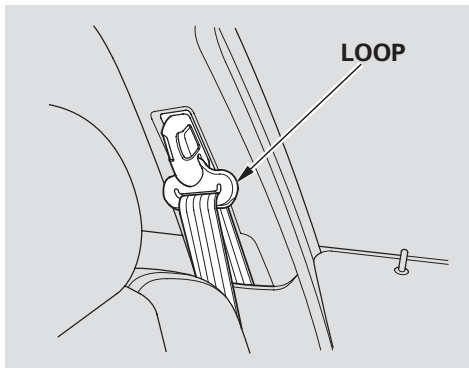

If your seat belts get dirty, use a soft brush with a mixture of mild soap and warm water to clean them. Do not use bleach, dye, or cleaning solvents. Let the belts air dry before you use the vehicle.

Dirt build-up in the loops of the seat belt anchors can cause the belts to retract slowly. Wipe the insides of the loops with a clean cloth dampened in mild soap and warm water or isopropyl alcohol.

Floor Mats

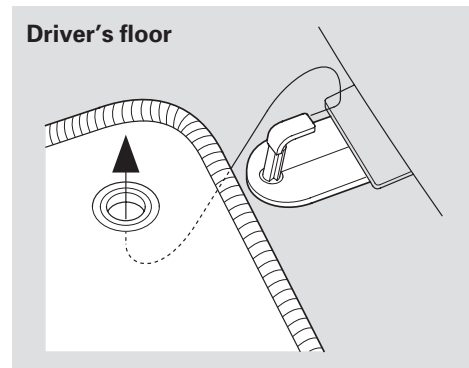

The floor mats that came with your vehicle hook over floor mat anchors. This keeps the floor mats from sliding forward/rearward and possibly interfering with the pedals or making the front passenger's weight sensor's ineffective.

Rear passenger's floor

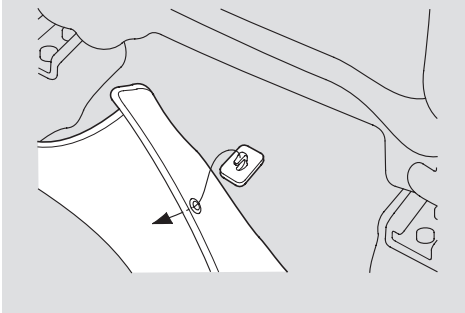

Make sure the rear floor mats are properly hooked to the floor mat anchors. Your vehicle is equipped with front passenger's seat weight sensors. If the rear passenger's floor mat is on the seat rail of the front passenger's seat, the sensors will detect the decreased weight on the seat, and they may not work properly.

If you remove a floor mat, make sure to re-anchor it when you put it back in your vehicle.

If you use a non-Acura floor mat, make sure it fits properly and that it can be used with the floor mat anchor. Do not put additional floor mats on top of the anchored mat.

Dust and Pollen Filter

This filter removes the dust and pollen that is brought in from the outside through the climate control system.

Have your dealer replace the filter when this service is indicated by a maintenance message on the multi-information display. It should be replaced every 15,000 miles (24,000 km) if you drive primarily in urban areas that have high concentrations of soot in the air, or if the flow from the climate control system becomes less than usual.

Wiper Blades

Check the condition of the wiper blades at least every six months. Look for signs of cracking in the rubber, or areas that are getting hard. Replace the blades if you find these signs, or if they leave streaks and unwiped areas when used.

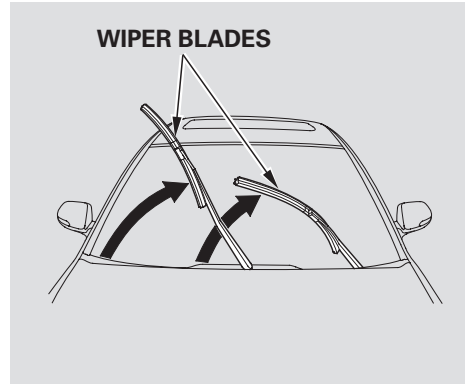

To replace a wiper blade:

1. Raise each wiper arm off the windshield, lifting the driver's side first, then the passenger's side.

NOTICE

Do not open the hood when the wiper arms are raised, or you will damage the hood and wiper arms.

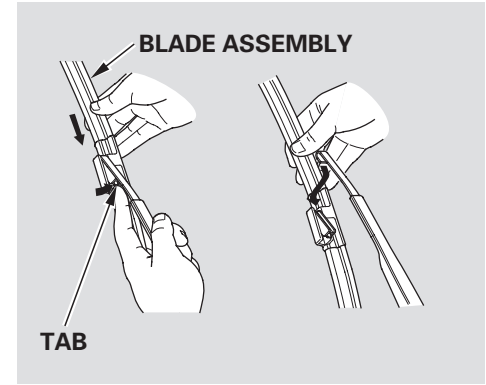

2. Disconnect the blade assembly from the wiper arm:
 - Press and hold the lock tab.
 - Slide the blade assembly toward the lock tab until it releases from the wiper arm.

When replacing a wiper blade, make sure not to drop the wiper blade or wiper arm down on the windshield.

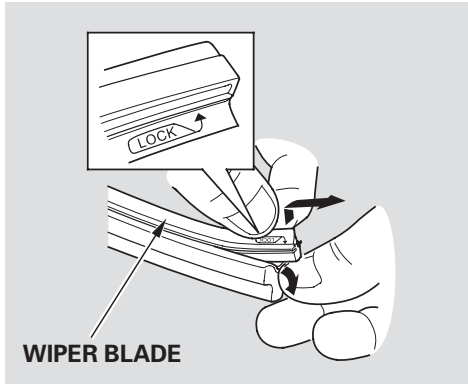

3. Remove the blade from the blade assembly:
 - Find the side of the blade labeled “LOCK.” This is the side you pull out.
 - Pull back the end of the blade assembly on the “LOCK” side of the blade. Then grab the end of the blade, and slide it out.

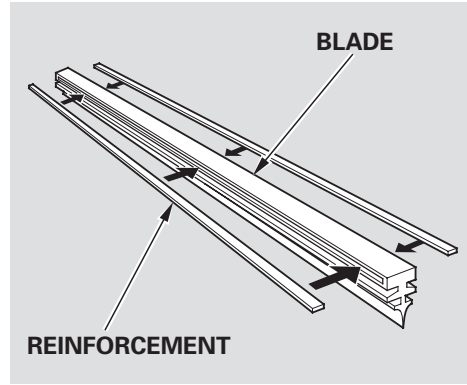

4. Examine the new wiper blades. If they have no plastic or metal reinforcement along the back edge, remove the metal reinforcement strips from the old wiper blade, and install them in the slots along the edge of the new blade.

5. Install the new blade onto the blade assembly:
 - Pull back either end of the blade assembly.
 - Place the side of the blade not labeled “LOCK” on the end of the blade assembly, and slide the blade onto the assembly until it is fully installed.
6. Slide the wiper blade assembly onto the wiper arm. Make sure it locks in place.
7. Make sure the blade is completely installed and that its edge is not bunched up.
8. Lower the wiper arm down against the windshield, the passenger’s side first, then the driver’s side.

Wheels, Tires

Wheels

Clean the wheels as you would the rest of the exterior. Wash them with the same solution, and rinse them thoroughly.

Aluminum alloy wheels have a protective clear-coat that keeps the aluminum from corroding and tarnishing. Cleaning the wheels with harsh chemicals (including some commercial wheel cleaners) or a stiff brush can damage the clear-coat. To clean the wheels, use a mild detergent and a soft brush or sponge.

Tires

To safely operate your vehicle, your tires must be the proper type and size, in good condition with adequate tread, and correctly inflated.

The following pages give more detailed information on how to take care of your tires and what to do when they need to be replaced.

WARNING

Using tires that are excessively worn or improperly inflated can cause a crash in which you can be seriously hurt or killed.

Follow all instructions in this owner's manual regarding tire inflation and maintenance.

Inflation Guidelines

Keeping the tires properly inflated provides the best combination of handling, tread life, and riding comfort.

- Underinflated tires wear unevenly, adversely affect handling and fuel economy, and are more likely to fail from being overheated.
- Overinflated tires can make your vehicle ride more harshly, are more prone to damage from road hazards, and wear unevenly.

The tire pressure monitoring system (TPMS) will warn you when a tire pressure is low. See page [263](#) for information on the TPMS.

Even though your vehicle is equipped with TPMS, we recommend that you visually check your tires every day. If you think a tire might be low, check it immediately with a tire gauge.

Use a gauge to measure the air pressure in each tire at least once a month. Even tires that are in good condition may lose 1 to 2 psi (10 to 20 kPa, 0.1 to 0.2 kgf/cm²) per month. Remember to check the spare tire at the same time.

Check the pressure in the tires when they are cold. This means the vehicle has been parked for at least three hours, or driven less than 1 mile (1.6 km). Add or release air, if needed, to match the recommended cold tire pressure.

If you check air pressures when the tires are hot [driven for several miles (kilometers)], you will see readings 4 to 6 psi (30 to 40 kPa, 0.3 to 0.4 kgf/cm²) higher than the cold readings. This is normal. Do not let air out to match the recommended cold air pressure. The tire will be underinflated.

You should use your own tire pressure gauge and use it whenever you check your tire pressures. This will make it easier for you to tell if a pressure loss is due to a tire problem and not due to a variation between gauges.

While tubeless tires have some ability to self-seal if they are punctured, you should look closely for punctures if a tire starts losing pressure.

Recommended Tire Pressures

The following charts show the recommended cold tire pressures for most normal and high-speed driving conditions.

| Tire Size | Cold Tire Pressure for Normal Driving |
|----------------|---|
| P215/50R17 93V | Front: 32 psi (220 kPa , 2.2 kgf/cm ²) Rear: 30 psi (210 kPa , 2.1 kgf/cm ²) |

The compact spare tire pressure is: 60 psi (420 kPa , 4.2 kgf/cm²)

For convenience, the recommended tire sizes and cold tire pressures are on a label on the driver's doorjamb.

For additional information about your tires, see page [355](#).

Tires

Tire Inspection

Every time you check inflation, you should also examine the tires for damage, foreign objects, and wear.

You should look for:

- Bumps or bulges in the tread or side of the tire. Replace the tire if you find either of these conditions.
- Cuts, splits, or cracks in the side of the tire. Replace the tire if you can see fabric or cord.
- Excessive tread wear.

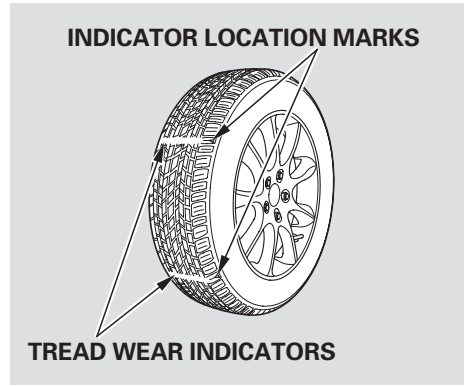

Your tires have wear indicators molded into the tread. When the tread wears down, you will see a 1/2 inch (12.7 mm) wide band across the tread. This shows there is less than 1/16 inch (1.6 mm) of tread left on the tire.

A tire this worn gives very little traction on wet roads. You should replace the tire if you can see three or more tread wear indicators.

Tire Service Life

The service life of your tires is dependent on many factors, including, but not limited to, driving habits, road conditions, vehicle loading, inflation pressure, maintenance history, speed, and environmental conditions (even when the tires are not in use).

In addition to your regular inspections and inflation pressure maintenance, it is recommended that you have annual inspections performed once the tires reach five years old. It is also recommended that all tires, including the spare, be removed from service after 10 years from the date of manufacture, regardless of their condition or state of wear.

The last four digits of the TIN (tire identification number) are found on the sidewall of the tire and indicate the date of manufacture (See **Tire Labeling** on page 355).

Tire Maintenance

In addition to proper inflation, correct wheel alignment helps to decrease tire wear. If you find a tire is worn unevenly, have your dealer check the wheel alignment.

Have your dealer check the tires if you feel a consistent vibration while driving. A tire should always be rebalanced if it is removed from the wheel. When you have new tires installed, make sure they are balanced. This increases riding comfort and tire life. For best results, have the installer perform a dynamic balance.

NOTICE

Improper wheel weights can damage your vehicle's aluminum wheels. Use only genuine Acura wheels weights for balancing.

Tire Rotation

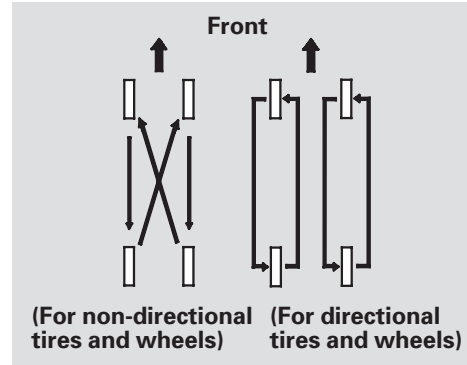

To help increase tire life and distribute wear more evenly, rotate the tires according to the maintenance messages displayed on the multi-information display. Move the tires to the positions shown in the illustration each time they are rotated. If you purchase directional tires, rotate only front-to-back.

When the tires are rotated, make sure the air pressures are checked.

Replacing Tires and Wheels

Replace your tires with radial tires of the same size, load range, speed rating, and maximum cold tire pressure rating (as shown on the tire's sidewall).

Mixing radial and bias-ply tires on your vehicle can reduce braking ability, traction, and steering accuracy. Using tires of a different size or construction can cause the ABS and vehicle stability assist system (VSA) to work inconsistently.

CONTINUED

Tires

The ABS and VSA system work by comparing the speed of each wheel. When replacing tires, use the same size originally supplied with the vehicle. Tire size and construction can affect wheel speed and may cause the system to activate.

It is best to replace all four tires at the same time. If that is not possible or necessary, replace the two front tires or two rear tires as a pair. Replacing just one tire can seriously affect your vehicle's handling.

If you ever replace a wheel, make sure that the wheel's specifications match those of the original wheels.

Also be sure you use only TPMS specific wheels. If you do not, the tire pressure monitoring system will not work.

Replacement wheels are available at your dealer.

WARNING

Installing improper tires on your vehicle can affect handling and stability. This can cause a crash in which you can be seriously hurt or killed.

Always use the size and type of tires recommended in this owner's manual.

Wheel and Tire Specifications

Wheel:

17 x 7 J (TPMS)

Tire:

P215/50R17 93V

See page [353](#) for DOT tire quality grading information, and page [352](#) for tire size information.

Winter Driving

Tires marked “M + S” or “All Season” on the sidewall have an all-weather tread design suitable for most winter driving conditions.

For the best performance in snowy or icy conditions, you should install snow tires or tire chains. They may be required by local laws under certain conditions.

Snow Tires

If you mount snow tires on your vehicle, make sure they are radial tires of the same size and load range as the original tires. Mount snow tires on all four wheels. The traction provided by snow tires on dry roads may be lower than your original tires. Check with the tire dealer for maximum speed recommendations.

Tire Chains

Mount tire chains on your tires when required by driving conditions or local laws. Install them only on the front tires.

Because your vehicle has limited tire clearance, Acura strongly recommends using the chains listed below, made by Security Chain Company (SCC).

Cable-type : SCC Radial Chain
CH2412T

When installing cables, follow the manufacturer’s instructions, and mount them as tight as you can. Make sure they are not contacting the brake lines or suspension. Drive slowly with them installed. If you hear them coming into contact with the body or chassis, stop and investigate. Remove them as soon as you begin driving on cleared roads.

NOTICE

Traction devices that are the wrong size or improperly installed can damage your vehicle’s brake lines, suspension, body, and wheels. Stop driving if they are hitting any part of the vehicle.

WARNING

Using the wrong chains, or not properly installing chains, can damage the brake lines and cause a crash in which you can be seriously injured or killed.

Follow all instructions in this owner’s manual regarding the selection and use of tire chains.

Checking the Battery

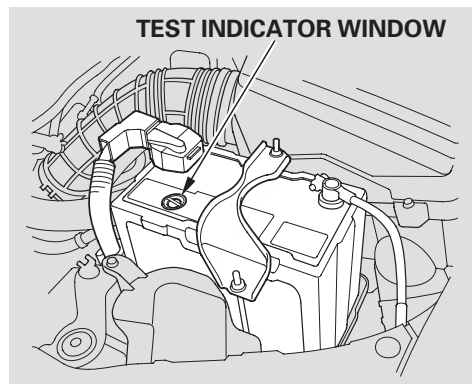

Check the condition of the battery monthly by looking at the test indicator window. The label on the battery explains the test indicator's colors.

Check the terminals for corrosion (a white or yellowish powder). To remove it, cover the terminals with a solution of baking soda and water. It will bubble up and turn brown. When this stops, wash it off with plain water. Dry off the battery with a cloth or paper towel. Coat the terminals with grease to help prevent future corrosion.

If additional battery maintenance is needed, see your dealer or a qualified technician.

WARNING: Battery posts, terminals, and related accessories contain lead and lead compounds. **Wash your hands after handling.**

If you need to connect the battery to a charger, disconnect both cables to prevent damaging your vehicle's electrical system. Always disconnect the negative (–) cable first, and reconnect it last.

WARNING

The battery gives off explosive hydrogen gas during normal operation.

A spark or flame can cause the battery to explode with enough force to kill or seriously hurt you.

Wear protective clothing and a face shield, or have a skilled technician do the battery maintenance.

If you need to park your vehicle for an extended period (more than 1 month), there are several things you should do to prepare it for storage. Proper preparation helps prevent deterioration and makes it easier to get your vehicle back on the road. If possible, store your vehicle indoors.

- Fill the fuel tank.
- Wash and dry the exterior completely.
- Clean the interior. Make sure the carpeting, floor mats, etc., are completely dry.
- Block the rear wheels.

- If the vehicle is to be stored for a longer period, it should be supported on jackstands so the tires are off the ground.
- Leave one window open slightly (if the vehicle is being stored indoors).
- Disconnect the battery.
- Support the front wiper blade arms with a folded towel or rag so they do not touch the windshield.
- To minimize sticking, apply a silicone spray lubricant to all door and trunk seals. Also, apply a vehicle body wax to the painted surfaces that mate with the door and trunk seals.

- Leave the parking brake off. Put the transmission in reverse (manual) or Park (automatic).
- Cover the vehicle with a “breathable” cover, one made from a porous material such as cotton. Non-porous materials, such as plastic sheeting, trap moisture, which can damage the paint.
- If possible, periodically run the engine until it reaches full operating temperature (the cooling fans cycle on and off twice). Preferably, do this once a month.

This section covers the more common problems that motorists experience with their vehicles. It gives you information about how to safely evaluate the problem and what to do to correct it. If the problem has stranded you on the side of the road, you may be able to get going again. If not, you will also find instructions on getting your vehicle towed.

| | |
|----------------------------------|-----|
| Compact Spare Tire..... | 324 |
| Changing a Flat Tire | 325 |
| If the Engine Won't Start..... | 329 |
| Jump Starting | 331 |
| If the Engine Overheats | 333 |
| Low Oil Pressure Indicator | 335 |
| Charging System Indicator..... | 336 |
| Malfunction Indicator Lamp | 336 |
| Readiness Codes..... | 337 |
| Brake System Indicator | 338 |
| Closing the Moonroof | 339 |
| Fuses | 340 |
| Fuse Locations..... | 343 |
| Emergency Towing | 345 |

Compact Spare Tire

Use the compact spare tire as a temporary replacement only. Get your regular tire repaired or replaced, and put it back on your vehicle as soon as you can.

Check the inflation pressure of the compact spare tire every time you check the other tires. It should be inflated to:
60 psi (420 kPa , 4.2 kgf/cm²)

Follow these precautions:

- Never exceed 50 mph (80 km/h).
- This tire gives a harsher ride and less traction on some road surfaces. Use greater caution while driving.

- Do not mount snow chains on the compact spare tire.
- Do not use your compact spare tire on another vehicle unless it is the same make and model.
- On models with manual transmission, do not drive for a long period with the compact spare tire mounted on a front wheel; it will damage the limited slip differential.
- After the flat tire is replaced with the spare tire, the low tire pressure/TPMS indicator stays on. After several miles (kilometers) driving with the spare, this indicator begins to flash, then stays on again. You will also see a “CHECK TPMS SYSTEM” message on the multi-information display (see page [267](#)).

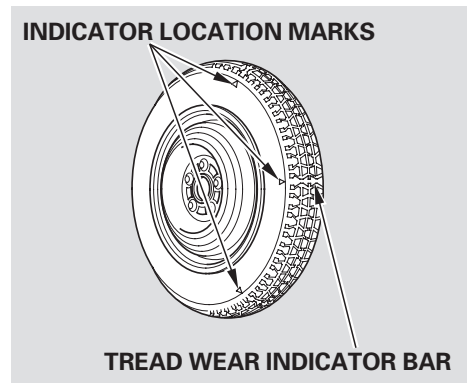

Replace the tire when you can see the tread wear indicator bars. The replacement should be the same size and design tire, mounted on the same wheel. The spare tire is not designed to be mounted on a regular wheel, and the spare wheel is not designed for mounting a regular tire.

If you have a flat tire while driving, stop in a safe place to change it. Drive slowly along the shoulder until you get to an exit or an area that is far away from the traffic lanes.

⚠ WARNING

The vehicle can easily roll off the jack, seriously injuring anyone underneath.

Follow the directions for changing a tire exactly, and never get under the vehicle when it is supported only by the jack.

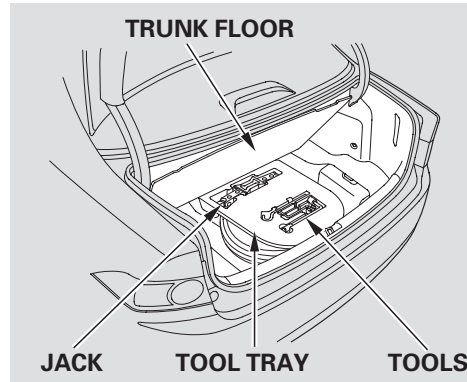

1. Park the vehicle on firm, level and non-slippery ground. Put the transmission in Park (automatic) or reverse (manual). Apply the parking brake.

2. Turn on the hazard warning lights, and turn the ignition switch to the LOCK (0) position. Have all passengers get out of the vehicle while you change the tire.

CONTINUED

Changing a Flat Tire

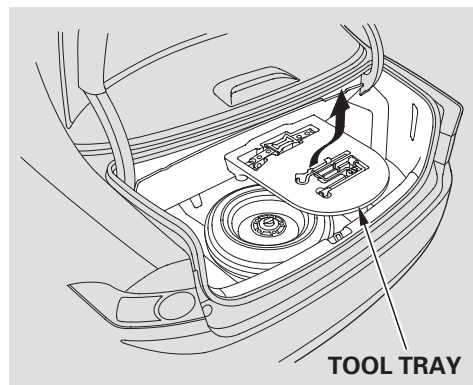

3. Open the trunk. Raise the trunk floor by lifting up on the back edge.
4. Take the tool tray out of the trunk, and remove the tools and the jack.
5. Unscrew the wing bolt and take the spare tire out of the trunk.
6. Loosen each wheel nut 1/2 turn with the wheel nut wrench.

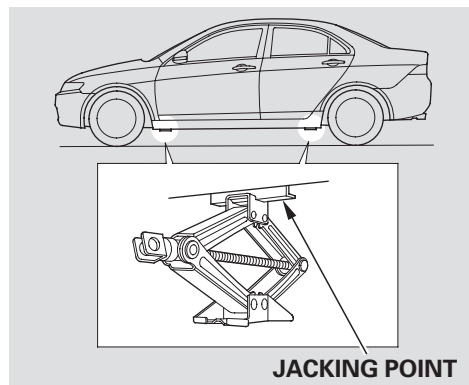

7. Place the jack under the jacking point nearest the tire you need to change. Turn the end bracket clockwise until the top of the jack contacts the jacking point. Make sure the jacking point tab is resting in the jack notch.

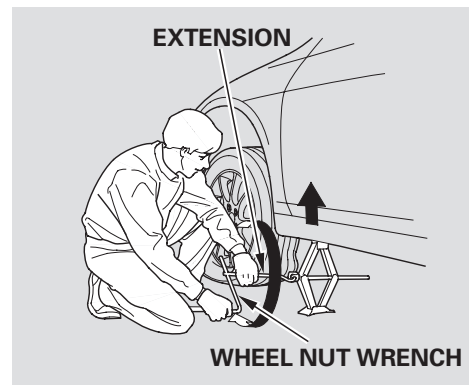

8. Use the extension and the wheel nut wrench as shown to raise the vehicle until the flat tire is off the ground.
9. Remove the wheel nuts and flat tire. Handle the wheel nuts carefully; they may be hot from driving. Place the flat tire on the ground with the outside surface of the wheel facing up.

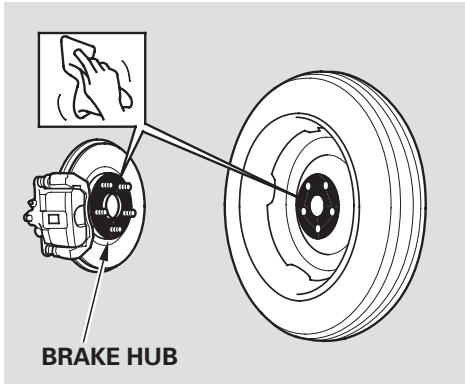

10. Before mounting the spare tire, wipe any dirt off the mounting surface of the wheel and hub with a clean cloth. Wipe the hub carefully; it may be hot from driving.

11. Put on the spare tire. Put the wheel nuts back on finger-tight, then tighten them in a crisscross pattern with the wheel nut wrench until the wheel is firmly against the hub. Do not try to tighten the wheel nuts fully.

12. Lower the vehicle to the ground, and remove the jack.

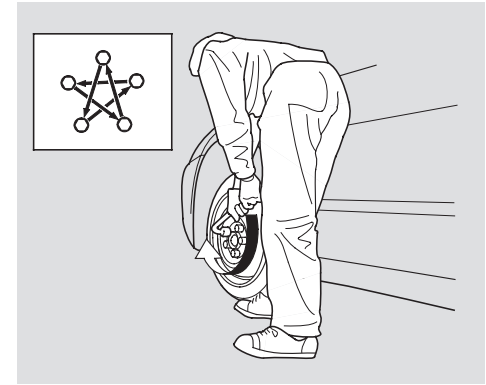

13. Tighten the wheel nuts securely in the same crisscross pattern. Have the wheel nut torque checked at the nearest automotive service facility.

Tighten the wheel nuts to:
80 lbf·ft (108 N·m , 11 kgf·m)

CONTINUED

Changing a Flat Tire

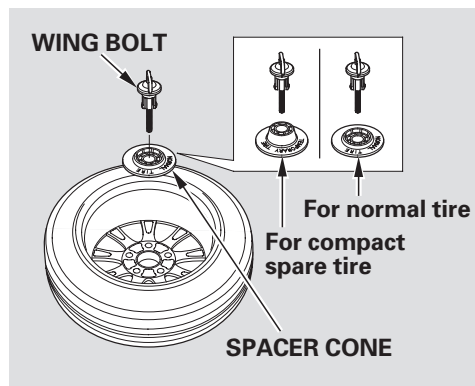

14. Remove the center cap before storing the flat tire in the trunk well.

15. Place the flat tire face down in the spare tire well.

16. Remove the spacer cone from the wing bolt, turn it over, and put it back on the bolt.

17. Secure the flat tire by screwing the wing bolt back into its hole.

18. Store the jack and tools in the tool tray, and place the tool tray back in the trunk.

WARNING

Loose items can fly around the interior in a crash and could seriously injure the occupants.

Store the wheel, jack, and tools securely before driving.

19. Store the wheel cover or center cap in the trunk. Make sure it does not get scratched or damaged. Lower the trunk floor, then close the trunk lid.

20. Your vehicle's original tire has a tire pressure monitoring system sensor. To replace a tire, refer to **Changing a Tire with TPMS** (see page [266](#)).

Diagnosing why the engine won't start falls into two areas, depending on what you hear when you turn the ignition switch to the START (III) position:

- You hear nothing, or almost nothing. The engine's starter motor does not operate at all, or operates very slowly.
- You can hear the starter motor operating normally, or the starter motor sounds like it is spinning faster than normal, but the engine does not start up and run.

Nothing Happens or the Starter Motor Operates Very Slowly

When you turn the ignition switch to the START (III) position, you do not hear the normal noise of the engine trying to start. You may hear a clicking sound, a series of clicks, or nothing at all.

Check these things:

- Check the transmission interlock. If you have a manual transmission, the clutch pedal must be pushed all the way to the floor or the starter will not operate. With an automatic transmission, it must be in Park or neutral.
- Turn the ignition switch to the ON (II) position. Turn on the headlights, and check their brightness. If the headlights are very dim or do not come on at all, the battery is discharged. See **Jump Starting** on page [331](#).

- Turn the ignition switch to the START (III) position. If the headlights do not dim, check the condition of the fuses. If the fuses are OK, there is probably something wrong with the electrical circuit for the ignition switch or starter motor. You will need a qualified technician to determine the problem. See **Emergency Towing** on page [345](#).

If the headlights dim noticeably or go out when you try to start the engine, either the battery is discharged or the connections are corroded. Check the condition of the battery and terminal connections (see page [320](#)). You can then try jump starting the vehicle from a booster battery (see page [331](#)).

If the Engine Won't Start

The Starter Operates Normally

In this case, the starter motor's speed sounds normal, or even faster than normal, when you turn the ignition switch to the START (III) position, but the engine does not run.

- Are you using a properly coded key? An improperly coded key will cause the immobilizer system indicator in the instrument panel to blink rapidly (see page [127](#)).
- Are you using the proper starting procedure? Refer to **Starting the Engine** on page [249](#).

- Do you have fuel? Check the fuel gauge; the low fuel indicator may not be working.
- There may be an electrical problem, such as no power to the fuel pump. Check all the fuses (see page [340](#)).

If you find nothing wrong, you will need a qualified technician to find the problem. See **Emergency Towing** on page [345](#).

Although this seems like a simple procedure, you should take several precautions.

⚠ WARNING

A battery can explode if you do not follow the correct procedure, seriously injuring anyone nearby.

Keep all sparks, open flames, and smoking materials away from the battery.

You cannot start your vehicle with an automatic transmission by pushing or pulling it.

To jump start your vehicle:

1. Open the hood, and check the physical condition of the battery. In very cold weather, check the condition of the electrolyte. If it seems slushy or frozen, do not try jump starting until it thaws.

NOTICE

If a battery sits in extreme cold, the electrolyte inside can freeze. Attempting to jump start with a frozen battery can cause it to rupture.

2. Turn off all the electrical accessories: climate control, audio system, lights, etc. Put the transmission in neutral (manual) or Park (automatic), and set the parking brake.

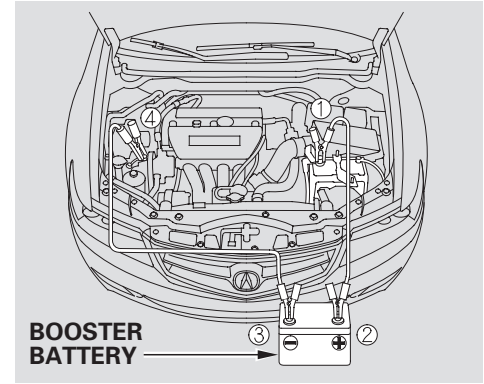

The numbers in the illustration show the order to connect the jumper cable.

3. Connect one jumper cable to the positive (+) terminal on your battery. Connect the other end to the positive (+) terminal on the booster battery.

CONTINUED

Jump Starting

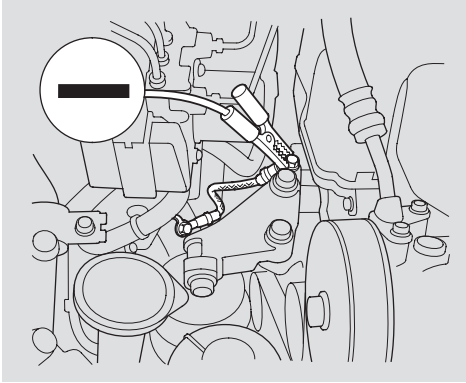

4. Connect the second jumper cable to the negative (-) terminal on the booster battery. Connect the other end to the grounding point as shown. Do not connect this jumper cable to any other part of the engine.

5. If the booster battery is in another vehicle, have an assistant start that vehicle and run it at a fast idle.
6. Start the vehicle. If the starter motor still operates slowly, check that the jumper cables have good metal-to-metal contact.

7. Once your vehicle is running, disconnect the negative cable from your vehicle, then from the booster battery. Disconnect the positive cable from your vehicle, then from the booster battery.

Keep the ends of the jumper cables away from each other and any metal on the vehicle until everything is disconnected. Otherwise, you may cause an electrical short.

The reading of the vehicle's temperature gauge should stay in the midrange. If it climbs to the red mark, you should determine the reason (hot day, driving up a steep hill, etc.).

If your vehicle overheats, you should take immediate action. The only indication may be the temperature gauge climbing to or above the red mark. Or you may see steam or spray coming from under the hood.

NOTICE

Driving with the temperature gauge pointer at the red mark can cause serious damage to the engine.

⚠ WARNING

Steam and spray from an overheated engine can seriously scald you.

Do not open the hood if steam is coming out.

1. Safely pull to the side of the road. Put the transmission in neutral (manual) or Park (automatic), and set the parking brake. Turn off all accessories, and turn on the hazard warning indicators.
2. If you see steam and/or spray coming from under the hood, turn off the engine. Wait until you see no more signs of steam or spray, then open the hood.
3. If you do not see steam or spray, leave the engine running and watch the temperature gauge. If the high heat is due to overloading, the engine should start to cool down almost immediately. If it does, wait until the temperature gauge comes down to the midpoint, then continue driving.
4. If the temperature gauge stays at the red mark, turn off the engine.
5. Look for any obvious coolant leaks, such as a split radiator hose. Everything is still extremely hot, so use caution. If you find a leak, it must be repaired before you continue driving (see **Emergency Towing** on page [345](#)).

CONTINUED

If the Engine Overheats

6. If you do not find an obvious leak, check the coolant level in the radiator reserve tank. Add coolant if the level is below the MIN mark.
7. If there was no coolant in the reserve tank, you may need to add coolant to the radiator. Let the engine cool down until the pointer reaches the middle of the temperature gauge or lower before checking the radiator.

WARNING

Removing the radiator cap while the engine is hot can cause the coolant to spray out, seriously scalding you.

Always let the engine and radiator cool down before removing the radiator cap.

8. Using gloves or a large heavy cloth, turn the radiator cap counterclockwise, without pushing down, to the first stop. After the pressure releases, push down on the cap, and turn it until it comes off.
9. Start the engine, and set the temperature to maximum heat (climate control to AUTO at “”). Add coolant to the radiator up to the base of the filler neck. If you do not have the proper coolant mixture available, you can add plain water. Remember to have the cooling system drained and refilled with the proper mixture as soon as you can.
10. Put the radiator cap back on tightly. Run the engine, and check the temperature gauge. If it goes back to the red mark, the engine needs repair (see **Emergency Towing** on page [345](#)).
11. If the temperature stays normal, check the coolant level in the radiator reserve tank. If it has gone down, add coolant to the MAX mark. Put the cap back on tightly.



This indicator should never come on when the engine is running. If it starts flashing or stays on, or if you see a “CHECK ENGINE OIL LEVEL” message on the multi-information display, the oil pressure has dropped very low or lost pressure. Serious engine damage is possible, and you should take immediate action.

NOTICE

Running the engine with low oil pressure can cause serious mechanical damage almost immediately. Turn off the engine as soon as you can safely get the vehicle stopped.

1. Safely pull off the road, and shut off the engine. Turn on the hazard warning indicators.
2. Let the vehicle sit for a minute. Open the hood, and check the oil level (see page [236](#)). An engine very low on oil can lose pressure during cornering and other driving maneuvers.
3. If necessary, add oil to bring the level back to the full mark on the dipstick (see page [291](#)).
4. Start the engine and watch the oil pressure indicator. If it does not go out within 10 seconds, turn off the engine. There is a mechanical problem that needs to be repaired before you can continue driving (see **Emergency Towing** on page [345](#)).

Charging System Indicator, Malfunction Indicator Lamp



Charging System Indicator

If the charging system indicator comes on brightly when the engine is running, or if you see a “CHECK CHARGING SYSTEM” message on the multi-information display, the battery is not being charged.

Immediately turn off all electrical accessories. Try not to use other electrically operated controls such as the power windows. Keep the engine running; starting the engine will discharge the battery rapidly. Go to a service station or garage where you can get technical assistance.



Malfunction Indicator Lamp

If this indicator comes on while driving, or if you see a “CHECK EMISSION SYSTEM” message on the multi-information display, it means one of the engine’s emissions control systems may have a problem. Even though you may feel no difference in your vehicle’s performance, it can reduce your fuel economy and cause increased emissions. Continued operation may cause serious damage.

If you have recently refueled your vehicle, the indicator could come on because of a loose or missing fuel fill cap. You will also see a “TIGHTEN FUEL CAP” message on the information display. Tighten the cap until it clicks at least once. Tightening the cap will not turn the indicator off immediately; it can take several days of normal driving.

If the indicator comes on repeatedly, even though it may turn off as you continue driving, have your vehicle checked by your dealer as soon as possible.

NOTICE

If you keep driving with the malfunction indicator lamp on, you can damage your vehicle's emissions controls and engine. Those repairs may not be covered by your vehicle's warranties.

If your vehicle has an automatic transmission, the malfunction indicator lamp may also come on with the “D” indicator.

You will also see a “CHECK EMISSION SYSTEM” message on the multi-information display (see page [84](#)).

Readiness Codes

Your vehicle has certain “readiness codes” that are part of the on-board diagnostics for the emissions systems. In some states, part of the emissions testing is to make sure these codes are set. If they are not set, the test cannot be completed.

If the battery in your vehicle has been disconnected or gone dead, these codes may be erased. It takes several days of driving under various conditions to set the codes again.

To check if they are set, turn the ignition switch to the ON (II) position, without starting the engine. The malfunction indicator lamp will come on for 20 seconds. If it then goes off, the readiness codes are set. If it blinks five times, the readiness codes are not set. If possible, do not take your vehicle for a state emissions test until the readiness codes are set. Refer to **Emissions Testing** for more information (see page [362](#)).

Brake System Indicator

U.S. Canada

BRAKE



The brake system indicator normally comes on when you turn the ignition switch to the ON (II) position, and as a reminder to check the parking brake. It will stay on if you do not fully release the parking brake.

If the brake system indicator comes on while driving, the brake fluid level is probably low. You will see a “BRAKE FLUID LOW” message on the multi-information display. Press lightly on the brake pedal to see if it feels normal. If it does, check the brake fluid level the next time you stop at a service station (see page [300](#)).

If the fluid level is low, take your vehicle to a dealer, and have the brake system inspected for leaks or worn brake pads.

However, if the brake pedal does not feel normal, you should take immediate action. A problem in one part of the system’s dual circuit design will still give you braking at two wheels. You will feel the brake pedal go down much farther before the vehicle begins to slow down, and you will have to press harder on the pedal.

You will also see a “CHECK BRAKE SYSTEM” message on the multi-information display when this indicator comes on.

Slow down by shifting to a lower gear, and pull to the side of the road when it is safe. Because of the long distance needed to stop, it is hazardous to drive the vehicle. You should have it towed and repaired as soon as possible (see **Emergency Towing** on page [345](#)).

If you must drive the vehicle a short distance in this condition, drive slowly and carefully.

If the ABS indicator and the VSA system indicator come on with the brake system indicator, have your vehicle inspected by your dealer immediately.

If the electric motor will not close the moonroof, do the following:

1. Check the fuse for the moonroof motor (see page 344). If the fuse is blown, replace it with one of the same or lower rating.
2. Try closing the moonroof. If the new fuse blows immediately or the moonroof motor still does not operate, you can close the moonroof manually.
3. Get the moonroof wrench out of the tool kit in the trunk.

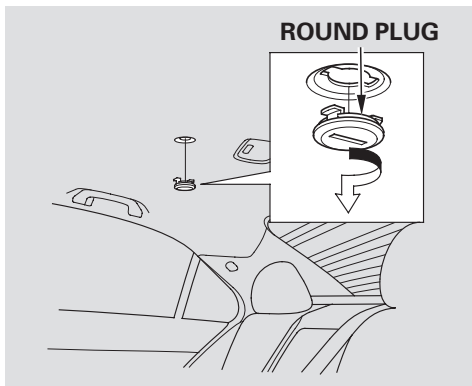

4. Use a screwdriver or coin to remove the round plug in the center of the headliner.
5. Insert the moonroof wrench into the socket behind this plug. Turn the wrench until the moonroof is fully closed.
6. Remove the wrench. Reinstall the round plug.

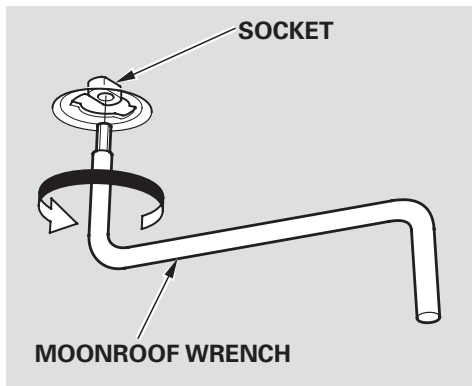

If you need to close the moonroof manually, it means the moonroof opening/closing function is developing a problem. Have your vehicle checked by your dealer.

Fuses

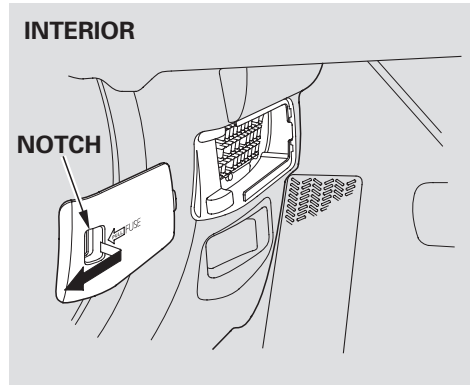

The interior fuse box is on the driver's lower left side. To remove the fuse box lid, pull it toward you and take it out of its hinges.

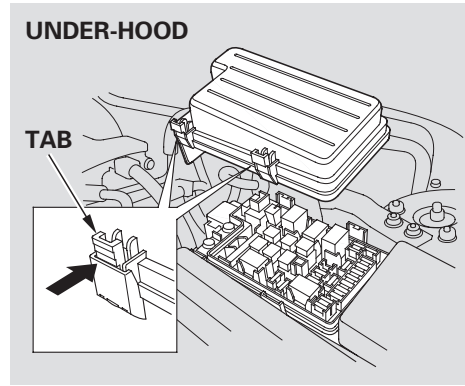

The under-hood fuse box is located near the back of the engine compartment on the driver's side. To open it, push the tabs as shown.

Checking and Replacing Fuses

If something electrical in your vehicle stops working, the first thing you should check for is a blown fuse. Determine from the chart on pages [343](#) and [344](#), or the diagram on the fuse box lid, which fuse or fuses control that device. Check those fuses first, but check all the fuses before deciding that a blown fuse is the cause. Replace any blown fuses, and check if the device works.

1. Turn the ignition switch to the LOCK (0) position. Make sure the headlights and all other accessories are off.
2. Remove the cover from the fuse box.

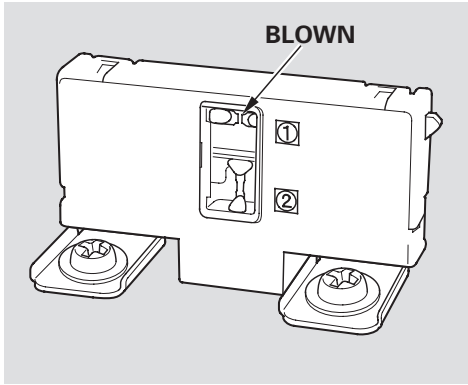

3. Check each of the large fuses in the under-hood fuse box by looking through the side window at the wire inside. Remove the screws with a Phillips-head screwdriver.

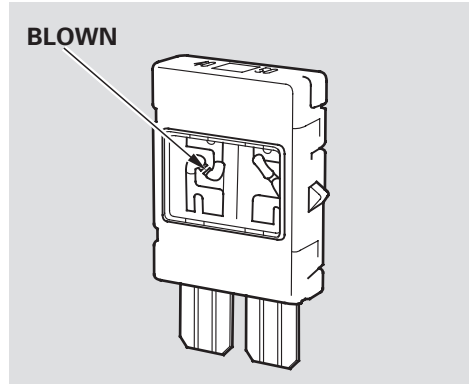

4. Check the smaller fuses in the under-hood fuse box and all the fuses in the interior fuse box by pulling out each one with the fuse puller provided in the under-hood fuse box.

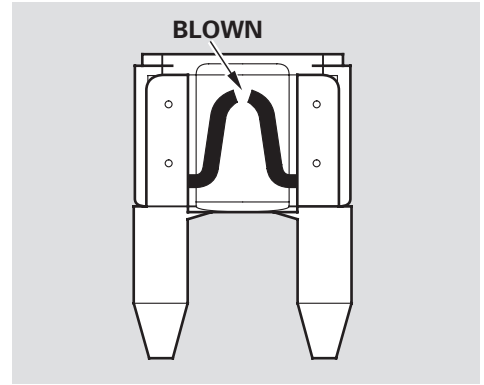

5. Look for a blown wire inside the fuse. If it is blown, replace the fuse with one of the spare fuses of the same rating or lower.

CONTINUED

Fuses

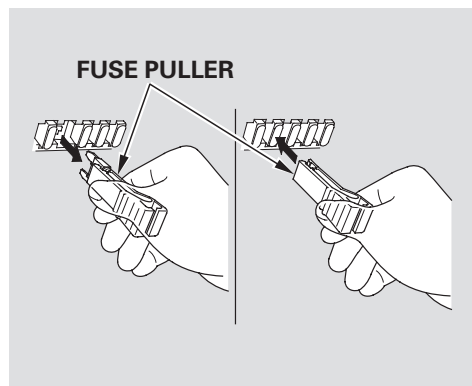

If you cannot drive the vehicle without fixing the problem, and you do not have a spare fuse, take a fuse of the same rating or a lower rating from one of the other circuits with the fuse puller provided in the underhood fuse box. Make sure you can do without that circuit temporarily (such as the accessory power socket or radio).

If you replace the blown fuse with a spare fuse that has a lower rating, it might blow out again. This does not indicate anything wrong. Replace the fuse with one of the correct rating as soon as you can.

NOTICE

Replacing a fuse with one that has a higher rating greatly increases the chances of damaging the electrical system. If you do not have a replacement fuse with the proper rating for the circuit, install one with a lower rating.

6. If the replacement fuse of the same rating blows in a short time, there is probably a serious electrical problem with your vehicle. Leave the blown fuse in that circuit, and have your vehicle checked by a qualified technician.

If the driver's power window fuse is removed, the AUTO function of the driver's window may be disabled. You should reset the AUTO feature, (see page [148](#)).

If the radio fuse is removed, the audio system will disable itself. The next time you turn on the radio you will see "CODE" in the frequency display. Use the preset buttons to enter the five-digit code (see page [203](#)).

UNDER-HOOD FUSE/RELAY BOX

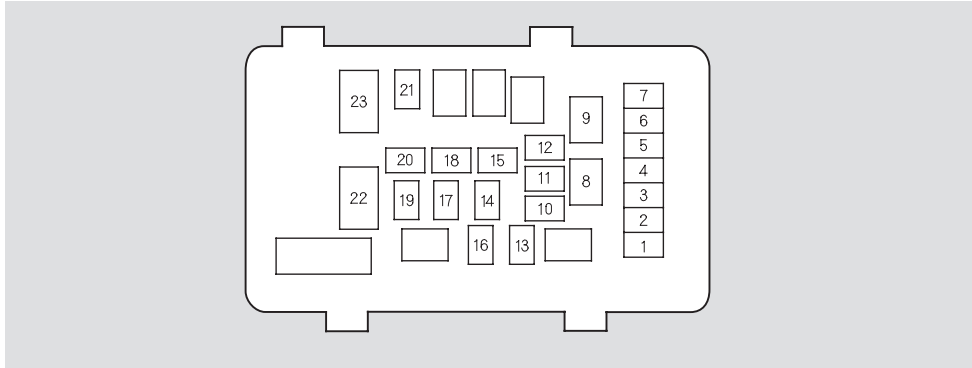

| No. | Amps. | Circuits Protected |
|-----|-------|---------------------|
| 1 | 15 A | Left Headlight Low |
| 2 | 30 A | Rear Defroster Coil |
| 3 | 10 A | Left Headlight Hi |
| 4 | 15 A | Small Light |
| 5 | 10 A | Right Headlight Hi |

| No. | Amps. | Circuits Protected |
|-----|-------|---------------------|
| 6 | 15 A | Right Headlight Low |
| 7 | 7.5 A | Back Up |
| 8 | 15 A | FI ECU (ECM/PCM) |
| 9 | 20 A | Condenser fan |
| 10 | 20 A | FR Fog Light |

| No. | Amps. | Circuits Protected |
|-----|-------|--------------------|
| 11 | 20 A | Cooling Fan |
| 12 | — | Not Used |
| 13 | 20 A | Horn, Stop |
| 14 | 40 A | Rear Defroster |
| 15 | 40 A | Back Up, ACC |
| 16 | 15 A | Hazard |
| 17 | 30 A | VSA Motor |
| 18 | 40 A | VSA |
| 19 | 40 A | OP 1 |
| 20 | 40 A | OP 2 |
| 21 | 40 A | Heater Motor |
| 22 | 100 A | Battery |
| | — | Not Used |
| 23 | 50 A | + B IGI Main |
| | 50 A | Power Window Main |

CONTINUED

Fuse Locations

INTERIOR FUSE BOX

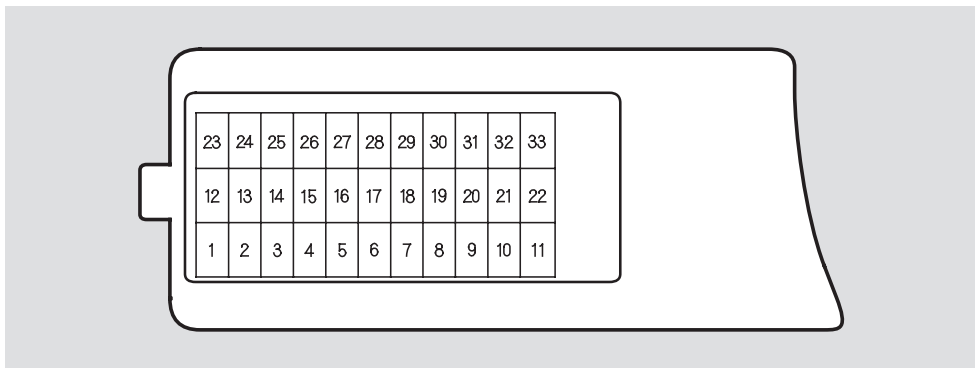

| No. | Amps. | Circuits Protected |
|-----|--------|------------------------|
| 1 | 15 A | DBW |
| 2 | 15 A | Ignition Coil |
| 3 | (10 A) | Daytime Running Light* |
| 4 | 10 A | LAF |
| 5 | 20 A | Audio Amp |
| 6 | 10 A | Interior Light |

| No. | Amps. | Circuits Protected |
|-----|-------|-------------------------|
| 7 | 10 A | Back-Up Lights |
| 8 | 20 A | Door Lock |
| 9 | 15 A | Front Accessory Sockets |
| 10 | 7.5 A | OPDS |
| 11 | 30 A | Wiper |
| 12 | 7.5 A | TPMS |

| No. | Amps. | Circuits Protected |
|-----|-------|----------------------------------|
| 13 | 20 A | Passenger's Power Seat Reclining |
| 14 | 20 A | Driver's Power Seat Sliding |
| 15 | 20 A | Heated Seat |
| 16 | 20 A | Driver's Power Seat Reclining |
| 17 | 20 A | Passenger's Power Seat Sliding |
| 18 | 15 A | ACG |
| 19 | 15 A | Fuel Pump |
| 20 | 10 A | Washer |
| 21 | 7.5 A | Meter |
| 22 | 10 A | SRS |
| 23 | 7.5 A | IGP (PGM-FI ECU) (ECM/PCM) |
| 24 | 20 A | Left Rear Power Window |
| 25 | 20 A | Right Rear Power Window |
| 26 | 20 A | Passenger's Power Window |
| 27 | 20 A | Driver's Power Window |
| 28 | 20 A | Moonroof |
| 29 | — | Not Used |
| 30 | 7.5 A | A/C |
| 31 | — | Not Used |
| 32 | 7.5 A | ACC |
| 33 | — | Not Used |

* : On Canadian models

If your vehicle needs to be towed, call a professional towing service or organization. Never tow your vehicle with just a rope or chain. It is very dangerous.

There are two ways to tow your vehicle:

Flat-bed Equipment – The operator loads your vehicle on the back of a truck. **This is the best way to transport your vehicle.**

Wheel-lift Equipment – The tow truck uses two pivoting arms that go under the tires (front) and lift them off the ground. The other two tires remain on the ground. **This is an acceptable way to tow your vehicle.**

If, due to damage, your vehicle must be towed with the front wheels on the ground, do this:

Manual transmission:

- Release the parking brake.
- Shift the transmission to neutral.
- Leave the ignition switch in the ACCESSORY (I) position so the steering wheel does not lock.

Automatic transmission:

- Release the parking brake.
- Start the engine.
- Shift to D, then to N.
- Turn off the engine.
- Leave the ignition switch in the ACCESSORY (I) position so the steering wheel does not lock.

NOTICE

Improper towing preparation will damage the transmission. Follow the above procedure exactly. If you cannot shift the transmission or start the engine (automatic transmission), your vehicle must be transported with the front wheels off the ground.

With the front wheels on the ground, it is best to tow the vehicle no farther than 50 miles (80 km), and keep the speed below 35 mph (55 km/h).

CONTINUED

Emergency Towing

NOTICE

Trying to lift or tow your vehicle by the bumpers will cause serious damage. The bumpers are not designed to support the vehicle's weight.

NOTICE

The steering system can be damaged if the steering wheel is locked. Leave the ignition switch in the ACCESSORY (I) position, and make sure the steering wheel turns freely before you begin towing.

The diagrams in this section give you the dimensions and capacities of your vehicle and the locations of the identification numbers. It also includes information you should know about your vehicle’s tires and emissions control systems.

- Identification Numbers..... 348
- Specifications 350
- DOT Tire Quality Grading
 (U. S. Vehicles) 353
- Uniform Tire Quality
 Grading 353
- Treadwear 353
- Traction..... 353
- Temperature 354
- Tire Labeling 355
- Tire Pressure Monitoring System
 (TPMS) – Required Federal
 Explanation..... 357
- Emissions Controls..... 359
- The Clean Air Act..... 359
- Crankcase Emissions Control
 System..... 359
- Evaporative Emissions Control
 System..... 359
- Onboard Refueling Vapor
 Recovery 359
- Exhaust Emissions Controls ... 360
- PGM-FI System 360
- Ignition Timing Control
 System..... 360

- Three Way Catalytic
 Converter 360
- Replacement Parts..... 360
- Three Way Catalytic Converter... 361
- Emissions Testing 362

Identification Numbers

Your vehicle has several identifying numbers in various places.

The vehicle identification number (VIN) is the 17-digit number your dealer uses to register your vehicle for warranty purposes. It is also necessary for licensing and insuring your vehicle. The easiest place to find the VIN is on a plate fastened to the top of the dashboard. You can see it by looking through the windshield on the driver's side. It is also on the certification label attached to the driver's doorjamb, and is stamped on the engine compartment bulkhead. The VIN is also provided in bar code on the certification label.

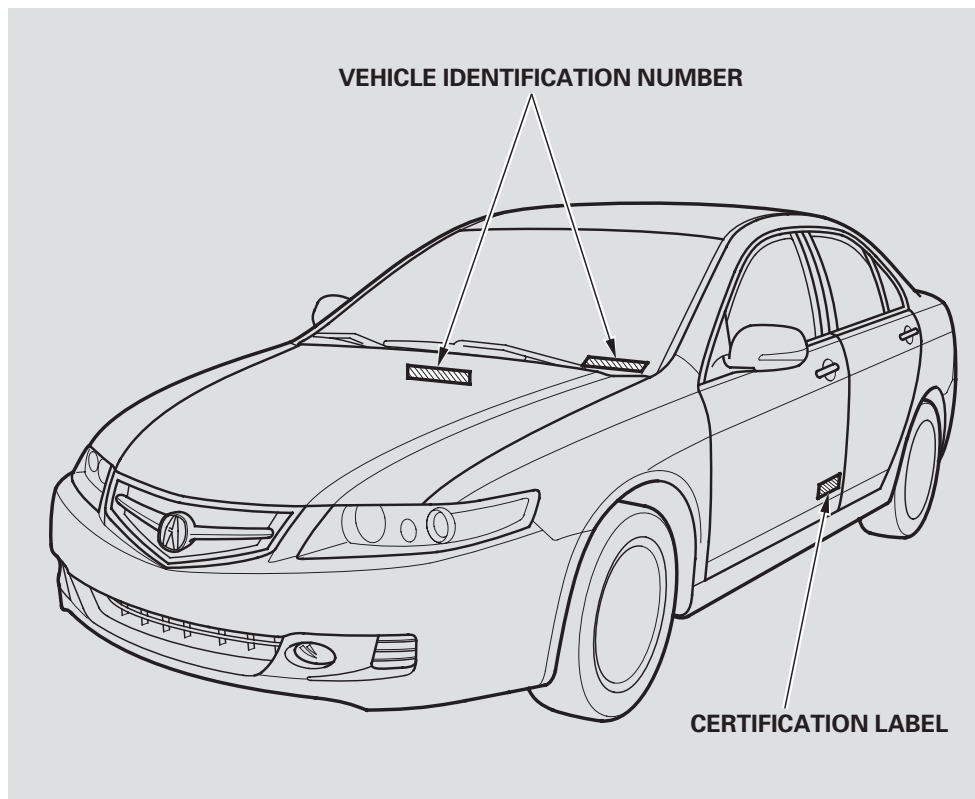

The engine number is stamped into the front of the engine block.

The transmission number is on a label on top of the transmission.

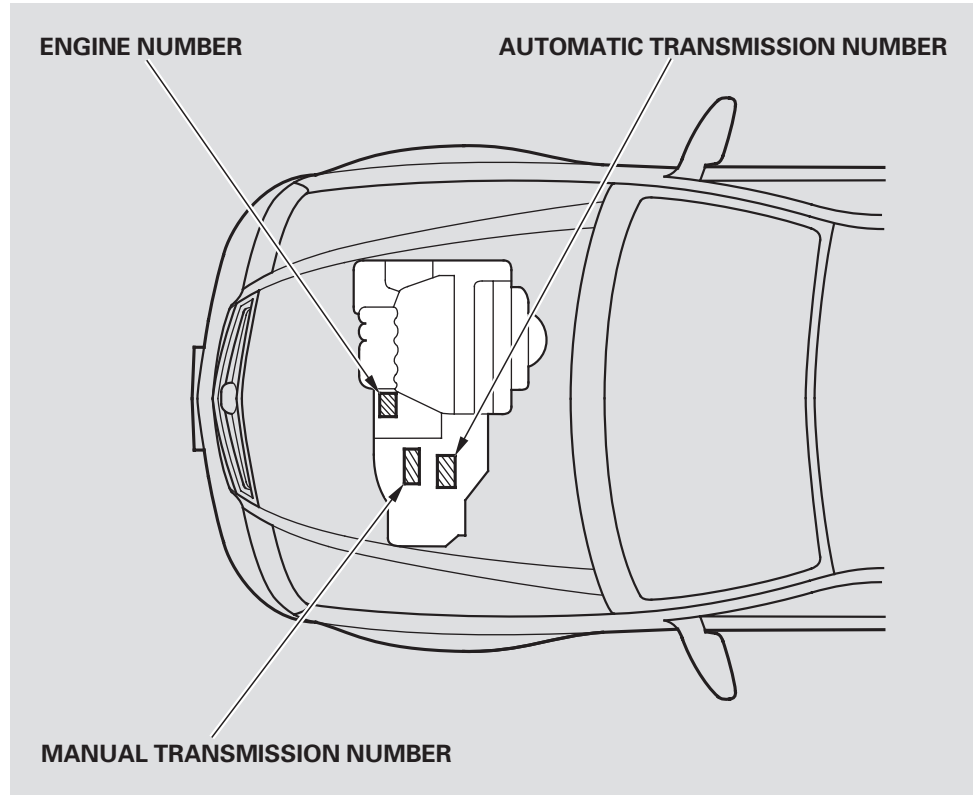

Specifications

Dimensions

| | | |
|-----------|-------|---------------------|
| Length | | 183.3 in (4,657 mm) |
| Width | | 69.4 in (1,762 mm) |
| Height | | 57.3 in (1,456 mm) |
| Wheelbase | | 105.1 in (2,670 mm) |
| Track | Front | 59.6 in (1,515 mm) |
| | Rear | 59.6 in (1,515 mm) |

Weights

| | |
|-----------------------------|--|
| Gross vehicle weight rating | See the certification label attached to the driver's doorjamb. |
|-----------------------------|--|

Seating Capacities

| | |
|-------|---|
| Total | 5 |
| Front | 2 |
| Rear | 3 |

Air Conditioning

| | |
|------------------|--------------------------|
| Refrigerant type | HFC-134a (R-134a) |
| Charge quantity | 17.6–19.4 oz (500–550 g) |
| Lubricant type | SP-10 |

Capacities

| | |
|-----------|---------------------------------|
| Fuel tank | Approx. 17.1 US gal (64.7 ℓ) |
|-----------|---------------------------------|

Capacities

| | | |
|------------------------------|----------------------|---------------------|
| Engine coolant | Change* ¹ | |
| | Manual | 1.40 US gal (5.3 ℓ) |
| | Automatic | 1.37 US gal (5.2 ℓ) |
| | Total | |
| Engine oil | Manual | 1.90 US gal (7.2 ℓ) |
| | Automatic | 1.88 US gal (7.1 ℓ) |
| | Change* ² | |
| | Including filter | 4.4 US qt (4.2 ℓ) |
| | Without filter | 4.2 US qt (4.0 ℓ) |
| | Total | 5.6 US qt (5.3 ℓ) |
| Manual transmission fluid | Change | 2.1 US qt (2.0 ℓ) |
| | Total | 2.3 US qt (2.2 ℓ) |
| Automatic transmission fluid | Change | 3.1 US qt (2.9 ℓ) |
| | Total | 6.9 US qt (6.5 ℓ) |
| Windshield washer reservoir | U.S. Models | 2.6 US qt (2.5 ℓ) |
| | Canada Models | 4.8 US qt (4.5 ℓ) |

* 1 : Including the coolant in the reserve tank and that remaining in the engine

Reserve tank capacity: 0.16 US gal (0.6 ℓ)

* 2 : Excluding the oil remaining in the engine

Lights

| | | |
|---|------|---------------|
| Headlights | High | 12 V – 55 W |
| | Low | 12 V – 35 W* |
| Front fog lights | | 12 V – 55 W |
| Front turn signal | | 12 V – 21 W |
| Front parking lights/ Side marker lights | | 12 V – 3 CP |
| Rear turn signal lights | | 12 V – 21 W |
| Stop/Taillights | | 12 V – 21/5 W |
| Taillights | | 12 V – 5 W |
| High-mount brake light | | 12 V – 21 W |
| Back-up lights | | 12 V – 21 W |
| Rear side marker lights | | 12 V – 3 CP |
| License plate light | | 12 V – 3 CP |
| Ceiling light | | 12 V – 8 W |
| Spotlights/Front ceiling lights | | 12 V – 8 W |
| Trunk light | | 12 V – 5 W |
| Door courtesy lights | | 12 V – 2 CP |
| Vanity mirror lights | | 12 V – 1.1 W |

* : On vehicles with high voltage discharge type headlights, replacement of a headlight bulb should be performed by your dealer.

Battery

| | |
|----------|-------------------|
| Capacity | 12 V – 36 AH/5 HR |
|----------|-------------------|

Fuses

| | |
|------------|---|
| Interior | See page 344 or the fuse label attached to the inside of the fuse box door on each side of the dashboard. |
| Under-hood | See page 343 or the fuse box cover. |

Engine

| | |
|-------------------|--|
| Type | Water cooled 4-stroke, DOHC i-VTEC 4-cylinder, gasoline engine |
| Bore x Stroke | 3.43 x 3.90 in (87.0 x 99.0 mm) |
| Displacement | 144 cu-in (2,354 cm ³) |
| Compression ratio | 10.5 : 1 |
| Spark plugs | NGK: IZFR6K-11 DENSO: SKJ20DR-M11 |

Alignment

| | | |
|--------|-------|------------------|
| Toe-in | Front | 0.00 in (0.0 mm) |
| | Rear | 0.08 in (2.0 mm) |
| Camber | Front | 0° |
| | Rear | -1° |
| Caster | Front | 3°13' |

CONTINUED

Specifications

Tires

| | | |
|----------|------------|---|
| Size | Front/Rear | P215/50R17 93V |
| | Spare | T135/80D16 101M |
| Pressure | Front | 32 psi (220 kPa , 2.2 kgf/cm ²) |
| | Rear | 30 psi (210 kPa , 2.1 kgf/cm ²) |
| | Spare | 60 psi (420 kPa , 4.2 kgf/cm ²) |

The tires on your vehicle meet all U.S. Federal Safety Requirements. All tires are also graded for treadwear, traction, and temperature performance according to Department of Transportation (DOT) standards. The following explains these gradings.

Uniform Tire Quality Grading

Quality grades can be found where applicable on the tire sidewall between tread shoulder and maximum section width. For example:

Treadwear 200

Traction AA

Temperature A

All passenger car tires must conform to Federal Safety Requirements in addition to these grades.

Treadwear

The treadwear grade is a comparative rating based on the wear rate of the tire when tested under controlled conditions on a specified government test course. For example, a tire graded 150 would wear one and one-half (1 1/2) times as well on the government course as a tire graded 100. The relative performance of tires depends upon the actual conditions of their use, however, and may depart significantly from the norm due to variations in driving habits, service practices and differences in road characteristics and climate.

Traction

The traction grades, from highest to lowest, are AA, A, B, and C. Those grades represent the tire's ability to stop on wet pavement as measured under controlled conditions on specified government test surfaces of asphalt and concrete. A tire marked C may have poor traction performance.

Warning: The traction grade assigned to this tire is based on straight-ahead braking traction tests, and does not include acceleration, cornering, hydroplaning, or peak traction characteristics.

DOT Tire Quality Grading (U.S. Vehicles)

Temperature

The temperature grades are A (the highest), B, and C, representing the tire's resistance to the generation of heat and its ability to dissipate heat when tested under controlled conditions on a specified indoor laboratory test wheel. Sustained high temperature can cause the material of the tire to degenerate and reduce tire life, and excessive temperature can lead to sudden tire failure. The grade C corresponds to a level of performance which all passenger car tires must meet under the Federal Motor Vehicle Safety Standard No. 109. Grades B and A represent higher levels of performance on the laboratory test wheel than the minimum required by law.

Warning: The temperature grade for this tire is established for a tire that is properly inflated and not overloaded. Excessive speed, underinflation, or excessive loading, either separately or in combination, can cause heat buildup and possible tire failure.

The tires that came on your vehicle have a number of markings. Those you should be aware of are described below.

TIRE LABELING EXAMPLE

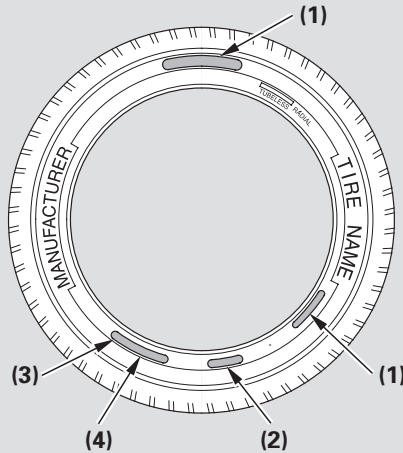

- (1) Tire Size
- (2) Tire Identification Number (TIN)
- (3) Maximum Tire Pressure
- (4) Maximum Tire Load

Tire Size

Whenever tires are replaced, they should be replaced with tires of the same size. Following is an example of tire size with an explanation of what each component means.

P215/50R17 93V

- P — Vehicle type (P indicates passenger vehicle).
- 215 — Tire width in millimeters.
- 50 — Aspect ratio (the tire's section height as a percentage of its width).

- R — Tire construction code (R indicates radial).
- 17 — Rim diameter in inches.
- 93 — Load index (a numerical code associated with the maximum load the tire can carry).
- V — Speed symbol (an alphabetical code indicating the maximum speed rating).

CONTINUED

Tire Identification Number (TIN)

The tire identification number (TIN) is a group of numbers and letters that look like the following example. TIN is located on the sidewall of the tire.

DOT B97R FW6X 2202

DOT — This indicates that the tire meets all requirements of the U.S. Department of Transportation.

B97R — Manufacturer's identification mark.

FW6X — Tire type code.

2202 — Date of manufacture.
└───┬───┬───
 Year
 Week

Maximum Tire Pressure

Max Press — The maximum air pressure the tire can hold.

Maximum Tire Load

Max Load — The maximum load the tire can carry at maximum air pressure.

Tire Pressure Monitoring System (TPMS) – Required Federal Explanation

Each tire, including the spare (if provided), should be checked monthly when cold and inflated to the inflation pressure recommended by the vehicle manufacturer on the vehicle placard or tire inflation pressure label.

(If your vehicle has tires of a different size than the size indicated on the vehicle placard or tire inflation pressure label, you should determine the proper tire inflation pressure for those tires.)

As an added safety feature, your vehicle has been equipped with a tire pressure monitoring system (TPMS) that illuminates a low tire pressure telltale



when one or more of your tires is significantly under-inflated.

Accordingly, when the low tire pressure telltale illuminates, you should stop and check your tires as soon as possible, and inflate them to the proper pressure.

Driving on a significantly under-inflated tire causes the tire to overheat and can lead to tire failure. Under-inflation also reduces fuel efficiency and tire tread life, and may affect the vehicle's handling and stopping ability.

Please note that the TPMS is not a substitute for proper tire maintenance, and it is the driver's responsibility to maintain correct tire pressure, even if under-inflation has not reached the level to trigger illumination of the TPMS low tire pressure telltale.

Tire Pressure Monitoring System (TPMS) – Required Federal Explanation

Your vehicle has also been equipped with a TPMS malfunction indicator to indicate when the system is not operating properly. The TPMS malfunction indicator is combined with the low tire pressure telltale. When the system detects a malfunction, the telltale will flash for approximately one minute and then remain continuously illuminated. This sequence will continue upon subsequent vehicle start-ups as long as the malfunction exists.

When the malfunction indicator is illuminated, the system may not be able to detect or signal low tire pressure as intended.

TPMS malfunctions may occur for a variety of reasons, including the installation of replacement or alternate tires or wheels on the vehicle that prevent the TPMS from functioning properly.

Always check the TPMS malfunction telltale after replacing one or more tires or wheels on your vehicle to ensure that the replacement or alternate tires and wheels allow the TPMS to continue to function properly.

The burning of gasoline in your vehicle's engine produces several by-products. Some of these are carbon monoxide (CO), oxides of nitrogen (NOx), and hydrocarbons (HC). Gasoline evaporating from the tank also produces hydrocarbons. Controlling the production of NOx, CO, and HC is important to the environment. Under certain conditions of sunlight and climate, NOx and HC react to form photochemical "smog." Carbon monoxide does not contribute to smog creation, but it is a poisonous gas.

The Clean Air Act

The United States Clean Air Act* sets standards for automobile emissions. It also requires that automobile manufacturers explain to owners how their emissions controls work and what to do to maintain them. This section summarizes how the emissions controls work.

* In Canada, Acura vehicles comply with the Canadian emission requirements, as specified in an agreement with Environment Canada, at the time they are manufactured.

Crankcase Emissions Control System

Your vehicle has a positive crankcase ventilation system. This keeps gasses that build up in the engine's crankcase from going into the atmosphere. The positive crankcase ventilation valve routes them from the crankcase back to the

intake manifold. They are then drawn into the engine and burned.

Evaporative Emissions Control System

As gasoline evaporates in the fuel tank, an evaporative emissions control canister filled with charcoal adsorbs the vapor. It is stored in this canister while the engine is off. After the engine is started and warmed up, the vapor is drawn into the engine and burned during driving.

Onboard Refueling Vapor Recovery

The onboard refueling vapor recovery (ORVR) system captures the fuel vapors during refueling. The vapors are adsorbed in a canister filled with activated carbon. While driving, the fuel vapors are drawn into the engine and burned off.

Emissions Controls

Exhaust Emissions Controls

The exhaust emissions controls include three systems: PGM-FI, ignition timing control, and three way catalytic converter. These three systems work together to control the engine's combustion and minimize the amount of HC, CO, and NOx that comes out the tailpipe. The exhaust emissions control systems are separate from the crankcase and evaporative emissions control systems.

PGM-FI System

The PGM-FI system uses sequential multiport fuel injection. It has three subsystems: air intake, engine control, and fuel control. The powertrain control module (PCM) in automatic transmission vehicles or the engine control module (ECM) in manual transmission vehicles uses various sensors to determine how much air is going into the engine. It then controls how much fuel to inject under all operating conditions.

Ignition Timing Control System

This system constantly adjusts the ignition timing, reducing the amount of HC, CO, and NOx produced.

Three Way Catalytic Converter

The three way catalytic converter is in the exhaust system. Through chemical reactions, it converts HC, CO, and NOx in the engine's exhaust to carbon dioxide (CO₂), nitrogen (N₂), and water vapor.

Replacement Parts

The emissions control systems are designed and certified to work together in reducing emissions to levels that comply with the Clean Air Act. To make sure the emissions remain low, you should use only new Acura replacement parts or their equivalent for repairs. Using lower quality parts may increase the emissions from your vehicle.

The emissions control systems are covered by warranties separate from the rest of your vehicle. Read your warranty manual for more information.

Three Way Catalytic Converter

The three way catalytic converter contains precious metals that serve as catalysts, promoting chemical reactions to convert the exhaust gasses without affecting the metals. The catalytic converter is referred to as a three-way catalyst, since it acts on HC, CO, and NOx. A replacement unit must be an original Acura part or its equivalent.

The three way catalytic converter must operate at a high temperature for the chemical reactions to take place. It can set on fire any combustible materials that come near it. Park your vehicle away from high grass, dry leaves, or other flammables.

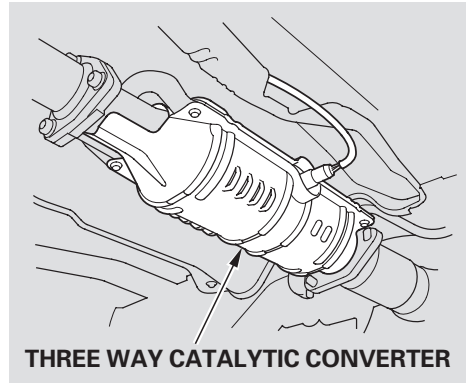

A defective three way catalytic converter contributes to air pollution, and can impair your engine's performance. Follow these guidelines to protect your vehicle's three way catalytic converter.

- Always use unleaded gasoline. Even a small amount of leaded gasoline can contaminate the catalyst metals, making the three way catalytic converter ineffective.

- Keep the engine well maintained.
- Have your vehicle diagnosed and repaired if it is misfiring, back-firing, stalling, or otherwise not running properly.

Emissions Testing

Testing of Readiness Codes

If you take your vehicle for an emissions test shortly after the battery has been disconnected or gone dead, it may not pass the test. This is because of certain “readiness codes” that must be set in the on-board diagnostics for the emissions systems. These codes are erased when the battery is disconnected, and set again only after several days of driving under a variety of conditions.

If the testing facility determines that the readiness codes are not set, you will be requested to return at a later date to complete the test. If you must get the vehicle retested within the next two or three days, you can condition the vehicle for retesting by doing the following.

1. Make sure the gas tank is nearly, but not completely, full (around 3/4).
2. Make sure the vehicle has been parked with the engine off for 6 hours or more.
3. Make sure the ambient temperature is between 40° and 95°F.
4. Without touching the accelerator pedal, start the engine, and let it idle for 20 seconds.
5. Keep the vehicle in Park (automatic) or neutral (manual). Increase the engine speed to 2,000 rpm, and hold it there until the temperature gauge rises to at least 1/4 of the scale (about 3 minutes).
6. Without touching the accelerator pedal, let the engine idle for 20 seconds.

7. Select a nearby lightly traveled major highway where you can maintain a speed of 50 to 60 mph (80 to 97 km/h) for at least 20 minutes. Drive on the highway in D (automatic) or 6th (manual). Do not use the cruise control. When traffic allows, drive for 90 seconds without moving the accelerator pedal. (Vehicle speed may vary slightly; this is okay.) If you cannot do this for a continuous 90 seconds because of traffic conditions, drive for at least 30 seconds, then repeat it two more times (for a total of 90 seconds).

8. Then drive in city/suburban traffic for at least 10 minutes. When traffic conditions allow, let the vehicle coast for several seconds without using the accelerator pedal or the brake pedal.

9. Make sure the vehicle has been parked with the engine off for 30 minutes.

If the testing facility determines the readiness codes are still not set, see your dealer.

Client Service Information 366
Warranty Coverages 367
Reporting Safety Defects
 (U.S. Vehicle) 368
Authorized Manuals..... 369

Client Service Information

Acura dealership personnel are trained professionals. They should be able to answer all your questions. If you encounter a problem that your dealership does not solve to your satisfaction, please discuss it with the dealership's management. The service manager or general manager can help. Almost all problems are solved in this way.

If you are dissatisfied with the decision made by the dealership's management, contact the Acura Client Services Office.

U.S. Owners:

American Honda Motor Co., Inc.
Acura Client Services
Mail Stop 500-2N-7E
1919 Torrance Blvd.
Torrance, CA 90501-2746

Tel: (800) 382-2238

Canadian Owners:

CLIENT RELATIONS RELATIONS AVEC LA CLIENTÉLE

Honda Canada Inc.
715 Milner Avenue
Toronto, ON
M1B 2K8

Tel: 1-888-9-ACURA-9
Fax: Toll-free 1-877-939-0909
Toronto (416) 287-4776

In Puerto Rico and the U.S. Virgin Islands:

Vortex Motor Corp.
Bella International
P.O. Box 190816
San Juan, PR 00919-0816

Tel: (787) 620-7546

When you call or write, please give us this information:

- Vehicle Identification Number (see page 348)
- Name and address of the dealer who services your vehicle
- Date of purchase
- Mileage on your vehicle
- Your name, address, and telephone number
- A detailed description of the problem
- Name of the dealer who sold the vehicle to you

U.S. Owners

Your new vehicle is covered by these warranties:

New Vehicle Limited Warranty — covers your new vehicle, except for the battery, emissions control systems, and accessories, against defects in materials and workmanship.

Emissions Control Systems Defects Warranty and Emissions Performance Warranty — these two warranties cover your vehicle's emissions control systems. Time, mileage, and coverage are conditional. Please read your warranty booklet for exact information.

Original Equipment Battery Limited Warranty — this warranty gives up to 100 % credit toward a replacement battery.

Seat Belt Limited Warranty — a seat belt that fails to function properly is covered by a limited warranty. Please read your warranty booklet for details.

Rust Perforation Limited Warranty — all exterior body panels are covered for rust-through from the inside for the specified time period with no mileage limit.

Accessory Limited Warranty — Acura accessories are covered under this warranty. Time and mileage limits depend on the type of accessory and other factors. Please read your warranty manual for details.

Replacement Parts Limited Warranty — covers all Acura replacement parts against defects in materials and workmanship.

Replacement Battery Limited Warranty — provides prorated coverage for a replacement battery purchased from your dealer.

Replacement Muffler Lifetime Limited Warranty — provides coverage for as long as the purchaser of the muffler owns the vehicle.

Restrictions and exclusions apply to all these warranties. Please read the 2008 Acura warranty information booklet that came with your vehicle for precise information on warranty coverages. Your vehicle's original tires are covered by their manufacturer. Tire warranty information is in a separate booklet.

Canadian Owners

Please refer to the 2008 warranty manual that came with your vehicle.

Reporting Safety Defects (U.S. Vehicles)

If you believe that your vehicle has a defect which could cause a crash or could cause injury or death, you should immediately inform the National Highway Traffic Safety Administration (NHTSA), in addition to notifying American Honda Motor Co., Inc.

If NHTSA receives similar complaints, it may open an investigation, and if it finds that a safety defect exists in a group of vehicles, it may order a recall and remedy campaign. However, NHTSA cannot become involved in individual problems between you, your dealer, or American Honda Motor Co., Inc.

To contact NHTSA, you may call the Vehicle Safety Hotline toll-free at 1-888-327-4236 (TTY: 1-800-424-9153); go to <http://www.safercar.gov>; or write to: Administrator, NHTSA, 400 Seventh Street, SW., Washington, DC 20590. You can also obtain other information about motor vehicle safety from <http://www.safercar.gov>.

Purchasing Factory Authorized Manuals (U.S. only)

The publications shown below can be purchased from Helm Incorporated. You can order by phone or online:

- Call Helm Inc. at 1-800-782-4356 (credit card orders only)
- Go online at www.helminc.com

If you are interested in other years or models, contact Helm Inc. at 1-800-782-4356.

| Publication Form Number | Form Description |
|-------------------------|--|
| 61SEA04 | 2008 Acura TSX Service Manual |
| 61SEA04EL | 2004-2008 Acura TSX Electrical Troubleshooting Manual |
| 61SEA30 | 2004-2008 Acura TSX Body Repair Manual |
| 31SEA640 | 2008 Acura TSX Owner's Manual |
| 31SEA810 | 2008 Acura TSX Navigation System Owner's Manual |
| 31SEAM10 | 2008 Acura TSX Maintenance Journal |
| 31SEAQ40 | 2008 Acura TSX Quick Start Guide |
| ACU-R | Order Form for Previous Years- Indicate Year and Model Desired |

Service Manual:

Covers maintenance and recommended procedures for repair to engine and chassis components. It is written for the journeyman mechanic, but it is simple enough for most mechanically inclined owners to understand.

Electrical Troubleshooting Manual:

Complements the Service Manual by providing in-depth troubleshooting information for each electrical circuit in your vehicle.

Body Repair Manual:

Describes the procedures involved in the replacement of damaged body parts.

A

Accessories..... 240

ACCESSORY (Ignition Key Position) 128

Accessory Power Sockets..... 156

Additives, Engine Oil..... 291

Adjusting the Sound..... 175

Adjust Outside Temperature
 Display 73, 96

Advice For Pregnant Women..... 17

Airbag (SRS) 9

Airbag, Additional Information..... 23

 Additional Safety Precautions.... 35

 Airbag Service..... 34

 Check Airbag System
 Message..... 83

 How the Passenger Airbag Off
 Indicator Works..... 33

 How the Side Airbag Off
 Indicator Works..... 32

 How the SRS Indicator Works... 32

 How Your Front Airbags
 Work..... 26

 How Your Side Airbags Work.... 30

 How Your Side Curtain
 Airbags Work..... 31

 SRS Components 23

Air Conditioning..... 160

 Usage 162

Air Pressure, Tires 315

Alignment 317

Alcohol in Gasoline..... 232

Anti-lock Brakes (ABS)
 Indicator..... 65, 261

 Message..... 83

 Operation 261

Anti-theft, Audio System..... 203

Anti-theft Steering Column
 Lock..... 128

Audio System 170

Automatic Lighting Off..... 122

Automatic Seat Belt Tensioners ... 21

Automatic Transmission..... 252

 Capacity, Fluid 350

 Checking Fluid Level 297

 Engine Speed Limiter 251

 Sequential SportShift Mode 254

 Shifting..... 252

 Shift Lever Position Indicator .. 252

 Shift Lever Positions 252

 Shift Lock Release..... 257

Auxiliary Input Jack..... 184

B

Battery
 Charging System
 Indicator..... 62, 336

 Message..... 84

 Jump Starting 331

 Maintenance..... 320

 Specifications 351

Before Driving 231

Belts, Seat 8

Beverage Holders 156

Bluetooth® Hands Free Link®..... 213

Booster Seats 52

CONTINUED

Index

| | | | |
|---------------------------------|---------|----------------------------------|----------|
| Brakes | | | |
| Anti-lock System (ABS) | 261 | Turn Signal Light | 304, 306 |
| Break-in, New Linings | 232 | Bulbs, Halogen..... | 302 |
| Bulb Replacement | 306 | | |
| Check ABS System Message..... | 83 | C | |
| Check Brake System Message.. | 84 | Capacities Chart..... | 350 |
| Fluid | 300 | Carbon Monoxide Hazard | 55 |
| Fluid Low Message | 79 | Carrying Cargo | 242 |
| Parking..... | 151 | CAUTION, Explanation of | iii |
| System Indicator..... | 63, 338 | CD Care | 194 |
| System Message | 84 | CD Changer..... | 185 |
| Wear Indicators | 260 | CD Error Messages | 193 |
| Braking Fluid Low Message | 79 | Center Pocket | 155 |
| Braking System..... | 260 | Certification Label..... | 348 |
| Brake-in, New Vehicle | 232 | Chains | 319 |
| Brightness Control, | | Changing a Flat Tire | 325 |
| Instruments | 123 | Changing Oil | |
| Brights, Headlights | 122 | How to..... | 293 |
| Bulb Replacement | | When to..... | 280 |
| Brake Lights..... | 306 | Charging System Indicator ... | 62, 336 |
| Fog Lights | 308 | Message..... | 84 |
| Front Parking Lights..... | 305 | Check ABS System Message | 83 |
| Headlights | 302 | Check Airbag System Message..... | 83 |
| High-mount Brake Light | 308 | Check Brake System Message | 84 |
| Rear License Plate..... | 308 | Check Charging System | |
| Specifications | 351 | Message..... | 84 |
| | | Check DRL System Message | 85 |
| | | Check Emission System | |
| | | Message..... | 84 |
| | | Check Engine Oil Level | |
| | | Message..... | 82 |
| | | Check Tire Pressure | |
| | | Message..... | 81, 265 |
| | | Check TPMS System | |
| | | Message..... | 80, 267 |
| | | Check Transmission Message..... | 83 |
| | | Check VSA System Message | 82 |
| | | Checklist, Before Driving..... | 248 |
| | | Child Safety | 36 |
| | | Booster Seats | 52 |
| | | Child Seats..... | 44 |
| | | Important Safety Reminders..... | 36 |
| | | Infants | 41 |
| | | Lap/Shoulder Belt..... | 48 |
| | | Larger Children | 51 |
| | | LATCH..... | 46 |
| | | Risk with Airbag | 37 |
| | | Small Children..... | 42 |
| | | Tethers..... | 49 |
| | | Where Should a Child Sit? | 37 |
| | | Childproof Door Locks | 130 |

Child Seats..... 36
 LATCH Anchorage System 46
 Lower Anchorage Points 46
 Tether Anchorage Points 49
 Client Service Office 366
 Climate Control Sensors..... 169
 Clock, Setting the 204
 Clutch Fluid..... 301
 Cold Weather, Starting in..... 249
 Compact Spare Tire..... 324
 Console Compartment 157
 Consumer Information..... 366
 Controls, Instruments and..... 59
 Coolant
 Adding..... 295
 Checking..... 236
 Proper Solution 295
 Temperature Gauge..... 68
 Crankcase Emissions Control
 System..... 359
 Cruise Control Message..... 85, 206
 Cruise Control Operation 206
 Cruise Main Indicator 66
 Cup Holders..... 156
 Customized Settings..... 86
 Default All..... 90

Door · Window Setup 110
 Lighting Setup..... 106
 Meter Setup..... 93
 Position Setup 104
 Setting to Default..... 90
 Wiper Setup..... 117

D

DANGER, Explanation of..... iii
 Dashboard 3, 60
 Daytime Running Lights..... 122
 Default All..... 90
 Defects, Reporting Safety..... 368
 Defogger, Rear Window 124
 Dimensions..... 350
 Dimming the Headlights 121
 Dipstick
 Automatic Transmission .. 297, 298
 Engine Oil..... 236
 Directional Signals..... 121
 Disc Brake Wear Indicators..... 260
 Display, Multi-information..... 69
 Disposal of Used Oil..... 294
 Doors
 Locking and Unlocking..... 129

Lockout Prevention..... 130
 And Trunk Open..... 11, 78
 Power Door Lock..... 129
 Door Lock Mode..... 111
 DOT Tire Quality Grading 353
 Downshifting, 6-speed Manual
 Transmission..... 250
 Driver and Passenger Safety..... 5
 Driver's ID 86
 Driving 247
 Economy 237
 Driving Position
 Memory System..... 143
 DRL, Check System Message 85
 Dual Temperature Control..... 167
 Dust and Pollen Filter 311

E

Economy, Fuel 237
 Elapsed Time Reset Condition.... 100

CONTINUED

Index

Emergencies on the Road..... 323
 Battery, Jump Starting 331
 Brake System Indicator 63, 338
 Changing a Flat Tire 325
 Charging System
 Indicator..... 62, 336
 Checking the Fuses..... 340
 Fuse Locations 343
 Hazard Warning Flashers 124
 Low Oil Pressure
 Indicator..... 62, 335
 Malfunction Indicator
 Lamp 62, 84, 336
 Manually Closing Moonroof ... 339
 Overheated Engine 333
 Towing 345
Emergency Brake..... 151
Emergency Flashers 124
Emergency Towing 345
Emergency Trunk Opener 136
Emission, Check System
 Message..... 84
Emissions Controls..... 359
Emissions Testing 362
Engine
 Check Engine Oil Message..... 82

 Coolant Temperature Gauge 68
 If It Won't Start 329
 Malfunction Indicator Lamp ... 336
 Oil Life Display 73, 280
 Oil Pressure Indicator 62, 335
 Oil, What Kind to Use 291
 Overheating..... 333
 Specifications 351
 Speed Limiter 251, 257
 Starting..... 249
Engine Speed Limiter
 A/T 257
 M/T 251
Ethanol in Gasoline 232
Evaporative Emissions Controls.. 359
Exhaust Fumes 55
Expectant Mothers, Use of Seat
 Belts by 17

F

Fan, Interior..... 164
Fasten Seat Belt Message 78
Features 159
Filling the Fuel Tank..... 233

Filter
 Dust and Pollen..... 311
 Oil 293
Flashers, Hazard Warning..... 124
Flat Tire, Changing a 325
Floor Mats 310
Fluids
 Automatic Transmission..... 297
 Brake 300
 Clutch..... 301
 Manual Transmission 299
 Power Steering..... 301
 Washer Fluid Low Message..... 81
 Windshield Washer 296
Fog Lights 122
 Indicator 66
Folding Rear Seat 141
Four-way Flashers 124
Front Airbags 26
Front Wiper Action..... 117

Fuel..... 232
 Cap Message..... 79
 Economy..... 237
 Fill Door and Cap..... 233
 Gauge..... 68
 Low Fuel Indicator..... 66
 Low Message..... 81
 Octane Requirement..... 232
 Refueling..... 233
 Tighten Fuel Cap..... 79
 Fuse Locations..... 343
 Fuses, Checking the..... 340

G

Gas Mileage, Improving..... 238
 Gasoline..... 232
 Gauge..... 68
 Low Fuel Indicator..... 66
 Low Fuel Message..... 81
 Octane Requirement..... 232
 Tank, Filling the..... 233
 Gas Station Procedures..... 233
 Gauges
 Engine Coolant Temperature 68
 Fuel..... 68

Speedometer..... 68
 Tachometer..... 68
 GAWR (Gross Axle Weight
 Rating)..... 271
 Gearshift Lever Positions
 Automatic Transmission..... 252
 Manual Transmission..... 250
 Glove Box..... 158

H

Halogen Headlight Bulbs..... 302
 HandsFreeLink®, Bluetooth®..... 213
 Message..... 85
 Hazard Warning Flashers..... 124
 Headlights..... 121
 Aiming..... 302
 Automatic Lighting Off..... 122
 Auto Off Timer..... 108
 Daytime Running Lights..... 122
 Fog Lights..... 122
 High Beam Indicator..... 66
 Lights On Indicator..... 63
 Low Beams, Turning on..... 121
 Reminder Chime..... 121
 Replacing Halogen Bulbs..... 302

Turning on..... 121
 Head Restraints..... 139
 Safety Information..... 14
 Heated Mirror..... 146
 Heated Seat..... 137
 High Altitude, Starting at..... 249
 High Beam Indicator..... 66
 HomeLink® Universal
 Transceiver..... 209
 Hood, Opening and Closing the... 234
 Horn..... 4, 119
 Hydraulic Clutch..... 301

I

Identification Number, Vehicle... 348
 Ignition
 Keys..... 126
 Switch..... 128
 Timing Control System..... 359
 Immobilizer System..... 127
 Important Safety Precautions..... 6

CONTINUED

Index

| | |
|--|-------------|
| Indicators | 61 |
| ABS (Anti-lock Brake System) .. | 65 |
| Brake (Parking and Brake System) | 63, 338 |
| Charging System | 62, 336 |
| Cruise Main | 66 |
| Fog Light | 66 |
| High Beam | 66 |
| Key (Immobilizer System) | 64 |
| Lights On | 63 |
| Low Fuel | 66 |
| Low Oil Pressure | 62, 335 |
| Low Tire Pressure/ TPMS | 67, 263 |
| Malfunction Indicator Lamp(MIL) | 62, 84, 336 |
| Passenger Airbag Off | 33 |
| Seat Belt Reminder | 62 |
| Security System | 67 |
| Side Airbag Off | 64 |
| SRS | 63 |
| System Message | 66 |
| Turn Signal and Hazard Warning | 65 |
| VSA (Vehicle Stability Assist) Activation | 65 |

| | |
|------------------------------------|-----|
| VSA System | 64 |
| Indicators, Instrument Panel | 62 |
| Infant Restraint | 41 |
| Infant Seats | 41 |
| Tether Anchorage Points | 49 |
| Information (Multi) Display | 69 |
| INFO Button | 71 |
| INFO Knob | 71 |
| Inflation, Proper Tire | 314 |
| Input Jack, Auxiliary | 184 |
| Inside Mirror | 146 |
| Inspection, Tire | 316 |
| Installing a Child Seat | 45 |
| Tether Anchorage Points | 49 |
| Using LATCH | 46 |
| Instrument Panel | 61 |
| Indicators | 62 |
| Instrument Panel Brightness | 123 |
| Interior Lights | 153 |
| Interior Light Dimming Time | 106 |
| Introduction | i |

| |
|----------|
| J |
|----------|

| | |
|------------------------------|-----|
| Jacking up the Vehicle | 326 |
| Jack, Tire | 325 |

| | |
|---------------------|-----|
| Jump Starting | 331 |
|---------------------|-----|

K

| | |
|---------------------------------------|-----|
| Key, Remove Message | 79 |
| Keyless Lock Acknowledgement | 113 |
| Keys and Locks | 126 |

L

| | |
|------------------------------------|--------------|
| Label, Certification | 348 |
| Lane Change, Signaling | 121 |
| Language Selection | 94 |
| Lap/Shoulder Belts | 20 |
| LATCH, Using | 46 |
| Lever, Release Parking Message .. | 78 |
| Lights Bulb Replacement | 302 |
| Indicator | 63 |
| Setup | 106 |
| Turn Signal | 65, 304, 306 |
| Load Limits | 243 |
| LOCK (Ignition Key Position) | 128 |

Locks
 Anti-theft Steering Column 128
 Childproof Door 130
 Fuel Fill Door 233
 Glove Box 158
 Lockout Prevention 130
 Power Door 129
 Trunk 135
 Low Coolant Level..... 236
 Low Fuel Indicator 66
 Lower Gear, Downshifting to a.... 250
 Low Oil Pressure Indicator ... 62, 335
 Lubricant Specifications Chart ... 350
 Luggage, Storing 242

M

Maintenance..... 277
 Owner Maintenance Checks.... 288
 Main Items 289
 Messages 74
 Minder..... 280
 Safety..... 278
 Malfunction Indicator Lamp .. 62, 336
 Manual Transmission..... 250
 Manual Transmission Fluid 299

Memory, Driving Position 143
 Memory Position Link 104
 Messages, System 75
 Meters, Gauges..... 68
 Mirrors, Adjusting 146
 Modifications..... 241
 Moonroof 150
 Closing Manually 339
 Operation 150
 Multi-Information Display 69
 Change Setting..... 92
 Customized Settings..... 86
 Default All..... 90

N

Neutral Gear Position..... 253
 New Vehicle Break-in 232
 Normal Shift Speeds..... 250
 NOTICE, Explanation of..... i
 Numbers, Identification..... 348

O

Octane Requirement, Gasoline.... 232
 Odometer..... 70

Oil
 Change, How to 293
 Change, When to 280
 Checking Engine 236
 Level Check Message..... 82
 Life Display 73
 Pressure Indicator 62, 335
 Pressure Message 82
 Selecting Proper Viscosity
 Chart 292
 ON (Ignition Key Position) 128
 Onboard Refueling Vapor
 Recovery 359
 Outside Mirrors 146
 Outside Temperature..... 73
 Overheating, Engine 333
 Owner Maintenance Checks..... 288

P

Panel Brightness Control 123
 Park Gear Position..... 253
 Parking Brake 151

CONTINUED

Index

Parking Brake and Brake System
 Indicator..... 63
 Message..... 84
 Release Parking Lever
 Message..... 78
Parking Lights..... 121
Parking Over Things that
 Burn..... 259, 360
Parking Tips..... 259
Passenger Airbag Off Indicator..... 33
Passenger Side Airbag Off
 Indicator..... 32, 64
 Message..... 82
PGM-FI System..... 360
Pollen Filter 311
Power Door Locks..... 129
Power Mirror Heaters..... 146
Power Socket Locations..... 156
Power Windows 147
Pregnancy, Using Seat Belts..... 17
Preparing to Drive 248
Primary Display Selection 102
Protecting Adults and Teens..... 11
 Additional Safety Precautions.... 18
 Advice for Pregnant Women..... 17
Protecting Children 36

Protecting Infants and Small
 Children 41
Protecting Larger Children 51
 Using a Booster Seat..... 52
Protecting Your CDs..... 194

R

Radiator Overheating..... 333
Radio/CD Sound System..... 170
Readiness Codes..... 337, 362
Rear Lights,
 Bulb Replacement 306, 307
Rear Seat, Folding 141
Rear View Mirror..... 145
Rear Window Defogger 124
Reclining the Seat Backs 138
Recommended Shift Speeds 250
Release Parking Lever Message ... 78
Reminder Indicators..... 62
Remote Transmitter..... 131
Remove Key Message..... 79
Replacement Information
 Engine Oil and Filter 293
 Fuses 340
 Light Bulbs..... 302

Minder..... 280
Tires 317
Wiper Blades..... 312
Replacing Seat Belts After a
 Crash 22
Reserve Tank, Coolant..... 295
Restraint, Child 36
Reverse Gear Position..... 253
Reverse Lockout..... 251
Rotation, Tire 317

S

Safety Belts..... 8
Safety Defects, Reporting..... 368
Safety Features 7
 Airbags..... 9
 Seat Belts 8
Safety Labels, Location of 56
Safety Messages iii
Satellite Digital Radio..... 179

| | | | | | |
|----------------------------------|--------|--------------------------------------|----------|----------------------------------|--------|
| Seat Belts | 8, 19 | Shift Lever Position Indicator | 252 | Indicator Works | 33 |
| Additional Information | 19 | Shift Lock Release | 257 | How the SRS Indicator Works ... | 32 |
| Automatic Seat Belt | | Side Airbags | 9, 30 | How Your Front Airbags | |
| Tensioners | 21 | How Your Side Airbags Work ... | 30 | Work | 26 |
| Cleaning | 310 | How the Side Airbag Off | | How Your Side Airbags Work ... | 30 |
| Fasten Seat Belt Message | 78 | Indicator Works | 32 | How Your Side Curtain Airbags | |
| Lap/Shoulder Belt | 20 | Side Curtain Airbags | 9, 31 | Work | 31 |
| Maintenance | 22 | How Your Side Curtain | | SRS Components | 23 |
| Reminder Indicator and | | Airbags Work | 31 | SRS Service | 34 |
| Beeper | 19, 62 | Side Marker Lights, Bulb | | SRS Indicator | 32, 63 |
| System Components | 19 | Replacement in | 305, 306 | Message | 83 |
| Use During Pregnancy | 17 | Signaling Turns | 121 | START (Ignition Key Position) .. | 128 |
| Wearing a Lap/Shoulder Belt ... | 20 | Snow Tires | 319 | Starting the Engine | 249 |
| Seat Heaters | 137 | Sockets, Accessory Power | 156 | In Cold Weather at High | |
| Seat Position Memory | 143 | Sound System | 175 | Altitude | 249 |
| Seats, Adjusting the | 138 | Spare Tire | | With a Dead Battery | 331 |
| Security System | 205 | Inflating | 324 | Steam Coming from Engine | 333 |
| Indicator | 67 | Specifications | 352 | Steering Wheel | |
| Security Relock Timer | 115 | Specifications Charts | 350 | Adjustment | 125 |
| Selecting a Child Seat | 44 | Speed Limiter | 251, 257 | Anti-theft Column Lock | 128 |
| Select/Reset Button | 72 | Speedometer | 68 | Storing Your Vehicle | 321 |
| Serial Number | 348 | Spotlights | 153 | Sun Visor | 152 |
| Service Manual | 369 | SRS, Additional Information | 23 | Sunglasses Holder | 158 |
| Service Station Procedure | 233 | Additional Safety Precautions ... | 35 | | |
| Setting the Clock | 204 | Airbag Service | 34 | | |
| Sequential SportShift Mode | 254 | How the Passenger Airbag Off | | | |

CONTINUED

Index

Supplemental Restraint
System..... 9, 23
Servicing 34
SRS Indicator..... 32, 63
System Components..... 23
Synthetic Oil..... 292
System Messages 75
System Message Indicator 66

T

Tachometer 68
Taillights, Changing Bulbs in..... 307
Taking Care of the Unexpected .. 323
Technical Descriptions
DOT Tire Quality Grading 353
Emissions Control Systems..... 359
Three Way Catalytic
Converter..... 360
Temperature Gauge 68
Temperature, Inside Sensor..... 169
Temperature, Outside..... 73
Tether Anchorage Points 49
Three Way Catalytic Converter.. 361
Tighten Fuel Cap Message 79
Tilt/Telescopic Steering Wheel .. 125

Time, Setting the 204
Tire Chains 319
Tire, How to Change a Flat 325
Tire Labeling..... 355
Tire Pressure Monitoring System
(TPMS) 263
Changing a Tire with TPMS 266
Check TPMS System
Message..... 267
Low Tire Pressure/TPMS
Indicator..... 67, 263
Required Federal
Explanation..... 357
Tire Pressure Monitor 264
Tire Pressure Readings 265
Tires 314
Air Pressure 315
Chains 319
Checking Wear 316
Compact Spare 324
DOT Tire Quality Grading 353
Inflation..... 314
Inspection 316
Replacing 317
Rotating..... 317
Service Life..... 316

Snow 319
Specifications 318, 352
Tools, Tire Changing 325
Towing
A Trailer..... 270
Emergency Wrecker 345
Equipment and Accessories..... 272
Weight Limit 270
Transmission
Check Message 83
Checking Fluid Level,
Automatic 297
Checking Fluid Level,
Manual 299
Fluid Selection 298, 299
Identification Number..... 348
Shifting the Automatic..... 252
Shifting the Manual..... 250
Treadwear 353
Trip A & AVG. Fuel Reset with
Refuel..... 98
Trip Meter 72

X

Trunk..... 135
 Emergency Opener 136
 Main Switch..... 136
 Opening the..... 135
 Open Monitor..... 78
 Turn Signals 65, 121

U

Unexpected, Taking Care of
 the..... 323
 Uniform Tire Quality Grading 353
 Unleaded Gasoline..... 232
 Upholstery Cleaning..... 310
 Used Oil, How to Dispose of 294

V

Vanity Mirror 152
 Vehicle Capacity Load 243
 Vehicle Dimensions..... 350
 Vehicle Identification Number.... 348
 Vehicle Stability Assist (VSA)
 System..... 268
 Activation Indicator 65, 268
 Message..... 82

Off Switch..... 269
 System Indicator..... 64, 268
 Vehicle Storage..... 321
 VIN 348
 Viscosity, Oil..... 292

W

WARNING, Explanation of iii
 Warning Labels, Location of 56
 Warranty Coverages 367
 Washer, Windshield
 Checking the Fluid Level 296
 Fluid Low Message 81
 Operation..... 120
 Wipers and Washers..... 120
 Wheels 314
 Adjusting the Steering 125
 Alignment and Balance..... 317
 Compact Spare 324
 Nut Wrench..... 326

Windows
 Auto Reverse..... 148
 Operating the Power 147
 Rear, Defogger 124

Windshield
 Cleaning 120
 Defroster 165
 Washers..... 120
 Wipers, Windshield
 Changing Blades..... 312
 Operation..... 120
 Worn Tires 316
 Wrecker, Emergency Towing..... 345

X

XM Radio 179

Y

Your Vehicle at a Glance 3
 Your Vehicle's Safety Features..... 7

2008 TSX

2008 TSX

Service Information Summary

Gasoline:

Premium unleaded gasoline, pump octane number of 91 or higher.

Fuel Tank Capacity:

17.1 US gal (64.7 ℓ)

Recommended Engine Oil:

API Premium grade 5W-30 detergent oil (see page [291](#)).

Oil change capacity (including filter):

4.4 US qt (4.2 ℓ)

Automatic Transmission Fluid:

Honda ATF-Z1 (Automatic Transmission Fluid) (see page [298](#)).

6-speed Manual Transmission

Fluid:

Honda Manual Transmission Fluid preferred, or an SAE 10W-30 or 10W-40 motor oil as a temporary replacement (see page [299](#)).

Capacity:

2.1 US qt (2.0 ℓ)

Power Steering Fluid:

Honda Power Steering Fluid preferred, or another brand of power steering fluid as a temporary replacement. Do not use ATF (see page [301](#)).

Brake Fluid:

Honda Heavy Duty Brake Fluid DOT 3 preferred, or a DOT 3 or DOT 4 brake fluid as a temporary replacement (see page [300](#)).

Tire Pressure (measured cold):

Front:

32 psi (220 kPa , 2.2 kgf/cm²)

Rear:

30 psi (210 kPa , 2.1 kgf/cm²)

Compact Spare Tire:

60 psi (420 kPa , 4.2 kgf/cm²)

Owner's Identification

OWNER _____

ADDRESS _____

STREET

_____ CITY

STATE/PROVINCE

ZIP CODE/
POSTAL CODE

V. I. N. _____

DELIVERY DATE _____

(Date sold to original retail purchaser)

DEALER NAME _____ DEALER NO. _____

ADDRESS _____

STREET

_____ CITY

STATE/PROVINCE

ZIP CODE/
POSTAL CODE

OWNER'S SIGNATURE _____

DEALER'S SIGNATURE _____

This owner's manual should be considered a permanent part of the vehicle and should remain with the vehicle when it is sold.

This owner's manual covers all models of the TSX. You may find descriptions of equipment and features that are not on your particular model.

The information and specifications included in this publication were in effect at the time of approval for printing. Honda Motor Co., Ltd. reserves the right, however, to discontinue or change specifications or design at any time without notice and without incurring any obligation whatsoever.

**POUR CLIENTS CANADIEN
AVIS IMPORTANT: Si vous avez
besoin d'un Manuel du Conducteur
en français, veuillez demander à
votre concessionnaire de
commander le numéro de pièce
33SEAC40**