

Congratulations! Your selection of a 2009 Acura TL was a wise investment. It will give you years of driving pleasure.

One of the best ways to enhance the enjoyment of your new vehicle is to read this manual. In it, you will learn how to operate its driving controls and convenience items. Afterwards, keep this owner's manual in your vehicle so you can refer to it at any time.

Several warranties protect your new vehicle. Read the warranty booklet thoroughly so you understand the coverages and are aware of your rights and responsibilities.

Maintaining your vehicle according to the maintenance minder shown in the instrument panel helps to keep your driving trouble-free while it preserves your investment. When your vehicle needs maintenance, keep in mind that your dealer's staff is specially trained in servicing the many systems unique to your vehicle. Your dealer is dedicated to your satisfaction and will be pleased to answer any questions and concerns.

As you read this manual, you will find information that is preceded by a **NOTICE** symbol. This information is intended to help you avoid damage to your vehicle, other property, or the environment.

Introduction

California Proposition 65 Warning

WARNING: This product contains or emits chemicals known to the State of California to cause cancer and birth defects or other reproductive harm.

Event Data Recorders

This vehicle is equipped with one or more devices commonly referred to as event data recorders. These devices record front seat belt use, front passenger seat occupancy, airbag deployment data, and the failure of any airbag system component. This data belongs to the vehicle owner and may not be accessed by anyone else except as legally required or with the permission of the vehicle owner.

Service Diagnostic Recorders

This vehicle is equipped with service-related devices that record information about powertrain performance. The data can be used to verify emissions law requirements and/or help technicians diagnose and solve service problems. It may also be combined with data from other sources for research purposes, but it remains confidential.

Your safety, and the safety of others, is very important. And operating this vehicle safely is an important responsibility.

To help you make informed decisions about safety, we have provided operating procedures and other information on labels and in this manual. This information alerts you to potential hazards that could hurt you or others.

Of course, it is not practical or possible to warn you about all the hazards associated with operating or maintaining your vehicle. You must use your own good judgement.

You will find this important safety information in a variety of forms, including:

- **Safety Labels** – on the vehicle.
- **Safety Messages** – preceded by a safety alert symbol  and one of three signal words: **DANGER**, **WARNING**, or **CAUTION**.
These signal words mean:

 **DANGER**

You **WILL** be **KILLED** or **SERIOUSLY HURT** if you don't follow instructions.

 **WARNING**

You **CAN** be **KILLED** or **SERIOUSLY HURT** if you don't follow instructions.

 **CAUTION**

You **CAN** be **HURT** if you don't follow instructions.

- **Safety Headings** – such as Important Safety Reminders or Important Safety Precautions.
- **Safety Section** – such as Driver and Passenger Safety.
- **Instructions** – how to use this vehicle correctly and safely.

This entire book is filled with important safety information – please read it carefully.

Owner's Identification Form

Introduction	i
A Few Words About Safety	iii
Your Vehicle at a Glance (main controls).....	3
Driver and Passenger Safety (seat belts, SRS, and child protection).....	5
Instruments and Controls (indicators, gauges, multi-information display, dashboard, and steering column).....	61
Features (climate control, audio, steering wheel, security, cruise control, Homelink®, and other convenience items).....	213
Before Driving (fuel, vehicle break-in, and cargo loading).....	485
Driving (engine and transmission operation).....	501
Maintenance (minder, fluid checking, minor services, and vehicle storage).....	533
Taking Care of the Unexpected (flat tire, dead battery, overheating, and fuses).....	581
Technical Information (vehicle specifications, tires, and emissions controls).....	611
Warranty and Client Relations (U.S. and Canada only) (warranty and contact information).....	629
Authorized Manuals (U.S. only) (how to order).....	633
Index	I

Service Information Summary (fluid capacities and tire pressures)

Overview of Contents

Contents

A convenient reference to the sections in this manual.

Your Vehicle at a Glance

A quick reference to the main controls in your vehicle.

Driver and Passenger Safety

Important information about the proper use and care of your vehicle's seat belts, an overview of the supplemental restraint system, and valuable information on how to protect children with child restraints.

Instruments and Controls

Explains the purpose of each instrument panel indicator and gauge, and how to use the controls on the dashboard and steering column.

Features

How to operate the climate control system, the audio system, and other convenience features.

Before Driving

What gasoline to use, how to break-in your new vehicle, and how to load luggage and other cargo.

Driving

The proper way to start the engine, shift the transmission, and park.

Maintenance

The maintenance minder shows you when you need to take your vehicle to the dealer for maintenance service. There is also a list of things to check and instructions on how to check them.

Taking Care of the Unexpected

This section covers several problems motorists sometimes experience, and details how to handle them.

Technical Information

ID numbers, dimensions, capacities, and technical information.

Warranty and Client Relations (U.S. and Canada only)

A summary of the warranties covering your new vehicle, and how to contact us for any reason. Refer to your warranty manual for detailed information.

Authorized Manuals (U.S. only)

How to order manuals and other technical literature.

Index

Service Information Summary

A summary of the information you need when you pull up to the fuel pump.

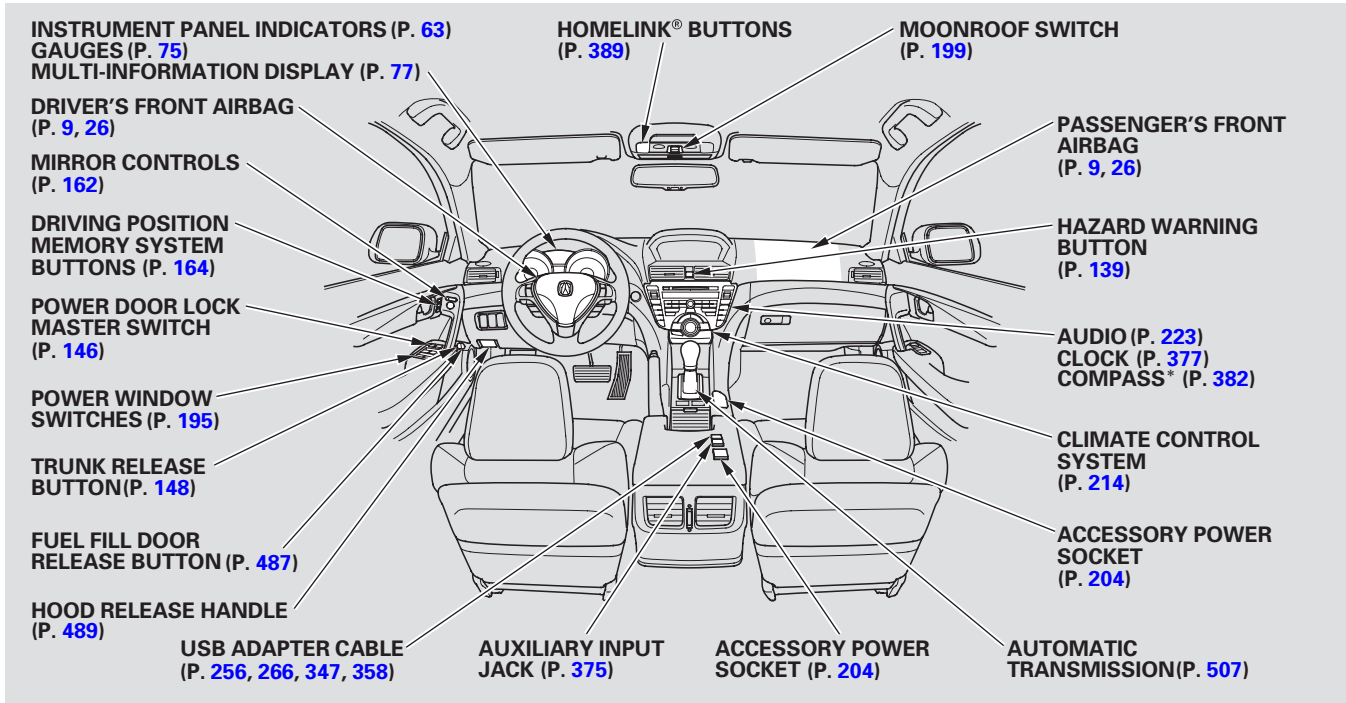

* : If equipped

Your Vehicle at a Glance

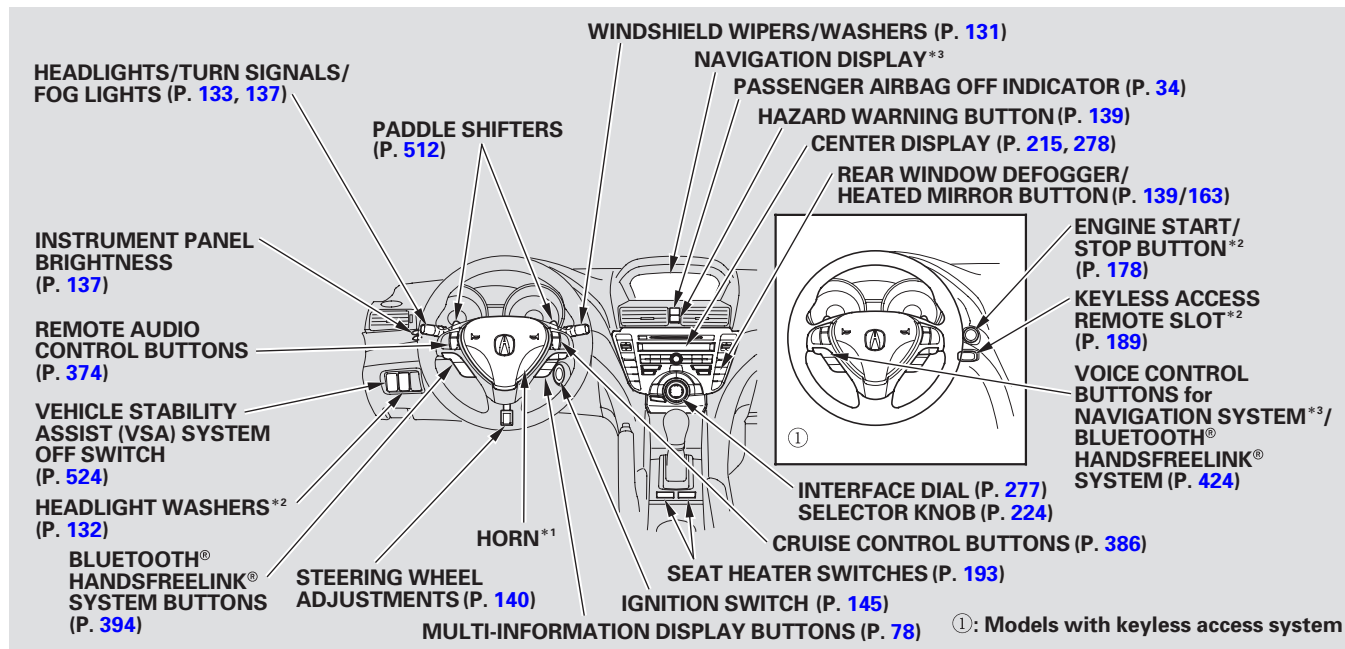

* 1: To use the horn, press the center pad of the steering wheel.

* 2: If equipped

* 3: Refer to the navigation system owner's manual.

This section gives you important information about how to protect yourself and your passengers. It shows you how to use seat belts. It explains how your airbags work. And it tells you how to properly restrain infants and children in your vehicle.

- Important Safety Precautions 6
- Your Vehicle’s Safety Features..... 7
 - Seat Belts..... 8
 - Airbags..... 9
- Protecting Adults and Teens..... 11
 - 1. Close and Lock the Doors 11
 - 2. Adjust the Front Seats 13
 - 3. Adjust the Seat-Backs 14
 - 4. Adjust the Head Restraints 15
 - 5. Fasten and Position the Seat Belts..... 16
 - 6. Maintain a Proper Sitting Position 18
- Advice for Pregnant Women..... 18
- Additional Safety Precautions.... 19

- Additional Information About Your Seat Belts 20
- Seat Belt System Components... 20
- Lap/Shoulder Belt..... 21
- Automatic Seat Belt Tensioners..... 22
- Seat Belt Maintenance..... 23
- Additional Information About Your Airbags 24
- Airbag System Components..... 24
- How Your Front Airbags Work..... 26
- How Your Side Airbags Work.... 30
- How Your Side Curtain Airbags Work..... 32
- How the SRS Indicator Works... 32
- How the Side Airbag Off Indicator Works..... 33
- How the Passenger Airbag Off Indicator Works..... 34
- Airbag Service..... 35
- Additional Safety Precautions.... 36
- Protecting Children – General Guidelines..... 37
- All Children Must Be Restrained 37

- All Children Should Sit in a Back Seat 38
- The Passenger’s Front Airbag Can Pose Serious Risks 38
- If You Must Drive with Several Children 40
- If a Child Requires Close Attention 40
- Additional Safety Precautions.... 41
- Protecting Infants and Small Children 42
- Protecting Infants..... 42
- Protecting Small Children 43
- Selecting a Child Seat..... 45
- Installing a Child Seat 46
 - With LATCH..... 47
 - With a Lap/Shoulder Belt 49
 - With a Tether..... 51
- Protecting Larger Children 53
- Checking Seat Belt Fit..... 53
- Using a Booster Seat..... 54
 - When Can a Larger Child Sit in Front..... 55
 - Additional Safety Precautions.... 56
- Carbon Monoxide Hazard 57
- Safety Labels 58

Important Safety Precautions

You'll find many safety recommendations throughout this section, and throughout this manual. The recommendations on this page are the ones we consider to be the most important.

Always Wear Your Seat Belt

A seat belt is your best protection in all types of collisions. Airbags are designed to supplement seat belts, not replace them. So even though your vehicle is equipped with airbags, make sure you and your passengers always wear your seat belts, and wear them properly (see page 16).

Restrain All Children

Children age 12 and under should ride properly restrained in a back seat, not the front seat. Infants and small children should be restrained in a child seat. Larger children should use a booster seat and a lap/shoulder belt until they can use the belt properly without a booster seat (see pages 37 – 56).

Be Aware of Airbag Hazards

While airbags can save lives, they can cause serious or fatal injuries to occupants who sit too close to them, or are not properly restrained. Infants, young children, and short adults are at the greatest risk. Be sure to follow all instructions and warnings in this manual.

Don't Drink and Drive

Alcohol and driving don't mix. Even one drink can reduce your ability to respond to changing conditions, and your reaction time gets worse with

every additional drink. So don't drink and drive, and don't let your friends drink and drive, either.

Control Your Speed

Excessive speed is a major factor in crash injuries and deaths. Generally, the higher the speed, the greater the risk, but serious injuries can also occur at lower speeds. Never drive faster than is safe for current conditions, regardless of the maximum speed posted.

Keep Your Vehicle in Safe Condition

Having a tire blowout or a mechanical failure can be extremely hazardous. To reduce the possibility of such problems, check your tire pressures and condition frequently, and perform all regularly scheduled maintenance (see page 568).

Your Vehicle's Safety Features

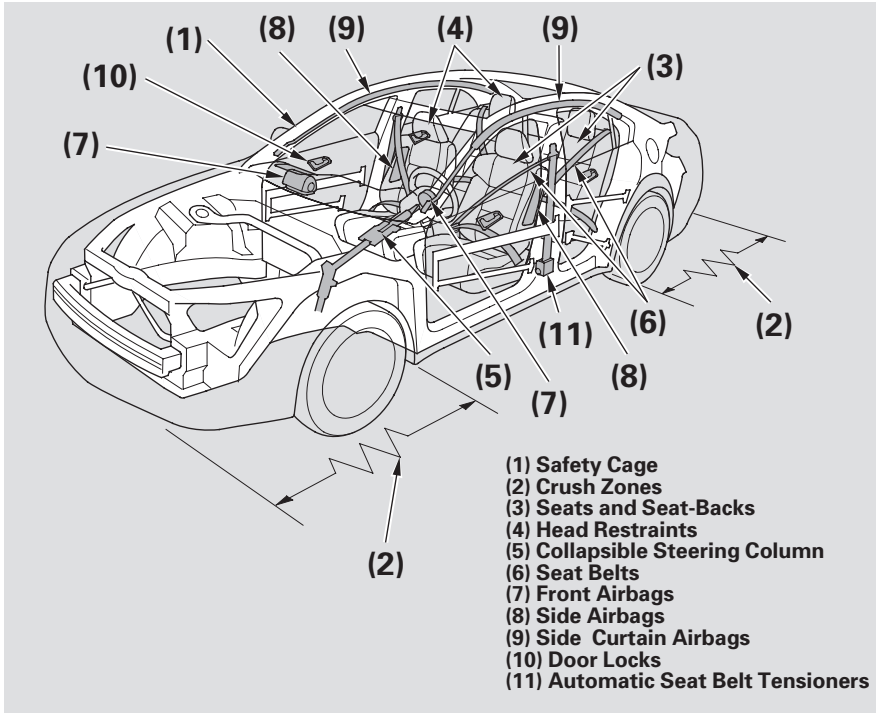

Your vehicle is equipped with many features that work together to protect you and your passengers during a crash.

Some features do not require any action on your part. These include a strong steel framework that forms a safety cage around the passenger compartment; front and rear crush zones; a collapsible steering column; and tensioners that tighten the front seat belts in a crash.

CONTINUED

Your Vehicle's Safety Features

However, you and your passengers can't take full advantage of these features unless you remain sitting in a proper position and ***always wear your seat belts***. In fact, some safety features can contribute to injuries if they are not used properly.

The following pages explain how you can take an active role in protecting yourself and your passengers.

Seat Belts

Your vehicle is equipped with seat belts in all seating positions.

Your seat belt system also includes an indicator on the instrument panel and a beeper to remind you and your passengers to fasten your seat belts.

Why Wear Seat Belts

Seat belts are the single most effective safety device for adults and larger children. (Infants and smaller children must be properly restrained in child seats.)

Not wearing a seat belt properly increases the chance of serious injury or death in a crash, even though your vehicle has airbags.

In addition, most states and all Canadian provinces require you to wear seat belts.

⚠ WARNING

Not wearing a seat belt properly increases the chance of serious injury or death in a crash, even though your vehicle has airbags.

Be sure you and your passengers always wear seat belts and wear them properly.

When properly worn, seat belts:

- Keep you connected to the vehicle so you can take advantage of the vehicle's built-in safety features.
- Help protect you in almost every type of crash, including frontal, side and rear impacts, and rollovers.

- Help keep you from being thrown against the inside of the vehicle and against other occupants.
- Keep you from being thrown out of the vehicle.
- Help keep you in a good position should the airbags ever deploy. A good position reduces the risk of injury from an inflating airbag and allows you to get the best advantage from the airbag.

Of course, seat belts cannot completely protect you in every crash. But in most cases, seat belts can reduce your risk of serious injury.

What You Should Do:

Always wear your seat belt, and make sure you wear it properly.

Airbags

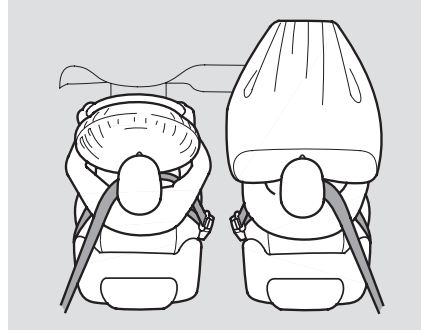

Your vehicle has a supplemental restraint system (SRS) with front airbags to help protect the heads and chests of the driver and a front seat passenger during a moderate to severe frontal collision (see page [26](#) for more information on how your front airbags work).

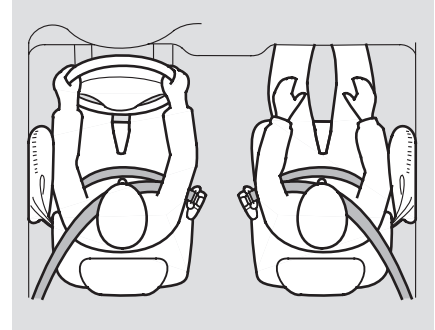

Your vehicle also has side airbags to help protect the upper torso of the driver or a front seat passenger during a moderate to severe side impact (see page [30](#) for more information on how your side airbags work).

CONTINUED

Your Vehicle's Safety Features

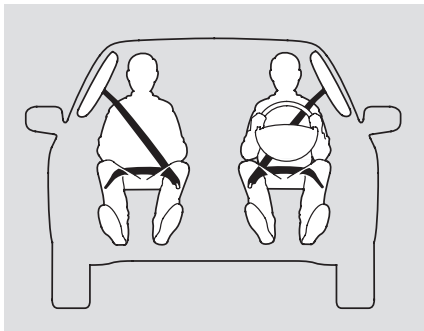

In addition, your vehicle has side curtain airbags to help protect the heads of the driver, front passenger, and passengers in the outer rear seating positions during a moderate to severe side impact (see page [32](#) for more information on how your side curtain airbags work).

The most important things you need to know about your airbags are:

- ***Airbags do not replace seat belts.*** They are designed to supplement the seat belts.
- ***Airbags offer no protection in rear impacts, or minor frontal or side collisions.***
- ***Airbags can pose serious hazards.*** To do their job, airbags must inflate with tremendous force. So while airbags help save lives, they can cause minor injuries or more serious or even fatal injuries if occupants are not properly restrained or sitting properly.

What you should do: Always wear your seat belt properly, and sit upright and as far back from the steering wheel as possible while allowing full control of the vehicle. A front passenger should move their seat as far back from the dashboard as possible.

The rest of this section gives more detailed information about how you can maximize your safety.

Remember however, that no safety system can prevent all injuries or deaths that can occur in a severe crash, even when seat belts are properly worn and the airbags deploy.

Introduction

The following pages provide instructions on how to properly protect the driver, adult passengers and teenage children who are large enough and mature enough to drive or ride in the front seat.

See pages 37 – 56 for important guidelines on how to properly protect infants, small children, and larger children who ride in your vehicle.

1. Close and Lock the Doors

After everyone has entered the vehicle, be sure the doors and trunk are closed and locked.



Your vehicle has a door/trunk open indicator (red) on the instrument panel to indicate when any door or the trunk lid is not tightly closed.

See page 146 for how to lock the doors, and page 12 for how the door/trunk open indicator works.

Your vehicle also has a door and trunk open indicator on the multi-information display to indicate when a specific door or the trunk is not tightly closed. You will see the appropriate indicator(s) for each condition.

You will also hear a beep when you turn the ignition switch* to the ON (II) position, and each time you open any door or the trunk with the key in the ON (II) position.

* : Models equipped with the keyless access system have an engine start/stop button instead of an ignition switch. ON Mode is the equivalent of ON (II). For more information, see pages 178 and 180.

CONTINUED

Protecting Adults and Teens



The above illustration shows that all doors and the trunk are open.



When the trunk is not tightly closed, the "TRUNK OPEN" indicator will come on.



When one or more doors or the trunk lid are not tightly closed, the corresponding indicator for each condition will come on.

The above example shows the front right and rear left doors, and the trunk open.

Locking the doors reduces the chance of someone being thrown out of the vehicle during a crash, and it helps prevent passengers from accidentally opening a door and falling out.

Locking the doors also helps prevent an outsider from unexpectedly opening a door when you come to a stop.

Your vehicle has the auto door locking/unlocking feature. For more information, see page [120](#).

2. Adjust the Front Seats

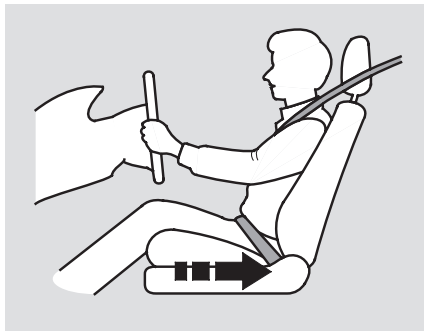

Adjust the driver's seat as far to the rear as possible while allowing you to maintain full control of the vehicle. Have a front passenger adjust their seat as far to the rear as possible.

If you sit too close to the steering wheel or dashboard, you can be seriously injured by an inflating front airbag, or by striking the steering wheel or dashboard.

The National Highway Traffic Safety Administration and Transport Canada recommend that drivers allow at least 10 inches (25 cm) between the center of the steering wheel and the chest. In addition to adjusting the seat, you can adjust the steering wheel up and down, and in and out (see page [140](#)).

If you cannot get far enough away from the steering wheel and still reach the controls, we recommend that you investigate whether some type of adaptive equipment may help.

CONTINUED

Protecting Adults and Teens

⚠ WARNING

Sitting too close to a front airbag can result in serious injury or death if the front airbags inflate.

Always sit as far back from the front airbags as possible.

See page [155](#) for how to adjust the front seats.

3. Adjust the Seat-Backs

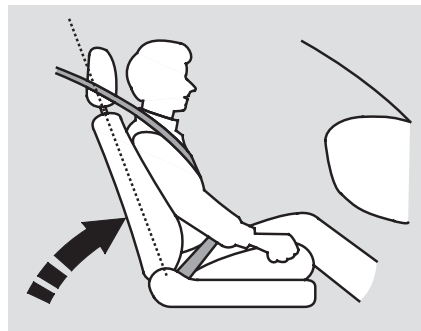

Adjust the driver's seat-back to a comfortable, upright position, leaving ample space between your chest and the airbag cover in the center of the steering wheel.

Passengers with adjustable seat-backs should also adjust their seat-back to a comfortable, upright position.

⚠ WARNING

Reclining the seat-back too far can result in serious injury or death in a crash.

Adjust the seat-back to an upright position, and sit well back in the seat.

Reclining a seat-back so that the shoulder part of the belt no longer rests against the occupant's chest reduces the protective capability of the belt. It also increases the chance of sliding under the belt in a crash and being seriously injured. The farther a seat-back is reclined, the greater the risk of injury.

See page [155](#) for how to adjust the seat-backs.

4. Adjust the Head Restraints

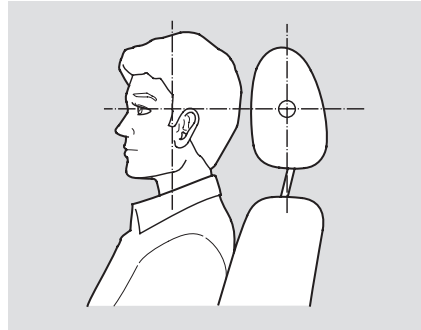

Adjust the driver's head restraint so the center of the back of your head rests against the center of the restraint.

Have passengers adjust their head restraints properly as well. Taller persons should adjust their restraint as high as possible.

⚠ WARNING

Improperly positioning head restraints reduces their effectiveness and you can be seriously injured in a crash.

Make sure head restraints are in place and positioned properly before driving.

CONTINUED

Protecting Adults and Teens

Properly adjusted head restraints will help protect occupants from whiplash and other crash injuries.

See page [156](#) for how to adjust the head restraints and how the driver's and front passenger's active head restraints work.

5. Fasten and Position the Seat Belts

Insert the latch plate into the buckle, then tug on the belt to make sure the belt is securely latched. Also check that the belt is not twisted, because a twisted belt can cause serious injuries in a crash.



Position the lap part of the belt as low as possible across your hips, then pull up on the shoulder part of the belt so the lap part fits snugly. This lets your strong pelvic bones take the force of a crash and reduces the chance of internal injuries.

If necessary, pull up on the belt again to remove any slack, then check that the belt rests across the center of your chest and over your shoulder. This spreads the forces of a crash over the strongest bones in your upper body.

⚠ WARNING

Improperly positioning the seat belts can cause serious injury or death in a crash.

Make sure all seat belts are properly positioned before driving.

If the seat belt touches or crosses your neck, or if it crosses your arm instead of your shoulder, you need to adjust the seat belt anchor height.

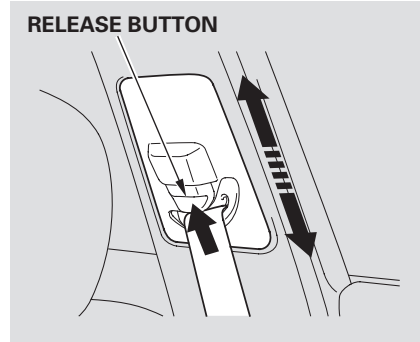

The front seats have adjustable seat belt anchors. To adjust the height of an anchor, press and hold the release button and slide the anchor up or down as needed (it has four positions).

Never place the shoulder portion of a lap/shoulder belt under your arm or behind your back. This could cause very serious injuries in a crash.

If a seat belt does not seem to work properly, it may not protect the occupant in a crash.

No one should sit in a seat with an inoperative seat belt. Using a seat belt that is not working properly can result in serious injury or death. Have your dealer check the belt as soon as possible.

See page [20](#) for additional information about your seat belts and how to take care of them.

Protecting Adults and Teens

6. Maintain a Proper Sitting Position

After all occupants have adjusted their seats and head restraints, and put on their seat belts, it is very important that they continue to sit upright, well back in their seats, with their feet on the floor, until the vehicle is parked and the engine is off.

Sitting improperly can increase the chance of injury during a crash. For example, if an occupant slouches, lies down, turns sideways, sits forward, leans forward or sideways, or puts one or both feet up, the chance of injury during a crash is greatly increased.

In addition, an occupant who is out of position in the front seat can be seriously or fatally injured in a crash by striking interior parts of the vehicle or being struck by an inflating front airbag.

WARNING

Sitting improperly or out of position can result in serious injury or death in a crash.

Always sit upright, well back in the seat, with your feet on the floor.

Advice for Pregnant Women



If you are pregnant, the best way to protect yourself and your unborn child when driving or riding in a vehicle is to always wear a seat belt, and keep the lap part of the belt as low as possible across the hips.

When driving, remember to sit upright and adjust the seat as far back as possible while allowing full control of the vehicle. When riding as a front passenger, adjust the seat as far back as possible.

This will reduce the risk of injuries to both you and your unborn child that can be caused by a crash or an inflating front airbag.

Each time you have a checkup, ask your doctor if it's okay for you to drive.

Additional Safety Precautions

- ***Two people should never use the same seat belt.*** If they do, they could be very seriously injured in a crash.
- ***Do not put any accessories on seat belts.*** Devices intended to improve occupant comfort or reposition the shoulder part of a seat belt can reduce the protective capability of the belt and increase the chance of serious injury in a crash.
- ***Do not place hard or sharp objects between yourself and a front airbag.*** Carrying hard or sharp objects on your lap, or driving with a pipe or other sharp object in your mouth, can result in injuries if your airbags inflate.
- ***Keep your hands and arms away from the airbag covers.*** If your hands or arms are close to an airbag cover, they could be injured if the airbags inflate.
- ***Do not attach or place objects on the front airbag covers.*** Objects on the covers marked “SRS AIRBAG” could interfere with the proper operation of the airbags or be propelled inside the vehicle and hurt someone if the airbags inflate.
- ***Do not attach hard objects on or near a door.*** If a side airbag or a side curtain airbag inflates, a cup holder or other hard object attached on or near the door could be propelled inside the vehicle and hurt someone.

Additional Information About Your Seat Belts

Seat Belt System Components

Your seat belt system includes lap/shoulder belts in all seating positions. The front seat belts are also equipped with automatic seat belt tensioners.

This system uses the same sensors as the front airbags to monitor whether the front seat belts are latched or unlatched, and how much weight is on the front passenger's seat (see pages [28](#) and [29](#)).



The seat belt system includes an indicator on the instrument panel and a beeper to remind you and your passengers to fasten your seat belts.

This system monitors the front seat belts. If you turn the ignition switch* to the ON (II) position before your seat belt is fastened, the beeper will sound and the indicator will flash. If your seat belt is not fastened before the beeper stops, the indicator will stop flashing but remain on.

You will also see a “FASTEN SEAT BELT” message on the multi-information display.

If a front passenger does not fasten their seat belt, the indicator will come on about 6 seconds after the ignition switch is turned to the ON (II) position.

If either the driver or a front passenger does not fasten their seat belt while driving, the beeper will sound and the indicator will flash again at regular intervals.

You will also see a “FASTEN SEAT BELT” or “FASTEN PASSENGER SEAT BELT” message on the multi-information display (see page [78](#)).

When no one is sitting in the front passenger's seat, or a child or small adult is riding there, the indicator should not come on and the beeper should not sound.

* : Models equipped with the keyless access system have an engine start/stop button instead of an ignition switch. ON Mode is the equivalent of ON (II). For more information, see pages [178](#) and [180](#).

Additional Information About Your Seat Belts

If the indicator comes on or the beeper sounds when the driver's seat belt is latched and there is no front seat passenger and no items on the front seat, something may be interfering with the monitoring system. Look for and remove:

- Any items under the front passenger's seat.
- Any object(s) hanging on the seat or in the seat-back pocket.
- Any object(s) touching the rear of the seat-back.

If no obstructions are found, have your vehicle checked by a dealer.

Lap/Shoulder Belt

The lap/shoulder belt goes over your shoulder, across your chest, and across your hips.

To fasten the belt, insert the latch plate into the buckle, then tug on the belt to make sure the buckle is latched (see page 16 for how to properly position the belt).

To unlock the belt, press the red PRESS button on the buckle. Guide the belt across your body so that it retracts completely. After exiting the vehicle, be sure the belt is out of the way and will not get closed in the door.

All seat belts have an emergency locking retractor. In normal driving, the retractor lets you move freely in your seat while it keeps some tension on the belt. During a collision or sudden stop, the retractor automatically locks the belt to help restrain your body.

The seat belts in all positions except the driver's have a lockable retractor that must be activated to secure a child seat (see page 49).

If the shoulder part of the belt is pulled all the way out, the lockable retractor will activate. The belt will retract, but it will not allow the passenger to move freely.

CONTINUED

Additional Information About Your Seat Belts

To deactivate the lockable retractor, unlatch the buckle and let the seat belt fully retract. To refasten the seat belt, pull it out only as far as needed.

Automatic Seat Belt Tensioners



For added protection, the front seat belts are equipped with automatic seat belt tensioners. When activated, the tensioners immediately tighten the belts to help hold the driver and a front passenger in position.

The tensioners are designed to activate in any collision severe enough to cause the front airbags to deploy.

If a side curtain airbag deploys during a side impact, the tensioner on that side of the vehicle will also deploy.

The tensioners can also be activated during a collision in which the front airbags *do not deploy*. In this case, the airbags would not be needed, but the additional restraint could be helpful.

When the tensioners are activated, the seat belts will remain tight until they are unbuckled.

Seat Belt Maintenance

For safety, you should check the condition of your seat belts regularly.

Pull each belt out fully, and look for frays, cuts, burns, and wear. Check that the latches work smoothly and the belts retract easily. If a belt does not retract easily, cleaning the belt may correct the problem (see page 564). Any belt that is not in good condition or working properly will not provide good protection and should be replaced as soon as possible.

Acura provides a limited warranty on seat belts. See your *Acura Warranty Information* booklet for details.

If a seat belt is worn during a crash, it must be replaced by your dealer. A belt that has been worn during a crash may not provide the same level of protection in a subsequent crash.

The dealer should also inspect the anchors for damage and replace them if needed. If the automatic seat belt tensioners activate during a crash, they must be replaced.

WARNING

Not checking or maintaining seat belts can result in serious injury or death if the seat belts do not work properly when needed.

Check your seat belts regularly and have any problem corrected as soon as possible.

Additional Information About Your Airbags

Airbag System Components

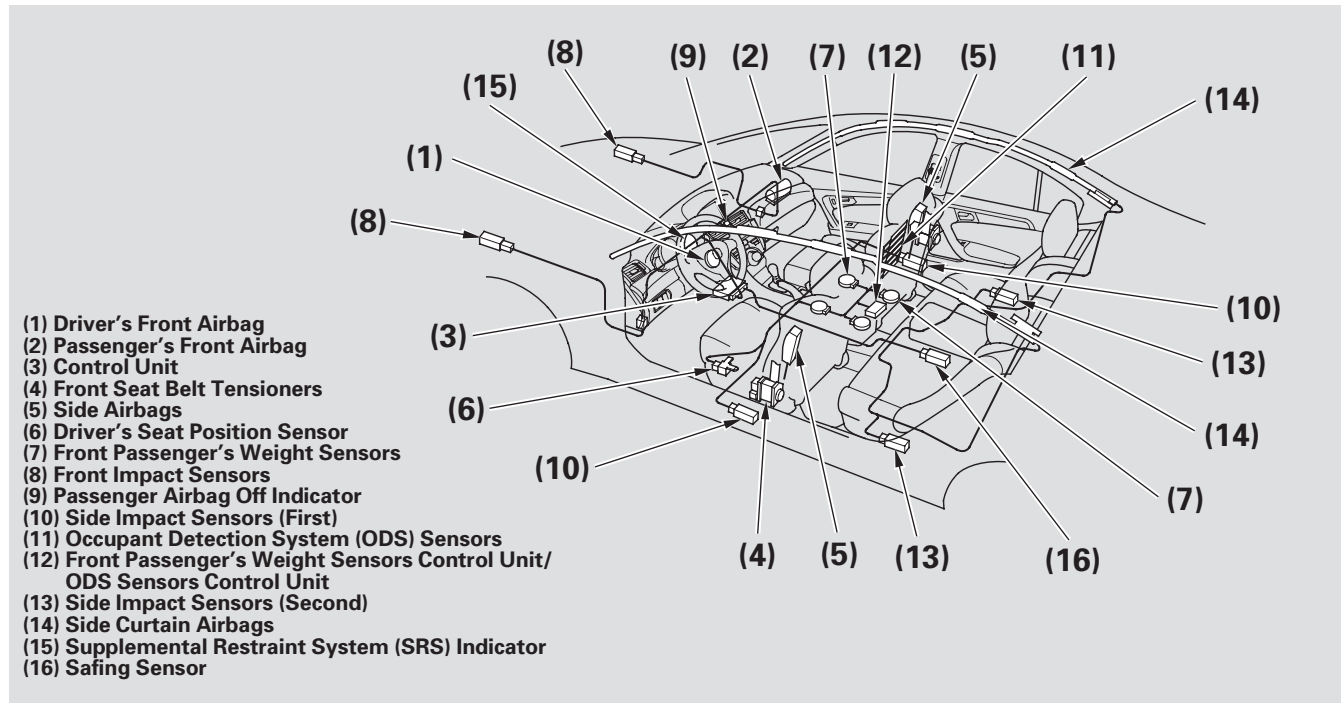

Additional Information About Your Airbags

Your airbag system includes:

- Two SRS (supplemental restraint system) front airbags. The driver's airbag is stored in the center of the steering wheel; the front passenger's airbag is stored in the dashboard. Both are marked "SRS AIRBAG" (see page 26).
- Two side airbags, one for the driver and one for a front passenger. The airbags are stored in the outer edges of the seat-backs. Both are marked "SIDE AIRBAG" (see page 30).
- Two side curtain airbags, one for each side of the vehicle. The airbags are stored in the ceiling, above the side windows. The front and rear pillars are marked "SIDE CURTAIN AIRBAG" (see page 32).
- Automatic front seat belt tensioners (see page 22).
- Sensors that can detect a moderate to severe front impact or side impact.
- Sensors that can detect whether a child is in the passenger's side airbag path and signal the control unit to turn the airbag off (see page 31).
- Sensors that can detect whether the driver's seat belt and the front passenger's seat belt are latched or unlatched (see page 20).
- A driver's seat position sensor that monitors the distance of the seat from the front airbag. If the seat is too far forward, the airbag will inflate with less force (see page 28).
- Weight sensors that monitor the weight on the front passenger's seat. If the weight is about 65 lbs (29 kg) or less (the weight of an infant or small child), the passenger's front airbag will be turned off (see page 29).

CONTINUED

Additional Information About Your Airbags

- A sophisticated electronic system that continually monitors and records information about the sensors, the control unit, the airbag activators, the seat belt tensioners, and driver and front passenger seat belt use when the ignition switch* is in the ON (II) position.

* : Models equipped with the keyless access system have an engine start/stop button instead of an ignition switch. ON Mode is the equivalent of ON (II). For more information, see pages [178](#) and [180](#).

- An indicator on the instrument panel that alerts you that the passenger's side airbag has been turned off (see page [33](#)).
- An indicator on the instrument panel that alerts you to a possible problem with your airbags, sensors, or seat belt tensioners (see page [32](#)).
- An indicator on the dashboard that alerts you that the passenger's front airbag has been turned off (see page [34](#)).
- Emergency backup power in case your vehicle's electrical system is disconnected in a crash.

How Your Front Airbags Work

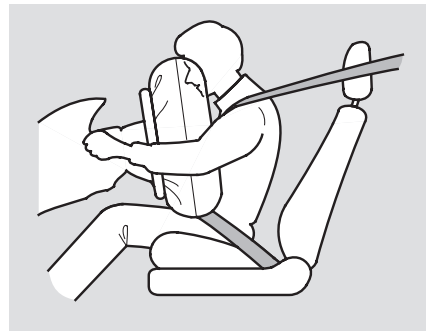

If you ever have a moderate to severe frontal collision, sensors will detect the vehicle's rapid deceleration.

If the rate of deceleration is high enough, the control unit will inflate the driver's and front passenger's airbags, at the time and with the force needed.

Additional Information About Your Airbags

During a frontal crash, your seat belt restrains your lower body and torso, and the front airbag helps protect your head and chest.

Although both airbags normally inflate within a split second of each other, it is possible for only one airbag to deploy.

This can happen if the severity of a collision is at the margin, or threshold, that determines whether or not the airbags will deploy. In such cases, the seat belt will provide sufficient protection, and the supplemental protection offered by the airbag would be minimal.

Only the driver's airbag can deploy if there is no passenger in the front seat, or if the advanced airbag system has turned the passenger's airbag off (see page 34).

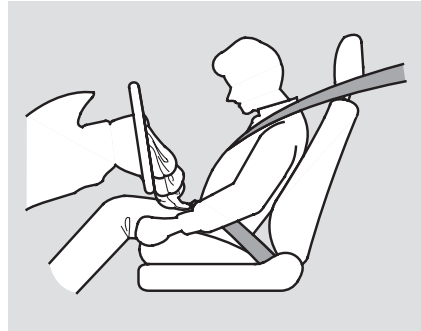

After inflating, the front airbags immediately deflate, so they won't interfere with the driver's visibility, or the ability to steer or operate other controls.

The total time for inflation and deflation is one-tenth of a second, so fast that most occupants are not aware that the airbags deployed until they see them lying in their laps.

After a crash, you may see what looks like smoke. This is actually powder from the airbag's surface. Although the powder is not harmful, people with respiratory problems may experience some temporary discomfort. If this occurs, get out of the vehicle as soon as it is safe to do so.

CONTINUED

Additional Information About Your Airbags

Dual-Stage Airbags

Your front airbags are dual-stage airbags. This means they have two inflation stages that can be ignited sequentially or simultaneously, depending on crash severity.

In a **more severe** crash, both stages will ignite simultaneously to provide the quickest and greatest protection.

In a **less severe** crash, one stage will ignite first, then the second stage will ignite a split second later. This provides longer airbag inflation time with a little less force.

Dual-Threshold Airbags

Your front airbags are also dual-threshold airbags. Airbags with this feature have two deployment thresholds that depend on whether sensors detect the occupant is wearing a seat belt or not.

If the occupant's belt is **not latched**, the airbag will deploy at a slightly lower threshold, because the occupant would need extra protection.

If the occupant's belt is **latched**, the airbag will inflate at a slightly higher threshold, when the airbag would be needed to supplement the protection provided by the seat belt.

Advanced Airbags

Your front airbags are also advanced airbags. The main purpose of this feature is to help prevent airbag-caused injuries to short drivers and children or small statured adults who ride in front.

For both advanced airbags to work properly:

- Occupants must sit upright and wear their seat belts properly.
- Do not spill any liquids on or under the seats, cover the sensors, or put any cargo or metal objects under the front seats.
- Back seat passengers should not wedge objects or intentionally force their feet under the front passenger seat.

Failure to follow these instructions could damage the sensors or prevent them from working properly.

Additional Information About Your Airbags

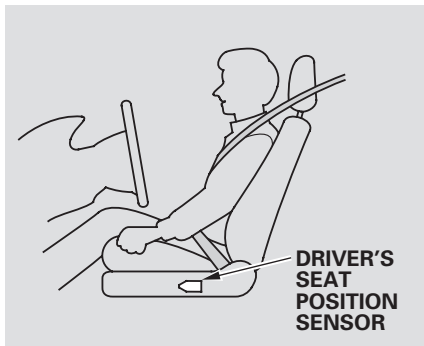

The driver's advanced front airbag system includes a seat position sensor under the seat. If the seat is too far forward, the airbag will inflate with less force, regardless of the severity of the impact.

If there is a problem with the sensor, the SRS indicator will come on, and the airbag will inflate in the normal manner regardless of the driver's seating position.

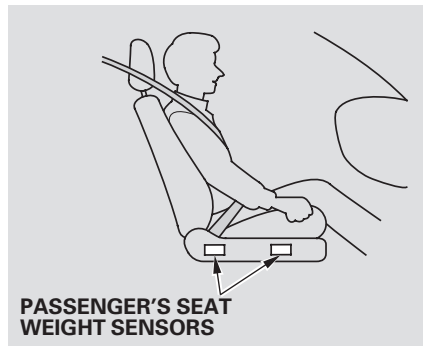

The passenger's advanced front airbag system has weight sensors under the seat. Although Acura does not encourage carrying an infant or small child in front, if the sensors detect the weight of an infant or small child (up to about 65 lbs or 29 kg), the system will automatically turn the passenger's front airbag off.

Be aware that objects placed on the passenger's seat can also cause the airbag to be turned off.

When the passenger airbag gets turned off by the weight sensors, a "passenger airbag off" indicator in the center of the dashboard comes on (see page 34).

If the weight sensors detect there is no passenger in the front seat, the airbag is automatically turned off. However, the passenger airbag off indicator in this situation will not come on.

CONTINUED

Additional Information About Your Airbags

To ensure that the passenger's advanced front airbag system will work properly, ***do not do anything that would increase or decrease the weight on the front passenger's seat.*** This includes:

- A rear passenger pushing or pulling on the back of the front passenger's seat.
- Moving the front seat or seat-back forcibly back against cargo on the seat or floor behind it.
- Hanging heavy items on the front passenger seat, or placing heavy items in the seat-back pocket.

- Also, make sure the floor mat behind the front passenger's seat is hooked to the floor mat anchor (see page 565). If it is not, the mat may interfere with the proper operation of the sensors and operation of the seat.

How Your Side Airbags Work

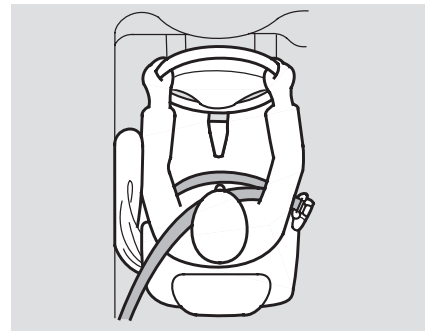

If you ever have a moderate to severe side impact, sensors will detect rapid acceleration and signal the control unit to instantly inflate either the driver's or the passenger's side airbag.

Additional Information About Your Airbags

Only one airbag will deploy during a side impact. If the impact is on the passenger's side, the passenger's side airbag will deploy even if there is no passenger.

To get the best protection from the side airbags, front seat occupants should wear their seat belts and sit upright and well back in their seats.

Side Airbag Cutoff System

Your vehicle has a side airbag cutoff system designed primarily to protect a child riding in the front passenger's seat.

Although Acura does not encourage children to ride in front, if the position sensors detect a child has leaned into the side airbag's deployment path, the airbag will shut off.

The side airbag may also shut off if a short adult leans sideways, or a larger adult slouches and leans sideways into the airbag's deployment path.

Objects placed on the front passenger seat can also cause the side airbag to be shut off.

If the side airbag off indicator comes on (see page 33), have the passenger sit upright. Once the passenger is out of the airbag's deployment path, the system will turn the airbag back on, and the indicator will go out.

There will be some delay between the moment the passenger moves into or out of the airbag deployment path and when the indicator comes on or goes off.

A front seat passenger should not use a cushion or other object as a backrest. It may prevent the cutoff system from working properly.

Additional Information About Your Airbags

How Your Side Curtain Airbags Work

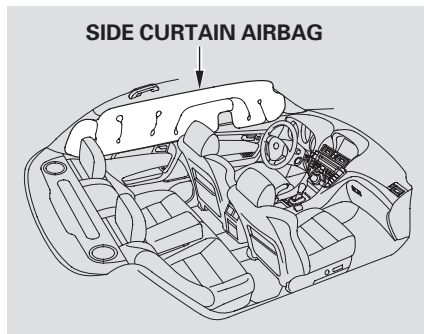

In a moderate to severe side impact, sensors will detect rapid acceleration and signal the control unit to instantly inflate the side curtain airbag and activate the seat belt tensioner on the driver's or the passenger's side of the vehicle.

If the impact is on the passenger's side, the passenger's side curtain airbag will inflate even if there are no occupants on that side of the vehicle.

One or both side curtain airbags may inflate in a moderate to severe frontal collision which causes the front airbags to deploy.

To get the best protection from the side curtain airbags, occupants should wear their seat belts and sit upright and well back in their seats.

How the SRS Indicator Works



The SRS indicator alerts you to a potential problem with your airbags or seat belt tensioners.

When you turn the ignition switch* to the ON (II) position, this indicator comes on briefly then goes off. This tells you the system is working properly.

* : Models equipped with the keyless access system have an engine start/stop button instead of an ignition switch. ON Mode is the equivalent of ON (II). For more information, see pages [178](#) and [180](#).

Additional Information About Your Airbags

If the indicator comes on at any other time, or does not come on at all, you should have the system checked by your dealer. For example:

- If the SRS indicator does not come on after you turn the ignition switch to the ON (II) position or on models with keyless access system, press the engine start/stop button to set ON mode (see page 180).
- If the indicator stays on after the engine starts.
- If the indicator comes on or flashes on and off while you drive.

You will also see a “CHECK AIRBAG SYSTEM” message on the multi-information display.

If you see any of these indications, the airbags and seat belt tensioners may not work properly when you need them.

WARNING

Ignoring the SRS indicator can result in serious injury or death if the airbag systems or tensioners do not work properly.

Have your vehicle checked by a dealer as soon as possible if the SRS indicator alerts you to a possible problem.

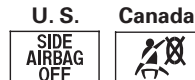

How the Side Airbag Off Indicator Works

This indicator alerts you that the passenger's side airbag has been automatically shut off. It does *not* mean there is a problem with your side airbags.

When you turn the ignition switch* to the ON (II) position, the indicator should come on briefly and then go out (see page 67). If it doesn't come on, stays on, or comes on while driving without a passenger in the front seat, have the system checked.

You will also see a “PASSENGER SIDE AIRBAG OFF” message on the multi-information display.

CONTINUED

Additional Information About Your Airbags

* : Models equipped with the keyless access system have an engine start/stop button instead of an ignition switch. ON Mode is the equivalent of ON (II). For more information, see pages [178](#) and [180](#).

How the Passenger Airbag Off Indicator Works

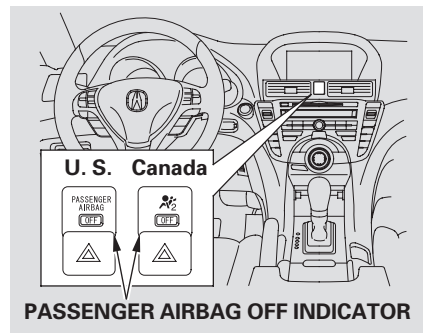

This indicator alerts you that the passenger's front airbag has been shut off because weight sensors detect about 65 lbs (29 kg) or less (the weight of an infant or small child) on the front passenger's seat. It does **not mean** there is a problem with the airbag.

Be aware that objects placed on the front seat can cause the indicator to come on.

If no weight is detected on the front seat, the airbag will be automatically shut off. However, the indicator will not come on.

The passenger airbag off indicator may come on and off repeatedly if the total weight on the seat is near the airbag cutoff threshold.

If an adult or teenage passenger is riding in front, move the seat as far to the rear as possible, and have the passenger sit upright and wear the seat belt properly.

If the indicator comes on with no front seat passenger and no objects on the seat, or with an adult riding there, something may be interfering with the weight sensors. Look for and remove:

- Any items under the front passenger's seat.
- Any object hanging on the seat or in the seat-back pocket.
- Any object(s) touching the rear of the seat-back.

If no obstructions are found, have your vehicle checked by a dealer as soon as possible.

Airbag Service

Your airbag systems are virtually maintenance free, and there are no parts you can safely service. However, you must have your vehicle serviced if:

- ***An airbag ever inflates.*** Any airbag that has deployed must be replaced along with the control unit and other related parts. Any seat belt tensioner that activates must also be replaced.

Do not try to remove or replace any airbag by yourself. This must be done by an authorized dealer or a knowledgeable body shop.

- ***The SRS indicator alerts you to a problem.*** Take your vehicle to an authorized dealer as soon as possible. If you ignore this indication, your airbags may not operate properly.
- ***If your vehicle has a moderate to severe impact.*** Even if your airbags do not inflate, your dealer should inspect the driver's seat position sensor, the front passenger's weight sensors, the front seat belt tensioners, and all seat belts and their anchors worn during a crash to make sure they are operating properly.

Additional Information About Your Airbags

Additional Safety Precautions

- **Do not attempt to deactivate your airbags.** Together, airbags and seat belts provide the best protection.
 - **Do not tamper with airbag components or wiring for any reason.** Tampering could cause the airbags to deploy, possibly causing very serious injury.
 - **Do not expose the front passenger's seat-back to liquid.** If water or another liquid soaks into a seat-back, it can prevent the side airbag cutoff system from working properly.
- **Do not remove or modify a front seat without consulting your dealer.** This could make the driver's seat position sensor or the front passenger's weight sensors ineffective. If it is necessary to remove or modify a front seat to accommodate a person with disabilities, first contact Acura Client Services at 800-382-2238.
 - **Do not cover or replace front seat-back covers without consulting your dealer.** Improperly replacing or covering front seat-back covers can prevent your side airbags from inflating during a side impact.

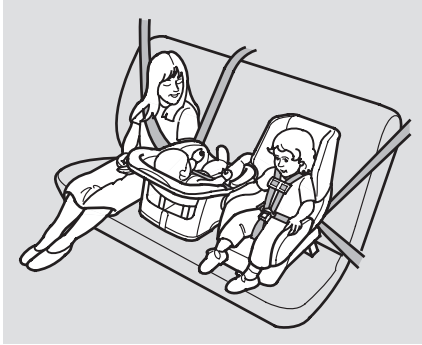

Children depend on adults to protect them. However, despite their best intentions, many adults do not know how to *properly* protect child passengers.

If you have children, or ever need to drive with a child in your vehicle, be sure to read this section. It begins with important general guidelines, then presents special information for infants, small children, and larger children.

All Children Must Be Restrained

Each year, many children are injured or killed in vehicle crashes because they are either unrestrained or not properly restrained. In fact, vehicle accidents are the number one cause of death of children age 12 and under.

To reduce the number of child deaths and injuries, every state and Canadian province requires that infants and children be properly restrained when they ride in a vehicle.

Infants and small children must be restrained in an approved child seat that is properly secured to the vehicle (see pages 42 – 52).

⚠ WARNING

Children who are unrestrained or improperly restrained can be seriously injured or killed in a crash.

Any child too small for a seat belt should be properly restrained in a child seat. A larger child should be properly restrained with a seat belt and use a booster seat if necessary.

Larger children must be restrained with a lap/shoulder belt and ride on a booster seat until the seat belt fits them properly (see pages 53 – 56).

Protecting Children – General Guidelines

All Children Should Sit in a Back Seat

According to accident statistics, children of all ages and sizes are safer when they are restrained in a back seat.

The National Highway Traffic Safety Administration and Transport Canada recommend that all children age 12 and under be properly restrained in a back seat. Some states have laws restricting where children may ride.

Children who ride in the back are less likely to be injured by striking interior vehicle parts during a collision or hard braking. Also, children cannot be injured by an inflating front airbag when they ride in the back.

The Passenger's Front Airbag Can Pose Serious Risks

Front airbags have been designed to help protect adults in a moderate to severe frontal collision. To do this, the passenger's front airbag is quite large, and it can inflate with enough force to cause very serious injuries.

Even though your vehicle has an advanced front airbag system that automatically turns the passenger's front airbag off (see page 34), please follow these guidelines:

Infants

Never put a rear-facing child seat in the front seat of a vehicle equipped with a passenger's front airbag. If the airbag inflates, it can hit the back of the child seat with enough force to kill or very seriously injure an infant.

Small Children

Placing a forward-facing child seat in the front seat of a vehicle equipped with a passenger's front airbag can be hazardous. If the vehicle seat is too far forward, or the child's head is thrown forward during a collision, an inflating front airbag can strike the child with enough force to kill or very seriously injure a small child.

Larger Children

Children who have outgrown child seats are also at risk of being injured or killed by an inflating passenger's front airbag. Whenever possible, larger children should sit in the back seat, on a booster seat if needed, and be properly restrained with a seat belt (see page 53 for important information about protecting larger children).

To remind you of the passenger's front airbag hazards, and that children must be properly restrained in a back seat, your vehicle has warning labels on the dashboard (U.S. models) and on the front visors. Please read and follow the instructions on these labels.

U.S. Models

SUN VISOR



Canadian Models

SUN VISOR

CAUTION

- TO AVOID SERIOUS INJURY:**
- FOR MAXIMUM SAFETY PROTECTION IN ALL TYPES OF CRASHES, YOU MUST ALWAYS WEAR YOUR SAFETY BELT.
 - DO NOT INSTALL REARWARD-FACING CHILD SEATS IN ANY FRONT PASSENGER SEAT POSITION.
 - DO NOT SIT OR LEAN UNNECESSARILY CLOSE TO THE AIR BAG.
 - DO NOT PLACE ANY OBJECTS OVER THE AIR BAG OR BETWEEN THE AIR BAG AND YOURSELF.
 - SEE THE OWNER'S MANUAL FOR FURTHER INFORMATION AND EXPLANATIONS.

PRECAUTIONS:

- POUR EVITER DES BLESSURES GRAVES:**
- POUR PROFITER D'UNE PROTECTION MAXIMALE LORS D'UNE COLLISION BOUCLEZ TOUJOURS VOTRE CEINTURE DE SECURITE.
 - N'INSTALLEZ JAMAIS UN SIEGE POUR ENFANTS FAISANT FACE A L'ARRIERE SUR LE SIEGE DU PASSAGER AVANT.
 - NE VOUS APPUYEZ PAS ET NE VOUS ASSOYEZ PAS PRES DU COUSSIN GONFLABLE.
 - NE DEPOSEZ AUCUN OBJET SUR LE COUSSIN GONFLABLE OU ENTRE LE COUSSIN GONFLABLE ET VOUS.
 - LISEZ LE GUIDE UTILISATEUR POUR DE PLUS AMPLES RENSEIGNEMENTS.

DASHBOARD

This Vehicle is Equipped with Advanced Air Bags

Even with Advanced Air Bags

Children can be killed or seriously injured by the air bag. The back seat is the safest place for children. Never put a rear-facing child seat in the front. Always use seat belts and child restraints. See owner's manual for more information about air bags.

To be removed by owner only.

Protecting Children – General Guidelines

If You Must Drive with Several Children

Your vehicle has a back seat where children can be properly restrained. If you ever have to carry a group of children, and a child must ride in front:

- Place the largest child in the front seat, provided the child is large enough to wear the lap/shoulder belt properly (see page [53](#)).
- Move the vehicle seat as far to the rear as possible (see page [155](#)).
- Have the child sit upright and well back in the seat (see page [18](#)).
- Make sure the seat belt is properly positioned and secured (see page [16](#)).

If a Child Requires Close Attention

Many parents say they prefer to put an infant or a small child in the front passenger seat so they can watch the child, or because the child requires attention.

Placing a child in the front seat exposes the child to hazards in a frontal collision, and paying close attention to a child distracts the driver from the important tasks of driving, placing both of you at risk.

If a child requires close physical attention or frequent visual contact, we strongly recommend that another adult ride with the child in the back seat. The back seat is far safer for a child than the front.

Additional Safety Precautions

- ***Never hold an infant or child on your lap.*** If you are not wearing a seat belt in a crash, you could be thrown forward and crush the child against the dashboard or a seat-back. If you are wearing a seat belt, the child can be torn from your arms and be seriously hurt or killed.
- ***Never put a seat belt over yourself and a child.*** During a crash, the belt could press deep into the child and cause serious or fatal injuries.
- ***Never let two children use the same seat belt.*** If they do, they could be very seriously injured in a crash.
- ***Use the childproof door locks to prevent children from opening the rear doors.*** This can prevent children from accidentally falling out (see page [147](#)).

- **Make sure any unused seat belt that a child can reach is buckled, the lockable retractor is activated, and the belt is fully retracted and locked.** If a child wraps a loose seat belt around their neck, they can be seriously or fatally injured. (See pages 50 and 51 for how to activate and deactivate the lockable retractor.)

- **Do not leave children alone in a vehicle.** Leaving children without adult supervision is illegal in most states, Canadian provinces/territories, and can be very hazardous.

For example, infants and small children left in a vehicle on a hot day can die from heatstroke. A child left alone with the key in the ignition switch* can accidentally set the vehicle in motion, possibly injuring themselves or others.

- **Lock all doors and the trunk when your vehicle is not in use.** Children who play in vehicles can accidentally get trapped inside. Teach your children not to play in or around vehicles. Know how to operate the emergency trunk opener and decide if your children should be shown how to use this feature (see page 150).

- **Keep vehicle keys/remote transmitters or keyless access remotes out of the reach of children.** Even very young children learn how to unlock vehicle doors, turn on the ignition switch*, and open the trunk, which can lead to accidental injury or death.

- * : *On models with keyless access system*
Your vehicle has the engine start/stop button instead of an ignition switch. For more information on selecting the power mode, see page 178.

Protecting Infants and Small Children

Protecting Infants

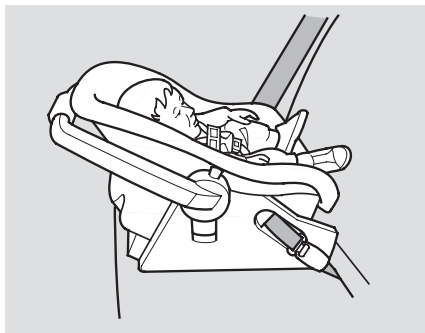

Child Seat Type

An infant must be properly restrained in a rear-facing, reclining child seat until the child reaches the seat maker's weight or height limit for the seat, and the child is at least one year old.

Only a rear-facing child seat provides proper support for a baby's head, neck, and back.

Two types of seats may be used: a seat designed exclusively for infants, or a convertible seat used in the rear-facing, reclining mode.

Do not put a rear-facing child seat in a forward-facing position. If placed facing forward, an infant could be very seriously injured during a frontal collision.

Rear-facing Child Seat Placement

A rear-facing child seat can be placed in any seating position in the back seat, but not in the front. ***Never put a rear-facing child seat in the front seat.***

If the passenger's front airbag inflates, it can hit the back of the child seat with enough force to kill or seriously injure an infant.

When properly installed, a rear-facing child seat may prevent the driver or a front passenger from moving their seat as far back as recommended, or from locking their seat-back in the desired position.

It can also interfere with proper operation of the passenger's advanced front airbag system.

In any of these situations, we strongly recommend that you install the child seat directly behind the front passenger's seat, move the seat as far forward as needed, and leave it unoccupied. Or, you may wish to get a smaller rear-facing child seat.

⚠ WARNING

Placing a rear-facing child seat in the front seat can result in serious injury or death during a collision.

Always place a rear-facing child seat in the back seat, not the front.

Protecting Small Children

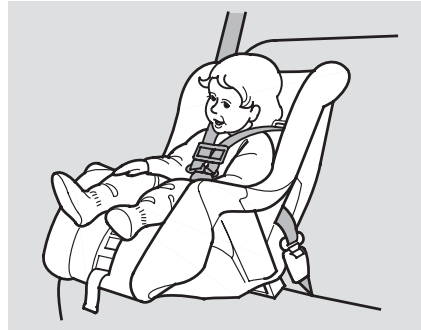

Child Seat Type

A child who is at least one year old, and who fits within the child seat maker's weight and height limits, should be restrained in a forward-facing, upright child seat.

Of the different seats available, we recommend those that have a five-point harness system as shown.

We also recommend that a small child use the child seat until the child reaches the weight or height limit for the seat.

Child Seat Placement

We strongly recommend placing a forward-facing child seat in a back seat, not the front.

Placing a forward-facing child seat in the front seat of a vehicle equipped with a passenger's airbag can be hazardous. If the vehicle seat is too far forward, or the child's head is thrown forward during a collision, an inflating airbag can strike the child with enough force to cause very serious or fatal injuries.

CONTINUED

Protecting Infants and Small Children

Even with advanced front airbags that automatically turn the passenger's front airbag off (see page 34), a back seat is the safest place for a small child.

If it is necessary to put a forward-facing child seat in the front, move the vehicle seat as far to the rear as possible, and be sure the child seat is firmly secured to the vehicle and the child is properly strapped in the seat.

WARNING

Placing a forward-facing child seat in the front seat can result in serious injury or death if the front airbag inflates.

If you must place a forward-facing child seat in front, move the vehicle seat as far back as possible, and properly restrain the child.

When buying a child seat, you need to choose either a conventional child seat, or one designed for use with the lower anchors and tethers for children (LATCH) system.

Conventional child seats must be secured to a vehicle with a seat belt, whereas LATCH-compatible seats are secured by attaching the seat to hardware built into the two outer rear seats.

Since LATCH-compatible child seats are easier to install and reduce the possibility of improper installation, we recommend selecting this style.

In seating positions and vehicles not equipped with LATCH, a LATCH-compatible child seat can be installed using a seat belt.

Whatever type of seat you choose, to provide proper protection, a child seat should meet three requirements:

- 1. *The child seat should meet U.S. or Canadian Motor Vehicle Safety Standard 213.*** Look for FMVSS 213 or CMVSS 213 on the box.
- 2. *The child seat should be of the proper type and size to fit the child.*** Rear-facing for infants, forward-facing for small children.

- 3. *The child seat should fit the vehicle seating position (or positions) where it will be used.***

Before purchasing a conventional child seat, or using a previously purchased one, we recommend that you test the seat in the specific vehicle seating position or positions where the seat will be used.

Installing a Child Seat

After selecting a proper child seat and a good place to install the seat, there are three main steps in installing the seat:

1. Properly secure the child seat to the vehicle. All child seats must be secured to the vehicle with the lap part of a lap/shoulder belt or with the LATCH (lower anchors and tethers for children) system. A child whose seat is not properly secured to the vehicle can be endangered in a crash.

2. Make sure the child seat is firmly secured. After installing a child seat, push and pull the seat forward and from side-to-side to verify that it is secure.

A child seat secured with a seat belt should be installed as firmly as possible. However, it does not need to be “rock solid.” Some side-to-side movement can be expected and should not reduce the child seat’s effectiveness.

If the child seat is not secure, try installing it in a different seating position, or use a different style of child seat that can be firmly secured.

3. Secure the child in the child seat. Make sure the child is properly strapped in the child seat according to the child seat maker’s instructions. A child who is not properly secured in a child seat can be seriously injured in a crash.

The following pages provide guidelines on how to properly install a child seat. A forward-facing child seat is used in all examples, but the instructions are the same for rear-facing child seats.

Installing a Child Seat with LATCH

Your vehicle is equipped with LATCH (Lower Anchors and Tethers for Children) at the outer rear seats.

The lower anchors are located between the seat-back and seat bottom, and are to be used only with a child seat designed for use with LATCH.

The location of each lower anchor is indicated by a small button above the anchor point.

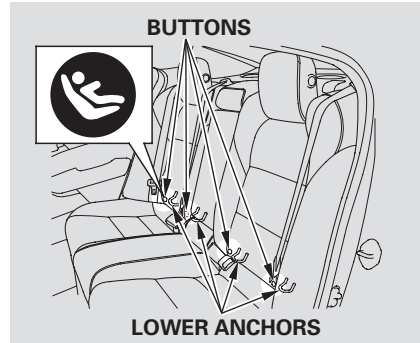

To install a LATCH-compatible child seat:

1. Move the seat belt buckle or tongue away from the lower anchors.

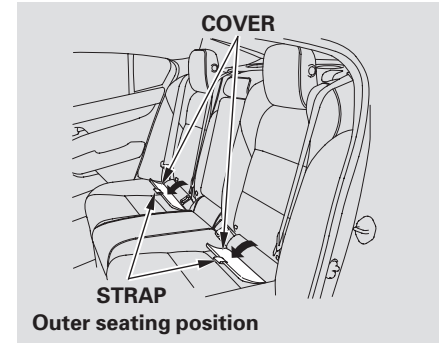

2. Use the pull strap to lower the anchor cover on the lower seat cushion that covers the LATCH anchor holes in the seat.
3. Make sure there are no objects near the anchors that could prevent a secure connection between the child seat and the anchors.

CONTINUED

Installing a Child Seat

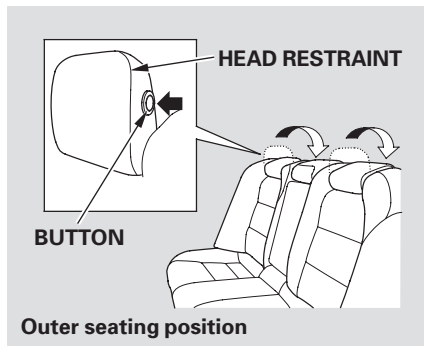

4. Push the buttons located next to each rear head restraint to pivot the head restraints down.

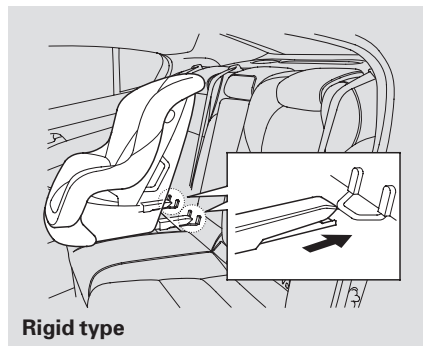

5. Place the child seat on the vehicle seat, then attach the seat to the lower anchors according to the child seat maker's instructions.

Some LATCH-compatible seats have a rigid-type connector as shown above.

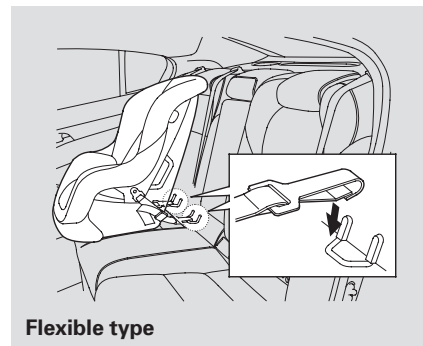

Other LATCH-compatible seats have a flexible-type connector as shown above.

6. Whatever type you have, follow the child seat maker's instructions for adjusting or tightening the fit.

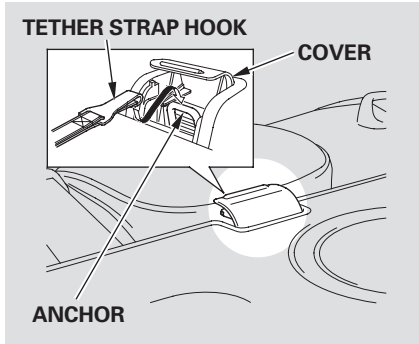

7. Route the tether strap over the head restraint, then attach the tether strap hook to the anchor, making sure the strap is not twisted.
8. Tighten the tether strap as instructed by the child seat maker.
9. Push and pull the child seat forward and from side-to-side to verify that it is secure.

Installing a Child Seat with a Lap/Shoulder Belt

When not using the LATCH system, all child seats must be secured to the vehicle with the lap part of a lap/shoulder belt.

In addition, the lap/shoulder belts in all seating positions except the driver's have a lockable retractor that must be activated to secure a child seat.



1. With the child seat in the desired seating position, route the belt through the child seat according to the seat maker's instructions, then insert the latch plate into the buckle.

CONTINUED

Installing a Child Seat

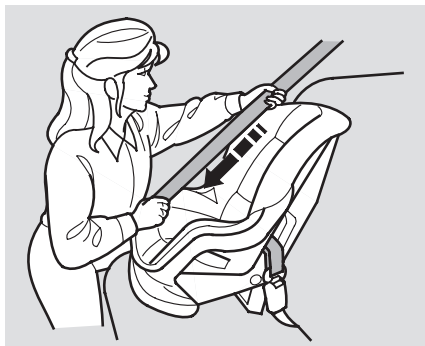

2. To activate the lockable retractor, slowly pull the shoulder part of the belt all the way out until it stops, then let the belt feed back into the retractor.
3. After the belt has retracted, tug on it. If the belt is locked, you will not be able to pull it out. If you can pull the belt out, it is not locked, and you will need to repeat these steps.



4. After confirming that the belt is locked, grab the shoulder part of the belt near the buckle, and pull up to remove any slack from the lap part of the belt. Remember, if the lap part of the belt is not tight, the child seat will not be secure.

To remove slack, it may help to put weight on the child seat, or push on the back of the seat while pulling up on the belt.

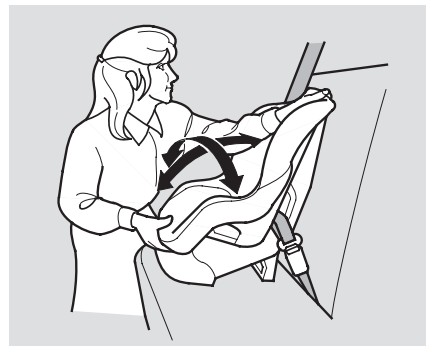

5. Push and pull the child seat forward and from side-to-side to verify that it is secure enough to stay upright during normal driving maneuvers. If the child seat is not secure, unlatch the belt, allow it to retract fully, then repeat these steps.

To deactivate the lockable retractor and remove a child seat, unlatch the buckle, unrout the seat belt, and let the belt fully retract.

Installing a Child Seat with a Tether

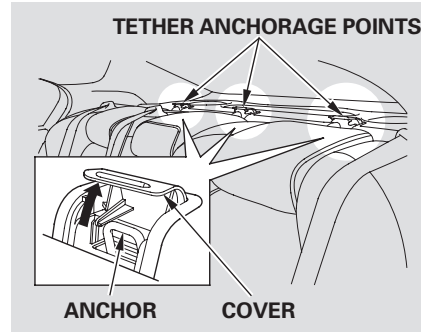

A child seat with a tether can be installed in any seating position in the back seat, using one of the anchorage points shown above.

Since a tether can provide additional security to the lap/shoulder belt installation, we recommend using a tether whenever one is required or available.

Using an Outer Anchor

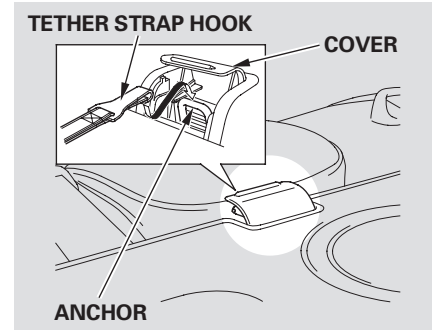

1. After properly securing the child seat with the lap/shoulder belt (see page 21), pivot the head restraint down (see page 156) and route the tether strap over the head restraint.

CONTINUED

Installing a Child Seat

2. Lift the anchor cover, then attach the tether strap hook to the anchor, making sure the strap is not twisted.
3. Tighten the strap according to the seat maker's instructions.

Using the Center Anchor

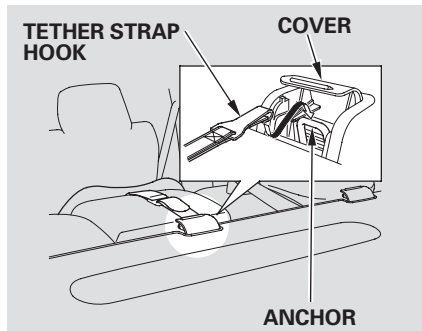

1. After properly securing the child seat (see page 49), push the head restraint down, then route the tether strap over the top of the seat-back.
2. Follow steps 2 and 3 in the previous column.

When a child reaches the recommended weight or height limit for a forward-facing child seat, the child should sit in a back seat on a booster seat and wear a lap/shoulder belt.

The following pages give instructions on how to check proper seat belt fit, what kind of booster seat to use if one is needed, and important precautions for a child who must sit in front.

⚠ WARNING

Allowing a child age 12 or under to sit in front can result in injury or death if the passenger's front airbag inflates.

If a child must ride in front, move the vehicle seat as far back as possible, use a booster seat if needed, have the child sit up properly and wear the seat belt properly.

Checking Seat Belt Fit



To determine if a lap/shoulder belt properly fits a child, have the child put on the seat belt, then ask yourself:

1. Does the child sit all the way back against the seat?
2. Do the child's knees bend comfortably over the edge of the seat?

CONTINUED

Protecting Larger Children

3. Does the shoulder belt cross between the child's neck and arm?
4. Is the lap part of the belt as low as possible, touching the child's thighs?
5. Will the child be able to stay seated like this for the whole trip?

If you answer yes to all these questions, the child is ready to wear the lap/shoulder belt correctly. If you answer no to any question, the child needs to ride on a booster seat.

Using a Booster Seat



A child who has outgrown a forward-facing child seat should ride in a back seat and use a booster seat until the lap/shoulder belt fits them properly without the booster.

Some states and Canadian provinces also require children to use a booster seat until they reach a given age or weight (e.g., 6 years or 60 lbs). Be sure to check current laws in the states or provinces where you intend to drive.

Booster seats can be high-back or low-back. Whichever style you select, make sure the booster seat meets federal safety standards (see page 45) and that you follow the booster seat maker's instructions.

If a child who uses a booster seat must ride in front, move the vehicle seat as far back as possible and be sure the child is wearing the seat belt properly.

A child may continue using a booster seat until the tops of their ears are even with the top of the vehicle's or booster's seat-back. A child of this height should be tall enough to use the lap/shoulder belt without a booster seat.

When Can a Larger Child Sit in Front

The National Highway Traffic Safety Administration and Transport Canada recommend that all children age 12 and under be properly restrained in the back seat.

If the passenger's front airbag inflates in a moderate to severe frontal collision, the airbag can cause serious injuries to a child who is unrestrained, improperly restrained, sitting too close to the airbag, or out of position.

A side airbag also poses risks. If any part of a larger child's body is in the path of a deploying side airbag, the child could receive possibly serious injuries.

Of course, children vary widely. And while age may be one indicator of when a child can safely ride in front, there are other important factors you should consider.

Physical Size

Physically, a child must be large enough for the lap/shoulder belt to properly fit (see pages 16 and 53). If the seat belt does not fit properly, with or without the child sitting on a booster seat, the child should not sit in front.

Maturity

To safely ride in front, a child must be able to follow the rules, including sitting properly, and wearing the seat belt properly throughout the ride.

CONTINUED

Protecting Larger Children

If you decide that a child can safely ride up front, be sure to:

- Carefully read the owner's manual, and make sure you understand all seat belt instructions and all safety information.
- Move the vehicle seat to the rear-most position.
- Have the child sit up straight, back against the seat, and feet on or near the floor.
- Check that the child's seat belt is properly and securely positioned.
- Supervise the child. Even mature children sometimes need to be reminded to fasten the seat belts or sit properly.

Additional Safety Precautions

- ***Do not let a child wear a seat belt across the neck.*** This could result in serious neck injuries during a crash.
- ***Do not let a child put the shoulder part of a seat belt behind the back or under the arm.*** This could cause very serious injuries during a crash. It also increases the chance that the child will slide under the belt in a crash and be injured.
- ***Two children should never use the same seat belt.*** If they do, they could be very seriously injured in a crash.

- ***Do not put any accessories on a seat belt.*** Devices intended to improve a child's comfort or reposition the shoulder part of a seat belt can make the belt less effective and increase the chance of serious injury in a crash.

Your vehicle's exhaust contains carbon monoxide gas. Carbon monoxide should not enter the vehicle in normal driving if you maintain your vehicle properly and follow the information on this page.

Have the exhaust system inspected for leaks whenever:

- The vehicle is raised for an oil change.
- You notice a change in the sound of the exhaust.
- The vehicle was in an accident that may have damaged the underside.

WARNING

Carbon monoxide gas is toxic. Breathing it can cause unconsciousness and even kill you.

Avoid any enclosed areas or activities that expose you to carbon monoxide.

High levels of carbon monoxide can collect rapidly in enclosed areas, such as a garage. Do not run the engine with the garage door closed. Even with the door open, run the engine only long enough to move the vehicle out of the garage.

With the trunk lid open, airflow can pull exhaust gas into your vehicle's interior and create a hazardous condition. If you must drive with the trunk open, open all the windows, and set the climate control system as shown below.

If you must sit in your parked vehicle with the engine running, even in an unconfined area, adjust the climate control system as follows:

1. Select the fresh air mode.
2. Select the  mode.
3. Set the fan speed to high.
4. Set the temperature control to a comfortable setting.

Safety Labels

These labels are in the locations shown. They warn you of potential hazards that could cause serious injury or death. Read these labels carefully.

If a label comes off or becomes hard to read (except for the U.S. dashboard label which may be removed by the owner), contact your dealer for a replacement.

RADIATOR CAP



DASHBOARD

U.S. models only

This Vehicle is Equipped with
Advanced Air Bags

Even with Advanced Air Bags

Children can be killed or seriously injured by the air bag. The back seat is the safest place for children. Never put a rear-facing child seat in the front. Always use seat belts and child restraints. See owner's manual for more information about air bags.

To be removed by owner only.

HOOD

U.S. models

SUPPLEMENTAL RESTRAINT SYSTEM (SRS)

This vehicle is equipped with front air bags, side air bags in the front seats, light-colored seatbelts, and side curtain air bags. All SRS electrical wiring and components are color-coded yellow.

Turn off the radio, disconnecting or using test equipment on the SRS wiring can impair the system's operation or cause accidental deployment.

▲ WARNING

Accidental deployment can seriously hurt or kill you.

Follow Service Manual instructions carefully.

Canadian models

<p>SUPPLEMENTAL RESTRAINT SYSTEM (SRS)</p> <p>This vehicle is equipped with front air bags, side air bags in the front seats, and side curtain air bags. All SRS electrical wiring and components are color-coded yellow.</p> <p>Turn off the radio, disconnecting or using test equipment on the SRS wiring can impair the system's operation or cause accidental deployment.</p>	<p>SYSTEME DE RETENUE SUPPLEMENTAIRE (SRS)</p> <p>Cette voiture est équipée de deux sièges avant, de deux sièges arrière et de deux sièges latéraux. Tous les câblages électriques et les composants du système SRS sont colorés en jaune.</p> <p>Éteignez la radio, déconnectez ou utilisez un équipement de test sur le câblage SRS, ce qui peut nuire au fonctionnement du système ou provoquer un déploiement accidentel.</p>
<p>▲ WARNING</p> <p>Accidental deployment can seriously hurt or kill you.</p> <p>Follow Service Manual instructions carefully.</p>	<p>▲ ATTENTION</p> <p>Le déploiement accidentel peut sérieusement blesser ou tuer.</p> <p>Consultez attentivement les instructions du manuel d'utilisation.</p>

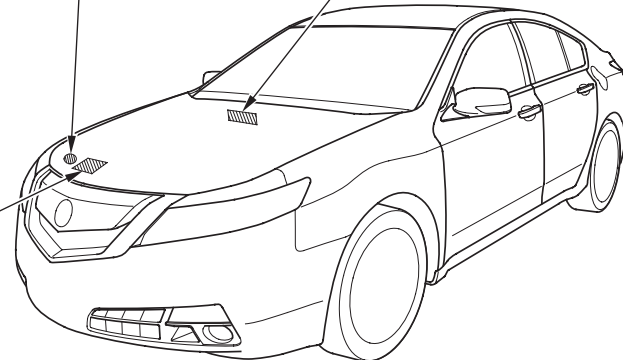

SUN VISOR

U.S. models



Canadian models

CAUTION
TO AVOID SERIOUS INJURY:
 • FOR MAXIMUM SAFETY PROTECTION IN ALL TYPES OF CRASHES, YOU MUST ALWAYS WEAR YOUR SAFETY BELT.
 • DO NOT INSTALL REARWARD-FACING CHILD SEATS IN ANY FRONT PASSENGER SEAT POSITION.
 • DO NOT SIT OR LEAN UNNECESSARILY CLOSE TO THE AIR BAG.
 • DO NOT PLACE ANY OBJECTS OVER THE AIR BAG OR BETWEEN THE AIR BAG AND YOURSELF.
 • SEE THE OWNER'S MANUAL FOR FURTHER INFORMATION AND EXPLANATIONS.

PRÉCAUTION:
POUR ÉVITER DES BLESSURES GRAVES:
 • POUR PROTÉGER D'UNE PROTECTION MAXIMALE LORS D'UNE COLLISION, BOUCLEZ TOUJOURS VOTRE CEINTURE DE SÉCURITÉ.
 • N'INSTALLEZ JAMAIS UN SIÈGE POUR ENFANTS FAISANT FACE À L'ARRIÈRE SUR LE SIÈGE DU PASSAGER AVANT.
 • NE VOUS APPUYEZ PAS ET NE VOUS ASSEYEZ PAS PRÈS DU COUSSIN GONFLABLE.
 • NE DÉPOSEZ AUCUN OBJET SUR LE COUSSIN GONFLABLE OU ENTRE LE COUSSIN GONFLABLE ET VOUS.
 • LISEZ LE GUIDE UTILISATEUR POUR DE PLUS AMPLES RENSEIGNEMENTS.

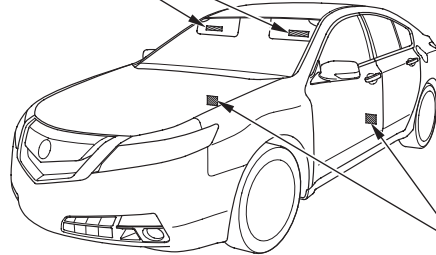

DOORJAMB

U.S. models

SIDE AIRBAG

- This car is equipped with side airbags in the front seats and side curtain airbags.
- Do not lean against the door.
- See owner's manual for more information.

Canadian models

SIDE AIRBAG

- This car is equipped with side airbags in the front seats and side curtain airbags.
- Do not lean against the door.
- See owner's manual for more information.

COUSSIN GONFLABLE LATÉRAL

- Cette automobile est équipée de coussins gonflables latéraux dans les sièges avant ainsi que de coussins gonflables latéraux de type rideau.
- Ne vous appuyez pas sur la porte.
- Consultez le Manuel du propriétaire pour en savoir plus.

This section gives information about the controls and displays that contribute to the daily operation of your vehicle. All the essential controls are within easy reach.

Control Locations	62	Trunk.....	148
Instrument Panel	63	Emergency Trunk Opener	150
Instrument Panel Indicators.....	64	Remote Transmitter.....	151
Gauges	75	Seats	155
Fuel Gauge	75	Trunk Pass-through Cover.....	160
Temperature Gauge.....	76	Mirrors.....	161
Multi-Information Display	77	Driving Position Memory	
Controls Near the Steering		System.....	164
Wheel.....	130	Keyless Access System.....	167
Windshield Wipers and		Keyless Access Remote.....	173
Washers.....	131	Engine Start/Stop Button.....	177
Turn Signals and Headlights.....	133	Seat Heaters	193
Automatic Lighting Off		Power Windows	195
Feature.....	135	Moonroof	199
Daytime Running Lights	136	Parking Brake	201
Fog Lights	137	Interior Convenience Items.....	202
Instrument Panel Brightness.....	137	Beverage Holders.....	203
Hazard Warning Button.....	139	Accessory Power Sockets.....	204
Rear Window Defogger	139	Glove Box	205
Steering Wheel Adjustments	140	Console Compartment.....	205
Keys and Locks.....	141	Vanity Mirror	206
Immobilizer System.....	143	Sun Visor	206
Ignition Switch	145	Center Pocket	207
Door Locks	146	Sunglasses Holder	207
Childproof Door Locks	147	Coat Hook.....	208
		Interior Lights	209

Control Locations

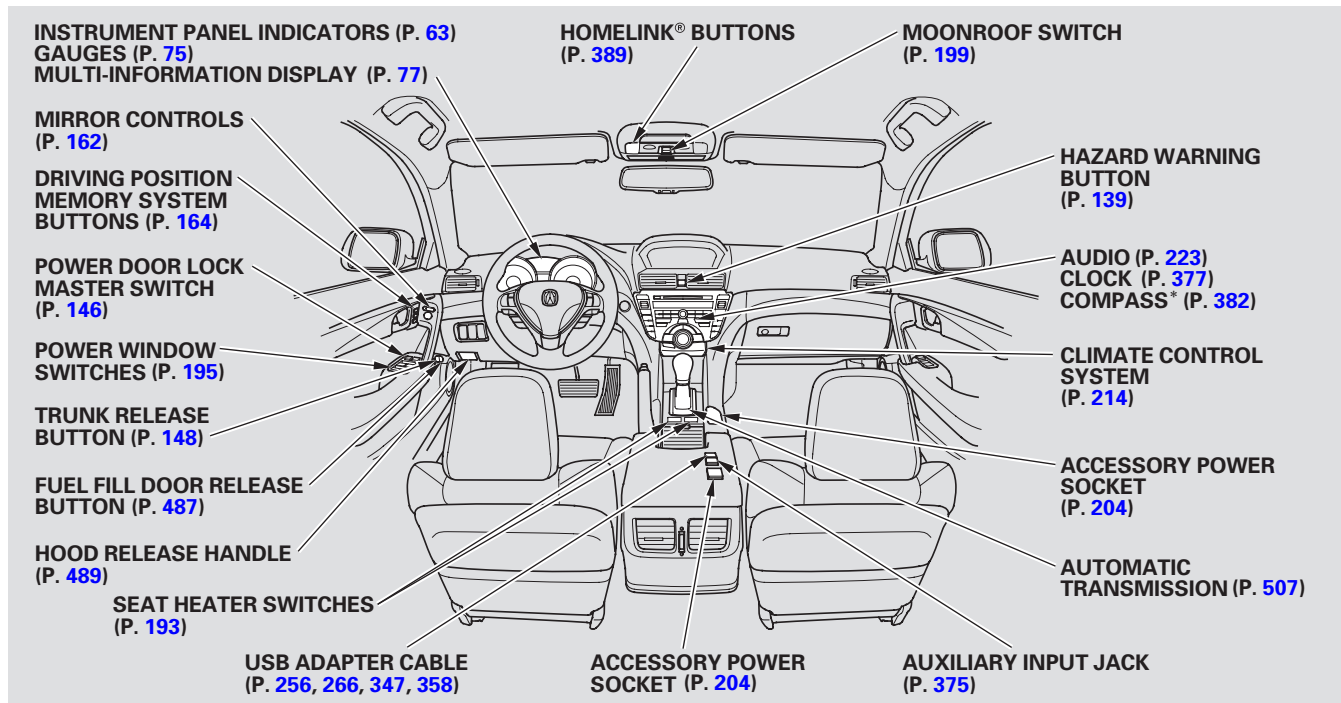

* : If equipped

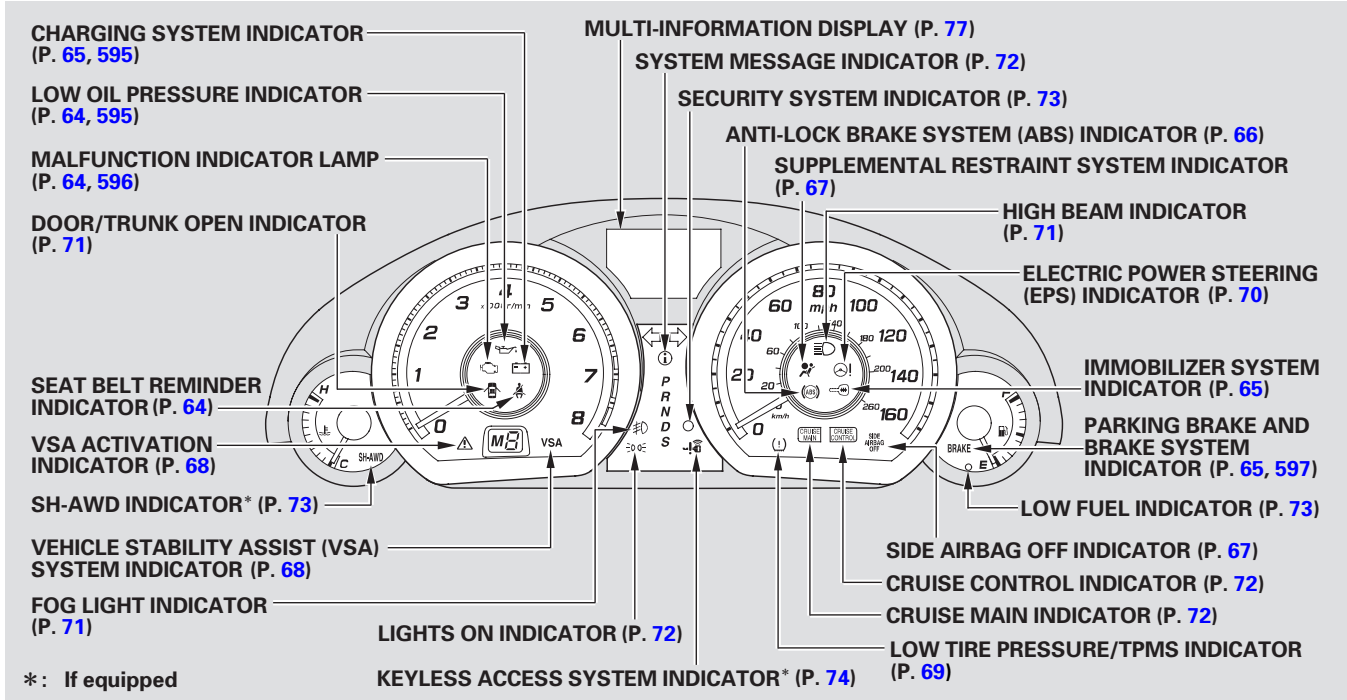

The U.S. instrument panel is shown. Differences for the Canadian models are noted in the text.

Instrument Panel Indicators

The instrument panel has many indicators to give you important information about your vehicle.



Seat Belt Reminder Indicator

This indicator comes on when you turn the ignition switch* to the ON (II) position. It reminds you and your passengers to fasten your seat belts. A beeper also sounds if you have not fastened your seat belt.

You will also see a “FASTEN SEAT BELT” message on the multi-information display.

If you turn the ignition switch to the ON (II) position before fastening your seat belt, the beeper sounds and the indicator flashes. If you do not fasten your seat belt before the beeper stops, the indicator stops flashing but remains on.

If your front passenger does not fasten their seat belt, the indicator comes on about 6 seconds after the ignition switch is turned to the ON (II) position.

If either of you do not fasten your seat belt while driving, the beeper will sound and the indicator will flash again at regular intervals, and you will see a “FASTEN SEAT BELT” or “FASTEN PASSENGER SEAT BELT” message on the multi-information display. For more information, see page [20](#) .

* : Models equipped with the keyless access system have an engine start/stop button instead of an ignition switch. ON Mode is the equivalent of ON (II). For more information, see pages [178](#) and [180](#) .



Malfunction Indicator Lamp

You will also see a “CHECK EMISSION SYSTEM” message on the multi-information display. For more information, see page [596](#) .



Low Oil Pressure Indicator

The engine can be severely damaged if this indicator flashes or stays on when the engine is running, and you will see a “CHECK ENGINE OIL LEVEL” message on the multi-information display. For more information, see page [595](#) .



Charging System Indicator

If this indicator comes on when the engine is running, the battery is not being charged, and you will also see a “CHECK CHARGING SYSTEM” message on the multi-information display. For more information, see page [595](#).



Immobilizer System Indicator

This indicator comes on briefly when you turn the ignition switch* to the ON (II) position. It will then go off if you have inserted a properly coded ignition key, on models with keyless access system, if an appropriate keyless access remote is used. If it is not a properly coded key or keyless access remote, the indicator will blink, and the engine’s fuel system will be disabled (see page [143](#)).

* : Models equipped with the keyless access system have an engine start/stop button instead of an ignition switch. ON Mode is the equivalent of ON (II). For more information, see pages [178](#) and [180](#).

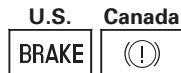

Parking Brake and Brake System Indicator

This indicator has two functions:

1. It comes on when you turn the ignition switch* to the ON (II) position. It is a reminder to check the parking brake. Driving with the parking brake not fully released can damage the brakes and tires.

If you drive without releasing the parking brake, a beeper will sound, and you will also see a “RELEASE PARKING BRAKE” message on the multi-information display (see page [201](#)).

CONTINUED

Instrument Panel Indicators

2. If it stays on after you have fully released the parking brake while the engine is running, or if it comes on while driving, it can indicate a problem in the brake system. You will also see a “LOW BRAKE FLUID” or “CHECK BRAKE SYSTEM” message on the multi-information display. For more information, see page [597](#).



Anti-lock Brake System (ABS) Indicator

This indicator normally comes on for a few seconds when you turn the ignition switch* to the ON (II) position. It may also come on briefly when the ignition switch is turned to the START (III) position.

If this indicator comes on at any other time, there is a problem in the ABS. If this happens, take the vehicle to your dealer to have it checked. With this indicator on, your vehicle still has normal braking ability but no anti-lock function. You will also see a “CHECK ABS SYSTEM” message on the multi-information display. For more information, see page [521](#).

- * : Models equipped with the keyless access system have an engine start/stop button instead of an ignition switch. ON Mode is the equivalent of ON (II), and START Mode is the equivalent of START (III). For more information, see pages [178](#) and [180](#).



Supplemental Restraint System Indicator

This indicator comes on briefly when you turn the ignition switch* to the ON (II) position. If it comes on at any other time, it indicates a potential problem with your front airbags. This indicator will also alert you to a potential problem with your side airbags, passenger's side airbag cutoff system, side curtain airbags, automatic seat belt tensioners, driver's seat position sensor, or the front passenger's weight sensors. You will also see a "CHECK AIRBAG SYSTEM" message on the multi-information display. For more information, see page [32](#).



U.S.

Canada



Side Airbag Off Indicator

This indicator comes on briefly when you turn the ignition switch* to the ON (II) position. If it comes on at any other time, it indicates that the passenger's side airbag has automatically shut off. For more information, see page [33](#).

You will also see a "PASSENGER SIDE AIRBAG OFF" message on the multi-information display.

* : Models equipped with the keyless access system have an engine start/stop button instead of an ignition switch. ON Mode is the equivalent of ON (II). For more information, see pages [178](#) and [180](#).

Instrument Panel Indicators

Vehicle Stability Assist (VSA) System Indicator

This indicator normally comes on for a few seconds when you turn the ignition switch* to the ON (II) position. It may also come on briefly when the ignition switch is turned to the START (III) position.

* : Models equipped with the keyless access system have an engine start/stop button instead of an ignition switch. ON Mode is the equivalent of ON (II), and START Mode is the equivalent of START (III). For more information, see pages [178](#) and [180](#).

If it comes on and stays on at any other time, or it does not come on when you turn the ignition switch* to the ON (II) position, there is a problem with the VSA or Hill Start Assist (on SH-AWD models only) system. You will also see a “CHECK VSA SYSTEM” message on the multi-information display. Take your vehicle to a dealer to have it checked. Without VSA, your vehicle still has normal driving ability, but will not have VSA traction and stability enhancement. For more information, see page [523](#).

VSA Activation Indicator

This indicator has three functions:

1. It comes on as a reminder that you have turned off the vehicle stability assist (VSA) system.
2. It flashes when VSA is active (see page [523](#)).
3. It comes on along with the VSA system indicator if there is a problem with the VSA or Hill Start Assist (on SH-AWD models only) system. You will also see a “CHECK VSA SYSTEM” message on the multi-information display.

This indicator normally comes on for a few seconds when you turn the ignition switch* to the ON (II) position. It may also come on briefly when the ignition switch is turned to the START (III) position. For more information, see page [523](#).

* : Models equipped with the keyless access system have an engine start/stop button instead of an ignition switch. ON Mode is the equivalent of ON (II), and START Mode is the equivalent of START (III). For more information, see pages [178](#) and [180](#).



Low Tire Pressure/ TPMS Indicator

This indicator normally comes on for a few seconds when you turn the ignition switch* to the ON (II) position.

* : Models equipped with the keyless access system have an engine start/stop button instead of an ignition switch. ON Mode is the equivalent of ON (II). For more information, see pages [178](#) and [180](#).

This indicator has two functions:

1. If it comes on while driving, it indicates that one or more of your vehicle's tires are significantly low on pressure.

You will also see a “CHECK TIRE PRESSURE” message on the multi-information display (see page [528](#)).

Check the tire pressure monitor on the multi-information display and determine the cause (see page [527](#)).

If this happens, pull to the side of the road when it is safe, check which tire has lost pressure on the multi-information display, and determine the cause. If it is because of a flat tire, have the flat tire repaired as soon as possible. If two or more tires are underinflated, call a professional towing service. For more information, see page [606](#).

CONTINUED

Instrument Panel Indicators

2. If this indicator begins to flash, there is a problem with the tire pressure monitoring system (TPMS). You will also see a “CHECK TPMS SYSTEM” message on the multi-information display. The indicator continues to flash for a while (approximately 1 minute), then stays on. If this happens, have your dealer check the system as soon as possible. For more information, see page [526](#).



Turn Signal and Hazard Warning Indicators

The left or right turn signal indicator blinks when you signal a lane change or turn. If an indicator does not blink or blinks rapidly, it usually means one of the turn signal bulbs is burned out (see pages [559](#) and [563](#)). Replace the bulb as soon as possible, since other drivers cannot see that you are signaling.

When you press the hazard warning button, both turn signal indicators and all turn signals on the outside of the vehicle flash.



Electric Power Steering (EPS) Indicator

This indicator normally comes on when you turn the ignition switch* to the ON (II) position and goes off after the engine starts. If it comes on at any other time, there is a problem in the electric power steering system.

- * : Models equipped with the keyless access system have an engine start/stop button instead of an ignition switch. ON Mode is the equivalent of ON (II). For more information, see pages [178](#) and [180](#).

If this happens, stop the vehicle in a safe place and turn off the engine. Reset the system by restarting the engine. The indicator will stay on, but should go off after driving a short distance. If it does not go off, or comes back on again while driving, take the vehicle to your dealer to have it checked. With the indicator on, the EPS may be turned off, making the vehicle harder to steer.

If you turn the steering wheel to the full left or right position repeatedly while stopping or driving at very low speed, you may feel slightly harder steering in order to prevent damage to the steering box caused by overheating.

You will also see a “CHECK POWER STEERING SYSTEM” message on the multi-information display.



Door/Trunk Open Indicator

This indicator comes on red if any door or the trunk lid is not closed tightly.

You will also see a corresponding indicator(s) on the multi-information display to indicate which door and/or the trunk is not closed tightly (see page 11).



High Beam Indicator

This indicator comes on with the high beam headlights. For more information, see page 134 .

This indicator also comes on with reduced brightness when the daytime running lights (DRL) are on (see page 136).





Fog Light Indicator

This indicator comes on when you turn on the fog lights. For more information, see page 137 .

Instrument Panel Indicators



Lights On Indicator

This indicator reminds you that the exterior lights are on. It comes on when the light switch is in either the  or  position. This indicator will also come on when the light switch is in AUTO and the lights turn on automatically. If you turn the ignition switch* to the ACCESSORY (I) or the LOCK (O) position without turning off the light switch, this indicator will remain on. A reminder chime will also sound when you open the driver's door.

* : Models equipped with the keyless access system have an engine start/stop button instead of an ignition switch. VEHICLE OFF (LOCK) Mode is the equivalent of LOCK (O) and ACCESSORY Mode is the equivalent of ACCESSORY (I). For more information, see pages [178](#) and [180](#).



Cruise Main Indicator

This indicator comes on when you turn on the cruise control system by pressing the CRUISE button on the steering wheel (see page [386](#)).



Cruise Control Indicator

This indicator comes on when you set the cruise control. See page [386](#) for information on operating the cruise control.



System Message Indicator

This indicator comes on when there is a system message on the multi-information display. Press the INFO button on the steering wheel (see page [78](#)) to see the message (see page [88](#)).

Most of the time, this indicator comes on along with other indicators in the instrument panel such as the seat belt reminder indicator, SRS indicator, VSA system indicator, etc.

Low Fuel Indicator

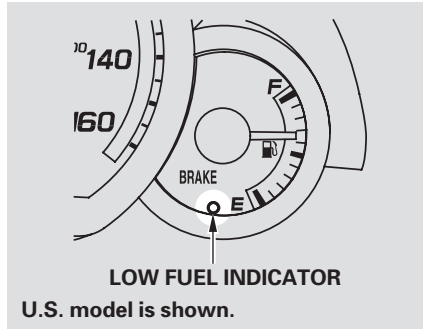

This indicator is in the fuel gauge. It comes on as a reminder that you must refuel soon. You will also see a “LOW FUEL” message on the multi-information display.

When the indicator comes on, there are about 2.5 U.S. gal (9.6 l) on SH-AWD models, and 2.8 U.S. gal (10.5 l) on 2WD models of fuel remaining in the tank.

When the needle reaches E, there is a very small amount of fuel in the tank.

Security System Indicator

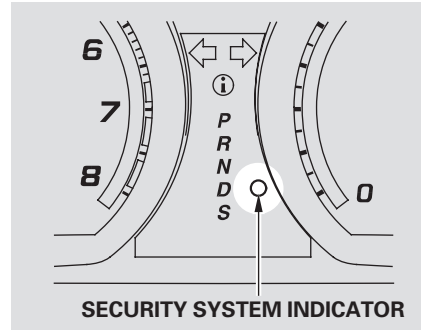

This indicator comes on when the security system is set. For more information, see page [380](#).



Super Handling-All Wheel Drive (SH-AWD) Indicator

On SH-AWD models

This indicator normally comes on for a few seconds when you turn the ignition switch* to the ON (II) position. If this indicator comes on at any other time, there is a problem in the SH-AWD system. You will also see a “CHECK SH-AWD SYSTEM” message on the multi-information display (see page [518](#)). Take your vehicle to a dealer to have it checked. For more information, see page [517](#).

* : Models equipped with the keyless access system have an engine start/stop button instead of an ignition switch. ON Mode is the equivalent of ON (II). For more information, see pages [178](#) and [180](#).

CONTINUED

Instrument Panel Indicators

If the indicator blinks while driving, the differential temperature is too high.

You will also see an “SH-AWD DIFF TEMP. HIGH” message on the multi-information display (see page [518](#)).

Pull to the side of the road when it is safe, shift to Park, and let the engine idle until the indicator goes out.

NOTICE

Continuing to drive with the SH-AWD indicator blinking may cause serious damage to the system.



Keyless Access System Indicator

On models with keyless access system
This indicator normally comes on for a few seconds when you select the ON mode with the engine start/stop button (see page [187](#)). If it comes on at any other time, it indicates that there is a problem with the system.

This indicator has two functions:

1. If this indicator comes on along with a “CHECK KEYLESS ACCESS SYSTEM” message on the multi-information display, there is a problem with the keyless access system. Have the vehicle checked by your dealer as soon as possible. For more information, see page [188](#).

2. If this indicator comes on along with a “CHECK KEYLESS STARTING SYSTEM” message on the multi-information display, there is a problem with the keyless starting system. In this case, your vehicle may not restart. If you can continue to drive safely, take the vehicle to your dealer and have it checked as soon as possible. For more information, see page [188](#).

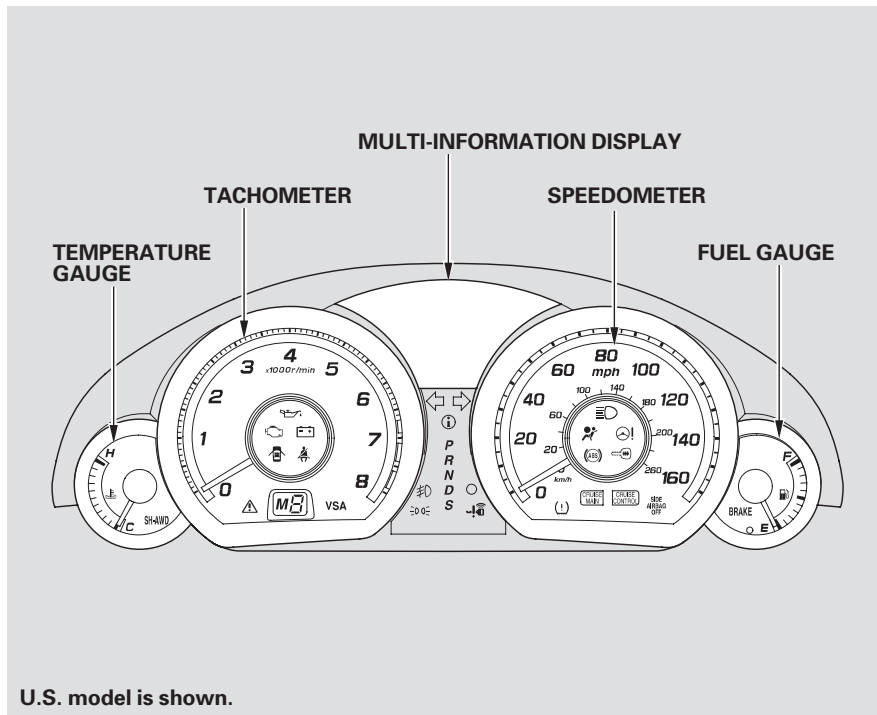

Fuel Gauge

This shows how much fuel you have. It may show slightly more or less than the actual amount. The needle returns to the bottom after you turn off the ignition/power mode.

NOTICE

Avoid driving with an extremely low fuel level. Running out of fuel could cause the engine to misfire, damaging the catalytic converter.

Gauges

Temperature Gauge

This shows the temperature of the engine's coolant. During normal operation, the pointer should rise from the bottom mark to about the middle of the gauge. In severe driving conditions, such as very hot weather or a long period of uphill driving, the pointer may rise to the upper zone. If it reaches the red (hot) mark, pull safely to the side of the road. Turn to page [593](#) for instructions and precautions on checking the engine cooling system.

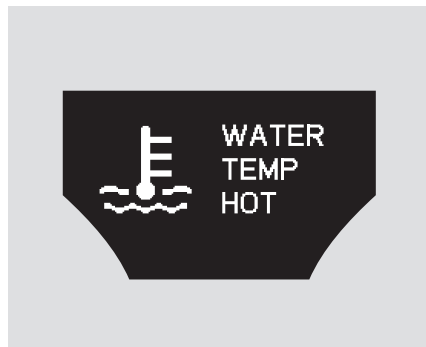

If the pointer of the temperature gauge reaches to or above the red mark, you will also see the “WATER TEMP HOT” message on the multi-information display. This will alert you that the engine should be cooled down.

The multi-information display in the instrument panel displays various information and messages when the ignition switch* is in the ON (II) position. Some of the messages help you operate your vehicle more comfortably. Others help to keep you aware of the periodic maintenance your vehicle needs for continued trouble-free driving.

* : Models equipped with the keyless access system have an engine start/stop button instead of an ignition switch. ON Mode is the equivalent of ON (II). For more information, see pages 178 and 180 .

There are three types of messages: normal display messages, engine oil life and maintenance messages, and system messages.

You can select the displayed language and also customize some vehicle control settings to your liking with the multi-information display and the three buttons on the steering wheel (see page 78).

Normal Display Messages

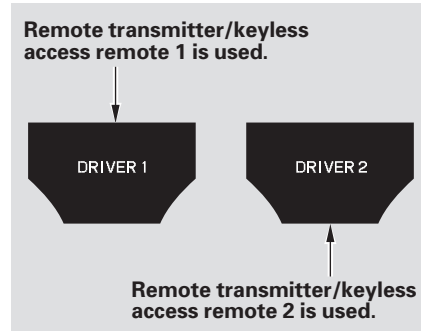

When you unlock and open the driver's door, the display shows "DRIVER 1" or "DRIVER 2" depending on which remote transmitter/keyless access remote

you use, and the driver's seat and the outside mirrors move to the position stored in that remote transmitter/keyless access remote (see page 164).

On models with keyless access system
The driver's ID (1 or 2) is displayed when the power mode is set to ON.

CONTINUED

Multi-Information Display



If you do not fasten your seat belt, you will also see a “FASTEN SEAT BELT” message on the multi-information display when you turn the ignition switch* to the ON (II) position.

These messages go off several seconds after the key is inserted into the ignition switch.

On models with keyless access system
These messages go off in about several seconds.

* : Models equipped with the keyless access system have an engine start/stop button instead of an ignition switch. ON Mode is the equivalent of ON (II). For more information, see pages [178](#) and [180](#).

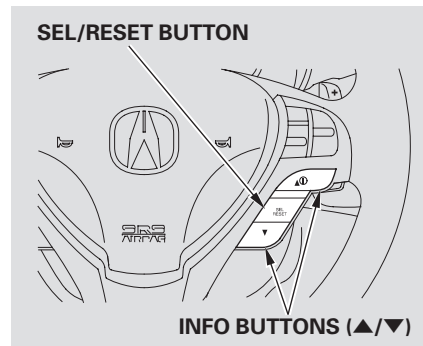

With the ignition switch* in the ON (II) position, the multi-information display changes as shown on page [80](#) each time you press the INFO (▲/▼) button or the SEL/RESET button.

When you turn the ignition switch* to the ON (II) position, your last selection is displayed.

- * : Models equipped with the keyless access system have an engine start/stop button instead of an ignition switch. ON Mode is the equivalent of ON (II). For more information, see pages [178](#) and [180](#) .

In the multi-information display, the system message is also displayed (see page [87](#)) and you can customize your vehicle control settings (see page [91](#)).

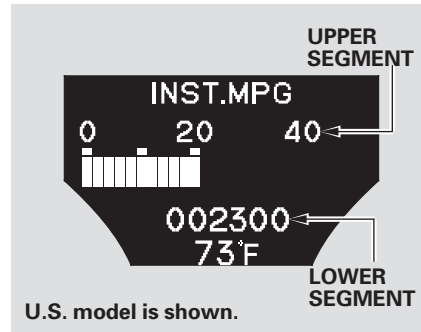

The multi-information display consists of an upper segment and a lower segment.

In the normal display mode, the upper segment displays trip computer information, such as fuel economy or average speed. The lower segment displays the odometer/trip meter (A/B), outside temperature, and engine oil life and maintenance item code(s).

On models with keyless access system
You will see some keyless access system messages until you select the ON mode by operating the engine start/stop button. These messages can be customized (see page [105](#)).

CONTINUED

Multi-Information Display

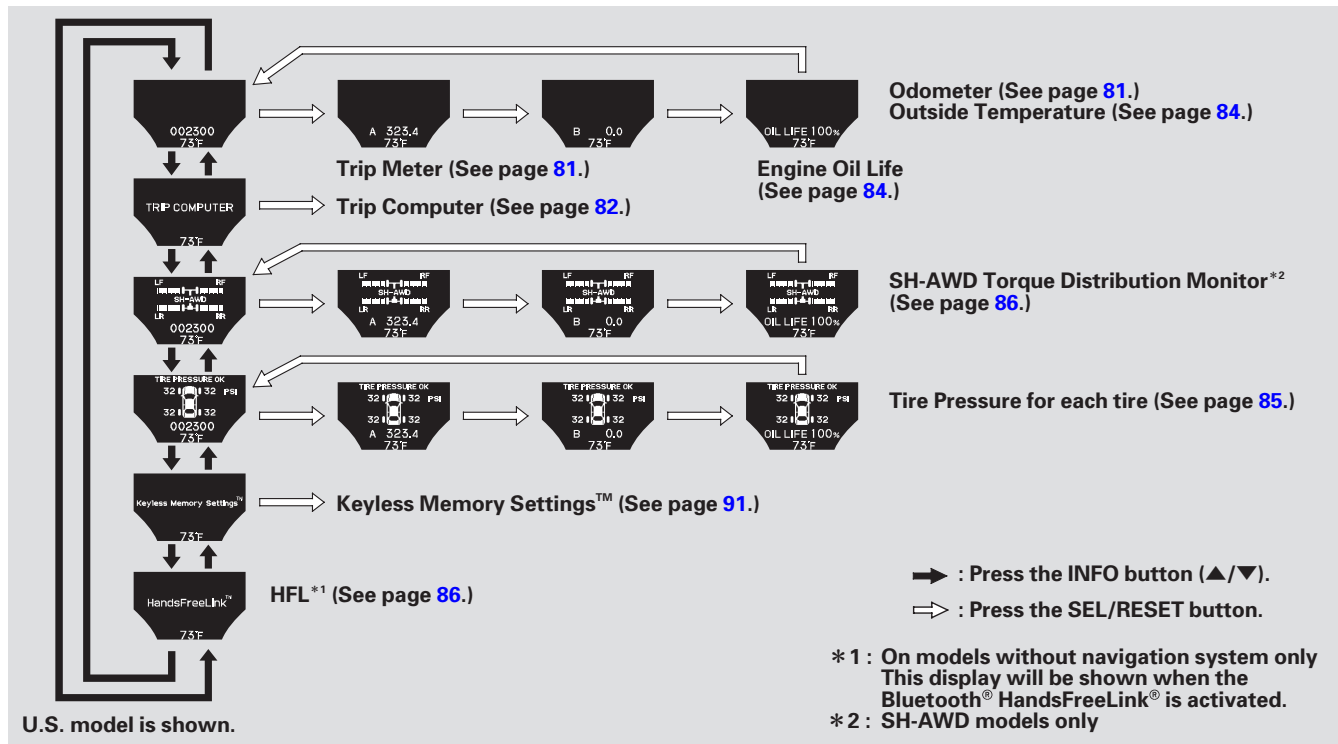

Odometer

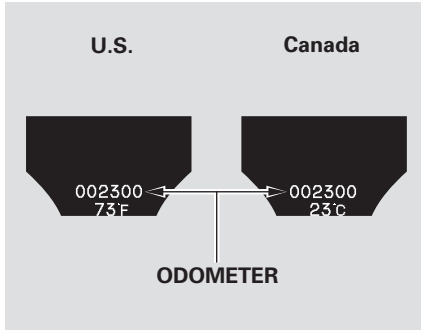

The odometer shows the total distance your vehicle has been driven. It measures miles in U.S. models and kilometers in Canadian models. It is illegal under U.S. federal law and Canadian provincial regulations to disconnect, reset, or alter the odometer with the intent to change the number of miles or kilometers indicated.

Trip Meter

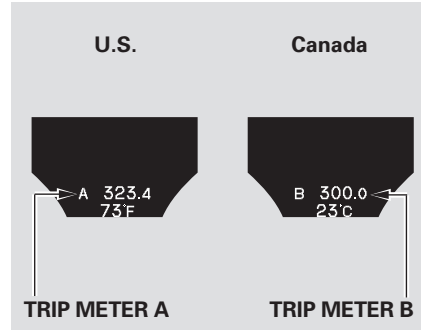

This meter shows the number of miles (U.S.) or kilometers (Canada) driven since you last reset it. There are two trip meters: Trip A and Trip B. Each trip meter works independently, so you can keep track of two different distances.

To reset a trip meter, display it, and then press and hold the SEL/RESET button until the number resets to "0.0."

When you reset Trip A, average fuel economy A, average vehicle speed A, and elapsed time A are reset at the same time. When you reset Trip B, average fuel economy B, average vehicle speed B, and elapsed time B are reset.

In the customizing mode, you can set Trip A and average fuel economy A to reset at the same time when you refuel your vehicle (see page 101).

CONTINUED

Multi-Information Display

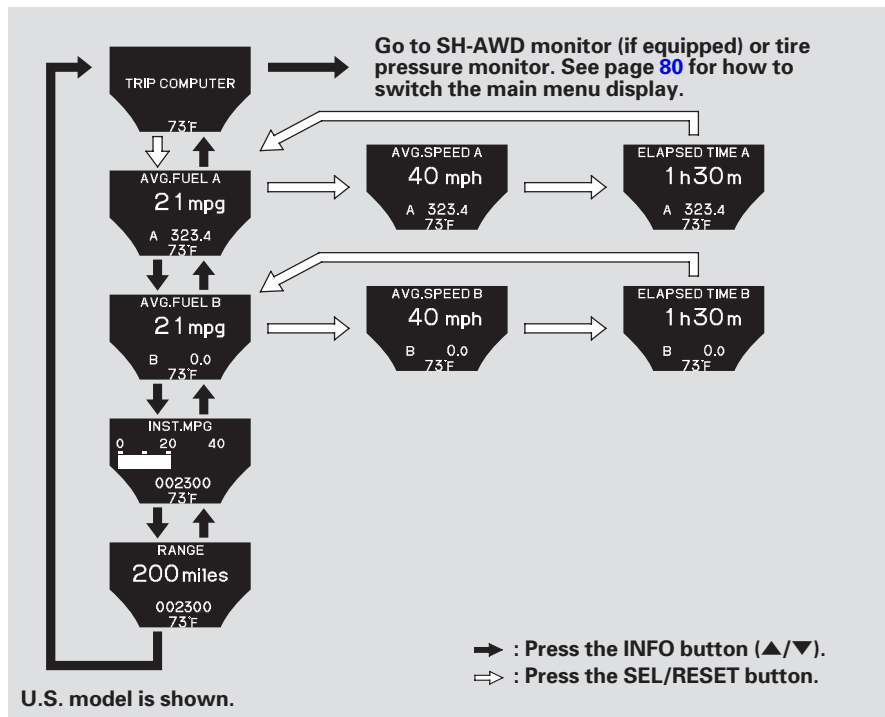

Trip Computer

Along with the trip meter, the trip computer calculates these values:

- Average Fuel Economy
- Average Vehicle Speed
- Elapsed Time
- Instant Fuel Economy
- Range

AVG. FUEL A/B

This shows your vehicle's average fuel economy in mpg (U.S. models) or liter/100 km (Canadian models) since you last reset Trip A or Trip B.

You can customize the Trip A and AVG. FUEL A reset condition on the multi-information display (see page 101).

AVG. SPEED A/B

This shows the average speed you are traveling in miles per hour (mph) for U.S. models or kilometers per hour (km/h) for Canadian models.

ELAPSED TIME A/B

This shows the time passed traveled since you last reset it. When you turn the ignition switch* to the ON (II) position, ELAPSED TIME A or B is reset.

* : Models equipped with the keyless access system have an engine start/stop button instead of an ignition switch. ON Mode is the equivalent of ON (II). For more information, see pages [178](#) and [180](#).

INST. MPG (U.S. models)/INST. L/100 km (Canadian models)

This shows your current fuel economy.

When you turn off the engine, INST. MPG or INST. L/100 km is also reset.

RANGE

This shows the estimated distance you can travel on the fuel remaining in the fuel tank. This distance is estimated from the fuel economy you received over the last several miles(U.S.) or kilometers (Canada), so it will vary with changes in speed, traffic, etc.

Multi-Information Display

Outside Temperature

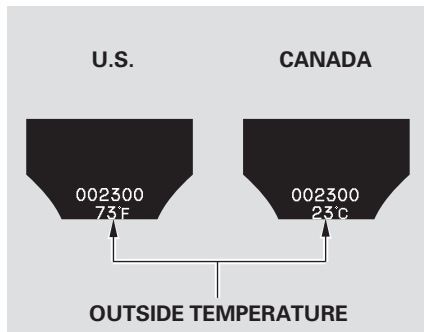

This shows the outside Fahrenheit temperature in U.S. models, and Celsius temperature in Canadian models.

The temperature sensor is in the front bumper. The temperature reading can be affected by heat reflection from the road surface, engine heat, and the exhaust from surrounding traffic. This can cause an incorrect temperature reading when your vehicle speed is under 19 mph (30 km/h). When you start your trip, the sensor is not fully acclimatized, therefore it may take several minutes until the proper temperature is displayed.

In certain weather conditions, temperature readings near freezing (32°F, 0°C) could mean that ice is forming on the road surface.

You can adjust the outside temperature display (see page [100](#)).

Engine Oil Life

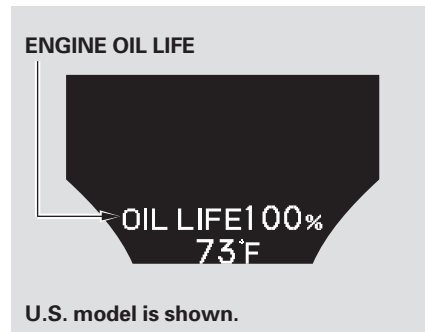

This shows the remaining engine oil life. It shows 100% after the engine oil is replaced and the display is reset. The engine oil life is calculated based on engine operating conditions. For more information, see page [535](#).

Tire Pressure Monitor

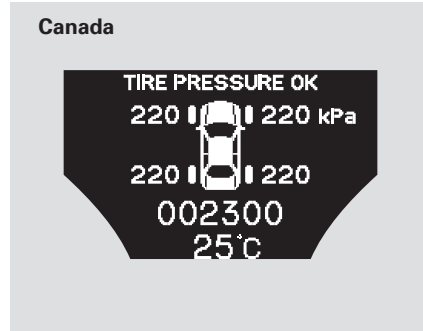
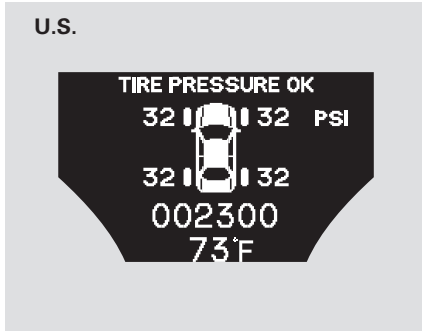

You can see the pressure of each tire in this monitor. If one or more tires are low, inflate them to the correct pressure. For more information, see [page 527](#).

Multi-Information Display

SH-AWD Torque Distribution Monitor

SH-AWD models only

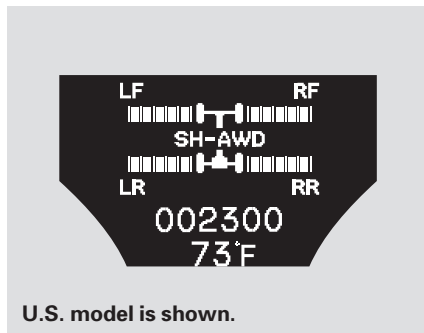

This monitor shows how much torque is being delivered to each wheel. For more information, see page [517](#).

Bluetooth® HandsFreeLink®



On models without navigation system
You can receive or make phone calls from your cell phone through your vehicle's Bluetooth® HandsFreeLink® (HFL) system without touching your cell phone.

To use the system, your cell phone and the HFL system must be linked. Not all cell phones are compatible with this system. Refer to page [392](#) for instructions on how to link your cell phone to HFL and how to receive or make phone calls, or visit the acura.com/handsfreelink website.

On models with navigation system
You can see HFL information on the navigation screen (see page [422](#)).

System Messages

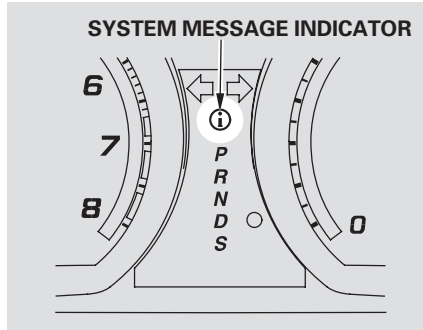

If there is a problem with your vehicle, for example, the engine oil level is low or a door is not fully closed, the multi-information display will show you the problem. It does this by interrupting the current display with one or more messages.

The system message(s) triggers the appropriate indicator(s) on the instrument panel, including the system message indicator, to come on. The system message indicator does not go off until the problem(s) is corrected.

You will also hear a beep when the system message comes on for the first time.

Most of the messages are displayed for about 5 seconds, and then the normal display returns. If there are several system messages to be shown, the display switches these messages every 5 seconds.

To switch the message(s) before 5 seconds have elapsed, press the INFO (▲/▼) button on the steering wheel.







Even if you press the INFO (▲/▼) button, some messages stay on or come on again at regular intervals until the problem is corrected.







If the system message indicator remains lit on the instrument panel, you can see the corresponding message(s) again by pressing the INFO (▲/▼) button repeatedly.







Here is a list of all messages:







CONTINUED





Multi-Information Display







	See page 11
	See page 20
	See page 20
	See page 33
<p>U.S.</p> 	See page 33
<p>Canada</p> 	

<p>U.S.</p> 	See page 201
<p>Canada</p> 	
<p>U.S.</p> 	See page 555
<p>Canada</p> 	
<p>U.S.</p> 	See page 597
<p>Canada</p> 	

	See page 595
	See page 596
	See page 595
	See page 521
	See page 523
	See page 76



<p>U.S.</p>  <p>TIRE PRESSURE OK 32 PSI 32 PSI 002300 73°F</p>	See page 527
<p>Canada</p>  <p>TIRE PRESSURE OK 220 kPa 220 kPa 002300 25°C</p>	
 <p>CHECK TIRE PRESSURE</p>	See page 528
 <p>LOW TIRE PRESSURE 24 PSI 32 PSI 002300 73°F</p> <p>U.S. model shown</p>	See page 528
 <p>TPMS CHECK TPMS SYSTEM</p>	See page 529
 <p>TPMS ERROR PSI 002300 73°F</p> <p>U.S. model shown</p>	See page 529

 <p>DRL CHECK DRL SYSTEM</p>	See page 136
 <p>CHECK STARTING SYSTEM</p>	<p><i>On models without keyless access system</i></p> <p>See page 504</p> <p><i>On models with keyless access system</i></p> <p>See page 506</p>
 <p>CHECK TRANSMISSION</p>	See page 507
 <p>LOW FUEL</p>	See page 73
 <p>TIGHTEN FUEL CAP</p>	See page 488





 <p>CHECK POWER STEERING SYSTEM</p>	See page 70
 <p>SH-AWD CHECK SH-AWD SYSTEM</p> <p>SH-AWD model only</p>	See page 518
 <p>SH-AWD SH-AWD DIFF TEMP. HIGH</p> <p>SH-AWD model only</p>	See page 518
 <p>SERVICE DUE SOON A123456</p>	See page 536
 <p>SERVICE DUE NOW A123456</p>	See page 537
 <p>10 miles SERVICE PAST DUE A123456</p>	See page 538





CONTINUED

Multi-Information Display

 <p>LOW WASHER FLUID</p> <p>Canadian models only</p>	<p>See page 552</p>
 <p>REMOVE KEY</p> <p>On models without keyless access system</p>	<p>See page 145</p>

On models with keyless access system

 <p>CHECK KEYLESS ACCESS SYSTEM</p>	<p>See page 188</p>
 <p>CHECK KEYLESS STARTING SYSTEM</p>	<p>See page 188</p>
 <p>KEYLESS REMOTE NOT DETECTED</p>	<p>See page 185</p>
 <p>CHANGE KEYLESS REMOTE BATTERY</p>	<p>See page 186</p>
 <p>INSERT KEYLESS REMOTE INTO SLOT</p>	<p>See page 190</p>

 <p>REMOVE KEYLESS REMOTE FROM SLOT</p>	<p>See page 191</p>
 <p>TO START ENGINE: BRAKE + PUSH</p>	<p>See page 181</p>
 <p>SHIFT TO PARK</p>	<p>See page 183</p>
 <p>TO UNLOCK WHEEL: ROTATE + PUSH</p>	<p>See page 182</p>
 <p>TO TURN ACCESSORY ON: PUSH</p>	<p>See page 181</p>
 <p>TO TURN VEHICLE OFF: PUSH TWICE</p>	<p>See page 183</p>

Keyless Memory Settings™

You can customize some vehicle control settings. To change the settings, the ignition switch* must be in the ON (II) position, and the vehicle must be stopped with the transmission in Park.

If you turn the ignition switch* to the ACCESSORY (I) or the LOCK (0) position, or move the shift lever out of Park, the display will change to the normal screen.

* : Models equipped with the keyless access system have an engine start/stop button instead of an ignition switch. VEHICLE OFF (LOCK) Mode is the equivalent of LOCK (0), ACCESSORY Mode is the equivalent of ACCESSORY (I), and ON Mode is the equivalent of ON (II). For more information, see pages [178](#) and [180](#).

If you try to enter the customizing mode while the vehicle is moving, you will see a “MUST STOP AND SHIFT TO PARK TO CHANGE SETTINGS” message and you cannot change the settings.

You can customize some vehicle control settings for “DRIVER 1” and “DRIVER 2” separately.

To have the driver’s ID detected, make sure the driver’s door is unlocked with a corresponding remote transmitter/keyless access remote.

On models without keyless access system

If you use the key to unlock the driver’s door, the system cannot recognize either “DRIVER 1” or “DRIVER 2.”

CONTINUED

Multi-Information Display

If you want to change any vehicle control settings, select Keyless Memory Settings™ by pressing either INFO button (▲/▼), then press the SEL/RESET button. Select CHG SETTING, then press the SEL/RESET button.

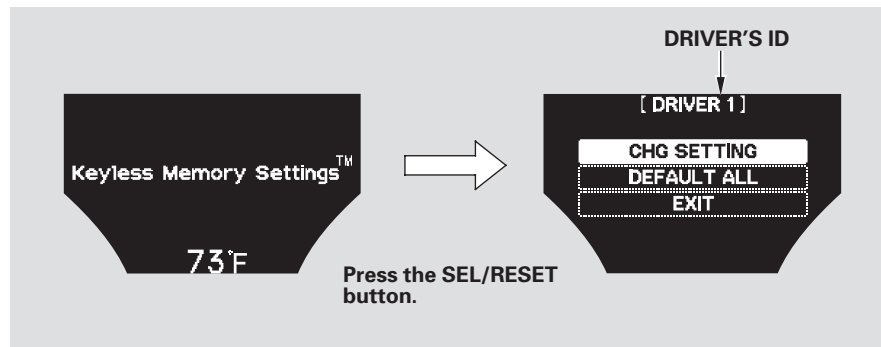

Refer to the table on the following pages about the settings you want to customize.

Multi-Information Display

Group Setup	Menu Item	Description	Setting Option	Page
METER SETUP (P.98)	LANGUAGE SELECTION	Changes the language used in the display.	ENGLISH* ¹	99
			FRENCH	
			SPANISH	
	ADJUST OUTSIDE TEMP. DISPLAY	Changes the outside temperature reading above or below its current reading.	-5°F ~ ±0°F* ¹ ~ 5°F (U.S.)	100
			-3°C ~ ±0°C* ¹ ~ 3°C (Canada)	
	TRIP COMPUTER TRIP A INFO RESET	Causes trip meter A and the average fuel economy to reset when you refuel.	WITH REFUEL* ¹	101
			MANUAL ONLY	
			IGN OFF	
	ADJUST ALARM VOLUME	Changes the indicator alarm volumes into three levels.	HIGH	103
			MID* ¹	
LOW				
AUTO INTERIOR ILLUMINATION	Changes the interior light sensitivity to your liking.	MAX	LOW	104
		HIGH	MIN	
		MID* ¹	OFF	
KEYLESS START GUIDANCE SCREENS* ²	Changes the display of the keyless start guidance screens.	ON* ¹	105	
		OFF		
POSITION SETUP (P.107)	MEMORY POSITION LINK	Changes the driver's seat and the outside mirror positions to a stored setting.	ON* ¹	108
			OFF	

*1 : Default setting

*2 : Only on models with Keyless Access system

CONTINUED

Multi-Information Display

Group Setup	Menu Item	Description	Setting Option		Page
KEYLESS ACCESS SETUP*2 (P.110)	DOOR UNLOCK MODE	Changes which doors unlock when you use the remote or grab the driver's door handle.	DRIVER DOOR*1		111
			ALL DOORS		
	KEYLESS ACCESS LIGHT FLASH	Causes some exterior lights to blink when you unlock/lock the doors by grabbing or touching the sensor/pushing the button on the driver's door handle.	ON*1		112
		OFF			
	KEYLESS ACCESS BEEP	Causes the beeper to sound when you unlock/lock the doors by grabbing or touching the sensor/pushing the button on the driver's door handle.	ON*1		113
			OFF		
LIGHTING SETUP (P.115)	INTERIOR LIGHT DIMMING TIME	Changes how long (in seconds) the interior lights stay on after you close the doors.	60 sec	15 sec	116
			30 sec*1		
	HEADLIGHT AUTO OFF TIMER	Changes how long (in seconds) the exterior lights stay on after you close the driver's door.	60 sec	0 sec	117
			30 sec		
			15 sec*1		
AUTO LIGHT SENSITIVITY	Changes the timing of when the headlights come on. The headlight switch needs to be in the AUTO position.	MAX	LOW	118	
		HIGH	MIN		
		MID*1			

*1 : Default setting

*2 : Only on models with keyless access system

Group Setup	Menu Item	Description	Setting Option	Page
DOOR/WINDOW SETUP (P.120)	AUTO DOOR LOCK	Changes when the doors automatically lock.	SHIFT FROM P	121
			WITH VEHICLE SPEED*	
			OFF	
	AUTO DOOR UNLOCK	Changes when the doors automatically unlock.	SHIFT TO P/DRIVER DOOR*	123
			SHIFT TO P/ALL DOORS	
			IGN OFF/DRIVER DOOR	
			IGN OFF/ALL DOORS	
	KEY AND REMOTE UNLOCK MODE	Changes which doors unlock with the remote transmitter/keyless access remote on the first push.	DRIVER DOOR*	125
			ALL DOORS	
	KEYLESS LOCK ACKNOWLEDGMENT	The exterior lights flash each time you press the LOCK or UNLOCK button. A beeper will also sound when you press the LOCK button twice.	ON*	126
OFF				
SECURITY RELOCK TIMER	Changes how long it takes (in seconds) for the doors to relock and the security system to set after you unlock but do not open the door.	90 sec	127	
		60 sec		
		30 sec*		
DEFAULT ALL (P.129)		Set/Cancel all the customized settings as default.	SET	129
			CANCEL	

* : Default setting

Multi-Information Display

Customize Settings

You can customize some of the vehicle control settings to your preference. Here are the settings you can customize:

- METER SETUP
- POSITION SETUP
- KEYLESS ACCESS SETUP*
- LIGHTING SETUP
- DOOR/WINDOW SETUP

*: Only on models with keyless access system

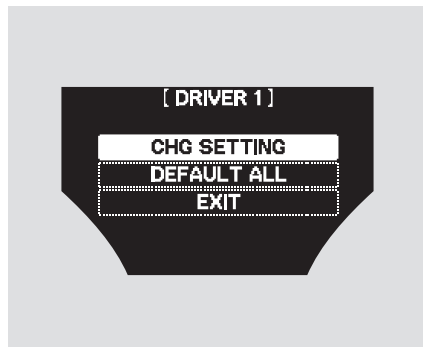

When you want to change the vehicle control settings, press the INFO (▲/▼) button to select CHG SETTING, then press the SEL/RESET button.

Each time you press the INFO (▲/▼) button, the screen changes as shown on the next page. Press the INFO (▲/▼) button until you see the setup you want to customize, then press the SEL/RESET button to enter your selection.

If you do not make any changes, select “EXIT,” the display returns to normal display.

If you want the settings as they were when the vehicle left the factory, select DEFAULT ALL, as described on page [129](#).

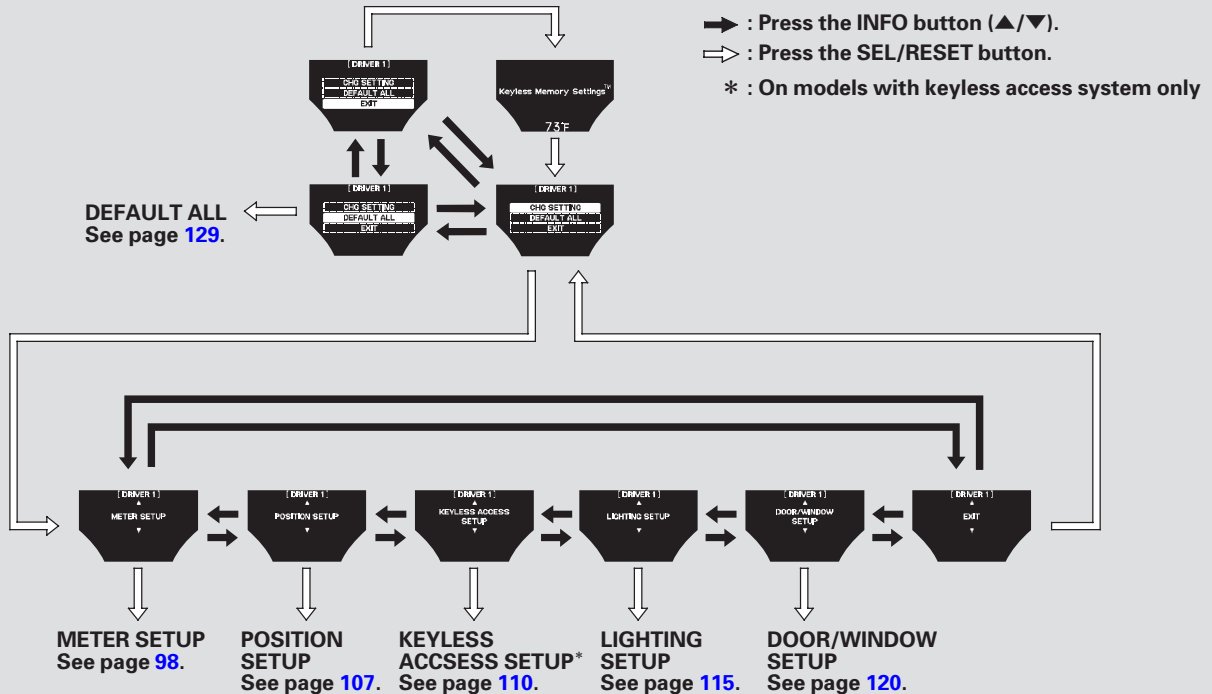

Multi-Information Display

Meter Setup

Here are the five or six custom settings for the meter setup:

- LANGUAGE SELECTION
- ADJUST OUTSIDE TEMP. DISPLAY
- TRIP COMPUTER TRIP A INFO RESET
- ADJUST ALARM VOLUME
- AUTO INTERIOR ILLUMINATION
- KEYLESS START GUIDANCE SCREENS
On models with keyless access system
- KEYLESS START GUIDANCE SCREENS

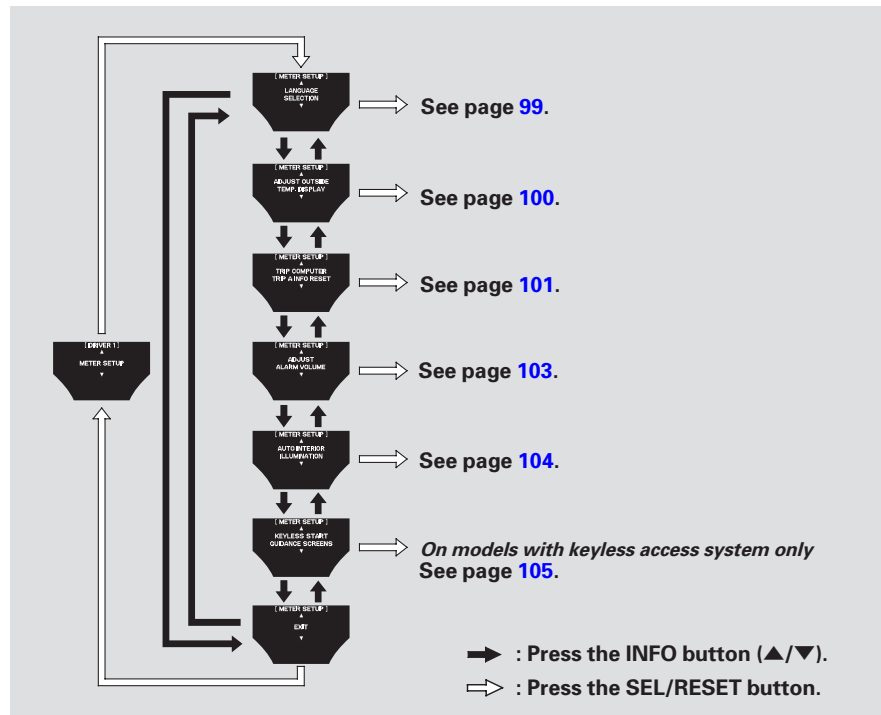

While “METER SETUP” is shown, press the SEL/RESET button to enter the customize mode.

Each time you press the INFO (▲/▼) button, the screen changes as shown in the illustration. Press the INFO (▲/▼) button until you see the setting you want to customize, then press the SEL/RESET button to enter your selection.

Language Selection

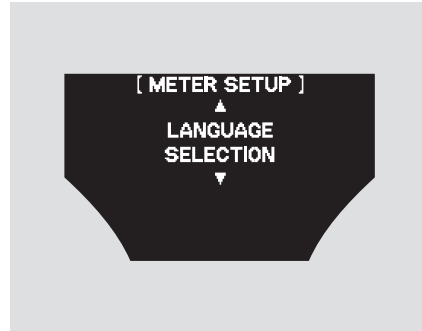

There are three language selections you can make: English, French, and Spanish. To choose the language you want, follow these instructions:

You can choose this item to customize from “METER SETUP” by pressing the INFO (▲/▼) button repeatedly.

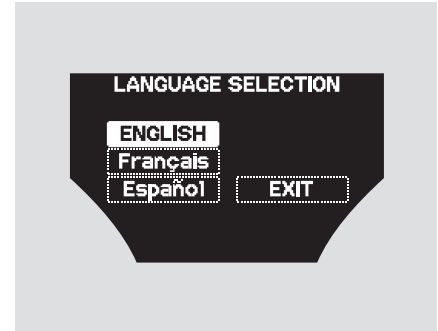

Press the SEL/RESET button to see the selections.

Select the desired language by pressing the INFO (▲/▼) button, then enter your selection by pressing the SEL/RESET button.

CONTINUED

Multi-Information Display

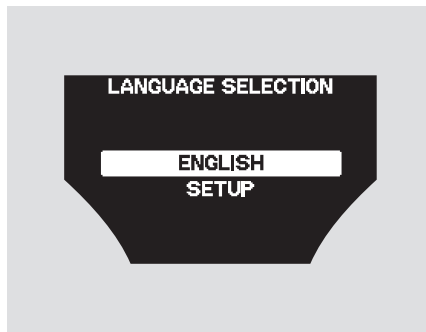

When your selection is successfully completed, the display changes as shown above, and then goes back to the customize item screen.

If the “SETTING INCOMPLETE” message appears, go back to “LANGUAGE SELECTION” and repeat the procedure again.

Adjust Outside Temp. Display

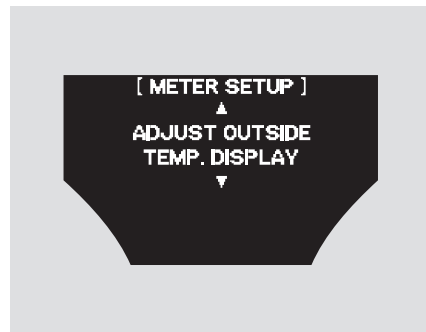

If you sometimes find that the temperature reading is a few degrees above or below the actual temperature, you can adjust it by following these instructions:

You can choose this item to customize from “METER SETUP” by pressing the INFO (▲/▼) button repeatedly. Press the SEL/RESET button to enter the setting.

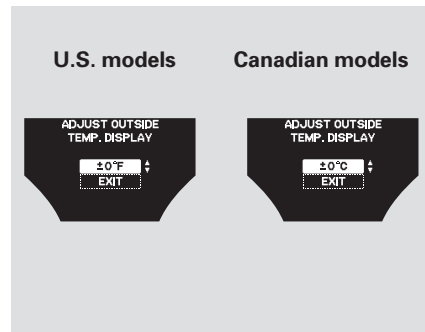

The displayed number is the current adjustment above or below the outside temperature.

Adjust the outside temperature value by pressing the INFO (▲/▼) button repeatedly. Press the SEL/RESET button to set the desired value.

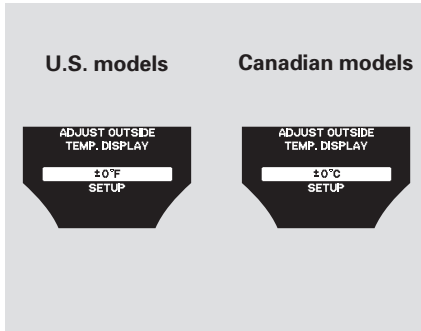

When your selection is successfully completed, the display changes as shown above, and then goes back to the customize item screen.

If the “SETTING INCOMPLETE” message appears, go back to “ADJUST OUTSIDE TEMP. DISPLAY” and repeat the procedure again.

Trip Computer Trip A Info Reset
You can select the reset timing of the Trip A information: Trip A, Average Fuel Economy A, Average Vehicle Speed A, and Elapsed Time A.

There are three reset choices you can make:

MANUAL ONLY — You can reset the Trip A information when Trip A is displayed (see page [81](#)).

IGN OFF — The Trip A information is reset when you turn the ignition switch* to the LOCK (0) position.

* : Models equipped with the keyless access system have an engine start/stop button instead of an ignition switch. VEHICLE OFF (LOCK) Mode is the equivalent of LOCK (0). For more information, see pages [178](#) and [180](#) .

WITH REFUEL — The Trip A information is reset every time you refuel your vehicle.

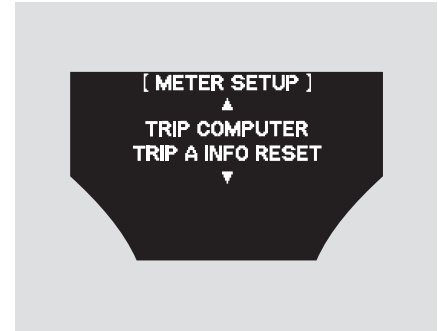

You can choose this item to customize from “METER SETUP” by pressing the INFO (▲/▼) button repeatedly.

CONTINUED

Multi-Information Display

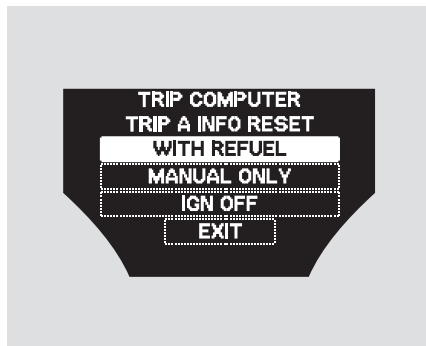

Press the SEL/RESET button to see the selections.

Select the desired setting by pressing the INFO (▲/▼) button, then enter your selection by pressing the SEL/RESET button.

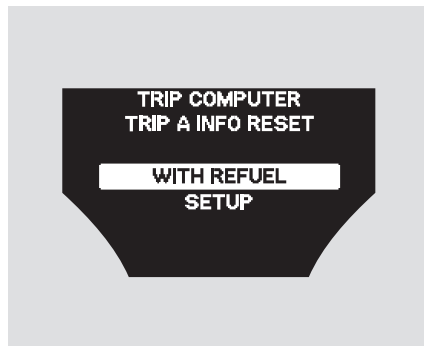

When your selection is successfully completed, the display changes as shown above, and then goes back to the customize item screen.

If the “SETTING INCOMPLETE” message appears, go back to “TRIP COMPUTER TRIP A INFO RESET” and repeat the procedure again.

Adjust Alarm Volume

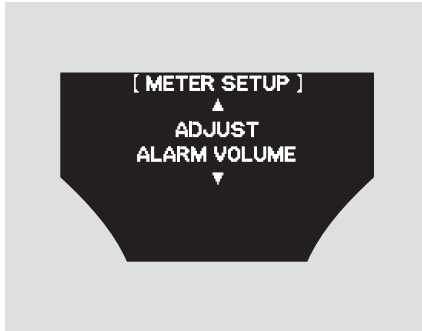

Select the warning alarm volume from three levels.

You can choose this item to customize from “METER SETUP” by pressing the INFO (▲/▼) button repeatedly.

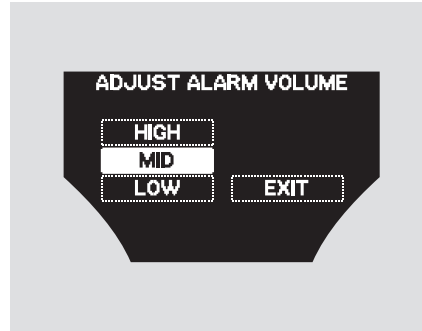

Press the SEL/RESET button to see the selections.

Select the desired level by pressing the INFO (▲/▼) button, then enter your selection by pressing the SEL/RESET button.

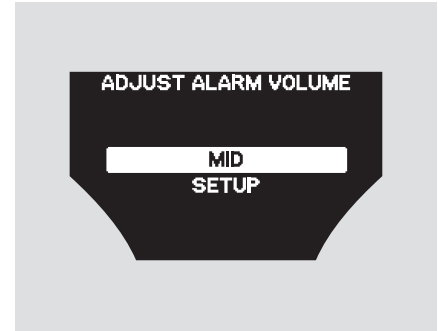

When your selection is successfully completed, the display changes as shown above, and then goes back to the customize item screen.

If the “SETTING INCOMPLETE” message appears, go back to “ADJUST ALARM VOLUME” and repeat the procedure again.

CONTINUED

Multi-Information Display

Auto Interior Illumination

While the headlight switch is turned on, the interior lights gradually dim, as the outside light level gets low. You can customize at which outside light level the lights start to dim.

There are MAX, HIGH, MID, LOW and MIN levels and OFF for the auto interior illumination settings.

If you want the illuminations to start dimming as early as possible, select MAX. For illuminations to start dimming as late as possible, select MIN. Choose HIGH, MID, or LOW for levels in between.

To disable the auto interior illumination function, select OFF.



You can choose this item to customize from “METER SETUP” by pressing the INFO (▲/▼) button repeatedly.

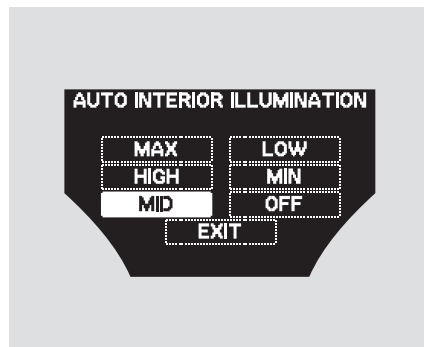

Press the SEL/RESET button to see the selections.

Select the desired setting by pressing the INFO (▲/▼) button, then enter your selection by pressing the SEL/RESET button.



When your selection is successfully completed, the display changes as shown above, and then goes back to the customize item screen.

If the “SETTING INCOMPLETE” message appears, go back to “AUTO INTERIOR ILLUMINATION” and repeat the procedure again.

Keyless Start Guidance Screens

On models with keyless access system
When this item is set to ON, you will see some guidance messages on the multi-information display. You can change this setting between on and off. For more information on start guidance messages, see page [181](#).

CONTINUED

Multi-Information Display



You can choose this item to customize from “METER SETUP” by pressing the INFO (▲/▼) button repeatedly.

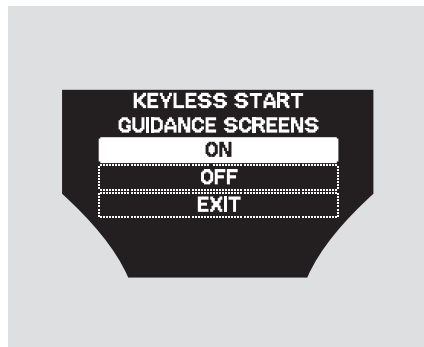

Press the SEL/RESET button to see the selections.

Select ON or OFF by pressing the INFO (▲/▼) button, then enter your selection by pressing the SEL/RESET button.

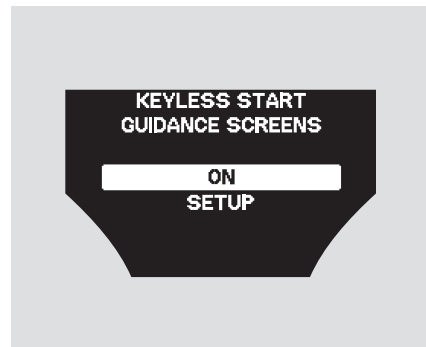

When your selection is successfully completed, the display changes as shown above, and then goes back to the customize item screen.

If the “SETTING INCOMPLETE” message appears, go back to “KEYLESS START GUIDANCE SCREENS” and repeat the procedure again.

Position Setup

You can customize the MEMORY POSITION LINK setting in position setup.

While “POSITION SETUP” is shown, press the SEL/RESET button to enter the customize mode.

Each time you press the INFO (▲/▼) button, the screen changes as shown in the illustration. Press the INFO (▲/▼) button until you see the custom setting then press the SEL/RESET button to enter your selection.

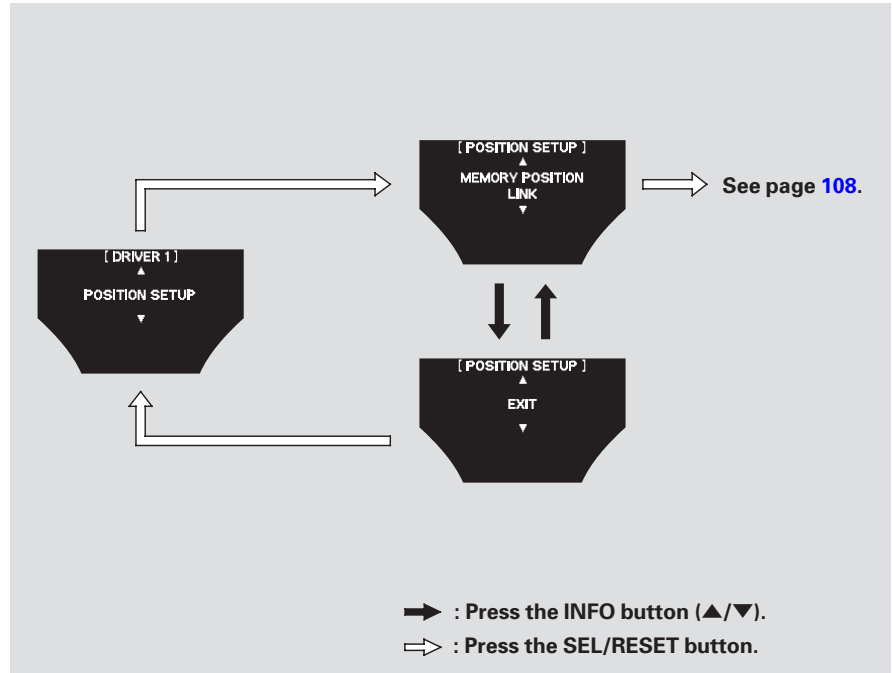

CONTINUED

Multi-Information Display

Memory Position Link

When Memory Position Link is set to ON, the driver's seat and the outside mirrors move to the positions stored in memory. To cause the memory to activate, open the driver's door with the remote transmitter. On models with keyless access system, open the driver's door with the remote, or grab the door handle while carrying the remote.

To set the memory positions, see page 164 .

On models with keyless access system
For information on using the remote, see page 167 .

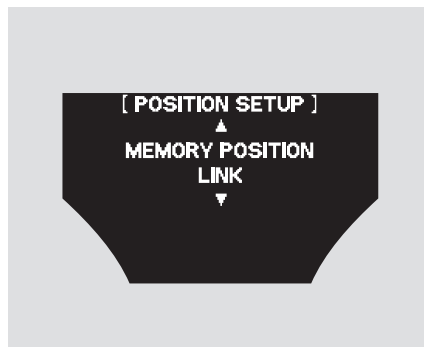

You can choose this item to customize from “POSITION SETUP” by pressing the INFO (▲/▼) button repeatedly.

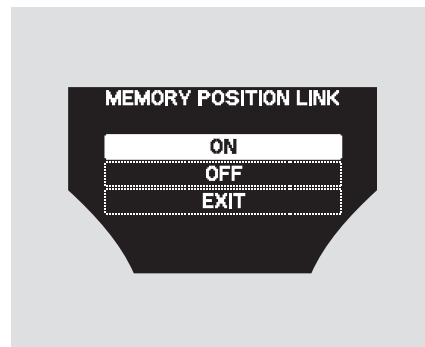

Press the SEL/RESET button to see the selections.

Select ON or OFF by pressing the INFO (▲/▼) button, then enter your selection by pressing the SEL/RESET button.

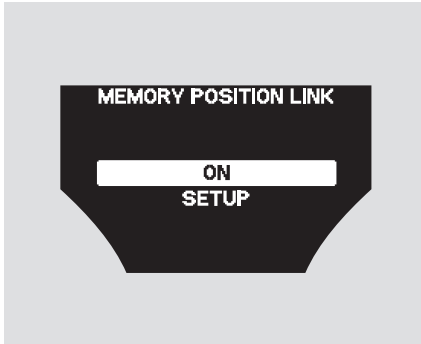

When your selection is successfully completed, the display changes as shown above, and then goes back to the customize item screen.

If the “SETTING INCOMPLETE” message appears, go back to “MEMORY POSITION LINK” and repeat the procedure again.

Multi-Information Display

Keyless Access Setup

On models with keyless access system

There are three custom settings for the keyless access setup:

- DOOR UNLOCK MODE
- KEYLESS ACCESS LIGHT FLASH
- KEYLESS ACCESS BEEP

While “KEYLESS ACCESS SETUP” is shown, press the SEL/RESET button to enter the customize mode.

Each time you press the INFO (▲/▼) button, the screen changes as shown in the illustration. Press the INFO (▲/▼) button, until you see the setting you want to customize, then press the SEL/RESET button to enter your selection.

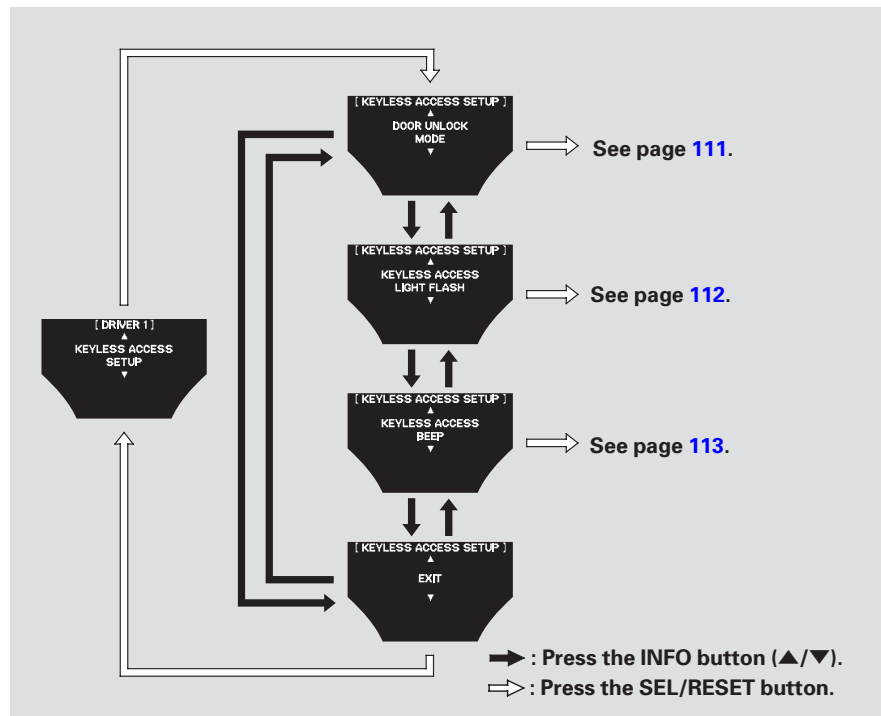

Door Unlock Mode



To select whether the driver's door or all doors unlock when you open the driver's door with the remote or by grabbing the door handle (while carrying the remote), follow these instructions:

You can choose this item to customize from "KEYLESS ACCESS SETUP" by pressing the INFO (▲/▼) button repeatedly.

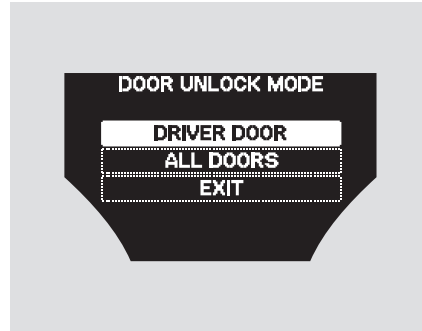

Press the SEL/RESET button to see the selections.

Select DRIVER DOOR or ALL DOORS by pressing the INFO (▲/▼) button, then enter your selection by pressing the SEL/RESET button.



When your selection is successfully completed, the display changes as shown above, and then goes back to the customize item screen.

If the "SETTING INCOMPLETE" message appears, go back to "DOOR UNLOCK MODE" and repeat the procedure again.

CONTINUED

Multi-Information Display

Keyless Access Light Flash

When KEYLESS ACCESS LIGHT FLASH is set to ON, some exterior lights blink twice when you unlock the doors by grabbing the driver's door handle while carrying the remote.

The same exterior lights blink once when you lock the doors by pushing the door lock button while carrying the remote.



You can choose this item to customize from “KEYLESS ACCESS SETUP” by pressing the INFO (▲/▼) button repeatedly.

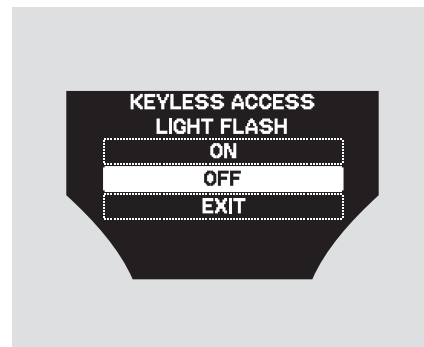

Press the SEL/RESET button to see the selections.

Select ON or OFF by pressing the INFO (▲/▼) button, then enter your selection by pressing the SEL/RESET button.

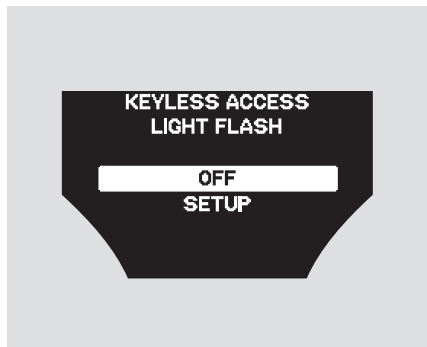

When your selection is successfully completed, the display changes as shown above, and then goes back to the customize item screen.

If the “SETTING INCOMPLETE” message appears, go back to “KEYLESS ACCESS LIGHT FLASH” and repeat the procedure again.

Keyless Access Beep

When KEYLESS ACCESS BEEP is set to ON, the beeper sounds twice when you unlock the doors by grabbing the drivers door handle while carrying the remote.

When you lock the doors by pushing the door lock button while carrying the remote, the beeper sounds once.



You can choose this item to customize from “KEYLESS ACCESS SETUP” by pressing the INFO (▲/▼) button repeatedly.

CONTINUED

Multi-Information Display

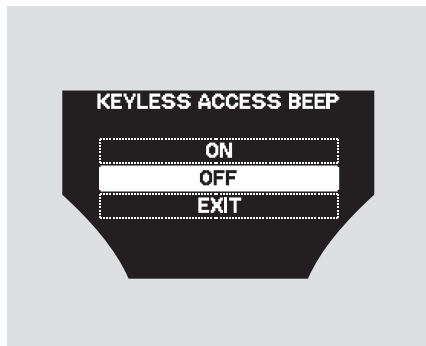

Press the SEL/RESET button to see the selections.

Select ON or OFF by pressing the INFO (▲/▼) button, then enter your selection by pressing the SEL/RESET button.

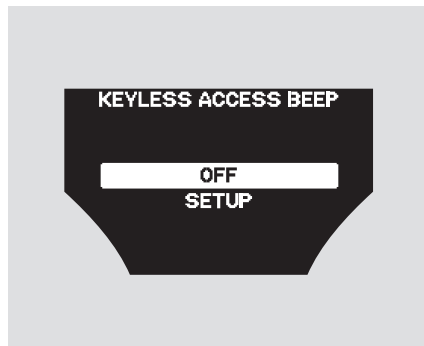

When your selection is successfully completed, the display changes as shown above, and then goes back to the customize item screen.

If the "SETTING INCOMPLETE" message appears, go back to "KEYLESS ACCESS BEEP" and repeat the procedure again.

Lighting Setup

Here are the three custom settings for the lighting setup:

- INTERIOR LIGHT DIMMING TIME
- HEADLIGHT AUTO OFF TIMER
- AUTO LIGHT SENSITIVITY

While “LIGHTING SETUP” is shown, press the SEL/RESET button to enter the customize mode.

Each time you press the INFO (▲/▼) button, the screen changes as shown in the illustration. Press the INFO (▲/▼) button until you see the setting you want to customize, then press the SEL/RESET button to enter your selection.

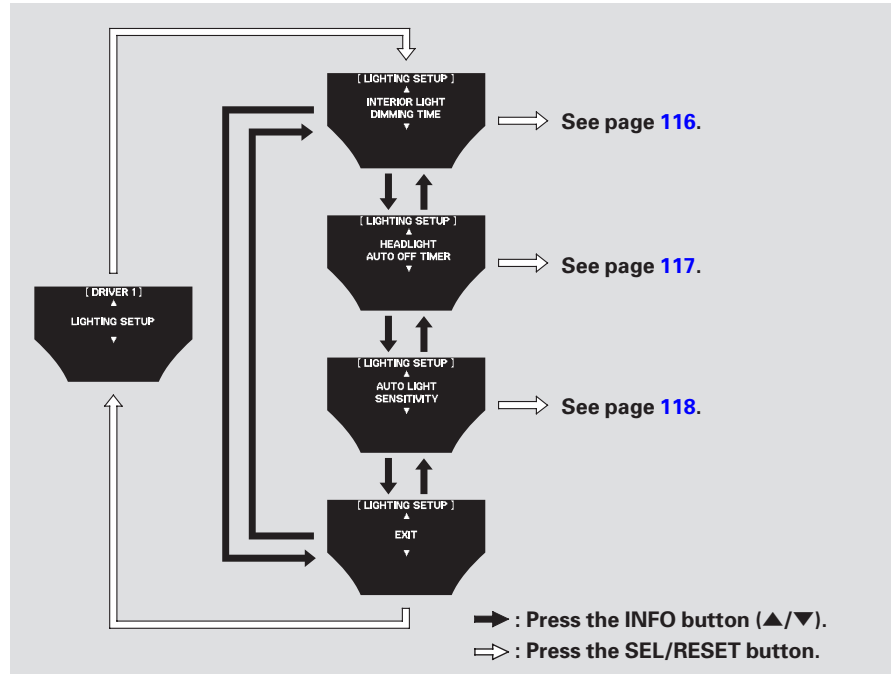

CONTINUED

Multi-Information Display

Interior Light Dimming Time

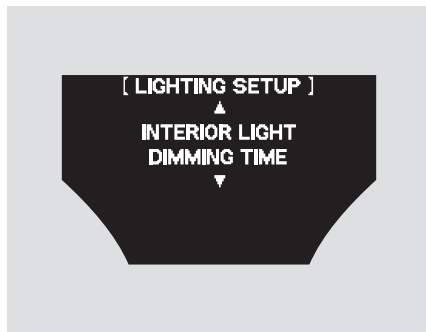

The interior lights fade out when you close all doors. To change how long the lights stay on before they fade out, follow these instructions:

You can choose this item to customize from “LIGHTING SETUP” by pressing the INFO (▲/▼) button repeatedly.

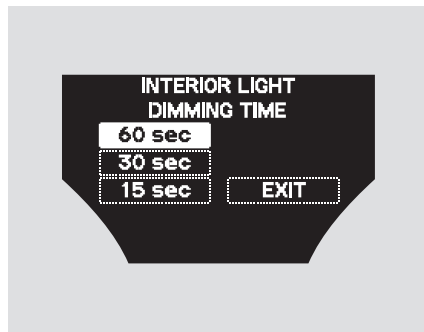

Press the SEL/RESET button to see the selections.

Select the desired setting (15 SEC, 30 SEC, or 60 SEC) by pressing the INFO (▲/▼) button, then enter your selection by pressing the SEL/RESET button.

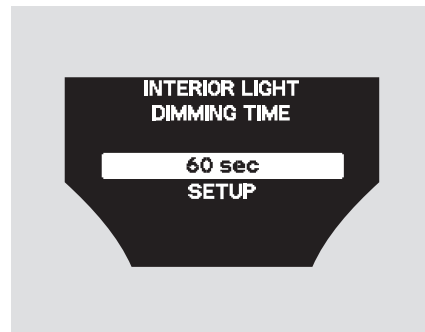

When your selection is successfully completed, the display changes as shown above, and then goes back to the customize item screen.

If the “SETTING INCOMPLETE” message appears, go back to “INTERIOR LIGHT DIMMING TIME” and repeat the procedure again.

Headlight Auto Off Timer

The headlights, parking lights, side marker lights, taillights, and license plate lights go off after the selected time when you remove the key from the ignition switch and close the driver's door. On models with keyless access system, the lights go off after the selected time when you close the driver's door and take the remote with you. To change how long the lights stay on before they go off, follow these instructions:

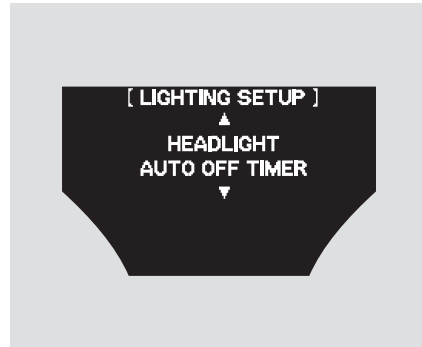

You can choose this item to customize from "LIGHTING SETUP" by pressing the INFO (▲/▼) button repeatedly.

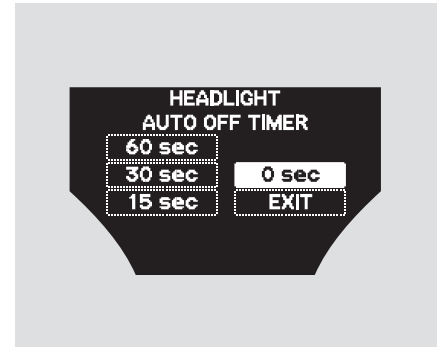

Press the SEL/RESET button to see the selections.

Select the desired setting (60 SEC, 30 SEC, 15 SEC or 0 SEC) by pressing the INFO (▲/▼) button, then enter your selection by pressing the SEL/RESET button.

CONTINUED

Multi-Information Display

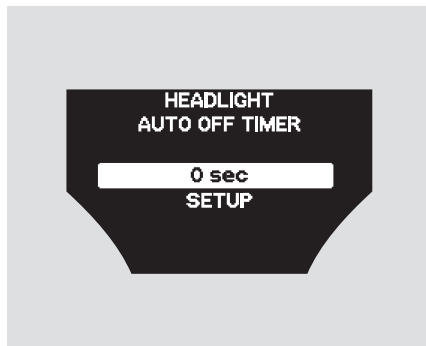

When your selection is successfully completed, the display changes as shown above, and then goes back to the customize item screen.

If the “SETTING INCOMPLETE” message appears, go back to “HEADLIGHT AUTO OFF TIMER” and repeat the procedure again.

Auto Light Sensitivity

The headlights automatically come on when the headlight switch is in the AUTO position and the ambient light reaches a changeable level. You can select the auto light sensitivity from the following five levels:

MAX —

The headlights come on when it is bright.

HIGH —

The headlights come on when it is somewhat bright.

MID —

The headlights come on when it is as bright as sunset or sunrise.

LOW —

The headlights come on when it is somewhat dark.

MIN —

The headlights come on when it is dark.

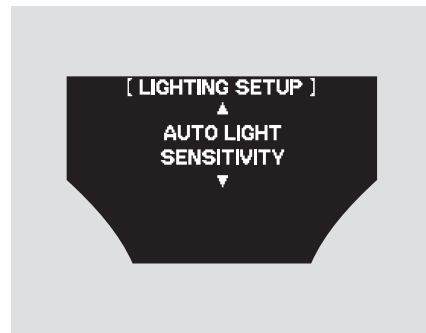

You can choose this item to customize from “LIGHTING SETUP” by pressing the INFO (▲/▼) button repeatedly.

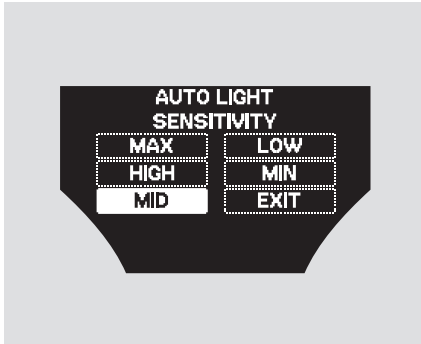

Press the SEL/RESET button to see the selections.

Select the desired setting (MAX, HIGH, MID, LOW or MIN) by pressing the INFO (▲/▼) button, then enter your selection by pressing the SEL/RESET button.

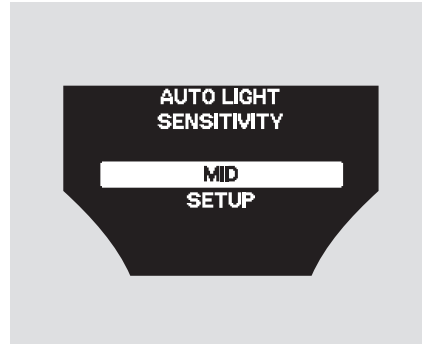

When your selection is successfully completed, the display changes as shown above, and then goes back to the customize item screen.

If the “SETTING INCOMPLETE” message appears, go back to “AUTO LIGHT SENSITIVITY” and repeat the procedure again.

Multi-Information Display

Door/Window Setup

Here are the five custom settings for the door setup:

- AUTO DOOR LOCK
- AUTO DOOR UNLOCK
- KEY AND REMOTE UNLOCK MODE
- KEYLESS LOCK ACKNOWLEDGMENT
- SECURITY RELOCK TIMER

While “DOOR/WINDOW SETUP” is shown, press the SEL/RESET button to enter the customize mode.

Each time you press the INFO (▲/▼) button, the screen changes as shown in the illustration. Press the INFO (▲/▼) button until you see the setting you want to customize, then press the SEL/RESET button to enter your selection.

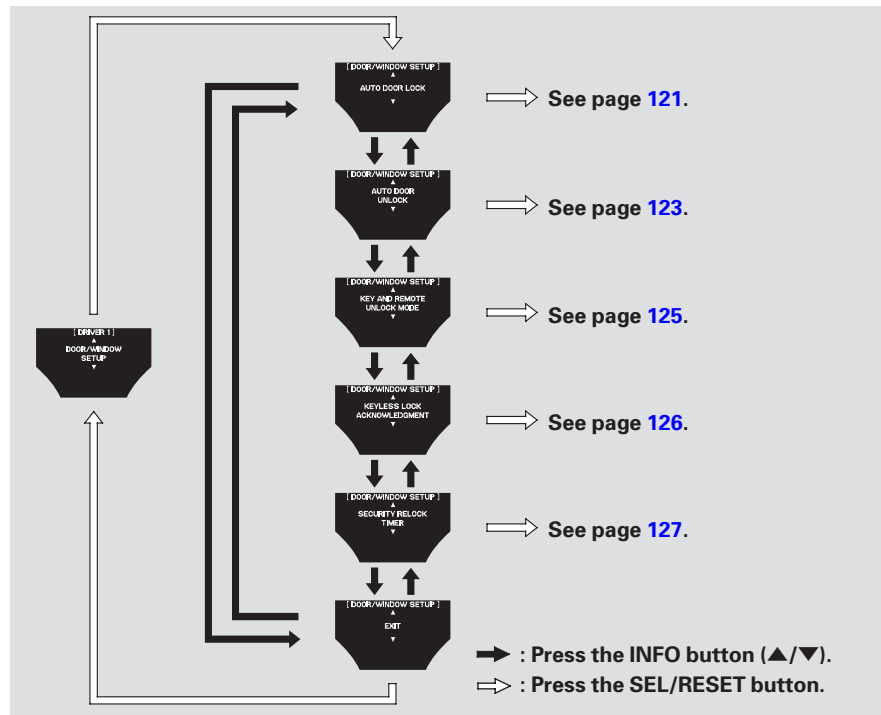

Auto Door Lock

There are three settings you can choose from:

SHIFT FROM P –

The doors lock whenever you move the shift lever out of Park.

WITH VEHICLE SPEED –

The doors lock when the vehicle speed reaches about 10 mph (about 16 km/h).

OFF –

The auto door lock is deactivated all the time.



You can choose this item to customize from “DOOR/WINDOW SETUP” by pressing the INFO (▲/▼) button repeatedly.

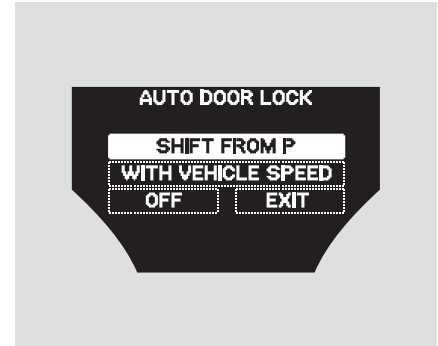

Press the SEL/RESET button to enter the selecting mode.

Select the desired setting by pressing the INFO (▲/▼) button, then enter your selection by pressing the SEL/RESET button.

CONTINUED

Multi-Information Display



When your selection is successfully completed, the display changes as shown above, and then goes back to the customize item screen.

If the “SETTING INCOMPLETE” message appears, go back to “AUTO DOOR LOCK” and repeat the procedure again.

Auto Door Unlock

There are five possible settings you can choose from:

DRIVER DOOR WITH SHIFT TO P

— The driver's door unlocks when you move the shift lever to Park.

ALL DOORS WITH SHIFT TO P

— All the doors unlock when you move the shift lever to Park.

DRIVER DOOR WITH IGN OFF

— The driver's door unlocks when you turn the ignition switch* to the LOCK (0) position.

ALL DOORS WITH IGN OFF

— All the doors unlock when you turn the ignition switch* to the LOCK (0) position.

OFF — The auto door unlock is deactivated all the time.

* : Models equipped with the keyless access system have an engine start/stop button instead of an ignition switch. VEHICLE OFF (LOCK) Mode is the equivalent of LOCK (0). For more information, see pages [178](#) and [180](#).



You can choose this item to customize from “DOOR/WINDOW SETUP” by pressing the INFO (▲/▼) button repeatedly.

CONTINUED

Multi-Information Display

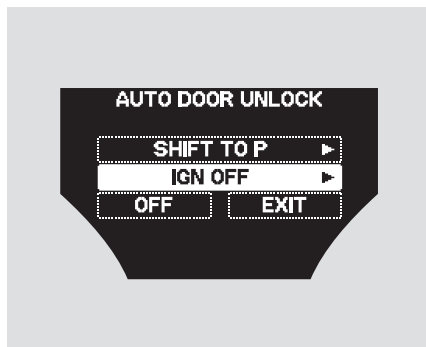

Press the SEL/RESET button to see the selections.

Select the desired setting by pressing the INFO (▲/▼) button, then enter your selection by pressing the SEL/RESET button.



If you choose "IGN OFF," you will see the above display.

Press the INFO (▲/▼) button to switch the door lock mode setting between the driver's door and all doors. Then, press the SEL/RESET button to enter your selection.

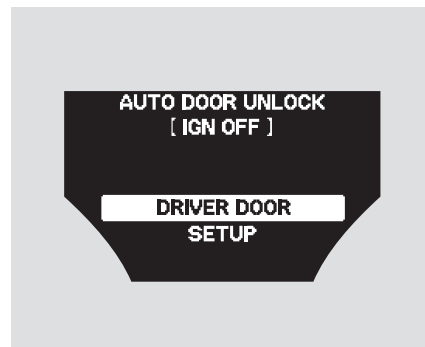

When your selection is successfully completed, the display changes as shown above, and then goes back to the customize item screen.

If the "SETTING INCOMPLETE" message appears, go back to "AUTO DOOR UNLOCK" and repeat the procedure again.

Key and Remote Unlock Mode



You can select whether the driver's door or all the doors unlock the first time you press the unlock button on the remote transmitter/keyless access remote.

You can choose this item to customize from "DOOR/WINDOW SETUP" by pressing the INFO (▲/▼) button repeatedly.

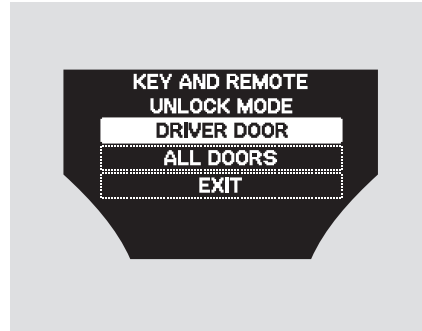

Press the SEL/RESET button to enter the selecting mode.

Select the desired setting by pressing the INFO (▲/▼) button, then enter your selection by pressing the SEL/RESET button.



When your selection is successfully completed, the display changes as shown above, and then goes back to the customize item screen.

If the "SETTING INCOMPLETE" message appears, go back to "KEY AND REMOTE UNLOCK MODE" and repeat the procedure again.

CONTINUED

Multi-Information Display

Keyless Lock Acknowledgment

When you push the LOCK button on the remote transmitter or the keyless access remote, some exterior lights flash, and a beeper sounds when you push the LOCK button again within 5 seconds to verify that the doors and the trunk are locked and the security system has set (see page 380). You can customize the exterior lights not to flash and the beeper not to sound.

When you press the UNLOCK button on the remote transmitter or the keyless access remote to unlock the driver's door/all the doors (depending on the customize setting), the exterior lights blink twice to verify that the door(s) is unlocked and the security system is turned off.

To turn this feature on or off, follow these instructions.



You can choose this item to customize from “DOOR/WINDOW SETUP” by pressing the INFO (▲/▼) button repeatedly.

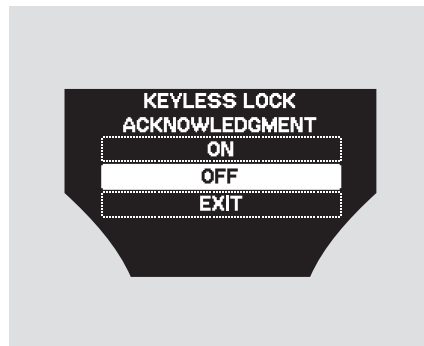

Press the SEL/RESET button to enter the selecting mode.

Select ON or OFF by pressing the INFO (▲/▼) button, then enter your selection by pressing the SEL/RESET button.



When your selection is successfully completed, the display changes as shown above, and then goes back to the customize item screen.

If the “SETTING INCOMPLETE” message appears, go back to “KEYLESS LOCK ACKNOWLEDGMENT” and repeat the procedure again.

Security Relock Timer

If you unlock the doors with the remote transmitter or the keyless access remote, but do not open any of the doors within 30 seconds, the doors automatically relock, and the security system sets.

You can change this relock time from 30 seconds to 60 or 90 seconds.

On models with keyless access system

When you unlock the doors by touching either front door handle while carrying the keyless access remote, the relock time is fixed in 30 seconds.



You can choose this item to customize from “DOOR/WINDOW SETUP” by pressing the INFO (▲/▼) button repeatedly.

CONTINUED

Multi-Information Display

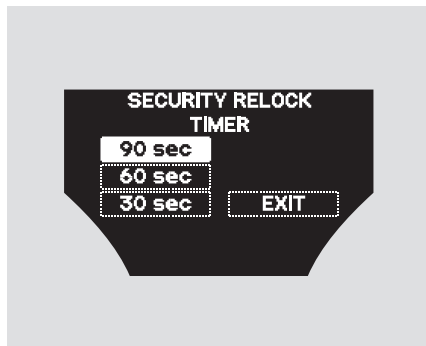

Press the SEL/RESET button to enter the selecting mode.

Select the desired setting by pressing the INFO (▲/▼) button, then enter your selection by pressing the SEL/RESET button.

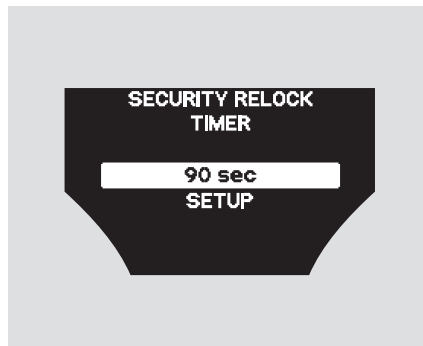

When your selection is successfully completed, the display changes as shown above, and then goes back to the customize item screen.

If the "SETTING INCOMPLETE" message appears, go back to "SECURITY RELOCK TIMER" and repeat the procedure again.

DEFAULT ALL

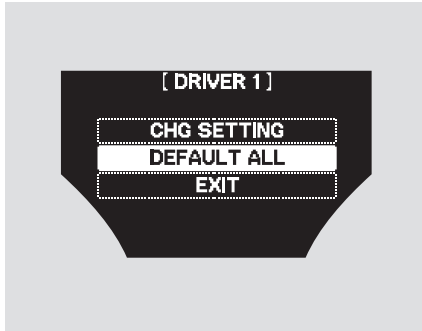

If you want to set the default settings, press the INFO (▲/▼) button to select DEFAULT ALL, then press the SEL/RESET button.

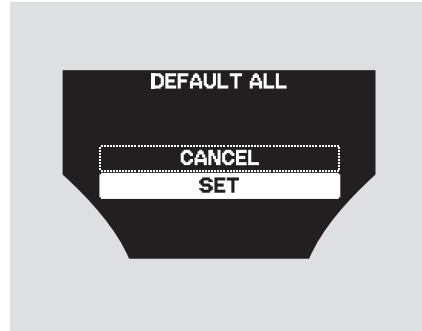

To set the default settings, press the INFO (▲/▼) button to select SET then press the SEL/RESET button.

If you want to cancel DEFAULT ALL, select CANCEL, then press the SEL/RESET button. The screen goes back to the previous display.

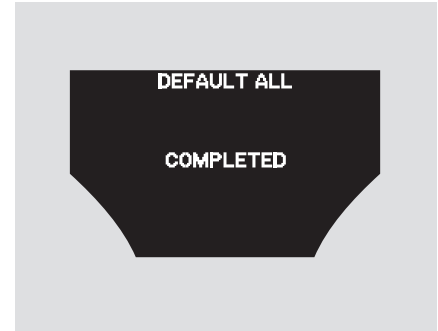

When DEFAULT ALL is set, you will see the above display for several seconds, then the screen returns to the default all setting display.

If the setting is not successfully completed, "FAILED" is shown for several seconds, and then the screen goes back to the normal message mode. Repeat the same procedure to select DEFAULT ALL.

Controls Near the Steering Wheel

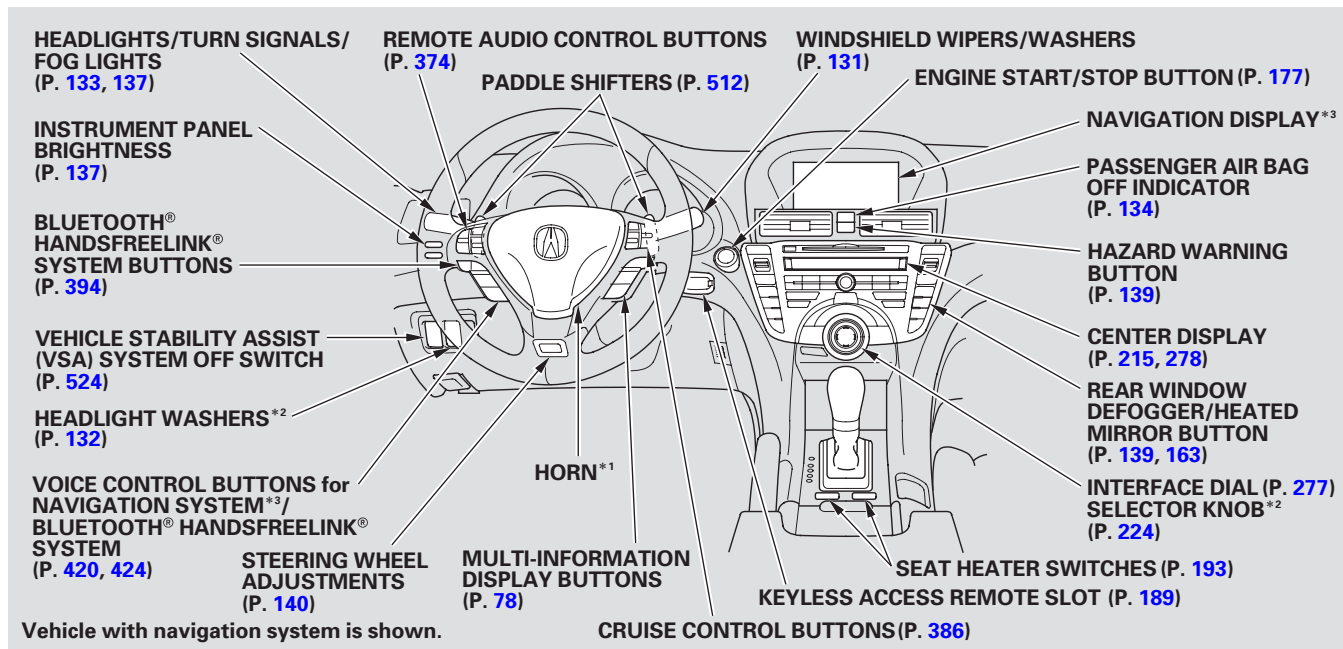

* 1 : To use the horn, press the center pad of the steering wheel.

* 2 : If equipped

* 3 : Refer to the navigation system owner's manual.

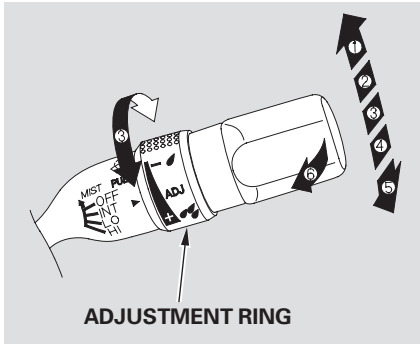

1. MIST
2. OFF
3. INT – Intermittent
4. LO – Low speed
5. HI – High speed
6. Windshield washers

Push the right lever up or down to select a position.

MIST – The wipers run at high speed until you release the lever.

OFF – The wipers are not activated.

INT – The length of the wipe interval is varied automatically according to vehicle's speed.

Vary the delay by turning the adjustment ring. If you turn it to the shortest delay ( position), the wipers change to low speed operation when the vehicle speed exceeds 12 mph (20 km/h).

LO – The wipers run at low speed.

HI – The wipers run at high speed.

Windshield Washers – Pull the wiper control lever toward you, and hold it. The washers spray until you release the lever. The wipers run at low speed, then complete one more sweep after you release the lever.

CONTINUED

Windshield Wipers and Washers

Canadian SH-AWD models only

When you activate the windshield washer with the headlights turned on, the headlight washer will be activated under certain conditions. For more information, see **Headlight Washers** section in the next column.

Headlight Washers

Canadian SH-AWD models only

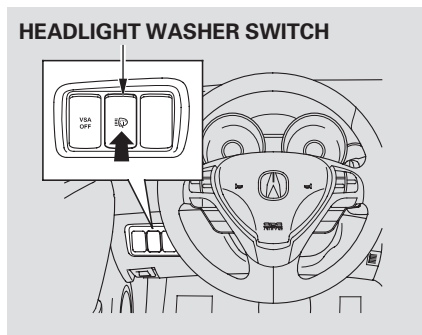

The headlight washers can be operated at any time by pressing the headlight washer button located next to the steering wheel column. The headlights must be turned on to use this button. In addition, the headlight washer operates without pressing the button at the first time you turn on the windshield washers after you turn the ignition switch* to the ON (II) position.

The headlight washers use the same fluid reservoir as the windshield washers.

* : Models equipped with the keyless access system have an engine start/stop button instead of an ignition switch. ON Mode is the equivalent of ON (II). For more information, see pages [178](#) and [180](#).

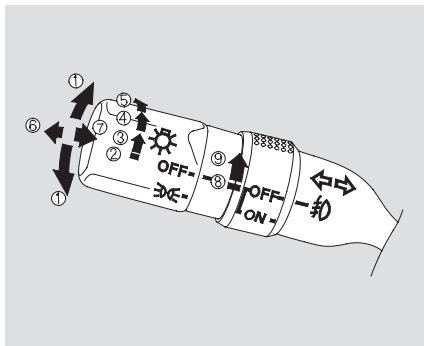

1. Turn Signal
2. Off
3. Parking and instrument panel
4. AUTO
5. Headlights on
6. High beams
7. Flash high beams
8. Fog lights off
9. Fog lights on

Turn Signal – Push down on the left lever to signal a left turn and up to signal a right turn. To signal a lane change, push lightly on the lever and hold it. The lever will return to the center when you release it or complete a turn.

Headlights – Turning the switch to the “” position turns on the parking lights, taillights, instrument panel lights, side-marker lights, and rear license plate lights.

Turning the switch to the “” position turns on the headlights.

When the light switch is in either of these positions, the lights on indicator comes on as a reminder.

This indicator stays on if you leave the light switch on and turn the ignition switch* to the ACCESSORY (I) or LOCK (O) position.

* : Models equipped with the keyless access system have an engine start/stop button instead of an ignition switch. VEHICLE OFF (LOCK) Mode is the equivalent of LOCK (O) and ACCESSORY Mode is the equivalent of ACCESSORY (I). For more information, see pages [178](#) and [180](#).

If you leave the lights on with the key removed from the ignition switch, or with the power mode* in VEHICLE OFF (LOCK), you will hear a reminder chime when you open the driver's door.

CONTINUED

Headlights

High Beams — Push the left lever forward until you hear a click. The blue high beam indicator will come on (see page 71). Pull the lever back to return to the low beams.

To flash the high beams, pull the lever back lightly, then release it. The high beams will stay on as long as you hold the lever back.

AUTO — The automatic lighting feature turns on the headlights and all other exterior lights when it senses low ambient light.

To turn on automatic lighting, turn the light switch to AUTO. The lights will come on automatically when the outside light level becomes low (at dusk, for example). The lights on indicator comes on as a reminder. The lights and indicator will turn off automatically when the system senses high ambient light.

On models without keyless access system

The lights will remain on when you turn off the ignition switch. They will turn off automatically when you remove the key and open the driver's door. To turn them on again, either turn the ignition switch to the ON (II) position or turn the light switch to the  position.

On models with keyless access system

The lights will remain on when you set the power mode to VEHICLE OFF (LOCK). They will turn off automatically when you open the driver's door and take the remote with you. To turn them on again, either set the power mode to ON or turn the light switch to the  position.

On all models

Even with the automatic lighting feature turned on, we recommend that you turn on the lights manually when driving at night or in a dense fog, or when you enter dark areas such as long tunnels or parking facilities.

To change the “AUTO LIGHT SENSITIVITY” setting, see page 118.

Do not leave the light switch in AUTO if you will not be driving the vehicle for an extended period (a week or more). You should also turn off the lights if you plan to leave the engine idling or off for a long time.

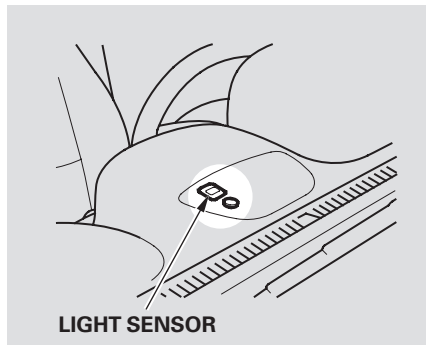

The automatic lighting feature is controlled by a sensor located on top of the dashboard. Do not cover this sensor or spill liquids on it.

Automatic Lighting Off Feature

The automatic lighting off feature turns off the headlights, all other exterior lights, and the instrument panel lights within 15 seconds after you remove the key and close the driver's door, or on models with keyless access system, set the power mode* to VEHICLE OFF (LOCK), take the remote with you, and close the driver's door.

To change the "HEADLIGHT AUTO OFF TIMER" setting, see page [117](#).

- * : On models with keyless access system
Your vehicle has the engine start/stop button instead of an ignition switch. For more information on selecting the power mode, see page [178](#).

If you remove the key (or the vehicle is in VEHICLE OFF mode on models with keyless access system), and the driver's door is opened and closed, the automatic lighting off feature activates with the headlight switch in the "☺☺☺" or "☹☹" position, or the lights turned on by setting the switch in the "AUTO" position.

If you turn the ignition switch* to the LOCK (0) position with the headlight switch on, but do not open the door and get out, the lights turn off after 10 minutes (3 minutes, if the switch is in the "AUTO" position).

CONTINUED

Headlights

The lights will turn on again when you unlock or open the driver's door. If you unlock the door, but do not open it within 15 seconds, the lights will go off. With the driver's door open, you will hear a lights on reminder chime.

- * : Models equipped with the keyless access system have an engine start/stop button instead of an ignition switch. VEHICLE OFF (LOCK) Mode is the equivalent of LOCK (0). For more information, see pages [178](#) and [180](#).

Daytime Running Lights

With the headlight switch off or in the OFF position, the high beam headlights and the high beam indicator come on with reduced brightness when you turn the ignition switch* to the ON (II) position and release the parking brake. They remain on until you turn the ignition switch off, even if you set the parking brake.

The headlights revert to normal operation when you turn them on with the switch.

- * : Models equipped with the keyless access system have an engine start/stop button instead of an ignition switch. ON Mode is the equivalent of ON (II). For more information, see pages [178](#) and [180](#).



If you see a “CHECK DRL SYSTEM” message on the multi-information display, there is a problem with the daytime running light system. Take your vehicle to a dealer to have it checked.

Fog Lights

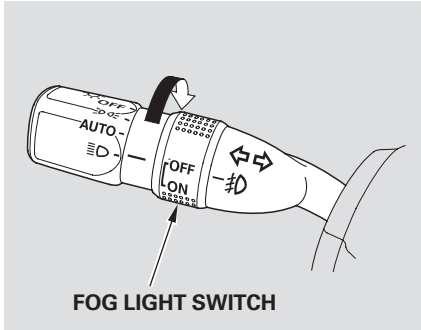

Turn the fog lights on and off by turning the switch next to the headlight switch.

You can use the fog lights only when the headlights are on low beam.

With the light switch in the AUTO position, you can also use the fog lights when the headlights turn on automatically. They will go off when the headlights turn off.

Instrument Panel Brightness

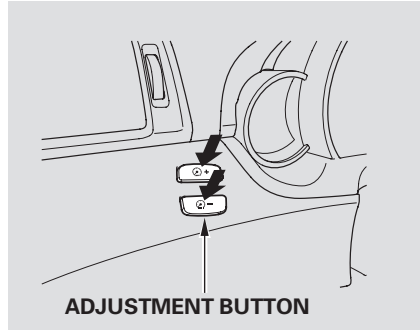

Adjust the brightness of the instrument panel by pressing the + or - button with the ignition switch* in the ON (II) position. Press the + button to increase the brightness and the - button to decrease it.

* : Models equipped with the keyless access system have an engine start/stop button instead of an ignition switch. ON Mode is the equivalent of ON (II). For more information, see pages [178](#) and [180](#).

CONTINUED

Instrument Panel Brightness



The level of brightness is shown on the multi-information display while you adjust it. It goes out 5 seconds after you finish adjusting.

To reduce glare at night, the instrument panel illumination dims when you turn the light switch to or . To cancel the glare reduction function, set the brightness to the highest level, then press the + button. You will hear a beep when it is canceled.

When the brightness reaches the maximum level, “BRIGHTNESS MAXIMUM LEVEL” appears on the display.

If your vehicle is equipped with the navigation system, the navigation system screen will also go to full brightness. This can be helpful when using the headlights during daylight hours.

Hazard Warning Button, Rear Window Defogger

Hazard Warning Button

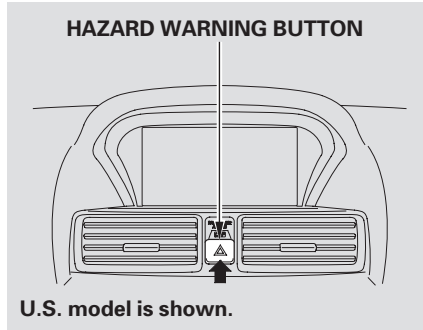

Push the button between the center vents to turn on the hazard warning lights (four-way flashers). This causes all four outside turn signals and both indicators in the instrument panel to flash. Use the hazard warning lights if you need to park in a dangerous area near heavy traffic, or if your vehicle is disabled.

Rear Window Defogger

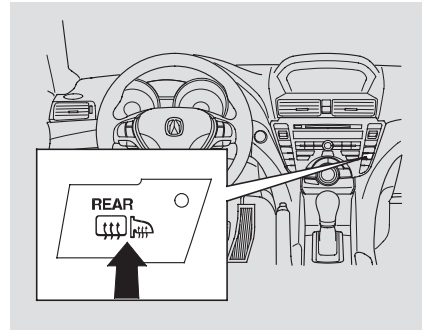

The rear window defogger clears fog, frost, and thin ice from the window. Push the defogger button to turn it on and off. The indicator in the button comes on to show the defogger is on. If you do not turn it off, the defogger will shut itself off within about 10 to 30 minutes according to the outside temperature. It also shuts off when you turn off the ignition switch, or set the power mode to VEHICLE OFF (LOCK) on

models with keyless access system. You have to turn it on again when you restart the vehicle.

Make sure the rear window is clear and you have good visibility before starting to drive.

The defogger and antenna wires on the inside of the rear window can be accidentally damaged. When cleaning the glass, always wipe side to side.

Pushing this button also turns the mirror heaters on or off. For more information, see page 163 .

Steering Wheel Adjustments

Make any steering wheel adjustments before you start driving.

⚠ WARNING

Adjusting the steering wheel position while driving may cause you to lose control of the vehicle and be seriously injured in a crash.

Adjust the steering wheel only when the vehicle is stopped.

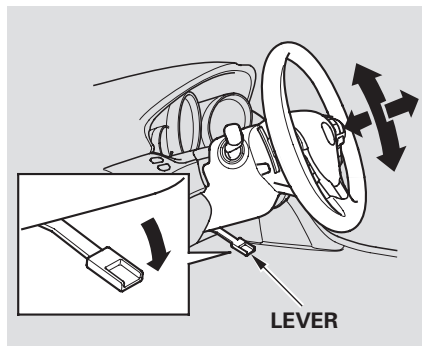

1. Push the lever under the steering column all the way down.
2. Move the steering wheel up or down, and in or out, so it points toward your chest, not toward your face. Make sure you can see the instrument panel gauges and indicators.

3. Push the lever up to lock the steering wheel in that position.
4. Make sure you have securely locked the steering wheel in place by trying to move it up, down, in, and out.

On models without keyless access system

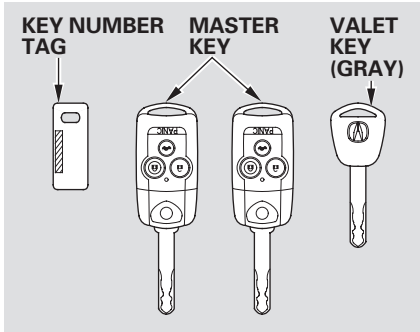

The master key fits all the locks on your vehicle.

The valet key works only in the ignition and the driver's door lock. You can keep the trunk pass-through cover and the glove box locked when you leave your vehicle and the valet key at a parking facility.

You should have received a key number tag with your key. You will need this key number if you ever have to get a lost key replaced. Use only an Acura-approved key blank.

These keys contain electronic circuits that are activated by the immobilizer system. They will not work to start the engine if the circuits are damaged.

- Protect the key from direct sunlight, high temperature, and high humidity.
- Do not drop the keys or set heavy objects on them.
- Keep the keys away from liquids. If they get wet, dry them immediately with a soft cloth.

The valet key does not contain a battery. Do not try to take it apart.

CONTINUED

Keys and Locks

Retractable Master Key

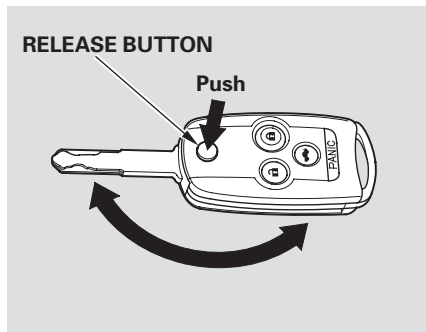

The master key can be retracted into the remote transmitter. To use the key, push the release button to release the key from the transmitter. The key should be fully extended. To retract the key, push the release button and at the same time push the key into the remote transmitter until it is securely latched.

Always make sure the key is fully extended when you insert it to the ignition switch. If the key is not fully extended the immobilizer system may not operate properly and prevent the engine from starting.

The key may come in contact with your finger while being retracted or extended. Make sure your fingers do not touch the pivot of the key when retracting or extending it.

On models with keyless access system

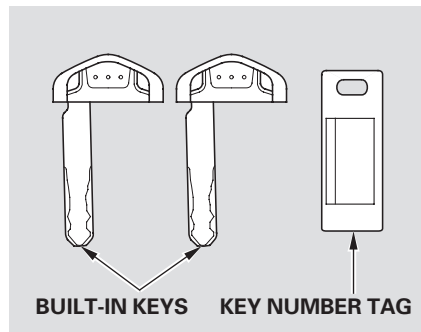

Each keyless access remote has the built-in key. This key is used to lock/unlock the doors when the remote battery becomes weak and the power door lock/unlock operation is disabled. You cannot start the engine with this key.

The built-in key (see page [191](#)) fits all the locks on your vehicle.

You should have received a key number tag with your keys. You will need this key number if you ever have to get a lost key replaced. Use only Acura-approved key blanks.

Immobilizer System

The immobilizer system protects your vehicle from theft. If an improperly coded key or keyless access remote* (or other device) is used, the engine's fuel system is disabled.

When you turn the ignition switch to the ON (II) position, or select the ON mode* with the engine start/stop button, the immobilizer system indicator should come on briefly, then go off. If the indicator starts to blink, it means the system does not recognize the coding of the key or keyless access remote.

On models without keyless access system, turn the ignition switch to the LOCK (0) position, remove the key, reinsert it, and turn the ignition switch to the ON (II) position again.

On models with keyless access system, set the power mode to VEHICLE OFF (LOCK), then select the ON mode again.

The system may not recognize your key's or remote's coding if another immobilizer key or other metal object (i.e. key chain) is near the ignition switch or the keyless access remote when you insert the key or set the power mode* to ON.

* : On models with keyless access system
Your vehicle has the engine start/stop button instead of an ignition switch. See page 180 for a comparison between conventional power switches and your engine start/stop button. For more information on selecting the power mode, see page 178.

CONTINUED

Immobilizer System

If the system repeatedly does not recognize the coding of your key or keyless access remote, contact your dealer.

Do not attempt to alter this system or add other devices to it. Electrical problems could result that may make your vehicle inoperable.

If you have lost your key or keyless access remote and you cannot start the engine, contact your dealer.

NOTICE

Always take the ignition key or the keyless access remote with the built-in key with you whenever you leave the vehicle alone.

As required by the FCC:

This device complies with Part 15 of the FCC rules. Operation is subject to the following two conditions: (1) This device may not cause harmful interference, and (2) this device must accept any interference received, including interference that may cause undesired operation.

Changes or modifications not expressly approved by the party responsible for compliance could void the user's authority to operate the equipment.

This device complies with Industry Canada Standard RSS-210.

Operation is subject to the following two conditions: (1) this device may not cause interference, and (2) this device must accept any interference that may cause undesired operation of the device.

On models without keyless access system

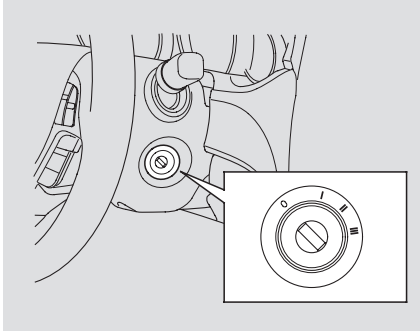

The ignition switch has four positions: LOCK (0), ACCESSORY (I), ON (II), and START (III).

LOCK (0) – You can insert or remove the key only in this position. To turn the key to the LOCK (0) position, the shift lever must be in Park, and you must push the key in slightly.

If the front wheels are turned, the anti-theft lock may make it difficult to turn the key. Firmly turn the steering wheel to the left or right as you turn the key.

ACCESSORY (I) – You can operate the audio system and the accessory power sockets in this position.

ON (II) – This is the normal key position when driving. Several of the indicators on the instrument panel come on as a test when you turn the ignition switch from the ACCESSORY (I) to the ON (II) position.

START (III) – Use this position only to start the engine. The switch returns to the ON (II) position when you let go of the key.

You will hear a reminder beeper if you leave the key in the ignition switch in the LOCK (0) or the ACCESSORY (I) position and open the driver's door. Remove the key to turn off the beeper.

You will also see a "REMOVE KEY" message on the multi-information display.

The shift lever must be in Park before you can remove the key from the ignition switch.

Door Locks

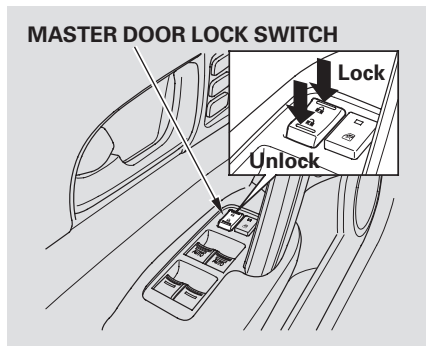

To lock all doors, push the front of the master door lock switch on either front door, pull the lock tab rearward on the driver's door, or turn the key* counterclockwise in the outside lock on the driver's door.

* *On models with keyless access system*

The built-in key can be used to lock/unlock the doors when the remote battery becomes weak and the power door lock/unlock operation is

disabled. For more information, see page [191](#).

Pushing the rear of either master door lock switch will unlock all doors. Pushing forward the lock tab on the driver's door unlocks only that door.

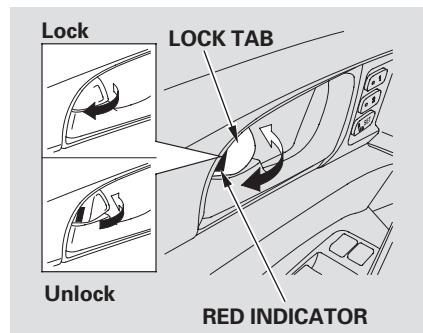

The lock tab on any passenger's door locks and unlocks that door.

When the door is unlocked, you can see the red indicator on the lock tab above the inner door handle.

All doors can be locked from the outside by using the key in the driver's door. To unlock only the driver's door, insert the key, turn it clockwise, and release it. The remaining doors unlock when you turn the key a second time within a few seconds.

You can customize the door lock/unlock settings (see page [120](#)).

You can open or close the windows and the moonroof by using the key in the driver's door (see page [197](#)).

To lock any passenger's door when getting out of the vehicle, pull the lock tab rearward and close the door.

On models without keyless access system

To lock the driver's door, remove the key from the ignition switch, pull the lock tab rearward or push the front of the master switch, then close the door.

Default setting

When the vehicle speed reaches about 10 mph (15 km/h) or more, all the doors lock automatically.

When you shift to P after driving, the driver's door unlocks.

Lockout Prevention

On models without keyless access system

If you forget and leave the key in the ignition switch, lockout prevention will not allow you to lock the driver's door. With any door open and the key in the ignition switch, locking with master door lock switch is disabled. If the driver's door is closed, the lock tab on the driver's door is not disabled. Pulling the driver's lock tab rearward will lock all doors. If you try to lock an open driver's door by pulling the lock tab rearward, the driver's door lock tab pops out and unlocks the driver's door.

Childproof Door Locks

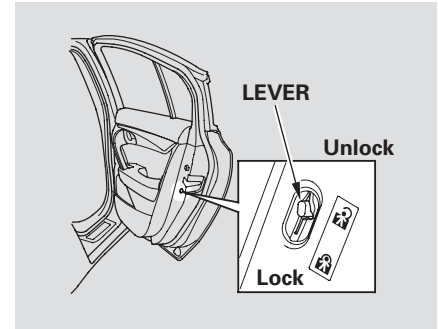

The childproof door locks are designed to prevent children seated in the rear from accidentally opening the rear doors. Each rear door has a lock lever near the edge. With the lever in the LOCK position (lever is down), the door cannot be opened from the inside regardless of the position of the lock tab. To open the door, push the lock tab forward and use the outside door handle.

Trunk

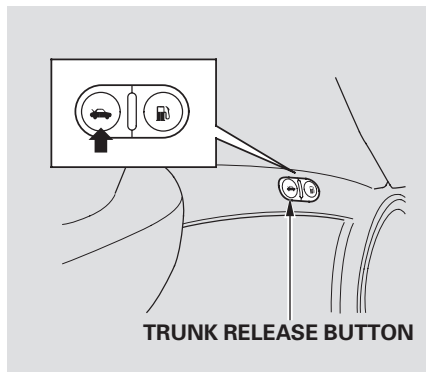

You can open the trunk in any of the following ways:

- Press the trunk release button on the driver's door.
- Press and hold the trunk release button on the remote transmitter or the keyless access remote.

On models with keyless access system

- If the doors are unlocked, press the trunk release switch on the trunk lid.
- If the doors are locked, press the trunk release switch on the trunk lid with the remote in keyless access operating range.

On models with keyless access system

The trunk will lock when you lock the driver's door with the key*, the keyless access remote, either master door lock switch, or the lock tab on the driver's door.

To unlock the trunk, turn the key* twice to unlock the doors, push the rear of either master door lock switch, or push UNLOCK twice on the keyless access remote.

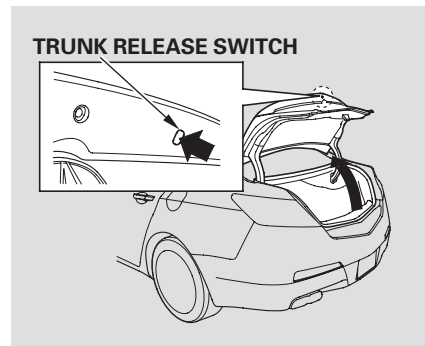

To open the trunk from the outside, push the release switch, then lift up.

- * : The built-in key can be used to lock/unlock the doors and trunk when the remote battery becomes weak and the power door lock/unlock operation is disabled. For more information, see page 191 .

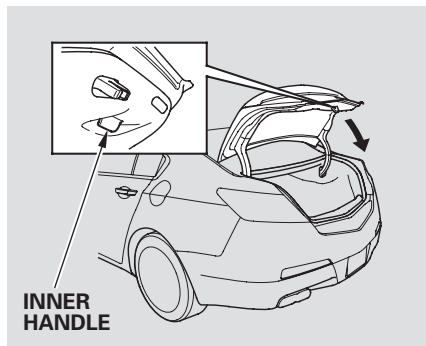

On all models

To close the trunk, use the inner handle to lower the lid, then press down on the back edge.

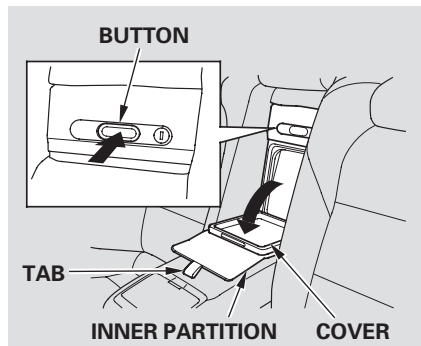

If your vehicle's battery goes dead or is disconnected, you can open the trunk from the rear seat by pulling the trunk release tab through the trunk pass-through.



Pull down the rear seat armrest. Pull on the tab at the top of the inner partition, and press on the button to fully release the cover. Reach in and locate the rubber tab, and pull it out.

Keep the trunk lid closed at all times while driving to avoid damaging it, and to prevent exhaust gas from getting into the interior. See **Carbon Monoxide Hazard**, page 57.

CONTINUED

Trunk

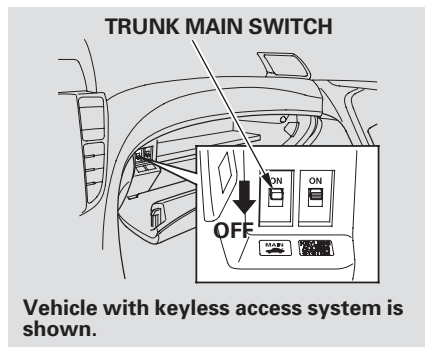

To protect items in the trunk, you can disable the trunk release button on the driver's door by turning off the trunk main switch in the glove box, locking the glove box, and locking the trunk pass-through cover with the master key or the built-in key.

On models without keyless access system

If you need to give the key to someone else, give them the valet key.

On models with keyless access system

To use the valet function, remove the built-in key from the remote by pressing the button, then give that remote to someone else as a valet key (see page [192](#)).

Emergency Fuel Lid Release

Your vehicle is equipped with the emergency fuel lid release in the trunk. Refer to page [598](#) for how to access it.

Emergency Trunk Opener



As a safety feature, your vehicle has a release lever on the trunk latch so the trunk can be opened from inside. To open the trunk, push the release lever in the direction pointed by an arrow.

Parents should decide if their children should be shown how to use this feature. For more information about child safety, see page [41](#).

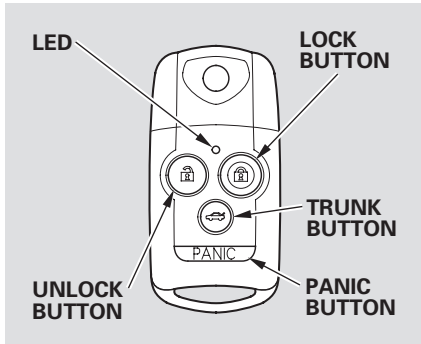

On models without keyless access system

LOCK — Press this button once to lock all doors. Some exterior lights will flash. When you push LOCK twice within 5 seconds, you will hear a beep to verify that the doors are locked and the security system has set. You cannot lock the doors if any door is not fully closed or if the key is in the ignition switch.

UNLOCK — Press this button once to unlock the driver's door or all the doors (depending on the keyless memory setting). Press it twice to unlock the other doors. Some exterior lights will flash twice each time you press the button.

If you do not open any door within 30 seconds, the doors automatically relock and the security system sets.

The door activated map lights come on when you press the UNLOCK button if the door activated position is selected by pressing the light control button (DOOR). If you do not open any door within 30 seconds (or whatever setting of the interior light dimming time is set to), the light(s) will fade out. If you relock the doors with the remote transmitter before 30 seconds have elapsed, the light(s) will go off immediately.

The keyless lock acknowledgment beep and flashing of the lights can be deactivated (see page 126).

To change the lock/unlock setting and the relock timer setting, refer to the customized settings on page 120.

You can also open all power windows and the moonroof from outside the vehicle with the remote transmitter (see page 197).

CONTINUED

Remote Transmitter

TRUNK — Press this button for about 1 second to open the trunk.

PANIC — Press this button for about 2 seconds to attract attention: the horn will sound, and the exterior lights will flash for about 30 seconds. To cancel panic mode, press any other button on the remote transmitter, or turn the ignition switch to the ON (II) position.

Remote Transmitter Care

- Avoid dropping or throwing the transmitter.
- Protect the transmitter from extreme temperature.
- Do not immerse the transmitter in any liquid.
- If you lose a transmitter, the replacement needs to be reprogrammed by your dealer.

Replacing the Transmitter Battery

If it takes several pushes on the button to lock or unlock the doors, replace the battery as soon as possible.

Battery type: CR1616

On models with keyless access system, see page 175 for how to replace the battery on the keyless access remote.

To replace the battery:

1. Remove the screw at the base of the transmitter with a small Phillips-head screwdriver.

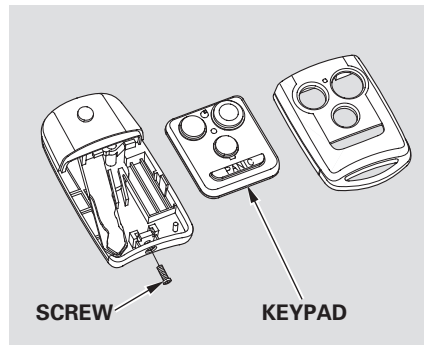

NOTE: Be careful when removing this screw as the head of the screw can strip out.

2. Separate the keypad from the transmitter by pushing any button from outside.

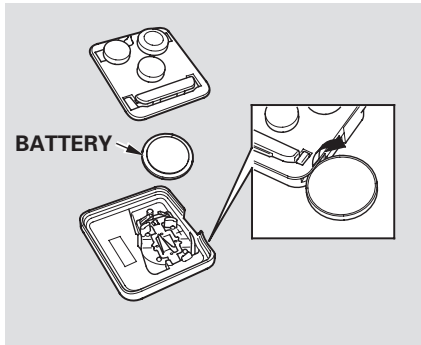

3. Place a cloth on the edge of the keypad, and remove the upper half by carefully prying on the edge with a small flat-tip screwdriver or coin.

4. Remove the old battery and note the polarity. Make sure the polarity of the new battery is the same (– side facing up), then insert it in the keypad.

An improperly disposed of battery can hurt the environment. Always confirm local regulations for battery disposal.

5. Snap the two halves of the keypad, then install the parts in reverse order.

As required by the FCC:

This device complies with Part 15 of the FCC rules. Operation is subject to the following two conditions: (1) This device may not cause harmful interference, and (2) this device must accept any interference received, including interference that may cause undesired operation.

Changes or modifications not expressly approved by the party responsible for compliance could void the user's authority to operate the equipment.

This device complies with Industry Canada Standard RSS-210.

Operation is subject to the following two conditions: (1) this device may not cause interference, and (2) this device must accept any interference that may cause undesired operation of the device.

Remote Transmitter

Recalling a Memorized Driving Position

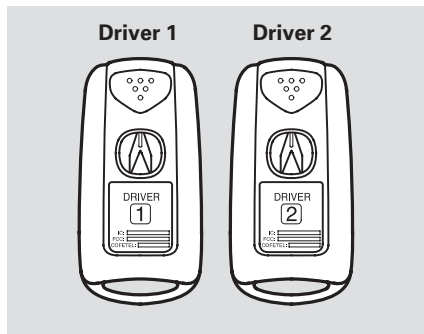

When you unlock the driver's door with your remote transmitter, each remote transmitter activates the customized settings related to that remote.

The driving position memory activated (Driver 1, Driver 2) is shown on the back of each transmitter. Make sure you store your desired driving position in the memory that is activated by the transmitter you normally carry.

Here are the settings activated with the remote:

- Customized settings (see page [96](#)).
- Driving position memory (see page [164](#)).
- Audio system settings (see page [224](#)).
- Climate control settings (see page [214](#)).

When you unlock and open the driver's door with the remote, the driver's seat (except power lumbar) and outside mirrors move to the positions stored in memory. An indicator on one of the driving position memory buttons on the driver's door also comes on.

You will also see the "DRIVER 1" or "DRIVER 2" message on the multi-information display, depending on which linked remote transmitter is used.

Front Seat Power Adjustments

See pages 13 – 15 for important safety information and warnings about how to properly position the seats and seat-backs.

The controls for the power adjustable front seats are on the outside edge of each seat bottom. You can adjust the seats with the ignition switch* in any position. Make all seat adjustments before you start driving.

The passenger seat has the same adjustments as the driver's seat but without any lumbar adjustment.

* : Models equipped with the keyless access system have an engine start/stop button instead of an ignition switch. VEHICLE OFF (LOCK) Mode is the equivalent of LOCK (0), ACCESSORY Mode is the equivalent of ACCESSORY (I),

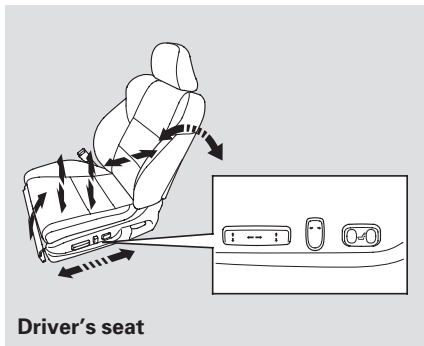

and ON Mode is the equivalent of ON (II). For more information, see pages 178 and 180.



Moves the seat forward and backward.



Moves the front of the seat up or down.



Raises or lowers the seat.



Moves the whole seat up and forward, or down and backward. The front of the seat also tilts up or down at the same time.



Adjusts the seat-back angle forward or backward.



Increases or decreases the lumbar support. (Driver's seat only)

CONTINUED

Seats

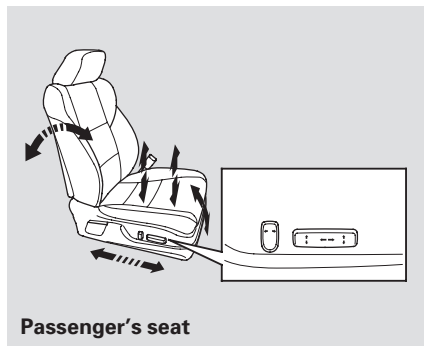

The driver's seat includes a memory feature. Two seat positions can be stored in separate memories. You can then select a memorized position by pushing the appropriate memory button. Refer to page 164 for how to memorize and select the seat positions.

Head Restraints

See page 15 for important safety information and a warning about improperly positioning head restraints.

Your vehicle is equipped with head restraints in all seating positions to help protect you and your passengers from whiplash and other injuries.

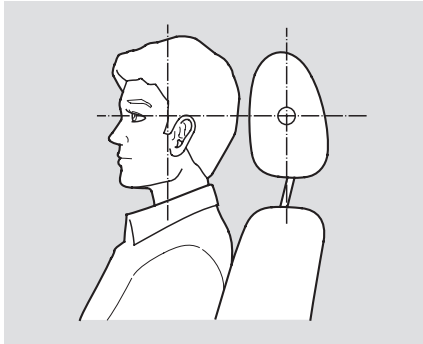

They are most effective when you adjust them so the center of the back of the occupant's head rests against the center of the restraint.

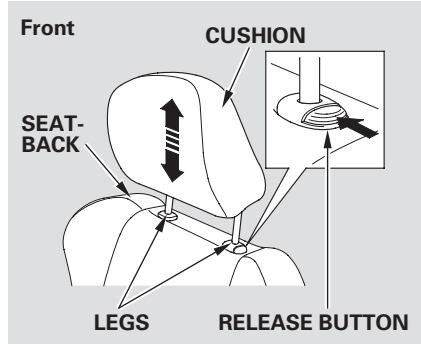

Adjusting the Head Restraint

The head restraints adjust for height. You need both hands to adjust the restraint. Do not attempt to adjust it while driving. To raise a front or rear center head restraint, pull upward. To lower the restraint, push the release button sideways, and push the restraint down.

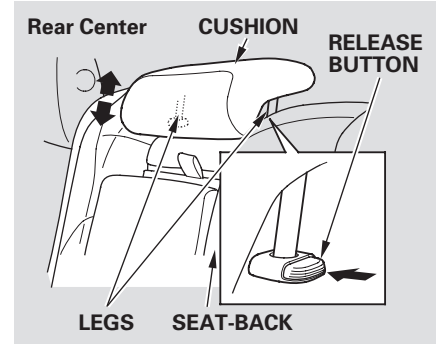

CONTINUED

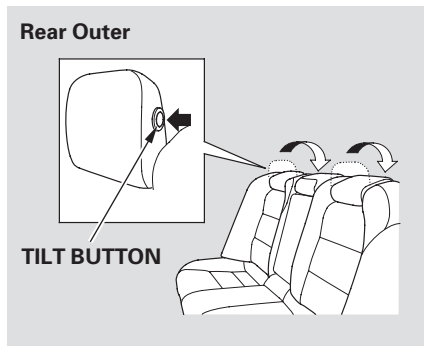

To lower either rear outer head restraint for better visibility, press the tilt button on the side of the head restraint. It folds down backward. To raise the rear outer head restraint, pull up it on the rear by hand. Make sure the head restraint locks in position when you lower or raise it.

Removing the Head Restraint

To remove a front or rear center head restraint for cleaning or repair, pull it up as far as it will go. Push the release button, then pull the restraint out of the seat-back.

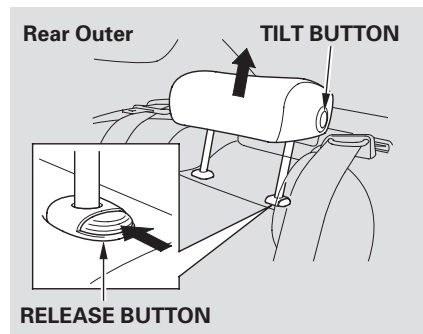

To remove either rear outer head restraint, push the tilt button, then fold the head restraint backward. Push the release button, then pull the restraint out of the seat-back.

⚠ WARNING

Failure to reinstall the head restraints can result in severe injury during a crash.

Always replace the head restraints before driving.

When reinstalling a head restraint, put the legs back in place. Then adjust it to the appropriate height while pressing the release button.

Make sure the head restraint locks in position when you reinstall it.

Active Head Restraints

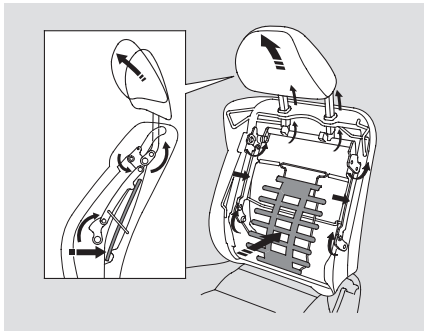

The driver's and front passenger's seats have active head restraints. If the vehicle is struck severely from the rear, the occupant properly secured with the seat belt will be pushed against the seat-back and the head restraint will automatically move forward.

This reduces the distance between the restraint and the occupant's head. It also helps protect the occupants

against whiplash and injuries to the neck and upper spine.

After a collision, the activated restraint should return to its normal position.

If the restraints do not return to their normal position, or in the event of a severe collision, have the vehicle inspected by an Acura dealer.

For a head restraint system to work properly:

- Do not hang any items on the head restraints, or from the restraint legs.
- Do not place any object between an occupant and the seat-back.
- Install each restraint in its proper location.
- Only use genuine Acura replacement head restraints.

Seats

Armrest

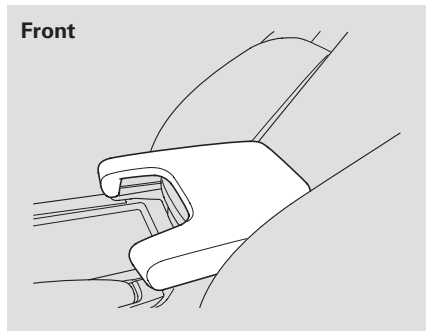

The lid of the console compartment can be used as an armrest.

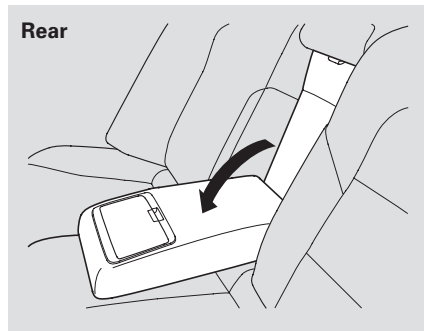

The rear seat armrest is in the center of the rear seat. Pivot it down to use it.

A beverage holder is located in the armrest.

Trunk Pass-through Cover

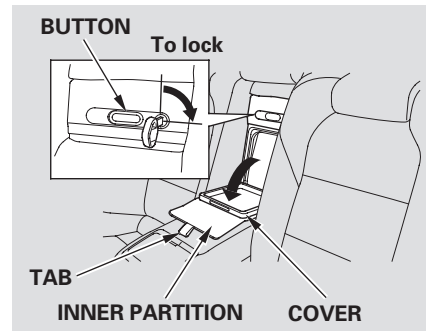

To open the cover, pull down the rear seat armrest. Pull on the tab at the top of the inner partition, and press on the button to fully release the cover. To close the cover, swing it up, and push firmly on the top. Make sure it latches properly.

Make sure all items in the trunk and those extending through the pass-through are secured.

For security, this cover can be locked and unlocked only with the master key (the built-in key on models with keyless access system). To lock the cover, insert the key, and turn it clockwise.

Never drive with this cover open and the trunk lid open. See **Carbon Monoxide Hazard** on page 57.

Mirrors

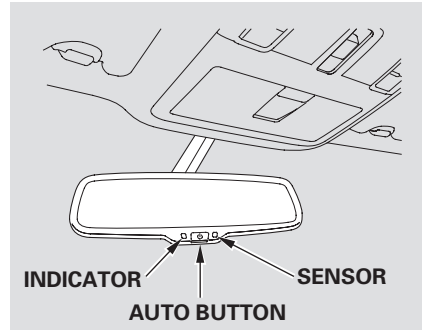

Keep the inside and outside mirrors clean and adjusted for best visibility. Be sure to adjust the mirrors before you start driving.

The inside mirror can automatically darken to reduce glare. To turn on this feature, press the button on the bottom of the mirror. The AUTO indicator comes on as a reminder. When it is on, the mirror darkens when it senses the headlights of a vehicle behind you, then returns to normal visibility when the lights are gone. Press the button again to turn off this feature.

NOTICE

There is also a sensor on the back of the mirror. Items hung on the mirror may block this sensor and affect its performance.

CONTINUED

Mirrors

Adjusting the Power Mirrors

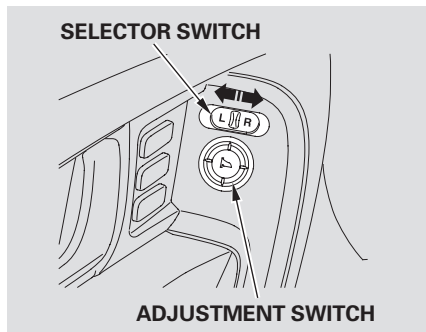

1. With the ignition switch* in the ON (II) position, move the selector switch to the L (driver's side), or R (passenger's side).
2. Push the appropriate edge of the adjustment switch to move the mirror right, left, up, or down.

3. When you finish, move the selector switch to the center (off) position. This turns the adjustment switch off to keep your settings.

* : Models equipped with the keyless access system have an engine start/stop button instead of an ignition switch. ON Mode is the equivalent of ON (II). For more information, see pages [178](#) and [180](#) .

Reverse Tilt Door Mirror

Both outside door mirrors have a reverse tilt feature. When in reverse, the selected mirror will tilt down slightly to improve your view as you parallel park. Shifting out of reverse will return the mirror to its original position.

- To tilt the driver's mirror, place the selector switch in the left position.
- To tilt the passenger's mirror, place the switch in the right position.
- To turn the feature off, place the switch in the center position.

Outside mirror positions can be stored in the driving position memory system (see page [164](#)).

Power Mirror Heaters

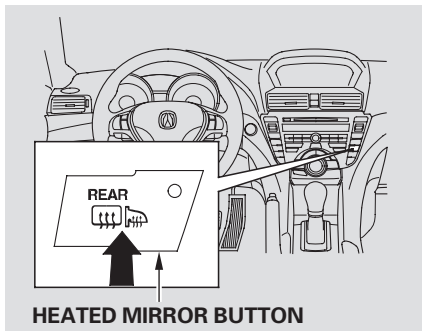

The outside mirrors are heated to remove fog and frost. With the ignition switch in the ON (II) position, or the power mode* ON, turn on the heaters by pressing the button. The indicator in the button comes on as a reminder. Press the button again to turn the heaters off. Pressing this button also turns the rear window defogger on and off.

This heated mirror function has a timer (see page [139](#)).

* : Models equipped with the keyless access system have an engine start/stop button instead of an ignition switch. ON Mode is the equivalent of ON (II). For more information, see pages [178](#) and [180](#).

Driving Position Memory System

Your vehicle has a memory feature for the driver's seat and outside mirror positions.

Seat, except for power lumbar, and outside mirror positions can be stored in separate memories. You select a memorized position by pushing the appropriate button or using the appropriate remote transmitter or the keyless access remote (Driver 1 or Driver 2).

Storing a Driving Position in Memory

Store a driving position only when the vehicle is parked.

1. Turn the ignition switch* to the ON (II) position. You cannot add a new driving position to the memory unless the ignition switch is in the ON (II) position. You can recall a memorized position with the ignition switch in any position.

* : Models equipped with the keyless access system have an engine start/stop button instead of an ignition switch. ON Mode is the equivalent of ON (II). For more information, see pages [179](#) and [180](#).

2. Adjust the seat to a comfortable position (see page [155](#)).

Adjust the outside mirrors for best visibility (see page [162](#)).

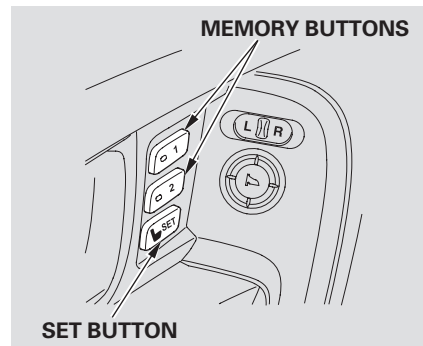

3. Press and release the SET button on the control panel. You will hear a beep. Immediately press and hold one of the memory buttons (1 or 2) until you hear two beeps. The indicator in the memory button will come on. The current positions of the driver's seat and outside mirrors are now stored.

Doing any of the following after pressing the SET button will cancel the storing procedure:

- Not press a memory button within 5 seconds.
- Readjust the seat position.
- Readjust the outside mirror position.

On models without keyless access system

- Turn the ignition switch out from the ON (II) position.

On models with keyless access system

- Change the power mode out from ON.

Each memory button stores only one driving position. Storing a new position erases the previous setting stored in that button's memory. If you want to add a new position while retaining the current one, use the other memory button.

Selecting a Memorized Position

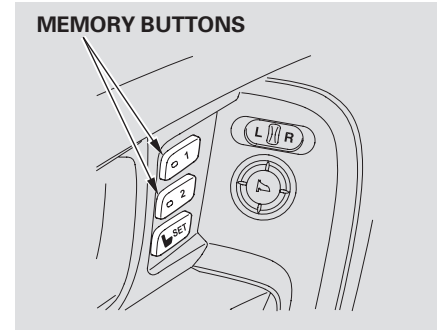

To select a memorized position, do this:

1. Make sure the shift lever is in Park.
2. Press the desired memory button (1 or 2) until you hear a beep, then release the button.

CONTINUED

Driving Position Memory System

The system will move the seat and outside mirrors to the memorized positions. The indicator in the selected memory button will flash during movement. When the adjustments are complete, you will hear two beeps, and the indicator will remain on.

To change the “MEMORY POSITION LINK” setting, see page [108](#).

To stop the system’s automatic adjustment, do any of these actions:

- Press any button on the driver’s door: SET, memory button 1 or 2.
- Push any of the adjustment switches for the seat.
- Shift out of Park.
- Adjust the outside mirrors.

If desired, you can use the adjustment switches to change the positions of the seat or outside mirrors after they are in their memorized positions. If you change the memorized position, the indicator in the memory button will go out. To keep this driving position for later use, you must store it in the driving position memory.

On models with navigation system

Your vehicle has a keyless access system. This system allows you to operate the vehicle without an ignition key. When you carry the remote with you, you can lock/unlock the door(s), unlock the trunk, and start the engine.

The system may not work if:

- The battery of the remote is weak.
- There is strong electrical current nearby.
- You carry a cell phone, a laptop computer, or other electrical device near the remote.
- The remote is covered by metal.
- A vehicle is being operated with a transmitter nearby.
- When the remote battery is dead.
- When the vehicle battery is dead.

Each keyless access remote has the built-in key. This key is used to lock/unlock the doors when the remote battery becomes weak and the power door lock/unlock operation is disabled. You cannot start the engine with this key.

Make sure the driver always carries the remote/built-in key set.

Protect the remote and the built-in key from direct sunlight, high temperature, and high humidity.

Do not drop the remote or the built-in key, and do not set heavy objects on them.

Keep the remote and the built-in key away from liquids. If they get wet, dry them immediately with a soft cloth.

The built-in keys do not contain batteries.

Always keep the remote and the built-in key away from any magnetic material.

You should have received a key number tag with your built-in key. You will need this key number if you ever have to get a lost key replaced. Use only Acura-approved key blanks.

Keyless Access System

Keys

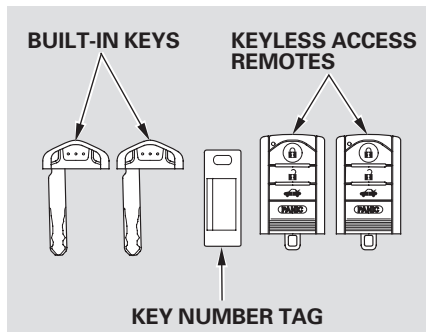

The following keys come with your vehicle. Refer to page 191 for how to separate the keys.

Built-in Key

This key is used to lock/unlock the doors, glove box, and trunk pass-through cover.

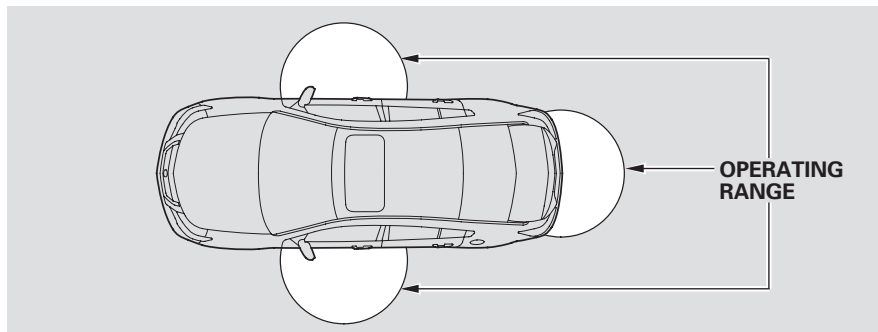

Keyless Access Remote

This remote is used to lock/unlock the doors and unlock the trunk. When you carry the remote, you can lock/unlock the doors, unlock the trunk, and start the engine.

You can lock/unlock the doors within about a 32 inch (about 80 cm) radius from the outside door handle. You can open the trunk within about a 32 inch (about 80 cm) radius from the trunk release switch.

Anyone can lock/unlock a door or open the trunk if the remote is within the operating range of the door or the trunk.

The remote may not work if:

- It is too close to the vehicle.
- It is above or below the vehicle, even when it is within its operating range.

Each front door has a LOCK/
UNLOCK feature.

Unlocking the Door(s)

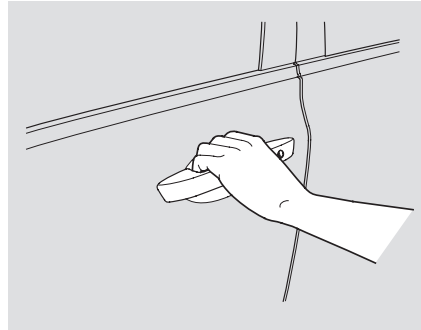

The handle of each front door has a sensor. That sensor works with the remote so you can automatically unlock the door(s).

By default, only the driver's door unlocks when you grab its handle.

To unlock the remaining doors and the trunk, press the remote or the rear of the master door lock switch on the driver's door.

To change the “DOOR UNLOCK MODE” setting, see page [111](#).

All the doors unlock when you grab the handle of the front passenger's door.

When you unlock the door(s), some exterior lights blink twice and the system beeps twice.

To change the “KEYLESS ACCESS LIGHT FLASH” setting, see page [112](#).

To change the “KEYLESS ACCESS BEEP” setting, see page [113](#).

If you wear a glove while grabbing a front door handle, the door sensor may be slow to respond or may not respond by unlocking the doors.

CONTINUED

Keyless Access System

If you do not open any of the doors within 30 seconds, they will automatically relock.

If a remote is within operating range while you wash your vehicle or when it is raining heavily, the door sensors may respond by unlocking the doors.

Each unlock sensor does not operate when:

- The remote is not within the operating range.
- The remote is too close to the vehicle.
- When the doors are unlocked.
- The remote battery is dead.
- The vehicle battery is dead.

Locking the Doors

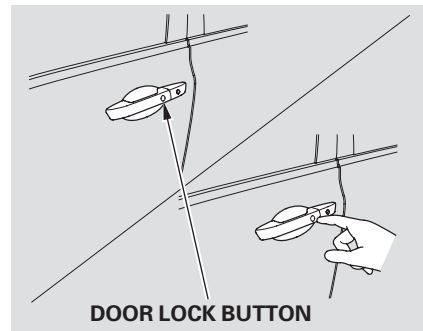

When you press the door lock button on the front door, all the doors and the trunk will lock.

Before locking the doors, make sure the remote is not inside the vehicle.

When you lock the doors, some exterior lights blink and the system beeps once. If no exterior lights blink and/or no beeper sounds, check to see if the trunk or hood is open.

To change the “KEYLESS ACCESS LIGHT FLASH” setting, see page [112](#).

To change the “KEYLESS ACCESS BEEP” setting, see page [113](#).

Within 2 seconds of pressing the door lock button to lock the doors or locking the doors with remote, pull the handle to make sure the doors are actually locked. The door unlock sensors will not operate for about 2 seconds after the doors are locked.

The door lock button does not work if:

- The remote is not within the operating range.
- Any door is open.
- The power mode is not set to VEHICLE OFF (LOCK).
- The remote is in the keyless access slot.
- The remote is too close to the vehicle.
- The remote battery is dead.
- The vehicle battery is dead.

Door Lock Prevention

If you open the driver’s door, pull its lock tab rearward on the door, and shut it when the remote is inside the vehicle, the driver’s door will unlock. Make sure you carry the remote with you when you lock the doors.

This function is also activated on the front passenger’s door. If you open the front passenger’s door, and shut it after pulling its lock tab rearward when the remote is inside the vehicle, all doors will unlock.

Keyless Access System

Locking and Unlocking the Trunk

When you close the trunk with all doors locked, the trunk will lock.

When you unlock all the doors with the remote, built-in key or power door lock master switch, the trunk will unlock.

The trunk cannot be locked if:

- The remote is too close to the trunk lid.
- The remote is on the interior rear panel.
- The remote is too close to the seat-back of the rear seat or the seat cushion.

Opening and Closing the Trunk

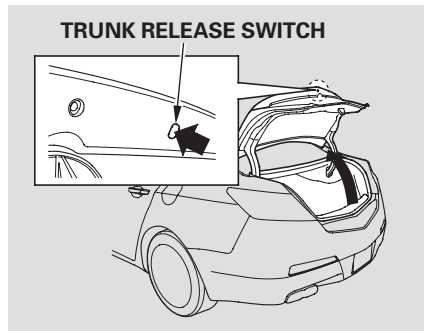

When the trunk is locked, you can open it in any of these ways:

- Press the trunk release button inside the vehicle.
- Press the trunk button on the remote.
- Push the trunk release switch when carrying the remote (if the doors are locked).

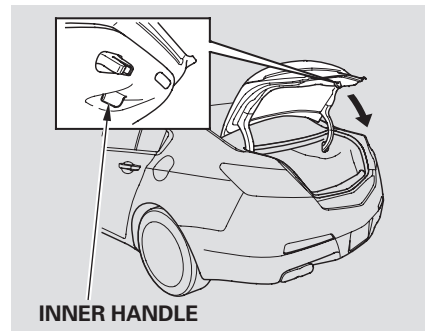

To close the trunk, use the inner handle to lower the lid, then press down on the back edge.

Before closing the trunk, make sure the remote is not in the trunk.

If you close the trunk when the remote is in it, the system beeps, and the trunk reopens.

Keep the trunk lid closed at all times while driving to avoid damaging the lid, and to prevent exhaust gas from getting into the interior. See **Carbon Monoxide Hazard** on page 57.

Keyless Access Remote

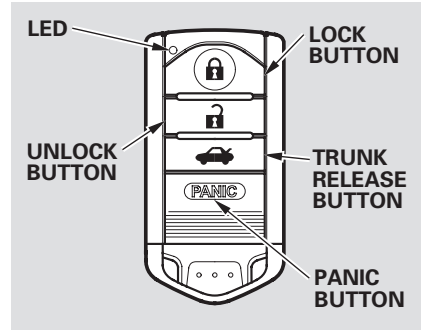

LOCK – Press this button once to lock all doors. Some exterior lights will flash. When you push the LOCK button twice within 5 seconds, you will hear a beep to verify that the doors are locked and the security system is set.

You cannot lock the doors if any door is not fully closed, if the remote is in the keyless access remote slot, or if the power mode is in any position except the VEHICLE OFF (LOCK).

When you cannot set the security system because the trunk or hood is open, no exterior light blinks and/or no beeper sounds.

CONTINUED

Keyless Access System

UNLOCK — Press this button once to unlock the driver's door. Press it twice to unlock the other doors. Some exterior lights will flash twice each time you press the button. The door activated map lights (if the door activated light switch is set) will come on when you press the UNLOCK button. If you do not open any door within 30 seconds, the map lights fade out. If you relock the doors with the remote before 30 seconds have elapsed, the lights will go off immediately.

To change the “KEY AND REMOTE UNLOCK MODE” setting, see page [125](#).

To change the “INTERIOR LIGHT DIMMING TIME,” see page [116](#).

If you unlock the doors with the remote, but do not open any doors within 30 seconds, the doors automatically relock and the security system sets.

To change the “SECURITY RELOCK TIMER” setting, see page [127](#).

To change the “KEYLESS LOCK ACKNOWLEDGMENT” setting, see page [126](#).

TRUNK — Press this button for about 1 second to open the trunk. You cannot open the trunk with the exterior trunk release switch if the remote is in the keyless access remote slot, or the power mode is in any position except VEHICLE OFF (LOCK). You cannot open the trunk with the remote if the trunk main switch in the glove box is turned off.

PANIC — Press this button for about 2 seconds to attract attention: the horn will sound and the exterior lights will flash for about 30 seconds. To cancel panic mode, press any other button on the remote.

Replacing the Remote Battery

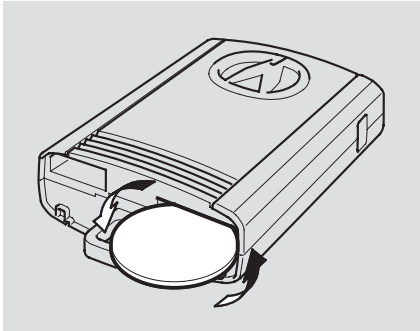

Replace the battery if necessary.
Battery type: CR2032

To replace the battery:

1. Remove the built-in key (see page 192).
2. Remove the upper half by carefully prying on the edge with a coin.

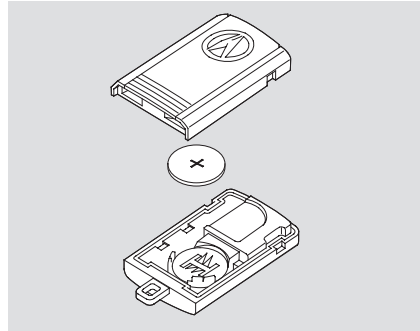

3. Replace the old battery with new battery. Place the battery so the + side is facing up. Snap the two halves of the remote case back together.

An improperly disposed of battery can hurt the environment. Always confirm local regulations for battery disposal.

As required by the FCC:

This device complies with Part 15 of the FCC rules. Operation is subject to the following two conditions: (1) This device may not cause harmful interference, and (2) this device must accept any interference received, including interference that may cause undesired operation.

Changes or modifications not expressly approved by the party responsible for compliance could void the user's authority to operate the equipment.

This device complies with Industry Canada Standard RSS-210.

Operation is subject to the following two conditions: (1) this device may not cause interference, and (2) this device must accept any interference that may cause undesired operation of the device.

Keyless Access System

Keyless Memory Settings™

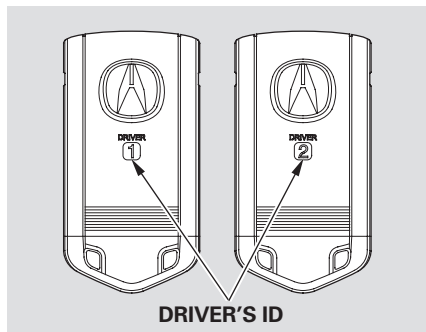

When you unlock the door with your remote, each remote activates the keyless memory settings related to that remote. The driver's ID (Driver 1 or Driver 2) is shown on the back of each remote.

Here are the settings activated with the remote:

- Driving position memory (see page [164](#)).
- Keyless memory settings (see page [96](#)).
- Audio system settings (see page [223](#)).
- Climate control settings (see page [214](#)).
- Navigation system preferences (see the navigation system manual).

Remote Care

- Avoid dropping or throwing the transmitter.
- Protect the transmitter from extreme temperature.
- Do not immerse the transmitter in any liquid.
- If you lose a transmitter, the replacement needs to be reprogrammed by your dealer.

Engine Start/Stop Button Operating Range

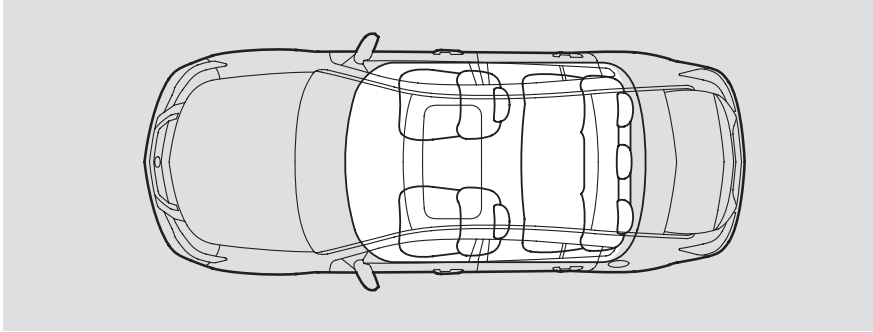

The engine may not run, and some malfunctions may occur, if the remote is outside the vehicle.

The engine may not start if the remote is subjected to strong radio waves.

Also, the engine may not start if the remote is too close to the windows.

NOTICE

Make sure you know where the remote is when you are inside the vehicle.

Remember that you can start the engine when the remote is inside the vehicle.

Make sure you always carry the remote with you.

Keyless Access System

Engine Start/Stop Button Operation

This system uses the engine start/stop button instead of an ignition switch to start and stop the engine. If you are carrying the keyless access remote, you can start the engine by pressing the engine start/stop button with the brake pedal depressed. You can also stop the engine by pushing this button when the vehicle is stopped.

Switching the Power Modes

The keyless access system has four power modes: VEHICLE OFF (LOCK), ACCESSORY, ON, and START.

Each time you press the engine start/stop button without pressing the brake pedal while carrying the keyless access remote, the power mode switches between VEHICLE OFF (LOCK), ACCESSORY, and ON.



You can start the engine at any time by pressing the engine start/stop button, while pressing the brake pedal, with the shift lever in Park or neutral position.

Changing the Power Mode without Starting the Engine

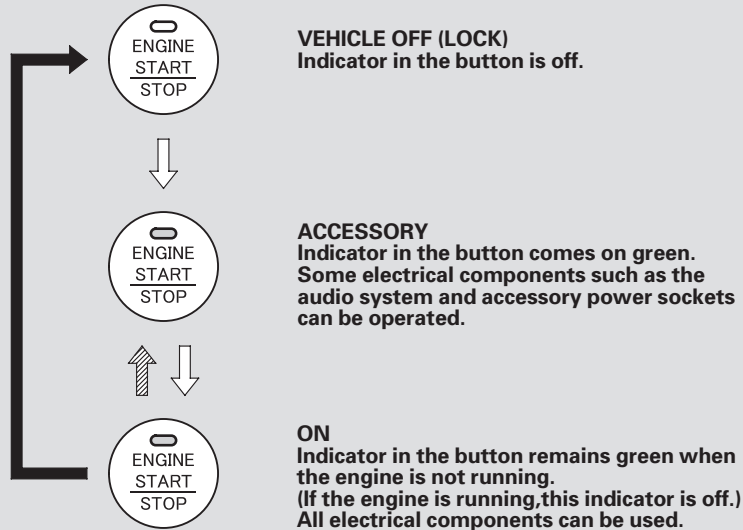
To change the power mode without turning on the engine, press the engine start/stop button without pressing the brake pedal. The power mode will be changed as shown on the next page.



Do the following without pressing the brake pedal.

-  : Press the engine start/stop button.
-  : Press the engine start/stop button without the shift lever in P.
-  : Shift to Park, then press the engine start/stop button.

How the mode is switched depends on the shift lever position (with or without the shift lever in Park).

With the shift lever in Park, the power mode changes from ON to VEHICLE OFF (LOCK) when you push the engine start/stop button.









To change the mode from ON to ACCESSORY with the shift lever position in Park, press the engine start/stop button twice.

To change the mode from ACCESSORY to OFF, shift to Park, then press the engine start/stop button twice.

NOTE: If the keyless access system main switch in the glove box is off, make sure to insert the keyless access remote into the keyless access slot to turn on your vehicle's power mode. For more information, refer to page [187](#).

Keyless Access System

Ignition Switch and Power Mode Comparison

Ignition Switch Position	LOCK (0) 	ACCESSORY (I) 	ON (II) 	START (III) 
Without Keyless Access System	<ul style="list-style-type: none"> • Engine is turned off and power is shut down. • The steering wheel is locked. • No electrical components can be used. 	<ul style="list-style-type: none"> • Engine is turned off. • Some electrical components such as the audio system and accessory power sockets can be operated. 	<ul style="list-style-type: none"> • Normal key position while driving. • All electrical components can be used. 	<ul style="list-style-type: none"> • Use this position to start the engine. • The ignition switch returns to the ON (II) position when you release the key.
Power Mode	VEHICLE OFF (LOCK) 	ACCESSORY 	ON   Green OFF	START 
With Keyless Access System and Engine Start/Stop Button	Indicator-Off <ul style="list-style-type: none"> • Engine is turned off and power is shut down. • The steering wheel is locked. • No electrical components can be used. 	Indicator-Green <ul style="list-style-type: none"> • Engine is turned off. • Some electrical components such as the audio system and accessory power sockets can be operated. 	Indicator-Green (engine is turned off) Off (engine is running) <ul style="list-style-type: none"> • All electrical components can be used. 	Indicator-Off <ul style="list-style-type: none"> • The mode automatically returns to ON after the engine starts.

Starting the Engine

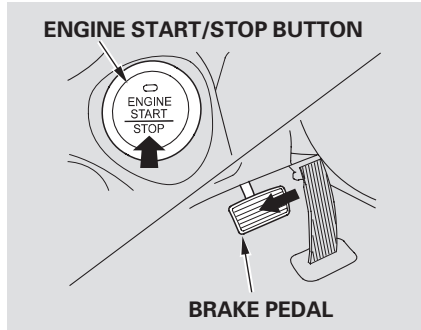

You can start the engine in any power mode.

To start the engine:

1. Move the shift lever to Park (P).
2. Depress the brake pedal and press the engine start/stop button.

Starting Guidance

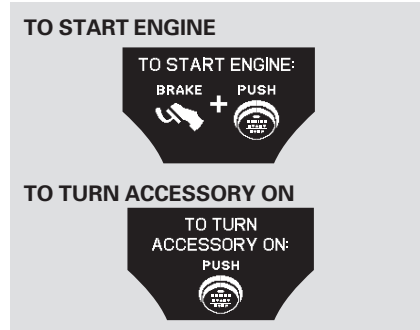

After you unlock and open the driver's door, you will see the "TO START ENGINE:" message on the multi-information display. The "TO TURN ACCESSORY ON:" message will be shown after three seconds. The display switches between the "TO START ENGINE:" and "TO TURN ACCESSORY ON:" messages every three seconds.

When the keyless access system main switch in the glove box is off, the multi-information display shows the "INSERT KEYLESS REMOTE INTO SLOT" message, then the "TO START ENGINE:" message will be shown after you insert the remote into the slot. Each time you press the engine start/stop button, the "INSERT KEYLESS REMOTE INTO SLOT" message is shown on the multi-information display if the remote is not in the slot.

CONTINUED

Keyless Access System



If the steering wheel is locked, the engine cannot start. The multi-information display shows you the above message and the indicator in the engine start/stop button blinks. To unlock the steering wheel, apply force by turning it left and right while pressing the engine start/stop button at the same time.

NOTE:

If the keyless access remote battery dies, you may have to use the built-in key to unlock/lock the vehicle. The built-in key is stored inside the keyless access remote (see page [191](#)).

After entering the vehicle, insert the keyless access remote into the slot to start the engine (see page [189](#)).

Stopping the Engine

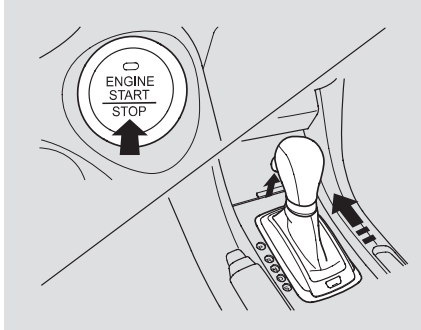

To turn the vehicle off when the vehicle is completely stopped, shift to Park (P), then press the engine start/stop button. The engine stops and the power mode switches from ON to VEHICLE OFF (LOCK).

Operation Guidance

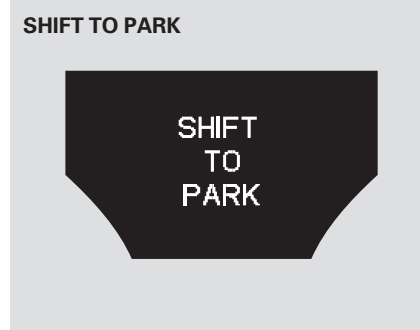

You can only place the vehicle in the VEHICLE OFF (LOCK) mode if the transmission is in Park. You will see the "SHIFT TO PARK" message on the multi-information display with the power mode in ACCESSORY if you open the driver's door with the shift lever in a position other than P (Park).

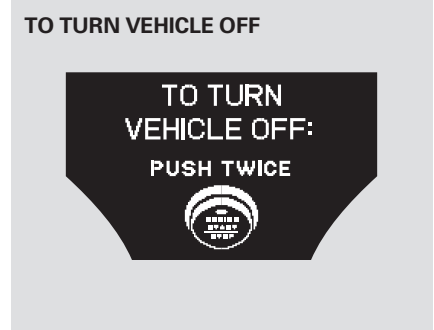

After shifting into Park, you will see the "TO TURN VEHICLE OFF:" message on the multi-information display. Press the engine start/stop button twice with your foot off the brake pedal to change the power mode from ACCESSORY to VEHICLE OFF (LOCK).

CONTINUED

Keyless Access System

Before leaving the vehicle, make sure it is off. You can verify if the power is off by checking the engine start/stop button LED indicator.

If you open the driver's door in the ACCESSORY mode, a beeper will sound. You will also see a "TO TURN VEHICLE OFF:" message on the multi-information display.

Press the engine start/stop button twice with your foot off the brake pedal to change the power mode to VEHICLE OFF (LOCK).

Before leaving the vehicle, make sure it is in VEHICLE OFF (LOCK).

Emergency Engine Stop

The engine start/stop button may be used to stop the engine due to an emergency situation even while driving. If you must stop the engine, do either of the following operations:

- Press and hold the engine start/stop button for three seconds.
- Firmly press the engine start/stop button three times.

Do not press the button while driving unless it is absolutely necessary for the engine to be switched off.

If you are driving, the power mode switches from ON to ACCESSORY or VEHICLE OFF (LOCK) whenever you perform either procedure. However, the steering wheel will NOT lock.

If you cannot stop the engine by pressing the engine start/stop button once when the vehicle is stopped and the shift lever is in Park, do either emergency engine stop procedure. In this case, the power mode will change to VEHICLE OFF (LOCK), however, the steering wheel may NOT lock.

Beeper and Message *Keyless Remote Not Detected*



If you take the keyless access remote out of the vehicle and close the door with the power mode ON, the inside and outside beepers sound and a “KEYLESS REMOTE NOT DETECTED” message will be displayed on the multi-information display.

The displayed message goes away when you bring the remote back inside the vehicle.

If the engine is running and you take the remote out of the vehicle, it will continue to run. Once the power mode is changed to VEHICLE OFF (LOCK), the engine will not restart until you bring back a remote into the vehicle.

The engine does not start if you push the engine start/stop button when the remote is outside the vehicle. Check where the remote is. Make sure that you carry the remote with you when you operate the engine start/stop button.

Even when the remote is inside the vehicle, the beeper may sound when the location of the remote is not detected due to surrounding conditions. It is not a failure. Make sure that you carry the remote with you.

CONTINUED

Keyless Access System

The outside beeper sounds when the power mode is in ACCESSORY, and a door is opened, then closed.

Keyless Remote Low Battery

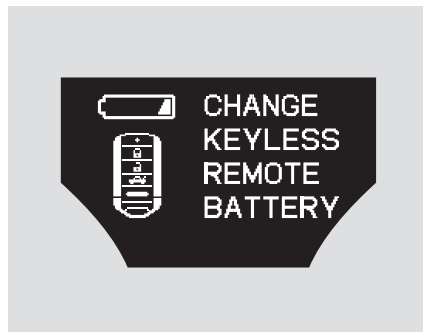

The battery in the remote normally last about 2 years. To ensure maximum battery life, do not store the remote close to electrical devices such as computers or TVs. When the multi-information display shows “CHANGE KEYLESS REMOTE BATTERY,” replace the battery as soon as possible (see page [175](#)).

If the remote battery becomes weak and the power door lock/unlock operation is disabled, you should insert the remote into the keyless access remote slot to set the power mode and start the engine. After inserting the remote to the slot, operate the engine start/stop button as previously described (see pages [178](#) and [181](#)). For more information on the keyless access slot, see page [189](#).

Inserting the remote does not charge the remote battery. You should replace the battery as soon as possible.

Keyless Access Remote System Main Switch

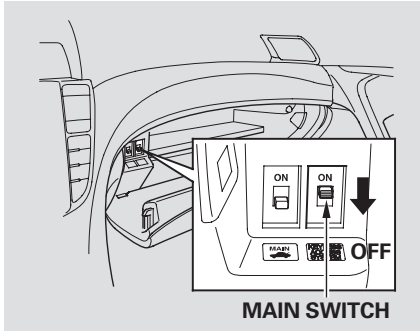

This switch is in the glove box. You can cancel the keyless access system features, which are locking/unlocking the doors, unlocking the trunk, and starting the engine while carrying the keyless access remote. To cancel the system, turn the keyless access system main switch off by pushing it down.

NOTE: Turning off the keyless access system will disable lockout prevention.

With the keyless access remote system main switch off, you should insert the keyless access remote into the keyless remote slot to start the engine. For more information, see page [189](#).



Keyless Access System Indicator

According to the message on the multi-information display, this indicator has two indications. A “CHECK KEYLESS ACCESS SYSTEM” message indicates a problem with the keyless access system. A “CHECK KEYLESS STARTING SYSTEM” message indicates a problem with the keyless starting system.

This indicator normally comes on for several seconds when you change the power mode to ON.

CONTINUED

Keyless Access System

Check Keyless Access System

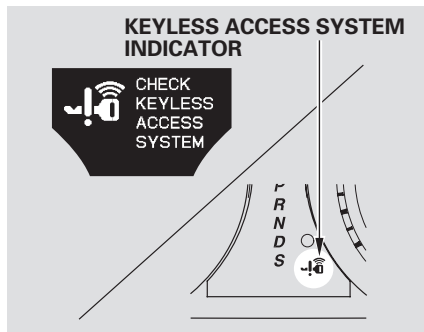

Have your vehicle checked by your dealer if:

- The keyless access system indicator comes on and stays on while you are driving.
- The indicator comes on after the engine has started.

- The multi-information display shows “CHECK KEYLESS ACCESS SYSTEM.”

In this case, use the built-in key to lock/unlock the doors and insert the keyless access remote into the slot to start the engine (see page 189).

Check Keyless Starting System

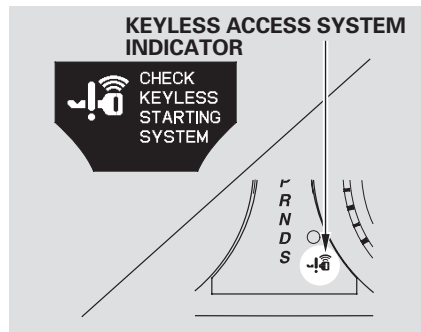

Have your vehicle checked by your dealer if:

- The keyless access system indicator comes on and stays on while you are driving.
- The indicator comes on and stays on in any power mode.

- The multi-information display shows “CHECK KEYLESS STARTING SYSTEM.”

In this case, you should not shut off your engine until you are in a safe location or at your dealer, as your vehicle may not restart.

Keyless Access Remote Slot

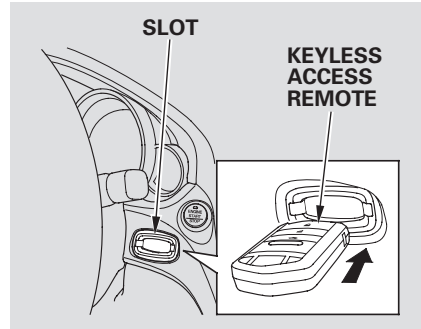

In either case, you have to insert the keyless access remote into the keyless access remote slot to set the power mode and start the engine.

- If the remote battery becomes weak and the power door lock/unlock operation is disabled.
- When the keyless access remote system main switch in the glove box is set to off.

Always insert the keyless access remote fully into the slot. To remove it, place the vehicle in the VEHICLE OFF (LOCK) mode, then pull out the keyless access remote.

If the keyless access remote has been inserted into the slot, it will lock into place when the power is on. The slot will unlock when the power is turned off.

NOTE: If the keyless access remote does not come out of the slot easily, try to push it in before pulling it out. Make sure the vehicle is in VEHICLE OFF (LOCK) mode.

CONTINUED

Keyless Access System

To avoid damaging the slot, do not insert any other objects into the slot or put a sticker on the keyless access remote.

Inserting the remote does not charge the remote battery. If necessary, you should replace the battery as soon as possible.

Operation Guidance

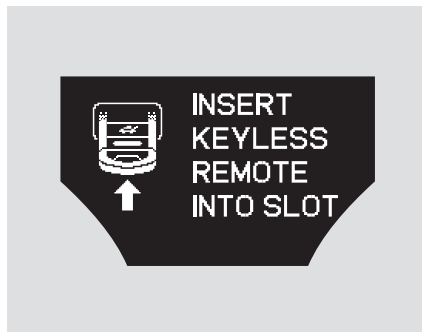

When you open the driver's door, and each time you press the engine start/stop button, you will see the "INSERT KEYLESS REMOTE INTO SLOT" message on the multi-information display in the following situations:

- When the keyless access system main switch (see page [187](#)) is off.

- When the keyless access remote is not in the vehicle.

If you turn off the vehicle and leave the remote in the keyless access remote slot, you will hear a reminder beeper, and one of the following messages will appear on the multi-information display.

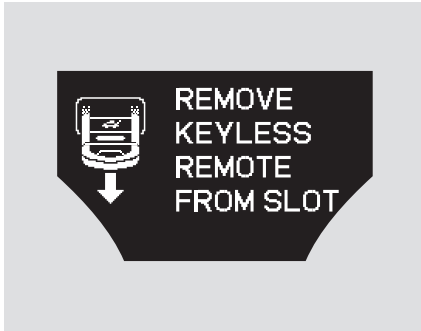

If the vehicle is left in the ACCESSORY mode, the “TO TURN VEHICLE OFF” message is shown on the multi-information display when you open the driver’s door. If the vehicle is left in the VEHICLE OFF (LOCK) mode with the keyless access remote in the slot, the “REMOVE KEYLESS REMOTE FROM SLOT” message is shown on the multi-information display.

The shift lever must be in Park before you can press the engine start/stop button twice without pressing the brake pedal to set the vehicle into the VEHICLE OFF (LOCK) mode.

Built-in key and Remote

The built-in key can be used to lock/unlock the doors and the trunk when the remote battery becomes weak and the power door lock/unlock operation is disabled.

CONTINUED

Keyless Access System

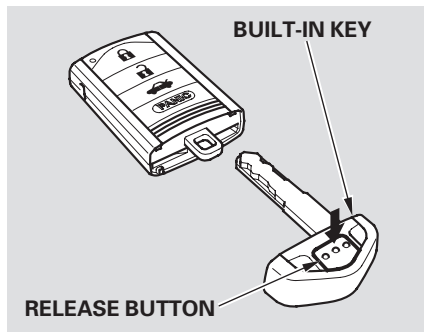

To remove the built-in key, pull it out while pressing the release button. To reinstall the built-in key, push the key into the remote until it clicks.

To avoid damaging the remote and the built-in key, never pull on the built-in key unless you are pressing the release button.

The keyless access system uses an electric field to identify the remote.

If you use medical equipment such as a cardiac pacemaker, ask your doctor if the electric field used by the remote will affect it.

Valet Function

The trunk and glove box cannot be opened when you turn the trunk main switch off and lock the glove box and trunk pass-through cover with the built-in key. Then, the trunk cannot be opened by using the remote or the exterior trunk release switch.

Remove the built-in key from the remote by pressing the button, then give that remote to someone else as a valet key.

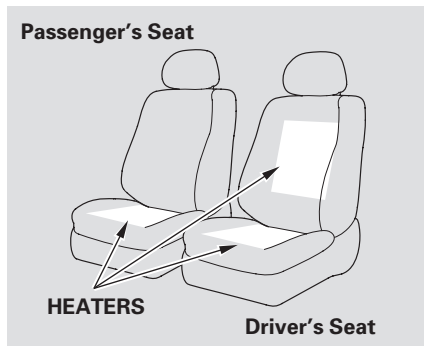

Both front seats are equipped with seat heaters. Because of the sensors for the side airbag cutoff system, there is no heater in the passenger's seat-back.

The ignition switch* must be in the ON (II) position to use the heaters.

* : Models equipped with the keyless access system have an engine start/stop button instead of an ignition switch. ON Mode is the equivalent of ON (II). For more information, see pages 178 and 180.

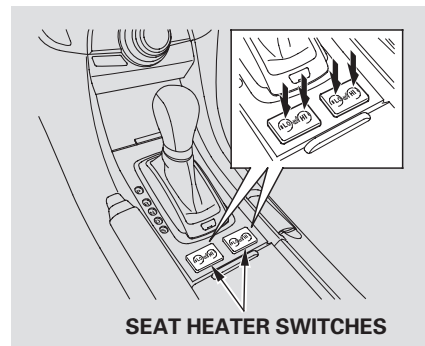

Push the right side of the switch, HI, to rapidly heat up the seat. After the seat reaches a comfortable temperature, select LO by pushing the left side of the switch. This will keep the seat warm.

CONTINUED

Seat Heaters

In the HI setting, the heater turns off when the seat gets warm, and turns back on after the seat's temperature drops.

In the LO setting, the heater runs continuously. It does not cycle with temperature changes.

Follow these precautions whenever you use the seat heaters:

- Use the HI setting only to heat the seats quickly, because it draws large amounts of current from the battery.
- If the engine is left idling for an extended period, do not use the seat heaters even on the LO setting. It can weaken the battery, causing hard starting.

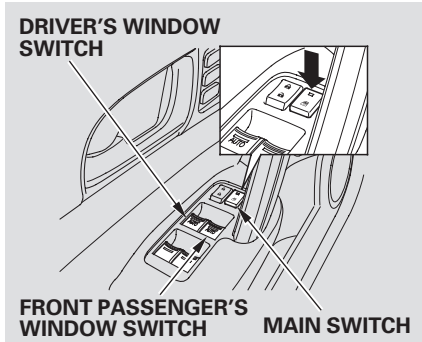

Turn the ignition switch* to the ON (II) position to raise or lower any window. To open a window, push the switch down and hold it. Release the switch when you want the window to stop. Pull back on the switch and hold it to close the window.

* : Models equipped with the keyless access system have an engine start/stop button instead of an ignition switch. ON Mode is the equivalent of ON (II). For more information, see pages 178 and 180 .

⚠ WARNING

Closing a power window on someone's hands or fingers can cause serious injury.

Make sure your passengers are away from the windows before closing them.

AUTO – To open either front window fully, push the window switch firmly down to the second detent, then release it. The window automatically goes down all the way. To stop the window from going all the way down, pull back on the window switch briefly.

To close either front window fully, pull back the window switch firmly to the second detent, then release it. The window automatically goes all the way up. To stop the window from going all the way up, push down on the window switch briefly.

CONTINUED

Power Windows

When you push the main switch in, the indicator comes on and the passengers' windows cannot be raised or lowered. Use the main switch when you have children in the vehicle so they do not injure themselves by operating the windows unintentionally. To cancel this feature, push on the switch again. The switch will pop out and the indicator will go off.

The windows and the main switch will operate for up to 10 minutes after you turn off the ignition switch (set VEHICLE OFF mode on models with keyless access system). Opening either front door cancels this function.

Auto Reverse

If either front window runs into any obstacle while it is closing automatically, it will reverse direction, and then stop. To close the window, remove the obstacle, then use the window switch again.

Auto reverse stops sensing when the window is almost closed. You should always check that all passengers and objects are away from the window before closing it.

NOTE: Only on the driver's window, the auto reverse function is disabled when you continuously pull up the switch.

Opening the Windows and Moonroof with the Remote Transmitter/Keyless Access Remote

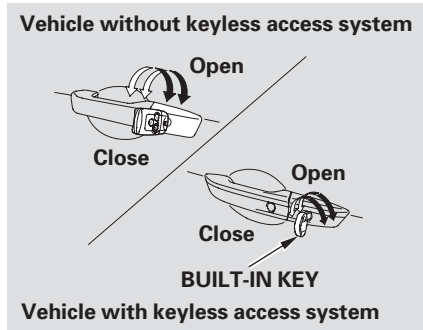

You can open all of the windows and the moonroof from outside with the remote transmitter.

1. Press the UNLOCK button once to unlock the driver's door.

2. Press the UNLOCK button a second time, and hold it. The remaining doors unlock, and all four windows and the moonroof start to open. To stop the windows and moonroof, release the button.
3. To open the windows and moonroof further, press the button again (within 10 seconds of step 1) and hold it. If the windows and the moonroof stop before the desired position, repeat steps 1 and 2.

You cannot close the windows or the moonroof with the remote transmitter.

Opening/Closing the Windows and Moonroof with the Key or the Built-in key

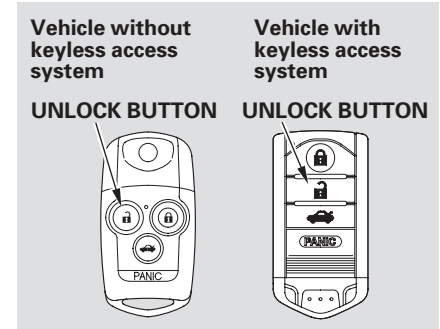

You can open and close the windows and moonroof with the key in the driver's door lock.

To open:

1. Insert the key in the driver's door lock.

CONTINUED

Power Windows

2. Turn the key clockwise, then release it.
3. Turn the key clockwise again, and hold it. All four windows and the moonroof start to open. To stop the windows and the moonroof, release the key.
4. To open the windows and the moonroof further, turn and hold the key again (within 10 seconds of step 2).

To close:

1. Insert the key in the driver's door lock.
2. Turn the key counterclockwise, then release it.
3. Turn the key counterclockwise again, and hold it. All four windows and the moonroof start to close. To stop the windows and the moonroof, release the key.
4. To close the windows and the moonroof further, turn and hold the key again (within 10 seconds of step 2).

NOTE: If the windows and the moonroof stop before the desired position, repeat steps 2 and 3.

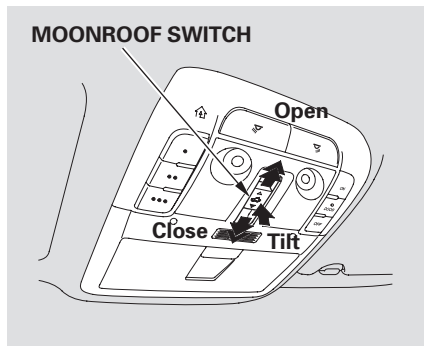

The moonroof can be tilted up in the back for ventilation, or it can be slid back into the roof. Use the switch on the front ceiling to operate the moonroof. You must turn the ignition switch* to the ON (II) position to operate the moonroof.

* : Models equipped with the keyless access system have an engine start/stop button instead of an ignition switch. ON Mode is the equivalent of ON (II). For more information, see pages 179 and 180 .

To tilt up the moonroof, push on the center of the moonroof switch. To stop the moonroof from tilting up fully, push the switch briefly.

To open the moonroof, pull back on the switch and hold it. Release the switch when the moonroof reaches the desired position. To close the moonroof, push the switch forward and hold it. Release the switch to stop the operation.

⚠ WARNING

Opening or closing the moonroof on someone's hands or fingers can cause serious injury.

Make sure all hands and fingers are clear of the moonroof before opening or closing it.

AUTO – To open the moonroof fully, pull back the moonroof switch firmly, then release it. The moonroof automatically opens all the way. To stop the moonroof from opening, push the switch briefly.

To close the moonroof fully, firmly push the moonroof switch forward, then release it. The moonroof automatically closes all the way. To stop the moonroof from closing, push the switch briefly.

CONTINUED

Moonroof

To open or close the moonroof partially, lightly pull the switch back or push it forward and hold it. The moonroof will stop when you release the switch.

Auto Reverse

If the moonroof runs into any obstacle while it is closing automatically, it will reverse direction, and then stop. To close the moonroof, remove the obstacle, then use the moonroof switch again.

Auto reverse stops sensing when the moonroof is almost closed. You should always check that all passengers and objects are away from the moonroof before closing it.

You can open and close the moonroof for up to 10 minutes after you turn off the ignition switch, on models with keyless access system, set the power mode to VEHICLE OFF (LOCK). Opening either front door cancels this function.

NOTICE

If you try to open the moonroof in below-freezing temperatures, or when it is covered with snow or ice, you can damage the moonroof panel or its motor.

You can use the remote transmitter/keyless access remote or the key/built-in key to operate the moonroof from the outside. Refer to page [197](#) for details.

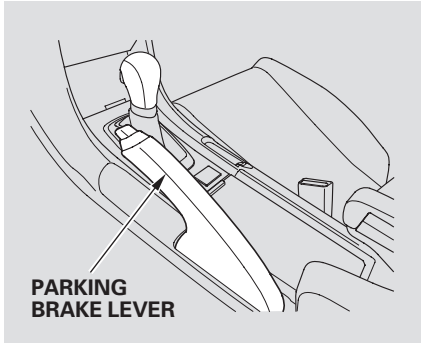

To apply the parking brake, pull the lever up fully. To release it, pull up slightly, push the button, and lower the lever. The parking brake indicator on the instrument panel should go out when the parking brake is fully released (see page 65).

If you drive without releasing the parking brake, a beeper will sound, and you will also see a “RELEASE PARKING BRAKE” message on the multi-information display (see page 65).

NOTICE

Driving the vehicle with the parking brake applied can damage the rear brakes and hubs. A beeper will sound if the vehicle is driven with the parking brake on.

Interior Convenience Items

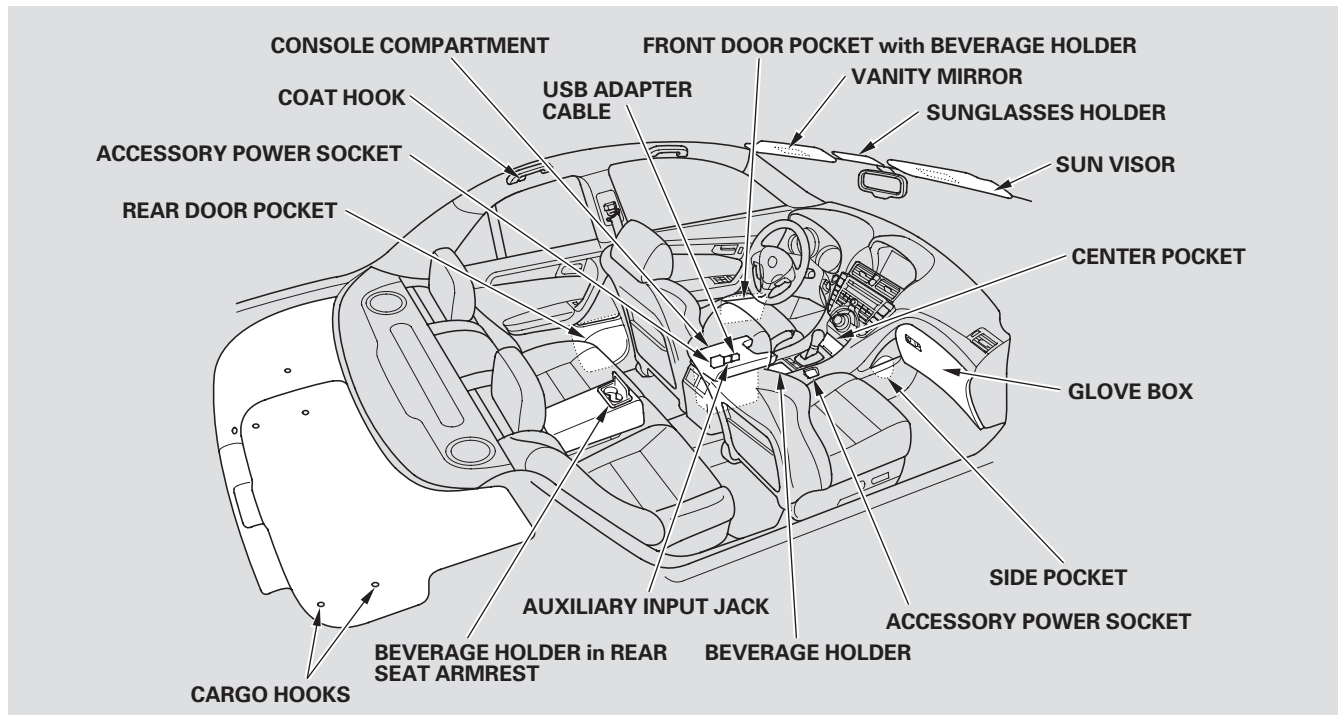

Beverage Holders

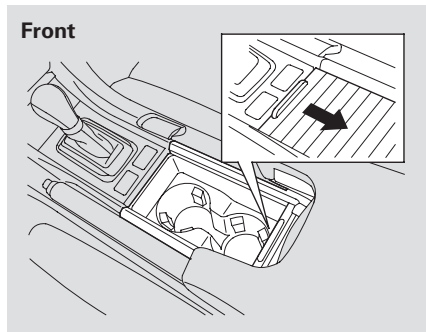

Open the front beverage holder by sliding its cover backward.

Be careful when you are using the beverage holders. A spilled liquid that is very hot can scald you or your passengers. Liquid can also spill from the door pocket beverage holders (if equipped) when you open or close the doors. Use only resealable containers in the door pockets.

Spilled liquids can damage the upholstery, carpeting, and electrical components in the interior.

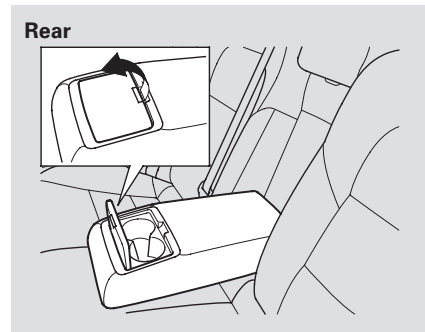

To open the rear beverage holder, pull out the lid by the tab. To close it, push it down.

Interior Convenience Items

Accessory Power Sockets

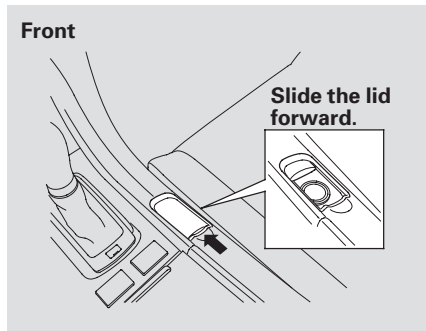

Your vehicle has two accessory power sockets. One is next to the shift lever. The other is in the console compartment.

To access the front accessory socket, slide the lid forward until it latches. To close it, push in on the lid to slide it backward.

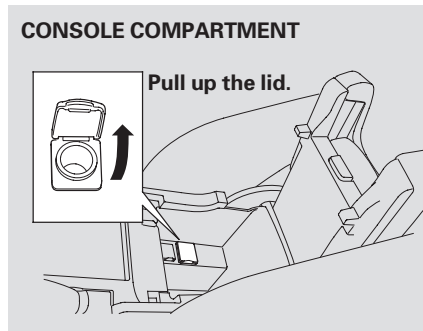

To use an accessory power socket, the ignition switch* must be in the ACCESSORY (I) or ON (II) position.

* : Models equipped with the keyless access system have an engine start/stop button instead of an ignition switch. ACCESSORY Mode is the equivalent of ACCESSORY (I), and ON Mode is the equivalent of ON (II). For more

information, see pages [178](#) and [180](#).

Each socket is intended to supply power for 12 volt DC accessories that are rated 120 watts or less (10 amps).

None of the sockets will power an automotive type cigarette lighter element.

Make sure to put the socket cover back in place to prevent any small foreign objects from getting into the socket.

Glove Box

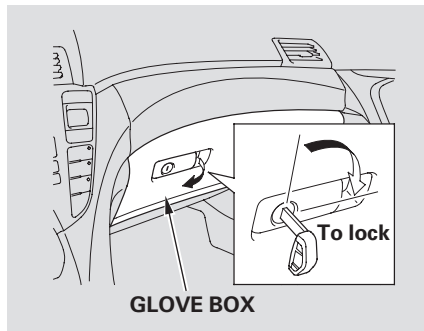

Open the glove box by pulling out the handle. Close it with a firm push. Lock or unlock the glove box with the master key or the built-in key on models with keyless access system.

The glove box light comes on only when the parking lights are on.

⚠ WARNING

An open glove box can cause serious injury to your passenger in a crash, even if the passenger is wearing the seat belt.

Always keep the glove box closed while driving.

Console Compartment

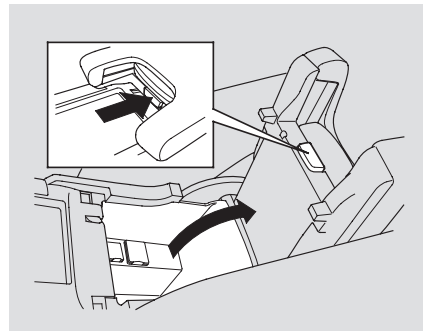

To open the console compartment, push in on the lever and lift the armrest. To close, lower the armrest, and push it down until it latches.

Make sure to slide back the tray before opening the console compartment.

CONTINUED

Interior Convenience Items

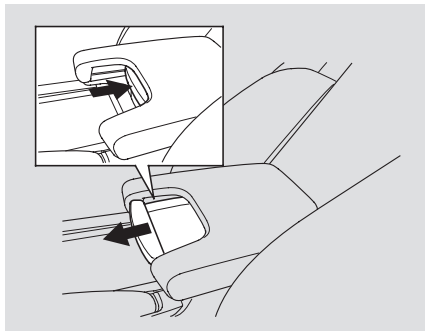

You can put small items in the sliding tray located in the console compartment lid. To use the tray, push it in to open it, then slide out fully. Make sure to slide back the tray firmly until you hear a click when not in use.

Vanity Mirror

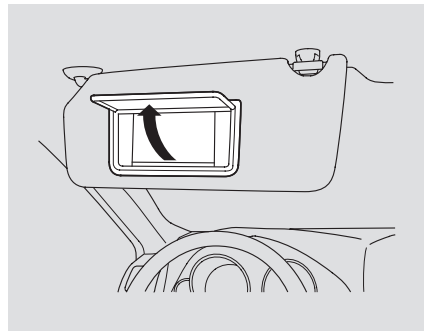

To use the vanity mirror on the back of the sun visor, pull up the cover.

The vanity mirror lights come on when you pull up the cover.

Sun Visor

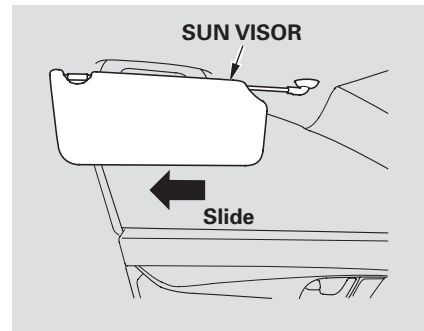

To use a sun visor, pull it down. You can also use a sun visor at the side window. Remove the support rod from the clip, and swing the sun visor toward the side window. You can extend the sun visor further by pulling it back.

Do not use the sun visor extension feature over the rear view mirror.

Make sure to slide the sun visor back to its original position before flipping it back in place.

Make sure you put the sun visor back in place when you are getting into or out of the vehicle.

Center Pocket

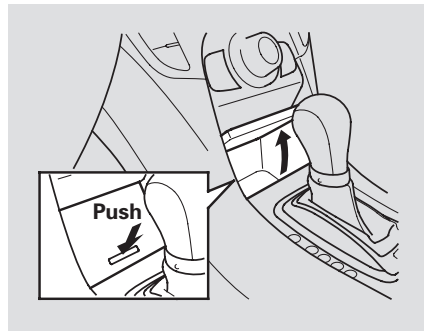

To open the center pocket, push on the lid. It will unlatch and swing up. To close it, push the lid down until it latches.

Sunglasses Holder

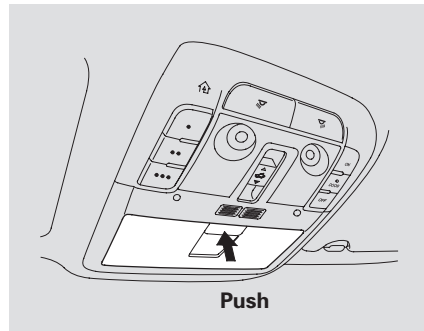

To open the sunglasses holder, push on the lid. It will unlatch and swing down. To close it, push it until it latches. Make sure the holder is closed while you are driving.

CONTINUED

Interior Convenience Items

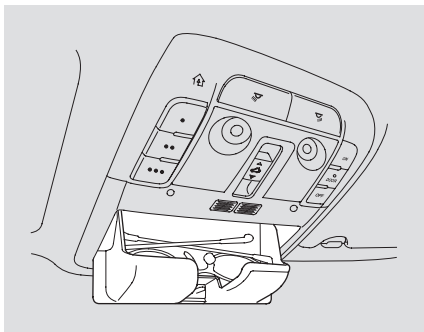

Some larger styles of sunglasses may not fit in the holder.

You may also store small items in this holder. Make sure they are small enough to let the holder close and latch, and that they are not heavy enough to cause the holder to pop open while driving.

Coat Hook

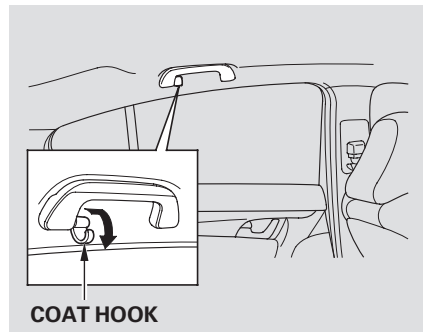

To use a coat hook, slide it out slightly, then pull it down.

Make sure the coat hook is pulled up when you are not using it. This hook is not designed for large or heavy items.

Light Control Buttons

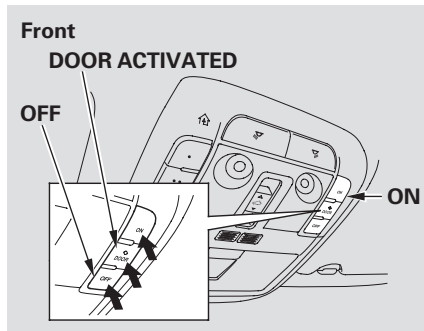



Your vehicle has the light control buttons on the front ceiling. With these buttons, you can select three positions: OFF, Door (door activated position), and ON. To select a position, press the appropriate button.

When you press the DOOR button, the green indicator in the button comes on as a reminder.

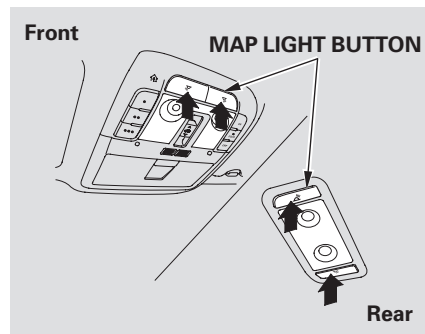

To turn off the setting, press the OFF button. On the door activated position, pressing the DOOR button again also turns off the setting.



OFF position:

- The front individual map lights can be turned on and off by pressing each map light button ( / ).
- The rear individual map lights cannot be turned on.

Door (Door activated position):

- The individual map lights in the front and rear come on when any door is opened, when the remote transmitter (the keyless access system) is used to unlock the doors. When the doors are closed, each light can be turned on and off by pushing the map light button ( / ).

After all doors are closed tightly, the lights dim slightly, then fade out in about 30 seconds.

To change the “INTERIOR LIGHT DIMMING TIME” setting, see page [116](#).

With any door left open, the lights stay on about 15 minutes, then go out.

CONTINUED

Interior Lights

On models without keyless access system

The lights also come on when the key is removed from the ignition switch.

On models with keyless access system





The lights also come on when the power mode is set to VEHICLE OFF (LOCK).

ON position:

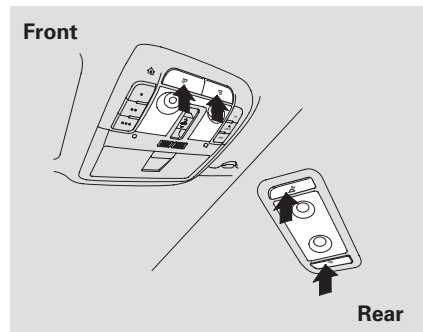
- All the individual map lights come on and stay on.

Individual Map Lights



Turn on the front individual map lights by pushing each map light button ( / ). Push the button again to turn it off. When the door activated position is selected with the light control button, the rear map lights can be turned on by pushing each map light button ( / ). Push the button again to turn it off.

If any map light is left on when the ignition switch is turned off or the VEHICLE OFF (LOCK) mode is set, and all doors are closed, it will turn off when the vehicle is locked with the remote transmitter (the keyless access remote on models with keyless access system), or after 15 minutes.

Courtesy Lights

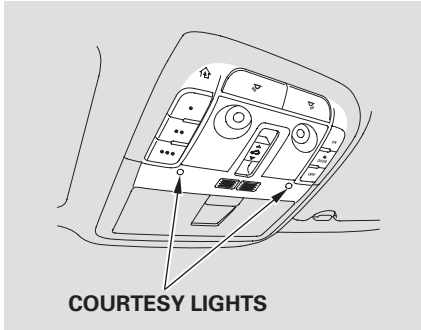

The courtesy lights come on when the parking lights are turned on. To adjust its brightness, press either of the instrument panel brightness control buttons (+ or -) with the ignition switch* in the ON (II) position.

* : Models equipped with the keyless access system have an engine start/stop button instead of an ignition switch. ON Mode is the equivalent of ON (II). For more information, see pages [178](#) and [180](#).

The courtesy light in each front door comes on when the door is opened, and goes out when the door is closed.

In addition to the courtesy light on the ceiling, the driver's ambient foot light comes on.

On models without keyless access system

Your vehicle also has a courtesy light in the ignition switch. This light comes on when you open the driver's door. It fades out in about 30 seconds after the door is closed.

Interior Lights

Keyless Access Remote Slot Light *On models with Keyless Access System*

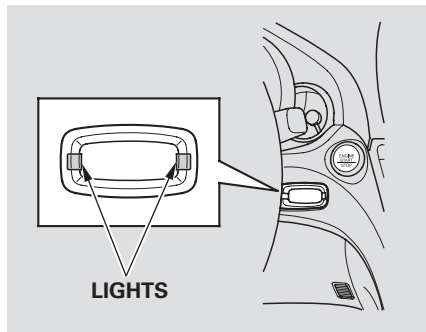

Your vehicle has a keyless access remote slot light. The light comes on when you:

- Open any door.

- Set the vehicle mode to VEHICLE OFF (LOCK).
- Remove the keyless access remote from the keyless access remote slot.

After all doors are closed tightly, the light dims slightly, then fades out in about 30 seconds (depending on the interior light dimming timer setting). The light turns off before 30 seconds have elapsed if you lock the driver's door.

The climate control system in your vehicle provides a comfortable driving environment in all weather conditions.

The standard audio system has many features. This section describes those features and how to use them.

Your vehicle has an anti-theft audio system that requires a code number to enable it.

The security system helps to discourage vandalism and theft of your vehicle.

Climate Control System.....	214
Using Automatic Climate Control.....	216
Dual Temperature and Mode Control.....	220

Climate Control Sensors.....	222
Audio System.....	223
<i>Models without navigation system</i>	
Audio System.....	224
Playing the AM/FM Radio.....	225
Playing the XM® Radio.....	233
Playing Discs.....	240
Disc Changer Error Messages....	250
Protecting Your Discs.....	251
Playing an iPod®.....	254
iPod® Error Messages.....	262
Playing a USB Flash Memory Device.....	263
USB Flash Memory Device Error Messages.....	271
Bluetooth® Audio System.....	272
<i>Models with navigation system</i>	
Audio System.....	277
Playing the AM/FM Radio.....	278
Playing the XM® Radio.....	292
Playing a Disc.....	300
Disc Player Error Messages.....	312
Protecting Your Discs.....	313
Playing Hard Disc Drive (HDD) Audio.....	316
Playing an iPod®.....	345

iPod® Error Messages.....	354
Playing a USB Flash Memory Device.....	355
USB Flash Memory Device Error Messages.....	366
Bluetooth® Audio System.....	367
AM/FM Radio Reception.....	372
Remote Audio Controls.....	374
Auxiliary Input Jack.....	375
Radio Theft Protection.....	376
Setting the Clock.....	377
Security System.....	380
Compass.....	382
Cruise Control.....	386
HomeLink® Universal Transceiver.....	389
Bluetooth® HandsFreeLink® (Models without navigation system).....	392
Bluetooth® HandsFreeLink® (Models with navigation system).....	420
AcuraLink (U.S. models only)....	467
Rearview Camera and Monitor....	483

Climate Control System

Models without navigation system

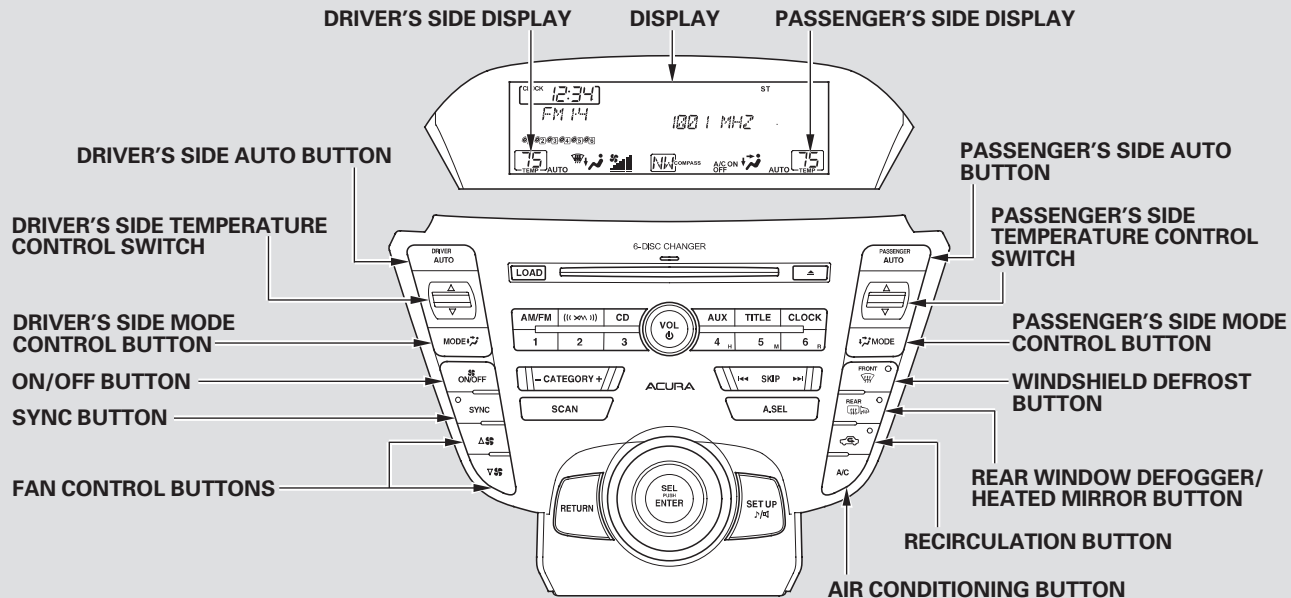

Models with navigation system

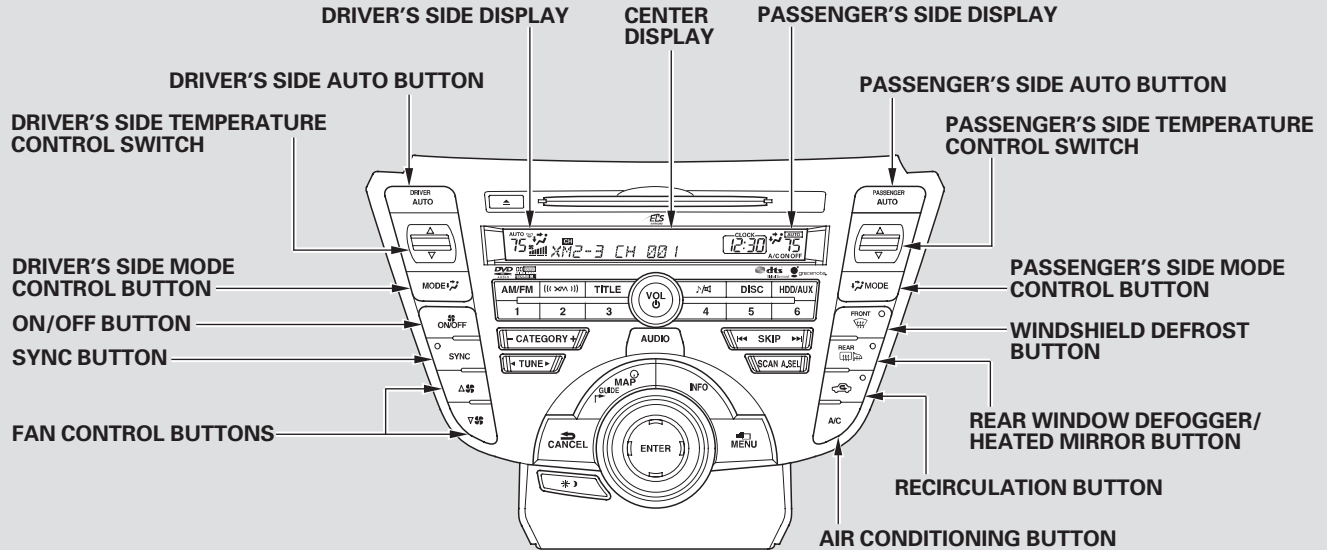

U.S. model is shown.

Climate Control System

Voice Control System

On models with navigation system

The climate control system can also be operated by voice control. See the Navigation section in your quick start guide for an overview of this system, and the navigation system manual for complete details.

Personalization Setting

When you unlock the doors with your remote transmitter (keyless access remote on models with navigation system), the driver's ID (Driver 1 or Driver 2) is detected, and the climate control settings are turned to the respective mode automatically with the ignition switch in the ON (II) position, or the power mode ON.

Using Automatic Climate Control

The automatic climate control system in your vehicle picks the proper combination of air conditioning, heating, and ventilation to maintain the interior temperature you select, and to remove moisture from the air and make the interior dry. The system also adjusts the fan speed and airflow levels.

1. Press the Driver's or Passenger's AUTO button. You will see AUTO and the selected temperature on the appropriate side of the display (in the center display on models with navigation system).
2. Set the desired temperature with the temperature control switch. You can set the driver's side temperature and the passenger's side temperature separately.

The system automatically selects the proper mix of conditioned and/or heated air that will, as quickly as possible, raise or lower the interior temperature to your preference. The system also dehumidify the interior.

Temperature Control

The driver's side temperature and the passenger's side temperature can be set separately. Push up the switch of the appropriate temperature control to increase the temperature of airflow. Push down the switch to decrease it. Each set temperature is shown in the display (in the center display on models with navigation system).

When you set the temperature to its lower limit (**L**) or its upper limit (**H**), the system runs at full cooling or heating only. It does not regulate the interior temperature.

When you adjust a fan control, the fan is taken out of AUTO mode.

You can also select the appropriate mode on the driver's side and the passenger's side separately. To change a mode, press and release the appropriate side mode control button. This will take the mode control out of AUTO mode.

On models with navigation system
In AUTO mode, the vehicle's interior temperature is independently regulated for the driver and front passenger according to each adjusted temperature. The system also regulates each temperature based on the information of the sun light sensor and the sun's position

which is updated automatically by the navigation's global positioning system (GPS). If one side of the vehicle is getting too much sun, the system lowers the temperature only on that side.

SYNC Button

When you press this button, the indicator in the button comes on, and the passenger's side temperature and mode control is synchronized to the driver's side set temperature and mode control. Changing the passenger's side temperature or mode control makes the indicator go off and takes the system out of SYNC mode.

ON/OFF Button

Each time you press this button, the climate control system switches between on and off. Turning on the system with this button selects your last climate control selection.

To Turn Everything Off

To turn the system completely off, press the ON/OFF button.

- Keep the system completely off for short periods only.
- To keep stale air and mustiness from collecting, you should have the fan running at all times.

Climate Control System

Semi-automatic Operation

You can manually select various functions of the climate control system when it is in fully automatic mode. All other features remain automatically controlled. Making any manual selection causes the word AUTO in the display to go out.

Fan Control

Press the ▲  button to increase the fan speed and airflow. Press the ▼  button to decrease it.

Air Conditioning (A/C) Button

This button turns the air conditioning on and off. You will see A/C ON or A/C OFF in the display (in the center display on models with navigation system).

When you turn the A/C off, the system cannot regulate the inside temperature if you set the temperature control below the outside temperature.

Recirculation Button

When the indicator in the button is on, air from the vehicle's interior is sent through the system again. When the indicator is off, air is brought in from the outside of the vehicle (fresh air mode).

The outside air intakes for the climate control system are at the base of the windshield. Keep this area clear of leaves and other debris.

The system should be left in fresh air mode under almost all conditions. Keeping the system in recirculation mode, particularly with the A/C off, can cause the windows to fog up.

Switch to recirculation mode when driving through dusty or smoky conditions, then return to fresh air mode.

Rear Window Defogger Button 
This button turns the rear window defogger on and off (see page 139).

Pushing this button also turns the power mirror heaters on and off.

Mode Controls

The driver's side mode and the passenger's side mode can be selected separately. Use the appropriate mode control button to select the vents the air flows from. Some air will flow from the dashboard vents in all modes.

 Airflow is divided between the floor and corner vents and the defroster vents at the base of the windshield.

This mode can only be selected from the driver's side, however the passenger's side controls can still change the temperature.

 Air flows from the floor vents.

 Airflow is divided between the vents in the dashboard and the floor vents.

 Air flows from the center and corner vents in the dashboard.

Windshield Defroster Button 
This button directs the main airflow to the windshield for faster defrosting. It also overrides any mode selection you may have made.

When you select , the system automatically switches to fresh air mode and turns on the A/C. For faster defrosting, the fan speed automatically increases. You can also increase airflow to the windshield by closing the center and corner vents on the dashboard. To close the vents, rotate the wheel on the side of each center and corner vent.

Select  to help clear the rear window.

When you turn off  by pressing the button again, the system returns to its former settings.

CONTINUED

Climate Control System

For your safety, make sure you have a clear view through all the windows before driving.

When the indicator in the  button is on, the SYNC indicator also comes on. The front passenger's temperature cannot be set separately from the driver's.

The climate control system adjusts the interior humidity and selects the defroster mode automatically if you select the driver's side AUTO mode.

Dual Temperature and Mode Control

Your vehicle has two temperature control switches and two mode control buttons, one for the driver, and one for the front passenger.

The driver's side and the passenger's side temperature and mode can be controlled independently.

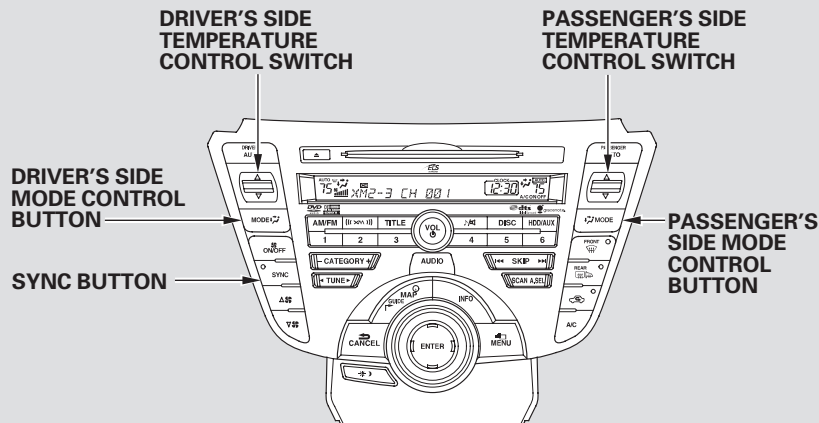

U.S. model with navigation system is shown.

Synchronized Control

The selected temperatures and mode appear in the display (in the center display on models with navigation system). When the indicator in the SYNC button is on, you can adjust both sides to the same temperature and mode by pushing the driver's side temperature control switch up or down.

When you set the temperature to its lower or upper limit, it is displayed as

Hi or **Lo**.

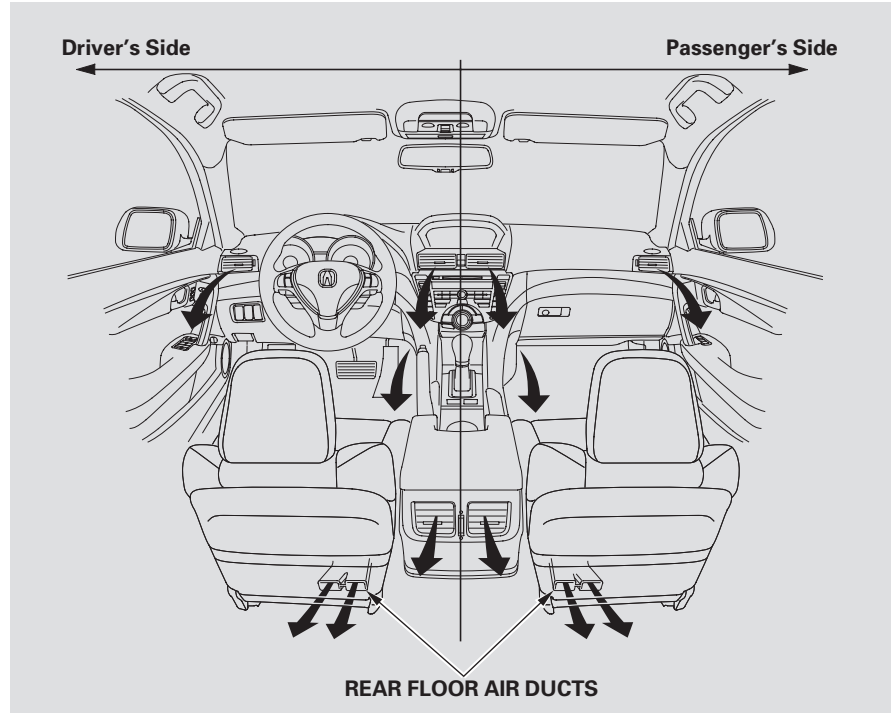

Climate Control System

Rear Ventilation

The airflow from the rear vents can be adjusted when either AUTO mode (driver or passenger) is selected or the fan mode is in the



You can adjust the direction of the airflow by moving the tab on each vent up-and-down and side-to-side. You can also open or close the vents with the dial between them.

Climate Control Sensors

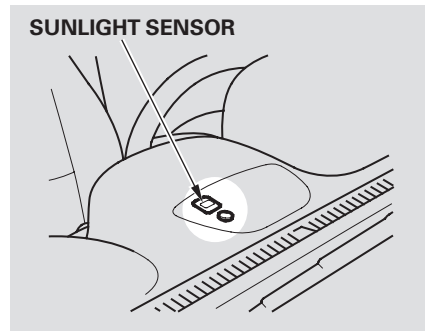

The climate control system has two sensors: a sunlight sensor on top of the dashboard, and a temperature and humidity sensor next to the steering column. Do not cover the sensors or spill any liquid on them.

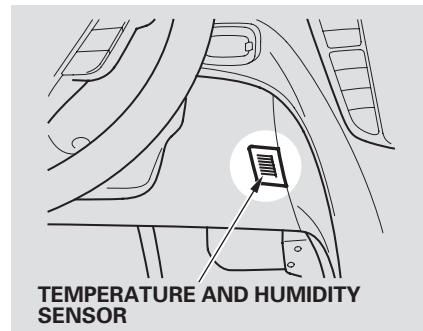

The humidity sensor helps reduce window fogging and also monitors and adjusts cabin humidity by automatically changing the mode to Defrost.

An audio system is standard on all models. Read the appropriate pages (as shown below) to use your vehicle's audio system.

For vehicles without navigation system, see pages [224](#) through [276](#).

For vehicles with navigation system, see pages [277](#) through [371](#).

Models Without navigation system

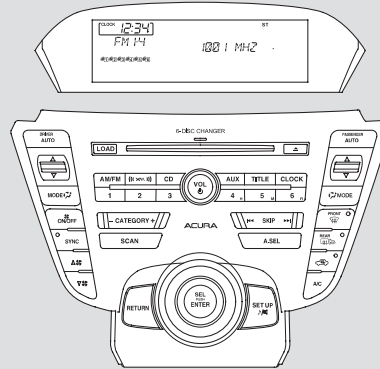

Models With navigation system

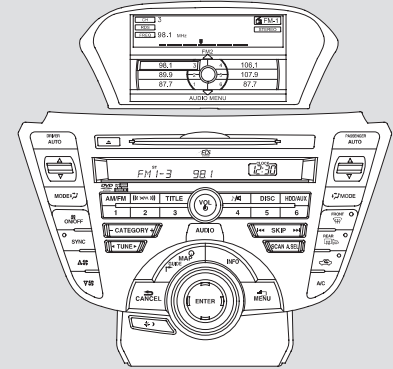

Audio System (Models without navigation system)

Selector Knob

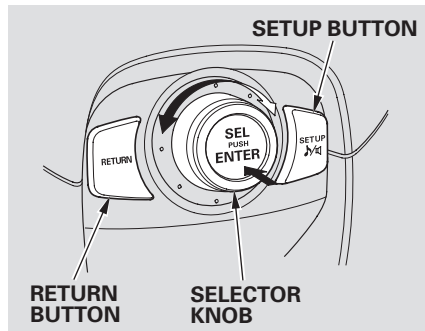

Most audio system functions can be controlled by standard buttons, bars, and knobs. In addition, you can access some functions by using the selector knob on the audio system.

The knob turns left and right. Use it to scroll through lists, or to make selections or adjustments to a list or menu item on the display. When you make a selection, push the center of the selector (ENTER) to go to that selection.

When the audio system is in XM satellite radio mode or playing discs, pushing the selector (ENTER) knob switches the display between the normal display and the extended display. The extended display has three segments to display the detailed information.

SETUP Display

To select any setting such as the clock or sound adjusting, press the SETUP button. To use any audio system function, the ignition switch must be in the ACCESSORY (I) or ON (II) position. You can select the item by turning the selector knob. To go back to the previous display, press the RETURN button.

Pressing the SETUP button again will also cancel the setup display mode.

Personalization Setting

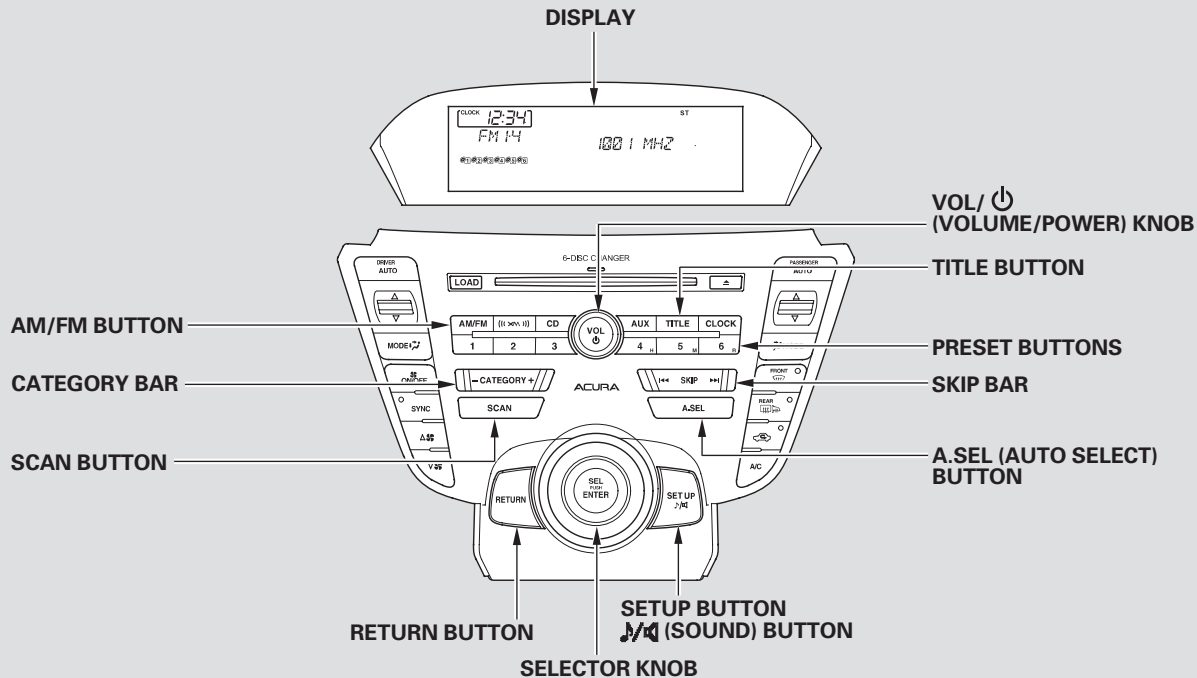

When you unlock the doors with your remote transmitter and turn the audio system on with the ignition switch in the ACCESSORY (I) or ON (II) position, the driver's ID (Driver 1 or Driver 2) is detected, and the radio presets and sound level settings (see page 231) are turned to the respective memorized mode automatically.

Playing the AM/FM Radio (Models without navigation system)



Playing the AM/FM Radio (Models without navigation system)

To Play the Radio

The ignition switch must be in the ACCESSORY (I) or ON (II) position. Turn the system on by pushing the VOL/  (power/volume) knob or the AM/FM button. Adjust the volume by turning the VOL/  knob.

The band and frequency that the radio was last tuned to are displayed. To change bands, press the AM/FM button. On the FM band, ST will be displayed if the station is broadcasting in stereo. Stereo reproduction in AM is not available.



On the AM band, AM noise reduction turns on automatically.

To Select a Station

You can use any of five methods to find radio stations on the selected band: tune, skip, scan, the preset buttons, and auto select.

On the FM band, you can also use the features provided by the radio data system (RDS). For more information on the RDS, see page [228](#).

TUNE — Use the selector knob to tune the radio to a desired frequency. Turn the knob right to tune to a higher frequency, or left to tune to a lower frequency.

SKIP — The skip function searches up and down from the current frequency to find a station with a strong signal. To activate it, press and hold the  or  side of the SKIP bar until you hear a beep, then release it.

SCAN — The scan function samples all stations with strong signals on the selected band. To activate it, press the SCAN button, then release it. You will see SCAN in the display. The system will scan for a station with a strong signal. When it finds one, it will stop and play that station for about 10 seconds.

If you do nothing, the system will scan for the next strong station and play it for 10 seconds. When it plays a station that you want to listen to, press the SCAN button again.

Playing the AM/FM Radio (Models without navigation system)

Preset — Each preset button can store one frequency on AM and two frequencies on FM.

1. Select the desired band, AM or FM. FM1 and FM2 let you store six stations each.
2. Use the tune, skip, scan, or RDS function to tune the radio to a desired station.
3. Pick a preset button, and hold it until you hear a beep.
4. Repeat steps 1 through 3 to store a total of six stations on AM and twelve stations on FM.

AUTO SELECT — If you are traveling far from home and can no longer receive your preset stations, you can use the auto select feature to find stations in the local area.

Press the A. SEL button. “A-SEL” flashes in the display, and the system goes into scan mode for several seconds. It stores the frequencies of six AM and twelve FM stations in the preset buttons.

You will see a “0” displayed after pressing a preset button if auto select cannot find a strong station for that preset button.

If you do not like the stations auto select has stored, you can store other frequencies on the preset buttons as previously described.

To turn off auto select, press the A. SEL (auto select) button. This restores the presets you originally set.

For information on AM/FM radio frequencies and reception, see page [372](#).

Playing the AM/FM Radio (Models without navigation system)

Radio Data System (RDS)

On the FM band, you can select a favorite station and display the program service name according to the information provided by the radio data system (RDS) if the station has the RDS information available.

RDS INFO Display

The RDS information display function shows the name of the RDS station you are listening to. With the audio system on and the FM band selected, you can turn this function on or off.

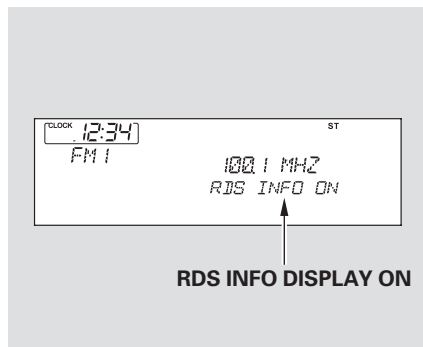

To switch the function between on and off, press and release the TITLE button. With the system on, you will see the “RDS INFO ON” message on the display. If the station you are listening to is an RDS station, the displayed frequency switches to the station name.

If the station you are listening to is not an RDS station, the display continues to show the frequency with the RDS information display function on.

When you turn off this function by pressing the TITLE button, the display shows “RDS NAME OFF.”

Playing the AM/FM Radio (Models without navigation system)

Radio Data System (RDS) Category

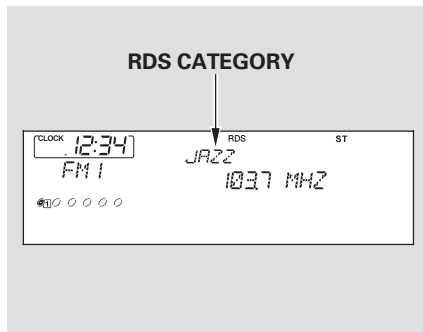

On the FM band selected, you can select the program category provided by the RDS. Press either side (- or +) of the CATEGORY bar to display and select an RDS category. The principal RDS categories are shown as follows:

ALL: All RDS category stations
ROCK: Rock, classic rock and soft rock music

COUNTRY: Country music
SOFT: Adult hits and soft music
TOP 40: Top 40 hits
OLDIES: Nostalgia music and oldies
R & B: Rhythm and blues, and soft rhythm and blues
RELIGION: Religious music and religious talk
CLASSIC: Classical music
JAZZ: Jazz
INFO: News, information, sports, talk, foreign language, personality, public, college, and weather
TRAFFIC: Traffic information

Press either side of the CATEGORY bar to select an RDS category. The display shows the selected RDS category name for about 10 seconds. You can use the search or scan function to find radio stations in the selected RDS category. If you do nothing while the RDS category name is displayed, the selected category is canceled.

RDS Program Search

This function searches up and down a frequency for the strongest signal from the frequencies that carry the selected RDS category information. This can help you to find a station in your favorite category. To activate it, press and release either side (◀◀ or ▶▶) of the SKIP bar. You will see the selected RDS category name blinking while searching it. When the system finds a station, the selected RDS category name will be displayed again for about 5 seconds.

If the system does not find a station, "NOTHING" will be blinking for about 5 seconds, then the system goes back to the last selected station.

CONTINUED

Playing the AM/FM Radio (Models without navigation system)

RDS Program SCAN

The scan function samples all stations with strong signals on the selected RDS category. To activate it, press and release the SCAN button. You will see SCAN in the display. The system will scan for a station with a strong signal in the selected RDS category. You will also see the selected RDS category name blinking while searching it. When it finds one, it will stop and play that station for about 10 seconds.

If you do nothing, the system will scan for the next strong station and play it for 10 seconds. When it plays a station that you want to listen to, press the SCAN button again.

If the system does not find a station, "NOTHING" will be blinking for about 5 seconds, then the system goes back to the last selected station.

You can use the RDS program search or scan function even if the RDS information display function is off. In this case, the display shows a frequency in place of a RDS name.

Playing the AM/FM Radio (Models without navigation system)

Adjusting the Sound

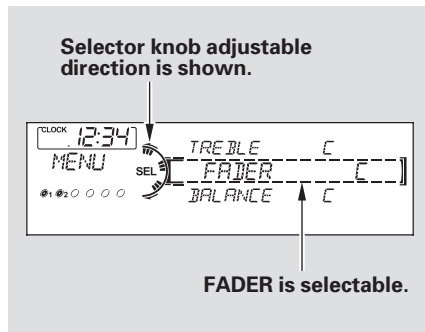

Press the SETUP button to display the sound settings. Turn the selector knob to select an appropriate setting: BASS, TREBLE, FADER, BALANCE, SUBW (subwoofer), CENTER, Dolby PL (ProLogic) II, and SVC (speed-sensitive volume compensation). Press the selector (ENTER) knob to enter the setting, then turn the selector knob to adjust the setting.

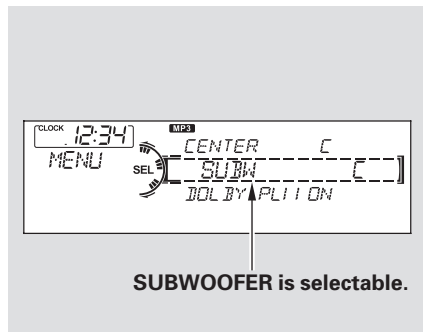

BASS – Adjusts the bass.

TREBLE – Adjusts the treble.

FADER – Adjusts the front-to-back strength of the sound.

BALANCE – Adjusts the side-to-side strength of the sound.

CENTER – Adjusts the strength of sound from the center speaker.

SUBW – Adjusts the strength of sound from the subwoofer speaker.

Dolby PL (ProLogic) II – Dolby PL (ProLogic) II signal processing creates multi-channel surround sound from 2 channel stereo audio sources. Dolby ProLogic II can only activate when listening to DISC (CD-DA, MP3/WMA), XM radio, and AUX. When ProLogic II is active, “PL II” is shown in the audio display.

Manufactured under license from Dolby Laboratories. “Dolby”, “ProLogic”, and the double-D symbol are trademarks of Dolby Laboratories.

CONTINUED

Playing the AM/FM Radio (Models without navigation system)

SVC – Adjusts the volume level based on the vehicle speed.

Each mode is shown in the display as it changes. Turn the selector knob to adjust the setting to your liking.

Except SVC adjustment

When the level reaches the center, you will see “C” in the display.

To return to normal play, push the RETURN or SETUP button after you stop adjusting a mode.

Speed-sensitive Volume Compensation (SVC)

The SVC mode controls the volume based on vehicle speed. The faster you go, the louder the audio volume becomes. As you slow down, the audio volume decreases.

The SVC has four modes; SVC OFF, SVC LOW, SVC MID, and SVC HIGH. Turn the selector knob to adjust the setting to your liking. If you feel the sound is too loud, choose low. If you feel the sound is too quiet, choose high.

This function is set to MID as the default setting when the vehicle leaves the factory.

Audio System Lighting

You can use the instrument panel brightness control buttons (+ or –) to adjust the illumination of the audio system (see page 137). The audio system illuminates when the parking lights are on, even if the radio is turned off.

Playing the XM® Radio (Models without navigation system)

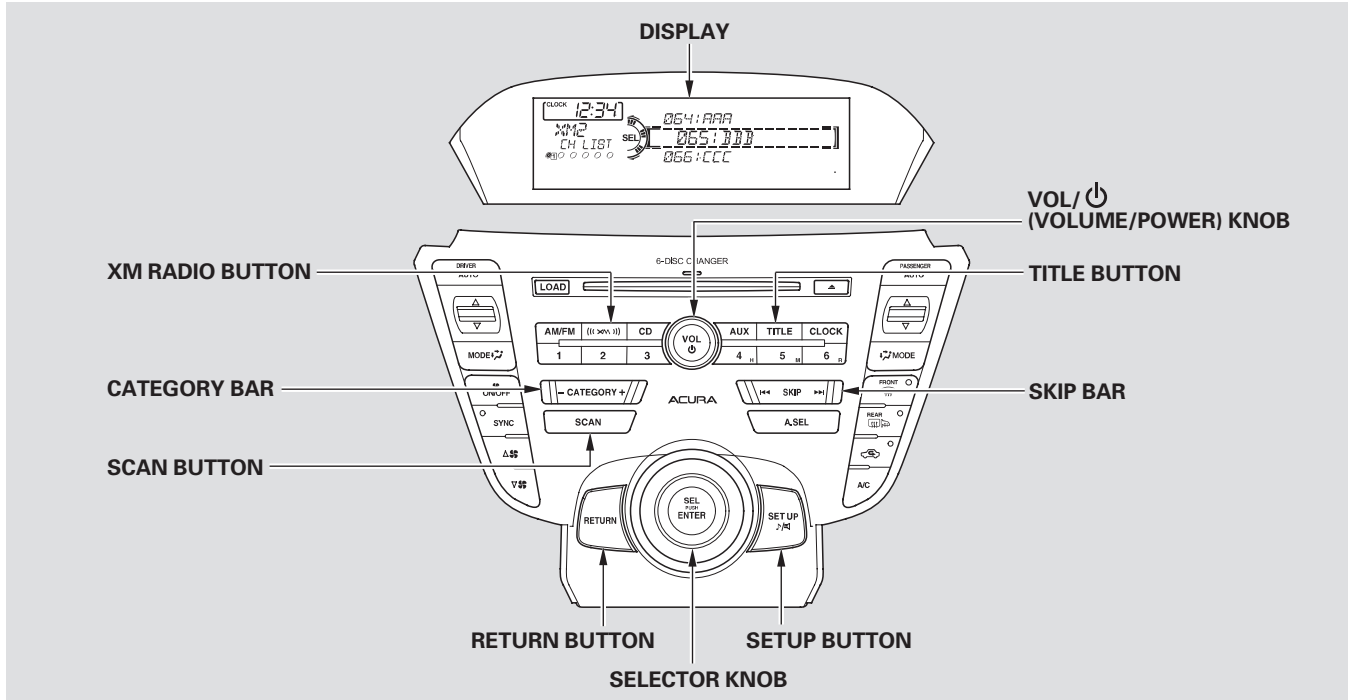

CONTINUED

Playing the XM® Radio (Models without navigation system)

Your vehicle is capable of receiving XM Radio anywhere in the United States, and Canada, except Hawaii and Alaska. XM is a registered trademark of XM Satellite Radio®, Inc.

XM Radio receives signals from two satellites to produce clear, high-quality digital reception. It offers many channels in several categories. Along with a large selection of different types of music, XM Radio allows you to view channel and category selections in the display.

Operating the XM Radio

To listen to XM Radio, turn the ignition switch to the ACCESSORY (I) or ON (II) position, and press the « XM » button. The last channel you listened to will show in the display. Adjust the volume by turning the VOL/  knob.

MODE – To switch between channel mode and category mode, press and hold the TITLE button until the mode changes.

In the channel mode, you can select all of the available channels. In the category mode, such as Jazz, Rock, Classical, etc., you can select all of the channels within that category.

Each time you press and release the TITLE button, the display changes in the following sequence: name, title, and category.

You can also change the mode from the menu items. Press the SETUP button to display the menu items, then turn the selector knob to select MODE/CATEGORY or MODE/CHANNEL and press the selector knob (ENTER). Each time you press and release the selector knob (ENTER), the display changes between CHANNEL and CATEGORY. To enter the setting, press the TITLE button.

You may experience periods when XM Radio does not transmit the artist's name and song title information. If this happens, there is nothing wrong with your system.

Playing the XM® Radio (Models without navigation system)

TUNE – Turn the selector knob to change channel selections. Turn the knob right for higher numbered channels and left for lower numbered channels. In the category mode, you can only select channels within that category.



Channel list is shown.

You can also select a channel or category from the list by using the selector knob. Push the selector knob (ENTER) to switch the display to the list displayed with three segments, then turn the knob to select a channel or category. Press the selector knob (ENTER) to set your selection.

CATEGORY (– or +) – Press either side of the CATEGORY bar to select another category.

SCAN – The SCAN function gives you a sampling of all channels while in the channel mode. In the category mode, only the stations within that category are scanned. To activate scan, press the SCAN button. The system plays each channel in numerical order for a few seconds, then selects the next channel. When you hear a channel you want to continue listening to, press the button again.

CONTINUED

Playing the XM® Radio (Models without navigation system)

Preset — You can store up to 12 preset channels using the six preset buttons. Each button stores one channel from the XM1 band and one channel from the XM2 band.

To store a channel:

1. Press the «XM» button. Either XM1 or XM2 will show in the display.
2. Use the selector knob, or the CATEGORY bar or SCAN button to tune to a desired channel.

In category mode, only channels within that category can be selected. In channel mode, all channels can be selected.

3. Pick the preset button you want for that channel. Press and hold the button until you hear a beep.

4. Repeat steps 2 and 3 to store the first six channels.
5. Press the «XM» button again. The other XM band will show. Store the next six channels using steps 2 and 3.

Once a channel is stored, simply press and release the proper preset button to tune to it.

XM Radio Display Messages

“LOADING” — XM is loading the audio or program information.

“OFF AIR” — The channel currently selected is no longer broadcasting.

“UPDATING” — The encryption code is being updated. Wait until the encryption code is fully updated. Channels 0 and 1 should still work normally.

“NO SIGNAL” — The signal is currently too weak. Move the vehicle to an area away from tall buildings, and with an unobstructed view of the southern horizon.

“ - - - - ” — The selected channel number does not exist, or is not part of your subscription, or this channel has no artist or title information at this time.

“NO INFO” — The selected channel has no artist or title information at this time.

“ANTENNA” — There is a problem with the XM antenna. Please consult your dealer.

Playing the XM[®] Radio (Models without navigation system)

The XM satellites are in orbit over the equator; therefore, objects south of the vehicle may cause satellite reception interruptions. To help compensate for this, ground-based repeaters are placed in major metropolitan areas.

Satellite signals are more likely to be blocked by tall buildings and mountains the farther north you travel from the equator. Carrying large items on a roof rack can also block the signal.

Depending on where you drive, you may experience reception problems. Interference can be caused by any of these conditions:

- Driving on the north side of an east/west mountain road.
- Driving on the north side of a large commercial truck on an east/west road.
- Driving in tunnels.

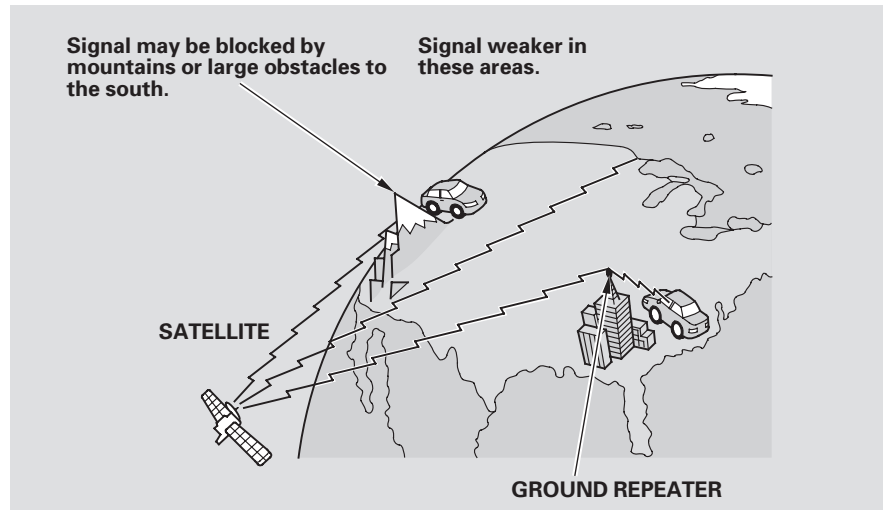

When DPLII is turned on (see page 231), sound coming from the rear speakers may be distorted due to the compression of the music being broadcast. Turn DPLII off if this happens.

- Driving on a road beside a vertical wall, steep cliff, or hill to the south of you.
- Driving on the lower level of a multi-tiered road.

CONTINUED

Playing the XM® Radio (Models without navigation system)

- Driving on a single lane road alongside dense trees taller than 50 ft. (15 m) to the south of you.

There may be other geographic situations that could affect XM Radio reception.

As required by the FCC:

Changes or modifications not expressly approved by the party responsible for compliance could void the user's authority to operate the equipment.

Receiving XM Radio Service

If your XM Radio service has expired or you purchased your vehicle from a previous owner, you can listen to a sampling of the broadcasts available on XM Radio. With the ignition switch in the ACCESSORY (I) or the ON (II) position, press the «XM» button. A variety of music types and styles will play.

If you decide to purchase XM radio service, contact XM® Radio at www.xmradio.com, or at 1-800-852-9696. In Canada, contact www.xmradio.ca, or call 1-877-438-9677. You will need to give them your radio I.D. number and your credit card number. To get your radio I.D. number, press the «XM» button, then turn the selector knob until “CH 000” appears in the display. Your I.D. will appear in the display.

After you've registered with XM Radio, keep your audio system in the XM Radio mode while you wait for activation. This should take about 30 minutes.

Playing the XM® Radio (Models without navigation system)

While waiting for activation, make sure your vehicle remains in an open area with good reception. Once your audio system is activated, “CATEGORY” or “CHANNEL” will appear in the display, and you’ll be able to listen to XM radio broadcasts. XM Radio will continue to send an activation signal to your vehicle for at least 12 hours from the activation request. If the service has not been activated after 36 hours, contact XM® Radio.

Playing Discs (Models without navigation system)

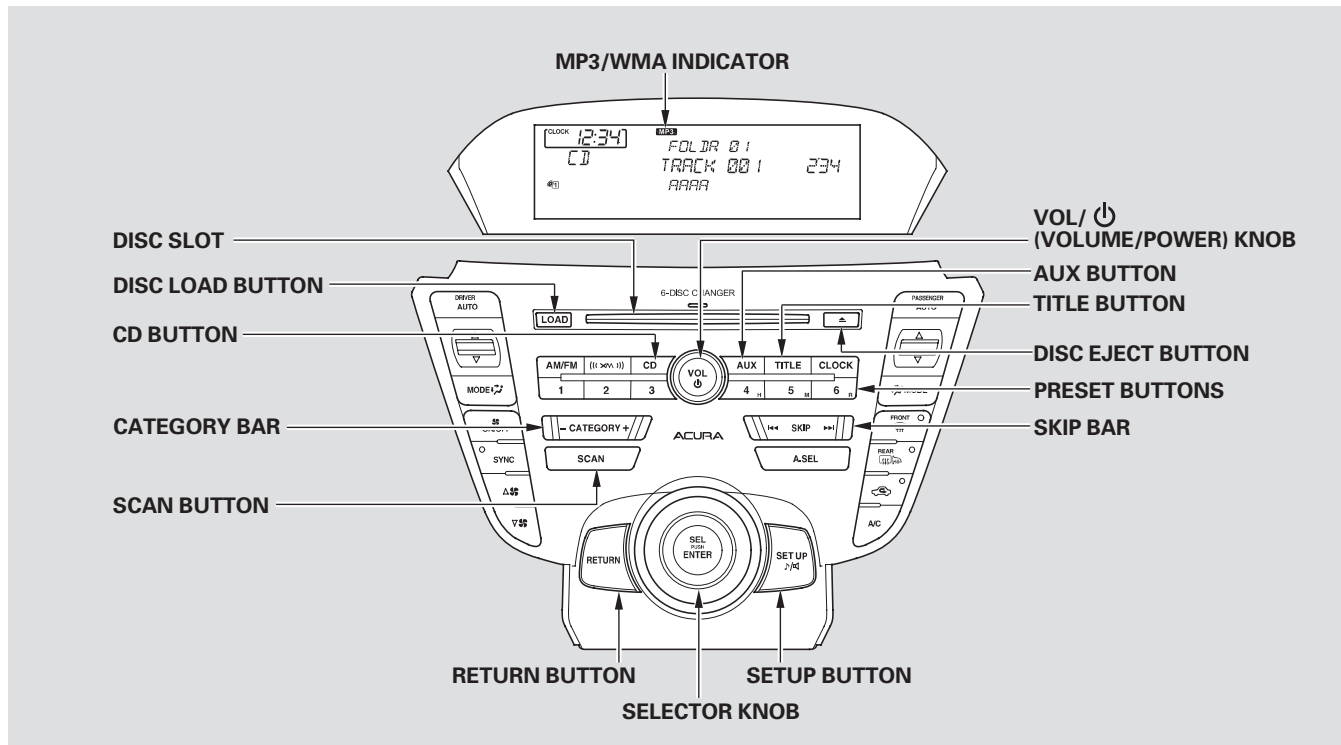

Playing Discs (Models without navigation system)

To Play a Disc

To load or play discs, the ignition switch must be in the ACCESSORY (I) or ON (II) position.

You operate the disc changer with the same controls used for the radio. To select the disc changer, press the CD button. You will see “CD” in the display. The disc and track numbers, and the elapsed time are shown in the display. You can also select the displayed information with the TITLE button (see page 243). The system will continuously play a disc until you change modes.

NOTICE

Do not use discs with adhesive labels. The label can curl up and cause the disc to jam in the unit.

This audio system can also play CD-Rs and CD-RWs compressed in MP3 or WMA format. When playing a disc in MP3, you will see “MP3” in the display. In WMA format, “WMA” will appear in the display. The disc, folder and track numbers are displayed. You can select up to 255 folders or tracks.

A disc compressed in AAC format cannot be played in this audio system.

Video CDs and DVDs do not work in this unit.

The specifications for compatible MP3 files are:

- Sampling frequency:
32/44.1/48 kHz (MPEG1),
16/22.05/24 kHz (MPEG2)
- Bitrate:
32/40/48/56/64/80/96/112/128/
160/192/224/256/320 kbps
(MPEG1), 8/16/24/32/40/48/56/
64/80/96/112/128/160 kbps
(MPEG2)
Compatible with variable bitrate
and multi-session.
- Maximum layers
(including ROOT): 8 layers

CONTINUED

Playing Discs (Models without navigation system)

The specifications for compatible WMA files are:

- Sampling frequency:
32/44.1/48 kHz
- Bitrate:
48/64/80/96/128/160/192 kbps
Compatible with variable bitrate
and multi-session
- Maximum layers
(including ROOT): 8 layers

NOTE:

If a file on an MP3 or WMA disc is protected by digital rights management (DRM), the audio unit displays **FORMAT**, and then skips to the next file.

Loading Discs

Your vehicle's in-dash disc changer holds up to six discs.

1. To load more than one disc, press the **LOAD** button until you hear a beep and see **"LOAD"** in the display. To load only one disc, press and release the **LOAD** button.
2. The disc number for an empty position begins blinking.
3. Insert the disc into the disc slot when the green disc load indicator comes on. Insert it only about halfway; the drive will pull it in the rest of the way. You will see **"BUSY"** in the display while the disc load indicator turns red and blinks as the disc is loaded.

You cannot load and play 3-inch (8-cm) discs in this unit.

4. When the disc load indicator turns green and **"LOAD"** appears in the display again, insert the next disc in the slot. Do not try to insert a disc until **"LOAD"** appears. You could damage the audio unit.
5. Repeat this until all six positions are loaded. If you are not loading all six positions, the system begins playing the last disc loaded.

You can also load a disc into an empty position while a disc is playing by pressing the appropriate preset button. The system stops playing the current disc and starts the loading sequence. It then plays the disc just loaded.

Playing Discs (Models without navigation system)

Text Data Display Function

Each time you press the TITLE button, the display shows you the text data on a disc, if the disc was recorded with text data.

If you select name off, the text display is turned off.

You can see the album, artist, and track name in the display. If a disc is recorded in MP3 or WMA, you can see the folder and file name, and the artist, album, and track tag.

With the folder name, you will see the FOLDER indicator in the display. The TRACK indicator is shown with the file or track name.

When you press and release the TITLE button while a disc without text data is playing, you will see “NO INFO” on the display.

The display shows up to 16 characters of selected text data (the folder name, file name, etc.).

If the text data has more than 16 characters, you will see the first 16 characters and the ► indicator in the display. Press and hold the TITLE button until the next 16 characters are shown. You can see up to 32 characters of the text data.

If you press and hold the TITLE button again, the display shows the first 16 characters again.

If any letter is not available, it is replaced with “.” (dot) in the display. When the disc has no text data, you will see “NO INFO” on the display.

You will also see some text data under these conditions:

- When a new folder, file, or track is selected.
- When you change the audio mode to play a disc with text data or in MP3 or WMA.
- When you insert a disc, and the system begins to play.

When playing a CD-DA with text data, the album and track name are shown in the display. With a disc in MP3 or WMA, the display shows the folder and file name.

When you turn on the audio system next time, the system keeps your selection with the TITLE button.

Playing Discs (Models without navigation system)

To Change or Select Tracks/Files

Use the SKIP bar while a disc is playing to select passages and change tracks (files in MP3 or WMA mode).

In MP3 or WMA mode, use the CATEGORY bar to select folders in the disc and use either side of the SKIP bar to change files.

To select a different disc, use the appropriate preset buttons (1 through 6). If you select an empty position, the system will go into the loading sequence (see page 242).

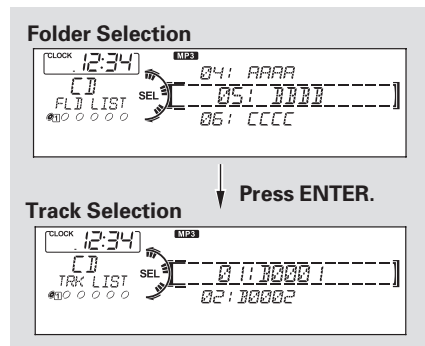

In MP3 or WMA mode, you can also select a folder or track/file from the list by using the selector knob. Push the selector knob (ENTER) to switch the display to the list displayed with three segments, then turn the knob to select a folder. Press the selector knob (ENTER) to change the display to the track/file list, then turn the same knob to select a track/file. Press the selector knob (ENTER) to set your selection.

SKIP — Each time you press and release the ►► side of the SKIP bar, the player skips forward to the beginning of the next track (file in MP3 or WMA mode). Press and release the ◀◀ side of the bar to skip backward to the beginning of the current track. Press it again to skip to the beginning of the previous track.

To move rapidly within a track or file, press and hold either side (◀◀ or ►►) of the SKIP bar.

Playing Discs (Models without navigation system)

In MP3 or WMA mode

FOLDER SELECTION – To select a different folder, press either side (+ or –) of the CATEGORY bar to move to the beginning of the next folder. Press the + side to skip to the next folder, and press the – side to skip to the beginning of the previous folder.

To Select Repeat, Random or Scan Mode:

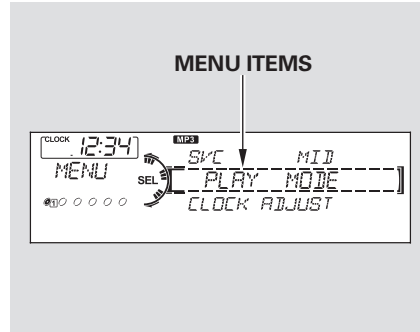

You can select any type of repeat, random and scan modes by using the SETUP button and the selector knob. Push the SETUP button to display the menu items, then turn the selector knob to select “PLAY MODE.” Press the selector knob (ENTER) to set the selection.

Turn the selector knob to select an appropriate repeat, random or scan mode, then press the selector knob (ENTER) to set your selection.

CONTINUED

Playing Discs (Models without navigation system)

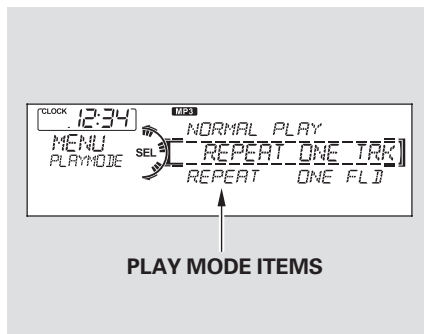

To cancel the selected repeat, random, or scan mode, press the SETUP button to show “PLAY MODE,” then press the selector knob (ENTER). When you see “NORMAL PLAY,” press ENTER again.

REPEAT ONE TRK — To continuously replay a track (file in MP3 or WMA mode), select REPEAT ONE TRK from the menu items. You will see REPEAT in the display. Select normal play to turn it off.

Pressing either side of the SKIP bar also turns off the repeat feature.

In MP3 or WMA mode

REPEAT ONE FLD — This feature, when activated, replays all the files on the selected folder in the order they are compressed in MP3 or WMA. To activate folder repeat mode, select REPEAT ONE FLD from the menu items. You will see F-REPEAT in the display. The system continuously replays the current folder. Select normal play to turn it off. Selecting a different folder with the CATEGORY bar also turns off the repeat feature.

REPEAT DISC — This feature continuously replays the current disc. To activate disc repeat, select REPEAT DISC from the menu items. You will see D-REPEAT in the display. Select normal play to turn it off.

In MP3 or WMA mode

RANDOM IN FLD — This feature, when activated, plays the files within the current folder in random order, rather than in the order they are compressed in MP3 or WMA. To activate folder random play, select RANDOM IN FLD from the menu items. You will see F-RANDOM in the display. The system will then select and play files randomly. This continues until you deactivate folder random play by selecting normal play, or you select a different folder with the CATEGORY bar.

Playing Discs (Models without navigation system)

RANDOM IN DISC – This feature plays the tracks within a disc (the files in MP3 or WMA mode) in random order. To activate random play, select RANDOM IN DISC from the menu items. You will see RANDOM in the display. Select normal play to return to normal play.

SCAN TRK – The SCAN function samples all the tracks on the disc in the order they are recorded on the disc (all files in the selected folder in MP3 or WMA mode). To activate the scan feature, press and release the SCAN button. You will see SCAN in the display. You will get a 10 second sampling of each track/file in the disc/folder. Press and hold the SCAN button to get out of scan mode and play the last track sampled.

You can also select the scan feature from the menu items with the selector knob (see page [245](#)).

In MP3 or WMA mode

SCAN FLD – This feature, when activated, samples the first file in each folder on the disc in the order they are recorded. To activate the folder scan feature, press and release the SCAN button repeatedly. You will see F-SCAN in the display. The system will then play the first file in the main folders for about 10 seconds. If you do nothing, the system will then play the following first files for 10 seconds each. When it plays a file that you want to continue listening to, press and hold the SCAN button.

You can also select the folder scan feature from the menu items with the selector knob (see page [245](#)).

CONTINUED

Playing Discs (Models without navigation system)

Pressing either side of the SKIP bar, or selecting a different disc (using the preset buttons) or folder (using the CATEGORY bar) turns off the SCAN or F-SCAN feature.

SCAN DISC – This feature, when activated, samples the first track on each disc in order (the first file in the main folder on each disc in MP3 or WMA mode). To activate the disc scan feature, press and release the SCAN button repeatedly until D-SCAN shows in the display. The system will then play the first track/file in the first main folder on the first disc for about 10 seconds. If you do nothing, the system will then play the following first track/file for 10 seconds each. When it plays a track/file that you want to continue listening to, press and hold the SCAN button again.

When the first track in the last disc, or the first file in the last main folder in the last disc begins to play, the disc scan mode will be canceled. Pressing either side of the SKIP bar or selecting a different folder with the CATEGORY bar also turns off the scan feature.

Each time you press and release the SCAN button, the mode changes from scan, disc scan, then to normal play.

In MP3 or WMA mode

Each time you press and release the SCAN button, the mode changes from file scan, folder scan, disc scan, then to normal play.

You can also select the disc scan feature from the menu items with the selector knob (see page [245](#)).

To Stop Playing a Disc

Press the eject button (▲) to remove the disc. If you eject the disc, but do not remove it from the slot, the system will automatically reload the disc after 10 seconds and begin playing.

To eject all discs, press and hold the eject button until the first disc begins to eject.

You can also eject the disc when the ignition switch is off.

To play the radio when a disc is playing, press the AM/FM or («»») button. Press the AUX button to switch to an appropriate audio unit (if it is connected to the auxiliary input jack or the USB adapter cable). Press the CD button again to switch back to the disc changer.

If you turn the system off while a disc is playing, either with the VOL/ (⏻) knob or by turning off the ignition switch, the disc will stay in the drive. When you turn the system back on, the disc will begin playing where it left off.

Removing Discs from the In-dash Disc Changer

To remove the disc currently in play, press the eject button. When a disc is removed from a slot, the system automatically begins the load sequence so you can load another disc in that position. If you do not remove the disc from the changer within 10 seconds, the disc will reload into the slot. Then the system returns to the previous mode (AM, FM, or XM Radio).

To remove a different disc from the changer, first select it with the appropriate preset button. When that disc begins playing, press the eject button. Continue pressing the eject button to remove all the discs from the changer.

You can also eject discs when the ignition switch is off. The disc that was last selected is ejected first.

Protecting Discs

For information on how to handle and protect compact discs, see page [251](#).

Disc Changer Error Messages (Models without navigation system)

The chart on the right explains the error messages you may see in the display while playing a disc.

If you see an error message in the display while playing a disc, press the eject button. After ejecting the disc, check it for damage or deformation. If there is no damage, insert the disc again. For additional information on damaged discs, see page 252.

The audio system will try to play the disc. If there is still a problem, the error message will reappear. Press the eject button, and pull out the disc. Insert a different disc. If the new disc plays, there is a problem with the first disc. If the error message cycle repeats and you cannot clear it, take your vehicle to a dealer.

Error Message	Cause	Solution
HEAT ERROR	High Temperature	Will disappear when the temperature returns to normal.
UNSUPPORTED	Track/File format not supported	Current track will be skipped. The next supported track or file plays automatically.
BAD DISC PLEASE CHECK OWNER'S MANUAL PUSH EJECT	Mechanical Error	Press the EJECT button and pull out the disc(s). Check the disc for serious damage, signs of deformation, excessive scratches, and/or dirt (see page 252). Insert the disc again. If the code does not disappear, or the disc(s) cannot be removed, consult your dealer. Do not try to force the disc out of the player.
MECH ERROR		
CHECK DISC LOAD		
BAD DISC PLEASE CHECK OWNER'S MANUAL	Servo Error	
CHECK DISC EJECT	Disc Error	Check the disc for serious damage, signs of deformation, excessive scratches, and/or dirt (see page 252).

Protecting Your Discs (Models without navigation system)

General Information

- When using CD-R or CD-RW discs, use only high quality discs labeled for audio use.
- When recording a CD-R or CD-RW, the recording must be closed for it to be used by the disc changer.
- Play only standard, round, 5-inch (12 cm) discs. Smaller or odd-shaped discs may jam in the drive or cause other problems.
- Handle your discs properly to prevent damage and skipping.

NOTICE

Do not use discs with adhesive labels. The label can curl up and cause the disc to jam in the unit.

Protecting Discs

When a disc is not being played, store it in its case to protect it from dust and other contamination. To prevent warpage, keep discs out of direct sunlight and extreme heat.

To clean a disc, use a clean soft cloth. Wipe across the disc from the center to the outside edge.

A new disc may be rough on the inner and outer edges. The small plastic pieces causing this roughness can flake off and fall on the recording surface of the disc, causing skipping or other problems. Remove these pieces by rubbing the inner and outer edges with the side of a pencil or pen.

Never try to insert foreign objects in the disc changer.

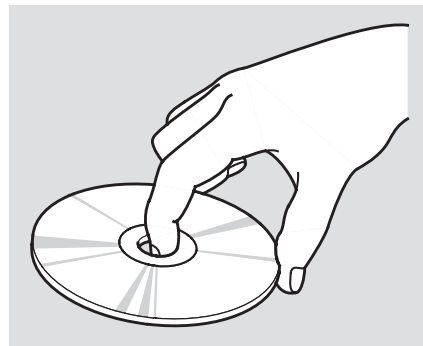

Handle a disc by its edges; never touch either surface. Do not place stabilizer rings or labels on the disc. These, along with contamination from finger prints, liquids, and felt-tip pens, can cause the disc to not play properly, or possibly jam in the drive.

Protecting Your Discs (Models without navigation system)

Additional Information on Recommended Discs

The in-dash disc player/changer has a sophisticated and delicate mechanism. If you insert a damaged disc as indicated in this section, it may become stuck inside and damage the audio unit.

Examples of these discs are shown to the right:

1. Bubbled, wrinkled, labeled, and excessively thick discs

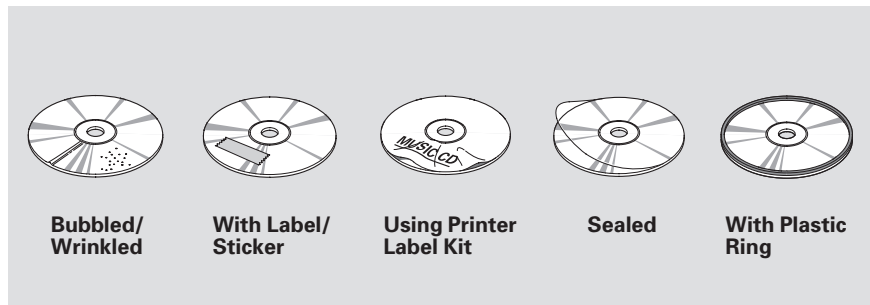

2. Damaged discs

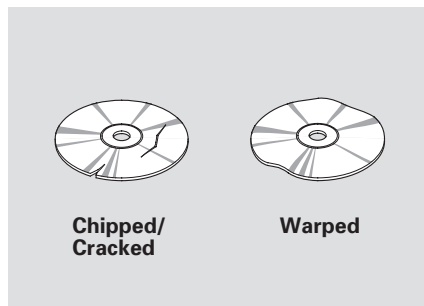

3. Poor quality discs

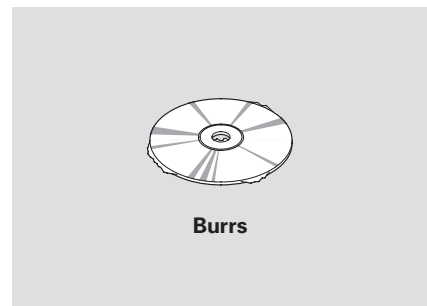

Protecting Your Discs (Models without navigation system)

4. Small, irregular shaped discs

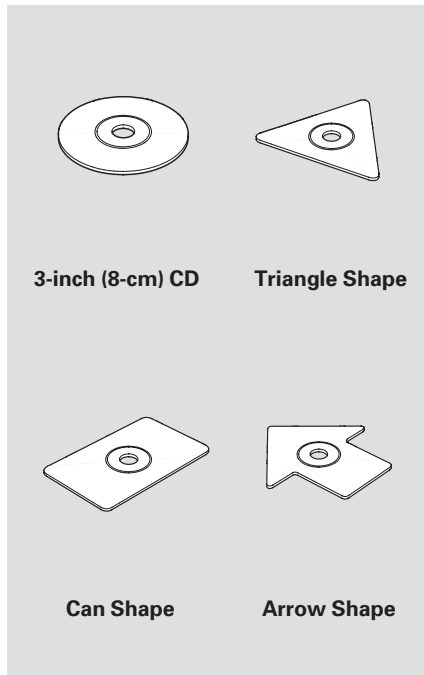

5. Discs with scratches, dirty discs

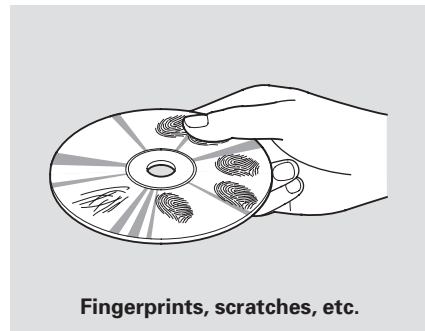

- CD-R or CD-RW may not play due to the recording conditions.
- Scratches and fingerprints on the discs may cause the sound to skip.

- Recommended discs are printed with the following logo.



- Audio unit may not play the following formats.



- This audio unit cannot play a Dual-disc®.

Playing an iPod® (Models without navigation system)

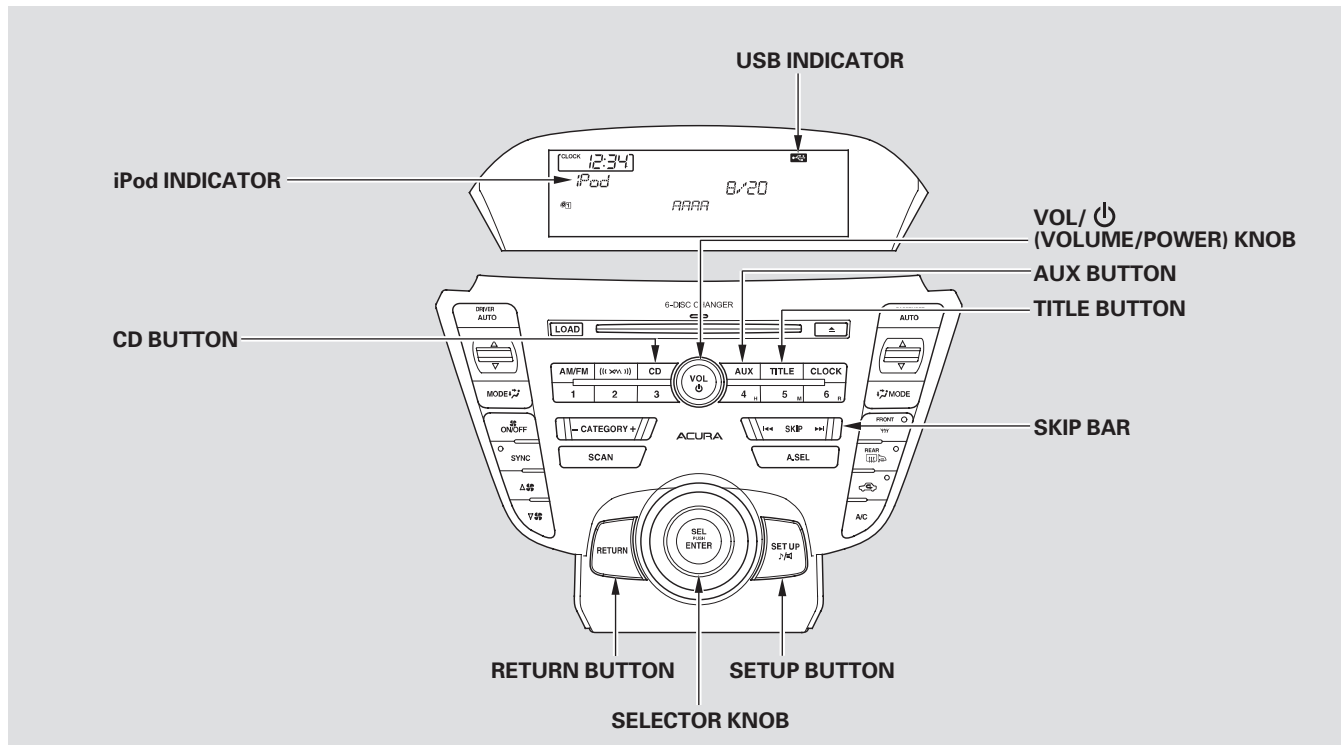

Playing an iPod® (Models without navigation system)

To Play an iPod®

This audio system can select and play the audio files on the iPod® with the same controls used for the disc player. To play an iPod, connect it to the USB adapter cable in the console compartment by using your dock connector, then press the AUX button. The ignition switch must be in the ACCESSORY (I) or ON (II) position. The iPod will also be charged with the ignition switch in these positions.

The audio system reads and plays playable sound files on the iPod. The system cannot operate an iPod as a mass storage device. The system will only play songs stored on the iPod with iTunes.

iPod and iTunes are registered trademarks owned by Apple Inc.

iPods compatible with your audio system using the USB adapter cable are:

Model	Firmware*
iPod 5th and 6th generations	Ver. 1.2 or more
iPod classic	Ver. 1.0 or more
iPod nano	Ver. 1.2 or more
iPod nano 2nd generation	Ver. 1.1.2 or more
iPod nano 3rd generation	Ver. 1.0 or more
iPod touch	Ver. 1.1.1 or more
iPhone	Ver. 1.1.1 or more

* : Use the latest firmware.

Use only compatible iPods with the latest software. iPods that are not compatible will not work in this audio unit.

CONTINUED

Playing an iPod® (Models without navigation system)

NOTE:

- Do not connect your iPod using a hub.
- Do not keep the iPod in the vehicle. Direct sunlight and high heat will damage it.
- Do not use an extension cable between the USB adapter cable equipped with your vehicle and your dock connector.
- We recommend backing up your data before playing it.

Connecting an iPod

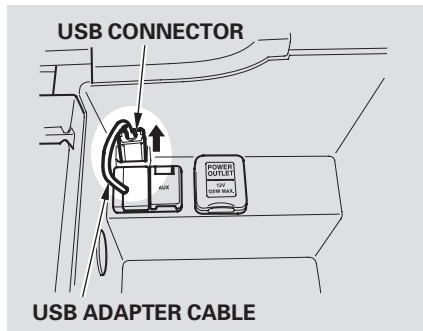

1. Pull out the USB connector from the holder.

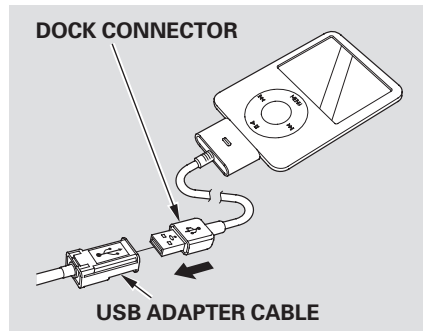

2. Connect your dock connector to the iPod correctly and securely.
3. Install the dock connector to the USB adapter cable securely.

Playing an iPod® (Models without navigation system)

Sample Display

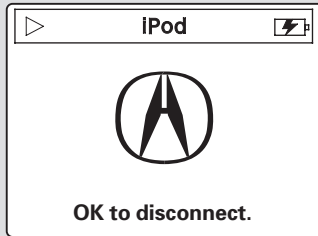

When the iPod is connected and the iPod mode is selected on the audio display, the USB and iPod indicators are shown in the display. After loading, you will see the Acura logo* on the iPod. That means you can only operate your iPod using the vehicle's audio unit.

* : It may take a few minutes for the Acura logo to display on the iPod. If the display does not change, this function is not supported on your iPod model or firmware.

If the iPod indicator does not appear in the audio display, check the connections, and try to reconnect the iPod a few times.

If the audio system still does not recognize the iPod, the iPod may need to be reset. Follow the instructions that came with your iPod, or you can find reset instructions online at www.apple.com/ipod.

Text Data Display Function

Each time you press the TITLE button the display mode switches between the album name, the song name, the artist name, or name off (which turns off the text display).

The display shows up to 16 characters (including spaces) of the selected data. If the text data has more than 16 characters, you will see the first 16 characters and the

▶ indicator in the display. Press and hold the TITLE button until the next 16 characters are shown.

CONTINUED

Playing an iPod® (Models without navigation system)

To Change or Select Files

Use the SKIP bar while an iPod is playing to select passages and change files.

SKIP — Each time you press and release the ►► side of the SKIP bar, the system skips forward to the beginning of the next file. Press and release the ◄◄ side of the bar, to skip backward to the beginning of the current file. Press it again to skip to the beginning of the previous file.

To move rapidly within a file, press and hold either side (►► or ◄◄) of the SKIP bar.

Turning the selector knob to the right or the left also changes the file.

To Select a File from iPod Menu

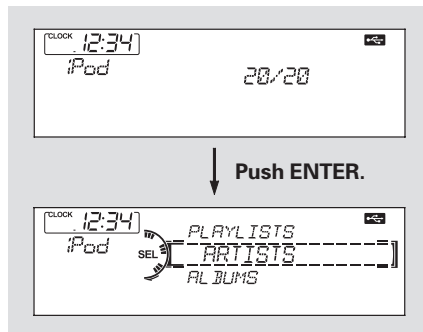

You can also select a file from any list on the iPod menu: playlists, artists, albums and songs, by using the selector knob. Push the selector knob (ENTER) to switch the display to an iPod menu, then turn the selector knob to select a desired list. Press ENTER to set your selection.

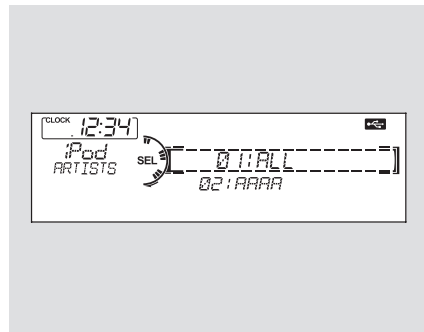

The display shows items on the selected list. Turn the selector knob to select an item, then press ENTER to set your selection.

If you select “ALL,” all available files on the selected list are played.

Playing an iPod® (Models without navigation system)

Pressing the RETURN button goes back to the previous display and pressing the SETUP button cancels this setting mode.

To Select Repeat or Shuffle Mode:

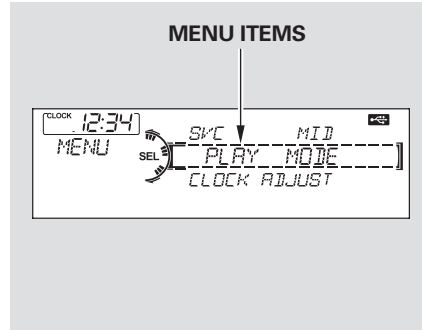

You can select any type of repeat and shuffle mode by using the SETUP button and the selector knob. Press the SETUP button to display the menu items, then turn the selector knob to select "PLAY MODE." Press ENTER to set the selection.

Turn the selector knob to select a play mode: normal play, shuffle off, shuffle all, shuffle album, repeat off, or repeat one track, then press ENTER to set your selection.

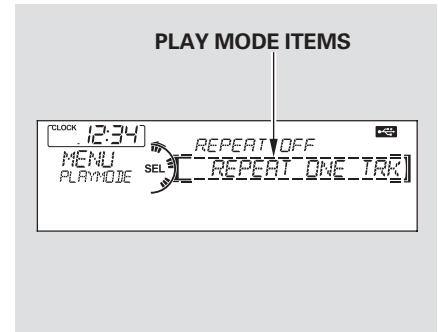

To cancel the selected mode, press the SETUP button and turn the selector knob to show "PLAY MODE," then press ENTER. When you see "NORMAL PLAY," press ENTER again.

CONTINUED

Playing an iPod® (Models without navigation system)

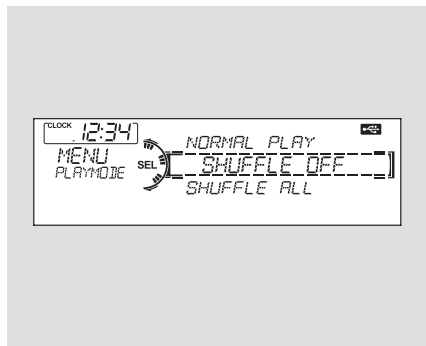

SHUFFLE OFF — This feature turns off either of the shuffle modes (SHUFFLE ALL and SHUFFLE ALBUM).

SHUFFLE ALL — This feature plays all available files in a selected list (playlists, artists, albums or songs) in random order. You will see SHUFFLE in the display. Select the normal play mode or SHUFFLE OFF to turn off this feature.

SHUFFLE ALBUM — This feature plays all available albums in a selected list (playlists, artists, albums or songs) in random order. The files in each album are played in the recorded order. You will see ALB SHUF in the display. Select the normal play mode or SHUFFLE OFF to turn off this feature.

REPEAT OFF — This feature turns off the repeat mode.

REPEAT ONE TRK — This feature continuously plays a file. You will see REPEAT in the display. Select normal play or REPEAT OFF to turn it off.

Pressing either side of the SKIP bar or turning the selector knob changes the file while keeping the repeat feature.

Pressing either side of the SKIP bar or turning the selector knob changes a file while keeping the shuffle function.

NOTE:
Available operating functions vary on models or versions. Some functions may not be available on the vehicle's audio system.

Playing an iPod® (Models without navigation system)

To Stop Playing Your iPod

To play the radio, press the AM/FM, or «» button. Press the CD button to switch to the disc mode (if a disc is loaded). Press the AUX button to switch the audio mode between the Bluetooth® audio and iPod.

You can also press the MODE button on the steering wheel to change modes.

Disconnecting an iPod

You can disconnect the iPod at any time when you see “OK to disconnect” message* in the iPod display. Always make sure you see “OK to disconnect” message in the iPod display before you disconnect it. Make sure to follow the iPod’s instructions on how to disconnect the dock connector from the USB adapter cable.

* : The displayed message may vary on models or versions. On some models, there is no message to disconnect.

If you reconnect the same iPod, the system may begin playing where it left off, depending on what mode the iPod is in when it is reconnected.

iPod® Error Messages

If you see an error message in the display, see page [262](#).

iPod® Error Messages (Models without navigation system)

If you see an error message on the audio display while playing an iPod, find the solution in the chart to the right. If you cannot clear the error message, take your vehicle to your dealer.

Error Message	Solution
FILE ERROR	The system cannot read the file(s). Check the files in the iPod. There is a possibility that the files have been damaged.
MEDIA ERROR	Appears when an unsupported iPod is inserted.

Playing a USB Flash Memory Device (Models without navigation system)

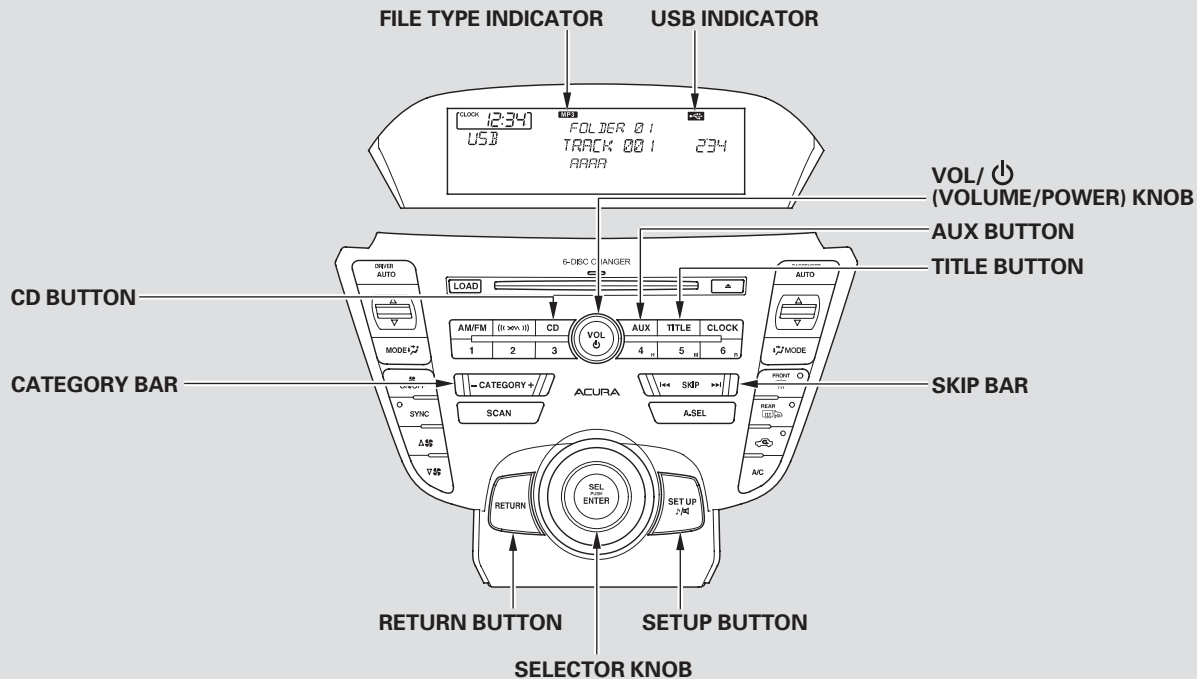

Playing a USB Flash Memory Device (Models without navigation system)

To Play a USB Flash Memory Device

This audio system can select and play the audio files on a USB flash memory device with the same controls used for the disc player. To play a USB flash memory device, connect it to the USB adapter cable in the console compartment, then press the AUX button. The ignition switch must be in the ACCESSORY (I) or ON (II) position.

The audio system reads and plays the audio files on the USB flash memory device in MP3, WMA or AAC* formats. Depending on the format, the display shows MP3, WMA or AAC when a USB flash memory device is playing. The USB flash memory device limit is up to 700 folders or up to 65535 files.

* : Only AAC format files recorded with iTunes are playable on this audio unit.

The recommended USB flash memory devices are 256 Mbyte or higher. Some digital audio players may be compatible as well.

Some USB flash memory devices (such as devices with security lock-out features, etc.) will not work in this audio unit.

NOTE:

- Do not use a device such as a card reader or hard drive as the device or your files may be damaged.
- Do not connect your USB flash memory device using a hub.
- Do not use an extension cable to the USB adapter cable equipped with your vehicle.
- Do not keep a USB flash memory device in the vehicle. Direct sunlight and high heat will damage it.
- We recommend backing up your data before playing a USB flash memory device.

Playing a USB Flash Memory Device (Models without navigation system)

- Depending on the type and number of files, it may take some time before they begin to play.
- Depending on the software the files were made with, it may not be possible to play some files, or display some text data.
- The order of files in USB playback may be different from the order of files displayed in PC or other devices etc. Files are played in the order stored in USB flash memory device.

The specifications for compatible MP3 files are:

- Sampling frequency:
32/44.1/48 kHz (MPEG1)
16/22.05/24 kHz (MPEG2)
- Bitrate:
32/40/48/56/64/80/96/112/128/
160/192/224/256/320/VBR kbps
(MPEG1)
8/16/24/32/40/48/56/64/80/96/

112/128/144/160/VBR kbps
(MPEG2)

- Supported standards:
MPEG1 Audio Layer3
MPEG2 Audio Layer3
- Partition: Top partition only
- Maximum layers: 8

The specifications for compatible WMA files are:

- Sampling frequency:
32/44.1/48 kHz
- Bitrate:
48–320/VBR kbps (Max 384)
- Supported standards:
WMA version 7/8/9
- Partition: Top partition only
- Maximum layers: 8

The specifications for compatible AAC files are:

- Sampling frequency:
8/11.025/12/16/22.05/24/32/
44.1/48 kHz
- Bitrate:
8–320 kbps

- Supported standards:
MPEG4/AAC LC
MPEG2/AAC LC
- Partition: Top partition only
- Maximum layers: 8

Some versions of MP3, WMA, or AAC format may not be supported. If an unsupported file is found, the audio unit displays UNSUPPORTED, then skips to the next file.

In WMA or AAC format, DRM (digital rights management) files cannot be played. If the system finds a DRM file, the audio unit displays UNPLAYABLE FILE, and then skips to the next file.

CONTINUED

Playing a USB Flash Memory Device (Models without navigation system)

Connecting a USB Flash Memory Device

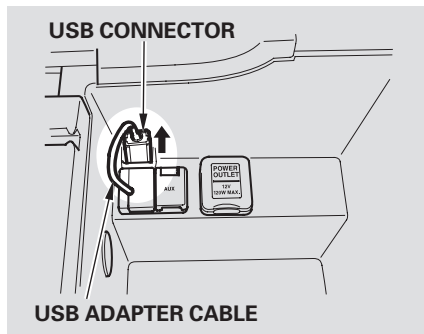

1. Pull out the USB connector from the holder.

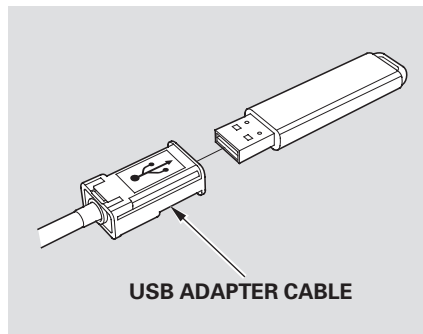

2. Connect the USB flash memory device to the USB adapter cable correctly and securely.

When the USB flash memory device is connected, the USB indicator is shown in the display.

Text Data Display Function

Each time you press the TITLE button, the display mode shows you in sequence, the folder name, the file name, the artist name, the album name, the song name, or name off (which turns off the text display).

The display shows up to 16 characters (including spaces) of the selected data. If the text data has more than 16 characters, you will see the first 16 characters and the

▶ indicator in the display. Press and hold the TITLE button until the next 16 characters are shown.

Playing a USB Flash Memory Device (Models without navigation system)

To Change or Select Files

Use the SKIP bar while a USB flash memory device is playing to select passages and change files.

SKIP — Each time you press and release the ►►| side of the SKIP bar, the system skips forward to the beginning of the next file. Press and release the |◄◄ side of the bar, to skip backward to the beginning of the current file. Press it again to skip to the beginning of the previous file.

To move rapidly within a file, press and hold either side (►►| or |◄◄) of the SKIP bar.

Turning the selector knob to the right or the left also changes the file.

Folder Selection — To select a different folder, press and release either side of the CATEGORY bar. Press the + side to skip to the next folder, and press the - side to skip to the beginning of the previous folder.

To Select a File from Folder and File Lists

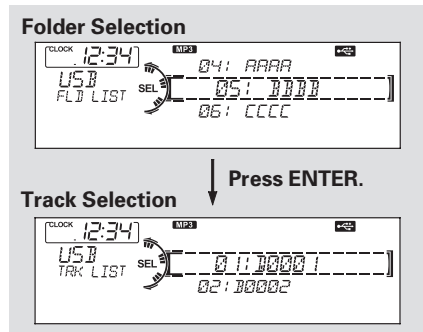

You can also select a folder or file from the list by using the selector knob. Push the selector knob (ENTER) to switch the display to the folder list, then turn the selector knob to select a folder. Press ENTER to change the display to the file list, then turn the same knob to select a file. Press ENTER to set your selection.

CONTINUED

Playing a USB Flash Memory Device (Models without navigation system)

Pressing the RETURN button goes back to the previous display and pressing the SETUP button cancels this setting mode.

To Select Repeat, Random or Scan Mode:

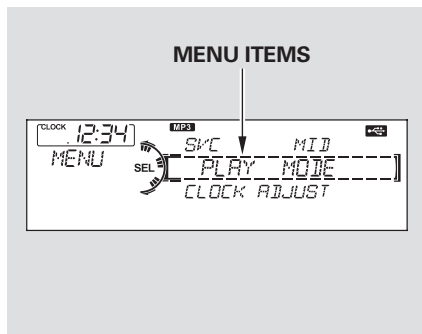

You can select any type of repeat, random and scan modes by using the SETUP button and the selector knob. Push the SETUP button to display the menu items, then turn the selector knob to select "PLAY MODE." Press the selector knob (ENTER) to set the selection.

Turn the selector knob to select an appropriate repeat, random or scan mode, then press the selector knob (ENTER) to set your selection.

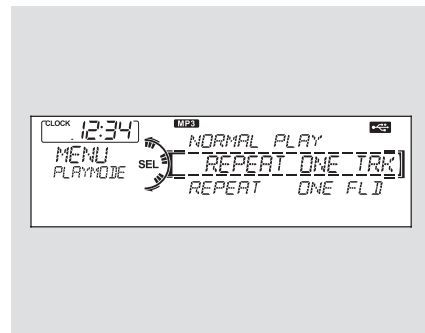

To cancel the selected mode, press the SETUP button and turn the selector knob to show "PLAY MODE," then press ENTER. When you see "NORMAL PLAY," press ENTER again.

Playing a USB Flash Memory Device (Models without navigation system)

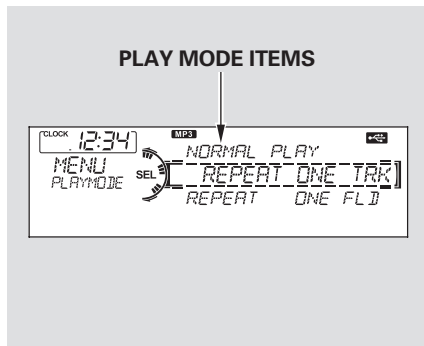

REPEAT ONE TRK — This feature continuously plays a file. Select normal play to turn it off. Pressing either side of the SKIP bar also turns off this feature.

REPEAT ONE FLD — This feature replays all the files on the selected folder in the order they are stored. Select normal play to turn it off. Pressing either side of the CATEGORY bar also turns off this feature.

RANDOM IN FLD — This feature plays the files in the selected folder in random order. You will see F-RANDOM in the display. Select normal play to turn it off.

RANDOM IN DISC — This feature plays all the files in random order. You will see RANDOM in the display. Select normal play to turn it off.

SCAN TRK — This function samples all files in the selected folder in the order they are stored. To activate the scan feature, press and release the SCAN button. You will see SCAN in the display. You will get a 10 second sampling of each file in the folder. Press and hold the SCAN button to get out of the scan mode and play the last file sampled.

You can also select the scan feature from the menu items with the selector knob (see page 268).

CONTINUED

Playing a USB Flash Memory Device (Models without navigation system)

SCAN FLD – This function samples the first file in each folder in the order they are stored. To activate the folder scan feature, press and release the SCAN button repeatedly. You will see F-SCAN in the display. You will get a 10 second sampling of the first file in each folder. Press and hold the SCAN button to get out of the folder scan mode and play the last file sampled.

You can also select the folder scan feature from the menu items with the selector knob (see page [268](#)).

Select normal play to turn either scan feature off. Pressing either side of the CATEGORY or SKIP bar also turns off the feature.

To Stop Playing a USB Flash Memory Device

To change modes, press the AM/FM or «» button. Press the CD button to switch to the disc mode (if a disc is loaded). Press the AUX button to switch the audio mode between the USB or Bluetooth® audio.

You can also press the MODE button on the steering wheel to change modes.

If you reconnect the same USB flash memory device, the system will begin playing where it left off.

Disconnecting a USB Flash Memory Device

You can disconnect the USB flash memory device at any time even if the USB mode is selected on the audio system. Make sure to follow the USB flash memory device's instructions when you remove it.

USB Flash Memory Device Error Messages

If you see an error message in the display, see page [271](#).

USB Flash Memory Device Error Messages (Models without navigation system)

If you see an error message on the audio display while playing a USB flash memory device, find the solution in the chart to the right. If you cannot clear the error message, take your vehicle to your dealer.

Error Message	Solution
FILE ERROR	The system cannot read the file(s). Check the files in the USB flash memory device. There is a possibility that the files have been damaged.
MEDIA ERROR	Appears when the unsupported USB flash memory device is inserted.

Bluetooth® Audio System (Models without navigation system)

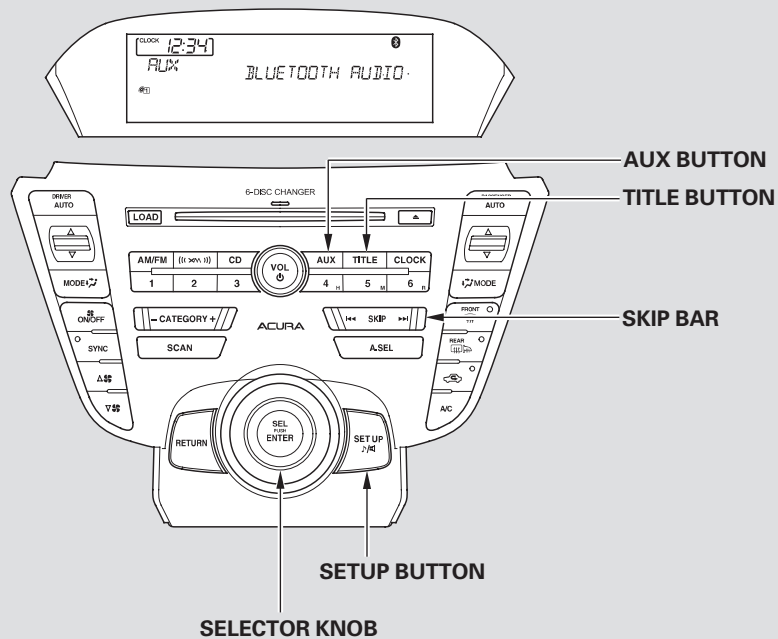

Bluetooth® Audio System (Models without navigation system)

Your vehicle is equipped with a Bluetooth® audio system, which allows you to listen to streaming audio from your Bluetooth audio compatible phone. This function is only available on Bluetooth Audio Compatible phones that are paired and linked to the vehicle's Bluetooth® HandsFreeLink® (HFL) system (see page 392).

Not all Bluetooth-enabled phones with streaming audio capabilities are compatible with the system. You can find an approved phone by visiting www.acura.com/handsfreelink, or by calling the HandsFreeLink® consumer support at 1-888-528-7876. In Canada, visit www.acura.ca, or call 1-888-9-ACURA-9.

NOTE: In some states, it may be illegal to perform some data device functions while driving.

To Play Bluetooth® Audio Files

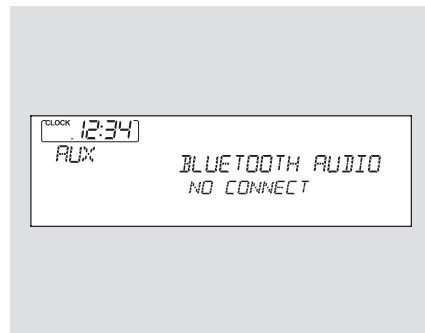

Make sure that your phone is paired and linked to the HFL. Press the AUX button* with the ignition switch in the ACCESSORY (I) or ON (II) position. The audio display shows the Bluetooth® Audio message and mark. Until the phone is recognized, you will see “NO CONNECT” on the display. This message will go off when the phone is recognized, then the system begins to play.

After a device is linked, press the TITLE button to confirm the device name. The name of the device will appear on the audio display.

If more than one phone is paired to the HFL system, there will be delay before the system begins to play.

To begin to play the audio files, you may need to operate your phone. If so, follow the phone maker's operating instructions.

*: If an iPod, USB flash memory device, or audio unit connected to the auxiliary input jack was selected at the last mode, you will see iPod, USB, or AUX in the audio display. Push the AUX button again to play audio files from your Bluetooth® Audio phone.

CONTINUED

Bluetooth® Audio System (Models without navigation system)

In the following conditions, the display shows “NO CONNECT” message.

- The phone is not linked to HFL.
- The phone is not turned on.
- The phone is not in the vehicle.
- Another HFL compatible phone, which is not compatible for Bluetooth® Audio, is already connected.

To skip a file

Press the ►►| side of the SKIP bar to skip forward to the next file, and press the |◄◄ side to skip backward to the beginning of the current file. Push the |◄◄ side again to skip to the previous file.

Turning the selector knob to the right or left also changes a file.

To pause or resume a file

The resume/pause mode can stop playing a file temporarily. Press the SETUP button to display the audio settings.

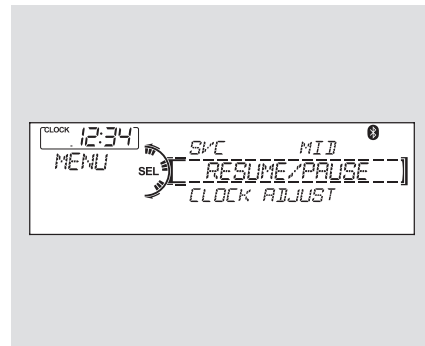

Turn the selector to select RESUME/PAUSE mode, then press ENTER to set your selection. Repeat to resume play.

NOTE: The pause function may not be available on some phone devices.

Bluetooth® Audio System (Models without navigation system)

To change sound settings



Press the SETUP button to display the audio settings. Turn the selector to select a desired sound mode, then press ENTER to set your selection. Turn the selector to your liking (see page 231 for more sound setting information).

To switch to HFL mode

If you receive a call when the Bluetooth® Audio is playing, press the HFL Talk button on the steering wheel. The display switches to the HFL mode (see page 394).

After ending the call, press the HFL Back button to go back to the Bluetooth® Audio mode.

If you receive a call while the system is in the pause mode, the mode will be canceled and Bluetooth® Audio will continue to play.

To turn off the Bluetooth® Audio mode

Select any other audio mode by pressing a button: AM/FM, «» or CD (if a disc is loaded), on the audio control panel, or press the mode button on the steering wheel to select another audio mode. If an iPod or USB flash memory device is connected to the USB adapter cable, or audio unit is connected to AUX jack, pressing the AUX button also changes the mode.

Switching to another mode pauses the music playing from your phone.

CONTINUED

Bluetooth® Audio System (Models without navigation system)

As required by the FCC:

This device complies with Part 15 of the FCC rules. Operation is subject to the following two conditions: (1) This device may not cause harmful interference, and (2) this device must accept any interference received, including interference that may cause undesired operation.

Changes or modifications not expressly approved by the party responsible for compliance could void the user's authority to operate the equipment.

This device complies with Industry Canada Standard RSS-210.

Operation is subject to the following two conditions: (1) this device may not cause interference, and (2) this device must accept any interference that may cause undesired operation of the device.

Interface Dial

Most audio system functions can still be controlled by standard buttons, dials, and knobs, but some functions can only be accessed using the interface dial. The interface dial has two parts, a dial and a selector.

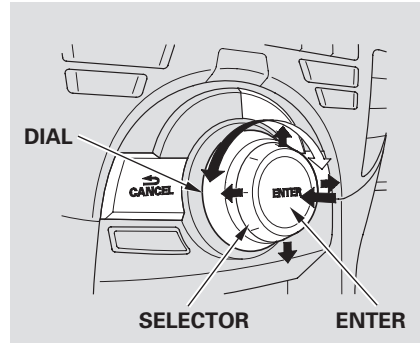

The dial turns left and right. Use it to make selections or adjustments to a list or menu on the screen.

The selector can be pushed left, right, up, down, and in. Use the selector to scroll through lists, to select menus, and to highlight menu items. When you make a selection, push the center of the selector (ENTER) to go to that selection.

Voice Control System

The audio system can also be operated by voice control. See the Navigation section in your quick start guide for an overview of this system, and the navigation system manual for complete details.

Personalization Setting

When you unlock the doors with your remote and turn the audio system on, the driver's ID (Driver 1 or Driver 2) is detected, and the radio presets and sound level settings (see page 288) are turned to the respective memorized mode automatically.

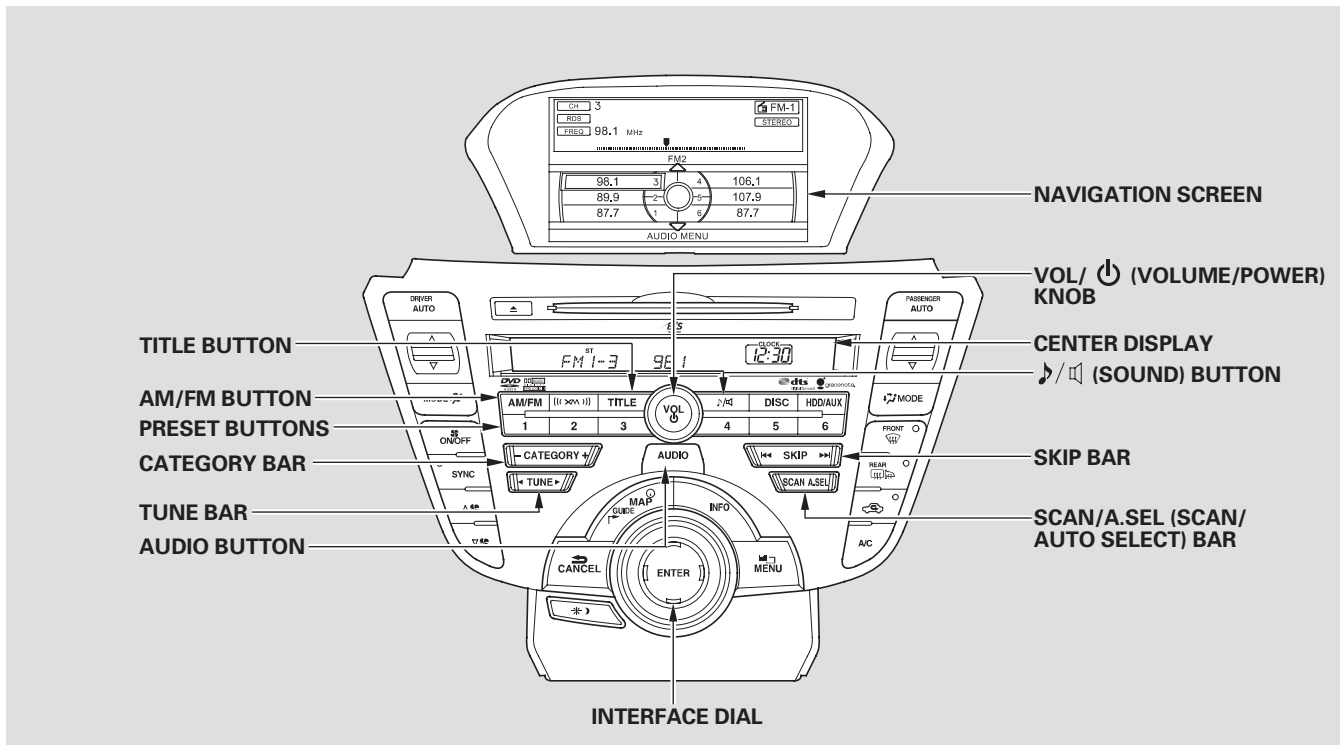

Playing the AM/FM Radio (Models with navigation system)

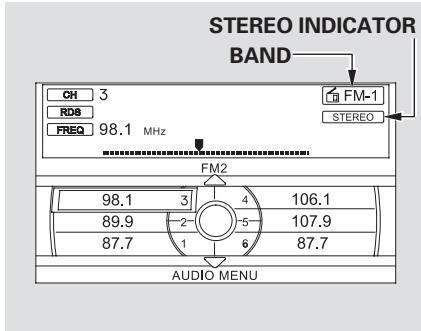

Playing the AM/FM Radio (Models with navigation system)

To Play the AM/FM Radio



The power mode must be in ACCESSORY or ON. Press the AUDIO button to view the audio control display. Turn the system on by pressing the VOL/  knob or the AM/FM button. Adjust the volume by turning the VOL/  knob.

Your vehicle has the engine start/stop button instead of an ignition switch. For more information to select the power mode, see page [178](#).

The band and frequency that the radio was last tuned to are shown on the display. To change bands, press the AM/FM button. You can also change bands by pushing the interface selector up. Each time you push it up, the band will change to FM1, FM2 or AM. On the FM bands, STEREO will be shown on the navigation screen and ST on the center display, if the station is broadcasting in stereo. Stereo reproduction on AM is not available. On the AM band, AM noise reduction turns on automatically.

To Select a Station

You can use any of five methods to find radio stations on the selected band: tune, skip (seek), scan, the preset buttons, and auto select. On the FM band, you can also use the features provided by the radio data system (RDS). For more information on the RDS, see page [282](#).

CONTINUED

Playing the AM/FM Radio (Models with navigation system)

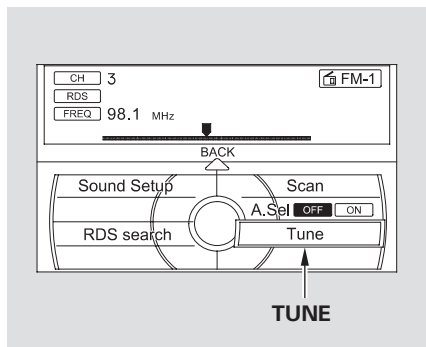

TUNE – Use the TUNE bar to tune the radio to a desired frequency. Press the ► side of the bar to tune to a higher frequency, or the ◀ side to tune to a lower frequency. To tune with the interface dial, push the interface selector down, and turn the interface dial to select Tune. Then press ENTER on the interface selector, and turn the interface dial to the desired frequency. To exit the TUNE mode, press ENTER on the

interface selector, then push the interface selector up to go back.

SKIP (SEEK) – The skip (seek) function searches up and down from the current frequency to find a station with a strong signal. To activate it, press either side (◀◀◀ or ▶▶▶) of the SKIP bar, then release it.

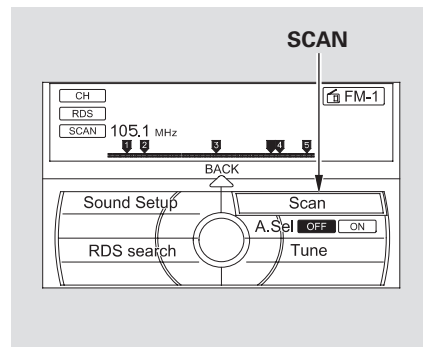

SCAN – The SCAN function samples all stations with strong signals on the selected band. To activate it, press the SCAN side of the SCAN A.SEL bar, then release it.

To scan with the interface dial, push the interface selector down, and turn the interface dial to select Scan, then press ENTER on the interface selector.

Playing the AM/FM Radio (Models with navigation system)

You will see SCAN on the screen. The system will scan for a station with a strong signal. When it finds one, it will stop and play that station for about 10 seconds. If you do nothing, the system will then scan for the next strong station and play it for 10 seconds. When it plays a station that you want to listen to, press the SCAN side of the bar again.

Preset – Each preset button or preset icon can store one frequency on AM and two frequencies on FM.

To store a preset memory location:

1. Select the desired band, AM or FM. FM1 and FM2 let you store six stations each.
2. Use the tune, skip (seek), scan, or RDS function to tune the radio to a desired station.

3. Press the preset button, and hold it until you hear a beep. You can also store frequencies with the interface dial. Select the preset icon you want to store the frequency on, then press ENTER on the interface selector, and hold it until you hear a beep.
4. Repeat steps 1 through 3 to store a total of six stations on AM and twelve stations on FM.

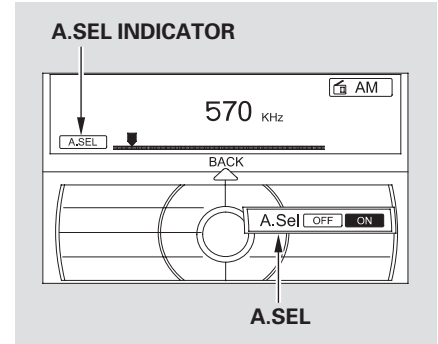

AUTO SELECT – If you are traveling far from home and can no longer receive your preset stations, you can use the auto select feature to find strong signal stations in the local area.

CONTINUED

Playing the AM/FM Radio (Models with navigation system)

Push the interface selector down to display the AUDIO MENU. Turn the interface dial to select A.SEL, then press ENTER on the interface selector. Turn the interface dial to select ON, then press ENTER on the interface selector. You will see A.SEL on the center display and the audio control display (if selected), and the system goes into auto select mode for several seconds.

You can also press the A.SEL side of the SCAN/A.SEL bar. You will see A.SEL on the center display or the screen, and the system goes into auto select mode for several seconds.

The system stores the frequencies of six AM and twelve FM stations in the preset buttons (icons).

You will see “0” displayed if auto select cannot find a strong station for every preset button (icon).

If you do not like the stations auto select has stored, you can store other frequencies on the preset buttons (icons) as previously described.

To cancel auto select, select A.Sel on the audio menu again and turn the interface dial to select A.SEL OFF, or press the A.SEL side of the bar again. This restores the presets you originally set.

For information on AM/FM radio frequencies and reception, see page [372](#).

Radio Data System (RDS)

On the FM band, you can select a favorite station and display the program service name according to the information provided by the radio data system (RDS) if the station has the RDS information available.

RDS INFO Display

The RDS INFO display function shows the name of the station you are listening to. With the audio system on and the FM band selected, you can turn this function on or off.

Playing the AM/FM Radio (Models with navigation system)

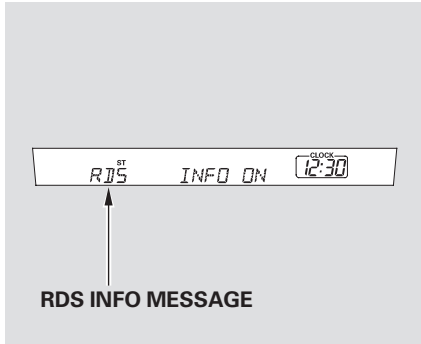

To switch the RDS INFO display function on and off, press and release the TITLE button. With the system on, you will see the “RDS INFO ON” message on the center display. If the station you are listening to is an RDS station, the displayed frequency switches to the station name.

If the station you are listening to is not an RDS station, the audio screen and the center display continue to show the frequency.

When you turn off this function by pressing the TITLE button, the center display shows “RDS INFO OFF.”

NOTE: If the station you are listening to is an RDS station, the audio screen will always display the RDS information.

Radio Data System (RDS) Category

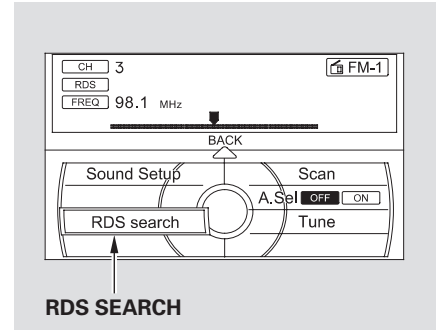

On the FM band selected, you can select the program type provided by the RDS. Press the AUDIO button to display the radio information on the screen. Push down the interface selector, then turn the interface dial to select RDS search. Press ENTER to set your selection. The principal RDS categories are shown as follows:

CONTINUED

Playing the AM/FM Radio (Models with navigation system)

ALL: All RDS category stations
COUNTRY: Country music.
TOP 40: Top 40 hits
ROCK: Rock, classic rock and soft rock music
OLDIES: Nostalgia music and oldies
JAZZ: Jazz
SOFT: Adult hits and soft music
R & B: Rhythm and blues, and soft rhythm and blues
CLASSIC: Classical music
RELIGION: Religious music and religious talk
INFO: News, information, sports, talk, foreign language, personality, public, college, and weather
TRAFFIC: Traffic information

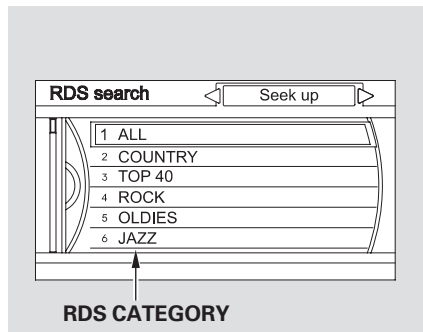

Turn the interface dial to select an RDS category. You can use the search or scan function to find radio stations on the selected RDS category by pressing the interface selector to the left or the right. Press ENTER to set your selection. If you do nothing while the RDS category is selected, the selected category is canceled.

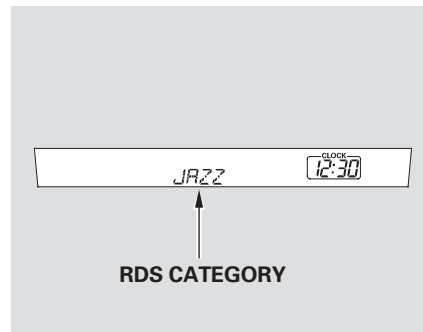

You can also select an RDS category with the CATEGORY bar. Press either side (+ or -) of the CATEGORY bar to display an RDS category in the center display. Select a category by pressing either side of the bar.

Playing the AM/FM Radio (Models with navigation system)

RDS Category Search

This function searches up and down for strong signal frequencies that carries the selected RDS category information. This can help you to find a station in your favorite category. To activate it, press and release either side (◀◀ or ▶▶) of the SKIP bar. You will also see the selected RDS category name blinking in the center display while searching it.

If the system does not find a station, “NOTHING” will blink for about 5 seconds on the center display, then “NOTHING” will blink for about 5 seconds on the navigation screen and the system will go back to the last selected station.

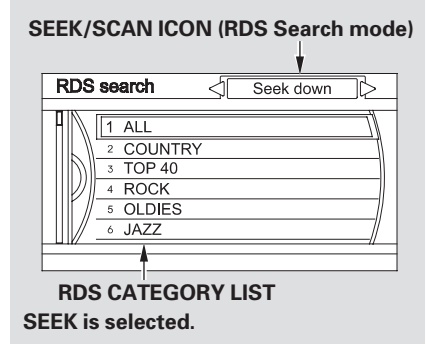

To activate RDS category search with the interface dial, push the AUDIO button to display the FM radio information on the screen. Push the interface selector down, and turn the interface dial to select RDS search. Press ENTER on the interface selector. The screen shows you the RDS category list.

Turn the interface dial to the desired RDS category.

While the RDS category is selected, move the interface selector to the left or right to select SEEK up, SEEK down, or SCAN in the upper right corner of the screen. When you press and release ENTER to select the RDS category, RDS category search (SEEK up/down) starts.

CONTINUED

Playing the AM/FM Radio (Models with navigation system)

RDS Category SCAN

The scan function samples all stations with strong signals on the selected RDS category one by one. To activate it, press and release the SCAN side of the SCAN/A.SEL bar. You will see SCAN in the center display. The system will scan for a station with a strong signal in the selected RDS category. You will also see the selected RDS category name blinking in the center display while scanning it. When the system finds one, it will stop and play that station for about 10 seconds.

If you do nothing, the system will scan for the next strong station and play it for 10 seconds. When it plays a station that you want to listen to, press the SCAN side of the SCAN/A.SEL bar again.

If the system does not find a station, “NOTHING” will blink for about 5 seconds on the center display, then “NOTHING” will blink for about 5 seconds on the navigation screen and the system will go back to the last selected station.

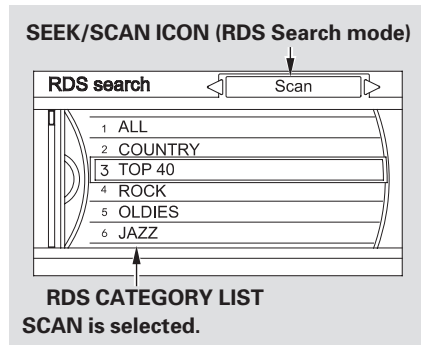

To activate RDS category scan with the interface dial, push the AUDIO button to display the FM radio information on the screen. Push the interface selector down, and turn the interface dial to select RDS search on the audio menu. Press ENTER on the interface selector. The screen shows you the RDS category list.

Playing the AM/FM Radio (Models with navigation system)

Turn the interface dial to the desired RDS category.

While the RDS category is selected, move the interface selector to the left or the right to select SCAN. When you press and release ENTER to select the RDS category, RDS program SCAN starts.

Radio Text Display

This function displays the radio text information of the selected RDS station.

If the selected RDS station has the radio text information, you will see the text indicator on the screen.

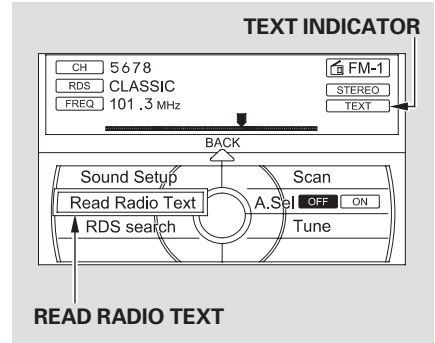

To activate radio text display, use the interface dial. Push the interface selector down, and turn the interface dial to select Read Radio Text. Press ENTER on the interface selector to enter the setting.

CONTINUED

Playing the AM/FM Radio (Models with navigation system)

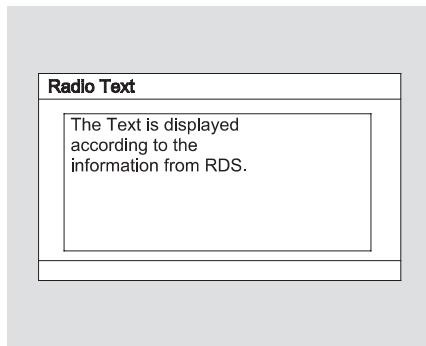

The display shows up to 64 characters on the selected RDS station.

Adjusting the Sound

BASS, TREBLE, FADER, and BALANCE are each adjustable. You can also adjust the strength of the sound coming from the center and subwoofer speakers. In addition, you can set the Dolby PL (ProLogic) II and Speed-sensitive volume compensation (SVC).

These adjustments can be made with the  (Sound) button or the interface dial.

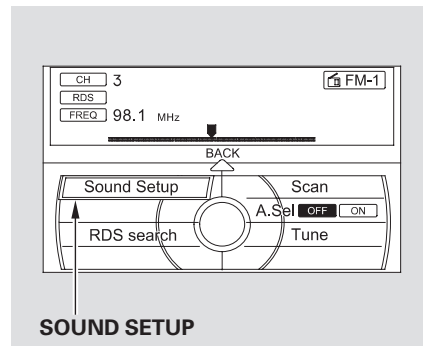

To adjust the sound, press the AUDIO button, push the interface selector down, and turn the interface dial to Sound Setup. Then press ENTER on the interface selector.

Select the mode you want to adjust by turning the interface dial.

Playing the AM/FM Radio (Models with navigation system)

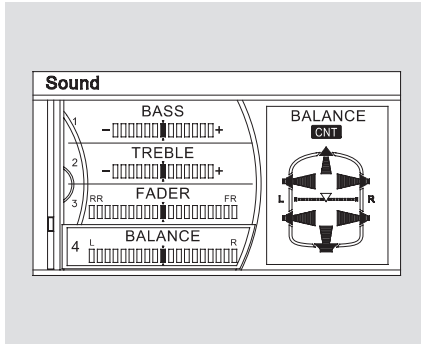

You can also adjust the sound by pushing the (Sound) button repeatedly. Each mode is shown in the center display as you push the button.

Turn the VOL/ knob or interface knob to adjust the setting to your liking. You can check the level on the navigation screen or on the center display. When the level reaches the center, you will see “C” in the center display.

The system will return to the audio playing mode in the center display about 10 seconds after you stop adjusting a mode.

If you do not make an adjustment within 10 seconds, you will need to select the mode again.

BASS/TREBLE — To adjust bass and treble, select BASS or TREBLE, and press ENTER on the interface selector. The current setting is shown on the display. Turn the interface dial or VOL/ knob to the desired level, and enter your selection by pressing ENTER on the interface selector.

FADER/BALANCE — These modes adjust the strength of the sound coming from each speaker. Fader adjusts the front-to-back strength, while balance adjusts the side-to-side strength. To adjust fader and balance, select FADER or BALANCE, then press ENTER on the interface selector. The current setting is shown on the screen. Turn the interface dial or VOL/ knob to the desired level, and enter your selection by pressing ENTER on the interface selector. To equalize the fader or balance, turn the interface dial or VOL/ knob until the marks on the sound grid come to the center of the adjustment bar.

If the fader adjustment is set to F9 (maximum front level), the subwoofer is turned off.

CONTINUED

Playing the AM/FM Radio (Models with navigation system)

CENTER — Adjusts the strength of sound from the center speaker.

SUBWOOFER — To adjust the strength of the sound from the subwoofer speaker, select it and press ENTER on the interface selector. Turn the interface dial to the desired level, and enter your selection by pressing ENTER on the interface selector.

Speed-sensitive Volume Compensation (SVC)

The SVC mode controls the volume based on vehicle speed. The faster you go, the louder the audio volume becomes. As you slow down, the audio volume decreases.

The SVC has four modes: OFF, LOW, MID, and HIGH. The default setting is MID. To change the SVC mode, select SVC, then press ENTER on the interface selector. The current setting is shown on the screen. Turn the interface dial to the desired level, and enter your selection by pressing ENTER on the interface selector. If you feel the sound is too loud, choose low. If you feel the sound is too quiet, choose high.

Dolby PL (ProLogic) II — Dolby PL (ProLogic) II signal processing creates multi-channel surround sound from 2 channel stereo audio sources. Dolby ProLogic II can only activate when listening to DISC (CD-DA, MP3, WMA, AAC), XM radio, AUX (USB, iPod®, AUX, Bluetooth® Audio), and HDD Audio. When ProLogic II is available, “PL II” is shown in the audio display.

When ProLogic II is not available in the selected audio source, “DPL2 N/A” is shown on the center display.

Playing the AM/FM Radio (Models with navigation system)

To set this feature on or off, select Dolby PL II, and press ENTER on the interface selector. Rotate the interface dial to ON or OFF, and press ENTER.

Manufactured under license from Dolby Laboratories. “Dolby”, “ProLogic”, and the double-D symbol are trademarks of Dolby Laboratories.

NOTE: In some audio playing modes (XM, AUX), when DPLII is on, the music coming from the rear speakers may sound distorted. This is due to compression of the music, and it does not indicate a problem with the setting.

Playing the XM® Radio (Models with navigation system)

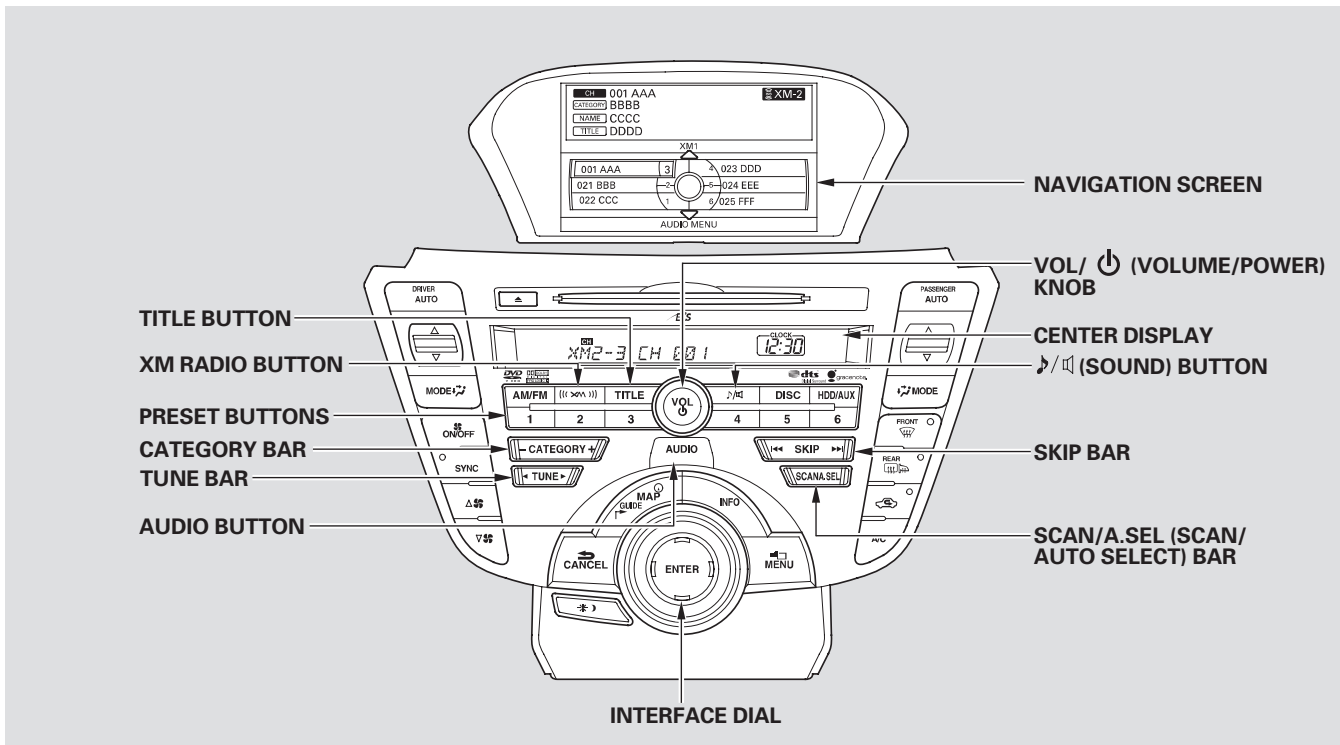



Playing the XM® Radio (Models with navigation system)

Your vehicle is capable of receiving XM Radio anywhere in the United States and Canada, except Hawaii, Alaska, and Puerto Rico. XM® is a registered trademark of XM Satellite Radio®, Inc.

XM radio receives signals from two satellites to produce clear, high-quality digital reception. It offers many channels in several categories. Along with a large selection of different types of music, XM radio also allows you to view channel and category selections in the audio display.

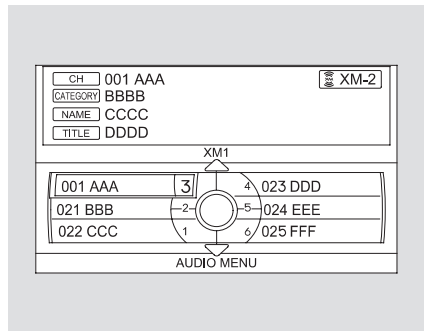
Operating the XM Radio



To listen to XM radio, set the power mode to ACCESSORY or ON. Push the «XM» button to select the XM radio. The last channel you listened to will show in the audio screen (if selected) and the center display. Adjust the volume by turning the VOL/  knob.

Your vehicle has the engine start/stop button instead of an ignition switch. For more information to select the power mode, see page 178.

Each time you push the interface selector up, the band will change to XM1 or XM2. Push the AUDIO button to display XM information on the screen. You can operate the XM radio system with the interface dial.

CONTINUED

Playing the XM® Radio (Models with navigation system)

MODE — To switch between the category mode and channel mode, push the interface selector down to display AUDIO MENU, then turn the interface dial to select Mode, and press ENTER on the interface selector.

Turn the interface dial to select CH or CAT, then press ENTER on the interface selector. Move the interface selector up to go back.

You can also switch the mode by pressing the TITLE button for 3 seconds.

In the category mode, such as Jazz, Rock, Classical, etc., you can navigate through all of the channels within that category. In the channel mode, you can select all of the available channels.

Each time you press and release the TITLE button, the center display changes in the following sequence: NAME (artist name), TITLE (music title), and CHANNEL NAME (channel name).

On the screen, you will see the selected CHANNEL (number), CATEGORY, NAME (artist name), and TITLE (music title).

You may experience periods when XM Radio does not transmit the artist's name and song title information. If this happens, there is nothing wrong with your system.

TUNE — Press either side of the TUNE bar to change channel selections. Press the ► side of the bar for higher numbered channels and the ◀ side for lower numbered channels. You can also change channels with the interface selector, push down the interface

selector to select AUDIO MENU, then turn the interface dial to choose Tune and press ENTER on the interface selector. Turn the interface dial to the appropriate direction. In the category mode, you can only select channels within that category.

CHANNEL LIST — Push down the interface selector to select AUDIO MENU, then turn the interface dial to select Channel List and press ENTER on the selector. Turn the interface dial to select a channel, then press ENTER to set your selection.

CATEGORY (– or +) — Press either side of the bar to select another category.

Playing the XM® Radio (Models with navigation system)

SCAN – The scan function gives you a sampling of all channels while in the channel mode. In the category mode, only the channels within that category are scanned. To activate SCAN, press the SCAN side of the category are scanned. To activate SCAN, press the SCAN side of the SCAN/A.SEL bar. You will see SCAN on the screen and center display.

The system plays each channel in numerical order for a few seconds, then selects the next channel. When you hear a channel you want to continue listening to, press the SCAN side of the bar to cancel.

CHANNEL SCAN – This function samples all channels. Push down the interface selector to select AUDIO MENU, then turn the interface dial to select Category Scan and press ENTER on the interface selector.

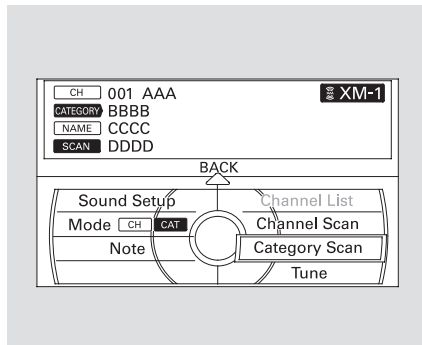

CATEGORY SCAN – This function samples the stations in the selected category. Push down the interface selector to select AUDIO MENU, then turn the interface dial to select Category Scan and press ENTER on the interface selector.

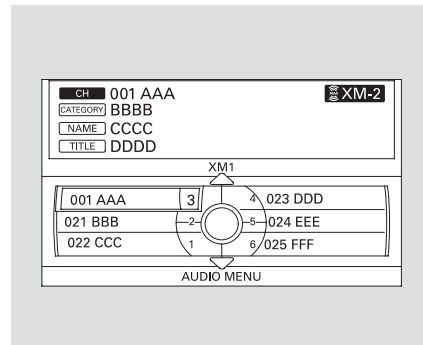

Preset – You can store up to 12 preset channels using the six preset buttons. Each button stores one channel from the XM1 band and one channel from the XM2 band.

To store a channel:

1. Press the «XM» button. Either XM1 or XM2 will be shown on the display.

CONTINUED

Playing the XM® Radio (Models with navigation system)

2. Use the tune, list, or scan function to tune to a desired channel.

In category mode, only channels within that category can be selected. In channel mode, all channels can be selected.

3. Pick the preset button you want for that channel. Press and hold the preset button until you hear a beep. You can also pick the number with the interface dial. Select your desired number and press and hold ENTER on the interface selector.
4. Repeat steps 2 and 3 to store the first six channels.
5. Press the «XM» button or scroll up again. The other XM band will be shown. Store the next six channels using steps 2 and 3.

Once a channel is stored, press and release the proper preset button to tune to it.

XM Radio Display Messages

“OFF AIR” – The channel currently selected is no longer broadcasting.

“LOADING” – XM is loading the audio or program information.

“UPDATING” – The encryption code is being updated. Wait until the encryption code is fully updated. Channels 0 and 1 should still work normally.

“NO SIGNAL” – The signal is currently too weak. Move the vehicle to an area away from tall buildings, and with an unobstructed view of the southern horizon.

“ - - - - ” – The selected channel number does not exist, or is not part of your subscription, or this channel has no artist or title information at this time.

“CHECK ANTENNA” – There is a problem with the XM antenna. Please consult your dealer.

Playing the XM® Radio (Models with navigation system)

The XM satellites are in orbit over the equator; therefore, objects south of the vehicle may cause satellite reception interruptions. To help compensate for this, ground-based repeaters are placed in major metropolitan areas. Satellite signals are more likely to be blocked by tall buildings and mountains the farther north you travel from the equator.

Depending on where you drive, you may experience reception problems. Interference can be caused by any of these conditions:

- Driving on the north side of an east/west mountain road.
- Driving on the north side of a large commercial truck on an east/west road.
- Driving in tunnels.

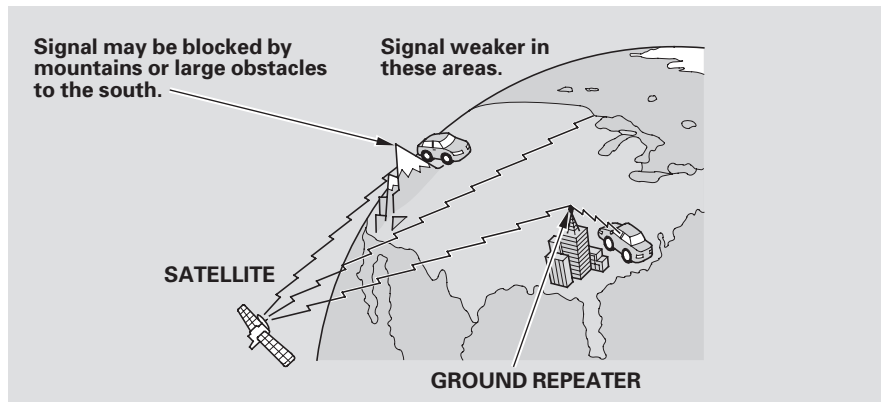

- Driving on a road beside a vertical wall, steep cliff, or hill to the south of you.
- Driving on the lower level of a multi-tiered road.
- Driving on a single lane road alongside dense trees taller than 50 ft. (15 m) to the south of you.

There may be other geographic situations that could affect XM Radio reception.

*As required by the FCC:
Changes or modifications not expressly approved by the party responsible for compliance could void the user's authority to operate the equipment.*

CONTINUED

Playing the XM® Radio (Models with navigation system)

Note Function

U.S. models only

This function stores the sound content played on the selected XM satellite radio station with the channel, category, name, and title information.

To activate this function, press and hold the «XM» button for about 2 seconds while a song or passage which you want to store is playing. You can record for up to 10 seconds. To stop recording, press the AM/FM button or «XM» button.

Once you store the recorded sound file, you can replay it and confirm the information. The system can store up to 30 sound files. If you continue to store more files, the oldest one will be deleted each time you add new file.

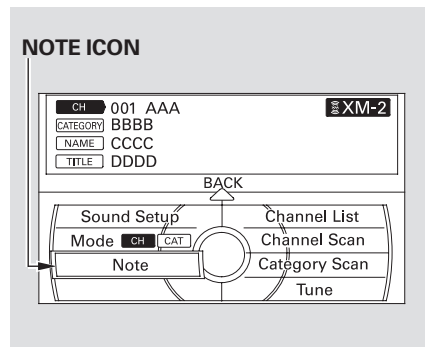

To replay and see the stored file, press the AUDIO button to select the audio display on the navigation screen.

Push down the interface selector to display the audio menu. Turn the interface dial to select Note, then press ENTER.

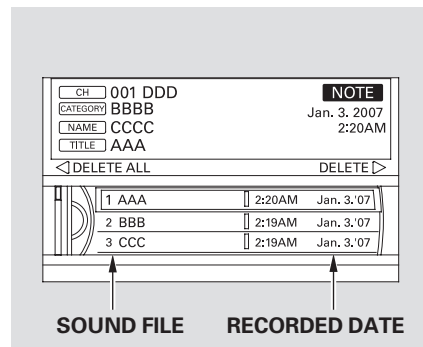

Turn the selector dial to select a sound file, then press ENTER. The display shows the category, name and title information of the selected file.

Playing the XM® Radio (Models with navigation system)

To delete all files, push the interface selector to the left to select “DELETE ALL,” then press ENTER on the interface selector. To delete one file, select the file you want to delete and push the interface selector to the right, then press ENTER on the interface selector.

Receiving XM Radio Service

If your XM Radio service has expired or you purchased your vehicle from a previous owner, you can listen to a sampling of the broadcasts available on XM Radio. With the power mode in ACCESSORY or ON, press the «XM» button. A variety of music types and styles will play.

Your vehicle has the engine start/stop button instead of an ignition switch. For more information to select the power mode, see page 178.

If you decide to purchase XM radio service, contact XM® Radio at www.xmradio.com, or at 1-800-852-9696. In Canada, contact www.xmradio.ca, or call 1-877-438-9677. You will need to give them your radio I.D. number and your credit card number. To get your radio I.D. number, press and release the ► side of the TUNE bar until “0” appears in the display. Your I.D.

will appear in the display.

After you have registered with XM Radio, keep your audio system in the satellite radio mode while you wait for activation. This should take about 30 minutes.

While waiting for activation, make sure your vehicle remains in an open area with good reception. Once your audio system is activated, CAT (category) or CH (channel) will appear in the center display, and you’ll be able to listen to XM Radio broadcasts. XM Radio will continue to send an activation signal to your vehicle for at least 12 hours from the activation request. If the service has not been activated after 36 hours, contact XM® Radio.

Playing a Disc (Models with navigation system)

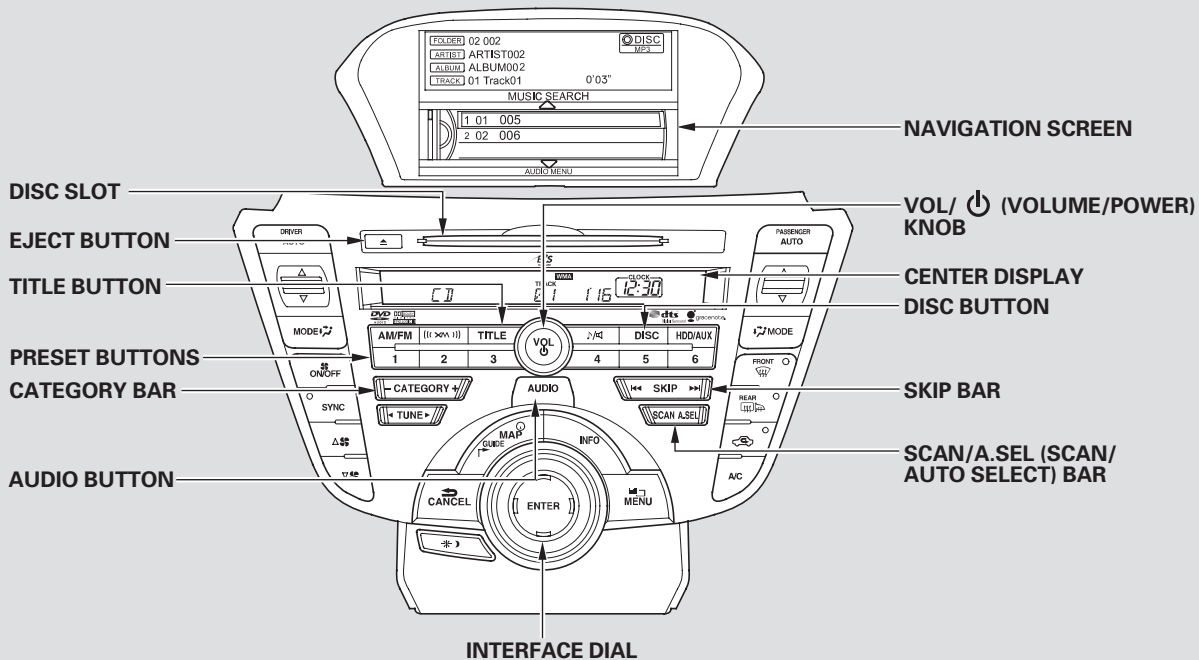

Playing a Disc (Models with navigation system)

Your vehicle's audio system has an internal disc player. To operate the disc player, the power mode must be in the ACCESSORY or ON.

Your vehicle has the engine start/stop button instead of an ignition switch. For more information on selecting the power mode, see page 178.

The CD player can play these disc formats:

- CD (CD-DA, CD-TEXT)
- CD-R/CD-RW (MP3, WMA, AAC)
- DVD-A
- DVD-R/DVD-RW (MP3, WMA, AAC)

The disc packages or jackets should have one of these marks.



The disc player can also play MP3, WMA, or AAC format that saved on CD-R/RW or DVD-R/RW (see page 306).

NOTE:

If a file on WMA or AAC disc is protected by digital rights management (DRM), the audio system skips to the next file.

DVD-A discs not meeting DVD verification standards may not be playable.

Video CDs and DVD-V format discs will not work in this unit.

Some CD-DA and CD-ROM mixed discs are not playable.

CONTINUED

Playing a Disc (Models with navigation system)

You cannot load and play 3-inch (8-cm) discs in this system.

It is possible to select up to 999 files for inclusion in CD-Rs and CD-RWs, and up to 3,500 files for inclusion in DVD-Rs and DVD-RWs.

NOTICE

Do not use discs with adhesive labels. The label can curl up and cause the disc to jam in the unit.



Manufactured under license under U.S. Patent #'s: 5,451,942; 5,956,674; 5,974,380; 5,978,762; 6,487,535 & other U.S. and worldwide patents issued & pending. DTS and DTS Digital Surround are registered trademarks and the DTS logos and Symbol are trademarks of DTS, Inc. © 1996-2007 DTS, Inc. All Rights Reserved.

To Load a Disc

Insert a disc about halfway into the disc slot. The drive will pull the disc in the rest of the way to play it. You operate the disc player with the same controls used for the radio. The number of the current track is shown in the display. When playing a disc in MP3, WMA or AAC, the numbers of the current folder and file are shown. The system will continuously play a disc until you change modes.

For information on how to handle and protect compact discs, see page [313](#).

To Play a Disc

Select the disc player by pressing the DISC button. The system will begin playing the last selected track in the disc. You will see the current track position highlighted.

Title information will be displayed by a list when the information is found in the Gracenote® Album Info (Gracenote® Media Database) on the built-in hard disk drive. When you play a CD recorded with text data, you will see the genre, artist name, album and track name on the screen. When you play MP3/WMA/AAC discs, you will see the genre, artist name, album name and track name on the screen. If the disc was not recorded with this information, it will not be displayed.

Each time you press the TITLE button, the center display changes from artist name to album name, to track name and then to normal display that shows the track number and the elapsed time. When playing a disc in MP3/WMA/AAC, the display mode changes from folder name, to file name, to artist tag, to album tag, to track tag, and then to normal display.

To Change Tracks

Each time you press and release the ►| side of the skip bar, the player skips forward to the beginning of the next track. Press and release the |◄◄ side of the skip bar to skip backward to the beginning of the current track. Press the ◄◄ side again to skip to the previous track. To move rapidly within a track, press and hold either side of the skip bar.

When you insert a CD for the first time, the system automatically starts recording to the hard disc. For information on recording from music CDs, see page 319 .

Playing a Disc (Models with navigation system)

To Choose a Track

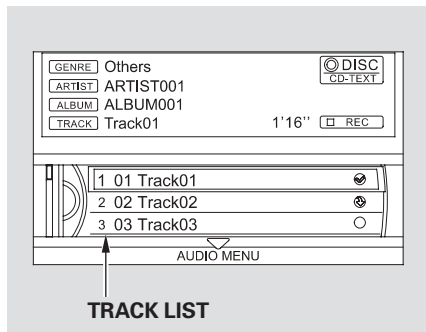

You can also choose a track directly from a track list. If there are no track names, you will see “No Title” displayed. Turn the interface dial to select the desired track, then press ENTER on the interface selector.

Track Repeat

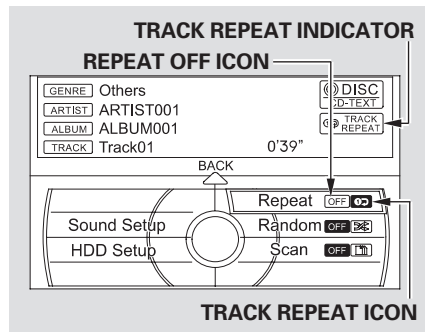

To replay the current track continuously, push the interface selector down while playing a disc. Turn the interface dial to select Repeat on the AUDIO MENU, and press ENTER on the interface selector. Turn the interface dial to select Repeat icon, and press ENTER on the interface selector.

To turn this feature off, turn the interface dial to select OFF icon, and press ENTER on the interface selector.

Playing a Disc (Models with navigation system)

Random Play

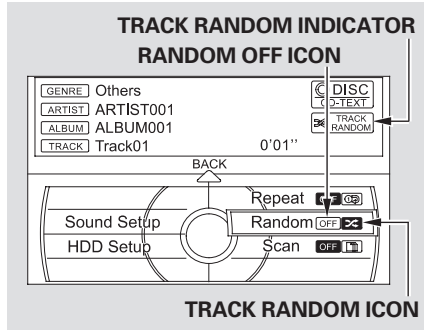

This feature plays the tracks within a disc in random order. When playing MP3, WMA or AAC format discs, all the tracks within the disc are played in random order, regardless of the configuration of the folder.

Push the interface selector down while playing a disc. Turn the interface dial to select Random on the AUDIO MENU, and press ENTER on the interface selector.

Turn the interface dial to select the track random icon, and press ENTER on the interface selector.

To turn this feature off, turn the interface dial to select OFF icon, and press ENTER on the interface selector.

Track Scan

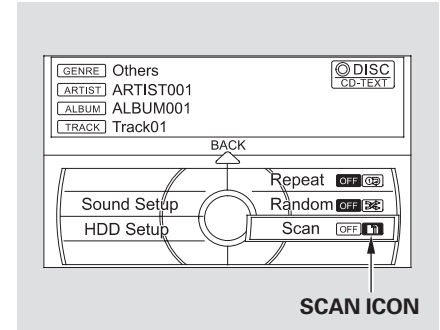

The scan function samples all tracks on the disc in the order they are recorded on the disc.

To activate scan, press the SCAN side of the SCAN/A.SEL bar, or push the interface selector down while playing a disc. Turn the interface dial to select Scan on the AUDIO MENU, and press ENTER on the interface selector.

CONTINUED

Playing a Disc (Models with navigation system)

Turn the interface dial to select the Scan icon, and press ENTER on the interface selector. You will hear a 10-second sampling of each track on the disc. When you return to disc mode, the disc will begin playing from where it left off.

To turn this feature off, press the SCAN button again, or turn the interface dial to select the OFF icon, and press ENTER on the interface selector. The system begins to play the last track sampled.

To Stop Playing a Disc

To take the system out of disc mode, press the AM/FM button, the «» button, or the HDD/AUX button. To return to disc mode, press the DISC button.

If you turn the system off while a disc is playing, either with the VOL/ knob or the engine start/stop button, the disc will stay in the drive. When you turn the system back on, the disc will begin playing where it left off.

Your vehicle has the engine start/stop button instead of an ignition switch. For more information to turn the power mode off, see page [178](#).

Playing an MP3/WMA/AAC Disc

This audio system plays CD-ROM, CD-R/RW, DVD-ROM, and DVD-R/RW compressed in MP3, WMA, or AAC formats. You can select up to 255 folders or tracks.

Disc	Maximum folders*	Maximum Files	Maximum layers*
CD-ROM			
CD-R	255	999	8
CD-RW			
DVD-ROM			
DVD-R	255	3500	8
DVD-RW			

*: Including Root folder

The specifications for compatible MP3 files are:

— Sampling frequency:

32/44.1/48 kHz (MPEG1)

16/22.05/24 kHz (MPEG2)

8/11.025/12 kHz (MPEG2.5)

- Bitrate:
32/40/48/56/64/80/96/112/128/
160/192/224/256/320 kbps
(MPEG1)
8/16/24/32/40/48/56/64/80/96/
112/128/160 kbps (MPEG2)
8/16/24/32/40/48/56/64/80/96/
112/128/144/160 kbps
(MPEG2.5)
- Compatible with variable bitrate
and multi-session.
- Maximum layers:
255 layers

The specifications for compatible
WMA files are:

- Sampling frequency:
8/11.025/16/22.05/32/44.1/48
kHz
- Bitrate:
5/6/8/10/12/16/20/22/32/48/
64/80/96/128/160/192/256/
320 kbps
- Compatible with variable bitrate
and multi-session

- Maximum layers:
255 layers

The specifications for compatible
AAC files are:

- Sampling frequency:
8/11.025/12/16/22.05/24/32/
44.1/48 kHz
- Bitrate:
8/16/20/24/28/32/40/48/56/64/
80/96/112/128/160/192/224/
256/320 kbps
- Compatible with multi-session.
- Maximum layers:
255 layers

NOTE:

Combining a low sampling frequency
with a low bitrate may result in
extremely degraded sound quality.

To play an MP3/WMA/AAC disc,
use the disc controls previously
described, along with the following
information.

Changing the Folders

While playing an MP3/WMA/AAC
disc, you can select a folder within
the disc by pressing either side of
the category bar. Each time you
press either side of the bar, the
folder title and its first file's
information appear on the center
display and on the navigation screen
in hierarchical order of the folders
which contain files within the disc.

CONTINUED

Playing a Disc (Models with navigation system)

Changing and Selecting the Folders/ Files

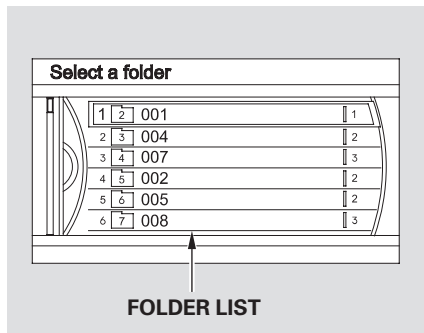

Using the interface selector, you can see the list of all the folders within a disc. While playing an MP3/WMA/AAC disc, push the interface selector up. The folder list in the currently playing disc will appear on the screen.

If the root folder has some additional folders in the lower layer, they will be listed on the screen.

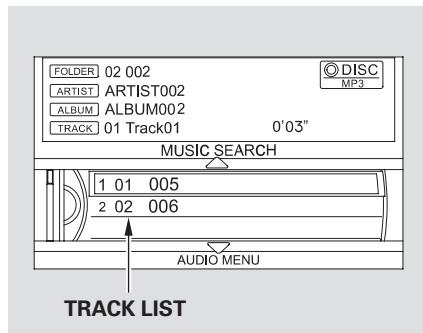

Select a desired folder by turning the interface dial, then press ENTER. The display returns to normal play, and the first track in the selected folder begins to play.

To change a file, turn the interface dial to select a desired file, then press ENTER.

Folder Repeat

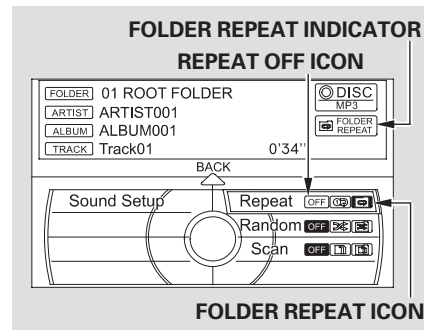

This feature, when activated, replays all files on the selected folder in the order they are compressed. To activate folder repeat play, push the interface selector down while playing a disc. Turn the interface dial to select Repeat on the AUDIO MENU, and press ENTER on the interface selector. Turn the interface dial to select the folder repeat icon, and press ENTER on the interface selector.

Playing a Disc (Models with navigation system)

To turn this feature off, turn the interface dial to select OFF icon, and press ENTER on the interface selector.

Folder Random

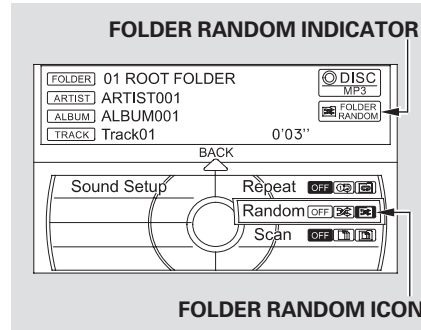

This feature, when activated, plays all files in the current folder in random order. To activate folder random play, push the interface selector down while playing a disc. Turn the interface dial to select Random on the AUDIO MENU, and press ENTER on the interface selector. Turn the interface dial to select the folder random icon, and press ENTER on the interface selector.

To turn this feature off, turn the interface dial to select OFF icon, and press ENTER on the interface selector.

Playing a Disc (Models with navigation system)

File Scan

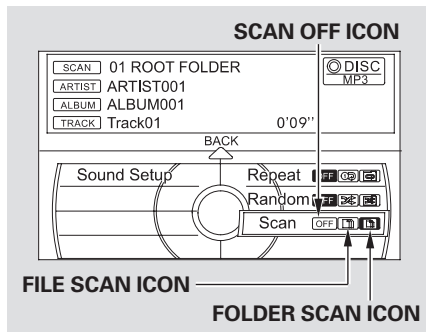

This feature samples all files in the selected folder in the order they are stored. To activate this feature, press the SCAN side of the SCAN/A.SEL bar. You can also select the SCAN icon with the interface dial. Push the selector down, turn the dial to select Scan on the AUDIO MENU, then press ENTER. Turn the dial to select the scan icon, then press ENTER. The system begins to play a file for about 10 seconds, and continues to

sample the remaining files.

To turn this feature off, press the SCAN side of the bar again, or select OFF icon by turning the dial, then press ENTER.

Folder Scan

This feature, when activated, samples the first file of each folder for 10 seconds. To scan a folder, press the SCAN side of the SCAN/A.SEL bar. Or, push the interface selector down while playing a disc. Turn the interface dial to select Scan on the AUDIO MENU, and press ENTER on the interface selector. Turn the interface dial to select the folder scan icon, and press ENTER on the interface selector.

The system plays the first file in the first folder for about 10 seconds. If you do nothing, the system will then play the first files in the next folders for 10 seconds. After playing the first file of the last folder, the system plays normally.

To turn this feature off, turn the interface dial to select OFF icon, and press ENTER on the interface selector. The last track sampled begins to play.

NOTE:

When playing MP3, WMA or AAC format disc, each time you press the SCAN side of the SCAN/A.SEL bar, the system changes in the following sequence: Scan → Scan first track in folder → OFF → Scan.

Removing Discs from the Disc Player

To remove the disc, press the eject (▲) button.

If you do not remove the disc from the slot, the system will reload the disc after 10 seconds. The disc starts playing automatically.

Playing a DVD-A Disc

Use the disc controls previously described.

Disc Player Error Messages (Models with navigation system)

The chart on the right explains the error messages you may see in the center display while playing a disc.

If you see an error message in the center display while playing a disc, press the eject button. After ejecting the disc, check it for damage or deformation. If there is no damage, insert the disc again. For additional information on damaged discs, see page [314](#).

The audio system will try to play the disc. If there is still a problem, the error message will reappear. Press the eject button, and pull out the disc. Insert a different disc. If the new disc plays, there is a problem with the first disc. If the error message cycle repeats and you cannot clear it, take your vehicle to a dealer.

Error Message	Cause	Solution
BAD DISC PLEASE CHECK OWNER'S MANUAL	Servo Error	Press the eject button and pull out the disc. Check the disc for serious damage, signs of deformation, excessive scratches, and/or dirt (see page 314). Insert the disc again. If the code does not disappear, or the disc cannot be removed, consult your dealer. Do not try to force the disc out of the player.
BAD DISC PLEASE CHECK OWNER'S MANUAL PUSH EJECT	Mechanical Error	
MECH ERROR		
CHECK DISC	FOUCS Error Disc violates copyright Disc not supported	
CHECK DISC LOAD	Load Error	
UNPLAYABLE FILE	Track/File format not supported	Current track will be skipped. The next supported track or file plays automatically.
HEAT ERROR	High Temperature	Will disappear when the temperature returns to normal.

Protecting Your Discs (Models with navigation system)

General Information

- When using CD-R, CD-RW, DVD-R or DVD-RW discs, use only high quality discs labeled for audio use.
- When recording a CD-R, CD-RW, DVD-R or DVD-RW the recording must be closed for it to be used by the disc player.
- When using DVD-R/RW discs, they should meet DVD verification standards.
- Play only standard, round, 5-inch (12 cm) discs. Smaller or odd-shaped discs may jam in the drive or cause other problems.
- Handle your discs properly to prevent damage and skipping.

NOTICE

Do not use discs with adhesive labels. The label can curl up and cause the disc to jam in the unit.

Protecting Discs

When a disc is not being played, store it in its case to protect it from dust and other contamination. To prevent warpage, keep discs out of direct sunlight and extreme heat.

To clean a disc, use a clean soft cloth. Wipe across the disc from the center to the outside edge.

A new disc may be rough on the inner and outer edges. The small plastic pieces causing this roughness can flake off and fall on the recording surface of the disc, causing skipping or other problems. Remove these pieces by rubbing the inner and outer edges with the side of a pencil or pen.

Never try to insert foreign objects in the disc player.

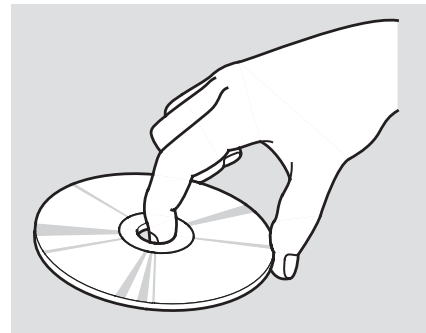

Handle a disc by its edges; never touch either surface. Do not place stabilizer rings or labels on the disc. These, along with contamination from finger prints, liquids, and felt-tip pens, can cause the disc to not play properly, or possibly jam in the drive.

Protecting Your Discs (Models with navigation system)

Additional Information on Recommended Discs

The in-dash disc player has a sophisticated and delicate mechanism. If you insert a damaged disc as indicated in this section, it may become stuck inside and damage the audio unit.

Examples of these discs are shown to the right:

1. Bubbled, wrinkled, labeled, and excessively thick discs

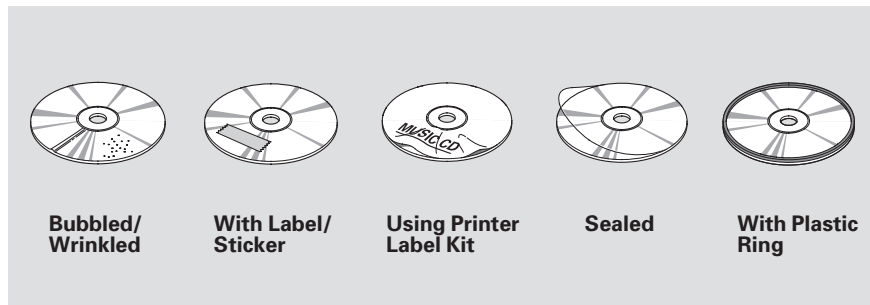

2. Damaged discs

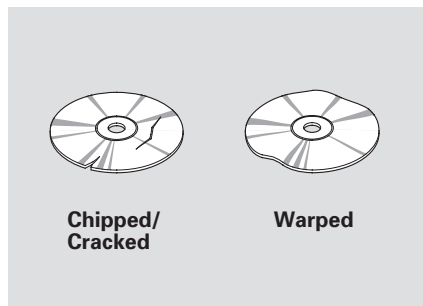

3. Poor quality discs

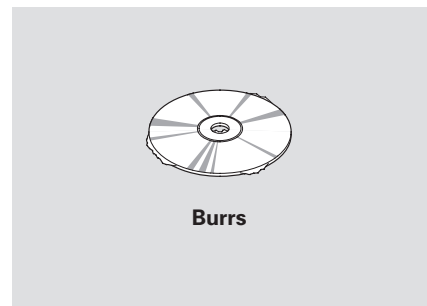

Protecting Your Discs (Models with navigation system)

4. Small, irregular shaped discs

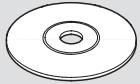

3-inch (8-cm) CD

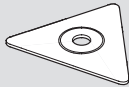

Triangle Shape

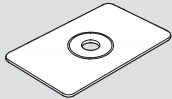

Can Shape

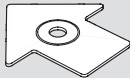

Arrow Shape

5. Discs with scratches, dirty discs

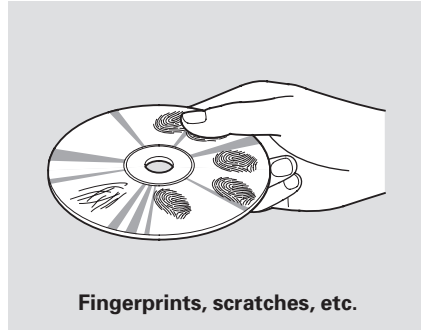

Fingerprints, scratches, etc.

- CD-R, CD-RW, DVD-R or DVD-RW may not play due to the recording conditions.
- Scratches and fingerprints on the discs may cause the sound to skip.

- Recommended discs are printed with the following logo.



- Audio unit may not play the following formats.



- This audio unit cannot play a Dual-disc®.

Playing Hard Disc Drive (HDD) Audio (Models with navigation system)

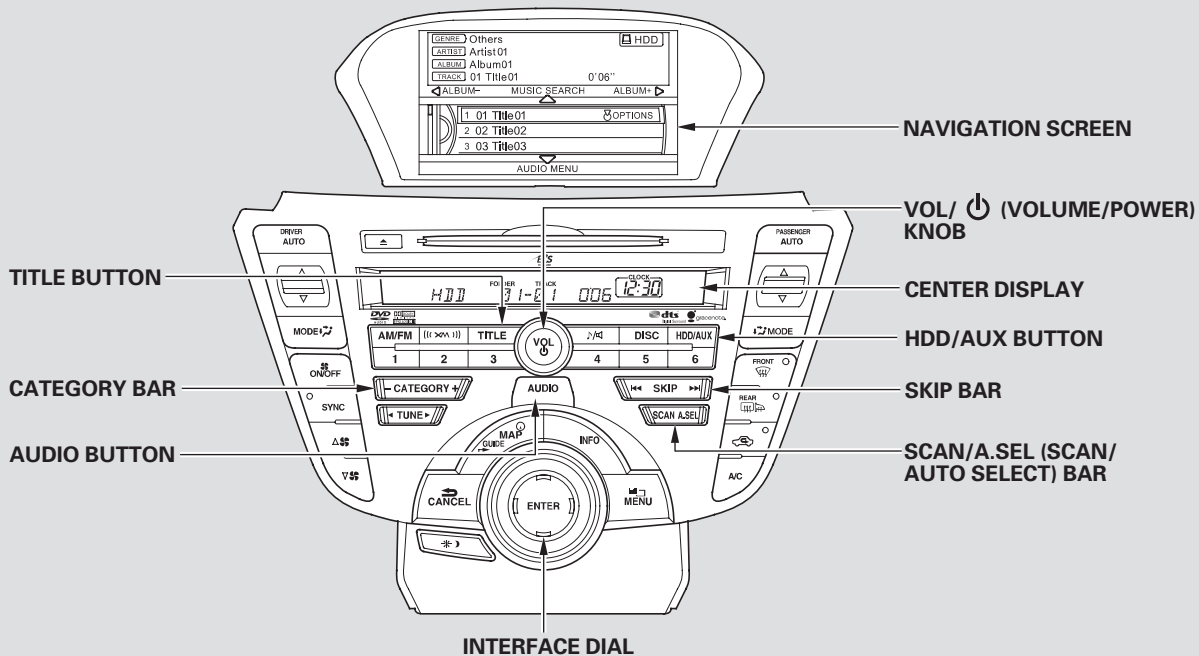

Playing Hard Disc Drive (HDD) Audio (Models with navigation system)

The Hard Disc Drive (HDD) Audio function can record tracks from music CDs to the navigation system's hard disc. This function also allows for various playing methods, such as playing recorded tracks on an artist-by-artist or genre-by-genre basis. For example, you can play the tracks that you want to listen to in any order that you like for each playlist.

NOTE:

- Only recordings from a standard CD-DA (44.1 kHz, 16 bit stereo PCM digital sound data) to HDD are supported.
- Digital music files, such as MP3, WMA, AAC etc., in CD-R, DVD-R and USB flash memory devices cannot be copied to HDD. Likewise, digital music files recorded to HDD cannot be copied to CD-R, DVD-R and USB devices.

- Music data recorded on HDD can only be used for personal enjoyment.
- Data is recorded using ultra-efficient compression technology, therefore, sound quality may vary slightly from the original.
- Title information will be displayed when the information is found in the Gracenote® Album Info (Gracenote® Media Database) on the built-in hard disk drive. See page [342](#).

- Recording function from following media is not supported.
 - CD-DA which prohibits the copy by SCMS
 - CD-DA with copy control
 - SACD (Super Audio CD)
 - DTS-CD
 - DVD-A
 - CD-R/RW
 - DVD-R/RW
 - Copy controlled CDs (Playback cannot be guaranteed)
 - DTS-CDs (Only enabled for playback)

If the HDD is ever replaced, all data will be lost and stored music will not be recovered.

Playing Hard Disc Drive (HDD) Audio (Models with navigation system)

Playlists

Playlists are track lists in a certain playback group.

Original Playlist

This playlist is automatically generated when the music CD is recorded. The maximum number of original playlists that can be stored to the HDD is 999, with 99 songs on each playlist. Each album name on the music CD is counted as a playlist.

User Playlist

The HDD has six playlist folders for user customizing. Each playlist can be edited by the user, and will store up to 999 songs. For more information of how to edit the user playlist, see page [329](#).

Track Search Methods

Songs that have been recorded on the HDD are categorized in groups for easy searching.

There are six categories:

Album record date: Album titles are arranged by date of recording.

Album: Album names are arranged in alphabetical order.

Artist: Artist names are arranged in alphabetical order.

Genre: Songs are arranged by genre.

Playlist: Any of six playlists that are arranged by the user

Track: Track titles are arranged in alphabetical order.

For more information of how to search a music, see page [325](#).

Playing Hard Disc Drive (HDD) Audio (Models with navigation system)

Recording a Music CD to HDD Audio

If you play a music CD that has not yet been recorded on the HDD, the system will automatically begin recording to the HDD once the disc is loaded. To turn this feature off, see page 320.

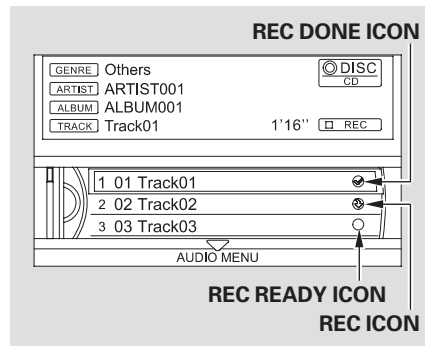

The icons show the recording conditions for each track:
Rec icon: Now recording
Rec ready icon: Next to be recorded
Rec done icon: Recording finished

NOTE:

- Please note that there will be no compensation offered in the case of unsuccessful recording of audio data or the loss of audio data due to any cause whatsoever.
- During recording, operation of this product may be slower.
- If you stop the engine or the power system is turned off while recording a CD, there may be pauses between songs when you play back from the HDD.
- Tracks from music CDs are recorded at four times the playback speed. You can listen to tracks as they are being recorded.
- Skip up/down, forward/rewind, repeat, random and scan functions are not available during recording.

CONTINUED

Playing Hard Disc Drive (HDD) Audio (Models with navigation system)

- You can listen to tracks from other playlists that have already been recorded while recording. Press the HDD/AUX button and switch over to HDD Audio.
- With the factory settings, all of the songs on a music CD are automatically recorded.
- Recording settings cannot be changed during recording.
- If the number of songs in the playlist exceeds 999, the oldest song will be overwritten each time you add a new song.

To Cancel Recording a Music CD to HDD

In order to suspend recording, push the interface selector down, select Cancel Rec to HDD, and press ENTER on the interface selector.

Changing the Recording Settings *Recording All of the Tracks on a Music CD Manually*

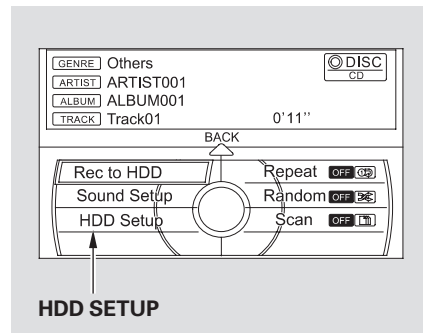

To change the setting to manual mode, push the interface selector down on the HDD screen. Turn the interface dial to select HDD Setup and press ENTER. Turn the interface dial to select Ripping, and press ENTER on the interface selector.

Playing Hard Disc Drive (HDD) Audio (Models with navigation system)

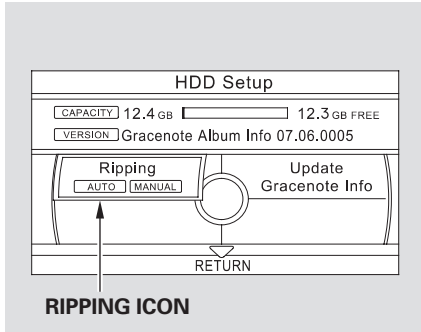

Turn the dial to select Ripping and press ENTER on the interface selector.

Turn the interface dial to select MANUAL and press ENTER on the interface selector.

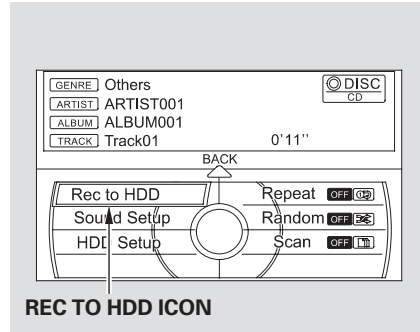

To record the music CD, push the HDD/AUX button, then push the interface selector down to display the audio menu. Turn the interface dial to select Rec to HDD, and then press ENTER on the interface selector.

Recording All of the Tracks on a Music CD Automatically

To change the setting to automatically record all of the tracks on a music CD, move the interface selector down on the HDD Audio screen. Turn the interface dial to select HDD Setup, and press ENTER on the interface selector.

Turn the interface selector to select Ripping, and press ENTER on the interface selector.

Turn the interface dial to select AUTO, and press ENTER on the interface selector.

Playing Hard Disc Drive (HDD) Audio (Models with navigation system)

Playing Tracks on HDD

To play tracks on HDD, push the HDD/AUX button until the HDD Audio screen appears. Playback will start automatically with the track previously selected.

Playing the Selected Track

To select tracks, press on the Category bar or the Skip bar.

Category Bar	
+	The next playlist is selected. If you press + during the last playlist, the first playlist is selected.
-	The previous playlist is selected. If you press - during the first playlist, the last playlist is selected.

Skip Bar	
◀◀	Returns to the beginning of the song that is being played. Otherwise, the previous track is selected. If you press this bar during the first song, the last song is selected.
▶▶	The next song is selected. If you press this bar during the last song, the first song is selected.

Fast Forwarding and Rewinding

To fast forward, press and hold the ▶▶| side of the SKIP bar. To rewind, press and hold the |◀◀ side of the SKIP bar.

Playing Hard Disc Drive (HDD) Audio (Models with navigation system)

Repeat Playback

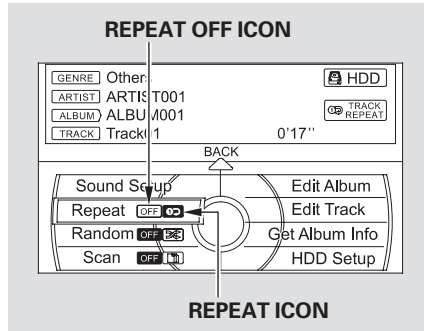

To replay the current track continuously, push the interface selector down during track playback.

Turn the interface dial to select Repeat on the HDD AUDIO MENU, and press ENTER on the interface selector. Turn the interface dial to select the repeat icon, then press ENTER on the interface selector.

To turn this feature off, turn the interface dial to select the OFF icon, then press ENTER on the interface selector.

Random Playback

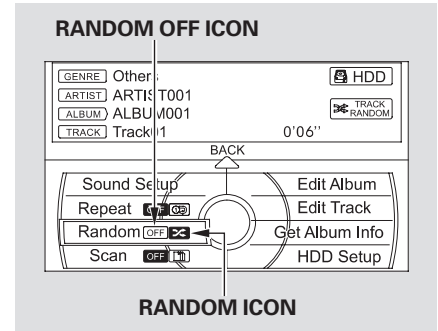

This function plays the tracks on the HDD in random order. To activate random play, push the interface selector down during track playback. Turn the interface dial to select Random on the HDD AUDIO MENU. Press ENTER on the interface selector.

CONTINUED

Playing Hard Disc Drive (HDD) Audio (Models with navigation system)

Turn the interface dial to select the track random icon, and press ENTER on the interface selector.

To turn this feature off, turn the interface dial to select the OFF icon, then press ENTER on the interface selector.

Scan Playback

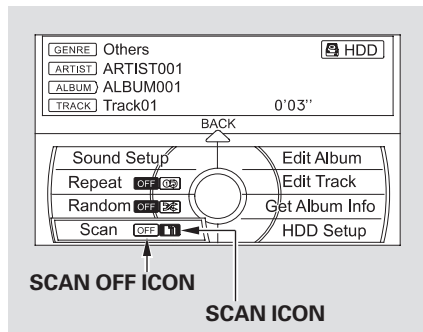

This function samples all the tracks on the HDD in the order that they were recorded.

To activate scan, push the interface selector down during track playback. Turn the interface dial to select Scan on the HDD AUDIO MENU, and press ENTER on the interface selector.

Turn the interface dial to select the scan icon. Press ENTER on the interface selector. You will hear a 10-second sampling of each track on the HDD.

To turn this feature off, turn the interface dial to select the OFF icon. Press ENTER on the interface selector to play the last track sampled.

Playing Hard Disc Drive (HDD) Audio (Models with navigation system)

Searching the Music

While playing music in the HDD playback screen, push the interface selector up to select MUSIC SEARCH. You can search a track by album, artist, track, playlist, genre, or album record date, or you can shuffle all tracks.

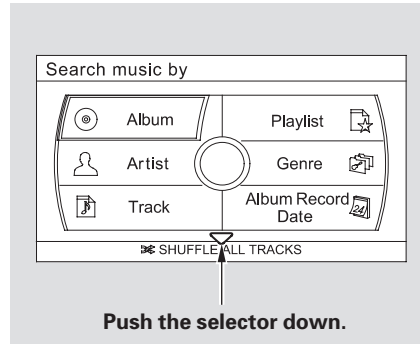

SHUFFLE ALL TRACKS

Shuffles the playback of all tracks that have been recorded on HDD.

To shuffle all tracks, push the interface selector up to display the Search music by screen, and then push the interface selector down. Shuffled playback begins.

Searching Music by Album

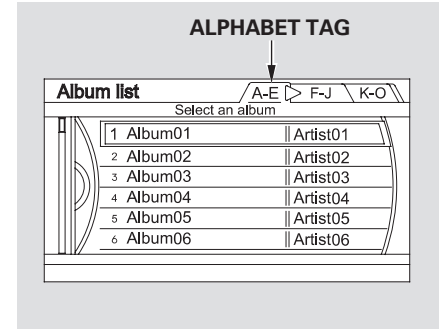

Push the interface selector up to display the Search music by screen, and turn the interface dial to select Album. Press ENTER on the selector, and the album list will be displayed in alphabetical order.

If you push the interface selector right or left, you can change the alphabet tag.

CONTINUED

Playing Hard Disc Drive (HDD) Audio (Models with navigation system)

Turn the interface dial to select the album you want to listen to, then press ENTER on the selector.

The first track on the selected album begins to play.

Searching Music by Artist

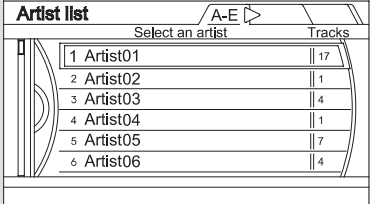

Artist list		A-E >
Select an artist		Tracks
1	Artist01	17
2	Artist02	1
3	Artist03	4
4	Artist04	1
5	Artist05	7
6	Artist06	4

Push the interface selector up to display the Search music by screen, and turn the interface dial to select Artist. Press ENTER on the interface selector, and the artist list will be displayed in alphabetical order.

Turn the interface dial to select the artist you want to listen to, and press ENTER on the interface selector.

If you push the interface selector right or left, you can change the alphabet tag.

The first track on the selected artist begins to play.

Playing Hard Disc Drive (HDD) Audio (Models with navigation system)

Searching Music by Track

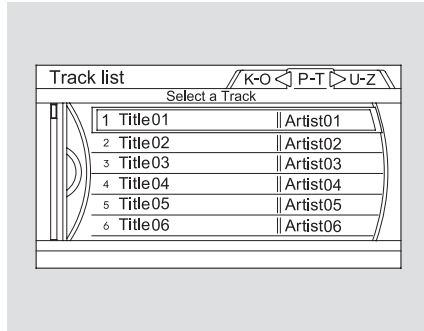

Push the interface selector up to display the Search music by screen, and turn the interface dial to select Track. Press ENTER on the interface selector, and the track list will be displayed in alphabetical order.

Turn the interface dial to select a track you want to listen to, then press ENTER on the interface selector.

If you push the interface selector right or left, you can change the alphabet tag.

The selected track begins to play.

Searching Music by Playlists

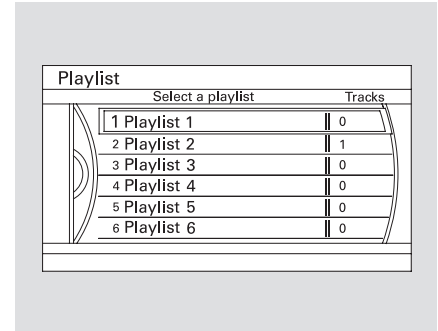

Push the interface selector up to display the Search music by screen, and turn the interface dial to select Playlist. Press ENTER on the interface selector then the playlist will be displayed.

CONTINUED

Playing Hard Disc Drive (HDD) Audio (Models with navigation system)

Turn the interface dial to select the playlist you want to listen to, then press ENTER on the interface selector.

The first track on the selected playlist begins to play.

Searching Music by Genre

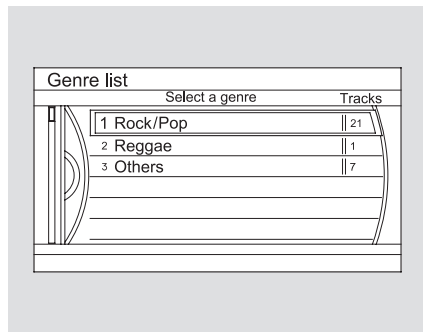

Genre list	Select a genre	Tracks
1	Rock/Pop	21
2	Reggae	1
3	Others	7

Push the interface selector up to display the Search music by screen, and turn the interface dial to select Genre. Press ENTER on the interface selector, and the genre list will be displayed.

Turn the interface dial to select the genre you want to listen to, and then press ENTER on the interface selector.

The first track on the selected genre begins to play.

Playing Hard Disc Drive (HDD) Audio (Models with navigation system)

Searching Music by Album Record Date

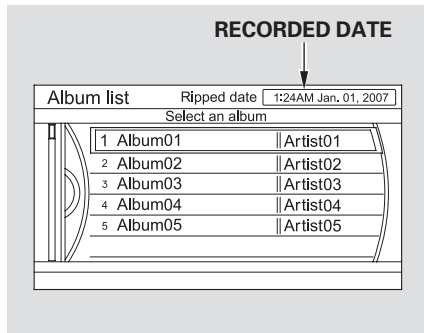

Push the interface selector up to display the Search music by screen, and turn the interface dial to select Album Record Date. Press ENTER on the interface selector. The album list will be displayed.

Turn the interface dial to select the album you want to listen to, then press ENTER on the selector.

The first track on the selected album begins to play.

Customizing Original/User Playlist

The HDD has two types of the playlists: original playlist and user playlist. On the original playlist, the music CD is recorded automatically when it is played. In addition, you can create up to six user playlists on the HDD. In each playlist, you can store a desired music data from the original playlists or music CDs.

After storing the data, you can change some items: order of tracks on the user playlist, name of the playlist, track title, artist name, and music genre. You can also add a track to the playlist, and delete the track or the album from the playlist.

Playing Hard Disc Drive (HDD) Audio (Models with navigation system)

Changing the Order of Tracks Within the User Playlist

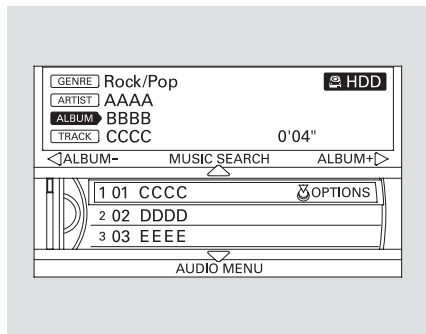

1. On the HDD audio screen, push up the interface selector to select MUSIC SEARCH. Select Playlist by turning the interface dial, then press ENTER.

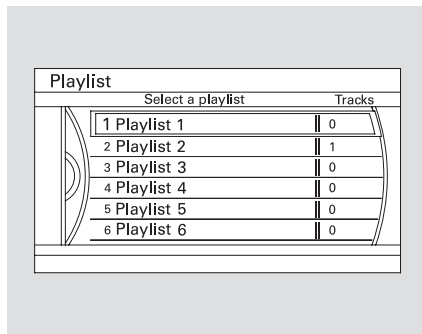

2. Turn the interface dial to select the playlist, then press ENTER.
3. Push the interface selector down to display the AUDIO MENU for the playlist.

4. Turn the interface dial and select Edit Playlist, then press ENTER on the interface selector.
5. Turn the interface dial to select Edit Order, then press ENTER on the interface selector.
6. Turn the interface dial to select the track to be moved, then press ENTER on the interface selector.

Playing Hard Disc Drive (HDD) Audio (Models with navigation system)

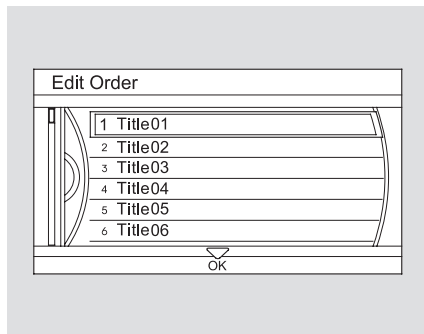

7. Turn the interface dial to select where the track is to be moved, then press ENTER on the interface selector.
8. Push the interface selector down to return to the Playback screen of the User Playlist.

Changing the Name of the Original Playlist or User Playlist

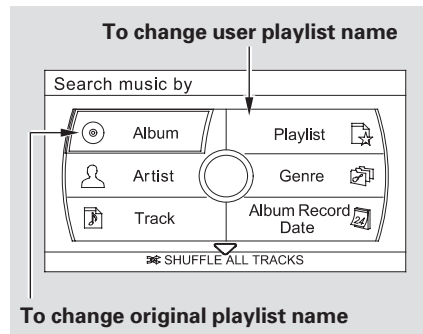

To change original playlist name

1. Select a desired playlist to change the user playlist name, or a desired album to change the original playlist name (album name). Refer to the Music Search function on page 325 for how to select a playlist or an album. Push the interface selector down to display AUDIO MENU for a selected playlist or album.

2. Turn the interface dial and select Edit Playlist (or Edit Album to edit Original Playlist), then press ENTER on the interface selector.
3. Turn the interface dial to select Edit Playlist Name (or Edit Album Name to edit Original Playlist), then press ENTER on the interface selector.
4. On the Edit Album Name screen, turn the interface dial to select Edit Album, then press ENTER on the interface selector.

CONTINUED

Playing Hard Disc Drive (HDD) Audio (Models with navigation system)

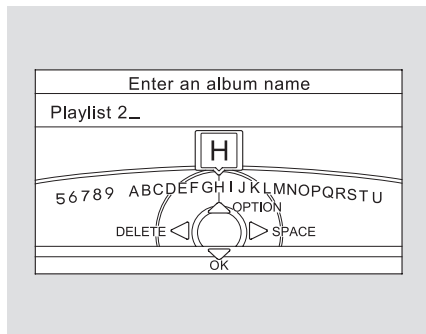

5. On the Enter an album name screen, input the new Original Playlist name or User Playlist name.

Select a letter by turning the interface dial, then press ENTER.

6. After inputting the name, push the interface selector down to select OK.
7. The confirmation screen is displayed. Confirm that the new name is correct, and then push the interface selector down to select OK. You will be returned to the Edit Album or Edit Playlist screen for the Original Playlist or User Playlist.

8. Push the selector down to select OK. The screen returns to the playlist.

Changing the Track Titles

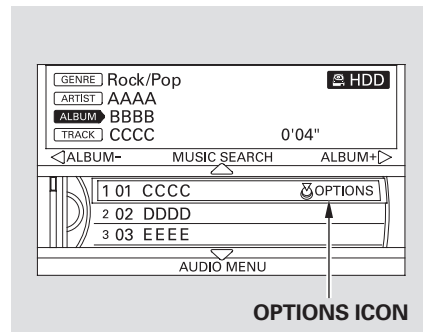

1. Select a desired playlist, then turn the interface dial to select the track of which you want to change the name, then press ENTER on the interface selector. Refer to the Music Search function on page [325](#) for how to select a playlist.
2. The OPTIONS icon will appear in the selected track. Press ENTER on the interface selector.

Playing Hard Disc Drive (HDD) Audio (Models with navigation system)

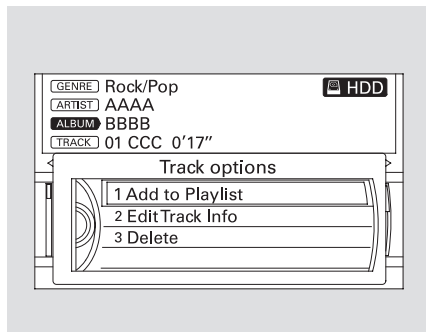

3. The track options box is displayed. Select Edit Track Info, then press ENTER on the interface selector.
4. On the Edit Track screen, turn the interface dial and select Edit Track Name, then press ENTER on the interface selector.

5. On the Edit Track Name screen, turn the interface dial and select Edit Track, then press ENTER on the interface selector.
6. Input the new track name on the Enter a track name screen.
7. After inputting the name, push the selector down to select OK.
8. The confirmation screen is displayed. Confirm that the new track name is correct, and then push the interface selector down to select OK. You will be returned to the Edit screen of the Original Playlist or User Playlist.
9. Push the selector down to select OK. The screen returns to the playlist.

NOTE:

After selecting the track for which you want to change the track title, you can also push the interface selector down to display the AUDIO MENU, and then select Edit Track. The subsequent procedure is the same as step 4.

Playing Hard Disc Drive (HDD) Audio (Models with navigation system)

Changing the Artist Name of the Original Playlist or User Playlist

1. Select a desired playlist to change the user playlist artist name or a desired album to change the original playlist artist name. Refer to the Music Search function on page 325 for how to select a playlist or an album. Push the interface selector down to display AUDIO MENU for a selected playlist or album.
2. Turn the interface dial and select Edit Album (or Edit Playlist if you want to edit User Playlist), then press ENTER on the interface selector.
3. Turn the interface dial to select Edit Album Name (or Edit Playlist Name), then press ENTER on the interface selector in Edit Album (or Edit Playlist) screen.

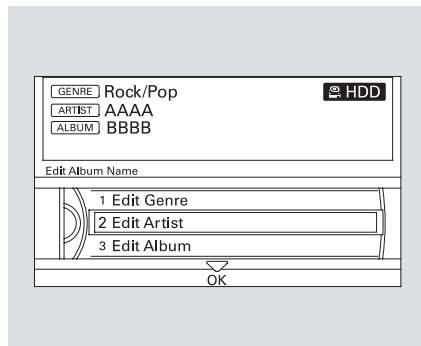

4. On the Edit Album Name screen, turn the interface dial to select Edit Artist, then press ENTER on the interface selector.
5. On the Enter an artist name screen input the new artist name.
6. After inputting the name, push the interface selector down to select OK.

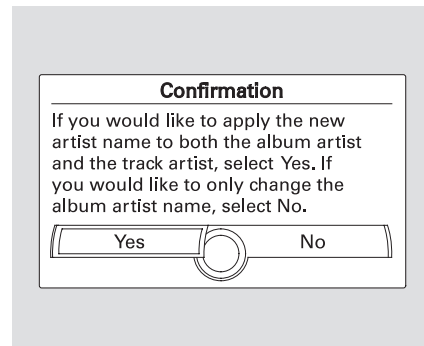

7. The confirmation screen is displayed. Choose if you would like to apply the new name to both the album artist and/or the track artist. Select Yes or No by turning the dial, then press ENTER.

Playing Hard Disc Drive (HDD) Audio (Models with navigation system)

8. Confirm that the new name is correct, and then push the interface selector down to select OK. You will be returned to the Edit Album Name screen.
9. Push the selector down to select OK. The screen returns to the playlist.

Changing the Artist Name of the Track

1. Select a desired playlist to change the artist name. Refer to the Music Search function on page 325 for how to select a playlist. Rotate the interface dial to select the currently playing track.

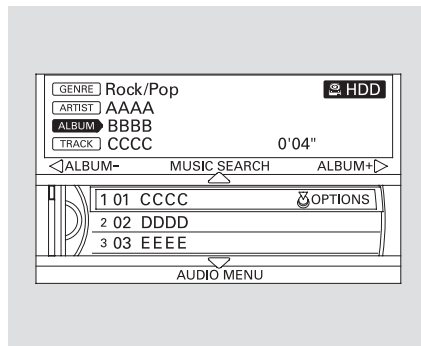

2. The OPTIONS icon will appear in the selected track. Press ENTER on the interface selector.
3. The track options box is displayed. Select Edit Track Info, then press ENTER on the interface selector.
4. On the Edit Track screen, turn the interface dial and select Edit Track Name, then press ENTER on the interface selector.

5. On the Edit Track Name screen, turn the interface dial and select Edit Artist, then press ENTER on the interface selector.

6. Input the new track name on the Enter an artist name screen.

7. After inputting the name, push the selector down to select OK. You will be returned to the Edit Track Name screen.

8. Push the selector down to select OK. The screen returns to the playlist.

NOTE:

After selecting the track for which you want to change the artist's name, you can also push the interface selector down to display the AUDIO MENU, and then select Edit Track. The subsequent procedure is the same as step 4.

Playing Hard Disc Drive (HDD) Audio (Models with navigation system)

Changing the Musical Genre

1. Select a desired playlist to change the user playlist music genre, or a desired album to change the original playlist music genre. Refer to the Music Search function on page 325 for how to select a playlist or an album. Push the interface selector down to display AUDIO MENU for a selected playlist or album.

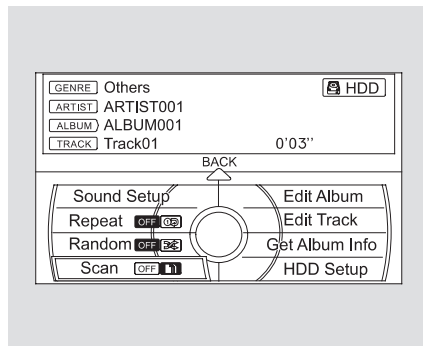

2. Turn the interface dial and select Edit Album (or Edit Playlist if you want to edit User Playlist), then press ENTER on the interface selector.
3. Turn the interface dial to select Edit Album Name (or Edit Playlist Name), then press ENTER on the interface selector in Edit Album (or Edit Playlist) screen.

4. On the Edit Album Name screen, turn the interface dial and select Edit Genre, and then press ENTER on the interface selector.
5. Turn the interface dial on the Select a genre screen to select the Original Playlist or User Playlist that you want to change the genre and then press ENTER on the interface selector. You will be returned to the Edit Album Name screen.
6. Push the selector down to select OK. The screen returns to the playlist.

Playing Hard Disc Drive (HDD) Audio (Models with navigation system)

Deleting a Track

1. Select the track with the interface dial from the playback screen while it is playing. Press ENTER on the interface selector.
2. The OPTIONS icon will appear in the selected track. Press ENTER on the interface selector.

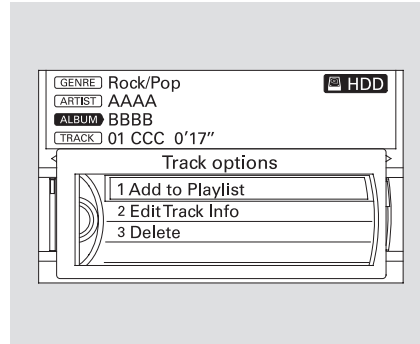

3. The track options box is displayed. Select Delete and press ENTER on the interface selector.
4. Select OK to confirm you want to delete the track. You will be returned to the Playback screen for the Original Playlist or User Playlist.

NOTE:

- When you delete a track from the Original Playlist, the track is also deleted from the User Playlist in which the deleted track was stored.
- Even if all the tracks are deleted from the User Playlist, the data folder for that playlist cannot be deleted, and their names (playlist and artist) are left. You can store tracks again on that playlist.

Playing Hard Disc Drive (HDD) Audio (Models with navigation system)

Deleting an Album

1. On the HDD playback screen of the album in which you want to delete, push the interface selector down to display AUDIO MENU.
2. Turn the interface dial and select Edit Album (or Edit Playlist if you want to edit User Playlist), then press ENTER on the interface selector.
3. On the Edit Album (or Edit Playlist) screen, turn the interface dial and select Delete Album (or Delete Playlist), then press ENTER on the interface selector.

4. The delete box is displayed. Select OK and then press ENTER on the interface selector. You will be returned to the Playback screen for the Original Playlist or User Playlist.

NOTE:

- When you delete the Original Playlist, any tracks stored in a User Playlist are also deleted.
- Even if all the tracks are deleted from the User Playlist, the data folder for that playlist cannot be deleted, and their names (playlist and artist) are left. You can store tracks again on that playlist.

Adding a Track or Album to the User Playlist

1. While playing back an Original Playlist or User Playlist that you want to add to a different User Playlist, push the interface selector down to display AUDIO MENU.

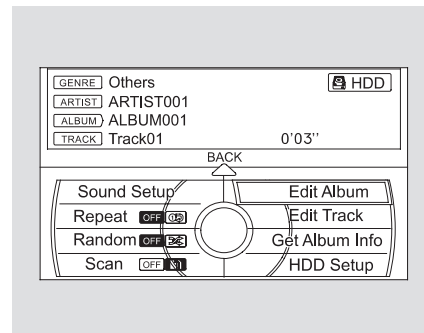

2. Turn the interface dial and select Edit Album (or Edit Playlist if you want to edit an User Playlist), and then press ENTER on the interface selector.

Playing Hard Disc Drive (HDD) Audio (Models with navigation system)

3. On the Edit Album (or Edit Playlist) screen, turn the interface dial and select Add to Playlist, and then press ENTER on the interface selector.
4. On the Playlist screen, turn the interface dial and select a desired User Playlist, then press ENTER on the interface selector. You will be returned to the Playback screen for the Original Playlist or User Playlist.

NOTE:

When adding from and to the same User Playlist, the same tracks will be stored twice.

Adding a Track to a User Playlist

1. While a track is playing on an Original Playlist or User Playlist Playback screen, turn the interface dial and select the track that you want to add to a User Playlist, then press ENTER on the interface selector.

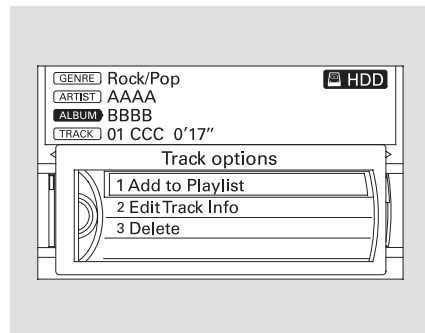

2. The track options box is displayed. Select Add to Playlist, then press ENTER on the interface selector.

3. On the Playlist screen, turn the interface dial and select the Playlist to which the song is to be added, then press ENTER on the interface selector. You will be returned to the Playback screen for the Original Playlist.

NOTE:

When adding from and to the same User Playlist, the same tracks will be stored twice.

Playing Hard Disc Drive (HDD) Audio (Models with navigation system)

Acquiring Title Information

1. Push the interface selector down to display AUDIO MENU.
2. Turn the interface dial and select Get Album Info, then press ENTER on the interface selector.
3. On the Select an Album screen, turn the interface dial and select the title information for the Original Playlist, then press ENTER on the interface selector. You will be returned to the Audio Menu screen.

Checking HDD Audio Capacity

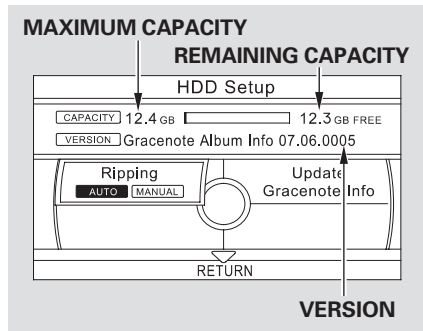

You can check the HDD Audio capacity and remaining space as well as the Gracenote Music Recognition Service (CDDB) version included with the navigation system on the HDD Setup screen.

Updating Gracenote® Album Info (Gracenote® Media Database)

You can update the Gracenote® Album Info (Gracenote® Media Database) that is included with the navigation system.

NOTE:

Consult your dealer, or visit www.acura.com (in U.S.), or www.acura.ca (in Canada), to acquire updated files.

1. Insert the update disc into the disc slot, or connect the USB flash memory device that includes the update.

Playing Hard Disc Drive (HDD) Audio (Models with navigation system)

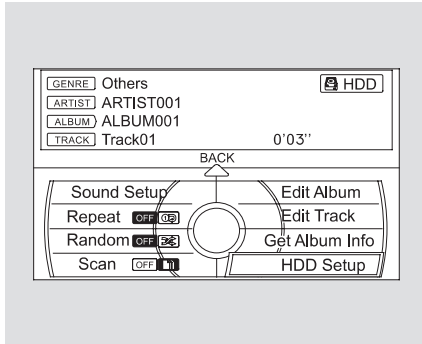

2. Push the interface selector down to select AUDIO MENU in the HDD playback screen or CD playback screen.
3. Turn the interface dial to select HDD Setup, then press ENTER on the interface selector.

4. Turn the interface dial and select Update Gracenote Info, then press ENTER on the interface selector.
5. Turn the dial to select USB or DISC on the Update Gracenote Album info screen, then press ENTER on the selector.
6. Turn the dial to select Yes on the confirmation screen, and the update will start.
7. Turn the interface dial to select OK on the confirmation screen.
8. After updating is complete, press ENTER on the confirmation screen.

NOTE:

Once you perform an update any information you edited before will be overwritten.

Clearing the HDD

Any music, data, calendar entries, etc. that have been stored on the HDD can be deleted.

1. Press the INFO button, rotate the interface dial to select **Set up**, and press ENTER.
2. Move the interface selector to the right to navigate to the **Set up (Other)** screen.
3. On the **Set up (Other)** tab, rotate the interface dial to select **Clear Personal Data**, and press ENTER.
4. Select the item you wish to delete.

CONTINUED

Playing Hard Disc Drive (HDD) Audio (Models with navigation system)

5. A pop-up screen verifying whether the deletion is to be continued or not will be displayed. Select Yes to delete, or No to cancel.
6. A second confirmation will appear. Select Yes to delete, or No to cancel.
7. When you are finished deleting the data, press the interface selector down to select **Done**.

NOTE: If you select **Music on HDD**, the system will automatically restart after deletion.

Gracenote Music Recognition Service (CDDB)



Music recognition technology and related data are provided by Gracenote®. Gracenote is the industry standard in music recognition technology and related content delivery. For more information, please visit <http://www.gracenote.com/>.

When music is recorded to the HDD from a CD, information such as the recording artist and track name are retrieved from the Gracenote Database and displayed (when available). Gracenote may not contain information for all albums.

Gracenote is an internet-based music recognition service that allows artist, album, and track information from CDs and MP3 files to display on the HDD. Gracenote users are allowed 4 free updates a year. More information about Gracenote, its features, and downloads are available at www.acura.com (in U.S.) or www.acura.ca (in Canada).

CD and music-related data from Gracenote, Inc., copyright© 2000—2008 Gracenote.

Playing Hard Disc Drive (HDD) Audio (Models with navigation system)

Gracenote Software, copyright© 2000 –2008 Gracenote. This product and service may practice one or more of the following U.S. Patents: # 5,987,525; # 6,061,680; # 6,154,773, # 6,161,132, # 6,230,192, # 6,230,207, # 6,240,459, # 6,330,593, and other patents issued or pending. Some services supplied under license from Open Globe, Inc. for U.S. Patent: # 6,304,523.

Gracenote and CDDB are registered trademarks of Gracenote. The Gracenote logo and logotype, and the “Powered by Gracenote” logo are trademarks of Gracenote.

Gracenote® End User License Agreement

Version 20061005

This application or device contains software from Gracenote, Inc. of Emeryville, California (“Gracenote”). The software from Gracenote (the “Gracenote Software”) enables this application to perform disc and/or file identification and obtain music-related information, including name, artist, track, and title information (“Gracenote Data”) from online servers or embedded databases (collectively, “Gracenote Servers”) and to perform other functions. You may use Gracenote Data only by means of the intended End-User functions or this application or device.

You agree that you will use Gracenote Data, the Gracenote Software, and Gracenote Servers for your own personal non-commercial use only.

You agree not to assign, copy, transfer or transmit the Gracenote Software or any Gracenote Data to any third party.

YOU AGREE NOT TO USE OR EXPLOIT GRACENOTE DATA, THE GRACENOTE SOFTWARE, OR GRACENOTE SERVERS, EXCEPT AS EXPRESSLY PERMITTED HEREIN.

You agree that your non-exclusive license to use the Gracenote Data, the Gracenote Software, and Gracenote Servers will terminate if you violate these restrictions. If your license terminates, you agree to cease any and all use of the Gracenote Data, the Gracenote Software, and Gracenote Servers.

CONTINUED

Playing Hard Disc Drive (HDD) Audio (Models with navigation system)

Gracenote reserves all rights in Gracenote Data, the Gracenote Software, and the Gracenote Servers, including all ownership rights. Under no circumstances will Gracenote become liable for any payment to you for any information that you provide. You agree that Gracenote, Inc. may enforce its rights under this Agreement against you directly in its own name.

The Gracenote service uses a unique identifier to track queries for statistical purposes. The purpose of a randomly assigned numeric identifier is to allow the Gracenote service to count queries without knowing anything about who you are. For more information, see the web page for the Gracenote Privacy Policy for the Gracenote service.

The Gracenote Software and each item of Gracenote Data are licensed to you "AS IS."

Gracenote makes no representations or warranties, express or implied, regarding the accuracy of any Gracenote Data from in the Gracenote Servers. Gracenote reserves the right to delete data from the Gracenote Servers or to change data categories for any cause that Gracenote deems sufficient. No warranty is made that the Gracenote Software or Gracenote Servers are error-free or that functioning of Gracenote Software or Gracenote Servers will be uninterrupted.

Gracenote is not obligated to provide you with new enhanced or additional data types or categories that Gracenote may provide in the future and is free to discontinue its services at any time.

GRACENOTE DISCLAIMS ALL WARRANTIES EXPRESS OR IMPLIED, INCLUDING, BUT NOT LIMITED TO, IMPLIED WARRANTIES OF MERCHANTABILITY, FITNESS FOR A PARTICULAR PURPOSE, TITLE, AND NON-INFRINGEMENT. GRACENOTE DOES NOT WARRANT THE RESULTS THAT WILL BE OBTAINED BY YOUR USE OF THE GRACENOTE SOFTWARE OR ANY GRACENOTE SERVER. IN NO CASE WILL GRACENOTE BE LIABLE FOR ANY CONSEQUENTIAL OR INCIDENTAL DAMAGES OR FOR ANY LOST PROFITS OR LOST REVENUES.

© Gracenote 2008

Playing an iPod® (Models with navigation system)

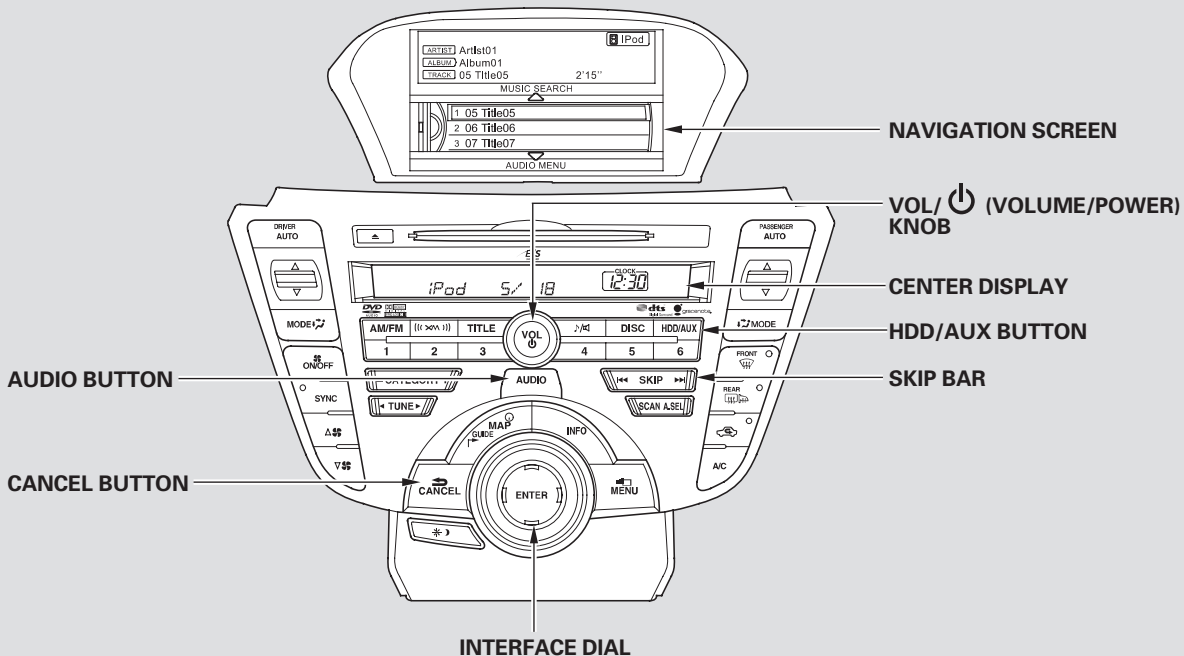

Playing an iPod® (Models with navigation system)

To Play an iPod®

This audio system can select and play the audio files on the iPod® with the same controls used for the in-dash disc player. To play an iPod, connect it to the USB adapter cable in the console compartment by using your dock connector, then press the HDD/AUX button. The power mode must be ACCESSORY or ON. The iPod will also be charged with the power mode in these settings.

Your vehicle has the engine start/stop button instead of an ignition switch. For more information to select the power mode, see page 178.

The audio system reads and plays sound files to be playable on the iPod. The system cannot operate an iPod as a mass storage device. The system will only play songs stored on the iPod with iTunes.

iPod and iTunes are registered trademarks owned by Apple Inc.

Voice Control System

You can select the AUX mode by using the navigation system voice control buttons, but cannot operate the play mode functions.

iPods that are compatible with your audio system are listed below.

Model	Firmware*
iPod 5G	Ver. 1.2 or more
iPod classic	Ver. 1.0 or more
iPod nano	Ver. 1.2 or more
iPod nano 2nd generation	Ver. 1.1.2 or more
iPod nano 3rd generation	Ver. 1.0 or more
iPod touch	Ver. 1.1.1 or more
iPhone	Ver. 1.1.1 or more

*: Use the latest firmware.

Use only compatible iPods with the latest firmware. iPods that are not compatible will not work in this audio unit.

Playing an iPod® (Models with navigation system)

NOTE:

- Do not connect your iPod using a hub.
- Do not keep the iPod and dock connector cable in the vehicle. Direct sunlight and high heat will damage it.
- Do not use an extension cable between the USB adapter cable equipped with your vehicle and your dock connector.
- We recommend backing up your data before playing it.

Connecting an iPod

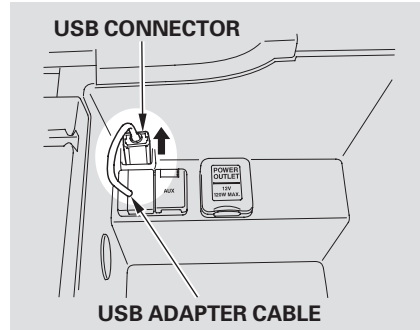

1. Unclip the USB connector by pulling it up, and pull out the USB adapter cable in the console compartment.

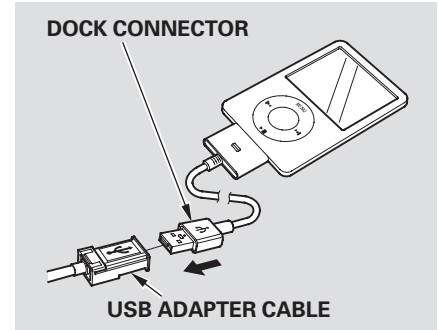

2. Connect your dock connector to the iPod correctly and securely.
3. Install the dock connector to the USB adapter cable securely.

CONTINUED

Playing an iPod® (Models with navigation system)

Sample Display

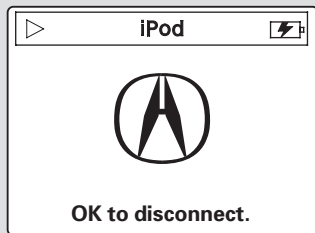

When the iPod is connected and the iPod mode is selected on the audio system, the iPod indicator is shown in the center display. If you selected the audio control display by pressing the AUDIO button, you will see the iPod icon on the screen. After loading, you will see the Acura logo* on the iPod. That means you can only operate your iPod using the vehicle's audio unit.

* : It may take a few minutes for the Acura logo to display on the iPod. If the display does not change, this function is not supported on your iPod model or firmware.

If the iPod indicator does not appear in the audio display, check the connections, and try to reconnect the iPod a few times.

If the audio system still does not recognize the iPod, the iPod may need to be reset. Follow the instructions that came with your iPod, or you can find reset instructions online at www.apple.com/ipod.

The current file number and total of the selected playable files are displayed in the center display. Pressing the AUDIO button displays the artist, album and track (file) names on the navigation screen.

Playing an iPod® (Models with navigation system)

To Change or Select Files

Use the SKIP bar while an iPod is playing to select passages and change files.

SKIP — Each time you press and release the ►►| side of the SKIP bar, the system skips forward to the beginning of the next track. Press and release the |◄◄ side of the bar to skip backward to the beginning of the current track. Press it again to skip to the beginning of the previous track.

To move rapidly within playing track, press and hold either side (►►| or |◄◄) of the SKIP bar.

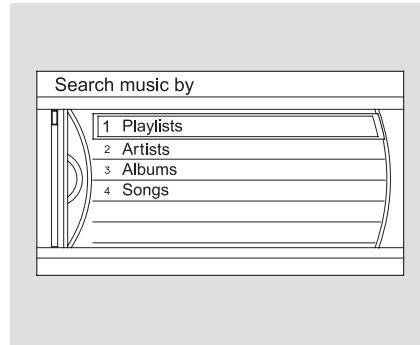

You can also select a track from any category on the list: playlists, artists, albums and songs, by using the interface dial.

Push the interface selector up to display the Music Search screen. Turn the interface dial to select a desired search method.

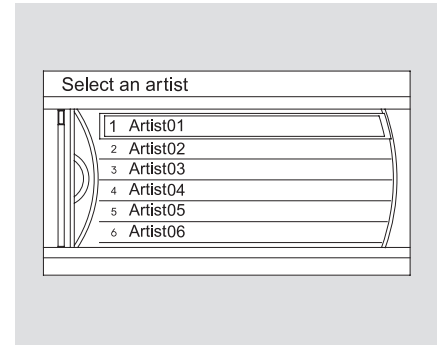

Press ENTER on the interface selector to display the items on that list, then turn the interface dial to make a selection. Press ENTER to set your selection.

CONTINUED

Playing an iPod® (Models with navigation system)

If you select “ALL” on the artists list, the albums list is displayed.

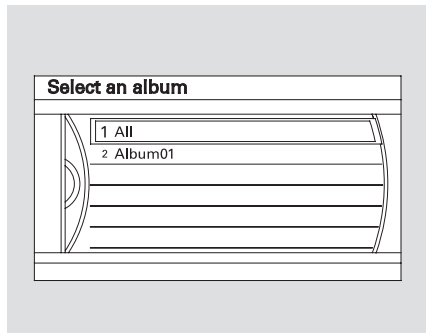

If you select “ALL” on the albums list, all the tracks become available for selection.

The track order that appears at this time varies depending on the iPod model and firmware.

Press the AUDIO button to go back to the normal audio playing display. Pressing the CANCEL button goes back to the previous screen, and pressing the MAP button cancels the audio control display on the screen.

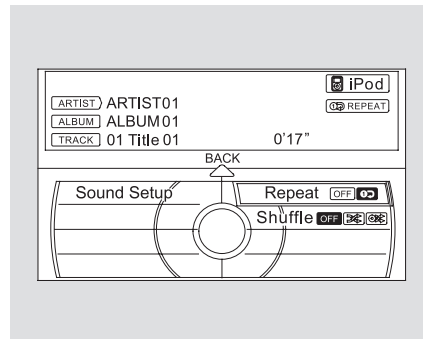

REPEAT – This feature continuously plays a file.

1. Press the AUDIO button to display the audio control screen, then push the interface selector down to display AUDIO MENU.
2. Turn the interface dial, select Repeat, and press ENTER on the interface selector.

Playing an iPod® (Models with navigation system)

3. Turn the interface dial, select the Repeat icon and press ENTER on the interface selector. Playback of the track that is currently being played will be repeated.

To cancel this function, turn the interface dial and select the Repeat OFF icon, and then press ENTER on the interface selector.

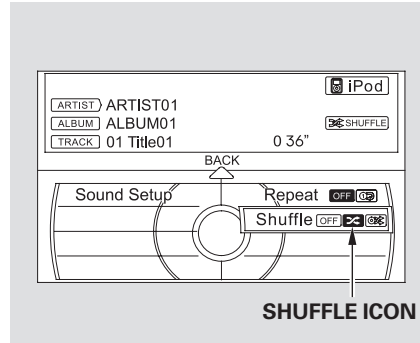

SHUFFLE – This feature shuffles playback of tracks contained within the iPod. This function can be established at the same time that Repeat Playback is set up.

1. On the iPod screen, push the interface selector down to display AUDIO MENU.

2. Turn the interface dial, select Shuffle and press ENTER on the interface selector.
3. Turn the interface dial, select the Shuffle icon and press ENTER on the interface selector.

Shuffle playback will begin. To cancel this function, turn the interface dial and select the Shuffle OFF icon, and then press ENTER on the interface selector.

CONTINUED

Playing an iPod® (Models with navigation system)

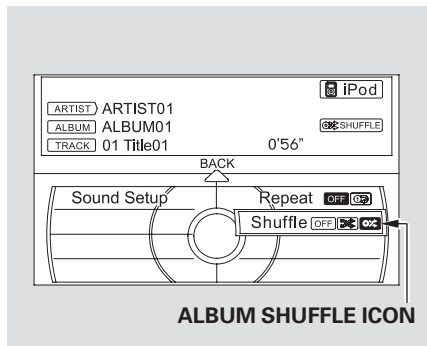

ALBUM SHUFFLE – Shuffles playback of all available albums, which are selected by the desired list: playlists, artists, albums or songs. This function can be selected at the same time that Repeat Playback is setup.

1. On the iPod screen, push the interface selector down to display AUDIO MENU.

2. Turn the interface dial, select Shuffle and press ENTER on the interface selector.
3. Turn the interface dial, select the Album Shuffle icon and press ENTER on the interface selector. Shuffle playback of the album will begin.

To cancel this function, turn the interface dial and select the Shuffle OFF icon, and then press ENTER on the interface selector.

NOTE:

Available operating functions vary on models or versions. Some functions may not be available on the vehicle's audio system.

To Stop Playing Your iPod

To play the radio, press the AM/FM, or «» button. Press the DISC button to switch to the disc mode. Press the HDD/AUX button to switch the audio mode between HDD Audio, USB and Bluetooth® Audio.

Disconnecting an iPod

You can disconnect the iPod at any time when you see “OK to disconnect” message* in the iPod display. Always make sure you see “OK to disconnect” message in the iPod display before you disconnect it. Make sure to follow the iPod’s instructions on how to disconnect the dock connector from the USB adapter cable.

* : The displayed message may vary on models or versions. On some models, there is no message to disconnect.

When you disconnect the iPod while it is playing, the center display and the audio screen (if selected) show USB NO DATA.

If you reconnect the same iPod, the system may begin playing where it left off, depending on what mode the iPod is in when it is reconnected.

NOTICE

When you connect your iPod to the navigation system, the most recent settings (Shuffle, Repeat, etc.) will be carried over.

iPod® Error Messages

If you see an error message in the center display, see page [354](#).

iPod® Error Messages (Models with navigation system)

If you see an error message in the center display while playing an iPod, find the solution in the chart to the right. If you cannot clear the error message, take your vehicle to your dealer.

Error Message	Solution
UNSUPPORTED Ver.	Appears when an unsupported iPod is inserted.
CONNECT RETRY	Appears when the iPod cannot be authenticated.
NO SONG	Appears when there are no files in the iPod.

Playing a USB Flash Memory Device (Models with navigation system)

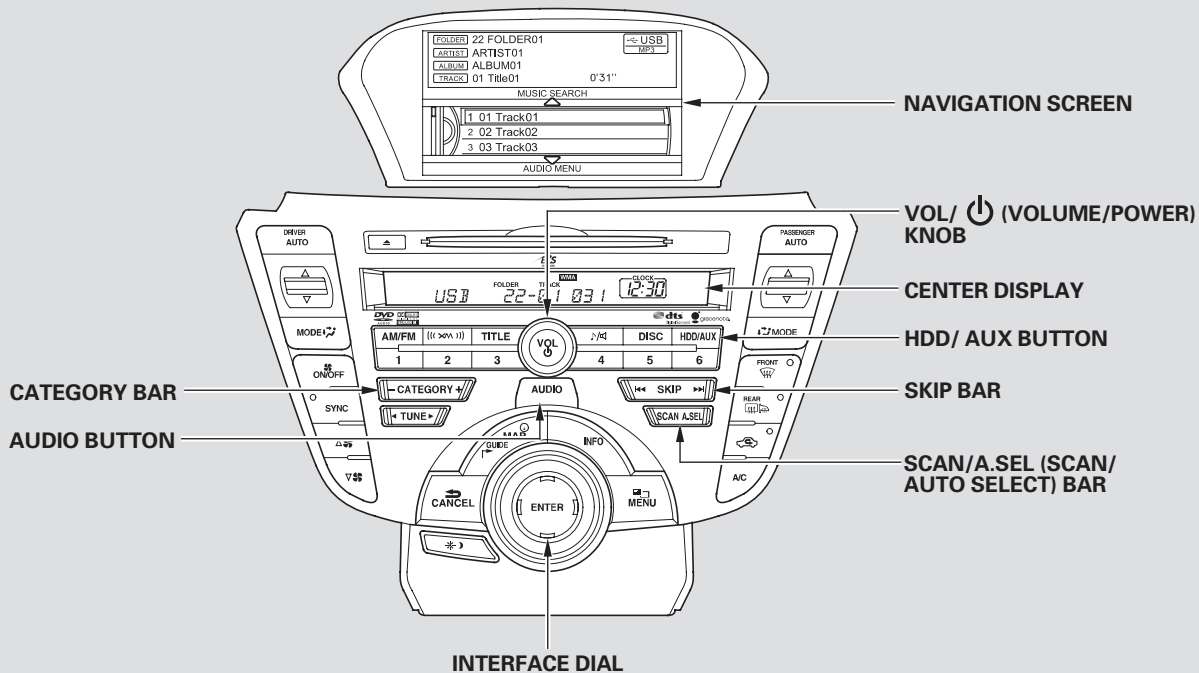

Playing a USB Flash Memory Device (Models with navigation system)

To Play a USB Flash Memory Device

This audio system can select and play the audio files on a USB flash memory device with the same controls used for the disc player. To play a USB flash memory device, connect it to the USB adapter cable in the console compartment, then press the HDD/AUX button until you see "AUX" in the display. The power mode must be ACCESSORY or ON.

Your vehicle has the engine start/stop button instead of an ignition switch. For more information to select the power mode, see page [178](#).

The audio system reads and plays the audio files on the USB flash memory device in MP3, WMA or AAC* formats. The USB flash memory device limit is up to 700 folders or up to 15000 files.

* : Only AAC format files recorded with iTunes are playable on this audio unit.

The recommended USB flash memory devices are 256 Mbyte or higher. Some digital audio players may be compatible as well.

Some USB flash memory devices (such as devices with security lock-out features, etc.) will not work in this audio unit.

NOTE:

- Do not use a device such as a card reader or hard drive as it or your files may be damaged.
- Do not connect your USB flash memory device using a hub.
- Do not use an extension cable to the USB adapter cable equipped with your vehicle.
- Do not keep a USB flash memory device in the vehicle. Direct sunlight and high heat will damage it.
- We recommend backing up your data before playing a USB flash memory device.
- Depending on the type and number of files, it may take some time before they begin to play.
- Depending on the software the files were made with, it may not be possible to play some files, or display some text data.

Playing a USB Flash Memory Device (Models with navigation system)

- The order of files in USB playback may be different from the order of files displayed in PC or other devices etc. Files are played in the order stored in USB flash memory device.

Voice Control System

You can select the AUX mode by using the voice control buttons, but cannot operate the play mode functions.

The specifications for compatible MP3 files are:

- Sampling frequency:
8/11.025/12/16/22.05/24/32/
44.1/48 kbps (MPEG1)
16/22.05/24/32/44.1/48/64/88.2/
96 kbps (MPEG2)
32/44.1/48/64/88.2/96/128/
176.4/192 kbps (MPEG2.5)
- Bitrate:
8 – 320 kHz
- Supported standards:
MPEG1 Audio Layer3
MPEG2 Audio Layer3
MPEG2.5 Audio Layer3
- Partition: Top partition only

The specifications for compatible WMA files are:

- Sampling frequency:
48 kHz
- Bitrate:
48 – 20 kbps

The specifications for compatible AAC files are:

- Sampling frequency:
8/11.025/12/16/22.05/24/32/
44.1/48 kHz
- Bitrate:
16/24/32/40/48/56/64/80/96/
112/128/144/160/192/224/256
kbps
- Partition: Top partition only

Some versions of MP3, WMA, or AAC format may not be supported. If an unsupported file is found, the audio unit displays **UNSUPPORTED**, then skips to the next file.

CONTINUED

Playing a USB Flash Memory Device (Models with navigation system)

In WMA or AAC format, DRM (digital rights management) files cannot be played. If the system finds a DRM file, the audio unit displays UNPLAYABLE FILE, and then skips to the next file.

NOTICE

Combining a low sampling frequency with a low bitrate may result in extremely degraded sound quality.

Connecting a USB Flash Memory Device

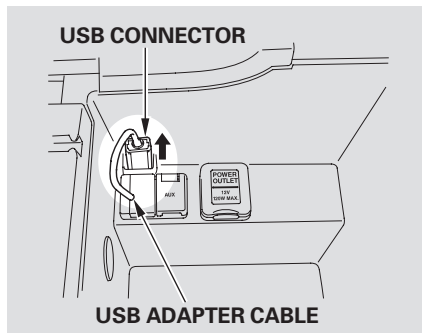

1. Unclip the USB connector by pulling it up, and pull out the USB adapter cable in the console compartment.

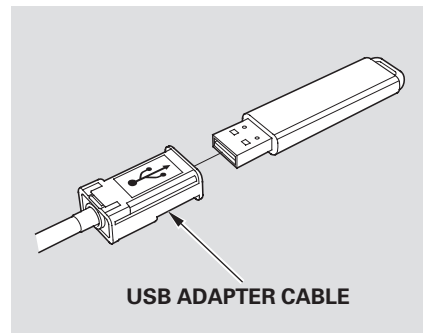

2. Connect the USB flash memory device to the USB adapter cable correctly and securely.

Playing a USB Flash Memory Device (Models with navigation system)

When the USB device is connected and the USB mode is selected on the audio system, the USB indicator is shown in the center display. It also shows the folder and file numbers. Pressing the AUDIO button displays the USB indicator, the folder and file names, and the elapsed time in the navigation screen.

To Change or Select Files

Use the SKIP bar while a USB flash memory device is playing to select passages and change files.

SKIP – Each time you press and release the ►► side of the SKIP bar, the system skips forward to the beginning of the next file. Press and release the ◀◀ side of the bar, to skip backward to the beginning of the current file. Press it twice to skip to the beginning of the previous file.

To move rapidly within a file, press and hold either side (►► or ◀◀) of the SKIP bar.

Folder Selection – To select a different folder, press and release either side of the CATEGORY bar. Press the + side to skip to the next folder, and press the – side to skip to the beginning of the previous folder.

To Select a File from Folder and File Lists

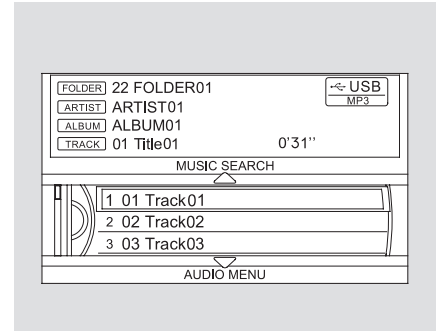

You can also select a folder or file from the list by using the interface dial. Press the AUDIO button to show the audio display on the navigation screen. Use the interface dial to highlight the file, then press ENTER to set your selection.

CONTINUED

Playing a USB Flash Memory Device (Models with navigation system)

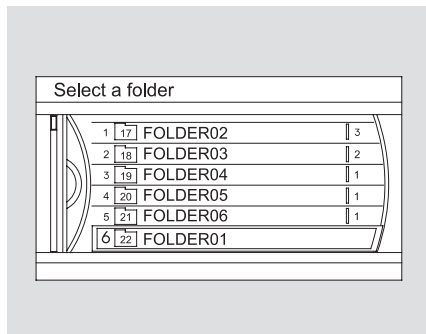

Push the selector up to display the folder list screen, then turn the interface dial to select a folder. Press ENTER to set your selection.

If you have more than one layer of folders (folders within folders), you can also see each folder on the screen.

To go back to the normal playing display, press the AUDIO button. Pressing the CANCEL button goes back to the previous screen and pressing the MAP button cancels the audio mode display.

To Select Repeat, Random or Scan Mode:

Push the interface selector down to display the AUDIO MENU.

You can select any type of repeat, random or scan mode on the audio menu screen.

Move the interface selector up to select BACK to show the USB screen, or press the CANCEL button to return to the previous screen.

TRACK REPEAT

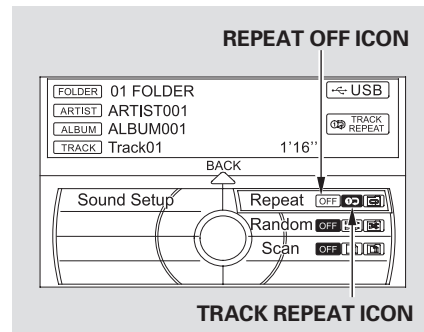

This function repeats playback of the track.

1. On the USB main screen, push the interface selector down to display AUDIO MENU.
2. Turn the interface dial to select Repeat and press ENTER on the interface selector.

Playing a USB Flash Memory Device (Models with navigation system)

3. Turn the interface knob, select the Track Repeat icon and press ENTER on the interface selector. Playback of the track that is currently being played will be repeated.

To cancel this function, turn the interface dial and select the Repeat OFF icon, and then press ENTER on the interface selector.

Pressing either side of the SKIP bar also cancels this function.

FOLDER REPEAT

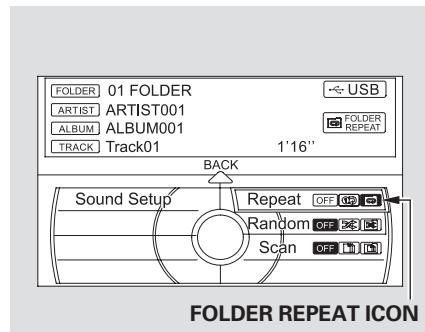

This function replays all the tracks in a folder in the order that they were stored.

1. On the USB main screen, push the interface selector down to display AUDIO MENU.
2. Turn the interface dial to select Repeat and press ENTER on the interface selector.

3. Turn the interface dial, select the Folder Repeat icon and press ENTER on the interface selector. Playback of the folder that is currently being played will be repeated.

To cancel this function, turn the interface dial and select the Repeat OFF icon, and then press ENTER on the interface selector.

Playing a USB Flash Memory Device (Models with navigation system)

TRACK RANDOM

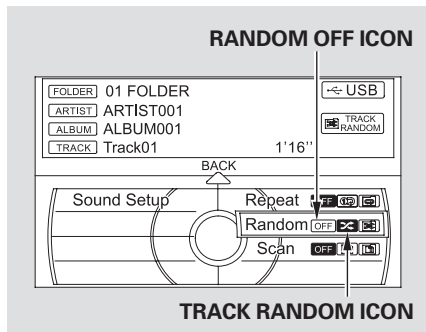

This function plays all the tracks on the USB flash memory device in random order.

1. On the USB main screen, push the interface selector down to display AUDIO MENU.
2. Turn the interface dial, select Random and press ENTER on the interface selector.

3. Turn the interface dial, select the Track Random icon and press ENTER on the interface selector. The tracks are played in random order.

To cancel this function, turn the interface dial and select the Random OFF icon, and then press ENTER on the interface selector.

FOLDER RANDOM

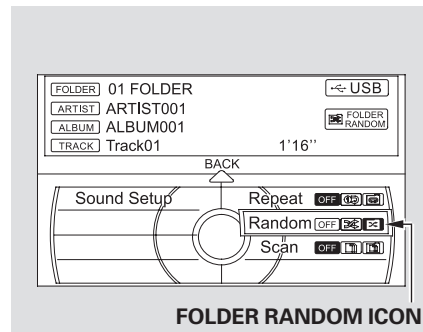

This function plays all of the tracks in the current folder in random order.

1. On the USB main screen, push the interface selector down to display AUDIO MENU.
2. Turn the interface dial, select Random and press ENTER on the interface selector.

Playing a USB Flash Memory Device (Models with navigation system)

- Turn the interface dial, select the Folder Random icon and press ENTER on the interface selector. The files are played in random order.

To cancel this function, turn the interface dial and select the Random OFF icon, and then press ENTER on the interface selector.

TRACK SCAN

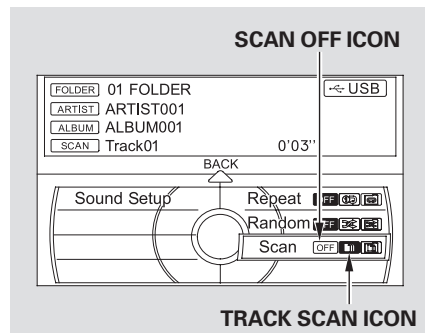

This function samples all the tracks in the current folder in the order that they were recorded.

- On the USB main screen, push the interface selector down to display AUDIO MENU.
- Turn the interface dial, select the Scan icon and press ENTER on the interface selector.

- Turn the interface dial, select Track Scan icon and press ENTER on the interface selector. Each track or file is sampled for 10 seconds. When all the tracks in the folder have been scanned, regular playback is resumed.

To cancel this function, turn the interface dial and select the Scan OFF icon, and then press ENTER on the interface selector to play the last track sampled.

Playing a USB Flash Memory Device (Models with navigation system)

FOLDER SCAN

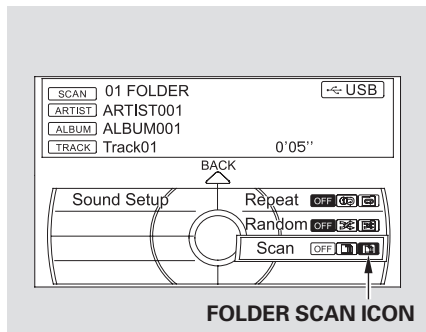

This function samples the first file in each folder within the USB flash memory device.

1. On the USB main screen, push the interface selector down to display AUDIO MENU.
2. Turn the interface dial, select the Scan icon and press ENTER on the interface selector.

3. Turn the interface dial, select Folder Scan icon and press ENTER on the interface selector.

The first file of the first folder is sampled for 10 seconds. If no other operations are carried out, the first files of the remaining folders are played for 10 seconds. After the first file of the last folder is played back, regular playback is resumed.

To cancel this function, turn the interface dial and select the Scan OFF icon, and then press ENTER on the interface selector.

To Stop Playing a USB Flash Memory Device

To play the radio, press the AM/FM, or XM button. Press the DISC button to switch to the disc mode. Press the HDD/AUX button to switch the mode between the HDD Audio, USB, and Bluetooth® Audio.

If you reconnect the same USB flash memory device, the system will begin playing where it left off.

Playing a USB Flash Memory Device (Models with navigation system)

Disconnecting a USB Flash Memory Device

You can disconnect the USB flash memory device at any time even if the USB mode is selected on the audio system. Always follow the USB flash memory device's instructions when you remove it.

When you disconnect the USB flash memory device while it is playing, the center display and the audio screen (if selected) show NO DATA.

USB Flash Memory Device Error Messages

If you see an error message in the center display, see page [366](#).

USB Flash Memory Device Error Messages (Models with navigation system)

If you see an error message in the center display while playing a USB flash memory device, find the solution in the chart to the right. If you cannot clear the error message, take your vehicle to your dealer.

Error Message	Solution
FILE ERROR	The system cannot read the file(s). Check the files in the USB flash memory device. There is a possibility that the files have been damaged.
UNSUPPORTED	Appears when the unsupported USB flash memory device is inserted.
UNPLAYABLE FILE	Appears when the file is copyright protected, such as DRM.
NO SONG	Appears when there are no playable files in the USB flash memory device.

Bluetooth® Audio System (Models with navigation system)

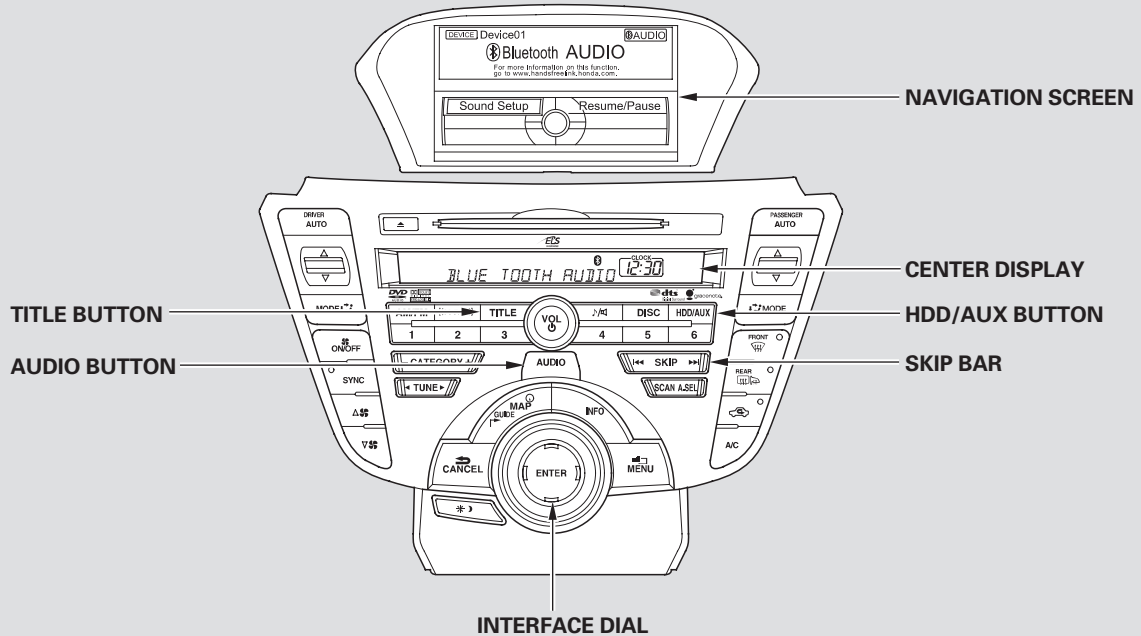

CONTINUED

Bluetooth® Audio System (Models with navigation system)

Your vehicle is equipped with a Bluetooth® audio system, which allows you to listen to streaming audio from your Bluetooth audio compatible phone. This function is only available on Bluetooth Audio Compatible phones that are paired and linked to the vehicle's Bluetooth® HandsFreeLink® (HFL) system (see page 426).

Not all Bluetooth-enabled phones with streaming audio capabilities are compatible with the system. You can find an approved phone by visiting www.acura.com/handsfreelink, or by calling the HandsFreeLink® consumer support at 1-888-528-7876. In Canada, visit www.acura.ca, or call 1-888-9-ACURA-9.

NOTE: In some states it may be illegal to perform some data device functions while driving.

To Play Bluetooth® Audio Files

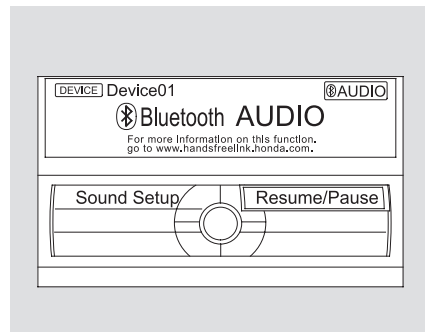

Make sure that your phone is paired and linked to the HFL.

To begin to play the audio files, you may need to operate your phone. If so, follow the phone maker's operating instructions.

Press the HDD/AUX button* with the power mode ACCESSORY or ON. When the phone is recognized, you will see the Bluetooth® Audio

message and icon on the center display and the audio control display on the navigation screen (if selected), and the system begins to play.

Your vehicle has the engine start/stop button instead of an ignition switch. For more information to select the power mode, see page 178.

*: If an iPod or USB flash memory device or audio unit connected to the auxiliary input jack was selected at the last mode, you will see iPod, USB or AUX in the center display and the audio control display on the navigation screen (if selected). Push the HDD/AUX button again to play audio files from your Bluetooth® Audio phone.

Bluetooth® Audio System (Models with navigation system)

Once a device is linked, the name of the device will appear on the screen. Pressing the TITLE button switches the center display between the Bluetooth® Audio and the device name.

If more than one phone is paired to the HFL system, there will be delay before the system begins to play.

In the following conditions, the display shows “NO CONNECT” message after pressing the TITLE button.

- The phone is not linked to HFL.
- The phone is not turned on.
- The phone is not in the vehicle.
- Another HFL compatible phone, which is not compatible for Bluetooth® Audio, is already connected.

If your Bluetooth® Audio compatible phone does not operate as described, make sure it is an Acura approved phone. To find out if your phone is approved, go to www.acura.com/handsfreelink (in Canada, www.acura.ca), or call the HandsFreeLink® consumer support at 1-888-528-7876.

Voice Control System

You can select the AUX mode by using the voice control buttons, but cannot operate the play mode functions.

To skip a file

Press the ►► side of the SKIP bar to skip forward to the next file, and press the ◀◀ side to skip backward to the beginning of the current file. Push the ◀◀ side again to skip to the previous file.

CONTINUED

Bluetooth® Audio System (Models with navigation system)

To pause or resume a file

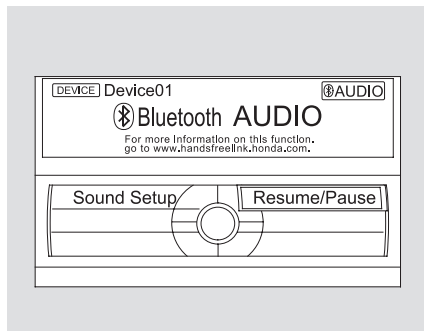

The resume/pause mode can stop playing a file temporarily.

Turn the interface dial to switch the setting between the resume/pause mode and the sound setup mode. Select Resume/Pause, then press ENTER to set your selection. Each time you press ENTER, the system switches between the resume mode and pause mode.

NOTE: The pause function may not be available on some phone devices.

To change sound settings

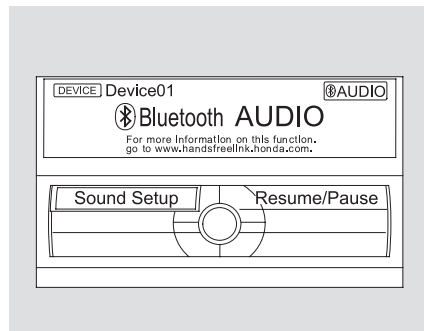

Press the AUDIO button to display the audio control display. Turn the dial to switch the setting between the resume/pause mode and the sound setup mode. Select Sound Setup, then press ENTER to set your selection.

Bluetooth® Audio System (Models with navigation system)

Turn the dial to select a sound setup mode, then press ENTER to set your selection. See page 288 for more sound setting information.

To switch to HFL mode

If you receive a call when the Bluetooth® Audio is playing, press the PICK-UP button on the steering wheel. The screen and the center display switch to the HFL mode (see page 424).

After ending the call, press the HANG-UP button to go back to the Bluetooth® Audio mode.

To turn off the Bluetooth® Audio mode

Select any other audio mode by pressing a button; AM/FM, («»»») or DISC on the audio control panel, or press the MODE button on the steering wheel to select another audio mode.

Switching to another mode pauses the music playing from your phone.

As required by the FCC:

This device complies with Part 15 of the FCC rules. Operation is subject to the following two conditions: (1) This device may not cause harmful interference, and (2) this device must accept any interference received, including interference that may cause undesired operation.

Changes or modifications not expressly approved by the party responsible for compliance could void the user's authority to operate the equipment.

This device complies with Industry Canada Standard RSS-210. Operation is subject to the following two conditions: (1) this device may not cause interference, and (2) this device must accept any interference that may cause undesired operation of the device.

AM/FM Radio Reception

Radio Frequencies

Your vehicle's radio can receive the complete AM and FM bands. Those bands cover these frequencies:

AM band: 530 to 1,710 kHz
FM band: 87.7 to 107.9 MHz

Radio stations on the AM band are assigned frequencies at least 10 kHz apart (530, 540, 550). Stations on the FM band are assigned frequencies at least 0.2 MHz apart (87.9, 88.1, 88.3).

Stations must use these exact frequencies. It is fairly common for stations to round-off the frequency in their advertising, so your radio could display a frequency of 100.9 even though the announcer may identify the station as "FM101."

Radio Reception

How well your vehicle's radio receives stations is dependent on many factors, such as the distance from the station's transmitter, nearby large objects, and atmospheric conditions.

A radio station's signal gets weaker as you get farther away from its transmitter. If you are listening to an AM station, you will notice the sound volume becoming weaker, and the station drifting in and out. If you are listening to an FM station, you will see the stereo indicator flickering off and on as the signal weakens. Eventually, the stereo indicator will go off and the sound will fade completely as you get out of range of the station's signal.

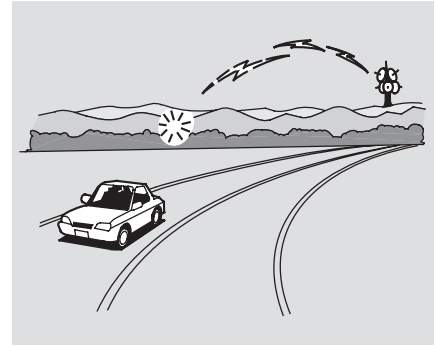

Driving very near the transmitter of a station that is broadcasting on a frequency close to the frequency of the station you are listening to can also affect your radio's reception. You may temporarily hear both stations, or hear only the station you are close to.

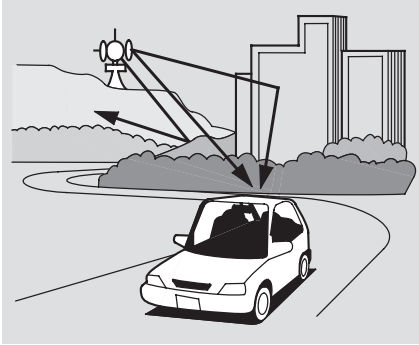

Radio signals, especially on the FM band, are deflected by large objects such as buildings and hills. Your radio then receives both the direct signal from the station's transmitter, and the deflected signal. This causes the sound to distort or flutter. This is a main cause of poor radio reception in city driving.



Radio reception can be affected by atmospheric conditions such as thunderstorms, high humidity, and even sunspots. You may be able to receive a distant radio station one day and not receive it the next day because of a change in conditions.

Electrical interference from passing vehicles and stationary sources can cause temporary reception problems.

*As required by the FCC:
Changes or modifications not expressly
approved by the party responsible for
compliance could void the user's
authority to operate the equipment.*

Remote Audio Controls

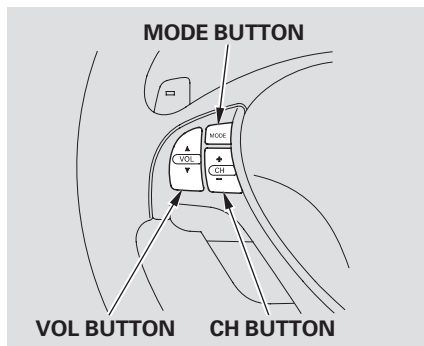

Three controls for the audio system are mounted in the steering wheel hub. These let you control basic functions without removing your hand from the wheel.

The VOL button adjusts the volume up (▲) or down (▼). Press the top or bottom of the button, hold it until the desired volume is reached, then release it.

The MODE button changes the mode. Pressing the button repeatedly selects FM1, FM2, AM, XM radio, disc (if a disc is loaded), HDD (on models with navigation system), Bluetooth® Audio (if paired), AUX (if an appropriate audio unit is connected).

If an iPod or a USB flash memory device is plugged into the system, you can also select AUX.

If you are listening to the radio, use the CH button to change stations. Each time you press the top (+) of the button, the system goes to the next preset station on the band you are listening to. Press the bottom (-) to go back to the previous preset station. If you press and hold the CH button (+) or (-), the system goes into the skip (seek) mode. It stops when it finds a station with a strong signal.

To activate the seek function, press and hold the top (+) or bottom (-) of the CH button until you hear a beep. The system searches up or down from the current frequency to find a station with a strong signal.

If you are playing a disc, the system skips to the beginning of the next track (file in MP3 or WMA format) each time you press the top (+) of the CH button. Press the bottom (-) to return to the beginning of the current track/file. Press it twice to return to the previous track/file.

You will see the track/file number and the elapsed time. If the disc has text data or is compressed in MP3 or WMA, you can also see any other information (track title, file name, folder name, etc.).

In MP3 or WMA mode, you can use the seek function to select folders. Press and hold the top (+) of the CH button until you hear a beep, to skip forward to the first file of the next folder. Press the bottom (–) to skip backward to the previous folder.

If you are playing a USB flash memory device or iPod with the USB adapter cable, press and release the top (+) of the CH button to skip forward to the beginning of the next file. Press the bottom (–) to skip backward to the beginning to the current file. Press it twice to return to the previous file.

When playing a USB flash memory device, you can also use the seek function to skip the folder. To activate this, press and hold either side of the CH button until you hear a beep.

On models without navigation system
If you are playing a conventional CD (without the text data and not compressed in MP3 or WMA), you can use the skip function to select discs. Press and hold the top (+) of the CH button until you hear a beep, to skip forward to the next disc. Press and hold the bottom (–) to skip backward to the previous disc.

Auxiliary Input Jack

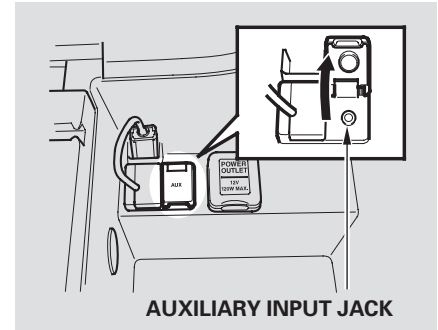

The auxiliary input jack is inside the console compartment. The system will accept auxiliary input from standard audio accessories using a 1/8 inch stereo miniplug.

When a compatible audio unit is connected to the jack, press the HDD/AUX button (AUX button on models without navigation system) to select it.

Radio Theft Protection

Your vehicle's audio system may disable itself if it is disconnected from electrical power for any reason. To make it work again, you must enter a specific five-digit code with the preset buttons. Because there are hundreds of number combinations possible from the five digits, making the system work without knowing the exact code is nearly impossible.

You should have received a radio code card that lists your audio system's code and serial numbers. It is best to store this card in a safe place at home. In addition, you should write the audio system's serial number in this owner's manual.

If you lose the card, you must obtain the code number from your dealer. To do this, you will need the audio system's serial number.

NOTE:

If you have a My Acura account, you can retrieve the anti-theft code online.

If your vehicle's battery is disconnected or goes dead, the audio system will disable itself. If this happens, you will see "ENTER CODE" in the frequency display (on the center display on models with navigation system) the next time you turn on the system. Use the preset buttons to enter the five-digit code. The code is on the radio code card included in your owner's manual kit. When it is entered correctly, the radio will start playing.

If you make a mistake entering the code, do not start over; complete the five-digit sequence, then enter the correct code. You have ten tries to enter the correct code. If you are unsuccessful in ten attempts, you must then leave the system on for 1 hour before trying again.

The system will retain your AM and FM presets even if power is disconnected.

On models without navigation system
To set the time, press the **CLOCK** button until you hear a beep. The displayed time begins to blink.

Change the hours by pressing the **H** (hour) button until the numbers advance to the desired time. Change the minutes by pressing the **M** (minute) button until the numbers advance to the desired time.

Press the **CLOCK** button again to enter the set time.

You can quickly set the time to the nearest hour. If the displayed time is before the half hour, press and hold the **CLOCK** button, then press the **R** (reset) button to set the time back to the previous hour. If the displayed time is after the half hour, the same procedure sets the time forward to the beginning of the next hour.

On models without navigation system

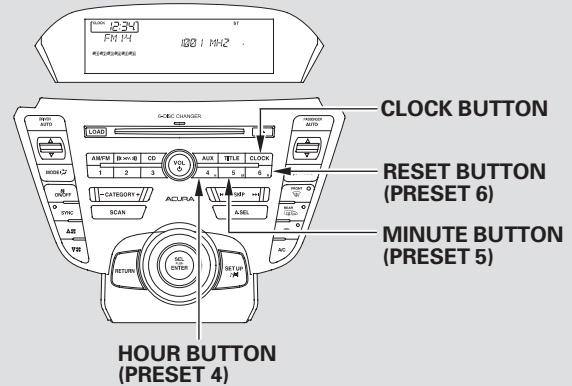

U.S. model is shown.

For example:

- 1:06 would RESET to 1:00.
- 1:52 would RESET to 2:00.

On models with navigation system

The navigation system receives signals from the global positioning system (GPS), and the displayed time is updated automatically by the GPS. Refer to the navigation system manual for how to adjust the time.

CONTINUED

Setting the Clock

On models without navigation system

Adjusting the Clock with SETUP Button

You can also adjust the clock and switch the clock display between 24-hours and 12-hours in the menu mode.

To adjust the clock setting:

1. Press and release the SETUP button. The display shows you the menu items.

You can adjust the clock setting with the ignition switch in the ACCESSORY (I) or ON (II) position.

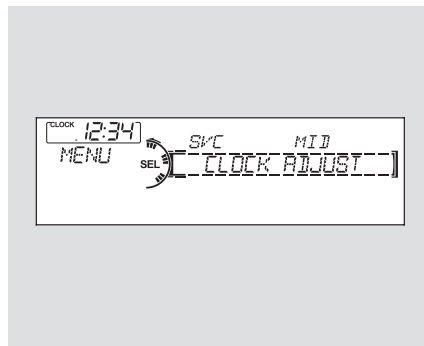

2. Turn the selector knob to select "CLOCK ADJUST."
3. Press the selector knob (ENTER) to enter your selection. The display changes to the clock adjusting display.

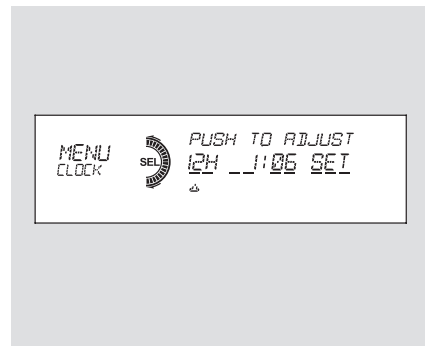

4. Turn the selector knob to select the item which you want to adjust. Turning the selector knob will change the selected item between the clock display setting, hours, minutes, and SET. The selected item is indicated with Δ in the display.

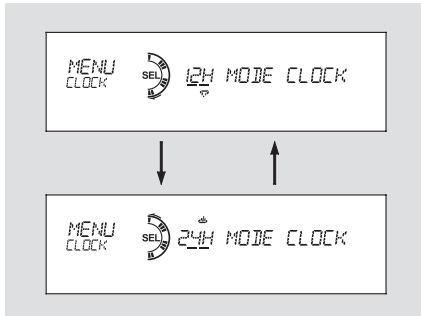

5. Turn the selector knob to change the setting between 12H and 24H.
6. Press the selector knob (ENTER) to enter your selection. The display will return to the clock adjusting display.

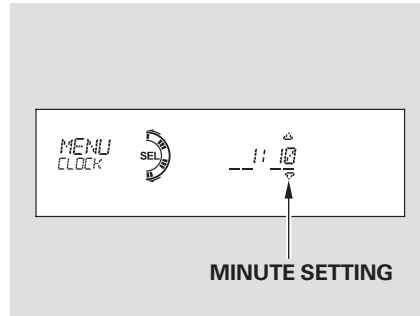

7. To set the time, turn the selector knob and select the hours or the minutes, then press the knob to enter your selection. The display changes to the setting display.
8. Turn the selector knob to count the numbers up or down.
9. Press the selector knob (ENTER) to enter your selection. The display will return to the clock adjusting display.

While setting the clock, pressing the RETURN button will go back to the previous display. Pressing the SETUP button again will cancel this setting mode.

CONTINUED

Setting the Clock, Security System

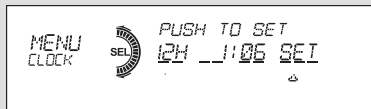

10. To enter the clock setting, turn the selector knob to select “SET,” then press the knob. The display will return to the menu item display.
11. Press either the RETURN or SETUP button to go back to the normal display.

Security System

The security system helps to protect your vehicle and valuables from theft. The horn sounds and a combination of headlights, parking lights, side marker lights and taillights flash if someone attempts to break into your vehicle or remove the audio unit. This alarm continues for 2 minutes, then the system resets. To reset an activated system before the 2 minutes have elapsed, unlock the driver’s door with the key or use the remote transmitter/keyless access remote.

On models with keyless access system
You can also turn off an activated system by grabbing either front door handle while carrying the keyless access remote to unlock the door.

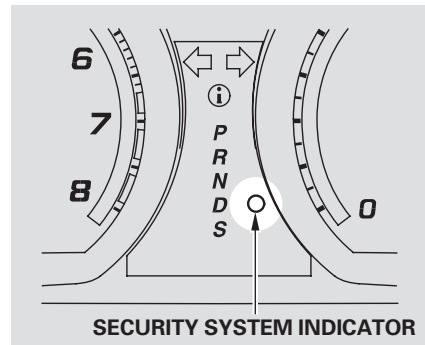

The security system automatically sets 15 seconds after you lock the doors, hood, and trunk. For the system to activate, you must lock the doors from the outside with the key, driver’s lock tab, master door lock switch, or remote transmitter (keyless access remote on models with keyless access system). The security system indicator on the instrument panel starts blinking immediately to show you the system is setting itself.

On models with keyless access system
You can also set the security system by pressing the lock button on either front door handle while carrying the keyless access remote.

Once the security system is set, opening any door (without using the key or the remote transmitter/keyless access remote), the hood, or the trunk will cause the system to alarm. It also alarms if the audio unit is removed from the dashboard or the wiring is cut.

With the system set, you can still open the trunk with the remote transmitter/keyless access remote without triggering the alarm. The alarm will sound if the trunk is opened with the trunk release button on the driver's door, the trunk release handle behind the trunk pass-through cover, or the emergency trunk opener.

NOTE: Use the remote transmitter/keyless access remote to quickly check that the hood, the trunk, and all doors are closed. Push the lock button twice within 5 seconds. There should be an audible confirmation beep.

The security system will not set if the hood, trunk, or any door is not fully closed. If the system will not set, check the door and trunk open monitor on the multi-information display (see page 11) to see if the doors and trunk are fully closed. Since it is not part of the monitor display, manually check the hood.

Do not attempt to alter this system or add other devices to it.

Compass

On models without navigation system

Compass Operation

Compass operation can be affected by driving near power lines or stations, across bridges, through tunnels, over railroad crossings, past large vehicles, or driving near large objects that can cause a magnetic disturbance. It can also be affected by accessories such as antennas and roof racks that are mounted by magnets.

When you turn the ignition switch to the ON (II) position, the compass is self-calibrating, then the compass display is shown in the display.

Compass Calibration

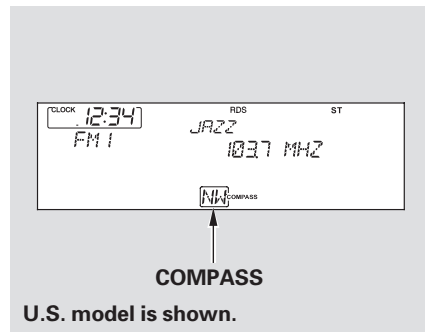

The compass may need to be manually calibrated after exposure to a strong magnetic field. If the compass seems to be continually showing the wrong direction and is not self-calibrating, or the compass display is blinking with the CAL indicator on, do the following.

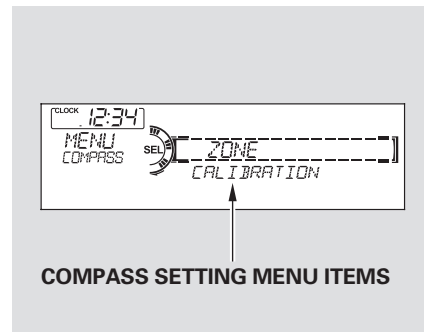

NOTE: Do this procedure in an open area, away from buildings, power lines, and other vehicles.

1. Turn the ignition switch to the ON (II) position.
2. Press and hold the SETUP button for about 5 seconds. The display shows you the compass setting menu items.

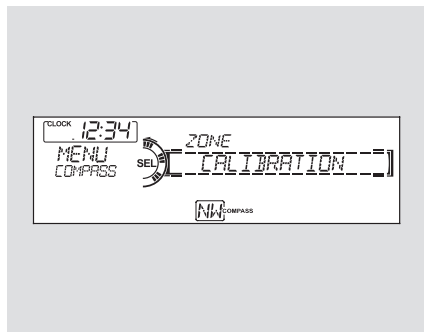

3. Turn the selector knob to select “CALIBRATION.”

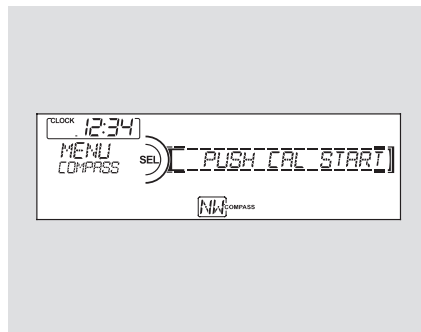

4. Press the selector knob (ENTER) to enter your selection. The display shows you “PUSH CAL START.”

While setting the compass, pressing the RETURN button will go back to the previous display. Pressing the SETUP button will cancel the compass setting mode.

5. Press the selector knob (ENTER). The compass display is blinking and the CAL indicator is shown.
6. Drive the vehicle slowly in two complete circles.

When the calibration is successfully completed, the CAL indicator goes off and the compass display will stop blinking and show an actual heading.

The audio system is not related to the compass system. Even if the compass system is calibrating, the display returns to the normal display which you last selected.

Compass

Compass Zone Selection

In most areas, there is a variation between magnetic north and true north. Zone selection is required so the compass can compensate for this variation. To check and select the zone, do this:

1. Turn the ignition switch to the ON (II) position.
2. Press and hold the SETUP button for about 5 seconds. The display shows you the compass setting menu items.
3. Turn the selector knob to select "ZONE." Press the selector knob (ENTER) to enter your selection. The display shows you the currently selected zone number.

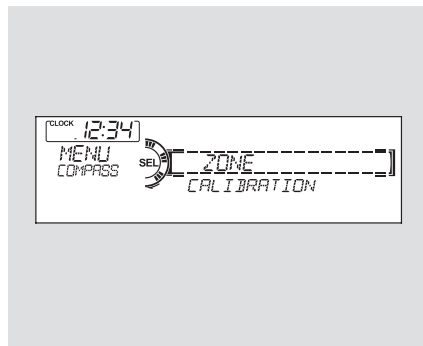

4. Find the zone for your area on the map (see page 385). If the correct zone is not shown, turn the selector knob to cycle the zone lists up or down.

If necessary, press the RETURN button to return to the previous display. Pressing the SETUP button will cancel the compass setting mode.

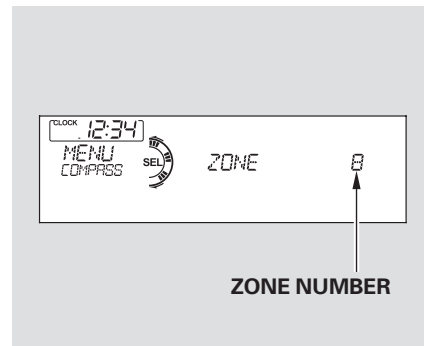

5. Once the correct zone is displayed, press the selector knob. The display then returns to normal.

The audio system is not related to the compass system. Even if the compass system is in the zone setting mode, the display returns to the normal display which you last selected.

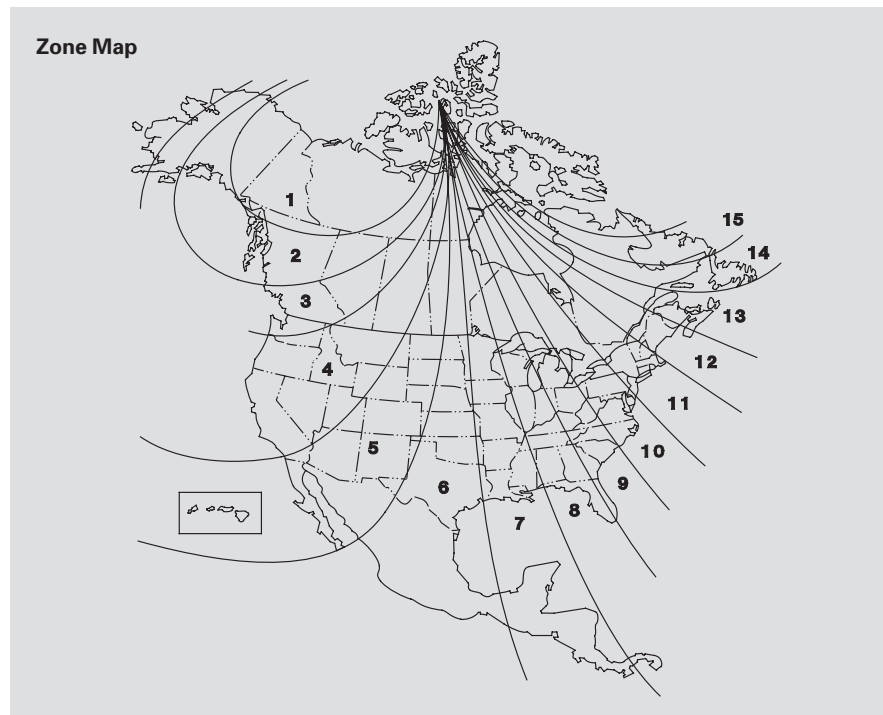

Cruise Control

Cruise control allows you to maintain a set speed above 25 mph (40 km/h) without keeping your foot on the accelerator pedal. It should be used for cruising on straight, open highways. It is not recommended for city driving, winding roads, slippery roads, heavy rain, or bad weather.

⚠ WARNING

Improper use of the cruise control can lead to a crash.

Use the cruise control only when traveling on open highways in good weather.

Using the Cruise Control

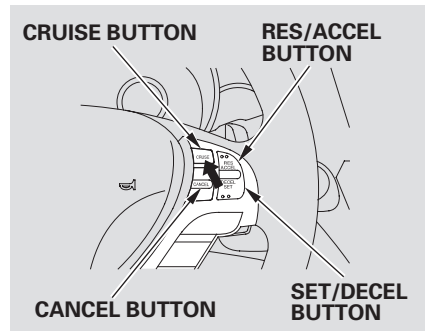

1. Push in the CRUISE button on the steering wheel. The CRUISE MAIN indicator on the instrument panel will come on.

The cruise control system can be left on, even when it is not in use.

2. Accelerate to the desired cruising speed above 25 mph (40 km/h).

3. Press and release the SET/DECEL button on the steering wheel. The CRUISE CONTROL indicator on the instrument panel comes on to show the system is now activated.

Cruise control may not hold the set speed when you are going up and down hills. If your vehicle speed increases going down a hill, use the brakes to slow down. This will cancel the cruise control. To resume the set speed, press the RES/ACCEL button. The CRUISE CONTROL indicator on the instrument panel will come back on.

When climbing a steep hill, the automatic transmission may downshift to hold the set speed.

Changing the Set Speed

You can increase the set cruising speed in any of these ways:

- Press and hold the RES/ACCEL button. When you reach the desired cruising speed, release the button.
- Push on the accelerator pedal. Accelerate to the desired cruising speed, then press the SET/DECEL button.
- To increase the speed in very small amounts, tap the RES/ACCEL button. Each time you do this, your vehicle speeds up about 1 mph (1.6 km/h).

You can decrease the set cruising speed in any of these ways:

NOTE: If you need to decrease your speed quickly, use the brakes as you normally would.

- Press and hold the SET/DECEL button. Release the button when you reach the desired speed.
- To slow down in very small amounts, tap the SET/DECEL button. Each time you do this, your vehicle will slow down about 1 mph (1.6 km/h).
- Tap the brake pedal lightly with your foot. The CRUISE CONTROL indicator on the instrument panel goes out. When the vehicle slows to the desired speed, press the SET/DECEL button.

Even with cruise control turned on, you can still use the accelerator pedal to speed up for passing. After completing the pass, take your foot off the accelerator pedal. The vehicle will return to the set cruising speed.

Resting your foot on the brake pedal causes cruise control to cancel.

Cruise Control

Canceling Cruise Control

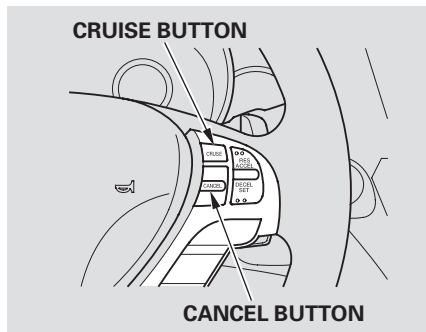

You can cancel cruise control in any of these ways:

- Tap the brake pedal.
- Push the CANCEL button on the steering wheel.
- Push the CRUISE button on the steering wheel.

Resuming the Set Speed

When you push the CANCEL button, or tap the brake pedal, the system remembers the previously set cruising speed. To return to that speed, accelerate to above 25 mph (40 km/h) and then press and release the RES/ACCEL button. The CRUISE CONTROL indicator comes on, and the vehicle accelerates to the same cruising speed as before.

Pressing the CRUISE button turns the system completely off and erases the previous cruising speed.

The HomeLink® Universal Transceiver built into your vehicle can be programmed to operate up to three remote controlled devices around your home, such as garage doors, lighting, or home security systems.

General Safety Information

Before programming your HomeLink to operate a garage door opener, confirm that the opener has an external entrapment protection system, such as an “electronic eye,” or other safety and reverse stop features.

If your garage door was manufactured before April 1, 1982, you may not be able to program HomeLink to operate it. These units do not have safety features that cause the motor to stop and reverse it if an obstacle is detected during closing, increasing the risk of injury. Do not use HomeLink with any

garage door opener that lacks safety stop and reverse features.

Units manufactured between April 1, 1982 and January 1, 1993 may be equipped with safety stop and reverse features. If your unit does not have an external entrapment protection system, an easy test to confirm the function and performance of the safety stop and reverse feature is to lay a 2 × 4 under the closing door. The door should stop and reverse upon contacting the piece of wood. As an additional safety feature, garage door openers manufactured after January 1, 1993 are required to have external entrapment protection systems, such as an electronic eye, which detect an object obstructing the door.

Important Safety Precautions

Refer to the safety information that came with your garage door opener

to test that the safety features are functioning properly. If you do not have this information, contact the manufacturer of the equipment. Before programming HomeLink to a garage door or gate opener, make sure that people and objects are out of the way of the device to prevent potential injury or damage. When programming a garage door opener, park just outside the garage.

Training HomeLink

Before you begin — If you just received your vehicle and have not trained any of the buttons in HomeLink before, you should erase any previously learned codes before training the first button. To do this, press and hold the two outside buttons on the HomeLink transceiver for about 20 seconds, until the red indicator flashes. Release the buttons, then proceed to step 1.

CONTINUED

If you are training the second or third buttons, go directly to step 1.

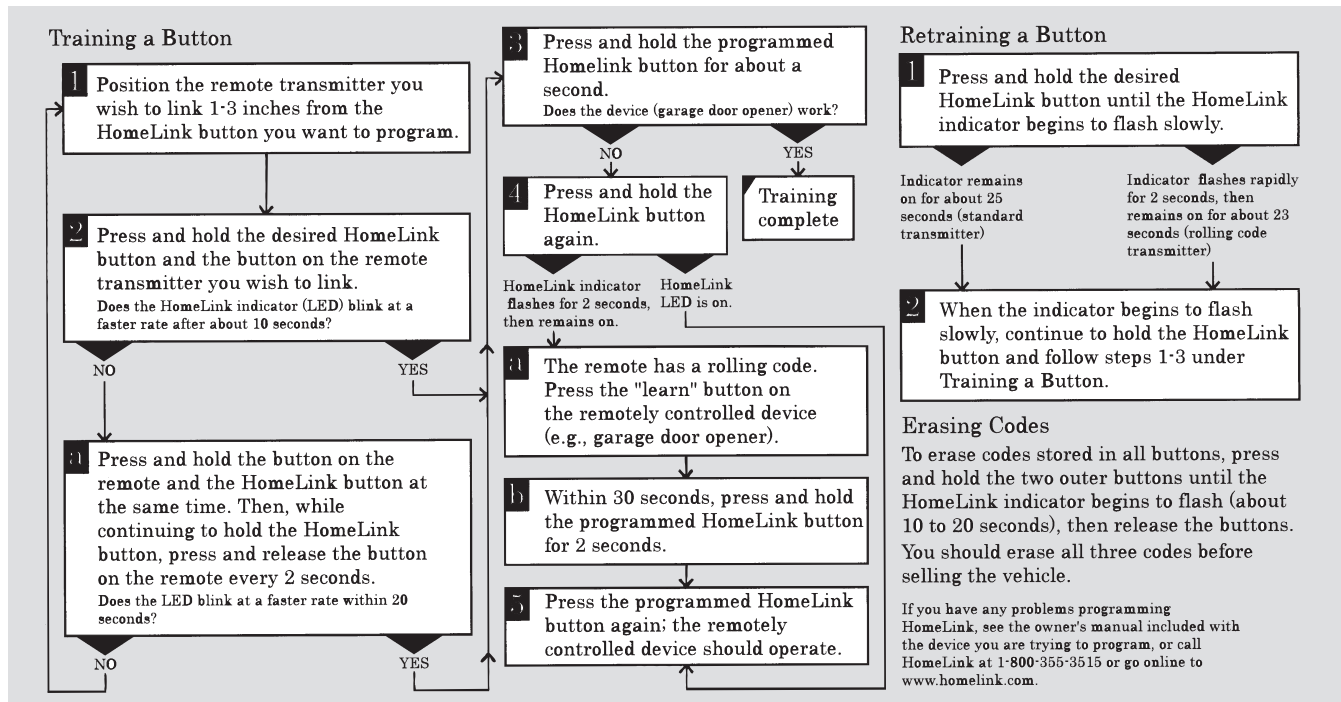

HomeLink® is a registered trademark of Johnson Controls, Inc.

As required by the FCC:

This device complies with Part 15 of the FCC rules. Operation is subject to the following two conditions: (1) This device may not cause harmful interference, and (2) this device must accept any interference received, including interference that may cause undesired operation.

Changes or modifications not expressly approved by the party responsible for compliance could void the user's authority to operate the equipment.

This device complies with Industry Canada Standard RSS-210.

Operation is subject to the following two conditions: (1) this device may not cause interference, and (2) this device must accept any interference that may cause undesired operation of the device.

Bluetooth® HandsFreeLink® (Models without navigation system)

On models without navigation system

Your vehicle is equipped with Bluetooth® HandsFreeLink® (HFL). HFL uses Bluetooth® technology to link your cell phone to your vehicle. With HFL, you can place and receive calls through your vehicle's audio system, without the distraction of handling your cell phone. To use this feature, you need a Bluetooth-compatible cell phone with the Hands Free Profile. For more information, and a list of compatible cell phones, visit www.acura.com/handstreeLink, or call 1-888-528-7876. In Canada, visit www.acura.ca, or call 1-888-9-ACURA-9. HFL is available in English on U.S. models, and in both English and French on Canadian models. To change the language, see page 418.

Here are the main features of HFL. Instructions for using HFL begin on page 407.

Voice Control

HFL recognizes simple voice commands, such as phone numbers and names. It uses these commands to automatically dial, receive, and store numbers. For more information on voice control, see Using Voice Control on page 396.

Bluetooth® Wireless Technology

The Bluetooth® name and logos are registered trademarks owned by Bluetooth SIG, Inc. and any use of such marks by Honda Motor Co., Ltd. is under license. Other trademarks and trade names are those of their respective owners.

Bluetooth is the wireless technology that links your phone to HFL. HFL uses a Class 2 Bluetooth, which means the maximum range between your phone and vehicle is 30 feet (10 meters).

To use HFL, your phone must have approved Bluetooth capability along with the Hands Free Profile. This type of phone is available through many phone makers and cellular carriers. You can also find an approved phone by visiting www.acura.com/handstreeLink, or by calling the HandsFreeLink® consumer support at 1-888-528-7876. In Canada, visit www.acura.ca, or call 1-888-9-ACURA-9.

Bluetooth® HandsFreeLink® (Models without navigation system)

Incoming/Outgoing Calls

With a linked phone, HFL allows you to send and receive calls in your vehicle without holding the phone.

Help Assistance

The HFL system has a help function to provide instructions for pairing a phone, and give hints on how to operate HFL properly. If your response or command is not correct, or the system cannot recognize a command, the HFL system will give you an appropriate command or play the help prompt.

Phonebook

HFL can store up to 50 names and phone numbers in its phonebook. With a linked phone, you can then automatically dial any name or number in the phonebook.

You can also store the desired number to the HFL phonebook directly from your cell phone using the receive contact function in HFL.

For more information on how to store the number, see page [415](#) . To make a call, see page [407](#) .

Microphone

The HFL microphone is on the ceiling, in front of the map lights.

Audio System

When HFL is in use, the sound comes through the vehicle's front audio system speakers. If the audio system is in use while operating either of the HFL buttons or making a call, HFL overrides the audio system. To change the volume level, use the audio system volume knob or the steering wheel volume controls.

Bluetooth® HandsFreeLink® (Models without navigation system)

HFL Buttons

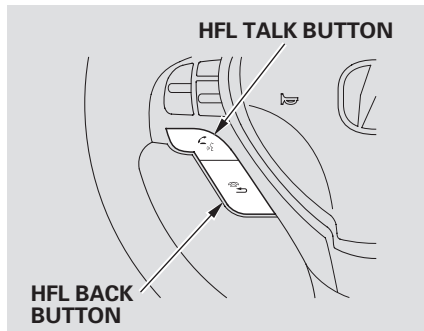

To operate HFL, use the HFL Talk and Back buttons on the left side of the steering wheel.

The HFL buttons are used as follows:

HFL Talk: This button is used before you give a command, and to answer incoming calls.

Press and release the button, then wait for a beep before giving a command.

HFL Back: This button is used to end a call, go back to the previous voice control command, and to cancel an operation.

Multi-Information Display

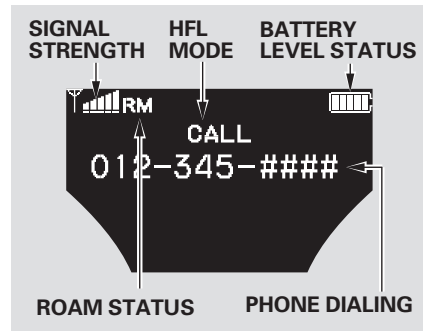



When you are operating HFL, or when you manually select HFL on the multi-information display, you will see this information on the screen:

Bluetooth® HandsFreeLink® (Models without navigation system)

- Signal Strength* — Indicates the network signal strength of the current phone. Five bars equals full strength.
 - ROAM Status* — Indicates your phone is roaming.
 - Battery Level Status* — Indicates the power currently remaining in your phone's battery. Five bars equals full battery strength.
 - HFL Mode — Indicates when you are dialing and receiving calls. Also displays which menu option has been selected.
 - Phone Dialing — Indicates the number you entered or the number of the incoming call.
- * : Some phones do not send this information to HFL.

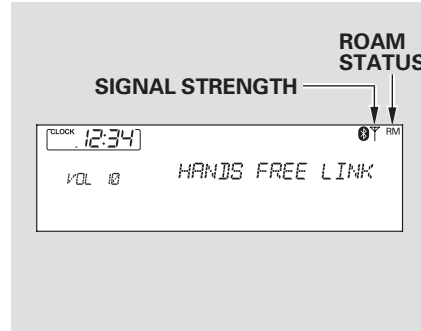
You can also see the signal strength and ROAM status on the audio display.



You will see “HANDS FREE LINK” and the “” indicator on the audio display when you operate HFL.

How to Use HFL

HFL is operated by the HFL Talk and Back buttons on the left side of the steering wheel. The next few pages provide instructions for all basic features of HFL.

NOTE: All phones may not operate identically, and some may cause inconsistent operation of HFL.

Bluetooth® HandsFreeLink® (Models without navigation system)

Using Voice Control

Here are some guidelines for using voice control:

- Adjust the airflow from both the dashboard and side vents so they do not blow against the microphone on the ceiling.
- Close the windows and the moonroof.
- To enter a command, press and release the HFL Talk button. After the beep, say your command in a clear, natural tone.
- When voice commands are used, the fan speed will be automatically adjusted to low. However, for better voice recognition, lowering the fan speed may be necessary.

- If the microphone picks up voices other than yours, the system may not interpret your voice commands correctly.
- If HFL does not recognize a command, its response is “Pardon.” If it doesn’t recognize the command it plays an appropriate Help prompt. Response time may vary depending on the voice command.
- To hear a list of available options at any time, press the HFL Talk button, wait for the beep, and say “Hands free help” or “Help.”
- When you are at the main menu, you can hear general HFL information such as pairing or setting up the system. Press the HFL Talk button, wait for the beep, and say “Tutorial.”

- Many commands can be spoken together. For example, you can say, “Dial 123-456-7891.”
- To enter a string of numbers in a Call or Dial command, you can say them all at once, or you can separate them in blocks of 3, 4, 7, 10, and 11.
- To skip a voice prompt, press the HFL Talk button while HFL is speaking. HFL will then begin listening for your next command.

Bluetooth® HandsFreeLink® (Models without navigation system)

- To go back one step in a command process, say “Go back,” or press the HFL Back button. If nothing is said while HFL is listening for a command, HFL will time out and stop its voice recognition, then prompt you with available options or help information. The next time you press the HFL Talk button, HFL begins listening from the point at which it timed out.
- To end a command sequence at any time, press and hold the HFL Back button, or press and release the HFL Talk button, wait for the beep, and say “Cancel.” The next time you press the HFL Talk button, HFL begins from the main menu.
- When you finish a command sequence, HFL returns to idle. For example, when you store the name “Eric,” the HFL system response is “Eric has been stored.” The next time you press the HFL Talk button, HFL begins from the main menu.

Pairing Your Phone

Your Bluetooth compatible phone with HandsFree Profile must be paired to HFL before you can make and receive hands-free calls. To confirm that your phone is Bluetooth compatible, visit www.acura.com/handsfreelink, or call (888) 528-7876. In Canada, visit www.acura.ca, or call (888) 9-ACURA-9. Your phone retailer should also be able to confirm if your phone is Bluetooth® compatible.

NOTE:

- HFL does not allow you to pair your phone if the vehicle is moving.
- For pairing, your phone must be in its discovery mode (searching for a Bluetooth related device).
- Up to six phones can be paired to HFL.

CONTINUED

Bluetooth® HandsFreeLink® (Models without navigation system)

- The following procedure works for most phones. If you cannot pair your phone to HFL with this procedure, refer to your phone's operating manual, visit www.acura.com/handsfreelink, call the HandsFreeLink® consumer support at (888) 528-7876, or call your phone retailer. In Canada, visit www.acura.ca, or call (888) 9-ACURA-9.
- During the pairing process, turn off any previously paired phones before pairing a new phone.
- Each time a phone is paired with HFL, the system selects a pairing code randomly or sequentially. You can switch this setting between random mode and fixed mode. To select a pairing code setting between Random and Fixed, refer to page [403](#).
- If after three minutes your phone is not ready to pair or a phone is not found, the system will time out and return to idle.
- Your phone's battery may drain faster when it is paired to HFL.

To pair your first phone, follow the prompts on the HFL system:

1. Park your vehicle. With your phone on and the ignition switch in the ACCESSORY (I) or ON (II) position, press and release the Talk button.
HFL prompts "Welcome to Bluetooth HandsFreeLink. This system enables hands-free usage of a mobile phone. Before using this system, a phone needs to be paired or connected with HandsFreeLink. Would you like to pair a phone now? Press the Bluetooth HandsFreeLink Talk button, and after the beep, say Yes, to begin the pairing process, or No, to continue."

Bluetooth® HandsFreeLink® (Models without navigation system)

2. Press and release the Talk button. After the beep, say “Yes.” HFL responds “Entering phone set up: pair menu. The pairing process requires operation of your Bluetooth phone. For safety, only perform this function while the vehicle is stopped.”

HFL responds “For proper system function a compatible Bluetooth phone is required. Please visit the HandsFreeLink® website, listed in the owner’s manual, for a list of approved phones and other system information. HandsFreeLink is waiting to pair with a Bluetooth phone. From your phone, search for Bluetooth devices and select HandsFreeLink.”

HFL responds “When prompted by your mobile phone, enter the pairing code: <1234*>.”

*: For example

Go to Step 4.

NOTE: Steps 4 and 5 show a common way to get your phone into its discovery mode (searching for a Bluetooth related device). If these steps do not work on your phone, refer to the phone’s operating manual.

3. Press and release the Talk button. After the beep, if you say No, HFL responds “Would you like to hear the Bluetooth HandsFreeLink tutorial now? Press the Talk button and after the beep, say yes to begin the tutorial, or say No to exit HandsFreeLink.”

If you say Yes, HFL will begin the tutorial. Follow the prompts on HFL.

4. Follow the prompts on your phone to get it into its discovery mode. The phone will search for HFL. When it comes up, select HandsFreeLink from the list of options displayed on your phone.

5. When asked by the phone, enter the four-digit code from step 3 into your phone.

HFL responds “HandsFreeLink has connected to a new phone. A name is needed to identify this phone. Press the Talk button and say a name. For example, John’s phone.”

CONTINUED

Bluetooth® HandsFreeLink® (Models without navigation system)

6. Press and release the Talk button. After the beep, say the name you want to use. For example, say “John’s phone.” HFL responds “<John’s phone> has been successfully paired.” HFL responds “Would you like to hear the Bluetooth HandsFreeLink tutorial now? Press the Talk button and after the beep, say Yes to begin the tutorial, or say No to exit HandsFreeLink.”

If you press and release the Talk button and say “Yes,” HFL begins Tutorial. If you say “No,” HFL returns to idle.

To pair another phone, do this:

1. With your phone on and the ignition switch in the ACCESSORY (I) or ON (II) position, press and release the Talk button. After the beep, say “Phone setup.” HFL responds “Phone setup options are pair, edit, delete, list, status, next phone, and set pairing code. Press the Talk button and say a command.”
2. Press and release the Talk button. After the beep, say “Pair.”
3. Repeat steps 2 through 6 on page [399](#).

To rename a paired phone, do this:

1. Press and release the Talk button. After the beep, say “Phone setup.” HFL responds “Phone setup options are pair, edit, delete, list, status, next phone, and set pairing code. Press the Talk button and say a command.”
2. Press and release the Talk button. After the beep, say “Edit.” HFL responds “Which phone would like to edit? Press the Talk button, and say a name, or say List, to hear the names of the paired phones”

With only one paired phone, for example, <John’s phone>, HFL responds “What is the new name for <John’s phone>?” Then go to step 4.

Bluetooth® HandsFreeLink® (Models without navigation system)

3. Press and release the Talk button. After the beep, say the name of the phone you want to rename. For example, say “John’s phone.” HFL responds “What is the new name for John’s phone? Press the Talk button and say a name.”
4. Press and release the Talk button. After the beep, say the new name of the phone. For example, say “Lisa’s phone.” HFL responds “The name has been changed.”

To delete a paired phone, do this:

1. Press and release the Talk button. After the beep, say “Phone setup.” HFL responds “Phone setup options are pair, edit, delete, list, status, next phone, and set pairing code. Press the Talk button and say a command.”
2. Press and release the Talk button. After the beep, say “Delete.” HFL responds “Which phone would like to delete? Press the Talk button and say a name, or say list, to hear the names of the paired phone.”

With only one paired phone, for example, <John’s phone>, HFL responds “Would you like to delete <John’s phone>?” Then go to step 4.

3. Press and release the Talk button. After the beep, say the name of the phone you want to delete. For example, say “John’s phone.” HFL responds “Would you like to delete John’s phone? Press the Talk button and say Yes or No.”
4. Press and release the Talk button. After the beep, say “Yes.” HFL responds “Preparing to delete John’s phone. Press the Talk button and say Continue; otherwise say Go Back or Cancel.”
5. Press and release the Talk button. After the beep, if you say “Continue.” HFL responds “The phone has been deleted.” “Go back” or “Cancel” does not delete the phone.

CONTINUED

Bluetooth® HandsFreeLink® (Models without navigation system)

To list all paired phones, do this:

1. Press and release the Talk button. After the beep, say “Phone setup.” HFL responds “Phone setup options are pair, edit, delete, list, status, next phone, and set pairing code. Press the Talk button and say a command.”
2. Press and release the Talk button. After the beep, say “List.” HFL responds by listing the name of each paired phone. When all phones paired to the system have been read, HFL responds “The entire list has been read.”

To find out the status of the phone being used, do this:

1. Press and release the Talk button. After the beep, say “Phone setup.” HFL responds “Phone setup options are pair, edit, delete, list, status, next phone, and set pairing code. Press the Talk button and say a command.”
2. Press and release the Talk button. After the beep, say “Status.” For example, HFL responds “John’s phone is linked. Battery strength is three bars. Signal strength is five bars, and the phone is roaming.”

Some Phones may not send the status information to the HFL system.

To change from the currently linked phone to another paired phone, do this:

1. Press and release the Talk button. After the beep, say “Phone setup.” HFL responds “Phone setup options are pair, edit, delete, list, status, next phone, and set pairing code. Press the Talk button and say a command.”
2. Press and release the Talk button. After the beep, say “Next phone.” HFL responds “Searching for the next phone.” The system then disconnects the linked phone and searches for another paired phone. If the system finds it, for example, HFL responds “Paul’s phone is linked.”

If no other phones are found or paired, the first phone remains linked. For example, HFL responds “No other paired phones were found/have been paired. Returning to <John’s phone>.”

Bluetooth® HandsFreeLink® (Models without navigation system)

Setting a Pairing Code

When you pair your phone to HFL, the HFL system will automatically select a pairing code at random or in order. You can customize this setting mode between Random and Fixed. If you select the fixed mode, the HFL system will select a pairing code sequentially.

To change the setting mode, do this:

1. Press and release the Talk button. After the beep, say “Phone setup.” HFL responds “Phone setup options are pair, edit, delete, list, status, next phone, and set pairing code. Press the Talk button and say a command.”
2. Press and release the Talk button. After the beep, say “Set Pairing Code.” HFL responds “Each time a phone is paired with HandsFreeLink, a pairing code is used for security. This code can be randomly generated by HandsFreeLink, or fixed, which is needed for some Bluetooth devices with a preset pairing code. Would you like to set the pairing code as Random or Fixed?”
3. Press and release the Talk button. After the beep, to select the fixed mode, say “Fixed.” HFL responds “What is the four digit number you would like to set as the pairing code? Press the Talk button and say the number.”
4. Press and release the Talk button. After the beep, say a desired four-digit number. For example, say “1000.” HFL responds “1000. Is this correct? Press the Talk button and say Yes or No.”
5. Press and release the Talk button. After the beep, if the number is correct, say “Yes.” HFL responds “HandsFreeLink will use this code when pairing to a Bluetooth device.”
6. If the number is not correct, say “No.” HFL goes back to step 3.

Bluetooth® HandsFreeLink® (Models without navigation system)

Setting Up the System

You can select or change some settings for the HFL system. Here are the settings you can select or change. To do this, make sure your vehicle is parked safely, with your phone on and the ignition switch in the ACCESSORY (I) or ON (II) position.

• Setting a security passcode

You can set a four-digit security passcode to lock the HFL system for security purposes.

If you forget your passcode, you cannot activate HFL. Consult your dealer to cancel the passcode. You can also select a “System Clear” command to reset HFL (see page 417).

• Changing a security passcode

You can change the security passcode.

• Selecting the incoming notification

The incoming notification can be set to a ring tone, a prompt, or no notification. The default setting is a prompt.

To set a security passcode, do this:

1. Press and release the Talk button. After the beep, say “System setup.” HFL responds “System setup options are security, change passcode, call notification, auto transfer, and clear. Press the Talk button and say a command.”
2. Press and release the Talk button. After the beep, say “Security.” HFL responds “Security is disabled. Would you like to enable security? Press the Talk button and say Yes or No.”

3. Press and release the Talk button. After the beep, say “Yes.” HFL responds “What is the four-digit number you would like to set as your security passcode? Press the Talk button and say the number.”

If you say “No,” HFL returns to idle.

4. Press and release the Talk button. After the beep, say the four-digit passcode you want to use. For example, say “1, 2, 3, 4.” HFL responds “1, 2, 3, 4. Is this correct? Press the Talk button and say Yes or No.”

Bluetooth® HandsFreeLink® (Models without navigation system)

5. Press and release the Talk button. After the beep, say “Yes.” HFL responds “Security is on. Each time the vehicle is turned on, the passcode will be required to use the system. If you forget this passcode, you must either go to the dealer to have it reset, or clear the entire system using the System Clear command.”

Once a passcode is set, HFL will prompt you for your passcode each time the ignition switch is turned to the ON (II) position and you press the Talk button. You will only be asked for the passcode once per ignition cycle.

To enter your passcode, do this;

1. Press and release the Talk button. After the beep, HFL prompts “The system is locked. What is the four-digit passcode?”
2. Press and release the Talk button. After the beep, say your four-digit passcode. For example, say “1, 2, 3, 4.”
3. If the passcode is correct, HFL responds “System is unlocked.”

If the passcode is not correct, please try again according to the HFL’s guidance.

You can also select a “System Clear” command to reset HFL (see page [417](#)).

To change your security passcode, do this:

1. Press and release the Talk button. After the beep, say “System setup.” HFL responds “System setup options are security, change passcode, call notification, auto transfer, and clear. Press the Talk button and say a command.”
2. Press and release the Talk button. After the beep, say “Change passcode.” HFL responds “What is the four digit number you would like to set as your security passcode? Press the Talk button and say the number.”
3. Press and release the Talk button. After the beep, say your four digit passcode, for example, say “1, 2, 3, 4.”

CONTINUED

Bluetooth® HandsFreeLink® (Models without navigation system)

4. HFL responds “1, 2, 3, 4. Is this correct? Press the Talk button and say Yes or No.”
5. Press and release the Talk button. After the beep, say “Yes.” HFL responds “Security passcode has been changed.”

To set the incoming notification, do this:

1. Press and release the Talk button. After the beep, say “System setup.” HFL responds “System setup options are security, change passcode, call notification, auto transfer, and clear. Press the Talk button and say a command.”
2. Press and release the Talk button. After the beep, say “Call notification.” HFL responds: “Would you like the incoming call notification to be a ring tone, a prompt, or off?”
3. Press and release the Talk button. After the beep, for example, say “Ring tone.” HFL responds “A ring tone will be used.” You will hear a ring tone through the audio speakers to announce an incoming call.

If you say, “Prompt.” HFL responds “An incoming call prompt will be used.” You will hear a “You have an incoming call.” prompt when receiving an incoming call.

If you say, “Off,” no audible notification of an incoming call will be selected. During an incoming call, there is no ring tone or prompt playback. The audio system will still mute, and the HFL message or the HFL notification screen will be displayed.

Bluetooth® HandsFreeLink® (Models without navigation system)

Making a Call

You can make calls using any phone number, or by using a name in the HFL phonebook. You can also redial the last number called. During a call, HFL allows you to talk up to 30 minutes after you remove the key from the ignition switch. Continuing a call without running the engine may discharge and weaken the vehicle's battery.

To make a call using a phone number, do this:

1. With your phone on and the ignition switch in the ACCESSORY (I) or ON (II) position, press and release the Talk button. After the beep, say "Call" or "Dial."
HFL responds "What name or number would you like to call/dial? Press the Talk button and say a name, a number, or say list to hear the phonebook entries."
2. Press and release the Talk button. After the beep, say the number you want to call. For example, say "123 456 7891."
HFL responds "123 456 7891. Press the Talk button and continue to add numbers, or say Call or Dial to place a call."

3. Press and release the Talk button. After the beep, say "Call" or "Dial."

HFL responds "Calling" or "Dialing."

Once connected, you will hear the person you called through the audio speakers. To change the volume, use the audio system volume knob or the steering wheel volume controls.

4. To end the call, press the Back button.

CONTINUED

Bluetooth® HandsFreeLink® (Models without navigation system)

To make a call using a name in the HFL phonebook, do this:

1. With your phone on and the ignition switch in the ACCESSORY (I) or ON (II) position, press and release the Talk button. After the beep, say “Call” or “Dial.”
HFL responds “What name or number would you like to call/dial? Press the Talk button and say a name, a number, or say list to hear the phonebook entries.”
2. Press and release the Talk button. After the beep, say the name you want to call. For example, say “John.”
HFL responds “Would you like to call John? Press the Talk button and say Yes or No.”

3. Press and release the Talk button. After the beep, say “Yes.”
HFL responds “Calling” or “Dialing.”
Once connected, you will hear the person you called through the audio speakers. To change the volume, use the audio system volume knob or the steering wheel volume controls.
4. To end the call, press the Back button.

To redial the last number called by the phone, do this:

Press and release the Talk button. After the beep, say “Redial.”
HFL responds “Redialing.”
Once connected, you will hear the person you called through the audio speakers. To change the volume, use the audio system volume knob or the steering wheel volume controls.

Sending Numbers or Names During a Call

HFL allows you to send numbers or names during a call. This is useful when you call a menu-driven phone system. You can also program account numbers into the HFL phonebook for easy retrieval during menu-driven calls.

To send a number during a call, do this:

1. Press and release the Talk button. After the beep, say “Send.” HFL responds “What name or number would you like to send?”
2. Press and release the Talk button. After the beep, say the number you want to send. For example, say “1, 2, 3.” HFL responds “1, 2, 3. Press the Talk button and continue to add numbers or say send.”

NOTE: To send a pound (#), say “pound.” To send a star (*), say “star.”

3. Press and release the Talk button. After the beep, say “Send.” The dial tones will be sent, and the call will continue.

To send a name during a call, do this:

1. Press and release the Talk button. After the beep, say “Send.” HFL responds “What name or number would you like to send?”
2. Press and release the Talk button. After the beep, say the name you want to send. For example, say “Account number.” HFL responds “Would you like to send account number? Press the Talk button and say Yes or No.”
3. Press and release the Talk button. After the beep, say “Yes.” The dial tones will be sent, and the call will continue.

Bluetooth® HandsFreeLink® (Models without navigation system)

Receiving a Call

If you receive a call when you are not on the phone, HFL interrupts the audio system (if it is on), and plays the incoming call notification, if activated. To answer the call, press the Talk button and begin speaking. If you don't want to answer the call, press the Back button.

If your phone has call waiting, and you receive a call when you are on the phone, press and release the Talk button to answer it. When you do this, the original call is placed on hold. To return to the original call, press the Talk button again. If you don't want to answer the new call, disregard it, and continue with your original call. If you want to hang up the original call and answer the new call, press the Back button.

Transferring a Call

You can transfer a call from HFL to your phone, or from your phone to HFL.

To transfer a call from HFL to your phone, or from your phone to HFL, do this:
Press and release the Talk button. After the beep, say "Transfer." The audio switches between HFL and the phone.

Automatic Transferring

This function allows you to transfer a call automatically to the HFL system. If you get into the vehicle while you are on the phone, a call will be transferred automatically to the HFL system when you turn the ignition switch to the ACCESSORY (I) position.

With this function activated, you can also make a call by dialing with the number keys on the phone which has been paired to the HFL system.

The automatic transferring function can be set to on or off.

Bluetooth® HandsFreeLink® (Models without navigation system)

To activate this function, do this:

1. Press and release the Talk button.
After the beep, say “System setup.”
HFL responds “System setup options are security, change passcode, call notification, auto transfer, and clear. Press the Talk button and say a command.”
2. Press and release the Talk button.
After the beep, say “Auto transfer.”
If this feature is set to off, HFL responds “Auto transfer is disabled. Calls dialed on the phone do not automatically transfer to Bluetooth HandsFreeLink. Would you like to enable Auto Transfer? Press the Talk button and say Yes or No.”

If this feature is set to on, HFL responds “Auto-transfer is enabled. Calls dialed on the phone will be automatically transferred to Bluetooth HandsFreeLink. Would you like to disable Auto Transfer? Press the Talk button and say Yes or No.”

3. If the setting changes from off to on, press and release the Talk button. After the beep, say “Yes.”
HFL responds “Auto transfer is enabled.”

When you make a call directly from the phone with the auto transfer on, make sure to stop your vehicle safely.

To end the call, press the Back button.

NOTE: Never try to dial from your phone directly if the vehicle is moving.

If the setting changes from on to off, HFL responds “Auto transfer is disabled. Use the Transfer command at the HandsFree main menu to manually transfer calls dialed on the phone.”

Bluetooth® HandsFreeLink® (Models without navigation system)

Muting a Call

During a call, you can mute or unmute your voice to the person you are talking to.

To mute your voice, do this:

Press and release the Talk button. After the beep, say “Mute.” HFL responds “Mute is active.”

To unmute your voice, do this:

Press and release the Talk button. After the beep, say “Mute.” HFL responds “Mute is canceled.”

Setting Up the Phonebook

The HFL phonebook can store up to 50 names with their associated numbers. These can be any types of numbers. For example, you can store a phone number and use it to make a call, or you can store an account number and use it during a call to a menu-driven phone system.

To add a name, do this:

1. Press and release the Talk button. After the beep, say “Phonebook.” HFL responds “Phonebook options are store, edit, delete, receive contact, and list. Press the Talk button and say a command.”
2. Press and release the Talk button. After the beep, say “Store.” HFL responds “What name would you like to store? Press the Talk button and say a name.”

3. Press and release the Talk button. After the beep, say the name you would like to store. For example, say “<John Smith>.” HFL responds “What is the number for <John Smith>? Press the Talk button and say the number.” You can also say an account number instead of <John Smith>.
4. Press and release the Talk button. After the beep, say the number. For example, say “123 456 7891.” HFL responds “123 456 7891. Press the Talk button and continue to add numbers or say Enter.”

Bluetooth® HandsFreeLink® (Models without navigation system)

NOTE:

- Avoid using duplicate name entries.
 - Avoid using “home” as a name entry.
 - HFL will be able to better recognize multisyllabic name entries (“Peter” instead of “Pete”), or a longer name (“John Smith” instead of “John”).
 - Use a consistent, even tone and reduce background noise when storing names, as the HFL voice recognition can be sensitive.
5. Press and release the Talk button. After the beep, say “Enter.” HFL responds “<John Smith> has been stored.”

To edit the number of a name, do this:

1. Press and release the Talk button. After the beep, say “Phonebook.” HFL responds “Phonebook options are store, edit, delete, receive contact, and list. Press the Talk button and say a command.”
2. Press and release the Talk button. After the beep, say “Edit.” HFL responds “What name would you like to edit? Press the Talk button and say a name or say list to hear the phonebook entries.”

If only one number is stored, HFL responds “What is the new number for Eric?” Then go to step 4.

3. Press and release the Talk button. After the beep, say the name you would like to edit. For example, say “Eric.” HFL responds “What is the new number for Eric? Press the Talk button and say the number.”
4. Press and release the Talk button. After the beep, say the new number for Eric. For example, say “987 654 3219.” HFL responds “987 654 3219. Press the Talk button and continue to add numbers or say enter.”
5. Press and release the Talk button. After the beep, say “Enter.” HFL responds “The number has been changed.”

CONTINUED

Bluetooth® HandsFreeLink® (Models without navigation system)

To delete a name, do this:

1. Press and release the Talk button.
After the beep, say "Phonebook."
HFL responds "Phonebook options are store, edit, delete, receive contact, and list. Press the Talk button and say a command."
2. Press and release the Talk button.
After the beep, say "Delete."
HFL responds "What name would you like to delete? Press the Talk button and say a name or say list to hear the phonebook entries."
3. Press and release the Talk button.
After the beep, say the name you would like to delete. For example, say "Eric."
HFL responds "Would you like to delete Eric? Press the Talk button and say Yes or No."

4. Press and release the Talk button.
After the beep, say "Yes."
HFL responds "The name has been deleted."

To list all names in the phonebook, do this:

1. Press and release the Talk button.
After the beep, say "Phonebook."
HFL responds "Phonebook options are store, edit, delete, receive contact, and list. Press the Talk button and say a command."
2. Press and release the Talk button.
After the beep, say "List."

HFL responds by listing the names in the phonebook in the order which they were stored. After all names are listed, HFL responds "The entire list has been read."

Bluetooth® HandsFreeLink® (Models without navigation system)

To call a name from the phonebook list, do this:

1. Press and release the Talk button. After the beep, say “Phonebook.” HFL responds “Phonebook options are store, edit, delete, receive contact, and list. Press the Talk button and say a command.”
2. Press and release the Talk button. After the beep, say “List.” HFL responds by listing the names in the phonebook. When it says the name you want to call, for example, <Eric>, press and release the Talk button. After the beep, say “Call.” HFL responds “Would you like to call <Eric>? Press the Talk button and say Yes or No.”

3. Press and release the Talk button. After the beep, say “Yes.” HFL responds “Calling.”

Once connected, you will hear the person you called through the audio speakers. To change the volume, use the audio system volume knob or the steering wheel volume controls.

Storing a Phone Number Directly from Your Phone

You can store the desired number to the HFL phonebook directly from your cell phone.

NOTE: Your phone may not have this capability. Visit www.acura.com/handsfreelink or call the HandsFreeLink® consumer support at 1-888-528-7876. In Canada, visit www.acura.ca, or call 1-888-9-ACURA-9. You can see your phone’s owner’s manual for information.

CONTINUED

Bluetooth® HandsFreeLink® (Models without navigation system)

1. With your phone on and the ignition switch in the ACCESSORY (I) or ON (II) position, press and release the Talk button. After the beep, say “Phonebook.”
HFL responds “Phonebook options are store, edit, delete, receive contact, and list. Press the Talk button and say a command.”
2. Press and release the Talk button. After the beep, say “Receive contact.”
HFL responds “The receive process requires operation of your Bluetooth device. For safety, only perform this function while the vehicle is stopped. HandsFreeLink is now waiting to receive a contact from a Bluetooth device.”
3. Select a desired number from the list on your phone, and send it via Bluetooth (steps will vary for phone types, follow your phone’s operating manual).
HFL responds, for example “<2> phone numbers have been received for this contact. What name would you like to store for the mobile number <1234567891>? Press the Talk button and say a name or say Discard, to discard this number.”
4. Press and release the Talk button. After the beep, say the name you would like to store. For example, say “Neil at work.”
HFL responds “Neil at work will be stored. Is this correct? Press the Talk button and say Yes or No.”
5. Press and release the Talk button. After the beep, say “Yes.”
HFL responds “Neil at work has been stored. Would you like HandsFreeLink to receive another contact? Press the Talk button and say Yes or No.”

Go to step 6.

If you say “No,” HFL returns to idle.
6. If you want to continue to store any other numbers, press and release the Talk button. After the beep, say “Yes.”
HFL responds “HandsFreeLink is now waiting to receive a contact from a Bluetooth device.”

Go back to step 3.

Clearing the System

This operation clears the HFL of your passcode, your paired phones, and all names in the HFL phonebook. Clearing is recommended before you sell your vehicle.

To clear the system, do this:

1. Press and release the Talk button. After the beep, say “System setup.” HFL responds “System setup options are security, change passcode, call notification, auto transfer, and clear. Press the Talk button and say a command.”
2. Press and release the Talk button. After the beep, say “Clear.” HFL responds “This process will clear all paired phones, clear all entries in the phonebook, clear the security passcode, and restore the defaults in the system setup. Is this what you would like to do? Press the Talk button and say yes or no.”
3. Press and release the Talk button. After the beep, say “Yes.” HFL responds “Preparing to clear the system, which may take up to two minutes to complete. To proceed, press the Talk button and say Continue, otherwise say Go Back or Cancel.”
4. After saying Continue, HFL responds “Please wait while the system is cleared.” HFL responds “The system has been cleared.”

Bluetooth® HandsFreeLink® (Models without navigation system)

Changing Language

Canadian models only

To change language, say a command with the current selected language. The following example is changing the language from English to French.

1. Press and release the Talk button. After the beep, say “Change language.”
HFL responds “English or French?”
2. Press and release the Talk button. After the beep, say “French.”
HFL responds “Vous avez sélectionné Français. Les noms enregistrés en mode Anglais ne seront pas accessibles en mode Français. Voulez-vous continuer? You have selected French. Name tags that were stored while in English mode will not be accessible in French mode. Would you like to continue? Press the Talk button and say Yes or No.”

3. Press and release the Talk button. After the beep, say “Oui” or “Yes.”
If there are no paired phones without French name tags, HFL responds “Veuillez attendre que le système change de langue. Please wait while the language is changed.”
HFL responds “La langue a été changée.”

NOTE: If there are paired phones without French name tags, the following prompts will continue.

If there are paired phones without French name tags, HFL responds “La langue a été changée. Pour que le système identifie les téléphones qui ont été jumelés dans une autre langue, les noms des téléphones doivent être ré-enregistrés.”

4. Example for changing name tags:
HFL responds “Quel est le nom Français pour <Paul’s phone >?”
Press and release the Talk button. After the beep, say “Téléphone de Paul.”

All paired phones missing a French name tag are recorded, the HFL system returns to idle.

This process will also be required if there are paired phones without English tags when changing from French to English. HFL responds “For the system to identify phones that were paired while in another language, the phone names need to be re-recorded.”

Quick Language Selection

Canadian models only

To select a language quickly, do the following.

For example, to change from French to English.

1. Press and release the Talk button. After the beep, say “Anglais.” HFL responds “You have selected English. Name tags that were stored while in French mode will not be accessible in English mode. Would you like to continue? Press the Talk button and say Yes or No.”

If you want to continue, follow steps 3 and 4 on page [418](#).

As required by the FCC:

This device complies with Part 15 of the FCC rules. Operation is subject to the following two conditions: (1) This device may not cause harmful interference, and (2) this device must accept any interference received, including interference that may cause undesired operation.

Changes or modifications not expressly approved by the party responsible for compliance could void the user's authority to operate the equipment.

This device complies with Industry Canada Standard RSS-210.

Operation is subject to the following two conditions: (1) this device may not cause interference, and (2) this device must accept any interference that may cause undesired operation of the device.

Bluetooth® HandsFreeLink® (Models with navigation system)

Your vehicle is equipped with Bluetooth® HandsFreeLink® (HFL). HFL uses Bluetooth technology to link your cell phone to your vehicle. With HFL, you can place and receive calls through your vehicle's navigation system, without the distraction of handling your cell phone.

To use this feature, you need a Bluetooth compatible cell phone with the HandsFree Profile. For more information, and a list of compatible cell phones, visit www.acura.com/handsfreelink, or call HandsFreeLink® customer support at (888) 528-7876. In Canada, visit www.acura.ca, or call (888) 9-ACURA-9. HFL is available in English, French, and Spanish.

Here are the main features of HFL. Instructions for using HFL begin on page [421](#).

Voice Control

HFL recognizes simple voice commands, such as phone numbers and names. It uses these commands to automatically dial, receive, and store numbers. Voice commands help to operate HFL on the navigation screen. For more information on voice control, see Using Voice Control on page [424](#).

Bluetooth® Wireless Technology

The Bluetooth® name and logos are registered trademarks owned by Bluetooth SIG, Inc. and any use of such marks by Honda Motor Co., Ltd. is under license. Other trademarks and trade names are those of their respective owners.

Bluetooth is the wireless technology that links your phone to HFL. HFL uses a Class 2 Bluetooth, which means the maximum range between your phone and vehicle is 30 feet (10 meters).

Incoming/Outgoing Calls

With a linked phone, HFL allows you to send and receive calls in your vehicle without holding the phone.

Bluetooth® HandsFreeLink® (Models with navigation system)

Phonebook

Your vehicle's HFL system allows you to import your cellular phonebook to HFL. Using the navigation system, you can make a call directly and store a desired number in HFL from the list shown on the navigation display. For more information on how to import the phonebook, see page 455 . To make a call, see page 433 .

NOTE: Your phone may not have phonebook import function. Visit www.acura.com/handsfreelink, or call HandsFreeLink® consumer support at (888) 528-7876. In Canada, visit www.acura.ca, or call (888) 9-ACURA-9. You can also see your phone's owner's manual for information.

Microphone

The HFL microphone is on the ceiling, in front of the map lights. The microphone is shared with the navigation system.

Audio System

When HFL is in use, the sound comes through the vehicle's front audio system speakers. If the audio system is in use while operating either of the HFL buttons or making a call, HFL overrides the audio system. To change the volume level, use the audio system volume knob or the steering wheel volume controls.

How to Use HFL

HFL is operable by interaction with the navigation screen with the Interface Dial, the HFL buttons on the steering wheel, or by voice.

NOTE: All phones may not operate identically, and some may cause inconsistent operation of HFL.

Bluetooth® HandsFreeLink® (Models with navigation system)

Interface Dial

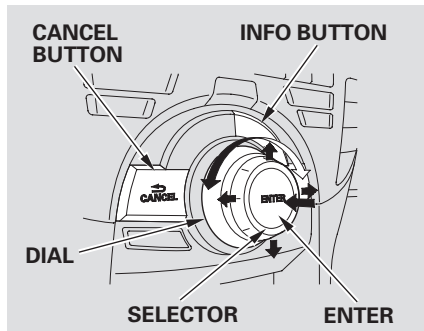

HFL system functions can be accessed using the interface dial. The interface dial has two parts, a dial and a selector.

The dial turns left and right. Use it to make selections from a list or menu on the screen.

The selector can be pushed left, right, up, down, and in. Use the selector to scroll through lists, to select menus, and to highlight menu items. When you make a selection, push the center of the selector (ENTER) to go to that selection.

The CANCEL button clears the current screen and returns to the previous display.

The INFO button takes you to the information menu, where you can select the Cellular Phone screen. You can also press the PICK-UP button on the steering wheel to go directly to the Cellular Phone screen.

HFL Display

If you receive a call and you are on the Cellular Phone screen, the following screen is displayed:

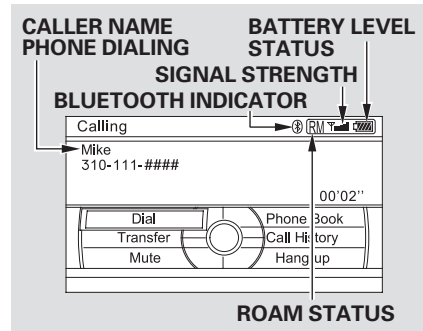

If this is not displayed, press the INFO button, select Cellular Phone, then press ENTER to display the Cellular Phone screen. You can also press the PICK-UP button on the steering wheel to go directly to the Cellular Phone screen.

Bluetooth® HandsFreeLink® (Models with navigation system)

- **Signal Strength*** – Indicates the network signal strength of the current phone. Five bars equals full strength.
- **Battery Level Status*** – Indicates the power currently remaining in your phone's battery. Five bars equals full battery strength.
- **ROAM Status*** – Indicates your phone is roaming.
- **Caller name/Phone dialing** – Indicates the number you dialed or received, and a caller or receiver name. Only the number will be displayed if the caller or receiver's information has not been stored in the phonebook.

You can also see the signal strength and ROAM status on the center display.

“” indicator will be displayed on the navigation display and center display if your phone is linked to the HFL system.

* : Some phones do not send this information to HFL.

Incoming Call Display

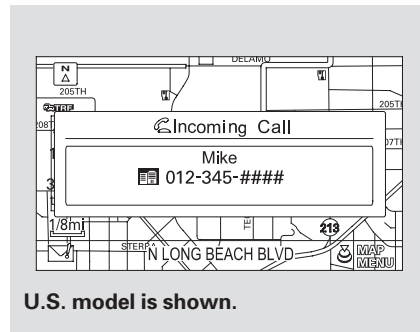

When you receive a phone call, a pop-up will interrupt the display as shown. This pop-up shows a caller name and the phone number that

has been stored in the phonebook (see page 455). While the system searches for information from the stored data, “Now acquiring call information” will be displayed. If the caller chooses to hide the number when making a call, “No Caller ID” will be displayed instead.

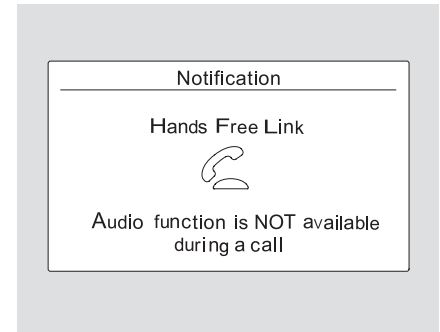

When you are operating HFL, or dialing or receiving calls with the audio system in use, you will see the above screen.

Bluetooth® HandsFreeLink® (Models with navigation system)

HFL Buttons

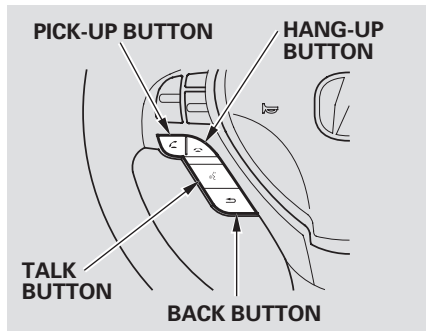

To operate HFL, use the Pick-Up and Hang-Up buttons on the left side of the steering wheel.

If you use the voice commands to operate HFL, also use the TALK and BACK buttons.

The HFL buttons are used as follows:

TALK Button: This button activates the voice control system and is used for all voice commands. Press and release it, wait for a beep, and give a voice command.

BACK Button: This button has the same function as the CANCEL button. When you press and release it, the current voice command is canceled and the display returns to the previous screen.

PICK-UP Button: This button is used to answer incoming calls or to make outgoing calls. You can also go directly to the Cellular Phone screen by pressing this button.

HANG-UP Button: This button is used to end a call.

Using Voice Control

Here are some guidelines for using voice control:

- Adjust the airflow from both the dashboard and side vents so they do not blow against the microphone on the ceiling.
- Close the windows and the moonroof.
- When voice commands are used, the fan speed will be automatically adjusted to low. However, for better voice recognition, lowering the fan speed may be necessary.
- To enter a command, press and release the Talk button. After the beep, say your command in a clear, natural tone.

Bluetooth® HandsFreeLink® (Models with navigation system)

- If the microphone picks up voices other than yours, the system may not interpret your voice commands correctly.
 - If HFL does not recognize a command, its response is “Pardon.” If it doesn’t recognize the command it plays an appropriate Help prompt. Response time may vary depending on the voice command.
 - To hear a list of available options at any time, press the Talk button, wait for the beep, and say “Help.”
- To enter a string of numbers in a Call or Dial command, you can say them all at once, or you can separate them.
 - To skip a voice prompt, press the Talk button while HFL is speaking. HFL will then wait for your next command.

Changing Language

You can change the voice guidance and system language to English, French, or Spanish. The language you select will be also used for the navigation system. Refer to the navigation system manual for details.

Bluetooth® HandsFreeLink® (Models with navigation system)

Pairing Your Phone

Your Bluetooth compatible phone with HandsFree Profile must be paired to HFL before you can make and receive hands-free calls. To confirm that your phone is Bluetooth compatible, visit www.acura.com/handsfreelink, or call (888) 528-7876. In Canada, visit www.acura.ca, or call (888) 9-ACURA-9. Your phone retailer should also be able to confirm if your phone is Bluetooth® compatible.

NOTE:

- HFL does not allow you to pair your phone if the vehicle is moving.
- Up to six phones can be paired to HFL.

- The following procedure works for most phones. If you cannot pair your phone to HFL with this procedure, refer to your phone's operating manual, visit www.acura.com/handsfreelink, call the HandsFreeLink® consumer support at (888) 528-7876, or call your phone retailer. In Canada, visit www.acura.ca, or call (888) 9-ACURA-9.
- During the pairing process, turn off any previously paired phones before pairing a new phone.
- Your phone's battery may drain faster when it is paired to HFL.
- HFL operates best if your phone is set to automatically recognize the system (Discovery mode).
- If after 3 minutes your phone is not ready to pair or a phone is not found, the system will time out and start the pairing process from the beginning.

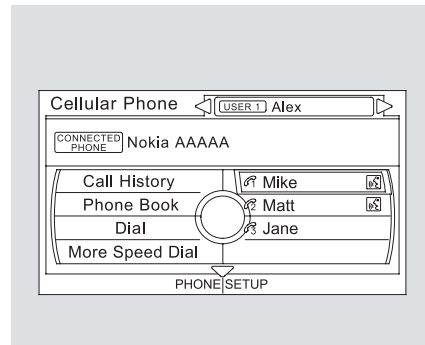

1. Park the vehicle. With your phone on and the vehicle's power mode in ACCESSORY or ON, press the INFO button, rotate the interface dial to select "Cellular Phone," and push ENTER, or press the Talk button and say "Cellular Phone." HFL responds "Which cellular phone item would you like to select?"

For more information on how to select the power mode, see page 178 .

Bluetooth® HandsFreeLink® (Models with navigation system)

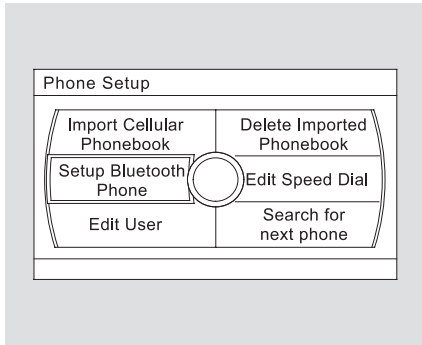

2. Move the interface selector down. The “Phone setup” screen appears. Rotate the dial to select “Setup Bluetooth Phone,” and press ENTER, or press the Talk button and say “Phone setup.” HFL responds “Please select the phone setup item.” Press the Talk button and say “Setup Bluetooth Phone.” HFL responds “Please select a Bluetooth Phone item to setup.”

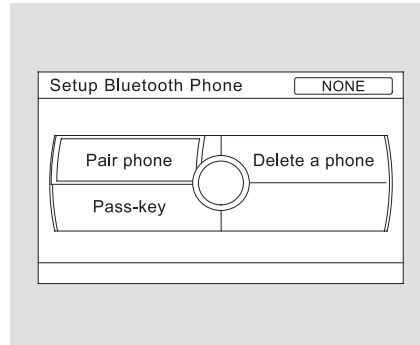

3. Make sure your phone is in Discovery mode at this point. Rotate the dial to select “Pair phone” and press ENTER, or press the Talk button and say “Pair phone.”

To get your phone into its discovery mode, refer to the phone’s operation manual.

Example

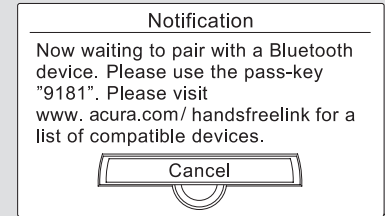

4. When a screen message appears that provides a pass-key, enter the pass-key on your cell phone when prompted in its discovery mode.

CONTINUED

Bluetooth® HandsFreeLink® (Models with navigation system)

NOTE: If you want to cancel the pairing process at this point, press ENTER to select “Cancel,” or press the Talk button and say “Cancel.”

5. When the pass-key is transferred to HFL, it recognizes and pairs your cell phone. HFL automatically attempts to connect to your cell phone that has just been paired.

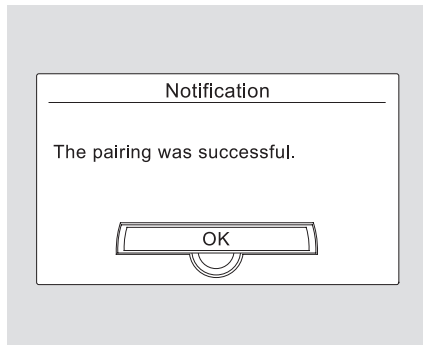

6. The notification is displayed. If OK, press ENTER. Then the message “Now your phone is ready for hands-free calls” appears. If you want to pair two or more phones, repeat steps 2–4.

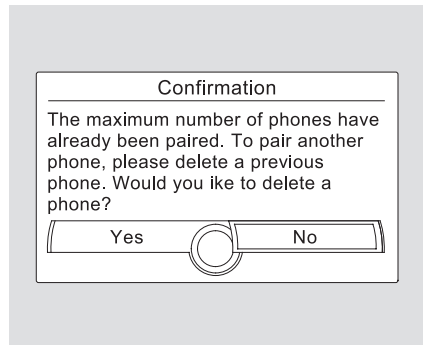

NOTE: The navigation system can manage up to six phones. If you attempt to pair a seventh phone, a screen message will appear, prompting you to delete one of your existing phones.

Bluetooth® HandsFreeLink® (Models with navigation system)

Rotate the interface dial to select “Yes” and press ENTER, or press the Talk button and say “Yes.” The display changes to the deleting procedure. To delete a phone, see page 431 . When the phone is deleted, you can pair the seventh (now sixth) phone to the system.

Specifying the Bluetooth® Pass-key

HFL uses a Bluetooth pass-key to pair a cellular phone. By default, the system generates and uses a random pass-key for any Bluetooth connection. You can change this setting to the fixed pass-key. Do the following.

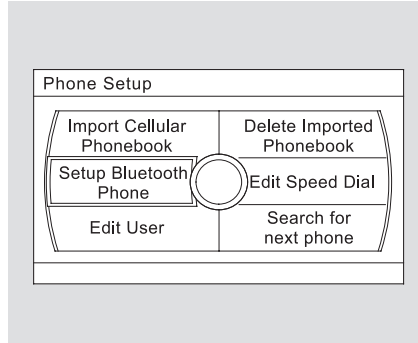

1. Select the Cellular Phone screen, then move the interface selector down. Rotate the dial to select “Setup Bluetooth Phone” and press ENTER, or press the Talk button and say “Setup Bluetooth Phone.” HFL responds “Please select a Bluetooth Phone item to setup.”

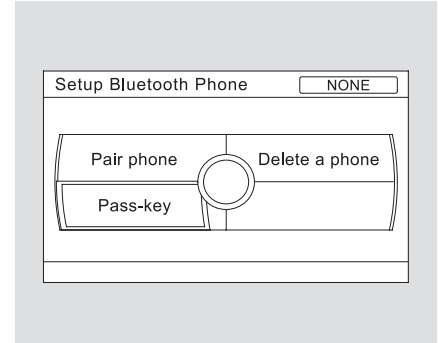

2. Rotate the dial to select “Pass-key” and press ENTER, or press the Talk button and say “Pass-key.” HFL responds “Would you like to setup a random or fixed Pass-key?”

CONTINUED

Bluetooth® HandsFreeLink® (Models with navigation system)

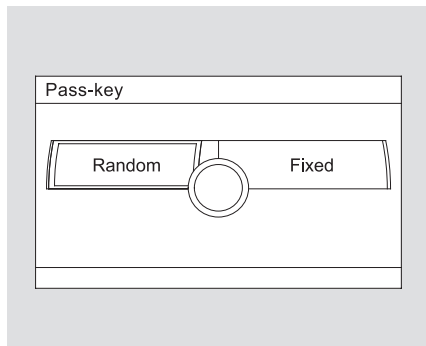

3. Rotate the dial to select either "Fixed" or "Random" and press ENTER, or press the Talk button and say "Fixed" or "Random."

When selecting "Random"

The navigation system generates and uses a random pass-key for subsequent phone pairing.

HFL returns to the Setup Bluetooth phone screen.

Example

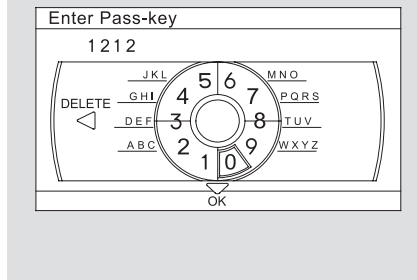

When selecting "Fixed"

Specify a 4-digit number in the pass-key entry screen and move the interface selector down. The specified number will be generated and used for subsequent phone pairing.

HFL responds "Please say your 4-digit pass-key."

Refer to the navigation system manual for information on how to enter numbers.

To delete a paired phone

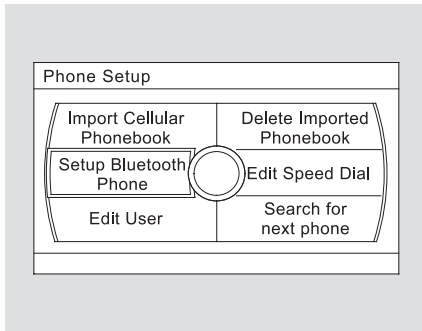

If you would like to delete a phone, do the following.

1. Select the Cellular Phone screen, then move the interface selector down. Rotate the dial to select "Setup Bluetooth Phone" and press ENTER, or press the Talk button and say "Setup Bluetooth Phone." HFL responds "Please select a Bluetooth Phone item to setup."

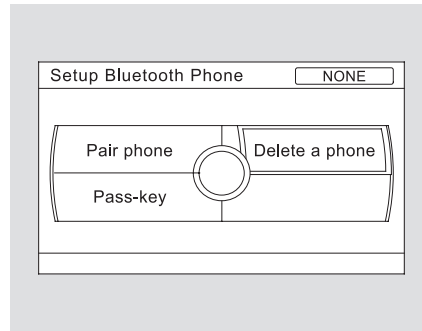

2. Rotate the dial to select "Delete a phone" and press ENTER, or press the Talk button and say "Delete a phone." HFL responds "Please select the number of the phone to delete from the list."

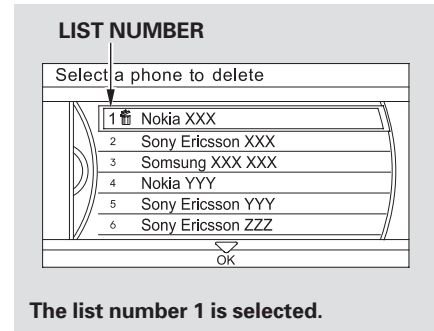

The list number 1 is selected.

3. Rotate the dial to select the phone you want to delete from the list, and press ENTER. Move the interface selector down for "OK." You can also press the Talk button and say the list number of the phone you want to delete, then say "OK."

CONTINUED

Bluetooth® HandsFreeLink® (Models with navigation system)

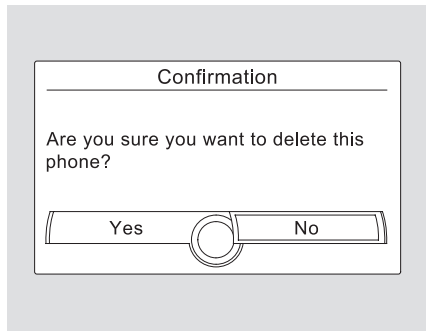

4. The above screen is displayed. Rotate the dial to select "Yes" and press ENTER, or press the Talk button and say "Yes."

To change from the currently linked phone to another paired phone when there are multiple paired phones.

1. Activate the Discovery mode of the Bluetooth-compatible phone you would like to link.

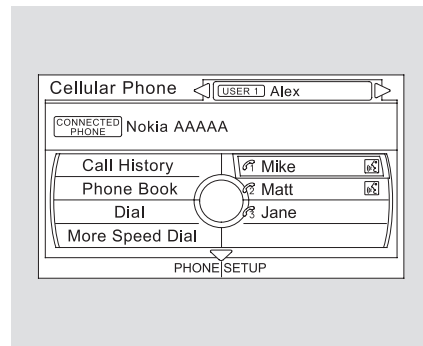

2. Press the INFO button, rotate the dial to select "Cellular Phone," and press ENTER, or press the Talk button and say "Cellular Phone." HFL responds "Which cellular phone item would you like to select?"

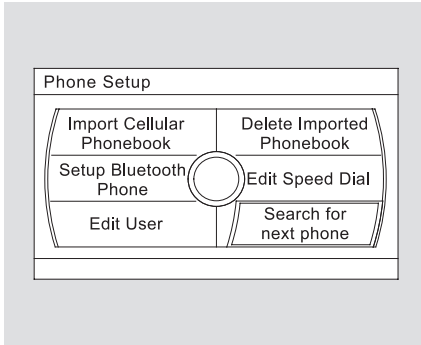

3. Move the interface selector down to select the “Phone setup” screen, or press the Talk button and say “Phone setup.” HFL responds “Please select the phone setup item.” Rotate the dial to select “Search for next phone” and press ENTER, or press the Talk button and say “Search for next phone.”

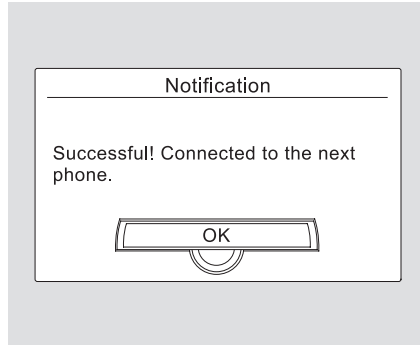

HFL attempts to connect with another paired phone, and the message “Searching for a Bluetooth phone” appears.

If the above screen is displayed, pairing has finished.

Making a Call

You can make calls using any phone number or by using a name in the HFL phonebook. You can also redial from an incoming or outgoing number. During a call, HFL allows you to talk up to 30 minutes after you set the power mode to VEHICLE OFF (LOCK). Continuing a call without running the engine may discharge and weaken the vehicle’s battery.

For more information on how to select the power mode, see page 178.

CONTINUED

Bluetooth® HandsFreeLink® (Models with navigation system)

To make a call by dialing a number, do this:

1. With your phone on and the power mode in ACCESSORY or ON, press the INFO button.

For more information on how to select the power mode, see page 178.

2. Rotate the dial to select “Cellular Phone” and press ENTER, or press the Talk button and say “Cellular Phone.” HFL responds “Which cellular phone item would you like to select?”

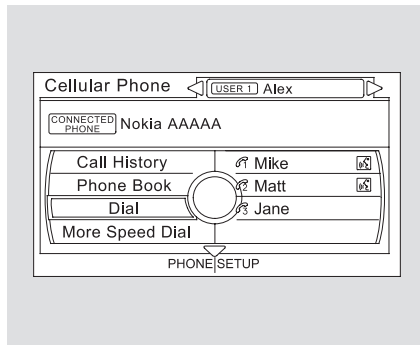

3. Rotate the dial to select “Dial” and press ENTER, or press the Talk button and say “Dial.” HFL responds “Please say the cellular phone number continuously.”

Example

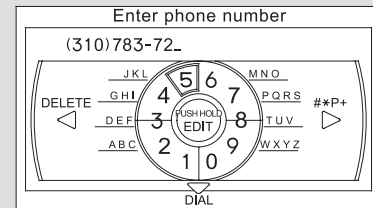

4. Rotate the dial and press ENTER to select each number, or press the Talk button and say the entire number as a continuous string. For example, say “123-456-7890.” If the wrong number is displayed on the screen, press the Talk button again and say “Delete” or “Clear.” All digits will be cleared.

Bluetooth® HandsFreeLink® (Models with navigation system)

To delete a number with the interface dial, move the selector to the left and release it. To delete all the numbers in one go, move the selector to the left and hold it.

NOTE: To enter a pound (#), say “pound.” To enter a star (*), say “star.”

On the screen, move the interface selector to the right to select a pound or star.

- When you have finished, press the Pick-Up button on the steering wheel or move the interface selector down to make the call, or press the Talk button and say “Dial.” HFL responds “Dialing.”

Example

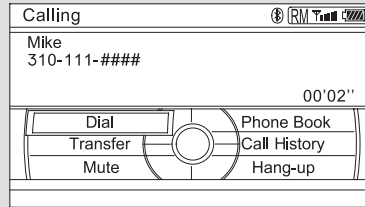

- HFL Calling display appears, notifying you that the system is dialing the entered phone number. Once connected, you will hear the person you called through the audio speakers. To change the volume, use the audio system volume knob or the steering wheel volume controls.

- To end the call, rotate the dial to select “Hang-up” and press ENTER, or press the Hang-Up button on the steering wheel.

CONTINUED

Bluetooth® HandsFreeLink® (Models with navigation system)

To make a call using a name in the HFL phonebook, do this:

1. With your phone on and the power mode in ACCESSORY or ON, press the INFO button.

For more information on how to select the power mode, see page 178.

2. Rotate the dial to select “Cellular Phone” and press ENTER, or press the Talk button and say “Cellular Phone.” HFL responds “Which cellular phone item would you like to select?”

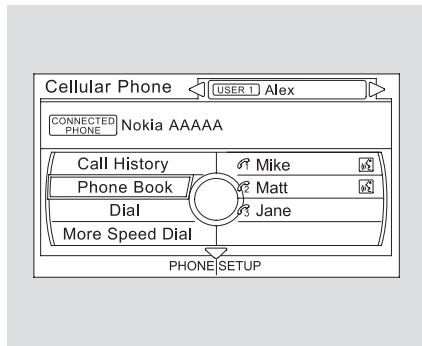

3. Rotate the dial to select “Phone Book” and press ENTER, or press the Talk button and say “Phone Book.” If a phonebook has already been imported, HFL responds “Please select the number of the phonebook from the list.” If a phonebook has not been imported, HFL will attempt to import it from your phone (see page 455).

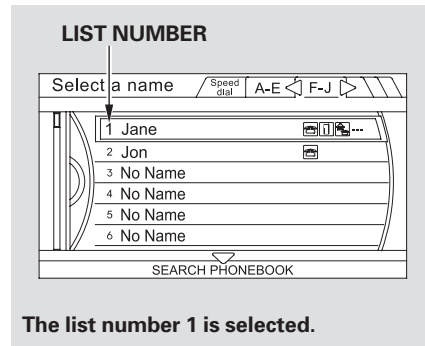

The list number 1 is selected.

4. Rotate the dial to select a contact name and press ENTER, or press the Talk button and say the list number of the name you want to select. HFL responds “Please select the number of the phone number from the list.”

Bluetooth® HandsFreeLink® (Models with navigation system)

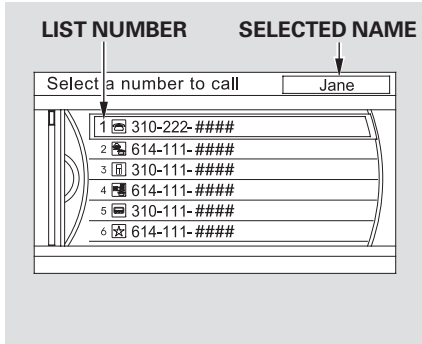

5. Select the person's phone number from the "Select a number to call" screen, or press the Talk button and say the list number of the phone number you want to select.

6. Press the Pick-Up button on the steering wheel or press ENTER to make the call, or press the Talk button and say "Dial." HFL responds "Dialing."

7. HFL Calling display appears, notifying you that the system is dialing the entered phone number. Once connected, you will hear the person you called through the audio speakers. To change the volume, use the audio system volume knob or the steering wheel volume controls.

8. To end the call, rotate the dial to select "Hang-up" and press ENTER, or press the Hang-Up button on the steering wheel.

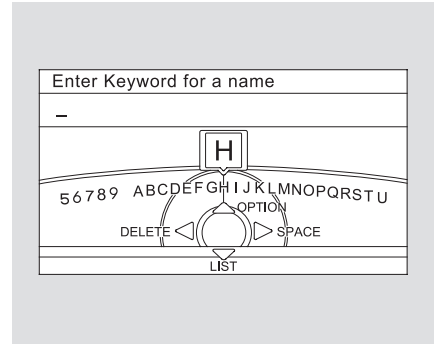

NOTE: On the "Select a name" screen, move the interface selector down to select "Search Phone Book," or press the Talk button and say "Search Phone Book." HFL responds "Please spell a keyword one letter at a time." Use the interface dial to enter the keyword. After the keyword for the name is entered, move the interface selector down to return to the "Select a name" screen.

CONTINUED

Bluetooth® HandsFreeLink® (Models with navigation system)

To make a call using the Call History, do this:

The HFL stores the last 30 incoming, the last 30 outgoing, and the last 30 missed calls, including the party name or phone number and call date.

NOTE: If you have made multiple calls to the same number, only the last call to that number will be recorded. For incoming calls, the call log also records missed calls.

1. Press the INFO button, rotate the dial to select “Cellular Phone,” and press ENTER, or press the Talk button and say “Cellular Phone.” HFL responds “Which cellular phone item would you like to select?”

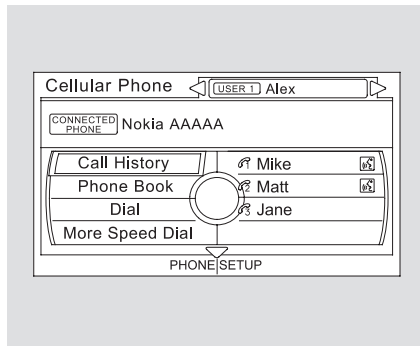

2. Rotate the dial to select “Call History” and press ENTER, or press the Talk button and say “Call History.” HFL responds “Please select the number of the call from the history list.”

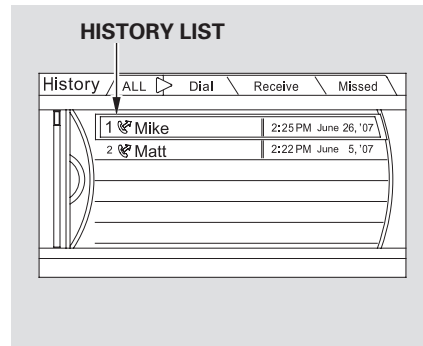

3. Move the interface selector sideways to switch between “All,” “Dial,” “Received,” or “Missed” call lists, or press the Talk button and say “All,” “Dial,” “Received,” or “Missed call.” HFL responds for Dial “Please select the number of the dialed call from the history list”, and for Received “Please select the number of the received call from the history list.”

Bluetooth® HandsFreeLink® (Models with navigation system)

4. Rotate the dial to scroll through each list and select the party name or phone number by pressing ENTER, or press the Talk button and say the list number of the call record you want to select.
5. Press the Pick-Up button on the steering wheel, or press ENTER to make the call.
6. HFL Calling display appears, notifying you that the system is dialing the entered phone number. Once connected, you will hear the person you called through the audio speakers. To change the volume, use the audio system volume knob or the steering wheel volume controls.

7. To end the call, rotate the dial to select “Hang-up” and press ENTER, or press the Hang-Up button on the steering wheel.

NOTE: You can delete all call history when you move the interface selector down when “All” is selected on the call history screen, or press the Talk button and say “Delete all.”

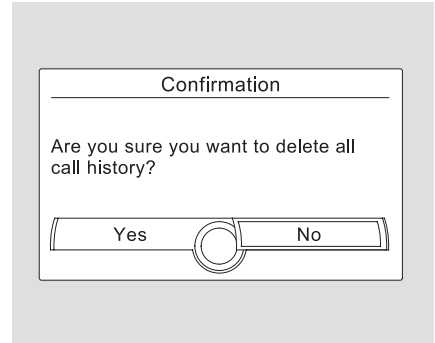

When the confirmation screen is displayed, rotate the dial to select “Yes” and press ENTER, or press the Talk button and say “Yes.”

CONTINUED

Bluetooth® HandsFreeLink® (Models with navigation system)

To make a call using a Speed Dial, do this:

Refer to page 443 for setting.

1. Press the INFO button, rotate the dial to select “Cellular Phone,” and press ENTER, or press the Talk button and say “Cellular Phone.” HFL responds “Which cellular phone item would you like to select?”

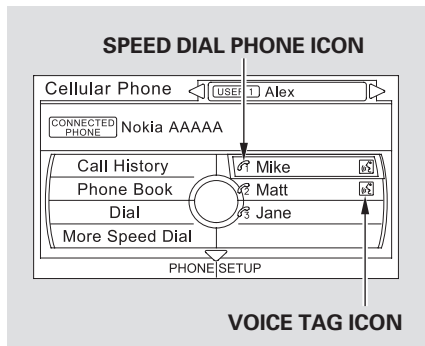

2. Rotate the dial to select a desired name with a speed dial phone icon and press ENTER, or press the Talk button and say “Call” and then the voice tag you stored for the number you want to call.

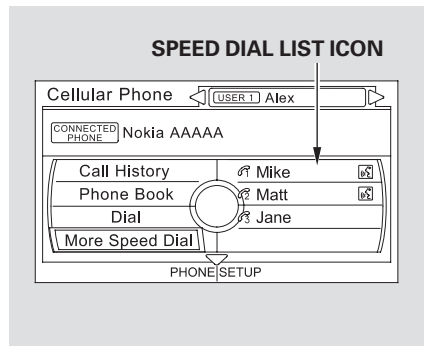

3. If you want to select a registered Speed Dial phone number other than the four entries viewable on the Cellular Phone screen, select “More Speed Dial” and press ENTER, or press the Talk button and say “More Speed Dial.” HFL responds “Please select the number of the Speed Dial from the list.”

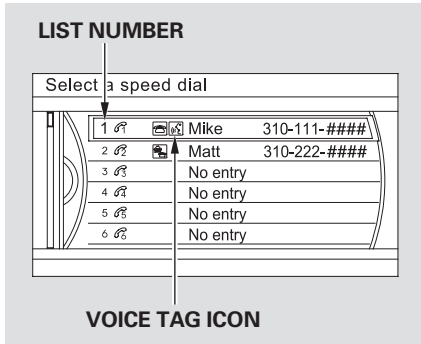

4. Rotate the dial to select a list number and press ENTER, or, if the number has a voice tag (voice tag icon is shown), press the Talk button and say “Call” and then the voice tag you stored.

NOTE: When you select a “No entry” field, HFL prompts you to enter a phone number from your phonebook or call history. See “Editing the Speed-Dial Numbers” for details (page 443).

5. HFL starts dialing the selected number. HFL Calling screen is displayed. Once connected, you will hear the person you called through the audio speakers. To change the volume, use the audio system volume knob or the steering wheel volume controls.
6. To end the call, rotate the dial to select “Hang-up” and press ENTER, or press the Hang-Up button on the steering wheel.

Receiving a Call

If you receive a call when you are not on the phone, the HFL incoming call screen appears. To answer the call, press the Pick-Up button on the steering wheel and begin speaking. If you don’t want to answer the call, press the Hang-Up button.

If your phone has Call Waiting and you receive a call when you are on the phone, press and release the Pick-Up button to answer it. When you do this, the original call is placed on hold. To return to the original call, press the Pick-Up button again. If you don’t want to answer the new call, disregard it and continue with your original call. If you want to hang up the original call and answer the new call, press the Hang-Up button.

Bluetooth® HandsFreeLink® (Models with navigation system)

Transferring a Call

During a call, you can transfer the call from HFL to your phone, or from your phone to HFL.

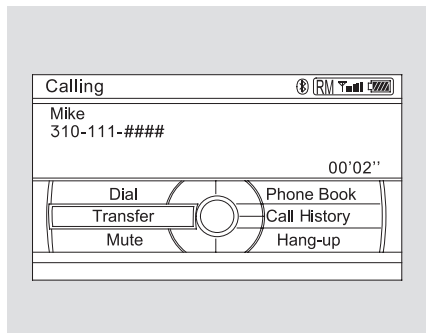

To transfer a call from HFL to your phone, do this:

When you are on the Calling screen, rotate the dial to select “Transfer” and press ENTER. The call switches from HFL to the phone.

To transfer a call from your phone to HFL, do this:

When you are on the call and the Calling screen is displayed, rotate the dial to select “Transfer” and press ENTER. The call switches from your phone to HFL.

Muting a Call

During a call, you can mute or unmute your voice to the person you are talking to.

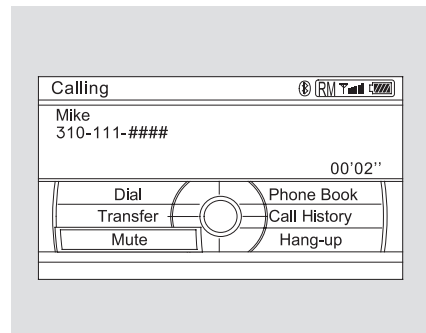

To mute your voice, do this:

When you are on the Calling screen, rotate the dial to select “Mute” and press ENTER. HFL responds “Mute is active.”

Bluetooth® HandsFreeLink® (Models with navigation system)

To unmute your voice, do this:

When you are on the Calling screen, rotate the dial to select “Mute” and press ENTER. HFL responds “Mute is canceled.”

Editing the Speed Dial Numbers

Speed Dial allows you to store up to 20 phone numbers, four of which are accessible on the “Cellular Phone” screen for quick access. They can be chosen and copied from your phonebook and call history. You can also clear and change a Speed Dial number.

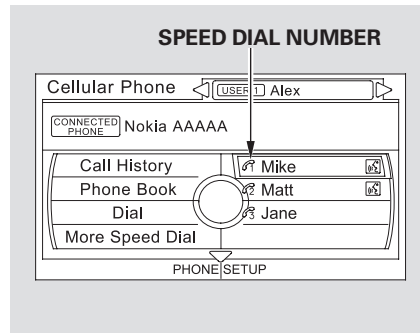

Storing the Speed Dial Numbers

You can store Speed Dial numbers in both the “Phone Setup” screen and the “Cellular Phone” screen.

Storing the Speed Dial Number in the “Phone Setup” Screen

You can store a maximum of 20 numbers in “Phone Setup.”

CONTINUED

Bluetooth® HandsFreeLink® (Models with navigation system)

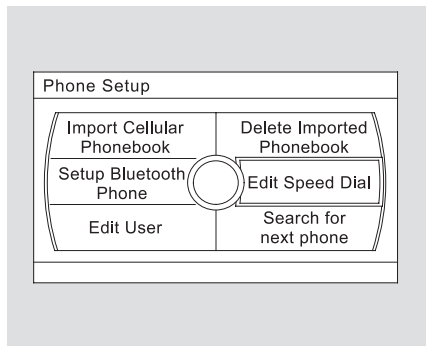

1. Select Cellular Phone screen, then move the interface selector down. Rotate the dial to select “Edit Speed Dial” and press ENTER, or press the Talk button and say “Edit speed dial” after the beep. HFL responds “Please select a method to edit.”

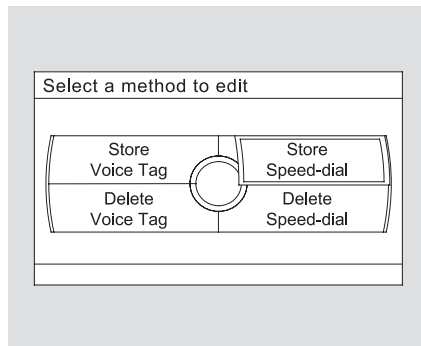

2. Rotate the dial to select “Store Speed Dial” and press ENTER, or press the Talk button and say “Store Speed Dial.” HFL responds “Please select the number to register from the list.”

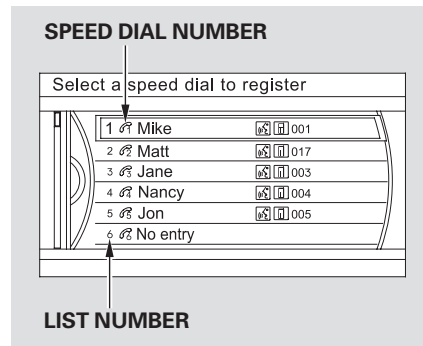

3. Rotate the dial to select a speed dial number and press ENTER, or press the Talk button and say the list number of Speed Dial you want to store. HFL responds “Would you like to register the Speed Dial from Phonebook or Call history?”

Bluetooth® HandsFreeLink® (Models with navigation system)

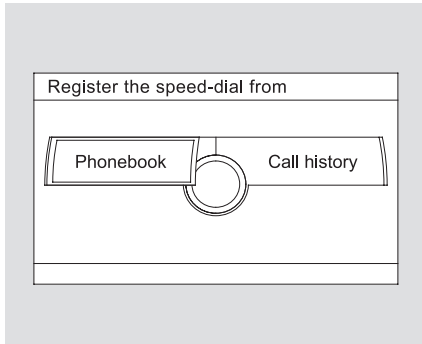

4. Rotate the dial to select "Phonebook" or "Call history" and press ENTER, or press the Talk button and say "Phonebook" or "Call history." HFL responds "Please select the number of the name from the list" when "Phonebook" is selected, and "Please select the number of the call from the history list" when "Call history" is selected.

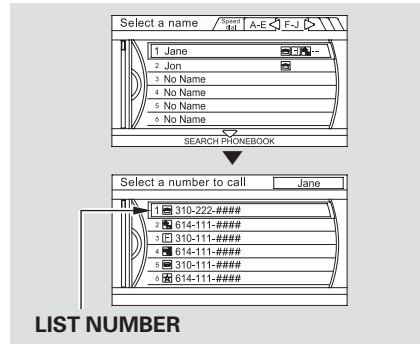

5. When "Phonebook" is selected, rotate the dial to select a name from the list, or press the Talk button and say the list number of the phone number you want to store. HFL responds "Please select the number of the phone number from the list."

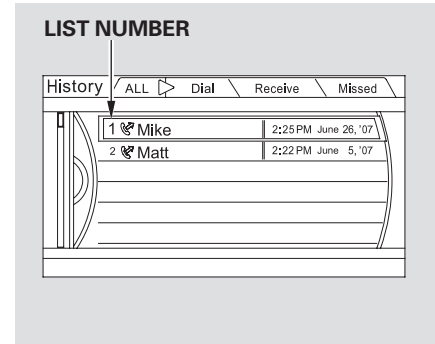

- When "Call history" is selected, rotate the dial to select a phone number or contact name from a list of dialed numbers or received calls, or press the Talk button and say a list number of the contact you want to store.

NOTE: The call history only records dialed, received, or missed phone numbers from HFL, not the phone.

CONTINUED

Bluetooth® HandsFreeLink® (Models with navigation system)

6. When storage of the Speed Dial number is completed, the following screen is displayed.

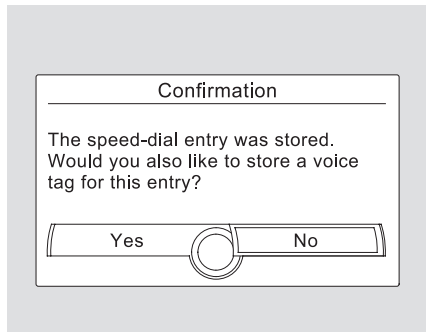

If you want to record a Voice Tag for the selected speed dial number, rotate the dial to select "Yes" and press ENTER, or press the Talk button and say "Yes." See page 450 .

Storing the Speed Dial Number in the "Cellular Phone" Screen

If any Speed Dial number is set up in "Phone Setup," numbers 1 through 4 are displayed in the "Cellular Phone" screen. If there is a blank, "No entry" is displayed. You can store a Speed Dial number directly from the "Cellular Phone" screen.

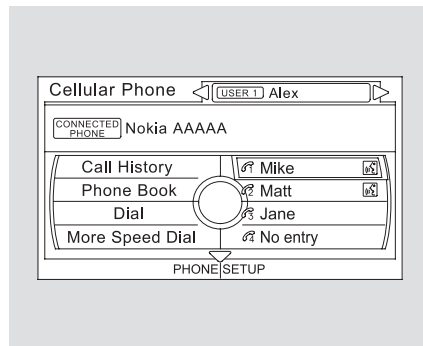

1. Rotate the dial to select a blank (No Entry) in the "Cellular Phone" screen and press ENTER, or press the Talk button and say the list number of the Speed Dial you want to store. HFL responds "Would you like to register the speed dial from the Phonebook or Call history?"

Bluetooth® HandsFreeLink® (Models with navigation system)

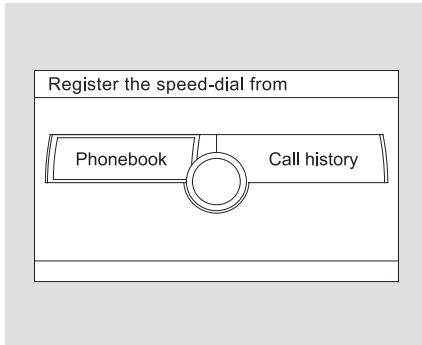

2. Rotate the dial to select “Phonebook” or “Call history” and press ENTER, or press the Talk button and say “Phonebook” or “Call history.” HFL responds “Please select the number of the name from the list” when “Phonebook” is selected, and “Please select the number of the call from the history list” when “Call history” is selected.

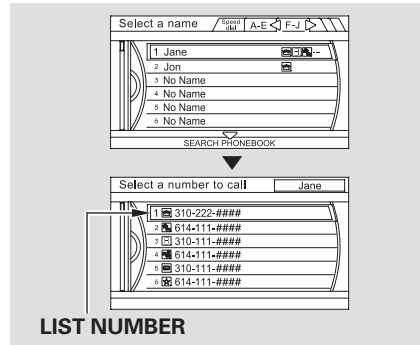

3. When “Phonebook” is selected, rotate the dial to select a name from the list, or press the Talk button and say the list number of the phone number you want to store. HFL responds “Please select the number of the phone number from the list.”

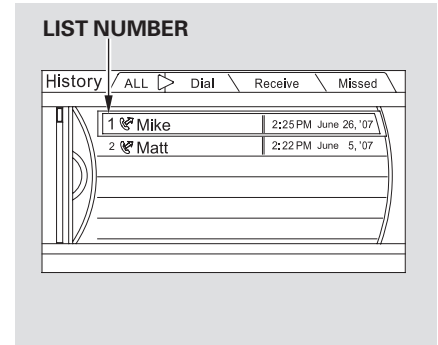

- When “Call history” is selected, rotate the dial to select a phone number or contact name from a list of your dialed numbers or received calls, or press the Talk button and say the number of the name or number you want to store.

NOTE: The call history only records dialed, received, or missed phone numbers from HFL, not the phone.

CONTINUED

Bluetooth® HandsFreeLink® (Models with navigation system)

4. When storage of the Speed Dial number is completed, the following screen is displayed.

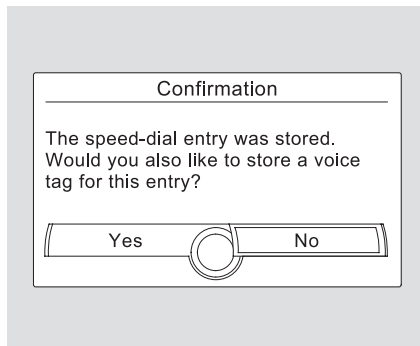

If you want to record a Voice Tag to the stored Speed Dial number, rotate the dial to select "Yes" and press ENTER, or press the Talk button and say "Yes." See page [450](#).

Deleting Speed Dial Numbers

1. Press the INFO button, rotate the dial to select "Cellular Phone," and press ENTER, or press the Talk button and say "Cellular Phone." HFL responds "Which cellular phone item would you like to select?"

Bluetooth® HandsFreeLink® (Models with navigation system)

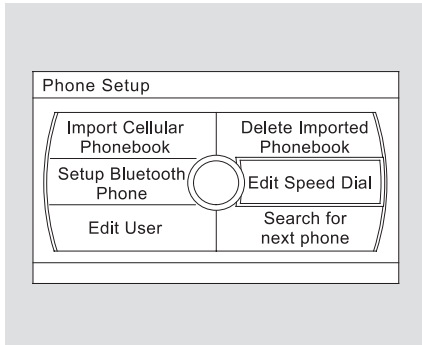

2. Move the interface selector down to select “Phone Setup,” or press the Talk button and say “Phone Setup.” Rotate the dial to select “Edit Speed Dial” and press ENTER, or press the Talk button and say “Edit Speed Dial.” HFL responds “Please select a method to edit.”

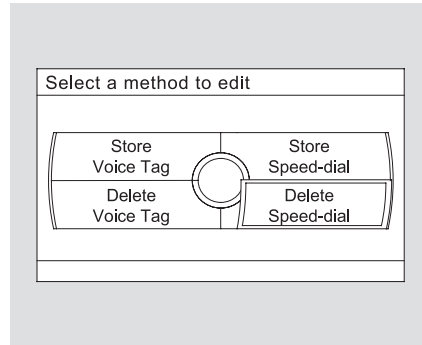

3. Rotate the dial to select “Delete Speed Dial” and press ENTER, or press the Talk button and say “Delete Speed Dial.” HFL responds “Please select the number from the list to delete.”

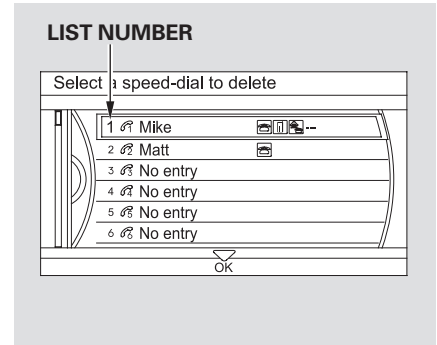

4. Rotate the dial to select the entry you want to delete from the list. Press ENTER, and move the interface selector down for “OK.” You can also press the Talk button, say the list number to delete, and say “OK.”

CONTINUED

Bluetooth® HandsFreeLink® (Models with navigation system)

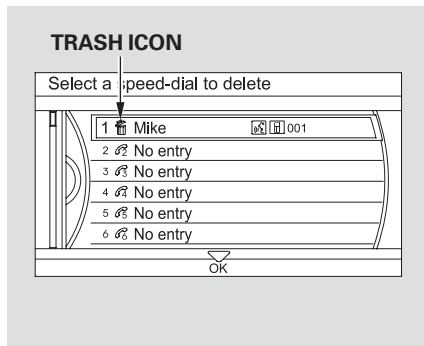

5. The selected entry will be highlighted and a trash icon will appear next to it. Move the interface selector down, or press the Talk button and say "OK" to delete the entry.

Storing a Voice Tag

1. Press the INFO button, rotate the dial to select "Cellular Phone," and press ENTER, or press the Talk button and say "Cellular Phone." HFL responds "Which cellular phone item would you like to select?"

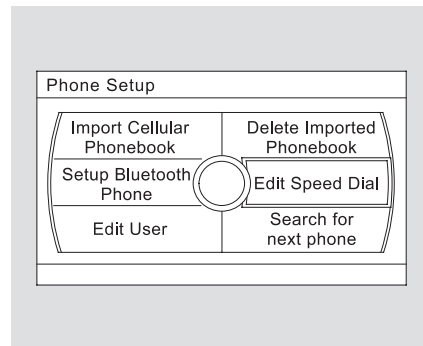

2. Move the interface selector down to select "Phone Setup," or press the Talk button and say "Phone Setup." Rotate the dial to select "Edit Speed Dial" and press ENTER, or press the Talk button and say "Edit Speed Dial." HFL responds "Please select a method to edit."

Bluetooth® HandsFreeLink® (Models with navigation system)

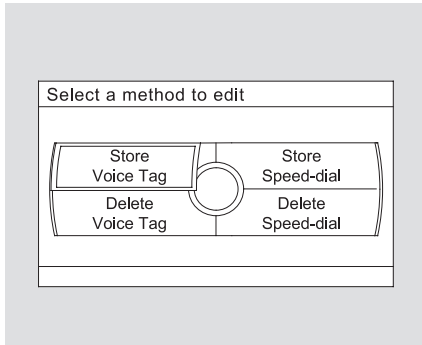

3. Rotate the dial to select “Store Voice Tag” and press ENTER, or press the Talk button and say “Store Voice Tag.” HFL responds “Please select the number of the speed dial to register the voice tag.”

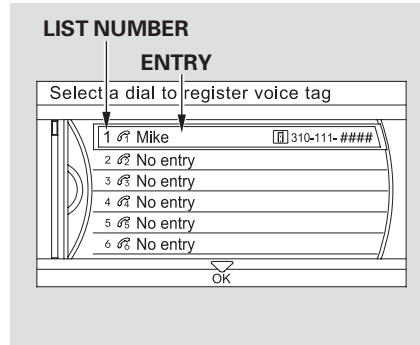

4. Rotate the dial to select the entry you want to store a voice tag for, press ENTER, and move the interface selector down for “OK.” You can also press the Talk button, say the list number of the entry you want to store a voice tag for, and say “OK.”



5. The above message will appear. Press the Talk button on the steering wheel and say the voice tag name (for example, “Mike”)

CONTINUED

Bluetooth® HandsFreeLink® (Models with navigation system)

6. When the system can recognize the voice tag, the following screen is displayed.

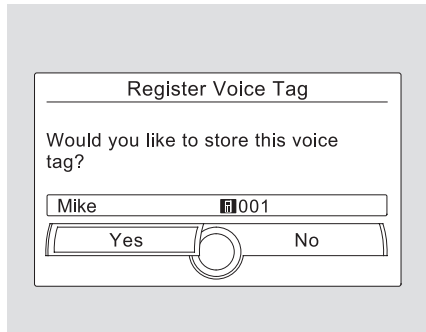

HFL will say “Do you want to store Voice tag Mike for this number?” Rotate the dial to select “Yes” or “No” and press ENTER, or press the Talk button and say “Yes.” When you select “Yes,” the voice tag is stored. You will see the voice tag icon on the Speed Dial entry.

NOTE: The system will return to step 5 if the voice tag name is not recognized.

If the voice tag name or similar-sounding one is already stored, the message “This voice tag already exists. Please say a different name” will be displayed.

NOTE:

- Avoid using duplicate name entries.
- Avoid using “home” as a name entry.
- HFL will be able to better recognize multisyllabic name entries (“Peter” instead of “Pete”), or a longer name (“John Smith” instead of “John”).
- Use a consistent, even tone and reduce background noise when storing names, as the HFL voice recognition can be sensitive.

Bluetooth® HandsFreeLink® (Models with navigation system)

Using a Voice Tag

1. Press the INFO button, rotate the dial to select “Cellular Phone,” and press ENTER, or press the Talk button and say “Cellular Phone.” HFL responds “Which cellular phone item would you like to select?”
2. Press the Talk button, and say “Call” and the Voice Tag right after it.
3. HFL starts dialing the phone number associated with the Voice Tag. HFL Calling screen is displayed. Once connected, you will hear the person you called through the audio speakers.
4. To end the call, rotate the dial to select “Hang-up” and press ENTER, or press the Hang-Up button on the steering wheel.

Deleting a Voice Tag

1. Press the INFO button, rotate the dial to select “Cellular Phone,” and press ENTER, or press the Talk button and say “Cellular Phone.” HFL responds “Which cellular phone item would you like to select?”

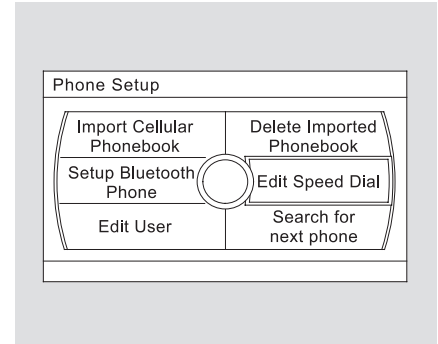

2. Move the interface selector down to select “Phone Setup,” or press the Talk button and say “Phone Setup.” Rotate the dial to select “Edit Speed Dial” and press ENTER, or press the Talk button and say “Edit Speed Dial.” HFL responds “Please select a method to edit.”

CONTINUED

Bluetooth® HandsFreeLink® (Models with navigation system)

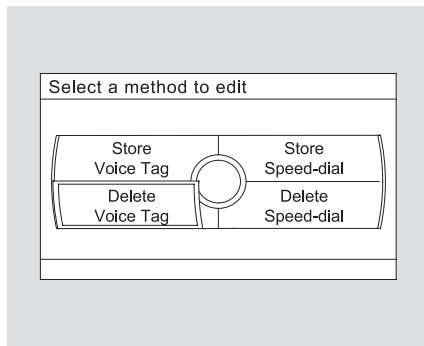

3. Rotate the dial to select “Delete Voice Tag” and press ENTER, or press the Talk button and say “Delete Voice Tag.” HFL responds “Please select the number of the voice tag to delete.”

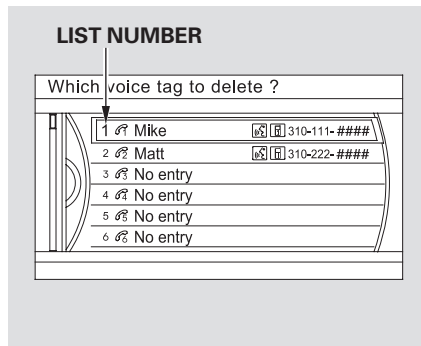

4. Rotate the dial to select the entry that you want to delete the voice tag for and press ENTER, or press the Talk button and say the list number of entry to delete.

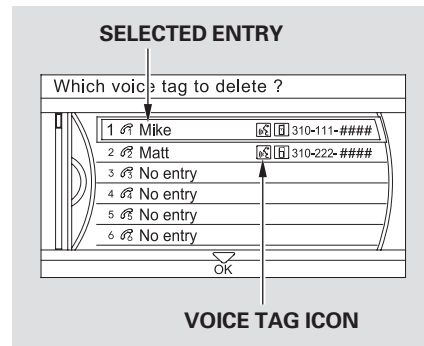

5. The selected entry will be highlighted. Move the interface selector down, or press the Talk button and say “OK” to delete the entry’s voice tag.

Bluetooth® HandsFreeLink® (Models with navigation system)

Setting Up the Cellular Phone Book

HFL can store up to six phones, with one phonebook for each. The Phonebook allows you to store up to 1,000 names and 10,000 phone numbers. The maximum names and numbers to be stored varies on the data size of each saved item. Once they are stored, you can then automatically dial any name or number in the phonebook.

NOTE: Your phone may not have this capability. Visit www.acura.com/handsfreelink or call the HandsFreeLink® consumer support at 1-888-528-7876. In Canada, visit www.acura.ca, or call 1-888-9-ACURA-9. You can see your phone's owner's manual for information.

To Import the Cellular Phonebook
Hands-free calls are more convenient if you import the phonebook from your phone to HFL.

For safety purposes, only perform this function while the vehicle is stopped.

NOTE: Once HFL starts importing from the phone, it does not accept phone-related operations until the process is finished.

1. Pair your phone to HFL (see page 426).
2. Press the INFO button, rotate the dial to select “Cellular Phone,” and press ENTER, or press the Talk button and say “Cellular Phone.” HFL responds “Which cellular phone item would you like to select?”
3. Move the interface selector down to select the “Phone setup” screen,

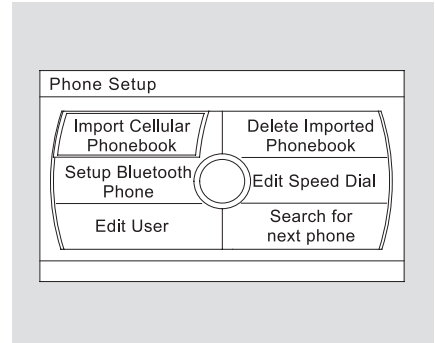

or press the Talk button and say “Phone setup.” HFL responds “Please select the phone setup item.”

4. Rotate the dial to select “Import Cellular Phonebook” and press ENTER, or press the Talk button and say “Import Cellular Phonebook.” HFL responds “Would you like to import Cellular Phonebook?”

CONTINUED

Bluetooth® HandsFreeLink® (Models with navigation system)

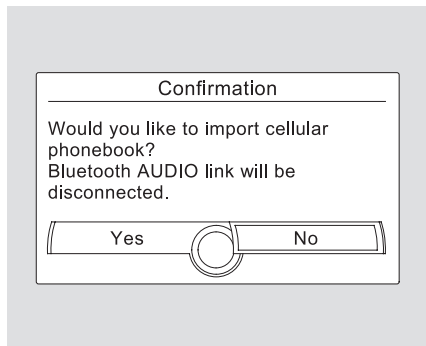

NOTE: If you are playing Bluetooth® Audio, the above screen is displayed. If you want to stop Bluetooth Audio and continue to import the Cellular Phonebook, rotate the dial to select "Yes" and press ENTER, or press the Talk button and say "Yes."

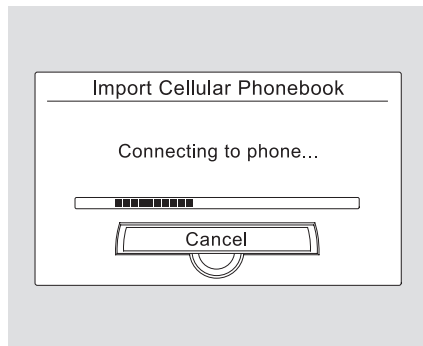

The Phonebook data is being imported when the above screen is displayed.

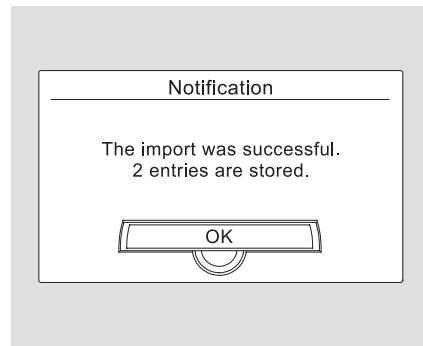

5. If the import is successful, you will see the above screen. Press ENTER to select "OK," and the screen will return to the "Cellular Phone."

NOTE: After returning to the "Cellular Phone" screen, rotate the dial to select "Phonebook" and press ENTER. Make sure the phonebook was imported successfully.

Bluetooth® HandsFreeLink® (Models with navigation system)

NOTE:

- HFL stores up to 10,000 phone numbers for each paired phone. If you try to import a phonebook with more than 10,000 numbers, or phonebook with no numbers at all, a screen message will notify you that data cannot be imported.
- When you update information in your cell phone's phonebook, you will need to repeat the import process.
- You may not be able to store the maximum number of names and numbers in some cases.

Up to three category icons are displayed in the right side of the list. These category icons indicate how many numbers are stored for the person. If a name has more than three category icons, “ --- ” is displayed. The following category icons will appear:

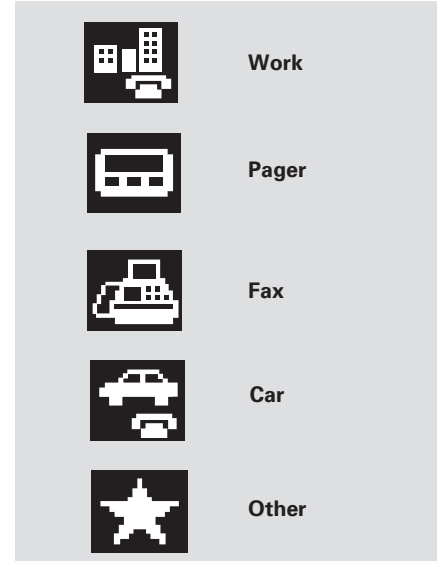
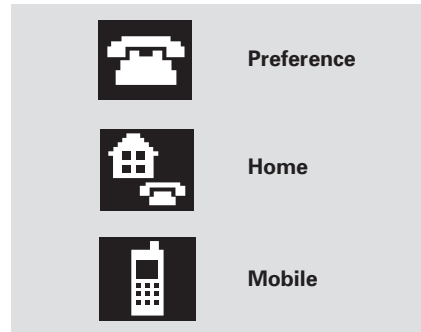

CONTINUED

Bluetooth® HandsFreeLink® (Models with navigation system)

To Delete the Imported Phonebook

1. Press the INFO button, rotate the dial to select “Cellular Phone,” and press ENTER, or press the Talk button and say “Cellular Phone.” HFL responds “Which cellular phone item would you like to select?”
2. Move the interface selector down to select the “Phone setup” screen, or press the Talk button and say “Phone setup.” HFL responds “Please select the phone setup item.”

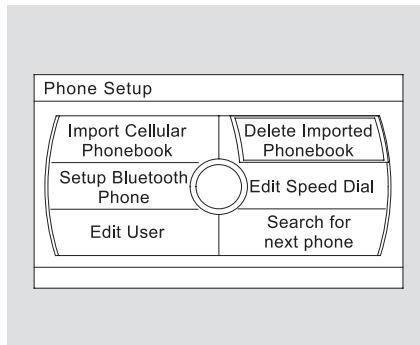

3. Rotate the dial to select “Delete Cellular Phonebook” and press ENTER, or press the Talk button and say “Delete Cellular Phonebook.” HFL responds “This will delete the imported Phonebook for the currently selected phone. Would you like to continue?”

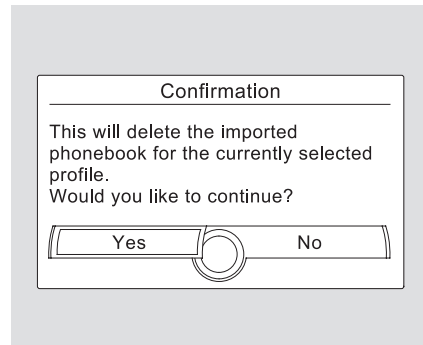

4. Rotate the dial to select “Yes” and press ENTER, or press the Talk button and say “Yes.”

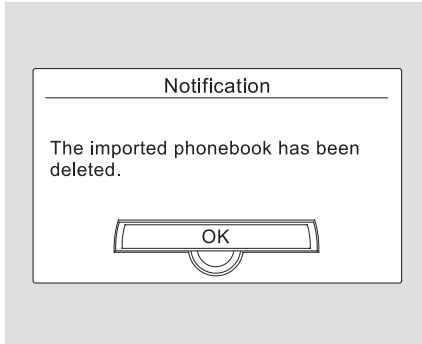

5. When the imported phonebook is deleted, the above screen is displayed.

Only the phonebook for the selected user will be deleted.

Setting the User

HFL can store up to six users. Each user has their own Phonebook, Speed Dial, and Call history. You can rename and delete a user name in the "Edit User" screen. You can also set a 4-digit PIN (password) to protect user information.

Store a user name

1. Press the INFO button, rotate the dial to select "Cellular Phone," and press ENTER, or press the Talk button and say "Cellular Phone." HFL responds "Which cellular phone item would you like to select?"

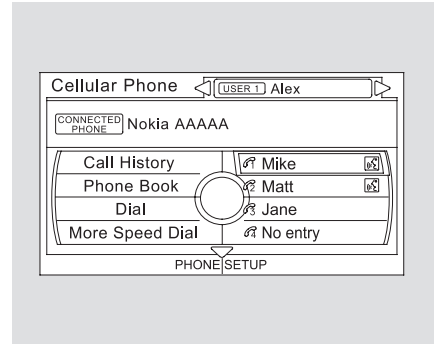

2. Move the interface selector down to select the "Phone setup" screen, or press the Talk button and say "Phone setup." HFL responds "Please select the phone setup item."

CONTINUED

Bluetooth® HandsFreeLink® (Models with navigation system)

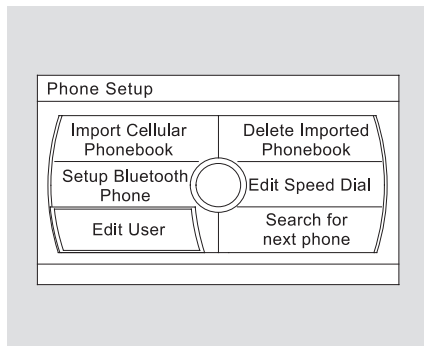

3. Rotate the dial to select “Edit User” and press ENTER, or press the Talk button and say “Edit User.” HFL responds “Please select an edit user item.”

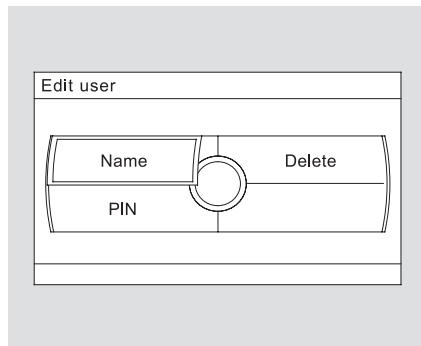

4. Rotate the dial to select “Name” and press ENTER, or press the Talk button and say “Name.” HFL responds “Please select the number of user name to edit from the list.”

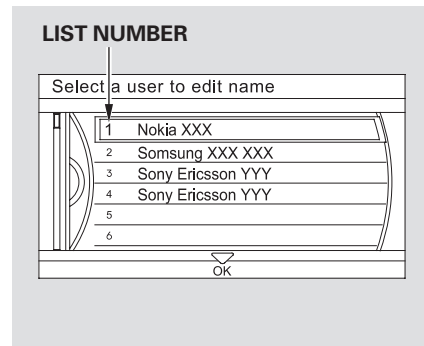

5. Rotate the dial to select the phone that you want to create a user name for, press ENTER, and move the interface selector down for “OK.” You can also press the Talk button, say the list number of the phone you want to create a user name for and say “OK.”

Bluetooth® HandsFreeLink® (Models with navigation system)

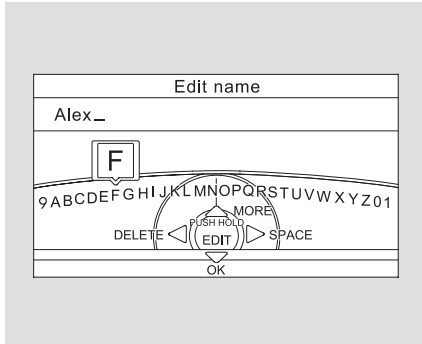

6. Rotate the dial and press ENTER to select the letters. After the new name is entered, move the interface selector down to create the user name.

Delete a user name

1. Press the INFO button, rotate the dial to select “Cellular Phone,” and press ENTER, or press the Talk button and say “Cellular Phone.” HFL responds “Which cellular phone item would you like to select?”
2. Move the interface selector down to select the “Phone setup” screen, or press the Talk button and say “Phone setup.” HFL responds “Please select the phone setup item.”

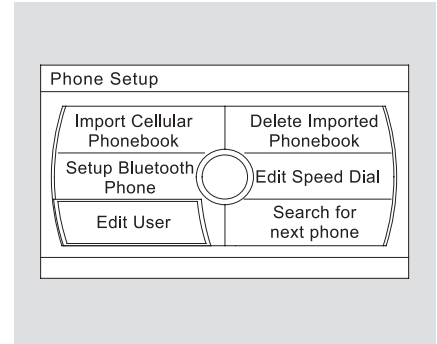

3. Rotate the dial to select “Edit User” and press ENTER, or press the Talk button and say “Edit User.” HFL responds “Please select an edit user item.”

CONTINUED

Bluetooth® HandsFreeLink® (Models with navigation system)

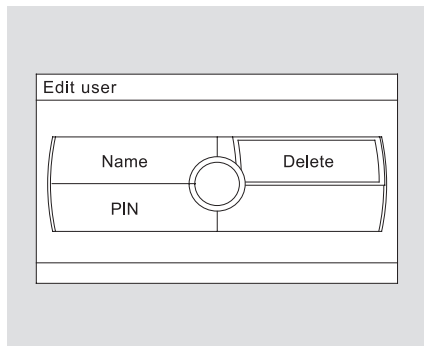

4. Rotate the dial to select “Delete” and press ENTER, or press the Talk button and say “Delete.” HFL responds “Please select the number of user name to edit from the list.”

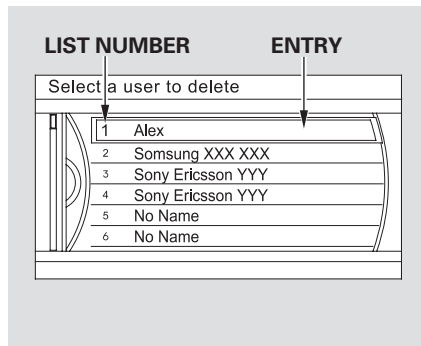

5. Rotate the dial to select the entry that you want to delete the user name for and press ENTER, or press the Talk button and say the number of the entry to delete.

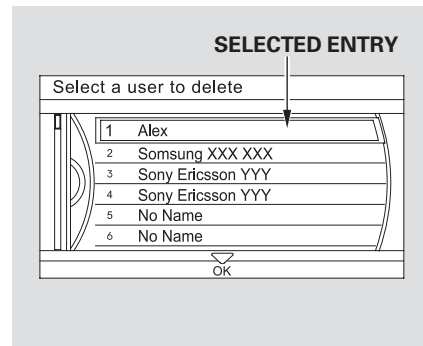

6. The selected entry will be highlighted. Move the interface selector down, or press the Talk button and say “OK,” to delete the name.

NOTE: If you delete the user name, the user name will be “No name.”

Bluetooth® HandsFreeLink® (Models with navigation system)

To add, change, or remove a PIN (password) from any user

1. Press the INFO button, rotate the dial to select “Cellular Phone,” and press ENTER, or press the Talk button and say “Cellular Phone.” HFL responds “Which cellular phone item would you like to select?”
2. Move the interface selector down to select the “Phone setup” screen, or press the Talk button and say “Phone setup.” HFL responds “Please select the phone setup item.”

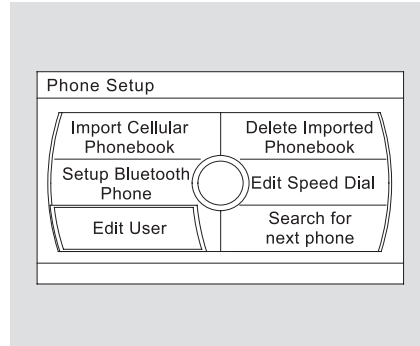

3. Rotate the dial to select “Edit User” and press ENTER, or press the Talk button and say “Edit User.” HFL responds “Please select an edit user item.”

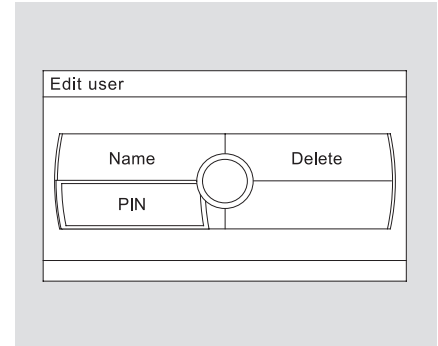

4. Rotate the dial to select “PIN” and press ENTER, or press the Talk button and say “PIN.” HFL responds “Please select the number of user to setup from the list.”

CONTINUED

Bluetooth® HandsFreeLink® (Models with navigation system)

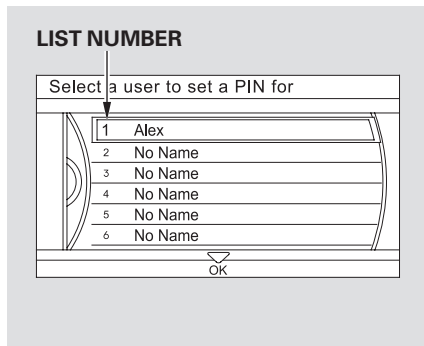

5. Rotate the dial to select the user that you want to set a PIN for, press ENTER, and move the interface selector down for “OK.” You can also press the Talk button, say the list number of the user you want to set a PIN for, and say the number, then “OK.” HFL responds “Please say your 4-digit PIN.”

NOTE: If the user you selected has already set a PIN, the “Enter password” screen will be displayed. Enter the PIN which is already set.

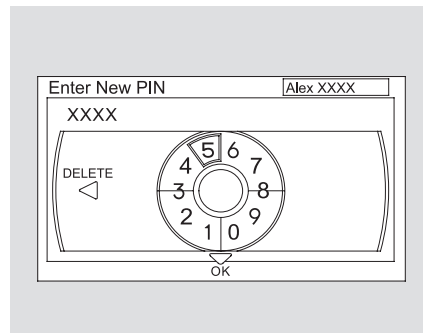

6. Rotate the dial and press ENTER to select 4 digits to set as the PIN. Move the interface selector down when you are done.

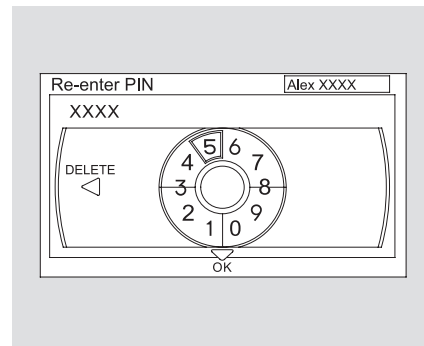

7. You will need to re-enter the same 4 digits for confirmation. Move the interface selector down when you are done.

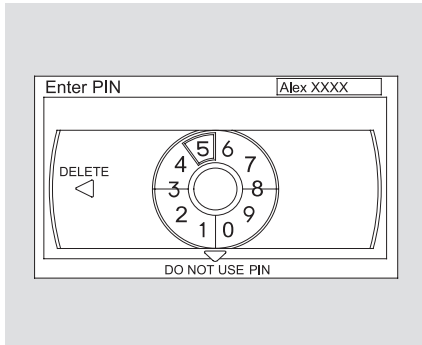

NOTE: If you choose not to use a PIN, move the interface selector down in step 6 to select “DO NOT USE PIN” without entering the 4-digit password.

Changing a User

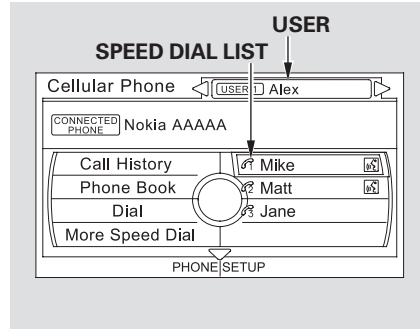

You can change a user in the “Cellular Phone” screen. To select a user, move the interface selector right or left.

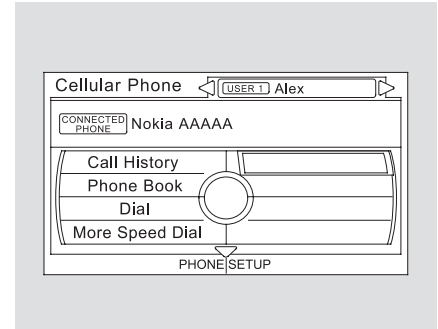

If you switch to a user with a PIN, the “Speed Dial” list on the right side of the screen will not appear until the PIN is entered.

When you select “Call history,” “Phone Book,” “Dial,” or “More Speed Dial,” the “Enter PIN” screen will be displayed. Enter the password.

Bluetooth® HandsFreeLink® (Models with navigation system)

HFL Limitations

While you are listening to the Bluetooth® audio, pause the system to operate HFL.

U.S. models only

In addition, you cannot use HFL while using AcuraLink.

As required by the FCC:

This device complies with Part 15 of the FCC rules. Operation is subject to the following two conditions: (1) This device may not cause harmful interference, and (2) this device must accept any interference received, including interference that may cause undesired operation.

Changes or modifications not expressly approved by the party responsible for compliance could void the user's authority to operate the equipment.

This device complies with Industry Canada Standard RSS-210.

Operation is subject to the following two conditions: (1) this device may not cause interference, and (2) this device must accept any interference that may cause undesired operation of the device.

On models with navigation system

AcuraLink enhances your ownership experience by providing a direct communication link between your vehicle and the Acura Server. Working through the XM radio satellite, AcuraLink works in conjunction with the navigation system, Bluetooth® HandsFreeLink® (HFL), and audio system in your vehicle. It displays and receives several kinds of messages, including:

- Operating tips and information on your vehicle's features.
- Important recall and safety information.
- Maintenance information to keep your vehicle in top condition.
- Diagnostic information to provide information about any problems with your vehicle.

Interface Dial

Most AcuraLink functions are controlled by the interface dial. The interface dial has two parts, a knob and a selector.

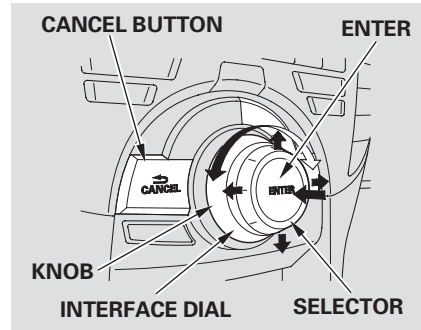

The knob turns left and right. Use it to make selections or adjustments to a list or menu on the screen.

The selector can be pushed left, right, up, down, and in. Use the selector to scroll through lists, to select menus, and to highlight menu items. When you make a selection, push the center of the selector (ENTER) to go to that selection.

AcuraLink (U.S. models only)

Reading Messages

If you have new messages, an envelope icon appears in the lower left hand part of the navigation screen.

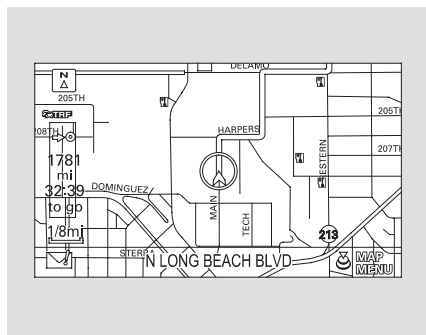

To open a message:
Press ENTER on the interface selector, then select New Message from the navigation system map menu.

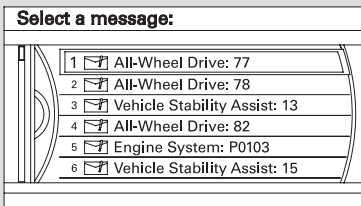

A list of all messages will be shown. New messages will be at the top. Select the message you want to read by pressing ENTER.

A red exclamation will be marked on an envelope icon with an important message.

To view previously read messages:

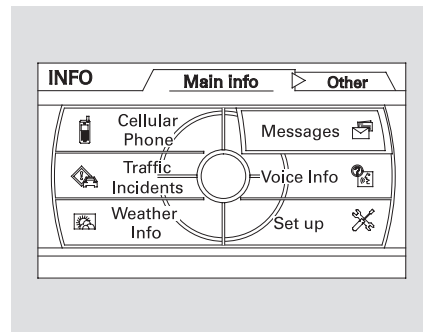

Press the INFO button. The information screen will be shown.

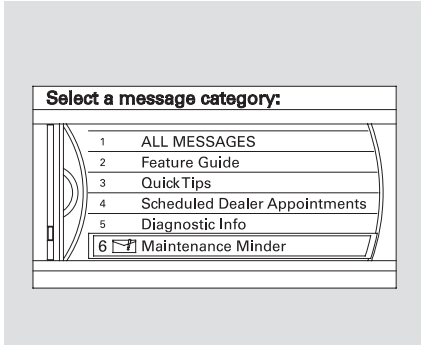

Select "Messages", then select a message category by pressing ENTER. Select the message you want to read and press ENTER.

Unread messages have a closed envelope icon next to them. The icon disappears when it has already been read.

NOTE: Only Diagnostic Info messages appear on the navigation screen while driving. They indicate if your vehicle has a problem that may need immediate attention (see page 478).

After purchasing your vehicle, messages may not appear immediately. Your dealer has to register the vehicle identification before you can receive messages. This can take several days to process.

Message Options

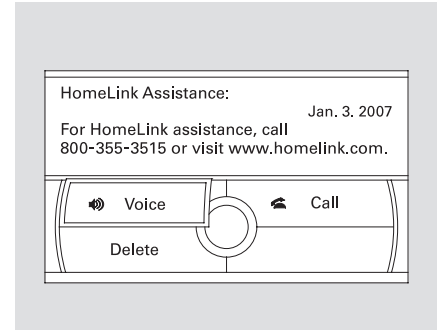

When you open a message, you can read a summary of it, and then choose one of several options. If an option is not available for a message, that option will not be highlighted.

CONTINUED

AcuraLink (U.S. models only)

Delete — Select this option to delete the current message.

Voice — Select this option to hear a voice read the entire message. This gives you more information than the screen can display at one time. When you select the Voice option, it changes to a Stop Reading option. Select the option again to stop the voice.

Call — Select this option to call a phone number embedded in the message. When you select **Call**, the Bluetooth® HandsFreeLink® (HFL) dials the number for you.

To make a call, your Bluetooth® compatible phone must be paired to the vehicle's HandsFreeLink system, powered on, and located within the vehicle (see page 426).

Find Nearest Dealer — Select this option to find the nearest Acura dealer using the navigation system.

Call Your Dealer — Select this option to call the Acura dealer you purchased your vehicle from. AcuraLink also directs you to this dealer so you can schedule a maintenance appointment or receive information about a message. If your assigned servicing dealer changes, AcuraLink will reset to call that dealer.

Diagnostic Info — Select this option to get more information about the current diagnostic message. To use this option, your cellphone must be paired with the HFL. In addition, the paired phone must have a compatible data service and be set up with the AcuraLink system to make a data connection. Access the handsfreelink.com website to find out which data services are currently compatible with AcuraLink.

Message Preferences

To set your AcuraLink preferences (the types of messages you want to receive, if any), visit the My Acura website at www.owners.acura.com, and choose what you would like to receive. If you do not have internet access, call Acura Client Services at (800) 382-2238; they can set your message preferences for you.

Deleting Messages

NOTE: Diagnostic info and recall/campaign messages can only be deleted by your dealer.

To delete a single message:

- Press the INFO button to bring up the Information screen.
- Scroll to the Messages option, then select it by pressing ENTER on the interface selector.
- Select the message category that contains the message you want to delete.
- Use the interface knob to scroll up or down to the message title you want to delete, and select it by pressing ENTER on the interface selector.
- Scroll to Delete with the interface knob, and select it by pressing ENTER on the interface selector.

To delete all messages:

NOTE: The Delete All Messages command does not apply to Diagnostic Info and Recall messages. They can only be deleted by your dealer.

- Press the SETUP button to view the setup screen.
- Select Other by pushing the interface selector to the right.

- Use the interface knob to scroll to the AcuraLink/Messages option, and select it by pressing ENTER on the interface selector.
- Scroll to the Delete Messages option, and select it by pressing ENTER on the interface selector.
- Scroll to the category with the messages you want to delete, and select the category by pressing ENTER on the interface selector.

AcuraLink (U.S. models only)

Message Categories

There are six message categories in AcuraLink: Quick Tips, Feature Guide, Maintenance Minder, Recalls/Campaigns, Diagnostic Info, and Scheduled Dealer Appointment. The system can store up to 255 messages.

Message categories can be added, revised, or deleted through broadcast messages from Acura.

Quick Tips

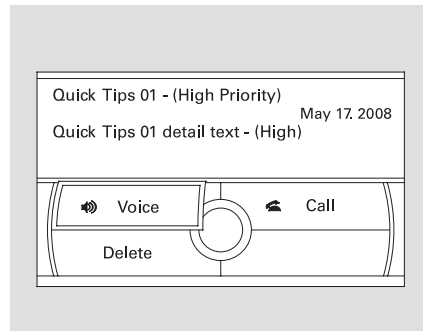

These messages, based on updated vehicle information and comments from other TL owners, supplement your Owner's Manual and Quick Start Guide. They provide you with relevant information for a safe and enjoyable ownership experience. For additional information, call Acura Client Services directly through the HFL.

Feature Guide

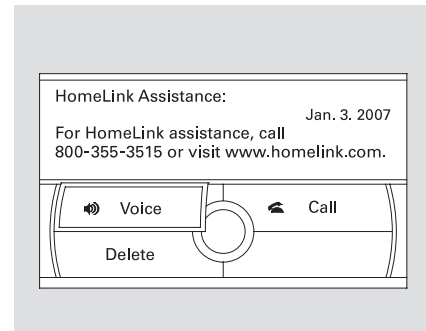

During the first 90 days of ownership, one of up to 17 different messages appears each day. These messages help you to use and understand the features of your vehicle.

Maintenance Minder

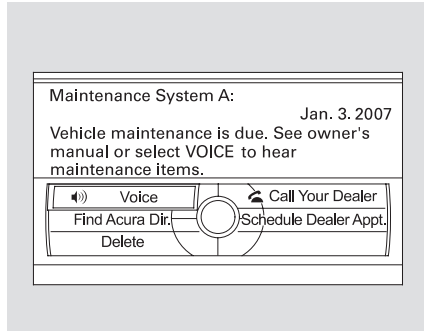

These messages provide detailed information about the service needed for your vehicle. When a maintenance message appears on the multi-information display, a list of needed maintenance items is provided through an AcuraLink message. These messages tell you the exact maintenance needed, helping you to avoid unnecessary maintenance costs.

You can use the following message options:

- Make an appointment from the schedule at the dealer.
- Reschedule the appointment with the dealer.
- Call your dealer for an appointment.
- Find the nearest dealer.

Automated Appointment

You can make an appointment with your dealer through the AcuraLink when you receive a maintenance minder message.

To use the automated appointment function, you should visit the My Acura website at www.owners.acura.com, register some required settings, and complete the Phone-Data Connection set-up (see page 481). Your Bluetooth® compatible phone should also be paired and linked to your vehicle's Bluetooth® HFL (see page 426).

CONTINUED

AcuraLink (U.S. models only)

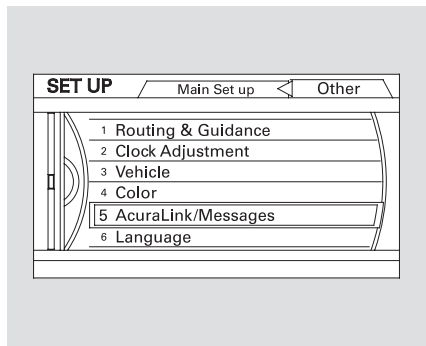

When you see the maintenance minder message on the multi-information display, you will also receive a message in the navigation screen. Select "AcuraLink/Messages" on the Setup screen, then press ENTER.

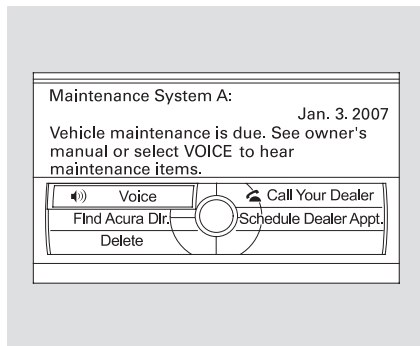

Select the received message, then press ENTER. You will see the message as shown. To make an appointment, select "Schedule Dealer Appt." then press ENTER.

The system will automatically connect to the Acura server, then show you an appropriate appointment date and time on the navigation screen. If you accept this appointment, select "Confirm Appointment," then press ENTER.

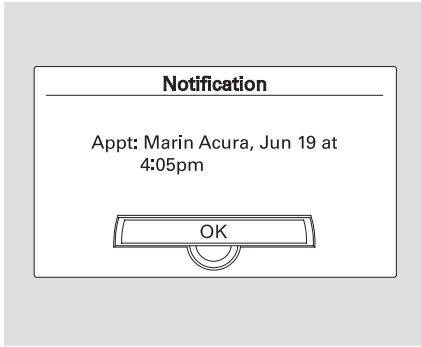

The confirmation message will be displayed on the screen. Make sure to confirm the appointment date, time and dealer. If it is OK, press ENTER.

If you want to change or reschedule the appointment date, select "Cancel," then press ENTER.

Scheduled Dealer Appointment *To reschedule the appointment:*

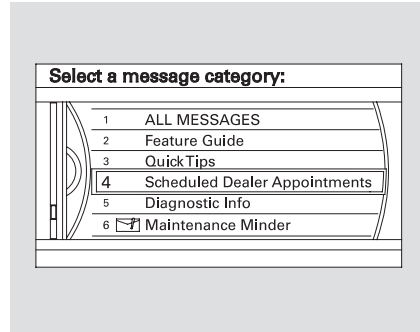

Select "AcuraLink/Messages" on the Setup screen, then press ENTER. Select "Scheduled Dealer Appointment," then press ENTER.

You will see the screen to reschedule as shown. To make an appointment, select "Reschedule Appointment," then press ENTER.

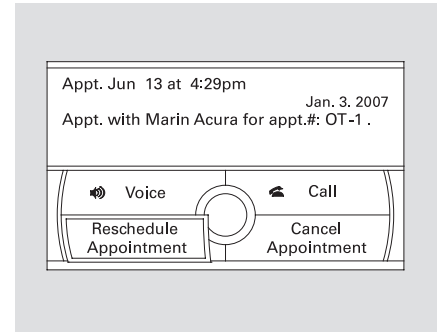

The system will automatically connect to the Acura server, then show you a new appointment date and time on the navigation screen. If you accept this appointment, select "Confirm Appointment," then press ENTER.

CONTINUED

AcuraLink (U.S. models only)

To cancel the appointment:

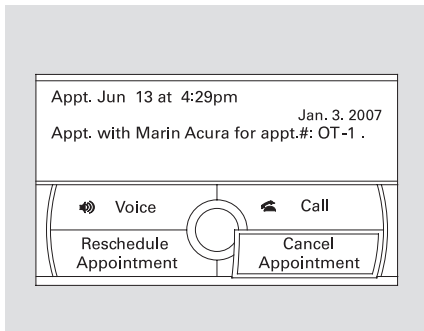

Select "AcuraLink/Messages" on the Setup screen, then press ENTER. Select the appointment message then press ENTER. You will see the screen to cancel as shown. To cancel the appointment, select "Cancel Appointment," then press ENTER.

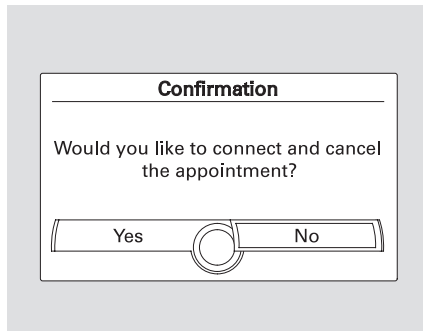

The system will request you to confirm the cancel on the navigation screen. To cancel the appointment, select "YES," then press ENTER. If you select "NO," the screen goes back to the previous message display.

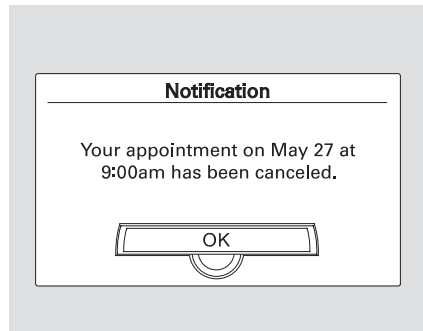

The system will automatically connect to the Acura server, then show you the confirmation on the navigation screen. If you accept the cancel, press ENTER.

If you select the cancel appointment, you cannot try to reschedule the appointment. If you want to change or reschedule the appointment date, call your dealer directly with the HFL.

Using automated appointment, your registered dealer through My Acura is automatically selected. If you want to select another dealer, such as in case of an emergency, find the nearest dealer and call the dealer directly with the HFL.

When a maintenance appointment is due soon, you will also receive an appointment reminder message.

Recall/Campaigns

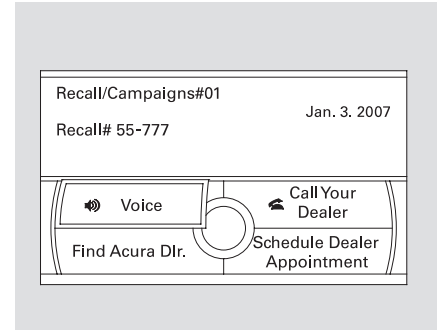

If your vehicle is affected by a recall or other important safety information, a letter will be mailed to you about the issue and how to fix it. If you don't get your vehicle fixed, you will also receive a reminder message through AcuraLink. You can then use the message options to call your dealer for an appointment or to find the nearest dealer.

CONTINUED

AcuraLink (U.S. models only)

For this reason, it is important that we retain your current phone number. Please update your information using My Acura at www.owners.acura.com.

Diagnostic Info

When an indicator comes on or a message is displayed on the Multi-Information Display (MID), AcuraLink can provide information about the cause of the indicator or message and the recommended action to address it. This helps you handle the problem as it occurs, preventing or limiting costly repairs.

The AcuraLink system cannot determine some mechanical problems (such as squeaks or rattles) that are not triggered by the diagnostic indicator monitors.

For more information on the instrument panel indicators, see page [64](#).

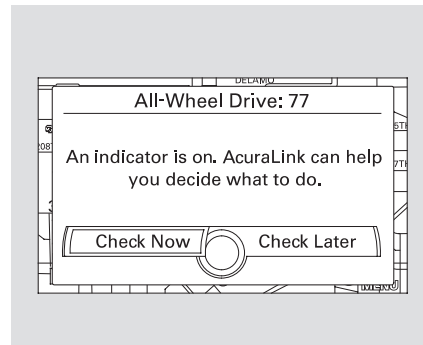

When any indicator comes on or a message is displayed on the MID, AcuraLink immediately notifies you with the message, "An indicator is on. AcuraLink can help you decide what to do."

If you do not want the information right away, select the Check Later option.

If you want the information now, select the Check Now option. (If the navigation screen is not active, you must select OK from the navigation disclaimer screen before you can check the information.)

Depending on the severity of the problem, the message will let you know if you should see your dealer immediately or if you can wait until a later date.

You can then use the message options to call your dealer for an appointment or to find the nearest dealer.

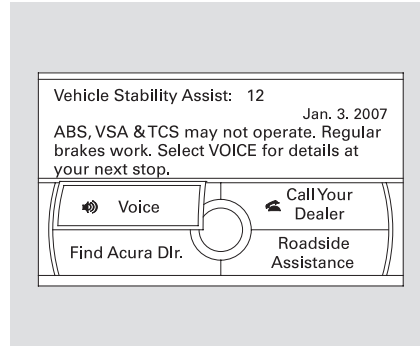

When viewing a diagnostic info message through the INFO menu, you can use the Diagnostic Info option to connect to the Acura server and retrieve the latest information regarding the problem.

NOTE: There may not be any additional information, depending on the time elapsed since the previous time you retrieved the information from the Acura server.

Reminder Message

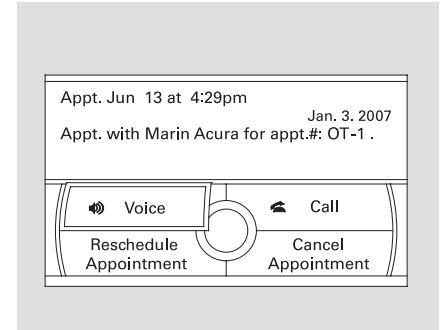

When you make an appointment through My Acura's online Schedule Service Appointment, you can be reminded in advance about that appointment through AcuraLink.

If you need to reschedule or cancel the appointment, see page [475](#).

CONTINUED

AcuraLink (U.S. models only)

Turning the Automated Appointment preference off will disable appointment notifications in the vehicle based on appointments created or changed at My Acura's online scheduling website.

Appointments can still be created, rescheduled, and canceled from the vehicle; however the appointment information stored in the vehicle will not be updated. Any changes to those appointments should be made from the My Acura website.

AcuraLink/Message Screen

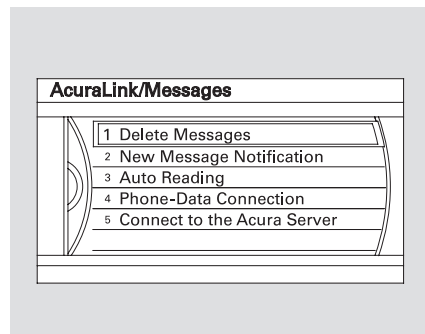
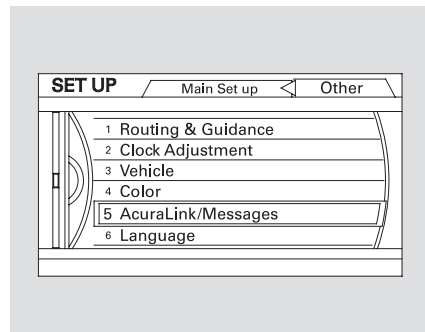

To access the following functions, press the SETUP option, push the interface selector to the right to select Other, then rotate the interface knob to select AcuraLink/ Messages.

Delete Messages – Select this option to delete all stored messages within a category, except for diagnostic info and recall campaign messages. These messages can only be deleted by a certified technician after the recall is done or the problem is corrected, or through a broadcast message from Acura.

New Message Notification –

Select ON if you want to be notified of new messages (envelope icon appears on the navigation screen). Select OFF if you do not want to be notified of new messages (envelope icon does not appear on the screen). Messages can still be accessed using the INFO menu. If you would like to stop receiving messages, visit the My Acura website at www.owners.acura.com to change your messaging preferences.

Auto Reading – Select ON to have the system automatically read each message to you. Select OFF to manually select the Voice option when you want a message read to you.

Phone-Data Connection – Select this option to begin the process required to connect to Acura. This is used to access the most recent diagnostic information when a problem occurs.

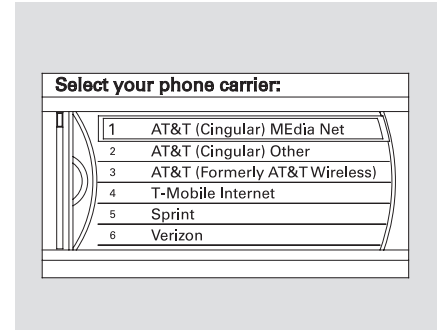
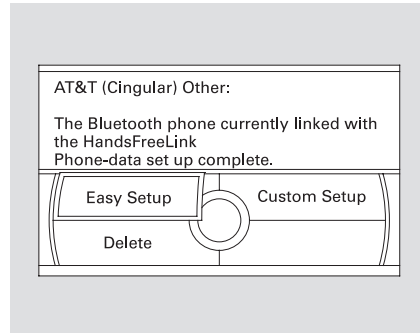

NOTE: For the Phone Data Connection button to be active, you need a Bluetooth® compatible and enabled cellphone paired to the Bluetooth® HandsFreeLink® (HFL). To complete the data connection setup, the paired phone must have a compatible data service.

CONTINUED

AcuraLink (U.S. models only)

To find more information on Bluetooth® compatible and enabled cell phones, visit www.acura.com/handsfreelink or call the HandsFreeLink® consumer support at 1-888-528-7876. In Canada, visit www.acura.ca, or call 1-888-9-ACURA-9.

Connect to the Acura Server — The default setting is prompt. When a diagnostic info message appears, and you select the Check Now option, the system will prompt you before connecting to the Acura server. If you do not wish to connect at that time, select No at the prompt, and you will see the information from the onboard database. The “Auto” setting will remove the prompt when you select the Check Now option and will automatically connect to the Acura server. This setting only applies when you have a Bluetooth® enabled phone that is paired with the HFL and you have completed the Phone-Data Connection setup.

*As required by the FCC:
This device complies with Part 15 of the FCC rules. Operation is subject to the following two conditions: (1) This device may not cause harmful interference, and (2) this device must accept any interference received, including interference that may cause undesired operation.*

Changes or modifications not expressly approved by the party responsible for compliance could void the user's authority to operate the equipment.

On models with navigation system

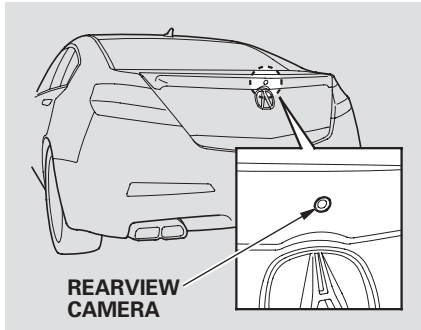

Whenever you shift to reverse (R) with your vehicle in the ON mode, the rearview is shown on the navigation system screen.

Parking guidelines are also included on the screen.

If the engine has just been started, it may take a short time for them to display.

For the best picture, always keep the rearview camera clean, and do not cover the camera lens. To avoid scratching the lens when you clean it, use a moist, soft cloth.

Since the rearview camera display area is limited, you should always back up slowly and carefully, and look behind you for obstacles.

You can adjust the brightness of the rearview camera image by turning the interface dial.

NOTICE

The camera brightness cannot be adjusted by voice control.

Before you begin driving your vehicle, you should know what gasoline to use and how to check the levels of important fluids. You also need to know how to properly store luggage or packages. The information in this section will help you. If you plan to add any accessories to your vehicle, please read the information in this section first.

Break-in Period	486
Fuel Recommendation	486
Service Station Procedures	487
Refueling.....	487
Tighten Fuel Cap Message	488
Opening and Closing the	
Hood.....	489
Oil Check.....	490
Engine Coolant Check	491
Fuel Economy	492
Accessories and Modifications	495
Carrying Cargo	497

Break-in Period, Fuel Recommendation

Break-in Period

Help assure your vehicle's future reliability and performance by paying extra attention to how you drive during the first 600 miles (1,000 km). During this period:

- Avoid full-throttle starts and rapid acceleration.
- Avoid hard braking for the first 200 miles (300 km).
- Do not change the oil until the multi-information display indicates it is needed.

You should also follow these recommendations with an overhauled or exchanged engine, or when the brakes are replaced.

Fuel Recommendation

Your vehicle is designed to operate on premium unleaded gasoline with a pump octane of 91 or higher. If this octane grade is unavailable, regular unleaded gasoline with a pump octane of 87 or higher may be used temporarily. The use of regular unleaded gasoline can cause metallic knocking noises in the engine and will result in decreased engine performance. The long-term use of regular-grade gasoline can lead to engine damage.

We recommend using quality gasolines containing detergent additives that help prevent fuel system and engine deposits.

In addition, in order to maintain good performance, fuel economy, and emissions control, we strongly recommend, in areas where it is available, the use of gasoline that does NOT contain manganese-based fuel additives such as MMT.

Use of gasoline with these additives may adversely affect performance, and cause the malfunction indicator lamp on your instrument panel to come on. If this happens, contact your dealer for service.

Some gasoline today is blended with oxygenates such as ethanol or MTBE. Your vehicle is designed to operate on oxygenated gasoline containing up to 10% ethanol by volume and up to 15% MTBE by volume. Do not use gasoline containing methanol.

If you notice any undesirable operating symptoms, try another service station, or switch to another brand of gasoline.

For further important fuel-related information, please refer to your **Quick Start Guide**.

Refueling

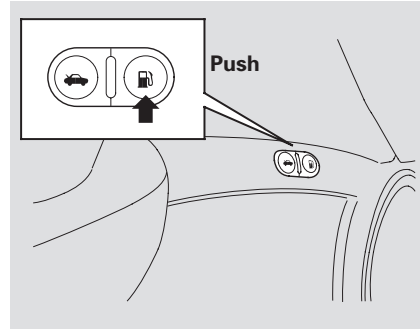

1. Park with the driver's side closest to the service station pump.
2. Open the fuel fill door by pressing the button in the driver's door (to open the fuel fill door manually, see page [598](#)).

⚠ WARNING

Gasoline is highly flammable and explosive. You can be burned or seriously injured when handling fuel.

- Stop the engine, and keep heat, sparks, and flame away.
- Handle fuel only outdoors.
- Wipe up spills immediately.

CONTINUED

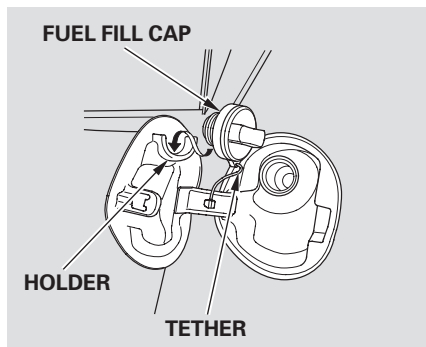

3. Remove the fuel fill cap slowly. You may hear a hissing sound as pressure inside the tank escapes. Place the cap in the holder on the fuel fill door.
4. Stop filling the tank after the fuel nozzle automatically clicks off. Do not try to “top off” the tank. This leaves some room in the fuel tank for the fuel to expand with temperature changes.

If the fuel nozzle keeps clicking off even though the tank is not full, there may be a problem with your vehicle’s fuel vapor recovery system. The system helps keep fuel vapor from going into the atmosphere. Try filling at another pump. If this does not fix the problem, consult your dealer.

5. Screw the fuel fill cap back on until it clicks at least once. If you do not properly tighten the cap, you will see a “TIGHTEN FUEL CAP” message on the multi-information display. If the system still detects an evaporative system leak after retightening the cap, the malfunction indicator lamp may come on (see page 596).
6. Push the fuel fill door closed until it latches.

Tighten Fuel Cap Message



Your vehicle’s on board diagnostic system will detect a loose or missing fuel fill cap as an evaporative system leak. The first time a leak is detected a “TIGHTEN FUEL CAP” message appears on the multi-information display.

Turn the engine off, and confirm the fuel fill cap is installed. If it is, loosen it, then retighten it until it clicks at least once. The message should go off after several days of normal driving once you tighten or replace the fuel fill cap. To scroll to another message, press the INFO button.

The “TIGHTEN FUEL CAP” message will appear each time you restart the engine until the system turns the message off.

If the system still detects a leak in your vehicle’s evaporative emissions system, the malfunction indicator lamp (MIL) comes on. If the fuel fill cap was not already tightened, turn the engine off, and check or retighten the fuel fill cap until it clicks at least once. The MIL should go off after several days of normal driving once the cap is tightened or replaced. If the MIL does not go off, have your vehicle inspected by a dealer. For more information, see page 596 .

Opening and Closing the Hood



1. Park the vehicle, and set the parking brake. Pull the hood release handle located under the lower left corner of the dashboard. The hood will pop up slightly.
2. Put your fingers between the front edge of the hood and the front grille to locate the hood latch handle. Push this handle up until it releases the hood. Lift the hood.

CONTINUED

Service Station Procedures

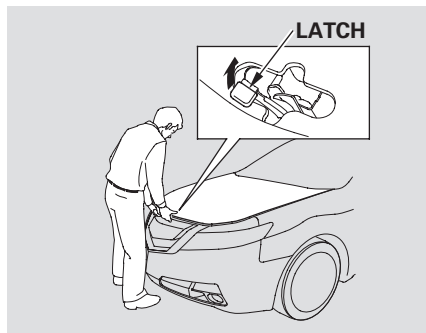

If the hood latch handle moves stiffly, or if you can open the hood without lifting the handle, the mechanism should be cleaned and lubricated.

3. Lift the hood up most of the way. The hydraulic supports will lift it up the rest of the way and hold it up.

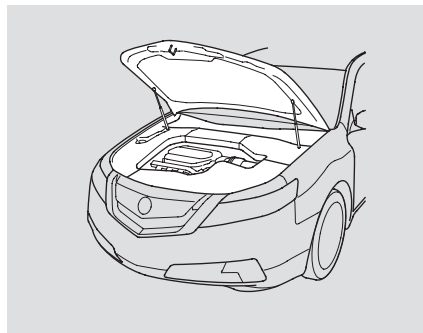

To close the hood, lower it to about a foot (30 cm) above the fender, then press down firmly with your hands. Make sure the hood is securely latched.

Oil Check

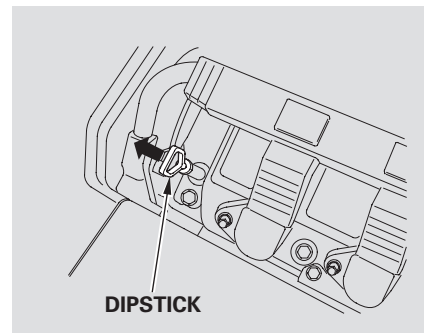

Park the vehicle on a level surface.

Wait a few minutes after turning the engine off before you check the oil.

1. Remove the dipstick (orange loop).
2. Wipe off the dipstick with a clean cloth or paper towel.
3. Insert the dipstick all the way back into its hole.

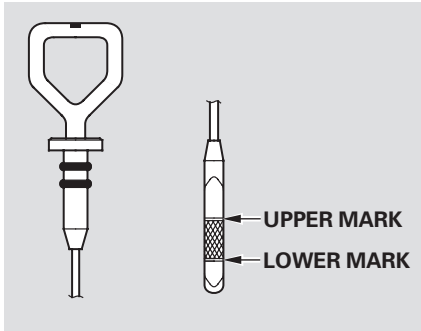

4. Remove the dipstick again, and check the level. It should be between the upper and lower marks.

If it is near or below the lower mark, see **Adding Engine Oil** on page 547.

Engine Coolant Check

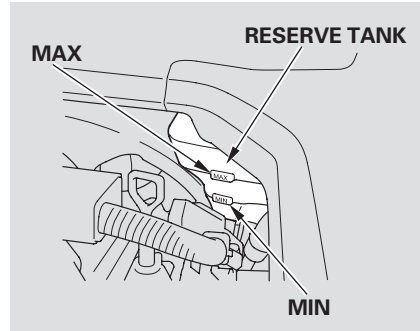

To access the radiator reserve tank, remove the right-side engine compartment cover (see page 546).

See page 545 for the engine coolant location.

Look at the coolant level in the radiator reserve tank. Make sure it is between the MAX and MIN lines. If it is below the MIN line, see **Adding Engine Coolant** on page 550 for information on adding the proper coolant.

Refer to **Owner's Maintenance Checks** on page 543 for information about checking other items on your vehicle.

Fuel Economy

Actual Mileage and EPA Fuel Economy Estimates Comparison.

Fuel economy is not a fixed number. It varies based on driving conditions, driving habits and vehicle condition. Therefore, it is not possible for one set of estimates to predict fuel economy precisely for all drivers in all environments.

The EPA fuel economy estimates shown in the example to the right are a useful tool for comparison when buying a vehicle. EPA estimates include:

City MPG – Represents urban driving in a vehicle in light traffic. A range of miles per gallon achieved is also provided.

Highway MPG – Represents a mixture of rural and interstate driving, in a warmed-up vehicle, typical of longer trips in free-flowing traffic. A range of miles per gallon

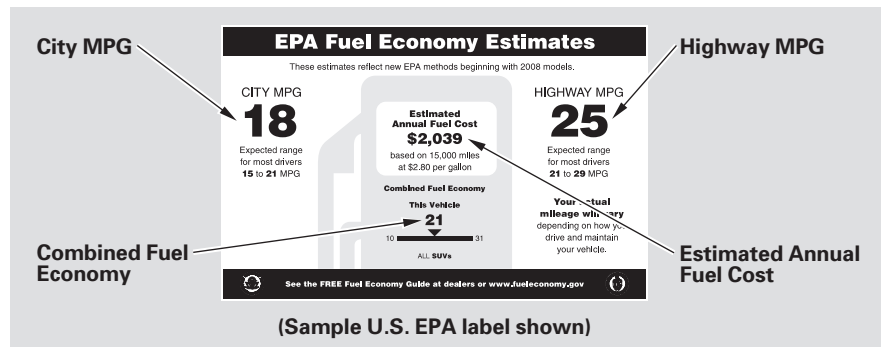

achieved is also provided.

Combined Fuel Economy – Represents a combination of city and highway driving. The scale represents the range of combined fuel economy for other vehicles in the class.

Estimated Annual Fuel Cost – Provides an estimated annual fuel cost, based on 15,000 miles (20,000 km) per year multiplied by the cost per gallon (based on EPA fuel cost data) divided by the combined fuel economy.

For more information on fuel economy ratings and factors that affect fuel economy, visit www.fueleconomy.gov (Canada: Visit www.vehicles.gc.ca)

Fuel Economy Factors

The following factors can lower your vehicle's fuel economy:

- Aggressive driving (hard acceleration and braking)
- Excessive idling, accelerating and braking in stop-and-go traffic
- Cold engine operation (engines are more efficient when warmed up)
- Driving with a heavy load or the air conditioner running
- Improperly inflated tires

Improving Fuel Economy

Vehicle Maintenance

A properly maintained vehicle maximizes fuel economy. Poor maintenance can significantly reduce fuel economy. Always maintain your vehicle according to the maintenance messages displayed on the information display (see **Owner's Maintenance Checks** on page 543). For example:

- **Use the recommended viscosity motor oil, displaying the API Certification Seal** (see page 547).
- **Maintain proper tire inflation** – An underinflated tire increases “rolling resistance,” which reduces fuel economy.
- **Avoid carrying excess weight in your vehicle** – It puts a heavier load on the engine, increasing fuel consumption.
- **Keep your vehicle clean** – In particular, a build-up of snow or mud on your vehicle's underside adds weight and rolling resistance. Frequent cleaning helps your fuel economy.

Drive Efficiently

- **Drive moderately** – Rapid acceleration, abrupt cornering, and hard braking increase fuel consumption.
- **Observe the speed limit** – Aerodynamic drag has a big effect on fuel economy at speeds above 45 mph (75 km/h). Reduce your speed and you reduce the drag. Trailers, car top carriers, roof racks and bike racks are also big contributors to increased drag.
- **Always drive in the highest gear possible** – If your vehicle has a manual transmission, you can boost your fuel economy by up shifting as early as possible.
- **Avoid excessive idling** – Idling results in 0 miles per gallon (0 kms per liter).

CONTINUED

Fuel Economy

- **Minimize the use of the air conditioning system** – The A/C puts an extra load on the engine which makes it use more fuel. Use the fresh-air ventilation when possible.
- **Plan and combine trips** – Combine several short trips into one. A warmed-up engine is more fuel efficient than a cold one.

Calculating Fuel Economy

Measuring Techniques

Direct calculation is the recommended source of information about your actual fuel economy. Using frequency of fill-ups or taking fuel gauge readings are NOT accurate measures of fuel economy. Fuel economy may improve over the first several thousand miles.

Checking Your Fuel Economy

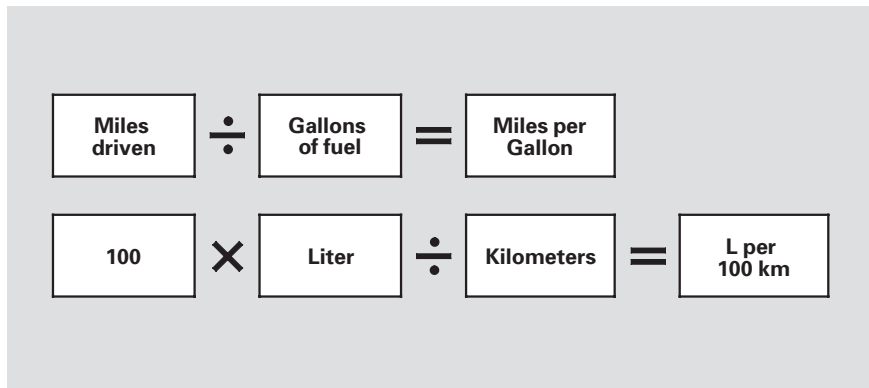

- 1) Fill the fuel tank until the nozzle automatically clicks off.
- 2) Reset trip counter to zero.
- 3) Record the total gallons (liters) needed to refill.
- 4) Follow one of the simple calculations above.

Modifying your vehicle, or installing some non-Acura accessories, can make it unsafe. Before you make any modifications or add any accessories, be sure to read the following information.

Accessories

Your dealer has Acura accessories that allow you to personalize your vehicle. These accessories have been designed and approved for your vehicle, and are covered by warranty.

Although non-Acura accessories may fit on your vehicle, they may not meet factory specifications, and could adversely affect your vehicle's handling and stability.

WARNING

Improper accessories or modifications can affect your vehicle's handling, stability, and performance, and cause a crash in which you can be hurt or killed.

Follow all instructions in this owner's manual regarding accessories and modifications.

When properly installed, cellular phones, alarms, two-way radios, and low-powered audio systems should not interfere with your vehicle's computer controlled systems, such as your airbags, anti-lock brakes, and tire pressure monitoring system.

Before installing any accessory:

- Make sure the accessory does not obscure any lights, or interfere with proper vehicle operation or performance.
- Be sure electronic accessories do not overload electrical circuits (see page 599) or interfere with proper operation of your vehicle.
- Before installing any electronic accessory, have the installer contact your dealer for assistance. If possible, have your dealer inspect the final installation.
- Do not install accessories on the side pillars or across the rear windows. Accessories installed in these areas may interfere with proper operation of the side curtain airbags.

Accessories and Modifications

Modifying Your Vehicle

Removing parts from your vehicle, or replacing components with non-Acura components could seriously affect your vehicle's handling, stability, and reliability.

Some examples are:

- Lowering your vehicle with a non-Acura suspension kit that significantly reduces ground clearance can allow the undercarriage to hit speed bumps or other raised objects, which could cause the airbags to deploy.
- Raising your vehicle with a non-Acura suspension kit can affect the handling and stability.
- Non-Acura wheels, can cause excessive stress on suspension components and may not be compatible with the tire pressure monitoring system (TPMS).

- Larger or smaller wheels and tires can interfere with the operation of your vehicle's anti-lock brakes and other systems.
- Modifying your steering wheel or any other part of your vehicle's safety features can make the systems ineffective.

If you plan to modify your vehicle, consult your dealer.

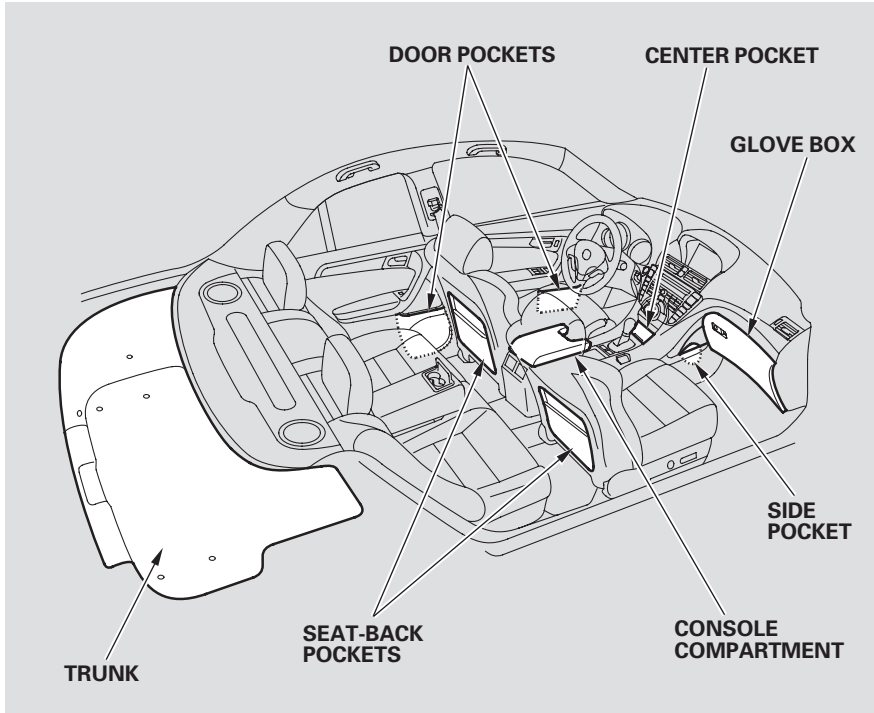

Your vehicle has several convenient storage areas:

- Glove box
- Door and seat-back pockets
- Center and side pockets
- Console compartment
- Trunk

In addition, the trunk pass-through allows you to carry longer items. However, carrying too much cargo, or improperly storing it, can affect your vehicle's handling, stability, stopping distance, and tires, and make it unsafe. Before carrying any type of cargo, be sure to read the following pages.

Carrying Cargo

Load Limits

The maximum load for your vehicle is 850 lbs (385 kg) for U.S. models and 395 kg for Canadian models.

See Tire And Loading Information label attached to the driver's doorjamb.

Label Example

TIRE AND LOADING INFORMATION			
SEATING CAPACITY: TOTAL 5 FRONT 2 REAR 3			
The combined weight of occupants and cargo should never exceed 385kg or 850lbs.			
TIRE	SIZE	COLD TIRE PRESSURE	SEE OWNER'S MANUAL FOR ADDITIONAL INFORMATION
FRONT	XXXX/XXXX XXX	XXXKPA, XXPSI	
REAR	XXXX/XXXX XXX	XXXKPA, XXPSI	
SPARE	XXXX/XXXX XXX	XXXKPA, XXPSI	

This figure includes the total weight of all occupants, cargo, and accessories, and the tongue load if you are towing a trailer.







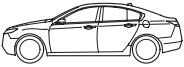

⚠ WARNING

Overloading or improper loading can affect handling and stability and cause a crash in which you can be hurt or killed.

Follow all load limits and other loading guidelines in this manual.

Steps for Determining Correct Load Limit –

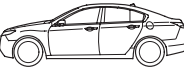
- (1) Locate the statement “The combined weight of occupants and cargo should never exceed XXX kg or XXX lbs.” on your vehicle’s placard.
- (2) Determine the combined weight of the driver and passengers that will be riding in your vehicle.
- (3) Subtract the combined weight of the driver and passengers from XXX kg or XXX lbs.
- (4) The resulting figure equals the available amount of cargo and luggage load capacity. For example, if the “XXX” amount equals 1,400 lbs. and there will be five 150 lb. passengers in your vehicle, the amount of available cargo and luggage load capacity is 650 lbs.
 $(1,400 - 750 (5 \times 150) = 650 \text{ lbs.})$
- (5) Determine the combined weight of luggage and cargo being loaded on the vehicle. That weight may not safely exceed the available cargo and luggage load capacity calculated in Step 4.
- (6) If your vehicle will be towing a trailer, load from your trailer will be transferred to your vehicle. Consult this manual to determine how this reduces the available cargo and luggage load capacity of your vehicle.

<p>Example 1</p>	 <p>Max Load (850 lbs)</p>	\geq  <p>Passenger Weight (150 lbs x 2 = 300 lbs)</p>	<p>+</p>  <p>Cargo Weight (550 lbs)</p>
<p>Example 2</p>	 <p>Max Load (850 lbs)</p>	\geq  <p>Passenger Weight (150 lbs x 4 = 600 lbs)</p>	<p>+</p>  <p>Cargo Weight (250 lbs)</p>
<p>Example 3</p>	 <p>Max Load (850 lbs)</p>	\geq  <p>Passenger Weight (150 lbs x 5 = 750 lbs)</p>	<p>+</p>  <p>Cargo Weight (100 lbs)</p>

In addition, the total weight of the vehicle, all occupants, accessories, cargo, and trailer tongue load must not exceed the Gross Vehicle Weight Rating (GVWR) or the Gross Axle Weight Rating (GAWR). Both are on a label on the driver's doorjamb.

Carrying Cargo in the Passenger Compartment

- Store or secure all items that could be thrown around and hurt someone during a crash.
- Do not put any items on top of the trunk panel. They can block your view and be thrown around the vehicle during a crash.

CONTINUED

Carrying Cargo

- Be sure items placed on the floor behind the front seats cannot roll underneath and interfere with the proper operation of the seats, the sensors under the seats, or the driver's ability to operate the pedals.

Also, keep all cargo below the bottom of the windows. If it is higher, it could interfere with the proper operation of the side curtain airbags.

- Keep the glove box closed while driving. If it is open, a passenger could injure their knees during a crash or sudden stop.

Carrying Cargo in the Trunk

- Distribute cargo evenly on the floor of the trunk, placing the heaviest items on the bottom and as far forward as possible.
- If you carry large items that prevent you from closing the trunk lid, exhaust gas can enter the passenger area. To avoid the possibility of **carbon monoxide poisoning**, follow the instructions on page 57 .

Cargo Hook Buttons

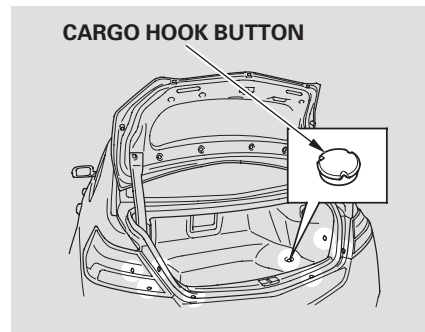

Cargo hook buttons in the trunk can be used to install a net for securing items.

Cargo Nets

If equipped

The cargo net can be used to help hold down items stored in the trunk.

This section gives you tips on starting the engine under various conditions, and how to operate the automatic transmission. It also includes important information on parking your vehicle, the braking system, the Super Handling-All Wheel Drive™ (SH-AWD®) system, vehicle stability assist (VSA®), aka electronic stability control (ESC), system and the tire pressure monitoring system (TPMS).

Preparing to Drive	502
Starting the Engine (Models without Keyless Access System)	503
Starting the Engine (Models with Keyless Access System)	505
Automatic Transmission.....	507
Driving with the Paddle Shifters.....	512
Super Handling-All Wheel Drive™ (SH-AWD®) System	517
Parking	519
Braking System.....	520
Anti-lock Brakes (ABS)	521
Vehicle Stability Assist (VSA®), aka Electronic Stability Control (ESC), System	523
Tire Pressure Monitoring System (TPMS)	526
Towing a Trailer	531
Towing Your Vehicle	531

Preparing to Drive

You should do these checks and adjustments before you drive your vehicle:

1. Make sure all windows, mirrors, and outside lights are clean and unobstructed. Remove frost, snow, or ice.
2. Check that the hood is fully closed.
3. Check that the trunk is fully closed.
4. Visually check the tires. If a tire looks low, use a gauge to check its pressure.
5. Check that any items you may be carrying are stored properly or fastened down securely.
6. Check the seat adjustment (see page 155).
7. Check the adjustment of the inside and outside mirrors (see page 161).
8. Check the steering wheel adjustment (see page 140).
9. Make sure the doors are securely closed and locked.
10. Fasten your seat belt. Check that your passengers have fastened their seat belts (see page 16).
11. When you start the engine, check the gauges and indicators in the instrument panel, and the messages on the multi-information display (see pages 63 , 75 and 77).

Starting the Engine (Models without Keyless Access System)

Your vehicle's starting system has an auto control mode. When you turn the ignition switch to the START (III) position, this feature keeps the engine's starter motor running until the engine starts. Follow these instructions to start the engine:

1. Apply the parking brake.
2. In cold weather, turn off all electrical accessories to reduce the drain on the battery.
3. Make sure the shift lever is in Park. Press on the brake pedal.
4. Without touching the accelerator pedal, turn the ignition switch to the START (III) position, then release the ignition switch. You do not need to hold the ignition switch in the START (III) position to start the engine. Depending on the outside temperature, the starter motor runs for about 6 to 9

seconds until the engine starts.

If you hold the ignition switch in the START (III) position for more than 7 seconds, the starter motor, depending on the outside temperature, runs for about 10 to 25 seconds until the engine starts.

If the engine does not start, wait at least 10 seconds before trying again.

NOTICE

The immobilizer system protects your vehicle from theft. If an improperly coded key (or other device) is used, the engine's fuel system is disabled. For more information, see page 143.

5. If the engine does not start within 15 seconds, or starts but stalls right away, repeat step 4 with the accelerator pedal pressed halfway down. If the engine starts, release pressure on the accelerator pedal so the engine does not race.
6. If the engine fails to start, press the accelerator pedal all the way down, and hold it there while starting to clear flooding. If the engine still does not start, return to step 5.

NOTICE

The engine is harder to start in cold weather. Also, the thinner air found at altitudes above 8,000 feet (2,400 meters) adds to this problem.

Starting the Engine (Models without Keyless Access System)

Check Starting System Message



If there is a problem with the starting system, you will see a “CHECK STARTING SYSTEM” message on the multi-information display when the ignition switch is turned to the ON (II) position. You will also see this message when the auto control mode of the starting system has a problem.

If this message is on, the ignition switch has to be held in the START (III) position manually until the engine starts. The ignition switch can be held in that position up to 15 seconds.

Even though you may be able to start the engine manually without the auto control mode of the starting system, have your vehicle inspected by a dealer.

Starting the Engine (Models with Keyless Access System)

Your vehicle's starting system has an auto control mode. When you have your keyless access remote and push the engine start/stop button while depressing the brake pedal, this feature keeps the engine's starter motor running until the engine starts. Follow these instructions to start the engine:

1. Apply the parking brake.
2. In cold weather, turn off all electrical accessories to reduce the drain on the battery.
3. Make sure the shift lever is in Park. Press on the brake pedal.

In either of the following cases, you should insert the keyless access remote into the keyless remote slot. For more information, see pages [186](#) and [187](#).

- The keyless access remote system main switch is off.

- The keyless access remote battery becomes weak or dead.
4. Without touching the accelerator pedal, push and release the engine start/stop button. You do not need to hold the engine start/stop button to start the engine. Depending on the outside temperature, the starter motor runs for about 6 to 9 seconds until the engine starts.

If you hold the engine start/stop button for more than 7 seconds, the starter motor, depending on the outside temperature, runs for about 10 to 25 seconds until the engine starts.

If the engine does not start, wait at least 10 seconds before trying again.

NOTICE

The immobilizer system protects your vehicle from theft. If an improperly coded keyless access remote (or other device) is used, the engine's fuel system is disabled. For more information, see page [143](#).

5. If the engine does not start within 15 seconds, or starts but stalls right away, repeat step 4 with the accelerator pedal pressed halfway down. If the engine starts, release pressure on the accelerator pedal so the engine does not race.
6. If the engine fails to start, press the accelerator pedal all the way down, and hold it there while starting to clear flooding. If the engine still does not start, return to step 5.

CONTINUED

Starting the Engine (Models with Keyless Access System)

NOTICE

The engine is harder to start in cold weather. Also, the thinner air found at altitudes above 8,000 feet (2,400 meters) adds to this problem.

Check Starting System Message



If there is a problem with the starting system, you will see a “CHECK STARTING SYSTEM” message on the multi-information display with the power mode ON.

You will also see this message when the auto control mode of the starting system has a problem.

If this message is on, you should press and hold the engine start/stop button until the engine starts. The engine start/stop button can be pressed up to 15 seconds.

Even though you may be able to start the engine manually without the auto control mode of the starting system, have your vehicle inspected by a dealer.

Your vehicle has the engine start/stop button instead of an ignition switch to select the power mode. For more information, see page [178](#).

Emergency Engine Start

If you cannot start the engine using the normal engine start procedure, do the following:

1. Set the parking brake.
2. Put the shift lever into Park.
3. Press the engine start/stop button to turn on the ACCESSORY mode.
4. Press and hold the engine start/stop button for about 15 seconds while pressing the brake pedal.

Do not follow this procedure unless it is a case of emergency. Even if you can start the engine using this method, the system may have a malfunction. Contact your dealer as soon as possible.

Shift Lever Position Indicators

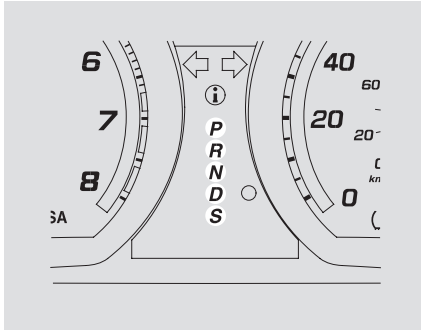

These indicators between the tachometer and speedometer show which position the shift lever is in.

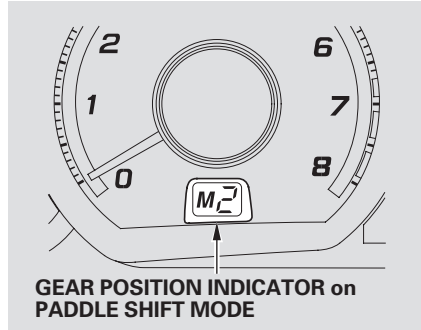

Using a paddle shift mode, the gear position indicator shows you the selected gear number (see page 512).

The “D” indicator comes on for a few seconds when you turn the ignition switch* to the ON (II) position. If it flashes while driving (in any shift position), it indicates a possible problem in the transmission.

* : Models equipped with the keyless access system have an engine start/stop button instead of an ignition switch. ON Mode is the equivalent of ON (II). For more information, see pages 178 and 180.

If the malfunction indicator lamp comes on along with the “D” indicator, there is a problem with the automatic transmission control system. Avoid rapid acceleration and have the transmission checked by your dealer as soon as possible.

When the “D” indicator warns of a possible problem with the transmission, you will see a “CHECK TRANSMISSION” message on the multi-information display.

CONTINUED

Automatic Transmission

Shifting



To shift from Park to any position, press firmly on the brake pedal, and press the release button on the front of the shift lever, then move the lever. You cannot shift out of Park when the ignition switch* is in the LOCK (0) or ACCESSORY (I) position.

* : Models equipped with the keyless access system have an engine start/stop button instead of an ignition switch. VEHICLE OFF (LOCK) Mode is the equivalent of LOCK (0) and ACCESSORY Mode is the equivalent of ACCESSORY (I). For more information, see pages [178](#) and [180](#) .

To shift from:	Do this:
P to R	Press the brake pedal and press the shift lever release button.
R to P N to R D to S	Press the shift lever release button.
S to D D to N N to D R to N	Move the shift lever.

Park (P) — This position mechanically locks the transmission. Use Park whenever you are turning off or starting the engine. To shift out of Park, you must press on the brake pedal and have your foot off the accelerator pedal. Press the release button on the front of the shift lever to move it.

If you have done all of the above and still cannot move the lever out of Park, see **Shift Lock Release** on page 510.

You must also press the release button to shift into Park. To avoid transmission damage, come to a complete stop before shifting into Park.

On models without keyless access system

The shift lever must be in Park before you can remove the key from the ignition switch.

On models with keyless access system

The shift lever must be in Park before you change the power mode from ON to VEHICLE OFF (LOCK).

Reverse (R) – Press the brake pedal and press the release button on the front of the shift lever to shift from Park to reverse. To shift from reverse to neutral, come to a complete stop, and then shift. Press the release button before shifting into reverse from neutral.

Neutral (N) – Use neutral if you need to restart a stalled engine, or if it is necessary to stop briefly with the engine idling. Shift to the Park position if you need to leave your vehicle for any reason. Press on the brake pedal when you are moving the shift lever from neutral to another gear.

Drive (D) – Use this position for your normal driving. The transmission automatically selects a suitable gear (1 through 5) for your speed and acceleration. You may notice the transmission shifting up at higher engine speeds when the engine is cold. This helps the engine warm up faster.

CONTINUED

Automatic Transmission

S Position (S) – To shift into the S position, press the release button on the front of the shift lever, and move the lever to S. This position is similar to D, except only gears from first to fourth are selected. The S position keeps the transmission from cycling between fourth and fifth gears in stop-and-go driving.

With the shift lever in D or S, you can also use the paddle shifters to shift the transmission up or down. With the paddle shifters, you can operate the transmission much like a manual transmission without a clutch pedal. For more information on driving with the paddle shifters, see page [514](#).

Engine Speed Limiter

If you exceed the maximum speed for the gear you are in, the engine speed will enter into the tachometer's red zone. If this occurs, you may feel the engine cut in and out. This is caused by a limiter in the engine's computer controls. The engine will run normally when you reduce the rpm below the red zone.

Shift Lock Release

This allows you to move the shift lever out of Park if the normal method of pushing on the brake pedal and pressing the release button does not work.

1. Set the parking brake.
2. *On models without keyless access system*
Remove the key from the ignition switch.

On models with keyless access system
Remove the built-in key from the keyless access remote (see page [192](#)).

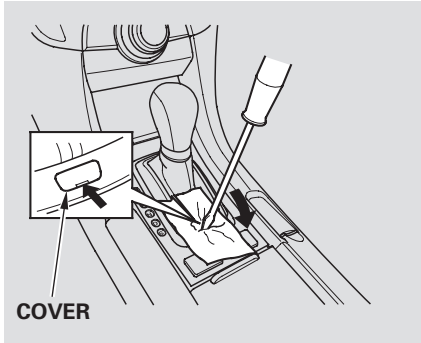

- Put a cloth on the edge of the shift lock release slot cover. Use a small flat-tipped screwdriver or metal fingernail file to carefully pry up the edge of the cover and remove it from the slot.



- Insert a key or built-in key in the shift lock release slot.
- Push down on the key or built-in key while you press the release button on the shift lever and move the shift lever out of Park to neutral.

- Remove the key or built-in key from the shift lock release slot, then reinstall the cover. Make sure the notch on the cover is on the rear side. Press the brake pedal, and restart the engine.

If you need to use the shift lock release, it means your vehicle is developing a problem. Have it checked by your dealer.

Driving with the Paddle Shifters

Using the Paddle Shifters in D position (D-Paddle Shift Mode)

When you are driving in D position, you can shift the transmission up or down manually with the paddle shifters.

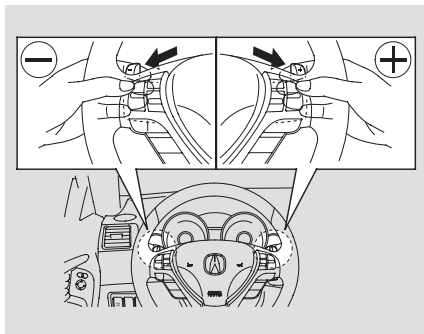

To shift up or down, use the + (right) or - (left) paddle shifter on each side of the steering wheel.

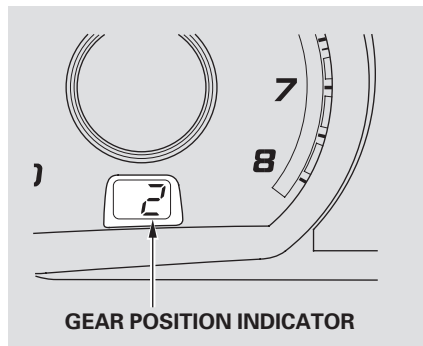

Each time you pull + (right), the transmission shifts to a higher gear. Pull - (left) to downshift. You will see the selected gear number on the instrument panel.

When you pull either paddle shifter, the gear position indicator shows you the selected gear number.

Downshifting with the paddle shifter allows you to increase the engine braking when going down steep or long hills, and provides more power when climbing uphill. You can upshift the transmission manually to reduce the rpm. Driving in the higher gear helps fuel economy.

The transmission control system monitors the accelerator pedal use and your driving conditions. When you press the accelerator pedal as in normal driving, the system judges that you are driving at a constant cruising speed without using the paddle shifters. Under these conditions, D-paddle shift mode is canceled, and the transmission automatically returns to drive mode (D).

Hold the + paddle shifter for 2 seconds to return to drive mode (D).

When the transmission returns to drive mode (D), the displayed gear number disappears.

The transmission remains in the selected gear if you do not accelerate.

Each time you pull either paddle shifter, the transmission shifts one gear up or down. If you want to shift up or down more than two gears, pull the paddle shifter twice, pause, and then pull it again.

The automatic transmission will not allow you to shift up or down if:

- You downshift before the engine speed falls below the upper limit of the lower gear.

If you try to do this, the gear position indicator will flash the number of the lower gear several times, then return to a higher gear.

- You upshift before the engine speed rises above the lower limit of the higher gear.
- You pull both paddle shifters at the same time.

The transmission downshifts to first gear and returns to drive mode (D) when the vehicle comes to a complete stop or the vehicle speed is about 9 mph (15 km/h).

If there is a problem in the transmission while you are driving with the paddle shifters, the D indicator flashes, the D-paddle shift mode is canceled, and the transmission returns to drive mode (D).

Driving with the Paddle Shifters

Using the Paddle Shifters in S position (Sequential Shift Mode)

With the shift lever in S position, you can manually shift up or down with the paddle shifters. The transmission goes into the sequential shift mode and holds the selected gear.

To enter the sequential shift mode, press the release button on the front of the shift lever, move the lever to the S position, then pull either paddle shifter. To return to drive mode (D), move the shift lever to the D position. While you are driving in the sequential shift mode, the transmission will not automatically return to drive mode (D).

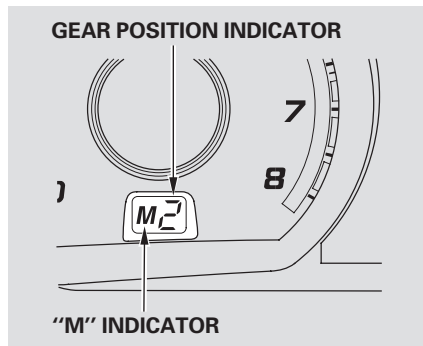

When you move the shift lever from "D" to "S" position and pull either paddle shifter, the gear position indicator displays "M" along with the selected gear number.

To upshift, pull the + (right) paddle shifter. To downshift, pull the - (left) paddle shifter.

When you accelerate from a stop, the transmission starts in first gear, and you must manually upshift between first and fifth gears. Make sure you upshift before the engine speed reaches the tachometer's red zone.

The transmission remains in the selected gear (5, 4, 3, 2, or 1). There is no automatic downshift when you push the accelerator pedal to the floor.

When you are driving in 4th or 5th gear, the transmission downshifts to the lower gear under the following conditions:

- The vehicle slows down to a certain speed.
- You press the brake pedal.

Downshifting with the paddle shifter allows you to increase the engine braking when going down steep or long hills, and provides more power when climbing uphill. You can upshift the transmission manually to reduce the rpm. Driving in the higher gear helps fuel economy.

The transmission also shifts automatically as the vehicle comes to a complete stop. It downshifts to first gear when the vehicle speed reaches 9 mph (15 km/h) or less.

The automatic transmission will not allow you to shift up or down if:

- You downshift before the engine speed falls below the upper limit of the lower gear.

If you try to do this, the gear position indicator will flash the number of the lower gear several times, then return to a higher gear.

If the vehicle speed decreases below the redline of the selected lower gear while the indicator is flashing, the transmission downshifts, and the indicator displays the selected gear.

- You upshift before the engine speed rises above the lower limit of the higher gear.
- You pull both paddle shifters at the same time.

CONTINUED

Driving with the Paddle Shifters

Here are the speed ranges for upshifting and downshifting.

To Shift from	Speed range
1 → 2	over 0 mph (0 km/h)
2 → 3	over 9 mph (15 km/h)
3 → 4	over 17 mph (28 km/h)
4 → 5	over 38 mph (60 km/h)

To Shift from	Speed range
5 → 4	under 130 mph (209 km/h)
4 → 3	under 94 mph (150 km/h)
3 → 2	under 63 mph (100 km/h)
2 → 1	under 37 mph (59 km/h)

Starting in Second Gear

When you are in sequential shift mode, and the vehicle is stopped, pull the + (right) paddle shifter to shift to second gear. You will see “M2” in the display. Starting in second gear helps to reduce wheelspin in deep snow or on a slippery surface.

Super Handling-All Wheel Drive™ (SH-AWD®) System

If equipped

The super handling-all wheel drive (SH-AWD) system is a full time all-wheel-drive system that automatically controls and transfers varying amounts of engine torque to all wheels independently, according to the driving conditions.

While the SH-AWD system helps to enhance the vehicle's driving stability in all situations, it is still your responsibility to drive and corner at reasonable speeds and to leave a sufficient margin of safety.

SH-AWD Torque Distribution Monitor

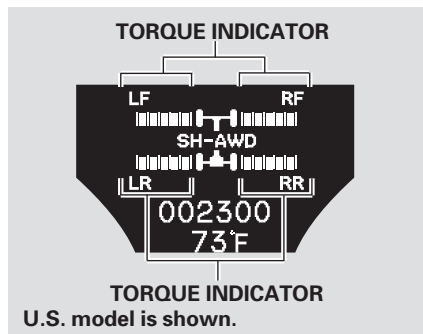

The SH-AWD torque distribution monitor on the multi-information display shows you the amount of torque being sent to the wheels. Each wheel – right front (RF), left front (LF), right rear (RR), and left rear (LR) – has its own torque indicator.

Each torque indicator is displayed as a bar graph divided into 5 segments. The number of segments represents the amount of torque distributed to each wheel.

When there is only a slight change in torque distribution while driving, such as cruising on level roads at the same speed, the torque distribution monitor may stop displaying the amount of torque. This is not a system problem. The monitor will show the amount if the system senses any change in torque distribution.

CONTINUED

Super Handling-All Wheel Drive™ (SH-AWD®) System



If the SH-AWD indicator blinks while driving, it indicates the differential temperature is too high. You will also see an “SH-AWD DIFF TEMP. HIGH” message on the multi-information display. If this happens, pull to the side of the road when it is safe, shift to Park, and let the engine idle until the indicator goes out. If the indicator does not go out, take your vehicle to a dealer to have it

checked.



If the SH-AWD indicator on the instrument panel stays on, and the “CHECK SH-AWD SYSTEM” message also appears on the multi-information display, there is problem with the SH-AWD system.

Your vehicle still has normal front-wheel drive with vehicle stability assist (VSA), but does not have the advantages of SH-AWD. Have your vehicle checked by a dealer as soon as possible.

Always use the parking brake when you park your vehicle. Make sure the parking brake is set firmly, or your vehicle may roll if it is parked on an incline.

If your vehicle has an automatic transmission, set the parking brake before you put the transmission in Park. This keeps the vehicle from moving and putting pressure on the parking mechanism in the transmission.

Parking Tips

- Make sure the moonroof and the windows are closed.
- Turn off the lights.
- Place any packages, valuables, etc., in the trunk or take them with you.
- Lock the doors.
- Check the indicator on the instrument panel to verify that the security system is set.
- Never park over dry leaves, tall grass, or other flammable materials. The hot three way catalytic converter could cause these materials to catch on fire.
- If the vehicle is facing uphill, turn the front wheels away from the curb.

- If the vehicle is facing downhill, turn the front wheels toward the curb.
- Make sure the parking brake is fully released before driving away. Driving with the parking brake partially set can overheat or damage the rear brakes.

On models with keyless access system

NOTE: If you are unable to stop the engine normally while in the Park position, see **Emergency Engine Stop** on page [184](#).

Braking System

Your vehicle is equipped with disc brakes at all four wheels. A power assist helps reduce the effort needed on the brake pedal. The emergency brake assist system increases the stopping force when you depress the brake pedal hard in an emergency situation. The anti-lock brake system (ABS) helps you retain steering control when braking very hard.

Resting your foot on the pedal keeps the brakes applied lightly, builds up heat, reduces their effectiveness and reduces brake pad life. In addition, fuel economy can be reduced. It also keeps your brake lights on all the time, confusing drivers behind you.

Constant application of the brakes when going down a long hill builds up heat and reduces their effectiveness. Use the engine to assist the brakes by taking your foot off the accelerator and downshifting to a lower gear.

Check your brakes after driving through deep water. Apply the brakes moderately to see if they feel normal. If not, apply them gently and frequently until they do. Be extra cautious and alert in your driving.

Braking System Design

The hydraulic system that operates the brakes has two separate circuits. Each circuit works diagonally across the vehicle (the left-front brake is connected with the right-rear brake, etc.). If one circuit should develop a problem, you will still have braking at two wheels.

Brake Wear Indicators

All four brakes have audible brake wear indicators.

If the brake pads need replacing, you will hear a distinctive, metallic screeching sound when you apply the brake pedal. If you do not have the brake pads replaced, they will screech all the time. It is normal for the brakes to occasionally squeal or squeak when you apply them.

The anti-lock brake system (ABS) helps prevent the wheels from locking up, and helps you retain steering control by pumping the brakes rapidly, much faster than a person can do it.

The electronic brake distribution (EBD) system, which is part of the ABS, also balances the front-to-rear braking distribution according to vehicle loading.

You should never pump the brake pedal. Let the ABS work for you by always keeping firm, steady pressure on the brake pedal. This is sometimes referred to as “stomp and steer.”

You will feel a pulsation in the brake pedal when the ABS activates, and you may hear some noise. This is normal: it is the ABS rapidly pumping the brakes. On dry pavement, you will need to press on the brake pedal very hard before the ABS activates. However, you may feel the ABS activate immediately if you are trying to stop on snow or ice.



ABS Indicator

If this indicator comes on, the anti-lock function of the braking system has shut down. The brakes still work like a conventional system, but without anti-lock. You should have your dealer inspect your vehicle as soon as possible.

When the ABS indicator comes on, you will also see a “CHECK ABS SYSTEM” message on the multi-information display.

If the ABS indicator comes on while driving, test the brakes as shown on page [597](#).

CONTINUED

Anti-lock Brakes (ABS)

If the ABS indicator and the brake system indicator come on together, and the parking brake is fully released, the EBD system may also be shut down.

Test your brakes as instructed on page 597 . If the brakes feel normal, drive slowly and have your vehicle repaired by your dealer as soon as possible. Avoid sudden hard braking which could cause the rear wheels to lock up and possibly lead to a loss of control.

The VSA indicator will come on along with the ABS indicator.

Important Safety Reminders
ABS does not reduce the time or distance it takes to stop the vehicle. It only helps with the steering control during braking.

ABS will not prevent a skid that results from changing direction abruptly, such as trying to take a corner too fast or making a sudden lane change. Always drive at a safe speed for the road and weather conditions.

ABS cannot prevent a loss of stability. Always steer moderately when you are braking hard. Severe or sharp steering wheel movement can still cause your vehicle to veer into oncoming traffic or off the road.

A vehicle with ABS may require a longer distance to stop on loose or uneven surfaces, such as gravel or snow, than a vehicle without anti-lock.

Vehicle Stability Assist (VSA®), aka Electronic Stability Control (ESC), System

The vehicle stability assist (VSA) system helps to stabilize the vehicle during cornering if the vehicle turns more or less than desired. It also assists you in maintaining traction while accelerating on loose or slippery road surfaces. It does this by regulating the engine's output, and by selectively applying the brakes.

When VSA activates, you may notice that the engine does not respond to the accelerator in the same way it does at other times. There may also be some noise from the VSA hydraulic system. You will also see the VSA activation indicator blink.

The VSA system cannot enhance the vehicle's driving stability in all situations and does not control your vehicle's entire braking system. It is still your responsibility to drive and corner at reasonable speeds and to leave a sufficient margin of safety.



VSA Activation Indicator

When VSA activates, you will see the VSA activation indicator blink.



Vehicle Stability Assist (VSA) System Indicator

If this indicator comes on while driving, pull to the side of the road when it is safe, and turn off the engine. Reset the system by restarting the engine. If the VSA system indicator stays on or comes back on while driving, have the VSA system inspected by your dealer.

If the indicator does not come on when the ignition switch* is turned to the ON (II) position, there may be a problem with the VSA system. Have your dealer inspect your vehicle as soon as possible.

* : Models equipped with the keyless access system have an engine start/stop button instead

of an ignition switch. ON Mode is the equivalent of ON (II). For more information, see pages [178](#) and [180](#).

When the VSA system indicator comes on, you will also see a "CHECK VSA SYSTEM" message on the multi-information display.

NOTE: The main function of the VSA system is generally known as Electronic Stability Control (ESC). The system also includes a traction control function.

On models with keyless access system
With the VSA system indicator on, you may not be able to stop the engine even if you park the vehicle safely. To stop the engine, see **Emergency Engine Stop** on page [184](#).

CONTINUED

Vehicle Stability Assist (VSA®), aka Electronic Stability Control (ESC), System

If the low tire pressure/TPMS indicator comes on (see page 526), or the multi-information display shows a “CHECK TPMS SYSTEM” message with the indicator flashing (see page 529), the VSA system automatically turns on even if the VSA system is turned off with the VSA OFF switch. In this case, you cannot turn the VSA system off by pressing the VSA OFF switch again.

Without VSA, your vehicle will have normal braking and cornering ability, but it will not have VSA traction and stability enhancement.

VSA OFF Switch

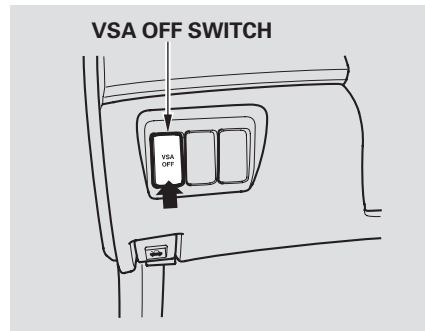

This switch is under the driver's side vent. To turn the VSA system on and off, press and hold it until you hear a beep.

When VSA is off, the VSA activation indicator comes on as a reminder. Press and hold the switch again. It turns the system back on.

VSA is turned on every time you start the engine, even if you turned it off the last time you drove the vehicle.

In certain unusual conditions when your vehicle gets stuck in shallow mud or fresh snow, it may be easier to free it with the VSA temporarily switched off. When the VSA system is off, the traction control system is also off. You should only attempt to free your vehicle with the VSA off if you are not able to free it when the VSA is on.

Immediately after freeing your vehicle, be sure to switch the VSA on again. We do not recommend driving your vehicle with the VSA and traction control systems switched off.

Vehicle Stability Assist (VSA®), aka Electronic Stability Control (ESC), System

VSA and Tire Sizes

Driving with varying tire or wheel sizes may cause the VSA to malfunction. When replacing tires, make sure they are of the same size and type as your original tires (see page 575).

If you install winter tires, make sure they are the same size as those that were originally supplied with your vehicle. Exercise the same caution during winter driving as you would if your vehicle was not equipped with VSA.

Hill Start Assist

On models with SH-AWD

Your vehicle is equipped with a hill start assist feature to help prevent the vehicle from rolling on steep inclines as you move your foot from the brake pedal to the accelerator.

This feature starts operating a few seconds after you are in any drive gear position (when faced uphill) or in reverse (when faced downhill). This feature requires that the vehicle has come to a complete stop before it can work.

Hill start assist may not prevent your vehicle from rolling downhill on a very steep or slippery slope.

Tire Pressure Monitoring System (TPMS)

Your vehicle is equipped with a tire pressure monitoring system (TPMS) that turns on every time you start the engine and monitors the pressure in your tires while driving.

Each tire has its own pressure sensor. If the air pressure of a tire becomes significantly low, the sensor in that tire immediately sends a signal that causes the low tire pressure/TPMS indicator in the instrument panel to come on. If this happens, you will see which tire is losing pressure on the multi-information display along with a “CHECK TIRE PRESSURE” message.



Low Tire Pressure/ TPMS Indicator

When the low tire pressure/TPMS indicator is on, one or more of your tires is significantly underinflated. You should stop and check your tires as soon as possible, and inflate them to the proper pressure as indicated on the vehicle's tire information placard.

It is possible that the pressures shown on the multi-information display and the pressures you manually measure are slightly different.

If the difference is significant or you cannot make the low tire pressure/TPMS indicator and message on the multi-information display go out after inflating the tires to the specified values, have your dealer check the system as soon as possible.

If you think you can safely drive a short distance to a service station, proceed slowly to the station, then inflate the tire to the recommended pressure shown on the driver's doorjamb.

If the tire is flat, or if the tire pressure is too low to continue driving, replace the tire with the compact spare tire (see page [583](#)).

Driving on a significantly under-inflated tire causes the tire to overheat and can lead to tire failure. Under-inflation also reduces fuel efficiency and tire tread life, and may affect the vehicle's handling and stopping ability.

Because tire pressure varies by temperature and other conditions, the low tire pressure/TPMS indicator may come on unexpectedly.

Tire Pressure Monitoring System (TPMS)

For example, if you check and fill your tires in a warm area, then drive in extremely cold weather, the tire pressure will be lower than measured and could be underinflated and cause the low tire pressure/TPMS indicator to come on. Or, if you check and adjust your tire pressure in cooler conditions, and drive into extremely hot conditions, the tire may become overinflated. However, the low tire pressure/TPMS indicator will not come on if the tires are overinflated.

Refer to page [568](#) for tire inflation guidelines.

If there is a problem with the TPMS, this indicator begins to flash. It stops flashing after approximately 1 minute, then stays on. You will also see a “CHECK TPMS SYSTEM” message on the multi-information display (see page [529](#)).

Although your tire pressure is monitored, you must manually check the tire pressures monthly.

Each tire, including the spare, should be checked monthly when the vehicle is cold, and set to the recommended inflation pressure as specified on the vehicle placard and in the owner’s manual (see page [570](#)).

Tire Pressure Monitor

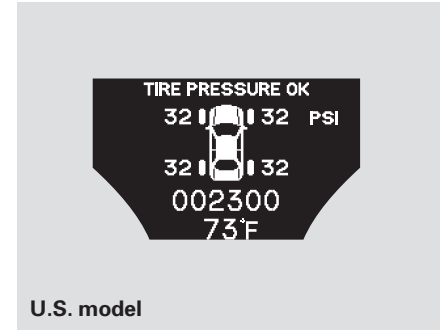

To select the tire pressure monitor, press the INFO button several times with the ignition switch* in the ON (II) position or with the power mode ON.

You will see the above display on the multi-information display when each tire pressure is normal.

CONTINUED

Tire Pressure Monitoring System (TPMS)

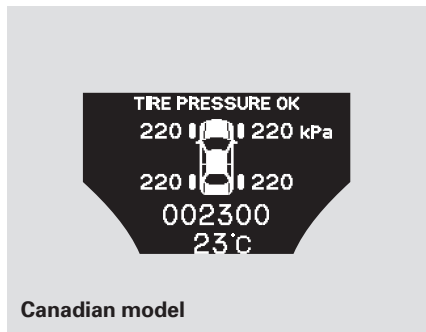

Each tire pressure is shown in PSI (U.S. models) or in kPa (Canadian models).

* : Models equipped with the keyless access system have an engine start/stop button instead of an ignition switch. ON Mode is the equivalent of ON (II). For more information, see pages [178](#) and [180](#).



Each tire has its own pressure sensor. If the air pressure of a tire becomes significantly low, the sensor in that tire immediately sends a signal that causes the low tire pressure/TPMS indicator in the instrument panel to come on. If this happens, you will see which tire is losing pressure on the multi-information display along with a "CHECK TIRE PRESSURE" message.

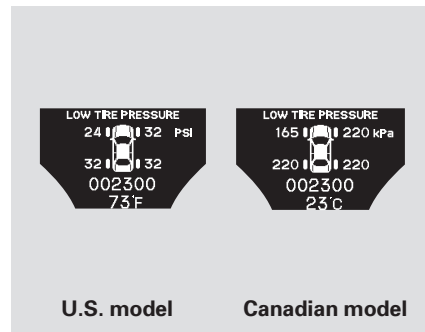

If any of the tires has low pressure, the tire pressure monitor also shows the above message and each tire pressure to warn you about the low tire pressure when you select the display by pressing the INFO button several times.

Tire Pressure Monitoring System (TPMS)

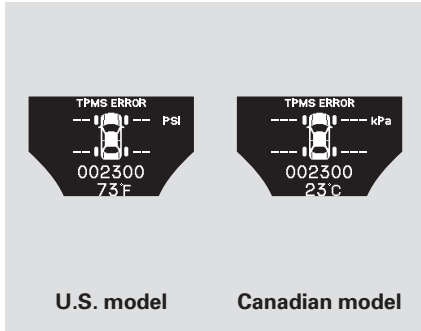

If there is a problem with the TPMS, the tire pressure monitor shows a “TPMS ERROR” message and the tire pressure readings are not displayed. If this happens, you will first see a system warning message “CHECK TPMS SYSTEM” on the multi-information display.

TPMS System Failure

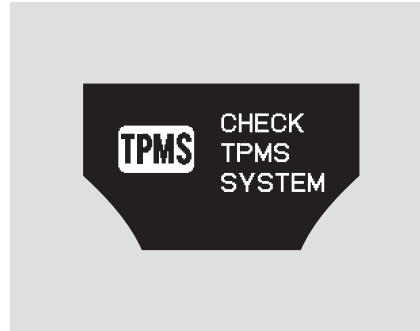

If there is a problem with the TPMS, you will see the above message on the multi-information display.

Also, the low tire pressure/TPMS indicator begins to flash, then stays on (see page [526](#)).

If you see this message, the system is off and is not monitoring the tire pressures. Have the system checked by your dealer as soon as possible.

If the low tire pressure/TPMS indicator comes on, or the multi-information display shows a “CHECK TPMS SYSTEM” message, the VSA system automatically turns on even when the VSA system is turned off by pressing the VSA OFF switch (see page [524](#)). If this happens, you cannot turn the VSA system off by pressing the VSA OFF switch again.

When you restart the vehicle with the compact spare tire, the TPMS system message will also be displayed on the multi-information display after several miles (kilometers) driving.

Tire Pressure Monitoring System (TPMS)

Changing a Tire with TPMS

If you have a flat tire, the low tire pressure/TPMS indicator and tire monitor indicator will come on. Replace the indicated flat tire with the compact spare tire (see page 583).

After the flat tire is replaced with the spare tire, the low tire pressure/TPMS indicator stays on while driving. After several miles (kilometers) driving, this indicator begins to flash, then stays on again. You will also see a “CHECK TPMS SYSTEM” message on the multi-information display. This is normal; the system cannot monitor the spare tire pressure. Manually check the spare tire pressure to be sure it is correct.

This indicator and the warning message on the multi-information display will go off, after several miles (kilometers) driving, when the spare tire is replaced with the specified regular tire equipped with the tire pressure monitor sensor.

Each wheel is equipped with a tire pressure sensor mounted inside the tire behind the valve stem. You must use TPMS specific wheels. It is recommended that you always have your tires serviced by your dealer or a qualified technician.

Never use a puncture-repairing agent in a flat tire. If used, you will have to replace the tire pressure sensor. Have the flat tire repaired by your dealer as soon as possible.

If the low tire pressure/TPMS indicator and the low tire position on the low tire pressure monitor do not go out after inflating the tires to the specified values, have your dealer check the system as soon as possible.

Tire Pressure Monitoring System (TPMS), Towing a Trailer, Towing Your Vehicle

As required by the FCC:

This device complies with Part 15 of the FCC rules. Operation is subject to the following two conditions: (1) This device may not cause harmful interference, and (2) this device must accept any interference received, including interference that may cause undesired operation.

Changes or modifications not expressly approved by the party responsible for compliance could void the user's authority to operate the equipment.

This device complies with Industry Canada Standard RSS-210.

Operation is subject to the following two conditions: (1) this device may not cause interference, and (2) this device must accept any interference that may cause undesired operation of the device.

Towing a Trailer

Your vehicle is not designed to tow a trailer. Attempting to do so can void your warranties.

Towing Your Vehicle

Your vehicle is not designed to be towed behind a motor home. If your vehicle needs to be towed in an emergency, see page [606](#).

This section explains why it is important to keep your vehicle well maintained and how to follow basic maintenance safety precautions.

This section also includes instructions on how to read the maintenance minder messages on the multi-information display, and instructions for simple maintenance tasks you may want to take care of yourself.

If you have the skills and tools to perform more complex maintenance tasks on your vehicle, you may want to purchase the service manual. See page 633 for information on how to obtain a copy, or see your dealer.

- Maintenance Safety 534
- Maintenance Minder..... 535
- Fluid Locations..... 545
- Engine Compartment Covers..... 546
- Adding Engine Oil 547
- Changing the Oil and Filter 548
- Engine Coolant..... 550
- Windshield Washers 552
- Automatic Transmission Fluid..... 553
- Brake Fluid 555
- Lights 556
- Cleaning the Seat Belts 564
- Floor Mats 565
- Dust and Pollen Filter 566
- Wiper Blades 566
- Tires 568
- Checking the Battery 577
- Vehicle Storage 578

Maintenance Safety

All service items not detailed in this section should be performed by a certified technician or other qualified mechanic.

Important Safety Precautions

To eliminate potential hazards, read the instructions before you begin, and make sure you have the tools and skills required.

- Make sure your vehicle is parked on level ground, the parking brake is set, and the engine is off.
- To clean parts, use a commercially available degreaser or parts cleaner, not gasoline.
- To reduce the possibility of fire or explosion, keep cigarettes, sparks, and flames away from the battery and all fuel-related parts.

- Wear eye protection and protective clothing when working with the battery or compressed air.

WARNING

Improperly maintaining this vehicle, or failing to correct a problem before driving can cause a crash in which you can be seriously hurt or killed.

Always follow the inspection and maintenance recommendations in this owner's manual.

Potential Vehicle Hazards

- **Carbon Monoxide poison from engine exhaust.** Be sure there is adequate ventilation whenever you operate the engine.
- **Burns from hot parts.** Let the engine and exhaust system cool

down before touching any parts.

- **Injury from moving parts.** Do not run the engine unless instructed to do so.

WARNING

Failure to properly follow maintenance instructions and precautions can cause you to be seriously hurt or killed.

Always follow the procedures and precautions in this owner's manual.

Some of the most important safety precautions are given here. However, we cannot warn you of every conceivable hazard that can arise in performing maintenance. Only you can decide whether or not you should perform a given task.

Your vehicle displays engine oil life and maintenance service items on the multi-information display to show you when you should have your dealer perform engine oil replacement and indicated maintenance service.

Based on the engine operating conditions and accumulated engine revolutions, the onboard computer in your vehicle calculates the remaining engine oil life and displays it as a percentage.

Engine Oil Life Indicator

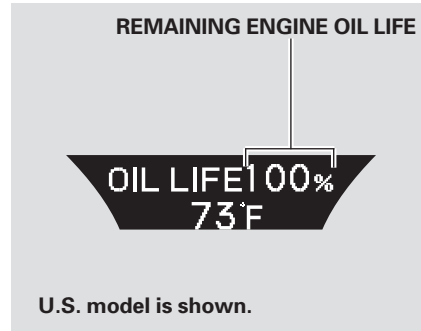

To see the current engine oil life displayed on the multi-information display, turn the ignition switch* to the ON (II) position, and press the SEL/RESET button on the steering wheel repeatedly until the engine oil life is displayed.

* : Models equipped with the keyless access system have an engine start/stop button instead of an ignition switch. ON Mode is the equivalent of ON (II). For more information, see pages 178 and 180.

CONTINUED

Maintenance Minder

The remaining engine oil life is shown on the multi-information display according to this table:

Calculated Engine Oil Life (%)	Displayed Engine Oil Life (%)
100 % – 91 %	100 %
90 % – 81 %	90 %
80 % – 71 %	80 %
70 % – 61 %	70 %
60 % – 51 %	60 %
50 % – 41 %	50 %
40 % – 31 %	40 %
30 % – 21 %	30 %
20 % – 16 %	20 %
15 % – 11 %	15 %
10 % – 6 %	10 %
5 % – 1 %	5 %
0 %	0 %



When the remaining engine oil life is 15 to 6 percent, the multi-information display shows a “SERVICE DUE SOON” message along with the maintenance item code(s) indicating the main and sub items required at the time of the oil change. Refer to page 544 for a complete list of the maintenance main items and sub items.

Pressing either INFO button (▲/▼) switches the display from the message to another display. Once you switch the display, this message will go off.

Along with the message, the system message indicator comes on (see page 72).

The message appears on the multi-information display each time you turn the ignition switch* to the ON (II) position.

* : Models equipped with the keyless access system have an engine start/stop button instead of an ignition switch. ON Mode is the equivalent of ON (II). For more information, see pages 178 and 180.

This message reminds you that your vehicle will soon be due for scheduled maintenance.

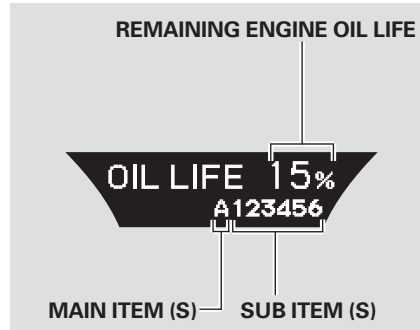

Press the SEL/RESET button on the steering wheel repeatedly to select the engine oil life information. Along with the “OIL LIFE” message, you will see the percentage of the remaining engine oil life and the maintenance item codes on the multi-information display.



When the remaining oil life is 5 to 1 percent, the multi-information display shows a “SERVICE DUE NOW” message with the same maintenance items “SERVICE DUE SOON” was displayed with. When you see this message, have the indicated maintenance performed as soon as possible.

CONTINUED

Maintenance Minder

Pressing either INFO button (▲/▼) switches the display from the message to another display. Once you switch the display, this message will go off.



Press the SEL/RESET button on the steering wheel repeatedly to select the engine oil life. The message "SERVICE," along with "5%," and the maintenance item code are displayed on the multi-information display when the calculated engine oil life is 1 to 5 percent (see page 536).



If the indicated maintenance service is not done and the remaining engine oil life reaches 0%, the multi-information display will show the message "SERVICE PAST DUE" and the maintenance item code(s). This message is displayed when the total distance traveled is less than 10 miles (for U.S. models) or 10 km (for Canadian models) after the engine oil life became 0%.

These messages will come on every time you turn the ignition switch* to the ON (II) position.

* : Models equipped with the keyless access system have an engine start/stop button instead of an ignition switch. ON Mode is the equivalent of ON (II). For more information, see pages [178](#) and [180](#).

Immediately have the service performed, and make sure to reset the display as described on page [541](#).

Pressing either INFO button (▲/▼) switches the display from the message to another display. To see the message again, press either INFO button repeatedly.



Press the SEL/RESET button on the steering wheel repeatedly to select the engine oil life. The message "SERVICE," along with "0%," and the maintenance item code are displayed on the multi-information display when the calculated engine oil life is 0 to 1 percent.

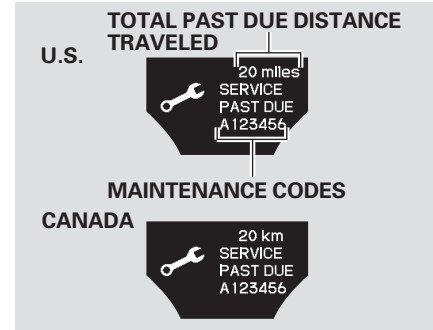

If the indicated required service is not done and the remaining engine oil life becomes 0%, the multi-information display will show a "SERVICE PAST DUE" message, the total distance traveled after the remaining oil life became 0%, and the maintenance item code(s).

CONTINUED

Maintenance

Maintenance Minder

This message is displayed again when you drive over 10 miles (for U.S. models) or 10 km (for Canadian models) after seeing the 0% message.

Immediately have the service performed, and make sure to reset the display as described on page 541.

Pressing either INFO button (▲/▼) switches the display from the message to another display. To see the message again, press either INFO button repeatedly.

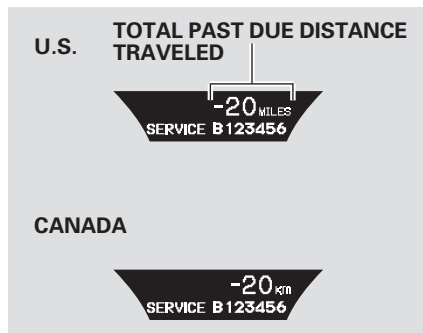

When you press the SEL/RESET button to select the engine oil life, the message "SERVICE," along with the maintenance item code(s) and the total negative distance traveled after the oil life became 0%, will be displayed on the multi-information display.

Maintenance Main Items and Sub Items

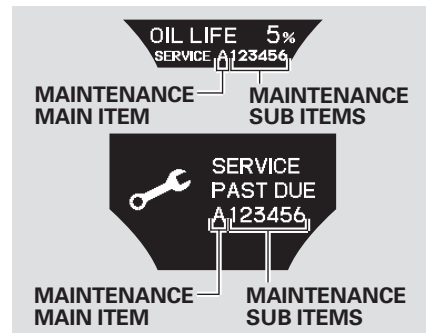

All maintenance items shown on the multi-information display are in code. For an explanation of these maintenance codes, see page 544.

Resetting the Engine Oil Life Display

Your dealer will reset the display after completing the required maintenance service. You will see “OIL LIFE 100%” on the display the next time you turn the ignition switch* to the ON (II) position.

* : Models equipped with the keyless access system have an engine start/stop button instead of an ignition switch. ON Mode is the equivalent of ON (II). For more information, see pages [178](#) and [180](#).

If maintenance service is done by someone other than your dealer, reset the maintenance minder as follows:

1. Turn the ignition switch* to the ON (II) position.

* : Models equipped with the keyless access system have an engine start/stop button instead of an ignition switch. ON Mode is the equivalent of ON (II). For more information, see pages [178](#) and [180](#).

2. If the engine oil life is not displayed, press the SEL/RESET button on the steering wheel repeatedly.

3. Press and hold the SEL/RESET button on the steering wheel for more than 10 seconds. The remaining engine oil life reset mode will be shown on the multi-information display.



4. Select “RESET” by pressing the INFO (▲/▼) button, then press the SEL/RESET button to reset the engine oil life display. The maintenance item code(s) will disappear, and the engine oil life will reset to “100.” If you want to cancel the oil life reset mode, select “CANCEL.”

CONTINUED

Maintenance Minder

Your authorized dealer knows your vehicle best and can provide competent, efficient service. However, service at a dealer is not mandatory to keep your warranties in effect. Maintenance may be done by any qualified service facility or person who is skilled in this type of automotive service. Keep all receipts as proof of completion, and have the person who does the work fill out your Maintenance Journal or Canadian Maintenance Log. Check your warranty booklet for more information.

We recommend using Acura parts and fluids whenever you have maintenance done. These are manufactured to the same high-quality standards as the original components, so you can be confident of their performance and durability.

Important Maintenance Precautions

If you have the required service done but do not reset the display, or reset the display without doing the service, the system will not show the proper maintenance intervals. This can lead to serious mechanical problems because you will no longer have an accurate record of when maintenance is needed.

U.S. Vehicles:
Maintenance, replacement, or repair of emissions control devices and systems may be done by any automotive repair establishment or individual using parts that are “certified” to EPA standards.

According to state and federal regulations, failure to perform maintenance on the items marked with # will not void your emissions warranties. However, all maintenance services should be performed in accordance with the intervals indicated by the multi-information display.

Owner's Maintenance Checks

You should check the following items at the specified intervals. If you are unsure of how to perform any check, turn to the appropriate page listed.

- Engine oil level — Check every time you fill the fuel tank. See page [490](#).
 - Engine coolant level — Check the radiator reserve tank every time you fill the fuel tank. See page [491](#).
 - Automatic transmission — Check the fluid level monthly. See page [553](#).
 - Brakes — Check the fluid level monthly. See page [555](#).
 - Tires — Check the tire pressure monthly. Examine the tread for wear and foreign objects. See page [568](#).
- Lights — Check the operation of the headlights, parking lights, taillights, high-mount brake light, and license plate lights monthly. See page [556](#).

CONTINUED

Maintenance Minder

Symbol	Maintenance Main Items
A	<ul style="list-style-type: none"> ● Replace engine oil*¹
B	<ul style="list-style-type: none"> ● Replace engine oil*¹ and oil filter ● Inspect front and rear brakes ● Check parking brake adjustment ● Inspect these items: <ul style="list-style-type: none"> ● Tie rod ends, steering gear box, and boots ● Suspension components ● Driveshaft boots ● Brake hoses and line (including ABS) ● All fluid levels and condition of fluids ● Exhaust system[#] ● Fuel lines and connections[#]

* 1 : If the message "SERVICE DUE NOW" does not appear more than 12 months after the display is reset, change the engine oil every year.

: See information on maintenance and emissions warranty on page 542.

NOTE: ● Independent of the maintenance messages on the multi-information display, replace the brake fluid every 3 years.
 ● Inspect idle speed every 160,000 miles (256,000 km).
 ● Adjust the valves during service 3 if they are noisy.

Symbol	Maintenance Sub Items
1	<ul style="list-style-type: none"> ● Rotate tires
2	<ul style="list-style-type: none"> ● Replace air cleaner element If you drive in dusty conditions, replace every 15,000 miles (24,000 km). ● Replace dust and pollen filter If you drive primarily in urban areas that have high concentrations of soot in the air from industry and from diesel-powered vehicles, replace every 15,000 miles (24,000 km). ● Inspect drive belt
3	<ul style="list-style-type: none"> ● Replace transmission fluid ● Replace transmission and transfer*² fluid
4	<ul style="list-style-type: none"> ● Replace spark plugs ● Replace timing belt and inspect water pump If you drive regularly in very high temperatures (over 110°F, 43°C), or in very low temperatures (under -20°F, -29°C), replace every 60,000 miles (U.S.)/ 100,000 km (Canada). ● Inspect valve clearance
5	<ul style="list-style-type: none"> ● Replace engine coolant
6	<ul style="list-style-type: none"> ● Replace rear differential fluid*² Driving in mountainous areas at very low vehicle speeds results in higher level of mechanical (shear) stress to fluid. This requires differential fluid changes more frequently than recommended by the maintenance minder. If you regularly drive your vehicle under these conditions, have the differential fluid changed at 7,500 miles (12,000 km), then every 15,000 miles (24,000 km).

* 2 : SH-AWD only

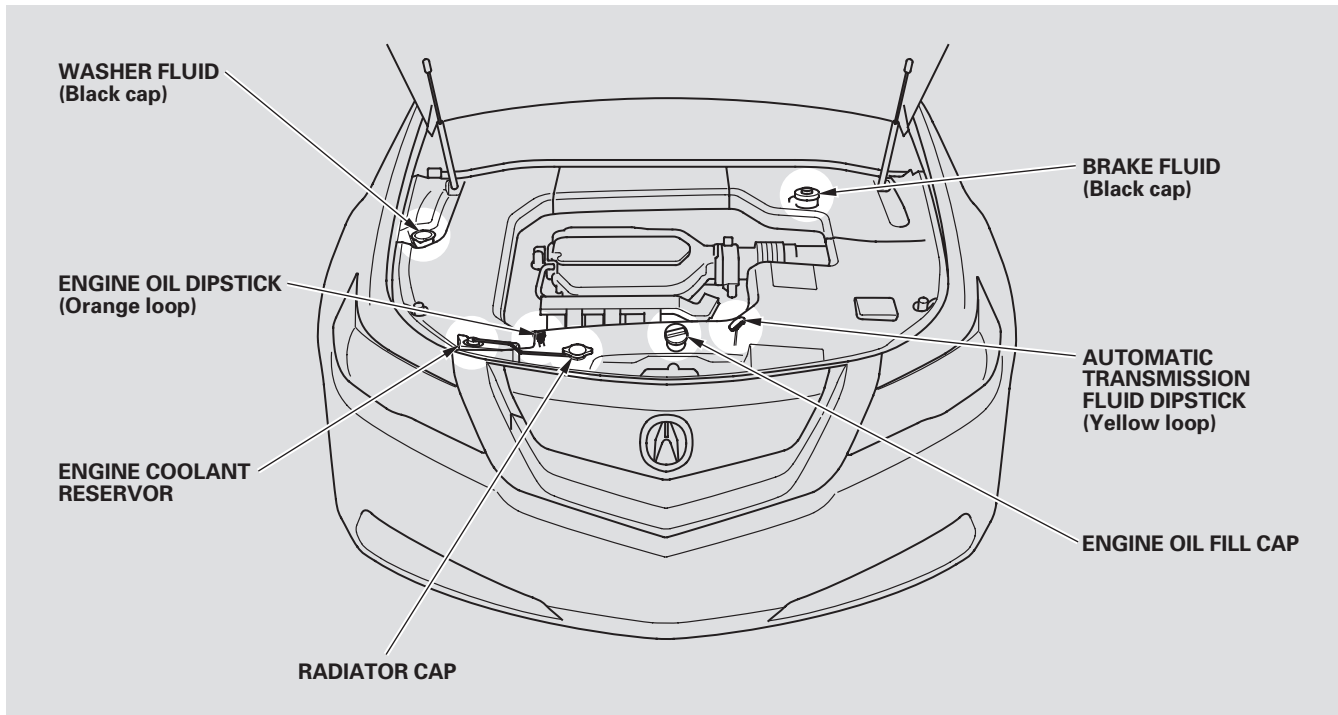

Engine Compartment Covers

The component parts in the engine compartment are protected by several covers. You may need to remove the covers when you perform some simple maintenance work.

All of the covers can be removed simply by pulling them straight up.

1. Remove the right and left engine compartment covers by sliding them apart.
2. Pull the bulkhead cover straight up to remove. When removing the cover, make sure to move the bulkhead cover slightly to the left so that the hood latch handle does not get in the way.
3. After replacing the right engine compartment cover, make sure the washer fluid cap is firmly in place.

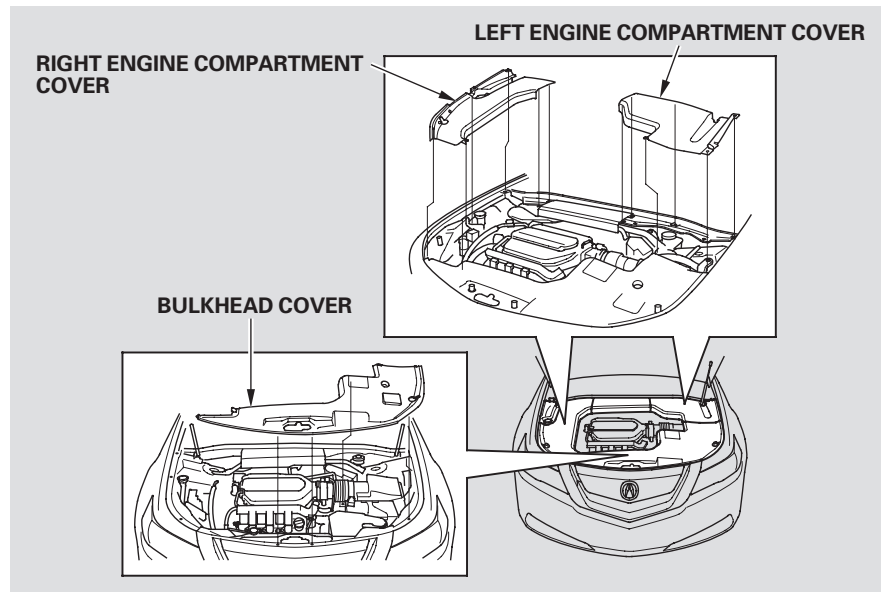

When reinstalling the covers, make sure the pins and tabs are in their proper positions.

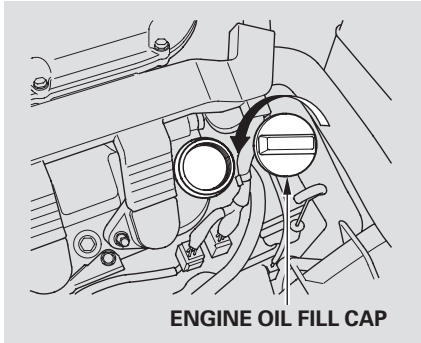

Unscrew and remove the engine oil fill cap on top of the valve cover. Pour in the oil slowly and carefully so you do not spill. Clean up any spills immediately. Spilled oil could damage components in the engine compartment. Install the engine oil fill cap, and tighten it securely. Wait a few minutes, and recheck the oil level (see page 490). Do not fill above the upper mark; you could damage the engine.

Recommended Engine Oil

Oil is a major contributor to your engine's performance and longevity. Always use a premium-grade 5W-20 detergent oil displaying the API Certification Seal. This seal indicates the oil is energy conserving, and that it meets the American Petroleum Institute's latest requirements.

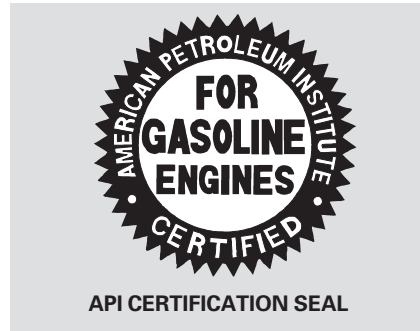

Acura Motor Oil is the preferred 5W-20 lubricant for your vehicle. It is highly recommended that you use Acura Motor Oil in your vehicle for optimum engine protection. Make sure the API Certification Seal says "For Gasoline Engines."

CONTINUED

Adding Engine Oil, Changing the Oil and Filter

The oil viscosity or weight is provided on the container's label. 5W-20 oil is formulated for year-round protection of your vehicle to improve cold weather starting and fuel economy.

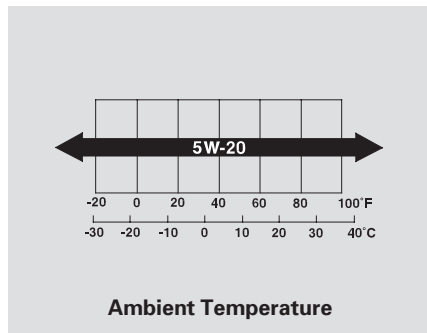

Synthetic Oil

You may use a synthetic motor oil if it meets the same requirements given for a conventional motor oil: it displays the API Certification Seal and it is the proper weight. You must follow the oil and filter change intervals shown on the multi-information display.

Engine Oil Additives

Your vehicle does not require any oil additives. Additives may adversely affect the engine or transmission performance and durability.

Changing the Oil and Filter

Always change the oil and filter according to the maintenance messages shown on the multi-information display. The oil and filter collect contaminants that can damage your engine if they are not removed regularly.

Changing the oil and filter requires special tools and access from underneath the vehicle. The vehicle should be raised on a service station-type hydraulic lift for this service. Unless you have the knowledge and proper equipment, you should have this maintenance done by a skilled technician.

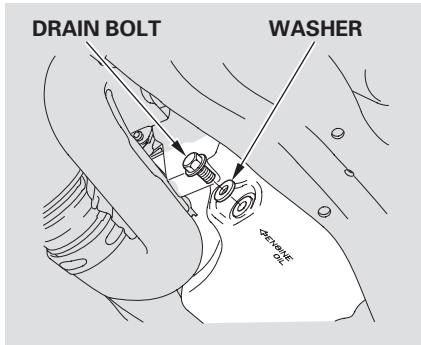

1. Run the engine until it reaches normal operating temperature, then shut it off.
2. Open the hood, and remove the engine oil fill cap. Remove the oil drain bolt and washer from the bottom of the engine. Drain the oil into an appropriate container.

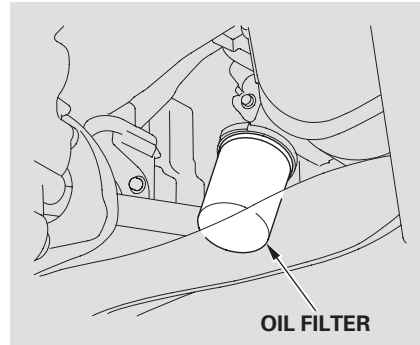

3. Remove the oil filter, and let the remaining oil drain. A special wrench (available from your dealer) is required.

Make sure the oil filter gasket is not stuck to the engine block. If it is, remove it before installing a new oil filter.

4. Install a new oil filter according to the instructions that come with it. Make sure to clean off any dirt and dust on the connecting surface of a new oil filter.
5. Put a new washer on the drain bolt, then reinstall the drain bolt. Tighten the drain bolt to:

29 lbf-ft (39 N·m , 4.0 kgf·m)

6. Refill the engine with the recommended oil.

Engine oil change capacity
(including filter):

4.5 US qt (4.3 ℓ)

CONTINUED

Changing the Oil and Filter, Engine Coolant

7. Reinstall the engine oil fill cap.
Start the engine. The oil pressure indicator should go out within 5 seconds. If it does not, turn off the engine and check your work.
8. Let the engine run for several minutes, then check the drain bolt and oil filter for leaks.
9. Turn off the engine, let it sit for several minutes, then check the oil level on the dipstick. If necessary, add more oil.

NOTICE

Improper disposal of engine oil can be harmful to the environment. If you change your own oil, please dispose of the used oil properly. Put it in a sealed container, and take it to a recycling center. Do not discard it in a trash bin or dump it on the ground.

Adding Engine Coolant

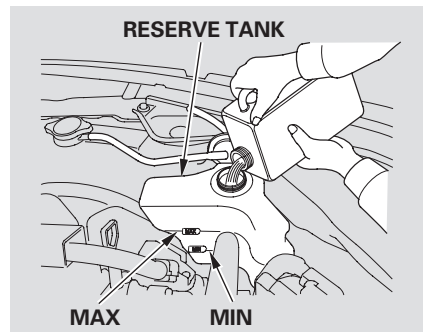

If the coolant level in the reserve tank is at or below the MIN line, add coolant to bring it up to the MAX line. Inspect the cooling system for leaks.

To access the radiator reserve tank, remove the right-side engine compartment cover (see page [546](#)).

Always use Honda Long-life Antifreeze/Coolant Type 2. This coolant is pre-mixed with 50 percent antifreeze and 50 percent distilled water. Never add straight antifreeze or plain water.

If Honda antifreeze/coolant is not available, you may use another major-brand non-silicate coolant as a temporary replacement. Make sure it is a high-quality coolant recommended for aluminum engines. Continued use of any non-Honda coolant can result in corrosion, causing the cooling system to malfunction or fail. Have the cooling system flushed and refilled with Honda antifreeze/coolant as soon as possible.

If the reserve tank is completely empty, you should also check the coolant level in the radiator.

⚠ WARNING

Removing the radiator cap while the engine is hot can cause the coolant to spray out, seriously scalding you.

Always let the engine and radiator cool down before removing the radiator cap.

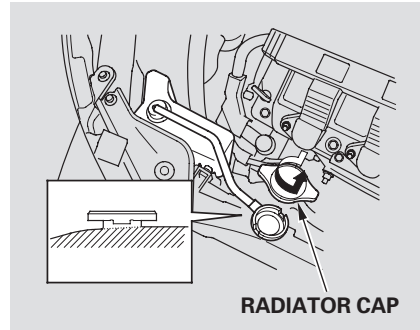

1. Remove all engine compartment covers (see page 546).
2. When the radiator and engine are cool, relieve any pressure in the cooling system by turning the radiator cap counterclockwise, without pressing down.
3. Remove the radiator cap by pushing down and turning counterclockwise.

4. The coolant level should be up to the base of the filler neck. Add coolant if it is low.

Pour the coolant slowly and carefully so you do not spill any. Clean up any spill immediately; it could damage components in the engine compartment.

5. Put the radiator cap back on and tighten it.
6. Pour coolant into the reserve tank. Fill it to halfway between the MAX and MIN marks. Put the cap back on the reserve tank.

Do not add any rust inhibitors or other additives to your vehicle's cooling system. They may not be compatible with the coolant or engine components.

Windshield Washers

Check the fluid level in the windshield washer reservoir at least monthly during normal use.

On U.S. models

To check washer fluid level, cover the reservoir cap center hole with your finger while lifting the cap and the attached measuring tube. The washer fluid level in the tube will indicate the washer fluid level in the reservoir.

On Canadian models

If the washer fluid is low, a “LOW WASHER FLUID” message appears on the multi-information display.

Fill the reservoir with a good-quality windshield washer fluid. This increases the cleaning capability and prevents freezing in cold weather.

When you refill the reservoir, clean the edges of the windshield wiper blades with windshield washer fluid on a clean cloth. This will help to condition the blade edges.

NOTICE

Do not use engine antifreeze or a vinegar/water solution in the windshield washer reservoir. Antifreeze can damage your vehicle's paint, while a vinegar/water solution can damage the windshield washer pump. Use only commercially-available windshield washer fluid.

The transmission should be drained and refilled with new fluid when this service is shown on a maintenance message in the multi-information display.

Check the fluid level with the engine at normal operating temperature.

1. Park the vehicle on level ground. Start the engine, let it run until the radiator fan comes on, then shut off the engine. For accurate results, wait about 60 seconds (but no longer than 90 seconds) before doing step 2.

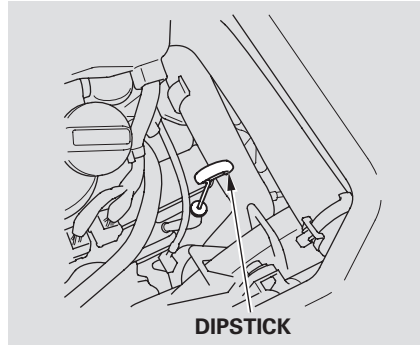

2. Remove the dipstick (yellow loop) from the transmission, and wipe it with a clean cloth.

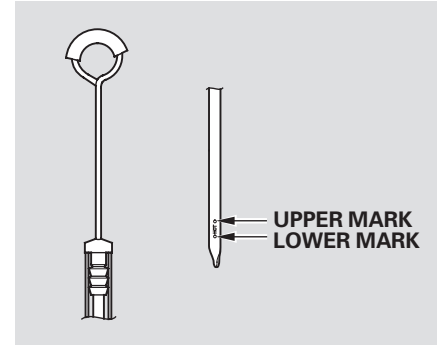

3. Insert the dipstick all the way into the transmission securely as shown in the illustration.
4. Remove the dipstick and check the fluid level. It should be between the upper and lower marks.

CONTINUED

Automatic Transmission Fluid

5. If the level is below the lower mark, add fluid into the filler hole to bring it to the level between the upper and lower marks.

Pour the fluid slowly and carefully so you do not spill any. Clean up any spill immediately; it could damage components in the engine compartment.

Always use Acura ATF-Z1 (automatic transmission fluid).

6. Insert the dipstick all the way back into the transmission securely as shown in the illustration.

Make sure the rubber cap on the dipstick fits in the dipstick guide and that you push the dipstick in all the way.

The transmission should be drained and refilled with new fluid when this service is shown on a maintenance message in the multi-information display.

If you are not sure how to check and add fluid, contact your dealer.

NOTICE

Use only Acura ATF-Z1 (Automatic Transmission Fluid). Do not mix with other transmission fluids. Using transmission fluid other than Acura ATF-Z1 may cause deterioration in transmission operation and durability, and could result in damage to the transmission. Damage resulting from the use of transmission fluid other than Acura ATF-Z1 is not covered by the Acura new vehicle warranty.

Check the brake fluid level in the reservoir monthly after removing the left engine compartment cover (see page 546).

You will also see a “LOW BRAKE FLUID” message on the multi-information display.

Replace the brake fluid when this service is indicated on a maintenance message in the multi-information display.

Always use Honda Heavy Duty Brake Fluid DOT 3. If it is not available, you should use only DOT 3 or DOT 4 fluid, from a sealed container, as a temporary replacement.

Using any non-Honda brake fluid can cause corrosion and decrease the life of the system. Have the brake system flushed and refilled with Honda Heavy Duty Brake Fluid DOT 3 as soon as possible.

Brake fluid marked DOT 5 is not compatible with your vehicle’s braking system and can cause extensive damage.

Brake System

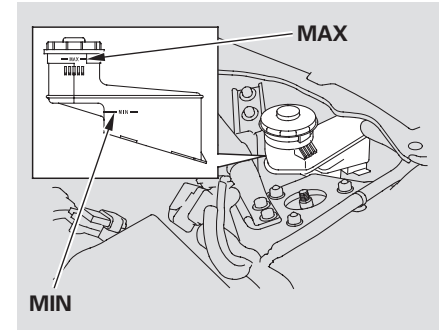

The fluid level should be between the MIN and MAX marks on the side of the reservoir. If the level is at or below the MIN mark, your brake system needs attention. Have the brake system inspected for leaks or worn brake pads.

You need remove the left engine compartment cover to check the fluid level (see page 546).

Lights

Headlight Aiming

The headlights were properly aimed when your vehicle was new. If you regularly carry heavy items in the trunk, readjustment may be required. Adjustments should be done by your dealer or another qualified technician.

Low Beam Headlight Bulb Replacement

The low beam headlight bulbs are a type of high voltage discharge tube. High voltage can remain in the circuit even with the light switch off and the key removed (or the vehicle is in VEHICLE OFF (LOCK) mode on models with keyless access system). Because of this, you should not attempt to examine or change a low beam headlight bulb yourself. If a low beam headlight bulb fails, take the vehicle to your dealer to have it replaced.

Replacing a High Beam Headlight/Daytime Running Light Bulb

Your vehicle has halogen high beam headlight bulbs which are also used for the daytime running light. Handle it by its base and protect the glass from contact with your skin or hard objects. If you touch the glass, clean it with denatured alcohol and a clean cloth.

NOTICE

Halogen bulbs get very hot when lit. Oil, perspiration, or a scratch on the glass can cause the bulb to overheat and shatter.

1. Open the hood.
2. Remove all engine compartment covers (see page 546).

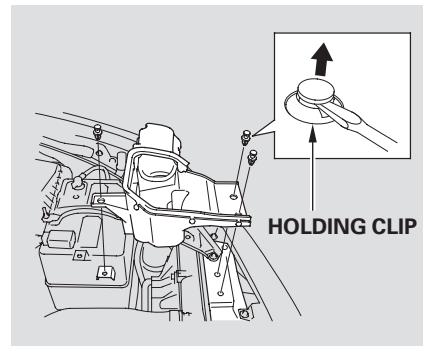

If you are replacing the bulb on the driver's side, remove the three holding clips with a flat-tipped screwdriver. Then remove the upper part of the air intake duct by pulling it straight up.

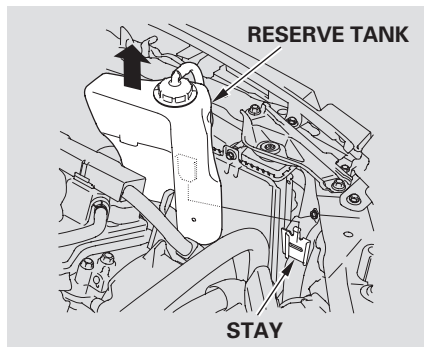

To change a bulb on the passenger's side, remove the engine coolant reserve tank by pulling it out of its stay.

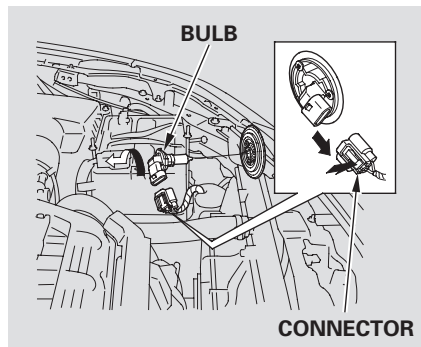

3. Remove the electrical connector from the bulb by pushing on the tab and pulling the connector down.
4. Remove the bulb by turning it one-quarter turn counterclockwise.
5. Insert the new bulb into the hole, and turn it one-quarter turn clockwise to lock it in place.

6. Push the electrical connector back onto the bulb. Make sure it is on all the way.
7. Turn on the lights to test the new bulb.
8. (Driver's side)
Install the upper part of the air intake duct.
9. (Passenger's side)
Install the engine coolant reserve tank.
10. Install the all engine compartment covers.

Lights

Replacing the Front Side Marker Light Bulb

1. Start the engine. If you are replacing a driver's side bulb, turn the steering wheel all the way to the right. If you are replacing a passenger's side bulb, turn the steering wheel to the left. Turn off the engine.

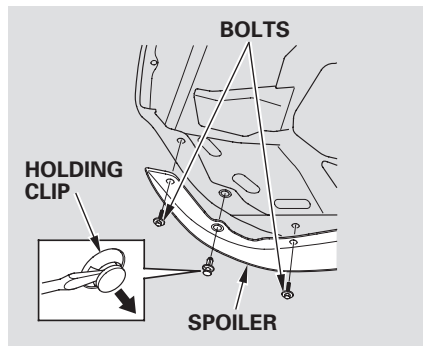

2. Remove the two undercover bolts and the holding clip with a flat-tipped screwdriver.

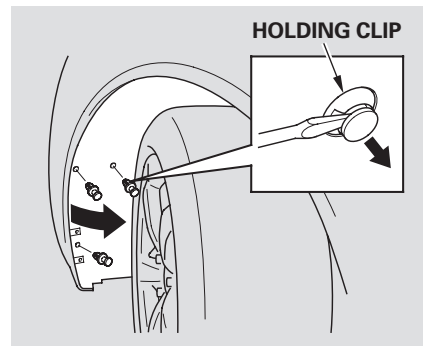

3. Use a flat-tipped screwdriver to remove the holding clips from the edge of the inner fender cover, and pull the inner fender cover back.

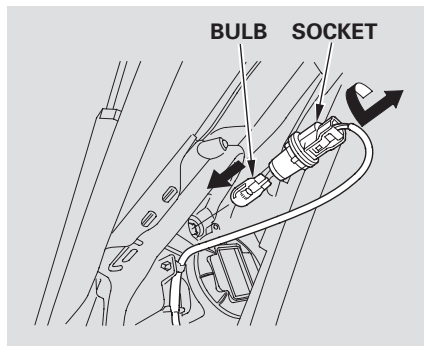

4. Remove the socket from the headlight assembly by turning it one-quarter turn counterclockwise.
5. Remove the bulb by pulling it straight out of its socket.

6. Install the new bulb in the socket by pushing it straight in the socket until it bottoms.
7. Insert the socket into the headlight assembly. Turn it clockwise to lock it in place.
8. Test the lights to make sure the new bulb is working.
9. Set the spoiler and inner fender cover in the original position. Install the bolts and holding clips, and lock them in place by pushing on their center.

Replacing a Front Turn Signal/ Parking Light Bulb

1. Start the engine. If you are replacing a driver's side bulb, turn the steering wheel all the way to the right. If you are replacing a passenger's side bulb, turn the steering wheel to the left. Turn off the engine.

CONTINUED

Lights

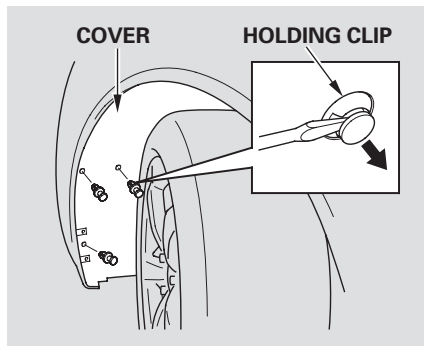

2. Use a flat-tipped screwdriver to remove the three holding clips from the inner fender.

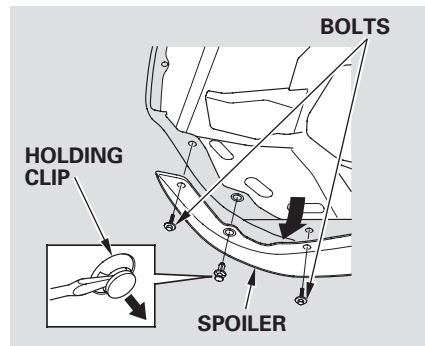

3. Use a 10 mm wrench to remove the two mounting bolts and remove the holding clip with a flat-tipped screwdriver.

Pull down the under cover from the bumper carefully.

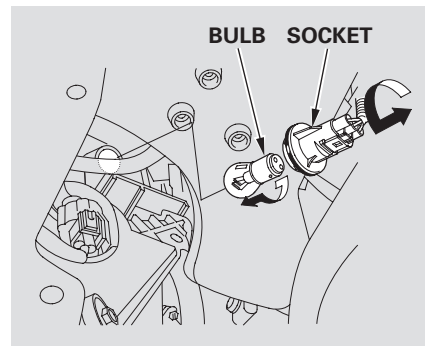

4. Remove the socket from the light assembly by turning it one-quarter turn counterclockwise.
5. Remove the bulb from the socket by pushing it in and turning it counterclockwise until it unlocks.

6. Install the new bulb in the socket. Turn it clockwise to lock it in place.
7. Insert the socket into the light assembly. Turn it clockwise to lock it in place.
8. Test the lights to make sure the new bulb is working.
9. Push the under cover in place and set the spoiler and inner fender cover in the original position. Install the bolts and holding clips, and lock them in place by pushing on their center.

Replacing a Front Fog Light Bulb

Your vehicle uses halogen light bulbs. When replacing a bulb, handle it by its plastic case, and protect the glass from contact with your skin or hard objects. If you touch the glass, clean it with denatured alcohol and a clean cloth.

NOTICE

Halogen bulbs get very hot when lit. Oil, perspiration, or a scratch on the glass can cause the bulb to overheat and shatter.

1. Start the engine. If you are replacing a driver's side bulb, turn the steering wheel all the way to the right. If you are replacing a passenger's side bulb, turn the steering wheel to the left. Turn off the engine.

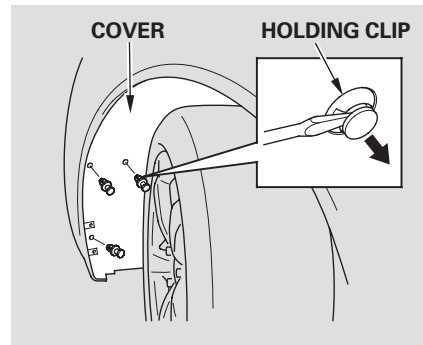

2. Use a flat-tipped screwdriver to remove the three holding clips from the inner fender.

CONTINUED

Lights

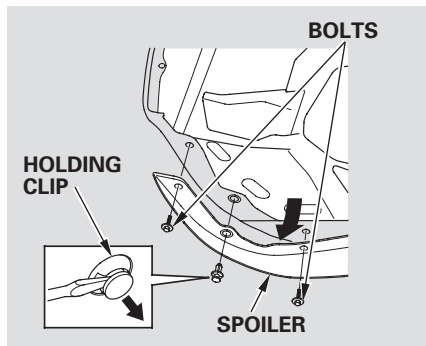

3. Use a 10 mm wrench to remove the two mounting bolts and remove the holding clip with a flat-tipped screwdriver.

Pull down the under cover from the bumper carefully.

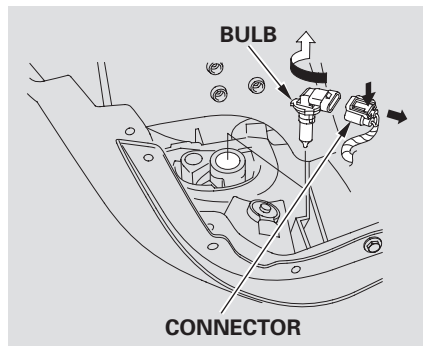

4. Remove the electrical connector from the bulb by pushing on the tab and pulling the connector down.
5. Remove the bulb by turning it about one-quarter turn counterclockwise.

6. Insert the new bulb into the hole, and turn it one-quarter turn clockwise to lock it in place.
7. Push the electrical connector back onto the bulb. Make sure it is on all the way.
8. Turn on the fog lights to test the new bulb.
9. Push the under cover in place and set the spoiler and inner fender cover in the original position. Install the bolts and holding clips, and lock them in place by pushing on their center.

Replacing Rear Bulbs

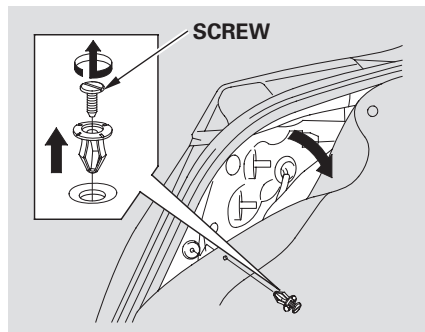

1. Open the trunk.
Remove the screw in the center of the holding clip on the side of the trunk lining. Pull the lining back.

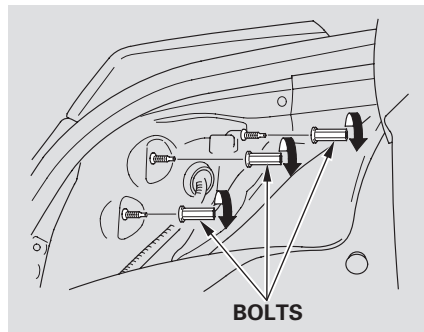

2. Remove the three stud bolts with a socket or wrench.

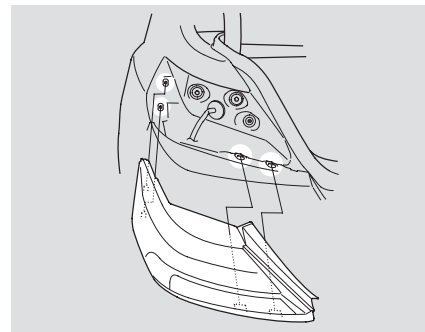

3. Pull the taillight assembly straight back out of the body.

CONTINUED

Lights, Cleaning the Seat Belts

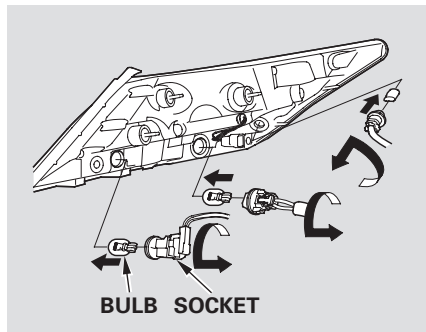

4. Determine which of the three bulbs is burned out: back-up light, turn signal, or side marker.
5. Remove the socket by turning it one-quarter turn counterclockwise, and pull the bulb straight out of its socket.

6. Push a new bulb straight into the socket until it bottoms, and reinstall the socket into the light assembly by turning it clockwise until it locks.
7. Test the new bulb to make sure it works.
8. Reinstall the trunk lining. Make sure it is installed under the edge of the trunk seal.
9. Put the holding clip into the hole on the side of the trunk lining. Reinstall the screw.

Cleaning the Seat Belts

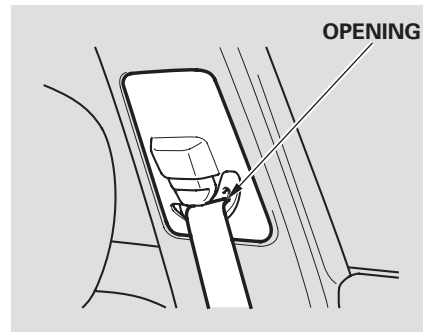

If your seat belts get dirty, use a soft brush with a mixture of mild soap and warm water to clean them. Do not use bleach, dye, or cleaning solvents. Let the belts air-dry before you use the vehicle.

Dirt build-up around the openings of the seat belt anchors can cause the belts to retract slowly. Wipe the openings with a clean cloth dampened in mild soap and warm water or isopropyl alcohol.

Floor Mats

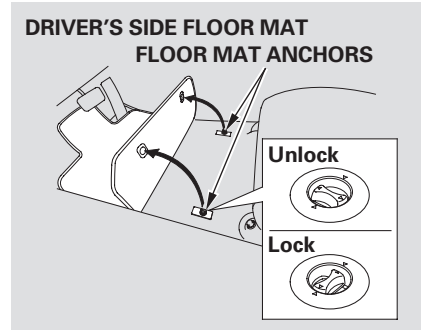

The floor mats that came with your vehicle hook over the floor mat anchors. To lock each anchor, turn the knob clockwise. This keeps the floor mats from sliding forward (possibly interfering with the pedals), or backwards (making the front passenger's weight sensors ineffective).

If you remove a floor mat, make sure to re-anchor it when you put it back in your vehicle.

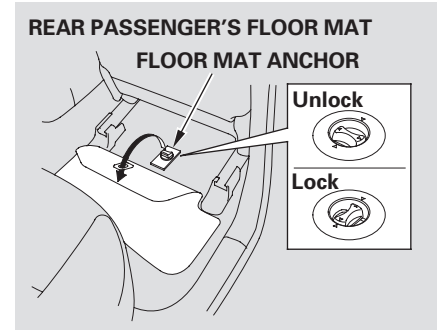

If you use non-Acura floor mats, make sure they fit properly and that they can be used with the floor mat anchors. Do not put additional floor mats on top of the anchored mats.

Make sure the rear floor mats are properly positioned. If not, the floor mat will prevent the seat operation and make the front passenger's weight sensors ineffective.

Dust and Pollen Filter, Wiper Blades

Dust and Pollen Filter

This filter removes the dust and pollen that is brought in from the outside through the climate control system.

Have your dealer replace the filter when this service is indicated by a maintenance message on the multi-information display. It should be replaced every 15,000 miles (24,000 km) if you drive primarily in urban areas that have high concentrations of soot in the air, or if the flow from the climate control system becomes less than usual.

Wiper Blades

Check the condition of the wiper blades at least every 6 months. Replace them if you find signs of cracking in the rubber, areas that are getting hard, or if they leave streaks and unwiped areas when used.

1. Raise each wiper arm off the windshield, lifting the driver's side first, then the passenger's side.

NOTICE

Do not open the hood when the wiper arms are raised, or you will damage the hood and wiper arms.

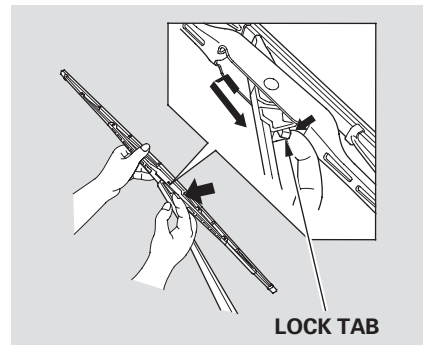

2. Disconnect the blade assembly from the wiper arm by pushing in the lock tab. Hold the lock tab in while you push the blade assembly toward the base of the arm.

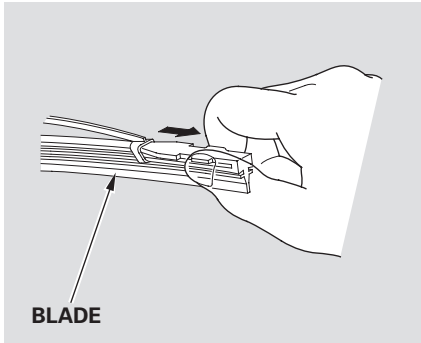

3. Remove the blade from its holder by grabbing the tabbed end of the blade. Pull up firmly until the tabs come out of the holder.
4. Examine the new wiper blades. If they have no plastic or metal reinforcement along the back edge, remove the metal reinforcement strips from the old wiper blade, and install them in the slots along the edge of the new blade.

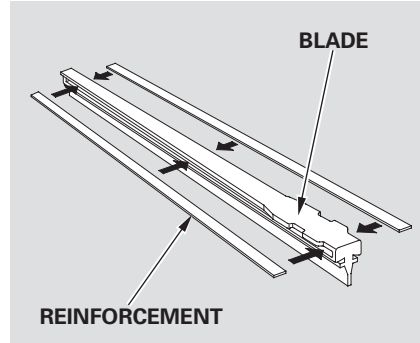

5. Slide the new wiper blade into the holder until the tabs lock.
6. Slide the wiper blade assembly onto the wiper arm. Make sure it locks in place.
7. Lower the wiper arm down against the windshield.

Tires

To safely operate your vehicle, your tires must be the proper type and size, in good condition with adequate tread, and correctly inflated.

The following pages give more detailed information on how to take care of your tires and what to do when they need to be replaced.

WARNING

Using tires that are excessively worn or improperly inflated can cause a crash in which you can be seriously hurt or killed.

Follow all instructions in this owner's manual regarding tire inflation and maintenance.

Tire Types

All models except SH-AWD model with high performance tires and SH-AWD TECH HPT models

Your vehicle is equipped with high performance all-season tires (marked All Season or M + S on the sidewalls). These tires provide excellent handling and braking performance in most driving situations.

SH-AWD model with high performance tires and SH-AWD TECH HPT models

Your vehicle is equipped with high performance summer tires. These tires have a high-traction compound and tread pattern to provide superior acceleration, cornering, and stopping under most driving conditions.

However, these tires are not suitable for driving on snow or ice, so all-season or winter tires must be installed for winter driving conditions.

See page [575](#) for **Winter Driving**.

Inflation Guidelines

Keeping the tires properly inflated provides the best combination of handling, tread life, and riding comfort.

- Underinflated tires wear unevenly, adversely affect handling and fuel economy, and are more likely to fail from being overheated.
- Overinflated tires can make your vehicle ride more harshly, are more prone to damage from road hazards, and wear unevenly.

The tire pressure monitoring system (TPMS) warns you when a tire pressure is low. See page [526](#) for more information on the TPMS.

Even though your vehicle is equipped with TPMS, we recommend that you visually check your tires every day. If you think a tire might be low, check it immediately with a tire gauge.

Use a gauge to measure the air pressure in each tire at least once a month. Even tires that are in good condition may lose 1 to 2 psi (10 to 20 kPa, 0.1 to 0.2 kgf/cm²) per month. Remember to check the spare tire at the same time.

Check the air pressures when the tires are cold. This means the vehicle has been parked for at least 3 hours, or driven less than 1 mile (1.6 km). Add or release air, if needed, to match the recommended cold tire pressures on the next page.

If you check air pressure when the tires are hot [driven for several miles (kilometers)], you will see readings 4 to 6 psi (30 to 40 kPa, 0.3 to 0.4 kgf/cm²) higher than the cold readings. This is normal. Do not let air out to match the recommended cold air pressure. The tire will be underinflated.

While tubeless tires have some ability to self-seal if they are punctured, you should look closely for punctures if a tire starts losing pressure.

You should get your own tire pressure gauge and use it whenever you check your tire pressures. This will make it easier for you to tell if a pressure loss is due to a tire problem and not due to a variation between gauges.

Tires

Recommended Tire Pressures

The following chart shows the recommended cold tire pressures for most normal driving conditions.

TL and TECH models

Tire Size	Cold Tire Pressure for Normal Driving
P245/50R17 98V	Front: 32 psi (220 kPa , 2.2 kgf/cm ²)
	Rear: 32 psi (220 kPa , 2.2 kgf/cm ²)

U.S. SH-AWD and SH-AWD TECH models

Tire Size	Cold Tire Pressure for Normal Driving
P245/45R18 96V	Front: 32 psi (220 kPa , 2.2 kgf/cm ²)
	Rear: 32 psi (220 kPa , 2.2 kgf/cm ²)

U.S. SH-AWD model with high performance tires and SH-AWD TECH HPT models

Tire Size	Cold Tire Pressure for Normal Driving
245/40ZR19 94Y	Front: 37 psi (255 kPa , 2.55 kgf/cm ²)
	Rear: 32 psi (220 kPa , 2.2 kgf/cm ²)

Canadian SH-AWD and SH-AWD TECH models

Tire Size	Cold Tire Pressure for Normal Driving
P245/45R18 96V	Front: 32 psi (220 kPa , 2.2 kgf/cm ²)
	Rear: 32 psi (220 kPa , 2.2 kgf/cm ²)

The compact spare tire pressure is: 60 psi (420 kPa , 4.2 kgf/cm²)

For convenience, the recommended tire sizes and cold tire pressures are on a label on the driver's doorjamb.

For additional technical information, see page [518](#).

High Speed Driving

We strongly recommend that you do not drive faster than the posted speed limits and conditions allow. If you ever drive in a sanctioned competitive event at sustained high speeds (over 118 mph or 190 km/h), be sure to adjust the cold tire pressures as shown below. If you do not, excessive heat can build up and cause sudden tire failure.

SH-AWD and SH-AWD TECH models

Tire Size	Cold Tire Pressure for High Speed Driving
P245/45R18 96V	Front: 33 psi (230 kPa , 2.3 kgf/cm ²)
	Rear: 32 psi (220 kPa , 2.2 kgf/cm ²)

Tire Inspection

Every time you check inflation, you should also examine the tires for damage, foreign objects, and wear.

You should look for:

- Bumps or bulges in the tread or side of the tire. Replace the tire if you find either of these conditions.
- Cuts, splits, or cracks in the side of the tire. Replace the tire if you can see fabric or cord.
- Excessive tread wear.

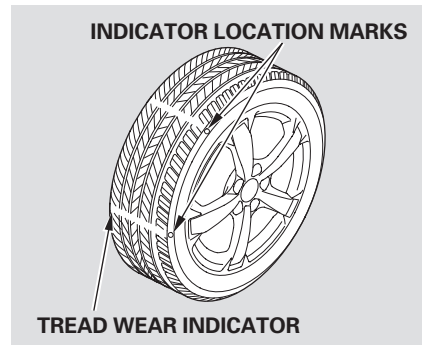

Your tires have wear indicators molded into the tread. When the tread wears down, you will see a band 1/2 inch (12.7 mm) wide band across the tread. This shows there is less than 1/16 inch (1.6 mm) of tread left on the tire.

A tire this worn gives very little traction on wet roads. You should replace the tire if you can see three or more tread wear indicators.

Tires

Tire Service Life

The service life of your tires is dependent on many factors, including, but not limited to, driving habits, road conditions, vehicle loading, inflation pressure, maintenance history, speed, and environmental conditions (even when the tires are not in use).

In addition to your regular inspections and inflation pressure maintenance, it is recommended that you have annual inspections performed once the tires reach five years old. It is also recommended that all tires, including the spare, be removed from service after 10 years from the date of manufacture, regardless of their condition or state of wear.

The last four digits of the TIN (tire identification number) are found on the sidewall of the tire and indicate the date of manufacture (See **Tire Labeling** on page [619](#)).

Tire Maintenance

In addition to proper inflation, correct wheel alignment helps to decrease tire wear. If you find a tire is worn unevenly, have your dealer check the wheel alignment.

Have your dealer check the tires if you feel a consistent vibration while driving. A tire should always be rebalanced if it is removed from the wheel. When you have new tires installed, make sure they are balanced. This increases riding comfort and tire life. For best results, have the installer perform a dynamic balance.

NOTICE

Improper wheel weights can damage your vehicle's aluminum wheels. Use only Acura wheel weights for balancing.

Tire Rotation

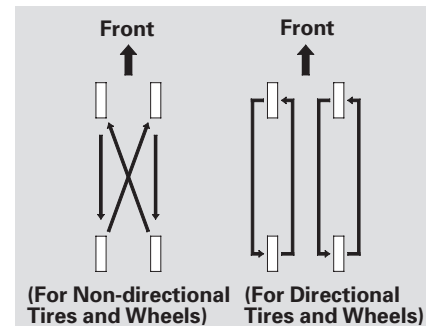

To help increase tire life and distribute wear more evenly, rotate the tires according to the maintenance messages displayed on the multi-information display. Move the tires to the positions shown in the illustration each time they are rotated. If you purchase directional tires, rotate only front-to-back.

When the tires are rotated, make sure the air pressures are checked.

Tires

Replacing Tires and Wheels

Replace your tires with radial tires of the same size, load range, speed rating, and maximum cold tire pressure rating (as shown on the tire's sidewall).

Mixing radial and bias-ply tires on your vehicle can reduce braking ability, traction, and steering accuracy. Using tires of a different size or construction can cause the ABS and vehicle stability assist system (VSA) to work inconsistently.

The ABS and VSA system work by comparing the speed of each wheel. When replacing tires, use the same size originally supplied with the vehicle. Tire size and construction can affect wheel speed and may cause the system to activate.

It is best to replace all four tires at the same time. If that is not possible or necessary, replace the two front tires or two rear tires as a pair. Replacing just one tire can seriously affect your vehicle's handling.

If you ever replace a wheel, make sure that the wheel's specifications match those of the original wheels.

Also be sure you use only TPMS specific wheels. If you do not, the tire pressure monitoring system will not work.

Replacement wheels are available at your dealer.

WARNING

Installing improper tires on your vehicle can affect handling and stability. This can cause a crash in which you can be seriously hurt or killed.

Always use the size and type of tires recommended in this owner's manual.

Wheel and Tire Specifications

Wheels:

On 2WD Models

17 x 8.0 J(TPMS)

On U.S. SH-AWD Models

18 x 8.0 J(TPMS)

19 x 8.0 J(TPMS)*

On Canadian SH-AWD Models

18 x 8.0 J(TPMS)

Tires:

On 2WD Models

P245/50R17 98V

On U.S. SH-AWD Models

P245/45R18 96V

245/40ZR19 94Y*

On Canadian SH-AWD Models

P245/45R18 96V

* : If equipped

See page 617 for DOT tire quality grading information, and page 619 for tire size information.

Winter Driving

Tires marked “M + S” or “All Season” on the sidewall have an all-weather tread design suitable for most winter driving conditions.

For the best performance in snowy or icy conditions, you should install snow tires or tire chains. They may be required by local laws under certain conditions.

Summer Tires

If your vehicle is equipped with summer tires, be aware that these tires are not designed for winter driving conditions. For more information, consult your dealer.

Snow Tires

If you mount snow tires on your vehicle, make sure they are radial tires of the same size and load range as original tires. Mount snow tires on all four wheels. The traction provided by snow tires on dry roads may be lower than your original tires. Check with the tire dealer for maximum speed recommendations.

Tire Chains

Mount tire chains on your tires when required by driving conditions or local laws. Install them only on the front tires. Do not use chains on the rear tires.

Because your vehicle has limited tire clearance, we strongly recommend using this Quality Chain Corp. tire chain:

Tires

Premium Cobra Cable Chain # 1042P with accessory adjusters*

This tire chain is available at many auto supply stores. To find a local store that carries the chain, call Quality Chain Corp at 1-800-843-8824. To order the tire chain online, go to www.qualitychaincorp.com, and enter your vehicle information. When you install the chains, follow the manufacturer's instructions, and mount them as tightly as you can. Drive slowly with the chains installed.

* : Rubber chain adjusters, or tensioners, must be used to prevent the chains from contacting the body or the chassis.

WARNING

Using the wrong chains, or not properly installing chains, can damage the brake lines and cause a crash in which you can be seriously injured or killed.

Follow all instructions in this owner's manual regarding the selection and use of tire chains.

If you ever hear the chains contacting the body or chassis, stop and investigate. If the chains have loosened, retighten them. Make sure they do not contact the brake lines or suspension.

Remove the chains as soon as you begin driving on cleared roads.

NOTICE

Traction devices that are the wrong size or improperly installed can damage your vehicle's brake lines, suspension, body, and wheels. Stop driving if they are hitting any part of the vehicle.

Wheels

Clean the wheels as you would the rest of the exterior. Wash them with the same solution, and rinse them thoroughly.

Aluminum alloy wheels have a protective clear-coat that keeps the aluminum from corroding and tarnishing. Cleaning the wheels with harsh chemicals (including some commercial wheel cleaners) or a stiff brush can damage the clear-coat. To clean the wheels, use a mild detergent and a soft brush or sponge.

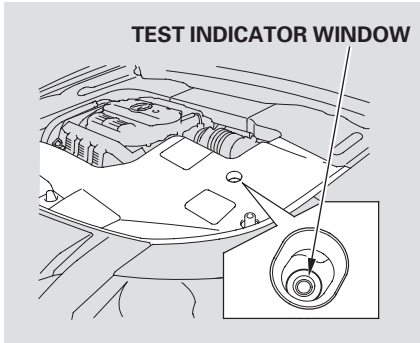

Check the condition of the battery monthly by looking at the test indicator window. The label on the battery explains the test indicator's colors.

Check the terminals for corrosion (a white or yellowish powder) after removing all engine compartment covers (see page 546). To remove it, cover the terminals with a solution of baking soda and water. It will bubble up and turn brown. When this stops, wash it off with plain water. Dry off the battery with a cloth or paper towel. Coat the terminals with grease to help prevent further corrosion.

If additional battery maintenance is needed, see your Acura dealer or a qualified technician.

WARNING: Battery posts, terminals, and related accessories contain lead and lead compounds. **Wash your hands after handling.**

If you need to connect the battery to a charger, disconnect both cables to prevent damaging your vehicle's electrical system. Always disconnect the negative (–) cable first, and reconnect it last.

⚠ WARNING

The battery gives off explosive hydrogen gas during normal operation.

A spark or flame can cause the battery to explode with enough force to kill or seriously hurt you.

Wear protective clothing and a face shield, or have a skilled technician do the battery maintenance.

Vehicle Storage

On models without navigation system

If your vehicle's battery is disconnected, or goes dead, the time setting may be lost. To reset the time, see page [377](#).

If your vehicle's battery is disconnected or goes dead, the audio system may disable itself. The next time you turn on the radio, you will see "ENTER CODE" in the frequency display. Use the preset buttons to enter the code (see page [376](#)).

On models with navigation system

The navigation system will also disable itself. The next time you set to the ON mode, the system will require you to enter a PIN before it can be used. Refer to the navigation system manual.

If you need to park your vehicle for an extended period (more than 1 month), there are several things you should do to prepare it for storage. Proper preparation helps prevent deterioration and makes it easier to get your vehicle back on the road. If possible, store your vehicle indoors.

- Fill the fuel tank.
- Wash and dry the exterior completely.
- Clean the interior. Make sure the carpeting, floor mats, etc., are completely dry.
- Leave the parking brake off. Put the transmission in Park.

- Block the rear wheels.
- If the vehicle is to be stored for a longer period, it should be supported on jackstands so the tires are off the ground.
- Leave one window open slightly (if the vehicle is being stored indoors).
- Disconnect the battery.
- Support the front wiper blade arms with a folded towel or rag so they do not touch the windshield.
- To minimize sticking, apply a silicone spray lubricant to all door and trunk seals. Also, apply a vehicle body wax to the painted surfaces that mate with the door and trunk seals.

- Cover the vehicle with a “breathable” cover, one made from a porous material such as cotton. Non-porous materials, such as plastic sheeting, trap moisture, which can damage the paint.
- If possible, periodically run the engine until it reaches full operating temperature (the cooling fans cycle on and off twice). Preferably, do this once a month.

This section covers the more common problems that motorists experience with their vehicles. It gives you information about how to safely evaluate the problem and what to do to correct it. If the problem has stranded you on the side of the road, you may be able to get going again. If not, you will also find instructions on getting your vehicle towed.

Compact Spare Tire.....	582
Changing a Flat Tire	583
If the Engine Won't Start.....	588
Jump Starting	591
If the Engine Overheats	593
Low Oil Pressure Indicator	595
Charging System Indicator.....	595
Malfunction Indicator Lamp	596
Brake System Indicator	597
Opening the Fuel Fill Door	
Manually	598
Fuses	599
Fuse Locations.....	603
Emergency Towing	606
If Your Vehicle Gets Stuck.....	608

Compact Spare Tire

Use the compact spare tire as a temporary replacement only. Get your regular tire repaired or replaced, and put it back on your vehicle as soon as you can.

Check the inflation pressure of the compact spare tire every time you check the other tires. It should be inflated to:

60 psi (420 kPa , 4.2 kgf/cm²)

Follow these precautions:

- Never exceed 50 mph (80 km/h).
- This tire gives a harsher ride and less traction on some road surfaces. Use greater caution while driving.

- Do not mount snow chains on the compact spare tire.
- Do not use your compact spare tire on another vehicle unless it is the same make and model.
- After the flat tire is replaced with the spare tire, the low tire pressure/TPMS indicator stays on. After several miles (kilometers) driving with the spare, this indicator begins to flash, then stays on again. You will also see a “CHECK TPMS SYSTEM” message on the multi-information display (see page 529).

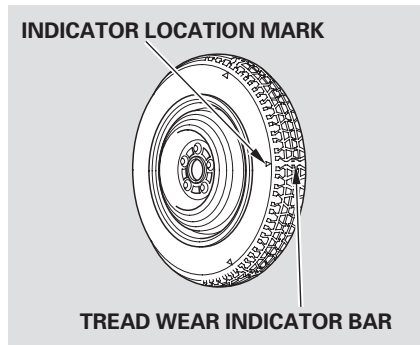

Replace the tire when you can see the tread wear indicator bars. The replacement should be the same size and design tire, mounted on the same wheel. The spare tire is not designed to be mounted on a regular wheel, and the spare wheel is not designed for mounting a regular tire.

If you have a flat tire while driving, stop in a safe place to change it. Drive slowly along the shoulder until you get to an exit or an area that is far away from the traffic lanes.

⚠ WARNING

The vehicle can easily roll off the jack, seriously injuring anyone underneath.

Follow the directions for changing a tire exactly, and never get under the vehicle when it is supported only by the jack.

1. Park the vehicle on firm, level, and non-slippery ground. Put the transmission in Park. Apply the parking brake.
2. Turn on the hazard warning lights, and turn the ignition switch to the LOCK (0) position. Have all passengers get out of the vehicle while you change the tire.

Models equipped with the keyless access system have an engine start/stop button instead of an ignition switch. VEHICLE OFF (LOCK) Mode is the equivalent of LOCK (0). See page 180 for ignition switch and power mode comparison.

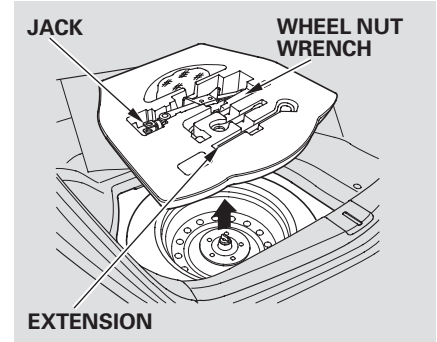

3. Open the trunk. Raise the trunk floor by lifting up on the back edge.
4. Take the tool case out of the spare tire.
5. Unscrew the wing bolt and take the spare tire out of its well.

CONTINUED

Changing a Flat Tire

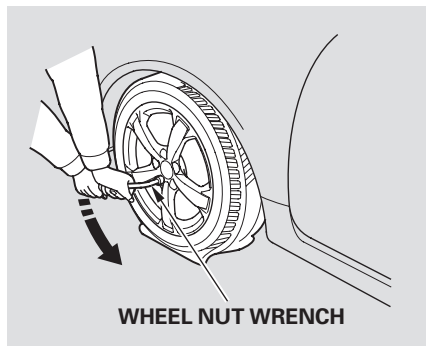

6. Loosen each wheel nut 1/2 turn with the wheel nut wrench.

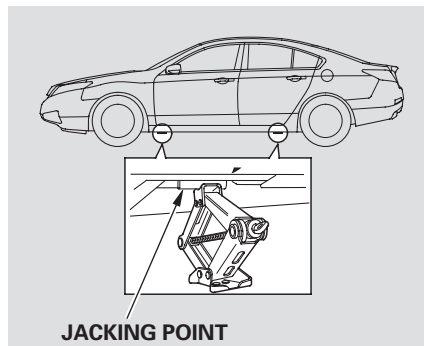

7. Locate the jacking point nearest the tire you need to change. It is pointed to by an arrow molded into the underside of the body. Place the jack under the jacking point. Turn the end bracket clockwise until the top of the jack contacts the jacking point. Make sure the jacking point tab is resting in the jack notch.

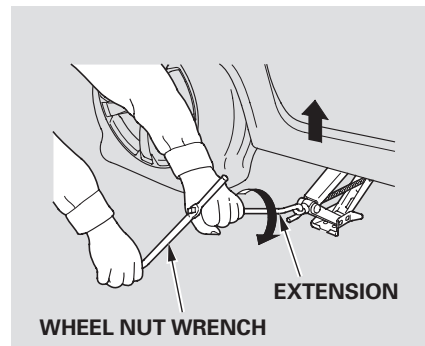

8. Use the extension and the wheel nut wrench as shown to raise the vehicle until the flat tire is off the ground.

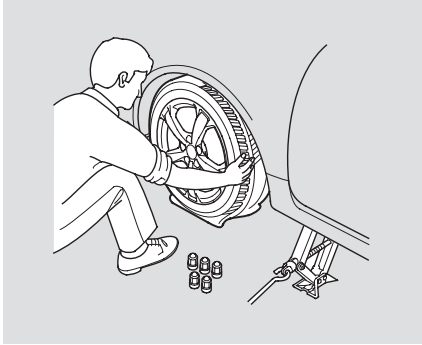

9. Remove the wheel nuts, then remove the flat tire. Handle the wheel nuts carefully; they may be hot from driving. Place the flat tire on the ground with the outside surface facing up.

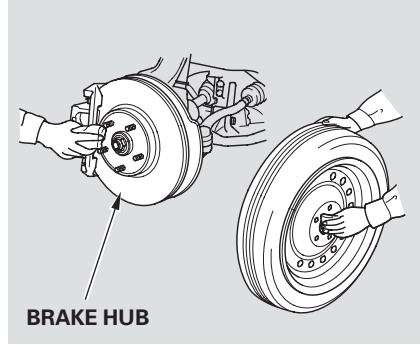

10. Before mounting the spare tire, wipe any dirt off the mounting surface of the wheel and hub with a clean cloth. Wipe the hub carefully; it may be hot from driving.

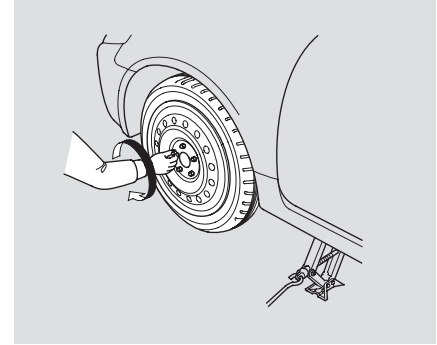

11. Put on the spare tire. Put the wheel nuts back on finger-tight, then tighten them in a crisscross pattern with the wheel nut wrench until the wheel is firmly against the hub. Do not try to tighten the wheel nuts fully.

CONTINUED

Changing a Flat Tire

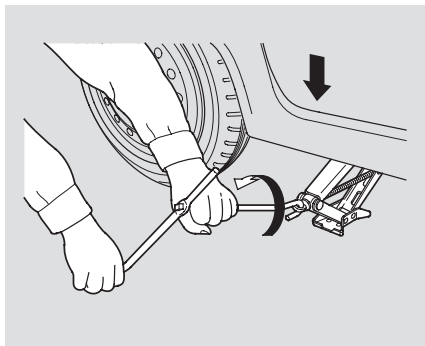

12. Lower the vehicle to the ground, and remove the jack.

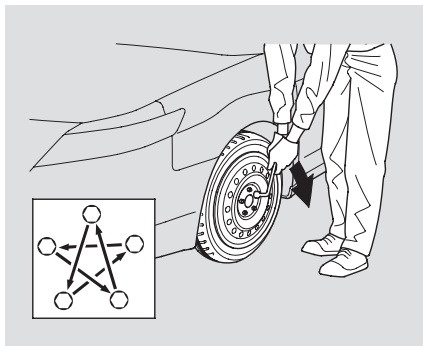

13. Tighten the wheel nuts securely in the same crisscross pattern. Have the wheel nut torque checked at the nearest automotive service facility.

Tighten the wheel nuts to:
94 lbf-ft (127 N·m , 13 kgf·m)

14. Remove the center cap before storing the flat tire in the trunk well.

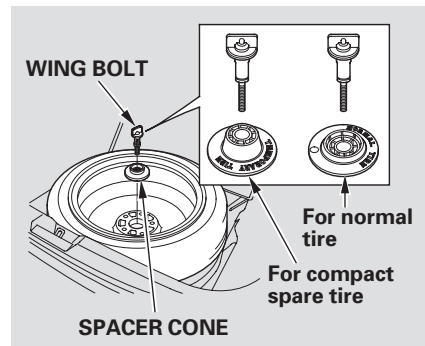

15. Place the flat tire face down in the spare tire well.

16. Remove the spacer cone from the wing bolt, turn it over, and put it back on the bolt.

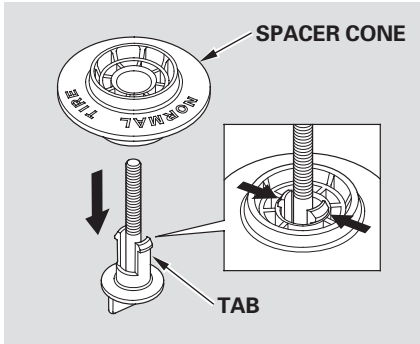

To remove the spacer cone, squeeze the tabs on the wing bolt to disengage it from the center of the spacer cone, then pull the bolt downward.

To install the wing bolt to the spacer cone, reverse this procedure.

17. Secure the flat tire by screwing the wing bolt back into its hole.

18. Store the jack and tools in the tool kit case. Place the tool kit case in the flat tire.

WARNING

Loose items can fly around the interior in a crash and could seriously injure the occupants.

Store the wheel, jack, and tools securely before driving.

19. Store the center cap in the trunk. Make sure it does not get scratched or damaged. Unhook the handle from the trunk opening and lower the trunk floor lid, then close the trunk lid.

20. Your vehicle's original tire has a tire pressure monitoring system sensor. To replace a tire, refer to **Changing a Tire with TPMS** (see page 530).

If the Engine Won't Start

Diagnosing why the engine won't start falls into two areas, depending on what you hear when you turn the ignition switch to the START (III) position or on models with keyless access system, press the engine start/stop button to set START Mode (see page 180):

- You hear nothing, or almost nothing. The engine's starter motor does not operate at all, or operates very slowly.
- You can hear the starter motor operating normally, or the starter motor sounds like it is spinning faster than normal, but the engine does not start up and run.

Nothing Happens or the Starter Motor Operates Very Slowly

When you turn the ignition switch to the START (III) position or on models with keyless access system, press the engine start/stop button to set START Mode (see page 180), you do not hear the normal noise of the engine trying to start. You may hear a clicking sound, a series of clicks, or nothing at all.

Check these things:

- Check the transmission interlock. The shift lever must be in Park or neutral.
- Turn the ignition switch to the ON (II) position or on models with keyless access system, press the engine start/stop button to set ON Mode (see page 180). Turn on the headlights, and check their brightness. If the headlights are very dim or do not come on at all, the battery is discharged. See **Jump Starting** on page 591.

- Turn the ignition switch to the START (III) position or on models with keyless access system, press the engine start/stop button to set START Mode (see page 180). If the headlights do not dim, check the condition of the fuses. If the fuses are OK, there is probably something wrong with the electrical circuit for the ignition switch or starter motor. You will need a qualified technician to determine the problem. See **Emergency Towing** on page 606 .

- If the headlights dim noticeably or go out when you try to start the engine, either the battery is discharged or the connections are corroded. Check the condition of the battery and terminal connections (see page 577). You can then try jump starting the vehicle from a booster battery (see page 591).

The Starter Operates Normally

In this case, the starter motor's speed sounds normal, or even faster than normal, when you turn the ignition switch to the START (III) position or on models with keyless access system, press the engine start/stop button to set START Mode (see page 180), but the engine does not run.

- Are you using a properly coded key? An improperly coded key will cause the immobilizer system indicator in the instrument panel to blink rapidly (see page 65).

CONTINUED

If the Engine Won't Start

On models with keyless access system

- Do you have your keyless access system remote with you? The vehicle will not start without the remote within operating range. The vehicle will not start without the remote within operating range and with the keyless access main switch in the glove box turned on.
- Are you using the proper starting procedure? Refer to **Starting the Engine** on pages 503 and 505 .
- Do you have fuel? Check the fuel gauge; the warning indicator may not be working.
- There may be an electrical problem, such as no power to the fuel pump. Check all the fuses (see page 600).

If you find nothing wrong, you will need a qualified technician to find the problem. See **Emergency Towing** on page 600 .

NOTE: If you are unable to stop the engine normally while in the Park position, see **Emergency Engine Stop** on page 184 .

Although this seems like a simple procedure, you should take several precautions.

⚠ WARNING

A battery can explode if you do not follow the correct procedure, seriously injuring anyone nearby.

Keep all sparks, open flames, and smoking materials away from the battery.

You cannot start a vehicle with an automatic transmission by pushing or pulling it.

To Jump Start Your Vehicle:

1. Open the hood, and check the physical condition of the battery. In very cold weather, check the condition of the electrolyte. If it seems slushy or like ice, do not try jump starting until it thaws.

NOTICE

If a battery sits in extreme cold, the electrolyte inside can freeze. Attempting to jump start with a frozen battery can cause it to rupture.

2. Turn off all the electrical accessories: climate control, audio system, lights, etc. Put the transmission in Park, and set the parking brake.

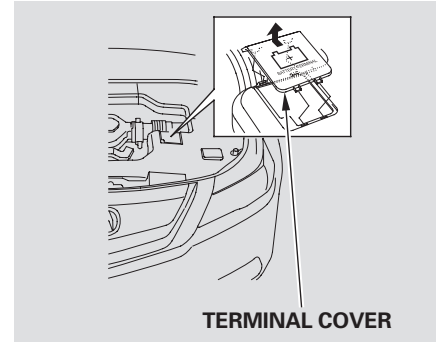

3. Pull up the battery terminal cover to remove. The battery terminal cover can be removed without removing front bulkhead cover.

CONTINUED

Jump Starting

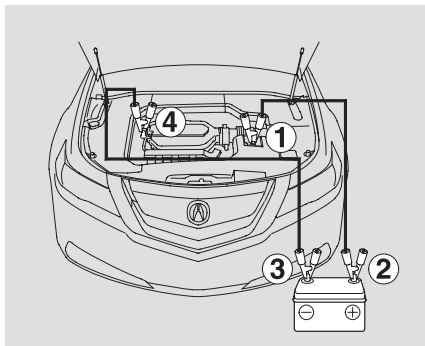

The numbers in the illustration show you the order to connect the jumper cables.

4. Connect one jumper cable to the positive (+) terminal on your battery. Connect the other end to the positive (+) terminal on the booster battery.

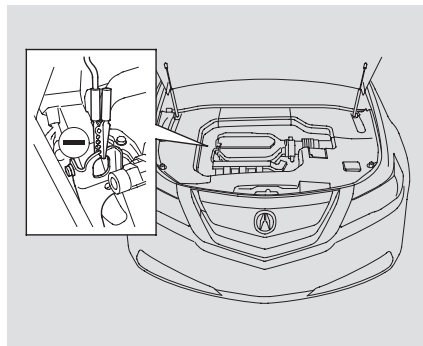

5. Connect the second jumper cable to the negative (-) terminal on the booster battery. Connect the other end to the grounding point as shown. Do not connect this jumper cable to any other part of the engine.
6. If the booster battery is in another vehicle, have an assistant start that vehicle and run it at a fast idle.

7. Start the vehicle. If the starter motor still operates slowly, check that the jumper cables have good metal-to-metal contact.
8. Once the vehicle is running, disconnect the negative cable from your vehicle, then from the booster battery. Disconnect the positive cable from your vehicle, and then from the booster battery.
9. Install the battery terminal cover.

Keep the ends of the jumper cables away from each other and any metal on the vehicle until everything is disconnected. Otherwise, you may cause an electrical short.

The pointer of the vehicle's temperature gauge should stay in the midrange. If it climbs to the red mark, you should determine the reason (hot day, driving up a steep hill, etc.).

If the vehicle overheats, you should take immediate action. The only indication may be the temperature gauge climbing to or above the red mark. Or you may see steam or spray coming from under the hood.

NOTICE

Driving with the temperature gauge pointer at the red mark can cause serious damage to the engine.

WARNING

Steam and spray from an overheated engine can seriously scald you.

Do not open the hood if steam is coming out.

1. Safely pull to the side of the road. Put the transmission in Park, and set the parking brake. Turn off all accessories, and turn on the hazard warning lights.
2. If you see steam and/or spray coming from under the hood, turn off the engine. Wait until you see no more signs of steam or spray, then open the hood.
3. If you do not see steam or spray, leave the engine running and watch the temperature gauge. If the high heat is due to overloading, the engine should start to cool down almost immediately. If it does, wait until the temperature gauge comes down to the midpoint, then continue driving.
4. If the temperature gauge stays at the red mark, turn off the engine.
5. Look for any obvious coolant leaks, such as a split radiator hose. Everything is still extremely hot, so use caution. If you find a leak, it must be repaired before you continue driving (see **Emergency Towing** on page 606).

CONTINUED

If the Engine Overheats

6. If you don't find an obvious leak, check the coolant level in the radiator reserve tank. Add coolant if the level is below the MIN mark (see **Adding Engine Coolant** on page 550).
 7. If there was no coolant in the reserve tank, you may need to add coolant to the radiator. Let the engine cool down until the pointer reaches the middle of the temperature gauge, or lower, before checking the radiator.
- ⚠ WARNING**

Removing the radiator cap while the engine is hot can cause the coolant to spray out, seriously scalding you.

Always let the engine and radiator cool down before removing the radiator cap.
8. Using gloves or a large heavy cloth, turn the radiator cap counterclockwise, without pushing down, to the first stop. After the pressure releases, push down on the cap, and turn it until it comes off.
 9. Start the engine, and set the temperature to maximum heat (climate control to AUTO at “H, ”). Add coolant to the radiator up to the base of the filler neck. If you do not have the proper coolant mixture available, you can add plain water. Remember to have the cooling system drained and refilled with the proper mixture as soon as you can.
 10. Put the radiator cap back on tightly. Run the engine, and check the temperature gauge. If it goes back to the red mark, the engine needs repair (see **Emergency Towing** on page 606).
 11. If the temperature stays normal, check the coolant level in the radiator reserve tank. If it has gone down, add coolant to the MAX mark. Put the cap back on tightly.

Low Oil Pressure Indicator, Charging System Indicator



Low Oil Pressure Indicator

This indicator should never come on when the engine is running. If it starts flashing or stays on, the oil pressure has dropped very low or lost pressure. Serious engine damage is possible, and you should take immediate action.

You will also see a “CHECK ENGINE OIL LEVEL” message on the multi-information display when this indicator comes on.

NOTICE

Running the engine with low oil pressure can cause serious mechanical damage almost immediately. Turn off the engine as soon as you can safely get the vehicle stopped.

1. Safely pull off the road, and shut off the engine. Turn on the hazard warning indicators.
2. Let the vehicle sit for a minute. Open the hood, and check the oil level (see page 490). An engine very low on oil can lose pressure during cornering and other driving maneuvers.
3. If necessary, add oil to bring the level back to the full mark on the dipstick (see page 547).
4. Start the engine, and watch the oil pressure indicator. If it does not go out within 10 seconds, turn off the engine. There is a mechanical problem that needs to be repaired before you can continue driving (see **Emergency Towing** on page 606).



Charging System Indicator

If the charging system indicator comes on brightly when the engine is running, the battery is not being charged.

You will also see a “CHECK CHARGING SYSTEM” message on the multi-information display (see page 88).

Immediately turn off all electrical accessories. Try not to use other electrically operated controls such as the power windows. Keep the engine running; starting the engine will discharge the battery rapidly. Go to a service station or garage where you can get technical assistance.

Malfunction Indicator Lamp



If this indicator comes on while driving, it means one of the engine's emissions control systems may have a problem. Even though you may feel no difference in your vehicle's performance, it can reduce your fuel economy and cause increased emissions. Continued operation may cause serious damage.

If you have recently refueled your vehicle, the indicator coming on could be due to a loose or missing fuel fill cap. You will also see a "TIGHTEN FUEL CAP" message on the multi-information display. Tighten the cap until it clicks at least once (see page 488). Tightening the cap will not turn the indicator off immediately; it can take several days of normal driving.

If the indicator comes on repeatedly, even though it may go off as you continue driving, have the vehicle checked by your dealer as soon as possible.

NOTICE

If you keep driving with the malfunction indicator lamp on, you can damage your vehicle's emissions controls and engine. Those repairs may not be covered by your vehicle's warranties.

If your vehicle has an automatic transmission, the malfunction indicator lamp may also come on with the "D" indicator.

You will also see a "CHECK EMISSION SYSTEM" message on the multi-information display (see page 88).

Readiness Code

Your vehicle has certain "readiness codes" that are part of the on-board diagnostics for the emissions systems. In some states, part of the emissions testing is to make sure these codes are set. If they are not set, the test cannot be completed.

If the battery in your vehicle has been disconnected or gone dead, these codes may be erased. It takes several days of driving under various conditions to set the codes again.

Malfunction Indicator Lamp, Brake System Indicator

To check if they are set, turn the ignition switch to the ON (II) position (set ON mode on models with keyless access system), without starting the engine. The malfunction indicator lamp will come on for 20 seconds. If it then goes off, the readiness codes are set. If it blinks five times, the readiness codes are not set. If possible, do not take your vehicle for an emissions test until the readiness codes are set. Refer to **Emissions Testing** for more information (see page 626).

U.S.



Canada



Brake System Indicator

The brake system indicator normally comes on when you turn the ignition switch* to the ON (II) position, and as a reminder to check the parking brake. It will stay on if you do not fully release the parking brake.

* : Models equipped with the keyless access system have an engine start/stop button instead of an ignition switch. ON Mode is the equivalent of ON (II). For more information, see pages 178 and 180.

If the brake system indicator comes on while driving, the brake fluid level is probably low. Press lightly on the brake pedal to see if it feels normal. If it does, check the brake fluid level the next time you stop at a service station (see page 555).

You will also see a “LOW BRAKE FLUID” message on the multi-information display.

If the fluid level is low, take your vehicle to a dealer, and have the brake system inspected for leaks or worn brake pads.

However, if the brake pedal does not feel normal, you should take immediate action. A problem in one part of the system’s dual circuit design will still give you braking at two wheels. You will feel the brake pedal go down much farther before the vehicle begins to slow down, and you will have to press harder on the pedal.

You will also see a “CHECK BRAKE SYSTEM” message on the multi-information display when this indicator comes on.

CONTINUED

Brake System Indicator, Opening the Fuel Fill Door Manually

Slow down by shifting to a lower gear, and pull to the side of the road when it is safe. Because of the long distance needed to stop, it is hazardous to drive the vehicle. You should have it towed and repaired by your dealer as soon as possible (see **Emergency Towing** on page 606).

If you must drive the vehicle a short distance in this condition, drive slowly and carefully.

If the ABS indicator and the VSA system indicator come on with the brake system indicator, have your vehicle inspected by your dealer immediately.

Opening the Fuel Fill Door Manually

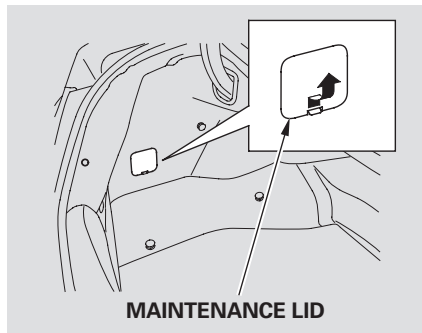

If the fuel fill door release button does not work, use the release lever inside the left maintenance lid in the trunk.

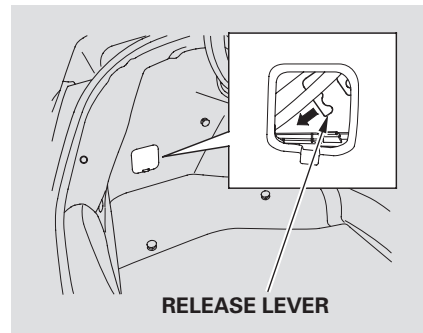

To open the fuel fill door, pull the release lever rearward.

DRIVER'S SIDE

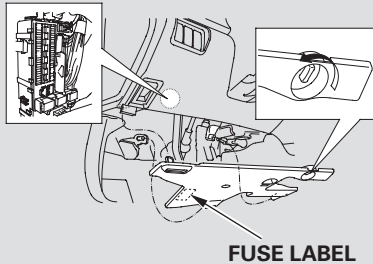

The vehicle's fuses are contained in three fuse boxes.

The interior fuse box is located under the dashboard on the driver's side. The fuse label is attached under the steering column.

PASSENGER'S SIDE

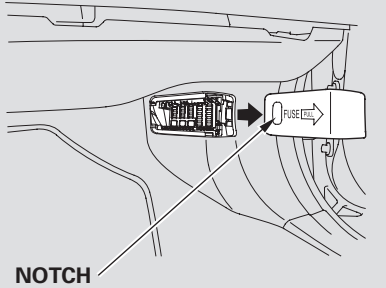

The passenger's side interior fuse box is on the lower passenger's side panel. To remove the fuse box lid, put your finger in the notch on the lid, and pull it upward slightly, then pull it toward you and take it out of its hinges.

UNDER-HOOD

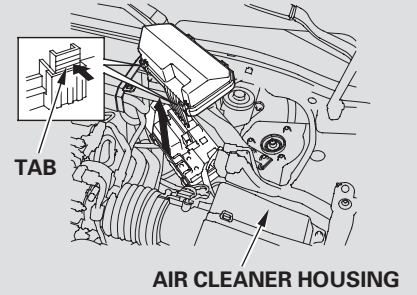

The under-hood fuse box is on the driver's side next to the air cleaner housing.

To access the under-hood fuse box, remove the left-side engine compartment cover (see page 546).

Fuses

Checking and Replacing Fuses

If something electrical in your vehicle stops working, the first thing you should check for is a blown fuse. Determine from the chart on pages [603](#) , [604](#) and [605](#) , or the diagram on the fuse box lid or the fuse label, which fuse or fuses control that component. Check those fuses first, but check all the fuses before deciding that a blown fuse is not the cause. Replace any blown fuses and check if the device works.

1. Turn the ignition switch to the LOCK (0) position. Make sure the headlights and all other accessories are off. Models equipped with the keyless access system have an engine start/stop button instead of an ignition switch. VEHICLE OFF (LOCK) Mode is the equivalent of LOCK (0). See page [180](#) for ignition switch and power mode comparison.

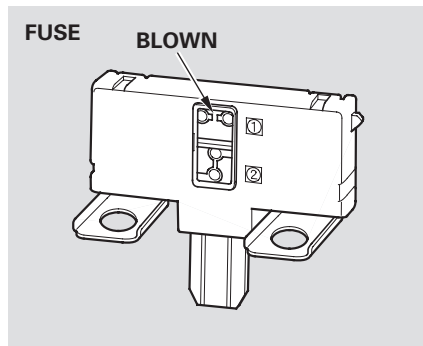

2. Remove the cover from the fuse box.
3. Check each of the large fuses in the under-hood fuse box by looking at the wire inside. Removing these fuses requires a Phillips-head screwdriver.

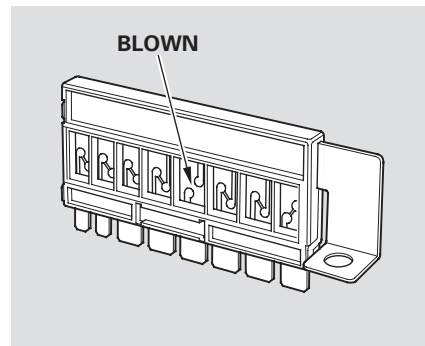

Also check the combined fuse box in the under-hood fuse box.

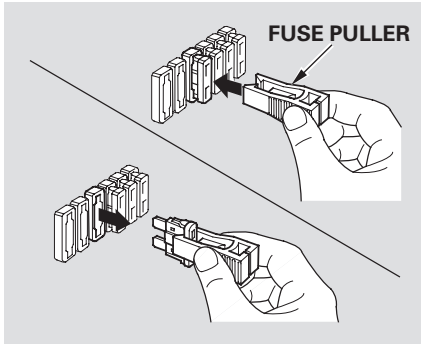

4. Check the smaller fuses in the under-hood fuse box and all the fuses in the interior fuse boxes by pulling out each one with the fuse puller provided on the back of the under-hood fuse box cover.

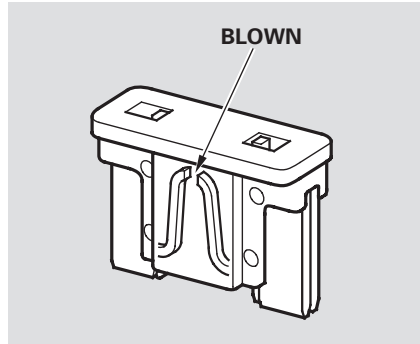

5. Look for a blown wire inside the fuse. If it is blown, replace it with one of the spare fuses of the same rating or lower.

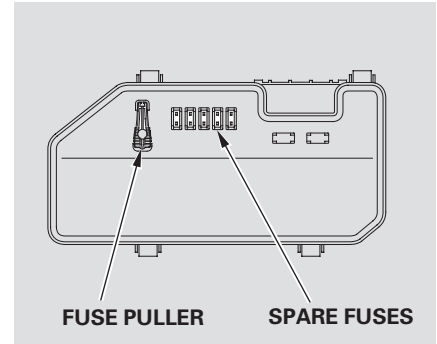

Your vehicle has spare fuses on the back of the under-hood fuse box cover.

CONTINUED

Fuses

If you cannot drive the vehicle without fixing the problem, and you do not have a spare fuse, take a fuse of the same rating or a lower rating from one of the other circuits. Make sure you can do without that circuit temporarily (such as the accessory power socket).

If you replace the blown fuse with a spare fuse that has a lower rating, it might blow out again. This does not indicate anything wrong. Replace the fuse with one of the correct rating as soon as you can.

NOTICE

Replacing a fuse with one that has a higher rating greatly increases the chances of damaging the electrical system. If you do not have a replacement fuse with the proper rating for the circuit, install one with a lower rating.

6. If the replacement fuse of the same rating blows in a short time, there is probably a serious electrical problem with your vehicle. Leave the blown fuse in that circuit, and have your vehicle checked by a qualified technician.

UNDER-HOOD FUSE BOX

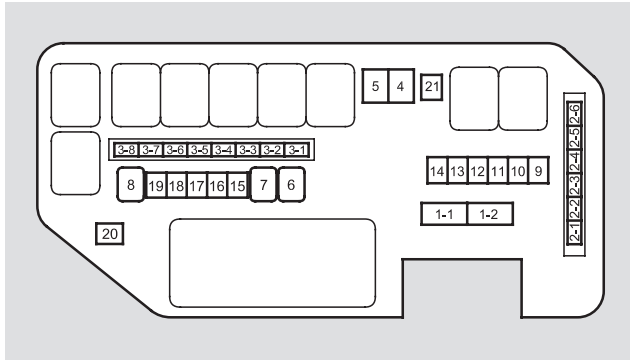

No.	Amps.	Circuits Protected
1-1	120 A	Battery
1-2	40 A	Passenger's Side Fuse Box
2-1	70 A	EPS
2-2	40 A	ABS/VSA MTR
2-3	30 A	ABS/VSA
2-4	40 A	Passenger's Side Fuse Box Option
2-5	30 A	Headlight Washer
2-6	30 A	SH-AWD

No.	Amps.	Circuits Protected
3-1	50 A	IG Main
3-2	40 A	Sub Fan Motor* ¹
3-3	30 A	Sub Fan Motor* ²
3-4	60 A	Driver's Side Fuse Box
3-5	40 A* ¹ 30 A* ²	Main Fan Motor
3-6	30 A	Driver's Side Light Main
3-7	30 A	Wiper Motor
3-8	30 A	Passenger's Side Light Main

No.	Amps.	Circuits Protected
4	40 A	Rear Defroster
5	—	Not Used
6	—	Not Used
7	—	Not Used
8	40 A	Heater Motor
9	15 A	Hazard
10	20 A	Horn and Stop
11	7.5 A	Keyless Access System
12	—	Not Used
13	15 A	IG Coil
14	15 A	FI Sub
15	10 A	Back Up
16	7.5 A	Interior Lights
17	15 A	FI Main
18	15 A	DBW
19	7.5 A	Back Up FI ECU
20	7.5 A	MG, Clutch
21	7.5 A	Radiator Fan Timer

* 1 : On SH-AWD models only

* 2 : On 2WD models only

CONTINUED

Fuse Locations

INTERIOR FUSE BOX

Driver's side

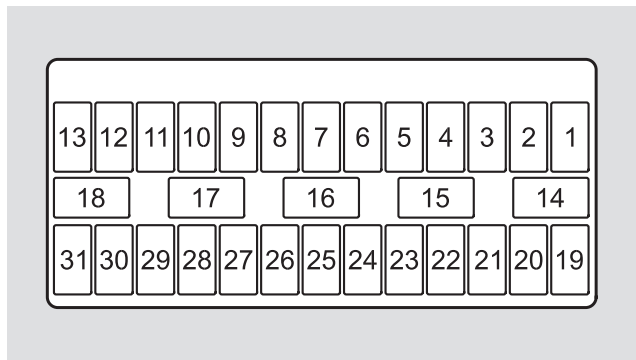

No.	Amps.	Circuits Protected
1	—	Not Used
2	7.5 A	SH-AWD
3	20 A	Washer
4	7.5 A	Wiper
5	7.5 A	ODS
6	7.5 A	ABS/VSA
7	—	Not Used
8	7.5 A	Starter Relay

No.	Amps.	Circuits Protected
9	20 A	Fuel Pump
10	10 A	VB SOL
11	10 A	SRS
12	7.5 A	Meter
13	15 A	ACG
14	—	Not Used
15	7.5 A	Daytime Running Light
16	7.5 A	A/C
17	7.5 A	Accessory, Key, Lock*
18	7.5 A	Accessory
19	20 A	Driver's Power Seat Sliding
20	20 A	Moonroof
21	20 A	Driver's Power Seat Reclining
22	20 A	Rear Left Power Window
23	15 A	Front ACC Socket
24	20 A	Driver's Power Window
25	15 A	Driver's Side Door Lock
26	10 A	Front Left Fog Light
27	10 A	Left Side Small Lights (Exterior)
28	10 A	Left Headlight High Beam
29	7.5 A	TPMS
30	15 A	Left Headlight Low Beam
31	—	Not Used

* : If equipped

INTERIOR FUSE BOX

Passenger's side

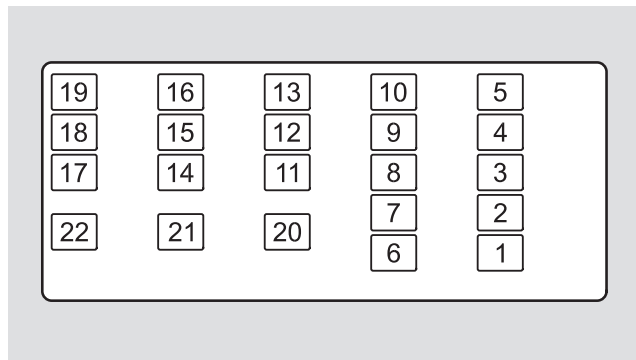

No.	Amps.	Circuits Protected
1	10 A	Right Headlight High Beam
2	10 A	Right Side Small Lights (Exterior)
3	10 A	Right Front Fog Light
4	15 A	Right Headlight Low Beam
5	—	Not Used
6	7.5 A	Interior Lights

No.	Amps.	Circuits Protected
7	—	Not Used
8	20 A	Passenger's Power Seat Reclining
9	20 A	Passenger's Power Seat Sliding
10	10 A	Right Side Door Lock
11	20 A	Rear Passenger's Side Power Window
12	10 A	Keyless Access System
13	20 A	Front Passenger's Power Window
14	—	Not Used
15	20 A	Premium amplifier*
16	15 A	Console ACC Socket
17	—	Not Used
18	7.5 A	Lumbar Support
19	20 A	Seat Heater
20	—	Not Used
21	—	Not Used
22	—	Not Used

* : If equipped

Emergency Towing

If your vehicle needs to be towed, call a professional towing service or organization. Never tow your vehicle with just a rope or chain. It is very dangerous.

(On SH-AWD models)

The only way you can safely tow your vehicle is with flat-bed equipment. The operator will load your vehicle on the back of a truck. Any other method of towing will damage the drive system. When you contact the towing agency, inform them a flat-bed is required.

NOTICE

Towing with only two tires on the ground will damage parts of the all-wheel-drive system. Your vehicle should be transported on a flat-bed truck or trailer.

(Except SH-AWD models)

There are two ways to tow your vehicle:

Flat-bed Equipment – The operator loads your vehicle on the back of a truck. **This is the best way to transport your vehicle.**

Wheel-lift Equipment – The tow truck uses two pivoting arms that go under the front tires and lift them off the ground. The rear tires remain on the ground. **This is an acceptable way to tow your vehicle.**

If, due to damage, your vehicle must be towed with the front wheels on the ground, do this:

- Release the parking brake.
- Start the engine.
- Shift to D position for 5 seconds, then to N.
- Turn off the engine.
Leave the ignition switch in the ACCESSORY (I) position so the steering wheel does not lock.

Models equipped with the keyless access system have an engine start/stop button instead of an ignition switch. ACCESSORY Mode is the equivalent of ACCESSORY (I). See page 180 for ignition switch and power mode comparison.

NOTICE

Improper towing preparation will damage the transmission. Follow the above procedure exactly. If you cannot shift the transmission or start the engine, your vehicle must be transported with the front wheels off the ground.

With the front wheels on the ground, it is best to tow the vehicle no farther than 50 miles (80 km), and keep the speed below 35 mph (55 km/h).

If your vehicle is equipped with a front spoiler, remove it before towing so it is not damaged.

NOTICE

Trying to lift or tow your vehicle by the bumpers will cause serious damage. The bumpers are not designed to support the vehicle's weight.

If you decide to tow your vehicle with all four wheels on the ground, make sure you use a properly-designed and attached tow bar. Prepare the vehicle for towing as described above, and leave the ignition switched* in the ACCESSORY (I) position so the steering wheel does not lock. Make sure the radio and any items plugged into the accessory power socket are turned off so they do not run down the battery.

NOTICE

The steering system can be damaged if the steering wheel is locked. Leave the ignition switch in the ACCESSORY (I) position, and make sure the steering wheel turns freely before you begin towing.*

* Models equipped with the keyless access system have an engine start/stop button instead of an ignition switch. ACCESSORY Mode is the equivalent of ACCESSORY (I). See page 178 for ignition switch and power mode comparison.

NOTICE

On models with the Keyless Access system, the ENGINE START/STOP BUTTON indicator will confirm that the power mode is in the ACCESSORY mode and that the steering lock is released. If the steering wheel does not turn freely, rotate the wheel right and left while pressing the ENGINE START/STOP BUTTON. This information also appears on the multi-information display (see page 182).

CONTINUED

Emergency Towing, If Your Vehicle Gets Stuck

On models with keyless access system

When you need to release the steering lock while your vehicle's battery is dead, do this:

1. Follow the proper jump starting procedures, Step 1 through Step 5, to apply the power to your vehicle (see pages [591](#) and [592](#)).
2. Press the ENGINE START/STOP button to set the power mode to ACCESSORY (see page [179](#)) and verify the steering lock is released.
3. Follow the jump starting procedures, Step 8 and Step 9, and the instructions to disconnect the jumper cable (see page [592](#)). The steering will remain unlocked even if the battery is dead.

Failure to comply means the steering lock may be damaged.

If Your Vehicle Gets Stuck

If your vehicle gets stuck in sand, mud, or snow, call a towing service to pull it out (see page [606](#)).

For very short distances, such as freeing the vehicle, you can use the detachable towing hook that mounts on the anchor in the front bumper.

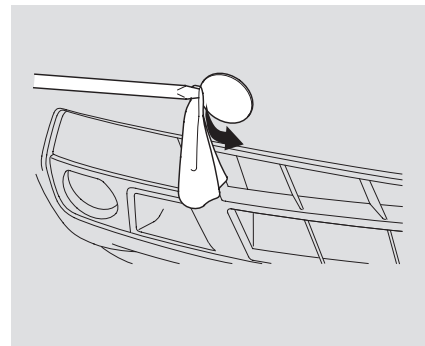

To use the towing hook:

1. Remove the cover from the front bumper using your fingers, or pry it off using a cloth and a flat-tipped screwdriver.
2. Remove the towing hook and wheel nut wrench from the tool case in the spare tire (see page [583](#)).

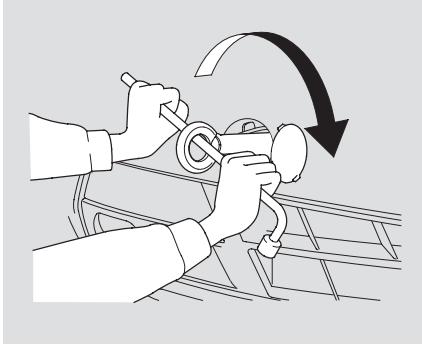

3. Screw the towing hook into the hole, and tighten it with the wheel nut wrench.

NOTICE

To avoid damage to your vehicle, use the towing hook for straight, flat ground towing only. Do not tow at an angle. The tow hook should not be used to tow the vehicle onto a flat bed. Do not use it as a tie down.

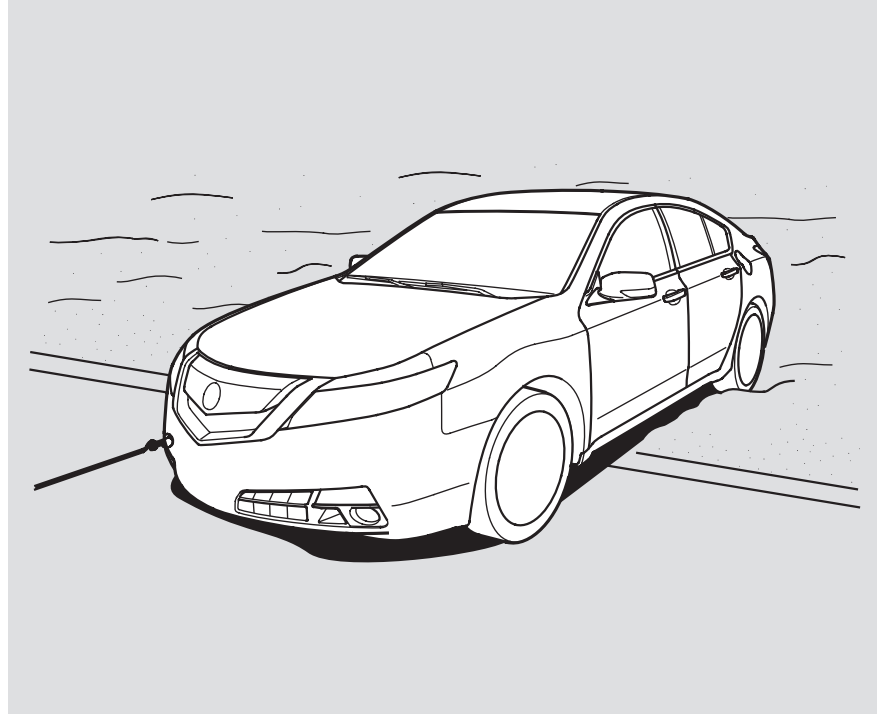

The diagrams in this section give you the dimensions and capacities of your vehicle and the locations of the identification numbers. It also includes information you should know about your vehicle's tires and emissions control systems.

Identification Numbers	612
Specifications	614
DOT Tire Quality Grading (U.S. Vehicles)	617
Tire Labeling	619
Tire Pressure Monitoring System (TPMS) — Required Federal Explanation.....	621
Emissions Controls.....	623
Three Way Catalytic Converter...	625
Emissions Testing	626

Identification Numbers

Your vehicle has several identifying numbers located in various places.

The vehicle identification number (VIN) is the 17-digit number your dealer uses to register your vehicle for warranty purposes. It is also necessary for licensing and insuring your vehicle. The easiest place to find the VIN is on a plate fastened to the top of the dashboard. You can see it by looking through the windshield on the driver's side. It is also on the certification label attached to the driver's doorjamb, and is stamped on the engine compartment bulkhead. The VIN is also provided in bar code on the certification label.

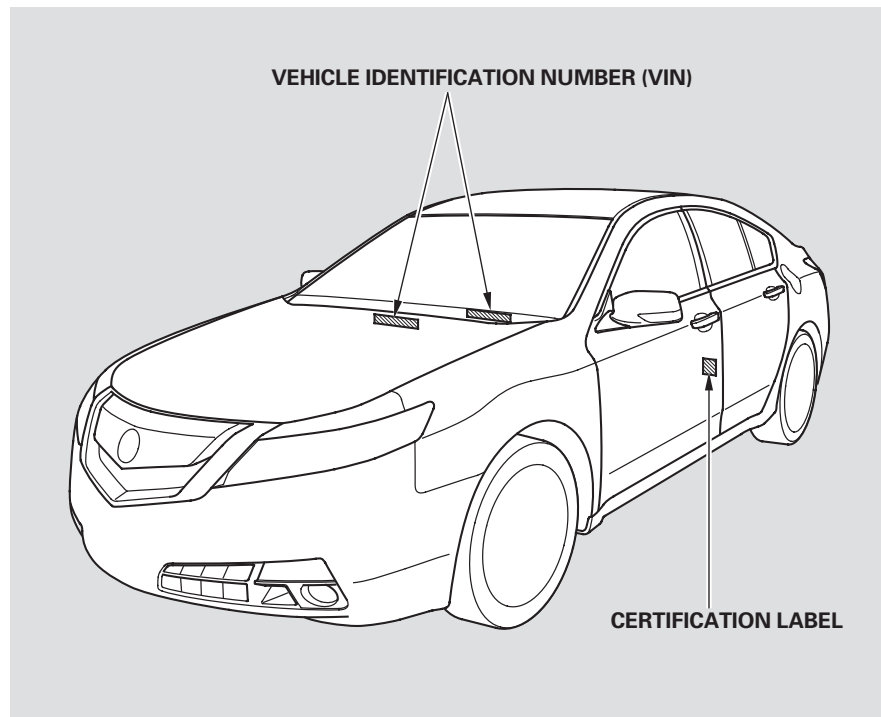

The engine number is stamped into the engine block.

The transmission number is on a label on top of the transmission.

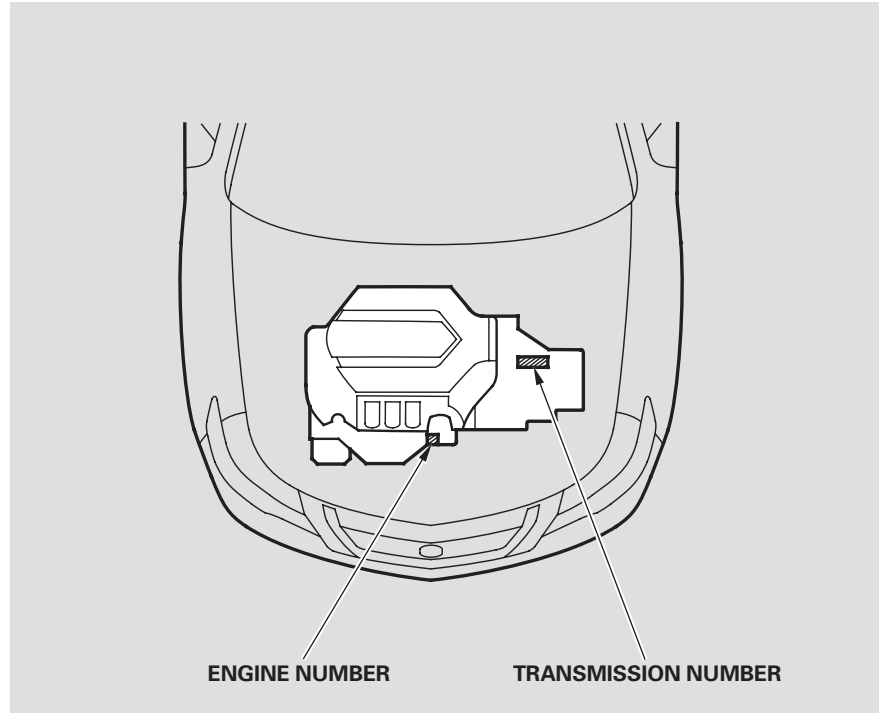

Specifications

Dimensions

Length		195.5 in (4,966 mm)
Width		74.0 in (1,880 mm)
Height		57.2 in (1,452 mm)
Wheelbase		109.3 in (2,775 mm)
Track	Front	63.2 in (1,605.5 mm)
	Rear	63.8 in (1,620 mm)

Weights

Gross vehicle weight rating	See the certification label attached to the driver's doorjamb.
-----------------------------	--

Seating Capacities

Total	5
Front	2
Rear	3

Air Conditioning

Refrigerant type	HFC-134a (R-134a)
Charge quantity	17.6 – 19.4 oz (500 – 550 g)
Lubricant type	ND-OIL8

Capacities

Fuel tank		Approx. 18.5 US gal (70 ℓ)
Engine coolant	Change* ¹	1.66 US gal (6.3 ℓ)
	Total	2.19 US gal (8.3 ℓ)
Engine oil	Change* ²	
	Including filter	4.5 US qt (4.3 ℓ)
	Without filter	4.2 US qt (4.0 ℓ)
Total	5.3 US qt (5.0 ℓ)	
Automatic transmission fluid	Change	
	2WD	3.5 US qt (3.3 ℓ)
	SH-AWD	3.0 US qt (2.8 ℓ)
Total		
	2WD	7.9 US qt (7.5 ℓ)
	SH-AWD	8.1 US qt (7.7 ℓ)
Rear differential fluid (SH-AWD)	Change	2.67 US qt (2.53 ℓ)
	Total	2.93 US qt (2.77 ℓ)
Transfer assembly fluid (SH-AWD)	Change	0.45 US qt (0.43 ℓ)
	Total	0.48 US qt (0.45 ℓ)
Windshield washer reservoir	U.S. Vehicle	2.6 US qt (2.5 ℓ)
	Canada Vehicle	6.1 US qt (5.8 ℓ)

* 1 : Including the coolant in the reserve tank and that remaining in the engine

Reserve tank capacity: 0.182 US gal (0.69 ℓ)

* 2 : Excluding the oil remaining in the engine

Lights

Headlight (Low beam*)	12 V – 35 W (D2S)
Headlight (High beam/DRL)	12 V – 60 W (HB3)
Front turn signal/parking lights	12 V – 24/2.2 CP (Amber)
Front side marker lights	12 V – 3 CP
Front fog lights	12 V – 55 W (H11)
Rear turn signal lights	12 V – 21 W (Amber)
Back-up lights	12 V – 16 W
Rear side marker lights	12 V – 3 CP
License plate light	12 V – 3 CP
Trunk light	12 V – 5 W
Door courtesy lights	12 V – 3.4 W
Vanity mirror lights	12 V – 1.1 W

* : On vehicles with high voltage discharge type low beam headlights, replacement of a bulb should be performed by your dealer.

Battery

Capacity	12 V – 60 AH/5 HR
	12 V – 72 AH/20 HR

Fuses

Interior	See pages 604 and 605 or the fuse label attached to the inside of the fuse box door on each side of the dashboard.
Under-hood	See page 603 or the fuse box cover.

Engine (2WD)

Type	Water cooled 4-stroke SOHC VTEC 6-cylinder (V6), gasoline engine
Bore x Stroke	3.50 x 3.66 in (89.0 x 93.0 mm)
Displacement	211.7 cu-in (3,471 cm ³)
Compression ratio	11.2 : 1
Spark plugs	NGK: ILZKR7B11 DENSO: SXU22HCR11

Engine (SH-AWD)

Type	Water cooled 4-stroke SOHC IN/EX VTEC 6-cylinder (V6), gasoline engine
Bore x Stroke	3.54 x 3.78 in (90.0 x 96.0 mm)
Displacement	223.5 cu-in (3,664 cm ³)
Compression ratio	11.2 : 1
Spark plugs	NGK: ILZKR7B-11S DENSO: SXU22HCR11S

Alignment

Toe-in	Front	0.00 in (0.0 mm)
	Rear	0.08 in (2.0 mm)
Camber	Front	–0.5°
	Rear	–1°
Caster	Front	3.8°

CONTINUED

Specifications

Tires

Size	Front/Rear	P245/50R17 98V *1, *2 P245/45R18 96V *3, *4 245/40ZR19 94Y *5, *6
	Spare	T135/80D17 103M
Pressure	Front	32 psi (220 kPa , 2.2 kgf/cm ²) *1, *2, *3, *4 37 psi (255 kPa , 2.55 kgf/cm ²) *5, *6
	Rear	32 psi (220 kPa , 2.2 kgf/cm ²) *5, *6
	Spare	60 psi (420 kPa , 4.2 kgf/cm ²)

* 1 : TL

* 2 : TECH

* 3 : SH-AWD

* 4 : SH-AWD TECH

* 5 : SH-AWD TECH HPT

* 6 : SH-AWD with high performance tires

The tires on your vehicle meet all U.S. Federal Safety Requirements. All tires are also graded for treadwear, traction, and temperature performance according to Department of Transportation (DOT) standards. The following explains these gradings.

Uniform Tire Quality Grading

Quality grades can be found where applicable on the tire sidewall between tread shoulder and maximum section width. For example:

Treadwear 200

Traction AA

Temperature A

All passenger car tires must conform to Federal Safety Requirements in addition to these grades.

Treadwear

The treadwear grade is a comparative rating based on the wear rate of the tire when tested under controlled conditions on a specified government test course. For example, a tire graded 150 would wear one and one-half (1 1/2) times as well on the government course as a tire graded 100. The relative performance of tires depends upon the actual conditions of their use, however, and may depart significantly from the norm due to variations in driving habits, service practices and differences in road characteristics and climate.

Traction

The traction grades, from highest to lowest, are AA, A, B, and C. Those grades represent the tire's ability to stop on wet pavement as measured under controlled conditions on specified government test surfaces of asphalt and concrete. A tire marked C may have poor traction performance.

Warning: The traction grade assigned to this tire is based on straight-ahead braking traction tests, and does not include acceleration, cornering, hydroplaning, or peak traction characteristics.

DOT Tire Quality Grading (U.S. Vehicles)

Temperature

The temperature grades are A (the highest), B, and C, representing the tire's resistance to the generation of heat and its ability to dissipate heat when tested under controlled conditions on a specified indoor laboratory test wheel. Sustained high temperature can cause the material of the tire to degenerate and reduce tire life, and excessive temperature can lead to sudden tire failure. The grade C corresponds to a level of performance which all passenger car tires must meet under the Federal Motor Vehicle Safety Standard No. 109. Grades B and A represent higher levels of performance on the laboratory test wheel than the minimum required by law.

Warning: The temperature grade for this tire is established for a tire that is properly inflated and not overloaded. Excessive speed, underinflation, or excessive loading, either separately or in combination, can cause heat buildup and possible tire failure.

The tires that came on your vehicle have a number of markings. Those you should be aware of are described below.

TIRE LABELING EXAMPLE

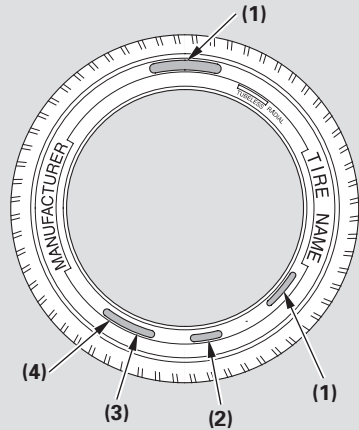

- (1) Tire Size
- (2) Tire Identification Number (TIN)
- (3) Maximum Tire Pressure
- (4) Maximum Tire Load

Tire Size

Whenever tires are replaced, they should be replaced with tires of the same size. Below is an example of tire size with an explanation of what each component means.

P245/50R17 98V

- P – Vehicle type (P indicates passenger vehicle).
- 245 – Tire width in millimeters.
- 50 – Aspect ratio (the tire's section height as a percentage of its width).
- R – Tire construction code (R indicates radial).
- 17 – Rim diameter in inches.

- 98 – Load index (a numerical code associated with the maximum load the tire can carry).
- V – Speed symbol (an alphabetical code indicating the maximum speed rating).

CONTINUED

Tire Labeling

Tire Identification Number (TIN)

The tire identification number (TIN) is a group of numbers and letters that look like the following example. TIN is located on the sidewall of the tire.

DOT 4MIC 001X 5207

DOT — This indicates that the tire meets all requirements of the U.S. Department of Transportation.

4MIC — Manufacturer's identification mark.

001X — Tire type code.

5207 — Date of manufacture.
└───┬───
 └─── Year
 └─── Week

Maximum Tire Pressure

Max Press — The maximum air pressure the tire can hold.

Maximum Tire Load

Max Load — The maximum load the tire can carry at maximum air pressure.

Tire Pressure Monitoring System (TPMS) – Required Federal Explanation

Each tire, including the spare (if provided), should be checked monthly when cold and inflated to the inflation pressure recommended by the vehicle manufacturer on the vehicle placard or tire inflation pressure label.

(If your vehicle has tires of a different size than the size indicated on the vehicle placard or tire inflation pressure label, you should determine the proper tire inflation pressure for those tires.)

As an added safety feature, your vehicle has been equipped with a tire pressure monitoring system (TPMS) that illuminates a low tire pressure telltale



when one or more of your tires is significantly under-inflated.

Accordingly, when the low tire pressure telltale illuminates, you should stop and check your tires as soon as possible, and inflate them to the proper pressure.

Driving on a significantly under-inflated tire causes the tire to overheat and can lead to tire failure. Under-inflation also reduces fuel efficiency and tire tread life, and may affect the vehicle's handling and stopping ability.

Please note that the TPMS is not a substitute for proper tire maintenance, and it is the driver's responsibility to maintain correct tire pressure, even if under-inflation has not reached the level to trigger illumination of the TPMS low tire pressure telltale.

CONTINUED

Tire Pressure Monitoring System (TPMS) – Required Federal Explanation

Your vehicle has also been equipped with a TPMS malfunction indicator to indicate when the system is not operating properly. The TPMS malfunction indicator is combined with the low tire pressure telltale. When the system detects a malfunction, the telltale will flash for approximately one minute and then remain continuously illuminated. This sequence will continue upon subsequent vehicle start-ups as long as the malfunction exists.

When the malfunction indicator is illuminated, the system may not be able to detect or signal low tire pressure as intended.

TPMS malfunctions may occur for a variety of reasons, including the installation of replacement or alternate tires or wheels on the vehicle that prevent the TPMS from functioning properly.

Always check the TPMS malfunction telltale after replacing one or more tires or wheels on your vehicle to ensure that the replacement or alternate tires and wheels allow the TPMS to continue to function properly.

The burning of gasoline in your vehicle's engine produces several by-products. Some of these are carbon monoxide (CO), oxides of nitrogen (NO_x), and hydrocarbons (HC). Gasoline evaporating from the tank also produces hydrocarbons. Controlling the production of NO_x, CO, and HC is important to the environment. Under certain conditions of sunlight and climate, NO_x and HC react to form photochemical "smog." Carbon monoxide does not contribute to smog creation, but it is a poisonous gas.

The Clean Air Act

The United States Clean Air Act* sets standards for automobile emissions. It also requires that automobile manufacturers explain to owners how their emissions controls work and what to do to maintain them. This section summarizes how the emissions controls work.

* In Canada, Acura vehicles comply with the Canadian Motor Vehicle Safety Standards (CMVSS) for Emissions valid at the time they are manufactured.

Crankcase Emissions Control System

Your vehicle has a positive crankcase ventilation system. This keeps gasses that build up in the engine's crankcase from going into the atmosphere. The positive crankcase ventilation valve routes them from the crankcase back to the intake manifold. They are then

drawn into the engine and burned.

Evaporative Emissions Control System

As gasoline evaporates in the fuel tank, an evaporative emissions control canister filled with charcoal adsorbs the vapor. It is stored in this canister while the engine is off. After the engine is started and warmed up, the vapor is drawn into the engine and burned during driving.

Onboard Refueling Vapor Recovery

The onboard refueling vapor recovery (ORVR) system captures the fuel vapors during refueling. The vapors are adsorbed in a canister filled with activated carbon. While driving, the fuel vapors are drawn into the engine and burned off.

Emissions Controls

Exhaust Emissions Controls

The exhaust emissions controls include four systems: PGM-FI, ignition timing control, exhaust gas recirculation, and three way catalytic converter. These four systems work together to control the engine's combustion and minimize the amount of HC, CO, and NOx that come out the tailpipe. The exhaust emissions control systems are separate from the crankcase and evaporative emissions control systems.

PGM-FI System

The PGM-FI system uses sequential multiport fuel injection. It has three subsystems: air intake, engine control, and fuel control. The powertrain control module (PCM) uses various sensors to determine how much air is going into the engine. It then controls how much fuel to inject under all operating conditions.

Ignition Timing Control System

This system constantly adjusts the ignition timing, reducing the amount of HC, CO, and NOx produced.

Exhaust Gas Recirculation (EGR) System

The exhaust gas recirculation (EGR) system takes some of the exhaust gas and routes it back into the intake manifold. Adding exhaust gas to the air/fuel mixture reduces the amount of NOx produced when the fuel is burned.

Three Way Catalytic Converter

The three way catalytic converter is in the exhaust system. Through chemical reactions, it converts HC, CO, and NOx in the engine's exhaust to carbon dioxide (CO₂), nitrogen (N₂), and water vapor.

Replacement Parts

The emissions control systems are designed and certified to work together in reducing emissions to levels that comply with the Clean Air Act. To make sure the emissions remain low, you should use only new Acura replacement parts or their equivalent for repairs. Using lower quality parts may increase the emissions from your vehicle.

The emissions control systems are covered by warranties separate from the rest of your vehicle. Read your warranty manual for more information.

The three way catalytic converter contains platinum, palladium, and rhodium. These metals serve as catalysts, promoting chemical reactions to convert the exhaust gasses without affecting the metals. The catalytic converter is referred to as a three-way catalyst, since it acts on HC, CO, and NOx. A replacement unit must be an original Acura part or its equivalent.

The three way catalytic converter must operate at a high temperature for the chemical reactions to take place. It can set on fire any combustible materials that come near it. Park your vehicle away from high grass, dry leaves, or other flammables.

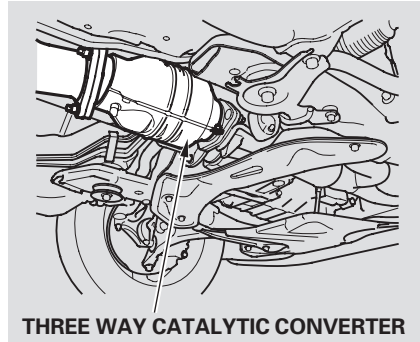

A defective three way catalytic converter contributes to air pollution, and can impair your engine's performance. Follow these guidelines to protect your vehicle's three way catalytic converter.

- Always use unleaded gasoline. Even a small amount of leaded gasoline can contaminate the catalyst metals, making the three way catalytic converter ineffective.

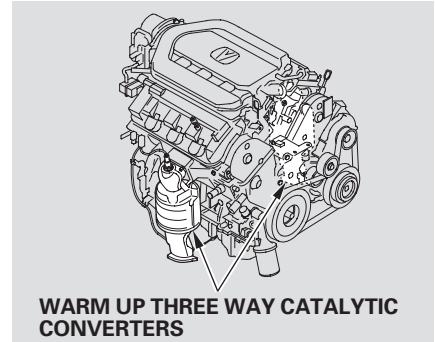

- Keep the engine well maintained.
- Have your vehicle diagnosed and repaired if it is misfiring, back-firing, stalling, or otherwise not running properly.

Emissions Testing

Testing of Readiness Codes

If you take your vehicle for an emissions test shortly after the battery has been disconnected or gone dead, it may not pass the test. This is because of certain “readiness codes” that must be set in the on-board diagnostics for the emissions systems. These codes are erased when the battery is disconnected, and set again only after several days of driving under a variety of conditions.

If the testing facility determines that the readiness codes are not set, you will be requested to return at a later date to complete the test. If you must get the vehicle retested within the next two or three days, you can condition the vehicle for retesting by doing the following.

1. Make sure the gas tank is nearly, but not completely, full (around 3/4).
2. Make sure the vehicle has been parked with the engine off for 6 hours or more.
3. Make sure the ambient temperature is between 40° and 95° F (4° and 35° C).
4. Without touching the accelerator pedal, start the engine, and let it idle for 20 seconds.
5. Keep the vehicle in Park. Increase the engine speed to 2,000 rpm, and hold it there until the temperature gauge rises to at least 1/4 of the scale (about 3 minutes).
6. Without touching the accelerator pedal, let the engine idle for 20 seconds.

7. Select a nearby lightly traveled major highway where you can maintain a speed of 50 to 60 mph (80 to 97 km/h) for at least 20 minutes. Drive on the highway in D. Do not use the cruise control. When traffic allows, drive for 90 seconds without moving the accelerator pedal. (Vehicle speed may vary slightly; this is okay.) If you cannot do this for a continuous 90 seconds because of traffic conditions, drive for at least 30 seconds, then repeat it two more times (for a total of 90 seconds).
8. Then drive in city/suburban traffic for at least 10 minutes. When traffic conditions allow, let the vehicle coast for several seconds without using the accelerator pedal or the brake pedal.
9. Make sure the vehicle has been parked with the engine off for 30 minutes.

If the testing facility determines the readiness codes are still not set, see your dealer.

Client Service Information 630
Warranty Coverages 631
Reporting Safety Defects
 (U.S. Vehicles) 632
Authorized Manuals 633

Client Service Information

Acura dealership personnel are trained professionals. They should be able to answer all your questions. If you encounter a problem that your dealership does not solve to your satisfaction, please discuss it with the dealership's management. The service manager or general manager can help. Almost all problems are solved in this way.

If you are dissatisfied with the decision made by the dealership's management, contact Acura Client Services.

U.S. Owners:

American Honda Motor Co., Inc.
Acura Client Services
Mail Stop 500-2N-7E
1919 Torrance Blvd.
Torrance, CA 90501-2746

Tel: (800) 382-2238

Canadian Owners:
Acura Client Services
Honda Canada Inc.
715 Milner Avenue
Toronto, ON
M1B 2K8

Tel: 1-888-9-ACURA-9

Fax: Toll-free (877) 939-0909
Toronto (416) 287-4776

In Puerto Rico and the U.S. Virgin Islands:

Vortex Motor Corp.
Bella International
P.O. Box 190816
San Juan, PR 00919-0816

Tel: (787) 620-7546

When you call or write, please give us this information:

- Vehicle identification number (see page [612](#))
- Name and address of the dealer who services your vehicle
- Date of purchase
- Odometer reading of on your vehicle
- Your name, address, and telephone number
- A detailed description of the problem
- Name of the dealer who sold the vehicle to you

U.S. Owners

Your new Acura is covered by these warranties:

New Vehicle Limited Warranty — covers your new vehicle, except for the battery, emissions control systems, and accessories, against defects in materials and workmanship.

Emissions Control Systems Defects Warranty and Emissions Performance Warranty — these two warranties cover your vehicle's emissions control systems. Time, mileage, and coverage are conditional. Please read your warranty booklet for exact information.

Original Equipment Battery Limited Warranty — this warranty gives up to 100% credit toward a replacement battery.

Seat Belt Limited Warranty — a seat belt that fails to function properly is covered by a limited warranty. Please read your warranty booklet for details.

Rust Perforation Limited Warranty — all exterior body panels are covered for rust-through from the inside for the specified time period with no mileage limit.

Accessory Limited Warranty — Acura accessories are covered under this warranty. Time and mileage limits depend on the type of accessory and other factors. Please read your warranty manual for details.

Replacement Parts Limited Warranty — covers all Acura replacement parts against defects in materials and workmanship.

Replacement Battery Limited Warranty — provides prorated coverage for a replacement battery purchased from your dealer.

Replacement Muffler Lifetime Limited Warranty — provides coverage for as long as the purchaser of the muffler owns the vehicle.

Restrictions and exclusions apply to all these warranties. Please read the 2009 Acura warranty information booklet that came with your vehicle for precise information on warranty coverages. Your vehicle's original tires are covered by their manufacturer. Tire warranty information is in a separate booklet.

Canadian Owners

Please refer to the 2009 warranty manual that came with your vehicle.

Reporting Safety Defects (U.S. Vehicles)

If you believe that your vehicle has a defect which could cause a crash or could cause injury or death, you should immediately inform the National Highway Traffic Safety Administration (NHTSA), in addition to notifying American Honda Motor Co., Inc.

If NHTSA receives similar complaints, it may open an investigation, and if it finds that a safety defect exists in a group of vehicles, it may order a recall and remedy campaign. However, NHTSA cannot become involved in individual problems between you, your dealer, or American Honda Motor Co., Inc.

To contact NHTSA, you may call the Vehicle Safety Hotline toll-free at 1-888-327-4236 (TTY: 1-800-424-9153); go to <http://www.safercar.gov>; or write to: Administrator, NHTSA, 1200 New Jersey Avenue, SE., Washington, DC 20590. You can also obtain other information about motor vehicle safety from <http://www.safercar.gov>.

Purchasing Factory Authorized Manuals (U.S. only)

The publications shown below can be purchased from Helm Incorporated. You can order by phone or online:

- Call Helm Inc. at 1-800-782-4356 (credit card orders only)
- Go online at www.helminc.com

If you are interested in other years or models, contact Helm Inc. at 1-800-782-4356.

Publication Form Number	Form Description
61TK400	2009 Acura TL Service Manual
61TK400EL	2009 Acura TL Electrical Troubleshooting Manual
61TK430	2009 Model Series Acura TL Body Repair Manual
31TK4600	2009 Acura TL Owner's Manual
31TK4800	2009 Acura TL Navigation Manual
31TK4M00	2009 Acura TL Maintenance Journal
31TK4Q00	2009 Acura TL Quick Start Guide
ACU-R	Order Form for Previous Years- Indicate Year and Model Desired

Service Manual:

Covers maintenance and recommended procedures for repair to engine and chassis components. It is written for the journeyman mechanic, but it is simple enough for most mechanically inclined owners to understand.

Electrical Troubleshooting Manual:

Complements the Service Manual by providing in-depth troubleshooting information for each electrical circuit in your vehicle.

Body Repair Manual:

Describes the procedures involved in the replacement of damaged body parts.

A	
AAC.....	265, 307, 357
Accessories and Modifications	495
Accessories.....	495
Modifications	496
ACCESSORY (Ignition Key Position)	145
ACCESSORY Mode (Power Mode)	178
Accessory Power Sockets.....	204
AcuraLink	467
Adding Engine Coolant.....	550
Adding Engine Oil	547
Additives, Engine Oil.....	548
Airbag (SRS)	9, 24
Additional Information.....	24
Servicing	35
System Components.....	24
Air Conditioning System.....	214
Air Pressure, Tires	568
Antifreeze	550
Anti-lock Brakes (ABS) Indicator.....	66, 521
Operation.....	521
Anti-theft, Audio System.....	376

Anti-theft Steering Column Lock.....	145
Audio System	223
Automatic Lighting Off Feature..	135
Automatic Seat Belt Tensioners	22
Automatic Speed Control.....	386
Automatic Transmission.....	507
Capacity, Fluid	614
Checking Fluid Level.....	553
Shifting.....	508
Shift Lever Position Indicator ..	507
Shift Lock Release.....	510

B	
Battery Charging System Indicator.....	65, 595
Jump Starting	591
Maintenance.....	577
Specifications	615
Before Driving	485
Belts, Seat	8, 20
Beverage Holder	203
Bluetooth® HandsFreeLink®	392

Brakes Anti-lock System (ABS)	521
Break-in, New Linings	486
Fluid	555
Parking.....	201
System Indicator	65, 597
Wear Indicators	520
Braking System.....	520
Break-in, New Vehicle	486
Brightness Control, Instruments	137
Built-In Key.....	142
Bulb Replacement Back-up Lights	563
Daytime Running Lights	556
Fog Lights	561
Specifications	345
Turn Signal Lights.....	559, 563
Bulbs, Halogen.....	556

C	
Capacities Chart.....	614
Carbon Monoxide Hazard	57

CONTINUED

Index

Carrying, Cargo	497	Clock	377	Defogger, Rear Window	139
CAUTION, Explanation of	iii	CO in the Exhaust	57, 624	Defrosting the Windows.....	219
Ceiling Light.....	209	Compact Spare tire	582	Dimensions.....	614
Certification Label.....	612	Compass.....	382	Dimming the Headlights	133
Chains, tires.....	575	Console Compartment	205	Dipstick	
Changing Oil		Consumer Information*	630	Automatic Transmission.....	553
How to.....	548	Controls, Instruments and.....	61	Engine Oil.....	490
When to.....	535	Coolant		Directional Signals.....	133
Changing a Flat Tire	583	Adding.....	550	Disc Brake Wear Indicators.....	520
Charging System Indicator	65, 595	Checking.....	491	Disc Changer.....	240
Checklist, Before Driving.....	502	Proper Solution	550	Disc Changer Error Messages	250
Childproof Door Locks	147	Temperature Gauge	76	Disposal of Used Oil.....	550
Child Safety	37	Crankcase Emissions Control		Doors	
Booster Seats	54	System.....	623	Door Lock Sensor Button.....	170
Child Seats.....	45	Cruise Control Indicator	72	Monitor Indicator	11, 88
Infants	42	Cruise Control Operation	386	Power Door Locks.....	146
Large Children	53	Cup Holders.....	203	DOT Tire Quality Grading*	617
LATCH.....	47	Customer Relations Office	630	Driver and Passenger Safety.....	5
Risks with Airbags.....	38			Driving	501
Small Children.....	43			Economy	492
Tethers.....	51			Driving Position Memory	
Where Should a Child Sit?	38			System.....	164
Cleaning					
Seat Belts.....	564				
Client Service Information	630				
Climate Control System.....	214				
		D			
		DANGER, Explanation of	iii		
		Dashboard	3, 62		
		Daytime Running Lights.....	136		
		Daytime Running Light Indicator..	72		
		Defects, Reporting Safety*	632		
				E	
				Economy, Fuel	492

Electronic Stability Control (ECS)..... 523

Emergencies on the Road..... 581

 Battery, Jump Starting 591

 Brake System Indicator 597

 Changing a Flat Tire 583

 Charging System Indicator 595

 Checking the Fuses..... 599

 Hazard Warning Flashers 139

 If Your Vehicle Gets Stuck..... 608

 Jump Starting 591

 Low Oil Pressure Indicator 595

 Malfunction Indicator Lamp ... 596

 Overheated Engine 593

 Towing 606

Emergency Brake..... 201

Emergency Flashers 139

Emergency Towing 606

Emergency Trunk Opener 150

Emissions Controls..... 623

Emissions Testing, State 626

Engine

 Coolant Temperature Gauge 76

 Malfunction Indicator Lamp 64, 596

 Oil Life 84, 535

Oil Pressure Indicator..... 64, 595

Oil, What Kind to Use 547

Overheating..... 593

Specifications 615

Speed Limiter 510

Starting..... 503

Engine, if it won't start..... 588

Engine Start/Stop Button..... 177

Ethanol in Gasoline 487

Evaporative Emissions Controls.. 623

Exhaust Fumes 57

Expectant Mothers, Use of Seat Belts by 18

F

Fan, Interior..... 218

Features, Comfort and Convenience..... 213

Filling the Fuel Tank..... 487

Filter, Oil..... 548

Flashers, Hazard Warning..... 139

Flat Tire, Changing a 583

Floor Mats 565

Fluids

 Automatic Transmission..... 553

Brake..... 555

Windshield Washers 552

FM Stereo Radio

 Reception..... 372

Fog Lights 137

Front Airbags 9, 26

Front Seats 155

 Adjusting..... 155

 Heaters..... 193

 Airbags..... 9, 26

Fuel..... 486

 Fill Door and Cap..... 487

 Gauge 75

 Octane Requirement 486

 Reserve Indicator..... 73

 Tank, Filling the..... 487

Fuses, Checking the..... 599

G

Gas Mileage, Improving..... 492

CONTINUED

Index

Gasoline	486
Fuel Reserve Indicator.....	73
Gauge	75
Octane Requirement.....	486
Tank, Filling the.....	487
Gas Station Procedures.....	487
Gauges	
Engine Coolant Temperature ...	76
Fuel.....	75
Speedometer	75
Tachometer	75
Gearshift Lever Positions	
Automatic Transmission.....	507
Glove Box	205

H

Halogen Fog Bulbs.....	556
HandsFreeLink® (HFL)	392, 420
Hazard Warning Flashers.....	139
Headlights	133
Aiming.....	556
Automatic Lighting Off	
Feature.....	135
Daytime Running Lights	136
High Beam Indicator.....	71

Reminder Chime.....	133
Turning on.....	133
Head Restraints	156
High-Low Beam Switch	133
HomeLink® Universal	
Transceiver.....	389
Hood, Opening the	489

I

Identification Number, Vehicle....	612
Ignition	
Keys.....	141
Switch.....	145
Timing Control System.....	624
Immobilizer System.....	143
Important Safety Precautions	6
Indicators	64
ABS (Anti-Lock Brake).....	66, 521
Brake (Parking and Brake	
System)	65, 597
Charging System	65, 595
Cruise Control.....	72
Fog Light	71
High Beam.....	71
Key (Immobilizer System)	65

Low Fuel	73
Low Oil Pressure	64, 595
Side Airbag Off	33, 67
SRS	26, 67
Turn Signal and Hazard	
Warning	70
VSA Activation	68
VSA System.....	68
Infant Restraint.....	42
Infant Seats.....	42
Tether Anchorage Points	51
Inflation, Proper Tire	568
Inside Mirror	161
Inspection, Tire	571
Instrument Panel	63
Instrument Panel Indicators.....	64
Instrument Panel Brightness	137
Interior Lights	209
Introduction.....	i

J

Jacking up the Vehicle	584
Jack, Tire	583
Jump Starting	591

IV

K

Keys..... 141
 Built-In..... 142
 Keyless Access Remote..... 168, 173
 Keyless Access Remote System
 Entry Main Switch..... 187
 Keyless Access System..... 167
 Keyless Memory Setting 176

L

Label, Certification..... 612
 Lane Change, Signaling 133
 Lap/Shoulder Belts..... 16, 21
 Lights
 Bulb Replacement 556
 Indicator 63
 Parking..... 133
 Turn Signal..... 70, 133
 LOCK (Ignition Key Position) 145
 Lockout Prevention 147
 Locks
 Anti-theft Steering Column 145
 Glove Box 205
 Power Door 146

Trunk 148
 Low Coolant Level..... 491
 Low Oil Pressure Indicator 64, 595
 Lubricant Specifications Chart 614
 Luggage, Storing (Cargo) 497

M

Maintenance..... 533
 Minder..... 535
 Owner Maintenance Checks.... 543
 Safety..... 534
 Malfunction Indicator
 Lamp 64, 596
 Memory, Driving Position 164
 Meters, Gauges..... 63, 75
 Mirrors, Adjusting..... 161
 Modifying Your Vehicle..... 496
 Moonroof 199
 Multi-Information Display 77

N

Neutral Gear Position..... 509
 New Vehicle Break-in 486
 NOTICE, Explanation of..... i

Numbers, Identification..... 612

O

Octane Requirement, Gasoline.... 486
 Odometer 81
 Odometer, Trip 81
 Oil
 Change, How to 548
 Change, When to 544
 Checking Engine 490
 Pressure Indicator 64, 595
 Selecting Proper Viscosity
 Chart 547
 ON (Ignition Key Position) 145
 ON Mode (Power Mode)..... 178
 Onboard Refueling Vapor
 Recovery 623
 Operating Range..... 168
 Outside Mirrors 161
 Outside Temperature..... 84
 Overheating, Engine 593
 Owner's Maintenance Checks 543

CONTINUED

Index

P

Panel Brightness Control	137
Park Gear Position.....	508
Parking.....	519
Parking Brake	201
Parking Brake and Brake System Indicator.....	65, 597
Parking Lights.....	133
Parking Over Things that Burn...	519
Passenger Airbag Off Indicator.....	34
PGM-FI System.....	624
Power Mode	178
ACCESSORY Mode	179
ON Mode	179
START Mode	180
VEHICLE OFF Mode	179
Power Socket Locations.....	202
Pregnancy, Using Seat Belts	18
Protecting Adults and Teens.....	11
Additional Safety Precautions....	19
Advice for Pregnant Women.....	18
Protecting Children	37
Installing a Child Seat Using Latch	47

Installing a Child Seat with a Lap/Shoulder Belt.....	49
Installing a Child Seat with a Tether	51
Selecting a Child Seat.....	45
Protecting Infants.....	42
Protecting Larger Children.....	53
Protecting Smaller Children	43
Protecting Your Discs.....	251, 313

R

Radiator Overheating.....	593
Radio/Disc Sound System....	225, 278
Readiness Codes.....	596, 626
Rear Lights, Bulb Replacement..	563
Rear Seat Armrest.....	160
Rear View Camera and Monitor..	483
Rear View Mirror.....	161
Rear Window Defogger	139
Reclining the Seat Backs	155
Reminder Lights	64
Remote Audio Controls.....	374
Remote Transmitter.....	151
Replacement Information Engine Oil and Filter.....	548

Fuses	599
Light Bulbs.....	556
Tires	568
Wiper Blades.....	566
Replacing Seat Belts After a Crash.....	23
Reserve Tank, Engine Coolant	491
Restraint, Child	37
Reverse Gear Position.....	509
Rotation, Tire	573

S

Safety Belts.....	8, 20
Safety Defects, Reporting*	632
Safety Features	7
Airbags.....	9
Door Locks	11
Head Restraints	15
Seat Belts.....	8
Seats and Seat-Backs	13, 14
Safety Labels, Location of	59
Safety Messages	iii
Satellite Radio	234, 293

Seat Belts 8, 20
 Additional Information..... 20
 Cleaning 564
 Lap/Shoulder Belt 21
 Maintenance..... 23
 Reminder Light and
 Beeper..... 20, 64
 System Components..... 20
 Use During Pregnancy..... 18
 Seat Heaters 193
 Seats, Adjusting the..... 155
 Security System 380
 Sequential Shift Mode..... 514
 Serial Number 612
 Service Intervals 544
 Service Manual* 633
 Service Station Procedures 488
 Setting the Clock 377
 SH-AWD® Indicator..... 73
 Shift Lever Position Indicator 507
 Shift Lock Release..... 510
 Shifting..... 508
 Side Airbags 9, 30
 Side Airbag Off Indicator 33, 67
 Side Curtain Airbags 32
 Signaling Turns..... 133

Snow Tires..... 575
 Sound System..... 223
 Spare Tire
 Inflating..... 582
 Specifications 582, 616
 Specifications Charts..... 614
 Speed Control..... 386
 SRS, Additional Information..... 24
 Additional Safety Precautions.... 36
 Airbag Components..... 24
 Airbag Service..... 35
 How the SRS Indicator
 Works..... 32
 How Your Front Airbags
 Work..... 26
 How Your Side Airbags Work.... 30
 How Your Side Curtain Airbags
 Work..... 32
 SRS Indicator..... 32, 67
 START (Ignition Key Position) .. 145
 START Mode (Power Mode)..... 178
 Start/Stop Button, Engine..... 178
 Starting the Engine 503, 506
 With a Dead Battery 591
 State Emissions Testing 623
 Steam Coming from Engine..... 593

Steering Wheel
 Adjustment 140
 Anti-theft Column Lock 145
 Stereo Sound System 223
 Storing Your Vehicle..... 578
 Sunglasses Holder 207
 Super Handling All-Wheel Drive
 (TM) (SH-AWD®) 73
 Supplemental Restraint System..... 24
 Servicing 35
 SRS Indicator..... 34
 System Components..... 24

T

Tachometer 75
 Taking Care of the Unexpected .. 581
 Technical Descriptions
 DOT Tire Quality Grading* 617
 Emissions Control Systems..... 623
 Three Way Catalytic
 Converter..... 625
 Temperature Gauge 76
 Temperature, Outside..... 84

CONTINUED

Index

- Temperature, Inside Sensor..... 222
- Tether Anchorage Points 51
- Three Way Catalytic Converter... 625
- Tilt the Steering Wheel..... 140
- Time, Setting the 377
- Tire Chains 575
- Tire, How to Change a Flat 583
- Tire Pressure Monitoring
System..... 526
 Low Tire Pressure/TPMS
 Indicator..... 69, 526
 TPMS System Failure 529
- Tire Pressure Monitoring System
Messages..... 527
- Tires 568
 Air Pressure 568
 Checking Wear 571
 Compact Spare 582
 DOT Tire Quality Grading 617
 Inflation..... 568
 Inspection 571
 Replacing 574
 Rotating..... 573
 Snow 575
 Specifications 616
 Summer Tire 575
- Traction Devices..... 575
 Winter Driving 575
- Tools, Tire Changing 583
- Torque Distribution Monitor
(SH-AWD®) 517
- Towing
 A Trailer..... 531
 Emergency Wrecker 606
- Traction Devices..... 575
- Transmission
 Checking Fluid Level,
 Automatic 553
 Checking Fluid Level Manual.. 555
 Fluid Selection 554, 555
 Identification Number..... 612
 Shifting the Automatic..... 508
- Treadwear 617
- Trip Computer 82
- Trip Meter 81
- Trunk..... 148
 Emergency Trunk Release..... 150
 Opening the 148
 Open Monitor Light 11, 88
- Turn Signals 133
- U**
- Unexpected, Taking Care
 of the 581
- Uniform Tire Quality Grading 617
- Unleaded Gasoline..... 486
- Used Oil, How to Dispose of 550
- V**
- Vehicle Capacity Load 498
- Vehicle Dimensions..... 614
- VEHICLE OFF Mode
 (Power Mode)..... 178
- Vehicle Identification Number..... 612
- Vehicle Stability Assist (VSA®),
 aka Electronic Stability
 Control (ESC), System 523
 VSA System Indicator 68, 523
 VSA Activation Indicator ... 68, 523
 VSA Off Switch..... 524
- Vehicle Storage 578
- VIN 612
- Viscosity, Oil..... 548

W

WARNING, Explanation of iii
 Warning Labels, Location of 58
 Warranty Coverages* 631
 Washer, Windshield
 Checking the Fluid Level 552
 Operation 131
 Wheels
 Adjusting the Steering 140
 Alignment and Balance 573
 Compact Spare 582
 Windows
 Operating the Power 195
 Rear, Defogger 139
 Windshield
 Cleaning 131
 Defroster 219
 Washers 552
 Wipers, Windshield
 Changing Blades 566
 Operation 131
 Worn Tires 571
 Wrecker, Emergency Towing 606

X

XM Satellite Radio 233, 292

* : U.S.

Service Information Summary

Gasoline:

Premium unleaded gasoline, pump octane number of 91 or higher.

Fuel Tank Capacity:

18.5 US gal (70 ℓ)

Recommended Engine Oil:

API Service SJ "Energy Conserving" oil, SAE 5W-20 viscosity (see page [547](#)).

Oil change capacity (including filter):

4.5 US qt (4.3 ℓ)

Automatic Transmission Fluid:

Acura ATF-Z1 (Automatic Transmission Fluid) (see page [553](#)).

On models with SH-AWD

Rear Differential Fluid:

Use Acura ATF-Z1 (Automatic Transmission Fluid) only.

Capacity:

SH-AWD differential case
2.67 US qt (2.53 ℓ)

Transfer Assembly Fluid:

SAE 90 or SAE 80W-90 viscosity hypoid gear oil, API service classified GL4 or GL5 only.

Brake Fluid:

Honda Heavy Duty Brake Fluid DOT 3 preferred, or a DOT 3 or DOT 4 brake fluid as a temporary replacement (see page [555](#)).

Tire Pressure (measured cold):

All models except SH-AWD with High Performance Tires and SH-AWD TECH HTP models

Front/Rear:

32 psi (220 kPa , 2.2 kgf/cm²)

SH-AWD with High Performance Tires and SH-AWD TECH HTP models

Front:

37 psi (255 kPa , 2.55 kgf/cm²)

Rear:

32 psi (220 kPa , 2.2 kgf/cm²)

Spare Tire Pressure:

60 psi (420 kPa , 4.2 kgf/cm²)

Owner's Identification

OWNER _____

ADDRESS _____

STREET

CITY

STATE/PROVINCE

ZIP CODE/
POSTAL CODE

V. I. N. _____

DELIVERY DATE _____

(Date sold to original retail purchaser)

DEALER NAME _____ DEALER NO. _____

ADDRESS _____

STREET

CITY

STATE/PROVINCE

ZIP CODE/
POSTAL CODE

OWNER'S SIGNATURE _____

DEALER'S SIGNATURE _____

This owner's manual should be considered a permanent part of the vehicle and should remain with the vehicle when it is sold.

This Owner's Manual covers all models of the Acura TL. You may find descriptions of equipment and features that are not on your particular model.

The information and specifications included in this publication were in effect at the time of approval for printing. Honda Motor Co., Ltd. reserves the right, however, to discontinue or change specifications or design at any time without notice and without incurring any obligation whatsoever.

**POUR CLIENTS CANADIEN
AVIS IMPORTANT: Si vous avez
besoin d'un Manuel du Conducteur
en français, veuillez demander à
votre concessionnaire de
commander le numéro de pièce
33TK4C00.**