

2011 TSX Owner's Manual (Unlinked)

This document does not contain hyperlinks and may be formatted for printing instead of web use. This is due to changes in content and specifications of the vehicle that happen throughout the model year. This manual will be replaced with a hyperlinked version at the end of the model year.

This owner's manual should be considered a permanent part of the vehicle and should remain with the vehicle when it is sold.

This owner's manual covers all models of the TSX. You may find descriptions of equipment and features that are not on your particular model.

Images throughout this owner's manual (including the front cover) represent features and equipment that are available on some, but not all, models. Your particular model may not have some of these features.

The information and specifications included in this publication were in effect at the time of approval for printing. Honda Motor Co., Ltd. reserves the right, however, to discontinue or change specifications or design at any time without notice and without incurring any obligation.

➤ Safe Driving P. 21

For Safe Driving P. 22

Seat Belts P. 26

Airbags P. 33

➤ Instrument Panel P. 63

Indicators P. 64

Gauges and Multi-Information Display P. 75

➤ Controls P. 87

Setting the Clock P. 88

Locking and Unlocking the Doors P. 89

Opening and Closing the Moonroof P. 103

Adjusting the Seats P. 116

➤ Features P. 137

Audio System P. 138

Audio System Basic Operation P. 141

General Information on the Audio System P. 161

➤ Driving P. 181

Before Driving P. 182

Towing a Trailer P. 187

Refueling P. 215

Fuel Economy P. 218

➤ Maintenance P. 221

Before Performing Maintenance P. 222

Maintenance Minder™ P. 225

Checking and Maintaining Wiper Blades P. 257

Climate Control System Maintenance P. 270

➤ Handling the Unexpected P. 275

Tools P. 276

If a Tire Goes Flat P. 277

Overheating P. 288

Indicator, Coming On/Blinking P. 290

When You Cannot Unlock the Fuel Fill Door P. 299

➤ Information P. 301

Specifications P. 302

Identification Numbers P. 306

Emissions Testing P. 309

Warranty Coverages P. 311

Contents

Child Safety P. 48

Exhaust Gas Hazard P. 60

Safety Labels P. 61

Opening and Closing the Trunk P. 95

Security System P. 98

Opening and Closing the Windows P. 100

Operating the Switches Around the Steering Wheel P. 104

Adjusting the Mirror P. 114

Interior Lights/Interior Convenience Items P. 125

Climate Control System P. 133

Audio Error Messages P. 158

Audio Remote Controls P. 160

HomeLink® Universal Transceiver P. 165

Bluetooth® HandsFreeLink® P. 167

Compass P. 179

When Driving P. 191

Braking P. 210

Parking Your Vehicle P. 214

Accessories and Modifications P. 219

Maintenance Under the Hood P. 229

Replacing Light Bulbs P. 247

Checking and Maintaining Tires P. 259

Battery P. 268

Remote Transmitter Care P. 269

Cleaning P. 271

Engine Does Not Start P. 283

Jump Starting P. 284

Shift Lever Does Not Move P. 287

Fuses P. 294

Emergency Towing P. 298

When you Cannot Open the Trunk P. 300

Devices that Emit Radio Waves P. 307

Reporting Safety Defects P. 308

Authorized Manuals P. 313

Client Service Information P. 314

Quick Reference Guide P. 2

Safe Driving P. 21

Instrument Panel P. 63

Controls P. 87

Features P. 137

Driving P. 181

Maintenance P. 221

Handling the Unexpected P. 275

Information P. 301

Index P. 315

Visual Index

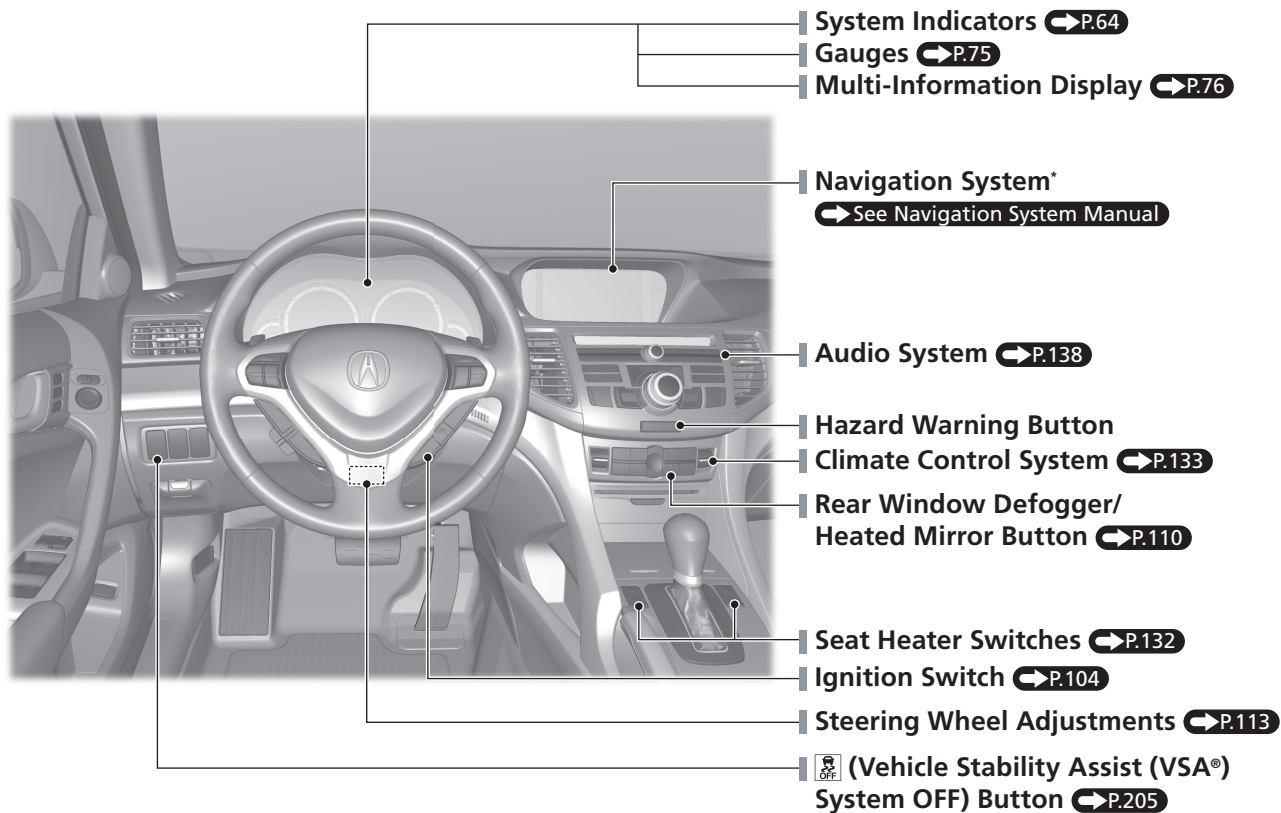

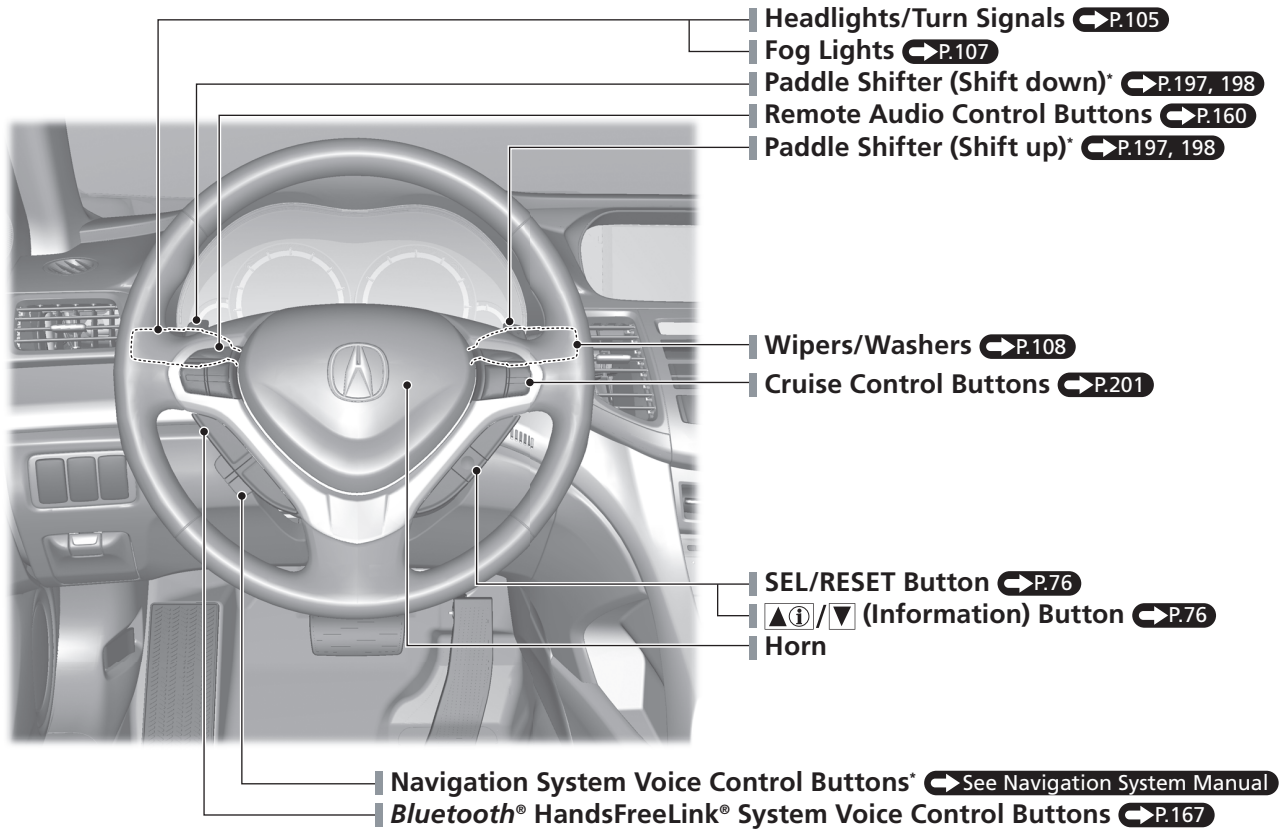

* Not available on all models

Visual Index

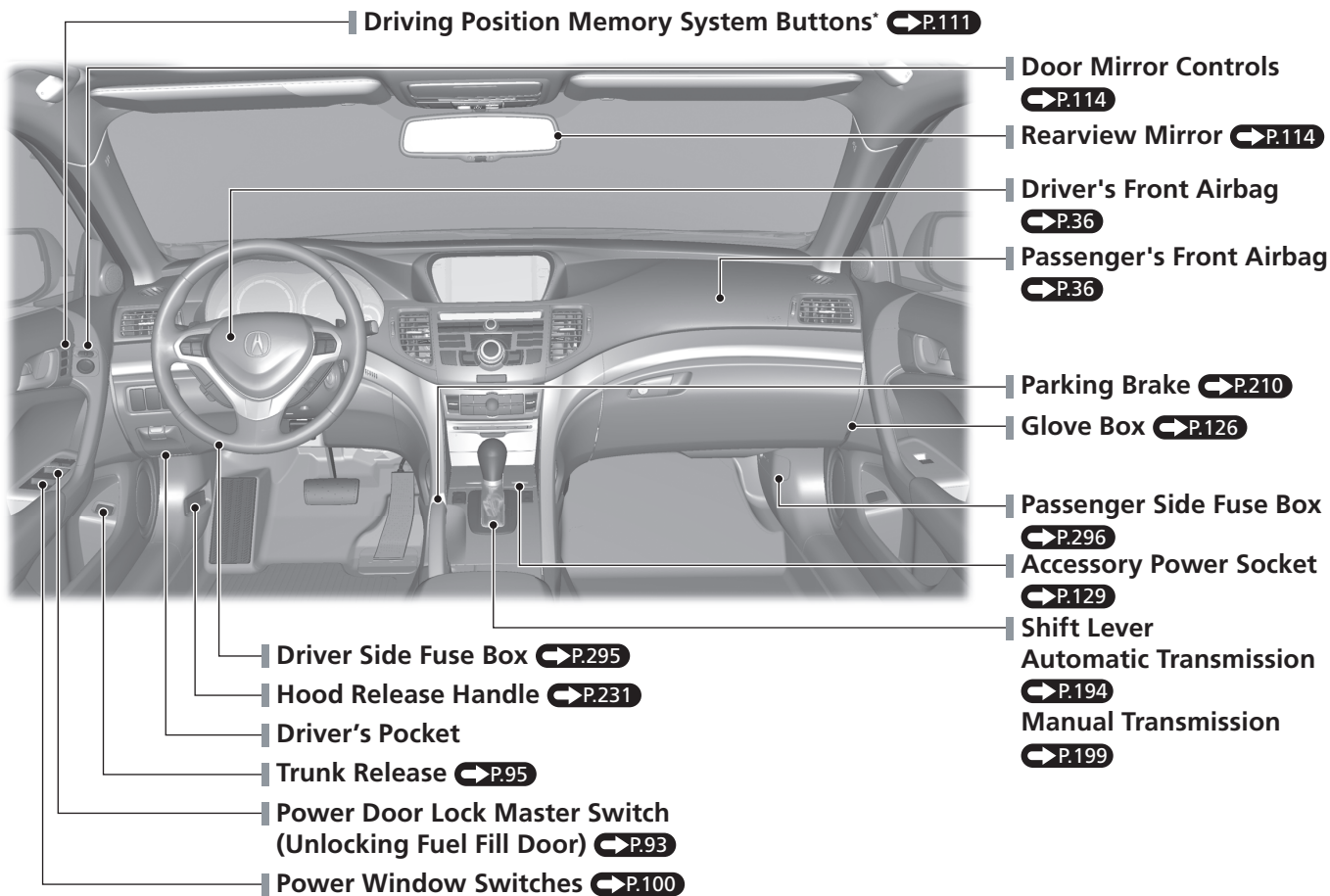

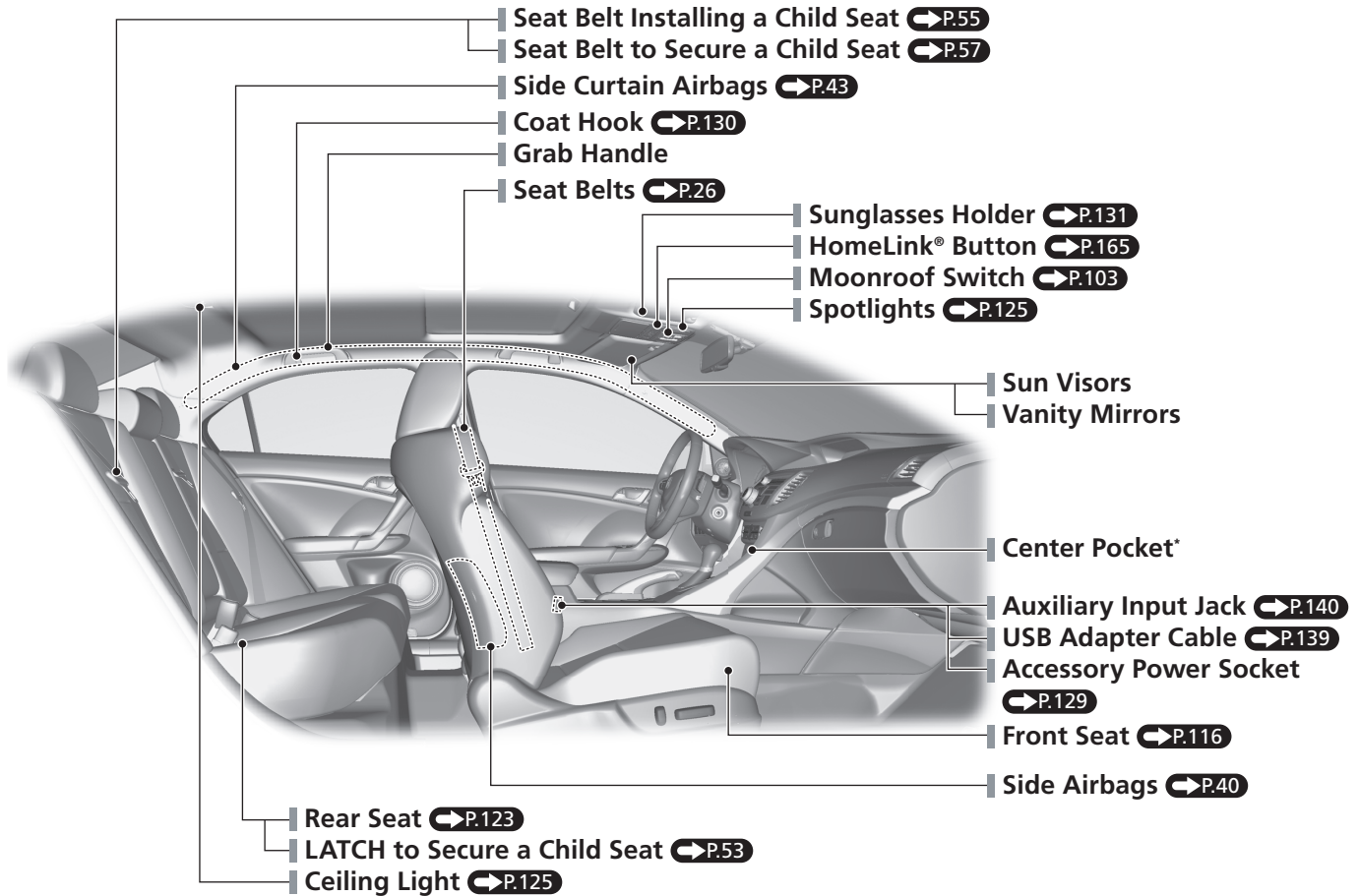

* Not available on all models

Visual Index

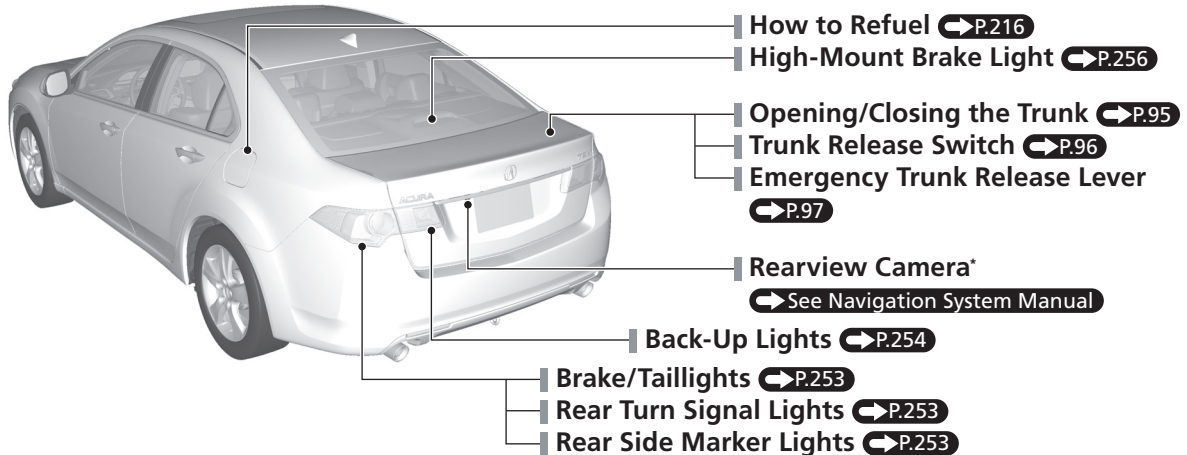
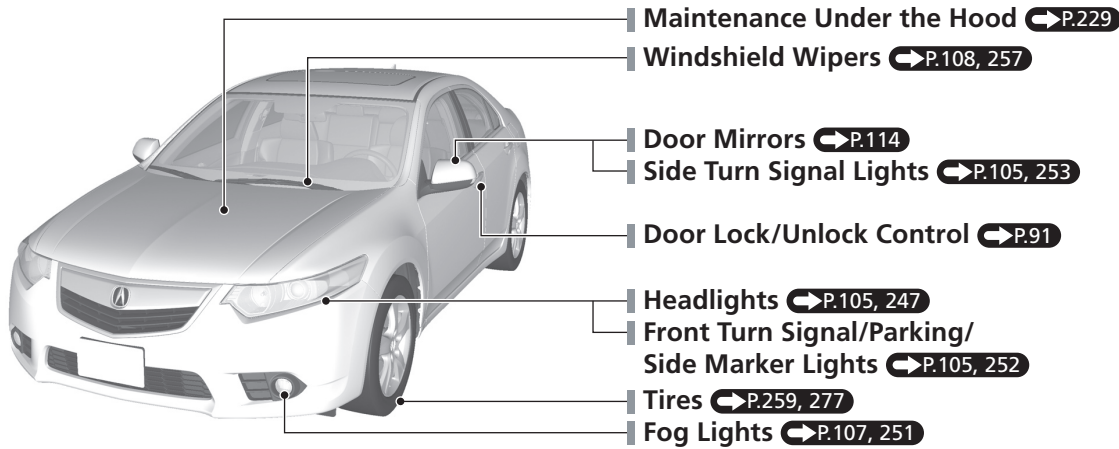

Safe Driving [↔P.21](#)

Airbags [↔P.33](#)

- Your vehicle is fitted with airbags to help protect you and your passengers during a moderate to severe collision.

Child Safety [↔P.48](#)

- All children 12 and younger should be seated in the rear seat.
- Smaller children should be properly restrained in a forward-facing child seat.
- Infants must be properly restrained in a rear-facing child seat.

Exhaust Gas Hazard [↔P.60](#)

- Your vehicle emits dangerous exhaust gases that contain carbon monoxide. Do not run the engine in confined spaces where carbon monoxide gas can accumulate.

Seat Belts [↔P.26](#)

- Fasten your seat belt and sit upright well back in the seat.
- Check that your passengers are wearing their seat belts correctly.

Before Driving Checklist [↔P.182](#)

- Before driving, check that the front seats, head restraints, steering wheel, and mirrors have been properly adjusted.



Fasten your lap belt as low as possible.

Instrument Panel P.63

Gauges P.75

Multi-Information Display P.76

System Indicators P.64

System Indicators

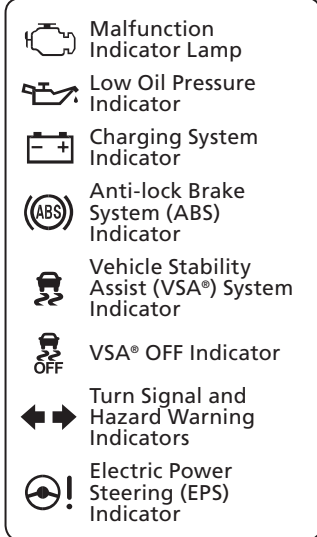

Lights Reminders

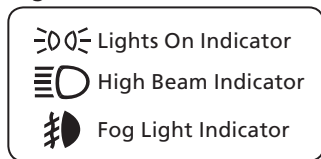

System Indicators

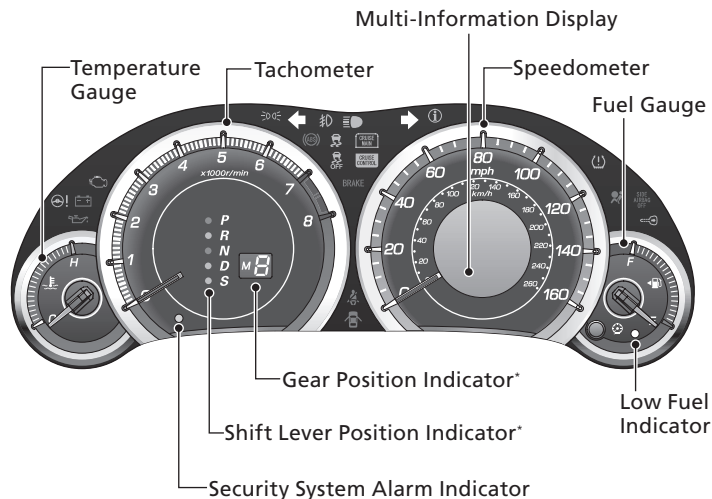
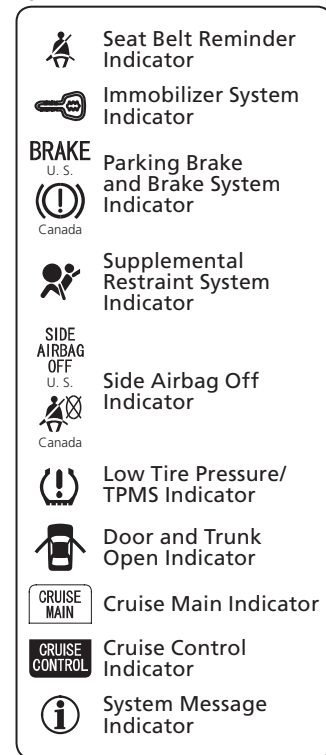

Controls ↔ P.87

Turn Signals ↔ P.105

Turn Signal Control Lever

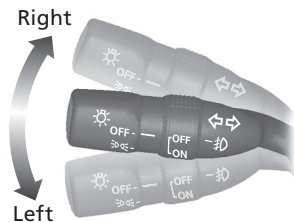

Lights ↔ P.105

Light Control Switches

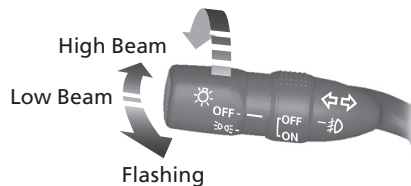

Wipers and Washers ↔ P.108

Wiper/Washer Control Lever

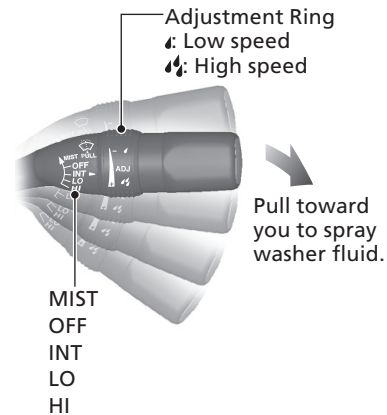

Steering Wheel P.113

- To adjust, pull the adjustment lever towards you, adjust to the desired position, then lock the lever back in place.

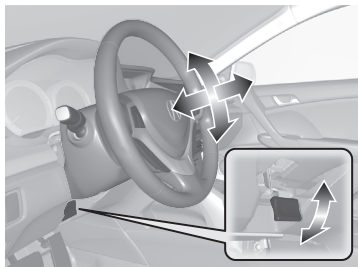

Trunk P.95

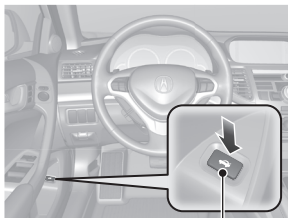

Trunk Release

- Push the trunk release on the driver's door, or on the remote transmitter. With the doors unlocked, press the trunk release switch on the trunk lid to open it.

Door Mirrors P.114

- With the ignition switch in ON , move the selector switch to L or R.
- Push the appropriate edge of the adjustment switch to adjust the mirror.

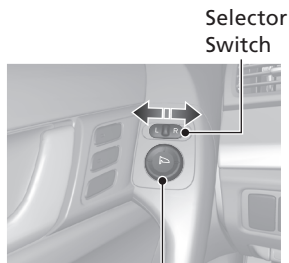

Selector Switch

Adjustment Switch

- Place the selector switch in the R position to use the reverse tilt door mirror feature.

Power Windows P.100

- With the ignition switch in ON , open and close the power windows.
- If the main switch is in the OFF position, each passenger's window can be opened and closed with its own switch.
- If the main switch is in the ON position (indicator is on), each passenger's window switch is disabled.

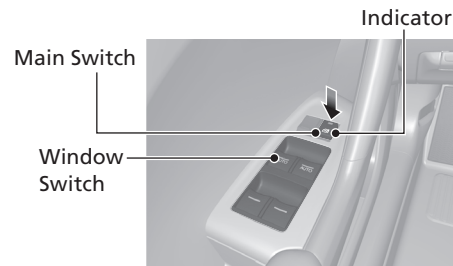

Indicator

Main Switch

Window Switch

Climate Control System P.133

- Press the AUTO button to activate the climate control system.
- Press the button to turn the system on or off.
- Press the button to defrost the windshield.

On models with navigation system

The climate control system is voice operable. See the navigation system manual for complete details.

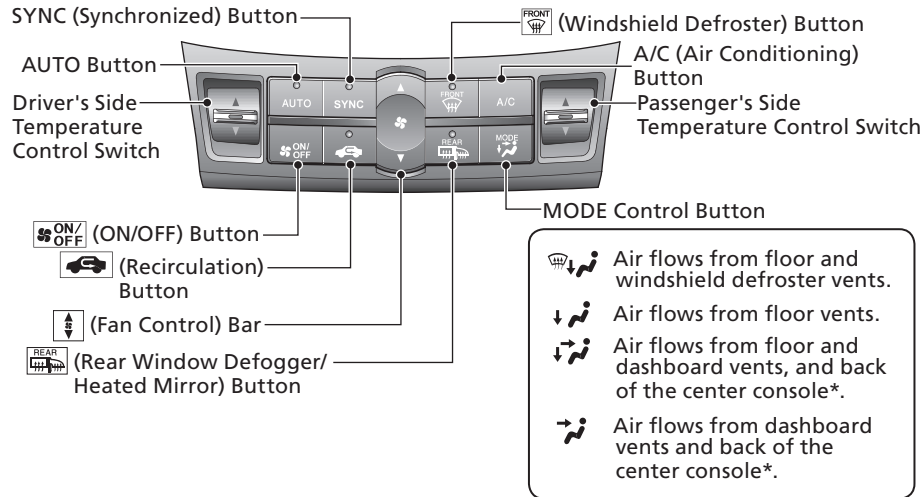

Clock P.88

Models without navigation system

- 1 Press the CLOCK button until the displayed time begins flashing.
- 2 Press Preset (Hour) or (Minute) to set the time. Press Preset (Reset) to set the time to the nearest hour.
- 3 Press the CLOCK button again to set the time.

Models with navigation system

The navigation system receives signals from GPS satellites, updating the clock automatically.

* Not available on all models

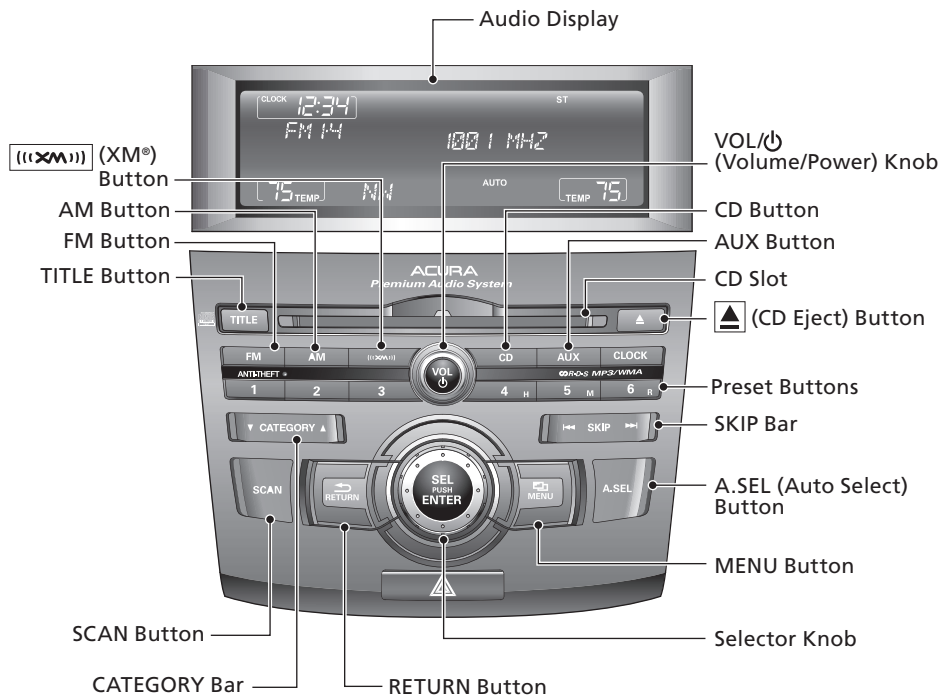

Features P.137

Audio System* P.141

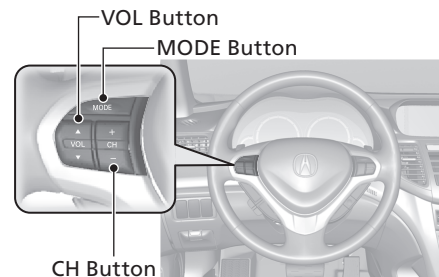

● Audio Remote Controls P.160



- VOL (volume) Button
Press  /  to adjust the volume up/down.
 - MODE Button
Press and release to change the audio mode: FM1/FM2/AM/XM1/XM2/CD/AUX.
 - CH (channel) Button
Radio: Press and release to change the preset station.
Press and hold to select the next or previous strong station.
- CD/USB device:
Press and release to skip to the beginning of the next song or return to the beginning of the current song.
Press and hold to change a folder.

Driving

Manual Transmission

Automatic Transmission

- Shift to **P** and depress the brake pedal when starting the engine.

● Shifting

P **Park**
Turn off or start the engine.
Transmission is locked.

R **Reverse**

N **Neutral**
Transmission is not locked.

D **Drive**
Normal driving. D-paddle shift mode can be used.

S **S Position**
Sequential shift mode can be used.

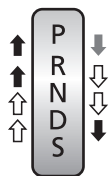
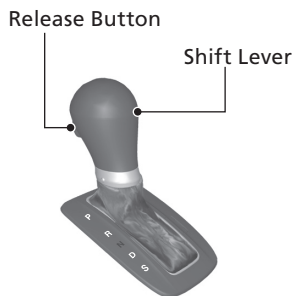

- ↓ Depress the brake pedal and press the release button to move out of **P**.
- ↓ ↑ Press the release button to move the shift lever.
- ↓ ↑ Move the shift lever without pressing the release button.

Paddle Shifters

- Paddle shifters allow you to shift gears much like a manual transmission (1st through 5th). This is useful for engine braking.

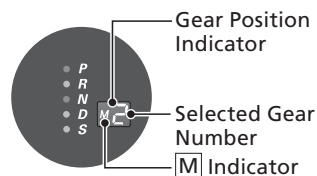

Shift Down **-**
Paddle Shifter

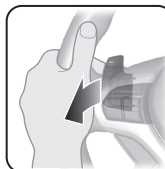

Shift Up **+**
Paddle Shifter

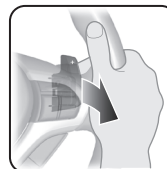

- D-paddle shift mode: The transmission will shift back to automatic mode once the system detects that the vehicle is cruising.
- Sequential shift mode: Holds the selected gear, and the M indicator comes on.

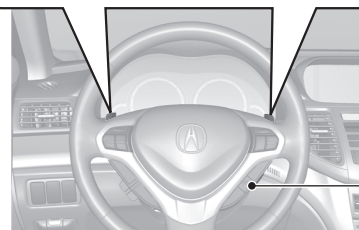

Ignition Switch

* Not available on all models

VSA® OFF Button P.205

- The vehicle stability assist (VSA®) system helps stabilize the vehicle during cornering, and helps maintain traction while accelerating on loose or slippery road surfaces.
- VSA® comes on automatically every time you start the engine.
- To turn VSA® on or off, press and hold the button until you hear a beep.

Cruise Control P.201

- Cruise control allows you to maintain a set speed without keeping your foot on the accelerator pedal.
- To use cruise control, press the CRUISE button, then press DECEL/SET when the vehicle speed is above 25 mph (40 km/h).

Tire Pressure Monitoring System (TPMS) P.206

- TPMS monitors tire pressure.
- TPMS is turned on automatically every time you start the engine.

Refueling P.215

Fuel recommendation: **4-cylinder models**
Premium unleaded gasoline with a pump octane number 91 or higher recommended

6-cylinder models
Premium unleaded gasoline with a pump octane number 91 or higher required

Fuel tank capacity: 18.5 US gal (70 L)

- 1** Unlock the driver's door.
- 2** Press on the edge of the fuel fill door to make it pop up slightly.
- 3** Turn the fuel fill cap slowly to remove the cap.
- 4** Place the cap in the holder on the fuel fill door.
- 5** After refueling, screw the cap back on until it clicks at least once.

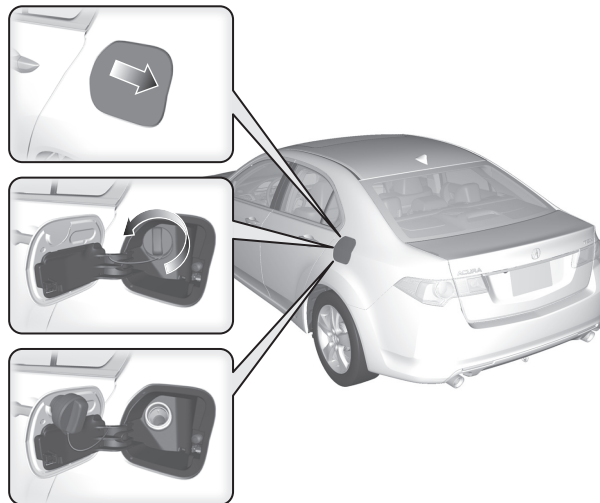

Maintenance P.221

Under the Hood P.229

- Check engine oil, engine coolant, and windshield washer fluid. Add when necessary.
- Check brake fluid and clutch fluid.
- Check the battery regularly.

- 1** Pull the hood release handle under the corner of the dashboard.

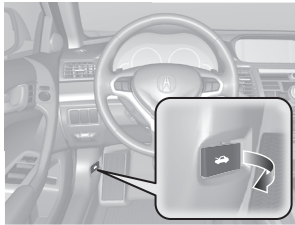

- 2** Locate the hood latch lever, pull the lever up, and lift up the hood.



- 3** When finished, close the hood and make sure it is firmly locked in place.

Wiper Blades P.257

- Replace blades if they leave streaks across the windshield.

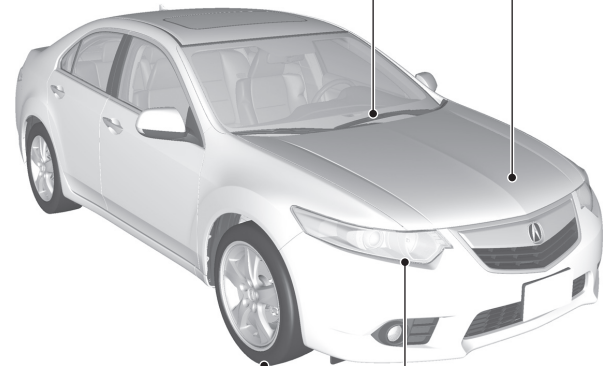

Tires P.259

- Inspect tires and wheels regularly.
- Check tire pressures regularly.
- Install snow tires for winter driving.

Lights P.247

- Inspect all lights regularly.

Handling the Unexpected ↔ P.275

Flat Tire ↔ P.277

- Park in a safe location and replace the flat tire with the compact spare tire in the trunk.



Engine Won't Start ↔ P.283

- If the battery is dead, jump start using a booster battery.

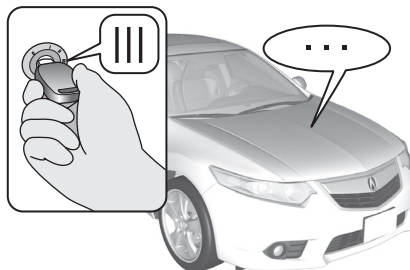

Overheating ↔ P.288

- Park in a safe location. If you do not see steam under the hood, open the hood, and let the engine cool down.



Indicators Come On

↔ P.290

- Identify the indicator and consult the owner's manual.



Blown Fuse ↔ P.294

- Check for a blown fuse if an electrical device does not operate.

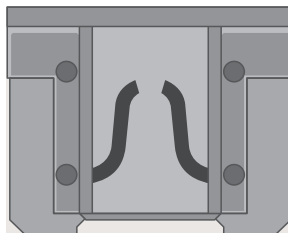

Emergency Towing ↔ P.298

- Call a professional towing service if you need to tow your vehicle.



What to Do If

Q The ignition switch does not turn from **0** to **I**. Why?

- A**
- The steering wheel may be locked.
 - Try to turn the steering wheel left and right while turning the ignition key.

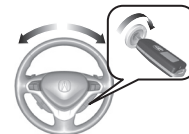

Q The ignition switch does not turn from **I** to **0** and I cannot remove the key. Why?

- A** The shift lever should be moved to **P**.

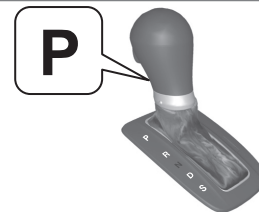

Q Why does the brake pedal pulsate slightly when applying the brakes?

- A** This can occur when the ABS activates, and does not indicate a problem. Apply firm, steady pressure on the brake pedal. Never pump the brake pedal.

Q The rear door cannot be opened from inside the vehicle. Why?

- A** Check if the childproof lock is in the LOCK position. If so, open the rear door with the outside door handle. To cancel this function, push the lever to the UNLOCK position.

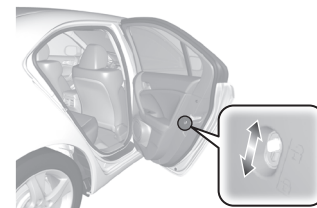

Q Why do the doors lock after I unlocked the doors using a remote transmitter?

- A** If you do not open the doors within 30 seconds, the doors are relocked automatically for security.

Q Why does the beeper sound when I open the driver's door?

A The beeper sounds when:

- The key is left in the ignition switch.
- The exterior lights are left on.

Q Why does the beeper sound when I start driving?

A The beeper sounds when:

- Driver and/or front passenger are not wearing their seat belts.
- The parking brake lever is not fully released.

Q Why do I hear a screeching sound when I apply the brake pedal?

A The brake pads may need to be replaced. Have your vehicle inspected by a dealer.

Q Is it possible to use unleaded gasoline with a Pump Octane Number (PON) of 87 or higher on this vehicle?

A If premium unleaded gasoline with a PON of 91 or higher is not available, you can temporarily use the gasoline with a PON of 87 or higher. This will result in decreased engine performance, and can cause occasional metallic knocking noise in the engine.

4-cylinder models
Unleaded gasoline with a PON of 91 or higher is recommended.

6-cylinder models
Unleaded gasoline with a PON of 91 or higher is required. The long-term use of a lower PON gasoline can lead to engine damage.

California Proposition 65 Warning

WARNING: This product contains or emits chemicals known to the state of California to cause cancer and birth defects or other reproductive harm.

Event Data Recorders

This vehicle is equipped with one or more devices commonly referred to as event data recorders. These devices record front seat belt use, front passenger seat occupancy, airbag deployment data, and the failure of any airbag system component. This data belongs to the vehicle owner and may not be accessed by anyone else except as legally required or with the permission of the vehicle owner.

Service Diagnostic Recorders

This vehicle is equipped with service-related devices that record information about powertrain performance. The data can be used to verify emissions law requirements and/or help technicians diagnose and solve service problems. It may also be combined with data from other sources for research purposes, but it remains confidential.

California Perchlorate Contamination Prevention Act

The airbags, seat belt tensioners, and CR type batteries in this vehicle may contain perchlorate materials - special handling may apply. See www.dtsc.ca.gov/hazardouswaste/perchlorate/

Information preceded by a **NOTICE** symbol is intended to help you avoid damage to your vehicle, other property, or the environment.

A Few Words About Safety

Your safety, and the safety of others, is very important. And operating this vehicle safely is an important responsibility.

To help you make informed decisions about safety, we have provided operating procedures and other information on labels and in this manual. This information alerts you to potential hazards that could hurt you or others.

Of course, it is not practical or possible to warn you about all the hazards associated with operating or maintaining your vehicle. You must use your own good judgement.

You will find this important safety information in a variety of forms, including:

- **Safety Labels** - on the vehicle.
- **Safety Messages** - preceded by a safety alert symbol  and one of three signal words: **DANGER**, **WARNING**, or **CAUTION**.

These signal words mean:

 **DANGER**

You **WILL** be **KILLED** or **SERIOUSLY HURT** if you don't follow instructions.

 **WARNING**

You **CAN** be **KILLED** or **SERIOUSLY HURT** if you don't follow instructions.

 **CAUTION**

You **CAN** be **HURT** if you don't follow instructions.

- **Safety Headings** - such as Important Safety Precautions.
- **Safety Section** - such as Safe Driving.
- **Instructions** - how to use this vehicle correctly and safely.

This entire book is filled with important safety information - please read it carefully.

Safe Driving

You can find many safety recommendations throughout this chapter, and throughout this manual.

For Safe Driving

Important Safety Precautions.....	22
Your Vehicle's Safety Features.....	24

Seat Belts

About Your Seat Belts.....	26
Fastening a Seat Belt.....	29
Seat Belt Inspection	32

Airbags

Airbag System Components.....	33
Types of Airbags	36
Front Airbags (SRS)	36
Side Airbags.....	40

Side Curtain Airbags.....	43
Airbag System Indicators.....	44
Airbag Care	47

Child Safety

Protecting Child Passengers	48
Safety of Infants and Small Children.....	50
Safety of Larger Children	58

Exhaust Gas Hazard

Carbon Monoxide Gas.....	60
--------------------------	----

Safety Labels

Label Locations	61
-----------------------	----

The following pages explain your vehicle's safety features and how to use them properly. The safety precautions below are ones that we consider to be among the most important.

Important Safety Precautions

■ Always wear your seat belt

A seat belt is your best protection in all types of collisions. Airbags are designed to supplement seat belts, not replace them. So even though your vehicle is equipped with airbags, make sure you and your passengers always wear your seat belts, and wear them properly.

■ Restrain all children

Children age 12 and under should ride properly restrained in a back seat, not the front seat. Infants and small children should be restrained in a child seat. Larger children should use a booster seat and a lap/shoulder seat belt until they can use the belt properly without a booster seat.

■ Be aware of airbag hazards

While airbags can save lives, they can cause serious or fatal injuries to occupants who sit too close to them, or are not properly restrained. Infants, young children, and short adults are at the greatest risk. Be sure to follow all instructions and warnings in this manual.

■ Don't drink and drive

Alcohol and driving don't mix. Even one drink can reduce your ability to respond to changing conditions, and your reaction time gets worse with every additional drink. So don't drink and drive, and don't let your friends drink and drive, either.

⌘ Important Safety Precautions

Some states, provinces and territories prohibit the use of cell phones other than hands-free devices by the driver while driving.

■ **Pay appropriate attention to the task of driving safely**

Engaging in cell phone conversation or other activities that keep you from paying close attention to the road, other vehicles, and pedestrians could lead to a crash. Remember, situations can change quickly, and only you can decide when it is safe to divert some attention away from driving.

■ **Control your speed**

Excessive speed is a major factor in crash injuries and deaths. Generally, the higher the speed, the greater the risk, but serious injuries can also occur at lower speeds. Never drive faster than is safe for current conditions, regardless of the maximum speed posted.

■ **Keep your vehicle in safe condition**

Having a tire blowout or a mechanical failure can be extremely hazardous.

To reduce the possibility of such problems, check your tire pressures and condition frequently, and perform all regularly scheduled maintenance.

Your Vehicle's Safety Features

Your vehicle is equipped with many features that work together to help protect you and your passengers during a crash.

Some features do not require any action on your part. These include a strong steel framework that forms a safety cage around the passenger compartment, front and rear crush zones, a collapsible steering column, and tensioners that tighten the front seat belts in a crash.

However, you and your passengers cannot take full advantage of these features unless you remain seated in the correct position and always wear your seat belts. In fact, some safety features can contribute to injuries if they are not used properly.

The following checklist will help you take an active role in protecting yourself and your passengers.

Safety CheckList

For the safety of you and your passengers, make a habit of checking these items each time before you drive.

- After everyone has entered the vehicle, be sure all doors are closed and locked. Locking the doors helps prevent an occupant from being ejected and an outsider from unexpectedly opening a door.

➤ **Locking/Unlocking the Doors from Inside** P.93

- Adjust your seat to a position suitable for driving. Be sure the front seats are adjusted as far to the rear as possible while allowing the driver to control the vehicle. Sitting too close to a front airbag can result in serious or fatal injury in a crash.

➤ **Adjusting the Seats** P.116

- Adjust head restraints to the proper position. Head restraints are most effective when the center of the head restraint aligns with the center of your head. Taller persons should adjust their head restraint to the highest position.

➤ **Adjusting the Head Restraints** P.118

- Always wear your seat belt, and make sure you wear it properly. Confirm that any passengers are properly belted as well.

➤ **Fastening a Seat Belt** P.29

- Protect children by using seat belts or child seats according to a child's age, height and weight.

➤ **Child Safety** P.48

➤ Safety CheckList

If the door and trunk open indicator is on, a door and/or the trunk is not completely closed. Close all doors and the trunk tightly until the indicator goes off.

➤ **Door and Trunk Open indicator** P.68

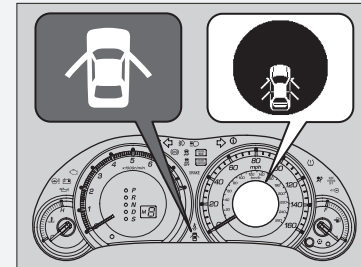

About Your Seat Belts

Seat belts are the single most effective safety device because they keep you connected to the vehicle so that you can take advantage of many built-in safety features. They also help keep you from being thrown against the inside of the vehicle, against other passengers, or out of the vehicle. When worn properly, seat belts also keep your body properly positioned in a crash so that you can take full advantage of the additional protection provided by the airbags.

In addition, seat belts help protect you in almost every type of crash, including:

- frontal impacts
- side impacts
- rear impacts
- rollovers

■ Lap/shoulder seat belts

All five seating positions are equipped with lap/shoulder seat belts with emergency locking retractors. In normal driving the retractor lets you move freely while keeping some tension on the belt. During a collision or sudden stop the retractor locks to restrain your body. The rear seat belts also have a lockable retractor for use with child seats.

➤ **Installing a Child Seat using the Lockable Retractor Seat Belt** P.55

ⓘ About Your Seat Belts

WARNING

Not wearing a seat belt properly increases the chance of serious injury or death in a crash, even though your vehicle has airbags.

Be sure you and your passengers always wear seat belts and wear them properly.

Seat belts cannot completely protect you in every crash. But in most cases, seat belts can reduce your risk of serious injury.

Most states and all Canadian provinces and territories require you to wear seat belts.

■ Proper use of seat belts

Follow these guidelines for proper use:

- All occupants should sit upright, well back in the seat, and remain in that position for the duration of the trip. Slouching and leaning reduces the effectiveness of the belt and can increase the chance of serious injury in a crash.
- Never place the shoulder part of a lap/shoulder seat belt under your arm or behind your back. This could cause very serious injuries in a crash.
- Two people should never use the same seat belt. If they do, they could be very seriously injured in a crash.
- Do not put any accessories on the seat belts. Devices intended to improve comfort or reposition the shoulder part of a seat belt can reduce the protective capability and increase the chance of serious injury in a crash.

■ Seat Belt Reminder

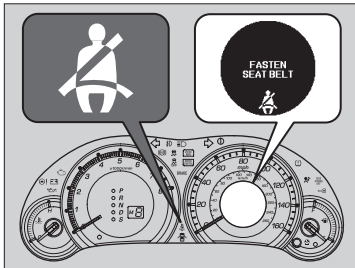

Your vehicle monitors front seat belt use. If the ignition switch is turned to ON **II** before the driver's seat belt is fastened, a beeper will sound and the indicator will blink. If the driver does not fasten the belt before the beeper stops, the indicator will remain on.

The beeper will also periodically sound and the indicator will blink while driving until the driver's and front passenger's seat belts are fastened.

▣ About Your Seat Belts

If a rear seat passenger moves around and extends the seat belt, the lockable retractor may activate. If this happens, release the retractor by unfastening the seat belt and allow the belt to retract completely. Then refasten the belt.

▣ Seat Belt Reminder

The indicator will also come on if a front passenger does not fasten their seat belt within 6 seconds after the ignition switch is turned to ON **II**. When no one is sitting in the front passenger's seat, or a child or small adult is riding there, the indicator will not come on. This is because the weight sensors in the seat cannot detect their presence.

Automatic Seat Belt Tensioners

The front seats are equipped with automatic seat belt tensioners to enhance safety.

The tensioners automatically tighten the front seat belts during a moderate-to-severe frontal collision, sometimes even if the collision is not severe enough to inflate the front airbags.

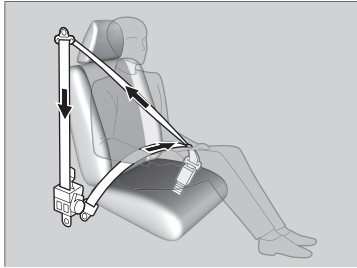

⊠ Automatic Seat Belt Tensioners

The seat belt tensioners can only operate once. If a tensioner is activated, the SRS indicator will come on. Have a dealer replace the tensioner and thoroughly inspect the seat belt system as it may not offer protection in a subsequent crash.

During a moderate-to-severe side impact, the tensioner on that side of the vehicle also activates.

Fastening a Seat Belt

After adjusting a front seat to the proper position, and while sitting upright and well back in the seat:

✎ Adjusting the Seats P.116

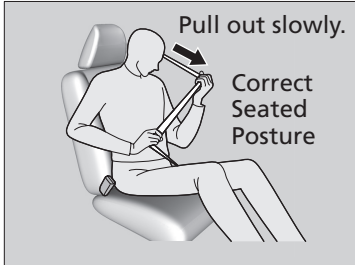

1. Pull the seat belt out slowly.

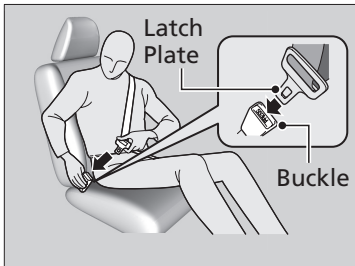

2. Insert the latch plate into the buckle, then tug on the belt to make sure the buckle is secure.

▶ Make sure that the belt is not twisted or caught on anything.

✎ Fastening a Seat Belt

No one should sit in a seat with an inoperative seat belt or one that does not appear to be working correctly. Using a seat belt that is not working properly may not protect the occupant in a crash. Have a dealer check the belt as soon as possible.

Never insert any foreign objects into the buckle or retractor mechanism.



3. Position the lap part of the belt as low as possible across your hips, then pull up on the shoulder part of the belt so the lap part fits snugly. This lets your strong pelvic bones take the force of a crash and reduces the chance of internal injuries.
4. If necessary, pull up on the belt again to remove any slack, then check that the belt rests across the center of your chest and over your shoulder. This spreads the forces of a crash over the strongest bones in your upper body.

⊗ Fastening a Seat Belt

⚠ WARNING

Improperly positioning the seat belts can cause serious injury or death in a crash.

Make sure all seat belts are properly positioned before driving.

To release the belt, push the red PRESS button then guide the belt by hand until it has retracted completely.

When exiting the vehicle, be sure the belt is out of the way and will not get closed in the door.

⊗ Adjusting the Shoulder Anchor

The shoulder anchor height can be adjusted to four levels. If the belt contacts your neck, lower the height one level at a time.

After an adjustment, make sure that the shoulder anchor position is secure.

Adjusting the Shoulder Anchor

The front seats have adjustable shoulder anchors to accommodate taller and shorter occupants.

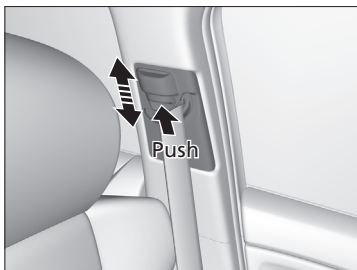

1. Move the anchor up and down while holding the release button.
2. Position the anchor so that the belt rests across the center of your chest and over your shoulder.

Advice for Pregnant Women

If you are pregnant, the best way to protect yourself and your unborn child when driving or riding in a vehicle is to always wear a seat belt and keep the lap part of the belt as low as possible across the hips.

Wear the shoulder belt across the chest avoiding the abdomen.



Wear the lap part of the belt as low as possible across the hips.

Advice for Pregnant Women

Each time you have a checkup, ask your doctor if it is okay for you to drive.

To reduce the risk of injuries to both you and your unborn child that can be caused by an inflating front airbag:

- When driving, sit upright and adjust the seat as far back as possible while allowing full control of the vehicle.
- When sitting in the front passenger's seat, adjust the seat as far back as possible.

Seat Belt Inspection

Regularly check the condition of your seat belts as follows:

- Pull each belt out fully, and look for frays, cuts, burns, and wear.
- Check that the latches work smoothly and the belts retract easily.
 - ▶ If a belt does not retract easily, cleaning the belt may correct the problem. Only use a mild soap and warm water. Do not use bleach or cleaning solvents. Make sure the belt is completely dry before allowing it to retract.

Any belt that is not in good condition or working properly will not provide proper protection and should be replaced as soon as possible.

A belt that has been worn during a crash may not provide the same level of protection in a subsequent crash. Have your seat belts inspected by a dealer after any collision.

⊗ Seat Belt Inspection

⚠ WARNING

Not checking or maintaining seat belts can result in serious injury or death if the seat belts do not work properly when needed.

Check your seat belts regularly and have any problem corrected as soon as possible.

Airbag System Components

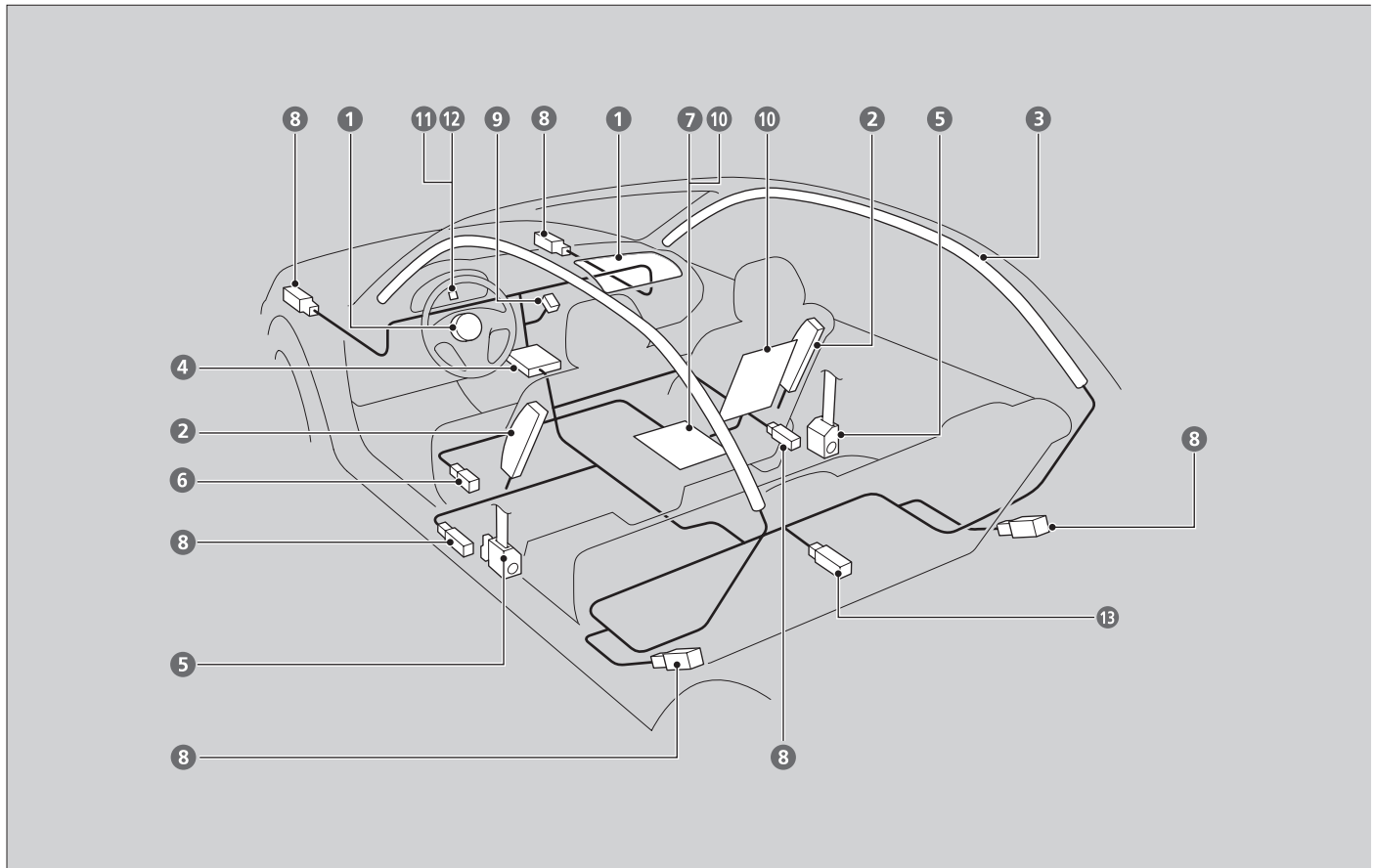

Continued

The front, front side, and side curtain airbags are deployed according to the direction and severity of impact. The airbag system includes:

- 1 Two SRS (Supplemental Restraint System) front airbags. The driver's airbag is stored in the center of the steering wheel; the front passenger's airbag is stored in the dashboard. Both are marked "SRS AIRBAG".
- 2 Two side airbags, one for the driver and one for a front passenger. The airbags are stored in the outer edges of the seat-backs. Both are marked "SIDE AIRBAG."
- 3 Two side curtain airbags, one for each side of the vehicle. The airbags are stored in the ceiling, above the side windows. The front and rear pillars are marked "SIDE CURTAIN AIRBAG."
- 4 An electronic control unit that continually monitors and records information about the sensors, the airbag activators, the seat belt tensioners, and driver and front passenger seat belt use when the ignition switch is in ON **II**.
- 5 Automatic front seat belt tensioners. The driver's and front passenger's seat belts incorporate sensors that detect whether or not they are fastened.
- 6 A driver's seat position sensor. If the seat is too far forward, the airbag will inflate with less force.
- 7 Weight sensors in the front passenger's seat. The front passenger's airbag will be turned off if the weight on the seat is 65 lbs (29 kg) or less (the weight of an infant or small child).
- 8 Impact sensors that can detect a moderate to severe front or side collision.
- 9 An indicator on the dashboard that alerts you that the front passenger's front airbag has been turned off.
- 10 Sensors that can detect if a child or small statured adult is in the deployment path of the front passenger's side airbag.
- 11 An indicator on the instrument panel that alerts you to a possible problem with your airbag system or seat belt tensioners.
- 12 An indicator on the instrument panel that alerts you that the front passenger's side airbag has been turned off.
- 13 Safing Sensor

Important Facts About Your Airbags

Airbags can pose serious hazards. To do their job, airbags must inflate with tremendous force. So, while airbags help save lives, they can cause minor injuries, sometimes even fatal ones if occupants are not properly wearing their seat belts properly and sitting correctly.

What you should do: Always wear your seat belt properly, and sit upright and as far back from the steering wheel as possible while allowing full control of the vehicle. A front passenger should move their seat as far back from the dashboard as possible.

Remember, however, that no safety system can prevent all injuries or deaths that can occur in a severe crash, even when seat belts are properly worn and the airbags deploy.

Do not place hard or sharp objects between yourself and a front airbag.

Carrying hard or sharp objects on your lap, or driving with a pipe or other sharp object in your mouth, can result in injuries if your front airbag inflates.

Do not attach or place objects on the front airbag covers. Objects on the covers marked "SRS AIRBAG" could interfere with the proper operation of the airbags or be propelled inside the vehicle and hurt someone if the airbags inflate.

⌘ Important facts about your airbags

Do not attempt to deactivate your airbags. Together, airbags and seat belts provide the best protection.

When driving, keep hands and arms out of the deployment path of the front airbag by holding each side of the steering wheel. Do not cross an arm over the airbag cover.

Types of Airbags

Your vehicle is equipped with three types of airbags:

- **Front airbags:** Airbags in front of the driver's and front passenger's seats.
- **Side airbags:** Airbags in the driver's and front passenger's seat-backs.
- **Side curtain airbags:** Airbags above the side windows.

Each is discussed in the following pages.

Front Airbags (SRS)

The front SRS airbags inflate in a moderate to severe frontal collision to help protect the head and chest of the driver and/or front passenger.

SRS (Supplemental Restraint System) indicates that the airbags are designed to supplement seat belts, not replace them. Seat belts are the occupant's primary restraint system.

Housing Locations

The front airbags are housed in the center of the steering wheel for the driver, and in the dashboard for the front passenger. Both airbags are marked SRS AIRBAG.

Types of Airbags

The airbags can inflate whenever the ignition switch is in ON **II**.

Front Airbags (SRS)

Dual-Stage, Multiple-Threshold Front Airbags (SRS)

Your vehicle is equipped with dual-stage, multiple-threshold front airbags (SRS).

During a frontal crash severe enough to cause one or both front airbags to deploy, the airbags can inflate at different rates, depending on the severity of the crash, whether or not the seat belts are latched, and/or other factors. Frontal airbags are designed to supplement the seat belts to help reduce the likelihood of head and chest injuries in frontal crashes.

■ Operation

Front airbags are designed to inflate during moderate-to-severe frontal collisions. When the vehicle decelerates suddenly, the sensors send information to the control unit which signals one or both front airbags to inflate.

A frontal collision can be either head-on or angled between two vehicles, or when a vehicle crashes into a stationary object, such as a concrete wall.

■ How the Front Airbags Work

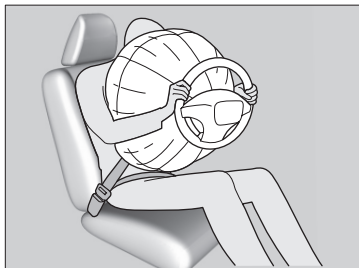

While your seat belt restrains your torso, the front airbag provides supplemental protection for your head and chest.

The front airbags deflate immediately so that they won't interfere with the driver's visibility or the ability to steer or operate other controls.

The total time for inflation and deflation is so fast that most occupants are not aware that the airbags deployed until they see them lying in front of them.

☒ How the Front Airbags Work

After a front airbag inflates in a crash, you may see what looks like smoke. This is actually powder from the airbag's surface. Although the powder is not harmful, people with respiratory problems may experience some temporary discomfort. If this occurs, get out of the vehicle as soon as it is safe to do so.

Although the driver's and front passenger's airbags normally inflate within a split second of each other, it is possible for only one airbag to deploy. This can happen if the severity of a collision is at the margin, or threshold, that determines whether or not the airbags will deploy. In such cases, the seat belt will provide sufficient protection, and the supplemental protection offered by the airbag would be minimal.

■ When front airbags should not deploy

Minor frontal crashes: Front airbags were designed to supplement seat belts and help save lives, not to prevent minor scrapes, or even broken bones that might occur during a less than moderate-to-severe frontal crash.

Side impacts: Front airbags can provide protection when a sudden deceleration causes a driver or front passenger to move towards the front of the vehicle. Side airbags and side curtain airbags have been specifically designed to help reduce the severity of injuries that can occur during a moderate-to-severe side impact which can cause the driver or passenger to move towards the side of the vehicle.

Rear impacts: Head restraints and seat belts are your best protection during a rear impact. Front airbags cannot provide any significant protection and are not designed to deploy in such collisions.

Rollovers: Seat belts, and in vehicles equipped with a rollover sensor, side airbags, and side curtain airbags offer the best protection in a rollover. Because front airbags could provide little if any protection, they are not designed to deploy during a rollover.

■ When front airbags deploy with little or no visible damage

Because the airbag system senses sudden deceleration, a strong impact to the vehicle framework or suspension might cause one or more of the airbags to deploy. Examples include running into a curb, the edge of a hole, or other low fixed object that causes a sudden deceleration in the vehicle chassis. Since the impact is underneath the vehicle, damage may not be readily apparent.

■ When front airbags may not deploy, even though exterior damage appears severe

Since crushable body parts absorb crash energy during an impact, the amount of visible damage does not always indicate proper airbag operation. In fact, some collisions can result in severe damage but no airbag deployment because the airbags would not have been needed or would not have provided protection even if they had deployed.

Advanced Airbags

Your front airbags have advanced features to reduce the likelihood of airbag related injuries to smaller occupants.

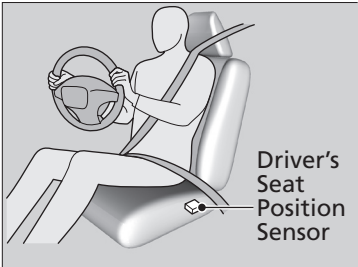

The driver's advanced front airbag system includes a seat position sensor. If the seat is too far forward, the airbag inflates with less force, regardless of the severity of the impact.

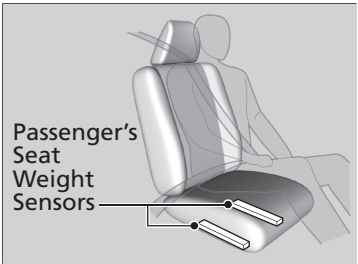

The passenger's advanced front airbag system includes weight sensors. Although Acura recommends against carrying an infant or small child in front, if the sensors detect the weight of a child (up to about 65 lbs or 29 kg), the system will automatically turn off the passenger's front airbag.

Advanced Airbags

If there is a problem with the driver's seat position sensor, the SRS indicator will come on and the airbag will inflate with full (normal) force, regardless of the driver's seating position.

- For both advanced front airbags to work properly:
- Do not spill any liquid on or under the seats.
 - Do not put any object under the passenger's seat.
 - Make sure any objects are positioned properly on the rear floor. Improperly positioned objects can interfere with the advanced airbag sensors.
 - All occupants should sit upright and wear their seat belts properly.

Side Airbags

The side airbags help protect the upper torso of the driver or a front passenger during a moderate to severe side impact.

Housing Locations



The side airbags are housed in the outside edge of the driver's and passenger's seat-backs.

Both are marked SIDE AIRBAG.

Operation

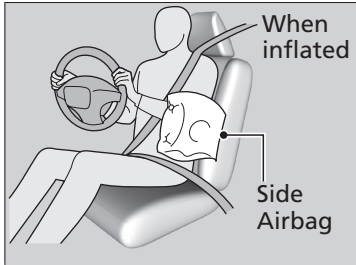

When the sensors detect a moderate-to-severe side impact, the control unit signals the side airbag on the impact side to immediately inflate.

Side Airbags

Do not attach accessories on or near the side airbags. They can interfere with the proper operation of the airbags, or hurt someone if an airbag inflates.

If the impact is on the passenger side, the airbag deploys even if there is no passenger in the passenger's seat.

Do not cover or replace the front seat-back covers without consulting a dealer. Improperly replacing or covering front seat-back covers can prevent your side airbags from properly deploying during a side impact.

■ When a side airbag deploys with little or no visible damage

Because the airbag system senses sudden acceleration, a strong impact to the side of the vehicle's framework can cause a side airbag to deploy. In such cases, there may be little or no damage, but the side impact sensors detected a severe enough impact to deploy the airbag.

■ When a side airbag may not deploy, even though visible damage appears severe

It is possible for a side airbag to not deploy during an impact that results in apparently severe damage. This can occur when the point of impact was towards the far front or rear of the vehicle, or when the vehicle's crushable body parts absorbed most of the crash energy. In either case, the side airbag would not have been needed nor provided protection even if it had deployed.

Side Airbag Cutoff System

To reduce the likelihood that a front passenger may be injured by an inflating side airbag, the passenger side airbag is automatically turned off when:

- The height sensors detect a child or short-statured adult is seated in the front passenger seat.
- The position sensor detects that the front passenger is leaning into the deployment path of the side airbag.

When the side airbag cutoff system is activated, the side airbag off indicator comes on.

➤ **Side Airbag Off Indicator** P.46

Side Airbag Off Indicator

If the side airbag off indicator comes on, have the passenger sit upright. A few seconds after the passenger is sitting properly, the side airbag will automatically be turned on, and the indicator will go off.

If the front passenger is a child, stop when it is safe to do so, and have the child sit properly restrained in a rear seat.

Side Airbag Cutoff System

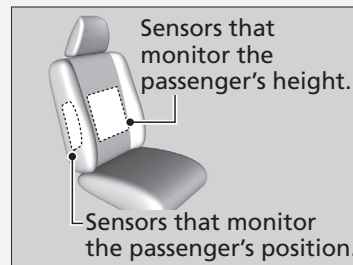

The sensors that monitor the front passenger's height and body position may not work if:

- The seat-back is wet
- The passenger is touching a metal or other electrical conductive object
- A seat cushion is on the seat
- The passenger is wearing excessively thick clothing

Side Curtain Airbags

The side curtain airbags help protect the heads of the driver and passengers in outer seating positions during a moderate-to-severe side impact.

Housing Locations

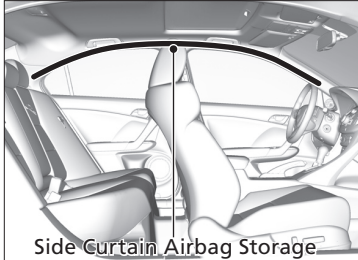

The side curtain airbags are located in the ceiling above the side windows on both sides of the vehicle.

Operation

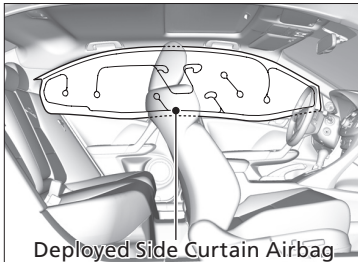

The side curtain airbag is designed to deploy in a moderate-to-severe side impact.

When side curtain airbags deploy in a frontal collision

One or both side curtain airbags may inflate in a moderate-to-severe angled frontal collision.

In this case, the side curtain airbags will deploy slightly after the front airbags.

Side Curtain Airbags

The side curtain airbags are most effective when an occupant is wearing their seat belt properly and sitting upright, well back in their seat.

Do not attach any objects to the side windows or roof pillars as they can interfere with the proper operation of the side curtain airbags.

Airbag System Indicators

If a problem occurs in the airbag system, the SRS indicator will come on and a message appears on the multi-information display.

■ SRS (Supplemental Restraint System) Indicator

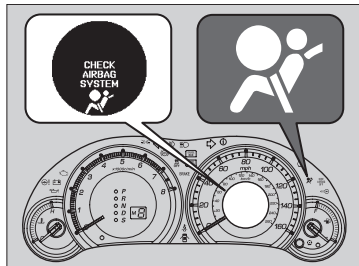

■ When the ignition switch is turned to ON

The indicator comes on briefly then goes off. This tells you the system is working properly.

If the indicator comes on at any other time, or does not come on at all, have the system checked by a dealer as soon as possible. If you don't, your airbags and seat belt tensioners may not work properly when they are needed.

⊗ Supplemental Restraint System (SRS) Indicator

⚠ WARNING

Ignoring the SRS indicator can result in serious injury or death if the airbag systems or tensioners do not work properly.

Have your vehicle checked by a dealer as soon as possible if the SRS indicator alerts you to a possible problem.

Passenger Airbag Off Indicator

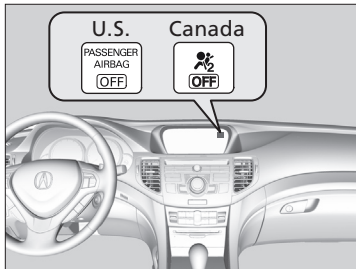

When the passenger airbag off indicator comes on

The indicator comes on to alert you that the passenger's front airbag has been turned off.

This occurs when the weight sensors detect 65 lbs (29 kg) or less, the weight of an infant or small child, on the seat.

Infants and small children should always ride properly restrained in a back seat.

➤ **Child Safety** P.48

Objects placed on the seat can also cause the indicator to come on.

If the front passenger seat is empty, the passenger's front airbag will not deploy and the indicator will not come on.

Passenger Airbag Off Indicator

If the indicator comes on with no front passenger and no objects on the passenger's seat, or with an adult riding there, something may be interfering with the weight sensors. Such as:

- An object hanging on the seat or in the seat-back pocket.
- A child seat or other object pressing against the rear of the seat-back.
- A rear passenger pushing or pulling on the back of the front passenger's seat.
- The front seat or seat-back is forced back against an object on the seat or floor behind it.
- An object placed under the front passenger's seat.

If none of these conditions exist, have your vehicle checked by a dealer as soon as possible.

The passenger airbag off indicator may come on and goes off repeatedly if the total weight on the seat is near the airbag cutoff threshold.

■ Side Airbag Off Indicator

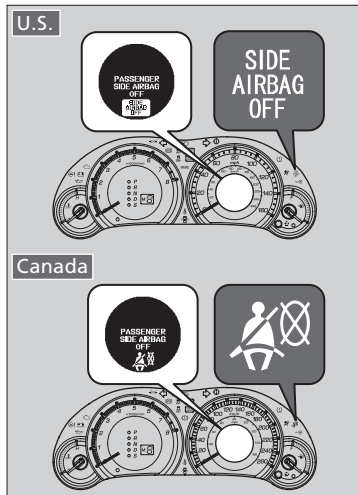

■ When the side airbag off indicator comes on

This indicator comes on if the passenger's side airbag has been turned off because the passenger is too small to be sitting in the front seat, is slouching or not sitting upright, or has leaned into the airbag's deployment path.

Unless the passenger is a smaller statured adult or a child, the indicator should go off when the passenger returns to a proper upright sitting position.

⊗ Side Airbag Off Indicator

When you turn the ignition switch to ON **II**, the indicator should come on briefly and then go out. If it doesn't come on, stays on, or comes on while driving without a passenger in the front seat, have the system checked by a dealer as soon as possible.

Airbag Care

You do not need to perform any maintenance to your airbag system. However, you should have your vehicle inspected by a dealer in the following situations:

■ When the airbags have deployed

If an airbag has inflated, the control unit and other related parts must be replaced. Similarly, once an automatic seat belt tensioner has been activated, it must be replaced.

■ When the vehicle has been in a moderate-to-severe collision

Even if the airbags did not inflate, have your dealer inspect the following: the driver's seat position sensor, weight sensors in the passenger's seat, front seat belt tensioners, and each seat belt that was worn during the crash.

■ Do not remove or modify a front seat without consulting a dealer

This would likely disable the driver's seat position sensor or the weight sensors in the passenger's seat. If it is necessary to remove or modify a front seat to accommodate a person with disabilities, contact an Acura dealer. For U.S. vehicles you can also contact Acura Client Service at 800-382-2238. For Canadian vehicles you can also contact Canadian Acura Client Service at 888-9-ACURA-9.

Protecting Child Passengers

Each year, many children are injured or killed in vehicle crashes because they are either unrestrained or not properly restrained. In fact, vehicle accidents are the number one cause of death of children age 12 and under.

To reduce the number of child deaths and injuries, every state, Canadian province and territory requires that infants and children be properly restrained when they ride in a vehicle.

Children should sit properly restrained in a rear seat. This is because:

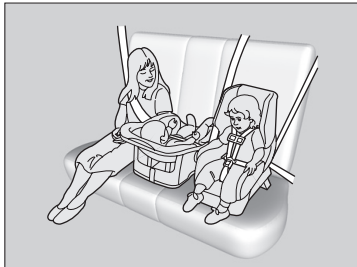

- An inflating front or side airbag can injure or kill a child sitting in the front seat.
- A child in the front seat is more likely to interfere with the driver's ability to safely control the vehicle.
- Statistics show that children of all sizes and ages are safer when they are properly restrained in a rear seat.

Protecting Child Passengers

⚠ WARNING

Children who are unrestrained or improperly restrained can be seriously injured or killed in a crash.

Any child too small for a seat belt should be properly restrained in a child seat. A larger child should be properly restrained with a seat belt, using a booster seat if necessary.

The National Highway Traffic Safety Administration and Transport Canada recommend that all children age 12 and under be properly restrained in a rear seat. Some states or provinces/territories have laws restricting where children may ride.

- Any child who is too small to wear a seat belt correctly must be restrained in an approved child seat that is properly secured to the vehicle using either the lap belt portion of the lap/shoulder belt or the lower anchors of the LATCH system.
- Never hold a child on your lap because it is impossible to protect them in the event of a collision.
- Never put a seat belt over yourself and a child. During a crash, the belt would likely press deep into the child and cause serious or fatal injuries.
- Never let two children use the same seat belt. Both children could be very seriously injured in a crash.
- Do not allow children to operate the doors, windows or seat adjustments.
- Do not leave children in the vehicle unattended, especially in hot weather when the inside of the vehicle can get hot enough to kill them. They could also activate vehicle controls causing it to move unexpectedly.

▶▶ Protecting Child Passengers

⚠ WARNING

Allowing a child to play with a seat belt or wrap one around their neck can result in serious injury or death.

Instruct children not to play with any seat belt and make sure any unused seat belt a child can reach is buckled, fully retracted, and locked.

To deactivate a lockable retractor, release the buckle and allow the seat belt to wind up all the way.

To remind you of the passenger's front airbag hazards and child safety, your vehicle has warning labels on the dashboard (U.S. models) and on the front visors. Please read and follow the instructions on these labels.

▶▶ **Safety Labels** P.61

Safety of Infants and Small Children

Protecting Infants

An infant must be properly restrained in a rear-facing, reclining child seat until the infant reaches the seat maker's weight or height limit for the seat, and the infant is at least one year old.

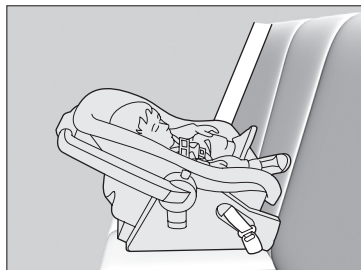

Positioning a rear-facing child seat

Child seats must be placed and secured in a rear seating position.

When properly installed, a rear-facing child seat may prevent the driver or a front passenger from moving their seat all the way back, or from locking their seat-back in the desired position.

It can also interfere with proper operation of the passenger's advanced front airbag system.

➤ **Airbags** P.33

If this occurs, we recommend that you install the child seat directly behind the front passenger's seat, move the seat as far forward as needed, and leave it unoccupied. Or, you may wish to get a smaller rear-facing child seat.

Protecting Infants

⚠ WARNING

Placing a rear-facing child seat in the front seat can result in serious injury or death during a crash.

Always place a rear-facing child seat in the rear seat, not the front.

Rear-facing child seats should never be installed in a forward facing position.

Always refer to the child seat manufacturer's instructions before installation.

Protecting Smaller Children

If a child is at least one year old and within the weight range indicated by the child seat manufacturer, the child should be properly restrained in a firmly secured forward-facing child seat.

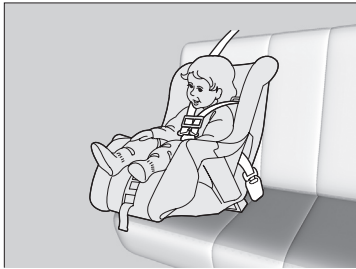

■ Forward-facing child seat placement

We strongly recommend placing a forward-facing child seat in a rear seating position.

Placing a forward-facing child seat in the front seat can be hazardous, even with advanced front airbags that automatically turn the passenger's front airbag off. A rear seat is the safest place for a child.

⌘ Protecting Smaller Children

⚠ WARNING

Placing a forward-facing child seat in the front seat can result in serious injury or death if the front airbag inflates.

If you must place a forward-facing child seat in front, move the vehicle seat as far back as possible, and properly restrain the child.

Educate yourself about the laws and regulations regarding child seat use where you are driving, and follow the child seat manufacturer's instructions.

Many experts recommend use of a rear-facing seat up to age two, if the child's height and weight are appropriate for a rear-facing seat.

■ Selecting a Child Seat

Most child seats are LATCH-compatible (Lower Anchors and Tethers for Children). Some have a rigid-type connector, while others have a flexible-type connector. Both are equally easy to use. Whichever one you choose, follow the manufacturer's use and care instructions.

LATCH-compatible child seats can be secured to the vehicle by using two lower anchors and a top tether anchor in one of the outer seating positions.

■ Important consideration when selecting a child seat

Make sure the child seat meets the following three requirements:

- The child seat is the correct type and size for the child.
- The child seat is the correct type for the seating position.
- The child seat is compliant with Federal Motor Vehicle Safety Standard 213 or Canadian Motor Vehicle Safety Standard 213.

☒ Selecting a Child Seat

Installation of a LATCH-compatible child seat is simple.

LATCH-compatible child seats have been developed to simplify the installation process and reduce the likelihood of injuries caused by incorrect installation.

Installing a LATCH-Compatible Child Seat

A LATCH-compatible child seat can be installed in either of the two outer rear seats. A child seat is attached to the lower anchors with either the rigid or flexible type of connectors.

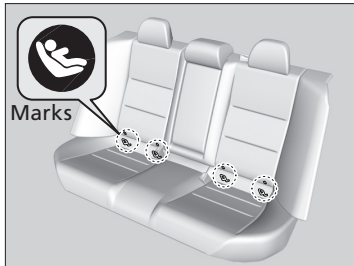

1. Locate the lower anchors under the marks.

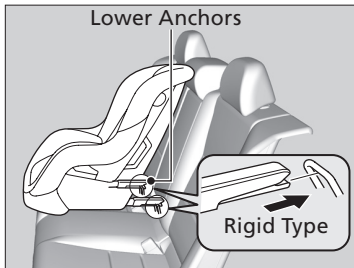

2. Place the child seat on the vehicle seat then attach the child seat to the lower anchors according to the instructions that came with the child seat.

- ▶ When installing the child seat, make sure that the lower anchors are not obstructed by the seat belt or any other object.

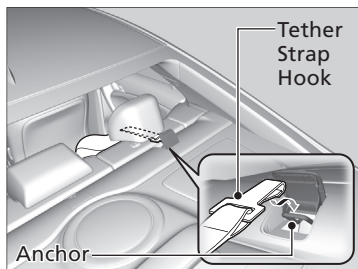
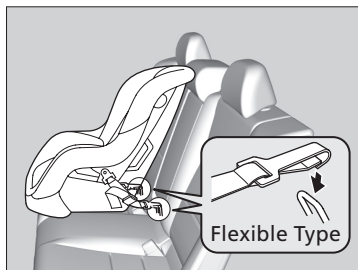

3. Open the tether anchor cover behind the head restraint.
4. Release the head restraint, then route the tether strap between the head restraint legs, and secure the tether strap hook onto the anchor.
5. Tighten the tether strap as instructed by the child seat maker.
6. Make sure the child seat is firmly secured by rocking it forward and back and side to side; little movement should be felt.
7. Make sure any unused seat belt that a child can reach is buckled, the lockable retractor is activated, and the belt is fully retracted and locked.

➤ **Enhancing Child Safety** P. 53

☒ **Installing a LATCH-compatible Child Seat**

For your child's safety, when using a child seat installed using the LATCH system, make sure that the seat is properly secured to the vehicle. A child seat that is not properly secured will not adequately protect a child in a crash and may cause injury to the child or other vehicle occupants.

Installing a Child Seat with a Lap/Shoulder Seat Belt

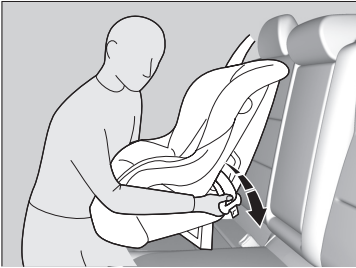

1. Place the child seat on the vehicle seat.
2. Route the seat belt through the child seat according to the seat maker's instructions, and insert the latch plate into the buckle.
 - ▶ Insert the latch plate fully until it clicks.

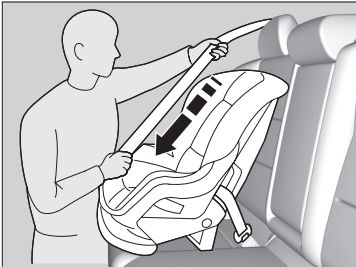

3. Slowly pull the shoulder part of the belt all the way out until it stops. This activates the lockable retractor.
4. Let the seat belt completely wind up into the retractor, then try to pull it out to make sure the retractor is locked.
 - ▶ If you are able to pull the shoulder belt out, the lockable retractor is not activated. Pull the seat belt all the way out, and repeat steps 2 – 4.



5. Grab the shoulder part of the seat belt near the buckle, and pull up to remove any slack from the lap part of the belt.
 - ▶ When doing this, place your weight on the child seat and push it into the vehicle seat.

Continued



6. Make sure the child seat is firmly secured by rocking it forward and back and side to side; little movement should be felt.
7. Make sure any unused seat belt that a child can reach is buckled, the lockable retractor is activated, and the belt is fully retracted and locked.

➤ **Enhancing Child Safety** P. 53

☒ Installing a Child Seat with a Seat Belt

A child seat that is not properly secured will not adequately protect a child in a crash and may cause injury to the child or other vehicle occupants.

To deactivate a lockable retractor, release the buckle and allow the seat belt to wind up all the way.

Adding Security with a Tether

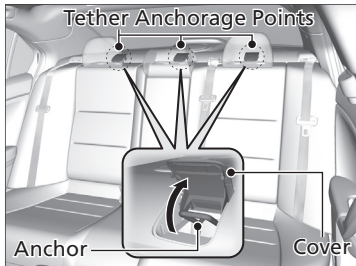

A tether anchorage point is provided behind each rear seating position. A child seat that is installed with a seat belt and comes with a tether can use the tether for additional security.

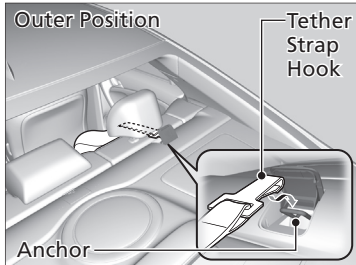

1. Locate the appropriate tether anchorage point and lift the cover.
2. If using an outer seating position, raise the head restraint to its highest position, then route the tether strap through the head restraint legs. Make sure the strap is not twisted.

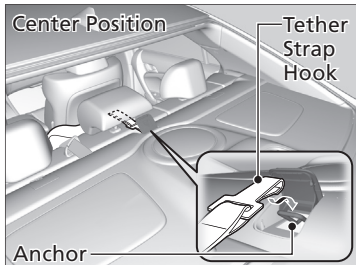

- If using the center seating position, raise the head restraint to its highest position, then route the tether strap through the head restraint legs. Make sure the strap is not twisted.
3. Lift the anchor cover and secure the tether strap hook onto the anchor.
 4. Tighten the tether strap as instructed by the child seat manufacturer.

Adding Security with a Tether

Since a tether can provide additional security to the lap/shoulder seat belt installation, we recommend using a tether whenever one is available.

Safety of Larger Children

■ Protecting Larger Children

The following pages give instructions on how to check proper seat belt fit, what kind of booster seat to use if one is needed, and important precautions for a child who must sit in front.

■ Checking Seat Belt Fit

When a child is too big for a child seat, secure the child in a rear seat using the lap/shoulder seat belt. Have the child sit upright and all the way back, then answer the following questions.

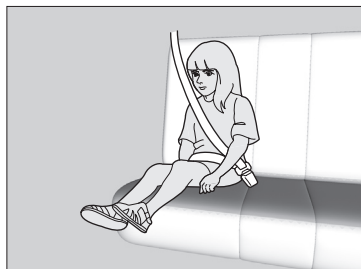

■ Checklist

- Do the child's knees bend comfortably over the edge of the seat?
- Does the shoulder belt cross between the child's neck and arm?
- Is the lap part of the seat belt as low as possible, touching the child's thighs?
- Will the child be able to stay seated like this for the whole trip?

If you answer yes to all these questions, the child is ready to wear the lap/shoulder seat belt correctly. If you answer no to any question, the child needs to ride on a booster seat until the seat belt fits properly without a booster seat.

☒ Safety of Larger Children

⚠ WARNING

Allowing a child to sit in front can result in serious injury or death if the passenger's front airbag inflates.

If a larger child must ride in front, move the vehicle seat as far to the rear as possible, have the child sit up properly and wear the seat belt properly, using a booster seat if needed.

Booster Seats



If a lap/shoulder seat belt cannot be used properly, position the child in a booster seat in a rear seating position. For the child's safety, check that the child meets the booster seat manufacturer's recommendations.

Protecting Larger Children - Final Checks

Your vehicle has a rear seat where children can be properly restrained. If you ever have to carry a group of children, and a child must ride in front:

- Make sure you read and fully understand the instructions and safety information in this manual.
- Move the front passenger seat as far back as possible.
- Have the child sit upright and well back in the seat.
- Check that the seat belt is properly positioned so that the child is secure in the seat.

Monitoring child passengers

We strongly recommend that you keep an eye on child passengers. Even older, more mature children sometimes need to be reminded to fasten their seat belts and sit up properly.

Booster Seats

When installing a booster seat, make sure to read the instructions that came with it, and install the seat accordingly.

There are high- and low-type booster seats. Choose a booster seat that allows the child to wear the seat belt correctly.

Some U.S. states and Canadian provinces, and territories require children to use a booster seat until they reach a given age or weight (e.g. 6 years or 60 lbs). Be sure to check current laws in the state or province, or territory where you intend to drive.

Carbon Monoxide Gas

The engine exhaust from this vehicle contains carbon monoxide, a colorless, odorless, and highly toxic gas. As long as you properly maintain your vehicle, carbon monoxide gas will not get into the interior.

■ Have the exhaust system inspected for leaks whenever

- The exhaust system is making an unusual noise.
- The exhaust system may have been damaged.
- The vehicle is raised for an oil change.

When you operate a vehicle with the trunk open, airflow can pull exhaust gas into the interior and create a hazardous condition. If you must drive with the trunk open, open all the windows and set the climate control system as shown below.

1. Select the fresh air mode.
2. Select the  mode.
3. Set the fan speed to high.
4. Set the temperature control to a comfortable setting.

Adjust the climate control system in the same manner if you sit in your parked vehicle with the engine running.

☒ Carbon Monoxide Gas

⚠ WARNING

Carbon monoxide gas is toxic. Breathing it can cause unconsciousness and even kill you.

Avoid any enclosed areas or activities that expose you to carbon monoxide.

An enclosed area such as a garage can quickly fill up with carbon monoxide gas. Do not run the engine with the garage door closed. Even when the garage door is open, drive out of the garage immediately after starting the engine.

Label Locations

These labels are in the locations shown. They warn you of potential hazards that can cause serious injury or death. Read these labels carefully.

If a label comes off or becomes hard to read (except for the U.S. dashboard label which may be removed by the owner), contact a dealer for a replacement.

Sun Visor

U.S. models



Canadian models

CAUTION
TO AVOID SERIOUS INJURY:
 • FOR MAXIMUM SAFETY PROTECTION IN ALL TYPES OF CRASHES, YOU MUST ALWAYS WEAR YOUR SAFETY BELT.
 • DO NOT INSTALL REARWARD-FACING CHILD SEATS IN ANY FRONT PASSENGER SEAT POSITION.
 • DO NOT SIT OR LEAN UNNECESSARILY CLOSE TO THE AIR BAG.
 • DO NOT PLACE ANY OBJECTS OVER THE AIR BAG OR BETWEEN THE AIR BAG AND YOURSELF.
 • SEE THE OWNER'S MANUAL FOR FURTHER INFORMATION AND EXPLANATIONS.

PRECAUTIONS:
POUR EVITER DES BLESSURES GRAVES:
 • POUR PROFITER D'UNE PROTECTION MAXIMALE LORS D'UNE COLLISION, BOUCLEZ TOUJOURS VOTRE CEINTURE DE SECURITE.
 • N'INSTALLEZ JAMAIS UN SIEGE POUR ENFANTS FAISANT FACE A L'ARRIERE SUR LE SIEGE DU PASSAGER AVANT.
 • NE VOUS APPUYEZ PAS ET NE VOUS ASSOYEZ PAS PRES DU COUSSIN GONFLABLE.
 • NE DEPOSEZ AUCUN OBJET SUR LE COUSSIN GONFLABLE OU ENTRE LE COUSSIN GONFLABLE ET VOUS.
 • LISEZ LE GUIDE UTILISATEUR POUR DE PLUS AMPLES RENSEIGNEMENTS.

Dashboard U.S. models only



Radiator Cap

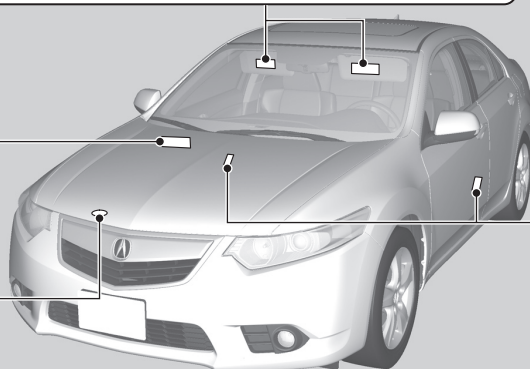

Doorjamb

U.S. models

SIDE AIRBAG

- This car is equipped with side airbags in the front seats and side curtain airbags.
- Do not lean against the door.
- See owner's manual for more information.

Canadian models

SIDE AIRBAG

- This car is equipped with side airbags in the front seats and side curtain airbags.
- Do not lean against the door.
- See owner's manual for more information.

COUSSIN GONFLABLE LATÉRAL





- Cette automobile est équipée de coussins gonflables latéraux dans les sièges avant ainsi que de coussins gonflables latéraux de type «côté».
- Ne vous appuyez pas sur la porte.
- Consultez le Manuel du propriétaire pour plus de détails.

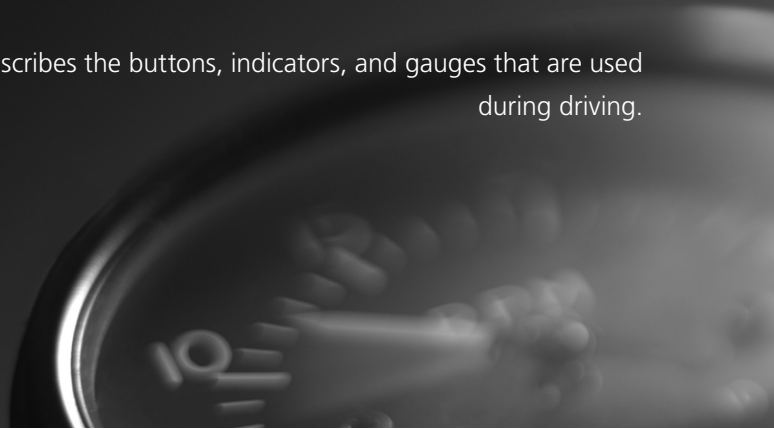





Instrument Panel

This chapter describes the buttons, indicators, and gauges that are used during driving.















Indicators	64
Multi-Information Display Warning and Information Messages.....	72
Gauges and Multi-Information Display	
Gauges	75
Multi-Information Display	76











Indicator	Name	On/Blinking	Explanation	Message
	Parking Brake and Brake System Indicator	<ul style="list-style-type: none"> Comes on briefly when you turn the ignition switch to ON , then goes off (comes on when the parking brake is applied). Comes on when the brake fluid level is low. Comes on if there is a problem with the brake system. The beeper sounds and the indicator comes on if you drive with the parking brake not fully released. 	<ul style="list-style-type: none"> Comes on while driving - Make sure the parking brake is released. Check the brake fluid level.  What to do when it comes on while driving P.292 Comes on along with the ABS indicator - Have the vehicle checked by a dealer.  If the Brake System Indicator Comes On P.292 	
	Low Oil Pressure Indicator	<ul style="list-style-type: none"> Comes on when you turn the ignition switch to ON , and goes off when the engine starts. Comes on when the engine oil pressure is low. 	<ul style="list-style-type: none"> Comes on during driving - Immediately stop in a safe place.  If the Low Oil Pressure Indicator Comes On P.290 	







Indicator	Name	On/Blinking	Explanation	Message
	Malfunction Indicator Lamp	<ul style="list-style-type: none"> Comes on when you turn the ignition switch to ON II, and goes off either when the engine starts or after several seconds if the engine is not started. If "readiness codes" have not been set, it blinks five times before it goes off. Comes on if there is a problem with the emissions control system. Blinks when a misfire in the engine's cylinders is detected. 	<ul style="list-style-type: none"> Readiness codes are part of the on board diagnostics for the emissions control systems. <ul style="list-style-type: none"> ▶ Readiness Codes P.309 Comes on during driving - Have the vehicle checked by a dealer. Blinks during driving - Stop in a safe place where there are no flammable objects. Stop the engine for 10 minutes or more, and wait for it to cool down. Then, take the vehicle to a dealer. <ul style="list-style-type: none"> ▶ If the Malfunction Indicator Lamp Comes On or Blinks P.291 	
	Charging System Indicator	<ul style="list-style-type: none"> Comes on when you turn the ignition switch to ON II, and goes off when the engine starts. Comes on when the battery is not charging. 	<ul style="list-style-type: none"> Comes on during driving - Turn off the climate control system and rear defogger in order to reduce electricity consumption. <ul style="list-style-type: none"> ▶ If the Charging System Indicator Comes On P.290 	
	Transmission Indicator (Shift position indicator)*	<ul style="list-style-type: none"> Comes on for a few seconds when you turn the ignition switch to ON II, then goes off. Blinks if the transmission system has a problem. 	<ul style="list-style-type: none"> Blinks during driving - Avoid sudden starts and acceleration and have the vehicle checked by a dealer immediately. 	







* Not available on all models





Indicator	Name	On/Blinking	Explanation	Message
	Seat Belt Reminder Indicator	<ul style="list-style-type: none"> • Comes on and the beeper sounds if you are not wearing a seat belt when you turn the ignition switch to ON [II]. If the front passenger is not wearing a seat belt, the indicator comes on about six seconds later. • Blinks during driving if either you or the front passenger has not fastened a seat belt. The beeper sounds and the indicator blinks at regular intervals. 	<ul style="list-style-type: none"> • The beeper stops and the indicator goes off when you and the front passenger fasten their seat belts. • Stays on after you or the front passenger has fastened the seat belt - A detection error may have occurred in the sensor. Have the vehicle checked by a dealer. <ul style="list-style-type: none"> ➤ Seat Belt Reminder Indicator P.27 	 
	Low Fuel Indicator	<ul style="list-style-type: none"> • Comes on when the fuel reserve is running low (approximately 2.8 U.S. gal./10.5 Liter left). • Blinks if there is a problem with the fuel gauge. 	<ul style="list-style-type: none"> • Comes on - Refuel your vehicle as soon as possible. • Blinks - Have the vehicle checked by a dealer. 	
	ABS (Anti-lock Brake System) Indicator	<ul style="list-style-type: none"> • Comes on for a few seconds when you turn the ignition switch to ON [II], then goes off. • If it comes on at any other time, there is a problem with the ABS. 	<ul style="list-style-type: none"> • Stays on constantly - Have the vehicle checked by a dealer. With this indicator on, your vehicle still has normal braking ability but no anti-lock function. <ul style="list-style-type: none"> ➤ ABS (Anti-lock Brake System) P.212 	

Indicator	Name	On/Blinking	Explanation	Message
	Supplemental Restraint System Indicator	<ul style="list-style-type: none"> • Comes on for a few seconds when you turn the ignition switch to ON II, then goes off. • Comes on if a problem with any of the following is detected: <ul style="list-style-type: none"> - Supplemental restraint system - Side airbag system - Side curtain airbag system - Seat belt tensioner 	<ul style="list-style-type: none"> • Stays on constantly or does not come on at all - Have the vehicle checked by a dealer. 	
	VSA® (Vehicle Stability Assist) System Indicator	<ul style="list-style-type: none"> • Comes on for a few seconds when you turn the ignition switch to ON II, then goes off. • Blinks when VSA® is active. • Comes on if there is a problem with the VSA® system. 	<ul style="list-style-type: none"> • Stays on constantly - Have the vehicle checked by a dealer. ➤ VSA® (Vehicle Stability Assist) System P.204 	
	VSA® (Vehicle Stability Assist) OFF Indicator	<ul style="list-style-type: none"> • Comes on for a few seconds when you turn the ignition switch to ON II, then goes off. • Comes on when you deactivate VSA®. 	➤ VSA® (Vehicle Stability Assist) System P.205	

Indicator	Name	On/Blinking	Explanation	Message
	Door and Trunk Open Indicator	<ul style="list-style-type: none"> Comes on for a few seconds if you turn the ignition switch to ON , then goes off. Comes on if the trunk or any door is not completely closed. 	<ul style="list-style-type: none"> Goes off if a door or the trunk is closed. 	
	EPS (Electric Power Steering System) Indicator	<ul style="list-style-type: none"> Comes on when you turn the ignition switch to ON , and goes off when the engine starts. Comes on if there is a problem with the EPS (Electric Power Steering System). 	<ul style="list-style-type: none"> Stays on constantly or does not come on at all - Have the vehicle checked by a dealer.  If the EPS Indicator Comes On P.292 	
	Low Tire Pressure/TPMS Indicator	<ul style="list-style-type: none"> Comes on briefly when you turn the ignition switch to ON . Comes on if the tire pressure of any of the tires becomes significantly low. Blinks for about one minute, and then stays on if there is a problem with the TPMS, or when a compact spare tire is temporarily installed. 	<ul style="list-style-type: none"> Comes on during driving - Stop in a safe place, check tire pressures, and inflate the tire(s) if necessary. Blinks and remains on - Have the vehicle checked by a dealer. If the vehicle is fitted with a compact spare, get your regular tire repaired or replaced and put back on your vehicle as soon as you can. 	 









Indicator	Name	On/Blinking	Explanation	Message
	System Message Indicator	<ul style="list-style-type: none"> Comes on along with a beep when a problem is detected. A system message on the multi-information display appears at the same time. 	<ul style="list-style-type: none"> While the indicator is on, press the  (information) button to see the message again. Refer to the Indicators information in this chapter when a system message appears on the multi-information display. Take the appropriate action for the message. The multi-information display does not return to the normal screen unless the warning is canceled, or the  button is pressed. 	—
	Turn Signal Indicators	<ul style="list-style-type: none"> The turn signal indicators blink when you operate the turn signal lever. If you press the hazard warning button, both indicators and all turn signals blink at the same time. 	<ul style="list-style-type: none"> Does not blink or blinks rapidly- A turn signal light bulb has blown. Change the bulb immediately.  Replacing Light Bulbs P.252, 253 	—
	High-Beam Indicator	<ul style="list-style-type: none"> Comes on when the high beam headlights are on. Comes on with reduced brightness when DRL (daytime running lights) are on. 	—	—
	Lights On Indicator	<ul style="list-style-type: none"> Comes on whenever the light switch is on, or in AUTO when the exterior lights are on. 	<ul style="list-style-type: none"> If you remove the key from the ignition switch while the light is on, a chime sounds when the driver's door is opened. 	—





Indicator	Name	On/Blinking	Explanation	Message
	Fog Light Indicator	<ul style="list-style-type: none"> Comes on when the fog lights are on. 	—	—
	Side Airbag Off Indicator	<ul style="list-style-type: none"> Comes on for a few seconds when you turn the ignition switch to ON II, then goes off. Comes on when the passenger side airbag system is automatically shut off. 	<ul style="list-style-type: none"> It does not mean there is a problem with your side airbags. Comes on when nobody is sitting in the passenger seat - Have the vehicle checked by a dealer. Comes on when someone is sitting in the seat - Have the passenger sit properly. 	 
	Immobilizer System Indicator	<ul style="list-style-type: none"> Comes on briefly when you turn the ignition switch to ON II, then goes off. Comes on if the immobilizer system cannot recognize the key information. 	<ul style="list-style-type: none"> Blinks - You cannot start the engine. Turn the ignition switch to LOCK 0, pull the key out, and then insert the key and turn it to ON II again. Repeatedly blinks - The system may be malfunctioning. Have the vehicle checked by a dealer. Do not attempt to alter this system or add other devices to it. Electrical problems can occur. 	—
	Security System Alarm Indicator	<ul style="list-style-type: none"> Blinks when the Security System Alarm has been set. 	<p> Security System Alarm P.98</p>	—



Indicator	Name	On/Blinking	Explanation	Message
	CRUISE MAIN Indicator	<ul style="list-style-type: none"> Comes on when you press the CRUISE button. 	 Cruise Control P.201	—
	CRUISE CONTROL Indicator	<ul style="list-style-type: none"> Comes on if you have set a speed for cruise control. 	 Cruise Control P.201	—

Multi-Information Display Warning and Information Messages

The following messages appear only on the multi-information display. Press the  (information) button to see the message again with the system message indicator on.

Message	Condition	Explanation
	<ul style="list-style-type: none"> Appears when the engine coolant temperature gets abnormally high. 	<ul style="list-style-type: none">  Overheating P.288
	<ul style="list-style-type: none"> Appears when the fuel fill cap is loose or is not installed. 	<ul style="list-style-type: none">  Tighten the Fuel Fill Cap P.291
	<ul style="list-style-type: none"> Appears if there is a problem with the DRL system. 	<ul style="list-style-type: none"> Have your vehicle checked by a dealer.  Daytime Running Lights P.107
<div style="border: 1px solid black; padding: 2px; display: inline-block;">Canadian models</div> 	<ul style="list-style-type: none"> Appears when washer fluid gets low. 	<ul style="list-style-type: none"> Refilling washer fluid.  Refilling Window Washer Fluid P.246

Message	Condition	Explanation
	<ul style="list-style-type: none"> • Appears when the scheduled maintenance is due soon. • Consequently, "SERVICE DUE NOW" and "SERVICE PAST DUE" follow. 	<p>🔧 Maintenance Minder™ P.225</p>
	<ul style="list-style-type: none"> • Appears when you open the driver's door while the ignition key is in ACCESSORY I. 	<ul style="list-style-type: none"> • Turn the ignition switch to LOCK 0, then remove the key.
	<ul style="list-style-type: none"> • Appears when the ignition key is turned to ACCESSORY I from ON II. (The driver's door is closed.) 	<p>—</p>
	<ul style="list-style-type: none"> • Appears when you open the driver's door while the ignition key is in LOCK 0. 	<ul style="list-style-type: none"> • Remove the key from the ignition switch.

Message	Condition	Explanation
<p>6-cylinder models</p> <p>U.S.</p>  <p>Canada</p> 	<ul style="list-style-type: none"> Appears when the starter system has a problem. 	<ul style="list-style-type: none"> As a temporary measure, hold the ignition switch to START  for up to 15 seconds and start the engine. Have the vehicle checked by a dealer.

Gauges

Gauges include the speedometer, tachometer, fuel gauge, and temperature gauge. They are displayed when the ignition switch is in ON .

Speedometer

Displays your driving speed in mph (U.S.) or km/h (Canada).

Fuel Gauge

Displays the amount of fuel left in the fuel tank.

Temperature Gauge

Displays the temperature of the engine coolant.

Tachometer

Shows the number of engine revolutions per minute.

» Fuel Gauge

NOTICE

You should refuel when the reading approaches . Running out of fuel can cause the engine to misfire, damaging the catalytic converter.

The actual amount of remaining fuel may differ from the fuel gauge reading.

» Temperature Gauge

NOTICE

If the engine is in danger of overheating. Driving with the temperature gauge pointer in the upper zone can cause serious engine damage. Pull safely to the side of the road and allow engine temperature to return to normal.



 **Overheating** P.288

Multi-Information Display

The multi-information display shows the odometer, trip meter, outside temperature indicator, and other gauges.

It also displays important messages such as warnings and other helpful information.

Switching the Display

Press the / (information) button or the SEL/RESET button to change the display.

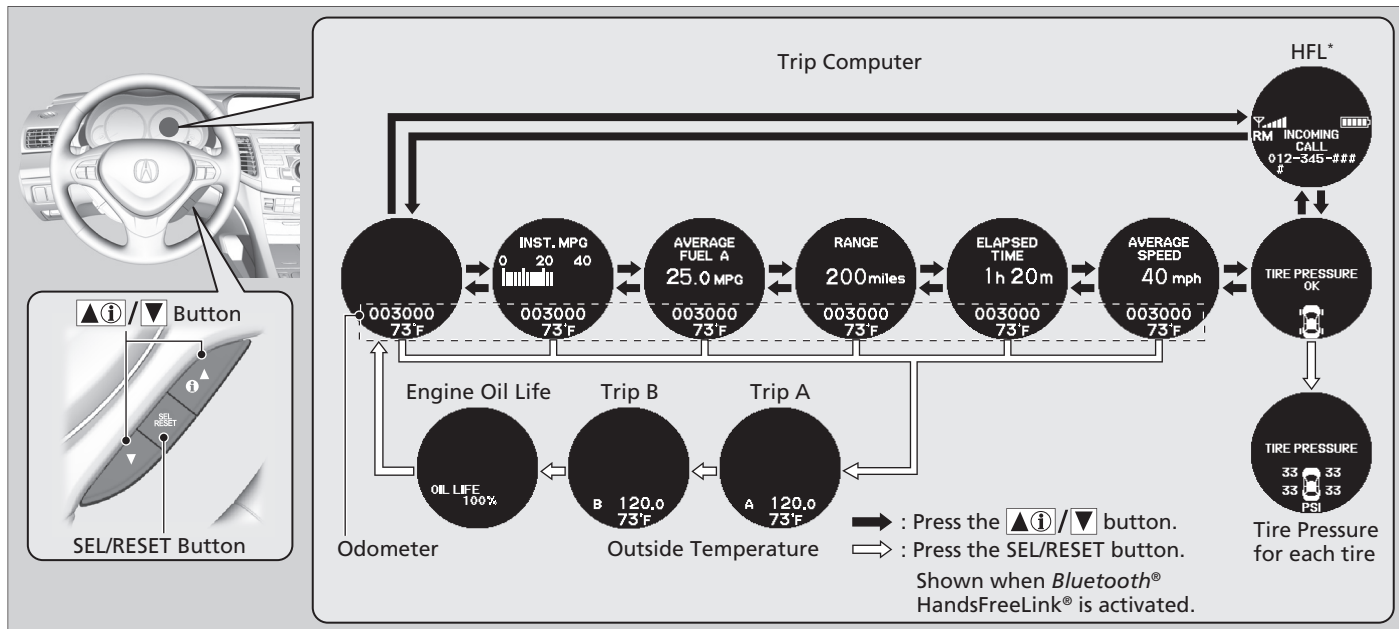

■ Odometer

Shows the total number of miles (U.S.) or kilometers (Canada) that your vehicle has accumulated.

■ Trip Meter

Shows the total number of miles (U.S.) or kilometers (Canada) driven since the last reset. Meters A and B can be used to measure 2 separate trips.

■ Resetting a trip meter

To reset a trip meter, display it, then press and hold the SEL/RESET button. The trip meter is reset to "0.0".

☒ Trip Meter

Switch between trip meter A and trip meter B by pressing the SEL/RESET button.

■ Outside Temperature

Shows the outside temperature in Fahrenheit (U.S.) or Celsius (Canada).

■ Adjusting the outside temperature display

Adjust the temperature reading up to $\pm 5^{\circ}\text{F}$ or $\pm 3^{\circ}\text{C}$ if the temperature reading seems incorrect.

Use the multi-information display's customized features to correct the temperature.

➤ **Customized Features** P.80

■ Instant Fuel Economy

Shows the instant fuel economy as a bar graph in mpg or l/100 km.

■ Average Fuel Economy

Shows the estimated average fuel economy of each trip meter in mpg (U.S.) or l/km (Canada). The display is updated at set intervals. When a trip meter is reset, the average fuel economy is also reset.

■ Range

Shows the estimated distance you can travel on the fuel remaining. This distance is estimated from the fuel economy of your trips in the past.

⊗ Outside Temperature

The temperature sensor is in the front bumper. Road heat and exhaust from another vehicle can affect the temperature reading when your vehicle speed is less than 19 mph (30 km/h).

It may take several minutes for the display to be updated after the temperature reading has stabilized.

⊗ Average Fuel Economy

You can choose to reset either Trip A or average fuel economy A when you refuel.

➤ **Customized Features** P.80

■ Elapsed Time

The elapsed time display shows the time during one drive cycle.

■ Average Speed

The display shows the average speed in mph (U.S.) or km/h (Canada) since the last time Trip A was reset.

■ Engine Oil Life

Shows the remaining oil life and Maintenance Minder™.

➤ **Maintenance Minder™** P.225

■ Tire Pressure Monitor

Shows each tire's pressure.

➤ **Tire Pressure Monitoring System** P.206

■ **Bluetooth® HandsFreeLink®**

Shows your paired cell phone's information.

➤ **Bluetooth® HandsFreeLink®** P.167

⌘ Elapsed Time



You can change the elapsed time reset criteria.

➤ **Customized Features** P.80

Customized Features

Use the multi-information display to customize certain features.

How to customize

Press and hold the  button for a few seconds while the ignition switch is in ON .

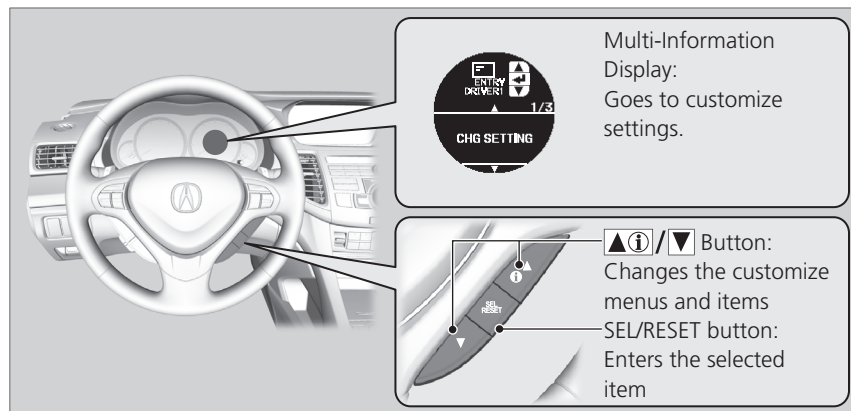

Customized Features

To customize other features, press the  button.

 **List of customizable options** P.82

 **Example of customization settings** P.84

Customization is possible when you see the driver's ID ("DRIVER 1" or "DRIVER 2") on the CHG setting screen.

The driver's ID indicates which remote transmitter you have used to unlock the driver's door. The customized settings are recalled every time you unlock the driver's door with that remote.

When you customize settings:

Automatic Transmission models

Shift to .

Manual Transmission models

Set the parking brake

■ Customization flow

Press and hold the /▼ button.

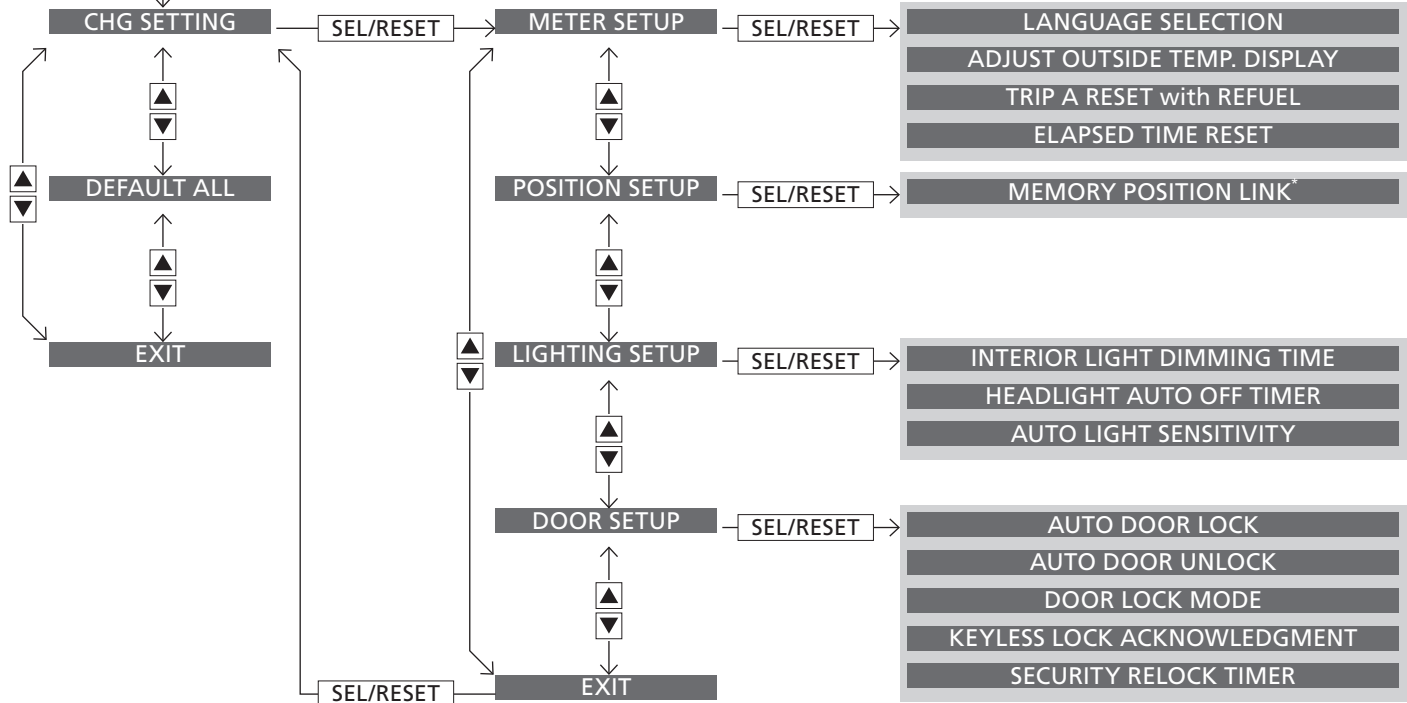

* Not available on all models

■ List of customizable options

Setup Group	Customizable Features	Description	Selectable settings
Meter Setup	Language Selection	Changes the displayed language.	English ^{*1} , French, Spanish
	Adjust Outside Temp. Display	Adjusts the temperature reading by a few degrees.	-5°F ~ ±0°F ^{*1} ~ +5°F (U.S) -3°C ~ ±0°C ^{*1} ~ +3°C (Canada)
	Trip A Reset with Refuel	Sets Trip A and the average fuel economy to reset when you refuel.	ON, OFF ^{*1}
	Elapsed Time Reset	Changes the resetting conditions of the elapsed time.	IGN OFF ^{*1} , Trip A, Trip B
Position Setup	Memory Position Link [*]	Changes the driver's seat position to a stored setting.	ON ^{*1} , OFF
Lighting Setup	Interior Light Dimming Time	Changes the length of time the interior lights stay on after you close the doors.	60 sec, 30 sec ^{*1} , 15 sec
	Headlight Auto Off Timer	Changes the length of time the exterior lights stay on after you close the driver's door.	60 sec, 30 sec, 15 sec ^{*1} , 0 sec
	Auto Light Sensitivity	Changes the timing for the headlights to come on.	Max, High, Mid ^{*1} , Low, Min

*1:Default Setting

* Not available on all models

Setup Group	Customizable Features	Description	Selectable settings
Door Setup	Auto Door Lock	Changes the setting for the automatic locking feature.	Shift from P (A/T only), With VEH SPD ^{*1} , OFF
	Auto Door Unlock	Changes the setting for when the doors unlock automatically.	Shift to P ^{*2} , IGN Off ^{*3} , OFF Driver Door ^{*1} , All Doors
	Door Lock Mode	Sets up either the driver's door or all doors to unlock on the first push of the remote.	Driver Door ^{*1} All Doors
	Keyless Lock Acknowledgment	LOCK/UNLOCK - The exterior lights flash LOCK (2nd push) - The beeper sounds	ON ^{*1} , OFF
	Security Relock Timer	Changes the time it takes for the doors to relock and the security system to set after you unlock the vehicle without opening any door.	90 sec, 60 sec, 30 sec ^{*1}
Default All		Sets/Cancel all the customized settings as default.	Set, Cancel

*1: Default Setting

*2: Default Setting for automatic transmission

*3: Default Setting for manual transmission

■ Example for customization settings

The steps for changing the "TRIP A RESET with REFUEL" setting to ON are shown below. The default setting for "TRIP A RESET with REFUEL" is OFF.

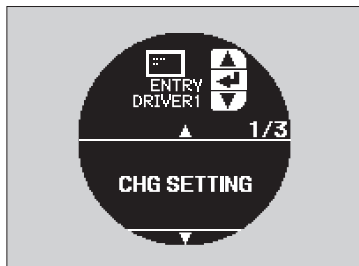

1. Press and hold / button until "CHG SETTING" appears on the display.



2. Press the SEL/RESET button to go into the "METER SETUP" group.
3. Press the SEL/RESET button again.
 - ▶ "LANGUAGE SELECTION" appears first in the display.



4. Press the /▼ button until "TRIP A RESET with REFUEL" appears on the display, then press the SEL/RESET button.

- ▶ The display switches to the "Customization setup" screen, where you can select "ON," "OFF, or" "EXIT."

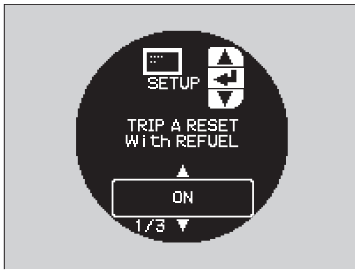

5. Press the /▼ button and select "ON," then press the SEL/RESET button.

- ▶ The "ON" setup screen appears, then the display returns to the "Customization menu" screen.

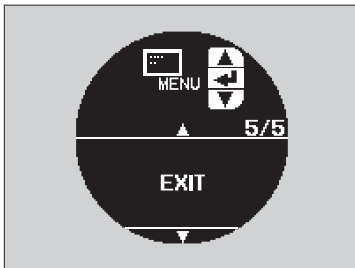

6. Press the /▼ button until "EXIT" appears in the display, then press the SEL/RESET button.

7. Repeat Step 6 until you return to the normal screen.

Controls

This chapter explains how to operate the various controls necessary for driving.



Setting the Clock	88
Locking and Unlocking the Doors	
Key Types and Functions	89
Locking/Unlocking the Doors from the Outside	91
Locking/Unlocking the Doors from the Inside	93
Childproof Door Locks	94
Auto Door Lock/Unlock	94
Opening/Closing the Trunk	95
Security System	98
Immobilizer System	98
Security System Alarm	98
Opening and Closing the Windows..	100

Opening and Closing the Moonroof	103
Operating the Switches Around the Steering Wheel	
Ignition Switch	104
Turn Signals	105
Light Switches.....	105
Fog Lights	107
Daytime Running Lights	107
Wipers and Washers	108
Brightness Control	109
Rear Defogger/Heated Door Mirror Button.....	110
Driving Position Memory System.....	111

Adjusting the Steering Wheel	113
Adjusting the Mirror	114
Interior Rearview Mirror	114
Door Mirrors.....	114
Adjusting the Seats.....	116
Adjusting the Seat Positions.....	116
Interior Lights/Interior Convenience Items	125
Interior Lights.....	125
Interior Convenience Items.....	126
Climate Control System	133
Using Automatic Climate Control.....	133
Automatic Climate Control Sensors.....	136

Clock

Models without navigation system

You can adjust the time in the clock display, using the CLOCK button.

Adjusting the Time

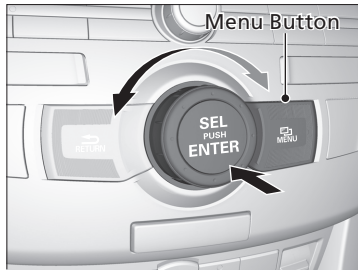

1. Press the MENU button.
2. Rotate to select CLOCK ADJUST in the display.
3. Press . CLOCK ADJUST appears.
4. Rotate to select the item you want to adjust (12/24 hour mode, hour, minute). Then press .
5. Rotate to make the adjustment.
6. Press to enter your selection. The display returns to CLOCK ADJUST. Repeat steps 4 to 6 to adjust other items.
7. To enter the selection, Rotate and select SET, then press .
8. Press the MENU button to go back to the normal display.

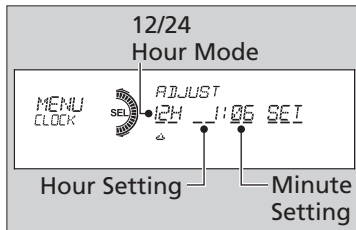

» Clock

You can switch the clock display between 24 hours and 12 hours when in the menu mode.

Selector Knob Icon details

Rotate to select.

Press to enter.

To set the time to the nearest hour:

Press and hold the CLOCK button until the clock display begins to blink, then press the (Reset) button.

Depending on the displayed time, the clock sets forward or backward.

Example:

1:06 will reset to 1:00

1:53 will reset to 2:00

Models with navigation system

The clock is automatically updated through the navigation system, so the time does not need to be adjusted.

Key Types and Functions

This vehicle comes with the following keys:

Retractable Master Keys

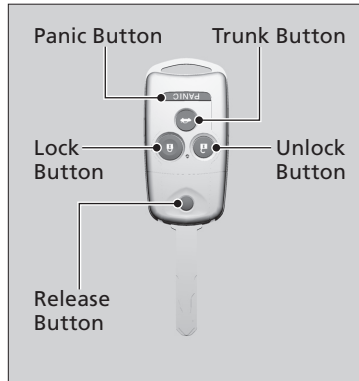

Use the keys to start and stop the engine, and to lock and unlock all the doors, trunk, and fuel fill door. You can also use the remote transmitter to lock and unlock the doors, trunk, and fuel fill door.

Models with a driving position system

The seat automatically moves to the preset position when you unlock the door using the remote transmitter on the master key.

Driving Position Memory System P.111

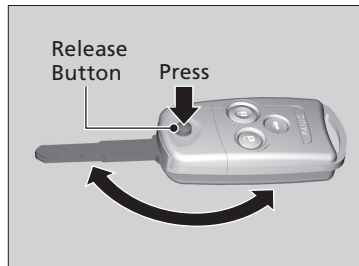

The master key folds up inside the remote transmitter.

1. Press the release button to release the key out from the transmitter.
 - ▶ Make sure to fully extend the key.
2. To close the key, press the release button then push the key inside the transmitter until you hear a click.

Key Types and Functions

All of the keys have an immobilizer system. The immobilizer system helps to protect against vehicle theft.

Immobilizer System P.98

The keys contain precision electronics.

Adhere to the following advice to prevent damage to the electronics:

- Do not leave the keys in direct sunlight, or in locations with high temperature or high humidity.
- Do not drop the keys or set heavy objects on them.
- Keep the keys away from liquids.
- Do not take the keys apart except for replacing the battery.

If the circuits in the keys are damaged, the engine may not start, and the remote transmitter may not work.

If the keys do not work properly, have them inspected by a dealer.

If the key is not fully extended, the immobilizer system may not work properly, and the engine may not start.

Avoid contact with the key whenever it extends or retracts.

■ Valet Key

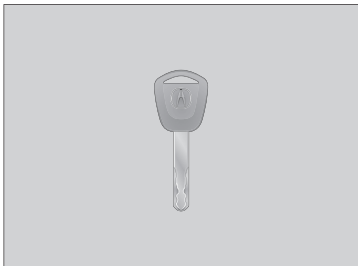

Can be used to start and stop the engine, and lock and unlock driver's door.

■ Key Number Tag

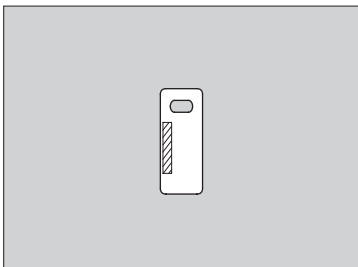

Contains a number that you will need if you purchase a replacement key.

☒ Valet Key

When you need to leave a key with a third party, leave the valet key.

☒ Key Number Tag

Keep the key number tag separate from the key in a safe place outside of your vehicle. If you wish to purchase an additional key, contact a dealer.

If you lose your key and you cannot start the engine, contact a dealer.

Locking/Unlocking the Doors from the Outside

■ Using the Remote Transmitter

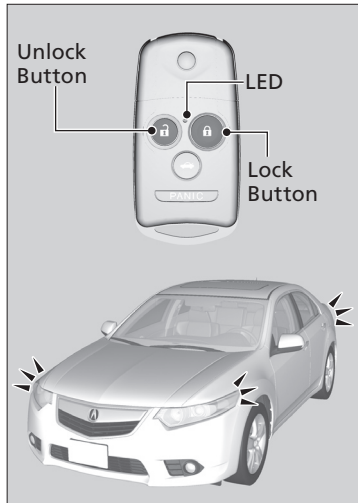

■ Locking the doors

Press the LOCK button.

Once:

- ▶ Some exterior lights will flash, all the doors, trunk, and fuel fill door will lock, and the security system sets.

Twice (within five seconds after the first push):

- ▶ A beeper sounds and verifies the security system is set.

■ Unlocking the doors

Press the UNLOCK button.

Once:

- ▶ Some exterior lights will flash twice, and the driver's door and fuel fill door unlocks.

Twice:

- ▶ The remaining doors and the trunk unlock.

▣ Using the Remote Transmitter

Open the door within 30 seconds.

If you do not open a door within 30 seconds of unlocking the vehicle with the remote transmitter, the doors will automatically relock.

If the interior light switch is in the door activated position, the interior lights come on when you press the UNLOCK button.

No doors opened: The lights fade out after 30 seconds.

Doors relocked with the remote: The lights go off immediately.

▣ Interior Lights P.125

The remote transmitter uses low-power signals, so the operating range may vary depending on the surroundings.

The remote transmitter will not work when the key is in the ignition switch. The remote will not lock the vehicle when a door is open.

If the distance at which it works varies, the battery is probably low.

If the LED does not come on when you press a button, the battery is dead.

▣ Replacing the Battery P.269

■ Locking/Unlocking the Doors Using a Key



Fully insert the key and turn it.
If you are using the master key, make sure it is fully extended.

■ Locking a Door Without Using a Key

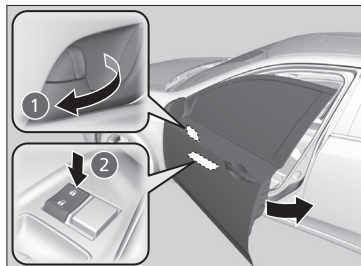

■ Locking the driver's door

Pull the lock tab rearward ① or push the master door lock switch in the lock direction ②, and close the door.

■ Locking the passenger's doors

Pull the lock tab rearward and close the door.

■ Lockout prevention system

The doors cannot be locked when the key is in the ignition switch, and any door is open.

⊗ Locking/Unlocking the Doors Using a Key

When you lock the driver's door with a key, all of the other doors, trunk, and fuel fill door lock at the same time. When unlocking, the driver's door and fuel fill door unlock first. Turn the key a second time within a few seconds to unlock the remaining doors and the trunk.

⊗ Locking a Door Without Using a Key

When you lock the driver's door, all the other doors, trunk, and fuel fill door lock at the same time. Make sure you have the key in your hand before locking the door to prevent it from being locked in the vehicle.

Locking/Unlocking the Doors from the Inside

■ Using the Lock Tab

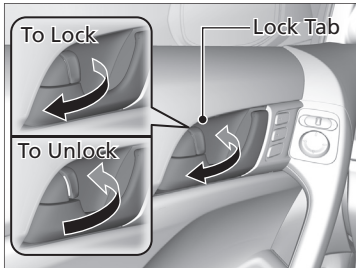

■ Locking a door

Pull the lock tab rearward.

■ Unlocking a door

Push the lock tab forward.

■ Using the Master Door Lock Switch

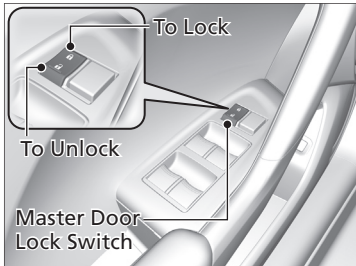

Press the master door lock switch in as shown to lock or unlock all doors.

☒ Using the Lock Tab

When you lock the door using the lock tab on the driver's door, all of the other doors, trunk, and fuel fill door lock at the same time.

When you unlock the door using the lock tab on the driver's door, only the driver's door will unlock.

☒ Using the Master Door Lock Switch

When you lock/unlock the driver's door using the master lock switch, all the other doors, trunk, and fuel fill door lock/unlock at the same time.

Childproof Door Locks

The childproof door locks prevent the rear doors from being opened from the inside regardless of the position of the lock tab.

■ Setting the Childproof Door Locks

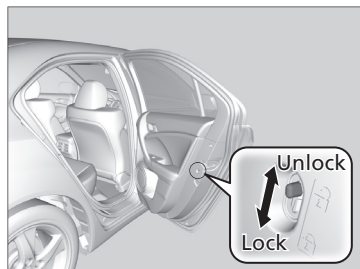

Slide the lever in the rear door to the lock position, and close the door.

■ When opening the door

Open the door using the outside door handle.

⊗ Child Proof Door Locks

To open the door from the inside when the childproof door lock is on, put the lock tab in the unlock position, lower the rear window, put your hand out of the window, and pull the outside door handle.

Auto Door Lock/Unlock

■ Auto door lock

The auto door lock function automatically locks all the doors and the trunk, and the fuel fill door when the vehicle reaches about 10 mph (15 km/h).

■ Auto door unlock

Automatic transmission models

When you depress the brake pedal and move the shift lever to **P**, the driver's door automatically unlocks.

Manual transmission models

When you depress the brake pedal and turn the ignition switch to LOCK **0**, the driver's door automatically unlocks.

⊗ Auto Door Lock/Unlock

The auto door lock/unlock settings can be customized using the multi-information display.

➤ **Customization Procedure** P. 80

Precautions for Opening/Closing the Trunk

■ Opening the trunk

Open the trunk all the way.

- ▶ If it is not fully opened, the trunk lid may begin to close under its own weight.

■ Closing the trunk

Keep the trunk lid closed while driving to:

- ▶ Avoid possible damage.
- ▶ Prevent exhaust gas from leaking into the vehicle.

☒ **Carbon Monoxide** P.60

Using the Trunk Opener

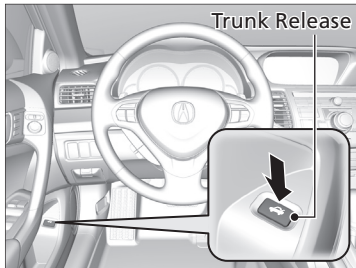

Pressing the trunk release to the lower left of the driver's seat unlocks and opens the trunk.

Using the Remote Transmitter



Press the trunk release button for approximately one second to unlock and open the trunk.

✘ Using the Remote Transmitter

When the driver's door is locked:
The trunk will lock when it is closed.
When the driver's door is unlocked:
The trunk will not lock when it is closed.

When the ignition switch is in any position except LOCK , you cannot open the trunk using the trunk release button on the remote transmitter.

Using the Trunk Release Switch

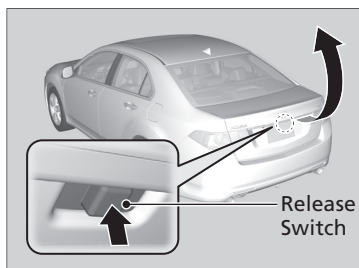

Push up the release switch on the trunk lid after the doors are unlocked.

Trunk Main Switch

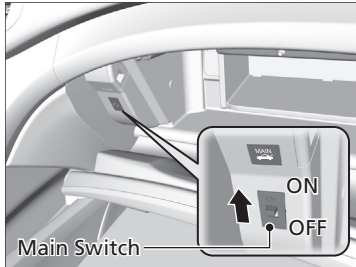

The trunk main switch disables the trunk opener on the driver's side and the trunk release button on the trunk lid to protect luggage in the trunk.

1. Make sure the rear seat-backs are not folded down.
2. Turn off the trunk main switch in the glove box.
3. Lock the glove box.

Emergency Trunk Opener

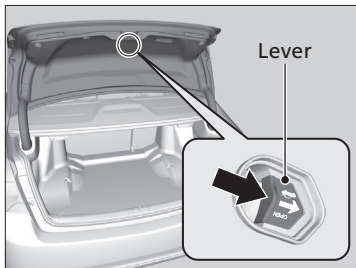

The trunk release lever allows you to open the trunk from inside for your safety.

Slide the release lever in the direction of the arrow.

Trunk Main Switch

If you need to give the key to someone else, give them the valet key.

The trunk release button on the remote transmitter is always enabled, even when the trunk main switch is off.

Emergency Trunk Opener

Parents should decide if their children should be shown how to use this feature.

Immobilizer System

The immobilizer system prevents a key that has not been pre-registered from starting the engine. Each key contains electronic transmitters that use electronic signals to verify the key.

Pay attention to the following when inserting the key into the ignition switch.

- Do not allow objects that emit strong radio waves near the ignition switch.
- Make sure the key is not covered by or touching a metal object.
- Do not bring a key from another vehicle's immobilizer system near the ignition switch.

Security System Alarm

The security system alarm activates when the doors, trunk, or hood are opened without the key, or remote transmitter. It also activates if you turn the ignition switch to ON  after locking the doors with the remote transmitter.

■ When the security system alarm activates

The horn sounds intermittently, and all of the exterior lights flash.

■ To deactivate the security system alarm

Unlock the vehicle using the key, or remote transmitter. The system, along with the horn and flashing lights, are deactivated.

⌘ Immobilizer System

NOTICE

Leaving the ignition key in the vehicle can result in theft or accidental movement of the vehicle. Always take the ignition key with you whenever you leave the vehicle unattended.

Do not alter the system or add other devices to it. Doing so may damage the system and make your vehicle inoperable.

⌘ Security System Alarm

The security alarm continues for a maximum of two minutes until the security system deactivates.

■ Setting the security system alarm

The security system alarm automatically sets when the following conditions have been met:

- The ignition switch is in LOCK **0**, and the key has been removed from the ignition switch.
- The hood is closed.
- All doors are locked.

■ When the security system alarm sets

The security system indicator in the instrument panel blinks. When the blinking interval changes after about 15 seconds, the security system is set.

■ To cancel the security system alarm

The security system is canceled when the vehicle is unlocked using the key or remote transmitter. The security system indicator goes off at the same time.

■ Panic Mode

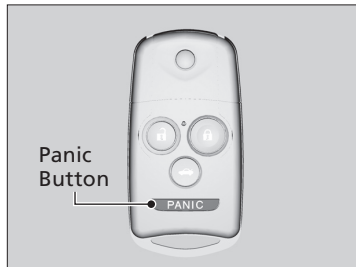

■ The panic button on the remote transmitter

If you press the panic button for approximately one second, the following will occur:

- The horn sounds.
- Some exterior lights flash for about 30 seconds.

■ Canceling panic mode

Press any button on the remote transmitter, or turn the ignition switch to ON **II**.

⌘ Security System Alarm

Do not set the security system alarm when someone is in the vehicle or a window is open. The system can accidentally activate when:

- Unlocking the door with the lock tab or the master door lock switch.
- Opening the trunk with the release button on the driver's door or the emergency trunk opener.

If the battery goes dead after you have set the security system alarm, the security alarm may go off once the battery is recharged or replaced.

If this occurs, deactivate the security system alarm by unlocking a door using the key or remote transmitter.

Do not attempt to alter this system or add another device to it.

Opening/Closing the Power Windows

The power windows can be opened and closed when the ignition switch is in ON  , using the switches on the doors. The driver's side switch can be used to open and close all of the windows.

The main switch on the driver's side must be switched off (not pushed in, indicator off) to open and close the windows from anywhere other than the driver's seat.

When the main switch is turned on (pushed in, indicator on), you can only operate the windows from the driver's seat. Turn the main switch on when children are in the vehicle.

Opening/Closing Windows with Auto-Open/Close Function

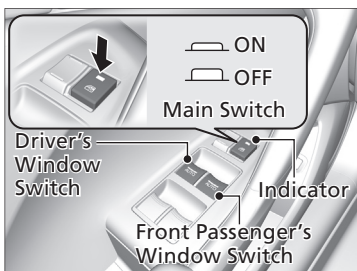

Automatic operation

To open: Push the switch down firmly

To close: Pull the switch up firmly.

The window opens or closes completely. To stop the window at any time, push or pull the switch briefly.

Manual operation

To open: Push the switch down lightly.

To close: Pull the switch up lightly.

Release the switch when the window reaches the desired position.

Opening/Closing the Power Windows

⚠ WARNING

Closing a power window on someone's hands or fingers can cause serious injury.

Make sure your passengers are away from the windows before closing them.

The power windows can be operated for up to 10 minutes after you turn the ignition switch off. Opening either front door cancels this function.

Auto Reverse

If a power window senses resistance when closing automatically, it will stop closing and reverse direction.

The driver's window auto reverse function is disabled when you continuously pull up the switch.

The auto reverse function stops sensing when the window is almost closed to ensure that it fully closes.

■ Opening/Closing Windows without Auto-Open/Close Function

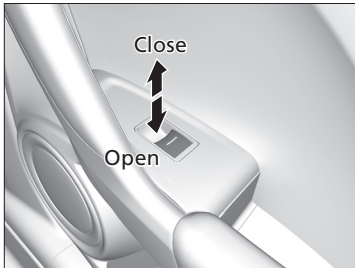

To open: Push the switch down.

To close: Pull the switch up.

Release the switch when the window reaches the desired position.

■ Opening Windows and Moonroof with the Remote Transmitter



To open: Press the UNLOCK button twice within 10 seconds and hold it down for the second time. If the windows stop midway, repeat the procedure.

⊠ Opening Windows and Moonroof with the Remote Transmitter

You cannot operate the power windows with the remote transmitter when the key is in the ignition switch.

■ Opening/Closing the Windows/Moonroof with the Key

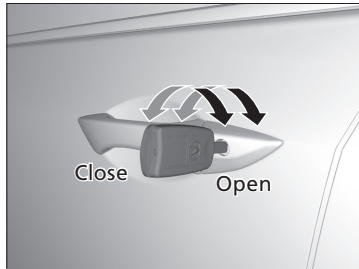

To open: Unlock the driver's door with the key. Within 10 seconds of returning the key to the central position, turn the key in the unlock direction and hold it there.

To close: Lock the driver's door with the key. Within 10 seconds of returning the key to the central position, turn the key in the lock direction and hold it there.

Release the key to stop the windows/moonroof at the desired position. If you want further adjustment, repeat the same operation.

☒ Opening/Closing the Windows/Moonroof with the Key

You cannot close the power windows with the key when the door is open.

Opening/Closing the Moonroof

You can only operate the moonroof when the ignition switch is in ON . Use the switch in the front of the ceiling to open and close the moonroof.



Automatic operation

To open: Pull the switch back firmly, then release.

To close: Push the switch forward firmly, then release.

The moonroof will automatically open or close all the way. To stop the moonroof midway, touch the switch briefly.

Manual operation

To open: Pull the switch back, and hold it until the desired position is reached.

To close: Push the switch forward, and hold it until the desired position is reached.

Tilting the moonroof up

To tilt: Push on the center of the moonroof switch.

To close: Push the switch forward firmly, then release.

Opening/Closing the Moonroof

WARNING

Opening or closing the moonroof on someone's hands or fingers can cause serious injury.

Make sure all hands and fingers are clear of the moonroof before opening or closing it.

NOTICE

Opening the moonroof in below freezing temperature or when it is covered with snow or ice can damage the moonroof panel or motor.

The power moonroof can be operated for up to 10 minutes after you turn the ignition switch off. Opening either front door cancels this function.

When resistance is detected, the auto reverse function causes the moonroof to change directions, then stop. Auto reverse stops sensing when the moonroof is almost closed to ensure that it fully closes. Make sure that all objects, including fingers, are clear of the moonroof.

Ignition Switch

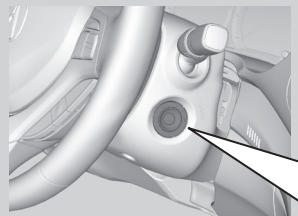

- 0** LOCK: Insert and remove the key in this position.
- I** ACCESSORY: Operate the audio system and other accessories in this position.
- II** ON: This is the position when driving.
- III** START: This position is for starting the engine. The switch returns to ON **II** when you let go of the key.

Ignition Switch

Manual transmission models

⚠ WARNING

Removing the key from the ignition switch locks the steering. If you do this while the vehicle is in motion, you can lose control of the vehicle.

Only remove the key from the ignition switch when parked.

Automatic transmission models

You cannot take the key out unless the shift lever is in **P**.

All models

If you open the driver's door when the key is in LOCK **0** or ACCESSORY **I**, a warning buzzer will sound to remind you to take the key out.

When this happens, the following messages appear on the multi-information display:

- In LOCK **0**: "REMOVE KEY."
- In ACCESSORY **I**: "REMOVE KEY" The buzzer will stop when you take the key out.

If the key won't turn from LOCK **0** to ACCESSORY **I**, turn the key while moving the steering wheel left and right. The steering wheel will unlock, allowing the key to turn.

Turn Signals

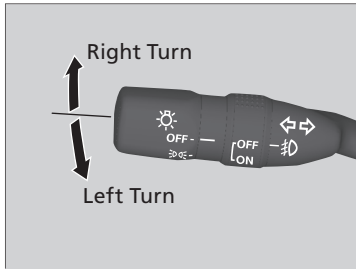

The turn signals can be used when the ignition switch is in ON [II].

Light Switches

Manual Operation

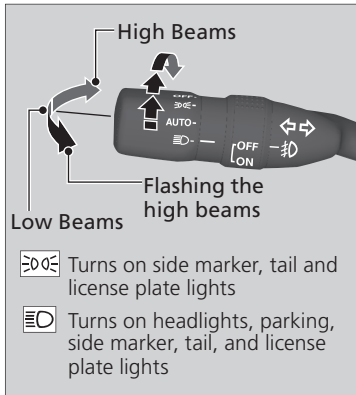

Rotating the light switch turns the lights on and off, regardless of the position of the ignition switch.

■ High beams

Push the lever forward until you hear a click.

■ Low beams

When in high beams, pull the lever back to return to low beams.

■ Flashing the high beams

Pull the lever back, and release it.

☒ Light Switches

If you remove the key with the lights on, a lights on reminder chime will sound.

When the lights are on, the lights on indicator in the instrument panel will be on.

☒ Indicators P.64

Repeatedly turning the headlights on and off reduces the life of the HID headlight bulbs. If you sense that the level of the headlights is abnormal, have the vehicle inspected by a dealer.

Do not leave the lights on when the engine is off because it will cause the battery to discharge.

■ Automatic Operation (automatic lighting control)

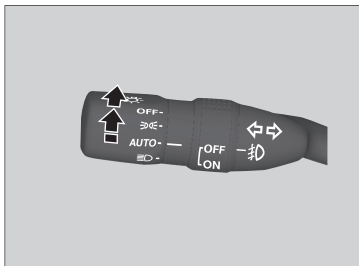

Automatic lighting control can be used when the ignition switch is in ON **II**.

When you turn the light switch to **AUTO**, the headlights and other exterior lights will switch on and off automatically depending on the ambient brightness.

■ Automatic lighting off feature

The headlights, all other exterior lights, and the instrument panel lights turn off within 15 seconds after you remove the key and close the driver's door.

If you turn the ignition switch to LOCK **0** with the headlight switch on, but do not open the door, the lights turn off after 10 minutes (3 minutes, if the switch is in the **AUTO** position).

The lights turn on again when you unlock or open the driver's door. If you unlock the door, but do not open it within 15 seconds, the lights go off. If you open the driver's door, you will hear a lights on reminder chime.

⊠ Automatic Operation (automatic lighting control)

We recommend that you turn on the lights manually when driving at night, in a dense fog, or in dark areas such as long tunnels or parking facilities.

The light sensor is in the location shown below. Do not cover this light sensor with anything; otherwise, the automatic lighting system may not work properly.

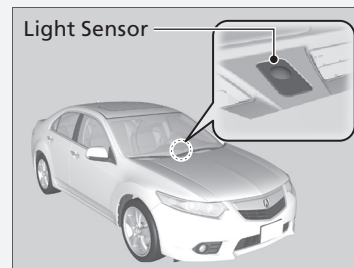

You can change the AUTO light sensitivity and automatic lighting off timer setting using the multi-information display.

⊠ **Customization Procedure** P. 80

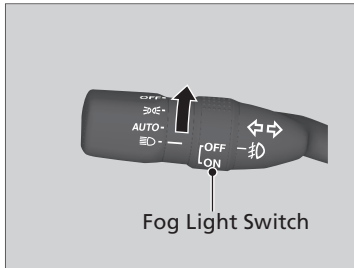

Fog Lights



When the low beam headlights are on, turn the fog light switch on to use the fog lights.

Daytime Running Lights

The high beam headlights and indicator come on slightly dimmer than normal.

- The ignition switch is in ON .
- The headlight switch is off, or in .
- The parking brake is released.

The lights remain on even if you set the parking brake. Turning off the ignition switch will turn off the daytime running lights.

The high beam headlights return to the original brightness once the headlight switch is turned on.

☒ Fog Lights

When the fog lights are on, the indicator in the instrument panel will be on.

They go off when the headlights turn off, or when the daytime running lights are on.

➤ **Indicators** P.64

Wipers and Washers

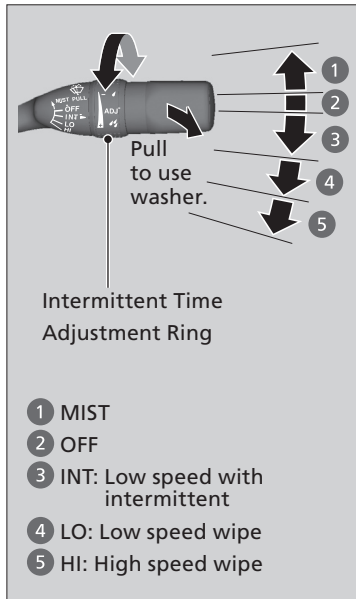

The windshield wipers and washers can be used when the ignition switch is in ON **II**.

■ MIST

The wipers run at high speed until you release the lever.

■ Wiper switch (OFF, INT, LO, HI)

Change the wiper switch setting according to the amount of rain.

■ Adjusting the delay

Turn the adjustment ring to adjust the wiper delay.

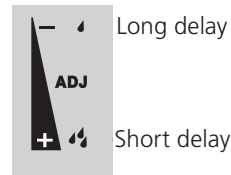

■ Washer

Sprays while you pull the lever toward you. When you release the lever, the wipers make two or three more sweeps before stopping.

⊗ Windshield Wipers and Washers

NOTICE

Do not use the wipers when the windshield is dry. The windshield will get scratched, or the rubber blades will get damaged.

NOTICE

In cold weather, the blades may freeze to the windshield, becoming stuck. Operating the wipers in this condition may damage the wipers. Use the defroster to warm the windshield, then turn the wipers on.

If the vehicle speeds up while the wipers are operating intermittently, the length of the wiper interval shortens. When the vehicle starts moving, the wipers make a single sweep. The wiper operation of the shortest delay setting  and the LO setting become the same when the vehicle speeds up.

Turn the washers off if no washer fluid comes out. The pump may get damaged.

Brightness Control

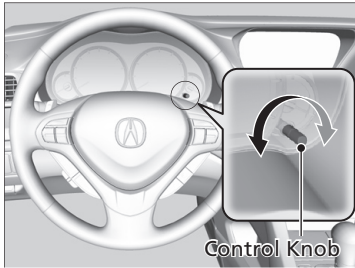

When the parking lights are turned on and the ignition switch is in ON , you can use the brightness control knob to adjust instrument panel brightness.

Brighten: Turn the knob to the right.

Dim: Turn the knob to the left.

You will hear the beeper when the brightness reaches minimum or maximum. The multi-information display will return to its original state several seconds after you adjust the brightness.

■ Brightness level indicator

The brightness level is shown on the multi-information display while you are adjusting it. As the brightness level increases to the right, the instrument panel gets brighter.



» Brightness Control

Instrument panel brightness varies, depending on whether the exterior lights are on or off. The instrument panel dims to reduce glare when they are on.

Pressing either / (information) button switches the display.

If you turn the knob to the right until the brightness display is up to max, the beeper sounds. This cancels the reduced instrument panel brightness when the parking lights are on.

The brightness can be set differently for when the exterior lights are on, and when they are off.

Rear Defogger/Heated Door Mirror Button

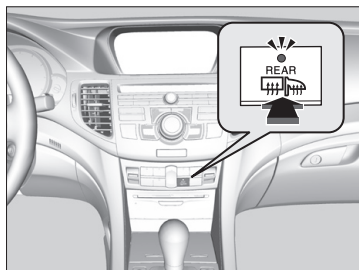

Press the rear defogger and heated door mirror button to defog the rear window and mirrors when the ignition is in ON .

The rear defogger and heated door mirrors automatically switch off after 10-30 minutes depending on the outside temperature. However, if the outside temperature is 32°F (0°C) or below, they do not automatically switch off.

⊗ Rear Defogger/Heated Door Mirror Button

NOTICE

When cleaning the inside of the rear window, be careful not to damage the heating wires. It is critical to wipe the window from side to side along the defogger heating wires.

This system consumes a lot of power, so turn it off when the window has been defogged. Also, do not use the system for a long period when the engine is idling. This may weaken the battery, making it difficult to start the engine.

Driving Position Memory System*

You can store two driver's seat positions with the driving position memory system. When you unlock and open the driver's door with a remote transmitter, the seat adjusts automatically to one of the two preset positions.

The multi-information display shows you which remote transmitter you used to unlock the vehicle when you enter.

- Driver 1 transmitter is linked to memory button 1.
- Driver 2 transmitter is linked to memory button 2.

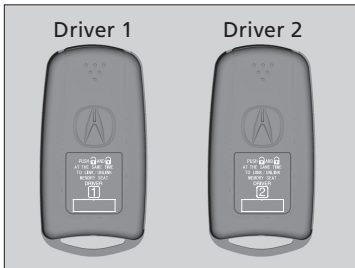

* Not available on all models

▣ Driving Position Memory System

Using the multi-information display, you can disable the automatic seat adjustment function.

▣ **Customization Procedure** P.80

You can cancel the driving position memory link and customized settings. Press and hold the LOCK and UNLOCK buttons at the same time. The LED in the remote transmitter blinks twice and the default settings are restored.

To turn the memory position link settings back on, repeat this procedure. The LED will blink once.

■ Storing a Position in Memory

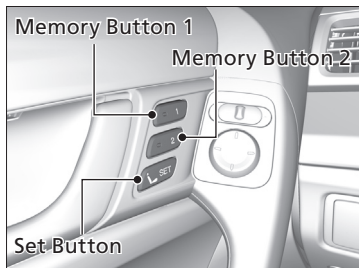

1. Adjust the driver's seat to the desired position, and turn the ignition switch to ON **II**.
2. Press the SET button.
 - ▶ You will hear the beeper, and the memory button indicator light will blink.
3. Press memory button **1** or **2** within five seconds of pressing the SET button.
 - ▶ Once the seat position has been memorized, the indicator light on the button you pressed stays on.

■ Recalling the Stored Position

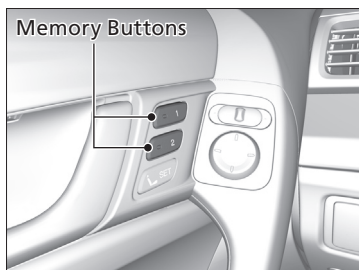

Automatic transmission models

1. Move the shift lever to **P**.
2. Apply the parking brake.
3. Press a memory button (**1** or **2**).
 - ▶ You will hear the beeper, and the indicator light will blink.

The seat will automatically move to the memorized position. When it has finished moving, you will hear the beeper, and the indicator light stays on.

All models

3. Press a memory button (**1** or **2**).
 - ▶ You will hear the beeper, and the indicator light will blink.

⊗ Storing a Position in Memory

After you press the SET button, the storing operation will be canceled when:

- You do not press the memory button within five seconds.
- You readjust the seat position before the double-beep.
- You turn the ignition switch to any position except ON **II**.

⊗ Recalling the Stored Position

The seat will stop moving if you:

- Press the SET button, or a memory button (**1** or **2**).
- Adjust the seat position.

Automatic transmission models

- Shift into any position except **P**.

Manual transmission models

- Release the parking brake.

Adjusting the Steering Wheel

The steering wheel height and distance from your body can be adjusted so that you can comfortably grip the steering wheel in an appropriate driving posture.

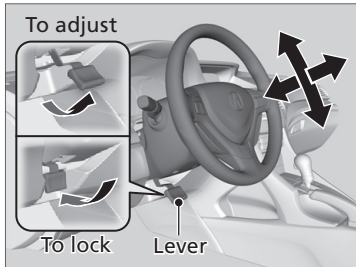

1. Pull the steering wheel adjustment lever up.
 - ▶ The steering wheel adjustment lever is under the steering column.
2. Move the steering wheel up or down, and in or out.
 - ▶ Make sure you can see the instrument panel gauges and indicators.
3. Push the steering wheel adjustment lever down to lock the steering wheel in position.
 - ▶ After adjusting the position, make sure you have securely locked the steering wheel in place by trying to move it up, down, in, and out.

Adjusting the Steering Wheel

⚠ WARNING

Adjusting the steering wheel position while driving may cause you to lose control of the vehicle and be seriously injured in a crash.

Adjust the steering wheel only when the vehicle is stopped.

Make any steering wheel adjustments before you start driving.

Interior Rearview Mirror

Adjust the angle of the rearview mirror when you are sitting in the correct driving position.

Automatic Dimming Rearview Mirror

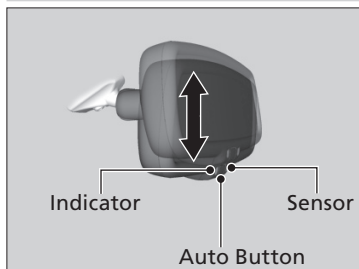

When driving after dark, the automatic dimming rearview mirror reduces the glare from headlights behind you. Press the AUTO button to turn this function on and off. When activated, the AUTO indicator comes on.

Adjusting the Mirror

Keep the inside and outside mirrors clean and adjusted for best visibility.

Adjust the mirrors before you start driving.

Adjusting the Seat Positions P. 116

Automatic Dimming Rearview Mirror

The auto dimming function cancels when the shift position is in R.

Door Mirrors

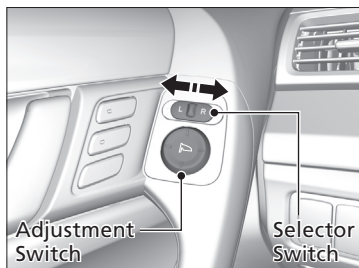

You can adjust the door mirrors when the ignition switch is in ON **II**.

Mirror position adjustment

L/R selector switch: Select the left or right mirror. After adjusting the mirror, return the switch to the center position.

Mirror position adjustment switch: Press the switch left, right, up, or down to move the mirror.

Reverse Tilt Door Mirror

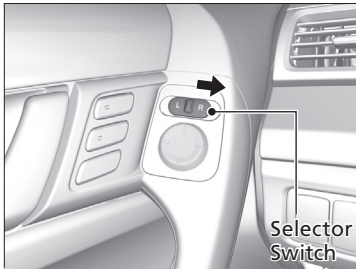

If activated, the passenger side door mirror automatically tilts downward when you put the shift lever in **R**; this improves close-in visibility on the passenger side of the vehicle when backing up. The mirror automatically returns to its original position when you shift out of **R**.

To activate this feature, turn the ignition switch to ON **II** and slide the selector switch to the passenger's side.

Adjusting the Seat Positions

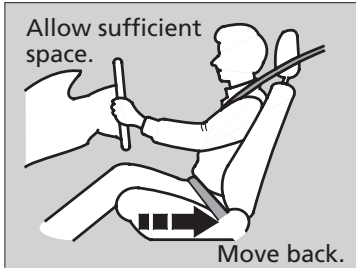

Adjust the driver's seat as far back as possible while allowing you to maintain full control of the vehicle. You should be able to sit upright, well back in the seat and be able to adequately press the pedals without leaning forward, and grip the steering wheel comfortably. The passenger's seat should be adjusted in a similar manner, so that it is as far back from the front airbag in the dashboard as possible.

Adjusting the Seats

WARNING

Sitting too close to a front airbag can result in serious injury or death if the front airbags inflate.

Always sit as far back from the front airbags as possible while maintaining control of the vehicle.

The National Highway Traffic Safety Administration and Transport Canada recommend that drivers allow at least 10 inches (25 cm) between the center of the steering wheel and the chest.

Always make seat adjustments before driving.

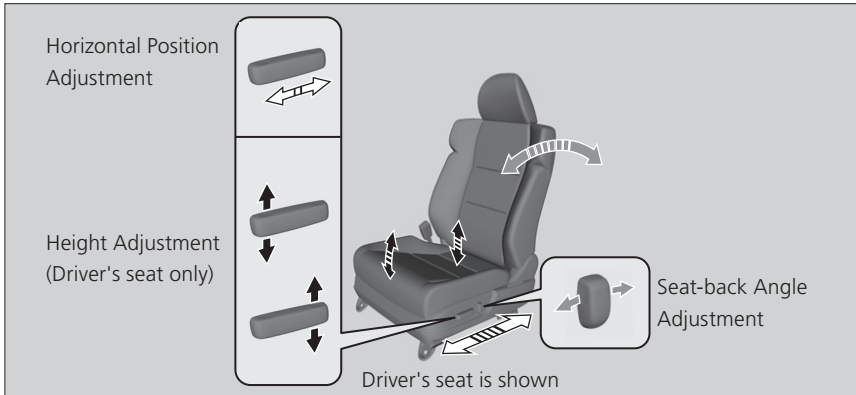

Adjusting the Seat-Backs

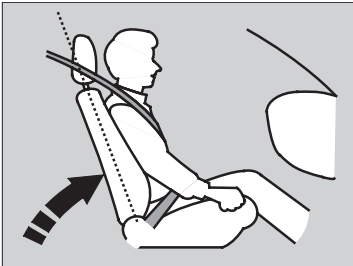

Adjust the driver's seat-back to a comfortable, upright position, leaving ample space between your chest and the airbag cover in the center of the steering wheel.

The front seat passenger should also adjust their seat-back to a comfortable, upright position.

Reclining a seat-back so that the shoulder part of the belt no longer rests against the occupant's chest reduces the protective capability of the belt. It also increases the chance of sliding under the belt in a crash and being seriously injured. The farther a seat-back is reclined, the greater the risk of injury.

Adjusting the Seat-Backs

⚠ WARNING

Reclining the seat-back too far can result in serious injury or death in a crash.

Adjust the seat-back to an upright position, and sit well back in the seat.

Do not put a cushion, or other object, between the seat-back and your back.

Doing so may interfere with proper seat belt or airbag operation.

If you cannot get far enough away from the steering wheel and still reach the controls, we recommend that you investigate whether some type of adaptive equipment may help.

■ Adjusting the Head Restraints

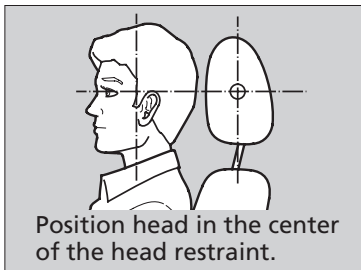

Your vehicle is equipped with head restraints.

Head restraints are most effective for protection against whiplash and other rear-impact crash injuries when the center of the back of the occupant's head rests against the center of the restraint. The tops of the occupant's ears should be level with the center height of the restraint.

■ Adjusting the front and rear outer head restraint positions

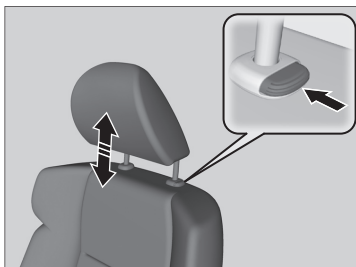

To raise the head restraint: Pull it upward.

To lower the head restraint: Push it down while pressing the release button.

⊠ Adjusting the Head Restraints

⚠ WARNING

Improperly positioning head restraints reduces their effectiveness and increases the likelihood of serious injury in a crash.

Make sure head restraints are in place and positioned properly before driving.

The driver's and front passenger's seats have active head restraints.

⊠ **Active Head Restraints** P.122

■ Changing the Center Rear Seat Head Restraint Position

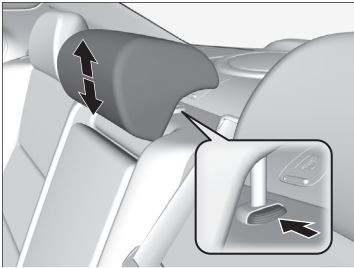

A passenger sitting in the center back seating position should adjust the height of their head restraint to an appropriate position before the vehicle begins moving.

To raise the head restraint:

Pull it upward.

To lower the head restraint:

Push it down while pressing the release button.

■ Removing and Reinstalling the Head Restraints

Head restraints can be removed for cleaning or repair.

To remove a head restraint:

Pull the restraint up as far as it will go. Then push the release button, and pull the restraint up and out.

To reinstall a head restraint:

Insert the legs back in place, then adjust the head restraint to an appropriate height while pressing the release button. Pull up on the restraint to make sure it is locked in position.

⌘ Removing and Reinstalling the Head Restraints

⚠ WARNING

Failure to reinstall the head restraints can result in severe injury during a crash.

Always replace the head restraints before driving.

■ Adjusting the Driver's Seat Lumbar Support



The firmness of the seat-back can be adjusted.

To make it firmer:

Pull the lever backward.

To make it less firm:

Push the lever forward.

■ Maintain a Proper Sitting Position

After all occupants have adjusted their seats and head restraints, and put on their seat belts, it is very important that they continue to sit upright, well back in their seats, with their feet on the floor, until the vehicle is safely parked and the engine is off.

Sitting improperly can increase the chance of injury during a crash. For example, if an occupant slouches, lies down, turns sideways, sits forward, leans forward or sideways, or puts one or both feet up, the chance of injury during a crash is greatly increased.

In addition, an occupant who is out of position in the front seat can be seriously or fatally injured in a crash by striking interior parts of the vehicle or being struck by an inflating front airbag.

ⓘ Maintain a Proper Sitting Position

WARNING

Sitting improperly or out of position can result in serious injury or death in a crash.

Always sit upright, well back in the seat, with your feet on the floor.

■ Active Head Restraints

The driver's and front passenger's seats have active head restraints. In a rear impact, an occupant properly secured by a seat belt will be pushed against the seat-back and the head restraint will move forward. This reduces the distance between the restraint and the occupant's head, which helps reduce the likelihood of whiplash and injuries to the neck and upper spine.

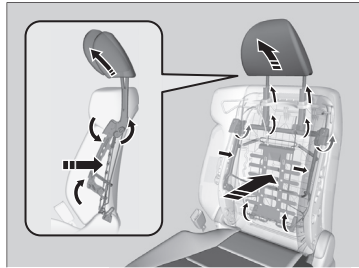

☒ Active Head Restraints

In order for the active head restraints to operate properly:

- Do not hang any items on the head restraints, or from the restraint legs.
- Do not place any object between an occupant and the seat-back.
- Install each restraint in its proper location.

After a collision, the activated restraint should return to its normal position. If the restraint does not return to its normal position, or in the event of a severe collision, have the vehicle inspected by a dealer.

Rear Seats

Folding Down the Rear Seats

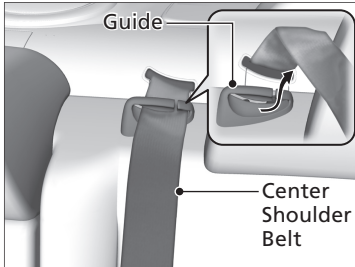

1. Remove the center shoulder belt from the guide.

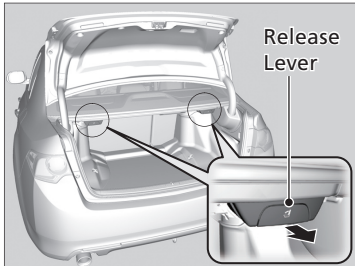

2. Pull the release lever in the trunk to release the lock.

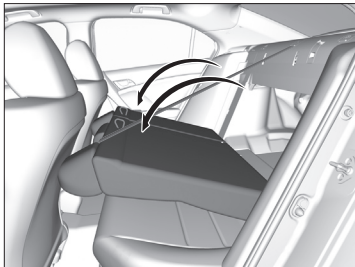

3. Fold the seat-back down.

If the rear head restraints get caught on the front seat-backs, remove the head restraints.

- **Removing and Reinstalling the Head Restraints** P.119

Folding Down the Rear Seats

The rear seat-backs can be folded down to accommodate bulkier items in the trunk.

Never drive with a seat-back folded down and the trunk lid open.

- **Carbon Monoxide Hazard** P. 60

To lock a seat-back upright, push it backwards until it locks.

When returning a seat-back to its original position, push it firmly back. Also, make sure all rear shoulder belts are positioned in front of the seat-back, and the center shoulder belt is re-positioned in the guide.

Make sure that the folded seat-back does not press against the front passenger seat, as this can cause the weight sensors in the front passenger seat to work improperly.

- **Passenger Airbag Off Indicator** P. 45

Also make sure all items in the trunk or items extending through the opening into the rear seats are properly secured. Loose items can fly forward if you have to brake hard.

Armrest

■ Using the Front Seat Armrest

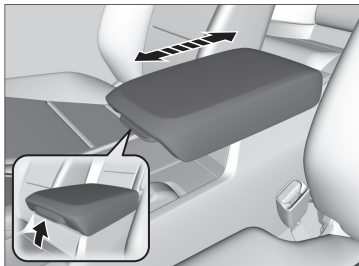

The console lid can be used as an armrest.

To adjust:

Push the release lever and slide the armrest to a desired position. Release the lever to lock the position.

■ Using the Rear Seat Armrest

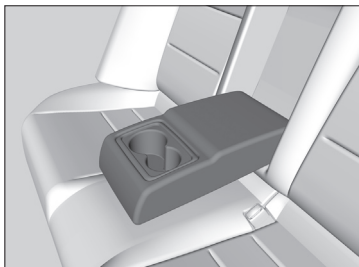

Pull down the armrest in the center seat-back.

Interior Lights

Interior Light Switches

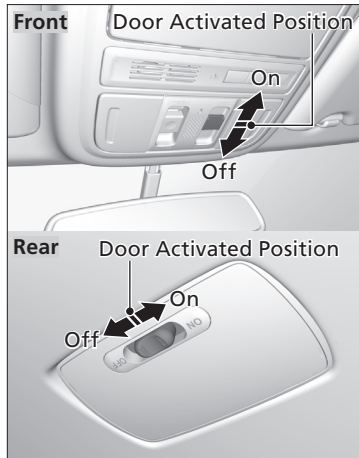

■ ON

The interior lights come on regardless of whether the doors are open or closed.

■ Door activated

The interior lights come on in the following situations:

- When any of the doors are opened.
- You unlock the driver's door.
- You remove the key from the ignition switch.

■ OFF

The interior lights remain off regardless of whether the doors are open or closed.

Map Lights

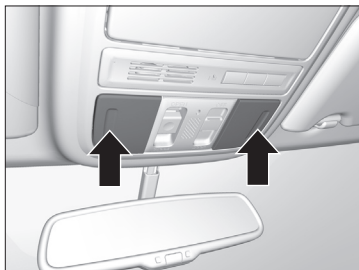

The map lights can be turned on and off by pressing the lenses.

☒ Interior Light Switches

In the door activated position, the interior lights fade out and go off about 30 seconds after the doors are closed.

The lights go off after 30 seconds in the following situations:

- When you unlock the driver's door but do not open it.
- When you remove the key from the ignition switch but do not open a door.

You can change the interior lights dimming time.

☒ **Customized Features** P.80

The interior lights go off immediately in the following situations:

- When you lock the driver's door.
- When you close the driver's door with the key in the ignition switch.
- When you turn the ignition switch to ON II.

If you leave any of the doors open without the key in the ignition switch, the interior lights go off after about 15 minutes.

☒ Map Lights

When the ceiling light switch is in the door activated position and any door is open, the map light will not go off when you press the lens.

Interior Convenience Items

Glove Box

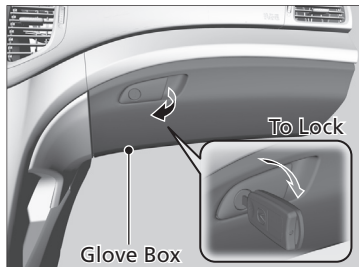

Pull the handle to open the glove box. You can lock the glove box with the master key.

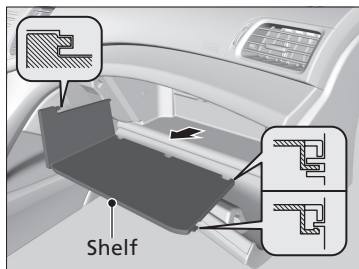

■ Detachable shelf

The shelf in the glove box is detachable. To remove it, disengage the tabs.

☒ Glove Box

⚠ WARNING

An open glove box can cause serious injury to your passenger in a crash, even if the passenger is wearing the seat belt.

Always keep the glove box closed while driving.

The glove box light comes on when the parking lights are on.

■ Console Compartment

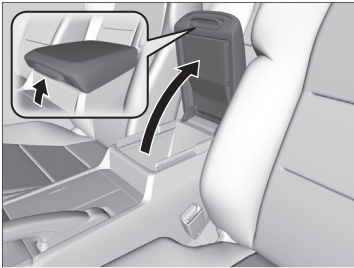

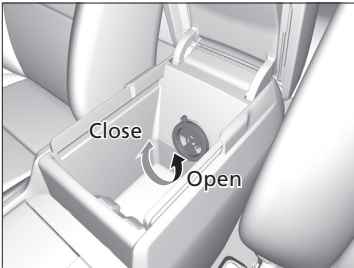

Pull the handle to open the console compartment.

To use the console lid as an armrest, slide it to the desired position while pulling up the release lever.



You can keep beverage bottles and cans cool with the air conditioning system.

1. Turn the dial counterclockwise to open the air vent in the console compartment.
2. Turn on the climate control system and adjust the temperature to cool.
3. Set the mode control  or .
 - The cool air is diverted through the air vent.

▣ Console Compartment

Use only resealable containers or keep unopened cans in the console compartment. Spilled liquids can damage the upholstery and electrical components in the console compartment.

When the heater begins to divert warm air, the airflow into the console compartment is shut off.

Beverage Holders

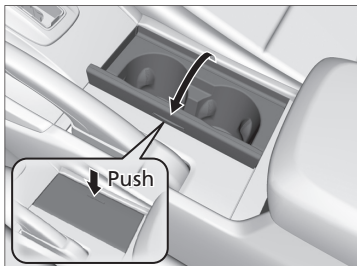

■ Front seat beverage holders

Press the raised detent to open the lid. To close the lid, push it down until it latches.

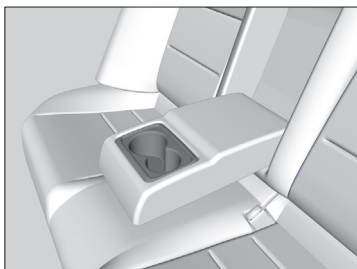

■ Rear seat beverage holders

Fold the armrest down to use the rear seat beverage holders.

⊗ Beverage Holders

NOTICE

Spilled liquids can damage the upholstery, carpeting, and electrical components in the interior.

Be careful when you are using the beverage holders. Hot liquid can scald you.

Accessory Power Sockets

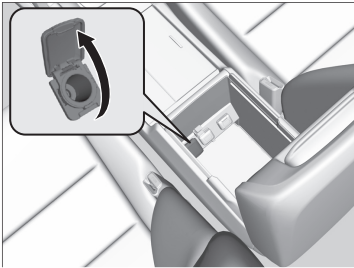

There are two accessory power sockets; one in the console compartment and the other at the front of the center console. They can be used when the ignition switch is in ACCESSORY **I** or ON **II**.

Open the cover to use it.

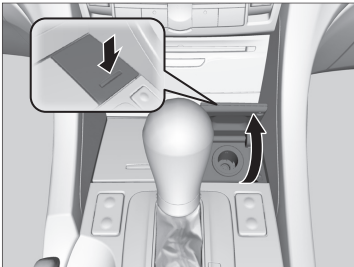

Accessory Power Sockets

NOTICE

Do not insert an automotive type cigarette lighter element. This can overheat the power socket.

The accessory power socket is designed to supply power for 12 volt DC accessories that are rated 120 watts or less (10 amps).

To prevent battery drain, only use the power socket with the engine running.

Coat Hooks

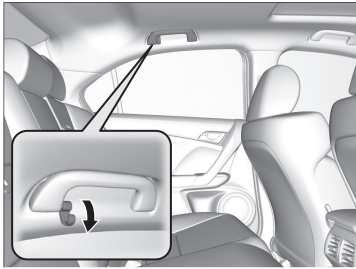

There are coat hooks on the rear left and right grab handles. Pull them down to use them.

Cargo Hooks

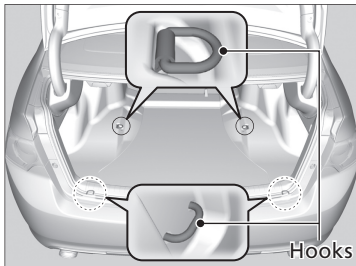

The cargo hooks in the trunk can be used to install a net for securing items.

☒ Coat Hooks

The coat hooks are not designed for large or heavy items.

☒ Cargo Hooks

Distribute cargo evenly on the floor of the trunk, placing the heaviest items on the bottom and as far forward as possible.

☒ **Maximum Load Limit** P.185

■ Sunglasses Holder

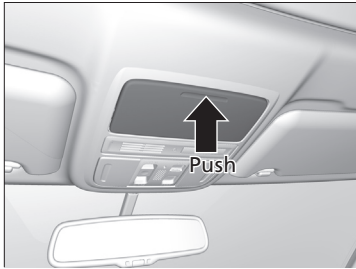

To open the sunglasses holder, push and release the indent. To close, push it again until it latches.

You can store eyeglasses and other small items in this holder.

▣ Sunglasses Holder

Keep the holder closed while driving except when accessing stored items.

Seat Heaters



If the ignition switch is in ON . The HI setting heats the seats faster than the LO setting.

There is no heater in the passenger's seat-back due to the side airbag cutoff system.

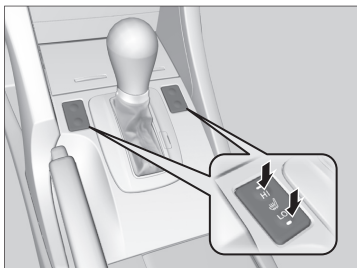

While in HI, the heater cycles on and off.

- The appropriate indicator will be on while the seat heater is on. Briefly press the button on the opposite side to turn the heater off. The indicator will be off. When a comfortable temperature is reached, select LO to keep the seat warm.

Seat Heaters

WARNING

Heat induced burns are possible when using seat heaters.

Persons with a diminished ability to sense temperature (e.g., persons with diabetes, lower-limb nerve damage, or paralysis) or with sensitive skin should not use seat heaters.

Do not use the seat heaters even in LO when the engine is off. Under such conditions, the battery may be weakened, making the engine difficult to start.

In the LO setting, the heater runs continuously and does not automatically turn off after a period of time.

Using Automatic Climate Control

The automatic climate control system maintains the interior temperature you select. The system also selects the proper mix of heated or cooled air that will as quickly as possible, raise or lower the interior temperature to your preference.

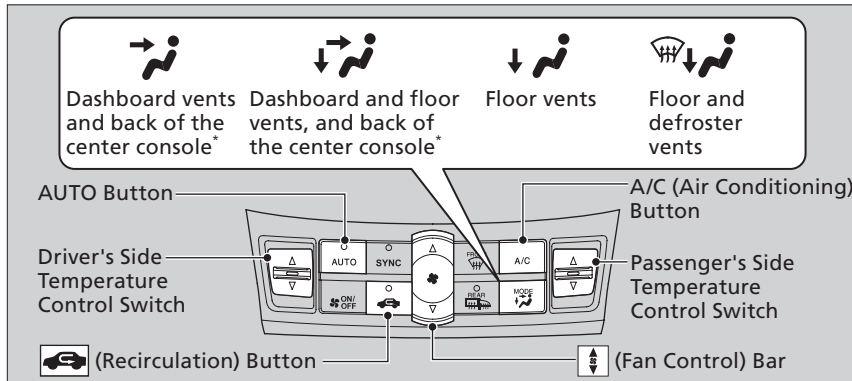

Use the system when the engine is running.

1. Press the AUTO button.
2. Adjust the interior temperature using the driver's side or passenger's side control switch.
3. Press the  button to cancel.

Switching between the recirculation and fresh air modes

Press the  button and switch the mode depending on environmental conditions.

Recirculation Mode (indicator on) : Recirculates air from the vehicle's interior through the system.

Fresh Air Mode (indicator off): Maintains outside ventilation. Keep the system in fresh air mode in normal situations.

* Not available on all models

Using Automatic Climate Control

If any buttons are pressed while using the climate control system in AUTO, the function of the button that was pressed will take priority.

The AUTO indicator will go off, but functions unrelated to the button that was pressed will be controlled automatically.

To prevent cold air from blowing in from outside, the fan may not start immediately when the AUTO button is pressed.

Once you have set the desired temperature, do not use the temperature control switches more than necessary.

Doing so may delay the time it takes to reach the set temperature.

If the interior is very warm, you can cool it down more rapidly by partially opening the windows, turning the system on AUTO, and setting the temperature to low. Change the fresh mode to recirculation mode until the temperature cools down.

When you set the temperature to the lower or upper limit, Lo or Hi is displayed.

Pressing the  button switches the climate control system between on and off. When turned on, the system returns to your last selection.

Defrosting the Windshield and Windows

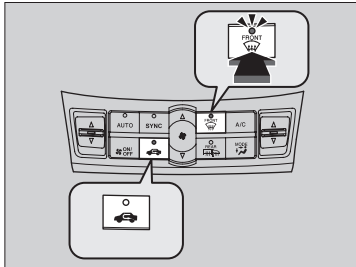

Pressing the  button turns the air conditioner system on and automatically switches the system to fresh air mode.

Press the  button again to turn off, the system returns to the previous settings.

⊗ Defrosting the Windshield and Windows

For your safety, make sure you have a clear view through all the windows before driving.

Do not set the temperature near the upper or lower limit.

When cold air hits the windshield, the outside of the windshield may fog up.

If the side windows fog up, adjust the vents so that the air hits the side windows.

⊗ To Rapidly Defrost or Defog the Windows

After defrosting or defogging the windows, switch over to fresh air mode.

If you keep the system in recirculation mode, the windows may fog up from humidity. This impedes visibility.

To rapidly defrost the windows

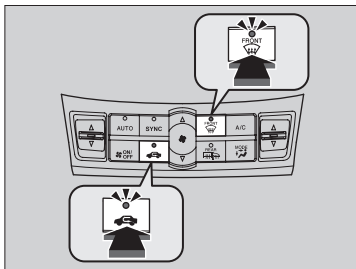

1. Press the  button.
2. Press the  button.

Synchronized Mode

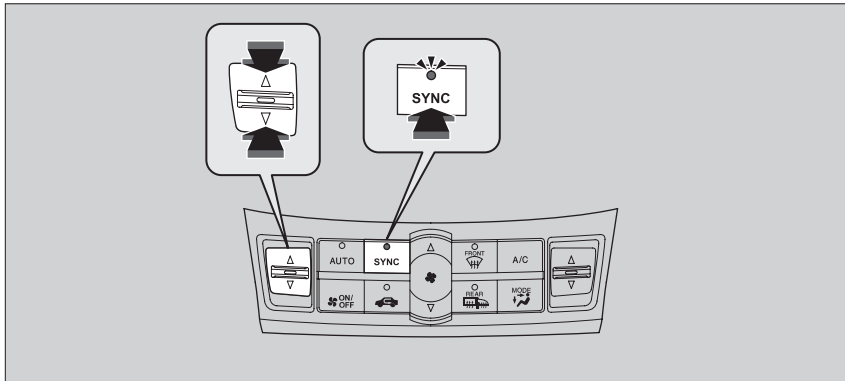

You can set the temperature synchronously for the driver side and the passenger side in synchronized mode.

1. Press the SYNC button.
 - The system will switch to synchronized mode.
2. Adjust the temperature using driver's side temperature control switch.

Press the SYNC button to return to dual mode.

☒ Synchronized Mode

When you press the  button, the system changes to synchronized mode.

When the system is in dual mode, the driver side temperature and the passenger side temperature can be set separately.

Automatic Climate Control Sensors

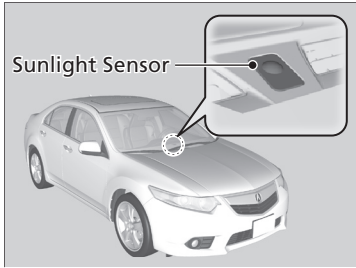

The automatic climate control system is equipped with a sunlight sensor and an interior temperature sensor. Do not cover or spill any liquid on them.

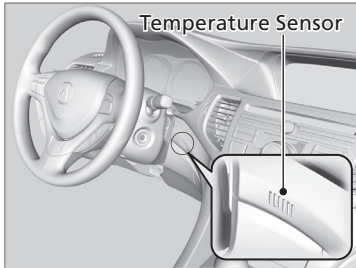

Features

This chapter describes how to operate technology features on models without the navigation system and HomeLink® Universal Transceiver.

Audio System		
About Your Audio System.....	138	
USB Adapter Cable.....	139	
Auxiliary Input Jack.....	140	
Audio System Theft Protection.....	140	
Audio System Basic Operation		
Adjusting the Sound.....	142	
Playing the AM/FM Radio.....	143	
Playing the XM® Radio.....	145	
Playing a CD.....	147	
Playing an iPod®.....	150	
Playing a USB Flash Drive.....	153	
Playing <i>Bluetooth</i> ® Audio.....	156	
Audio Error Messages		
CD Player.....	158	
iPod®/USB Flash Drive.....	159	
Audio Remote Controls	160	
General Information on the Audio System		
XM® Radio Service.....	161	
Recommended CDs.....	162	
Compatible iPod® and USB Flash Drives.....	164	
HomeLink® Universal Transceiver		
Training HomeLink.....	165	
<i>Bluetooth</i>® HandsFreeLink®	167	
Using HFL.....	167	
HFL Menus.....	169	
Compass	179	

About Your Audio System

On models with the navigation system, see the Navigation System Manual for operation of the audio system, AcuraLink*, Bluetooth® HandsFreeLink®, and voice commands for these features.

The audio system features AM/FM radio and the XM® Radio service. It can also play CDs, WMA/MP3/AAC files, iPods®, USB flash drives, and Bluetooth® devices.

You can operate the audio system from the buttons and switches on the panel, or the remote controls on the steering wheel.

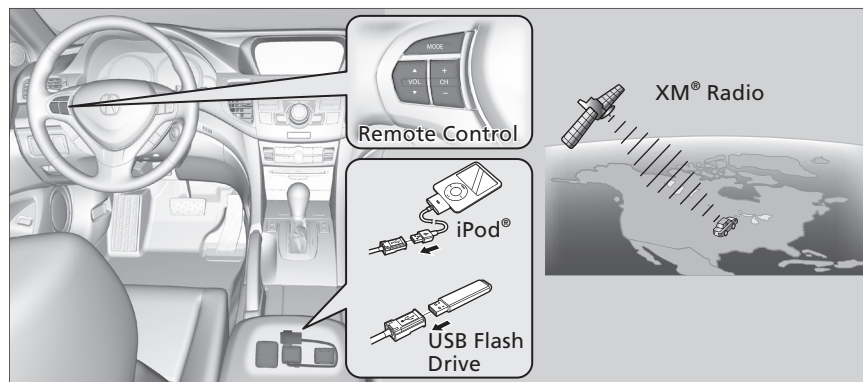

About Your Audio System

XM® Radio is available on a subscription basis only. For more information on XM® Radio, contact a dealer.

General Information on the Audio System P. 161

XM® Radio is available in the United States and Canada, except Hawaii, Alaska, and Puerto Rico.

XM® is a registered trademark of Sirius XM Radio, Inc.

Video CDs, DVDs, and 3-inch (8-cm) mini CDs are not supported.

iPod® is a registered trademark owned by Apple Inc.

MP3 and AAC are standard audio compression formats. WMA is an audio compression format developed by Microsoft Corporation.



USB Adapter Cable

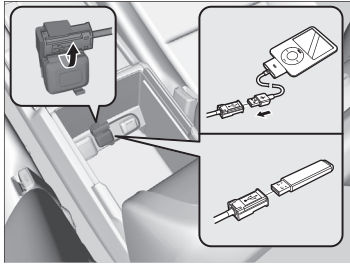

1. Unclip the USB connector and loosen the adapter cable.
2. Connect the iPod® dock connector or the USB flash drive to the USB connector.

⌘ USB Adapter Cable

- Do not leave the iPod® or USB flash drive in the vehicle. Direct sunlight and high temperatures may damage it.
- Do not use an extension cable with the USB adapter cable.
- Do not connect the iPod® or USB flash drive using a hub.
- Do not use a device such as a card reader or hard disk drive, as the device or your files may be damaged.
- We recommend backing up your data before using the device in your vehicle.
- Displayed messages may vary depending on the device model and software version.

If the audio system does not recognize the iPod®, try reconnecting it a few times or reboot the device. To reboot, follow the manufacturer's instructions provided with the iPod® or visit www.apple.com/ipod.

Auxiliary Input Jack

Use the jack in the console compartment to connect standard audio devices.

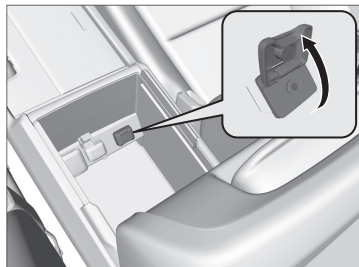

1. Open the AUX cover.
2. Connect a standard audio device to the input jack using a 1/8 inch (3.5 mm) stereo miniplug.

- ▶ The audio system automatically switches to the AUX mode.

⊗ Auxiliary Input Jack

To switch the mode, press any of the audio mode buttons. You can return to the AUX mode by pressing the AUX button.

You cannot use the auxiliary input jack if you replace the audio system.

⊗ Audio System Theft Protection

Find the audio system's security code and serial number on the radio code card.

Do not store the card in your vehicle. If you lose the radio code card, you must obtain the information from a dealer.

Audio System Theft Protection

The audio system is disabled when it is disconnected from the power source, such as when the battery is disconnected or goes dead.

■ Entering the audio security code

"ENTER CODE" appears on the display when the power is reconnected.

1. Turn on the audio system.
2. Enter the audio security code using the preset buttons. If you enter an incorrect digit, continue to the last digit, then try again. If you do not enter the code correctly after 10 tries, you need to visit a dealer to have the system reset.

Audio System Basic Operation

To use the audio system function, the ignition switch must be in ACCESSORY **I** or ON **II**.

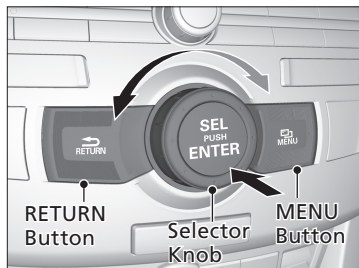

Use the selector knob or MENU button to access some audio functions.

Press  to switch between the normal and extended display for some functions. The extended display has three segments to display detailed information.

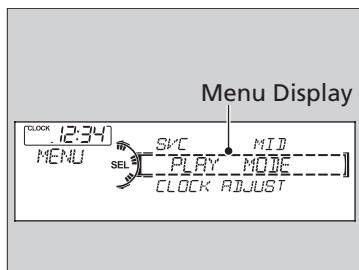

Selector knob: Rotate left or right to scroll through the available choices. Press  to set your selection.

MENU button: Press to select any setting such as the clock, sound control, or the compass. Press this button again to cancel the menu display mode.

RETURN button: Press to go back to the previous display.

Audio System Basic Operation

These indications are used to show how to operate the selector knob.

Rotate  to select.

Press  to ENTER.

Adjusting the Sound

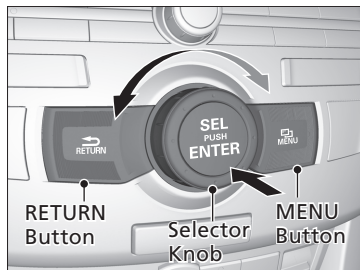

Press the MENU button, and rotate to adjust the setting. Rotate to scroll through the following choices:

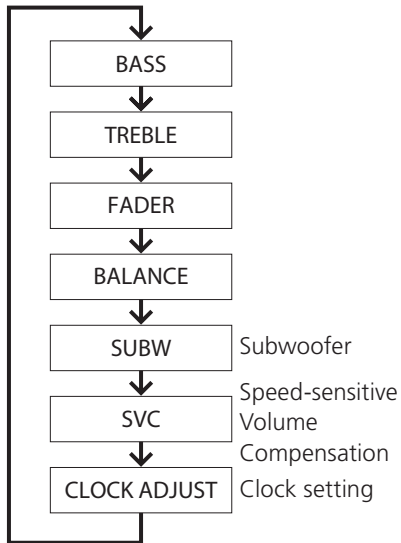
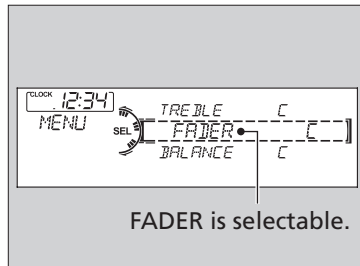

Adjusting the Sound

When the adjustment level reaches the center, you will see "C" in the display.

The SVC has four modes: OFF, LOW, MID, and HIGH.

SVC adjusts the volume level based on the vehicle speed. As you go faster, audio volume increases. As you slow down, audio volume decreases.

Playing the AM/FM Radio

AM/FM Button

Press to select a band.

TITLE Button

Press to switch the RDS name on and off.

CATEGORY Bar

Press either side to display and select an RDS category.

SCAN Button

Press to sample each of the strongest stations on the selected band for 10 seconds. To turn off scan, press the button again.

VOL/⏻ Knob

Press to turn the audio system ON and OFF. Turn to adjust the volume.

Preset Buttons (1-6)

To store a station:

1. Tune to the selected station.
2. Pick a preset button and hold it until you hear a beep.

To listen to a stored station, select a band, then press the preset button.

SKIP Bar

Press and hold to search up and down the selected band for a station with a strong signal.

A.SEL (Auto Select) Button

Press to scan both bands and store the strongest station in each preset. To turn off auto select, press the button again. This restores the presets you originally set.

Selector Knob

Turn to tune the radio frequency.

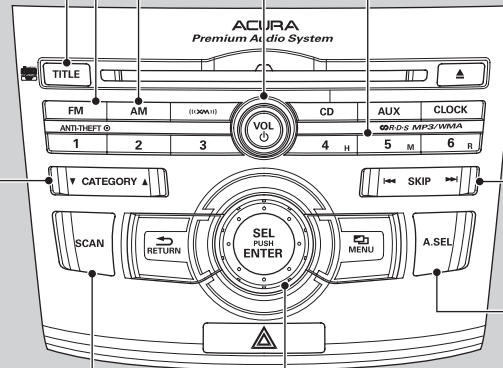

■ Radio Data System (RDS)

Provides text data information related to your selected RDS capable FM station.

■ RDS INFO ON

Press the TITLE button while listening to an RDS capable station. "RDS INFO ON" appears, and the station name is displayed.

■ To find an RDS station from your selected program category

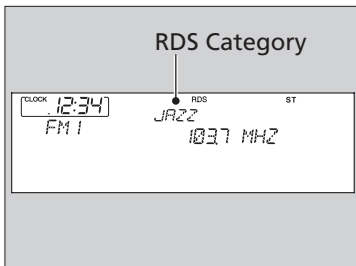

1. Press the CATEGORY bar to display and select an RDS category.
2. Use SKIP or SCAN to select an RDS station.

☒ Playing the AM/FM Radio

The ST indicator appears on the display indicating stereo FM broadcasts.

Stereo reproduction in AM is not available.

Switching the Audio Mode

Press the MODE button on the steering wheel.

☒ Audio Remote Controls P. 160

You can store six AM stations and twelve FM stations in the preset buttons. FM1 and FM2 let you store six stations each.

A.SEL function scans and stores up to six AM stations and twelve FM stations with a strong signal in the preset buttons.

If you do not like the stations auto select has stored, you can store other frequencies in the preset buttons manually.

☒ Radio Data System (RDS)

The display shows up to 31 characters of text data. Press and hold the TITLE button to see additional characters. ▷ indicates that the text data continues. The display goes back to the previous screen if you press and hold the button again.

Playing the XM® Radio

(((XM))) (XM®) Button
Press to select XM® Radio.

VOL/⏻ Knob
Press to turn the audio system ON and OFF.
Turn to adjust the volume.

TITLE Button
Press and release to cycle the display between the name, title, and category.

Preset Buttons (1-6)
To store the channel:
1. Select the channel.
2. Pick a preset button and hold it until you hear a beep.

To listen to a stored station, select XM, then press the preset button.

CATEGORY Bar
Press either side to display and select an XM® Radio category.

SKIP Bar
Press to skip to the previous or next channel.



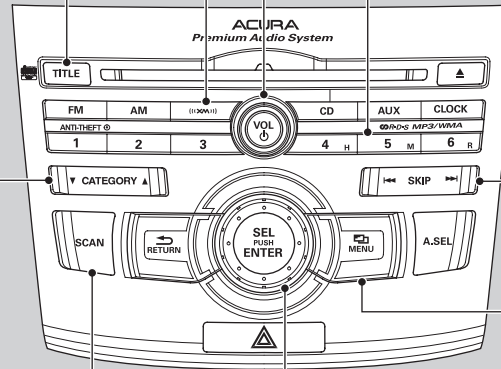

SCAN Button
Press to sample all channels (in the channel mode), or channels within a category (in the category mode).
Each sampling continues for a few seconds.
Press SCAN again to cancel scanning and continue listening to the channel.

MENU Button
Press to display the menu items.

Selector Knob
Turn to select channels.





■ To Play the XM® Radio

1. Press the  button to select the XM® radio band (XM1 or XM2).
2. Press and hold the TITLE button to switch between the channel mode and category mode.
If you press the MENU button, rotate  to select **MODE/CATEGORY** or **MODE CHANNEL**. Each time you press , the mode switches between them.
Press the  button to enter the setting.
3. Select a channel using the TUNE () , SKIP, CATEGORY, SCAN, or Preset buttons.

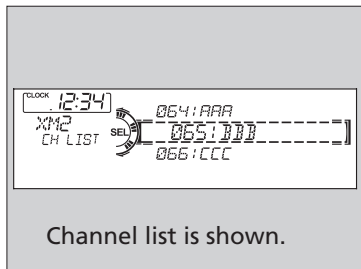
■ To Select a Channel from a List



1. Press  to display a channel list.
2. Rotate  to select a channel, then press .

▣ Playing the XM® Radio

In the channel mode, all available channels are selectable. In the category mode, you can select a channel within a category (Jazz, Rock, Classical, etc.).

You can store twelve XM® stations in the preset buttons. XM1 and XM2 let you store six stations each.

There may be instances when XM® Radio does not broadcast all the data fields (artist name, title). This does not indicate a problem with your audio system.

Playing a CD

Your audio system supports audio CDs, CD-Rs, and CD-RWs in either MP3 or WMA format. With the CD loaded, press the CD button.

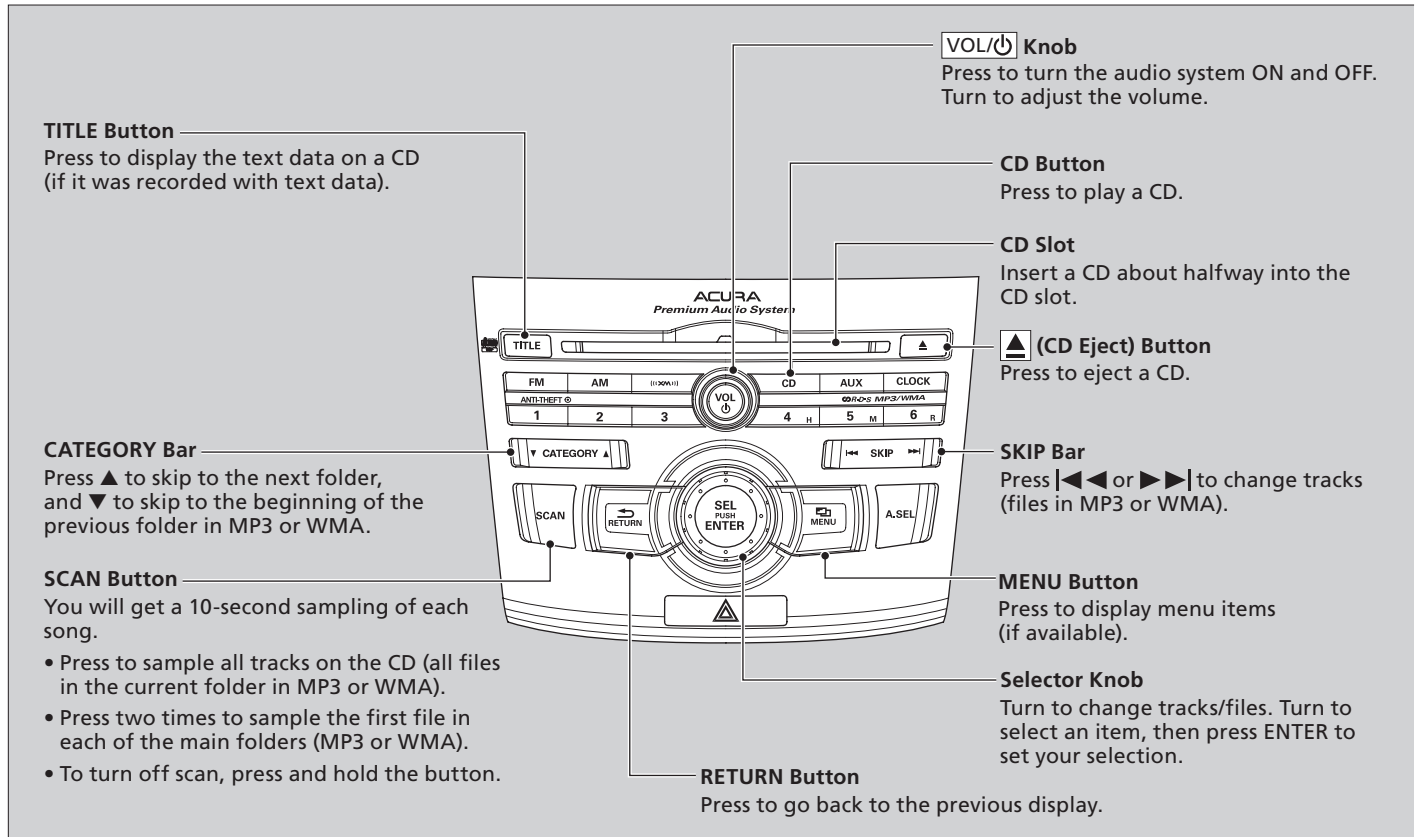

How to Select a File from a Folder with the Selector Knob (MP3/WMA)

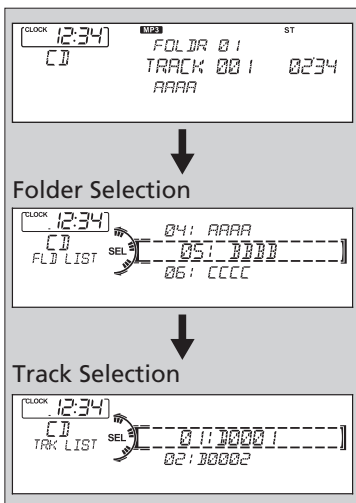

1. Press to switch the display to a folder list.
2. Rotate to select a folder.
3. Press to change the display to a list of files in that folder.
4. Rotate to select a file, then press .

Playing a CD

NOTICE

Do not use CDs with adhesive labels. The label can cause the CD to jam in the unit.

WMA files protected by digital rights management (DRM) cannot be played. The audio system displays UNSUPPORTED, then skips to the next file.

Text data appears on the display under the following circumstances:

- When you select a new folder, file, or track.
- When you change the audio mode to CD.
- When you insert a CD.

The display shows up to 31 characters of text data. Press and hold the TITLE button to see additional characters. ▷ indicates that the text data continues. The display goes back to the previous screen if you press and hold the button again.

If you eject the CD but do not remove it from the slot, the system reloads the CD automatically after several seconds.

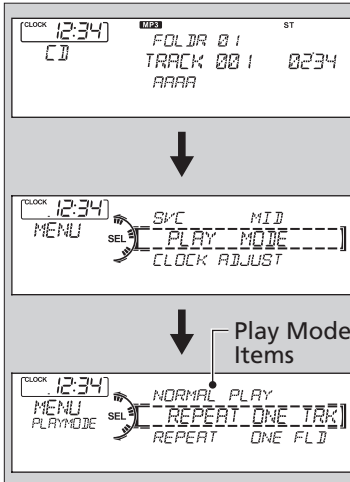

How to Select a Play Mode

You can select repeat, random, and scan modes when playing a track or files.



1. Press the MENU button.

2. Rotate  to select **PLAY MODE**, then press .

3. Rotate  to select a mode, then press .

To turn off a play mode

1. Press the MENU button.

2. Rotate  to select **PLAY MODE**, then press .

3. Rotate  to select **NORMAL PLAY**, then press .

How to Select a Play Mode

Press the RETURN button to go back to the previous display, and press the MENU button to cancel this setting mode.

Play Mode Menu Items

NORMAL PLAY

REPEAT ONE TRACK: Repeats the current track/file(s).

REPEAT ONE FLD : Repeats all files in the current folder.

RANDOM IN DISC : Plays all tracks/files in random order.

RANDOM IN FLD : Plays all files in the current folder in random order.

SCAN TRK: Samples all tracks on the CD.

: Samples all files in the current folder.

SCAN FLD : Samples the first file in each folder.

Playing an iPod®

Connect the iPod® using your dock connector to the USB adapter cable, then press the AUX button.

▶ **USB Adapter Cable** P. 139

TITLE Button

Press to display the text data.

VOL/⏻ Knob

Press to turn the audio system ON and OFF.
Turn to adjust the volume.

AUX Button

Press to select iPod® (if connected).

SKIP Bar

Press ◀◀ or ▶▶ to change songs.

RETURN Button

Press to go back to the previous display.

MENU Button

Press to display menu items.

Selector Knob

Turn to select a song, file, menu item, or play mode. Press ENTER to set your selection.

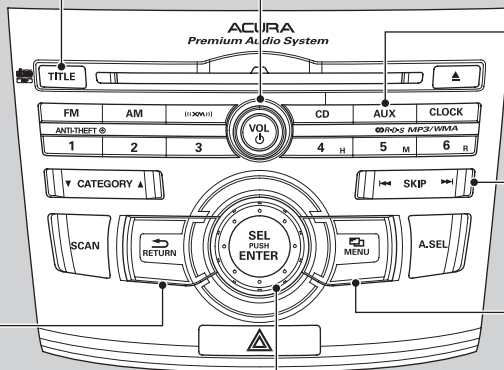

How to Select a File from the iPod® Menu

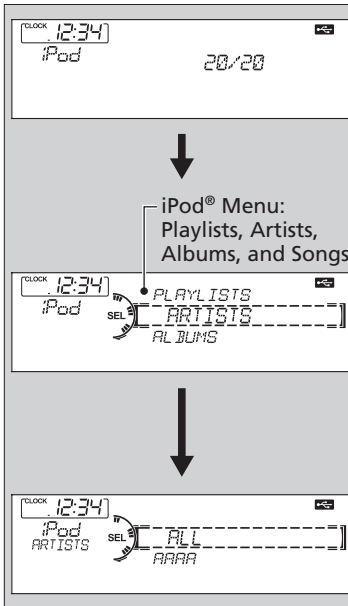

1. Press to display the iPod® menu.

2. Rotate to select a menu.

3. Press to display the items on that menu.

4. Rotate to select an item, then press .

▶▶ Playing an iPod®

Available operating functions vary on models or versions. Some functions may not be available on the vehicle's audio system.

If there is a problem, you may see an error message on the audio display.

iPod®/USB Flash Drive P. 159

■ How to Select a Play Mode

You can select repeat and shuffle modes when playing a file.

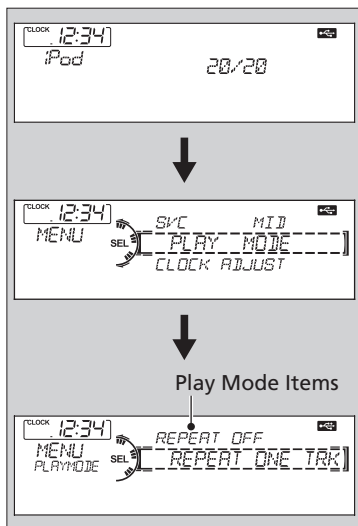

1. Press the MENU button.

2. Rotate  to select **PLAY MODE**, then press .

3. Rotate  to select a mode, then press .

■ To turn off a play mode

1. Press the MENU button.

2. Rotate  to select **PLAY MODE**, then press .

3. Rotate  to select **NORMAL PLAY**, then press .

☒ How to Select a Play Mode

Play Mode Menu Items

NORMAL PLAY

SHUFFLE OFF: Turns off the shuffle mode.

REPEAT OFF: Turns off the repeat mode.

REPEAT ONE TRACK: Repeats the current track.

SHUFFLE ALL: Plays all available files in a selected list (playlists, artists, albums or songs) in random order.

SHUFFLE ALBUM: Plays all available albums in a selected list (playlists, artists, albums, or songs) in random order.

Playing a USB Flash Drive

Your audio system reads and plays sound files on a USB flash drive in either MP3, WMA or AAC^{*1} format.

Connect your USB flash drive to the USB adapter cable, then press the AUX button.

USB Adapter Cable P. 139

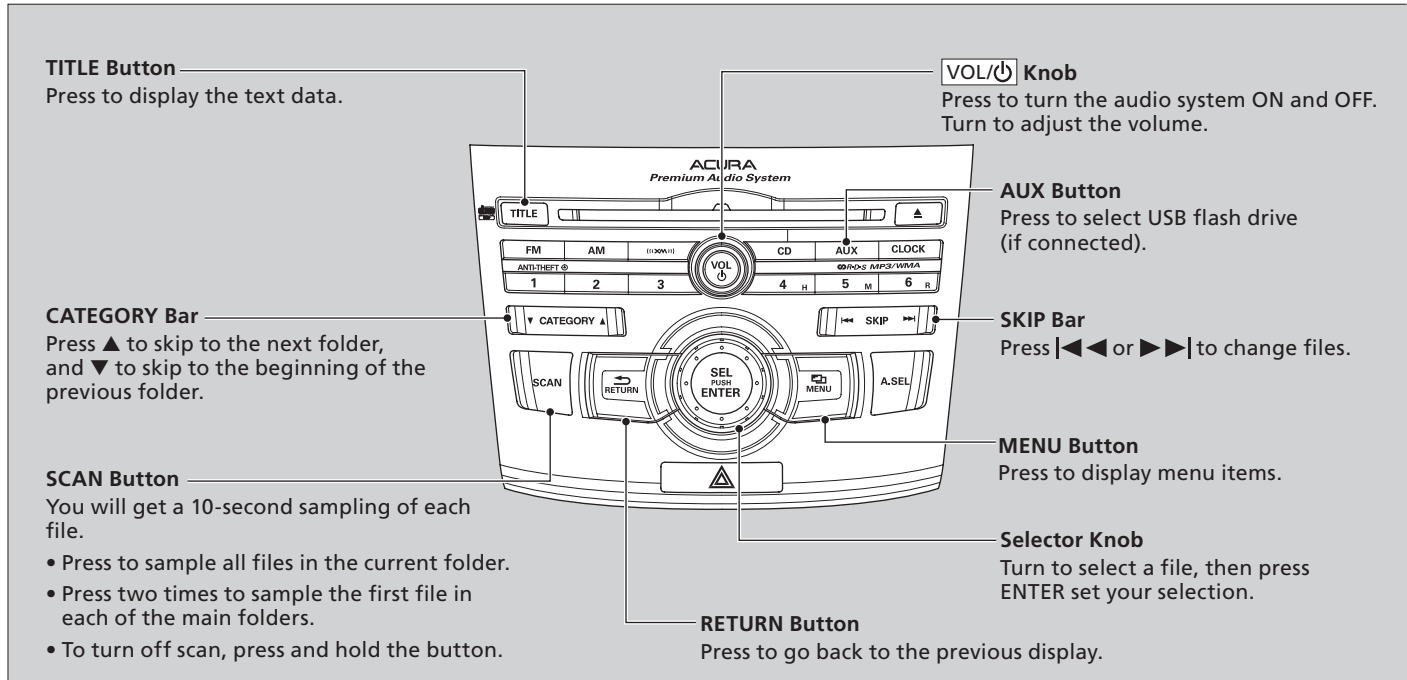

*1: Only AAC format files recorded with iTunes® are playable on this audio unit.

How to Select a File from a Folder with the Selector Knob

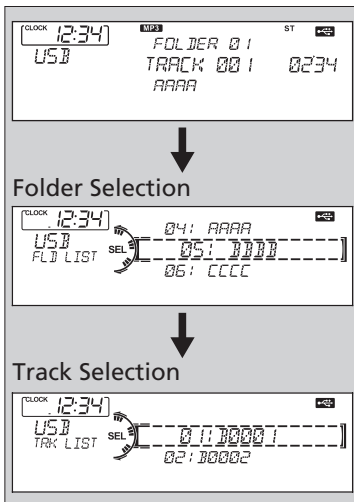

1. Press  to switch the display to a folder list.

2. Rotate  to select a folder.

3. Press  to change the display to a list of files in that folder.

4. Rotate  to select a file, then press .

▶▶ Playing a USB Flash Drive

Use the recommended USB flash drives.

 **General Information on the Audio System**
P. 161

Files in WMA format protected by digital rights management (DRM) are not played. The audio system displays UNPLAYABLE FILE, and then skips to the next file.

If there is a problem, you may see an error message on the audio display.

 **iPod®/USB Flash Drive** P. 159

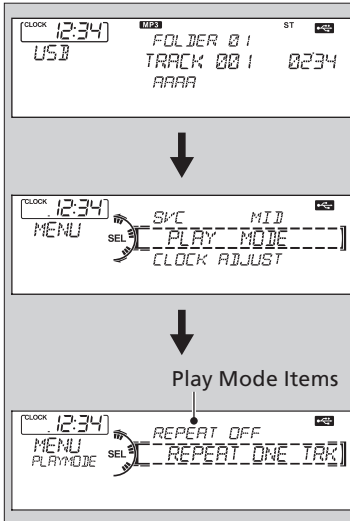

How to Select a Play Mode

You can select repeat, random, and scan modes when playing a file(s).



1. Press the MENU button.

2. Rotate  to select **PLAY MODE**, then press .

3. Rotate  to select a mode, then press .

To turn off a play mode

1. Press the MENU button.

2. Rotate  to select **PLAY MODE**, then press .

3. Rotate  to select **NORMAL PLAY**, then press .

How to Select a Play Mode

Play Mode Menu Items

NORMAL PLAY

REPEAT ONE TRACK: Repeats the current file.

REPEAT ONE FLD: Repeats all files in the current folder.

RANDOM IN FLD: Plays all files in the current folder in random order.

RANDOM ALL: Plays all files in random order.

SCAN TRK: Samples all files in the current folder.

SCAN FLD: Samples the first file in each folder.

Playing *Bluetooth*® Audio

Your audio system allows you to listen to music from your *Bluetooth*®-compatible phone.

This function is available when the phone is paired and linked to the vehicle's *Bluetooth*® HandsFreeLink® (HFL) system.

☒ **Phone Setup** P. 171

☒ Playing *Bluetooth*® Audio

Not all *Bluetooth*-enabled phones with streaming audio capabilities are compatible with the system. You can find an approved phone by visiting www.acura.com/handsfreelink, or by calling the HandsFreeLink® consumer support at 1-888-528-7876. In Canada, visit www.handsfreelink.ca, or call (888) 528-7876.

In some states, it may be illegal to perform some data device functions while driving.

If more than one phone is paired to the HFL system, there will be a delay before the system begins to play.

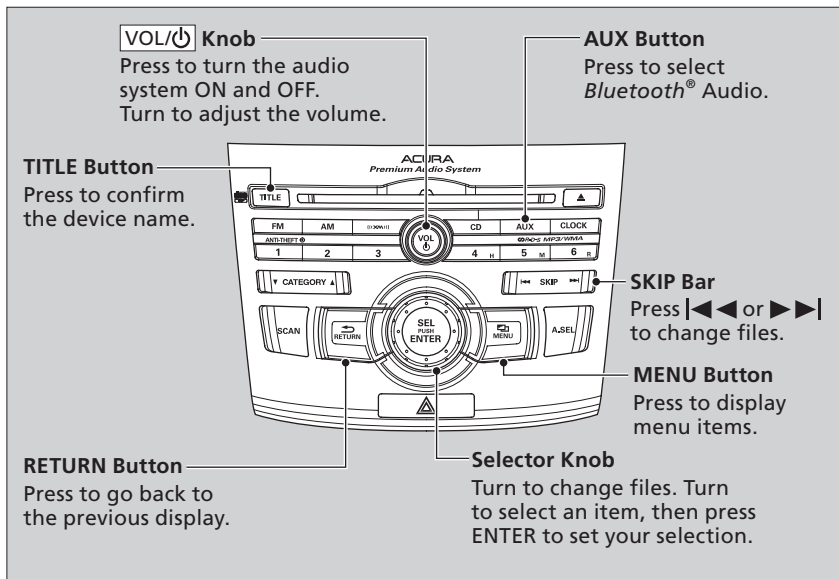



■ To Play *Bluetooth*® Audio Files

1. Make sure that your phone is linked to HFL.
2. Press the AUX button.

Check the following if the phone is not recognized:

Another HFL-compatible phone, which is not compatible for *Bluetooth*® Audio, is already linked.

■ To pause or resume a file

1. Press the MENU button.
2. Rotate  to select RESUME/PAUSE, then press .

Each time you press , the setting switches between PAUSE and RESUME.

■ Switching to HFL

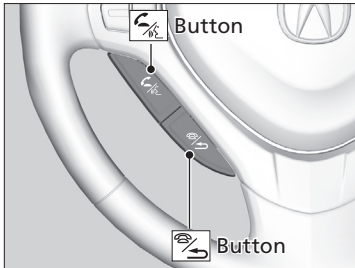

Press the  (HFL Talk) button on the steering wheel to receive a call when *Bluetooth*® Audio is playing.

▶ *Bluetooth*® HandsFreeLink® (HFL) P. 167

Press the  (HFL Back) button to end the call and return to *Bluetooth*® Audio.

▶▶ To Play *Bluetooth*® Audio Files

To play the audio files, you may need to operate your phone. If so, follow the phone maker's operating instructions.

The pause function may not be available on some phones.

If any audio device is connected to the auxiliary input jack, you may need to press the AUX button repeatedly to select the *Bluetooth*® Audio system.





Switching to another mode pauses the music playing from your phone.

▶▶ Switching to HFL

If you receive a call while *Bluetooth*® Audio is in the pause mode, it will resume play after ending the call.

CD Player

If a disc error occurs, you may see the following messages.

Error Message	Cause	Solution
HEAT ERROR	High temperature	<ul style="list-style-type: none"> Turn the audio system off and allow the player to cool down until the error message is cleared.
UNSUPPORTED	Track/file format not supported	<ul style="list-style-type: none"> Current track/file will be skipped. The next supported track/file plays automatically.
BAD DISC PLEASE CHECK OWNERS MANUAL PUSH EJECT	Mechanical error	<ul style="list-style-type: none"> Press the  (eject) button and remove the disc, and check that the error message is cleared. Check that the disc is not damaged or deformed, and insert the disc again. <p> Protecting CDs P. 163</p> <ul style="list-style-type: none"> If the error message reappears, press the  button, and pull out the disc. Insert a different disc. <p>If the new disc plays, there is a problem with the first disc.</p> <ul style="list-style-type: none"> If the error message repeats, or the disc cannot be removed, contact your dealer. <p>Do not try to force the disc out of the player.</p>
MECH ERROR		
CHECK DISK LOAD		
BAD DISC PLEASE CHECK OWNERS MANUAL	Servo error	<ul style="list-style-type: none"> If the error message repeats, or the disc cannot be removed, contact your dealer. <p>Do not try to force the disc out of the player.</p>
CHECK DISC	Disc error	<ul style="list-style-type: none"> Check that the disc is not damaged or deformed. <p> Protecting CDs P. 163</p>

iPod®/USB Flash Drive

If an error occurs while playing an iPod® or USB flash drive, you may see the following error messages. If you cannot clear the error message, contact a dealer.

Error Message	Solution
USB ERROR	There is a problem with the USB adapter unit.
BAD USB DEVICE PLEASE CHECK OWNERS MANUAL	An incompatible device is connected. Disconnect the device. Then turn the audio system off, and turn it on again. Do not reconnect the device that caused the error.
iPod NO SONG	Appears when the iPod® is empty.
UNSUPPORTED VER.	Appears when an unsupported iPod® is connected. If it appears when a supported iPod® is connected, update the iPod® software to the newer version.
CONNECT RETRY	Appears when the system does not acknowledge the iPod®. Reconnect the iPod®.
UNPLAYABLE FILE	Appears when the files in the USB flash drive are DRM or an unsupported format. This error message appears for about 3 seconds, then plays the next song.
USB NO SONG	Appears when the USB flash drive is empty or there are no MP3, WMA, or AAC files in the USB flash drive.
UNSUPPORTED	Appears when an unsupported device is connected. If it appears when the supported device is connected, reconnect the device.

Allows you to operate the audio system while driving.

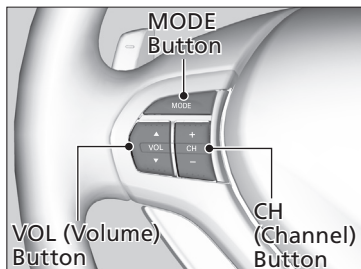

MODE Button

Cycles through the audio modes as follows:
FM1→FM2→AM→XM1→XM2→CD→AUX

VOL Button

Press : Increases the volume

Press : Decreases the volume

CH Button

- When listening to radio

Press : Selects the next preset radio station.

Press : Selects the previous preset radio station

- When listening to a CD, USB flash drive or iPod®, or *Bluetooth*® audio

Press : Skips to the next song.

Press : Goes back to the beginning of the current or previous song.

Audio Remote Controls

The CD mode appears only when a CD is loaded.

When in the AUX mode, the following are operable from the remote controls:

- iPod®/USB flash drive connected to the USB adapter cable
- *Bluetooth*® audio (with some phones only)

XM® Radio Service

Subscribing to XM® Radio

1. You need your radio ID ready before registering for subscription.
To see the ID in the display: Turn the selector knob until "0" appears.
2. Have your radio ID and credit card number ready, and either call or visit the XM® website to subscribe.

Receiving XM® Radio

Press the  (XM®) button and stay in this mode for about 30 minutes until the service is activated. Make sure your vehicle is in an open area with good reception.

XM® Radio Display Messages

LOADING: XM® is loading the audio or program information.

OFF AIR: The channel is not currently broadcasting.

UPDATING: The encryption code is being updated. Channels 0 and 1 still work normally.

NO SIGNAL: The signal is too weak in the current location.

-----: No such channel exists, the channel is not part of your subscription, or the artist or title information available.

ANTENNA: There is a problem with the XM® antenna. Contact a dealer.

Subscribing to XM® Radio

Contact Information for XM® Radio:

US: XM® Radio at www.xmradio.com or (800) 852-9696

Canada: XM® Canada at www.xmradio.ca, or (877) 209-0079

Receiving XM® Radio

The XM® satellites are in orbit over the equator; therefore, objects south of the vehicle may cause satellite reception interruptions. Satellite signals are more likely to be blocked by tall buildings and mountains the farther north you travel from the equator.

You may experience reception problems under the following circumstances:

- In a location with an obstruction to the south of your vehicle.
- In tunnels
- On the lower level of a multi-tiered road
- Large items carried on the roof rack

Recommended CDs

- Use only high-quality CD-R or CD-RW discs labeled for audio use.
- Use only CD-R or CD-RW discs on which the recordings are closed.
- Play only standard round shaped CDs.

The CD packages or jackets should have one of these marks.



CDs with MP3, WMA or AAC files

- Some software files may not allow for audio play or text data display.
- Some versions of MP3, WMA, or AAC formats may be unsupported.

Recommended CDs

A Dual-disc cannot play on this audio unit. If recorded under certain conditions, a CD-R or CD-RW may not play either.

■ Protecting CDs

Follow these precautions when handling or storing CDs:

- Store a CD in its case when it is not being played.
- When wiping a CD, use a soft clean cloth from the center to the outside edge.
- Handle a CD by its edge. Never touch either surface.
- Never insert foreign objects into the CD player.
- Keep CDs out of direct sunlight and extreme heat.
- Do not place stabilizer rings or labels on the CD.
- Avoid fingerprints, liquids, and felt-tip pens on the CD.

» Protecting Discs

NOTICE

Do not insert a damaged CD. It may be stuck inside and damage the audio unit.

Examples:

- Bubbled, wrinkled, labeled, and excessively thick CDs



Bubbled/
Wrinkled



With Label/
Sticker



Using Printer
Label Kit



Sealed



With Plastic Ring

- Damaged CDs



Chipped/
Cracked



Warped

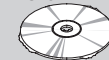

Burrs

- Poor quality CDs

- Small CDs



3-inch
(8-cm)
CD

Compatible iPod® and USB Flash Drives

■ iPod® Model Compatibility

Model
iPod classic® (80/160G)
iPod classic® (120G)
iPod® with video (iPod® 5th generation)
iPod nano®
iPod nano® 2nd generation
iPod nano® 3rd generation
iPod nano® 4th generation
iPod nano® 5th generation
iPod touch®
iPod touch® 2nd generation

■ USB Flash Drives

- Use a recommended USB flash drive of 256 MB or higher.
- Some digital audio players may not be compatible.
- Some USB flash drives (e.g., a device with security lockout) may not work.
- Some software files may not allow for audio play or text data display.
- Some versions of MP3, WMA, or AAC formats may be unsupported.

☒ iPod® Model Compatibility

This system may not work with all software versions of these devices.

☒ USB Flash Drives

Files on the USB flash drive are played in their stored order. This order may be different from the order displayed on your PC or device.

The HomeLink® Universal Transceiver can be programmed to operate up to three remote controlled devices around your home, such as garage doors, lighting, or home security systems.

■ Important Safety Precautions

Refer to the safety information that comes with your garage door opener to test that the safety features are functioning properly. If you do not have the safety information, contact the manufacturer.

Before programming HomeLink, make sure that people and objects are out of the way of the garage or gate to prevent potential injury or damage.

When programming a garage door opener, park just outside the garage door's path.

Training HomeLink

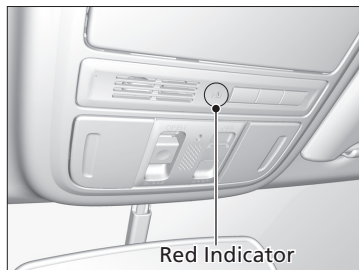

If you have not trained any of the buttons in HomeLink before, you should erase any previously learned codes. To do this:

- Press and hold the two outside buttons for about 20 seconds, until the red indicator blinks. Release the buttons, and proceed to step 1.
- If you are training the second or third button, go directly to step 1.

☒ HomeLink® Universal Transceiver

HomeLink® is a registered trademark of Johnson Controls, Inc.

Before programming HomeLink to operate a garage door opener, confirm that the opener has an external entrapment protection system, such as an "electronic eye," or other safety and reverse stop features. If it does not, HomeLink may not be able to operate it.

■ Training a Button

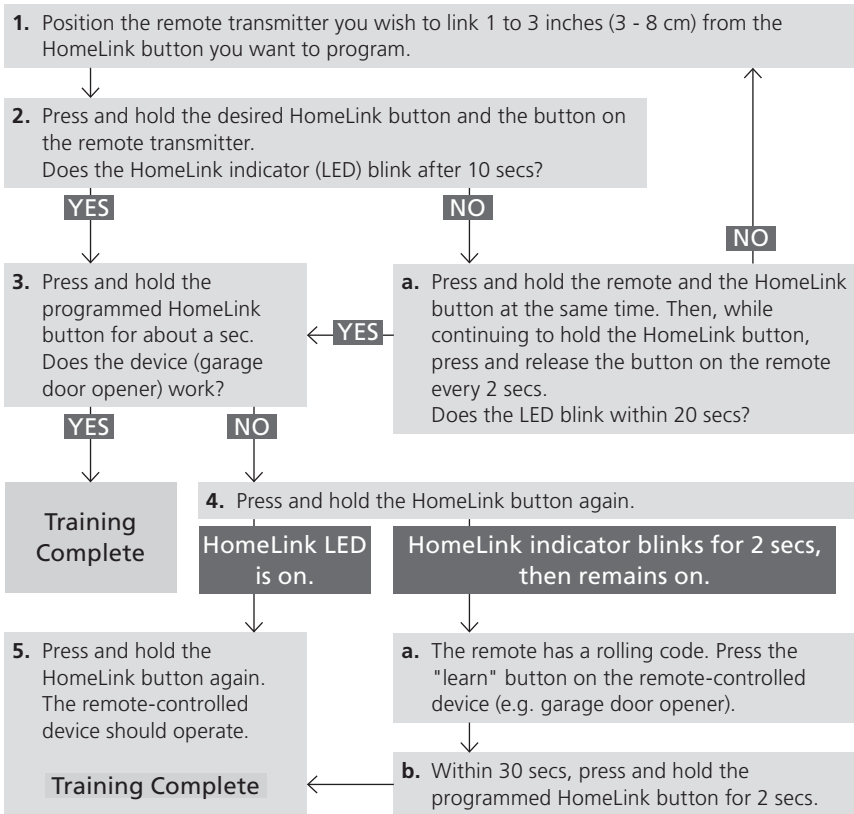

▣ Training HomeLink

Retraining a Button
If you want to retrain a programmed button for a new device, you do not have to erase all button memory. You can replace the existing memory code using this procedure:

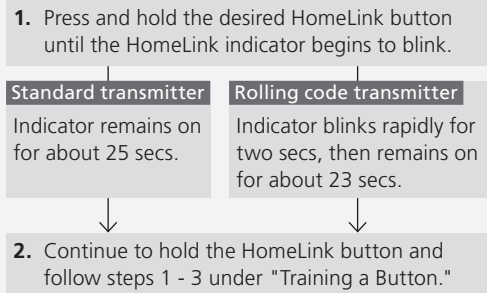

Erasing Codes
To erase all the codes, press and hold the two outside buttons until the HomeLink indicator begins to blink (about 10 to 20 secs). You should erase all codes before selling the vehicle.

If you have any problems, see the device's instructions, visit www.homelink.com, or call HomeLink at (800) 355-3515.

Models with navigation system

For models with the navigation system, see the Navigation System Manual for how to operate *Bluetooth*® HandsFreeLink®.

Models without navigation system

Bluetooth® HandsFreeLink® (HFL) allows you to place and receive phone calls using your vehicle's audio system, without handling your cell phone.

Using HFL

HFL Buttons

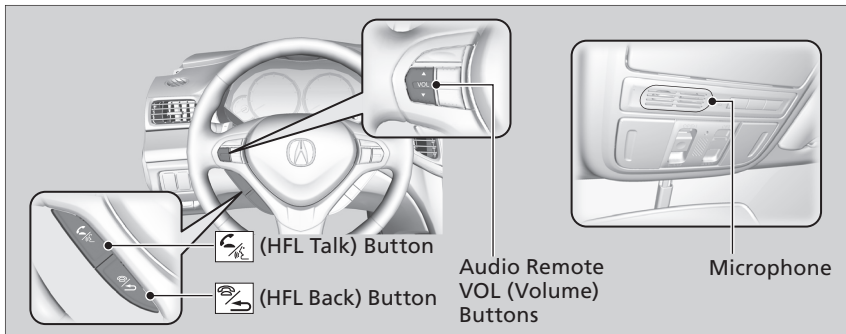

 **Button:** Press to give a command or answer a call.

 **Button:** Press to end a call, go back to the previous command, or cancel a command.

Bluetooth® HandsFreeLink®

To use HFL, you need a *Bluetooth*-compatible cell phone. For a list of compatible phones, pairing procedures, and special feature capabilities:

- U.S.: Visit www.acura.com/handsfreelink, or call (888) 528-7876.
- Canada: Visit www.handsfreelink.ca, or call (888) 528-7876.

Voice control tips:

- Aim the vents away from the ceiling and close the windows, as noise coming from them may interfere with the microphone.
- Press and release the  button before giving a command. Speak clearly and naturally after a beep.
- If the microphone picks up voices other than yours, the command may be misinterpreted.
- A command that consists of several words can be spoken together. For example, say "Call 123-456-7890" at once.
- When HFL is in use, navigation voice commands cannot be recognized.
- To change the volume level, use the audio system's volume knob or the remote audio controls.

■ Help Features

- To hear general HFL information and help, say "Tutorial."
- Say "Hands free help" or "Help" any time to get help or hear a list of commands.

■ Information Display

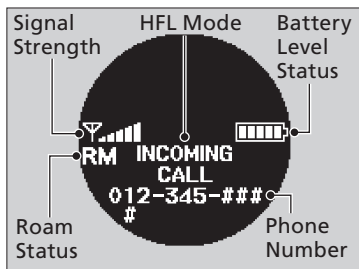

The multi-information display notifies you when there is an incoming call.

☒ Bluetooth® HandsFreeLink®

Bluetooth® Wireless Technology
Bluetooth® name and logos are registered trademarks owned by *Bluetooth* SIG, Inc., and any use of such marks by Honda Motors Co., Ltd., is under license. Other trademarks and trade names are those of their respective owners.

HFL Limitations

An incoming call on HFL will interrupt *Bluetooth®* Audio when it is playing. Audio will resume when the call is ended.

☒ Information Display

The information that appears on the multi-information display varies between phone models.

HFL Menus

The ignition switch must be in ACCESSORY **I** or ON **II** to use HFL.

▶▶ HFL Menu

To use HFL, you must first pair your *Bluetooth*-compatible cell phone to the system while the vehicle is parked.

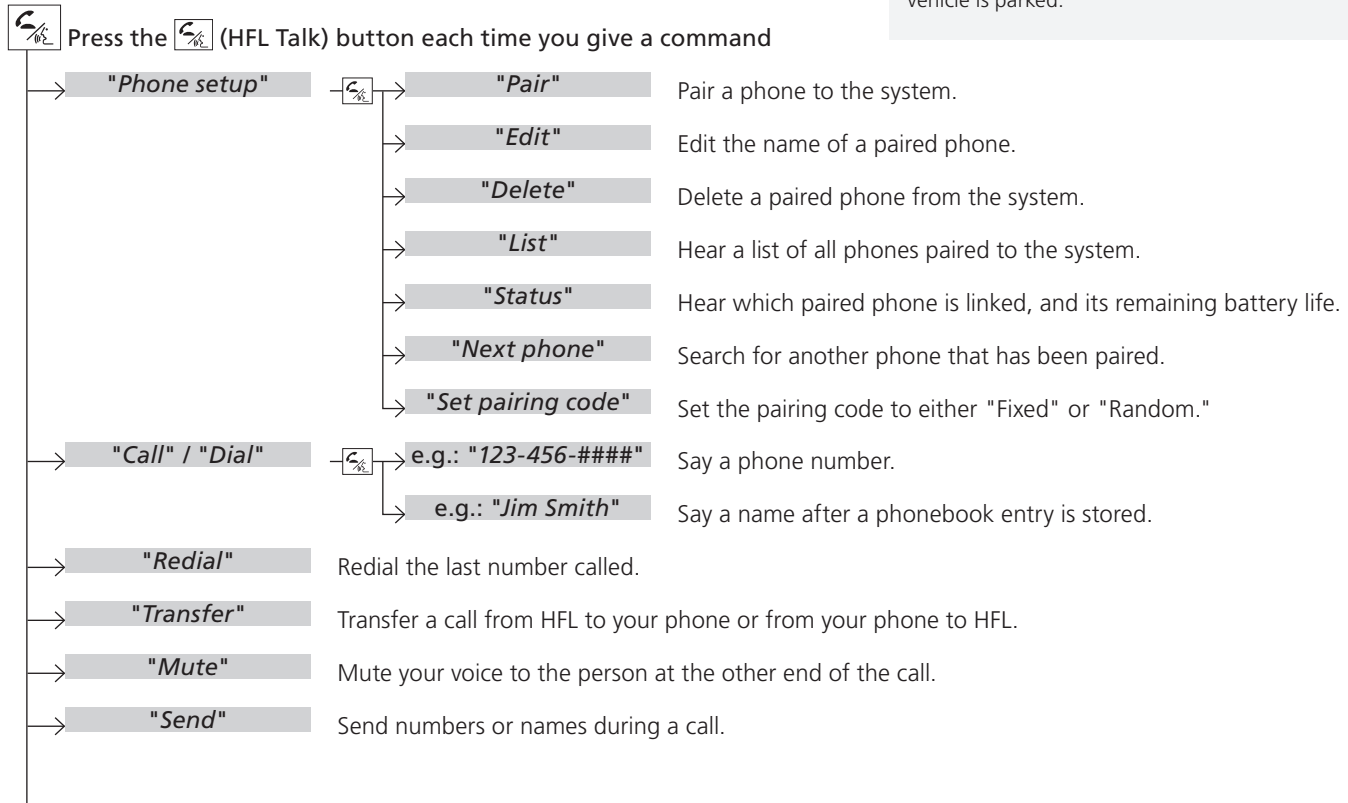

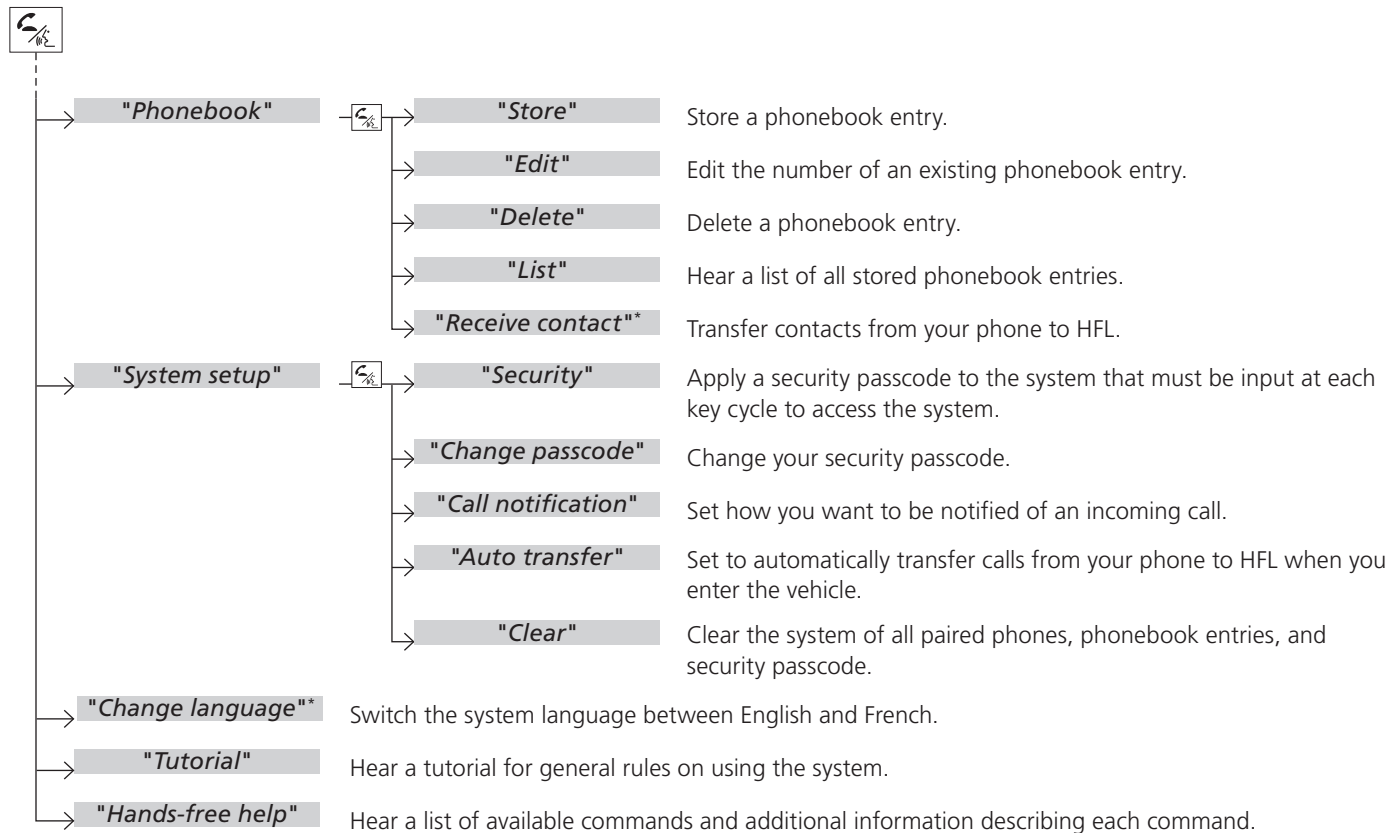

* Not available on all models

Phone Setup

To pair a cell phone

1. If no phone has been paired to the system before, HFL gives you information about how to pair the first phone.
If a phone has already been paired: say "Phone Setup" and "Pair" after the HFL prompts.
2. Follow the HFL prompts and put your phone in discovery or search mode.
▶ HFL gives you a four-digit code and begins searching for your phone.
3. When your phone finds a *Bluetooth*® device, select HFL from the options and enter the four-digit code.
4. Follow the HFL prompts and name the newly paired phone.

To rename a paired phone

1. Say "Phone Setup."
2. Say "Edit" after the prompts.
3. Follow the HFL prompts and rename the phone.
▶ If there is more than one phone paired to the system, HFL will ask you which phone's name you want to change.

To delete a paired phone

1. Say "Phone Setup."
2. Say "Delete" after the prompts.
3. Follow the HFL prompts.
▶ HFL will ask you which phone you want to delete.

Phone Setup

Press the  button and wait for a beep before giving a command.

Your *Bluetooth*-compatible phone must be paired to HFL before you can make and receive hands-free calls.

Phone Pairing Tips:

- You cannot pair your phone while the vehicle is moving.
- Your phone must be in the discovery or search mode when pairing the phone. Refer to your phone's manual.
- Up to six phones can be paired.
- Your phone's battery may drain faster when it is paired to HFL.
- If your phone is not ready for pairing or not found by the system within three minutes, the system will time out and returns to idle.

■ To hear the name of all paired phones

1. Say "Phone Setup."
2. Say "List" after the prompts.
3. HFL reads out all the paired phones' names.

■ To hear which paired phone is currently linked

1. Say "Phone Setup."
2. Say "Status" after the prompts.
3. HFL will tell you which phone is linked with the system.

■ To change the currently linked phone

1. Say "Phone Setup."
2. Say "Next Phone" after the prompts.
3. HFL disconnects the current phone, and searches for another paired phone.
4. Once another phone is found, it is connected to the system. HFL will inform you which phone is now linked.

■ To change the pairing code setting

1. Say "Phone Setup."
2. Say "Set Pairing Code" after the prompts.
3. If you want HFL to create a random code each time you pair a phone, say "Random." If you want to create your own four-digit code, say "Fixed."
4. Follow the HFL prompts.

☒ Phone Setup

If no other phones are found or paired when trying to switch to another phone, HFL will inform you that the original phone is linked again.

The "Status" and "Next Phone" commands use: Only one paired phone at a time can be linked to HFL. When there are two or more paired phones in the vehicle, the first paired phone that the system finds is linked.

■ Making a Call

You can make calls using any phone number or a name in the HFL phonebook, and redial the last number called.

■ Direct dialing a phone number

1. Say "Call" or "Dial."
2. Say the number you want to dial after the prompts.
3. Say "Call" or "Dial" after the prompts.

■ From the HFL phonebook

1. Say "Call" or "Dial."
2. Say the name stored in the HFL phonebook after the prompts.
3. Follow the HFL prompts.

■ To redial the last number called by HFL

Say "Redial."

■ To end a call

Press the  (HFL back) button.



☒ Making a Call

Press the  button and wait for a beep before giving a command.

HFL uses a Class 2 Bluetooth, with has a maximum range of about 30 feet (10 meters).

HFL allows you to talk up to 30 minutes after you remove the key from the ignition switch. However, this may weaken the vehicle's battery.

■ Receiving a Call

Press the  button to answer the call, or the  button to hang up. When there is an incoming call, a call notification (if activated) sounds and a message appears on the display.

■ Transferring a Call

You can transfer a call from HFL to your phone, or from your phone to HFL. Press the  button and say "Transfer."

■ Muting a Call

To mute or unmute your voice during a call, press and release the  button and say "Mute."

■ Sending Numbers or Names During a Call

You can send numbers and names during a call. This is useful when calling a menu-driven phone system.

■ To send a number or name during a call

1. Say "Send."
2. Say the number or name you want to send after the prompts.
3. Follow the HFL prompts.

☒ Receiving a Call

Call Waiting

Press the  button and put the original call on hold to answer the incoming call.



Press the  button again to return to the original call.

Ignore the incoming call if you do not want to answer it.

Press the  button if you want to hang up the original and answer the incoming call.

☒ Sending Numbers or Names During a Call

Press the  button before a command.

To send a , say "Pound." To send a , say "Star."

HFL Phonebook

You can store up to 50 names with their associated numbers in HFL. The numbers you store can be account numbers or passwords. These numbers can be sent to a menu-driven call.

■ To store a phonebook entry

1. Say "Phonebook."
2. Say "Store" after the prompts.
3. Say a name you want to list as your phonebook entry.
4. Say the number you want to store for the name entry.
5. Follow the HFL prompts and say "Enter" to store the entry.

■ To edit the number stored for a name

1. Say "Phonebook."
2. Say "Edit" after the prompts.
3. Say a name you want to edit. When asked, say the new number for that name.
4. Follow the HFL prompts and say "Enter" to store the entry.

☒ HFL Phonebook

- Avoid using duplicate name entries.
- Avoid using "home" as a name entry.
- It is easier for HFL to recognize a multisyllabic or longer name. For example, use "Peter" instead of "Pete," or "John Smith" instead of "John."

■ **To delete a name**

1. Say "Phonebook."
2. Say "Delete" after the prompts.
3. Say a name you want to delete.
4. Say "Yes," and follow the HFL prompts.

■ **To list all names in the phonebook**

1. Say "Phonebook."
2. Say "List" after the prompts.
3. HFL begins reading the names in the order they were stored.
4. When you hear a name you want to call, say "Call."

■ **To store a specific phone number from your cell phone directly to the HFL phonebook***

1. Say "Phonebook."
2. Say "Receive Contact" after the prompts.
3. Follow the HFL prompts, select a number from your cell phone, and send it to HFL.
 - ▶ If it is not the number you want to store, say "Discard."
4. Say the name for that number.
5. Follow the HFL prompts to continue.

System Setup

This command group allows you to change or customize HFL basic settings.

■ To set a four-digit passcode to lock the HFL system for security

1. Say "System Setup."
2. Say "Security."
3. Follow the HFL prompts and say the four-digit number of your choice.
4. Follow the HFL prompts and confirm the number.

■ To change the security passcode

1. Say "System Setup."
2. Say "Change Passcode" after the prompts.
3. Say the new four-digit passcode after the HFL prompts.
4. Follow the HFL prompts.

■ To select a ring tone or a prompt as the incoming call notification

1. Say "System Setup."
2. Say "Call Notification" after the prompts.
3. Say "Ring Tone" or "Prompt" after the prompts. For no audible notification, say "Off."

System Setup

Press the  button before a command.

Once a passcode is set, you are required to enter the passcode with every new key cycle to use HFL. If you forget the code, go to your dealer to have the passcode reset. You can also cancel the passcode by clearing all the data stored in the HFL system.

▶ To clear the system P. 178

The default setting of the incoming notification is a ring tone.

■ To activate or deactivate the auto transfer function

The call on your cell phone can be automatically transferred to HFL when you get into the vehicle and turn on the ignition.

1. Say "System Setup."
2. Say "Auto Transfer" after the prompts. HFL lets you know the current status.
3. Follow the HFL prompts to change the setting.

■ To clear the system

Paired phones, all stored or imported phonebook data, and any passcodes are erased.

1. Say "System Setup."
2. Say "Clear" after the prompts.
3. Follow the HFL prompts.

■ Change Language*

You can set the system language to French or English.

1. Say "Change Language."
2. Follow the HFL prompts.

If you have not named your paired phone in the selected language, HFL will ask you to name it in that language.

☒ System Setup

Press the  button before a command.

You can clear the system when you have forgotten the passcode and cannot access HFL. When HFL asks you for the passcode, say "System Clear."

☒ Change Language

Press the  button before a command.

Quick Language Selection

If you want to change the language, to French for example, say "Français," and follow the prompt.

When you turn the ignition switch to ON , the compass self-calibrates, and the compass display appears.



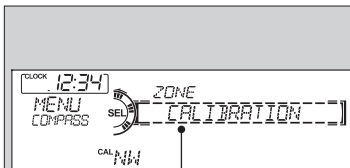

Compass Calibration

If the compass indicates the wrong direction, or the CAL indicator blinks, you need to manually calibrate the system.

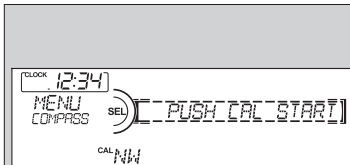

Compass Setting Menu Items



1. Turn the ignition switch to ON .
2. Press and hold the MENU button until the display shows the compass setting menu list.
3. Rotate  to select **CALIBRATION**, then press .
4. When the display changes to **PUSH CAL START**, press .
5. Drive the vehicle slowly in two circles.
 - ▶ The compass starts to show a direction after the calibration. The CAL indicator goes off.

Compass

Compass operation can be affected under the following conditions:

- Driving near power lines or stations
- Crossing a bridge
- Passing a large vehicle, or driving near a large object that can cause a magnetic disturbance
- When accessories such as antennas and roof racks are mounted by magnets

Compass Calibration





Calibrate the compass in an open area.

While setting the compass:

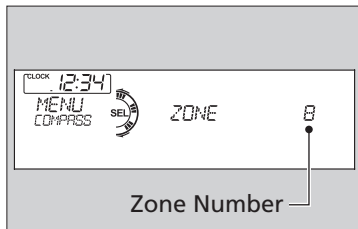
- The RETURN button returns to the previous screen.
- The MENU button cancels the setting mode.

Compass Zone Selection



1. Turn the ignition switch to ON .
2. Press and hold the MENU button until the display shows the compass setting menu list.
3. Rotate  to select **ZONE**, then press . The display shows the current zone number.
4. Rotate  to select the zone number of your area (See Zone Map), then press .

☒ Compass Zone Selection

The zone selection is done to compensate the variation between magnetic north and true north.

If the calibration starts while the audio system is in use, the display returns to normal after the calibration is completed.

Zone Map

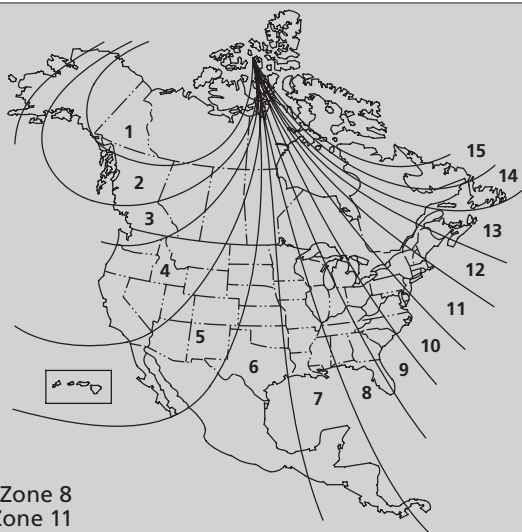

Guam Island : Zone 8
Puerto Rico : Zone 11

Driving



This chapter discusses driving, refueling, and information on items such as accessories.

Before Driving

Driving Preparation	182
Maximum Load Limit	185

Towing a Trailer

Towing Preparation.....	187
Driving Safely with a Trailer.....	189
Towing Your Vehicle	190

When Driving

Starting the Engine	191
Precautions While Driving	193
Automatic Transmissions.....	194
Shifting (Automatic Transmission)	195
Shifting (Manual Transmission).....	199

Cruise Control.....	201
VSA® (Vehicle Stability Assist), aka ESC (Electronic Stability Control), System.....	204
TPMS (Tire Pressure Monitoring System)	206
Tire Pressure Monitoring System (TPMS)- Required Federal Explanation	208

Braking

Brake System	210
ABS (Anti-lock Brake System)	212
Brake Assist System.....	213

Parking Your Vehicle

When Stopped.....	214
Parking	214

Refueling

Fuel Information	215
How to Refuel.....	216

Fuel Economy..... 218

Improving Fuel Economy.....	218
-----------------------------	-----

Accessories and Modifications

Accessories	219
Modifications.....	219

Driving Preparation

Check the following items before you start driving.

Exterior Checks

- Make sure there are no obstructions on the windows, door mirrors, exterior lights, or other parts of the vehicle.
 - ▶ Remove any frost, snow, or ice.
 - ▶ Remove any snow on the roof, as this can slip down and obstruct your field of vision while driving. If frozen solid, remove ice once it has softened.
 - ▶ When removing ice from around the wheels, be sure not to damage the wheel or wheel components.
- Make sure the hood is securely closed.
 - ▶ If the hood opens while driving, your front view will be blocked.
- Make sure the tires are in good condition.
 - ▶ Check air pressures, check for damage and excessive wear.
- **🔧 Checking and Maintaining Tires** P.259
- Make sure there are no people or objects behind or around the vehicle.
 - ▶ There are blind spots from the inside.

Exterior Checks

NOTICE

When doors are frozen shut, use warm water around the door edges to melt any ice. Do not try to force them open, as this can damage the rubber trim around the doors. When done, wipe dry to avoid further freezing.

Do not pour warm water into the key cylinder. You will be unable to insert key if the water freezes in the hole.

Interior Checks

- Store or secure all items on board properly.
 - ▶ Carrying too much cargo, or improperly storing it, can affect your vehicle's handling, stability, stopping distance, and tires, and make it unsafe.
 - **Maximum Load Limit** P.185
- Do not pile items higher than the seat height.
 - ▶ They can block your view and may be thrown forward in the event of sudden braking.
- Do not place anything in the front seat footwells. Make sure to secure the floor mat.
 - ▶ An object or unsecured floor mat can interfere with your brake and accelerator pedal operation while driving.
- If you have any animals on board, do not let them move around in the vehicle.
 - ▶ They may interfere with driving and a crash could occur.
- Securely close and lock all doors and the trunk.
 - **Locking/Unlocking the Door from Inside** P.93
- Adjust your seating position properly.
 - ▶ Adjusting the head restraint, too.
 - **Adjusting the Seats** P.116
 - **Adjusting the Head Restraints** P.118
- Adjust the mirrors and steering wheel properly for your driving.
 - ▶ Adjust them while sitting in the proper driving position.
 - **Adjusting the Mirrors** P.114
 - **Steering Wheel Adjustments** P.113

Interior Checks

The headlight aim is set by the factory, and typically does not need to be adjusted. However, if you regularly carry heavy items in the trunk or tow a trailer, have the aiming readjusted at a dealer or by a qualified technician.

- Be sure items placed on the floor behind the front seats cannot roll under the seats.
 - ▶ They can interfere with the driver's ability to operate the pedals, the operation of the seats, or the operation of the sensors under the seats.
- Everyone in the vehicle must fasten their seat belt.
 - ▶ **Fastening a Seat Belt** P.29
- Make sure that the indicators in the instrument panel come on when you start the vehicle, and go off soon after.
 - ▶ Always have a dealer check the vehicle if a problem is indicated.
 - ▶ **Indicators** P.64

Maximum Load Limit

The maximum load for your vehicle is 850 lbs (385 kg).
See Tire and Loading Information label attached to the driver's doorjamb.

Maximum Load Limit

⚠ WARNING

Overloading or improper loading can affect handling and stability and cause a crash in which you can be hurt or killed.

Follow all load limits and other loading guidelines in this manual.

Gross Vehicle Weight Rating (GVWR):
The maximum allowable weight of the vehicle, all occupants, all accessories, all cargo, and the tongue load.

➤ **Specifications** P. 302, 304

Gross Axle Weight Rating (GAWR):
The maximum allowable weight of the vehicle axle.

➤ **Specifications** P. 302, 304

Label Example

TIRE AND LOADING INFORMATION			
SEATING CAPACITY: TOTAL 5 FRONT 2 REAR 3			
The combined weight of occupants and cargo should never exceed 385kg or 850lbs.			
TIRE	SIZE	COLD TIRE PRESSURE	SEE OWNER'S MANUAL FOR ADDITIONAL INFORMATION
FRONT	XXXX/XXXXX XXX	XXXKPA, XXPSI	
REAR	XXXX/XXXXX XXX	XXXKPA, XXPSI	
SPARE	XXXX/XXXXX XXX	XXXKPA, XXPSI	

This figure includes the total weight of all occupants, cargo, and accessories, and the tongue load if you are towing a trailer.

Steps for Determining Correct Load Limit -







- (1)** Locate the statement "The combined weight of occupants and cargo should never exceed XXX kg or XXX lbs." on your vehicle's placard.
- (2)** Determine the combined weight of the driver and passengers that will be riding in your vehicle.
- (3)** Subtract the combined weight of the driver and passengers from XXX kg or XXX lbs.
- (4)** The resulting figure equals the available amount of cargo and luggage load capacity. For example, if the "XXX" amount equals 1,400 lbs. and there will be five 150 lb. passengers in your vehicle, the amount of available cargo and luggage load capacity is 650 lbs.
(1,400 - 750 (5 x 150) = 650 lbs.)

Continued

- (5) Determine the combined weight of luggage and cargo being loaded on the vehicle. That weight may not safely exceed the available cargo and luggage load capacity calculated in step 4.
- (6) If your vehicle will be towing a trailer, load from your trailer will be transferred to your vehicle. Consult this manual to determine how this reduces the available cargo and luggage load capacity of your vehicle.

In addition, the total weight of the vehicle, all occupants, accessories, cargo, and trailer tongue load must not exceed the Gross Vehicle Weight Rating (GVWR) or the Gross Axle Weight Rating (GAWR). Both are on a label on the driver's doorjamb.

Load Limits Example

<p>Example1</p>  <p>MaxLoad 850lbs (385 kg)</p>	\geq	 <p>Passenger Weight 150 lbs x 2 = 300lbs (68 kg x 2 = 136 kg)</p>	<p>+</p>	 <p>Cargo Weight 550lbs (249 kg)</p>
<p>Example2</p>  <p>MaxLoad 850lbs (385 kg)</p>	\geq	 <p>Passenger Weight 150 lbs x 5 = 750lbs (68 kg x 5 = 340 kg)</p>	<p>+</p>	 <p>Cargo Weight 100lbs (45 kg)</p>

Towing Preparation

Towing Load Limits

Your vehicle can tow a trailer if you carefully observe the load limits, use the proper equipment, and follow the towing guidelines. Check the load limits before driving.

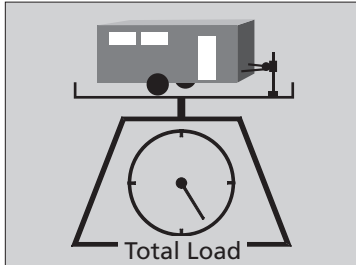

■ Total trailer weight

Maximum allowable weight of the trailer, cargo, and everything in or on it must not exceed 1,000 lbs (450 kg). Towing loads in excess of this can seriously affect vehicle handling and performance and can damage the engine and drivetrain.

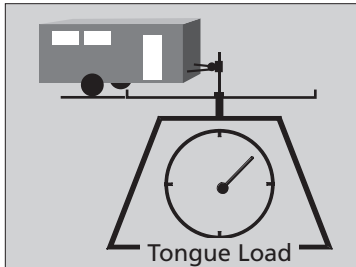

■ Tongue load

The weight of the tongue with a fully loaded trailer on the hitch should be approximately 10% of the total trailer weight.

- Excessive tongue load reduces front tire traction and steering control. Too little tongue load can make the trailer unstable and cause it to sway.
- To achieve a proper tongue load, start by loading 60% of the load toward the front of the trailer and 40% toward the rear. Readjust the load as needed.

⌘ Towing Load Limits

⚠ WARNING

Exceeding any load limit or improperly loading your vehicle and trailer can cause a crash in which you can be seriously hurt or killed.

Check the loading of your vehicle and trailer carefully before starting to drive.

Check if all loads are within limits at a public scale. If a public scale is not available, add the estimated weight of your cargo load to the weight of your trailer (as quoted by the manufacturer), and the tongue load.

Break-in Period

Avoid towing a trailer during your vehicle's first 600 miles (1,000 km).

■ Towing Equipment and Accessories

Towing equipment varies by the size of your trailer, how much load you are towing, and where you are towing.

■ Hitches

The hitch must be of an approved type and properly bolted to the underbody.

■ Safety chains

Always use safety chains when you tow a trailer. Leave enough slack to allow the trailer to turn corners easily, but do not allow the chains to drag on the ground.

■ Trailer brakes

There are two common types of trailer brakes: surge and electric. Surge brakes are common for boat trailers, since the brakes will get wet. If you choose electric brakes, be sure they are electronically actuated. Do not attempt to attach trailer brakes to your vehicle's hydraulic system, as it will lower braking effectiveness and create a potential hazard.

■ Additional towing equipment

Many states and provinces/territories require special outside mirrors when towing a trailer. Even if mirrors are not required in your locale, you should install special mirrors if visibility is restricted in any way.

■ Trailer light

Trailer lights and equipment must comply with federal, state, province/territory, and local regulations. Check with your local trailer sales or rental agency for the requirements in the area where you plan to tow.

☒ Towing Equipment and Accessories

Make sure that all equipment is properly installed and maintained, and that it meets federal, state, province/territory, and local regulations.

Consult your trailer sales or rental agency if any other items are recommended or required for your towing situation.

The lighting and wiring of trailers can vary by type and brand. If a connector is required, it should only be installed by a qualified technician.

Driving Safely with a Trailer

■ Things You Need To Know Before Towing a Trailer

- Have the trailer properly serviced and keep it in good condition.
- Make sure that all the weights and load in the vehicle and trailer are within limits.

📖 Towing Load Limits P.187

- Securely attach the hitch, safety chains, and other necessary parts to the trailer.
- Securely store all the items in and on the trailer so that they do not shift while driving.
- Check if the lights and brakes on the trailer are working properly.
- Check the pressures of the trailer tires, including the spare.

■ Towing Speeds and Gears

- Drive slower than normal.
- Obey posted speed limits for vehicles with trailers.

Automatic transmission models

- Use the **D** position when towing a trailer on level roads.

■ Turning and Braking

- Turn more slowly and with a wider turning arc than normal.
- Allow more time and distance for braking.
- Do not brake or turn suddenly.

📖 Driving Safely with a Trailer

Parking

In addition to the normal precautions, place wheel chocks at each of the trailer's tires.

Driving in Hilly Terrain

- Monitor your temperature gauge. If it nears the red (Hot) mark, turn off the air conditioning and reduce speed. Pull to the side of the road safely to cool down the engine if necessary.

Automatic transmission models

- Shift to the **S** position if the transmission shifts frequently.

Towing Your Vehicle

Your vehicle is not designed to be towed behind a motor home. If your vehicle needs to be towed in an emergency, refer to the emergency towing information.

➔ **Emergency Towing** P.298

Driving in Hilly Terrain

If you use the paddle shifters when driving uphill and downhill, select 3rd, 2nd, or 1st gear, depending on the vehicle speed and road conditions. Do not use 4th and 5th gears.

Gear Position	Speed Range
1st	0 - 42 mph (0 - 67 km/h)
2nd,3rd	19 - 62 mph (30 - 100 km/h)

Automatic transmission models

If the automatic transmission fluid temperature exceeds the specified limit, the transmission will also automatically downshift to the 1st gear, even in the sequential shift mode. The gear position indicator blinks for a few seconds, then stays on.

Starting the Engine

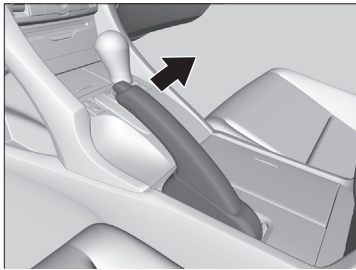

1. Make sure the parking brake is applied.

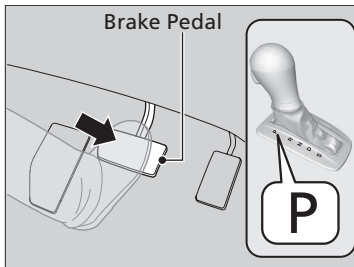

Automatic transmission models

2. Check that the shift lever is in **P**, then depress the brake pedal.
 - ▶ Although it is possible to start the vehicle in **N**, it is safer to start it in **P**.

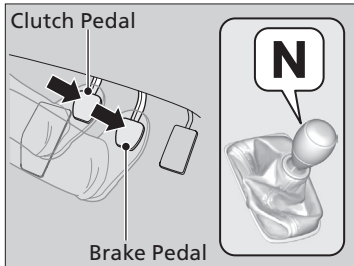

Manual transmission models

2. Check that the shift lever is in **N**. Then depress the brake pedal with your right foot, and the clutch pedal with your left foot.
 - ▶ The clutch pedal must be fully depressed to start the engine.

Starting the Engine

Keep your foot firmly on the brake pedal when starting the engine.

The engine is harder to start in cold weather and in thinner air found at altitudes above 8,000 feet (2,400 meters).

When starting the engine in cold weather, turn off all electrical accessories such as the lights, climate control system, and rear defogger in order to reduce battery drain.

If exhaust sounds abnormal or you can smell exhaust gas inside the vehicle, have your vehicle checked by a dealer. There may be a problem with the engine or exhaust system.

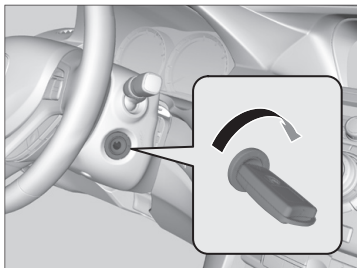

3. Turn the ignition switch to START IIII without depressing the accelerator pedal.

Starting to Drive

Automatic transmission models

1. Keeping your right foot on the brake pedal, release the parking brake. Check that the brake system indicator has gone off.

🔧 **Parking Brake** P.210

2. Put the shift lever in **D**. Select **R** when reversing.
3. Gradually release the brake pedal and gently depress the accelerator pedal to pull away.

🔧 Starting the Engine

Do not hold the key in START IIII for more than 15 seconds.

- If the engine does not start right away, wait for at least 10 seconds before trying again.
- If the engine starts, but then immediately stops, wait at least 10 seconds before repeating step 3 while gently depressing the accelerator pedal. Release the accelerator pedal once the engine starts.

The immobilizer system protects your vehicle from theft. If an improperly coded key (or other device) is used, the engine's fuel system is disabled

🔧 **Immobilizer System** P.98

Precautions While Driving

In Rain

Avoid driving in deep water and on flooded roads. This can damage the engine or cause electrical component failure.

Other Precautions

If there is a strong impact with something under the vehicle, stop in a safe location. Check the underside of the vehicle for damage any fluid leaks.

» Precautions While Driving

NOTICE

Do not operate the shift lever while pressing the accelerator pedal. You could damage the transmission.

If the ignition switch is turned to ACCESSORY [I] or LOCK [0] while driving, the engine will shut down and all steering and brake power assist functions will stop, making it difficult to control the vehicle.

Do not put the shift lever in [N], as you will lose engine braking (and acceleration) performance.

During the first 600 miles (1,000 km) of operation, avoid sudden acceleration or full throttle operation so as to not damage the engine or powertrain.

Avoid hard braking for the first 200 miles (300 km). You should also follow this when the brakes are replaced.

Automatic Transmission

■ Creeping

The following conditions cause the engine to run at high revolutions, and increase creeping:

- Immediately after the engine starts.
- When the climate control system is in use.

Keep the brake pedal firmly depressed when stopped.

■ Kickdown

Depressing the accelerator pedal while driving uphill may cause the transmission to drop to a lower gear, unexpectedly increasing vehicle speed. Depress the accelerator pedal carefully, especially on slippery roads and curves.

Automatic transmission models

Shifting

Change the shift position in accordance with your driving need.

■ Shift lever positions

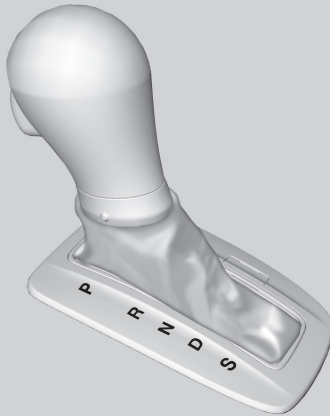

- P** **Park**
Used when parking or starting the engine
- R** **Reverse**
Used when backing up
- N** **Neutral**
Used when idling
- D** **Drive**
Used for:
 - Normal driving (gears change between 1st and 5th automatically)
 - Temporarily driving in the sequential mode
- S** **Drive (S)**
Used for:
 - Automatically changing gears between 1st and 4th (4th gear is used only at high speed)
 - Driving in the sequential mode

» Shifting

You cannot turn the ignition switch to LOCK **O** and remove the key unless the shift lever is in **P**.

The vehicle may move forward very slightly even in **N** while the engine is cold. Depress the brake pedal firmly and, when necessary, apply the parking brake.

Shift Lever Operation

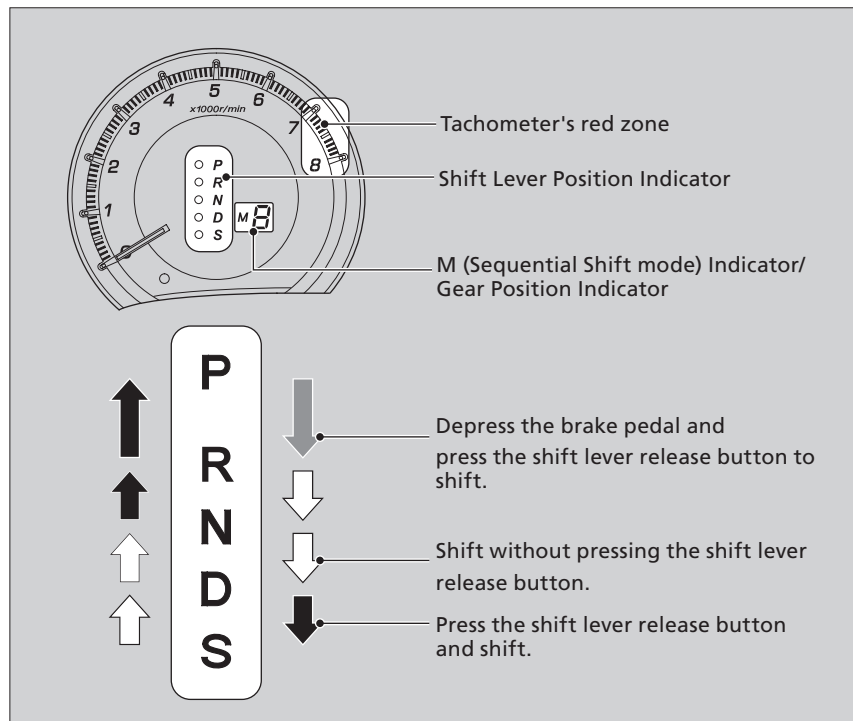

Shift Lever Operation

NOTICE

When you change the shift lever from **D** to **R** and vice versa, come to a complete stop and keep the brake pedal depressed.

Operating the shift lever before the vehicle has come to a complete standstill can damage the transmission.

Use the shift lever position indicator to check the lever position before pulling away.

Whichever position the shift lever is in when driving, a blinking **D** indicator indicates a transmission problem.

Avoid sudden acceleration and have the transmission checked by a dealer as soon as possible.

The fuel supply may be cut off if you drive at engine speeds in or over the tachometer red zone (engine speed limit). If this happens, you may experience a slight jolt.

It may not be possible to operate the shift lever if the brake pedal is applied while the shift lever release button is held down. Depress the brake pedal first.

Sequential Shift Mode

Use the paddle shifters to change between 1st and 5th gears without removing your hands from the steering wheel. The transmission will switch to the sequential shift mode.

■ When the shift lever is in **D**:

The vehicle will go into the sequential shift mode momentarily, and the gear position indicator will come on.

Once you start traveling at a constant speed, the sequential shift mode will automatically switch off, and the gear position indicator will go off.

Hold the **+** paddle shifter for two seconds to return to normal drive.

■ When the shift lever is in **S**:

The vehicle will go into the sequential shift mode, and the **M** (sequential shift) indicator and gear position indicator will come on. At speeds of 6 mph (10 km/h) or less, the vehicle automatically shifts down into 1st gear. It will not automatically shift up, even if vehicle speed increases.

You can only pull away in 1st or 2nd gear.

When switching out of the sequential shift mode, move the shift lever from **S** to **D**. When the sequential shift mode is canceled, the sequential shift mode indicator and shift indicator go off.

■ Second gear lock mode

If you pull the **+** paddle shifter while stopped or driving at 6 mph (10 km/h) or less, the gear position will be locked in 2nd gear. This makes it easier to pull away on slippery surfaces such as snow covered roads.

To cancel the 2nd gear lock mode, pull the **-** paddle shifter, or move the shift lever from **S** to **D**.

■ Sequential Shift Mode Operation

▣ Sequential Shift Mode Operation

Each paddle shift operation makes a single gear change.

To change gears continuously, release the paddle shifter before pulling it again for the next gear.

Recommended Shift Points

Use this table as a guideline for efficient fuel economy and effective emission control.

Shift Up	Normal Acceleration
1st to 2nd	15 mph (24 km/h)
2nd to 3rd	25 mph (40 km/h)
3rd to 4th	40 mph (64 km/h)
4th to 5th	45 mph (72 km/h)

If the gear position indicator blinks when you try to shift up or down, this means your vehicle speed is not in its allowable gear shifting range. Slightly accelerate to shift up and decelerate to shift down while the indicator is blinking.

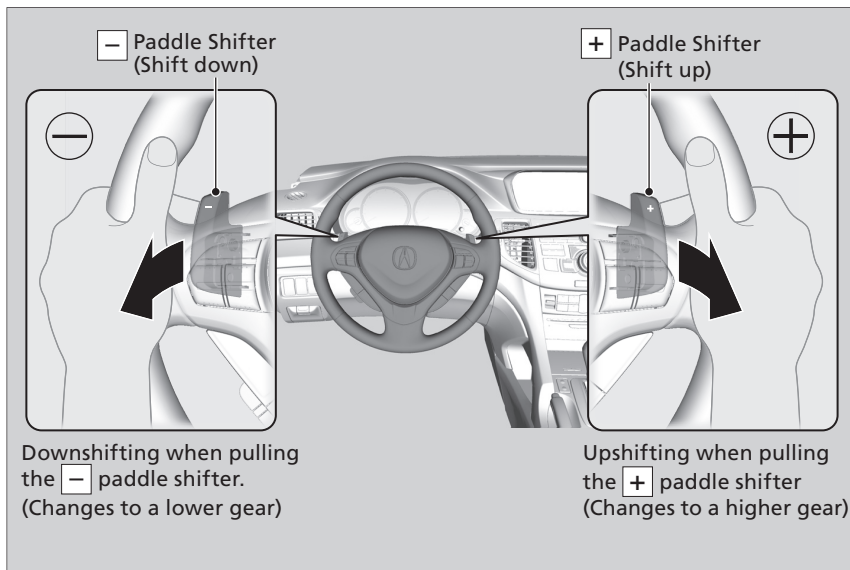

Manual transmission models

Shifting

Shift Lever Operation

Fully depress the clutch pedal to operate the shift lever and change gears, then slowly release the pedal.

Depress the clutch pedal, and pause for a few seconds before shifting into **R**, or shift into one of the forward gears for a moment. This stops the gears so they do not “grind.”

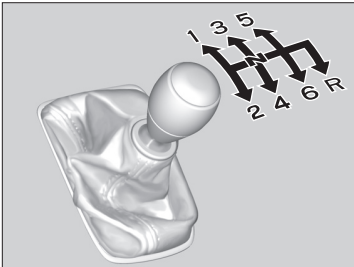

When you are not shifting, do not rest your foot on the clutch pedal. This can cause your clutch to wear out faster.

Shifting

NOTICE

Do not shift to **R** before the vehicle comes to a complete stop.

Shifting to **R** before stopping can damage the transmission.

NOTICE

Before downshifting, make sure the engine will not go into the tachometer's red zone. Should this occur, it can severely damage your engine.

There is a metallic part on the shift lever. If you leave the vehicle parked outside for a long time on a hot day, be careful before moving the shift lever. Because of heat, the shift lever may be extremely hot. If the outside temperature is low, the shift lever may feel cold.

Recommended Shift Points

Driving in the highest gear that allows the engine to run and accelerate smoothly helps to optimize fuel economy and effective emissions control. The following shift points are recommended:

Shift Up	Normal Acceleration
1st to 2nd	17 mph (27 km/h)
2nd to 3rd	29 mph (46 km/h)
3rd to 4th	37 mph (59 km/h)
4th to 5th	43 mph (69 km/h)
5th to 6th	49 mph (79 km/h)

If you exceed the maximum speed for the gear you are in, the engine speed will enter into the tachometer's red zone. When this happens, you may experience a slight jolt.

Continued

Reverse Lockout

The manual transmission has a lockout mechanism that stops you from accidentally shifting into **R** from a forward gear while the vehicle is moving at a certain speed.

If you cannot shift to **R** when the vehicle is stopped, do the following:

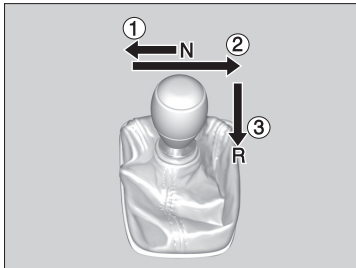

1. Depress the clutch pedal, move the shift lever all the way to the left, and shift to **R**.
2. If you still cannot shift into **R**, apply the parking brake, and turn the ignition switch to ACCESSORY **I** or LOCK **O**.
3. Depress the clutch pedal and shift into **R**.
4. Keep depressing the clutch pedal and start the engine.

Have the vehicle checked by a dealer if you have to go through this procedure repeatedly.

Cruise Control

Maintains a constant vehicle speed without having to keep your foot on the accelerator. Use cruise control on freeways or open roads where you can travel at a constant speed with little acceleration or deceleration.

When to use

- Vehicle speed for cruise control:
Desired speed in a range above roughly 25 mph (40 km/h) ~

Automatic transmission models

- Shift positions for cruise control:
In **D** or **S**, in 2nd gear or higher

Always keep sufficient distance between you and the vehicle in front of you.



How to use

- Press the **CRUISE** button on the steering wheel



⌘ Cruise Control

⚠ WARNING

Improper use of the cruise control can lead to a crash.

Use the cruise control only when traveling on open highways in good weather.

When the ignition switch is in ACCESSORY **I** or LOCK **0**, cruise control automatically goes off.

It may not be possible to maintain a constant speed when driving uphill or downhill.

■ To Set the Vehicle Speed

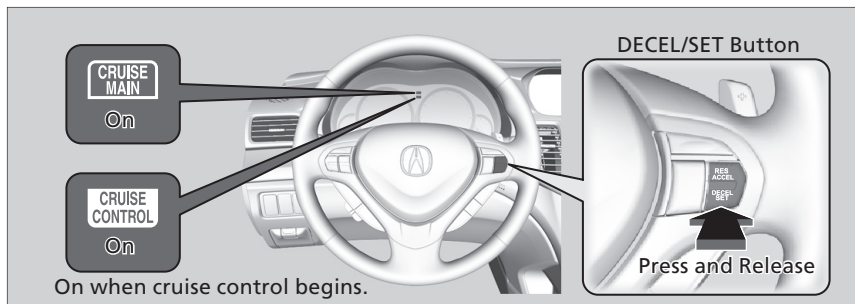

Press the DECEL/SET button when you reach the desired speed using the accelerator pedal.

The moment you release the DECEL/SET button, the set speed is fixed, and cruise control begins. The **CRUISE CONTROL** indicator comes on.

■ To Cancel

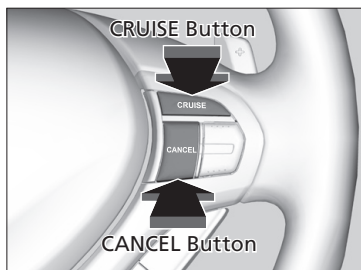

To cancel cruise control, do any of the following.:

- Press the CANCEL button.
- Press the CRUISE button.
- Depress the brake pedal.
- Depress the clutch pedal.

The **CRUISE CONTROL** indicator goes off.

⌘ To Set the Vehicle Speed

When not using cruise control:
Turn off cruise control by pressing the CRUISE button.

⌘ To Cancel

Resuming the prior set speed:
After cruise control has been canceled, you can still resume the prior set speed by pressing the RES/ACCEL button while driving at a speed of at least 25 mph (40 km/h) or more.

You cannot set or resume in the following situations:

- When vehicle speed is less than 25 mph (40 km/h)
- When the CRUISE button is turned off

At vehicle speeds of 22 mph (35 km/h) or less, cruise control is canceled automatically.

■ To Adjust the Vehicle Speed

Increase or decrease the vehicle speed using the accelerator and brake pedals, and set the vehicle speed with the DECEL/SET button on the steering wheel.

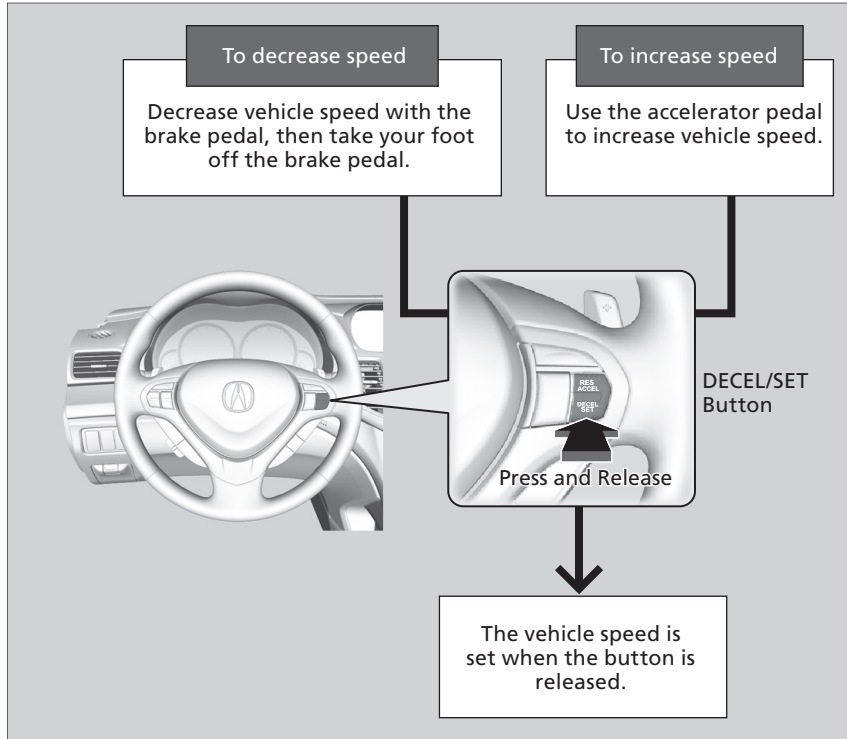

☒ To Adjust the Vehicle Speed

Vehicle speed can be increased or decreased also using the RES/ACCEL or DECEL/SET buttons on the steering wheel.

RES/ACCEL Button

- Each time you press the button, vehicle speed is increased by about 1 mph (1.6 km/h).
- If you keep it pressed, vehicle speed increases until you release it. This speed is then set.

DECEL/SET Button

- Each time you press it, vehicle speed decreases by about 1 mph (1.6 km/h).
- If you keep it pressed, vehicle speed decreases until you release it. This speed is then set.

VSA® (Vehicle Stability Assist), aka ESC (Electronic Stability Control), System

VSA® helps to stabilize the vehicle during cornering if the vehicle turns more or less than what was intended. It also assists in maintaining traction on slippery surfaces. It does so by regulating engine output and selectively applying the brakes.

■ VSA® Operation

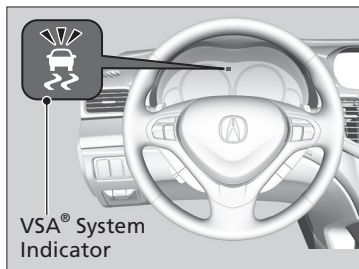

When VSA® activates, you may notice that the engine does not respond to the accelerator. You may also notice some noise from the hydraulic system. You will also see the indicator blink.

☒ VSA® (Vehicle Stability Assist), aka ESC (Electronic Stability Control), System

The VSA® may not function properly if tire type and size are mixed. Make sure to use the same size and type of tire, and the air pressures as specified.

When the VSA® indicator comes on and stays on while driving, there may be a problem with the system. While this may not interfere with normal driving, have your vehicle checked by a dealer immediately.

VSA® cannot enhance stability in all driving situations and does not control the entire braking system. You still need to drive and corner at speeds appropriate for the conditions and always leave a sufficient margin of safety.

The main function of the VSA® system is generally known as Electronic Stability Control (ESC). The system also includes a traction control function.

VSA® On and Off

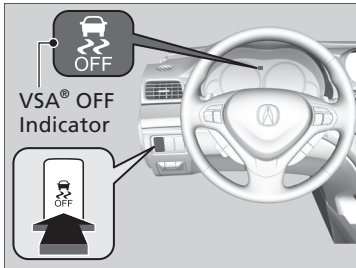

This button is on the driver side control panel. To turn the VSA® system on and off, press and hold it until you hear a beep.

VSA® will stop and the indicator will come on.

To turn it on again, press the  (VSA® OFF) button until you hear a beep.

VSA® is turned on every time you start the engine, even if you turned it off the last time you drove the vehicle.

✘ VSA® (Vehicle Stability Assist), aka ESC (Electronic Stability Control), System

Without VSA®, your vehicle will have normal braking and cornering ability, but it will not have VSA® traction and stability enhancement.

In certain unusual conditions when your vehicle gets stuck in shallow mud or fresh snow, it may be easier to free it with the VSA® temporarily switched off.

When the VSA® system is off, the traction control system is also off. You should only attempt to free your vehicle with the VSA® off if you are not able to free it when the VSA® is on.

Immediately after freeing your vehicle, be sure to switch VSA® on again. We do not recommend driving your vehicle with the VSA® and traction control systems switched off.

If the low tire pressure/TPMS indicator comes on or blinks, the VSA® system comes on automatically. In this case, you cannot turn the system off by pressing the  button.



You may hear a motor sound coming from the engine compartment while system checks are being performed immediately after starting the engine or while driving. This is normal.

TPMS (Tire Pressure Monitoring System)

Monitors the tire pressure while you are driving. If your vehicle's tire pressure becomes significantly low, the low tire pressure/TPMS indicator comes on and a message appears on the multi-information display.

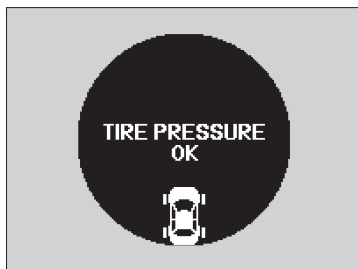
Tire Pressure Monitor



To select the tire pressure monitor, turn the ignition switch to ON  and press the /  (information) button until you see the tire pressure screen.

If all the tire pressures are normal, "TIRE PRESSURE OK" will be displayed.



To display the pressure of all four tires, press the SEL/RESET button.

The pressure for each tire is displayed in PSI (U.S.) or kPa (Canada).

TPMS (Tire Pressure Monitoring System)

Conditions such as low ambient temperature and altitude change directly affect tire pressure and can trigger the low tire pressure/TPMS indicator to come on.

If the Low Tire Pressure/TPMS Indicator Comes On or Blinks P.293

Tire Pressure Monitor

The pressure displayed on the multi-information display can be slightly different from the actual pressure as measured by a gauge. If there is a significant difference between the two values, or if the low tire pressure/TPMS indicator and the message on the multi-information display do not go off after you have inflated the tire to the specified pressure, have the system checked by a dealer.

"SYSTEM FUNCTION ERROR" may appear if you drive with the compact spare tire, or there is a problem with the TPMS.



If any tire has low pressure, "LOW TIRE PRESSURE" is displayed on the multi-information display. Check the pressure of each tire by pressing the SEL/RESET button.



"CHECK TIRE PRESSURE" is displayed when a tire has significantly low pressure. The specific tire is displayed on the screen.

⌘ TPMS (Tire Pressure Monitoring System)

Tire pressure checked and inflated in:

- Warm weather can become under-inflated in colder weather.
- Cool weather can become over-inflated in warmer weather.

The low tire pressure/TPMS indicator will not come on as a result of over inflation.

U.S. models

Tire Pressure Monitoring System (TPMS) - Required Federal Explanation

Each tire, including the spare (if provided), should be checked monthly when cold and inflated to the inflation pressure recommended by the vehicle manufacturer on the vehicle placard or tire inflation pressure label.

(If your vehicle has tires of a different size than the size indicated on the vehicle placard or tire inflation pressure label, you should determine the proper tire inflation pressure for those tires.)

As an added safety feature, your vehicle has been equipped with a tire pressure monitoring system (TPMS) that illuminates a low tire pressure telltale



when one or more of your tires is significantly under-inflated.

Accordingly, when the low tire pressure telltale illuminates, you should stop and check your tires as soon as possible, and inflate them to the proper pressure.

Driving on a significantly under-inflated tire causes the tire to overheat and can lead to tire failure. Under-inflation also reduces fuel efficiency and tire tread life, and may affect the vehicle's handling and stopping ability.

Please note that the TPMS is not a substitute for proper tire maintenance, and it is the driver's responsibility to maintain correct tire pressure, even if under-inflation has not reached the level to trigger illumination of the TPMS low tire pressure telltale.

Your vehicle has also been equipped with a TPMS malfunction indicator to indicate when the system is not operating properly. The TPMS malfunction indicator is combined with the low tire pressure telltale. When the system detects a malfunction, the telltale will flash for approximately one minute and then remain continuously illuminated. This sequence will continue upon subsequent vehicle start-ups as long as the malfunction exists.

When the malfunction indicator is illuminated, the system may not be able to detect or signal low tire pressure as intended.

TPMS malfunctions may occur for a variety of reasons, including the installation of replacement or alternate tires or wheels on the vehicle that prevent the TPMS from functioning properly.

Always check the TPMS malfunction telltale after replacing one or more tires or wheels on your vehicle to ensure that the replacement or alternate tires and wheels allow the TPMS to continue to function properly.

Brake System

Parking Brake

Use the parking brake to keep the vehicle stationary when parking.

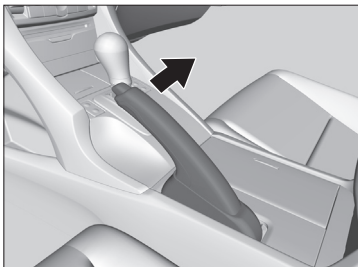

To apply:

Pull the lever fully up without pressing the release button.

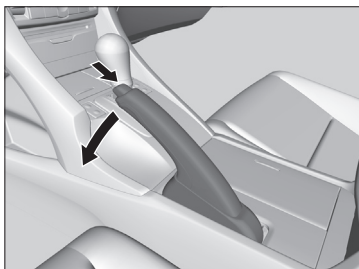

To release:

1. Pull the lever slightly, and press and hold the release button.
2. Lower the lever down all the way, then release the button.

⌘ Parking Brake

NOTICE

Release the parking brake fully before driving. The rear brakes and axle can be damaged if you drive with the parking brake applied.

If you start driving without fully releasing the parking brake, a buzzer sounds as a warning, and "RELEASE PARKING BRAKE" appears on the multi-information display.

Always apply the parking brake when parking.

To prevent the parking brake from freezing when the outside temperature is extremely cold, do not apply it, but do the following:

Automatic transmission models

Put the shift lever in **P**, then use a block or other wheel chock to stop the wheels from turning.

Manual transmission models

Put the shift lever in **R** or **1**, then use a block or other wheel chock to stop the wheels from turning.

■ Foot Brake

Your vehicle is equipped with disc brakes at all four wheels. A power assist helps reduce the effort needed on the brake pedal. The brake assist system increases the stopping force when you depress the brake pedal hard in an emergency situation. The anti-lock brake system (ABS) helps you retain steering control when braking very hard.

🔧 **Brake Assist System** P.213

🔧 **ABS (Anti-lock Brake System)** P.212

🔧 Foot Brake

Check the brakes after driving through deep water, or if there is a buildup of road surface water. If necessary, dry the brakes by lightly depressing the pedal several times.

If you hear a continuous metallic friction sound when applying the brakes, the brake pads need to be replaced. Have the vehicle checked by a dealer.

Constantly using the brake pedal while going down a long hill builds up heat, which reduces the brake effectiveness. Apply engine braking by taking your foot off the accelerator pedal and downshifting to a lower gear. With manual transmission use a lower gear for greater engine braking.

Do not rest your foot on the brake pedal while driving, as it will lightly apply the brakes and cause them to lose effectiveness over time and reduce pad life. It will also confuse drivers behind you.

ABS (Anti-lock Brake System)

ABS

Helps prevent the wheels from locking up, and helps you retain steering control by pumping the brakes rapidly, much faster than you.

The electronic brake distribution (EBD) system, which is part of the ABS, also balances the front-to-rear braking distribution according to vehicle loading.

You should never pump the brake pedal. Let the ABS work for you by always keeping firm, steady pressure on the brake pedal. This is sometimes referred to as "stomp and steer."

ABS operation

The brake pedal may pulsate slightly when the ABS is working. Keep holding the pedal firmly down. On dry pavement, you will need to press on the brake pedal very hard before the ABS activates. However, you may feel the ABS activate immediately if you are trying to stop on snow or ice.

When the vehicle speed goes under 6 mph (10 km/h), the ABS stops.

ABS (Anti-lock Brake System)

NOTICE

The ABS may not function correctly if you use an incorrect tire type and size.

When the ABS indicator comes on while driving, there may be a problem with the system. While normal braking is not affected, there is a possibility of the ABS not operating. Have the vehicle checked by a dealer immediately.

The ABS does not reduce the time or distance it takes to stop the vehicle. It only helps with steering control during hard braking.

In the following cases, your vehicle may need more stopping distance than a vehicle without ABS:

- When driving on rough road surfaces, including when driving on uneven surfaces, such as gravel or snow.
- When tire chains are installed.

You may hear a motor sound coming from the engine compartment while system checks are being performed immediately after starting the engine or while driving. This is normal.

Brake Assist System

■ Brake Assist System

Designed to assist the driver by generating greater braking force when you depress the brake pedal hard during emergency braking.

■ Brake assist system operation

Press the brake pedal firmly for more powerful braking.

When brake assist operates, the pedal may wiggle slightly and an operating noise may be heard. This is normal. Keep holding the brake pedal firmly down.

When Stopped

1. Always use the parking brake when you park your vehicle.
2. Make sure the parking brake is set firmly, or your vehicle may roll if parked on an incline.

» Parking Your Vehicle

Do not park your vehicle near flammable objects, such as dry grass, oil, or timber. Heat from the exhaust can cause a fire.

» When Stopped

Automatic transmission models

NOTICE

The following can damage the transmission:

- Depressing the accelerator and brake pedals simultaneously.
- Holding the vehicle in place when facing uphill by depressing the accelerator pedal.
- Moving the shift lever into **P** before the vehicle stops completely.

» Parking

Raise the wiper arms when snow is expected.

Parking

Automatic transmission models

1. Depress the brake pedal firmly with the shift lever in **D**.
2. Apply the parking brake while holding the brake pedal down.
3. Move the shift lever to **P**.
4. Turn off the engine.

Fuel Information

Fuel recommendation

Unleaded premium gasoline, pump octane number 91 or higher

4-cylinder models

Use of a lower octane gasoline can cause occasional metallic knocking noise in the engine and will result in decreased engine performance.

Use of a gasoline with a pump octane less than 87 can lead to engine damage.

6-cylinder models

Your vehicle is designed to operate on premium unleaded gasoline with a pump octane of 91 or higher.

If this octane grade is unavailable, regular unleaded gasoline with a pump octane of 87 or higher may be used temporarily.

The use of regular unleaded gasoline can cause metallic knocking noises in the engine and will result in decreased engine performance. The long-term use of regular-grade gasoline can lead to engine damage.

Top tier detergent gasoline

Because the level of detergency and additives in gasoline vary in the market, Honda endorses the use of "TOP TIER Detergent Gasoline" where available to help maintain the performance and reliability of your vehicle. TOP TIER Detergent Gasoline meets a new gasoline standard jointly established by leading automotive manufacturers to meet the needs of today's advanced engines.

» Fuel Information

NOTICE

We recommend quality gasoline containing detergent additives that help prevent fuel system and engine deposits. In addition, in order to maintain good performance, fuel economy, and emissions control, we strongly recommend, the use of gasoline that does NOT contain harmful manganese-based fuel additives such as MMT, if such gasoline is available.

Use of gasoline with these additives may adversely affect performance, and cause the malfunction indicator lamp on your instrument panel to come on. If this happens, contact your dealer for service. Some gasoline today is blended with oxygenates such as ethanol or MTBE. Your vehicle is designed to operate on oxygenated gasoline containing up to 10% ethanol by volume. Do not use gasoline containing methanol. If you notice any undesirable operating symptoms, try another service station or switch to another brand of gasoline.

Qualifying gasoline retailers will, in most cases, identify their gasoline as having met "TOP TIER Detergent Gasoline" standards at the retail location. This fuel is guaranteed to contain the proper level of detergent additives and be free of metallic additives. The proper level of detergent additives, and absence of harmful metallic additives in gasoline, help avoid build-up of deposits in your engine and emission control system.

For further important fuel-related information for your vehicle, or on information on gasoline that does not contain MMT, visit My Acura at owners.acura.com In Canada, visit www.acura.ca for additional information on gasoline. For more information on top tier gasoline, visit www.toptiergas.com.

■ **Fuel tank capacity: 18.5 US gal (70 liters)**

How to Refuel

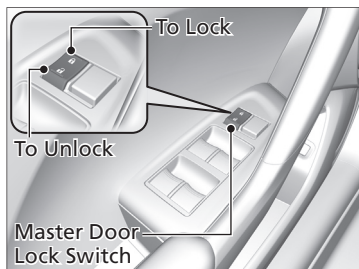

1. Stop your vehicle with the service station pump on the left side of the vehicle in the rear.
2. Turn off the engine.
3. Unlock the driver's door using the master door lock switch.
 - ▶ The fuel fill door on the outer side of the vehicle will unlock.

☒ How to Refuel

⚠ WARNING

Gasoline is highly flammable and explosive. You can be burned or seriously injured when handling fuel.

- Stop the engine, and keep heat, sparks, and flame away.
- Handle fuel only outdoors.
- Wipe up spills immediately.

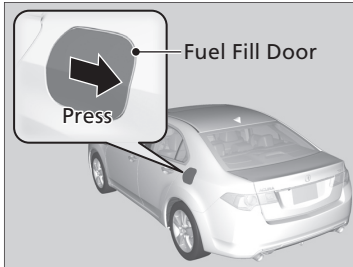

4. Press the area indicated by the arrow to release the fuel fill door. You will hear a click

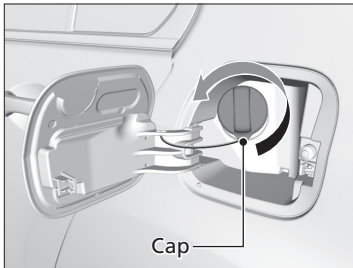

5. Remove the fuel fill cap slowly. If you hear a release of air, wait until this stops, then turn the knob slowly to open the fuel fill cap.

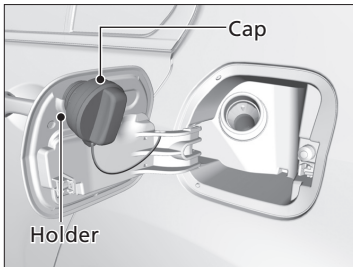

6. Place the fuel fill cap in the holder.
7. Insert the filler nozzle fully.
 - ▶ When the tank is full, the fuel nozzle will click off automatically. This leaves space in the fuel tank in case the fuel expands with a change in the temperature.
8. After filling, replace the fuel fill cap, tightening it until you hear it click at least once.
 - ▶ Shut the fuel fill door by hand.

▶▶ How to Refuel

Use the master door lock switch to unlock the fuel fill door.

The vehicle doors and fuel fill door automatically relock if the remote unlock function is used. This can be deactivated by briefly opening then closing the driver's door.

NOTICE

The fuel fill door and its latching mechanism can be permanently damaged if the fuel fill door is forced closed when the driver's door is locked.

The filler nozzle automatically stops to leave space in the fuel tank so that fuel does not overflow as a result of changes in air temperature.

If the fuel nozzle keeps turning off when the tank is not full, there may be a problem with the pump's fuel vapor recovery system. Try filling at another pump. If this does not fix the problem, consult a dealer.

Do not continue to add fuel after the nozzle has automatically stopped. Additional fuel can exceed the full tank capacity.

Improving Fuel Economy

Fuel economy depends on several conditions, including driving conditions, your driving habits, the condition of your vehicle, and loading. Depending on these and other conditions, you may or may not achieve the rated fuel economy of this vehicle.

Maintenance and Fuel Economy

You can optimize your fuel economy with proper maintenance of your vehicle. Always maintain your vehicle in accordance with the messages displayed on the multi-information display.

- Use the recommended viscosity engine oil, displaying the API Certification Seal.
- Maintain the specified tire pressure.
- Do not load the vehicle with excess cargo.
- Keep your vehicle clean. A buildup of snow or mud on your vehicle's underside adds weight and increases wind resistance.

Improving Fuel Economy

Direct calculation is the recommended method to determine actual fuel consumed while driving.

Miles driven	÷	Gallons of fuel	=	Miles per Gallon		
100	×	Liter	÷	Kilometers	=	L per 100 km

In Canada, posted fuel economy numbers are established following a simulated test. For more information on how this test is performed, please visit <http://oee.nrcan.gc.ca/>

Accessories

When installing accessories, check the following:

- Do not install accessories on the windshield. They can obstruct your view and delay your reaction to driving conditions.
- Do not install accessories on the side pillars or across the side windows. Accessories installed in these areas may interfere with proper operation of the side curtain airbags.
- Be sure electronic accessories do not overload electrical circuits or interfere with proper operation of your vehicle.
 - **Fuse** P.294
- Before installing any electronic accessory, have the installer contact a dealer for assistance. If possible, have a dealer inspect the final installation.

Modifications

Do not modify your vehicle or use non-Acura components that can affect its handling, stability, and reliability.

Overall vehicle performance can be affected. Always make sure all equipment is properly installed and maintained, and that it meets federal, state, province, territory, and local regulations.

Accessories and Modifications

WARNING

Improper accessories or modifications can affect your vehicle's handling, stability, and performance, and cause a crash in which you can be seriously hurt or killed.

Follow all instructions in this owner's manual regarding accessories and modifications.

Acura Genuine accessories are recommended to ensure proper operation on your vehicle.

Maintenance

This chapter discusses basic maintenance.



Before Performing Maintenance

Inspection and Maintenance	222
Safety When Performing Maintenance	223
Parts and Fluids Used in Maintenance Service	224

Maintenance Minder™

Maintenance Under the Hood

Maintenance Items Under the Hood ..	229
Opening the Hood	231
Recommended Engine Oil	234
Oil Check	235
Adding Engine Oil	237

Engine Coolant	240
Transmission Fluid	242
Brake/Clutch Fluid	244
Refilling Window Washer Fluid	246

Replacing Light Bulbs..... 247

Checking and Maintaining Wiper

Blades

Checking and Maintaining Tires	
Checking Tires	259
Tire and Loading Information Label....	260
Tire Labeling	260
DOT Tire Quality Grading (U.S. Vehicles).....	262

Wear Indicators.....	264
Tire Service Life.....	264
Tire and Wheel Replacement	265
Tire Rotation	266
Winter Tires	267

Battery..... 268

Remote Transmitter Care..... 269

Replacing the Battery	269
-----------------------------	-----

Climate Control System

Maintenance

Cleaning	
Interior Care.....	271
Exterior Care.....	273

Inspection and Maintenance

For your safety, perform all listed inspections and maintenance to keep your vehicle in good condition. If you become aware of any abnormality (noise, smell, insufficient brake fluid, oil residue on the ground, etc.), have your vehicle inspected by a dealer. (Note, however, that service at a dealer is not mandatory to keep your warranties in effect.) Refer to the separate maintenance booklet for detailed maintenance and inspection information.

Types of Inspection and Maintenance

Daily inspections

Perform inspections before long distance trips, when washing the vehicle, or when refueling.

Periodic inspections

- Check the automatic transmission fluid level monthly.
 - **Automatic Transmission Fluid** P.242
- Check the brake fluid level monthly.
 - **Brake/Clutch Fluid** P.244
- Check the tire pressure monthly. Examine the tread for wear and foreign objects.
 - **Checking and Maintaining Tires** P.259
- Check the operation of the exterior lights monthly.
 - **Replacing Light Bulbs** P.247
- Check the condition of the wiper blades at least every six months.
 - **Checking and Maintaining Wiper Blades** P.257

Inspection and Maintenance

U.S. models

Maintenance, replacement, or repair of emissions control devices and systems may be done by any automotive repair establishment or individuals using parts that are "certified" to EPA standards.

According to state and federal regulations, failure to perform maintenance on the maintenance main items marked with # will not void your emissions warranties. However, all maintenance services should be performed in accordance with the intervals indicated by the multi-information display.

➤ **Maintenance Service Items** P.227

If you want to perform complex maintenance tasks that require more skills and tools, purchase the service manual.

➤ **Authorized Manual** P.313

If you want to perform maintenance yourself, make sure that you have the necessary tools and skills first.

After performing maintenance, update the records in the separate maintenance booklet.

Safety When Performing Maintenance

Some of the most important safety precautions are given here.

However, we cannot warn you of every conceivable hazard that can arise in performing maintenance. Only you can decide whether or not you should perform a given task.

Maintenance Safety

- To reduce the possibility of fire or explosion, keep cigarettes, sparks, and flames away from the battery and all fuel related parts.
- To clean parts, use a commercially available degreaser or parts cleaner, not gasoline.
- Wear eye protection and protective clothing when working with the battery or compressed air.
- Engine exhaust contains carbon monoxide, which is poisonous and can kill you.
 - ▶ Only operate the engine if there is sufficient ventilation.

Vehicle Safety

- The vehicle must be in a stationary condition.
 - ▶ Make sure your vehicle is parked on level ground, the parking brake is set, and the engine is off.
- Be aware that hot parts can burn you.
 - ▶ Make sure to let the engine and exhaust system cool thoroughly before touching vehicle parts.
- Be aware that moving parts can injure you.
 - ▶ Do not start the engine unless instructed, and keep your hands and limbs away from moving parts.

☒ Safety When Performing Maintenance

WARNING

Improperly maintaining this vehicle or failing to correct a problem before driving can cause a crash in which you can be seriously hurt or killed.

Always follow the inspection and maintenance recommendations according to the schedules in this owner's manual.

WARNING

Failure to properly follow maintenance instructions and precautions can cause you to be seriously hurt or killed.

Always follow the procedures and precautions in this owner's manual.

Parts and Fluids Used in Maintenance Service

The use of Acura genuine parts and fluids is recommended when maintaining and servicing your vehicle. Acura genuine parts are manufactured according to the same high quality standards used in Acura vehicles.

If the engine oil life is less than 15%, you will see the Maintenance Minder messages appear on the multi-information display every time you turn the ignition switch to ON **II**. The messages notify you when to change the engine oil, or when to bring your vehicle to a dealer for indicated maintenance services.

■ Displaying the Engine Oil Life

1. Turn the ignition switch to ON **II**.
2. Press the SEL/RESET button repeatedly until the engine oil life appears on the multi-information display.

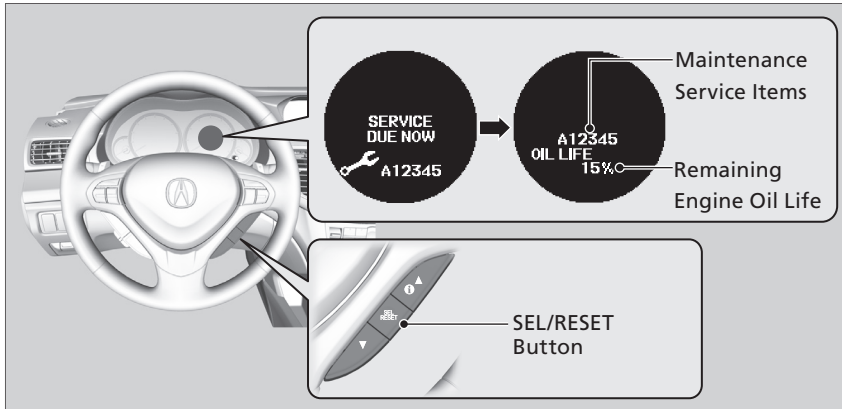









The system message indicator (i) comes on along with the Maintenance Minder message.

⌘ Displaying the Engine Oil Life

Based on the engine operating conditions, the remaining engine oil life is calculated and displayed as a percentage.

Displayed Engine Oil Life (%)	Calculated Engine Oil Life (%)
100	100 to 91
90	90 to 81
80	80 to 71
70	70 to 61
60	60 to 51
50	50 to 41
40	40 to 31
30	30 to 21
20	20 to 16
15	15 to 11
10	10 to 6
5	5 to 1
0	0

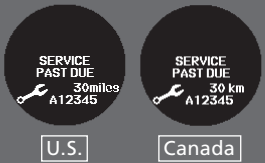
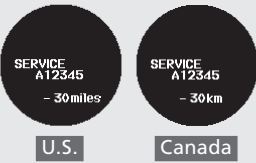
Maintenance Minder Messages on the Multi-Information Display

Maintenance Message	Oil Life Display	Explanation	Information
<p>SERVICE DUE SOON</p> 	<p>15 %</p> 	<p>The remaining engine oil life is 15 to 6 percent. Once you switch the display by pressing the /▼ (Information) button this message will go off.</p>	<p>The engine oil is approaching the end of its service life, and the maintenance items should be inspected and serviced soon.</p>
<p>SERVICE DUE NOW</p> 	<p>5 %</p> 	<p>The remaining engine oil life is 5 to 1 percent. Press the /▼ button to switch to another display.</p>	<p>The engine oil has almost reached the end of its service life, and the maintenance items should be inspected and serviced as soon as possible.</p>
<p>SERVICE PAST DUE</p> 	<p>Negative Distance</p> 	<p>The remaining engine oil life has passed its service life, and a negative distance appears after driving over 10 miles (U.S. models) or 10 km (Canadian models). Press the /▼ button to switch to another display.</p>	<p>The engine oil life has passed. The maintenance items must be inspected and serviced immediately.</p>

Maintenance Service Items

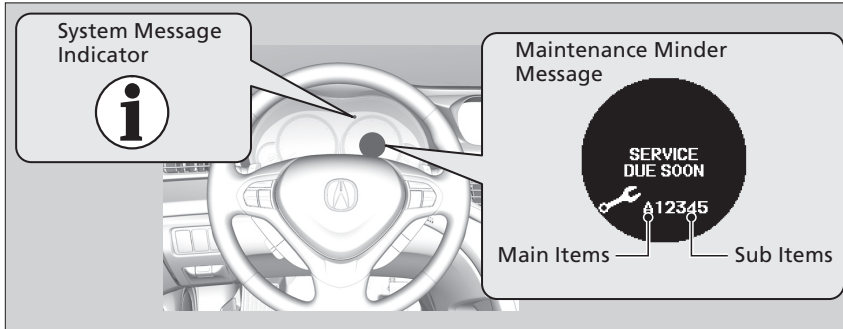

Maintenance Service Items

- Independent of the Maintenance Minder information, replace the brake fluid every 3 years.
- Inspect idle speed every 160,000 miles (256,000 km).
- Adjust the valves during services A, B, 1, 2, or 3 only if they are noisy.

CODE	Maintenance Main Items
A	<ul style="list-style-type: none"> • Replace engine oil*¹
B	<ul style="list-style-type: none"> • Replace engine oil*¹ and oil filter • Inspect front and rear brakes • Check parking brake adjustment • Inspect tie rod ends, steering gear box, and boots • Inspect suspension components • Inspect driveshaft boots • Inspect brake hoses and lines (Including ABS) • Inspect all fluid levels and condition of fluids • Inspect exhaust system[#] • Inspect fuel lines and connections[#]

CODE	Maintenance Sub Items
1	<ul style="list-style-type: none"> • Rotate tires
2	<ul style="list-style-type: none"> • Replace air cleaner element*² • Replace dust and pollen filter*³ • Inspect drive belt
3	<ul style="list-style-type: none"> • Replace transmission fluid*⁴
4	<ul style="list-style-type: none"> • Replace spark plugs • Replace timing belt and inspect water pump*⁵ • Inspect valve clearance
5	<ul style="list-style-type: none"> • Replace engine coolant



*1: Change the engine oil according to the Maintenance Minder, or annually, whichever comes first.
 *2: If you drive primarily in dusty conditions, replace the air cleaner element every 15,000 miles (24,000 km).
 *3: If you drive primarily in urban areas that have high concentrations of soot in the air from industry and from diesel-powered vehicles, replace the dust and pollen filter every 15,000 miles (24,000 km).

*4: If you drive regularly in mountainous areas or tow a trailer, replace the transmission fluid at 60,000 miles (100,000 km), then every 30,000 miles (48,000 km). (automatic transmission models only)
 *5: If you drive regularly in very high temperatures (over 110 °F, 43 °C), in very low temperatures (under -20 °F, -29 °C), or tow a trailer, replace every 60,000 miles/100,000 km. (6-cylinder models only)
 #: See information on maintenance and emissions warranty.

Resetting the Display

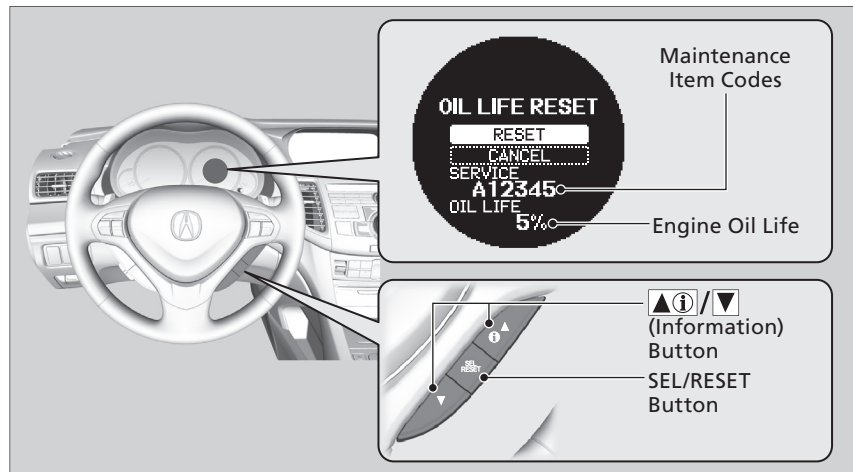
Reset the engine oil life display if you have performed the maintenance service.



1. Turn the ignition switch to ON .
2. Display the engine oil life by repeatedly pressing the SEL/RESET button.
3. Press and hold the SEL/RESET button for 10 seconds or more.
 - ▶ The oil life reset mode is displayed on the multi-information display.
4. Select "RESET" with the  button.
 - ▶ The service code will disappear and the engine oil life display will return to 100 %.

To cancel the oil life reset mode, select "CANCEL", then press the SEL/RESET button.

Resetting the Display

NOTICE

Failure to reset the engine oil life after a maintenance service results in the system showing incorrect maintenance intervals, which can lead to serious mechanical problems.

The dealer will reset the engine oil life display after completing the required maintenance service. If someone other than a dealer performs maintenance service, reset the engine oil life display yourself.

Maintenance Items Under the Hood

4-cylinder models

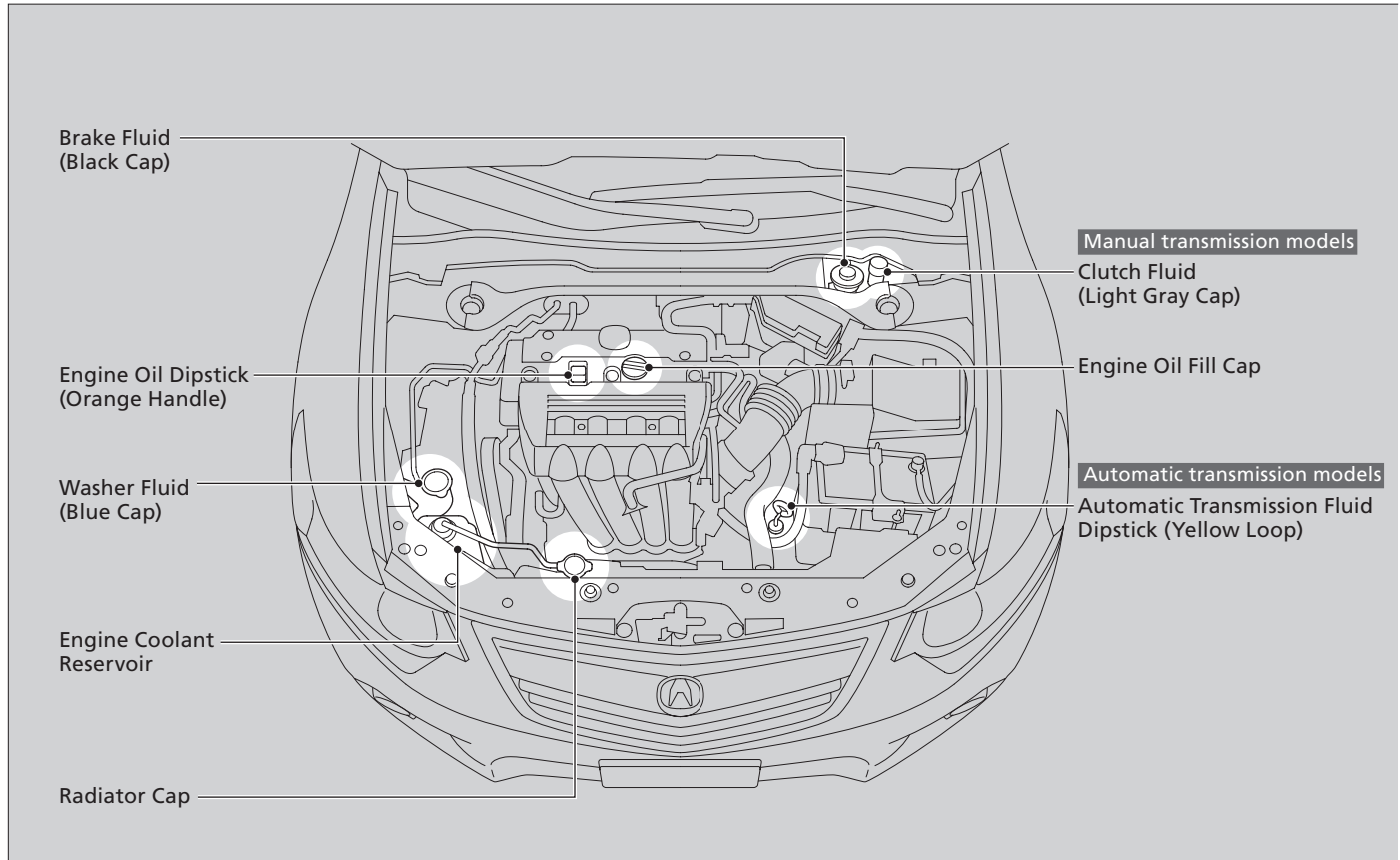

6-cylinder models

Engine Oil Dipstick
(Orange Loop)

Washer Fluid
(Blue Cap)

Engine Coolant
Reservoir*

Radiator Cap*

Brake Fluid
(Black Cap)

Engine Oil Fill Cap

Automatic
Transmission
Fluid Dipstick
(Yellow Loop)

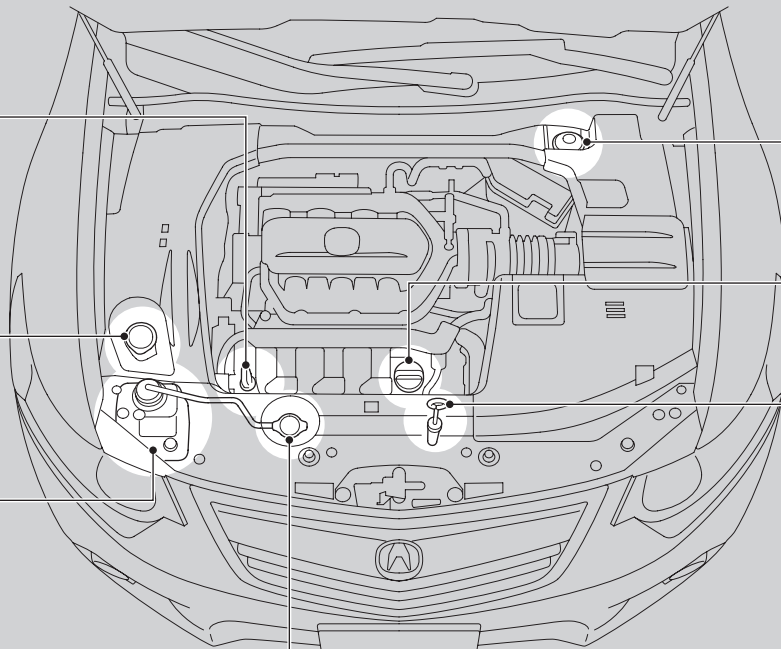

* : Located under the cover

Opening the Hood

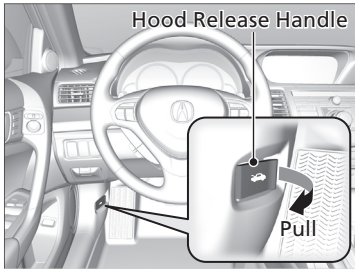

1. Park the vehicle on a level surface, and set the parking brake.
2. Pull the hood release handle under the lower left corner of the dashboard.
 - The hood will pop up slightly.

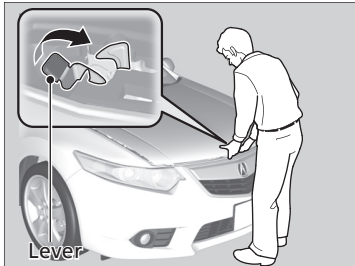

3. Push up the hood latch lever in the center of the hood to release the lock mechanism, and open the hood.

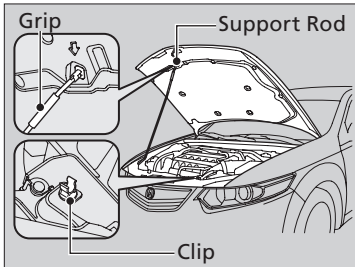

4-cylinder models

4. Remove the support rod from the clamp using the grip. Mount the support rod in the hood.

When closing, remove the support rod, and stow it in the clamp, then gently lower the hood. Remove your hand at a height of approximately 12 inches (30 cm) and let the hood close.

Opening the Hood

NOTICE

Do not open the hood when the wiper arms are raised. The hood will strike the wipers, and may damage either the hood or the wipers.

When closing the hood, check that the hood is securely latched.

If the hood latch lever moves stiffly, or if you can open the hood without lifting the lever, the latch mechanism should be cleaned and lubricated.

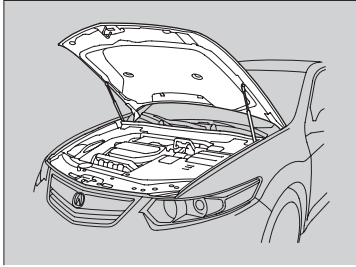

6-cylinder models

- 4.** Lift the hood up most of the way.
 - ▶ The hydraulic supports will lift it up the rest of the way and hold it up.

When closing, lower it to approximately 12 inches (30 cm), then press down firmly with your hands.

Engine Compartment Covers*

The component parts in the engine compartment are protected by three covers. You may need to remove the covers when you perform certain maintenance work. To remove the covers:

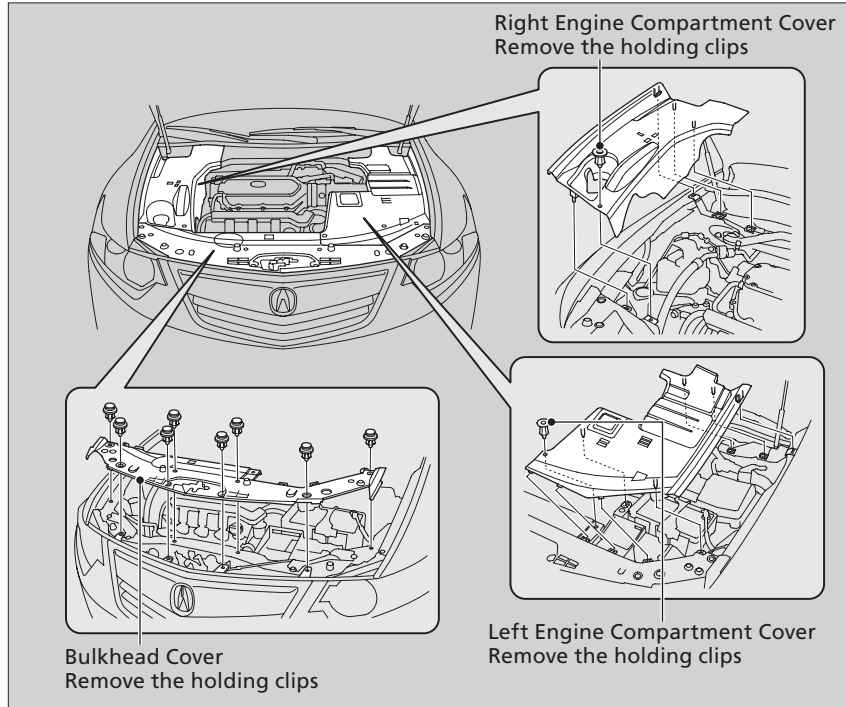

* Not available on all models

Engine Compartment Covers

When removing the clip, insert a flat-tip screwdriver, then lift and remove the central pin.

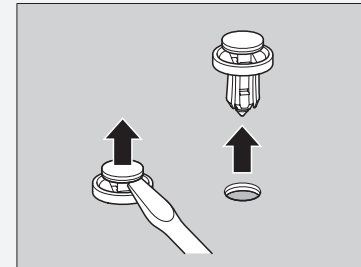

When mounting the clip, insert while keeping the central pin of the clip raised, then push until the pin is flat.

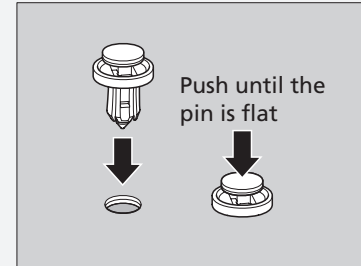

Recommended Engine Oil

Oil is a major contributor to your engine's performance and longevity. If you drive the vehicle with insufficient or deteriorated oil, the engine may fail or be damaged.



- **Genuine Acura Motor Oil**
- **Commercially available engine oil that comes with this seal.**

This seal indicates the oil is energy conserving and that it meets the American Petroleum Institute's latest requirements.

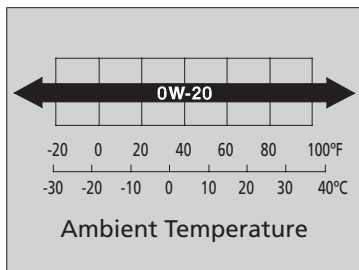

Use Genuine Acura Motor Oil or another commercial engine oil of suitable viscosity for the ambient temperature as shown below.

■ Synthetic oil

You may also use synthetic motor oil if it is labeled with the API Certification Seal and is the specified viscosity grade.

☒ Recommended Engine Oil

Engine Oil Additives

Your vehicle does not require oil additives. In fact, they may adversely affect the engine performance and durability.

Oil Check

We recommend that you check the engine oil level every time you refuel. Park the vehicle on level ground. Wait approximately three minutes after turning the engine off before you check the oil.

4-cylinder models

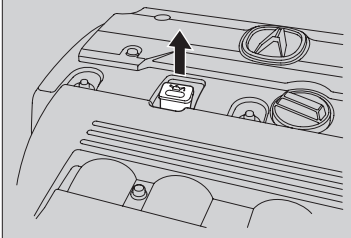

4-cylinder models

1. Remove the dipstick (orange handle).

6-cylinder models

1. Remove the dipstick (orange loop).

All models

2. Wipe the dipstick with a clean cloth or paper towel.
3. Insert the dipstick back all the way into its hole.

6-cylinder models

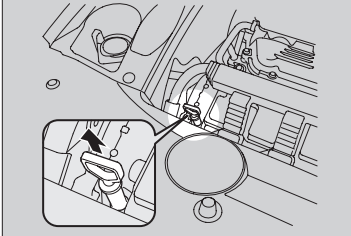

Oil Check

If it is near or below the lower mark, slowly add oil being careful not to overfill.

4-cylinder models

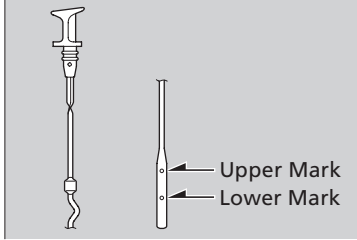

4. Remove the dipstick again, and check the level. It should be between the upper and lower marks. Add oil if necessary.

6-cylinder models

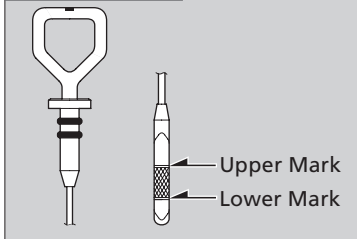

Adding Engine Oil

4-cylinder models

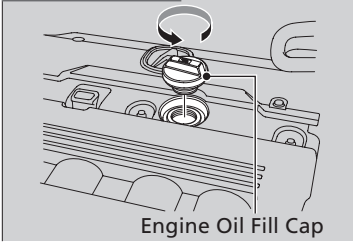

Engine Oil Fill Cap

6-cylinder models

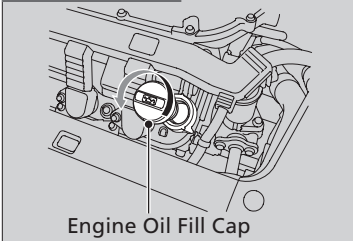

Engine Oil Fill Cap

1. Unscrew and remove the engine oil fill cap.
2. Add oil slowly.
3. Reinstall the engine oil fill cap, and tighten it securely.
4. Wait for three minutes and recheck the engine oil dipstick.

Adding Engine Oil

If any oil spills, wipe it up immediately. Spilled oil may damage the engine compartment components.

NOTICE

Do not fill the engine oil above the upper mark. Overfilling the engine oil can result in leaks and engine damage.

Changing the Engine Oil and Oil Filter

You must change the engine oil and oil filter regularly in order to maintain the engine's lubrication. The engine may be damaged if they are not changed regularly.

Change the oil and filter in accordance with the maintenance message on the multi-information display.

4-cylinder models

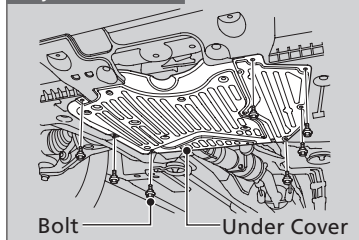

1. Run the engine until it reaches normal operating temperature, and then turn the engine off.
2. Open the hood and remove the engine oil fill cap.

4-cylinder models

3. Remove the bolts on the undercarriage and remove the under cover.

4-cylinder models

Drain Bolt

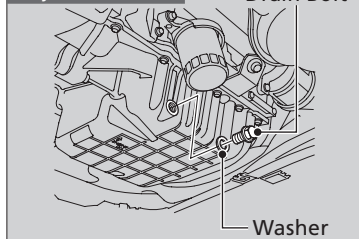

All models

4. Remove the drain bolt and washer from the bottom of the engine, and drain the oil into a suitable container.
5. Remove the oil filter and dispose of the remaining oil.

✕ Changing the Engine Oil and Oil Filter

NOTICE

You may damage the environment if you do not dispose of the oil in a suitable way. If you are changing the oil by yourself, appropriately dispose of the used oil. Put the oil in a sealed container and take it to a recycling center. Do not throw the oil away into a garbage can or onto the ground.

6-cylinder models Drain Bolt

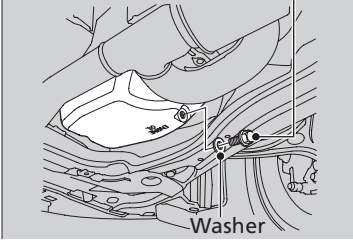

4-cylinder models

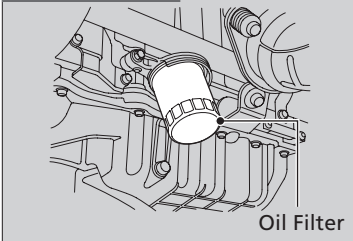

6-cylinder models

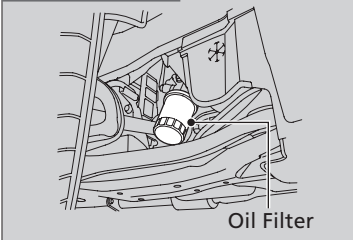

6. Check that the filter gasket is not stuck to the engine contact surface.

► If it is stuck, you must detach it.

7. Wipe away dirt and dust adhering to the contact surface of the engine block, and install a new oil filter.

8. Put a new washer on the drain bolt, then reinstall the drain bolt.

► Tightening torque: 29 lbf·ft (39 N·m, 4.0 kgf·m)

9. Pour the recommended engine oil into the engine.

► Engine oil change capacity (including filter):

4-cylinder models

4.2 US qt (4.0 L)

6-cylinder models

4.5 US qt (4.3 L)

10. Reinstall the engine oil fill cap securely and start the engine.

11. Run the engine for a few minutes, and then check that there is no leak from the drain bolt or oil filter.

12. Stop the engine, wait for three minutes, and then check the oil level on the dipstick.

► If necessary, add more engine oil.

▣ Changing the Engine Oil and Oil Filter

You will need a special wrench to replace the oil filter. You can buy this wrench from a dealer.

When installing the new oil filter follow the instructions supplied with the oil filter.

Reinstall the engine oil fill cap. Start the engine. The low oil pressure indicator should go off within five seconds. If it does not, turn off the engine, and check your work.

Engine Coolant

Specified coolant: Honda Long Life Antifreeze/Coolant Type 2

This coolant is premixed with 50% antifreeze and 50% water. Do not add any straight antifreeze or water.

We recommend you check the engine coolant level every time you refuel. Check the reserve tank first. If it is completely empty, also check the coolant level in the radiator. Add the engine coolant accordingly.

Reserve Tank

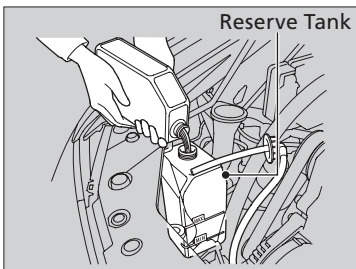
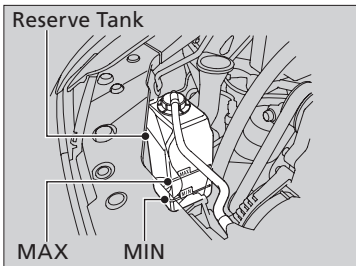

6-cylinder models

1. Remove the right-side engine compartment cover.

► **Engine Compartment Covers** P.233

All models

2. Check the amount of coolant in the reserve tank.
3. If the coolant level is below the MIN mark, add the specified coolant until it reaches the MAX mark.
4. Inspect the cooling system for leaks.

Engine Coolant

4-cylinder models

NOTICE

You will need a more concentrated coolant if you are driving in extremely cold temperature below -31°F (-35°C). Consult your Acura dealer for details about a suitable coolant mixture.

If Honda antifreeze/coolant is not available, you may use another major brand non-silicate coolant as a temporary replacement. Check that it is a high quality coolant recommended for aluminum engines. Continued use of any non-Honda coolant can result in corrosion, causing the cooling system to malfunction or fail. Have the cooling system flushed and refilled with Honda antifreeze/coolant as soon as possible.

Do not add rust inhibitors or other additives to your vehicle's coolant system. They may not be compatible with the coolant or with the engine components.

Radiator

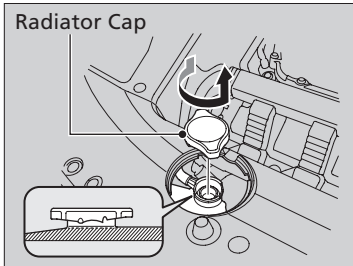

6-cylinder models

1. Remove the radiator cap cover.

All models

2. **Make sure the engine and radiator are cool.**

3. Turn the radiator cap counterclockwise and relieve any pressure in the coolant system. Do not press the cap down when turning.

4. Push down and turn the radiator cap counterclockwise to remove it.

5. The coolant level should be up to the base of the filler neck. Add coolant if it is low.

6. Put the radiator cap back on, and tighten it fully.

7. Pour coolant into the reserve tank until it reaches the MAX mark. Put the cap back on the reserve tank.

» Radiator

⚠ WARNING

Removing the radiator cap while the engine is hot can cause the coolant to spray out, seriously scalding you.

Always let the engine and radiator cool down before removing the radiator cap.

NOTICE

Pour the fluid slowly and carefully so you do not spill any. Clean up any spills immediately; they can damage components in the engine compartment.

Transmission Fluid

Automatic Transmission Fluid

Specified fluid: Acura ATF DW-1 (automatic transmission fluid)

Check the fluid level when the engine is at normal operating temperature.

4-cylinder models

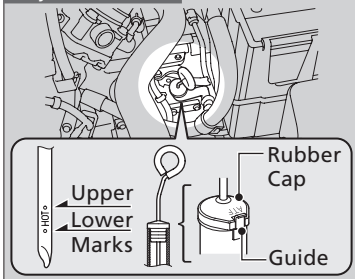

6-cylinder models

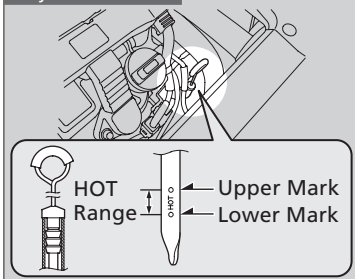

1. Park on level ground, and start the engine.
2. Wait until the radiator fan starts and then turn off the engine.
 - Perform step 3 after waiting for about 60 seconds (less than 90 seconds).
3. Remove the dipstick (yellow loop) from the transmission and wipe it with a clean cloth.
4. Insert the dipstick all the way back into the transmission securely, as shown in the image.
5. Remove the dipstick and check the fluid level.
 - It should be between the upper and lower marks in the HOT range.
6. If the level is below the lower mark, add fluid into the dipstick hole to bring it to the level between the upper and lower marks, and have your vehicle checked by a dealer immediately.

Automatic Transmission Fluid

NOTICE

Do not mix Acura ATF DW-1 with other transmission fluids.

Using a transmission fluid other than Acura ATF DW-1 may adversely affect the operation and durability of your vehicle's transmission, and damage the transmission.

Any damage caused by using a transmission fluid that is not equivalent to Acura ATF DW-1 is not covered by Acura's new vehicle warranty.

NOTICE

Pour the fluid slowly and carefully so you do not spill any. Clean up any spills immediately; they can damage components in the engine compartment.

Manual Transmission Fluid

Specified fluid: Acura Manual Transmission Fluid (MTF)

Check the fluid level when the engine is at normal operating temperature.

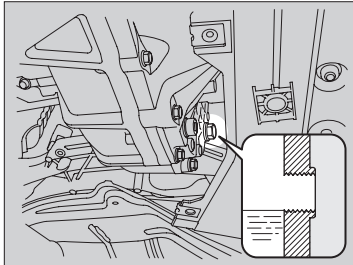
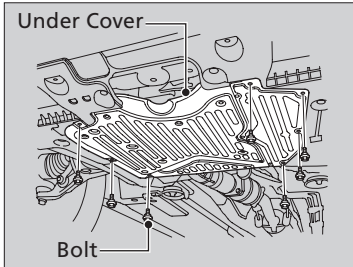

1. Park the vehicle on level ground.
2. Remove the bolts with a wrench, then carefully remove the under cover.
3. Remove the transmission filler bolt and washer. Carefully feel inside the bolt hole with your fingers.
 - Check if the fluid level is up to the edge of the bolt hole.
4. If the fluid level is not up to the edge of the bolt hole, add Acura Manual Transmission Fluid (MTF) until it runs out of the hole.
5. Put a new washer on the filler bolt, then reinstall the filler bolt.
 - Tightening torque: 33 lbf-ft (44 N·m, 4.5 kgf·m)
6. Reinstall the under cover with the bolts.

Manual Transmission Fluid

If Acura MTF is not available, you may use the API certificated SAE 0W-20 or 5W-20 viscosity motor oil as a temporary measure.

Replace with MTF as soon as possible. Motor oil does not contain the proper additives for the transmission and continued use can cause decreased shifting performance and lead to transmission damage.

Brake/Clutch Fluid

Specified fluid: Honda Heavy Duty Brake Fluid DOT 3

Use the same fluid for both the brakes and clutch.

Checking the Brake Fluid

4-cylinder models

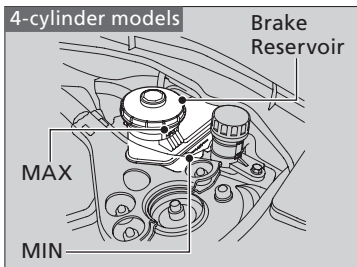

The fluid level should be between the MIN and MAX marks on the side of the reservoir.

6-cylinder models

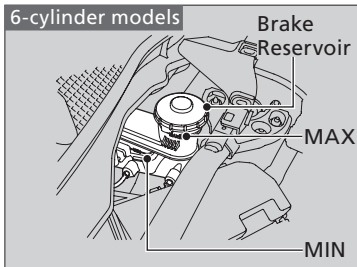

Brake/Clutch Fluid

NOTICE

Brake fluid marked DOT 5 is not compatible with your vehicle's braking system and can cause extensive damage.

If the specified brake fluid is not available, you should use only DOT 3 or DOT 4 fluid from a sealed container as a temporary replacement.

Using any non-Honda brake fluid can cause corrosion and decrease the longevity of the system. Have the brake system flushed and refilled with Honda Heavy Duty Brake Fluid DOT 3 as soon as possible.

If the brake fluid level is at or below the MIN mark, have a dealer inspect for leaks or worn brake pads as soon as possible.

■ Checking the Clutch Fluid

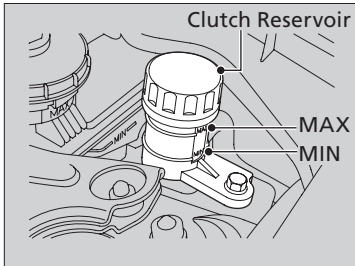

The fluid level should be between the MIN and MAX marks on the side of the reservoir.

▣ Checking the Clutch Fluid

If the clutch fluid level is at or below the MIN mark, have a dealer inspect for leaks or an excessively worn clutch plate as soon as possible.

Refilling Window Washer Fluid

Check the amount of window washer fluid using the washer fluid level gauge on the cap.

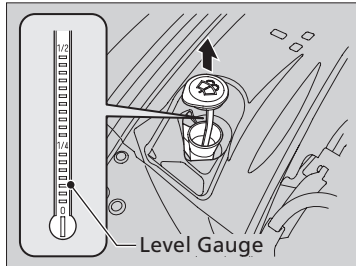

If the level is low, fill the washer reservoir.

⊗ Refilling Window Washer Fluid

NOTICE

Do not use engine antifreeze or a vinegar/water solution in the windshield washer reservoir. Antifreeze can damage your vehicle's paint. A vinegar/water solution can damage the windshield washer pump.

Headlight Bulbs

When replacing, use the following bulbs.

High beam headlight: 60W (HB3)
Low beam headlight: 55W (H1 for halogen bulb Type)
35W (D2S for high voltage discharge type)

High Beam Headlight

4-cylinder models

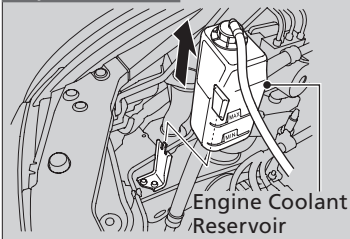

6-cylinder models

1. Remove all the engine compartment covers.

➤ **Engine Compartment Covers** P.233

Passenger side

All models

2. Remove the engine coolant reservoir.

6-cylinder models

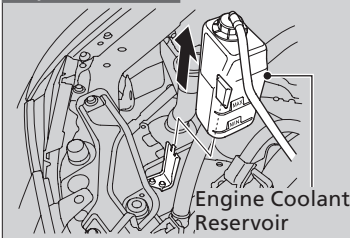

Headlight Bulbs

NOTICE

Halogen bulbs get very hot when lit. Oil, perspiration, or a scratch on the glass can cause the bulb to overheat and shatter.

The headlight aim is set by the factory, and typically does not need to be adjusted. However, if you regularly carry heavy items in the trunk or tow a trailer, have the aiming readjusted at a dealer or by a qualified technician.

The HB3 and H1 types are halogen bulbs. When replacing a bulb, handle it by its base, and protect the glass from contact with your skin or hard objects. If you touch the glass, clean it with denatured alcohol and a clean cloth.

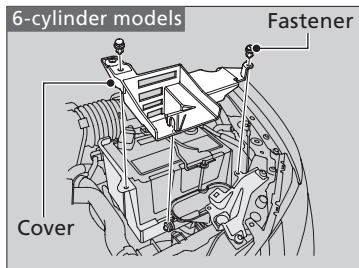
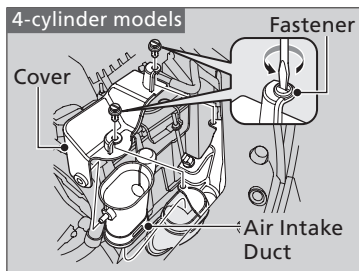

Driver side

4-cylinder models

3. Remove the fasteners, using a flat-tip screwdriver. Remove the cover of the air intake duct and its upper part.

6-cylinder models

3. Remove the fasteners, and remove the air intake duct cover.

⊗ Headlight Bulbs

The exterior lights' inside lenses (headlights, brake lamps, etc.) may fog temporarily after a vehicle wash or while driving in the rain. This does not impact the exterior light function. However, if you see a large amount of water or ice accumulated inside the lenses, have your vehicle inspected by a dealer.

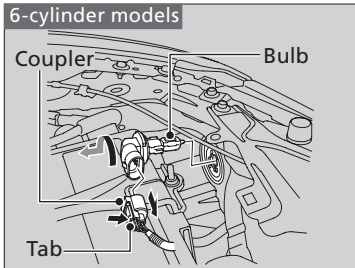
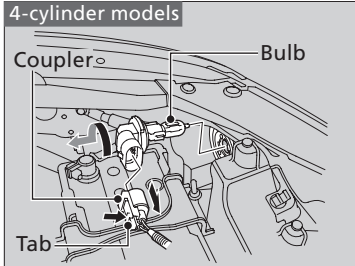

Driver and passenger side

All models

4. Remove the coupler.
 - ▶ It can be removed by pushing the tab.
5. Rotate the old bulb to the left to remove.
6. Insert a new bulb into the headlight assembly and turn it right.
7. Insert the coupler into the connector of the bulb.

High Voltage Discharge Type

Low Beam Headlights

High voltage can remain in the circuit for a long period of time after the light is switched off. Do not attempt to inspect or replace the high voltage discharge type bulbs yourself. Ask a dealer to inspect and replace low beam headlights.

Halogen Type

Low Beam Headlights

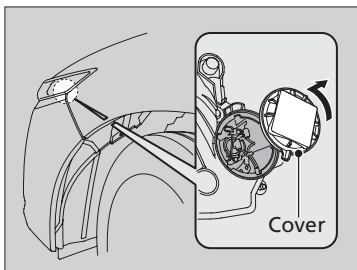
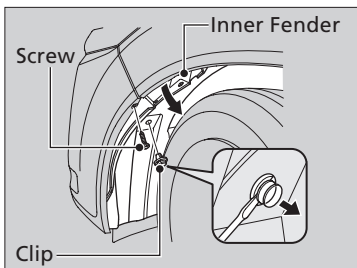

1. Turn the steering wheel all the way to the opposite side from the headlight being replaced.

Passenger side: Turn the steering wheel to the left.

Driver side: Turn the steering wheel to the right.

2. Remove the holding clips and screws, and pull the inner fender back.

3. Rotate the cover to the left, and remove.

Low Beam Headlights

When removing the clip, insert a flat-tip screwdriver, and lift and remove the central pin.

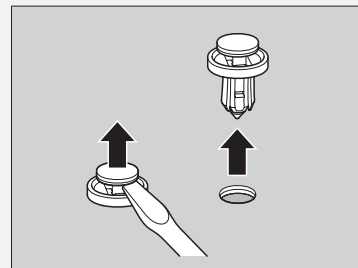

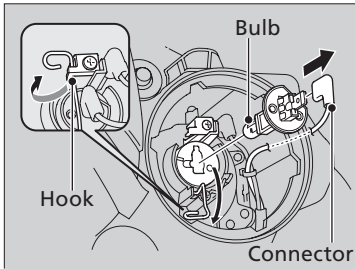

4. Unhook the hook, and pull out the connector.
5. Remove the old bulb and insert the new bulb.
6. Put the connector back into the headlight assembly.

Fog Light Bulbs

When replacing, use the following bulbs.

Fog Lights: 55W

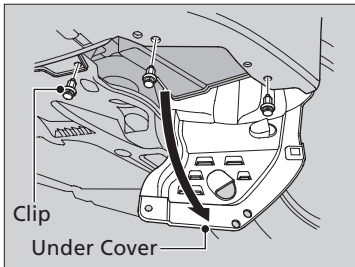

1. Remove the clip using a flat-tip screwdriver, and lower the under cover.

Low Beam Headlights

When mounting the clip, insert while keeping the central pin of the clip raised, and push until the pin is flat.

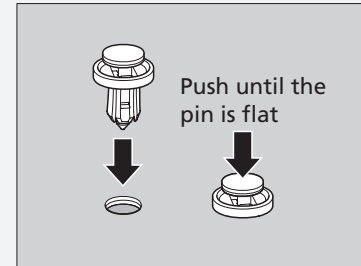

Fog Light Bulbs

NOTICE

Halogen bulbs get very hot when lit. Oil, perspiration, or a scratch on the glass can cause the bulb to overheat and shatter.

The fog lights are halogen bulbs. When replacing a bulb, handle it by its plastic case, and protect the glass from contact with your skin or hard objects. If you touch the glass, clean it with denatured alcohol and a clean cloth.

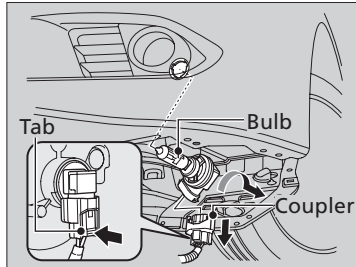

2. Remove the coupler.
 - It can be removed by pushing the tab.
3. Rotate the old bulb to the left to remove.
4. Insert new bulb.

Front Turn Signal/Parking/Side Marker Light Bulbs

When replacing, use the following bulbs.

Front Turn Signal/Parking/Side Marker: 21/5W

Turn the steering wheel and pull the inner fender back in the same way as when replacing the low beam headlights.

☞ Changing the Low Beam Headlight P.250

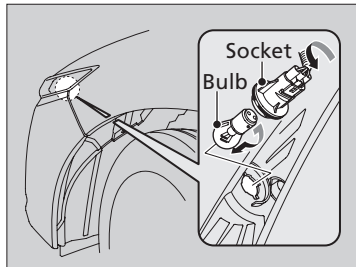

1. Turn the socket to the left and remove it.
2. Push in the old bulb, rotate to the left until it unlocks, and remove.
3. Insert a new bulb.

Side Turn Signal/Emergency Indicator Light Bulbs

Door mirrors have the side turn lights. Have an authorized Acura dealer inspect and replace the light bulbs.

Brake Light, Taillight, Rear Turn Signal Light and Rear Side Marker Light Bulbs

When replacing, use the following bulbs.

Brake/Taillight: 21/5W
Rear Turn Signal Light: 21W
Rear Side Marker Light: 3CP

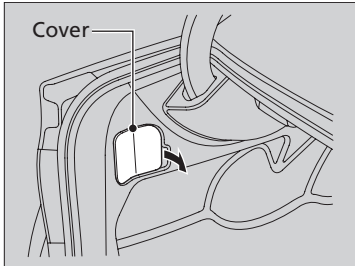

1. Pull out and remove the cover.

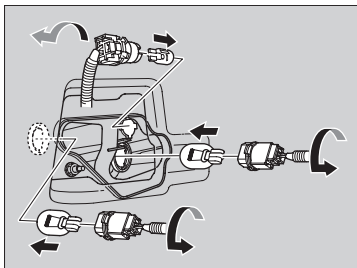

2. Turn the socket to the left and remove it.
Remove the old bulb.
3. Insert a new bulb.

Back-Up Light Bulbs

When replacing, use the following bulbs.

Back-Up Light: 21W

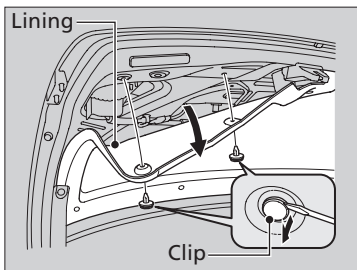

1. Remove the clip in the trunk using a flat-tip screwdriver.
2. Pull out the lining.

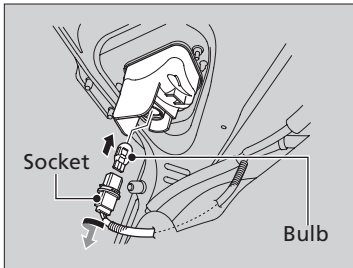
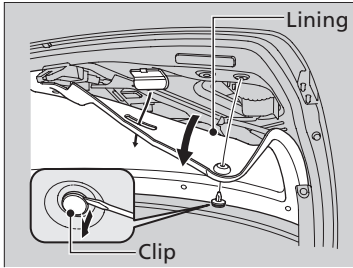

3. Turn the socket to the left and remove.
4. Remove the old bulb and insert the new bulb.

Rear License Plate Light Bulbs

Have an authorized Acura dealer inspect and replace the light bulbs.

High-Mount Brake Light Bulbs

When replacing, use the following bulbs.

High-Mount Brake Light: 21W

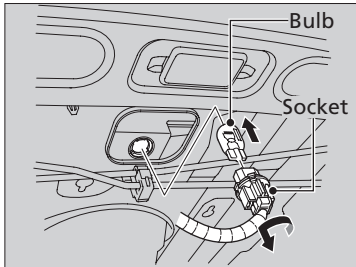

1. Open the trunk.
2. Turn the socket to the left and remove it.
3. Remove the old bulb and insert the new bulb.

Checking Wiper Blades

If the wiper blade rubber has deteriorated, it will leave streaks and the metal wiper arm may scratch the window glass.

Changing the Wiper Blade Rubber

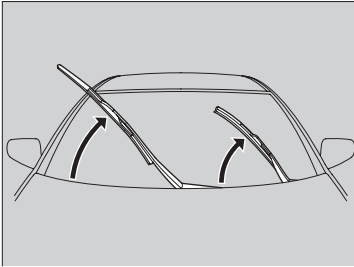

1. Lift the driver side wiper arms first, then the passenger side.

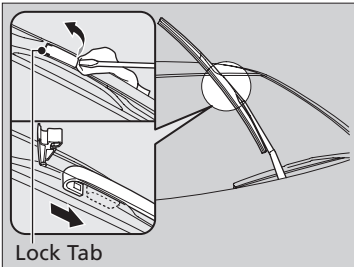

2. Place a cloth on the edge of the lock tab. Push the lock tab up with a flat-tip screw driver.
3. Slide the blade from the wiper arm.

Changing the Wiper Blade Rubber

NOTICE

Avoid dropping the wiper blade; it may damage the windshield.

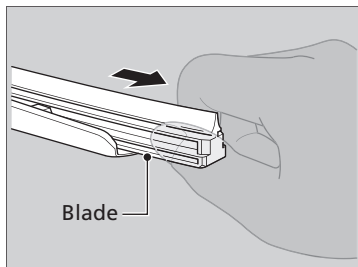

4. Slide the wiper blade out from its holder by pulling the tabbed end out.

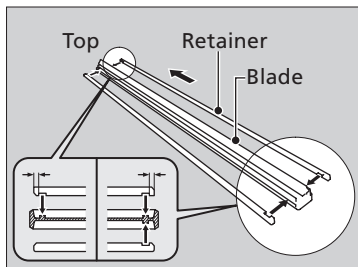

5. Remove the retainer from the rubber blade that has been removed, and mount to a new rubber blade.

► Correctly align the rubber protrusion and the retainer groove.

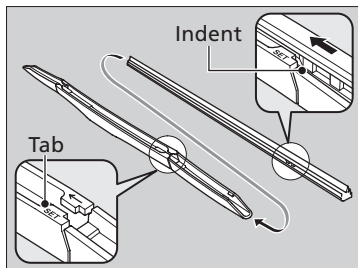

6. Slide the new wiper blade onto the holder from the bottom end.

► The tab on the blade should fit in the indent of the wiper blade.

7. Slide the wiper blade onto the wiper arm, then push down the lock tab.

8. Lower the passenger side wiper arm first, then the driver side.

Checking Tires

To safely operate your vehicle, your tires must be of the proper type and size, in good condition with adequate tread, and properly inflated.

■ Inflation guidelines

Properly inflated tires provide the best combination of handling, tread life, and comfort. Refer to the driver's doorjamb label or specification's page for the specified pressure.

Underinflated tires wear unevenly, adversely affect handling and fuel economy, and are more likely to fail from overheating.

Overinflated tires make your vehicle ride harshly, are more prone to road hazard, and wear unevenly.

Every day before you drive, look at each of the tires. If one looks lower than the others, check the pressure with a tire gauge.

At least once a month or before long trips, use a gauge to measure the pressure in all tires, including the spare. Even tires in good condition can lose 1 to 2 psi (10 to 20 kPa, 0.1 to 0.2 kgf/cm²) per month.

■ Inspection guidelines

Every time you check inflation, also examine the tires and valve stems.

Look for:

- Bumps or bulges on the side or in the tread. Replace the tire if you find any cuts, splits, or cracks in the side of the tire. Replace it if you see fabric or cord.
- Remove any foreign objects and inspect for air leaks.
- Uneven tread wear. Have your dealer check the wheel alignment.
- Excessive tread wear.

Wear Indicators P.264

- Cracks or other damage around valve stem.

» Checking Tires

WARNING

Using tires that are excessively worn or improperly inflated can cause a crash in which you can be seriously hurt or killed.

Follow all instructions in this owner's manual regarding tire inflation and maintenance.

Measure the air pressure when tires are cold. This means the vehicle has been parked for at least three hours, or driven less than 1 mile (1.6 km). If necessary, add or release air until the specified pressure is reached.

If checked when hot, tire pressure can be as much as 4–6 psi (30–40 kPa, 0.3–0.4 kgf/cm²) higher than if checked when cold.

Have a dealer check the tires if you feel a consistent vibration while driving. New tires and any that have been removed and reinstalled should be properly balanced.

Tire and Loading Information Label

The label attached to the driver's doorjamb provides necessary tire and loading information.

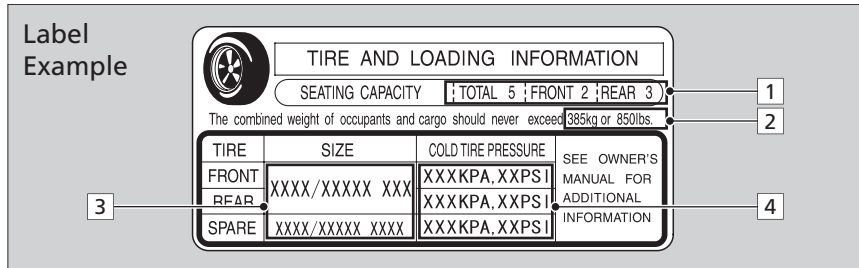

▣ Tire and Loading Information Label

The tire and loading information label attached to the driver's doorjamb contains:

- 1 The number of people your vehicle can carry.
- 2 The total weight your vehicle can carry. Do not exceed this weight.
- 3 The original tire sizes for front, rear and spare.
- 4 The proper cold tire pressure for front, rear and spare.

Tire Labeling

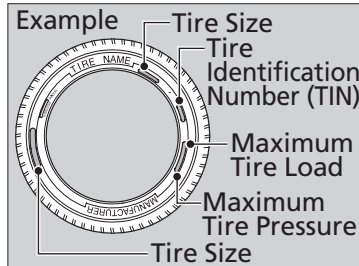

The tires that came on your vehicle have a number of markings. Those you should be aware of are described below.

▣ Tire Size

Following is an example of tire size with an explanation of what each component means.

P225/50 R17 93V

P: Vehicle type (P indicates passenger vehicle).

225: Tire width in millimeters.

50: Aspect ratio (the tire's section height as a percentage of its width).

R: Tire construction code (R indicates radial).

17: Rim diameter in inches.

93: Load index (a numerical code associated with the maximum load the tire can carry).

V: Speed symbol (an alphabetical code indicating the maximum speed rating).

Tire Size

Whenever tires are replaced, they should be replaced with tires of the same size.

■ Tire Identification Number (TIN)

The tire identification number (TIN) is a group of numbers and letters that look like the example in the side column. TIN is located on the sidewall of the tire.

■ Glossary of Tire Terminology

Cold Tire Pressure – The tire air pressure when the vehicle has been parked for at least three hours or driven less than 1 mile (1.6 km).

Load Rating – Means the maximum load that a tire is rated to carry for a given inflation pressure.

Maximum Inflation Pressure – The maximum tire air pressure that the tire can hold.

Maximum Load Rating – Means the load rating for a tire at the maximum permissible inflation pressure for that tire.

Recommended Inflation Pressure – The cold tire inflation pressure recommended by the manufacturer.

Treadwear Indicators (TWI) – Means the projections within the principal grooves designed to give a visual indication of the degrees of wear of the tread.

☒ Tire Identification Number (TIN)

DOT B97R FW6X 2209

DOT: This indicates that the tire meets all requirements of the U.S. Department of Transportation.

B97R: Manufacturer's identification mark.

FW6X: Tire type code.

2209: Date of manufacture.



DOT Tire Quality Grading (U.S. Vehicles)

The tires on your vehicle meet all U.S. Federal Safety Requirements. All tires are also graded for treadwear, traction, and temperature performance according to Department of Transportation (DOT) standards. The following explains these gradings.

Uniform Tire Quality Grading

Quality grades can be found where applicable on the tire sidewall between tread shoulder and maximum section width.

Treadwear

The treadwear grade is a comparative rating based on the wear rate of the tire when tested under controlled conditions on a specified government test course. For example, a tire graded 150 would wear one and one-half (1 1/2) times as well on the government course as a tire graded 100. The relative performance of tires depends upon the actual conditions of their use, however, and may depart significantly from the norm due to variations in driving habits, service practices and differences in road characteristics and climate.

Uniform Tire Quality Grading

For example:
Treadwear 200
Traction AA
Temperature A

All passenger car tires must conform to Federal Safety Requirements in addition to these grades.

■ Traction

The traction grades, from highest to lowest, are AA, A, B, and C. Those grades represent the tire's ability to stop on wet pavement as measured under controlled conditions on specified government test surfaces of asphalt and concrete. A tire marked C may have poor traction performance.

■ Temperature

The temperature grades are A (the highest), B, and C, representing the tire's resistance to the generation of heat and its ability to dissipate heat when tested under controlled conditions on a specified indoor laboratory test wheel. Sustained high temperature can cause the material of the tire to degenerate and reduce tire life, and excessive temperature can lead to sudden tire failure. The grade C corresponds to a level of performance which all passenger car tires must meet under the Federal Motor Vehicle Safety Standard No. 109. Grades B and A represent higher levels of performance on the laboratory test wheel than the minimum required by law.

☒ Traction

Warning: The traction grade assigned to this tire is based on straight-ahead braking traction tests, and does not include acceleration, cornering, hydroplaning, or peak traction characteristics.

☒ Temperature

Warning: The temperature grade for this tire is established for a tire that is properly inflated and not overloaded. Excessive speed, underinflation, or excessive loading, either separately or in combination, can cause heat buildup and possible tire failure.

Wear Indicators

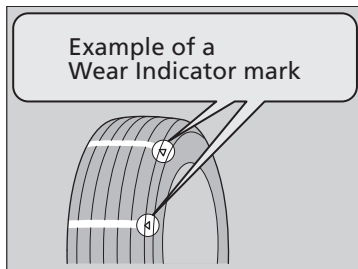

The groove where the wear indicator is located is 1/16 inch (1.6 mm) shallower than elsewhere on the tire. If the tread has worn so that the indicator is exposed, replace the tire. **Worn out tires have poor traction on wet roads.**

Tire Service Life

The life of your tires is dependent on many factors, including driving habits, road conditions, vehicle loading, inflation pressure, maintenance history, speed, and environmental conditions (even when the tires are not in use).

In addition to regular inspections and inflation pressure maintenance, it is recommended that you have annual inspections performed once the tires reach five years old. All tires, including the spare, should be removed from service after 10 years from the date of manufacture, regardless of their condition or state of wear.

☒ Checking Tires

High speed driving

We recommend that you do not drive faster than the posted speed limits and conditions allow. If you drive at sustained high speeds (over 118 mph or 190 km/h), adjust the tire pressures as shown below to avoid excessive heat build up and sudden tire failure.

6-cylinder models

Tire Size	P235/45R18 94V
Pressure	35 psi (240 kPa, 2.4 kgf/cm ²)

4-cylinder models

Tire Size	P225/50R17 93V
Pressure	35 psi (240 kPa, 2.4 kgf/cm ²)

If you do not, excessive heat can build up and cause sudden tire failure.

Tire and Wheel Replacement

Replace your tires with radials of the same size, load range, speed rating, and maximum cold tire pressure rating (as shown on the tire's sidewall). Using tires of a different size or construction can cause the ABS and VSA® (vehicle stability assist) system to work incorrectly.

It is best to replace all four tires at the same time. If that isn't possible, replace the front or rear tires in pairs.

If you replace a wheel, only use TPMS specified wheels approved for your vehicle. Make sure that the wheel's specifications match those of the original wheels.

ⓘ Tire and Wheel Replacement

WARNING

Installing improper tires on your vehicle can affect handling and stability. This can cause a crash in which you can be seriously hurt or killed.

Always use the size and type of tires recommended in this owner's manual.

Tire Rotation

Rotating tires according to the maintenance messages on the multi-information display helps to distribute wear more evenly and increase tire life.

■ Tires without rotation marks

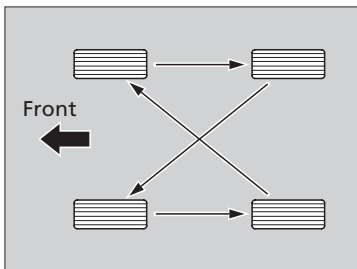

Rotate the tires as shown here.

■ Tires with rotation marks

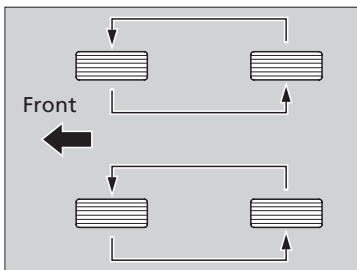

Rotate the tires as shown here.

☒ Tire Rotation

Tires with directional tread patterns should only be rotated front to back (not from one side to the other).

Directional tires should be mounted with the rotation indication mark facing forward, as shown below.

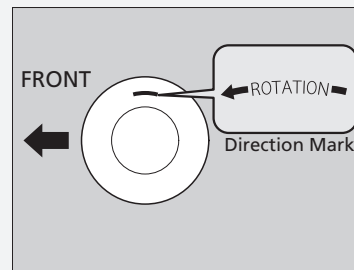

When the tires are rotated, make sure the air pressures are checked.

Winter Tires

If driving on snowy or frozen roads, mount all season marked "M+S" tires, snow tires, or tire chains; reduce speed; and maintain sufficient distance between vehicles when driving.

Be particularly careful when operating the steering wheel or brakes to prevent skidding.

Use tire chains, snow tires, or all season tires when necessary or according to the law.

When mounting, refer to the following points.

For winter tires:

- Select the size and load ranges that are the same as the original tires.
- Mount the tires to all four wheels.

For tire chains:

- Install them on the front tires only. Because your vehicle has limited tire clearance, Acura strongly recommends using the chains listed below:

4-cylinder models

Cable-type: SCC Radial Chain SC1034

6-cylinder models

Cable-type: SCC Radial Chain SC1038

- Follow the chain manufacturer's instruction when installing. Mount them as tightly as you can.
- Check that the chains do not touch the brake lines or suspension.
- Drive slowly.

ⓘ Winter Tires

⚠ WARNING

Using the wrong chains, or not properly installing chains, can damage the brake lines and cause a crash in which you can be seriously injured or killed.

Follow all instructions in this owner's manual regarding the selection and use of tire chains.

NOTICE

Traction devices that are the wrong size or improperly installed can damage your vehicle's brake lines, suspension, body, and wheels. Stop driving if they are hitting any part of the vehicle.

When tire chains are mounted, follow the chain manufacturer's instructions regarding vehicle operational limits.

Checking the Battery

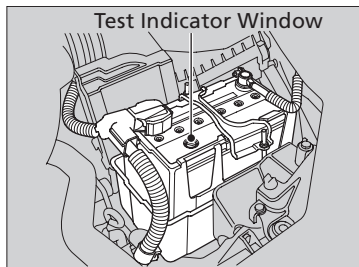

Check the battery condition monthly. Look at the test indicator window and check the terminals for corrosion.

If your vehicle's battery is disconnected or goes dead:

- The audio system is disabled.
 - **Entering the audio security code** P.140
- The clock resets.
 - **Setting the Clock** P.88
- The navigation system is disabled. A PIN code will be required.
 - **Refer to the navigation system manual**

Charging the Battery

Disconnect both battery cables to prevent damaging your vehicle's electrical system. Always disconnect the negative (-) cable first, and reconnect it last.

⚠ Battery

⚠ WARNING

The battery gives off explosive hydrogen gas during normal operation.

A spark or flame can cause the battery to explode with enough force to kill or seriously hurt you.

Wear protective clothing and a face shield, or have a skilled technician do any battery maintenance.

WARNING: Battery post, terminals, and related accessories contain lead and lead compounds.

Wash your hands after handling.

The test indicator's color information is on the battery.

When you find corrosion, clean the battery terminals by applying a baking powder and water solution. Rinse the terminals with water. Cloth/towel dry the battery. Coat the terminals with grease to help prevent future corrosion.

Replacing the Battery

If the indicator does not come on when the button is pushed, replace the battery.

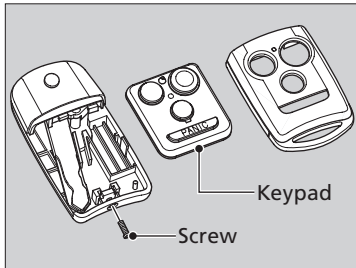

Battery type: CR1616

1. Unscrew the cover with a small Phillips-head screwdriver. Push a button to pry open the transmitter.
2. Open the keypad.
 - ▶ Wrap the small flat-tip screwdriver with a cloth to prevent scratching the transmitter.
3. Make sure to replace the battery with the correct polarity.

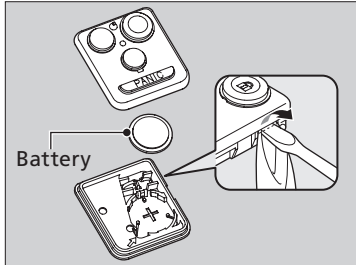

Replacing the Battery

NOTICE

An improperly disposed of battery can hurt the environment. Always confirm local regulations for battery disposal.

Replacement batteries are commercially available or at a dealer.

If You Don't Use the Climate Control System Regularly

To insure oil is circulated in the system, occasionally turn on the A/C or set the defroster mode for several minutes with the engine idling.

Dust and Pollen Filter

The climate control system is equipped with a dust and pollen filter that collects pollen, dust, and other debris in the air, and removes odors such as diesel exhaust and tobacco. The Maintenance Minder™ messages will let you know when to replace the filter.

We recommend that you replace the dust and pollen filter sooner when using your vehicle in areas with high concentrations of dust.

⌘ Dust and Pollen Filter

Using an air freshener may reduce the deodorizing effect of the dust and pollen filter, and may reduce its life.

If the air flow from the climate control system deteriorates noticeably, and the windows fog up easily, the filter may need to be replaced. Please contact a dealer for replacement.

Interior Care

Use a damp cloth with a mixture of mild detergent and warm water to remove dirt. Use a clean cloth to remove detergent residue.

Cleaning Seat Belts

Use a soft brush with a mixture of mild soap and warm water to clean the seat belts. Let the belts air dry. Wipe the openings of the seat belt anchors using a clean cloth.

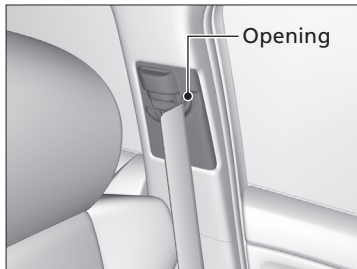

Interior Care

Do not spill liquids inside the vehicle. Electrical devices and systems may malfunction if liquids are splashed on them.

Do not use silicone based sprays on electrical devices such as audio devices and switches. Doing so may cause the items to malfunction or a fire inside the vehicle. If a silicone based spray is inadvertently used on electrical devices, consult a dealer.

Depending on their composition, chemicals and liquid aromatics may cause discoloration, wrinkles, and cracking to resin-based parts and textiles. Do not use alkali solvents or organic solvents such as benzene or gasoline.

After using chemicals, make sure to gently wipe them off using a dry cloth. Do not place used cloths on top of resin based parts or textiles for long periods of time without washing.

Floor Mats

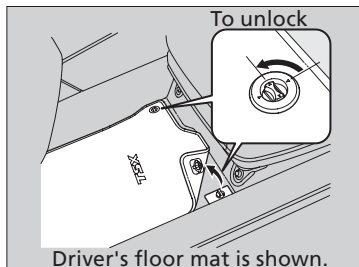

The front floor mats hook over the floor anchors, which keep the mats from sliding forward. To remove a mat for cleaning, turn the anchor knobs to the unlock position. When reinstalling the mat after cleaning, turn the knobs to the lock position.

Do not put additional floor mats on top of the anchored mats.

Maintaining Genuine Leather*

Vacuum dirt and dust from the leather frequently. Pay close attention to the pleats and seams. Clean the leather with a soft cloth dampened with a 90% water and 10% neutral soap solution. Then buff it with a clean, dry cloth. Remove any dust or dirt on leather surfaces immediately.

⊗ Floor Mats

If you use any floor mats that were not originally provided with your vehicle, make sure they are designed for your specific vehicle, fit correctly, and are securely anchored by the floor anchors. Position the rear seat floor mats properly. If they are not, the floor mat can interfere with the front passenger seat's weight sensors.

Exterior Care

Dust off the vehicle body after you drive.

Regularly inspect your vehicle for scratches on painted surfaces. A scratch on a painted surface can result in body rust. If you find a scratch, promptly repair it.

■ Washing the Vehicle

Wash your vehicle regularly. Wash more frequently when driving in the following conditions:

- If driving on roads with road salt.
- If driving in coastal areas.
- If tar, soot, bird droppings, insects, or tree sap are stuck to painted surfaces.

■ Using an Automated Vehicle Wash

Fold in the door mirrors. Make sure to follow the instructions indicated on the automated vehicle wash.

■ Using High Pressure Cleaners

- Keep sufficient distance between the cleaning nozzle and the vehicle body.
- Take particular care around the windows. Standing too close may cause water to enter the vehicle interior. Do not spray water into the engine compartment.

» Washing the Vehicle

Do not spray water into the air intake vents or engine compartment. It can cause a malfunction.

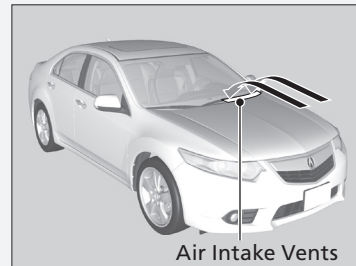

Air Intake Vents

■ Applying Wax

A good coat of automotive body wax helps protect your vehicle's paint from the elements. Wax will wear off over time and expose your vehicle's paint to the elements, so reapply as necessary.

■ Maintaining the Bumpers and Other Resin Coated Parts

If you get gasoline, oil, engine coolant, or battery fluid on resin coated parts, they may be stained or the coating may peel. Promptly wipe it away using a soft cloth and clean water.

■ Cleaning the Window

Wipe using a glass cleaner.

■ Maintaining Aluminum Wheels

Aluminum is susceptible to deterioration caused by salt and other road contaminants. Use a sponge and mild detergent to wipe away promptly. Be careful not to use harsh chemicals (including some commercial wheel cleaners) or a stiff brush. They can damage the clear coat of the aluminum alloy wheels that helps keep the aluminum from corroding and tarnishing.

⌘ Applying Wax

NOTICE

Chemical solvents and strong cleaners can damage the paint, metal, and plastic on your vehicle. Wipe up spills immediately.

⌘ Maintaining the Bumpers and Other Resin Coated Parts

Ask a dealer about the correct coating material when you want to repair the painted surface of the parts made of resin.

⌘ Cleaning the Window

Wires are mounted to the inside of the rear window. Wipe along the same direction as the wires with a soft cloth so as not to damage them.

Handling the Unexpected

This chapter explains how to handle unexpected troubles.

Tools.....	276
Types of Tools	276
If a Tire Goes Flat.....	277
Changing a Flat Tire	277
Engine Does Not Start	
Checking the Engine	283
Jump Starting	284
Shift Lever Does Not Move	287
Overheating	288
How to Handle Overheating	288

Indicator, Coming On/Blinking	
If the Low Oil Pressure Indicator Comes On	290
If the Charging System Indicator Comes On	290
If the Malfunction Indicator Lamp Comes On or Blinks.....	291
If the Brake System Indicator Comes On	292
If the EPS Indicator Comes On	292
If the Low Tire Pressure/TPMS Indicator Comes On or Blinks.....	293

Fuses	
Fuse Locations	294
Inspecting and Changing Fuses.....	297
Emergency Towing.....	298
When You Cannot Unlock the Fuel Fill Door	299
When You Cannot Open the Trunk	300

Types of Tools

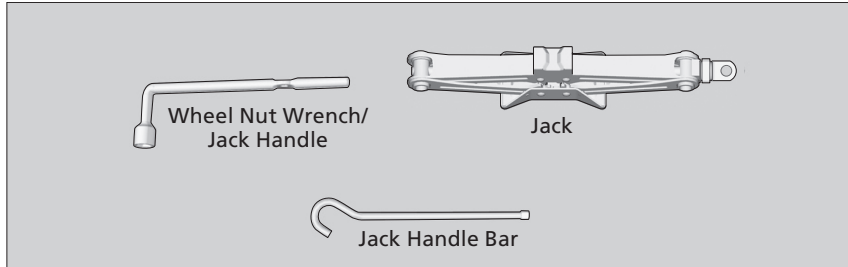

Types of Tools

➤ **Using a Jack** P.280

Changing a Flat Tire

If a tire goes flat while driving, grasp the steering wheel firmly, and brake gradually to reduce speed. Then, stop in a safe place. Replace the flat tire with the compact spare tire. Go to a dealer as soon as possible to have the full size tire repaired or replaced.

1. Park the vehicle on firm, level, and non-slippery ground.

Automatic transmission models

2. Put the shift lever in **P**.

Manual transmission models

2. Put the shift lever in **R**.

All models

3. Set the parking brake.
4. Turn on the hazard warning lights and turn the ignition switch to LOCK **O**.

Changing a Flat Tire

Periodically check the tire pressure of the compact spare. It should be set to the specified pressure. Specified Pressure: 60 psi (420 kPa, 4.2 kgf/cm²)

When driving with the compact spare tire, keep the vehicle speed under 50 mph (80 km/h). Replace with a full size tire as soon as possible.

The compact spare tire and wheel in your vehicle are specifically for this model. Do not use them with another vehicle. Do not use another type of compact spare tire or wheel with your vehicle.

Do not mount tire chains on a compact spare tire. If a chain-mounted front tire goes flat, remove one of the full-size rear tires and replace it with the compact spare tire. Remove the flat front tire and replace it with the full size tire that was removed from the rear. Mount the tire chains on the front tire.

Do not use a puncture-repairing agent on a flat tire, as it can damage the tire pressure sensor.

Getting Ready to Replace the Flat Tire

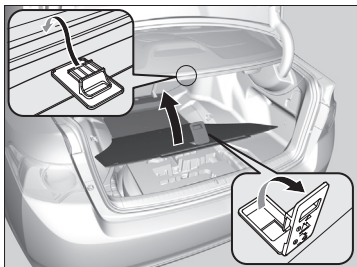

1. Pull the handle on the trunk floor lid and open the lid. Hook the handle to the edge of the trunk opening.

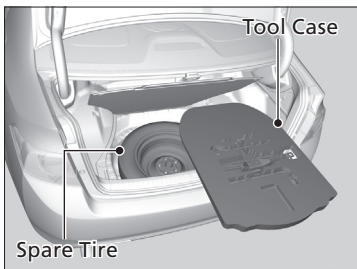

2. Take the tool case out of the trunk. Take the jack and wheel nut wrench out of the tool case.
3. Unscrew the wing bolt, and remove the spacer cone. Then, remove the spare tire.

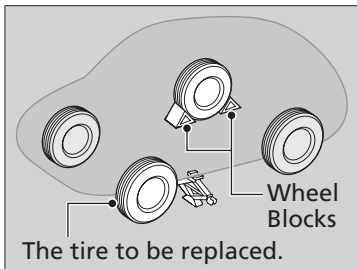

4. Place a wheel block or rock in front and rear of the wheel diagonal to the flat tire.

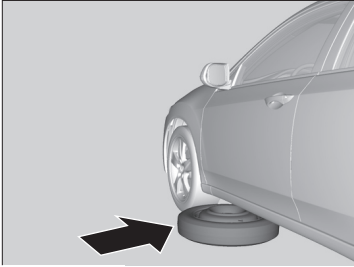

5. Place the compact spare tire (wheel side up) under the vehicle body, near the tire that needs to be replaced.



6. Loosen each wheel nut about one turn using the wheel nut wrench.

How to Set Up the Jack

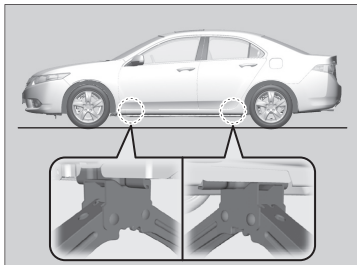

1. Place the jack under the jacking point closest to the tire to be changed.

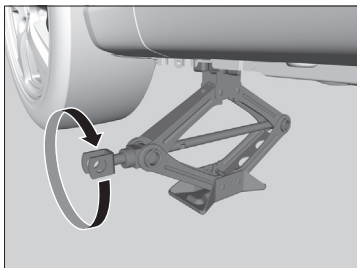

2. Turn the end bracket (as shown in the image) clockwise until the top of the jack contacts the jacking point.

▶ Make sure that the jacking point tab is resting in the jack notch.

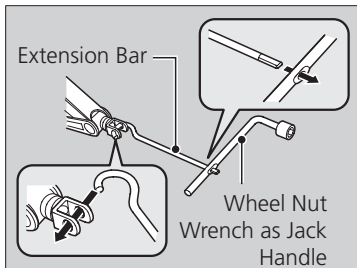

3. Raise the vehicle, using the extension bar and the jack handle, until the tire is off the ground.

How to Set Up the Jack

⚠ WARNING

The vehicle can easily roll off the jack, seriously injuring anyone underneath.

Follow the directions for changing a tire exactly, and never get under the vehicle when it is supported only by the jack.

Do not use the jack with people or luggage in the vehicle.

Use the jack provided in your vehicle. Other jacks may not support the weight ("load") or their shape may not match.

The following instructions must be followed to use the jack safely.

- Do not use while the engine is running.
- Use only where the ground is firm and level.
- Use only at the jacking points.
- Do not get in the vehicle while using the jack.
- Do not put anything on top of or underneath the jack.

Replacing the Flat Tire

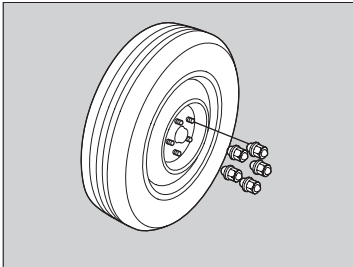

1. Remove the wheel nuts and flat tire.

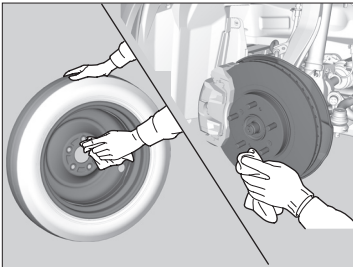

2. Wipe the mounting surfaces of the wheel with a clean cloth.

3. Mount the compact spare tire.

4. Screw the wheel nuts until they touch the lips around the mounting holes, and stop rotating.

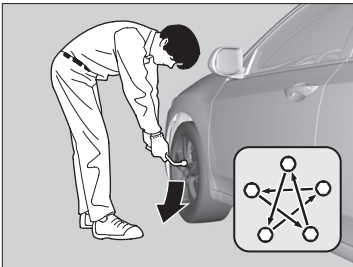

5. Lower the vehicle and remove the jack. Tighten the wheel nuts in the order indicated in the image. Go around, tightening the nuts, two to three times in this order.

Wheel nut torque:

80 lbf-ft (108 N·m, 11 kgf·m)

Replacing the Flat Tire

Do not over tighten the wheel nuts by applying extra torque using your foot or a pipe.

■ Storing the Flat Tire

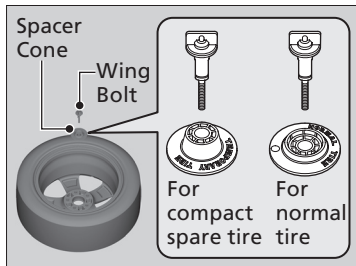

1. Remove the center cap and place the flat tire face down in the spare tire well.
2. Remove the spacer cone from the wing bolt, flip it over, and insert it back on the bolt. Secure the flat tire with the wing bolt.
3. Securely put the jack and wheel nut wrench back in the tool case. Store the case in the trunk.

■ TPMS and the Spare Tire

If you replace a flat tire with the spare tire, the low tire pressure/TPMS indicator comes on while you are driving. After driving for a few miles (kilometers), the indicator will start blinking for a short time and then stay on. "CHECK TPMS SYSTEM" appears on the multi-information display, but this is normal.

If you replace the tire with a specified regular tire, the warning message on the multi-information display and the TPMS indicator will go off after a few miles (kilometers).

☒ Storing the Flat Tire

⚠ WARNING

Loose items can fly around the interior in a crash and can seriously injure the occupants.
Store the wheel, jack, and tools securely before driving.

☒ TPMS and the Spare Tire

The system cannot monitor the pressure of the spare tire. Manually check the spare tire pressure to be sure that it is correct.

Use TPMS specific wheels. Each is equipped with a tire pressure sensor mounted inside the tire behind the valve stem.

Checking the Engine

If the engine does not start, turn the ignition switch to START  and check the starter.

☞ Checking the Engine

If you must start the vehicle immediately, use an assisting vehicle to jump start it.

☞ **Jump Starting** P.284

Starter condition	Checklist
<p>Starter doesn't turn or turns over slowly. The battery may be dead. Check each of the items on the right and respond accordingly.</p>	<p>Check brightness of the interior light. Turn on interior lights and check brightness.</p> <ul style="list-style-type: none">• If the interior lights are dim or do not come on at all ☞ Battery Inspection and Maintenance P.268• If the interior lights come on normally ☞ Fuse Inspection and Replacement P.294
<p>The starter turns over normally but the engine doesn't start. There may be a problem with the fuse. Check each of the items on the right and respond accordingly.</p>	<p>Review the engine start procedure. Follow its instructions, and try to start the engine again. ☞ Starting the Engine P.191</p> <hr/> <p>Check the immobilizer system indicator. When the immobilizer system indicator is blinking, the engine cannot be started. ☞ Immobilizer System P.98</p>
	<hr/> <p>Check the fuel level. There should be enough fuel in the tank. ☞ Fuel Gauge P.75</p>
	<hr/> <p>Check the fuse. Check all fuses, or have the vehicle checked by a dealer. ☞ Inspecting and Changing Fuses P.297</p>
	<hr/> <p>If the problem continues: ☞ Emergency Towing P.298</p>

Jump Starting Procedure

Turn off the power to electric devices, such as audio and lights. Turn off the engine, then open the hood.

6-cylinder models

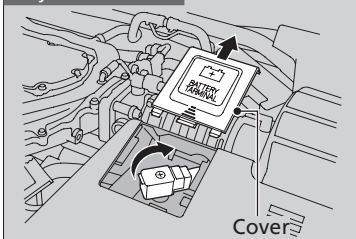

6-cylinder models

1. Slide out the battery terminal cover.

All models

2. Connect the first jumper cable to your vehicle's battery ⊕ terminal.

3. Connect the other end of the first jumper cable to the assisting vehicle's ⊕ terminal.

▶ Use a 12-volt booster battery only.

4. Connect the second jumper cable to the assisting vehicle's ⊖ terminal.

4-cylinder models

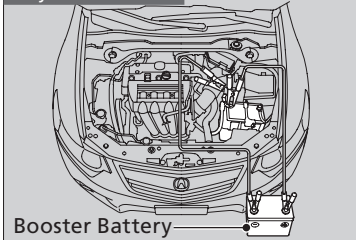

Jump Starting

⚠ WARNING

A battery can explode if you do not follow the correct procedure, seriously injuring anyone nearby.

Keep all sparks, open flames, and smoking materials away from the battery.

Securely attach the jumper cables clips so that they do not come off when the engine vibrates. Also be careful not to tangle the jumper cables or allow the cable ends to touch each other while attaching or detaching the jumper cables.

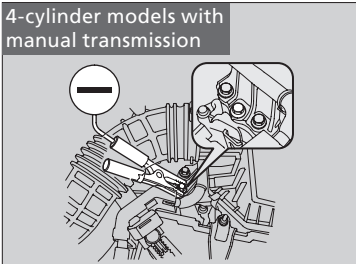
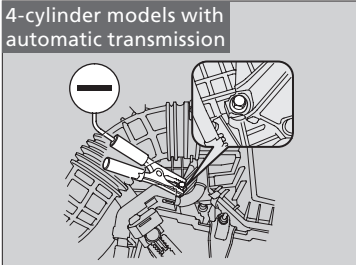
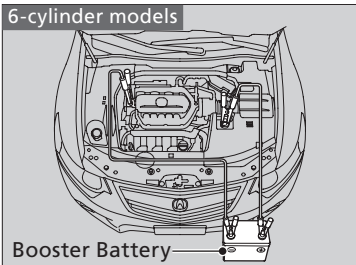

5. Connect the other end of the second jumper cable:

4-cylinder models with automatic transmission

Engine mounting bolt

4-cylinder models with manual transmission

Transmission mounting bolt

6-cylinder models

Engine hanger

Do not connect this jumper cable to any other part of the engine.

6. If your vehicle is connected to another vehicle, start the assisting vehicle's engine and increase its rpm slightly.

7. Attempt to start your vehicle's engine. If it turns over slowly, check that the jumper cables have good metal-to-metal contact.

» Jump Starting

Battery performance degrades in cold conditions and may prevent the engine from starting.

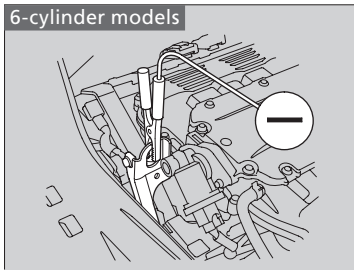

What to Do After the Engine Starts

Once your vehicle's engine has started, remove the jumper cables in the following order.

1. Disconnect the jumper cable from your vehicle's ground.
2. Disconnect the other end of the jumper cable from the assisting vehicle's battery ⊖ terminal.
3. Disconnect the jumper cable from your vehicle's battery ⊕ terminal.
4. Disconnect the other end of the jumper cable from the assisting vehicle's battery ⊕ terminal.

Have your vehicle inspected by a nearby service station or a dealer.

Shift Lever Does Not Move

Automatic transmission models

Follow the procedure below if you cannot move the shift lever out of **P** position.

Releasing the Lock

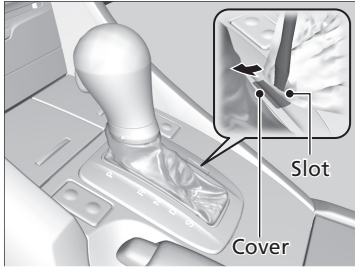

1. Set the parking brake.
2. Remove the key from the ignition switch.
3. Wrap a cloth around the tip of a small flat-tip screwdriver and remove the cover of the shift lock release slot.

► Put the tip of the flat-tip screwdriver into the slot and remove it as shown in the image.

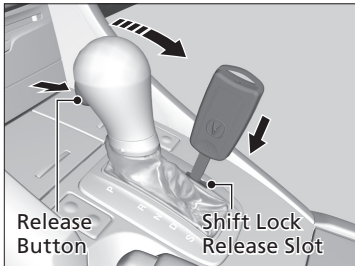

4. Insert the key into the shift lock release slot.
5. While pushing on the key, press the shift lever release button and place the shift lever into **N**.

► The lock is now released. Have the shift lever checked by a dealer as soon as possible.

How to Handle Overheating

Overheating symptoms are as follows:

- The temperature gauge needle is at the **H** mark or the engine suddenly loses power.
- Steam is coming out of the engine compartment.

■ First thing to do

1. Immediately park the vehicle in a safe place.

Automatic transmission models

- ▶ Move the shift lever to **P** and set the parking brake. Turn off all accessories and turn on the hazard warning lights.

Manual transmission models

- ▶ Move the shift lever to **N** and set the parking brake. Turn off all accessories and turn on the hazard warning lights.

2. **No steam coming out:** Keep the engine running and open the hood.

Steam coming out: Turn off the engine and wait until steam goes away. Then, open the hood.

☒ How to Handle Overheating

⚠ WARNING

Steam and spray from an overheated engine can seriously scald you.

Do not open the hood or engine compartment if steam is coming out.

NOTICE

Continuing to drive with the temperature gauge needle at the **H** mark may damage the engine.

■ Next thing to do

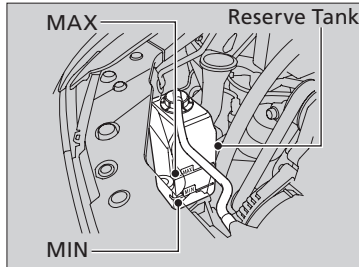

1. Check that the cooling fan is operating and stop the engine once the temperature gauge needle comes down.
 - ▶ If the cooling fan is not operating, immediately stop the engine.
2. Once the engine has cooled down, inspect the coolant level and check the cooling system components for leaks.
 - ▶ If the coolant level in the reserve tank is low, add coolant until it reaches the MAX mark.
 - ▶ If there is no coolant in the reserve tank, check that the radiator is cool. Cover the radiator cap with a heavy cloth and open the cap. If necessary, add coolant up to the base of the filler neck, and put the cap back on.

■ Last thing to do

Once the engine has cooled sufficiently, restart it and check the temperature gauge.

If the temperature gauge needle has gone down, resume driving. If it has not gone down, contact a dealer for repairs.

▣ How to Handle Overheating

⚠ WARNING

Removing the radiator cap while the engine is hot can cause the coolant to spray out, seriously scalding you.

Always let the engine and radiator cool down before removing the radiator cap.

If the coolant is leaking, contact a dealer for repairs.

Use water as an emergency/temporary measure only. Have a dealer flush the system with proper antifreeze as soon as possible.

If the Low Oil Pressure Indicator Comes On



■ Reasons for the indicator to come on

Comes on when the engine oil pressure is low.

■ What to do as soon as the indicator comes on

1. Immediately park the vehicle in a safe place.
2. If necessary, turn the hazard warning lights on.

■ What to do after parking the vehicle

1. Stop the engine and let it sit for about one minute.
2. Open the hood and check the oil level.
 - ▶ Add oil as necessary.
3. Start the engine and check the low oil pressure indicator.
 - ▶ The light goes out: Start driving again.
 - ▶ The light does not go out within 10 seconds: Stop the engine and contact a dealer for repairs immediately.

If the Charging System Indicator Comes On



■ Reasons for the indicator to come on

Comes on when the battery is not being charged.

■ What to do when the indicator comes on

Turn the climate control system, rear defogger, and other electrical systems, and immediately contact a dealer for repairs.

⊗ If the Low Oil Pressure Indicator Comes On

NOTICE

Running the engine with low oil pressure can cause serious mechanical damage almost immediately.

⊗ If the Charging System Indicator Comes On

If you need to stop temporarily, do not turn off the engine. Restarting the engine may rapidly discharge the battery.

If the Malfunction Indicator Lamp Comes On or Blinks



■ Reasons for indicator lamp to come on or blink

- Comes on when there is a problem with the engine emissions control system, or the fuel fill cap is missing, or loose.
- Blinks when engine misfiring is detected.

■ What to do when the indicator lamp comes on

Avoid high speeds and immediately get your vehicle inspected at your dealer.

■ What to do when the indicator lamp blinks

Park the vehicle in a safe place with no flammable items and wait at least ten minutes or more with the engine stopped until it cools.

■ Tighten Fuel Fill Cap Message

■ The message appears on when:

An evaporative system leak is detected. This may be caused by the fuel fill cap being loose or not being installed.

■ What to do when the message appears:

1. Stop the engine.
2. Check that the fuel fill cap is fully installed.
 - ▶ If not, loosen the cap, and then retighten it until it clicks at least once.
3. Drive for several days of normal driving.
 - ▶ The message should go off.

■ When the malfunction indicator lamp comes on:

Malfunction indicator lamp comes on if the system continues to detect a leak of gasoline vapor. If this happens, check the fuel fill cap using the procedures described above.

▶ If the Malfunction Indicator Lamp Comes On or Blinks

NOTICE

If you drive with the malfunction indicator lamp on, the emissions control system and the engine could be damaged.

If the malfunction indicator lamp blinks again when restarting the engine, drive to the nearest dealer at 31 mph (50 km/h) or less. Have your vehicle inspected.

If the Brake System Indicator Comes On

U.S.



■ Reasons for the indicator to come on

- The brake fluid is low.
- There is a malfunction in the brake system.

Canada



■ What to do when the indicator comes on while driving

Press the brake pedal lightly to check pedal pressure.

- If normal, check the brake fluid level the next time you stop.
- If abnormal, take immediate action. If necessary, downshift the transmission to slow the vehicle using engine braking.

If the EPS Indicator Comes On



■ Reasons for the indicator to come on

- Comes on when there is a problem with EPS.
- If you depress the accelerator pedal repeatedly to increase the engine speed while the engine is idling, the indicator comes on, and sometimes the steering wheel becomes harder to operate.

■ What to do when the indicator comes on

Stop the vehicle in a safe place and restart the engine.

If the indicator comes on and stays on, immediately have your vehicle inspected by a dealer.

⊗ If the Brake System Indicator Comes On

Have your vehicle repaired immediately. It is dangerous to drive with low brake fluid. If there is no resistance from the brake pedal, stop immediately in a safe place. If necessary downshift the gears.

If the brake system indicator and ABS indicator come on simultaneously, the brake distribution system is not working. This can result in vehicle instability under sudden braking. Have your vehicle inspected by a dealer immediately.

⊗ If the EPS Indicator Comes On

NOTICE

If you repeatedly turn the steering wheel at an extremely low speed, or hold the steering wheel on the full left or right position for a while, the system heats up. The system goes into a protective mode, and limits its performance. The steering wheel becomes harder and harder to operate. Once the system cools down, EPS is restored. Repeated operation under these conditions can eventually damage the system.

If the Low Tire Pressure/TPMS Indicator Comes On or Blinks



■ Reasons for the indicator to come on or blink

A tire pressure is significantly low. If there is a problem with the TPMS or the compact spare tire is installed, the indicator blinks for about one minute, and then stays on.

■ What to do when the indicator comes on

Stop your vehicle in a safe place. Check the tire pressure and adjust the pressure to the specified level. The specified tire pressure is on a label on the driver side doorjamb.

■ What to do when the indicator blinks

Have the tire inspected by a dealer as soon as possible. If the compact spare tire has triggered the indicator to blink, change the tire to a full size tire. The indicator goes off after a while.

▶▶ If the Low Tire Pressure/TPMS Indicator Comes On or Blinks

NOTICE

Driving on an extremely underinflated tire can cause it to overheat. An overheated tire can fail. Always inflate your tires to the prescribed level.

Fuse Locations

If any electrical devices are not working, turn the ignition switch to LOCK **0** and check to see if any applicable fuse is blown.

Engine Compartment Fuse Box

Located near the brake fluid reservoir. Push the tabs to open the box.

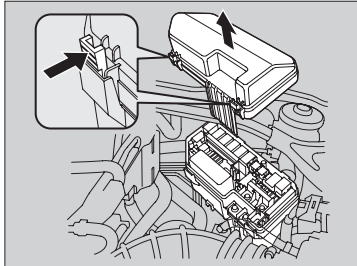

Circuit protected and fuse rating

	Circuit Protected	Amps
1	Battery	100 A ^{*1}
		120 A ^{*2}
	Passenger's Side Fuse Box	40A
2	EPS	70 A
	Passenger's Side Fuse Box	(40 A)
	ABS/VSA FSR	30 A
	–	–
	ABS/VSA Motor	30 A
	–	–

	Circuit Protected	Amps
3	IG	50 A
	Driver's Side Fuse Box	(40 A)
	Passenger's Side Light Main	30 A
	Driver's Side Fuse Box	(60 A)
	Driver's Side Light Main	30 A
	Main Fan Motor	30 A
	– ^{*1}	–
	Wiper Motor ^{*2}	30 A
	Wiper Motor ^{*1}	30 A
	Sub Fan Motor ^{*2}	30 A
4	Rear Defogger	40 A
	Sub Fan Motor ^{*1}	20 A
5	– ^{*2}	–
	–	–
6	–	–
	–	–
7	–	–
	–	–
8	Heater Motor	40 A
	–	–
9	Hazard	15 A
	–	–

Fuse Locations

Fuse locations are shown on the fuse box cover. Locate the fuse in question by the fuse number and box cover number.

	Circuit Protected	Amps
10	Horn	10 A
11	–	–
12	Stop	15 A
13	IG Coil	15 A
14	FI Sub	15 A
15	Backup	10A
16	Interior Lights	7.5 A
17	FI Main	15 A
18	DBW	15 A
19	– ^{*1}	–
	Back Up FI ECU ^{*2}	7.5A
20	MG Clutch	7.5 A
21	Engine Oil Level ^{*1}	7.5 A
	Fan RLY ^{*2}	

*1: 4-cylinder models

*2: 6-cylinder models

Driver Side Fuse Box

Located under the dashboard.

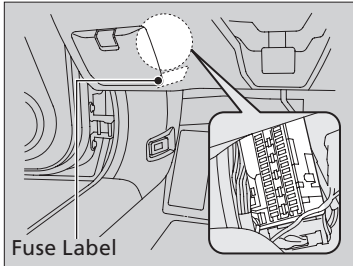

☒ Fuse Locations

Fuse locations are shown on the label on the side panel.

Locate the fuse in question by the fuse number and label number.

■ Circuit protected and fuse rating

	Circuit Protected	Amps
1	–	–
2	Seat Memory	(7.5 A)
3	Washer	15 A
4	Wiper	10 A
5	Meter	7.5 A
6	ABS/VSA	7.5 A
7	ACG	15 A
8	STS ^{*1} Starter DIAG ^{*2}	(7.5 A)
9	Fuel Pump	20 A
10	VB SOL*	(10 A)
11	SRS	10 A
12	ODS	7.5 A

	Circuit Protected	Amps
13	– ^{*1} STS ^{*2}	(7.5 A)
14	–	–
15	Daytime Running Lights	7.5 A
16	A/C	7.5 A
17	Accessory, Key, Lock	7.5 A
18	Accessory	7.5 A
19	Driver's Power Seat Sliding	(20 A)
20	Moonroof	(20 A)
21	Driver's Power Seat Reclining	(20 A)
22	Rear Driver's Side Power Window	20 A
23	Front Accessory Power Socket	20 A
24	Driver's Power Window	20 A

	Circuit Protected	Amps
25	Driver's Side Door Lock	15 A
26	Left Front Fog Light	(10 A)
27	Left Side Small Lights (Exterior)	10 A
28	Left Headlight High Beam	10 A
29	TPMS	10 A
30	Left Headlight Low Beam	15 A
31	–	–
32	Engine Oil Level*	(7.5 A)

*1: 4-cylinder models

*2: 6-cylinder models

* Not available on all models

Continued

Passenger Side Fuse Box

Located on the lower side panel. Take off the cover to open.

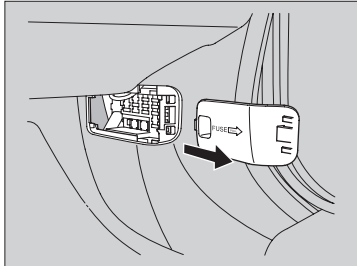

☒ Fuse Locations

Fuse locations are shown on the fuse box cover. Locate the fuse in question by the fuse number and box cover number.

■ Circuit protected and fuse rating

	Circuit Protected	Amps
1	Right Headlight High Beam	10 A
2	Right Side Small Lights (Exterior)	10 A
3	Right Front Fog Light	10 A
4	Right Headlight Low Beam	15 A
5	–	–
6	Interior Lights	7.5 A
7	–	–
8	Passenger's Side Power Seat Reclining	20 A

	Circuit Protected	Amps
9	Passenger's Side Power Seat Sliding	20 A
10	Right Side Door Lock	10 A
11	Rear Passenger's Side Power Window	20 A
12	Console Accessory Power Socket	20 A
13	Front Passenger's Power Window	20 A
14	–	–

	Circuit Protected	Amps
15	Premium AMP	20 A
16	–	–
17	–	–
18	–	–
19	Seat Heater	20 A
20	–	–
21	–	–
22	–	–

Inspecting and Changing Fuses

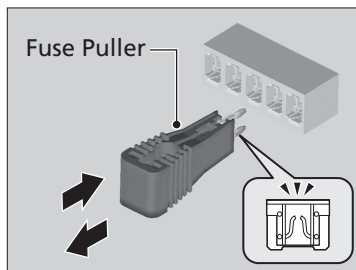
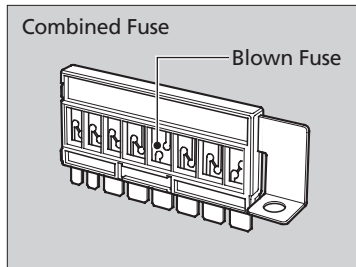
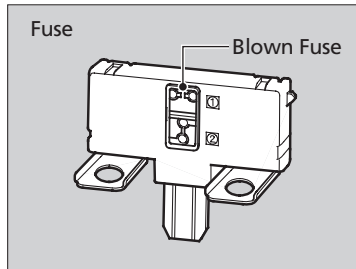

1. Turn the ignition switch to LOCK 0. Turn headlights and all accessories off.
2. Remove the fuse box cover.
3. Check the large fuse in the engine compartment.
 - If the fuse is blown, use a Phillips-head screwdriver to remove the screw and replace it with a new one.
4. Inspect the small fuses in the engine compartment and the vehicle interior.
 - If there is a burned out fuse, remove it with the fuse puller and replace it with a new one.

Inspecting and Changing Fuses

NOTICE

Replacing a fuse with one that has a higher rating greatly increases the chances of damaging the electrical system. If you do not have a replacement fuse with the proper rating for the circuit, install one with a lower rating.

Replace fuse with a spare fuse of the same specified amperage.
Confirm the specified amperage using the charts on P.294 to P.296.

There is a fuse puller on the back of the engine compartment fuse box.

Call a professional towing service if you need to tow your vehicle.

■ Flat bed equipment

The operator loads your vehicle on the back of a truck.

This is the best way to transport your vehicle.

■ Wheel lift equipment

The tow truck uses two pivoting arms that go under the front tires and lift them off the ground. The rear tires remain on the ground. **This is an acceptable way**

to tow your vehicle.

» Emergency Towing

NOTICE

Trying to lift or tow your vehicle by the bumpers will cause serious damage. The bumpers are not designed to support the vehicle's weight.

NOTICE

Improper towing such as towing behind a motorhome or other motor vehicle can damage the transmission.

Never tow your vehicle with just a rope or chain. It is very dangerous, since ropes or chains may shift from side to side or break.

What to Do When Unable to Unlock the Fuel Fill Door

If you cannot unlock the fuel fill door, use the following procedure.

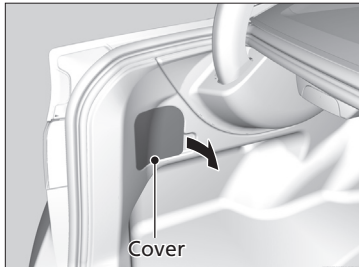

1. Open the trunk and pull off the left inside cover.

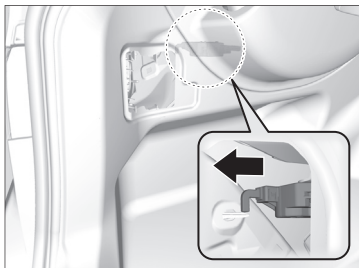

2. Pull the release lever towards you.
 - ▶ The release lever unlocks the fuel fill door when it is pulled, and locks when returned to its original position.

What to Do When Unable to Unlock the Fuel Fill Door

After taking these steps, contact a dealer to have the vehicle checked.

What to Do When Unable to Open the Trunk

If you cannot open the trunk, use the following procedure.

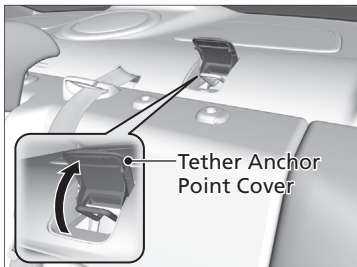

1. Remove the rear outer head restraint on the rear left side, and open the tether anchor point cover.

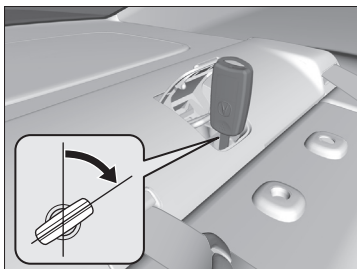

2. Insert the key into the cylinder and turn the key to the right.

What to Do When Unable to Open the Trunk

After taking these steps, contact a dealer to have the vehicle checked.

Information

This chapter includes your vehicle's specifications, locations of identification numbers, and other information required by regulation.

Specifications.....	302
Identification Numbers.....	306
Vehicle Identification Number (VIN) ...	306
Engine Number and Transmission Number.....	306
Devices that Emit Radio Waves.....	307
Reporting Safety Defects	308
Emissions Testing	
Testing of Readiness Codes.....	309
Warranty Coverages	311
Authorized Manuals	313
Client Service Information.....	314

Specifications

4-cylinder models

Vehicle Specifications

Model	Acura TSX
No. of Passengers:	
Front	2
Rear	3
Total	5
Weights:	
Gross Vehicle Weight Rating	U.S.: 4,475 lbs (2,030 kg) ^{*1} Canada: 2,030 kg ^{*1} U.S.: 4,395 lbs (1,995 kg) ^{*2} Canada: 1,995 kg ^{*2}
Gross Axle Weight Rating (Front)	U.S.: 2,410 lbs (1,095 kg) ^{*1} Canada: 1,095 kg ^{*1} U.S.: 2,325 lbs (1,055 kg) ^{*2} Canada: 1,055 kg ^{*2}
Gross Axle Weight Rating (Rear)	U.S.: 2,090 lbs (950 kg) Canada: 950 kg
Air Conditioning:	
Refrigerant Type	HFC-134a (R-134a)
Charge Quantity	15.8 – 17.6 oz (450 – 500 g)
Lubricant Type	SP-10

*1: Automatic transmission models

*2: Manual transmission models

Engine Specifications

Displacement	144 cu-in (2,354 cm ³)	
Spark Plugs	NGK	ILZKR7B-11S
	DENSO	SXU22HCR11S

Fuel

Fuel Type	Unleaded gasoline, Pump octane number of 91 or higher
Fuel Tank Capacity	18.5 US gal (70 ℓ)

Battery

Capacity/Type	36AH(5)/45AH(20)/47AH(20)
---------------	---------------------------

Washer Fluid

Tank Capacity	U.S.: 2.6 US qt (2.5 ℓ) Canada: 4.8 US qt (4.5 ℓ)
---------------	--

Light Bulbs

Headlights (Low Beam)	35W (D2S) ^{*3} 55W (H1) ^{*4}
Headlights (High Beam)	60W (HB3)
Fog Lights	55W (H11)
Front Turn Signal/Parking/Side Marker Lights	21/5W
Side Turn Signal Lights (on Door Mirrors)	LED
Brake/Taillights	21/5W
Rear Turn Signal Lights	21W
Back-Up Lights	21W
Rear Side Marker Lights	3CP
High-Mount Brake Light	21W
License Plate Lights	5W
Trunk Light	5W
Interior Lights	
Spotlight	8W
Ceiling Light	8W
Vanity Mirror Lights	2W
Courtesy Lights	3.8W

*3: Vehicle with discharge headlights

*4: Vehicle with halogen bulb low beam headlights

■ Brake/Clutch Fluid

Specified	Honda Heavy Duty Brake Fluid DOT 3	
-----------	------------------------------------	--

■ Transmission Fluid

Specified ^{*1}	Acura ATF DW-1 (automatic transmission fluid)	2.6 US qt (2.5 ℓ) (Change)
Specified ^{*2}	Acura Manual Transmission Fluid	2.0 US qt (1.9 ℓ) (Change)

*1: Automatic transmission models

*2: Manual transmission models

■ Engine Oil

Recommended	Acura Genuine Motor Oil	API Premium grade 0W-20
	Change	4.0 US qt (3.8 ℓ)
Capacity	Change including filter	4.2 US qt (4.0 ℓ)

■ Engine Coolant

Specified	Honda Long-Life Antifreeze/Coolant Type2	
Ratio	50/50 with distilled water	
Capacity ^{*1}	1.64 US gal (6.2 ℓ) (change including the remaining 0.196 US gal (0.74 ℓ) in the reserve tank)	
Capacity ^{*2}	1.66 US gal (6.3 ℓ) (change including the remaining 0.196 US gal (0.74 ℓ) in the reserve tank)	

*1: Automatic transmission models

*2: Manual transmission models

■ Tire

Regular	Size	P225/50R17 93V
	Pressure psi (kPa[kgf/cm ²])	33 (230 [2.3])
Compact Spare	Size	T135/80D16 101M
	Pressure psi (kPa[kgf/cm ²])	60 (420 [4.2])
Wheel Size	Regular	17 x 7.5J
	Compact Spare	16 x 4T

Specifications

6-cylinder models

Vehicle Specifications

Model	Acura TSX
No. of Passengers:	
Front	2
Rear	3
Total	5
Weights:	
Gross Vehicle Weight Rating	U.S.: 4,630 lbs (2,100 kg) Canada: 2,100 kg
Gross Axle Weight Rating (Front)	U.S.: 2,557 lbs (1,160 kg) Canada: 1,160 kg
Gross Axle Weight Rating (Rear)	U.S.: 2,083 lbs (945 kg) Canada: 945 kg
Air Conditioning:	
Refrigerant Type	HFC-134a (R-134a)
Charge Quantity	15.8 – 17.6 oz (450 – 500 g)
Lubricant Type	SP-10

Engine Specifications

Displacement	212 cu-in (3,471 cm ³)
Spark Plugs	NGK ILZKR7B11
	DENSO SXU22HCR11

Fuel

Fuel Type	Unleaded gasoline, Pump octane number of 91 or higher
Fuel Tank Capacity	18.5 US gal (70 ℓ)

Battery

Capacity/Type	55AH(5)/72AH(20)
---------------	------------------

Washer Fluid

Tank Capacity	U.S.: 2.6 US qt (2.5 ℓ) Canada: 4.8 US qt (4.5 ℓ)
---------------	--

Light Bulbs

Headlights (Low Beam)	35W (D2S)
Headlights (High Beam)	60W (HB3)
Fog Lights	55W (H11)
Front Turn Signal/Parking/Side Marker Lights	21/5W
Side Turn Signal Lights (on Door Mirrors)	LED
Brake/Taillights	21/5W
Rear Turn Signal Lights	21W
Back-Up Lights	21W
Rear Side Marker Lights	3CP
High-Mount Brake Light	21W
License Plate Lights	5W
Trunk Light	5W
Interior Lights	
Spotlight	8W
Ceiling Light	8W
Vanity Mirror Lights	2W
Courtesy Lights	3.8W

■ **Brake/Clutch Fluid**

Specified	Honda Heavy Duty Brake Fluid DOT 3	
-----------	------------------------------------	--

■ **Transmission Fluid**

Specified	Acura ATF DW-1 (automatic transmission fluid)	3.5 US qt (3.3 ℓ) (Change)
-----------	--	----------------------------------

■ **Engine Oil**

Recommended	Acura Genuine Motor Oil	API Premium grade 0W-20
	Change	4.2 US qt (4.0 ℓ)
Capacity	Change including filter	4.5 US qt (4.3 ℓ)

■ **Engine Coolant**

Specified	Honda Long-Life Antifreeze/Coolant Type2
Ratio	50/50 with distilled water
Capacity	1.77 US gal (6.7 ℓ) (change including the remaining 0.196 US gal (0.74 ℓ) in the reserve tank)

■ **Tire**

Regular	Size	P235/45R18 94V
	Pressure psi (kPa[kgf/cm ²])	33 (230 [2.3])
Compact Spare	Size	T135/80D16 101M
	Pressure psi (kPa[kgf/cm ²])	60 (420 [4.2])
Wheel Size	Regular	18 x 8J
	Compact Spare	16 x 4T

Vehicle Identification Number (VIN)

Your vehicle has a 17-digit vehicle identification number (VIN) used to register your vehicle for warranty purposes, and for licensing and insuring your vehicle. See the image below for the VIN locations.

Engine Number and Transmission Number

See the image below for the locations of your vehicle's engine number and transmission number.

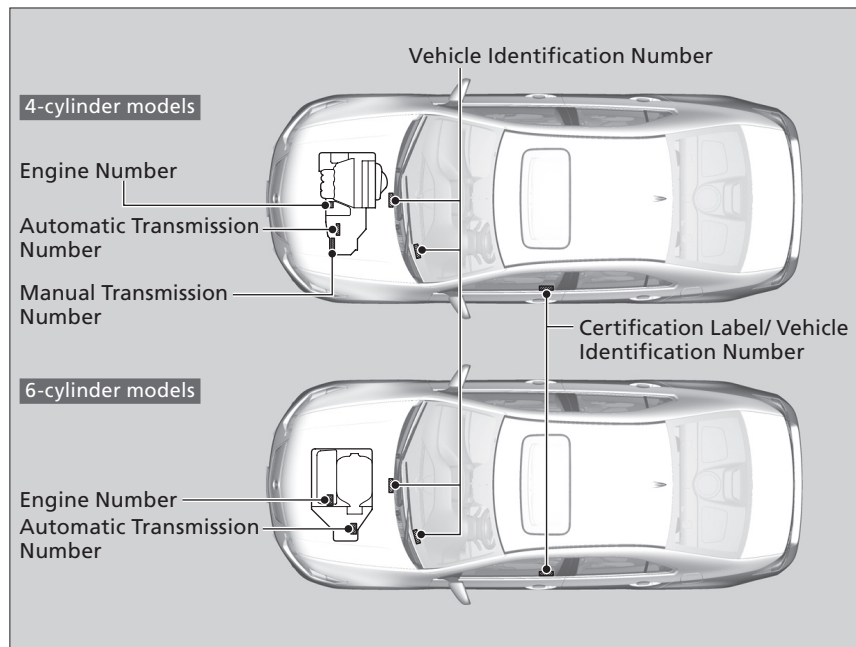

Devices that Emit Radio Waves

The following products and systems on your vehicle emit radio waves when in operation.

AcuraLink (U.S. models only)	Audio System
<i>Bluetooth</i> [®] Audio	<i>Bluetooth</i> [®] HandsFreeLink [®]
HomeLink [®] Universal Transceiver	Immobilizer System
Remote Transmitter	Tire Pressure Monitoring System (TPMS)

Each of the above complies with the appropriate requirements or the required standards of FCC (Federal Communication Commission) and Industry Canada Standard, described below:

As required by the FCC:

This device complies with Part 15 of the FCC rules. Operation is subject to the following two conditions: (1) This device may not cause harmful interference, and (2) this device must accept any interference received, including interference that may cause undesired operation.

Changes or modifications not expressly approved by the party responsible for compliance could void the user's authority to operate the equipment.

This device complies with Industry Canada Standard RSS-210. Operation is subject to the following two conditions: (1) this device may not cause interference, and (2) this device must accept any interference that may cause undesired operation of the device.

In the U.S.

If you believe that your vehicle has a defect which could cause a crash or could cause injury or death, you should immediately inform the National Highway Traffic Safety Administration (NHTSA) in addition to notifying American Honda Motor Co., Inc.

If NHTSA receives similar complaints, it may open an investigation, and if it finds that a safety defect exists in a group of vehicles, it may order a recall and remedy campaign. However, NHTSA cannot become involved in individual problems between you, your dealer, or American Honda Motor Co., Inc.

To contact NHTSA, you may call the Vehicle Safety Hotline toll-free at 1-888-327-4236 (TTY: 1-800-424-9153); go to <http://www.safercar.gov>; or write to: Administrator, NHTSA, 1200 New Jersey Avenue, SE., Washington, DC 20590. You can also obtain other information about motor vehicle safety from <http://www.safercar.gov>.

In Canada

If you believe that your vehicle has a defect which could cause a crash or could cause injury or death, you should immediately inform Honda Canada Inc. and you may also inform Transport Canada.

If Transport Canada receives similar complaints, it may open an investigation, and if it finds that a safety defect exists in a group of vehicles, it may lead to a recall and remedy campaign. However, Transport Canada cannot become involved in individual problems between you, your dealer, or Honda Canada Inc.

To contact Transport Canada's Defect Investigations and Recalls Division, you may call 1-800-333-0510. For more information on reporting safety defects or about motor vehicle safety, go to <http://www.tc.gc.ca/roadsafety>.

Testing of Readiness Codes

Your vehicle uses "readiness codes," as part of its onboard self diagnostic system. Some states refer to these codes during testing to see if your vehicle's emissions components are working properly. The codes may not be read if you go through the testing just after the battery has gone dead or been disconnected.

To check if they are set, turn the ignition switch to ON **[II]**, without starting the engine. The malfunction indicator lamp will come on for several seconds. If it then goes off, the readiness codes are set. If it blinks five times, the readiness codes are not set.

If you are required to have your vehicle tested before the readiness codes are ready, prepare the vehicle for retesting by doing the following:

1. Fill the gas tank to approximately 3/4 full.
2. Park the vehicle and leave the engine off for 6 hours or more.
3. Make sure the ambient temperature is between 40 °F and 95 °F (4 °C and 35 °C).
4. Start the engine without touching the accelerator pedal, and let it idle for 20 seconds.
5. Keep the vehicle in **[P]** (automatic transmission) or **[N]** (manual transmission). Increase the engine speed to 2,000 rpm, and hold it there until the temperature gauge rises to at least 1/4 of the scale (about 3 minutes).
6. Let the engine idle with your foot off the accelerator for 20 seconds.

Testing of Readiness Codes

The readiness codes are erased when the battery is disconnected, and set again only after several days of driving under a variety of conditions.

If a testing facility determines that the readiness codes are not set, you may be requested to return at a later date to complete the test.

If the testing facility determines the readiness codes are still not set, see a dealer.

7. Select a nearby, lightly traveled major highway where you can maintain a speed of 50 to 60 mph (80 to 97 km/h) for at least 20 minutes. Drive on the highway in **D** (automatic) or 5th (manual). Do not use cruise control. When traffic allows, drive for 90 seconds without moving the accelerator pedal. (Vehicle speed may vary slightly; this is okay.) If you cannot do this for a continuous 90 seconds because of traffic conditions, drive for at least 30 seconds, then repeat it two more times (for a total of 90 seconds).
8. Drive in city/suburban traffic for at least 10 minutes. When traffic conditions allow, let the vehicle coast for several seconds without using the accelerator pedal or the brake pedal.
9. Park the vehicle and leave the engine off for 30 minutes.

■ U.S. Owners

Your new vehicle is covered by these warranties:

New Vehicle Limited Warranty – covers your new vehicle, except for the emissions control systems, and accessories, against defects in materials and workmanship.

Emissions Control Systems Defects Warranty and Emissions Performance Warranty – these two warranties cover your vehicle's emissions control systems. Time, mileage, and coverage are conditional. Please read your warranty booklet for exact information.

Seat Belt Limited Warranty – a seat belt that fails to function properly is covered by a limited warranty. Please read your warranty booklet for details.

Rust Perforation Limited Warranty – all exterior body panels are covered for rust-through from the inside for the specified time period with no mileage limit.

Accessory Limited Warranty – Acura accessories are covered under this warranty. Time and mileage limits depend on the type of accessory and other factors. Please read your warranty booklet for details.

Replacement Parts Limited Warranty – covers all Acura replacement parts against defects in materials and workmanship.

Replacement Battery Limited Warranty – provides prorated coverage for a replacement battery purchased from your dealer.

Replacement Muffler Lifetime Limited Warranty – provides coverage for as long as the purchaser of the muffler owns the vehicle.

Restrictions and exclusions apply to all these warranties. Please read the 2011 Acura warranty information booklet that came with your vehicle for precise information on warranty coverages. Your vehicle's original tires are covered by their manufacturer. Tire warranty information is in a separate booklet.

■ **Canadian Owners**

Please refer to the 2011 warranty manual that came with your vehicle.

■ For U.S. Owners:

The publications listed below can be purchased from Helm Incorporated. You can order a manual by phone at (800) 782-4356 (credit card orders only), or online at www.helminc.com.

Make an inquiry to Helm Inc. at (800) 782-4356 if you are interested in ordering other models' or other years' manuals.

Publication Form Number	Form Description
61TL202	2011 Acura TSX Service Manual
61TP101	2011 Acura TSX V6 Service Manual
61TL202EL	2009-2011 Acura TSX Electrical Troubleshooting Manual
61TP101EL	2011 Acura TSX V6 Electrical Troubleshooting Manual
61TL231	2009-2011 Acura TSX Body Repair Manual
31TL1620	2011 Acura TSX Owner's Manual
31TL1820	2011 Acura TSX Navigation System Owner's Manual
31TL1M20	2011 Acura TSX Maintenance Journal
31TL1Q20	2011 Acura TSX Advanced Technology Guide
ACU-R	Order Form for Previous Years- Indicate Year and Model Desired

☒ Authorized Manuals

Service Manual:

Covers maintenance and recommended procedures for repair to engine and chassis components. It is written for the journeyman technician, but it is simple enough for most mechanically inclined owners to understand.

Electrical Troubleshooting Manual:

Complements the Service Manual by providing in-depth troubleshooting information for each electrical circuit in your vehicle.

Body Repair Manual:

Describes the procedures involved in the replacement of damaged body parts.

For Canadian Owners:

Si vous avez besoin d'un Manuel du Conducteur en français, veuillez demander à votre concessionnaire de commander le numéro de pièce 33TL1C20

Acura dealer personnel are trained professionals.

They should be able to answer all your questions. If you encounter a problem that your dealership does not solve to your satisfaction, please discuss it with the dealership's service manager or general manager. If you are dissatisfied with the decision made by the dealership's management, contact Acura Client Services.

U.S. Owners:

American Honda Motor Co., Inc.
Acura Client Services
Mail Stop 500-2N-7E
1919 Torrance Blvd.
Torrance, CA 90501-2746
Tel: (800) 382-2238

Canadian Owners:

Honda Canada Inc.
Acura Client Services
180 Honda Boulevard
Markham, ON
L6C 0H9

Tel: 1-888-9-ACURA-9
Fax: 1-877-939-0909
E-Mail: ch_acura_cr@ch.honda.com

In Puerto Rico and the U.S.

Virgin Islands:

Bella International
P.O. Box 190816
San Juan, PR 00919-0816
Tel: (787) 620-7546

Client Service Information

When you call or write, please give us the following information:

- Vehicle Identification Number
 - **Vehicle Identification Number** P.306
- Date of Purchase
- Odometer reading of your vehicle
- Your name, address, and telephone number
- A detailed description of the problem
- Name of the dealer who sold the vehicle to you

A		
ABS (Anti-lock Brake System)	212	
Accessories and Modifications	219	
Accessory Power Sockets	129	
Active Head Restraints	122	
Adding	237	
Coolant	240	
Engine Oil	237	
Washer	246	
Additives, Engine Oil	234	
Adjusting	113	
Armrest	124	
Front Seats	116	
Head Restraints	118	
Headlights	247	
Mirrors	114	
Rear Seats	123	
Steering Wheel	113	
Temperature	78	
Airbags	33	
Advanced Airbags	39	
After a Collision	37	
Airbag Care	47	
Event Data Recorder	19	
Front Airbags (SRS)	36	
Indicator	44,67,70	
Passenger Airbag Off Indicator	45	
Sensors	33	
Side Airbag	40	
Side Airbag Cutoff System	42	
Side Airbag Off Indicator	42	
Side Curtain Airbag	43	
Air Conditioning System (Climate Control System)	133	
Changing the Mode	133	
Defrosting the Windshield and Windows ..	134	
Dust and Pollen Filter	270	
Recirculation/Fresh Air Mode	133	
Sensors	136	
Synchronized Mode	135	
Using Automatic Climate Control	133	
Air Pressure	260,303,305	
AM/FM Audio	143	
Anti-lock Brake System (ABS)	212	
Indicator	66	
Armrest	124	
Auto Door Lock/Unlock	94	
Customize	81,83	
Automatic Lighting	106	
Audio System	138	
Adjusting the Sound	142	
Auxiliary Input Jack	140	
Error Messages	158	
General Information	161	
MP3/WMA/AAC	153	
Recommended Devices	164	
Recommended CDs	162	
Remote Controls	160	
Security Code	140	
Theft Protection	140	
USB Adapter Cable	139	
USB Flash Drives	164	
Authorized Manual	313	
Automatic Transmission	194	
Creeping	194	
Fluid	242	
Kickdown	194	
Operating the Shift Lever	13,195,196	
Sequential Shift Mode	197	
Shifting	195	
Shift Lever Dose Not Move	287	
Auxiliary Input Jack	140	
Average Fuel Economy	78	
Average Speed	79	
B		
Battery	268	
Charging System Indicator	65,290	
Jump Starting	284	
Maintenance (Checking the Battery)	268	
Replacing	269	
Belts (Seat)	26	
Beverage Holders	128	
Bluetooth® Audio	156	
Bluetooth® HandsFreeLink®	167	
Booster Seats (For Children)	59	
Brake System	210	
Anti-lock Brake System (ABS)	212	
Brake Assist System	213	
Fluid	244	
Foot Brake	211	
Indicator	64,292	

Parking Brake 210

Brightness Control (Instrument Panel)..... 109

Bulb Replacement..... 247

 Back-Up Lights 254

 Brake, Taillight, Rear Turn Light and
 Rear Side Marker Lights 253

 Fog Lights..... 251

 Front Turn/Parking/Side Marker Lights..... 252

 Headlights..... 247

 High-Mount Brake Light 256

 License Plate 255

 Side Turn Signal/Emergency Indicator
 Lights..... 253

Bulb Specifications..... 302,304

C

Carbon Monoxide Hazard..... 60

Cargo Hooks..... 130

Carrying Cargo..... 183,185

Certification Label..... 306

CD Player..... 147

Changing Bulbs..... 247

Charging System Indicator..... 65,290

Child Proof Door Locks..... 94

Child Safety..... 48

 Emergency Trunk Opener 97

Child Seat..... 48

 Booster Seats 59

 Child Proof Door Locks..... 94

 Child Seat for Infants..... 50

 Child Seat for Small Children 51

 Installing a Child Seat with a Lap/Shoulder
 Seat Belt 55

 Larger Children 58

 Rear Facing Child Seat 50

 Selecting a Child Seat 52

 Using Tether..... 57

Cleaning the Exterior..... 273

Cleaning the Interior..... 271

Client Service Information..... 314

Climate Control System..... 133

 Changing the Mode..... 133

 Defrosting the Windshield and Windows .. 134

 Dust and Pollen Filter..... 270

 Recirculation/Fresh Air Mode 133

 Sensors..... 136

 Synchronized Mode..... 135

 Using Automatic Climate Control 133

Clock..... 88

Clutch Fluid..... 245

Coat Hooks..... 130

Compact Spare Tire..... 277,303,305

Compass..... 179

Console Compartment..... 127

Controls..... 87

Coolant (Engine)..... 240

 Adding to the Radiator..... 241

 Adding to the Reserve Tank 240

 Overheating 288

 Temperature Gauge 75

Creeping (Automatic Transmission)..... 194

Cruise Control..... 201

 Indicator 71

Cup Holder..... 128

Customized Features..... 80

D

Daytime Running Lights..... 107

Dead Battery..... 284

**Defrosting the Windshield and
Windows**..... 134

Detachable Shelf..... 126

Dimming

 Headlights..... 105

 Rear View Mirror..... 114

Dipstick (Engine Oil)..... 235

Directional Signals (Turn Signals)..... 105

Door Mirrors..... 114

Doors..... 89

 Auto Door Lock 94

 Auto Door Unlock..... 94

 Door and Trunk Open Indicator 25,68

 Keys 89

 Locking/Unlocking the Doors from Inside... 93

 Locking/Unlocking the Doors from
 Outside..... 91

 Lockout Prevention System..... 92

DOT Tire Quality Grading..... 262

Driving..... 181

 Automatic Transmission..... 194

 Braking..... 210

Cruise Control.....	201
Shifting Gear.....	199
Starting the Engine.....	191
Driving Position Memory System	111
Dust and Pollen Filter	270

E

Elapsed Time	79
Electric Power Steering System (EPS) .. 68,292	
Indicator.....	68,292
Electronic Stability Control (ESC)	204
Emergency	298
Emergency Trunk Opener	97
Emissions Testing (Readiness Codes)	309
Engine	306
Coolant.....	240
Jump Starting.....	284
Oil.....	234
Starting.....	191
Switch Buzzer.....	104
Engine Coolant	240
Adding to the Radiator.....	241
Adding to the Reserve Tank.....	240
Overheating.....	288
Temperature Gauge.....	75
Engine Oil	234
Adding.....	237
Checking.....	235
Displaying Oil Life.....	225
Low Oil Pressure Indicator.....	64,290

Recommended Engine Oil.....	234
EPS (Electric Power Steering System) .. 68,292	
Exhaust Hazard (Carbon Monoxide)	60
Exterior Mirrors	114
Exterior Care (Cleaning)	273

F

Features	137
Filters	
Dust and Pollen.....	270
Oil.....	238
Flat Tire	277
Floor Mats	272
Fluids	
Automatic Transmission.....	242
Brake/Clutch.....	244
Engine Coolant.....	240
Manual Transmission.....	243
Windshield Washer.....	246
Fog Light Indicator	70
Folding Down the Rear Seats	123
Foot Brake	211
Front Airbags (SRS)	36
Front Seats	116
Adjusting.....	116
Fuel	14,215
Economy.....	218
Gauge.....	75
Instant Fuel Economy.....	78
Low Fuel Indicator.....	66

Range.....	78
Recommendation.....	215
Refueling.....	215
Fuel Economy	218
Fuel Fill Cap	14,217
Message.....	291
Fuel Fill Door	14,217
Unable to Unlock.....	14,216
Fuses	294
Inspecting and Changing.....	297
Locations.....	294,295,296

G

Gasoline (Fuel)	
Economy.....	218
Gauge.....	75
Information.....	215
Instant Fuel Economy.....	78
Low Fuel Indicator.....	66
Refueling.....	215
Gauges	75
Gear Shift Lever Positions	199
Automatic Transmission.....	195
Manual Transmission.....	199
Glass (care)	274
Glove Box	126

H

Halogen Bulbs	247
----------------------------	-----

HandsFreeLink® (HFL).....	167	Ignition Switch.....	104	Instrument Panel.....	63
Change Language.....	178	Illumination Control.....	109	Brightness Control.....	109
Help Features.....	168	Knob.....	109	Interior Lights.....	125
Information Display.....	168	Immobilizer System.....	98	Interior Rearview Mirror.....	114
Making a Call.....	173	Indicator.....	70		
Menus.....	169	Indicators.....	64	J	
Muting a Call.....	174	ABS (Anti-lock Brake System).....	66	Jack (Wheel Nut Wrench).....	280
Phone Setup.....	171	Charging System.....	65	Jump Starting.....	284
Phonebook.....	175	CRUISE CONTROL.....	71,202		
Receiving a Call.....	174	CRUISE MAIN.....	71,201,202	K	
Transferring a Call.....	174	Door and Trunk Open.....	68	Keyless Lockout Prevention.....	92
Sending Numbers or Names During		EPS (Electric Power Steering System).....	68	Key Number Tag.....	90
a Call.....	174	Fog Light.....	70	Keys.....	89
Hazard Warning Button.....	2	High Beam.....	69	Lockout Prevention.....	92
Head Restraints.....	118	Immobilizer System.....	70	Number Tag.....	90
Headlights.....	105	Lights On.....	69	Remote Transmitter.....	91
Aiming.....	247	Low Fuel.....	66	Rear Doors Won't Open.....	94
Automatic Operation.....	106	Low Oil Pressure.....	64	Retractable Master Keys.....	89
Dimming.....	105,107	Low Tire Pressure/TPMS.....	68	Types and Functions.....	89
Operating.....	105	Malfunction Indicator Lamp.....	65	Valet Key.....	90
Heaters (Seat).....	132	Parking Brake and Brake System.....	64	Won't turn.....	17
Heated Door Mirrors.....	110	Seat Belt Reminder.....	66	Kickdown (Automatic Transmission).....	194
HFL (HandsFreeLink®).....	167	Security System.....	70		
High Beam Indicator.....	69	Side Airbag Off.....	46,70	L	
HomeLink® Universal Transceiver.....	165	Supplemental Restraint System.....	67	Language (HFL).....	178
		Transmission.....	65	LATCH (Child Seats).....	53
I		Turn Signal.....	69	Lights.....	105,247
Identification Numbers.....	306	VSA® (Vehicle Stability Assist).....	67	Automatic.....	106
Engine and Transmission.....	306	VSA® OFF.....	67,205		
Vehicle Identification.....	306	Information Buttons.....	76		
		Instant Fuel Economy.....	78		

Bulb Replacement.....247
 Daytime Running Lights.....107
 Fog Lights.....107
 High Beam Indicator Light.....69
 Interior.....125
 Light Switches.....105
 Lights On Indicator.....69
 Turn Signals.....105
Load Limits.....185
Locking/Unlocking.....89
 Auto Door Lock/Unlock.....94
 Childproof Door Locks.....94
 From Inside.....93
 From Outside.....91
 Keys.....89
 Lockout Prevention System.....92
 Using a Key.....92
Lockout Prevention System.....92
Low Battery Charge.....290
Lower Anchors.....53
Low Fuel Indicator.....66
Low Oil Pressure Indicator.....64,290
Lubricant Specifications Chart.....303,305
Luggage (Maximum Load Limit).....185

M

Maintenance.....221
 Battery.....268
 Brake/Clutch Fluid.....244
 Cleaning.....271

Climate Control.....270
 Coolant.....240
 Maintenance Minder™.....225
 Oil.....235
 Precautions.....222
 Radiator.....241
 Remote Transmitter.....269
 Replacing Light Bulbs.....247
 Safety.....223
 Service Items.....226
 Tires.....259
 Transmission Fluid.....242
 Under the Hood.....229
Malfunction Indicator Lamp.....65,291
Manual Transmission.....199
Map Lights.....125
Maximum Load Limit.....185
Meters, Gauges.....75
Mirrors.....114
 Adjusting.....114
 Automatic Dimming.....114
 Door.....114
 Exterior.....114
 Interior Rearview.....114
Modifications (and Accessories).....219
Moonroof.....103
MP3.....147,153
Multi-information Display.....76

N

Numbers (Identification).....306

O

Odometer.....77
Oil (Engine).....234
 Adding.....237
 Checking.....235
 Displaying Oil Life.....225
 Low Oil Pressure Indicator.....64,290
 Recommended Engine Oil.....234
 Viscosity.....234
Opening/Closing
 Hood.....231
 Moonroof.....103
 Power Windows.....100
 Trunk.....95
Outside Temperature Display.....78
Overheating.....288

P

Paddle Shifters (Sequential Shift Mode).....13,197
Panic Mode.....99
Parking.....214
Parking Brake.....210
Parking Brake and Brake System Indicator.....64,292
Passenger Airbag Off Indicator.....45

Passing Indicators 105
 Power Windows 100
 Precautions While Driving 193
 Rain 193
 Pregnant Women 31
 Puncture (Tire) 277

R

Radiator 241
 Radio (AM/FM) 143
 Radio Data System (RDS) 144
 Range 78
 RDS (Radio Data System) 144
 Readiness Codes (Emissions Testing) 309
 Rear Defogger/Heated Door Mirror
 Button 110
 Rear Seats (Folding Down) 123
 Rearview Mirror (Automatic Dimming) 114
 Refueling 215
 Fuel Gauge 8,75
 Gasoline 215,302,304
 Low Fuel Indicator 66
 Regulations 208,262,307
 Remote Transmitter 91
 Replacement
 Battery 268
 Bulbs 247
 Fuses 294,295,296
 Tires 277
 Wiper Blade Rubber 257

Reporting Safety Defects 308
 Resetting a Trip Meter 77
 Retractable Master Keys 89
 Reverse Tilt Mirror 115

S

Safety Check 25
 Safety Labels 61
 Safety Message 20
 Seat Belts 26
 Adjusting the Shoulder Anchor 30
 Automatic Seat Belt Tensioners 28
 Checking 32
 Fastening 29
 Installing a Child Seat with a Lap/Shoulder
 Seat Belt 55
 Pregnant Women 31
 Reminder 27
 Warning Indicator 27,66
 Seat Heaters 132
 Seats 116
 Adjusting 116
 Driver's Seat Lumbar Support 120
 Front Seats 116
 Rear Seats 123
 Seat Heaters 132
 Security System 98
 Immobilizer System Indicator 70
 Indicator 70
 SEL/RESET Button 76

Select Lever 13,195,199
 Operation 13,195,199
 Releasing 287
 Won't Move 287
 Selecting a Child Seat 52
 Selector Knob (Audio) 141
 Sequential Shift Mode 197
 Setting the Clock 88
 Shift Indicator 65,196
 Shifting (Transmission) 195,199
 Shift Lever 195,199
 Shoulder Anchor 30
 Side Airbag 40
 Cutoff System 42
 Off Indicator 42
 Side Curtain Airbag 43
 Snow Tires 267
 Spare Tire 277,303,305
 Spark Plugs 302,304
 Specifications 302,303,304,305
 Specified Fuel 215,302,304
 Speedometer 75
 SRS Airbags (Airbags) 36
 Starting the Engine 191
 Does Not Start 283
 Engine Switch Buzzer 104
 Jump Starting 284
 Steering Wheel 113
 Adjusting 113
 Stopping 214
 Sunglasses Holder 131

Switches (Around the Steering Wheel) ... 2,3
 Supplemental Restraint System (SRS) 36
 SYNC Mode 135
 System Message Indicator 69

T

Tachometer 75
 Temperature 78
 Gauge 8
 Outside Temperature Display 78
 Temperature Sensor 136
 Time (Setting) 88
 Tires 259
 Air Pressure 260,303,305
 Checking and Maintaining 259
 Inspection 259
 Labeling 260
 Puncture (Flat Tire) 277
 Regulations 262
 Rotation 266
 Spare Tire 277,303,305
 Tire Chains 267
 Wear Indicators 264
 Winter 267
 Tire Pressure Monitoring System
 (TPMS) 206
 Indicator 68,293
 Tools 276
 Towing a Trailer 187
 Equipment and Accessories 188

Load Limits 187
 Towing Your Vehicle 190
 Emergency 298
 TPMS (Tire Pressure Monitoring
 System) 206
 Transmission 195,199
 Automatic 195
 Fluid 242,243
 Manual 199
 Number 306
 Sequential Shift Mode 197
 Shift Position Indicator 13,196
 Trip Meter 77
 Trip/Reset Switch 77
 Troubleshooting 275
 Blown Fuse 294,295,296
 Brake Pedal Vibrates 17
 Buzzer Sounds When Opening Door 18
 Emergency Towing 298
 Engine Won't Start 283
 Noise When Braking 18
 Overheating 288
 Premium Gasoline 215,302,304
 Puncture/Flat Tire 277
 Rear Door Won't Open 17,94
 Select Lever Won't Move 287
 Warning Indicators 64
 Trunk 95
 Lid 96
 Main Switch 97
 Unable to Open 300

Trunk Light Bulb 302,304
 Turn signals 105
 Indicators (Instrument Panel) 69

U

Unlocking the Doors 91
 USB Adapter 138,139
 USB Device 164

V

Valet Key 90
 Vanity Mirrors 5
 Vehicle Identification Numbers 306
 Vehicle Stability Assist (VSA®) 204
 Off Indicator 67
 Off Switch 205
 System Indicator 67
 Ventilation 133
 Viscosity (Oil) 234,303,305
 VSA® (Vehicle Stability Assist) 204

W

Warning and Information Message 72
 Warning Indicator On/Blinking 290
 Warning Labels 61
 Warranties (Warranty Manual provided
 separately) 311
 Watts 302,304

Wear Indicators (Tire)	264
Wheel Nut Wrench (Jack Handle)	280
Windows (Opening and Closing).....	100
Window Washers	108
Adding/Refilling Fluid	246
Switch.....	108
Windshield	108
Cleaning.....	274
Defrosting/Defogging	134
Wipers and Washers.....	108
Washer Fluid.....	246
Wiper Blades	257
Winter Tires.....	267
Snow Tires	267
Tire Chains.....	267
Wipers and Washers.....	108
Checking and Replacing Wiper Blades.....	257
WMA.....	147,153
Worn Tires	259

X

XM® Radio	145
-----------------	-----

