

Owner's Manual
for Vehicle



The Ultimate
Driving Machine



323i
328i
328i xDrive
335i
335i xDrive

Owner's Manual for Vehicle

Congratulations, and thank you for choosing a BMW.

Thorough familiarity with your vehicle will provide you with enhanced control and security when you drive it. We therefore have this request:

335d

Please take the time to read this Owner's Manual and familiarize yourself with the information that we have compiled for you before starting off in your new vehicle. It contains important data and instructions intended to assist you in gaining maximum use and satisfaction from your BMW's unique range of technical features. The manual also contains information on maintenance designed to enhance operating safety and contribute to maintaining the value of your BMW throughout an extended service life.

This manual is supplemented by a Service and Warranty Information Booklet for US models or a Warranty and Service Guide Booklet for Canadian models.

We wish you an enjoyable driving experience.

BMW AG

© 2008 Bayerische Motoren Werke
Aktiengesellschaft
Munich, Germany
Reprinting, including excerpts, only with the
written consent of BMW AG, Munich.
US English X/08, 08 09 500
Printed on environmentally friendly paper,
bleached without chlorine, suitable for recycling.

Contents

The fastest way to find information on a particular topic or item is by using the index, refer to page 250.

Using this Owner's Manual

- 4 Notes
- 6 Reporting safety defects

At a glance

- 10 Cockpit
- 16 iDrive
- 21 Letters and numbers
- 22 Voice activation system

Controls

- 26 Opening and closing
- 41 Adjustments
- 49 Transporting children safely
- 53 Driving
- 67 Everything under control
- 80 Technology for driving comfort and safety
- 90 Lamps
- 94 Climate
- 99 Practical interior accessories

Driving tips

- 114 Things to remember when driving

Navigation

- 122 Navigation system
- 123 Destination entry
- 133 Destination guidance
- 139 What to do if ...

Entertainment

- 142 On/off and tone
- 145 Radio
- 148 Satellite radio
- 150 CD player and CD changer
- 157 Music collection
- 161 AUX-IN port
- 162 USB-audio interface/mobile phone audio interface

Communications

- 168 Telephone
- 179 Contacts
- 181 BMW Assist

Mobility

- 190 Refueling
- 195 Wheels and tires
- 211 Under the hood
- 216 Maintenance
- 218 Care
- 222 Replacing components
- 230 Giving and receiving assistance

Reference

- 238 Technical data
- 243 Short commands for the voice activation system
- 250 Everything from A-Z

Notes

Using this Owner's Manual

We have tried to make all the information in this Owner's Manual easy to find. The fastest way to find specific topics is to refer to the detailed index at the back of the manual. If you wish to gain an initial overview of your vehicle, you will find this in the first chapter.

Should you sell your BMW some day, please remember to hand over the Owner's Manual as well; it is an important component of your vehicle.

Additional sources of information

Should you have any other questions, your BMW center will be glad to advise you at any time.

Information on BMW, e.g. on technical aspects, can also be found on the Internet at www.bmwusa.com.

Symbols used



Indicates precautions that must be followed precisely in order to avoid the possibility of personal injury and serious damage to the vehicle. ◀



Indicates information that will assist you in gaining the optimum benefit from your vehicle and enable you to care more effectively for your vehicle. ◀



Refers to measures that can be taken to help protect the environment. ◀

◀ Marks the end of a specific item of information.

* Indicates special equipment, country-specific equipment and optional accessories, as well as equipment and functions not yet available at the time of printing.

"..." Identifies Control Display texts used to select individual functions.

›...‹ Verbal instructions to use with the voice activation system.

››...‹‹ Identifies the answers generated by the voice activation system.

Symbols on vehicle components



Indicates that you should consult the relevant section of this Owner's Manual for information on a particular part or assembly.

The individual vehicle

When you ordered your BMW, you chose various items of equipment. This Owner's Manual describes the entire array of options and equipment available with a specific BMW model.

Please bear in mind that the manual may contain information on accessories and equipment that you have not specified for your own vehicle. Sections describing options and special equipment are marked by asterisks * to assist you in identifying possible differences between the descriptions in this manual and your own vehicle's equipment.

If equipment in your BMW is not described in this Owner's Manual, please refer to the accompanying Supplementary Owner's Manuals.

Editorial notice

BMW pursues a policy of continuous, ongoing development that is conceived to ensure that our vehicles continue to embody the highest quality and safety standards combined with advanced, state-of-the-art technology. For this reason, it is possible in exceptional cases that features described in this Owner's Manual could differ from those on your vehicle.

For your own safety

Maintenance and repair



Advanced technology, e.g. the use of modern materials and powerful electronics, requires specially adapted maintenance and repair methods. You should therefore have the corresponding work on your vehicle performed only by your BMW center or at a workshop that works according to BMW repair procedures with correspondingly trained personnel. If this work is not carried out properly, there is a danger of subsequent damage and related safety hazards. ◀

Parts and accessories



For your own safety, use genuine parts and accessories approved by BMW.

When you purchase accessories tested and approved by BMW and Original BMW Parts, you simultaneously acquire the assurance that they have been thoroughly tested by BMW to ensure optimum performance when installed on your vehicle.

BMW warrants these parts to be free from defects in material and workmanship.

BMW will not accept any liability for damage resulting from installation of parts and accessories not approved by BMW.

BMW cannot test every product made by other manufacturers to verify if it can be used on a BMW safely and without risk to either the vehicle, its operation, or its occupants.

Original BMW Parts, BMW Accessories and other products approved by BMW, together with professional advice on using these items, are available from all BMW centers.

Installation and operation of non-BMW approved accessories such as alarms, radios, amplifiers, radar detectors, wheels, suspension components, brake dust shields, telephones, including operation of any mobile phone from within the vehicle without using an externally mounted antenna, or transceiver equipment, for instance, CBs, walkie-talkies, ham radio or similar accessories, may cause extensive damage

to the vehicle, compromise its safety, interfere with the vehicle's electrical system or affect the validity of the BMW Limited Warranty. See your BMW center for additional information. ◀

 Maintenance, replacement, or repair of the emission control devices and systems may be performed by any automotive repair establishment or individual using any certified automotive part. ◀

California Proposition 65 warning

California law requires us to issue the following warning:

 Engine exhaust and a wide variety of automobile components and parts, including components found in the interior furnishings in a vehicle, contain or emit chemicals known to the State of California to cause cancer and birth defects and reproductive harm. In addition, certain fluids contained in vehicles and certain products of component wear contain or emit chemicals known to the State of California to cause cancer and birth defects or other reproductive harm.

Battery posts, terminals and related accessories contain lead and lead compounds. Wash your hands after handling.

Used engine oil contains chemicals that have caused cancer in laboratory animals. Always protect your skin by washing thoroughly with soap and water. ◀

Service and warranty

We recommend that you read this publication thoroughly.

Your BMW is covered by the following warranties:

- ▷ New Vehicle Limited Warranty
- ▷ Rust Perforation Limited Warranty
- ▷ Federal Emissions System Defect Warranty
- ▷ Federal Emissions Performance Warranty
- ▷ California Emission Control System Limited Warranty

Detailed information about these warranties is listed in the Service and Warranty Information Booklet for US models or in the Warranty and Service Guide Booklet for Canadian models.

Reporting safety defects

For US customers

The following only applies to vehicles owned and operated in the US.

If you believe that your vehicle has a defect which could cause a crash or could cause injury or death, you should immediately inform the National Highway Traffic Safety Administration, NHTSA, in addition to notifying BMW of North America, LLC, P.O. Box 1227, Westwood, New Jersey 07675-1227, Telephone 1-800-831-1117.

If NHTSA receives similar complaints, it may open an investigation, and if it finds that a safety defect exists in a group of vehicles, it may order a recall and remedy campaign. However, NHTSA cannot become involved in individual problems between you, your dealer, or BMW of North America, LLC.

To contact NHTSA, you may call the Vehicle Safety Hotline toll-free at 1-888-327-4236 (TTY: 1-800-424-9153); go to <http://www.safercar.gov>; or write to: Administrator, NHTSA, 400 Seventh Street, SW., Washington, DC 20590. You can also obtain other information about motor vehicle safety from <http://www.safercar.gov>

For Canadian customers

Canadian customers who wish to report a safety-related defect to Transport Canada, Defect Investigations and Recalls, may call 1-800-333-0510 toll-free from anywhere in Canada or 1-613-993-9851 from the Ottawa region and from other countries, or contact Transport Canada by mail at: Transport Canada, ASFAD, Place de Ville, Tower C, 330 Sparks Street, Ottawa, ON, K1A 0N5.

You can also obtain other information about motor vehicle safety from <http://www.tc.gc.ca>







At a glance



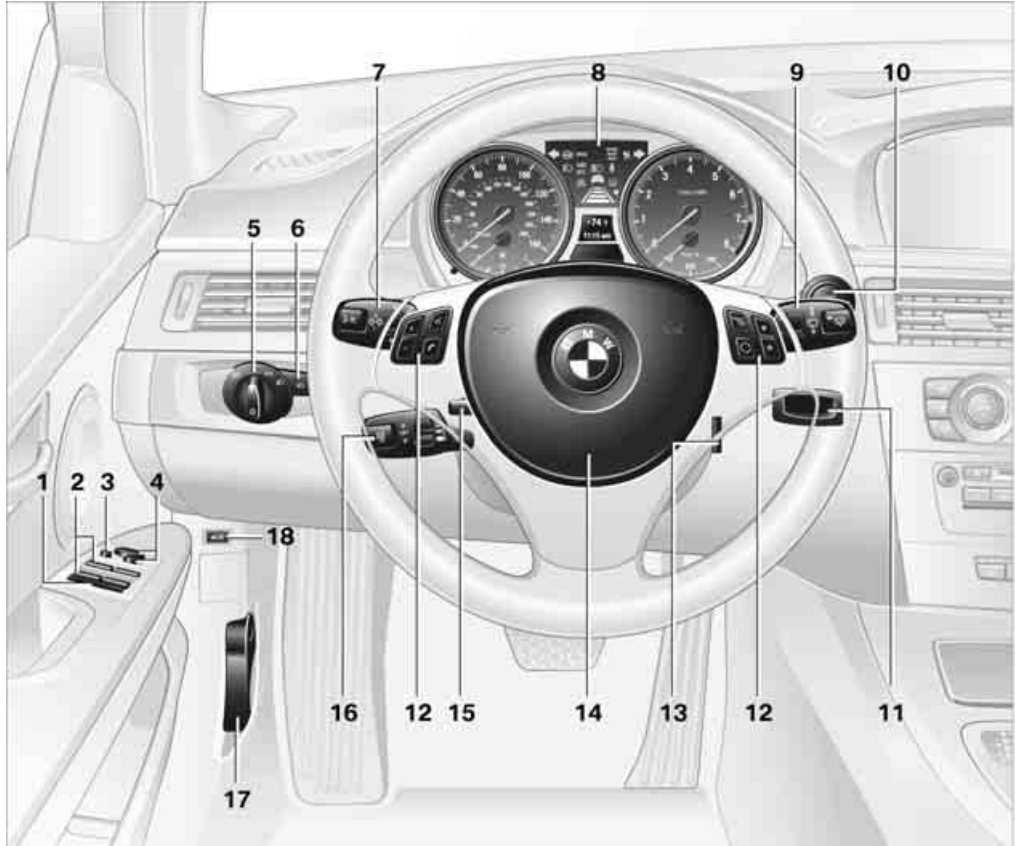

This overview of buttons, switches and displays is intended to familiarize you with your vehicle's operating environment. The section will also assist you in becoming acquainted with the control concepts and options available for operating the various systems.





















Cockpit

Around the steering wheel: controls and displays



- 1  Safety switch for electric rear windows [36](#)
- 2  Opening and closing windows [36](#)
- 3  Folding exterior mirrors in and out* [47](#)
- 4  Adjusting exterior mirrors, automatic curb monitor* [47](#)

- 5  Parking lamps [90](#)
- 6  Fog lamps [92](#)
-  Low beams [90](#)
-  Automatic headlamp control* [90](#)
-  Adaptive Head Light* [91](#)

- 7  Turn signals 57
-  High beams, headlamp flasher 92
-  Roadside parking lamps* 92
- BC** Computer 69
-  Settings and information about the vehicle 70
-  Instrument lighting 92
- 8 Instrument cluster 12
- 9  Windshield wipers 58
-  Rain sensor* 58
-  Sports Wagon:
Rear window wiper 59
- 10  Switching the ignition on/off and starting/stopping the engine 53
- 11 Ignition lock 53
- 12 Buttons on the steering wheel
-  Telephone*:
- ▷ Press: accepting and ending a call; dialing* the selected phone number; redialing if no phone number is selected
 - ▷ Press longer: redialing
-  Volume
-  Activating/deactivating voice activation system* 22
-  Changing radio station
-  Selecting music track
-  Scrolling through phone book and lists with stored phone numbers
-  Next entertainment source
-  Recirculated-air mode 96
- 13  Steering wheel heating* 48
- 14 Horn, the entire surface
- 15 Adjusting the steering wheel 48
- 16  Cruise control* 59
-  Active cruise control* 61
- 17 Releasing the hood 211
- 18 Opening the tailgate/luggage compartment lid 30

Instrument cluster



- 1 Speedometer
- 2 Indicator lamps for turn signals
- 3 Indicator and warning lamps [13](#)
- 4 Displays for active cruise control* [61](#)
- 5 Tachometer [67](#)
- 6 Engine oil temperature* [68](#)
Energy Control* [68](#)
- 7 Display for
 - ▷ Clock [67](#)
 - ▷ Outside temperature [67](#)
 - ▷ Indicator and warning lamps [75](#)
- 8 Display for
 - ▷ Position of automatic transmission* [55](#)
 - ▷ Computer [69](#)
 - ▷ Date of next scheduled service, and remaining distance to be driven [71](#)
 - ▷ Odometer and trip odometer [67](#)
 - ▷ Checking engine oil level* [212](#)
 - ▷ Settings and information [70](#)
 - ▷ ▲ There is a Check Control message [75](#)
- 9 Fuel gauge [68](#)
- 10 Resetting the trip odometer [67](#)

Indicator and warning lamps

The concept



Indicator and warning lamps can light up in a variety of combinations and colors.

Some lamps are checked for proper functioning and thus come on briefly when the engine is started or the ignition is switched on.

Explanatory text messages



Text messages at the top edge of the Control Display describe the meanings of the indicator and warning lamps.

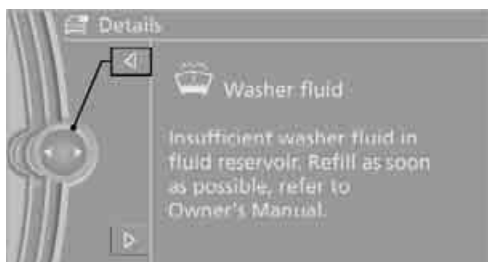

You can call up more information, e.g. on the cause of a malfunction and on how to respond, via Check Control, refer to page 75.

In urgent cases, this information will be shown as soon as the corresponding lamp comes on.

Indicator lamps without text messages

The following indicator lamps notify you that certain functions are active:

 High beams/headlamp flasher 92

 Fog lamps 92

 Lamp flashes:
DSC or DTC is regulating the propulsive forces in order to maintain driving stability 82

 BRAKE Parking brake applied 54

 Canada: parking brake applied 54

 SERVICE ENGINE SOON Engine malfunction with adverse effect on exhaust emissions 217

 Canada: engine malfunction with adverse effect on exhaust emissions 217

Around the center console: controls and displays



- 1 Microphone for voice activation system* and for telephone in hands-free mode* 230
- 2 SOS: initiating an Emergency Request call* 230
- 3 Reading lamps 93
- 4 Glass roof/panorama glass roof* 37
- 5 Interior lamps 93
- 6 Passenger airbag status lamp* 89
- 7 Control Display 16
- 8 Hazard warning flashers
- 9 Dynamic Traction Control DTC 81
- 10 Central locking system 30
- 11 Automatic climate control



Air distribution to the windshield 95



Air distribution to the upper body area 95



Air distribution to the footwell 95

AUTO

Automatic air distribution and flow rate 95



Cooling function 96



Automatic recirculated-air control AUC 96



Recirculated-air mode 96



Maximum cooling 95



Residual heat mode 96



Air flow rate 95



Defrosting windows 96



Rear window defroster 97

- 12 CD/DVD drive 150
- 13 Changing the audio and entertainment sources
- 14 Selecting AM or FM waveband

15 Changing

- ▷ Radio station 145
- ▷ Track 150

16



Heated seats* 45



Park Distance Control PDC* 80



Sedan:
Roller sun blind* 102



Hill Descent Control HDC* 82

17 Controller 16

Can be turned, pressed, or moved in four directions

18 Buttons on the controller 16

Selecting menus directly

19 Programmable memory keys 20

20 Switching audio sources on/off and adjusting volume 142

21 Ejecting CD/DVD 150

iDrive integrates the functions of a large number of switches. This allows these functions to be operated from a single central position. The following section provides an introduction to

basic menu navigation. The control of the individual functions is described in connection with the relevant equipment.

Controls

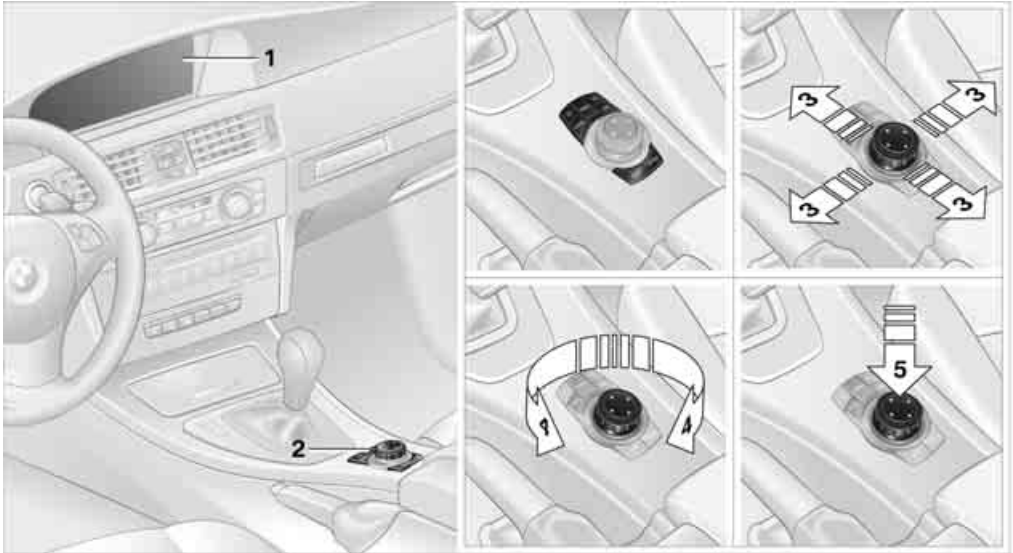

1 Control Display

2 Controller with buttons

You can use the buttons to open the menus directly. The controller can be used to select the menu items and create settings.

- ▷ Move in four directions, arrow **3**
- ▷ Turn, arrow **4**
- ▷ Push, arrow **5**

⚠ Operate the controller only when traffic and road conditions allow this, to avoid endangering the car's occupants and other road users by being distracted. ◀

Buttons on the controller

Button	Function
MENU	Open the main menu
RADIO	Open the Radio menu
CD	Open the CD/Multimedia menu
NAV	Open the Navigation menu
TEL	Open the Telephone menu
BACK	Display the previous menu
OPTION	Open the Options menu

Operating principle

With the ignition at radio readiness or beyond, refer to page 53, the following message is displayed on the Control Display:

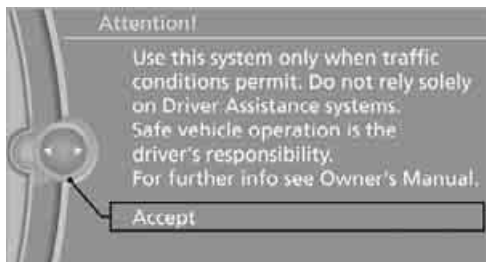

To hide the message:
Press the controller.
The main menu is displayed.

The message is automatically hidden after approx. 10 seconds.

Opening the main menu

Press the **MENU** button.
The main menu is displayed.

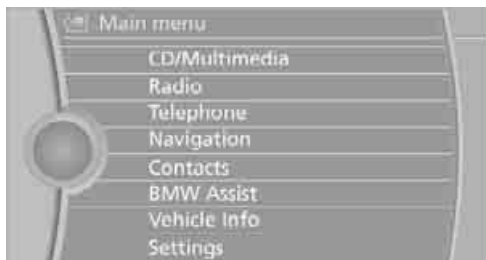

All iDrive functions can be called up via the main menu.

Selecting a menu item

The menu items shown in white can be selected.

1. Turn the controller until the desired menu item is highlighted.

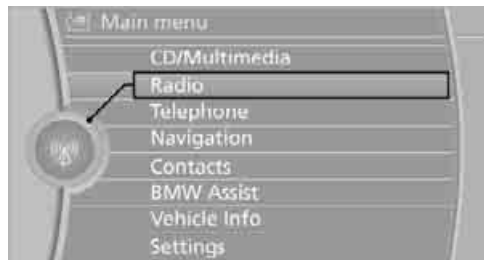

2. Press the controller.

A new menu is displayed or the function is executed.

Menu items in the Owner's Manual

In the Owner's Manual, menu items that can be selected are set in quotation marks, e.g. "Settings"

Changing between panels

After selecting a menu item, e.g. "Radio", a new menu is displayed on a panel. The panels can overlap.

Move the controller to the left or right to change between the panels.

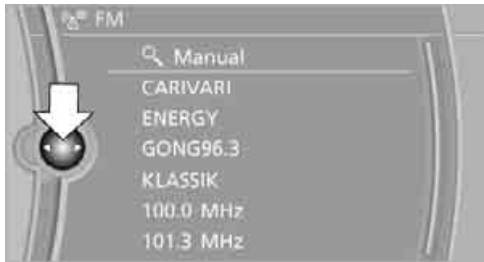

White arrows pointing to the left or right indicate that additional panels can be opened.

Open the Options menu

Press the **OPTION** button.
The "Options" menu is displayed.



Additional options: move the controller to the right repeatedly until the "Options" menu appears.

The "Options" menu contains the following:

- ▶ Screen settings, refer to page 19.
- ▶ Control options for the selected menu.

Adjusting settings

1. Select a field.
2. Turn the controller until the desired setting is displayed.

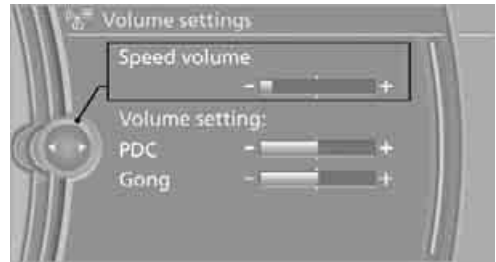

3. Press the controller to confirm the setting.

 The scroll bar on the right side indicates whether additional menu items or settings can be selected that are currently not visible. ◀

Example: setting the clock

1. Press the **MENU** button.
The main menu is displayed.
2. Turn the controller until "Settings" is highlighted, and then press the controller.

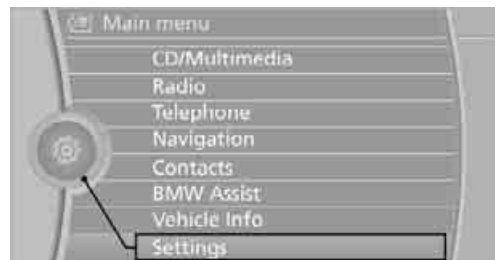

3. Turn the controller until "Time/Date" is highlighted, and then press the controller.



- Turn the controller until "Time:" is highlighted, and then press the controller.

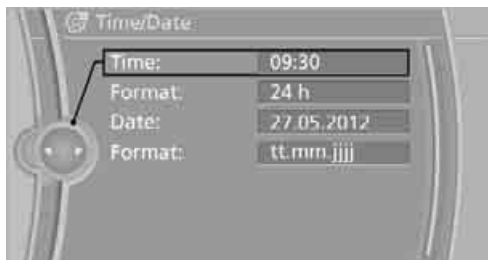

- Turn the controller to set the hours and press the controller.
- Turn the controller to set the minutes and press the controller.

Status information



- Time
- Display for:
 - Reception strength of the wireless network, depends on the mobile phone
 - Incoming, outgoing or missed call
 - SMS* received
- Display for:
 - Entertainment: Radio, CD/DVD, external devices, TV*
 - Telephone*: Name of the mobile phone paired with the vehicle

- Sound output is switched off or display for traffic bulletins*:
 - "TI": Traffic bulletins are switched on.
 - No display: Traffic bulletins are switched off.

Other displays:

Status information is temporarily hidden during Check Control message displays or entries via the voice activation system*.

Switching the control display on/off

- Press the **OPTION** button.
- "Switch off display"

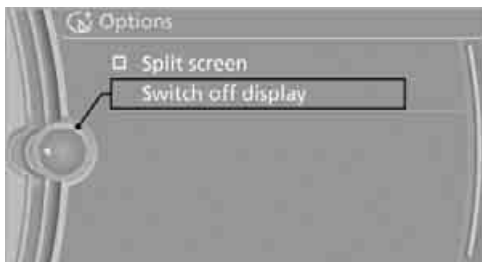

Press the controller to switch on.

Split screen

Additional information can be displayed on the right side of the split screen, e.g. information from the computer.

In the divided screen view, the so-called split screen, this information remains visible even when you change to another menu.

Switching the split screen on and off

- Press the **OPTION** button.
- "Split screen"
 - The split screen is activated.

Selecting the display for the split screen content

When the split screen is switched on, you can select the content displayed on the screen.



1. Move the controller to the right repeatedly until the split screen content is selected.
2. Select the display.



Programmable memory keys



Certain iDrive functions can be stored on the programmable memory keys and called up directly, e.g. radio stations, navigation destinations, phone numbers and entry points into the menu.

Storing functions

1. Highlight the function via the iDrive.
2.  ...  Press the desired key for longer than two seconds.

Example for programmable memory keys

Switch the voice instructions for the navigation on/off.

1. "Navigation"
2. "Map"
3. Select the  symbol using the controller.
4.  ...  Press the desired key for longer than two seconds.

Executing a function

 ...  Press the button.

The function is executed immediately. This means, for example, that the number is dialed when a phone number is selected.

Displaying memory key assignments

Touch the button with a finger. Do not wear gloves or use objects.



Displaying brief information

 ...  Touch the button.

The key assignment is displayed at the top edge of the screen.



Displaying detailed information

 ...  Press the button for an extended period.

Letters and numbers

Entering letters and numbers

1. Turn the controller: select the letters or numbers.
2. Select additional letters or numbers if needed.
3. "OK": confirm the entry.

Symbol	Function
	Press the controller: delete one letter or number
	Press the controller for an extended period: delete all letters or numbers
	Enter a blank space

Switching between letters and numbers

Depending on the menu, you can switch between entering letters and numbers:

Symbol	Function
	Entering letters
	Entering numbers

Wordmatch concept during navigation

Entry of names and addresses: the selection is narrowed down every time a letter is entered and letters may be added automatically.

Destination search: the entries are continuously compared to the data stored in the vehicle.

- ▷ The only letters offered for entering addresses are those for which data are available.

Town/city names can be entered with the spelling used in any of the languages available on the Control Display.

Voice activation system*

The concept

The voice activation system allows you to control operation of various vehicle systems without removing your hands from the steering wheel.

Individual menu items on the Control Display can be spoken as commands. It is not necessary to use the controller.



The voice activation system transforms your oral commands into control signals for the selected systems and provides support in the form of instructions or questions.

The voice activation system uses a special microphone located in the area of the interior rearview mirror, refer to page 14.

Precondition

Via iDrive, select the language in which the voice activation system is operating, so that the spoken commands can be identified. Selecting the language for iDrive, refer to page 78.

Symbols in the Owner's Manual

-  ›...‹ Say the specified commands word for word.
-  ››...‹‹ Indicates responses of the voice activation system.

Saying commands

Activating voice activation system

1. Press the  button on the steering wheel.



 This symbol on the Control Display and an acoustic signal indicate that the voice activation system is ready to receive spoken commands.

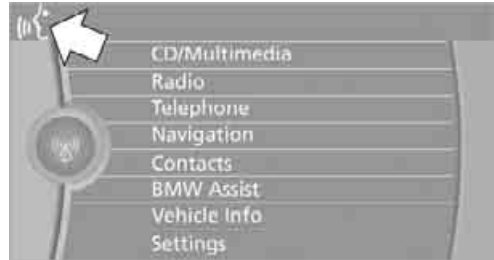

2. Say the command.
The command appears on the Control Display.

 This symbol appears on the Control Display when you can enter additional commands. If no further commands are possible, continue by operating the item of equipment via iDrive.

Terminating or canceling voice activation system

Press the  button on the steering wheel or

 ›Cancel‹

In dialogs that call for a text of your choice, the procedure can only be canceled using the button on the steering wheel.

Possible commands

The commands available in each case depend on the menu item selected on the Control Display.

To have the available commands read aloud:

 ›Voice commands‹

For example, if "CD/DVD" is selected, the commands for operating CD/Multimedia are read aloud .

Using alternative commands

There are often a number of commands to run a function, e.g.:

 ›Radio on‹ or ›Radio‹

Calling up functions immediately via short commands

Short commands enable you to perform certain functions immediately, irrespective of which menu item is selected, refer to page 243.

Example: selecting the track of a CD

1. If necessary, switch on entertainment audio output.
2. Press the  button on the steering wheel.

 3. Select the music track, e.g.:
›CD track 4‹
System says:
››Track 4‹‹

Setting the voice dialog

You can set whether the system should use the standard dialog or a shorter variant. In the shorter variant of the voice dialog, the prompts and responses from the system are abbreviated.

1. "Settings"
2. "Language/Units"
3. "Speech mode:"



4. To select the setting:
 - ▷ "Default"
 - ▷ "Short"

Notes

 For information on voice control of the telephone, refer to page 175. ◀

For voice commands, bear in mind the following:

- ▷ Do not use the voice activation system to initiate an Emergency Request. In stressful situations, the voice and vocal pitch can change. This can unnecessarily delay the establishment of a telephone connection.
- ▷ Pronounce the commands and digits smoothly and at normal volume, avoiding excessive emphases and pauses. This also applies when spelling out and saying a full word during destination entry.
- ▷ When selecting a radio station, use the standard pronunciation of the station name.
- ▷ For entries in the voice-activated phone book, only use names in the language of the voice activation system and no abbreviations.
- ▷ Keep the doors, windows and glass roof/panorama glass roof closed to prevent interference from outside noise.
- ▷ Avoid ambient noise in the vehicle while speaking.



A close-up, blue-tinted photograph of a car's interior controls. The image shows a circular dial on the left, a vertical slider or button in the center, and a rectangular control panel on the right. The background is blurred, focusing attention on the controls.

Controls

This chapter is intended to provide you with information for complete control of your vehicle. All features and accessories that are useful for driving and your safety, comfort and convenience, are described here.

Opening and closing

Remote control



Each remote control contains a rechargeable battery that is automatically recharged when it is in the ignition lock while the car is being driven. Use each remote control at least twice a year for longer road trips in order to maintain the batteries' charge status. In cars with convenient access*, the remote control contains a replaceable battery, refer to page 35.

The settings called up and implemented when the car is unlocked depend on which remote control is used to unlock the car, refer to Personal Profile, next column.

In addition, information about service requirements is stored in the remote control, refer to Service data in the remote control, page 216.

Integrated key



Press button 1 to release the key.

The integrated key fits the following locks:

- ▷ Glove compartment, refer to page 102
- ▷ Driver's door, refer to page 29

New remote controls

Your BMW center can supply new remote controls with integrated keys as additional units or as replacements in the event of loss.

Personal Profile

The concept

You can set many of your BMW's functions to suit your personal needs and preferences. Without any action on your part, Personal Profile ensures that most of these settings are stored for the remote control currently in use. When you unlock the car, the remote control used for the purpose is recognized and the settings stored for it are called up and implemented.

This means that your personal settings will be activated for you, even if in the meantime your car was used by someone else with another remote control and the corresponding settings. The individual settings are stored for a maximum of four remote controls. They are stored for two remote controls if convenient access* is in use.

Personal Profile settings

For more information on specific settings, refer to the specified pages.

- ▷ Assignment of programmable memory keys, refer to page 20
- ▷ Response of the central locking system when the car is unlocked, refer to page 27
- ▷ Automatic locking of the vehicle, refer to page 30
- ▷ Automatic call-up* of the driver's seat position after unlocking, refer to page 45
- ▷ Triple turn signal activation, refer to page 58

- ▷ Settings for the display on the Control Display and in the instrument cluster:
 - ▷ 12h/24h format of the clock, refer to page 74
 - ▷ Date format, refer to page 75
 - ▷ Brightness of Control Display, refer to page 78
 - ▷ Language on the Control Display, refer to page 78
 - ▷ Units of measure, refer to page 71
- ▷ Show visual warning for Park Distance Control PDC*, refer to page 80
- ▷ Light settings:
 - ▷ Welcome lamps, refer to page 90
 - ▷ Pathway lighting, refer to page 91
 - ▷ Daytime running lamps, refer to page 91
- ▷ Automatic climate control: activating/deactivating AUTO program, cooling function and automatic recirculated-air control, setting temperature, air flow rate and distribution, refer to page 95 ff
- ▷ Entertainment:
 - ▷ Audio volume, refer to page 142
 - ▷ Tone control, refer to page 142
 - ▷ Speed-dependent volume control, refer to page 143

Central locking system

The concept

The central locking system functions when the driver's door is closed.

The system simultaneously engages and releases the locks on the following:

- ▷ Doors
- ▷ Luggage compartment lid/tailgate
- ▷ Fuel filler door

Operating from outside

- ▷ Via the remote control
- ▷ Via the door lock*

- ▷ In cars with convenient access*, via the handles on the driver's and front passenger's doors

In addition, if the remote control is used, the interior lamps and the door's courtesy lamps* are also switched on or off. The alarm system* is also armed or disarmed.

For further details of the alarm system, refer to page 33.

Operating from inside

By means of the button for central locking, refer to page 30.

In the event of a sufficiently severe accident, the central locking system unlocks automatically. In addition, the hazard warning flashers and interior lamps come on.

Opening and closing: Using the remote control



Persons or animals in a parked vehicle could lock the doors from the inside. You should therefore take the remote control with you when you leave the vehicle so that the latter can be opened from outside. ◀

Unlocking

Press the  button.

The interior lamps, the courtesy lamps* and the welcome lamps come on.

Setting unlocking characteristics

You can set whether only the driver's door or the entire vehicle is to be unlocked when the button is pressed for the first time.



iDrive, for operating principle refer to page 16.

1. "Settings"
2. "Door locks"

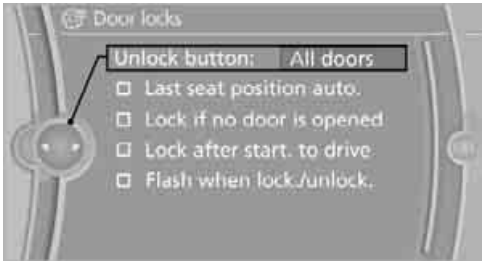
3. "Unlock button"



4. Select a menu item:

- ▷ "All doors"
Press the  button once to unlock the entire vehicle.
- ▷ "Driver's door only"
Pressing the  button once unlocks the driver's door and fuel filler door. Press the button twice to unlock the entire vehicle.
- ▷ "Comfort opening", refer to page 28

5. Press the controller.

Convenient opening

Hold the  button down.
The windows and the glass roof*/panorama glass roof* are opened.

Locking

Press the  LOCK button.

Switching on interior lamps

While the car is locked:
Press the  LOCK button.
You can also use this function to locate your vehicle in parking garages etc.

Sedan: Unlocking the luggage compartment lid

Press the  button for approx. 1 second.
The luggage compartment lid opens a short distance, regardless of whether it was locked or unlocked.

 The luggage compartment lid swings back and up when opened. Ensure that

there is sufficient clearance. To avoid locking yourself out by accident, do not place the remote control in the cargo bay. A previously locked luggage compartment lid is locked again after closing.

Before and after each trip, check that the luggage compartment lid has not been inadvertently unlocked. ◀



Sports Wagon: Unlocking the tailgate

Press the  button for approx. 1 second.

The tailgate opens a short distance, regardless of whether it was locked or unlocked.

The tailgate swings back and up when opened. Ensure that there is sufficient clearance. To avoid locking yourself out by accident, do not place the remote control in the cargo bay. A previously locked tailgate is locked again after closing.

Before and after each trip, check that the tailgate has not been inadvertently unlocked. ◀

 If you press the  button on the remote control a second time for a longer period within three seconds, the roll-up cover is raised*. Before closing the tailgate, press the roll-up cover downward until it engages. ◀

Confirmation signals

You can activate or deactivate the confirmation signals.

iDrive, for operating principle refer to page 16.

1. "Settings"
2. "Door locks"
3. "Flash when lock./unlock."



4. Press the controller.

✓ Flashing when locking/unlocking the vehicle is switched on.

Malfunions

The remote control may malfunction due to local radio waves. If this occurs, unlock and lock the car at the door lock with the integrated key. In vehicles without an alarm system* or convenient access*, only the driver's door can be locked and unlocked with the integrated key via the door lock.

If the car can no longer be locked with a remote control, the battery in the remote control is discharged. Use the remote control on an extended trip to recharge the battery, refer to page 26. The remote control for convenient access* contains a battery that may have to be changed, refer to page 35.

For US owners only

The transmitter and receiver units comply with part 15 of the FCC/Federal Communications Commission regulations. Operation is governed by the following:

FCC ID:
LX8766S
LX8766E
LX8CAS

Compliance statement:

This device complies with part 15 of the FCC Rules. Operation is subject to the following two conditions:

- ▶ This device must not cause harmful interference, and
- ▶ This device must accept any interference received, including interference that may cause undesired operation.

▶ Any unauthorized modifications or changes to these devices could void the user's authority to operate this equipment. ◀

Opening and closing: Using the door lock

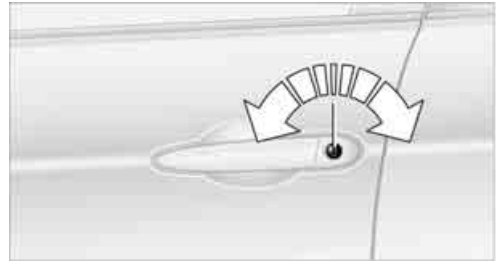

You can set the way in which the car is unlocked, refer to page 27.

▶ In vehicles without an alarm system* or convenient access*, only the driver's door can be locked via the door lock. ◀

To lock all doors, the fuel filler door and the luggage compartment lid at once:

1. With the doors closed, lock the vehicle using the button for the central locking system in the interior, refer to page 30.
2. Unlock and open the driver's or front passenger's door, refer to page 30.
3. Lock the vehicle.
 - ▶ Lock the driver's door via the door lock using the integrated key, or
 - ▶ push down the locking knob on the front passenger's door and close the door from the outside.

Convenient operation

If the vehicle is equipped with an alarm system* or convenience access*, you can also operate the windows and the glass roof*/panorama glass roof* via the door lock.

Hold the key in the position for unlocking or locking.

⚠ Watch during the closing process to ensure that no one is injured. Releasing the key stops the operation. ◀

Manual operation

In the event of an electrical malfunction, you can lock and unlock the driver's door by turning the

integrated key to the corresponding limit positions in the door lock.

Opening and closing: From inside

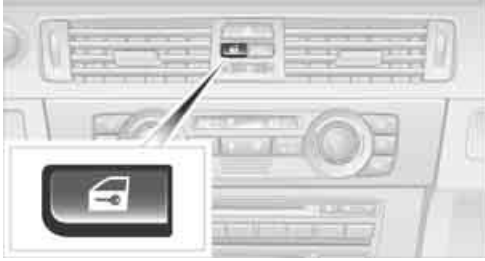

This button serves to unlock or lock doors and the luggage compartment lid/tailgate, but does not activate the anti-theft system. The fuel filler door remains unlocked.

Automatic locking

You can also set the situations in which the car locks:

iDrive, for operating principle refer to page 16.

1. "Settings"
2. "Door locks"
3. Select the desired function:
 - ▷ "Lock if no door is opened"
The central locking system locks the vehicle after a brief time if no door has been opened.
 - ▷ "Lock after start. to drive"
The central locking system locks the vehicle when you drive away.

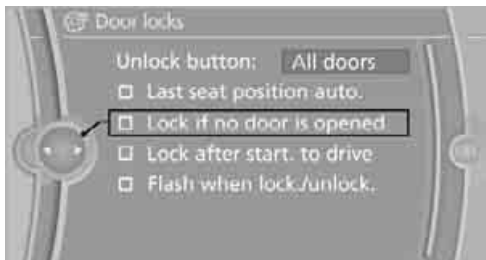

Automatic locking is switched on and is stored for the remote control currently in use.

Unlocking and opening doors

- ▷ Either unlock the doors together using the button for the central locking system and then pull the door handle above the armrest or
- ▷ pull on the door handle of each door twice: the first time unlocks the door, the second time opens it.

Locking

- ▷ Use the central locking button to lock all of the doors simultaneously, or
- ▷ press down the safety lock button of a door. To prevent you from being locked out, the open driver's door cannot be locked using the lock button.

 Persons or animals in a parked vehicle could lock the doors from the inside. You should therefore take the remote control with you when you leave the vehicle so that the latter can be opened from outside. ◀

Luggage compartment lid/ tailgate

 In order to avoid damage, make sure there is sufficient clearance before opening the luggage compartment lid/tailgate. ◀

Opening from inside





Press the button: the luggage compartment lid/ tailgate opens unless it has been locked.

Opening from outside

Sedan





Press the button, see arrow, or the  button on the remote control for a longer period. The luggage compartment lid will open slightly. It can now be swung upwards.

 In the event of a malfunction, please contact your BMW center or a workshop that works according to BMW repair procedures with correspondingly trained personnel. ◀

Sports Wagon



Press the button, see arrow, or the  button on the remote control for a longer period. The tailgate will open slightly. It can now be swung upwards.

Press the button, see arrow, or the  button on the remote control a second time for a longer period within three seconds: the roll-up cover is raised.



Before closing the tailgate, press the cover downward until it engages.

Opening manually

Sports Wagon

In the event of an electrical malfunction:

1. From the cargo bay, swing the cover on the tailgate upward.

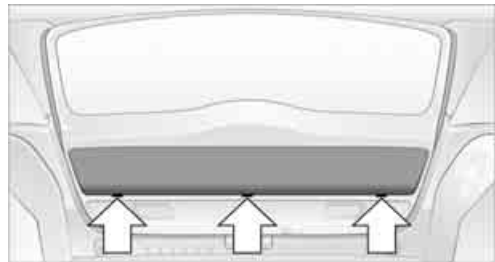

2. Pull the ring upward. The tailgate is unlocked.

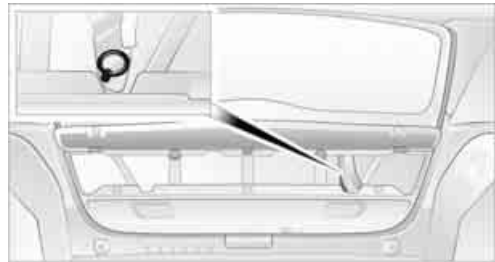

3. Open the tailgate and close the cover again. The tailgate is locked as soon as it is pressed shut.

Locking or unlocking separately

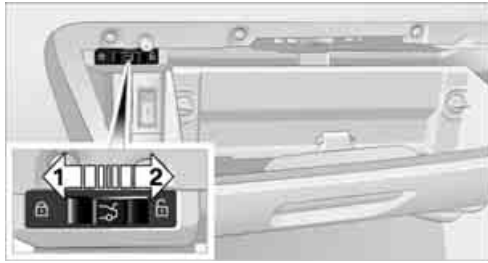

The switch is located in the glove compartment.

- 1 Locking the luggage compartment lid
- 2 Unlocking the luggage compartment lid

Locking separately

Push the switch in the direction of arrow **1**. The luggage compartment lid is locked and cannot be unlocked using the central locking system.

If you give the remote control without the integrated key to someone else while the glove compartment is locked, the luggage compartment lid cannot be opened. This is an advantage when valet parking, for example. Locking the glove compartment, refer to page **103**.

Unlocking separately

Push the switch in the direction of arrow **2**.

Emergency release



Pull the lever in the cargo bay. The luggage compartment lid is unlocked.

Closing

The handle recesses on the interior trim of the luggage compartment lid/tailgate make it easier to pull down.

 Make sure that the closing path of the luggage compartment lid/tailgate is clear, otherwise injuries may result. ◀

Sedan



Sports Wagon



Sports Wagon: opening and closing the rear window

Small items can be loaded and unloaded quickly when the rear window is opened separately.

 The roll-up cover is raised when the rear window is opened. Before closing the rear window, press the roll-up cover downward until it engages. ◀

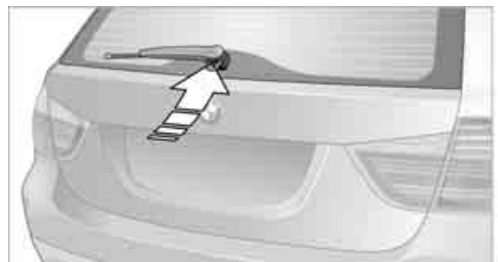

Press the button: the rear window opens slightly. It can now be swung upwards.

Press the window shut to close it.

 Make sure that the corners of any pointed or sharp-edged cargo are padded if they could bump against the rear window while the vehicle is in motion, otherwise the heating elements of the rear window could be damaged. ◀

Alarm system*

The concept

The vehicle alarm system responds:

- ▶ When a door, the hood or the luggage compartment lid/tailgate is opened
- ▶ To movements inside the vehicle: Interior motion sensor, refer to page 33
- ▶ When the car's inclination changes, for instance if an attempt is made to jack it up and steal the wheels or to raise it prior to towing away
- ▶ When there is an interruption in the power supply from the battery

The alarm system signals unauthorized entry attempts for a short time by means of:

- ▶ An acoustic alarm
- ▶ Switching on the hazard warning flashers
- ▶ Flashing the high beams

Arming and disarming

When you lock or unlock the vehicle, either with the remote control or at the door lock, the alarm system is armed or disarmed at the same time.

You can open the luggage compartment lid/tailgate even when the alarm system is armed, by pressing the  button on the remote control, refer to page 28. The lid is locked and monitored again as soon as you close it.

Panic mode*

You can trigger the alarm system if you find yourself in a dangerous situation:

Press the  button for at least three seconds.

To switch off the alarm: press any button.

Switching off an alarm

- ▶ Unlock the car with the remote control, refer to page 27.
- ▶ Insert the remote control all the way into the ignition lock.

Indicator lamp displays



- ▶ The indicator lamp under the inside rearview mirror flashes continuously: the system is armed.
- ▶ The indicator lamp flashes after locking: doors, hood, luggage compartment lid/tailgate or rear window are not properly closed. Even if you do not close the alerted area, the system begins to monitor the remaining areas, and the indicator lamp flashes continuously after approx. 10 seconds. The interior motion sensor and the tilt alarm sensor are not activated.
- ▶ The indicator lamp goes out after unlocking: your vehicle has not been disturbed while you were away.
- ▶ If the indicator lamp flashes after unlocking until the remote control is inserted in the ignition, but for no longer than approx. 5 minutes: your vehicle has been disturbed while you were away.

Tilt alarm sensor

The tilt of the vehicle is monitored. The alarm system reacts, e.g. to attempts to steal a wheel or tow the vehicle.

Interior motion sensor

In order for the interior motion sensor to function properly, the windows and glass roof must be completely closed*.

Avoiding unintentional alarms

The tilt alarm sensor and interior motion sensor may be switched off at the same time. This prevents unintentional alarms, e.g. in the following situations:

- ▷ In duplex garages
- ▷ During transport on car-carrying trains, boats/ships or on a trailer
- ▷ When animals are to remain in the vehicle

Switching off tilt alarm sensor and interior motion sensor

Press the  LOCK button on the remote control again as soon as the vehicle is locked.

The indicator lamp lights up briefly and then flashes continuously. The tilt alarm sensor and the interior motion sensor are switched off until the next time the vehicle is unlocked and subsequently locked again.

Convenient access*

Convenient access enables you to enter your vehicle without needing to hold the remote control in your hand. All you need to do is wear the remote control close to your body, e.g. in your jacket pocket. The vehicle detects the corresponding remote control within the immediate vicinity or in the passenger compartment.

Convenient access supports the following functions:

- ▷ Unlocking/locking the vehicle
- ▷ Unlocking the luggage compartment lid/tailgate separately
- ▷ Engine starting
- ▷ Convenient closure

Functional requirement

- ▷ The vehicle or the luggage compartment lid/tailgate can only be locked when the vehicle detects that the remote control currently in use is outside of the vehicle.
- ▷ The vehicle cannot be locked or unlocked again until after approx. 2 seconds.

- ▷ The engine can only be started when the vehicle detects that the remote control currently in use is inside the vehicle.

Comparison to the standard remote control

In general, there is no difference between using convenient access or pressing the buttons on the remote control to carry out the functions mentioned above. You should therefore first familiarize yourself with the instructions on opening and closing starting on page 26.

Special features regarding the use of convenient access are described below.

- ▷ If you notice a brief delay while opening or closing windows or the glass roof/panorama glass roof, the system is checking whether a remote control is inside the vehicle. Please repeat the opening or closing procedure, if necessary. ◀

Unlocking

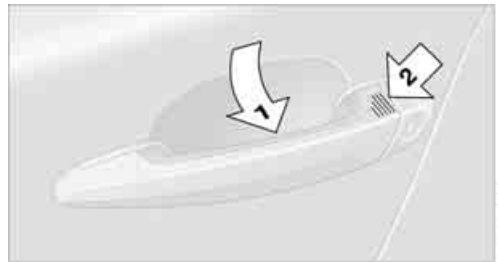

Grasp the handle on the driver's or front passenger's door completely, arrow 1. This corresponds to pressing the  button.

Locking

Touch the surface, arrow 2, with your finger for approx. 1 second. This corresponds to pressing the  LOCK button.

- ▷ To preserve the battery, please make sure that the ignition and all electrical consumers are switched off before locking the vehicle. ◀

Convenient closure

For convenient closure, keep your finger on the surface, arrow 2.

Unlocking the luggage compartment lid/tailgate separately

Press the button on the outside of the luggage compartment lid/tailgate. This corresponds to pressing the  button.

 If the vehicle detects that a remote control has been accidentally left inside the locked vehicle's cargo bay after the luggage compartment lid/tailgate or rear window is closed, the lid will reopen. The hazard warning flashers flash and an acoustic signal* sounds. ◀

Switching on radio readiness

Radio readiness is switched on by pressing the start/stop button, refer to page 53.

 Do not depress the brake or the clutch, otherwise the engine will start. ◀

Starting the engine

You can start the engine or switch on the ignition when a remote control is inside the vehicle. It is not necessary to insert a remote control into the ignition switch, refer to page 53.

Switching off the engine in cars with automatic transmission

The engine can only be switched off when the selector lever is in position P, refer to page 54. To switch the engine off when the selector lever is in position N, the remote control must be in the ignition switch.

Malfunction

Convenient access may malfunction due to local radio waves. If this happens, open or close the vehicle via the buttons on the remote control or using the integrated key. To start the engine afterward, insert the remote control into the ignition switch.

Warning lamps



The warning lamp in the instrument cluster lights up when you attempt to start the engine: the engine cannot be started. The remote control is not inside the vehicle or is malfunctioning. Take the remote control with you inside the vehicle or have it checked. If necessary, insert another remote control into the ignition switch.



The warning lamp in the instrument cluster lights up while the engine is running: the remote control is no longer inside the vehicle. After the engine is switched off, the engine can only be restarted within approx. 10 seconds.



The indicator lamp in the instrument cluster comes on and a message appears on the Control Display: replace the battery in the remote control.

Replacing the battery

The remote control for convenient access contains a battery that will need to be replaced from time to time.

1. Take the integrated key out of the remote control, refer to page 26.



2. Remove the cover.
3. Insert the new battery with the plus side facing up.
4. Press the cover on to close.



Take the old battery to a battery collection point or to your BMW center. ◀

Windows

 To prevent injuries, watch the windows while closing them.

Take the remote control with you when you leave the car, otherwise children could operate the electric windows and possibly injure themselves. ◀

Opening, closing



- ▷ Press the switch to the resistance point: The window opens as long as you press the switch.
- ▷ Press the switch beyond the resistance point: The window opens automatically. Press the switch again to stop the opening movement.

You can close the windows in the same manner by pulling the switch.

There are separate switches in the rear seat armrests.

After switching off the ignition

When the remote control is removed or the ignition is switched off, you can still operate the windows for approx. 1 minute as long as no door is opened.

Convenient operation

For information on convenient operation via the remote control or the door lock, refer to page 27 or 29. For information on closing with convenient access, refer to Locking on page 28.

Pinch protection system

If the closing force exceeds a specific value as a window closes, the closing action is interrupted and the window reopens slightly.

 Despite the pinch protection system check and clear the window's travel path prior to closing it, otherwise the safety system might fail to detect certain kinds of obstructions, such as thin objects, and the window would continue closing.

Do not install any accessories that might interfere with window movement. Otherwise the pinch protection system could be impaired. ◀

Closing without pinch protection

If there is an external danger, or if ice on the windows, etc., prevents you from closing the windows normally, proceed as follows:

1. Pull the switch past the resistance point and hold it there. Pinch protection is limited and the window reopens slightly if the closing force exceeds a certain value.
2. Pull the switch again past the resistance point within approx. 4 seconds and hold it there. The window closes without pinch protection.

Safety switch



With the safety switch, you can prevent the rear windows from being opened or closed via the switches in the rear passenger area, by children, for example. When the safety function is switched on, the LED comes on.

 Always press the safety switch when children ride in the rear, otherwise unchecked closing of the windows could lead to injuries. ◀

Sedan: glass roof*, electric

 To prevent injuries, watch the glass roof while closing it.

Take the remote control with you when you leave the car, otherwise children could operate the roof and possibly injure themselves. ◀



Raising

Press the switch.

- ▶ The closed glass roof is raised and the sliding visor opens slightly.
- ▶ The open glass roof automatically travels into the raised position. The sliding visor remains completely open.

Opening, closing

- ▶ Press the switch backwards to the resistance point.
The glass roof and the sliding visor open together as long as you hold the switch in this position.
- ▶ Press the switch backwards past the resistance point.
The glass roof and the sliding visor open automatically. Briefly press the switch again to stop the opening movement.

You can close the glass roof in a similar manner by pressing the switch forwards. The sliding visor remains open and can be closed by hand.

For information on convenient operation via the remote control or door lock, refer to page 27 or 29.

After switching off the ignition

When the remote control is removed or the ignition is switched off, you can still operate the roof

for approx. 1 minute as long as no door has been opened.

Pinch protection system

If the glass roof encounters an obstruction during closing from approximately the middle of the opening in the roof, or during closing from the raised position, the closing movement is interrupted and the glass roof is opened again slightly.

 Despite the pinch protection system check and clear the roof's travel path prior to closing it, otherwise the safety system might fail to detect certain kinds of obstructions, such as very thin objects, and the roof would continue closing. ◀

Closing without pinch protection

If there is an external danger, press the switch forward past the resistance point. The roof closes without pinch protection.

Following interruptions in electrical power supply

After a power failure, there is a possibility that the glass roof can only be raised. The system must be initialized. BMW recommends having this work done by your BMW center.

Closing manually*

In the event of an electrical malfunction, you can move the glass roof manually:

1. Unclip the front of the cover of the interior lamps using the screwdriver from the onboard tool kit, refer to page 222.



2. Insert the screwdriver into the openings on each side to press the clips.



3. Remove the control unit.
4. Unplug the motor. Considerably less effort will be required for manual operation.

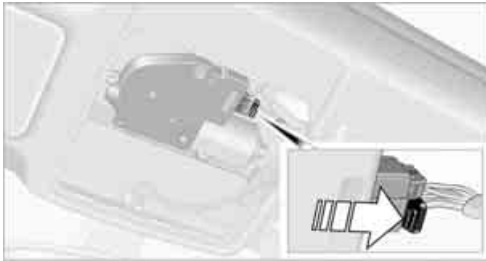

5. Insert the Allen wrench* supplied with the onboard tool kit, refer to page 222, into the opening provided. Move the glass roof in the desired direction.

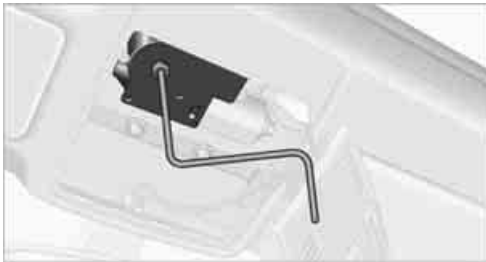

6. Reinstall the control unit and reattach the lamp cover.

Sports Wagon: Panorama glass roof*

-  To prevent injuries, exercise care when closing the panorama glass roof and keep

it in your field of vision until it is shut. Take the remote control with you when you leave the car, otherwise children could operate the roof and possibly injure themselves. ◀



Raising

Press the switch.

The closed roof is raised and the sliding visor opens slightly.

-  Do not close the sliding visor forcibly with the roof in the raised position, as this would damage the mechanism. ◀

Opening, closing

Sliding visor

The sliding visor can be opened or closed separately when the roof is in the closed or raised position.

- ▷ Press the switch backwards to the resistance point. The sliding visor opens as long as you keep the switch in this position.
- ▷ Tap the switch backwards past the resistance point. The sliding visor opens automatically. Tapping the switch again stops the operation.

You can close the sliding visor in a similar manner by pressing the switch forwards.

Panorama glass roof

When the sliding visor is open, proceed as described under Sliding visor.

For information on convenient operation via the remote control or door lock, refer to page 28 or 29.

Opening and closing the roof and sliding visor at the same time

Tap the switch twice in quick succession beyond the resistance point.
Tapping the switch again stops the operation.

Convenience functions

- ▶ With the roof open, press the switch twice: The roof is raised.
- ▶ With the roof open, tap the switch twice in the direction for opening: The roof is opened fully.

Comfort position

In the comfort position, the roof is not completely open, thus reducing wind noise in the passenger compartment.

Each time the panorama glass roof is opened or closed completely, it stops in the comfort position. If desired, continue the movement by pressing the switch.

After switching off the ignition

When the remote control is removed or the ignition is switched off, you can still operate the roof for approx. 1 minute as long as no door has been opened.

Pinch protection system

If the panorama glass roof or the sliding visor encounters an obstruction while closing from a position about two-thirds closed, or during closing from the raised position, the closing movement is interrupted and the panorama glass roof and the sliding visor are opened again slightly.

 Despite the pinch protection system check and clear the roof's travel path prior to closing it, otherwise the safety system might fail to detect certain kinds of obstructions, such as very thin objects, and the roof would continue closing. ◀

Closing without pinch protection

If there is an external danger, press the switch forward past the resistance point and hold it there. The roof closes without pinch protection.

Following interruptions in electrical power supply

After a power failure, there is a possibility that the panorama glass roof can only be raised. The system must be initialized. BMW recommends having this work done by your BMW center.

Closing manually*

In the event of an electrical malfunction, you can move the panorama glass roof manually:

1. Unclip the front of the cover of the interior lamps using the screwdriver from the onboard tool kit, refer to page 222.



2. Insert the screwdriver into the openings on each side to press the clips.



3. Remove the control unit.

4. Unplug the motor. Considerably less effort will be required for manual operation.

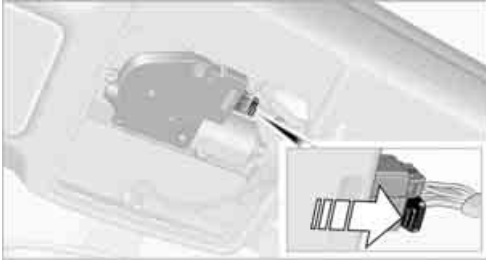

5. Insert the Allen wrench* supplied with the onboard tool kit, refer to page [222](#), into the opening provided. Move the panorama glass roof in the desired direction.

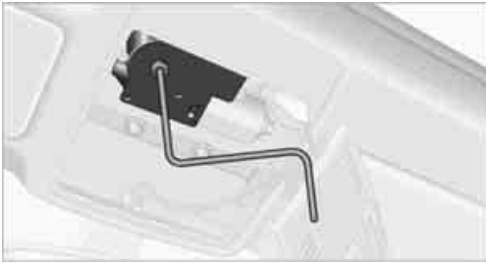

6. Reinstall the control unit and reattach the lamp cover.

Adjustments

Sitting safely

The ideal sitting position can make a vital contribution to relaxed, fatigue-free driving. In conjunction with the safety belts, the head restraints and the airbags, the seated position has a major influence on your safety in the event of an accident. To ensure that the safety systems operate with optimal efficiency, we strongly urge you to observe the instructions contained in the following section.

For additional information on transporting children safely, refer to page 49.

Airbags

 Always maintain an adequate distance between yourself and the airbags. Always grip the steering wheel on the rim, with your hands in the 3 o'clock and 9 o'clock positions, to minimize the risk of injury to the hands or arms in the event of the airbag being triggered off.

No one and nothing is to come between the airbags and the seat occupant.

Do not use the cover of the front airbag on the front passenger side as a storage area. Make sure that the front passenger is sitting correctly, e.g. not resting feet or legs on the dashboard, otherwise leg injuries can occur if the front airbag is triggered.

Make sure that passengers do not lean their heads against the side or head airbags, otherwise serious injuries could result if the airbags suddenly deployed. ◀

Even if you follow all the instructions, injuries resulting from contact with airbags cannot be fully excluded, depending on the circumstances. The ignition and inflation noise may provoke a mild hearing loss in extremely sensitive individuals. This effect is usually only temporary.

For airbag locations and additional information on airbags, refer to page 88.

Head restraint

A correctly adjusted head restraint reduces the risk of neck injury in the event of an accident.

 Adjust the head restraint in such a way that its center is at approx. ear level. Otherwise, there is an increased risk of injury in the event of an accident. ◀

Head restraints, refer to page 43.

Safety belt

Before every drive, make sure that all occupants wear their safety belts. Airbags complement the safety belt as an additional safety device, but they do not represent a substitute.

Your vehicle has five seats, each of which is equipped with a safety belt.

 Never allow more than one person to wear a single safety belt. Never allow infants or small children to ride in a passenger's lap. Make sure that the belt in the lap area sits low across the hips and does not press against the abdomen.

The safety belt must not rest against the throat, run across sharp edges, pass over hard or fragile objects or be pinched. Fasten the safety belt so that it sits as snugly as possible against the lap and shoulder without being twisted. Otherwise the belt could slide over your hips and injure your abdomen in the event of a frontal collision.

Avoid wearing bulky clothing and regularly pull the belt in the upper-body area taut, otherwise its restraining effect could be impaired.

Sports Wagon: if the rear center safety belt is used, the wider backrest must be locked in place, refer to page 107. Otherwise the safety belt will have no restraining effect. ◀

Safety belts, refer to page 46.

Seats

Note before adjusting

⚠ Never attempt to adjust your seat while the vehicle is moving. The seat could respond with unexpected movement, and the ensuing loss of vehicle control could lead to an accident.

On the front passenger seat as well, do not incline the backrest too far to the rear while the vehicle is being driven, otherwise there is a danger in the event of an accident of sliding under the safety belt, eliminating the protection normally provided by the belt. ◀

Comply with the instructions on head restraint height on page 43, and on damaged safety belts on page 46.

Manual adjustment

⚠ Observe the adjustment instructions on page 42 to ensure the best possible personal protection. ◀

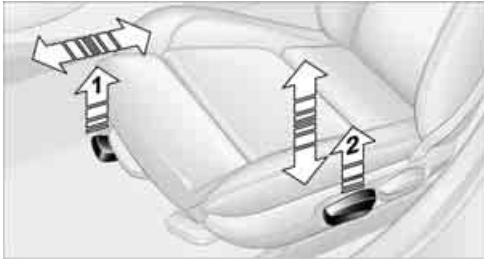

Longitudinal direction

Pull lever **1** and slide the seat to the desired position. After releasing the lever, move the seat gently forward or back to make sure it engages properly.

Height

Pull lever **2** and apply your weight to the seat or lift it off, as necessary.

Backrest

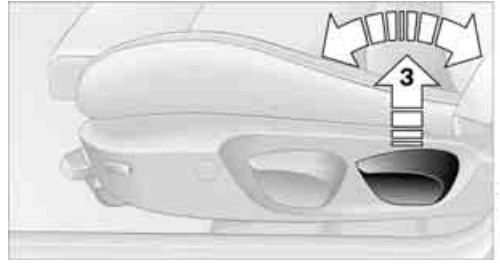

Pull lever **3** and apply your weight to the backrest or lift it off, as necessary.

Tilt*

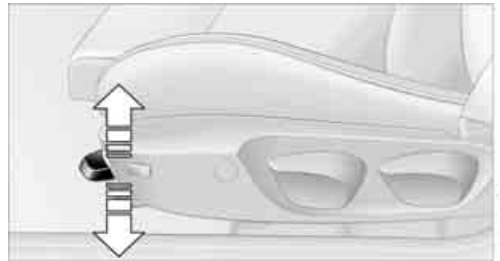

Pull the lever and apply your weight to the seat or lift it off, as necessary.

Thigh support*

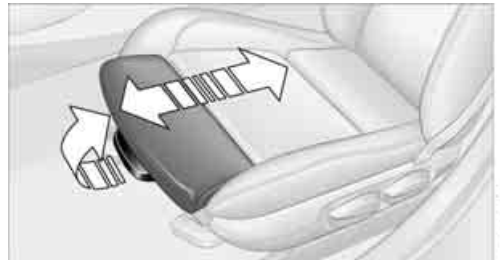

Pull the lever and move the thigh support forward or back.

Electrical adjustment

⚠ Observe the adjustment instructions on page 42 to ensure the best possible personal protection. ◀

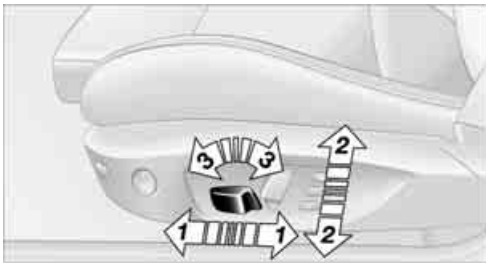

- 1 Longitudinal direction
- 2 Height
- 3 Angle



4 Backrest

The head restraints are adjusted manually, refer to Head restraints below.

Lumbar support*



You can also adjust the contour of the backrest to obtain additional support in the lumbar region.

The upper hips and spinal column receive supplementary support to help you maintain a relaxed, upright sitting position.

- ▷ Increase or decrease curvature: press the switch at the front or rear, respectively.

- ▷ Shift curvature up or down: press the switch at the top or bottom, respectively.

Backrest width*



You can change the width of the backrest to suit your individual preferences by adjusting the lateral-support pads.

Press the front or rear end of the switch. Backrest width decreases or increases accordingly.

Head restraints

A correctly adjusted head restraint reduces the risk of neck injury in the event of an accident.

- ⚠ Adjust the head restraint in such a way that its center is at approx. ear level. Otherwise, there is an increased risk of injury in the event of an accident. Only remove a head restraint if no one will be sitting on the seat in question. Reinstall the head restraint before transporting anyone on that seat. Otherwise, the passenger will be without protection from the head restraint. ◀

Front active head restraints

In a rear collision of a sufficient strength, the active head restraint reduces the distance to the head.

- ⚠ Do not use seat or head restraint covers that could impair the function of the active head restraint. Otherwise, the protective function of the active head restraint will not be ensured and its full potential in reducing the risk of injury in the event of a rear collision may not be realized.

In the event of malfunctions, deactivation or

triggering of the active head restraints, have the testing, repair and removal executed only by a BMW center or a workshop that works according to repair procedures of BMW with correspondingly trained personnel and that has the required explosives licenses. Unprofessional attempts to work on the system could lead to failure in an emergency or to undesired airbag activation, either of which could result in personal injury. ◀

▷ For technical reasons, the head restraint cannot be removed. ◀

Front seats

Height adjustment

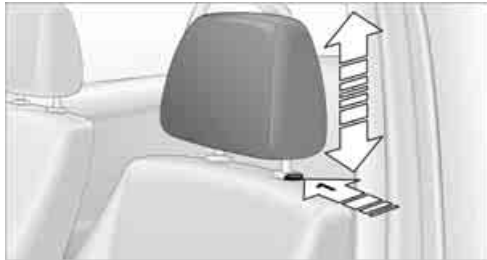

- ▷ To raise: pull up.
- ▷ To lower: press the button, arrow **1**, and slide the head restraint down.

Rear seats

Height adjustment

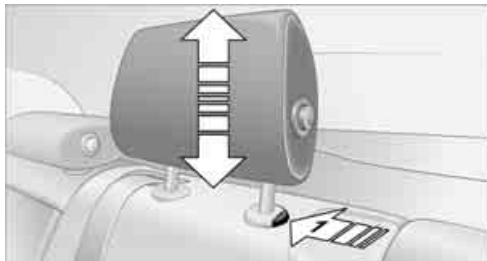

- ▷ To raise: pull up.
- ▷ To lower: press the button, arrow **1**, and slide the head restraint down.

The center head restraint is not height-adjustable.

Removing

Sedan:

Only with through-loading system:

1. Pull up as far as it will go.
2. Press the button, arrow **1**, tilt the rear seat backrest slightly forward and pull the head restraint all the way out.

▷ Only remove the head restraints if no passengers will be sitting in the rear. Reinstall head restraints before transporting passengers in the rear. ◀

Folding head restraints down and back up

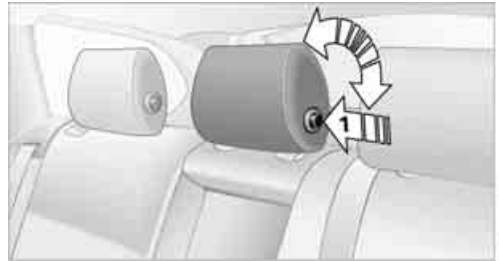

Folding down:

Press the button, arrow **1**.

Folding up:

Pull the head restraint.

Depending on the equipment version, it may be possible to fold down the outer rear head restraints as well.

▷ Only fold the head restraints down if no passengers will be sitting in the rear. Fold up the head restraints before transporting passengers in the rear. ◀

Heated seats*



Press once for each temperature level. Three LEDs indicate the highest temperature.

To switch off:

Press button longer.

If you continue driving within approx. the next 15 minutes, the seat heating is automatically activated at the previously set temperature.

The temperature is lowered or the heating is switched off entirely to save on battery power. The LEDs stay lit.

Seat and mirror memory*

You can store and call up two different combinations of driver's-seat and exterior-mirror positions.

Settings for the backrest width and lumbar support are not stored in memory.

Storing

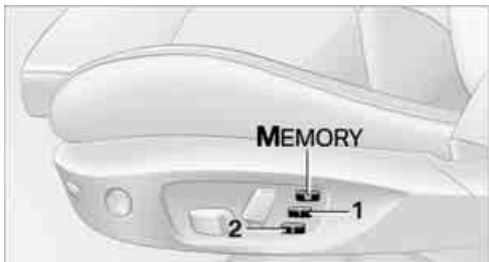

1. Switch on radio readiness or the ignition, refer to page 53.
2. Adjust the seat and exterior mirrors to the desired positions.

3. Press the **M** button. The LED in the button lights up.
4. Press the desired memory button **1** or **2**: the LED goes out. The driver's seat and exterior mirror positions are stored for the remote control currently in use.

Call-up

 Do not call up memory while you are driving, otherwise unexpected seat movement could result in an accident. ◀

Convenience mode

1. Unlock and open the driver's door or switch on radio readiness, refer to page 53.
2. Briefly press the desired memory button **1** or **2**.

The adjusting procedure is halted immediately when you touch a seat adjustment switch or one of the memory buttons.

Safety feature

1. Close the driver's door and switch the ignition on or off, refer to page 53.
2. Press the desired memory button **1** or **2** and keep it pressed until the adjustment process has been completed.

If the **M** button was pressed accidentally: Press the button again; the LED goes out.

Call-up with the remote control

The driver's seat position last stored is stored for the remote control currently in use.

You can select the occasion on which the seat is reset to that position.

- ▷ Call-up when the vehicle is unlocked.
- ▷ Call-up when the driver's door is opened.

 When this Personal Profile function is used, first make sure that the footwell behind the driver's seat is free of obstacles. Failure to do so could cause injury to persons or damage to objects as a result of a rearward movement of the seat. ◀

The adjusting procedure is halted immediately when you touch a seat adjustment switch or one of the memory buttons.

Selecting automatic call-up

iDrive, for operating principle refer to page 16.

1. "Settings"
2. "Door locks"
3. "Last seat position auto."



 The function for automatically calling up the last seat position is switched on and is stored for the remote control currently in use.

Switching off automatic call-up

Deactivate "Last seat position automatic".

Safety belts

 Observe the adjustment instructions on page 42 to ensure the best possible personal protection. ◀

Before every drive, make sure that all occupants wear their safety belts. Airbags complement the safety belt as an additional safety device, but they do not represent a substitute.

On the rear seats, the center belt buckle marked with the letters CENTER is solely intended for the center passenger.



Closing

Make sure you hear the latch plate engage in the belt buckle.

The upper belt anchor is suitable for adults of any stature as long as the seat is adjusted properly, refer to page 42.

Opening

1. Grasp the belt firmly.
2. Press the red button in the buckle.
3. Guide the belt into its reel.

'Fasten safety belts' reminder for front seats



The indicator lamps light up and an acoustic signal sounds. In addition, a message appears on the Control Display. Check whether the safety belt has been fastened correctly.

The 'Fasten safety belts' reminder is issued as long as the driver's safety belt has not been fastened. The 'Fasten safety belts' reminder is also activated at road speeds above approx. 5 mph or 8 km/h if the front passenger's safety belt is not fastened, if objects are placed on the front passenger seat, or if driver or front passenger unfasten their safety belts.

Damage to safety belts

 If the safety belts are damaged or stressed in an accident: have the belt system, including any belt tensioners or child-restraint systems, replaced and the belt anchors checked. Have this work done only by your BMW center or at a workshop that works according to BMW repair procedures with cor-

responsively trained personnel. Otherwise, it is not guaranteed that the safety devices will function properly. ◀

Rear center safety belt

With through-loading system*:

Before using the center rear seat, release the latch plate from the fixture on the rear window shelf and insert it into the belt lock of the center safety belt. Make sure you hear the latch plate engage in the belt buckle.

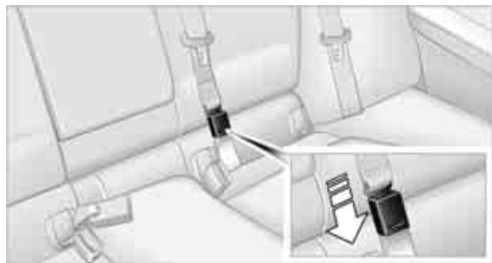

Mirrors

Exterior mirrors

! The front passenger's mirror is more convex than the driver's mirror. The objects seen in the mirror are closer than they appear. Do not gauge your distance from traffic behind you on the basis of what you see in the mirror; otherwise there is an increased risk of an accident. ◀

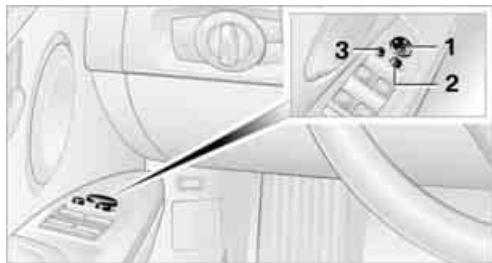

- 1 Adjustments
- 2 Switching to the other mirror or automatic curb monitor*
- 3 Folding mirrors in and out*

The setting for the exterior mirrors is stored for the remote control currently in use*. The stored position is called up automatically when the vehicle is unlocked.

Manual adjustment

The mirrors can also be adjusted manually: press the edge of the glass.

Folding mirrors in and out*

At driving speeds up to approx. 12 mph/ 20 km/h, you can fold the mirrors in and out by pressing button **3**. This can be beneficial in narrow streets, for example, or for moving mirrors that were folded in by hand back out into their correct positions. Mirrors that were folded in are folded out automatically at a speed of approx. 25 mph/40 km/h.

! Before entering an automatic car wash, fold in the exterior mirrors manually or with button **3** to prevent them from being damaged, depending on the width of the vehicle. ◀

Automatic heating*

Depending on the outside temperature, both exterior mirrors are heated automatically when the engine is running or the ignition is switched on.

Passenger-side mirror tilt function – automatic curb monitor*

Activating

1. Push the switch to the position for the driver's-side mirror, arrow 1.

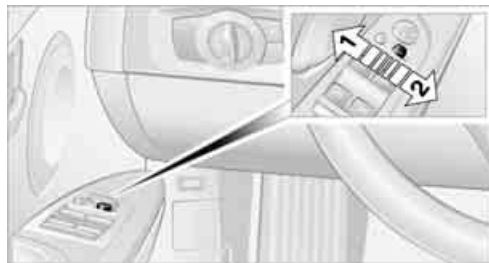

2. Shift to reverse or engage selector lever position R.

The glass of the mirror on the passenger side tilts slightly down. This allows the driver to see the area immediately adjacent to the vehicle, e.g. a curb, when backing into a parking space.

Deactivating

Push the switch to the position for the passenger-side mirror, arrow 2.

Interior rearview mirror



Turn the knob to reduce glare from the headlamps of cars behind you when driving at night.

Interior and exterior mirrors, automatic dimming feature*

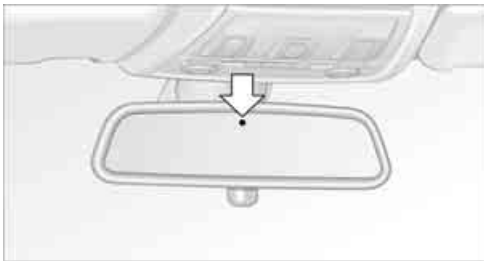

The automatic dimming feature of the interior and exterior mirrors* is controlled by two photo cells in the interior rearview mirror. One photo cell is in the mirror frame, see arrow; the other is on the back of the mirror.

In order to ensure that the system functions correctly, keep the photo cells clean, do not cover the area between the interior rearview mirror and windshield, and do not affix adhesive labels or stickers of any kind to the windshield directly in front of the mirror.

Steering wheel

Adjustments

 Do not adjust the steering wheel position while the car is in motion, otherwise there is a risk of accident due to an unexpected movement. ◀

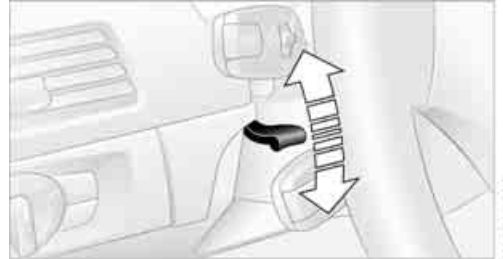

1. Fold the lever down.
2. Move the steering wheel to the preferred height and angle to suit your seated position.
3. Swing the lever back up.

 Do not use force to swing the lever back up, otherwise the mechanism will be damaged. ◀

Steering wheel heating*



Press the button.

The LED in the button lights up when the steering wheel heating is switched on.

Transporting children safely

The right place for children

⚠ Do not leave children unattended in the vehicle, otherwise they could endanger themselves and/or other persons by opening the doors, for example. ◀

The rear center seat is not suitable for installing child-restraint systems for all age groups, approved for the age group in question.

Children always in the rear

Accident research has shown that the safest place for children is on the rear seat.

⚠ Children under the age of 13 or smaller than 5 ft/150 cm may be transported only in the rear in suitable child-restraint systems appropriate for their age, weight and size. Otherwise there is an increased risk of injury in the event of an accident. ◀

Children 13 years of age or older must be buckled in with a safety belt as soon as there no longer is any child-restraint system that is appropriate for their age, size and weight.

Exception for front passenger seat

⚠ Should it be necessary to use a child-restraint system on the front passenger seat, the front and side airbags for the front passenger must be deactivated. Otherwise, a child traveling on that seat will face a significant risk of injury if the airbags are triggered off, even with a child-restraint system. ◀

For more information on automatic deactivation of the front passenger airbags refer to page 88.

Installing child-restraint systems

⚠ Observe the child-restraint system manufacturer's instructions when selecting, installing and using child-restraint systems. Otherwise the protective effect may be diminished. ◀

Standard child-restraint systems are designed to be secured with a lap belt or with the lap-belt section of a lap-and-shoulder belt. Incorrectly or improperly installed child-restraint systems can increase the risk of injury to children. Always follow the installation instructions for the system with the greatest care.

On the front passenger seat

⚠ After installing a child-restraint system on the front passenger seat, make sure that the front and side airbags for the front passenger are deactivated, otherwise there is an increased risk of injury if the airbags deploy. ◀

Backrest width*

⚠ The backrest width of the front passenger's seat must be at its widest possible setting. Do not change the setting after installing the child seat. Otherwise the child seat's stability on the front passenger's seat is limited. ◀

1. Adjust the backrest width to its widest setting, refer to page 43.
2. Install the child seat.

Child seat security



The rear safety belts and the front passenger's safety belt can be prevented from being pulled out in order to fasten child-restraint systems.

To lock the safety belt

1. Secure the child-restraint system with the belt.
2. Pull the belt strap all the way out.
3. Allow the belt strap to retract and pull it taut against the child-restraint system.

The safety belt is locked.

To unlock the safety belt

1. Open the belt buckle.
2. Remove the child-restraint system.
3. Allow the safety belt strap to retract all the way.

LATCH child-restraint fixing system

LATCH: Lower Anchors and Tethers for Children.

⚠ To install and use the LATCH child restraint system, follow the operating and safety instructions provided by the manufacturer of the system, otherwise the protective function of the seat may be compromised. ◀

Before installing the child seat, pull the belt out of the area for the child-restraint fixing system.

⚠ Ensure that both lower LATCH anchors are correctly engaged and that the child restraint system is resting firmly against the backrest, otherwise the protective function of the seat may be compromised. ◀

Rear seats with through-loading system



The anchor points for the lower LATCH anchors are located behind the labeled protective caps.

Rear seats without through-loading system

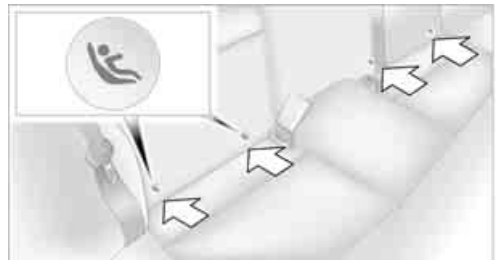

The anchor points for the lower LATCH anchors are located at the positions indicated by arrows, in the gap between the seat and the backrest.

Child-restraint system with tether strap

⚠ Use the top tether anchors to secure child-restraint systems only, otherwise the anchors could be damaged. ◀

Sedan

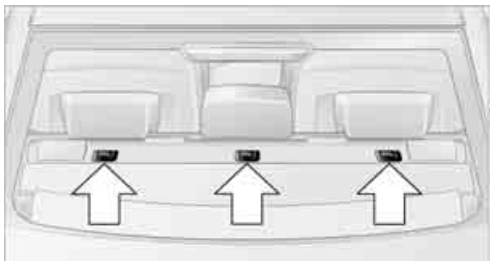

There are three additional anchors for child-restraint systems with tether straps, see arrows.

Sports Wagon

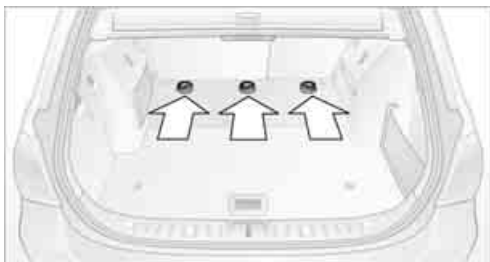

There are three additional anchors under a cover for child-restraint systems with tether straps, see arrows.

Placement of the tether strap

 Make sure the upper retaining strap does not run over sharp edges and is not twisted as it passes to the top anchor. Otherwise the strap will not properly secure the child-restraint system in the event of an accident. ◀

Sedan

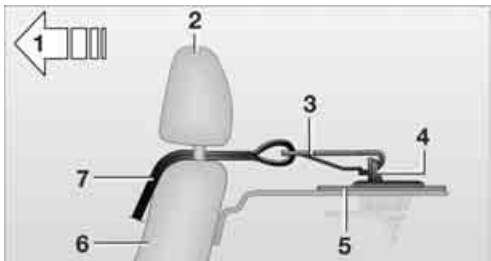

Sports Wagon

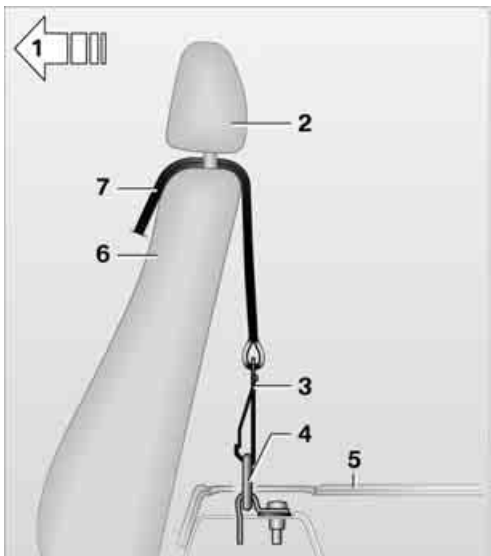

- 1 Direction of travel
- 2 Head restraint
- 3 Hook for upper retaining strap
- 4 Anchor
- 5 Rear window shelf/cargo bay floor
- 6 Seat backrest
- 7 Upper retaining strap of child-restraint system

Fold the anchors and, if necessary, the head restraints* upward before use.

1. Push the head restraint upward.
2. Guide the upper retaining strap between the head restraint holders.

3. Use the hook to clip the retaining strap to the anchor.
4. Push the head restraint into its lowermost position.
5. Pull the retaining strap taut.

On journeys

Child-safety locks for rear doors



Slide down the safety lever on the rear door:

The door can now be opened from the outside only.

Safety switch for power windows

Press the safety switch for the power windows, refer to page 36, if children are traveling on the rear seat.

Ignition lock

Insert the remote control into the ignition lock



Insert the remote control all the way into the ignition lock.

- ▷ Radio readiness is switched on. Individual electrical consumers can operate.

Convenient access*

If the car is equipped with convenient access, only insert the remote control into the ignition lock under special circumstances, refer to page 34.

Removing the remote control from the ignition lock

 Do not forcibly pull the remote control out of the ignition lock as this may cause damage. ◀

Before removing the remote control, push it all the way in to release the locking mechanism.

- ▷ The ignition is switched off if it was on.

Automatic transmission

You cannot take out the remote control unless the selector lever is in the P position: interlock.

Start/stop button

Pressing the start/stop button switches radio readiness or the ignition on or off.

- ▷ Manual transmission: the engine is started when you press the start/stop button and depress the clutch.
Automatic transmission: the engine is started when you press the start/stop button and depress the brake. ◀

Radio readiness

Individual electrical consumers can operate. The time and the outside temperature are displayed in the instrument cluster.

Radio readiness is switched off automatically:

- ▷ When the remote control is removed from the ignition lock
- ▷ In cars with convenient access*, by touching the surface above the door lock, refer to Locking on page 34

Ignition on

All electrical consumers can operate. The odometer and trip odometer are displayed in the instrument cluster.

- ▷ When the engine is off, please switch off the ignition and any unnecessary electrical consumers in order to preserve the battery. ◀

Radio readiness and ignition off

All indicator and warning lamps as well as displays in the instrument cluster go out.

Starting the engine

- ▷  Do not run the engine in closed rooms, otherwise the inhalation of toxic exhaust gases can cause unconsciousness and death. The exhaust gases contain carbon monoxide, an odorless and colorless, but highly toxic gas. Never leave an unattended vehicle with the engine running, otherwise such a vehicle represents a potential safety hazard. Before leaving the car with the engine running,

place the transmission in neutral or engage selector lever position P and forcefully apply the parking brake to prevent the car from moving. ◀

 Avoid frequent starting in quick succession as well as repeated start attempts in which the engine does not start. Otherwise, the fuel is not burned or incompletely burned and there is a danger of overheating and damaging the catalytic converter. ◀

Do not wait for the engine to warm up while the vehicle remains stationary. Start driving right away, but at moderate engine speeds.

Manual transmission

Remote control in the ignition lock or, with convenient access, inside the vehicle, refer to page 34.

1. Depress the brake.
2. Depress the clutch and shift to neutral position.
3. Press the start/stop button.

The starter operates automatically for a certain time, and stops automatically as soon as the engine has started.

Automatic transmission

Remote control in the ignition lock or, with convenient access, inside the vehicle, refer to page 34.

1. Depress the brake.
2. Move the selector lever to position P.
3. Press the start/stop button.

The starter operates automatically for a certain time, and stops automatically as soon as the engine has started.

Diesel engine

When the engine is cold and temperatures are below approx. 32 °F / 0 °C, the starting process may take a little more time due to automatic preheating. The preheating indicator lamp in the instrument cluster comes on; at the same time a message appears on the Control Display.

Switching off the engine

 Always take the remote control with you when you leave the vehicle. When parking, apply the parking brake forcefully, otherwise the vehicle could begin to roll. ◀

Manual transmission

1. With the car at a standstill, press the start/stop button.
2. Shift into first gear or reverse.
3. Forcefully apply the parking brake.
4. Removing the remote control from the ignition lock, refer to page 53.

Automatic transmission

1. With the car at a standstill, move the selector lever to position P.
2. Press the start/stop button.
3. Forcefully apply the parking brake.
4. Removing the remote control from the ignition lock, refer to page 53.

Parking brake

The parking brake is primarily intended to prevent the vehicle from rolling while parked; it brakes the rear wheels.

Indicator lamp

 The indicator lamp is lit, and when you drive off an acoustic signal sounds in addition. The parking brake is still applied.

 Indicator lamp for Canadian models.

Applying

The lever locks in position automatically.

Releasing

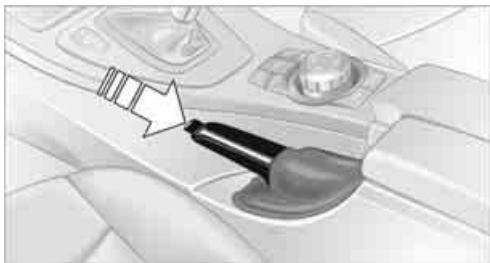

Pull slightly upwards, press the button and lower the lever.

⚠ In exceptional cases, if the parking brake has to be used to slow or stop the car, do not pull the lever up too hard. In doing so, continuously press the button of the parking brake lever.

Otherwise, excessive force on the parking brake can lock up the rear wheels and cause the rear of the car to swerve. ◀

▶ To prevent corrosion and one-sided braking action, occasionally apply the parking brake lightly when the vehicle is slowly coming to a stop if the traffic conditions are suitable. The brake lamps do not light up when the parking brake is applied. ◀

Manual transmission



⚠ When shifting into 5th or 6th gear, press the gearshift lever to the right. Otherwise the engine could be damaged if you inadvertently shift into 3rd or 4th gear. ◀

Reverse gear

Select this only when the vehicle is stationary. When the gearshift lever is pressed to the left, a slight resistance has to be overcome.

Automatic transmission with Steptronic*

In addition to fully automatic operation, you can also manually shift with the Steptronic, refer to page 56.

Vehicle parking

⚠ To prevent the vehicle from rolling, always select position P and apply the parking brake before leaving the vehicle with the engine running. ◀

Disengaging the remote control

In order to remove the remote control from the ignition lock, you must first move the selector lever to position P and switch off the engine: interlock. Removing the remote control from the ignition lock, refer to page 53.

Selector lever positions

P R N D M/S + -

Displays in the instrument cluster



P R N D DS M1 to M6

The selector lever position is displayed, or the current gear in the manual mode.

Changing selector lever positions

- ▷ With the ignition switched on or the engine running, the selector lever can be moved out of position P: interlock.
- ▷ Before moving the lever away from P or N with the vehicle stationary, first depress the brake; otherwise the selector lever will refuse to move: shiftlock.



To prevent the vehicle from creeping after you select a driving position, depress the brake until you are ready to start. ◀



A lock prevents you from inadvertently engaging selector lever positions R and P. To cancel the lock, press the button on the front of the selector lever, see arrow.

P Park

Select this only when the vehicle is stationary. The rear wheels are locked.

R Reverse

Select this only when the vehicle is stationary.

N Neutral

You can select this in a car wash, for example. The vehicle can roll.

D Drive, automatic position

Position for normal vehicle operation. All forward gears are selected automatically.

Under normal operating conditions, fuel consumption is lowest when you are driving in position D.

Kick-down

Kick-down enables you to achieve maximum performance.

Press the accelerator pedal beyond the full-throttle resistance point.

Sport program and manual operation M/S



Move selector lever from position D toward the left into the M/S shifting slot:

The sport program is activated and DS is displayed in the instrument cluster. This position is recommended for a performance-oriented driving style.

To use the automatic mode again, move the selector lever to the right into position D.

Shifting gears via the selector lever

When you press the selector lever forwards or backwards, the manual mode is activated and Steptronic changes gear. M1 through M6 are displayed in the instrument cluster.

Upshifts and downshifts are executed only when they will result in a plausible combination of engine and vehicle speed; thus, for example, a downshift that would cause the engine to overrev will not be executed by the system. The gear selected is briefly displayed in the instrument cluster, followed by the gear actually in use.

Shifting gears via shift paddles* on the steering wheel

The shift paddles allow you to shift gears quickly since both hands can remain on the steering wheel.

- ▷ When you use the shift paddles on the steering wheel to shift gears in automatic mode, the transmission switches to manual mode.
- ▷ If you do not accelerate or shift gears using the shift paddles for a certain amount of time, the transmission switches back to automatic mode.

 If the selector lever is in the M/S gear plane, manual mode remains active. ◀

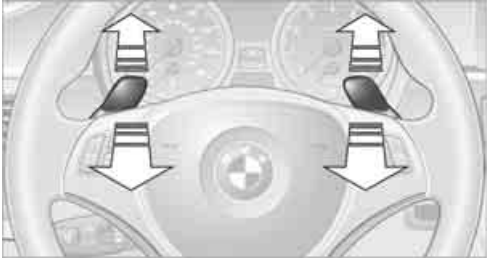

- ▷ To shift up: pull one of the shift paddles.
- ▷ To shift down: press one of the shift paddles.

Upshifts and downshifts are executed only when they will result in a plausible combination of engine and vehicle speed; thus, for example, a downshift that would cause the engine to overrev will not be executed by the system. The gear selected is briefly displayed in the instrument cluster, followed by the gear actually in use.

Overriding selector lever lock

Should the selector lever refuse to move out of position P although the button on the selector lever is pressed, the selector lever lock can be overridden:

1. Unclip the sleeve of the selector lever.
2. Pull the sleeve up over the selector lever until the sleeve is inside out.

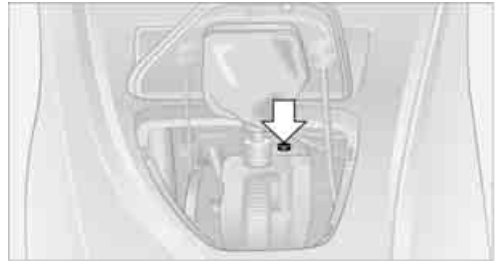

3. Using the screwdriver from the onboard tool kit, refer to page 222, press the red lever while moving the selector lever to the desired position.

Turn signals/ headlamp flasher

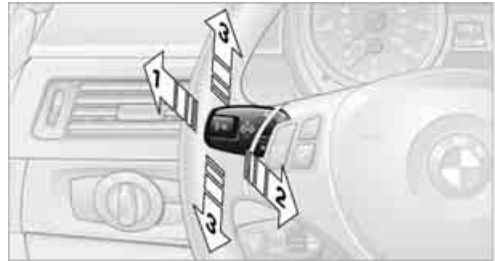

- 1 High beams
- 2 Headlamp flasher
- 3 Turn signals

Using turn signals

Press the lever beyond the resistance point.

To turn off manually, press the lever to the resistance point.

 Unusually rapid flashing of the indicator lamp indicates that a turn signal indicator has failed. ◀

Indicating a turn briefly

Press the lever as far as the resistance point for as long as you wish to indicate a turn.

Triple turn signal activation

Press the lever as far as the resistance point. The turn signals flash three times.

You can activate or deactivate this function.

iDrive, for operating principle refer to page 16.

1. "Settings"
2. "Lighting"
3. "Triple turn signal"



Triple turn signal activation is activated and is stored for the remote control currently in use.

Wiper system

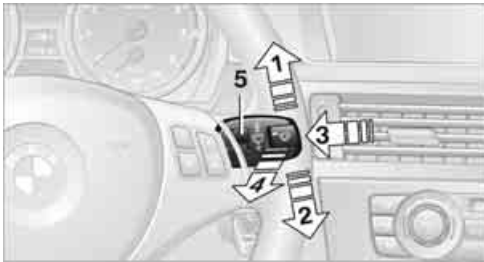

- 1 Switching on wipers
- 2 Switching off wipers or brief wipe
- 3 Activating/deactivating intermittent wipe or rain sensor*
- 4 Cleaning windshield and headlamps*
- 5 Setting speed for intermittent wipe, or sensitivity of the rain sensor

Switching on wipers

Press the lever upward, arrow 1.

The lever automatically returns to its initial position when released.

Normal wiper speed

Press once.

The system switches to operation in the intermittent mode when the vehicle is stationary.

Fast wiper speed

Press twice or press beyond the resistance point.

The system switches to normal speed when the vehicle is stationary.

Intermittent wipe or rain sensor*

If the car is not equipped with a rain sensor, the intermittent-wipe time is a preset.

If the car is equipped with a rain sensor, the time between wipes is controlled automatically and depends on the intensity of the rainfall. The rain sensor is mounted on the windshield, directly in front of the interior rearview mirror.

Activating intermittent wipe or rain sensor

Press the button, arrow 3. The LED in the button lights up.

Setting speed for intermittent wipe or sensitivity of the rain sensor

Turn knurled wheel 5 up or down.

Deactivating intermittent wipe or rain sensor

Press the button again, arrow 3. The LED goes out.

 Deactivate the rain sensor before entering an automatic car wash. Failure to do so could result in damage caused by undesired wiper activation. ◀

Cleaning windshield and headlamps*

Pull the lever, arrow 4.

Washer fluid is sprayed onto the windshield and the wipers are operated for a short time.

When the vehicle lighting system is switched on, the headlamps are cleaned at regular and appropriate intervals.

 Do not use the washers if there is any danger that the fluid will freeze on the windshield. If you do, your vision could be obscured. Antifreeze should therefore be added to the fluid, refer to Washer fluid. Do not use the washers when the washer fluid reservoir is empty, otherwise you will damage the washer pump. ◀

Windshield washer nozzles

The windshield washer nozzles are heated automatically while the engine is running or the ignition is switched on*.

Sports Wagon: rear window wiper

- 1 Intermittent operation. When reverse gear is engaged, the system switches to continuous operation.
- 2 Cleaning the rear window

The rear window wiper does not move if the lever is in position **1** before the ignition is switched on.

To switch on the rear window wiper:

1. Move the lever to its home position.
2. Reselect the desired position.

 Do not use the washers when the washer fluid reservoir is empty, otherwise you will damage the washer pump. ◀

Washer fluid

 Washer fluid antifreeze is flammable. Therefore, keep it away from ignition sources and only store it in the closed original container that is kept out of reach of children, otherwise there is a risk of personal injury. Comply with the instructions on the container. ◀

Washer fluid filler neck

 Only refill washer fluid when the engine is cool to avoid contact with hot engine parts. Otherwise, fluid spills constitute a fire hazard and a risk to personal safety. ◀

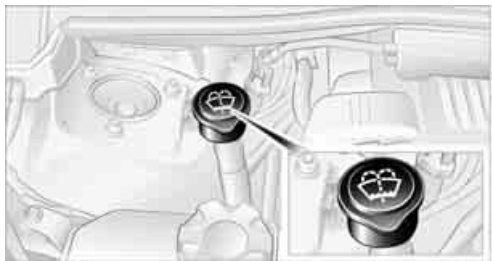

All washer nozzles are supplied with washer fluid by the same reservoir.

Fill with water and, if required, with a washer antifreeze, according to manufacturer's recommendations.

 Mix the water and antifreeze before filling the washer fluid reservoir to make sure the correct concentration is maintained. ◀

Capacity

Approx. 6.3 US quarts/6 liters.

Cruise control*

The concept

Cruise control is available for use at speeds of approx. 20 mph or 30 km/h. The car then stores and maintains the speed that you specify using the lever on the steering column. In order to maintain the specified speed, the system brakes the vehicle when the engine braking effect is insufficient on downhill gradients.

 Do not use cruise control when driving at constant speed is prevented by adverse conditions, e.g. winding roads, dense traffic or poor road conditions due to, e.g. snow, rain, ice or loose surfaces. Otherwise you could lose control of the vehicle and cause an accident as a result. ◀

Manual transmission

You can shift gears while cruise control is activated. An indicator lamp notifies you that you should shift gears when you drive for an extended period at very high or very low engine speeds, or the system is deactivated.

One lever for all functions

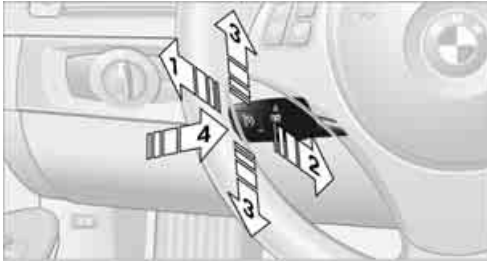

- 1 Storing and maintaining speed or accelerating
- 2 Storing and maintaining speed or decelerating
- 3 Deactivating cruise control
- 4 Resuming a speed stored beforehand

Maintaining current speed

Tap the lever, arrow **1**, or pull it briefly, arrow **2**. The car's current speed is stored and maintained. It is displayed on the speedometer and briefly in the instrument cluster.

On uphill gradients, it may prove impossible to maintain the set speed if current engine power output is insufficient. If the engine braking effect is insufficient on downhill slopes, the system will brake the vehicle slightly.

Increasing desired speed

Repeatedly press the lever to the resistance point or beyond, arrow **1**, until the desired speed is reached.

- ▷ Each time the lever is pressed to the resistance point, the desired speed is increased by approx. 1 mph or 1 km/h.
- ▷ Each time the lever is pressed beyond the resistance point, the desired speed is increased by up to 5 mph or 10 km/h.

The system stores and maintains the speed.

Accelerating using the lever

Accelerating slightly:

Press the lever to the resistance point, arrow **1**, until the desired speed is reached.

Accelerating significantly:

Press the lever beyond the resistance point, arrow **1**, until the desired speed is reached.

The vehicle accelerates without pressure on the accelerator pedal. The system stores and maintains the speed.

Decreasing speed

Repeatedly pull the lever to the resistance point or beyond, arrow **2**, until the desired speed is displayed.

- ▷ Each time the lever is pulled to the resistance point, the desired speed is decreased by approx. 1 mph or 1 km/h.
- ▷ Each time the lever is pulled beyond the resistance point, the desired speed is reduced by up to 5 mph or 10 km/h until the minimum speed of 20 mph or 30 km/h is achieved.

The system stores and maintains the speed.

Deactivating cruise control

Tap the lever upwards or downwards, arrow **3**. The displays on the speedometer disappear.

In addition, the system is automatically deactivated:

- ▷ When you brake the vehicle
- ▷ When you switch gears very slowly or shift to neutral in cars with a manual transmission
- ▷ When you engage selector lever position N in cars with an automatic transmission
- ▷ When you activate DTC or deactivate DSC
- ▷ When DSC or ABS is intervening

Cruise control is not deactivated by depressing the accelerator pedal. Once the accelerator pedal is released, the stored speed is achieved again and maintained.

Warning lamp



The warning lamp comes on when cruise control has been deactivated by applying the parking brake or as a result of DSC intervention. A message appears on the Control Display.

Resuming a speed stored beforehand

Press the button, arrow 4. The last stored speed is resumed and maintained.

In the following instances, the stored speed is deleted and can no longer be resumed:

- ▶ When driving stability control systems are intervening
- ▶ In cars with a manual transmission: when you switch gears very slowly or shift to neutral
- ▶ In cars with an automatic transmission: when you engage selector lever position N
- ▶ When the ignition is switched off

Displays in the instrument cluster



- 1 Stored speed
- 2 Selected speed is displayed briefly

▶ If --- mph or --- km/h temporarily appears in the instrument cluster display, it is possible that the system prerequisites for operation are currently not met.

Calling up Check Control messages, refer to page 76. ◀

Malfunction



The warning lamp comes on when the system has failed. A message appears on the Control Display. You can find more information starting on page 75.

Active cruise control*

The concept

With active cruise control, you can select a desired speed which is not only automatically

maintained when driving on open roadways, but also varied to maintain a selected distance setting as slower traffic is encountered.

Active cruise control is a technological advance over the familiar cruise control and is a welcome relief from the constant adjustment of speed that can accompany driving in traffic on highways or other high-speed thoroughfares. Especially on longer trips, the system can reduce fatigue and tension, while increasing your enjoyment of driving. Please use it safely and responsibly.

Within the limits of its capability, the system automatically adapts the car's speed to that of a slower vehicle in front of you. You can specify the distance to be maintained from the vehicle in front in four stages. For safety reasons, the distance is speed-dependent. Based on your selected distance setting, the system automatically decreases the throttle setting and lightly applies the brakes if necessary. The vehicle brake lamps will automatically illuminate to signal a following driver to take action. In addition, it may be necessary for the vehicle or the driver to downshift, depending on the kind of transmission your vehicle is equipped with, to maintain the distance setting selected. If the vehicle ahead speeds up or when the lane ahead becomes clear, your vehicle will accelerate to the speed you have selected by increasing the throttle setting and shifting gears automatically or by the driver as needed. Your selected speed will be held when driving downhill, too.

Since this active cruise control system is a new technology and operates differently from conventional cruise control systems which you may be accustomed to, you are strongly urged to read all of the pages relating to this system before use. Pay special attention to the System limitations section beginning on page 65.

Braking sensation

- ▶ If you step on the brake pedal while the system is braking, pedal sensation will be slightly different from the usual.
- ▶ Possible noises during automatic braking are normal.

Manual transmission

You can shift gears while cruise control is activated. An indicator lamp notifies you that you should shift gears when you drive for an extended period at very high or very low engine speeds, or the system is deactivated.

Range of applications

The minimum desired speed is 20 mph or 30 km/h, the maximum desired speed is 110 mph or 180 km/h.

⚠ As with conventional cruise control systems, active cruise control in no way diminishes or substitutes for the driver's own personal responsibility, alertness and awareness in adjusting speed, braking or otherwise controlling the vehicle. The driver should decide when to use the system on the basis of road, traffic, visibility, and weather conditions. Active cruise control is intended for use on highway-type roadways where traffic is moving relatively smoothly. Do not use this system in city driving; heavy traffic such as during rush hour; on curvy, winding roads, slippery roads or roads with sharp curves such as highway off-ramps; during inclement weather such as snow, strong rain or fog; or when entering interchanges, service/parking areas or toll booths. It is also important to regulate your vehicle's speed and distance setting within applicable legal limits. Always be ready to take action or apply the brakes if necessary, especially when the system is actively following a vehicle in front of you. Otherwise driving situations could result that pose the risk of accidents. ◀

One lever for all functions

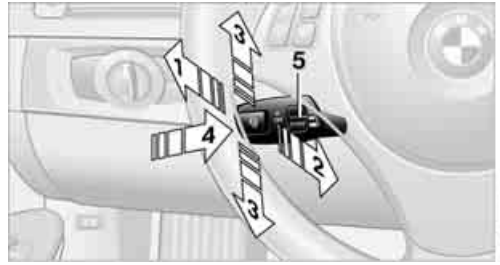

- 1 Store and increase desired speed
- 2 Store and decrease desired speed
- 3 Deactivate system, refer to page 63
- 4 Resume stored desired speed and distance, refer to page 64
- 5 Select distance to vehicle driving ahead, refer to page 63

Storing current speed

Briefly press the lever, arrow 1, or briefly pull it, arrow 2, at a driving speed of more than approx. 20 mph or 30 km/h.



The car's current speed is stored. It is displayed on the speedometer and briefly in the instrument cluster.

Increasing desired speed

Press or tap the lever to the resistance point or beyond, arrow 1, until the desired speed is displayed.

- ▷ Each time the lever is tapped to the resistance point, the desired speed is increased by approx. 1 mph or 1 km/h.
- ▷ Each time the lever is tapped beyond the resistance point, the desired speed is increased by up to 5 mph or 10 km/h until

the maximum speed of 110 mph or 180 km/h is achieved.

The speed then displayed is stored and achieved on a clear road.

Decreasing desired speed

Pull the lever, arrow **2**, until the desired speed is displayed.

The other functions work analogously to those described under Increasing desired speed.

Selecting distance

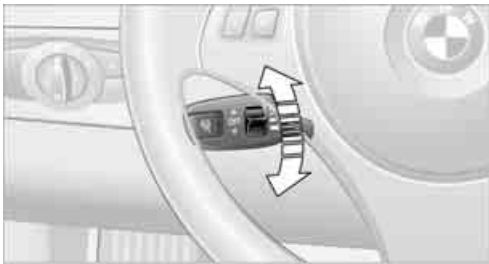

- ▷ Press downward:
Increase distance.
- ▷ Press upward:
Decrease distance.

The selected distance is displayed in the instrument cluster.



Distance 1



Distance 2



Distance 3



Distance 4
This distance is always set when the system is used for the first time after starting the engine.

 Use good judgment to select the appropriate following distance given road conditions, traffic, applicable laws and driving recommendations for safe following distance. Otherwise, an accident risk could result. ◀

Deactivating cruise control

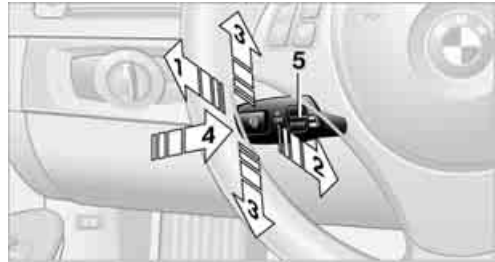

Press the lever upward or downward, arrow **3**. The displays on the speedometer disappear.

In addition, the system is automatically deactivated:

- ▷ When you brake the vehicle
- ▷ When the speed is reduced to below 20 mph or 30 km/h due to a traffic situation
- ▷ When you switch gears very slowly or shift to neutral in cars with a manual transmission
- ▷ When you engage selector lever position N in cars with an automatic transmission
- ▷ When you activate the DTC Dynamic Traction Control
- ▷ When you deactivate the DSC Dynamic Stability Control
- ▷ When DSC or ABS is intervening
- ▷ When the system does not recognize any objects for a longer period of time, e.g. on infrequently traveled roads without a shoulder or guard rails, or if the radar sensor is covered with dirt, refer to page 64
- ▷ When you apply the parking brake

 When the system is deactivated, you must brake the vehicle yourself and/or maneuver as necessary, otherwise there is a risk of accident. ◀

Warning lamp



The warning lamp comes on when active cruise control has been automatically deactivated due to a driving speed below 20 mph or 30 km/h, an application of the parking brake or a DSC intervention. A message appears on the Control Display.

Resuming stored desired speed and distance

Briefly press the button, arrow **4**.

The stored speed and distance are regained and maintained.

In the following instances, the stored speed is deleted and can no longer be resumed:

- ▶ When driving stability control systems are intervening
- ▶ In cars with a manual transmission: when you switch gears very slowly or shift to neutral
- ▶ In cars with an automatic transmission: when you engage selector lever position N
- ▶ When the ignition is switched off

Displays in the instrument cluster



- 1** Stored desired speed
- 2** Shows yellow: vehicle detected ahead
Flashes in red: system cannot maintain distance; driver must brake the vehicle
Flashes in yellow: driving stability control systems are intervening; cruise control is deactivated
- 3** Selected distance to vehicle ahead
The indicator lights up as soon as the system is activated.

- 4** Selected desired speed is temporarily displayed



If --- mph or --- km/h temporarily appears in the instrument cluster display, it is possible that the system prerequisites for operation are currently not met. Calling up Check Control messages, refer to page 76. ◀

Warning lamps



The indicator **2** flashes in red; a signal sounds.

The system indicates that you must brake and/or maneuver the vehicle yourself. Active cruise control cannot automatically restore the distance to the vehicle ahead.

This indicator does not release you from your responsibility to adapt your desired speed and driving style to prevailing driving conditions.

This indicator does not release you from your responsibility to adapt your desired speed and driving style to prevailing driving conditions.



The indicator **2** flashes in yellow.

The prerequisites for operating active cruise control are not met, e.g. as a result of ABS or DSC interventions. Active cruise control is deactivated. You can reactivate the system, if desired, by tapping or pulling the lever when road and traffic conditions permit. It is not possible to resume a stored speed.

The prerequisites for operating active cruise control are not met, e.g. as a result of ABS or DSC interventions. Active cruise control is deactivated. You can reactivate the system, if desired, by tapping or pulling the lever when road and traffic conditions permit. It is not possible to resume a stored speed.

Radar sensor

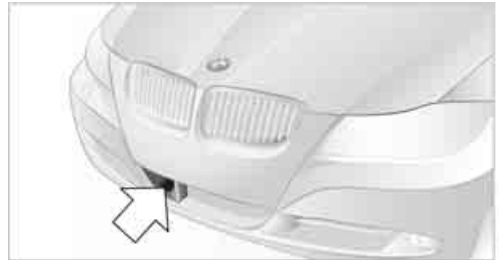

The sensor's ability to detect vehicles ahead may be restricted as a result of heavy rain, dirt, snow or ice. If necessary, clean the radar sensor located in the front bumper, see arrow. Be sure to use particular care when removing any layers of snow or ice from the sensor.

When the radar sensor is not properly positioned, active cruise control cannot be activated at all.

Malfunction



The warning lamp comes on when the system has failed. A message appears on the Control Display. You can find more information starting on page 75.

System limitations

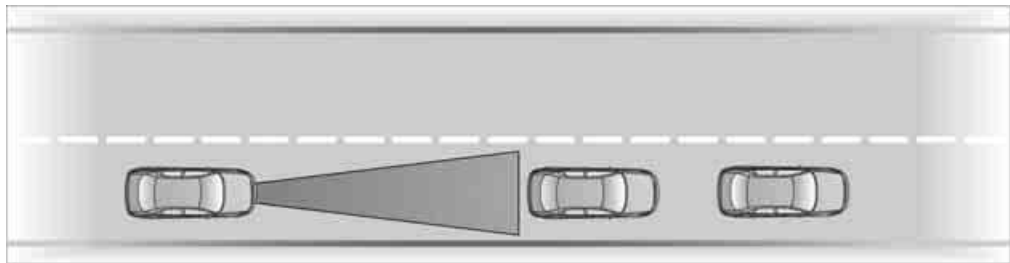

! Always remember that the range and ability of the system does have physical limitations. It will not apply the brakes or decelerate your vehicle when there is a slow-moving vehicle, stopped vehicle or stationary object ahead of you, as for example, at a traffic light or a parked vehicle. Also, the system does not react to oncoming traffic, pedestrians or other types of potential traffic such as a rider on horseback. It is also possible that the system may not detect smaller moving objects such as motorcycles or bicycles. Be especially alert when encountering any of these situations as the system will neither automatically brake, nor provide a warning to you. Also, be aware that every decrease in the distance setting allows your vehicle to come closer to a vehicle in front of you and requires a heightened amount of alertness. ◀

! Active cruise control is not and must not be used as a collision avoidance/warning system. ◀

If while your vehicle is actively following a vehicle in front of you and the vehicle ahead speeds up or the lane ahead becomes clear, then your vehicle will accelerate to the speed you have selected. Be aware that changing to a clear, unobstructed lane will also result in your vehicle accelerating.

! Be certain to deactivate the system when you pull into an exit lane for a highway off-ramp. ◀

Also, vehicles traveling in a staggered manner on a highway may cause a delay in the system's reaction to a vehicle in front of you or may cause the system to react to a vehicle actually in the lane next to you. Always be ready to take action or apply the brakes if necessary.

! While active cruise control is capable of braking your vehicle automatically when you approach a slower vehicle ahead, it is important to be aware that the ability of the system to apply the brakes is also limited, e.g. when you reduce your desired speed sharply. The system cannot stop your vehicle. It uses only a portion of braking system capacity and does not utilize the full capacity of the vehicle braking system. Therefore, the system cannot decrease your speed for large differences in speed between your vehicle and the vehicle ahead. Examples: when you approach a vehicle traveling at a much lower speed than your own speed such as approaching a toll booth or when a much slower vehicle cuts in front of you at close range. ◀

Active cruise control can only decelerate the vehicle to approx. 20 mph or 30 km/h.

Swerving vehicles

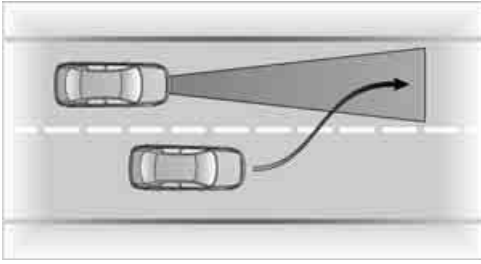

When a vehicle moves from an adjacent lane into your lane, active cruise control will not recognize this vehicle until it is fully in your lane ahead of your vehicle.

⚠ When a vehicle ahead suddenly swerves into your lane, the system may not be able to maintain the selected distance automatically. This also applies to great differences in speed between you and vehicles ahead, e.g. when quickly approaching a truck. There is a risk of collision. Once the system has established that a vehicle is indeed in front of you, it will indicate that you must brake and/or maneuver the vehicle yourself. Take action yourself, otherwise there is a risk of an accident. ◀

Behavior in curves



Because of the limited range of the system, it is possible that in curves or on the peaks and valleys of hilly roads, a vehicle ahead may be recognized late, or not at all. Therefore, it is up to the driver to select a speed that is prudent in view of the curves and terrain of the roadway.



In approaching a curve, it is possible that active cruise control would react briefly to a vehicle in the adjacent lane. In addition, the system can sense if your vehicle is in a curve and may not accelerate. If your vehicle decelerates in either case, you can choose to overcome the deceleration by briefly pressing the accelerator pedal.

Your responsibility

Your actions have priority at all times. When you press the accelerator pedal while driving with active cruise control, the automatic braking function will be temporarily interrupted. Once you release the accelerator pedal, the desired speed or the selected distance to the vehicle ahead is achieved again.

⚠ Do not leave your foot on the accelerator pedal and make sure that no objects such as floor mats are lying on the accelerator pedal. Otherwise the system may not be able to brake the vehicle. ◀

Everything under control

Odometer, outside temperature display, clock



- 1 Knob in the instrument cluster
- 2 Outside temperature display and clock
- 3 Odometer and trip odometer

Knob in the instrument cluster

- ▷ To reset the trip odometer while the ignition is switched on
- ▷ To display the time, outside temperature and odometer briefly while the ignition is switched off

Units of measure

To select the respective units of measure, miles or km for the odometer as well as °F or °C for the outside temperature, refer to page 71.

The setting is stored for the remote control currently in use.

Time, outside temperature display

Setting the time, refer to page 73.

Outside temperature warning

When the displayed temperature sinks to approx. +37 °F / +3 °C, a signal sounds and a warning lamp lights up. There is an increased risk of black ice.

 Black ice can also form at temperatures above. Select the symbol. +37 °F / +3 °C. You should therefore drive carefully on bridges

and shaded roads, for example, otherwise there is an increased risk of an accident. ◀

Odometer and trip odometer

Resetting trip odometer:

With the ignition switched on, press button 1 in the instrument cluster.

When the vehicle is parked

If you still want to view the time, outside temperature and odometer reading briefly after the remote control has been taken out of the ignition lock:

Press button 1 in the instrument cluster.

Tachometer



Never force the engine speed up into the red warning field, see arrow. In this range, the fuel supply is interrupted to protect the engine.

Coolant temperature

A warning lamp will come on if the coolant, and therefore the engine, becomes too hot. In addition, a message will appear on the Control Display.

Check coolant level, refer to page 215.

Energy Control*



Displays the current fuel consumption. This allows you to see whether your current driving style is conducive to fuel economy with minimum exhaust emissions.

Engine oil temperature*



When the engine is at normal operating temperature, the engine oil temperature is between approx. 210 °F / 100 °C and approx. 300 °F / 150 °C.

If the engine oil temperature is too high, a message appears on the Control Display.

Fuel gauge



Fuel tank capacity: approx. 16.1 US gallons/ 61 liters.

You can find information on refueling on page 191.

If the tilt of the vehicle varies for a longer period, when you are driving in mountainous areas, for example, the indicator may fluctuate slightly.

Reserve

Once the fuel level has fallen to the reserve zone, a message briefly appears on the Control Display and the cruising range for the remaining amount of fuel is displayed on the computer. Under a cruising range of approx. 30 miles/ 50 km, the message remains in the Control Display.



Refuel as soon as possible once your cruising range falls below 30 miles/ 50 km, otherwise engine functions are not ensured and damage can occur. ◀

Computer

Displays in the instrument cluster

Calling up information



Press the button in the turn indicator lever. The following items of information are displayed in the order listed:

- ▷ Cruising range
- ▷ Average speed
- ▷ Average fuel consumption
- ▷ Current fuel consumption*
- ▷ No information

To set the corresponding units of measure, refer to Units of measure on page 71.

Cruising range

Displays the estimated cruising range available with the remaining fuel. The range is calculated on the basis of the way the car has been driven over the last 18 miles/30 km and the amount of fuel currently in the tank.

 Refuel as soon as possible once your cruising range falls below 30 miles/50 km, otherwise engine functions are not ensured and damage can occur. ◀

Average speed

Periods with the vehicle parked and the engine switched off are not included in the calculations of average speed.

With the trip computer, refer to page 70, you can have the average speed for another trip displayed.

To reset average speed: press the button in the turn indicator lever for approx. 2 seconds.

Average fuel consumption

The average fuel consumption is calculated for the time during which the engine is running.

With the trip computer, refer to page 70, you can have the average consumption for another trip displayed.

To reset average fuel consumption: press the button in the turn indicator lever for approx. 2 seconds.

Current fuel consumption*

Displays the current fuel consumption. This allows you to see whether your current driving style is conducive to fuel economy with minimum exhaust emissions.

Displays on the Control Display

You can also open the computer via iDrive; for operating principle refer to page 16.

1. "Vehicle Info"
2. "Onboard info" or "Trip computer"



Displays on the "Onboard info":

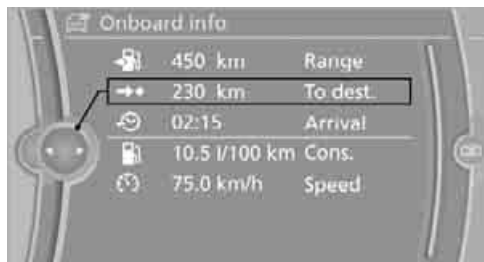

- ▷ Cruising range

- ▷ Distance from destination
- ▷ Estimated time of arrival if:
 - ▷ A distance was manually entered into the computer, refer to information below.
 - ▷ A destination was entered in the navigation system*, refer to page 123.

Displays on the "Trip computer":



- ▷ Departure time
- ▷ Trip duration
- ▷ Trip distance

Both displays show:

- ▷ The average speed and
- ▷ the average fuel consumption.

Resetting the fuel consumption and speed

You can reset the values for average speed and average consumption:

1. Select the respective menu item and press the controller.
2. Press the controller again to confirm your selection.

Resetting the Trip computer

1. "Vehicle Info"
2. "Trip computer"
3. Select
 - ▷ "Reset" all values are reset
 - ▷ "Automatically reset" all values are reset approx. 4 hours after the engine is switched off

Settings and information

Operating principle



- 1 Button for:
 - ▷ Selecting display
 - ▷ Setting values
- 2 Button for:
 - ▷ Confirming selected display or set values
 - ▷ Calling up computer information 69

Exiting displays

The outside-temperature reading and the time reappear when you press button **2** or if you make no entries within approx. 15 seconds. If required, complete the current setting first.

Units of measure

Setting the units of measure

You can change the units for fuel consumption, route/distance, temperature and pressure.

iDrive, for operating principle refer to page 16.

1. "Settings"
2. "Language/Units"



3. Select the desired menu item.
4. Select the desired unit.

The settings are stored for the remote control currently in use.

- 3 When the lights are on: instrument lighting brightness 92
- 4 Calling up Check Control 75
- 5 Checking engine oil level 212
- 6 Setting the time 73
- 7 Setting the date 74
- 8 Viewing service requirement display 71

Service requirements



The remaining driving distance and the date of the next scheduled service are displayed briefly immediately after you start the engine or switch on the ignition.

▷ The extent of service work required can be read out from the remote control by your BMW Service Advisor. ◀

For certain maintenance operations, you can view the respective distance remaining or due date individually in the instrument cluster.



1. Switch on the ignition, refer to page 53.
2. Push button **1** in the turn indicator lever up or down repeatedly until the appropriate symbol appears in the display, accompanied by the words "SERVICE-INFO".
3. Press button **2**.

- Use button **1** to scroll through the individual service items.

Possible displays



- Button for selecting functions
- Service requirements
- Engine oil
- Roadworthiness test*
- Front brake pads
- Rear brake pads
- Brake fluid

The sequence of displayed service items may vary. The data for the next service appointment is shown first.

More information

Detailed information on service requirements

More information on the scope of service required can be displayed on the Control Display.

iDrive, for operating principle refer to page 16.

- "Vehicle Info"
- "Vehicle status"



- "Service required"

Required maintenance procedures and legally mandated inspections are displayed.

You can request more detailed information on every entry:

Select the entry and press the controller.

To exit from the menu:

Move the controller to the left.

Symbols

 No service is currently required.

 The deadline for service or a legally mandated inspection is approaching. Please schedule a service appointment.

 The service deadline has already passed.

Entering deadlines for legally required inspections*

Make sure the date on the Control Display is set correctly, refer to page 74, otherwise the effectiveness of CBS Condition Based Service is not ensured.

iDrive, for operating principle refer to page 16.

1. "Vehicle Info"
2. "Vehicle status"
3. "Service required"



4. "§ Vehicle inspection"

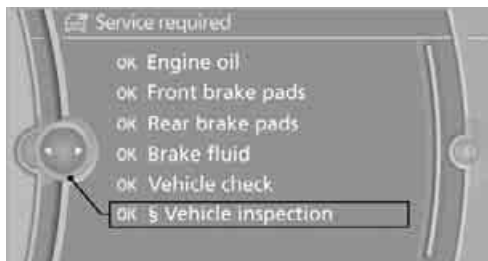

5. Open the menu for entering the deadline.
6. "Date:"
7. Create the settings.
8. Press the controller to apply the setting. The year is highlighted.

9. Turn the controller to make the adjustment.
10. Press the controller to apply the setting. The date entry is stored.

To exit from the menu:

Move the controller to the left.

More information on the BMW Maintenance System can be found on page 216.

Automatic Service Request*

Data regarding the maintenance status or legally mandated inspections of the vehicle are automatically transmitted to your BMW center prior to a service due date.

You can check when your BMW center was notified.

iDrive, for operating principle refer to page 16.

1. "Vehicle Info"
2. "Vehicle status"

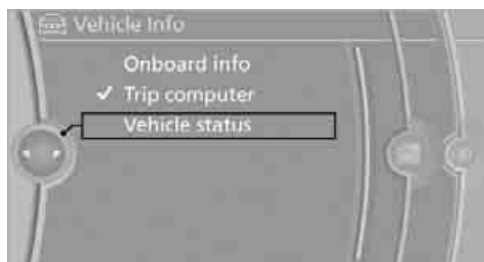

3. "Options"
4. "Last Service Request"

Clock

The settings are stored for the remote control currently in use, refer also to Personal Profile on page 26.

Setting the time

In the instrument cluster

To set the 12h/24h mode, refer to Setting the time format below.



1. Push button **1** in the turn indicator lever up or down repeatedly until the appropriate symbol appears in the display, accompanied by the time and the word "SET".
2. Press button **2**.
3. Use button **1** to set the hours.
4. Press button **2** to confirm the entry.
5. Use button **1** to set the minutes.
6. Press button **2** to confirm the entry.
7. Press button **2**.
The system accepts the new time.

Via iDrive

iDrive, for operating principle refer to page 16.

1. Press the **MENU** button.
The main menu is displayed.

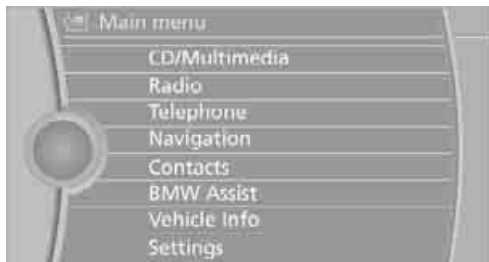

2. "Settings"

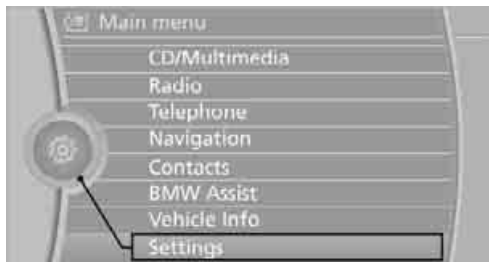

Setting the time

iDrive, for operating principle refer to page 16.

1. "Settings"
2. "Time/Date"

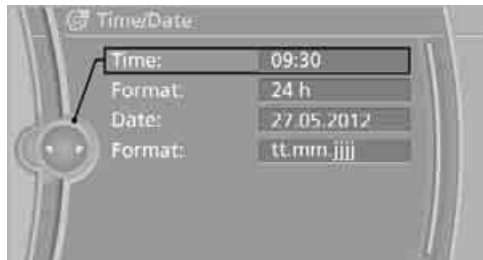

3. "Time:"
4. Turn the controller until the desired hours are displayed, and then press the controller.
5. Turn the controller until the desired minutes are displayed, and then press the controller.

The time is stored.

Setting the time format

iDrive, for operating principle refer to page 16.

1. "Settings"
2. "Time/Date"
3. "Time:"
4. "Format:"
5. Select the desired format and press the controller.

The time format is stored.

Date

The settings are stored for the remote control currently in use, refer also to Personal Profile on page 26.

Setting the date

In the instrument cluster

To set the dd/mm or mm/dd date format, refer to Setting the date format below.



1. Push button **1** in the turn indicator lever up or down repeatedly until the appropriate symbol appears in the display, accompanied by the date and the word "SET".
2. Press button **2**.
3. Use button **1** to set the day of the month.
4. Press button **2** to confirm the entry.
5. Set the month and the year in the same way.
6. Press button **2**.
The system stores the new date.

Via iDrive

iDrive, for operating principle refer to page 16.

1. "Settings"
2. "Time/Date"
3. "Date:"
4. Turn the controller until the desired day is displayed, and then press the controller.
5. Create the necessary settings for the month and year.

The date is stored.

Setting the date format

iDrive, for operating principle refer to page 16.

1. "Settings"
2. "Time/Date"

3. "Format:"



4. Select the desired format.
The date format is stored.

Check Control

The concept

The Check Control monitors vehicle functions and alerts you to any malfunctions in the systems monitored. A Check Control message involves the indicator and warning lamps in the instrument cluster, an acoustic signal if applicable, and text messages on the Control Display.

Indicator and warning lamps



Indicator and warning lamps can light up in a variety of combinations and colors.



⚠ indicates that Check Control messages have been stored. You can view the Check Control messages whenever it is convenient for you.

Explanatory text messages

Text messages at the upper edge of the Control Display explain the meaning of the displayed indicator and warning lamps.

For most Check Control messages, you can view more information later, e.g. regarding the cause of a malfunction and how to respond; refer to the information provided below.

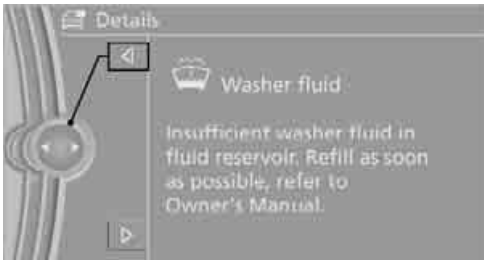

In urgent cases, this information will be shown as soon as the corresponding lamp comes on.

To exit the displayed information:
Move the controller to the left.

Hiding Check Control messages

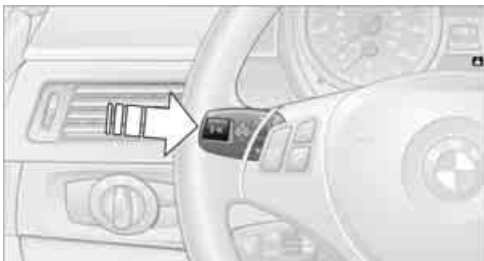

Press the button in the turn indicator lever.

Some Check Control messages are displayed until the malfunctions have been rectified. They cannot be hidden. If several malfunctions occur at the same time, they are displayed in succession.

⚠ They are marked with the symbol shown here.

Other messages are automatically hidden after approx. 20 seconds, but are kept in memory.

⚠ They are marked with the symbol shown here.

Viewing stored Check Control messages



1. Push button 1 in the turn indicator lever up or down repeatedly until the appropriate symbol appears in the display, accompanied by the words "CHECK CONTROL".
2. Press button 2.
"CHECK OK" appears if there are no Check Control messages.
If a Check Control message has been stored, the corresponding lamp comes on. It is accompanied by a text message on the Control Display.
3. Push button 1 to check for other messages.
4. Press button 2.
The display again shows the outside temperature and the time.

Displaying stored Check Control messages

iDrive, for operating principle refer to page 16.

1. "Vehicle Info"
2. "Vehicle status"

3. "Check Control"



4. Select the text message.

Speed limit

You can enter a speed, and a Check Control message will indicate when you reach this speed. This enables you, for example, to receive warnings if you exceed a speed limit in an urban area.

You are only warned of reaching this speed a second time if your vehicle speed falls below it again by at least 3 mph or 5 km/h.

Displaying, setting or changing the limit

iDrive, for operating principle refer to page 16.

1. "Settings"
2. "Limit"
3. "Limit:"

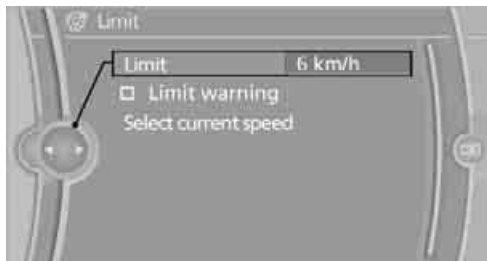

4. Turn the controller until the desired limit is displayed.
5. Press the controller.

The speed limit is stored.

Applying your current speed as the limit

iDrive, for operating principle refer to page 16.

1. "Settings"
2. "Limit"
3. "Select current speed"

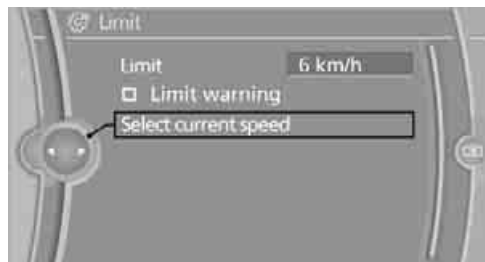

4. Press the controller.

The system adopts your current speed as the limit.

Activating/deactivating the limit

iDrive, for operating principle refer to page 16.

1. "Settings"
2. "Limit"
3. "Limit warning"

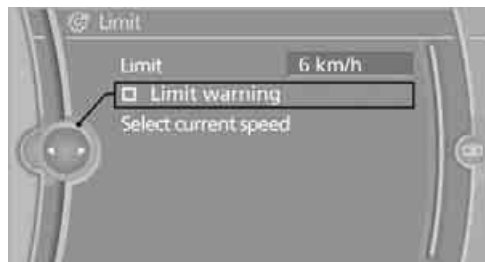

4. Press the controller.

The limit warning is switched on.

Settings on the Control Display

Language on the Control Display

Setting the language

iDrive, for operating principle refer to page 16.

1. "Settings"
2. "Language/Units"
3. "Language:"

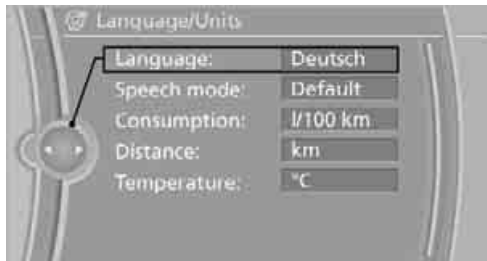

4. Select the desired language.

The setting is stored for the remote control currently in use.

Setting the voice dialog

Switch between a standard dialog and a short dialog.

iDrive, for operating principle refer to page 16.

1. "Settings"
2. "Language/Units"
3. "Speech mode:"
4. Select the desired dialog.

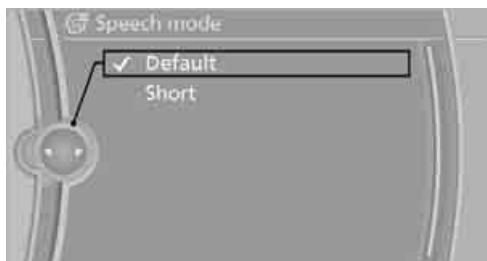

The setting is stored for the remote control currently in use.

Warning signal volume

In vehicles equipped with a single drive, you can raise or lower the volume of the warning signals, e.g. the 'fasten safety belt' reminder, relative to the entertainment sound output. The warning signals have a fixed minimum and maximum volume that cannot be dropped below or exceeded.

iDrive, for operating principle refer to page 16.

1. "Settings"
2. "Tone"
3. "Volume settings"

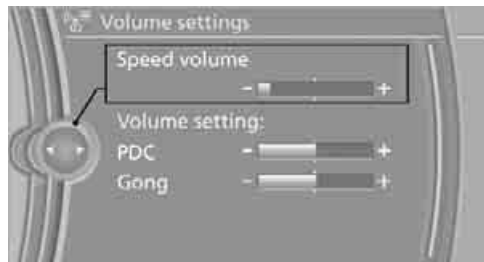

- ▷ "Speed volume": speed-dependent volume control
- ▷ "PDC": volume of the PDC* signal tone relative to the entertainment sound output
- ▷ "Gong": volume of the signal tone, e.g. for the 'fasten safety belt' reminder, relative to the entertainment sound output

Brightness of Control Display

The brightness is automatically adapted to the ambient lighting conditions. However, you can change the basic setting.

iDrive, for operating principle refer to page 16.

1. "Settings"
2. "Central display"

3. "Brightness"



4. Turn the controller until the desired setting is selected.

5. Press the controller.

The setting is stored for the remote control currently in use. In bright conditions, for example, the brightness control may not be clearly visible.

Technology for driving comfort and safety

Park Distance Control PDC*

The concept

The PDC assists you with maneuvering in tight parking spaces. Acoustic signals and a visual indicator warn you of the presence of an object behind your vehicle. To measure the distance, there are four ultrasonic sensors in either bumper.

These sensors have a range of approx. 6.5 ft/ 2 m. However, an acoustic warning does not sound until an object is approx. 24 in/60 cm from the corner sensors, or approx. 5 ft/1.50 m from the center sensors.

 PDC is a parking aid that can indicate objects when they are approached slowly, as is usually the case when parking. Avoid approaching an object at high speed, otherwise physical circumstances may lead to the system warning being issued too late. ◀

Switching on automatically

With the engine running or the ignition switched on, the system is activated after approx. 1 second when you engage reverse gear or move the automatic transmission selector lever to position R. Wait this short period before driving.

Switching off automatically

After approx. 165 ft/50 m of driving or above approx. 20 mph/approx. 30 km/h, the system switches off and the LED goes out.

Signal tones

When nearing an object, its position is indicated correspondingly by an interval tone. As the distance between vehicle and object decreases, the intervals between the tones become shorter. If the distance to the nearest object falls to below roughly 1 ft/30 cm, then a continuous tone sounds.

An interval tone is interrupted after approx. 3 seconds

- ▷ if you remain in front of an object that has been detected by only one of the corner sensors
- ▷ if you are driving parallel to a wall.

Malfunction



The indicator lamp in the instrument cluster comes on. PDC is malfunctioning. A message appears on the Control Display. Have the system checked.

To avoid this problem, keep the sensors clean and free of ice or snow in order to ensure that they will continue to operate effectively. When using a high-pressure cleaner, do not spray the sensors for extended periods of time and only from a distance of at least 4 in/10 cm.

PDC with visual warning

The approach of the vehicle to an object is shown on the Control Display. Objects that are farther away are displayed on the Control Display before a signal tone sounds. The display appears on the Control Display as soon as PDC is activated.

System limitations



Even with PDC, final responsibility for estimating the distance between the vehicle and any obstructions always remains with the driver. Even when sensors are provided, there is a blind spot in which objects can no longer be detected. The system is also subject to the physical limits that apply to all forms of ultrasonic measurement, such as those encountered with trailer towbars and hitches, thin or wedge-shaped objects, etc. Low objects that have already been displayed, e.g. curbs, can disappear again from the detection area of the sensors before or after a continuous tone sounds. Higher, protruding objects, e.g. ledges, cannot be detected. Therefore, always drive cautiously, otherwise there is a risk of personal injury or property damage.

Loud sound sources outside or inside the car

can drown out the PDC signal. Therefore, always drive cautiously, otherwise there is a risk of personal injury or property damage. ◀

Driving stability control systems

Your BMW has a number of systems that help to maintain the vehicle's stability even in adverse driving conditions.

Antilock Brake System ABS

ABS prevents locking of the wheels during braking. Safe steering response is maintained even during full braking. Active safety is thus increased.

The ABS is operational every time you start the engine. Braking safely, refer to page 116.

Electronic brake-force distribution

The system controls the brake pressure in the rear wheels to ensure stable braking behavior.

Dynamic Brake Control DBC

When you apply the brakes rapidly, this system automatically produces the maximum braking force boost and thus helps to achieve the shortest possible braking distance during full braking. This system exploits all of the benefits provided by ABS.

Do not reduce the pressure on the brake for the duration of the full braking application.

Dynamic Stability Control DSC

DSC prevents the driving wheels from losing traction when you pull away from rest or accelerate. The system also recognizes unstable driving conditions, for example if the rear of the car is about to swerve or if momentum is acting at an angle past the front wheels. In these cases, DSC helps the vehicle maintain a safe course within physical limits by reducing engine output and through braking actions at the individual wheels.

 The laws of physics cannot be repealed, even with DSC. An appropriate driving

style always remains the responsibility of the driver. Therefore, do not reduce the additional safety margin again by taking risks, as this could result in an accident. ◀

Deactivating DSC



Press the button for at least 3 seconds; the indicator lamps for DSC in the instrument cluster light up. Dynamic Traction Control DTC and DSC have been simultaneously deactivated. Stabilizing and drive-output promoting actions are no longer executed.

328i, 335i: in the same way as with a differential interlock, even if DSC is deactivated, brake actions are still performed on the rear axle to enhance drive output if the drive wheels experience a significant loss of traction.

To increase vehicle stability, activate DSC again as soon as possible.

Activating DSC

Press the button again; the indicator lamps in the instrument cluster go out.

For better control



If the indicator lamp flashes:
DSC controls the drive forces and brake forces.



If the indicator lamps are on:
DSC is deactivated.



Dynamic Traction Control DTC

DTC is a version of DSC in which the drive output is optimized for particular road conditions, e.g. unplowed snow-covered roads. The system assures the maximal drive output, but with

reduced driving stability. It is therefore necessary to drive with appropriate caution.

You may find it useful to briefly activate DTC under the following special circumstances:

- ▷ When driving uphill on snow-covered roads, in slush or on unplowed, snow-covered roads
- ▷ When rocking a stuck vehicle free or starting off in deep snow or on loose ground
- ▷ When driving with snow chains

Activating DTC



Press the button; the indicator lamps for DTC in the instrument cluster come on.

For better control



If the indicator lamp flashes:
DTC controls the drive forces and brake forces.

DTC



If the indicator lamps are on:
DTC has been activated.

Deactivating DTC

Press the button again; the DTC indicator lamps in the instrument cluster go out.

xDrive*

xDrive is your BMW's four-wheel-drive system. The combined efforts of xDrive and DSC help to further optimize traction and driving dynamics. The xDrive four-wheel-drive system distributes driving power variably to the front and rear axles depending on the driving situation and road conditions.

Hill Descent Control HDC*

HDC is a downhill driving assistant that controls your speed on steep downhill gradients and makes it even easier to control your BMW's handling under these conditions. The vehicle then moves slightly faster than double walking speed without the driver needing to intervene.

HDC can be activated as long as you are driving under approx. 20 mph or 35 km/h. When driving downhill at a speed of under approx. 20 mph or 35 km/h, the vehicle's speed is automatically reduced to slightly more than double walking speed and maintained.

Increasing or decreasing speed

By accelerating or braking you can change this speed within a range from approx. 3 to 15 mph, approx. 5 to 25 km/h.

You can specify a target speed within the same range using the cruise control* lever on the steering column.

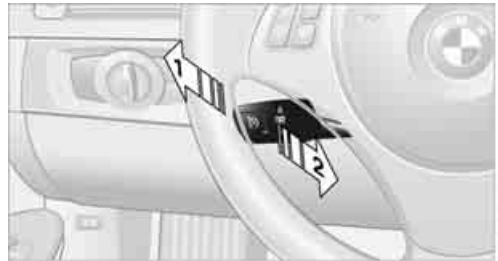

- 1 To increase speed
- 2 To decrease speed

Activating HDC



Press the button; the LED lights up. When the vehicle is being braked automatically, the LED flashes.

Deactivating HDC

Press the button again; the LED goes out.

HDC is automatically deactivated at speeds greater than approx. 35 mph/60 km/h.

Using HDC

In cars with manual transmission:

Use HDC in lower gears and in reverse gear.

With automatic transmission:

You can use HDC in any drive position.

Displays in the instrument cluster*



- 1 Display for target speed
- 2 HDC display

Malfunction

The HDC display disappears during HDC operation, or does not appear:

HDC is temporarily unavailable due to excessive brake temperature, or DSC has failed.

Drive-off assistant

The drive-off assistant enables you to drive off smoothly on uphill gradients. It is not necessary to use the parking brake for this.

1. Hold the car in place by depressing the brake.
2. Release the brake and drive off without delay.

 The drive-off assistant holds the car in place for approx. 2 seconds after the brake is released. Drive off without delay after releasing the brake. Otherwise, the drive-off assistant will no longer hold the car in place

after approx. 2 seconds and the car will start to roll backwards. ◀

Flat Tire Monitor FTM*

The concept

The Flat Tire Monitor detects pressure loss in a tire by comparing the rotating speeds of the individual tires while moving.

In the event of pressure loss, the rolling circumference changes and, thus, the rotating speed of the affected wheel. This change is detected and is reported as a flat tire.

Functional requirement

In order to assure the reliable reporting of a flat tire, the system must be initialized for the correct tire inflation pressure.

 The system must be reinitialized each time a tire inflation pressure has been corrected or a wheel or tire has been changed. ◀

System limitations

 The Flat Tire Monitor is unable to warn the driver of sudden, severe tire damage caused by external factors, nor can it identify the gradual loss of pressure that will inevitably occur in all four tires over a lengthy period of time. ◀

In the following situations, the system could be delayed or malfunction:

- ▷ System has not been initialized
- ▷ Driving on snowy or slippery road surface
- ▷ Performance-oriented style of driving: slip in the drive wheels, high lateral acceleration
- ▷ Snow chains are attached

Initializing the system

 The initialization is completed during driving, which can be interrupted at any time. When driving resumes, the initialization is continued automatically.

Do not initialize the system while snow chains are attached. ◀

iDrive, for operating principle refer to page 16.

1. "Vehicle Info"
2. "Vehicle status"
3. "Reset"



4. Start the engine - do not drive away.
5. Start the initialization using "Reset".
6. Start to drive.

The initialization is completed during the trip. "Status: Flat Tire Monitor active" is displayed again on the Control Display.

Indication of a flat tire



The warning lamps come on in yellow and red. A message appears on the Control Display. In addition, an acoustic signal sounds. There is a flat tire or substantial loss of tire pressure.

1. Cautiously reduce speed to below 50 mph or 80 km/h. Avoid sudden braking and steering maneuvers. Do not exceed a speed of 50 mph or 80 km/h.



If the car is not equipped with Run-Flat Tires, refer to page 209, the standard equipment by design, do not continue driving. Otherwise a severe accident could result if you continue driving. ◀

2. At the next opportunity, check the air pressure in all four tires.



If all four tires are inflated to the correct pressures, the Flat Tire Monitor might not have been initialized. The system must then be initialized. ◀

3. In the event of complete tire pressure loss, 0 psi/0 kPa, you can estimate the possible

distance for continued driving on the basis of the following guidelines:

- ▷ With a light load:
1 to 2 persons without luggage:
approx. 155 miles/250 km
- ▷ With a medium load:
2 persons, cargo bay full, or 4 persons without luggage:
approx. 90 miles/150 km
- ▷ With a full load:
4 or more persons, cargo bay full:
approx. 30 miles/50 km



Drive cautiously and do not exceed a speed of 50 mph or 80 km/h, otherwise there is a risk of an accident. In the event of pressure loss, vehicle handling changes. This includes reduced tracking stability in braking, extended braking distance and altered natural steering characteristics.

If unusual vibration or loud noises occur during the journey, this may be an indication that the damaged tire has finally failed. Reduce your speed and pull over as soon as possible at a suitable location. Otherwise parts of the tire could come loose, resulting in an accident. Do not continue driving. Instead, contact your BMW center. ◀

Malfunction



The warning lamps come on in yellow. A message appears on the Control Display. The Flat Tire Monitor has a malfunction or has failed. Have the system checked as soon as possible.

Tire Pressure Monitor TPM*

The concept

TPM checks the inflation pressures of the four mounted tires. The system notifies you if there is a significant loss of pressure in one or more tires.

Functional requirement

In order to assure the reliable reporting of a flat tire, the system must be reset while all tire inflation pressures are correct.

Always use wheels with TPM electronics. Otherwise, the system may malfunction.

 Each time a tire inflation pressure has been corrected or a wheel or tire has been changed, reset the system. ◀

System limitations

 TPM cannot warn you in advance of sudden severe tire damage caused by outside influences. ◀

The system does not work correctly if it has not been reset; for example, a flat tire may be indicated even though the tire inflation pressures are correct.

The system is inactive and cannot indicate a flat tire if a wheel without TPM electronics, such as a compact spare wheel, has been mounted, or if TPM is temporarily malfunctioning due to other systems or devices using the same radio frequency.

Status indicator on the Control Display

The color of the tires represents the status of the tires and the system.

TPM takes into account that tire pressures change while the vehicle is being driven. The tire pressures do not need to be corrected unless the TPM instructs you to do so by means of color indicators.

Green

The tire inflation pressure corresponds to the established target value.

"TPM active" appears on the Control Display.

One wheel yellow

There is a flat tire or substantial loss of tire pressure in the indicated tire. A message appears on the Control Display.

All wheels yellow

There is a flat tire or substantial loss of tire pressure in several tires. A message appears on the Control Display.

Gray

The system cannot detect a puncture.

Possible reasons for this:

- ▷ TPM is being reset
- ▷ Temporary malfunction caused by systems or devices using the same radio frequency
- ▷ Malfunction

Resetting the system

 Each time a tire inflation pressure has been corrected or a wheel or tire has been changed, reset the system. ◀

iDrive, for operating principle refer to page 16.

1. "Vehicle Info"
2. "Vehicle status"
3. "Reset TPM"



4. Start the engine - do not drive away.
5. Start the initialization using "Reset TPM".
6. Start to drive.
The tires are shown in gray and "Resetting TPM..." is displayed.

After driving a few minutes, the set inflation pressures in the tires are accepted as the target values to be monitored. The system reset is completed during your drive, and can be interrupted at any time. When driving resumes, the reset is continued automatically. On the Control Display, the tires are shown in green and "Status: TPM active" is displayed again.



If a flat tire is detected while the system is resetting and determining the inflation pressures, all tires on the Control Display are displayed in yellow. The message "Tire low!" is shown. ◀

Message for low tire inflation pressure



The warning lamps come on in yellow and red. A message appears on the Control Display. In addition, a signal sounds. There is a flat tire or substantial loss of tire pressure.

1. Cautiously reduce speed to below 50 mph/80 km/h. Avoid sudden braking and steering maneuvers. Do not exceed a speed of 50 mph/80 km/h.



If the car is not equipped with Run-Flat Tires, refer to page 209, the standard equipment by design, do not continue driving. Otherwise a severe accident could result after a tire puncture if you continue driving. ◀

2. In the event of complete pressure loss, 0 psi/0 kPa, you can estimate the possible distance for continued driving on the basis of the following guidelines:

- ▷ With a light load:
1 to 2 persons without luggage:
approx. 155 miles/250 km
- ▷ With a medium load:
2 persons, cargo bay full, or 4 persons without luggage:
approx. 95 miles/150 km
- ▷ With a full load:
4 or more persons, cargo bay full:
approx. 30 miles/50 km



Drive cautiously and do not exceed a speed of 50 mph/80 km/h. In the event of pressure loss, vehicle handling changes. This includes reduced tracking stability in braking, extended braking distance and altered natural steering characteristics.

If unusual vibration or loud noises occur during the journey, this may be an indication that the damaged tire has finally failed. Reduce your speed and pull over as soon as possible at a suitable location. Otherwise parts of the tire

could come loose, resulting in an accident. Do not continue driving. Instead, contact your BMW center. ◀

Malfunction



The small warning lamp flashes in yellow and then lights up continuously; the larger warning lamp comes on in yellow. On the Control Display, the tires are shown in gray and a message appears. No punctures can be detected.

This type of message is shown in the following situations:

- ▷ If there is a malfunction
Have the system checked.
- ▷ If a wheel without TPM electronics has been mounted
- ▷ If TPM is temporarily malfunctioning due to other systems or devices using the same radio frequency.

Message for unsuccessful system reset



The warning lamp lights up yellow. A message will appear on the Control Display. The system is not reset after a tire has been changed, for example.

Check the tire inflation pressure and reset the system, refer to page 85.

Declaration according to NHTSA/ FMVSS 138 Tire Pressure Monitoring Systems

Each tire should be checked monthly when cold and inflated to the inflation pressure recommended by the vehicle manufacturer on the vehicle placard or tire inflation pressure label. If your vehicle has tires of a different size than the size indicated on the vehicle placard or tire inflation pressure label, you should determine the proper tire inflation pressure for those tires. As an added safety feature, your vehicle has been equipped with a tire pressure monitoring system, TPMS, that illuminates a low tire pressure telltale when one or more of your tires are significantly under-inflated. Accordingly, when the low tire pressure telltale illuminates, you should

stop and check your tires as soon as possible, and inflate them to the proper pressure. Driving on a significantly underinflated tire causes the tire to overheat and can lead to tire failure. Underinflation also reduces fuel efficiency and tire tread life, and may affect the vehicle's handling and stopping ability. Please note that the TPMS is not a substitute for proper tire maintenance, and it is the driver's responsibility to maintain correct tire pressure, even if underinflation has not reached the level at which the TPMS low tire pressure telltale illuminates.

The TPMS malfunction indicator is combined with the low tire pressure telltale. When the system detects a malfunction, the telltale will flash for approximately one minute and then remain continuously lit. This sequence will continue upon subsequent vehicle startups as long as the malfunction exists. When the malfunction indicator is illuminated, the system may not be able to detect or signal low tire pressure as intended. TPMS malfunctions may occur for a variety of reasons, including the installation of replacement or alternate tires or wheels on the vehicle that prevent the TPMS from functioning properly. Always check the TPMS malfunction telltale after replacing one or more tires or wheels on your vehicle to ensure that the replacement or alternate tires and wheels allow the TPMS to continue to function properly.

Active steering*

The concept

Active steering varies the turning angle of the front wheels in relation to steering wheel movements. It also varies the steering force required to turn the wheels depending on the speed at which you are driving.

When you are driving in the low road-speed range, e.g. in a town or when parking, the steering angle increases, i.e. the steering becomes very direct, and less effort is required to turn the wheels. In the higher speed range, on the other hand, the steering angle is reduced more and more. This improves the handling capability of your BMW over the entire speed range.

In critical situations, the system can make targeted corrections to the steering angle provided by the driver and thus stabilize the vehicle before the driver intervenes. This stabilizing intervention is simultaneously deactivated when DSC is switched off, refer to page 81.

Malfunction



The warning lamps come on. Active steering is no longer operational. At low speeds, greater steering wheel movements are required, whereas at

higher speeds the vehicle reacts more sensitively to steering wheel movements. The stability-enhancing feature may also be deactivated. Drive cautiously and think well ahead. Have the system checked.

Brake force display

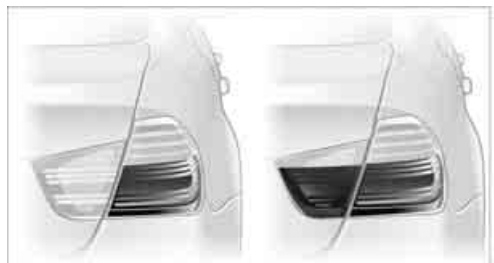

On the left: normal braking

On the right: sharp braking.

Airbags

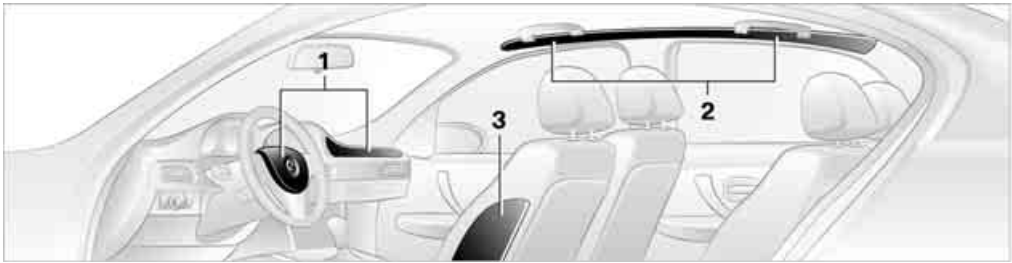

The following airbags are located under the marked covers:

- 1 Front airbags
- 2 Head airbags
- 3 Side airbags in the seat backrests

Protective action

 Observe the adjustment instructions on page 41 to ensure the best possible personal protection. ◀

The front airbags help protect the driver and front passenger by responding to frontal impacts in which safety belts alone cannot provide adequate restraint. When needed, the head and side airbags help provide protection in the event of side impact. The relevant side airbag supports the side upper body area. The head air bag supports the head.

The airbags have been designed to not be triggered in every collision situation, e.g. not in minor accidents or rear-end collisions.

 Do not apply adhesive materials to the cover panels of the airbags, cover them or modify them in any other way.

Keep the dashboard and windows on the front passenger side clear, i.e. do not cover with adhesive labels or coverings, and do not attach holders such as for navigation instruments or mobile phones.

Do not attach seat covers, cushions or other objects not specifically approved for seats with integral side airbags to the front seats. Do not hang items of clothing such as coats or jackets over the backrests. Do not attempt to remove

the airbag retention system from the vehicle. Do not modify the individual components of the system or its wiring in any way. This includes the upholstered covers on the steering wheel, instrument panel, seats and roof posts, as well as the sides of the roof lining. Do not attempt to remove or dismantle the steering wheel.

Do not touch the individual components immediately after the system has been triggered, because there is a danger of burns.

In the event of malfunctions, deactivation or triggering of the airbag restraint system, have the testing, repair, removal and disposal of airbag generators executed only by a BMW center or a workshop that works according to repair procedures of BMW with correspondingly trained personnel and that has the required explosives licenses. Unprofessional attempts to work on the system could lead to failure in an emergency or to undesired airbag activation, either of which could result in personal injury. ◀

Warning notices and information about the airbags can also be found on the sun visors.

Automatic deactivation of the front passenger airbags

An analysis of the impression in the front passenger seat cushion determines whether and how the seat is occupied. The front and side airbags for the front passenger are activated or deactivated by the system accordingly.

 The indicator lamp above the interior rearview mirror shows the current status of the front passenger airbags, deactivated or

activated, refer to Status of front passenger airbags below. ◀

! Before transporting a child on the front passenger seat, read the safety precautions and handling instructions under Transporting children safely, refer to page 49. The front and side airbags can also be deactivated by adolescents and adults sitting in certain positions; the indicator lamp for the front passenger airbags comes on. In such cases, the passenger should change his or her sitting position so that the front passenger airbags are activated and the indicator lamp goes out. If the desired airbag status cannot be achieved by changing the sitting position, transport the relevant passenger on a rear seat. Do not attach seat covers, seat cushion padding, ball mats or other items to the front passenger seat unless they are specifically recommended by BMW. Do not place any items under the seat which could press against the seat from below. Otherwise a correct analysis of the seat cushion is not ensured. ◀

Status of front passenger airbags



The indicator lamp for the front passenger airbags shows the functional status of the front passenger's front and side airbags in accordance with whether and how the front passenger seat is occupied. The indicator lamp shows whether the front passenger airbags are activated or deactivated.

- ▶ The indicator lamp lights up when a child in a specially designated child-restraint system is detected, as intended, on the seat. The front and side airbags for the front passenger are not activated.

▶ Most child seats are detected by the system, especially child seats required by the NHTSA at the time of vehicle production. After mounting a child seat, ensure that the indicator lamp for the front passenger airbag is lit. It indicates that the child seat has been detected and that the front passenger airbags are deactivated. ◀

- ▶ The indicator lamp does not come on as long as a person of sufficient size and in a correct sitting position is detected on the seat. The front and side airbags for the front passenger are activated.
- ▶ The indicator lamp does not come on if the seat is empty. The front and side airbags for the front passenger are not activated.

Operational readiness of airbag system



As of radio readiness, refer to page 53, the warning lamp comes on briefly to indicate that the entire airbag system and the belt tensioners are operational.

Airbag system malfunction

- ▶ Warning lamp does not light up at radio readiness or beyond.
 - ▶ Warning lamp remains permanently on.
- !** In the event of a fault in the airbag system, have it checked without delay, otherwise there is the risk that the system will not function as intended even if a sufficiently severe accident occurs. ◀

Lamps

Parking lamps/low beams

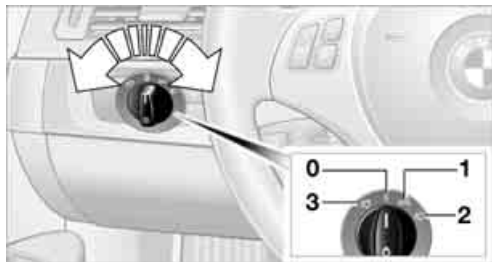

- 0** Lamps off, daytime running lamps
- 1** Parking lamps and daytime running lamps
- 2** Low-beam headlamps and welcome lamps
- 3** Automatic headlamp control*, daytime running lamps, welcome lamps and Adaptive Head Light*

When you open the driver's door with the ignition switched off, the exterior lighting is automatically switched off if the light switch is in position **0**, **2** or **3**.

Switch on the parking lamps if necessary, switch position **1**.

Parking lamps

In switch position **1**, the front, rear and side vehicle lighting is switched on. You can use the parking lamps for parking.

When the ignition is switched off and the switch is in position **1**, only the outside sections of the rear lamps are illuminated, refer to page 226.

 The parking lamps will discharge the battery. Therefore, do not leave them on for unduly long periods of time, otherwise the battery might not have enough power to start the engine. It is preferable to switch on the left-hand or right-hand roadside parking lamps, refer to page 92. ◀

Low beams

The low beams light up when the light switch is in position **2** and the ignition is on.

Automatic headlamp control*

When the switch is in position **3**, the low beams are switched on and off automatically depending on ambient light conditions, e.g. in a tunnel, in twilight, or if there is precipitation. The Adaptive Head Light* is active. The LED next to the symbol is illuminated when the low beams are on. You can also activate the daytime running lamps, refer to page 91. In the situations described above, the lamps then automatically switch from daytime running lamps to low beams.

The headlamps may also come on when the sun is sitting low on a blue sky.

 The low beams remain switched on regardless of the ambient lighting conditions when you switch on the fog lamps. ◀

 The automatic headlamp control cannot serve as a substitute for your personal judgment in determining when the lamps should be switched on in response to ambient lighting conditions. For example, the system cannot detect fog or hazy weather. To avoid safety risks, you should always switch on the low-beam headlamps manually under these conditions. ◀

Welcome lamps

If you leave the light switch in position **2** or **3** when you park the car, the parking lamps and the interior lamps light up briefly when you unlock the vehicle.

Activating/deactivating welcome lamps

iDrive, for operating principle refer to page 16.

1. "Settings"
2. "Lighting"

3. "Welcome light"

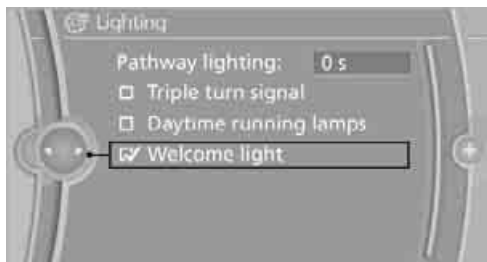

✓ Welcome lamps are activated and are stored for the remote control currently in use.

Pathway lighting

If you activate the headlamp flasher after parking the car, with the lights switched off, the low beams come on and remain on for a certain time.

Setting or deactivating the duration

iDrive, for operating principle refer to page 16.

1. "Settings"
2. "Lighting"
3. "Pathway lighting:"
4. Set or deactivate the duration.

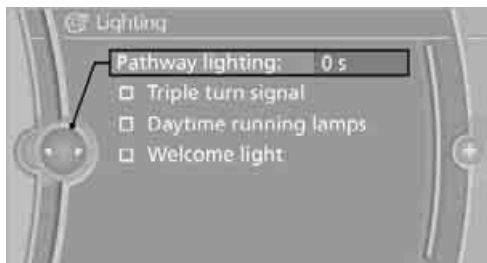

The setting is stored for the remote control currently in use.

Daytime running lamps

The daytime running lamps light up in switch positions **0**, **1** and **3**.

Activating/deactivating daytime running lamps

iDrive, for operating principle refer to page 16.

1. "Settings"
2. "Lighting"
3. "Daytime running lamps"

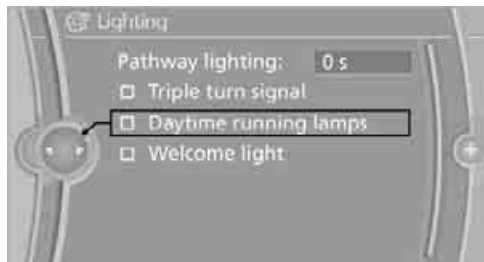

✓ Daytime running lamps are activated and are stored for the remote control currently in use.

Adaptive Head Light*

The concept

Adaptive Head Light is a variable headlamp control system that enables better illumination of the road surface. Depending on the steering angle and other parameters, the light from the headlamp follows the course of the road.

Activating Adaptive Head Light

With the ignition switched on, turn the light switch to position **3**, refer to page 90.

To avoid dazzling the drivers of oncoming vehicles, Adaptive Head Light is not active when the car is driven in reverse, and directs the light to the front passenger's side when the vehicle is at a standstill.

Malfunction

The LED next to the symbol for automatic headlamp control flashes. Adaptive Head Light is malfunctioning or has failed. Have the system checked as soon as possible.

High beams/roadside parking lamps

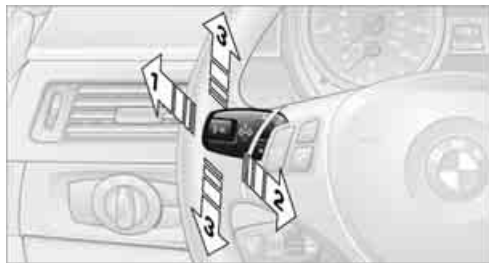

- 1 High beams
- 2 Headlamp flasher
- 3 Roadside parking lamps*

Roadside parking lamps, left or right*

There is an additional option of switching on the lamps on the side of the car facing the road when parked.

Switching on

After parking the vehicle, press the lever up or down beyond the pressure point for a longer period, arrow 3.

 The roadside parking lamps drain the battery. Therefore, do not leave them on for unduly long periods of time, otherwise the battery might not have enough power to start the engine. ◀

Switching off

Press the lever in the opposite direction to the pressure point, arrow 3.

Fog lamps



 The parking lamps or low beams must be switched on for the fog lamps to operate. The green indicator lamp in the instrument cluster lights up whenever the fog lamps are on.

The fog lamps are switched off while you activate the headlamp flasher or switch on the high beams.

 If the automatic headlamp control is activated, the low beams will come on automatically when you switch on the fog lamps. ◀

Instrument lighting

You can adjust the brightness of the instrument lighting only when the parking lamps or the low beams are switched on.



1. Push button 1 up or down repeatedly until the appropriate symbol appears in the display, accompanied by the brightness setting and scale the word "SET".
2. Press button 2.



3. Push button **1** up or down to select the desired brightness level.
4. Press button **2**.
The display again shows the outside temperature and the time.

Interior lamps

The interior lamps, footwell lamps*, entry lamps*, cargo bay lamp and courtesy lamps* are controlled automatically.

The LEDs for the courtesy lamps are set in the door handles and illuminate the ground in front of the doors.

 To avoid draining the battery, all lamps inside the car are switched off about 8 minutes after the ignition is switched off, refer to Start/stop button on page 53. ◀

Switching interior lamps on/off manually



Interior lamps, front and rear*:
To switch on and off, press the button.

To switch off the interior lamps, footwell lamps*, entry lamps* and courtesy lamps* permanently, press the button for the front interior lamps for about 3 seconds.

Reading lamps



There are reading lamps at the front and rear*, next to the interior lamps. To switch on and off, press the button.



- | | |
|--|--|
| <p>1 Airflow directed toward the windshield and side windows</p> <p>2 Air to the upper body area
Draft-free ventilation 97</p> <p>3 Air to the footwell</p> <p>4 Air distribution, manual</p> <p>5 Temperature adjustment, left-hand side of passenger compartment</p> <p>6 Maximum cooling</p> <p>7 AUTO program</p> <p>8 Air flow rate, manual</p> <p>9 Automatic recirculated-air control AUC/
Recirculated-air mode</p> | <p>10 Temperature adjustment, right-hand side of passenger compartment</p> <p>11 Residual heat</p> <p>12 Defrosting windows and removing condensation</p> <p>13 Switching cooling function on/off manually</p> <p>14 Rear window defroster</p> <p>15 Air grill for interior temperature sensor – please keep clear and unobstructed</p> <p>The current setting for the air distribution is displayed on the Control Display, refer to page 95.</p> |
|--|--|

Automatic climate control

Comfortable interior climate

AUTO program 7 offers the ideal air distribution and air flow rate for almost all conditions, refer to AUTO program below. All you need to do is select an interior temperature which is comfortable for you.

The following sections inform you in detail about how to adjust the settings.

Most settings are stored for the remote control currently in use, refer also to Personal Profile settings on page 26.

Adjusting air distribution manually



The air distribution can be switched on and off manually. The air is directed to the windshield, to the upper body area and to the

footwell. Automatic air distribution adjustment is deactivated.

The current setting is briefly displayed on the Control Display when a button is pressed.

You can switch the automatic air distribution back on by pressing the AUTO button. This automatically switches on the cooling function.

Temperature



Set the desired temperatures individually for the driver's and front passenger's sides.

The automatic climate control achieves this temperature as quickly as possible regardless of the season, using maximum cooling or heating power if necessary, and then maintains it.

When you switch between different temperature settings in quick succession, the automatic climate control does not have enough time to achieve the set temperature.

You can achieve maximum heating power with the highest setting, regardless of the outside temperature.

The lowest setting effects continuous cooling.

Maximum cooling



At outside temperatures above 32 °F / 0 °C and when the engine is running, you obtain a maximum cooling effect as soon as possible.

The automatic climate control goes into recirculated-air mode at the lowest temperature. Air flows at maximum rate from the vents for the upper body area. You should therefore open them for maximum cooling.

AUTO program



The AUTO program adjusts the air distribution to the windshield and side windows, towards the upper body area and into the footwell for you. The air flow rate and your temperature specifications will be adapted to outside influences as a result of seasonal changes, e.g. sunlight or window condensation.



The cooling is switched on automatically with the AUTO program.

Intensity of the AUTO program

Press the AUTO button repeatedly to set the intensity of the AUTO program. The current setting is displayed on the Control Display when the button is pressed.



Select the intensity of the AUTO program:

- ▷  – Low
- ▷  – Medium
- ▷  – High

Adjusting air flow rate manually



Press the left side of the button to reduce airflow. Press the right side of the button to increase it.

You can reactivate the automatic mode for the air flow rate with the AUTO button.

The air flow rate may be reduced or the blower may be switched off entirely to save on battery power. The display remains the same.

Switching the system on/off

With the blower at its lowest setting, press the left side of the button to switch off the automatic climate control. All displays are cleared except for the rear window defroster if it is switched on.

Press any button except REST or rear window defroster to reactivate the automatic climate control.

 The recirculated-air mode is switched on when you switch off the automatic climate control. If the air quality deteriorates or the window fogs over, switch the system back on and increase the air volume. ◀

Automatic recirculated-air control AUC/Recirculated-air mode



Switch on the desired operating mode by pressing this button repeatedly:

- ▷ LED off: outside air flows in continuously.
- ▷ Left-hand LED on, AUC mode: a sensor detects pollutants in the outside air. If necessary, the system blocks the supply of outside air and recirculates the inside air. As soon as the concentration of pollutants in the outside air has decreased sufficiently, the system automatically switches back to outside air supply.
- ▷ Right-hand LED on, recirculated-air mode: the supply of outside air is permanently shut off. The system then recirculates the air currently within the vehicle.

 If condensation starts to form on the inside window surfaces during operation in the recirculated-air mode, you should switch it off while also increasing the air flow rate as required.

The recirculated-air mode should not be used over an extended period of time, otherwise the

air quality inside the car will deteriorate continuously. ◀

Residual heat



The heat stored in the engine is used to heat the passenger compartment, e.g. while stopped at a school to pick up a child.

The function can be switched on when the following conditions are met:

- ▷ Up to 15 minutes after the engine has been switched off
- ▷ While the engine is at operating temperature
- ▷ As long as battery voltage is sufficient
- ▷ At an outside temperature below 77 °F / 25 °C

The LED is lit when the function is on.

As of radio readiness, you can set the interior temperature, the air flow rate and the air distribution.

Defrosting windows and removing condensation



Quickly removes ice and condensation from the windshield and front side windows.

Switch on the cooling function as well.

Switching cooling function on/off



The cooling function cools and dehumidifies the incoming air before reheating it as required, according to the temperature setting. This function is only available while the engine is running.

The cooling function helps prevent condensation on the windows or removes it quickly.

Depending on the weather, the windshield may fog over briefly when the engine is started.

Pressing the AUTO button automatically switches on the cooling function.

Rear window defroster



The defroster is switched off automatically after a certain time.

Depending on your vehicle's equipment, the upper wires serve as an antenna and are not part of the rear window defroster.

Ventilation

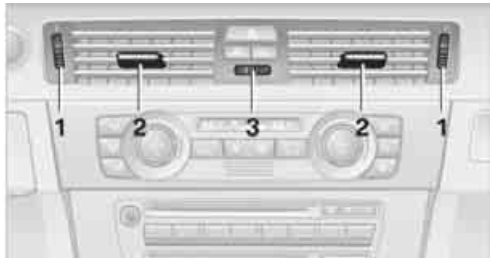

- 1 Use the knurled wheels to smoothly open and close the air vents
- 2 Use the lever to change the direction of the airflow
- 3 Knurled wheel for more or less cool air from the vents for the upper body area

Ventilation for cooling

Adjust the vent outlets to direct the flow of cool air in your direction, for instance if it has become too hot in the car.

Draft-free ventilation

Set the vent outlets so that the air flows past you and not straight at you.

Ventilation in the rear

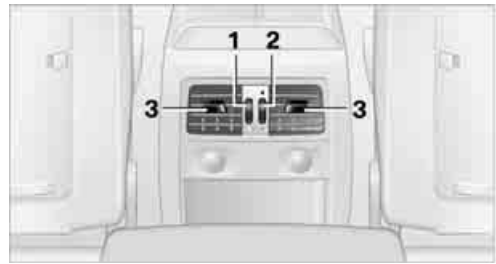

- 1 Use the knurled wheel to smoothly open and close the air vents
- 2 Use the knurled wheel to adjust the temperature:
 - ▷ Turn toward blue: colder
 - ▷ Turn toward red: warmer
- 3 Use the lever to change the direction of the airflow

Microfilter/activated-charcoal filter

The microfilter traps dust and pollen in the incoming air. The activated-charcoal filter provides additional protection by filtering gaseous pollutants from the outside air. Your BMW center replaces this combined filter during routine maintenance.

Parked car ventilation

The concept

The parked car ventilation provides ventilation to the passenger compartment and lowers its temperature, if necessary. It is ready for use at any outside temperature, as of radio readiness.

The parked car ventilation remains switched on for approx. 30 minutes. Two different switch-on times can be preselected. The system can also be switched on and off directly.

Due to its high power consumption, it should not be switched on twice in a row without driving in between to allow the battery to recharge.

The air emerges from the air vents for the upper body area in the instrument panel. The air vents must therefore be open.

The parked car ventilation system is operated via iDrive.

Switching on/off directly

iDrive, for operating principle refer to page 16.

1. "Settings"
2. "Climate"
3. "Activate parked-car vent."

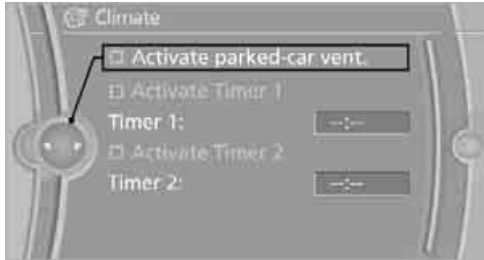

- ✔ The parked car ventilation is switched on.
- ☞ The symbol on the automatic climate control display flashes.

Preselecting switch-on times

iDrive, for operating principle refer to page 16.

1. "Settings"
2. "Climate"
3. "Activate Timer 1" or "Activate Timer 2"
4. "Timer 1:" or "Timer 2:"

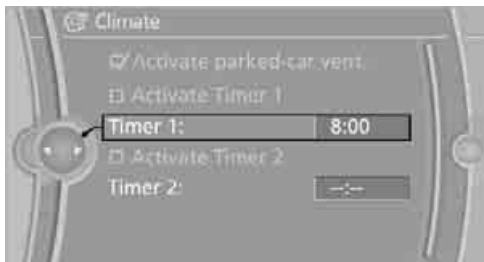

5. Turn the controller: set the hours.
6. Press the controller: the setting is accepted.
7. Turn the controller: set the minutes.
8. Press the controller: the setting is accepted.

- ✔ The switch-on time is activated.
- ☞ The symbol on the automatic climate control display lights up.
- ☞ The symbol on the automatic climate control display flashes when the system has switched on.
- ▶ The respective system is switched on within the next 24 hours only. After these have elapsed, it must be reactivated. ◀

Integrated universal remote control*

The concept

The integrated universal remote control can replace as many as three hand-held transmitters for various remote-controlled devices, such as garage doors and gates or lighting systems. The integrated universal remote control registers and stores signals from the original hand-held transmitters.

The signal of an original hand-held transmitter can be programmed on one of the three memory buttons **1**. After this, the programmed memory button **1** will operate the system in question. The LED **2** flashes to confirm transmission of the signal.

Should you sell your vehicle one day, be sure to delete the stored programs beforehand for your safety, refer to page **100**.

 To prevent possible damage or injury, before programming or using the integrated universal remote control, always inspect the immediate area to make certain that no people, animals or objects are within the pivoting or travel range of the device being operated. Comply also with the safety instructions supplied with the original hand-held transmitter. ◀

Checking compatibility

 If this symbol appears on the package or in the instructions supplied with the original hand-held transmitter, you can assume that the radio remote control device will be compatible with the integrated universal remote control.

For additional information, please contact your BMW center or call: 1-800-355-3515.

You can also obtain information on the Internet at:

www.bmwusa.com or
www.homelink.com.

HomeLink is a registered trademark of Johnson Controls, Inc. ◀

Programming



- 1 Memory buttons
- 2 LED

Fixed-code hand-held transmitters

1. Switch on the ignition, refer to page **53**.
2. When starting operation for the first time: press the left and right memory buttons **1** for approx. 20 seconds until the LED **2** flashes rapidly. The three memory buttons are cleared.
3. Hold the original hand-held transmitter at a distance of approx. 4 to 12 in/10 to 30 cm from the memory buttons **1**.

 The required distance between the hand-held transmitter and the memory buttons **1** depends on the system of the respective original hand-held transmitter used. ◀

4. Simultaneously press the transmit key on the original hand-held transmitter and the desired memory button **1** on the integrated universal remote control. The LED **2** flashes slowly at first. As soon as the LED **2** flashes rapidly, release both buttons. If the LED **2** does not flash rapidly after approx. 15 seconds, alter the distance and repeat this step.
5. To program other original hand-held transmitters, repeat steps 3 and 4.

The corresponding memory button **1** is now programmed with the signal of the original hand-held transmitter.

You can operate the device while the ignition is switched off.

 If the device fails to function even after repeated programming, check whether the original hand-held transmitter uses an alternating-code system. To do so, either read the instructions for the original hand-held transmitter or hold down the programmed memory button **1** of the integrated universal remote control. If the LED **2** on the integrated universal remote control flashes rapidly and then remains lit for about two seconds, the original hand-held transmitter uses an alternating-code system. If it uses an alternating-code system, program the memory buttons **1** as described under Alternating-code hand-held transmitters. ◀

Alternating-code hand-held transmitters

To program the integrated universal remote control, consult the operating instructions for the device to be set. You will find information there on the possibilities for synchronization. When programming hand-held transmitters that employ an alternating code, please observe the following supplementary instructions:

 Programming will be easier with the aid of a second person. ◀

1. Park your vehicle within the range of the remote-controlled device.
2. Program the integrated universal remote control as described above in the section Fixed-code hand-held transmitters.
3. Locate the button on the receiver of the device to be set, e.g. on the drive unit.
4. Press the button on the receiver of the device to be set. After step 4, you have approx. 30 seconds for step 5.
5. Press the programmed memory button **1** of the integrated universal remote control three times.

The corresponding memory button **1** is now programmed with the signal of the original hand-held transmitter.

 If you have any questions, please contact your BMW center. ◀

Deleting all stored programs

Press the left and right memory buttons **1** for approx. 20 seconds until the LED **2** flashes rapidly: all stored programs are deleted.

Reassigning individual programs

1. Hold the original hand-held transmitter at a distance of approx. 4 to 12 in/10 to 30 cm from the memory buttons **1**.

 The required distance between the hand-held transmitter and the memory buttons **1** depends on the system of the respective original hand-held transmitter used. ◀

2. Press the desired memory button **1** of the integrated universal remote control.
3. If the LED **2** flashes slowly after approx. 20 seconds, press the transmit key of the original hand-held transmitter. Release both buttons as soon as the LED **2** flashes rapidly. If the LED **2** does not flash rapidly after approx. 15 seconds, alter the distance and repeat this step.

Digital compass*

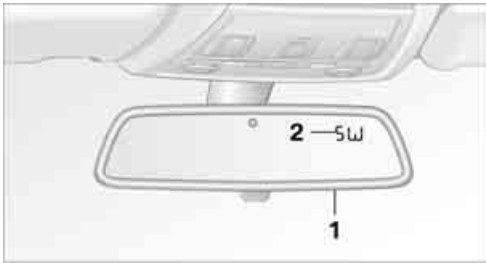

- 1 Adjustment button
- 2 Display

The display shows you the main or secondary compass direction in which you are driving.

Operating principle

You can call up various functions by pressing the adjustment button with a pointed object

such as a pen or similar item. The following adjustment options are displayed one after the other, depending on how long you keep the adjustment button pressed:

- ▷ Press briefly: switch display on/off
- ▷ 3 to 6 seconds: set the compass zone
- ▷ 6 to 9 seconds: calibrate the compass
- ▷ 9 to 12 seconds: set left-hand/right-hand steering
- ▷ 12 to 15 seconds: set the language

Setting compass zones

Set the compass zone corresponding to your vehicle's geographic location so that the compass can function correctly; refer to the world map with compass zones.

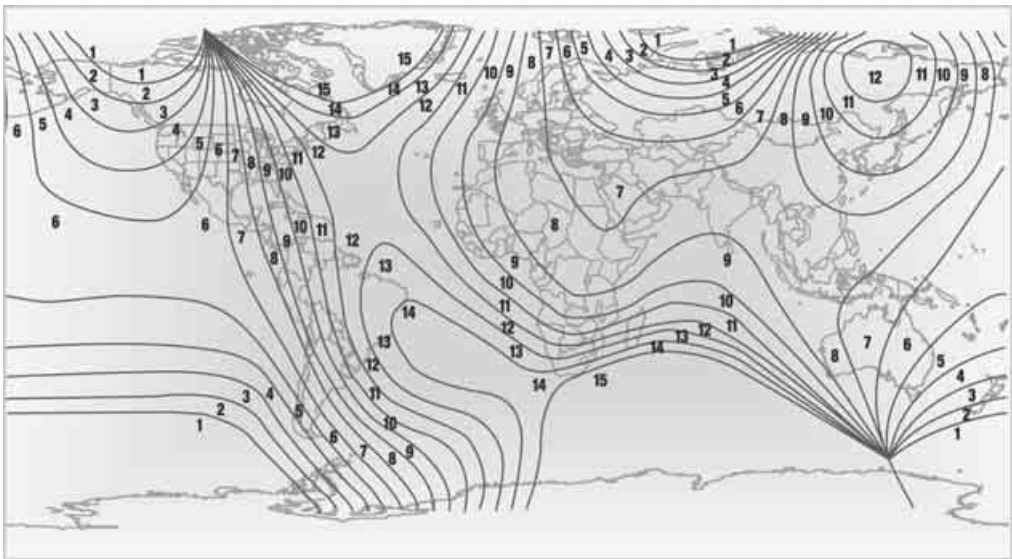

To set the compass zone, press the adjustment button for approx. 3-4 seconds. The number of the compass zone set is shown in the display.

To change the zone setting, briefly press the adjustment button repeatedly until the display shows the number of the compass zone corresponding to your current location.

The compass is operational again after approx. 10 seconds.

Calibrating the digital compass

The digital compass must be calibrated in the following situations:

- ▷ An incorrect compass direction is shown.

- ▷ The compass direction shown does not change although the direction of travel does.
- ▷ Not all compass directions are shown.

Procedure

1. Make sure that no large metal objects or overhead power lines are in the vicinity of your vehicle and that you have enough space to drive in a circle.
2. Set the currently valid compass zone.
3. Press the adjustment button for approx. 6-7 seconds to call up C. Then drive in at least one full circle at a speed of no more than 4 mph or 7 km/h.
If calibration is successful, the display changes from C to a compass direction.

Setting right-hand/left-hand steering

Your digital compass is factory-set to right-hand or left-hand steering, in accordance with your vehicle.

Setting the language

You can set the language of the display:

Press the adjustment button for approx. 12-13 seconds. Briefly press the adjustment button again to switch between English, "E", and German, "O".

The setting is automatically saved after approx. 10 seconds.

Roller sun blinds*

Rear window blind

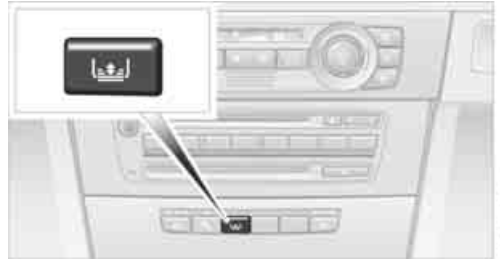

Tap the button in the center console to raise or lower the roller sun blind.

Roller sun blinds for rear side windows

Pull loop of roller sun blind and hook onto bracket.

 Do not open the window when the roller sun blind has been pulled up, otherwise there is a risk of damage at high speeds that may result in personal injury. ◀

Glove compartment

Opening

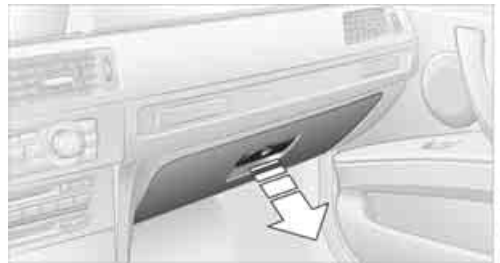

Pull the handle.

The light in the glove compartment comes on.

 To prevent injury in the event of an accident while the vehicle is being driven, close the glove compartment immediately after use. ◀

Closing

Fold cover up.

Locking

To lock the glove compartment, use the integrated key of the remote control, refer to page 26.

USB interface for data transmission



Port for importing and exporting data on USB devices, e.g. music collections, refer to page 160.

Observe the following when connecting:

- ▷ Do not use force when plugging the connector into the USB audio interface.
- ▷ Do not connect devices such as fans or lamps to the USB audio interface.
- ▷ Do not connect USB hard disks.
- ▷ Do not use the USB interface to recharge external devices.

Center armrest

Storage compartment

The center armrest between the front seats contains either a compartment or the cover for the snap-in adapter*, depending on the equipment version. For more information about this mobile phone base plate, refer to page 177.



Opening

Press the button, see arrow.

Settings*



Slide the center armrest into the desired position on the driver's side.

Connection for external audio device

You can connect an external audio device such as a CD or MP3 player and play audio tracks over the car's loudspeaker system:

- ▷ AUX-IN port, refer to page 161
- ▷ USB-audio interface*, refer to page 162

Storage compartments inside the vehicle

Depending on your vehicle's equipment, you will find compartments beside the steering column*, in the front doors and in the center console*.

There are nets* on the front-seat backrests.

Clothes hooks

There are clothes hooks on the grab handles in the rear passenger compartment.

! Items of clothing hung from the hooks must not obstruct the driver's view. Do not hang heavy objects from the hooks, otherwise they could endanger the car's occupants, e.g. in case of heavy braking or sudden swerving. ◀

Cup holders

! Use lightweight and shatterproof containers and do not transport hot beverages, otherwise there is an increased risk of injury in the event of the accident. Do not force containers that are too large into the cup holders, otherwise damage could result. ◀

Front

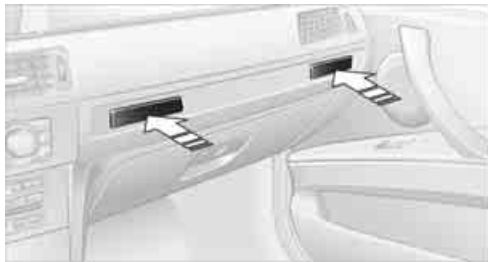

Opening

Briefly press the center of the cover.

Closing

Briefly press the cover in the center and push in the cup holder.

Ashtray, front

Opening



Push the ridge on the cover.

Emptying



Lift out the insert.

Lighter



With the engine running or the ignition switched on, press in the cigarette lighter.

The lighter can be pulled out as soon as it pops back out.

! Hold or touch the hot cigarette lighter by the knob only. Holding or touching it in other areas could result in burns. When leaving the car, always remove the

remote control so that children cannot operate the cigarette lighter and burn themselves. ◀

Ashtray, rear

Opening

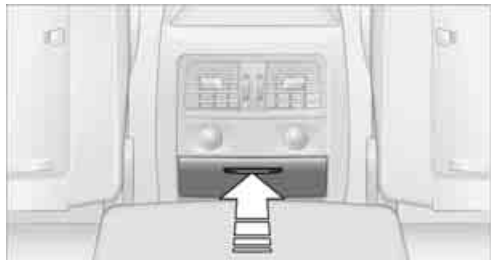

Push the ridge on the cover.

Emptying

Lift out the insert.

Connecting electrical appliances

In your BMW, when the engine is running or the ignition is switched on, you can use electrical devices such as a flashlight, car vacuum cleaner, etc., up to approx. 200 watts at 12 volts, as long as one of the following sockets is available. Avoid damaging the sockets by attempting to insert plugs of unsuitable shape or size.

Cigarette lighter socket*

To access the socket: take the cigarette lighter out of the socket.

Socket in the center armrest

External audio device, refer to page 103.

Sockets in the rear center console*

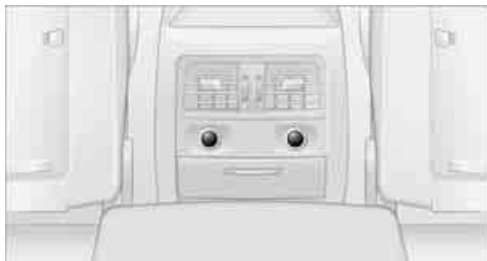

Remove corresponding cover.

Socket in the cargo bay*

Sedan



Sports Wagon



Open the cap.

Sedan: Through-loading system*

Opening

1. Open the belt lock of the rear center safety belt. To do so, press the red button in the belt lock **2** using the latch plate **1**.

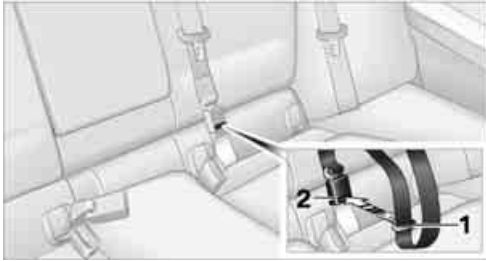

2. Insert the latch plate at the end of the belt into the specially designated fixture on the rear window shelf.

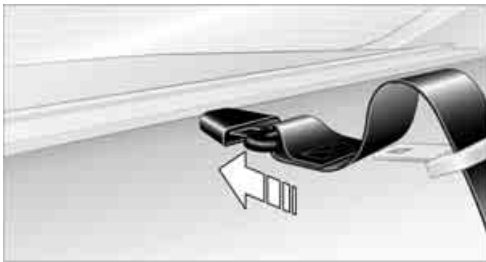

3. Push the corresponding head restraint down as far as it will go, refer to page 44.
4. To release the rear seat backrest, pull the corresponding lever in the cargo bay.

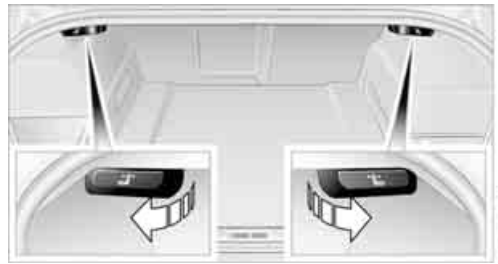

5. The unlocked rear seat backrest moves forward slightly. Fold the backrest forward by the head restraint.



Closing

1. Return the rear seat backrest to its upright position and engage it.



When returning the backrest into its seating position, make sure that the seat's locking mechanism engages properly. Otherwise, cargo could be thrown around in the event of sharp braking or swerving and endanger the occupants. ◀

2. Release the latch plate from the fixture on the rear window shelf and insert it into the belt lock of the center safety belt. Make sure you hear the latch plate engage in the belt buckle.

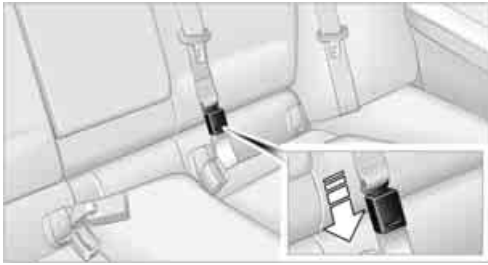

The lashing eyes in the cargo bay provide you with a way to attach cargo bay nets* or draw straps for securing suitcases and luggage, refer to page 118.

Sports Wagon: Cargo bay

Roll-up cover

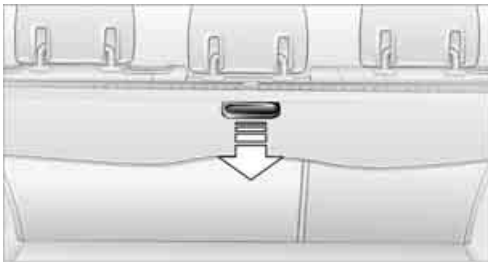

Pull out the cover and hook it into the retaining fixtures.

! Do not place objects on the cover, otherwise they could endanger the car's occupants, e.g. in the case of braking or sudden swerving.

Do not let the cover retract, otherwise it could be damaged. ◀

▷ The roll-up cover is raised when the rear window or tailgate is opened*. Before closing the rear window or tailgate, press the roll-up cover downward until it engages. ◀

Expanding the cargo bay

The rear seat backrest is divided. You can fold down either division in order to expand the cargo bay.



Reach into the recess and pull forwards.

! When folding the backrest back up, make sure that the catch engages properly. If you cannot see a red warning area in the recess, the catch is properly engaged. Otherwise, cargo can be thrown around inside the passenger compartment and endanger the car's occupants, e.g. in the case of braking or sudden swerving. ◀

! Observe the instructions concerning the safety belt on page 41 to ensure the best possible personal protection. ◀

Partition net

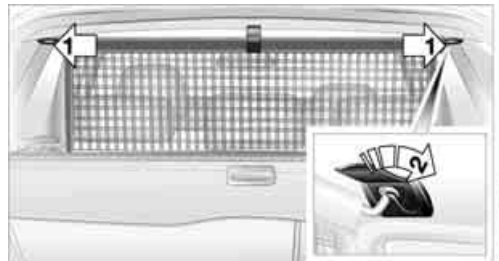

! Do not let the partition net retract, otherwise there is a risk of danger and the partition net could be damaged. ◀

Use the loop strap to pull the partition net out of the casing. Grip the bar on both ends and insert it into the retaining fixtures, arrow 1. This can best be done from the rear seat.

When you no longer require the partition net, grip both ends of the bar and take it out of the retaining fixtures, arrow 2. Let the partition net slide into the casing slowly.

With cargo bay expanded

1. Fold down both rear seat backrests, refer to Expanding the cargo bay.
2. Use the buttons to unlatch the casing on both sides, arrow 1.

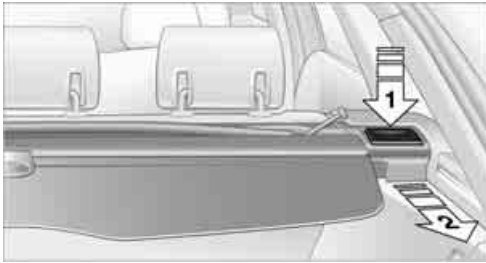

3. Pull the casing out backwards, arrow 2, without tilting it.

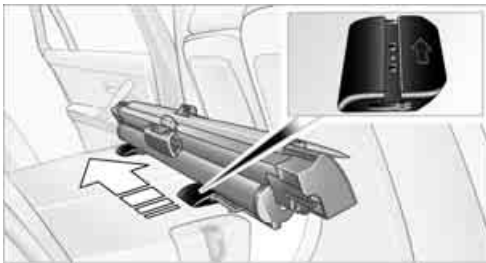

4. Slide the casing into the guides on the backs of the seat backrests.
5. Carefully pull out the partition net and insert it into the front retaining fixtures, refer to Partition net above. This can best be done from the front seat.

Follow the same steps in reverse order to return the partition net and seats to their original positions. Finally, slide the casing into both retaining fixtures on the sides until it engages. Tug on the casing to check if it is properly locked in place.

Storage compartments inside the cargo bay

Sedan

Depending on your vehicle's equipment, the following storage spaces can be found in the cargo bay:

- ▷ Left storage compartment, e.g. for storing a box of cleaning tissues or up to 12 CD jackets, depending on vehicle equipment version
- ▷ Net* for securing smaller objects, to be attached to the fixtures on the floor panel
- ▷ Hooks for hanging up, e.g. shopping bags or tote bags
- ▷ Rubber strap on the left trim panel for securing small objects such as a folding umbrella
- ▷ Net for small objects on the right trim panel of the cargo bay
- ▷ Folding, removable box* under the floor panel, e.g. for wet or dirty items
- ▷ Storage compartment under the floor panel
- ▷ Insertable dividers* and removable storage tray for the storage compartment under the floor panel

Sports Wagon

The following storage spaces can be found in the cargo bay:

- ▷ Umbrella holder on the bottom of the partition net casing



- ▷ Rubber strap on the left and right trim panel for securing small objects such as a folding umbrella
- ▷ Hooks for hanging up shopping bags or tote bags, for example, on the left and right-hand sides of the cargo bay
- ▷ Net for small objects on the right trim panel of the cargo bay
- ▷ Storage compartment under the floor panel

Depending on your vehicle's equipment, other storage spaces can be found in the cargo bay:

- ▷ Net* for securing smaller objects, to be attached to the fixtures on the floor panel
- ▷ Net* on the left side trim of the cargo bay instead of the rubber strap
- ▷ Reversible floor panel with integrated plastic cover* for cargo bay or bumper
- ▷ Folding, removable box* under the floor panel, e.g. for wet or dirty items
- ▷ Insertable dividers* and removable storage tray for the storage compartment under the floor panel

Folding up the floor panel

 Do not exceed the maximum permissible load of 55 lbs/25 kg for the storage compartment under the floor panel, otherwise damage could result. ◀

Sedan

Press the floor panel against the ceiling of the cargo bay; a locking device holds the floor panel in place. To detach the floor panel, pull it out of the locking device.

Sports Wagon

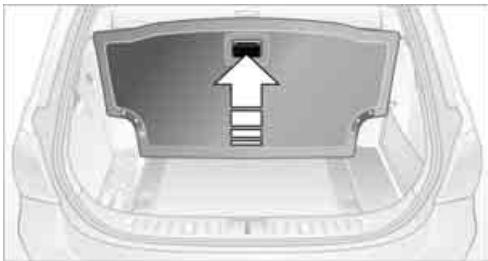

Fold up the floor panel and take it out or lean it forward.

Lashing eyes

You will find lashing eyelets in the cargo bay for securing luggage items with nets or tensioning straps, refer to page 118.

Ski bag*

The ski bag is designed for safe, clean transport of up to 4 pairs of standard skis or up to 2 snowboards.

With the ski bag you can stow skis with a length of up to 6 ft 10 in/2.10 m. When skis of 6 ft 10 in/2.10 m length are loaded, the overall capacity of the ski bag is reduced due to its tapered design.

Loading

1. Fold down the center armrest.
2. Press the button, reach into the recess and fold down the cover.



3. Open the Velcro fastener, spread the ski bag between the front seats and insert the skis or snowboards. The zip fastener makes objects in the ski bag easier to reach.
4. Insert the latch plate of the ski bag's retaining strap in the center belt buckle.



Only place clean skis in the ski bag. Wrap sharp edges to prevent damage.

Securing cargo

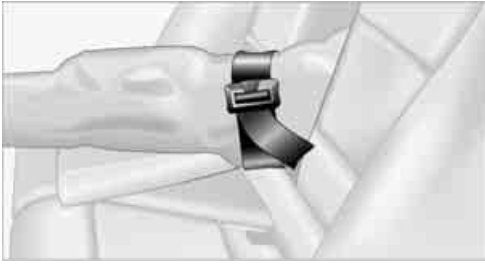

After loading, secure the ski bag and its contents. Tighten the retaining strap on the tensioning buckle for this purpose.

⚠ Secure the ski bag in the manner described, otherwise it could endanger the car's occupants, e.g. in case of heavy braking or sudden swerving. ◀

To store the ski bag, perform the steps described for loading in reverse order.

Removing the ski bag

The ski bag can be completely removed, e.g. for faster drying or to allow you to use other inserts.

1. Fold down the center panel in the rear seat backrest.
2. Pull the handle, arrow 1.



3. Pull out the insert, arrow 2.

▶ For more information on the various inserts available, contact your BMW center. ◀



Driving tips

This section provides you with information useful in dealing with specific driving and operating conditions.

Things to remember when driving

Break-in period

Moving parts need breaking-in time to adjust to each other. Please follow the instructions below in order to achieve the optimal service life and economy of operation for your vehicle.

Engine and differential

Always obey all official speed limits.

Up to 1,200 miles/2,000 km

Drive at varying engine and road speeds but do not exceed:

- ▷ Gasoline engine
4,500 rpm or 100 mph/160 km/h
- ▷ Diesel engine
3,500 rpm or 93 mph/150 km/h

Avoid full-throttle operation and use of the transmission's kick-down mode.

After driving 1,200 miles/2,000 km

Engine and vehicle speeds can be gradually increased.

Tires

Due to technical factors associated with their manufacture, tires do not achieve their full traction potential until after an initial break-in period. Therefore, drive cautiously during the first 200 miles/300 km.

Brake system

Brakes require an initial break-in period of approx. 300 miles/500 km to achieve optimized contact and wear patterns between brake pads and rotors. Drive cautiously during this break-in period.

Clutch

The function of the clutch reaches its optimal level only after a distance driven of approx. 300 miles/500 km. During this break-in period, engage the clutch gently.

Following part replacement

The same break-in procedures should be observed if any of the components mentioned above have to be renewed in the course of the vehicle's operating life.

Saving fuel

The fuel consumption of your vehicle depends on several factors. You can lower fuel consumption and the environmental impact by taking certain measures, adjusting your driving style and having the vehicle serviced regularly.

Remove any unneeded cargo

Additional weight increases fuel consumption.

Remove any mounted parts after you have finished using them

Remove unneeded additional mirrors, the roof rack and the rear luggage rack after use. Mounted parts affect the vehicle's aerodynamics and increase fuel consumption.

Close the windows and glass roof

An open glass roof or window causes higher air resistance and thus increases fuel consumption.

Check tire inflation pressure regularly

Check the tire inflation pressure at least twice a month and before embarking on a long journey, and correct it if necessary.

Low tire inflation pressure causes higher rolling resistance and thus increases fuel consumption and tire wear.

Set off immediately

Do not let the engine warm up while the car is still standing, but set off immediately at moderate engine speed. This is the fastest way for the cold engine to reach its operating temperature.

Drive defensively

Avoid unnecessary acceleration and braking maneuvers. To do so, keep an adequate distance to the forward vehicle. A defensive and smooth driving style keeps fuel consumption down.

Avoid high engine speeds

Only use first gear when setting off. In second and higher gears, accelerate without hesitation or pauses. When accelerating, shift up before reaching high engine speeds.

When you reach the desired speed, shift into the highest applicable gear and drive with the engine speed as low as possible and at a constant speed.

As a rule: driving at low engine speeds lowers fuel consumption and reduces wear.

Coasting

When approaching a red light, take your foot off the accelerator and coast to a stop in the highest applicable gear.

On a downhill slope, take your foot off the accelerator and coast in a suitable gear.

The fuel supply is interrupted when coasting.

Switch off the engine during lengthy stops

Switch off the engine when stopping for lengthy periods, e.g. at traffic lights, railroad crossings or in traffic congestions. You achieve fuel savings even if standing time is as short as approx. 4 seconds.

Switch off functions you do not need at the moment

Functions such as the air conditioner and the seat or rear window heating draw large amounts of power and consume additional fuel. Especially in city traffic and in stop and go driving they have a considerable impact. Therefore, switch these functions off when they are not really needed.

Have the vehicle serviced

Have the vehicle serviced regularly to achieve good economy and a long vehicle life. BMW recommends having the vehicle serviced at a BMW center. Also note the BMW service system, refer to page 216.

General driving notes

Close the luggage compartment lid/ tailgate



Operate the vehicle only when the luggage compartment lid/tailgate and rear window are closed. Otherwise, exhaust fumes could enter the interior of the vehicle. ◀

If the vehicle must be driven with the luggage compartment lid/tailgate open:

1. Close all windows and the glass roof.
2. Greatly increase the air volume of the automatic climate control system, refer to page 95.

Hot exhaust system



In all vehicles, extremely high temperatures are generated in the exhaust system. Do not remove the heat shields installed adjacent to various sections of the exhaust system, and never apply undercoating to them. When driving, standing at idle and while parking, take care to avoid possible contact between the hot exhaust system and any highly flammable materials such as hay, leaves, grass, etc. Such contact could lead to a fire, with the risk of serious personal injuries and property damage. Do not touch hot exhaust tail pipes. Otherwise there is a risk of burns. ◀

Diesel particulate filter*

The diesel particulate filter collects soot particles and burns them periodically at high temperatures. This cleaning process takes several minutes. During cleaning, you may notice that the engine temporarily runs less smoothly and that a somewhat higher engine speed is necessary to achieve the accustomed performance. Also, noises may be heard and a slight amount

of smoke may emerge from the exhaust, even for a short period after the engine is switched off.

Hydroplaning

 When driving on wet or slushy roads, reduce road speed. If you do not, a wedge of water can form between tires and road surface. This situation, known as hydroplaning, means that the tire can completely lose contact with the road surface, so that neither the car can be steered nor the brake be properly applied. ◀

The risk of hydroplaning increases with declining tread depth on the tires, refer also to Minimum tread depth on page 208.

Driving through water

 Drive through water on the road only if it is not deeper than 1 ft/30 cm, and then only at walking speed at the most. Otherwise, the vehicle's engine, the electrical systems and the transmission may be damaged. ◀

Use the parking brake on inclines

 On inclines, do not hold the vehicle for a lengthy period using the clutch; use the parking brake instead. Otherwise greater clutch wear will result. ◀

For more information about the drive-off assistant, refer to page 83.

Braking safely

Your BMW is equipped with ABS as a standard feature. Applying the brakes fully is the most effective way of braking in situations in which this is necessary. Since the vehicle maintains steering responsiveness, you can still avoid possible obstacles with a minimum of steering effort.

Pulsation of the brake pedal, combined with sounds from the hydraulic circuits, indicate that ABS is in its active mode.

Driving in wet conditions

When roads are wet or there is heavy rain, briefly exert gentle pressure on the brake pedal every few miles. Monitor traffic conditions to

ensure that this maneuver does not endanger other road users. The heat generated in this process helps dry the pads and rotors. Full braking efficiency will then be available when you need it.

Hills

 To prevent overheating and the resulting reduced efficiency of the brake system, drive long or steep downhill gradients in the gear in which the least braking is required. Even light but consistent brake pressure can lead to high temperatures, brake wear and possibly even brake failure. ◀

You can increase the engine's braking effect by shifting down, all the way to first gear if necessary. This strategy helps you avoid placing excessive loads on the brake system. Downshifting in manual mode of the automatic transmission, refer to page 56.

 Never drive with the clutch held down, with the transmission in neutral or with the engine switched off; otherwise, engine braking action will not be present or there will be no power assistance to the brakes or steering. Never allow floor mats, carpets or any other objects to protrude into the area around the pedals, otherwise pedal function could be impaired. ◀

Corrosion on brake rotors

When the vehicle is driven only occasionally, during extended periods when the vehicle is not used at all, and in operating conditions where brake applications are less frequent, there is an increased tendency for corrosion to form on rotors, while contaminants accumulate on the brake pads. This occurs because the minimum pressure which must be exerted by the pads during brake applications to clean the rotors is not reached.

Should corrosion form on the brake rotors, the brakes will tend to respond with a pulsating effect that even extended application will fail to cure.

When the vehicle is parked

Condensation forms while the automatic climate control is in operation, and then exits under the vehicle. Traces of condensed water under the vehicle are therefore normal.

Before driving into a car wash

General information on caring for your BMW can be found on page 218.

Sports Wagon: rear window wiper

Driving through an automatic car wash can result in damage to the rear window wiper. If necessary, ask the operator of the car wash about protective measures you should take.

With convenient access and automatic transmission

Insert the remote control into the ignition switch.

The engine can be switched off when the selector lever is in position N. Refer also to page 218.

Cargo loading

 To avoid loading the tires beyond their approved carrying capacity, never overload the vehicle. Overloading can lead to overheating and increases the rate at which damage develops inside the tires. This can ultimately result in a sudden blow-out. ◀

 Make sure that no liquids are spilled or leak from their containers in the cargo bay, as this could result in damage to the vehicle. ◀

Determining loading limit



1. Locate the following statement on your vehicle's placard*:
 -  The combined weight of occupants and cargo should never exceed XXX kg or YYY lbs. Otherwise, overloading can result in damage to the vehicle and unstable driving conditions. ◀
2. Determine the combined weight of the driver and passengers that will be riding in your vehicle.
3. Subtract the combined weight of the driver and passengers from XXX kilograms or YYY pounds.
4. The resulting figure equals the available amount of cargo and luggage load capacity. For example, if the YYY amount equals 1,400 lbs. and there will be five 150-lb. passengers in your vehicle, the amount of available cargo and luggage load capacity is 650 lbs:

$$1,400 \text{ lbs.} - 750 \text{ lbs.} = 650 \text{ lbs.}$$
5. Determine the combined weight of luggage and cargo being loaded on the vehicle. That weight may not safely exceed the available cargo and luggage load capacity calculated in step 4.
6. If your vehicle will be towing a trailer, part of the load from your trailer will be transferred to your vehicle. Consult the manual for transporting a trailer to determine how this may reduce the available cargo and luggage load capacity of your vehicle.

Load

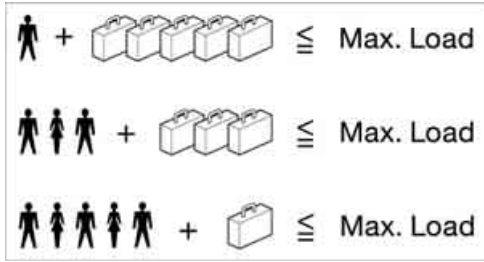

The permissible load is the total of the weight of occupants and cargo/luggage. The greater the weight of the occupants, the less cargo/luggage can be transported.

Stowing cargo

- ▷ Position heavy objects as low and as far forward as possible, ideally directly behind the respective seat backrests.
- ▷ Cover sharp edges and corners.
- ▷ For very heavy cargo when the rear seat is not occupied, secure each safety belt in the opposite buckle.

Sedan

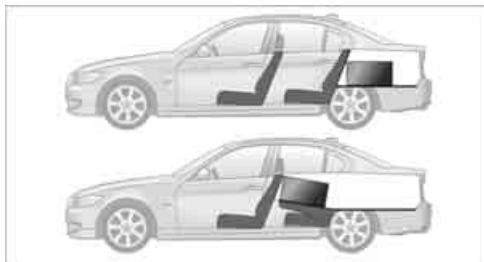

Sports Wagon

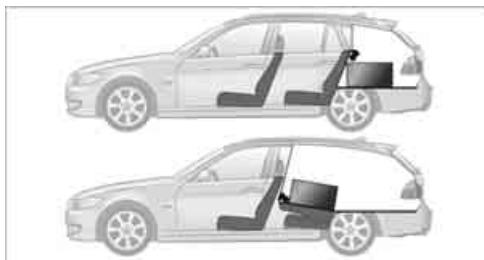

- ▷ Use the partition net to protect passengers, refer to page 107. Make sure that objects cannot penetrate the partition net.
- ▷ Do not stack cargo higher than the upper edge of the backrests.
- ▷ Place protective material around any objects which could bump against the rear window while the vehicle is in motion.

Securing cargo



- ▷ Secure smaller and lighter items using retaining straps, a cargo bay net* or draw straps*.
- ▷ Heavy-duty cargo straps* for securing larger and heavier objects are available at your BMW center. Four lashing eyes are provided for attaching the cargo straps. Two are located on the cargo bay sidewalls **1**, two more are on the rear cargo bay panel **2**. Please comply with the information supplied with the cargo straps.

! Always position and secure the cargo as described above, so that it cannot endanger the car's occupants, for example if sudden braking or swerving is necessary.

Never exceed either the approved gross vehicle weight or either of the approved axle loads, refer to page 241, as excessive loads can pose a safety hazard, and may also place you in violation of traffic safety laws.

Heavy or hard objects should not be carried loose inside the car, since they could be thrown around, for example as a result of heavy braking, sudden swerves, etc., and endanger the occupants.

Only attach the cargo straps using the lashing eyes shown in the illustration. Do not secure cargo with the anchors for tether straps, refer to page 50, otherwise these could be damaged. ◀

Roof-mounted luggage rack*

A special rack system is available as an option for your BMW. Comply with the directions given in the installation instructions.

Mounting points



The mounting points are located in the roof/ along the roof rails*.

Loading roof-mounted luggage rack

Because roof racks raise the vehicle's center of gravity when loaded, they have a major effect on vehicle handling and steering response.

You should therefore always remember not to exceed the approved roof load capacity, the approved gross vehicle weight or the axle loads when loading the rack.

You can find the applicable data under Weights on page 241.

The roof load must be distributed uniformly and should not be too large in area. Heavy items should always be placed at the bottom. Be sure that adequate clearance is maintained for raising the glass roof, and that objects do not project into the opening path of the luggage compartment lid/tailgate.

Fasten roof-mounted cargo correctly and securely to prevent it from shifting or falling off during the trip.

Drive smoothly. Avoid sudden acceleration and braking maneuvers. Take corners gently.



Navigation

This chapter describes how you can enter destinations and specify your route so that your navigation system guides you reliably to your destination.

Navigation system*

General information

With the help of satellites, the navigation system is able to ascertain the precise position of the vehicle and guide you reliably to any destination you enter.

The navigation data is stored in the vehicle and can be updated using navigation DVDs.

⚠ Make all entries while the vehicle is stationary

Enter data only when the vehicle is stationary, and always give priority to the applicable traffic regulations in the event of any contradiction between traffic and road conditions and the instructions issued by the navigation system. Failure to take to this precaution can place you in violation of the law and put vehicle occupants and other road users in danger. ◀

Updating the navigation data

The navigation data is stored in the vehicle and can be updated using a navigation DVD. Please contact the BMW center if you have any questions.

Inserting navigation DVD

1. Insert the navigation DVD into the DVD player with the labeled side facing up.
2. Follow the instructions on the display.
3. Enter the authorization code of the navigation DVD and change the DVD if needed.

Displaying information on the version

1. "Navigation"
2. Open "Options".
3. "Navigation system version". Information on the data version is displayed.

Removing navigation DVD



1. **⏏** Press button 1.
The DVD emerges slightly from the drive.
2. Remove the DVD.

If the DVD is not ejected, the drive may be blocked. In this case, a message will appear on the Control Display.

Destination entry

In entering your destination you can select from the following options:

- ▷ Entering a destination manually, see below
- ▷ Selecting destination from the address book, refer to page 125
- ▷ Last destinations, refer to Last destinations, page 126
- ▷ Special destinations, refer to page 126
- ▷ Entering a destination on the map, refer to page 128
- ▷ Selecting a home address, refer to page 126
- ▷ Entering a destination by voice commands*, refer to page 129

You can also store a navigation destination on the programmable memory keys, refer to page 20.

 Enter data only when the vehicle is stationary, and always give priority to the applicable traffic regulations in the event of any contradiction between traffic and road conditions and the instructions issued by the navigation system. Otherwise, vehicle occupants and other road users may be endangered. ◀

Entering a destination manually

The system's word-matching principle makes it easier for you to enter the names of towns or streets. This allows you to enter different spellings and completes your entry automatically so that stored names can be called up quickly.

1. "Navigation"
2. "Enter address"



The system also supports you with the following features:

- ▷ If you do not enter a street, the system will guide you to the downtown area of a town or city.
- ▷ You can skip the entry of state/province and locality if the current entries should be retained for your new destination.

Entering a state/province



1. "Navigation"
2. "Enter address"
3. Select "State/Province" or the displayed state/province.

Entering a town/city

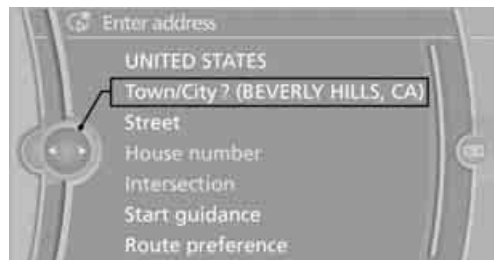
1. Select "Town/City/Zip Code" or the displayed town/city, or select letters.



Delete letters, if necessary:

- ▷ To delete individual letters:
Turn the controller to select , and then press the controller.
- ▷ To delete all letters:
Turn the controller to select , and then press the controller for an extended period.
- ▷ To enter spaces:
Select the _ symbol.

The list gradually grows smaller each time you enter a new letter.

2. Move the controller to the right.
3. Select the name of the town/city from the list. The three destinations stored last are displayed.

If there are several towns/cities with the same name:

1. Change to the list of town/city names.
2. Highlight the town/city: a preview map is displayed.
3. Select the town/city.

Entering the postal code

1. Select "Town/City/Zip Code" or the displayed town/city.
2. Select the  symbol.
3. Select the digits.
4. Change to the list of postal codes and towns/cities.
5. Highlight the postal code. A preview map is displayed in the assistance window.
6. Select the postal code.

Entering street and intersection

1. Select "Street" or the displayed street.
2. Enter a street and intersection as you would the town/city.

After the street you can also enter the intersection or the house number.

If there are several streets with the same name:

1. Change to the list of street names.
2. Highlight the street: a preview map is displayed.
3. Select the street.

Entering a street without a destination town/city

You can also enter a street without specifying a town/city. In this case, all streets of the same name in the designated state/province are offered. The corresponding town/city is displayed after the street name.

If a town/city has already been entered, you can negate this entry. This could be helpful in instances where the desired street does not exist in the entered town/city because it belongs to another suburb, for example.

1. "Navigation"
2. "Enter address"
3. Select "Street" or the displayed street.
4. Change to the list of street names.
5. "Find streets in" the state/province currently displayed.



6. Select the letters.
7. Change to the list of street names.
8. Highlight the street. A preview map is displayed in the assistance window.
9. Select the street.

Entering a house number

You can enter any house number stored in the navigation data for the street.

1. "House number"
2. Select the digits.

3. Change to the list of house numbers.
4. Select a house number or range of house numbers.

Selection after destination entry

- ▷ "Start guidance".
Destination guidance is started immediately.
- ▷ "Route preference"
refer to page 133.
- ▷ "Points of Interest at dest."
refer to page 126.

If a new town/city is selected during destination guidance, the current destination guidance is terminated.

Address book

To create contacts, refer to page 179.

Selecting a destination from the address book

1. "Navigation"
2. "Address book"
Contacts with addresses are displayed.

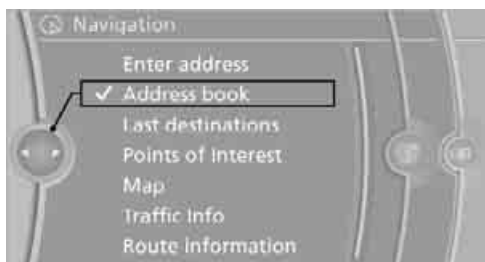

3. Select a contact from the list or, if necessary, using "A-Z search".
4. Select "Business address" or "Home address".
5. "Start guidance"

Storing a destination in the address book

Store the destination in the address book after entering the destination.

1. Open "Options".
2. "Store as new contact" or "Add to existing contact"



3. Select an existing contact, if available.
4. Select "Business address" or "Home address".
5. Enter "Last name" and, if necessary, "First name".
6. "Store in "My Contacts""

Storing the position

Your current position can be stored in the address book.

1. "Navigation"
2. Open "Options".
3. "Store position as contact" or "Add position to contact"

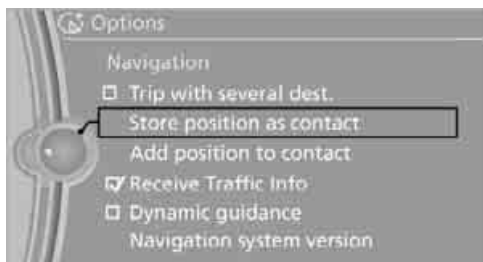

4. Depending on the selection, select an existing contact from the list or the type of address and enter the last and first name.
5. "Store in "My Contacts""

Editing or deleting an address

1. "Navigation"
2. "Address book"

3. Highlight the entry.
4. Open "Options".
5. "Edit in Contacts" or "Delete entry".

Using home address as destination

The home address must be stored as a destination. Refer to Specifying a contact as the home address, page 179.

1. "Navigation"
2. "Address book"
3. "Home address"

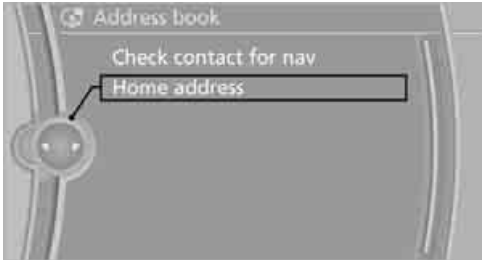

4. "Start guidance"

Last destinations

The last destinations are stored automatically. These destinations can be called up and used as a destination for destination guidance.

Opening the last destinations

1. "Navigation"
2. "Last destinations"



3. Select the destination.
4. "Start guidance"

Editing a destination

Destinations can be edited, for example, to change the house number of an existing entry.

1. "Navigation"
2. "Last destinations"
3. Highlight the destination.
4. Open "Options".
5. "Edit destination"

Deleting the last destinations

1. "Navigation"
2. "Last destinations"
3. Highlight the destination.
4. Open "Options".
5. "Delete entry" or "Delete all last destinations".

Special destinations

You can search for special destinations, e.g. hotels and places of interest, and start destination guidance to this location.

The search can be narrowed by entering the location and type of special destination.

 The scope of information provided depends on the particular set of navigation data you are using. ◀

Opening the search for special destinations

1. "Navigation"
2. "Points of Interest"

Special destination location

Search for a special destination according to its location relative to a locality or route.

1. "Search destination"



2. Select the location where the system is to search for the special destination:
 - ▷ "At current location"
 - ▷ "At destination"
 - ▷ "At a different destination"
 - ▷ "Along route"

Special destination category

1. "Category"
2. Select "All" or a specific category, e.g. hotels or restaurants.
3. "Route Points of Interest"*

Category details

Additional details can be displayed for some special destinations, e.g. Italian restaurants.

1. "Points of Interest"
2. "Category details"

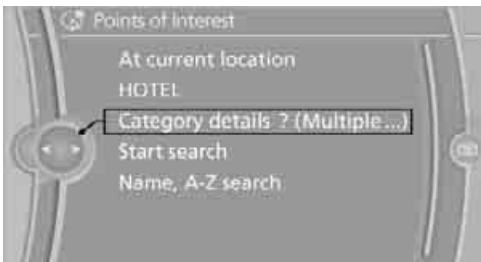

Starting the search for special destinations

1. "Start search" after the criteria have been defined.
2. A list of the special destinations is displayed.
 - ▷ Special destinations "At current location" are listed according to their distance from the current location and are displayed with a directional arrow pointing to the destination.
 - ▷ Destinations of the selected category are displayed in the map display as symbols. The display depends on the map scale and the category.
 - ▷ Special destinations "At destination", "At a different destination", "Along route" are listed according to their distance from the location where the search is being performed.
3. Highlight the special destination. The destination is displayed in the preview map.
4. Select the special destination.
5. Select the  symbol. Destination guidance to the special destination is started. If a phone number is available, a connection can be established, if desired.

Entering special destinations by name

1. "Name, A-Z search"
2. Enter the letters.

Depending on the distance, the search may take some time. The list can contain a maximum of 100 entries.
3. Change to the list of special destinations.
4. Highlight the special destination. The destination is displayed in the preview map.
5. Select the special destination.
6. Select the  symbol to start destination guidance.

Displaying special destinations in the map

To display symbols of the special destinations in the map:

1. "Navigation"
2. "Map"
3. Open "Options".
4. "Display Points of Interest"

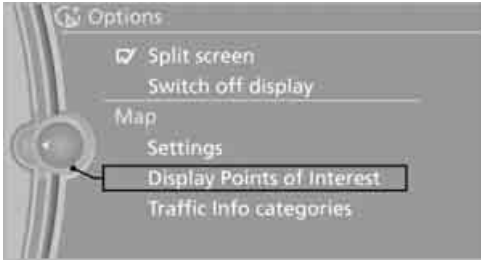

5. Select the settings.

Entering the destination via the map

If you only know the location of the town or street, you can enter the destination using the map.

Opening the map

1. "Navigation"
2. "Map"

A map section is displayed on the Control Display. The map shows the current position of the vehicle.

Selecting the destination

1. Select the  symbol. The interactive map is started.
2. Select the destination with the cross-hairs.



- ▷ Turn the controller: change the scale.
 - ▷ Move the controller in one direction: move the map.
 - ▷ First move the controller and turn it at the same time: move the map diagonally to select a destination in one of the four regions.
3. Press the controller to display additional menu items:
 - ▷ Select the  symbol: start destination guidance.

Specifying the street

If the system cannot recognize a street or town/city, it displays a street name in the vicinity or the coordinates of the destination.

Interactive map

In the interactive map, the scale can be adjusted and the visible map section can be shifted. In

addition, pressing the controller makes further functions available:





- ▶ Select the  symbol: start destination guidance.
- ▶ "Exit interactive map"
- ▶ "View in northern direction"
- ▶ "Display destination"
The map section around the destination is displayed.
- ▶ "Display current location"
The map section around your current location is displayed.
- ▶ "Find points of interest", refer to page 126.

Entering a destination by voice commands*

You can enter a desired destination via the voice activation system. During the destination input, you can switch between voice entry and entry via iDrive at any time. To do so, reactivate the voice activation system if necessary.

 You can have the possible commands read aloud via ›Voice commands‹. ◀

Entering an address

1. Press the  button on the steering wheel.
-  2. ›Enter address‹
3. Wait for the system to prompt you for a particular part of the address.
-  4. Say the particular part of the address, e.g. ›State‹

5. Say the name of the destination state/province in the language of the voice activation system.

Entering a town/city

The destination town/city can be spelled or entered as a complete word*.

 The methods of entry depend on the navigation data in use and the country and language settings. ◀

Spelling the destination

To enter a destination, spell it in the way it is commonly spelled in the destination country. Pronounce the letters smoothly and at normal volume, avoiding excessive emphases and pauses.

-  1. To spell the name of a town/city: Say at least the first three letters of the town/city. The more letters you say, the more accurately the system will recognize the town/city.

The system can suggest up to 20 destinations that meet your entries. Up to 7 entries at a time appear on the Control Display.

-  The system suggests a location.
2. Select a location:
 - ▶ Select a highlighted town/city: ›Yes‹
 - ▶ Select another town/city: ›No‹
 - ▶ Select an entry, e.g. ›Entry ...‹
 - ▶ Re-enter the town/city: ›New entry‹

The town/city can also be selected from the list via iDrive: turn the controller until the destination is selected and press the controller.

Entering the destination as a complete word

The names of towns/cities and streets located in the region in which the language of the voice activation system is spoken can be entered as an entire word.

Example: to enter a destination in a state/province as a complete word, the system language must be English.

Speak smoothly and at normal volume, and avoid excessive emphases and pauses.

1. Wait for the system to ask for the town/city of destination.

2. Say the name of the destination town/city.

The system may suggest multiple destinations that meet your entries.

- The system suggests a location.

3. Select a location:
 - ▶ Select a highlighted town/city: ›Yes‹
 - ▶ Select another town/city: ›No‹
 - ▶ Select an entry, e.g. ›Entry ...‹
 - ▶ Enter the town/city by spelling: ›Spell city‹

▶ Identical-sounding towns/cities that cannot be distinguished by the system are compiled in a separate list and shown as a destination followed by three dots.

If necessary, select this entry with ›Yes‹. Then select the desired town/city from that list. ◀

Entering street and house number

The street is entered in the same way as the destination town/city.

To enter the house number:

1. ›House number‹
2. Say the house number.

Starting destination guidance

- ›Start guidance‹

Destination guidance starts immediately.

Storing destinations

The destination is added to the destination list and is displayed in the list of last destinations.

Trip planner

The trip planner can be used to plan a trip with several legs to different destinations.

New trip

Various intermediate destinations can be entered for a trip.

1. "Navigation"
2. Open "Options".
3. Activate "Trip with several dest."

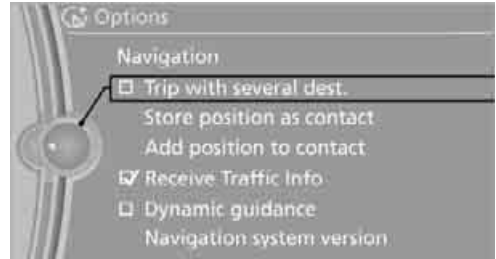

4. "Trip list".
5. "New trip"

Entering intermediate destinations

1. "Enter first dest. in the trip", if applicable, "Another destination in the trip"
2. "Enter address using:"
3. Select the type of destination entry and enter the intermediate destination.

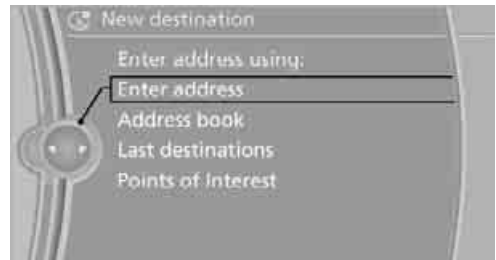

4. Select the location where the intermediate destination is to be inserted: "As first destination", "As last destination" or "Insert within list".
5. If applicable, select "Another destination in the trip".

Starting the trip

After entering all of the intermediate destinations, open a stored trip directly via "Start guidance" or via "Trip list".

Storing a trip

In the trip planner, created trips can be stored in the trip list.

1. Open "Options".
2. "Store trip"
3. Enter the letters.

The trip is stored in the trip list under the entered name.

Changing the trip direction

Intermediate destinations are displayed in reverse order in the list. This function is not available for imported trips.

1. "Trip list"
2. Open "Options".
3. "Reverse order of trip dest."

Arranging the order of intermediate destinations

This function is not available for imported trips.

1. "Trip entry"
2. Select an intermediate destination.
3. "Reposition dest. in the trip"
4. Move the intermediate destination to another position in the list.

Deleting an intermediate destination

This function is not available for imported trips.

1. "Trip entry"
2. Select an intermediate destination.
3. Open "Options".
4. "Delete dest. in the trip"

Deleting a trip

1. "Trip list"
2. Select the desired trip.
3. Open "Options".
4. "Delete all trips" or "Delete trip".

Opening the trip list

The stored trips are listed in alphabetical order in the trip list.

1. "Trip planner"
2. "Yes"
3. "Trip list"
4. Select a trip.

Importing trips

A maximum of 30 trips with at most 50 intermediate destinations per trip can be stored.

Connect the USB device to the USB interface in the glove compartment.

1. "Navigation"
2. "Trip planner"
3. "Yes"
4. "Trip list"
5. Highlight the trip.
6. Open "Options".
7. Select "Import trip".
8. "USB device" or "BMW Search"*
9. "OK"

Terminating trip planning

To return to the direct entry of destinations:

1. "Navigation"
2. Open "Options".
3. Deactivate "Trip with several dest.".

Word-matching principle

The system's word-matching principle makes it easier for you to enter the names of towns or streets. The system runs ongoing checks, comparing your destination entries with the data stored in the vehicle as the basis for instant response. The benefits for you include:

- ▷ Names of towns entered may differ from the official versions if you are using a spelling that is customary in another country.

Example:

Instead of the German spelling "München" you can also enter the English spelling "Munich" or the Italian spelling "Monaco".

- ▷ When you are entering the names of towns and streets the system will complete them automatically as soon as enough letters are available to ensure unambiguous identification.
- ▷ The system offers only those letters for selection of name entries that are stored in the vehicle. Thus, entry of erroneous or unregistered names is impossible.

Destination guidance

Starting destination guidance

1. "Navigation"
2. "Enter address"
3. Select the destination.
4. "Start guidance"

After the route is calculated, the route is displayed in the map on the Control Display.

Terminating destination guidance

1. "Navigation"
2. "Map"
3. Select the  symbol

Continuing destination guidance

If the destination was not reached at the end of the last trip, the system asks whether it should continue destination guidance.

Select "Resume guidance" or "Stop guidance".

Route criteria

General information

You can influence the calculated route by choosing certain route criteria. You can change the route criteria as often as you like during destination entry or during destination guidance.

The route is planned according to fixed rules. The type of road is taken into account, e.g. whether it is a highway or a winding road. As a result, the routes recommended by the navigation system may not always be the same ones that you would choose based on personal experience.

The settings are stored for the remote control currently in use.

Changing route criteria

1. "Navigation"
2. "Map"
3. "Route preference"
4. Selecting a criterion:
 - ▷ "Fast route": time-optimized route, which is a combination of the shortest possible route and the fastest roads
 - ▷ "Efficient route": optimized combination of the fastest and shortest roads
 - ▷ "Short route": short distance, irrespective of how fast or slow progress will be
 - ▷ "Alternative routes": other suggested alternative routes



5. Select additional route criteria, if desired. Where possible, the selected criteria will be avoided on the route.
 - ▷ "Avoid highways"
 - ▷ "Avoid toll roads"
 - ▷ "Avoid ferries"
 - ▷ "Avoid area": define an area that the route is to avoid

The setting applies to the current route and to the planning of future routes.

Dynamic destination guidance

"Dynamic guidance" is switched on:

The route is automatically changed in the event

of traffic obstructions. The system does not point out traffic obstructions along the original route.

Depending on the type of road and the nature and length of the traffic obstruction, the route can also be calculated so that you travel through the traffic obstruction.

1. "Navigation"
2. Open "Options".
3. "Dynamic guidance"

 If the "Avoid highways", "Avoid toll roads" or "Avoid ferries" route criteria are selected, route calculation may take considerably longer. ◀

Route

General information

Depending on the equipment in your vehicle, different views of the route are available during destination guidance.

- ▷ Map display
- ▷ Arrow display
- ▷ Display of the streets and towns/cities on the route.

Displaying a list of the streets or towns/cities on the route

When destination guidance is started, a list of the streets and towns/cities on the route is displayed. The driving distances and traffic bulletins are displayed for each route section.

- ▷ Display a list of the streets and towns/cities on the route.
- ▷ Display the traffic bulletins and the driving distance for each route section.

1. "Navigation"
2. "Route information"
3. Highlight a section.

The section is displayed in the preview map.

Bypassing a section of the route

During destination guidance, you can revise the navigation system's route recommendations to avoid particular stretches of road. Enter the number of miles/kilometers that you want to travel before returning to the original route.

A section of the route up to 32 miles/50 km in length can be bypassed.

1. "Navigation"
2. "Route information"
3. "New route for:"



4. Turn the controller: enter the desired number.

If the route section should no longer be bypassed: "Remove blocking"

Gas station recommendations

The vehicle calculates the range and recommends several gas stations along the route.

1. "Navigation"
2. "Route information"
3. "Recommended refuel"
4. Select a gas station.
5. Select the  symbol to start destination guidance.

Destination guidance through voice instructions

Switching voice instructions on/off

Voice instructions can be switched on or off during destination guidance.

1. "Navigation"
2. "Map"
3. Select the  symbol

 The voice instructions are switched on.

For rapid access, the feature can be stored on a programmable memory key, refer to page 20.

Repeating a voice instruction

1. "Navigation"
2. "Map"
3. Select the  symbol twice.

Adjusting volume for voice instructions

The volume can be adjusted only while a voice instruction is being issued.

1. Have the last voice instruction repeated, if necessary.
2. Turn the button during the voice instruction to select the desired volume.

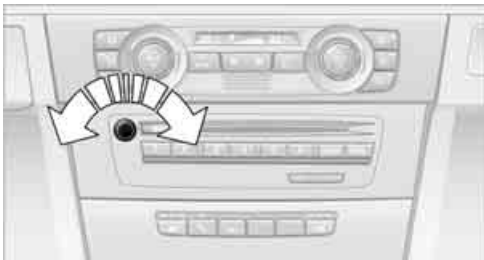

The setting is stored for the remote control currently in use.

Map display

Map display

You can have your current position displayed on a map. After starting the destination guidance, the planned route is shown on the map.

1. "Navigation"
2. "Map"

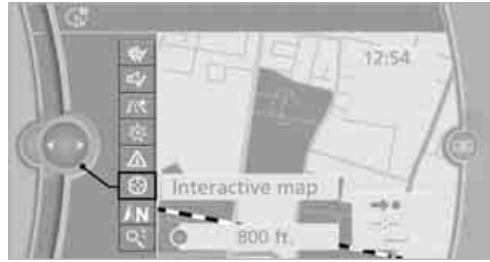



The following functions are directly available in the map display:

- 1 Starting/stopping destination guidance
- 2 Switching voice instructions on/off
- 3 Changing route criteria or selecting route alternatives
- 4 Special destinations
- 5 Displaying traffic bulletins
- 6 Interactive map
- 7 Settings for the map display
- 8 Changing scale

Information in the map display:

- ▷ Time, entertainment source, sound output, map orientation
- ▷ Distance from destination, estimated time of arrival, if destination guidance is active.
- ▷ Any traffic obstructions are highlighted in color.

Viewing the map

1. Select the    symbol.
2. Select a setting:
 - ▷ "View facing north"
 - ▷ "View in direction of travel"
 - ▷ "Perspective view"
 - ▷ "Arrow display"
3. Press the controller.

Changing scale

1. Select the  symbol.
2. Turn the controller to adjust the scale.

Automatic scaling of the map

In the map display facing north, turn the controller in any direction until AUTO is displayed as the map scale.

The map shows the entire range from your location to the destination.

Settings for the map display

1. "Navigation"
2. "Map"
3. Open "Options".
4. "Settings"
 - ▷ Optimized view "Night mode"
 - ▷ Optimized view with spatial display: "Perspective view in 3D" prominent areas are shown in the map.

Split screen settings

The map settings for the split screen can be created separately from the main screen.

1. Open "Options".
2. "Split screen"
3. Move the controller to the right until the split screen is selected.
4. Press the controller.
5. Select the settings:
 - ▷ "View facing north"
 - ▷ "View in direction of travel"
 - ▷ "Perspective view"
6. To change the scale:
 - ▷ Move the controller: change the scale.

Traffic bulletins*

You can display the traffic bulletins from radio stations that broadcast the TMC (Traffic Message Channel) of a traffic information service. This information from the traffic information service is continuously updated on the basis of measurement data from traffic control centers and information on traffic congestion. During destination guidance, traffic bulletins that are relevant to areas along the route are

automatically displayed and taken into account in the route planning. You can open all traffic bulletins manually via iDrive.

The traffic bulletins are shown in the map display.

Activating/deactivating reception

1. "Navigation"
2. Open "Options".
3. "Receive Traffic Info"

In many metropolitan areas you can receive traffic information broadcast by radio stations. The traffic conditions are monitored by traffic control centers and the traffic information is updated periodically.

During destination guidance, the traffic bulletins relevant to your planned route are automatically shown. Whether destination guidance is active or not, you can have the traffic bulletins displayed in the map view or in the traffic bulletin list.

Traffic bulletins in a list

A list of the traffic bulletins can be opened via the menu or map display.

Opening the traffic bulletins

1. "Navigation"
2. "Traffic Info"
 - First, the traffic bulletins on the planned route are displayed. The traffic bulletins are sorted in the order of their distance from the current vehicle position.
3. Select a traffic bulletin.

Additional information can be displayed for some traffic bulletins:

1. Select the  symbol.
2. Additional information is displayed.



3. To exit from the menu:
Move the controller to the left.

Highlighting traffic bulletins

1. "Navigation"
2. "Map"
3. Open "Options".
4. "Settings"

The map is optimized for displaying the traffic bulletins. Symbols for the special destinations are no longer displayed.

Symbols in the map display

The appearance of the symbols indicating a traffic obstruction depends on the scale and the position of the traffic obstruction relative to the route.

- ▷ Smaller map scale, e.g. 1 mile/2 km: white sign with the traffic obstruction symbol
- ▷ Larger map scale, e.g. 50 miles/100 km: white sign with an arrow in the relevant direction

Additional information in the map display

When using a smaller map scale, the traffic obstructions are displayed as gray bars at the edge of the calculated route.

Filtering of traffic bulletins

You can filter which traffic bulletins are to be displayed by the system:

1. "Navigation"
2. "Traffic Info"
3. Open "Options".

The map is optimized for displaying the traffic bulletins. Symbols for the special destinations are no longer displayed.

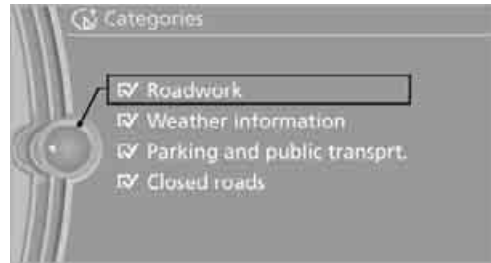

4. Select the filter:

Traffic bulletins of the selected category are displayed.

- ▷ Traffic bulletins on incidents along the route are always displayed.
- ▷ For your own safety, traffic bulletins that notify you of potentially dangerous situations, such as wrong-way drivers, cannot be hidden.

Traffic bulletins during destination guidance

System response will vary depending on whether or not "Dynamic guidance" is selected.

Information on sources of great danger, such as wrong-way drivers, is displayed regardless of the setting.

Traffic obstructions

The system calculates the optimized route, taking into consideration traffic obstructions and road types.

Selecting a detour

1. "Navigation"
2. "Traffic Info"
3. Select the traffic obstruction that is to be taken into consideration.
4. "Detour"

Taking into consideration all traffic obstructions

1. "Navigation"
2. "Traffic Info"

First, the traffic bulletins on the planned route are displayed. The traffic bulletins are sorted in the order of their distance from the current vehicle position.

3. Select "Recommended detour".

This information is displayed even if you have called up another application on the Control Display.

What to do if ...

What to do if ...

- ▷ The current position cannot be displayed?
The position is in an unrecognized region, in a poor reception area, or the system is in the process of determining the position. Try again later.
- ▷ Destination guidance does not accept an address without the street name?
A downtown area cannot be determined for the town or city that has been entered. Input any street in the selected town/city and start destination guidance.
- ▷ The letters for a destination cannot be selected during destination entry?
The stored data do not contain the data of the destination. Select a destination that is as close as possible to the original.
- ▷ Voice instructions are no longer issued before intersections during destination guidance?
The area has not yet been fully recorded
- ▷ The system does not react to entries?
If the battery was disconnected, it takes up to 15 minutes before the system is once again operational.





Entertainment

Operation of the radio, CD equipment and external audio devices as well as their tone settings are described in this chapter.

On/off and tone

The following audio and video sources share the same control elements and adjustments:

- ▷ Radio
- ▷ CD player
- ▷ CD changer*
- ▷ Video
- ▷ External devices, e.g. MP3 player

Controls

The audio and video sources can be controlled using the:

- ▷ Buttons near the CD player
- ▷ iDrive
- ▷ Buttons on the steering wheel, refer to page 11
- ▷ Programmable memory keys, refer to page 20
- ▷ Voice activation system

Buttons near the CD player

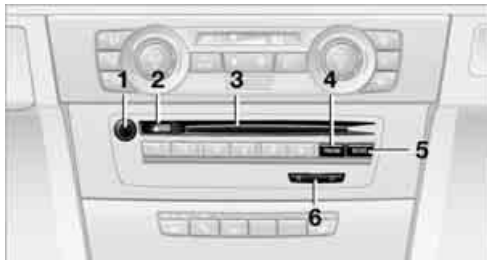

- 1** Sound output for entertainment on/off, volume
 - ▷ Press: switch on/off.
When you switch on the unit, the last set radio station or track is played.
 - ▷ Turn: adjust volume.
- 2**  Eject the CD
- 3** CD/DVD drive
- 4** **FM/AM:** change the radio station waveband

- 5** **MODE:** change the audio and video sources
- 6**  Station scan/track search
 - ▷ Change radio station.
 - ▷ Select track for CD player and CD changer.

Switching on/off

In order to switch the entertainment sound output on and off:

Press button **1** next to the CD player.

 This symbol on the Control Display indicates that sound output is switched off.

If equipped with a single drive, the sound output is available for approx. 20 minutes after the ignition is switched off.

For sound output, switch the unit back on.

Adjusting volume

Turn button **1** next to the CD player until the desired volume is obtained.

You can also adjust the volume with buttons on the steering wheel, refer to page 11.

With the ignition at radio readiness or beyond, the setting is stored for the remote control currently in use.

Tone control

You can alter various tone settings, e.g. treble and bass or the speed-dependent volume increase.

The tone settings are applied to all audio sources.

With the ignition at radio readiness or beyond, the settings are stored for the remote control currently in use.

Opening the tone settings

1. "Radio" or "CD/Multimedia"
2. "Tone"



Treble, bass, balance, fader

- ▷ "Balance": left/right volume distribution
- ▷ "Fader": front/rear volume distribution

1. Select the desired tone setting.



2. To adjust: turn the controller.
3. To store: press the controller.

Equalizer*

You can set individual sound frequency ranges.

1. "Equalizer"
2. Select the desired setting.



- ▷ To adjust: turn the controller.
- ▷ To store: press the controller.

Individual High-End Audio System* or LOGIC7*

You can choose between stereo and surround. "L7 Surround"



Multi-channel playback is simulated when playing back an audio track in stereo.

Surround is automatically activated or deactivated, depending on the audio track selected.

LOGIC7 and the LOGIC7 logo are registered trade marks of Lexicon, Inc., a company of the Harman International Group.

Volume

- ▷ "Speed volume": speed-dependent volume control
- ▷ "PDC"*: volume of the PDC signal tone relative to the entertainment sound output
- ▷ "Gong": volume of the signal tone, e.g. for the 'fasten safety belt' reminder, relative to the entertainment sound output

Adjustments

1. "Volume settings"
2. Select the desired volume setting.

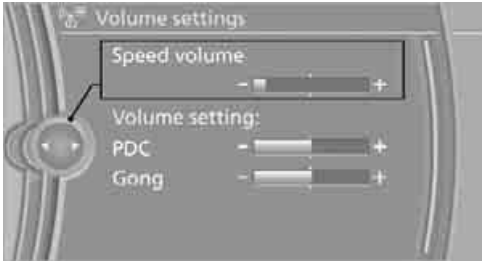

3. To adjust: turn the controller.
4. To store: press the controller.

Resetting tone settings

You can reset all tone settings to the default setting.

"Reset"

Radio

Your radio provides reception of the FM and AM wavebands.

Selecting a station



Press the button if the sound output is switched off.

iDrive, for operating principle refer to page 16.

1. "Radio"

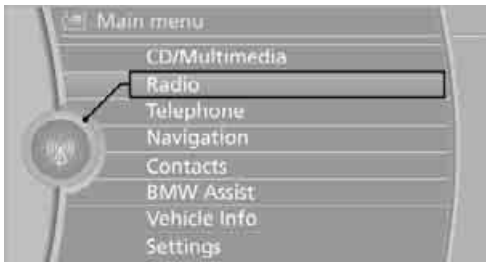

2. "FM" or "AM"
3. Call up the desired station.

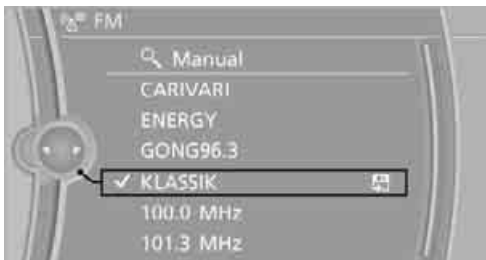

Changing stations

Turn the controller.

or

Press the button for the corresponding direction.

or

Buttons on the steering wheel, refer to page 11.

Selecting the frequency manually

In "Manual", you can set stations that can be received in addition to those already being displayed.

1. "FM" or "AM"
2. "Manual"
3. Call up the frequency.



To store the station: press the controller.

Storing a station

Via iDrive

1. "FM" or "AM"
2. Select the desired station.

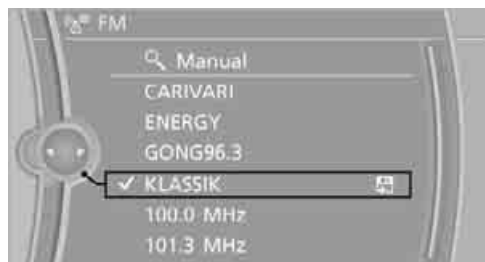



3. Press the controller again.

4. Select the desired memory location.
The station is stored.

The stations are stored for the remote control currently in use.

Via programmable memory keys

You can store a station on the programmable memory keys, refer also to page 20.

1. Select a station.
2.  ...  Press the desired button for a longer period.

Radio Data System RDS

On the FM waveband, additional information is broadcast via RDS. If the reception conditions are good, the station names are shown on the Control Display. Where reception is poor or in the event of interference, it may take some time before the station names will appear in the display.

Switching RDS on/off*

1. "FM"
2. Open "Options".
3. "RDS"



The setting is stored for the remote control currently in use.

High Definition Radio*

Many stations transmit analog and digital signals. You can receive these stations digitally for improved sound quality.

A digital radio network must be available to be able to receive digital stations.

Switching digital radio reception on/off

iDrive, for operating principle refer to page 16.

1. "FM" or "AM"
2. Open "Options".
3. "HD radio"

 This symbol is displayed when a station is received digitally.

Some stations do not transmit the digital and analog signals simultaneously. If you are in an area in which digital reception of the selected station is not possible continuously, reception will alternate between analog and digital. This can cause repetitions or interruptions. In this case it may be preferable to switch off digital reception.

Displaying additional information

With digital stations, additional information on the current track can be displayed, e.g. the name of the artist.

1. Open "Options".
2. "Station info"

Selecting a substation

1. Select a station.
2. Press the controller.
3. Select the substation.

Presets

Storing a station

1. "Presets"
2. "Store station"



3. Select the desired station.
4. Select the desired memory location.

Deleting a station

1. Select a station.
2. Open "Options".
3. "Delete entry"

Satellite radio*

You can receive over 100 different channels with high sound quality.

The channels are offered to you in predefined packages. To receive the channels of your choice, you must have the corresponding packages enabled.

 With this new technology, signal losses can occur from time to time and result in audio interruptions. ◀

Enabling or disabling channels

Enabling the channels

iDrive, for operating principle refer to page 16.

1. Ensure that reception is reliable. It is usually at its best when you have an unobstructed view of the sky.
2. "Satellite radio"
3. Open "All Channels" or the desired category.



4. Select the channel.

5. If the channel has not yet been enabled, then a phone number and the ESN electronic serial number are displayed.

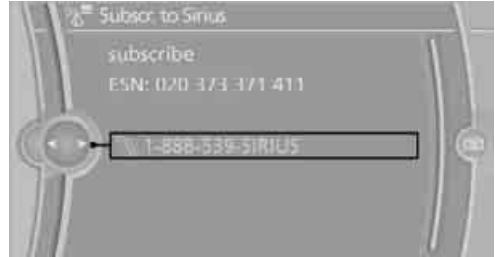

6. Call the phone number to have the channel enabled.

The channels can be disabled again via this phone number.

Disabling channels

The channels can be disabled by phone. To do so, have the electronic serial number ESN ready.

1. "Satellite radio".
2. Open "All Channels" or the desired category.



3. Open "Options".
4. The electronic serial number is displayed.
5. Call Sirius to have the channel disabled.

Selecting a channel

Selecting a channel

1. "Satellite radio"
2. Select "All Channels" or the desired category.



3. Select the desired channel.

Storing a channel

1. "Satellite radio"
2. Open "All Channels" or the desired category.
3. "Store Channel".
4. Call up the desired memory location.

The channel is stored. The channels of the last selection criterion are displayed again after a short time.

Displaying information about another channel

Information about a track currently being played on another channel can be displayed.

1. Highlight the channel on which you wish to display information.
2. Open "Options".
3. "Channel info"



Changing the channel using the buttons below the CD/DVD drive

 Press the button for the corresponding direction.

The system switches to the next enabled channel.

Notes

If more than 4 seconds go by and no signal is received, a message appears on the Control Display.

 Under some circumstances, e.g. depending on environmental or topographic conditions, it may not be possible to receive a signal. The satellite radio cannot influence this. A signal may not be available in tunnels or underground garages, next to high-rise buildings, in the vicinity of trees, mountains or other strong sources of radio interference. Reception usually resumes as soon as the signal becomes available again. ◀

CD player and CD changer*

CD/DVD playback



Inserting a CD/DVD

Insert the CD/DVD into the drive with the printed side up. The CD/DVD is drawn in automatically.

Playback starts automatically if the sound output is on. When playing CDs/DVDs with compressed audio files, it can take the player approx. 1 minute to read in the data, depending on the directory structure.

Playable formats

CD/DVD player

- ▷ DVD: DVD-ROM, DVD-R, DVD+R, DVD-RW, DVD+RW, DVD-R DL, DVD+R DL, DVD audio (video part only), DVD video
- ▷ CD: CD-ROM, CD-R, CD-RW, CD-DA, VCD, SVCD
- ▷ Compressed audio files: MP3, WMA, AAC

CD changer*

- ▷ CD: CD-ROM, CD-R, CD-RW, CD-DA

Start playback

Via iDrive

Fill and insert the CD magazine, refer to page 155.

To start playback if a CD is already located in the player or changer:

iDrive, for operating principle refer to page 16.

1. "CD/Multimedia"

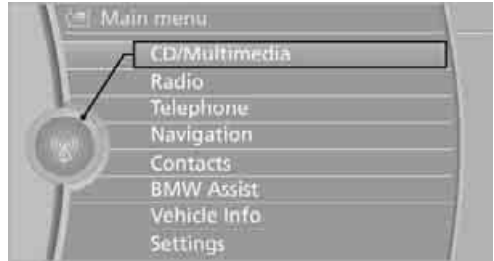

2. "CD/DVD"

3. Select the desired CD or DVD:

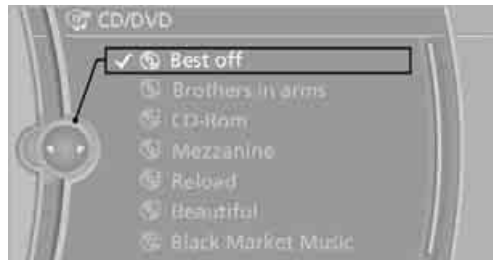

Ejecting a CD

Press the button next to the CD player. The CD emerges slightly from the drive.

Symbol	Function
	CD/DVD player
	CD changer

Audio playback

Selecting a track

Press the button for the appropriate direction as often as necessary until the desired track is reached.

Audio CDs

Select the desired track to begin playback.



CDs with compressed audio files*

Depending on the data, some letters and numbers of the CD/DVD may not be displayed correctly.

1. Select the directory, if necessary.
To change to a higher level directory: move the controller to the left.



2. Select a track and press the controller.



Displaying information about the track*

If information about a track has been stored, it is displayed automatically:



- ▷ Artist
- ▷ Album title
- ▷ Number of tracks on the CD/DVD
- ▷ Track file name

Random play sequence

The tracks on the current CD are played once each in random order.

1. Open "Options".
2. "Random"



CDs/DVDs with compressed audio files: the directories and the tracks contained therein are played back in random sequence.

Random mode is switched off if the audio source is changed and the ignition is switched off.

Fast forward/reverse

 Press and hold the button for the corresponding direction.

Video playback*

Country codes

Only DVDs with the code of the home region can be played back; also refer to the information on your DVD.

Code	Region
1	USA, Canada
2	Japan, Europe, Middle East, South Africa
3	Southeast Asia
4	Australia, Central and South America, New Zealand
5	Northwest Asia, North Africa
6	China

Start playback

The video image is displayed on the Control Display up to a vehicle speed of approx. 2 mph/ 3 km/h.

In some country versions, playback is either not possible at all or only possible with the parking brake set.

DVD video

1. "CD/DVD"
2. Select a DVD with video content.
3.  "DVD menu"



4. Start the DVD via the DVD menu.

VCD/SVCD

1. "CD/DVD"
2. Select a CD with video content.
3.  "Select track"











4. Select the desired track.
The CD is started.

Video menu

To open the Video menu:

1. Turn the controller during playback.
2. Press the controller when "Back" is displayed.

The Video menu is displayed:

Symbol	Function
	Open the DVD menu*
	Start playback
	Pause
	Stop
	Next chapter/next track
	Previous chapter/previous track
	Fast forward
	Reverse

In fast forward/reverse: the speed increases every time the controller is pressed. To stop, start playback.

DVD menu

1. If necessary, turn the controller to open the video menu.
2.  "DVD menu"
The DVD menu is displayed. The display depends on the contents of the DVD.
- ▶ To select menu items: move and press the controller.
- ▶ To change to the Video menu: turn the controller and select "Back".

DVD/VCD settings

For some DVDs, settings can only be made via the DVD menu; refer also to the information on your DVD.

Language*

1. Turn the controller during playback.
2. Open "Options".

3. "Audio/Language"



4. Select the desired language.

The languages that are available depend on the DVD.

Subtitles*

Subtitles can be selected if they are contained on the DVD.

1. Turn the controller during playback.
2. Open "Options".
3. "Subtitles"
4. Select the desired language or "Do not display subtitles".



Brightness, contrast, color

1. Turn the controller during playback.
2. Open "Options".
3. "Display settings"

4. "Brightness", "Contrast" or "Color"



5. Turn the controller until the desired setting is displayed and then press the controller.

Zoom

Display the video image on the full screen.

1. Turn the controller during playback.
2. Open "Options".
3. "Additional options"
4. "Zoom mode"

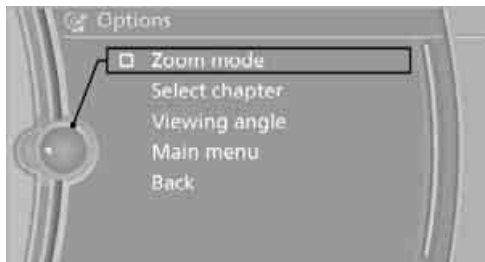

Selecting track

DVD video:

1. Turn the controller during playback.
2. Open "Options".
3. "Additional options"
4. "Select chapter"
5. Select the desired track.

VCD/SVCD

1. "Select track"
2. Select the desired track.

Camera angle*

The camera angle depends on the DVD.

1. Turn the controller during playback.
2. Open "Options".
3. "Additional options"
4. "Viewing angle"
5. Select the desired camera angle.

Opening the main menu, back

These functions are not contained on every DVD. Therefore, they may not be available for use.

CD magazine

The BMW CD changer for six CDs is behind the left side panel in the cargo bay.

Sedan



Sports Wagon

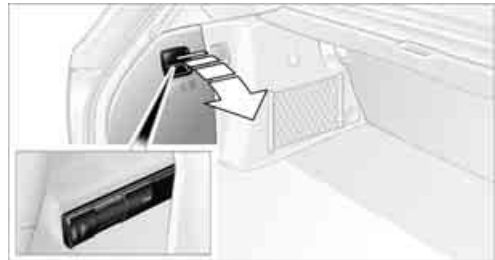

Removing the CD magazine

To insert or remove CDs from the CD magazine, you must first remove it from the CD changer:

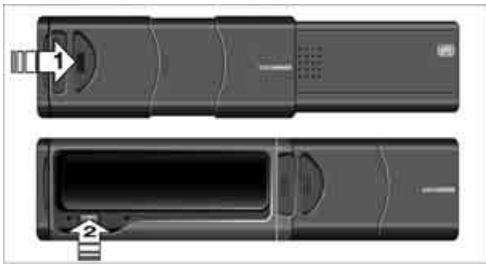

1. Push the cover to one side, arrow 1.
2. Press the button, arrow 2.
The CD magazine is ejected.

Push the magazine back in after at least 2 seconds have passed so that the inserted CDs can be read in again.

Inserting/removing CDs from the CD magazine



When loading CDs into or removing them from the CD magazine, hold them at their edges and do not touch the reflective signal-sensing area.

Inserting CDs:

Insert one CD per compartment with the labeled side up.

Removing CDs:

Pull out the desired compartment and take out the CD.

Inserting the CD magazine



Insert the CD magazine all the way in the direction of arrow 1 and close the cover, arrow 2.

The CD changer automatically reads the loaded CDs and is then ready for operation.

Notes



BMW CD/DVD players and changers are officially designated Class 1 laser products. Do not operate if the cover is damaged, otherwise severe eye damage can result. Do not use self-recorded CDs/DVDs with labels applied as these can become detached during playback due to heat build-up and can cause irreparable damage to the device. Only use round CDs/DVDs with a standard diameter of 4.7 in/12 cm and do not play CDs/DVDs with an adapter, e.g. Single-CDs, otherwise the CDs or the adapter can jam and will no longer eject. Do not use a combined CD/DVD, e.g. DVD^{Plus}, otherwise the CD/DVD can jam and will no longer eject. ◀

General malfunctions

BMW CD/DVD changers and players have been optimized for performance in vehicles. In some instances they may be more sensitive to faulty CDs/DVDs than stationary devices would be.

If a CD/DVD cannot be played, first check if it has been inserted correctly.

Humidity

High levels of humidity can lead to condensation on the CD/DVD or the laser's scan lens and temporarily prevent playback.

Malfunctions with individual CDs/DVDs

If malfunctions only occur with individual CDs/DVDs, one of the following factors may be the cause.

Self-recorded CDs/DVDs

Possible reasons for malfunctions with self-recorded CDs/DVDs are, e.g. inconsistent data-creation or recording processes, or poor quality or high age of the CD/DVD blank.

Only label CDs/DVDs on the top, with a pen designed for this purpose.

Damaged CDs/DVDs

Avoid leaving fingerprints, as well as dust, scratches or moisture on the CDs/DVDs. Keep CDs/DVDs in protective sleeves or cases. Do not subject CDs/DVDs to temperatures over 122 °F /50 °C, high levels of humidity or direct sunlight.

CDs/DVDs with copy protection

CDs/DVDs are often copy-protected by the manufacturer. This can mean that some CDs/DVDs cannot be played or can only be played to a limited extent.

Care

Clean the reflective signal side of CDs/DVDs as needed by wiping it with a commercially available cleaning tissue in straight lines from the center of the disc outwards.

Music collection

Storing music

Music tracks from CDs and DVDs can be stored in the music collection in the vehicle and played from there.

- ▶ **Audio CD:** tracks are converted into a compressed audio format when they are stored. The CD is stored in the vehicle as an album. If available, information on the album, such as the artist, is stored as well.
- ▶ **CDs with compressed audio files:** the entire CD is stored in the vehicle as an album. After storing, the tracks and directories can be deleted individually. Files are only stored in the WMA, MP3, and AAC formats. Tracks with DRM copy protection can be stored in the vehicle but cannot be played back.

Storing files from CDs/DVDs

1. Insert the CD into the CD player.
2. "CD/DVD"
3.  Select the symbol for the CD/DVD player.
4. "Store in vehicle"



The music collection is displayed and the first track on the CD is played back. During the storage process, the tracks are played in sequence. Observe the following during the storage process:

Do not switch to the CD/DVD player and do not remove the CD from the CD/DVD player, as this will interrupt the storage process. You can switch to the other audio sources without inter-

rupting the storage process. Tracks from the current CD that have already been stored can be called up.

Interrupting storage

1. "CD/DVD"
2. "Storing..."



3. "Cancel storing"

The storage process is interrupted and can be continued at any time.

Continuing the storage process

"Continue storing"

Storage of the CD continues at the beginning of the track at which storage was interrupted.

Album information

During storage, information such as the name of the artist is stored with the track, if this information is available in the vehicle database or on the CD.

Gracenote technology

Music recognition technology and related data are provided by Gracenote®. Gracenote® is the industry standard in music recognition technology and related content delivery. For more information, please visit www.gracenote.com.

Storing from a USB device

The entire content of the USB device is stored in the music collection as an album. After stor-

ing, the tracks and directories can be deleted individually.

1. Connect the USB device to the USB interface in the glove compartment.
2. "Music collection"
3. Open "Options".
4. "Music import/export"
5. "Import music (USB)"



Music is stored in the vehicle. The entire content of the USB device is stored as a separate album and is named automatically.

Playing music

Music search

All tracks for which additional information has been stored can be accessed by the music search. Tracks without additional information can be called up via the corresponding album.

1. "CD/Multimedia"
2. "Music collection"
3. "Music search"



4. Select the desired category.



All entries are displayed in a list.

5. To select the desired entry:
 - ▷ Open "A-Z search" and enter the desired entry.
 - or
 - ▷ Select the desired entry from the list.
6. Select additional categories if desired.

The tracks found are listed in alphabetical order.

Not all categories need to be selected. For example, to search for all tracks by a certain artist, call up that artist only. All of the tracks by that artist are then displayed.

"Start play"

Restarting the music search

"New search"

Current playback

The list of tracks that was generated last by the music search or the album selected last.

1. "Current playback"



2. Select the desired track, if necessary.

Top 50

List of the 50 most frequently played tracks.

1. "Top 50"
2. Select the desired track, if necessary.

Albums

All stored albums, listed in order of their storage dates. Symbols indicate the format.

- ▷  Audio CD
- ▷  Compressed audio files

Select the desired album.



Depending on the album, the tracks or the sub-directories of the album are displayed. The first track is played automatically, if possible.

To select tracks, change directories if needed. To go up one level in the directory, move the controller to the left.

Random play sequence

All tracks of the selection are played back in random order.

1. Open "Options".
2. "Random"

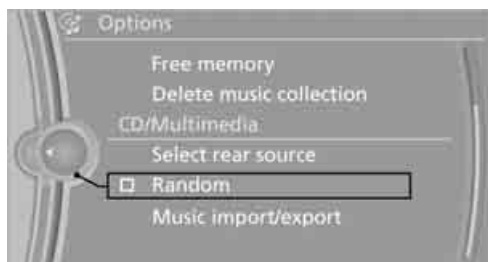

Managing music

Albums

Renaming an album

The name of the album, if available, is automatically entered when the album is stored. If the name is unknown it can be changed later if needed.

1. "CD/Multimedia"
2. "Music collection"
3. Highlight the album.
4. Open "Options".



5. "Rename album"
6. Select the letters individually.

Deleting an album

An album cannot be deleted while a track from that album is being played.

1. Highlight the album.
2. Open "Options".
3. "Delete album"

Deleting a track and directory

1. Highlight the directory or track.
2. Open "Options".
3. "Delete folder" or "Delete track"

Free memory capacity

Display the free memory capacity in the music collection.

1. Open "Options".
2. "Free memory"

Music collection

Backing up the music collection

The entire music collection can be stored on a USB medium. Make sure there is enough free memory capacity on the USB device.

Depending on the number of tracks, backing up the music collection may take several hours. Therefore, it is best to perform the backup during a long trip.

1. Start the engine.
2. Connect the USB device to the USB interface in the glove compartment.
3. "CD/Multimedia"
4. "Music collection"
5. Open "Options".
6. "Music import/export"



7. "Backup music on USB device"



Storing the music collection in the vehicle

 When storing music from the USB medium, the existing music collection in the vehicle is replaced.

1. "CD/Multimedia"
2. "Music collection"

3. Open "Options".
4. "Music import/export"
5. "Restore music from USB"

Deleting the music collection

1. "CD/Multimedia"
2. "Music collection"
3. Open "Options".
4. "Delete music collection"

AUX-IN port

You can connect an external audio device, for instance an MP3 player, and play audio tracks over the car's loudspeaker system. You can adjust the tone using iDrive.

Connecting

Lift up the center armrest.

Open the covers of the center armrest.



Connection for audio playback:
TRS connector 1/8 in/3.5 mm

To play audio tracks over the car's loudspeaker system, connect the headset or line-out port of the external device to the AUX-IN port.

Starting audio playback

Connect the audio device, switch it on and select a track. Operate the system on the audio device.

Via iDrive

iDrive, for operating principle refer to page 16.

1. "CD/Multimedia"
2.  "AUX (front)"

Adjusting volume

The volume of the sound output depends on the audio device. If the volume varies greatly from the other audio sources, it makes sense to adjust the volume to the same level.

1. "CD/Multimedia"
2.  "AUX (front)"
3. "Volume"

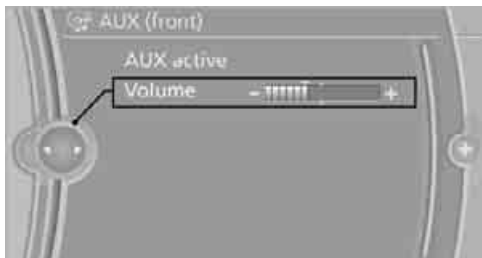

4. Turn the controller until the desired volume is set and then press the controller.

USB-audio interface/mobile phone audio interface*

Connectable devices

iPod/iPhone, mobile phone or USB devices (MP3 player, USB flash drive). These devices can be operated via iDrive.

Standard audio formats, e.g. MP3, WMA, WAV (PCM) and AAC, and playlists in the M3U format can be played.

Due to the large number of different audio devices/mobile phones available on the market, it cannot be ensured that every audio device/mobile phone is operable on the vehicle.

Ask about suitable audio devices/mobile phones at your BMW center.

Connecting

Lift up the center armrest.



- 1 AUX-IN connection for audio playback: TRS connector 1/8 in/3.5 mm
- 2 USB interface

iPod

To connect the iPod use the BMW cable adapter for Apple iPod. For more information, contact your BMW center or go to the Internet: www.bmw.com

To play audio tracks over the vehicle's loud-speaker system, connect the iPod to ports **1** and **2**.

The iPod's menu structure is supported by the USB-audio interface/mobile phone audio interface.

USB storage device



To connect the device, use a flexible adapter cable to protect the USB interface and your USB device against physical damage. ◀

To play audio tracks over the vehicle's loud-speaker system, connect the USB device to port **1**.

After the device is connected for the first time, the information on all tracks (e.g. artist, type of music) and the playlists are transferred from the USB device to the vehicle. This procedure may take some time. The duration depends on the USB device and the number of tracks.

During transfer, you can select the tracks using the directories and file names.

After transfer, you can call up the tracks using the information and playlists.

Information from up to four USB devices can be stored in the vehicle, or a total of about 16,000 tracks.

If a fifth USB device is connected, the information stored in the vehicle on the tracks of the first USB device is deleted.



Music tracks with integrated Digital Rights Management (DRM) cannot be played. ◀

Starting audio playback

If the audio device has a device name, the name is displayed.

1. "CD/Multimedia"
2. "External devices"

3.  Select the symbol.
The name of the audio device may appear.

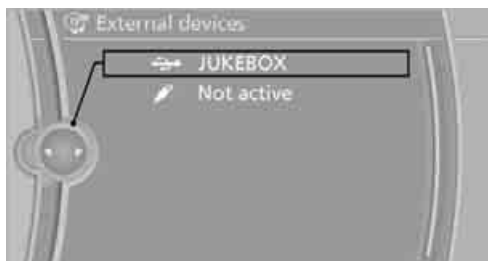

If, for example, an iPhone is connected to the USB interface at the same time that an audio device is connected to the AUX-IN port, the audio signal of the AUX-IN port is played.

Information about the track

If information about a track has been stored, it is displayed automatically:

- ▷ Artist
- ▷ Album title
- ▷ Number of tracks
- ▷ Track file name

Track search

You can call up the tracks using the playlists and information. With USB devices you can also call up tracks using the file directory.

1. "CD/Multimedia"
2. "External devices"
3.  Select the symbol.
The name of the audio device may appear.
4. Select the desired category, "Genre", "Artist".



All entries are displayed in a list. The "A-Z search" is available depending on the number of entries.

- ▷ Open "A-Z search" and enter the desired entry.
 - ▷ Select the desired entry from the list.
5. Select additional categories if desired.
The tracks found are listed. Not all categories need to be selected. For example, to search for all tracks by a certain artist, call up that artist only. All of the tracks by that artist are then displayed.
 6. "Start play"

Restarting a track search

"New search"

Random play sequence

You can play the tracks in the selected list in random order, e.g. all tracks of a single artist.

1. Open "Options".
2. "Random"

Fast forward/reverse

 Press and hold the button for the corresponding direction.

Notes

 Do not expose the audio device to extreme environmental conditions, e.g. very high temperatures, refer to the operating instructions of the audio device. Otherwise the audio device may become damaged, which could compromise safety while driving. ◀

Depending on the configuration of the audio files, e.g. bit rates greater than 256 KBit/s, the files may not play back correctly in every case.

Notes on connecting

- ▷ The USB-audio interface acts as the power supply to the connected audio devices, pro-

vided that this is supported by the audio device. Therefore, do not connect the USB audio device to the power socket in the vehicle during operation.

- ▷ Do not forcibly connect the plug to the USB interface.
- ▷ Do not connect devices such as fans or lamps to the USB-audio interface.
- ▷ Do not connect USB hard disks.
- ▷ Do not use the USB-audio interface to charge external devices.



Communications

This chapter describes how to use the telephone, BMW Assist and BMW TeleService.

Telephone*

The concept

Your BMW is equipped with a full mobile phone preparation package. After pairing a suitable mobile phone with the vehicle once, you can operate the mobile phone via iDrive, the buttons on the steering wheel or via voice commands.

Once a mobile phone has been paired with your vehicle, it is automatically recognized as soon as it is inside the vehicle while the engine is running or the ignition is switched on. You can store the pairing data for up to four mobile phones simultaneously. If several mobile phones are detected at the same time, the mobile phone last paired can be operated via the vehicle.

Using the telephone inside the vehicle

Using the snap-in adapter*

The so-called snap-in adapter, a holder for mobile phones, allows you to charge the mobile phone's battery and connect the mobile phone to your vehicle's outside antenna. This ensures better network reception and consistent reproduction quality. Please contact your BMW center to find out for which mobile phones there are snap-in adapters available.

For your safety

A car phone makes life more convenient in many ways, and can even save lives in an emergency. While you should consult your mobile phone's separate operating instructions for a detailed description of safety precautions and information, we request that you direct your particular attention to the following:

 Only make entries when the traffic situation allows you to do so. Do not hold the mobile phone in your hand while you are driving; use the hands-free system instead. If you do not observe this precaution, your being dis-

tracted can endanger vehicle occupants and other road users. ◀

Suitable mobile phones

Please ask your BMW center which mobile phones with Bluetooth interface are supported by the mobile phone preparation package and which mobile phones are compatible with the snap-in adapter. By virtue of their particular software versions, these mobile phones support the functions described in this Owner's Manual. Malfunctions may occur with other mobile phones.

Operating options

You can operate the mobile phone* using:

- ▷ Buttons on the steering wheel, refer to page 10
- ▷ iDrive, refer to page 16
- ▷ Voice commands, refer to page 175
- ▷ Programmable memory keys, refer to page 20

Avoid operating a mobile phone recognized by the vehicle via the mobile phone's keypad, otherwise malfunctions may result.

Start-up

Pairing the mobile phone with the vehicle

The following prerequisites must be met:

- ▷ Compatible mobile phone: the mobile phone is supported by the mobile phone full preparation package. You can obtain information on the Internet at: www.bmw.com
- ▷ The mobile phone is ready to operate.
- ▷ Bluetooth is activated in the vehicle, refer to page 170, and on the mobile phone.

- ▷ Certain presettings may be necessary on some mobile phones: e.g. using the following menu items:
 - ▷ Bluetooth switched on
 - ▷ Connection must be allowed without requiring further confirmation
 - ▷ Reconnection
- ▷ Depending on the mobile phone type, the power-saving mode setting, for example, may result in a paired mobile phone not being detected by the vehicle.
- ▷ For pairing purposes, define any 4 to 16-digit number as a Bluetooth passkey, e.g. 25081107. A long and complex number offers the best protection against unauthorized access. This Bluetooth passkey is no longer required after pairing has been successful.
- ▷ The ignition is switched on.

⚠ Pair the mobile phone with the vehicle only when the car is stationary, to avoid endangering the car's occupants and other road users by being distracted. ◀

Switch on ignition

1. Insert remote control all the way into the ignition lock.
2. Switch on ignition without operating the brake or clutch or pressing the start/stop button.

Preparation via iDrive

iDrive, for operating principle refer to page 16.

3. "Telephone"
4. "Bluetooth"
5. "Add new phone"



The Bluetooth name of the vehicle is displayed.

Preparation via the mobile phone

6. Further steps must be carried out with the mobile phone and vary depending on the model. Please refer to your mobile phone's operating instructions, e.g. under the topics of Searching for a Bluetooth device, Linking or Pairing. The Bluetooth name of the vehicle also appears on the mobile phone display.
7. Select the Bluetooth name of the vehicle on the mobile phone display.

Logging in

Depending on your mobile phone, you will see messages, first on the mobile phone display or on the iDrive, requesting you to enter the same Bluetooth passkey previously determined by you.

8. Enter the Bluetooth passkey. Depending on the mobile phone, you will have approx. 30 seconds to enter your Bluetooth passkey on the mobile phone and the Control Display.

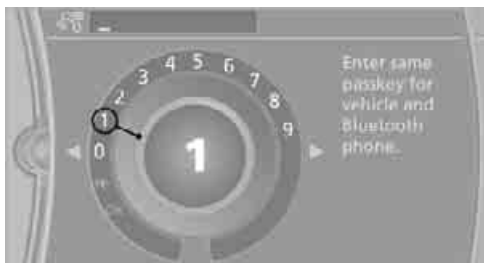

If pairing was successful, the mobile phone appears at the top of the mobile phone list.

As soon as a mobile phone is detected by the vehicle, the phone book entries stored on the SIM card or on your mobile phone are transmitted to the vehicle. This data transfer depends on your mobile phone and can take several minutes; please refer to your mobile phone's operating instructions, if necessary.

If not all phone book entries are displayed:

- ▷ Transfer all phone book entries from the SIM card to the mobile phone, if necessary.
- ▷ Phone book entries with special characters may not be displayed.

Checks to perform if pairing is unsuccessful

- ▷ Is the mobile phone supported by the mobile phone preparation package? You can obtain information on the Internet at: www.bmw.com.
- ▷ Do the Bluetooth passkeys on the mobile phone and vehicle match? The same Bluetooth passkey must be entered on the mobile phone's display and via iDrive.
- ▷ Did it take you more than 30 seconds to enter the Bluetooth passkey? Then repeat the pairing procedure.
- ▷ Only a limited number of devices can be connected with the mobile phone. If necessary, delete connections with other devices.
- ▷ Is the mobile phone no longer responding? Switch the mobile phone off and on or briefly disconnect the power supply.

Connecting a particular mobile phone

If more than one mobile phone is detected by the vehicle, the mobile phone at the top of the list is connected. A different mobile phone can be connected by selecting it.

iDrive, for operating principle refer to page 16.

1. "Telephone"
2. "Bluetooth"
3. Select the desired mobile phone.



Unpairing the mobile phone from the vehicle

1. Switch off the mobile phone.
2. "Telephone"
3. "Bluetooth"
4. Highlight the mobile phone that is to be unpaired.
5. Open "Options".
6. "Remove phone from list"



The unpaired mobile phone is deleted from the list.

The phone book entries and the lists of stored phone numbers are deleted as well.

Activating/deactivating the Bluetooth link

▷ The use of Bluetooth technology is not permitted in all countries. Observe all applicable local regulations. Temporarily deactivate the Bluetooth link between the vehicle and the mobile phone, if necessary.

If the Bluetooth link is deactivated, you can no longer operate the mobile phone via the vehicle, and other devices with a Bluetooth interface can be used in combination with the mobile phone, e.g. a laptop. ◀

To temporarily deactivate the Bluetooth link between the vehicle and your mobile phone:

1. "Telephone"
2. "Bluetooth"
3. Open "Options".

All paired mobile phones are listed.

4. "Bluetooth"

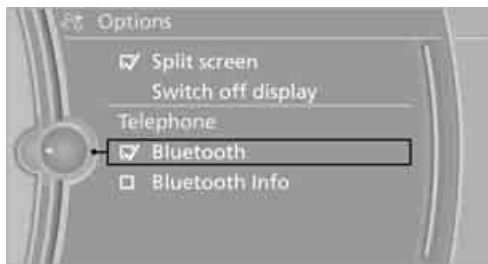

Adjusting volume

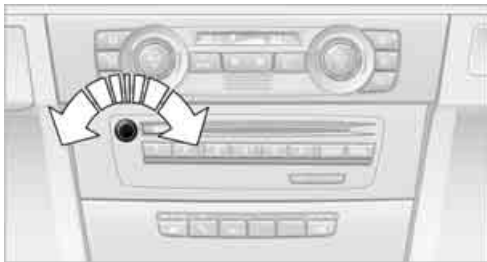

Turn the knob during a call to select the desired volume.

This volume for the hands-free system is maintained, even if the other audio sources are set to minimum volume.

The setting is stored for the remote control currently in use.

Operation via iDrive

You can operate the following functions using iDrive:

- ▶ Accepting/rejecting calls
- ▶ Dialing phone numbers
- ▶ Selecting phone numbers from the phone book
- ▶ Selecting stored phone numbers, e.g. from the list of received calls
- ▶ Ending calls

When the ignition is switched off or in radio readiness, e.g. after taking the remote control out of the ignition switch, you can continue an ongoing call via the hands-free system for several minutes.

Voice quality

If the person you are talking to is having difficulties understanding you, this may be due to excessive background noise. The full mobile phone preparation package can compensate for these noises to a certain extent. To optimize voice quality during a call, we recommend that you:

- ▶ Reduce background noise, e.g. by closing the windows, reducing air flow from the automatic climate control or pointing the open front air vents downward
- ▶ Reduce the volume of the hands-free system

Requirements

- ▶ The mobile phone's pairing data are stored by the vehicle and the mobile phone is operational.
- ▶ The engine is running or the ignition is switched on.
- ▶ The mobile phone is recognized by the vehicle.

Receiving calls

If you have the phone number of the caller stored in the phone book and the phone number has been transmitted, the name of the entry is displayed.

Accepting a call

Press the  button on the steering wheel.

or

"Accept"

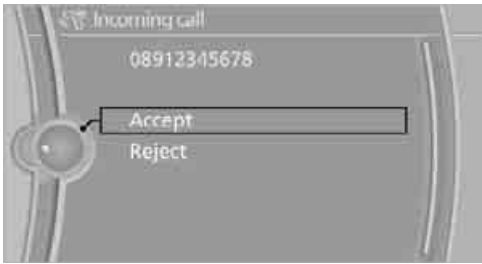

Rejecting a call

"Reject"

The caller is diverted to your mailbox if it has been activated.

Ending a call

Press the  button on the steering wheel.
or

1. Select the phone number and press the controller.

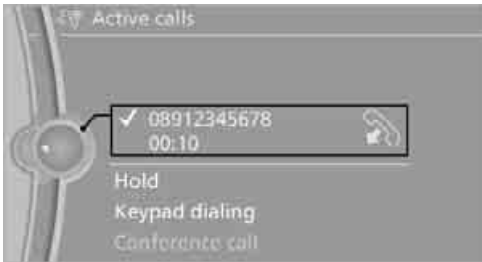

Dialing phone numbers

1. "Telephone"
2. "Dial number"
3. Select the digits individually.
4.  Select this symbol to establish the connection.



or:

Press the  button on the steering wheel.

For your phone number to be displayed to the person you are talking to, the display of phone numbers must be enabled by your provider.

Toggling between calls, telephone conference

These functions are available if supported by your mobile phone. Toggling may not be supported by the service provider or may need to be enabled separately.

Accepting a call while speaking to another party

This function may need to be enabled by the service provider and the mobile phone may have to be set up accordingly.

If a second call comes in during an active call, you will hear a call waiting signal.

"Accept"

The call is accepted and the existing call is put on hold.

Establishing a second call

Establish another call during an active call.

1. "Telephone"
2. "Active calls"
3. "Hold"

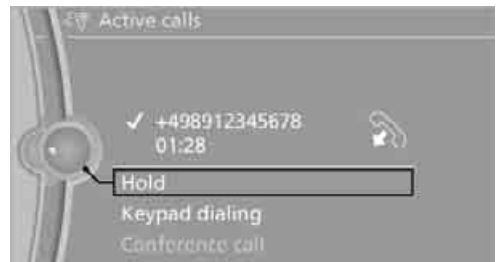

The existing call is put on hold.

4. Dial the new phone number or select it from a list.

Switching between two calls, toggling

- ▷ Active call: indicated by a red handset

- ▷ Call on hold: indicated by a green handset. To switch to the call on hold, select this handset.

Establishing a conference call

Two calls can be connected to a single telephone conference call.

1. Establish two calls.
2. "Conference call"

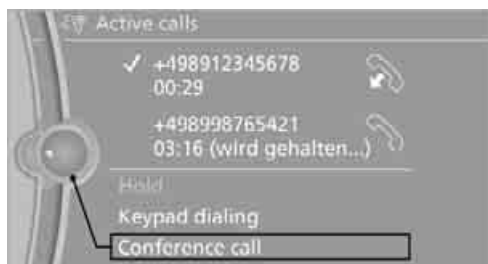

When terminating a conference call, both calls are ended.

Phone book

The phone book accesses the contacts and shows all contacts for which a phone number has been stored. The entries can be selected to make a call.

1. "Telephone"
2. "Phone book"

All contacts with a phone number are displayed. A symbol indicates the storage location of the contacts.



Symbol	Storage location*
No symbol	In the vehicle; the address has not been checked as a destination.
	In the vehicle; the address has been checked as a destination.
	Mobile phone

Calling a contact

1. Select the desired contact.
A connection is established immediately if calling contacts with one phone number.
For contacts with several phone numbers:
2. Select the desired phone number.
The connection is established.

Editing a contact

The entries in the contacts can be changed. When a contact from the mobile phone is changed, the changes are not stored on the mobile phone. A copy of the entry is stored in the vehicle.

1. Highlight the contact.
 2. Open "Options".
 3. "Edit entry"
- The contact can be edited.

Redialing

The ten phone numbers dialed last are stored.

Dialing the number via iDrive

1. "Telephone"
2. "Redial"

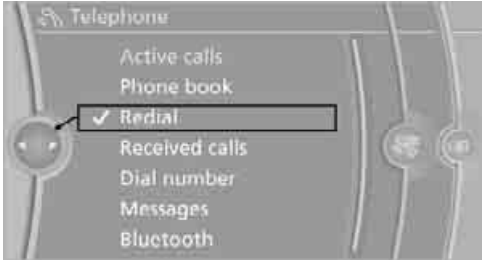

3. Select the desired entry.
4. The connection is established.

Deleting entries

1. Highlight an entry.
2. Open "Options".
3. "Delete entry" or "Delete list"

Saving an entry in the contacts

1. Highlight an entry.
2. Open "Options".
3. "Store as new contact" or "Add to existing contact"
4. Complete the entries if necessary.

Received calls

The 20 calls that were last received are displayed.

1. "Telephone"
2. "Received calls"



Dialing a number

Select an entry.

The connection is established.

Deleting entries

1. Highlight an entry.
2. Open "Options".
3. "Delete entry" or "Delete list".

Saving an entry in the contacts

1. Highlight an entry.
2. Open "Options".
3. "Store as new contact" or "Add to existing contact"

Switching between mobile phone and hands-free system

From mobile phone to hands-free system*

You can continue ongoing calls outside of the vehicle's Bluetooth range via the hands-free system as long as the engine is running or the ignition is switched on. Depending on your mobile phone, the system automatically switches to hands-free mode.

With mobile phones that do not automatically switch to hands-free mode:

Depending on the type of mobile phone you are using, it may be possible to continue the conversation via the hands-free system. Refer to the display on your mobile phone and/or your mobile phone's operating instructions.

From hands-free system to mobile phone

If you are making a call via the hands-free system, it may be possible to continue the call via the mobile phone, depending on your mobile phone model. Refer to the display on your mobile phone and/or your mobile phone's operating instructions.

Alternatively, you can deactivate the Bluetooth link.

Depending on the type of mobile phone you are using, it may occur that calls are switched from the hands-free system to the mobile phone if reception of the wireless network is poor.

Operation by voice commands*

The concept

You can operate your mobile phone without having to take a hand off the steering wheel. During your entries, you will be guided in many cases by announcements or questions.

The same prerequisites apply as for operation via iDrive, refer to page 171.

Saying commands

Activating the system

1. Briefly press the  button on the steering wheel.
A sound signal indicates that you can say commands.
2. Say the command.

Example: dialing phone numbers

Start the dialog:

Press the button on the steering wheel.

You say	Voice control response
›Dial number‹	››Please say the number‹‹
e.g. ›123 456 7890‹	Depending on your equipment version: ››123 456 7890. Continue ?‹‹
›Dialing‹	››Dialing number‹‹

Adjusting the volume of the instructions

You can adjust the volume for the instructions from the system:

Ending/canceling operation by voice commands

Press the  button on the steering wheel or

 ›Cancel‹.

In dialogs where text, e.g. a name, rather than a command is spoken, canceling is only possible using the button on the steering wheel.

Having the possible commands read aloud

The system recognizes specific commands that must be pronounced exactly word for word. You can have the possible commands for any function read aloud to you:

 ›Voice commands‹.

Using alternative commands

Often there is more than a single command to run a function, e.g.:

 ›Dial number‹ or ›Name‹.

Digits from zero to nine are recognized.

You can say each digit individually or group them into a sequence to accelerate the input.

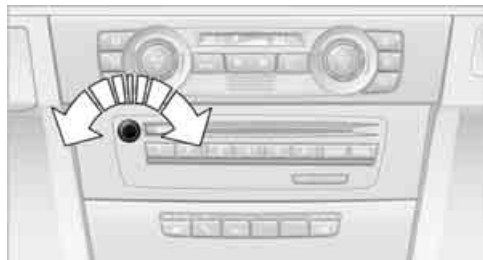

Turn the button during an instruction.

This volume for the instructions is maintained, even if the other audio sources are set to minimum volume.

The setting is stored for the remote control currently in use.

Calling

Dialing phone numbers

1. ›Dial number‹.
2. Say the phone number.
For telephone calls abroad, say ›Plus‹ and then the country code.
3. ›Dialing‹.

The connection to the desired subscriber is established.

Correcting phone numbers

After the last spoken sequence of digits has been repeated by the system, you can delete this sequence of digits.

- ›Correct number‹.
The digits are deleted.

The command ›Correct number‹ can be repeated as often as you like.

Deleting phone numbers

- ›Delete‹

All digits entered up to this point are deleted.

Voice phone book

A separate voice phone book is needed for operation using voice commands.

The entries must be entered using voice commands and are separate from the memory in the mobile phone. In this case, phone numbers stored on the mobile phone cannot be called up or saved there using voice commands. Up to 50 entries can be set up. An entry always consists of a name and a phone number.

Creating and editing a voice phone book*

To store an entry:

An entry always consists of a name and a phone number.

1. ›Save name‹.
2. Say the name.
Saying the name for the voice phone book should not take longer than approx. 2 seconds.
3. Say the phone number after being prompted to do so by the system.
4. To save the phone number:
›Save‹.

To delete an entry:

You can delete any entry from the voice phone book.

1. ›Delete name‹.
The dialog for deleting an entry opens.
2. Say the name when prompted.
3. Confirm the query with ›Yes‹.

To delete all entries:

›Delete phonebook‹ deletes all entries in the phone book.

1. ›Delete phonebook‹.
The dialog for deleting the phone book opens.
2. Confirm the query with ›Yes‹.
3. Confirm the query again with ›Yes‹.

To read and dial entries:

You can have all entries in your voice phone book read aloud in the order in which they were entered and select a specific entry to establish a connection:

1. ›Read phonebook‹.
The dialog for reading the phone book opens.
2. Say ›Dial number‹ when the desired entry is read.

Selecting an entry

The connection to the phone number of the selected entry is established.

1. ›Dial name‹.
The dialog for dialing an entry is opened.
2. Say the name when prompted.
3. Confirm the query with ›Yes‹.

Redialing

To redial the phone number dialed last:

- ›Redial‹

Notes

Important for voice commands

For voice commands, bear in mind the following:

- ▶ Pronounce the commands smoothly and at normal volume, avoiding excessive emphases and pauses.
- ▶ Keep the doors, windows and glass roof closed to prevent interference from outside noise.
- ▶ Avoid ambient noise in the vehicle while speaking.

Inserting/removing the snap-in adapter

1. Press button **1** and remove the cover.

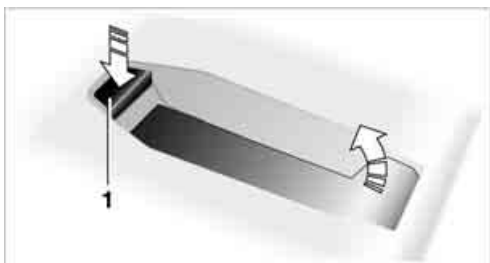

2. Insert the snap-in adapter at the front and press it downward until it engages.



To remove the snap-in adapter:
Press button **1**.

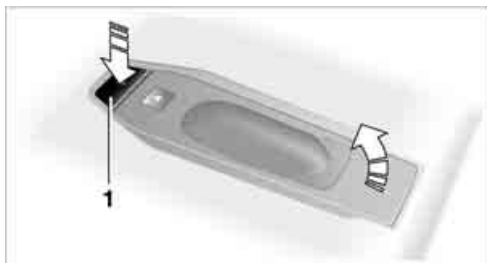

Inserting mobile phone

1. If applicable, remove the protective cap from the mobile phone's antenna connector so that the mobile phone can engage in the snap-in adapter.
2. With its buttons facing upward, slide the mobile phone up towards the electrical contact points and press it downward until it engages.

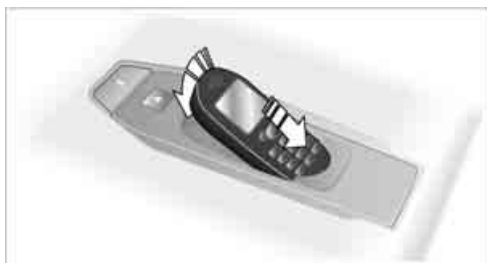

The mobile phone's battery is charged as soon as the vehicle is in radio readiness or the steering is unlocked.

 To conserve battery power, you should avoid using the mobile phone when the ignition is switched off. ◀

Removing mobile phone

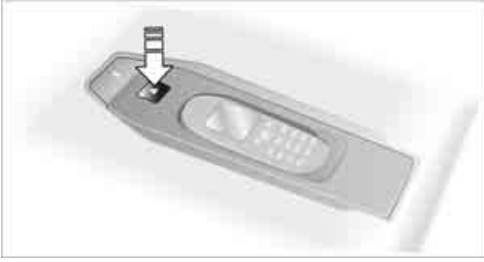

Press the button.

Contacts

You can create and edit contacts. Contacts from the mobile phone* are also displayed. The addresses can be used as destinations for navigation and the phone numbers can be dialed.

New contact

1. "Contacts"
2. "New contact"



3. If the entry fields are still filled with previous entries, select "Delete input fields".
4. To fill in the entry fields:
Select the symbol next to the entry field.



5. Enter the text.
 Only addresses contained in the navigation data in the vehicle can be entered. This ensures that destination guidance is possible for all addresses. ◀
6. "Store contact in vehicle"

Specifying a contact as the home address

A contact can be stored as a home address. It is placed at the top of "My contacts".

1. "Contacts"
2. "New contact"
3. Fill in the entry fields.
Select the symbol next to the entry field.
4. Open "Options".
5. "Store as home address"



If the home address is deleted, only the content of the home address entry is deleted and not the entry itself.

My contacts





A list of all contacts in the vehicle and on the mobile phone*.

Displaying contacts

"My contacts"

All contacts are listed in alphabetical order. Depending on the number of contacts, an A-Z

search is offered. A symbol indicates the storage location of the contacts:

Symbol	Storage location*
No symbol	In the vehicle; the address has not been checked as a destination.
	In the vehicle; the address has been checked as a destination.
	Mobile phone

Displaying the detailed view

Select the desired contact.

All fields that have been filled in for that contact are displayed.

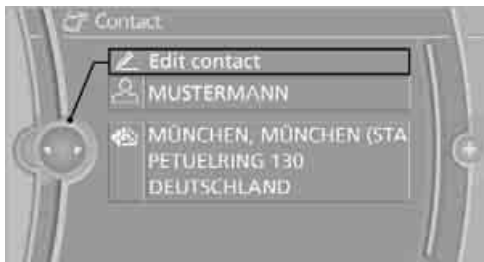

Selecting a contact as the navigation destination

1. "My contacts"
2. Select the desired contact.
3. Select the desired address.

Contacts from the mobile phone may contain addresses that do not match the navigation data contained in the vehicle and thus cannot be used for destination guidance. In this case: Manually correct the address.

Checking the address as a destination*

An address that is to be used for destination guidance must match the navigation data contained in the vehicle. An address that is stored on the mobile phone can be matched to the navigation data.

1. Select the desired contact.
2. Open "Options".

3. "Check as destination"
4. Correct and store the address, if necessary.

After an address has been corrected, the contact can be stored in the vehicle. The address is not changed on the mobile phone.

Dialing phone numbers

1. "My contacts"
2. Select the desired contact.
3. Select the desired phone number.

The connection is established.

Editing a contact

1. "My contacts"
2. Select the desired contact.
3. "Edit contact"

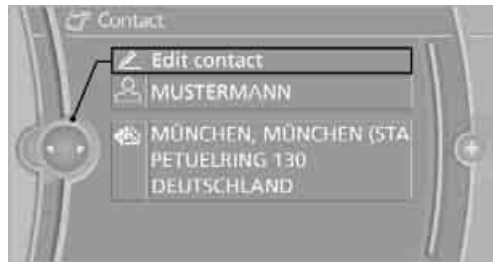

4. Change the entries.
5. Move the controller to the left.
6. "Yes"

If a contact from the mobile phone is edited, the changes are not stored on the mobile phone. A copy of the entry is stored in the vehicle, and only this copy is displayed.

Deleting contacts

Only contacts that are stored in the vehicle are deleted. The contacts on the mobile phone cannot be deleted.

1. "My contacts"
2. Highlight the contact.
3. Open "Options".
4. "Delete contact" or "Delete all contacts"

Concierge service*

When you call the BMW Assist Concierge, you can obtain information about, for example, restaurants, emergency pharmacy services, gas stations or hotels, as well as receive the corresponding telephone numbers and addresses. You can then dial a phone number directly or use an address for destination guidance.

Starting the concierge service

1. "BMW Assist"
2. "Concierge"



3. "Start service"

A voice connection is established to the BMW Concierge.

You are connected to an employee of the BMW Concierge to obtain the required information. You can then have the phone number and address sent to you and, for example, use it for destination guidance in the navigation system. Many hotels can be booked directly through the BMW Concierge. When an information message is received, a list of the received messages is displayed automatically.

Messages

The BMW Concierge messages and MyInfo messages from the BMW Assist portal are listed here.

1. "BMW Assist"
2. "Messages"
3. Select the desired message.

Using an address for destination guidance

1. "Start guidance" or "Insert as dest. in the trip"



Dialing a phone number

1. "Call number in message"

Saving an address

1. Open "Options".
2. "Store contact in vehicle"

Answering messages

The message answering function is only available for MyInfo messages if answers are predefined in the messages.

1. Select the message that you wish to respond to.
2. Open "Options".
3. Open "Answer".
4. Select the desired answer.

Deleting messages

1. Select the message to be deleted.
2. Open "Options".
3. "Delete message" or "Delete all messages".

Roadside Assistance

You can call BMW Roadside Assistance* should you require help in the event of a breakdown.

Starting Roadside Assistance

Vehicle not equipped with BMW Assist or BMW TeleService

1. "BMW Assist"
2. "Roadside Assistance"



The Roadside Assistance number is displayed.

3. Dial the number. If a mobile phone* is paired, a connection is established to BMW Roadside Assistance.

Vehicle equipped with BMW Assist or BMW TeleService

1. "BMW Assist"
2. Depending on the equipment, select "Roadside Assistance" or "Roadside Assistance".
3. "Start service"

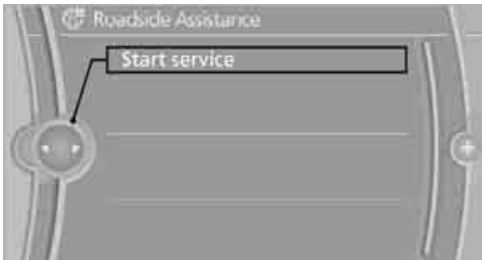

TeleService Diagnosis*

TeleService Diagnosis enables the wireless transmission of detailed vehicle data that are important for vehicle diagnosis. These data are transmitted automatically if the vehicle is equipped with BMW TeleService.

TeleService Help*

TeleService Help enables an in-depth diagnosis of the vehicle by Roadside Assistance via wireless transmission. TeleService Help can be started after a prompt by Roadside Assistance and termination of the voice connection.

Starting TeleService Help

1. Park the vehicle in a safe place.
2. Leave the ignition switched on.
3. Set the parking brake.
4. "TeleService Help"

After completion of TeleService Help, a voice connection is established to Roadside Assistance.

Activating BMW Assist*

If the services included in a valid BMW Assist subscription are not displayed, they may need to be activated.

1. Make sure that the vehicle can determine its current position. Reception is usually best when you have an unobstructed view to the sky.
2. Switch on the ignition.
3. "Activate BMW Assist"

Activation may take several minutes. If another menu is opened, activation continues running in the background.

BMW Search*

BMW Search provides access to a trade search engine.

BMW Search is always displayed across the full screen.

Requirements

- ▷ The Convenience Plan has been applied for.
- ▷ The vehicle is located within wireless network coverage.

- ▷ The date setting on the Control Display is current.

Starting BMW Search

1. "BMW Assist"
2. "BMW Search"



3. Select "OK", if necessary.
The BMW Search start page is displayed.

Using BMW Search

To select and display content:

- ▷ Turn the controller to highlight an element.
- ▷ Press the controller to display an element.

Opening the start page

1. Open "Options".
2. "Home"

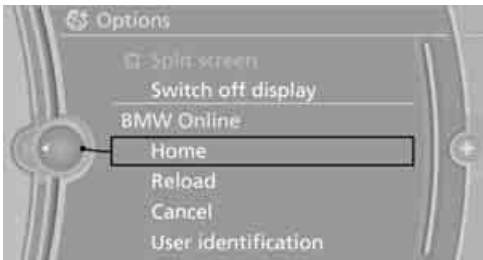

Loading a new page

1. Open "Options".
2. "Update"

Canceling

1. Open "Options".
2. "Cancel loading"

Internet*

1. "BMW Assist"
2. "Internet"











The start page is displayed. The Internet pages may not be displayed in the same way as on a PC screen. Flash and Java applications cannot be displayed.

Using the Internet

Menu bar

A menu bar that offers functions for using the Internet is displayed. To activate the menu bar, move the controller to the left until the cursor is located in the menu bar.

Symbol	Function
	Activate the mouse cursor
	Open the start page
	Refresh
	Cancel
	Back
	Enter a URL



	Bookmarks/favorites
	Zoom
	Leave the browser

Navigating with the mouse pointer

1. Select the  symbol.
2. Use the mouse pointer to navigate on the page.
 - ▷ To move the mouse pointer: move the controller in the required direction
 - ▷ To select an element: press the controller
 - ▷ To scroll: turn the controller

Status display

A symbol at the top left of the screen shows the following statuses.

Symbol	Function
	No connection possible
	Data transfer
	Secure connection

Entering an Internet address

1. I- "Enter URL"
2. Individually select the letters and characters of the desired address.
3. Select "OK".



Bookmarks/favorites

Adding a bookmark

The page currently being displayed is stored as a bookmark.

1. Select the  symbol.
2. "Add to bookmarks"



Selecting a bookmark

1. Select the  symbol.
2. Select the desired bookmark.

Deleting a bookmark

1. Select the  symbol.
2. Open "Options".
3. "Delete bookmark" or "Delete all bookmarks"

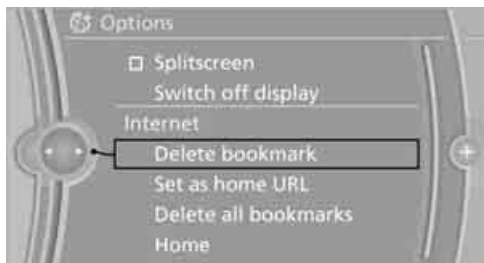

Defining a bookmark as the start page

1. Select the  symbol.
2. Open "Options".
3. "Set as home URL"

Settings

Suppressing cookies

1. Open "Options".
2. "Suppress cookies"

Suppressing pop-ups

1. Open "Options".
2. "Suppress pop-ups"

Suppressing safety warnings

1. Open "Options".
2. "Block HTTPS pop-ups"

Activating TeleService*

If the services are not displayed, they may need to be activated.

1. "BMW Assist"
2. "Activate TeleService"

Customer Relations

Contact Customer Relations for information on all aspects of your vehicle.

Vehicle equipped with BMW Assist or TeleService

1. "BMW Assist"
2. "Customer Relations"
3. "Start service"

A voice connection is established to Customer Relations.

Vehicle not equipped with BMW Assist or TeleService

1. "BMW Assist"
2. "Customer Relations"

The Customer Relations phone number is displayed. If the vehicle is equipped with BMW

Assist or the mobile phone preparation package, a voice connection is established.



Service Request*

You can send a request to your BMW center to arrange a service appointment. The TeleService data is transmitted during a Service Request. Your BMW center will contact you.

Starting a Service Request

1. "BMW Assist"
2. "Service Request"
3. "Start service"

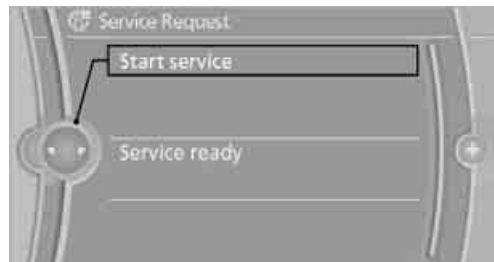

Automatic Service Request*

The TeleService data necessary for servicing the vehicle are automatically sent to your BMW center prior to the service deadline. The center will contact you and a service appointment can be arranged.

You can check when the BMW center was notified.

1. "Vehicle Info"
2. "Vehicle status"

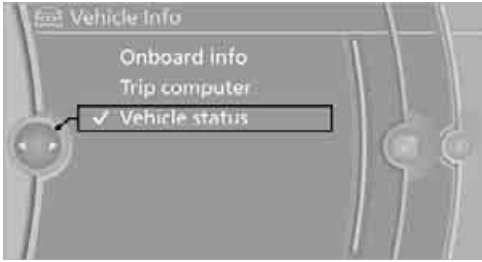

3. Open "Options".
4. "Last Service Request"

BMW center*

Address and contact data of the BMW center.

1. "BMW Assist"
2. "Your BMW center"

Data transfer

The status of the data transfer is displayed.

1. "BMW Assist"
2. "Data transfer"

Services status

Display of all services available in the vehicle.

1. "BMW Assist"
2. "Service status"
3. "Available services"

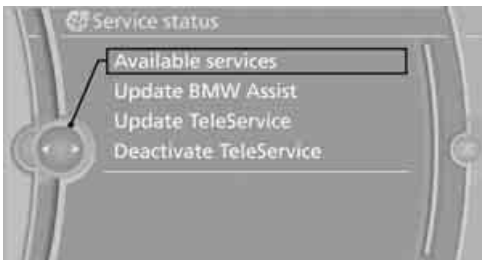

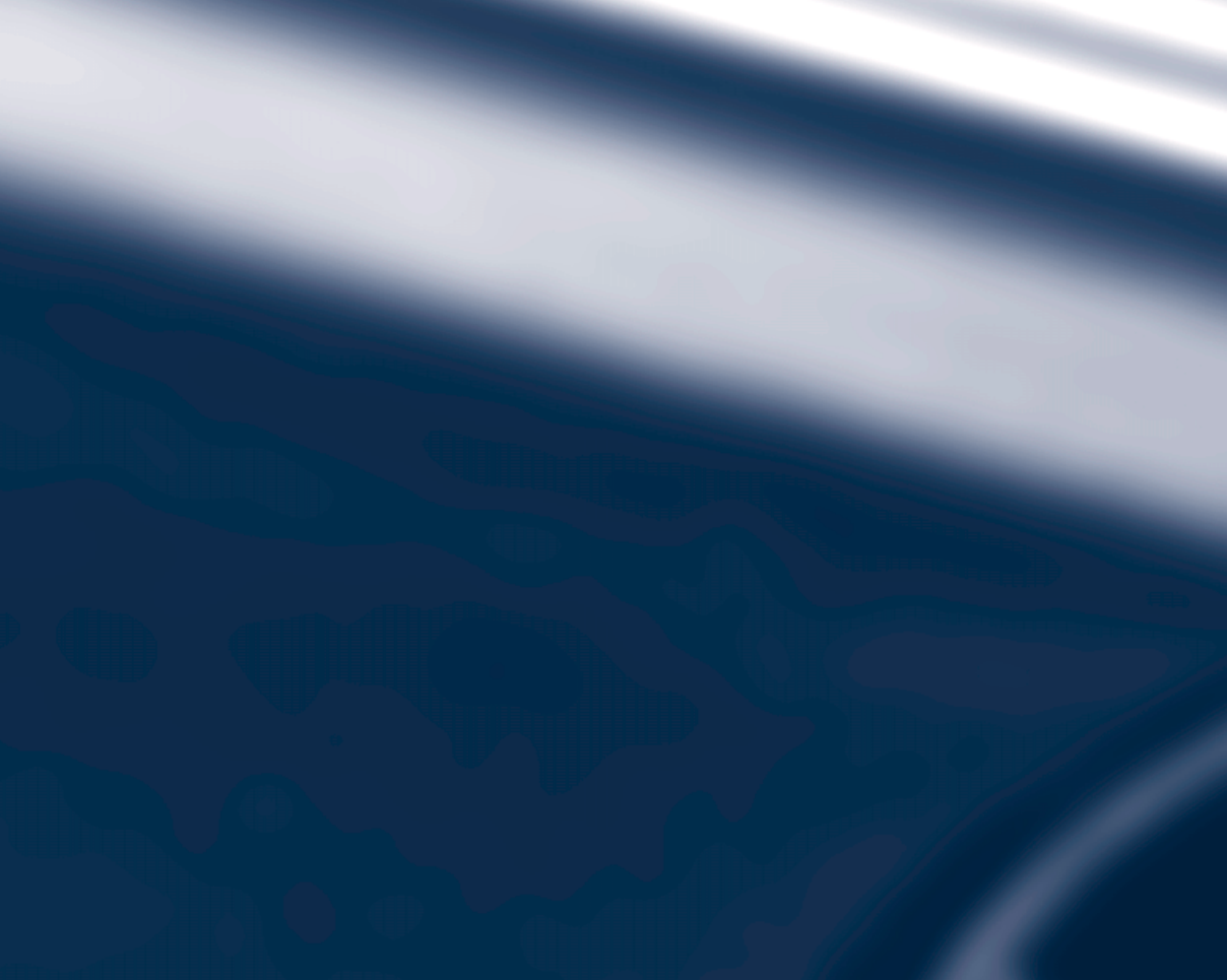



Mobility

This section helps you maintain your car's mobility by supplying important information on vital topics including fuels and lubricants, wheels and tires, service, maintenance and breakdown assistance.

Refueling

⚠ Always switch off the engine before refueling, otherwise, fuel cannot be added to the tank and a message will be displayed. ◀

⚠ Take all precautionary measures and observe all applicable regulations when handling fuel. Do not carry any spare fuel containers in your vehicle. They can develop a leak and cause an explosion or cause a fire in the event of an accident. ◀

Fuel filler door

Opening

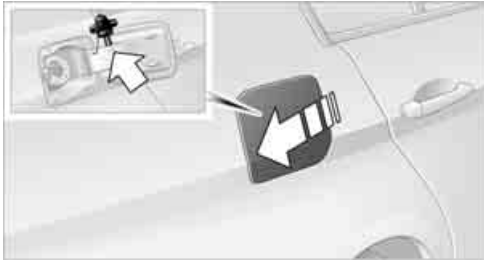

1. Open fuel filler door. To do so, lightly press the rear edge.
2. Turn the gas cap counterclockwise.
3. Place the gas cap in the bracket attached to the fuel filler door.

Closing

Fit the cap and turn it clockwise until you clearly hear a click.

⚠ Do not pinch the band attached to the cap, otherwise the cap cannot be closed properly and fuel vapors can escape. A message will be displayed if the gas cap is loose or missing. ◀

Manually releasing the fuel filler door

In the event of a malfunction, you can release the fuel filler door manually:

Sedan



1. Remove the cover from the right-hand side wall of the cargo bay.
2. Pull the knob with the fuel pump symbol. The fuel filler door is released.

Sports Wagon

1. Fold up the cargo bay floor panel.
2. Remove the cover from the right-hand side wall of the cargo bay. To do so, turn the screws, arrows 1, 90° and take out the cover, arrow 2.

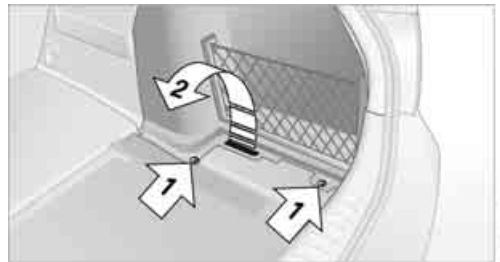

3. Pull the knob with the fuel pump symbol. The fuel filler door is released.

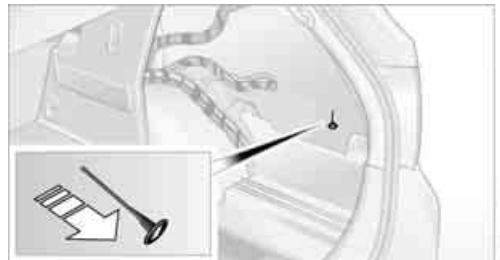

Observe the following when refueling

 When handling fuels, follow the safety instructions provided at filling stations, otherwise there is a risk of personal injury or property damage. ◀

When refueling, insert the filler nozzle completely into the filler pipe. Avoid lifting the filler nozzle while filling the tank, as that would lead to

- ▷ premature pump shutoff
- ▷ reduced efficiency of the fuel-vapor recovery system.

The fuel tank is full when the filler nozzle clicks off the first time.

Fuel tank capacity

 Refuel as soon as possible once your cruising range falls below 30 miles/50 km, otherwise engine functions are not ensured and damage can occur. ◀

Gasoline engine

Approx. 16.1 US gallons/61 liters, including the reserve capacity of 2.1 US gallons/8 liters.

Diesel engine

Approx. 16.1 US gallons/61 liters, including the reserve capacity of 1.7 US gallons/6.5 liters.

Fuel specifications

Gasoline engine: required fuel

 Do not refuel with leaded fuel; otherwise, the catalytic converter will be damaged. Do not fill the tank with E85, i.e. fuel containing 85% ethanol, nor with FlexFuel. Otherwise the engine and fuel supply system will be damaged. ◀

Super Premium Gasoline/AKI 91

This gasoline is highly recommended.

However, you may also use gasoline with less AKI. The minimum AKI Rating is:

- ▷ 323i, 328i/xDrive: 87

- ▷ 335i/xDrive: 89.

If you use gasoline with this minimum AKI Rating, the engine may produce knocking sounds when starting at high outside temperatures. This has no effect on the engine life.

 Do not use any gasoline below the specified minimum fuel grade. Otherwise the engine could be damaged. ◀

Use high-quality brands

Field experience has indicated significant differences in fuel quality: volatility, composition, additives, etc., among gasolines offered for sale in the United States and Canada. Fuels containing up to and including 10% ethanol or other oxygenates with up to 2.8% oxygen by weight, that is, 15% MTBE or 3% methanol plus an equivalent amount of co-solvent, will not void the applicable warranties with respect to defects in materials or workmanship.

 The use of poor-quality fuels may result in driveability, starting and stalling problems especially under certain environmental conditions such as high ambient temperature and high altitude.

Should you encounter driveability problems which you suspect could be related to the fuel you are using, we recommend that you respond by switching to a recognized high-quality brand such as gasoline that is advertised as Top Tier Detergent Gasoline.

Failure to comply with these recommendations may also result in unscheduled maintenance. ◀

BMW Advanced Diesel: required fuel

Ultra-low sulfur diesel

The engine of your BMW is designed for diesel with low sulfur content:

Ultra-low sulfur diesel ASTM D 975-07a.

 Refuel with ultra-low sulfur diesel only. The percentage of biodiesel in the fuel may not exceed 5%; this type of fuel is referred to as B5. Do not refuel with gasoline. After refueling with the wrong fuel, e.g. with gasoline, do not start the engine; otherwise, engine damage may occur. ◀

If you refueled with the wrong fuel, contact your BMW center.

 The filler neck is designed for refueling at diesel fuel pumps.

If the filler nozzle cannot be inserted into your BMW's filler pipe, please ensure that you are refueling at a diesel fuel pump and that it is equipped with a diesel filler nozzle. ◀

Winter diesel

To ensure that the diesel engine remains operational in the winter, please use winter diesel, which is available at gas stations during winter months. The fuel filter heating system, included as a standard feature, prevents disruption of the fuel supply while driving.

 Do not add additives, including gasoline; otherwise, engine damage may occur. ◀

BMW Advanced Diesel

The concept

BMW Advanced Diesel reduces nitrogen oxide in the diesel emissions of your vehicle by means of a mechanism that injects diesel exhaust fluid, a reduction agent, into the exhaust tract. A chemical reaction occurs in the catalytic converter that minimizes the nitrogen oxide content.

To be able to start the engine as usual, a sufficient amount of diesel exhaust fluid must be present in a separate reservoir.

Warming the system

To warm the system to its operating temperature after starting with a cold engine, the automatic transmission delays shifting to the next higher gear, if necessary.

Reserve display

A display in the instrument cluster informs you about the remaining distance you can drive with the fluid remaining in the reservoir.



The reserve display appears beginning at approx. 1,000 miles/1,600 km before the supply is used up.

 When this reserve display appears in the instrument cluster, have diesel exhaust fluid refilled to avoid not being able to start the engine. ◀

Diesel exhaust fluid at the minimum level



Even if the display indicates -- mls, the engine continues running if it is not switched off and if all other requirements continue to be met, e.g. a sufficient supply of fuel.

 Do not drive to the end of the indicated distance. Otherwise, it will not be possible to start the engine again after switching it off. ◀

Wrong fluid



A warning lamp lights up:
The wrong fluid was filled into the reservoir.

Please contact your BMW center.

Having diesel exhaust fluid refilled

Diesel exhaust fluid is refilled by your BMW center during regular service. If the service intervals are adhered to, it generally does not need to be refilled between service appointments.

Under certain conditions, e.g. especially frequent accelerations or operation of the vehicle at high altitudes, it may become necessary to refill the fluid between service appointments.

When this reserve display appears in the instrument cluster, have diesel exhaust fluid refilled to avoid not being able to start the engine.

You can have the fluid refilled by a BMW center.

Diesel exhaust fluid at low temperatures

Because of its physical properties, it may be necessary to refill diesel exhaust fluid between regular service appointments at temperatures below +23 °F / -5 °C.

The need to add fluid is indicated by the reserve display in the instrument cluster, refer to page 192.

Refilling diesel exhaust fluid in exceptional cases

To be able to reach the next BMW center, you can refill diesel exhaust fluid yourself while adhering to the following warnings.

Do not come into contact with diesel exhaust fluid as it can lead to skin or eye irritations. Wear goggles and gloves, if necessary. Follow the safety instructions on the bottle. Vapors with a sharp odor can escape from the bottle or container when it is opened. Before refilling, completely close the windows and doors of the vehicle to prevent the vapors from intruding into the interior. If handling diesel exhaust fluid in an enclosed area, ensure that the room is well ventilated.

After handling diesel exhaust fluid, wash your hands thoroughly; otherwise, inadvertently touching your eyes, for example, may lead to eye irritations.

If eye irritations occur, rinse the eyes thoroughly with water and consult a physician if necessary.

If diesel exhaust fluid comes into contact with the surface of your vehicle, rinse the affected areas with water to prevent surface damage. Keep diesel exhaust fluid away from children.

Suitable diesel exhaust fluid

- ▶ Preferred: BMW Diesel Exhaust Fluid. Diesel exhaust fluid can be refilled conveniently with this bottle and its special adapter.
- ▶ Alternatively: NOx reduction agent AUS 32

You can obtain diesel exhaust fluid from your BMW center.

Refilling quantity

Refilling quantity when the reserve display first appears:

Approx. 1 US gallon/3.7 liters

Opening the diesel exhaust fluid reservoir

1. Remove the cover in the bumper by pressing on it, see arrow.

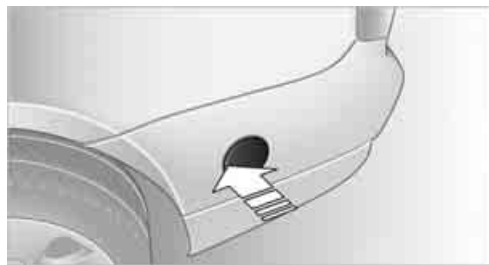

2. Place the handle of the screwdriver from the onboard tool kit, page 222, onto the bottom cap and open the cap, arrow.



Refilling BMW Diesel Exhaust Fluid

1. Attach the bottle and screw it all the way on, see arrow. The line on the bottle should point upward.

 Hold the attached bottle to prevent the thread on the vehicle from becoming damaged by the weight of the bottle. ◀

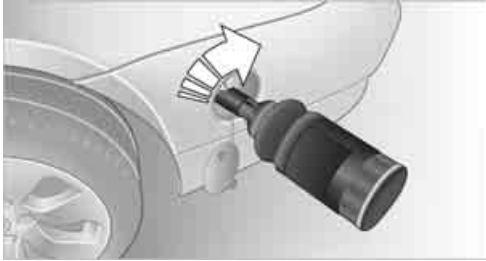

2. Press the bottle toward the vehicle, see arrow. The reservoir in the vehicle is filled.

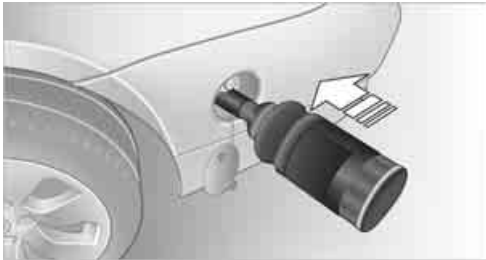

3. The reservoir is full when the filling level in the bottle stops changing. It is not possible to overfill the reservoir. Pull back the bottle, see arrow, and unscrew it.

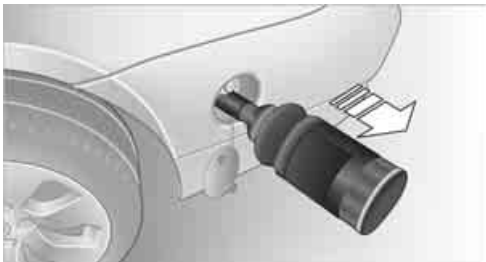

Closing the reservoir

After refilling, close the reservoir again using the handle of the screwdriver.

After refilling diesel exhaust fluid

Wrong fluid

 If you add the wrong fluid, e.g. antifreeze for washer fluid, do not start the engine; otherwise, there is a danger of fire. ◀
Contact your BMW center.

Disposing of the bottle

 You can dispose of the bottles for diesel exhaust fluid at your BMW center. Only dispose of empty bottles in household refuse if local regulations allow. ◀

Reserve display



After refilling, the reserve display continues to be displayed after the engine is started. It goes out after the vehicle has been driven for several minutes.

Wheels and tires

Tire inflation pressures

Information for your safety

It is not merely the tires' service life, but also driving comfort and, to a great extent, driving safety that depend on the condition of the tires and the maintenance of the specified tire pressure.

 Check the tire inflation pressure regularly and correct it, if necessary: at least twice a month and before starting long trips. If you fail to observe this precaution you may be driving on tires with incorrect tire pressures, a condition that can not only compromise your vehicle's driving stability, but also lead to tire damage and the risk of an accident. Do not drive with deflated, i.e. flat tires, except when using Run-Flat Tires. A flat tire will seriously impair your vehicle's handling and braking response. Attempts to drive on a flat tire can lead to loss of control over the vehicle. ◀

Checking pressure

Only check tire inflation pressure when the tires are cold. This means after a maximum of 1.25 miles/2 km driving or when the vehicle has been parked for at least 2 hours. When tires are warm, the tire inflation pressure is higher.

 After correcting the tire inflation pressure, reinitialize the Tire Pressure Monitor, refer to page 85, or the Flat Tire Monitor, refer to page 83. ◀

Inflation pressure specifications

The tables below provide all the correct inflation pressures for the specified tire sizes at ambient temperature.

 The inflation pressures apply to the tire sizes approved and tire brands recommended by BMW; a list of these is available from your BMW center. ◀

For correct identification of the right tire inflation pressures, observe the following:

- ▷ Tire sizes for your vehicle
- ▷ Load conditions
- ▷ Maximum allowable driving speed

Tire inflation pressures for driving up to 100 mph or 160 km/h

For normal driving up to 100 mph or 160 km/h and to achieve optimum driving comfort, adjust pressures to the respective tire inflation pressures listed on the following pages in the columns for traveling speeds up to a maximum of 100 mph or 160 km/h.

These tire inflation pressures can also be found on the driver's-side door post when the driver's door is open.



 The maximum permissible speed for these tire pressures is 100 mph or 160 km/h. Do not exceed this speed, otherwise tire damage and accidents could occur. ◀

Tire inflation pressures for driving above 100 mph or 160 km/h

 In order to drive at maximum speeds in excess of 100 mph or 160 km/h, adjust pressures to the respective tire inflation pressures listed on the following pages in the columns for traveling speeds including those exceeding 100 mph or 160 km/h. Otherwise tire damage and accidents could occur. ◀



Observe all national and local maximum speed limits, otherwise violations of the laws could occur.



Sedan: tire inflation pressures for the 323i, for Canada only

Tire size	Pressure specifications in psi/kPa					
	Traveling speeds up to a max. of 100 mph / 160 km/h		Traveling speeds including those exceeding 100 mph / 160 km/h			
All pressure specifications in the table are indicated in psi/kilopascal with cold tires. Cold = ambient temperature						
	without Sports package					
	205/55 R 16 91 H M+S	32/220	35/240	32/220	36/250	35/240
225/50 R 16 92 V						
225/50 R 16 92 H M+S	32/220	35/240	32/220	33/230	32/220	39/270
225/45 R 17 91 H M+S						
225/45 R 17 91 V	32/220	36/250	32/220	36/250	35/240	42/290
225/45 R 17 94 V M+S XL	32/220	38/260	32/220	36/250	35/240	42/290
Front: 225/45 R 17 91 V	32/220	-	32/220	-	35/240	-
Rear: 255/40 R 17 94 V	-	33/230	-	32/220	-	38/260
Front: 225/40 R 18 88 W	32/220	-	32/220	-	35/240	-
Rear: 255/35 R 18 90 W	-	38/260	-	35/240	-	41/280
Front: 225/35 R 19 88 Y XL	35/240	-	32/220	-	35/240	-
Rear: 255/30 R 19 91 Y XL	-	42/290	-	36/250	-	42/290
with Sports package						
205/55 R 16 91 H M+S						
225/50 R 16 92 V	32/220	35/240	32/220	36/250	35/240	42/290
225/50 R 16 92 H M+S						
225/45 R 17 91 V						
225/45 R 17 91 H M+S	32/220	36/250	33/230	41/280	41/280	48/330
225/45 R 17 94 V M+S XL	32/220	38/260	33/230	41/280	41/280	48/330
Front: 225/45 R 17 91 V	32/220	-	33/230	-	41/280	-
Rear: 255/40 R 17 94 V	-	33/230	-	36/250	-	42/290
Front: 225/40 R 18 88 W	32/220	-	33/230	-	38/260	-
Rear: 255/35 R 18 90 W	-	38/260	-	39/270	-	45/310
Front: 225/35 R 19 88 Y XL	35/240	-	33/230	-	38/260	-
Rear: 255/30 R 19 91 Y XL	-	42/290	-	39/270	-	45/310

More details on the permissible load and weights can be found on page 241.



Sedan: tire inflation pressures for the 328i

Tire size	Pressure specifications in psi/kPa					
	Traveling speeds up to a max. of 100 mph / 160 km/h		Traveling speeds including those exceeding 100 mph / 160 km/h			
All pressure specifications in the table are indicated in psi/kilopascal with cold tires. Cold = ambient temperature						
			max.			
without Sports package						
205/55 R 16 91 H M+S						
225/50 R 16 92 V	32/220	36/250	32/220	35/240	33/230	41/280
225/50 R 16 92 H M+S						
225/45 R 17 91 H M+S						
225/45 R 17 91 V	32/220	38/260	32/220	36/250	36/250	44/300
225/45 R 17 94 V M+S XL	32/220	39/270	32/220	36/250	36/250	44/300
Front: 225/45 R 17 91 V	32/220	-	32/220	-	36/250	-
Rear: 255/40 R 17 94 V	-	35/240	-	33/230	-	39/270
Front: 225/40 R 18 88 W	32/220	-	32/220	-	36/250	-
Rear: 255/35 R 18 90 W	-	39/270	-	36/250	-	44/300
Front: 225/40 R 18 88 Y	32/220	-	32/220	-	32/220	-
Rear: 255/35 R 18 90 Y	-	39/270	-	33/230	-	39/270
Front: 225/35 R 19 88 Y XL	35/240	-	32/220	-	36/250	-
Rear: 255/30 R 19 91 Y XL	-	44/300	-	38/260	-	44/300

Tire size	Pressure specifications in psi/kPa					
	Traveling speeds up to a max. of 100 mph / 160 km/h		Traveling speeds including those exceeding 100 mph / 160 km/h			
All pressure specifications in the table are indicated in psi/kilopascal with cold tires. Cold = ambient temperature						
	with Sports package					
205/55 R 16 91 H M+S						
225/50 R 16 92 H M+S	32/220	36/250	32/220	38/260	38/260	45/310
225/50 R 16 92 V						
225/45 R 17 91 H M+S	32/220	38/260	32/220	38/260	38/260	45/310
225/45 R 17 91 V						
225/45 R 17 94 V M+S XL	32/220	39/270	33/230	41/280	42/290	49/340
Front: 225/45 R 17 91 V	32/220	-	32/220	-	38/260	-
Rear: 255/40 R 17 94 V	-	35/240	-	36/250	-	44/300
Front: 225/40 R 18 88 W	32/220	-	33/230	-	39/270	-
Rear: 255/35 R 18 90 W	-	39/270	-	39/270	-	46/320
Front: 225/40 R 18 88 Y	32/220	-	32/220	-	36/250	-
Rear: 255/35 R 18 90 Y	-	39/270	-	36/250	-	44/300
Front: 225/35 R 19 88 Y XL	35/240	-	33/230	-	39/270	-
Rear: 255/30 R 19 91 Y XL	-	44/300	-	39/270	-	46/320



More details on the permissible load and weights can be found on page [241](#).

Sedan: tire inflation pressures for the 328xi

Tire size	Pressure specifications in psi/kPa						
	Traveling speeds up to a max. of 100 mph / 160 km/h		Traveling speeds including those exceeding 100 mph / 160 km/h				
All pressure specifications in the table are indicated in psi/kilopascal with cold tires. Cold = ambient temperature							
	without Sports package:						
	205/55 R 16 91 H M+S						
225/50 R 16 92 H M+S							
225/50 R 16 92 V	32/220	36/250	32/220	35/240	35/240	41/280	
225/45 R 17 91 H M+S							
225/45 R 17 91 W							
225/45 R 17 94 V M+S XL	32/220	38/260	32/220	36/250	35/240	42/290	
Front: 225/45 R 17 91 V	32/220	-	32/220	-	35/240	-	
Rear: 255/40 R 17 94 V	-	33/230	-	32/220	-	36/250	
Front: 225/40 R 18 88 W	33/230	-	33/230	-	36/250	-	
Rear: 255/35 R 18 90 W	-	38/260	-	35/240	-	41/280	
Front: 225/35 R 19 88 Y XL	39/270	-	35/240	-	39/270	-	
Rear: 255/30 R 19 91 Y XL	-	42/290	-	36/250	-	42/290	
with Sports package:							
205/55 R 16 91 H M+S							
225/50 R 16 92 H M+S	32/220	36/250	32/220	35/240	35/240	41/280	
225/45 R 17 91 H M+S							
225/50 R 16 92 V	32/220	36/250	35/240	39/270	38/260	45/310	
225/45 R 17 91 W	32/220	36/250	35/240	39/270	38/260	45/310	
225/45 R 17 94 V M+S XL	32/220	38/260	35/240	41/280	41/280	48/330	
Front: 225/45 R 17 91 V	32/220	-	35/240	-	38/260	-	
Rear: 255/40 R 17 94 V	-	33/230	-	36/250	-	42/290	
Front: 225/40 R 18 88 W	33/230	-	38/260	-	41/280	-	
Rear: 255/35 R 18 90 W	-	38/260	-	39/270	-	45/310	
Front: 225/35 R 19 88 Y XL	39/270	-	38/260	-	42/290	-	
Rear: 255/30 R 19 91 Y XL	-	42/290	-	39/270	-	45/310	

More details on the permissible load and weights can be found on page 241.

Sedan: tire inflation pressures for the 335i

Tire size	Pressure specifications in psi/kPa					
	Traveling speeds up to a max. of 100 mph / 160 km/h			Traveling speeds including those exceeding 100 mph / 160 km/h		
All pressure specifications in the table are indicated in psi/kilopascal with cold tires. Cold = ambient temperature						

without Sports package:



225/45 R 17 91 H M+S 225/45 R 17 94 W	32/220	39/270	32/220	38/260	36/250	44/300
225/45 R 17 94 V M+S XL	33/230	41/280	32/220	38/260	38/260	45/310
Front: 225/45 R 17 91 V	32/220	-	32/220	-	36/250	-
Rear: 255/40 R 17 94 V	-	35/240	-	35/240	-	41/280
Front: 225/40 R 18 88 W	33/230	-	32/220	-	36/250	-
Rear: 255/35 R 18 90 W	-	41/280	-	38/260	-	44/300
Front: 225/40 R 18 88 Y	33/230	-	32/220	-	33/230	-
Rear: 255/35 R 18 90 Y	-	41/280	-	35/240	-	41/280
Front: 225/35 R 19 88 Y XL	38/260	-	35/240	-	38/260	-
Rear: 255/30 R 19 91 Y XL	-	45/310	-	39/270	-	45/310

with Sports package:

225/45 R 17 91 H M+S 225/45 R 17 94 W	32/220	39/270	33/230	39/270	39/270	46/320
225/45 R 17 94 V M+S XL	33/230	41/280	36/250	44/300	42/290	49/340
Front: 225/45 R 17 91 V	32/220	-	33/230	-	39/270	-
Rear: 255/40 R 17 94 V	-	35/240	-	36/250	-	44/300
Front: 225/40 R 18 88 W	33/230	-	36/250	-	41/280	-
Rear: 255/35 R 18 90 W	-	41/280	-	41/280	-	48/330
Front: 225/40 R 18 88 Y	33/230	-	32/220	-	36/250	-
Rear: 255/35 R 18 90 Y	-	41/280	-	36/250	-	44/300
Front: 225/35 R 19 88 Y XL	38/260	-	36/250	-	41/280	-
Rear: 255/30 R 19 91 Y XL	-	45/310	-	41/280	-	48/330

More details on the permissible load and weights can be found on page 241.

Sedan: tire inflation pressures for the 335xi

Tire size	Pressure specifications in psi/kPa					
	Traveling speeds up to a max. of 100 mph / 160 km/h		Traveling speeds including those exceeding 100 mph / 160 km/h			
All pressure specifications in the table are indicated in psi/kilopascal with cold tires. Cold = ambient temperature						

without Sports package:

225/45 R 17 91 H M+S	33/230	38/260	33/230	36/250	36/250	42/290
225/45 R 17 91 W						
225/45 R 17 94 V M+S XL	33/230	39/270	33/230	36/250	38/260	44/300
Front: 225/45 R 17 91 W	33/230	-	33/230	-	36/250	-
Rear: 255/40 R 17 94 W	-	33/230	-	33/230	-	36/250
Front: 225/40 R 18 88 W	36/250	-	36/250	-	39/270	-
Rear: 255/35 R 18 90 W	-	39/270	-	36/250	-	42/290
Front: 225/40 R 18 88 Y	36/250	-	33/230	-	36/250	-
Rear: 255/35 R 18 90 Y	-	39/270	-	33/230	-	39/270
Front: 225/35 R 19 88 Y XL	42/290	-	38/260	-	42/290	-
Rear: 255/30 R 19 91 Y XL	-	44/300	-	38/260	-	44/300

with Sports package:

225/45 R 17 91 H M+S	33/230	38/260	33/230	36/250	36/250	42/290
225/45 R 17 94 V M+S XL	33/230	39/270	38/260	42/290	42/290	48/330
225/45 R 17 91 W	33/230	38/260	36/250	39/270	39/270	45/310
Front: 225/45 R 17 91 W	33/230	-	36/250	-	39/270	-
Rear: 255/40 R 17 94 W	-	33/230	-	36/250	-	42/290
Front: 225/40 R 18 88 W	36/250	-	39/270	-	44/300	-
Rear: 255/35 R 18 90 W	-	39/270	-	39/270	-	46/320
Front: 225/40 R 18 88 Y	36/250	-	36/250	-	39/270	-
Rear: 255/35 R 18 90 Y	-	39/270	-	36/250	-	42/290
Front: 225/35 R 19 88 Y XL	42/290	-	39/270	-	45/310	-
Rear: 255/30 R 19 91 Y XL	-	44/300	-	41/280	-	46/320

More details on the permissible load and weights can be found on page [241](#).

Sedan: tire inflation pressures for the 335d

Tire size	Pressure specifications in psi/kPa					
	Traveling speeds up to a max. of 100 mph / 160 km/h			Traveling speeds including those exceeding 100 mph / 160 km/h		
All pressure specifications in the table are indicated in psi/kilopascal with cold tires. Cold = ambient temperature						

without Sports package:





225/45 R 17 91 H M+S	33/230	41/280	33/230	39/270	39/270	46/320
225/45 R 17 91 W						
225/45 R 17 94 V M+S XL	35/240	42/290	33/230	39/270	39/270	46/320
Front: 225/45 R 17 91 V	33/230	-	33/230	-	39/270	-
Rear: 255/40 R 17 94 V	-	36/250	-	36/250	-	41/280
Front: 225/40 R 18 88 W	35/240	-	33/230	-	39/270	-
Rear: 255/35 R 18 90 W	-	41/280	-	38/260	-	45/310
Front: 225/40 R 18 88 Y	35/240	-	32/220	-	35/240	-
Rear: 255/35 R 18 90 Y	-	41/280	-	36/250	-	41/280
Front: 225/35 R 19 88 Y XL	41/280	-	36/250	-	41/280	-
Rear: 255/30 R 19 91 Y XL	-	46/320	-	41/280	-	46/320

with Sports package:

225/45 R 17 91 H M+S	33/230	41/280	35/240	42/290	41/280	48/330
225/45 R 17 91 W						
225/45 R 17 94 V M+S XL	35/240	42/290	39/270	45/310	42/290	49/340
Front: 225/45 R 17 91 V	33/230	-	35/240	-	41/280	-
Rear: 255/40 R 17 94 V	-	36/250	-	39/270	-	45/310
Front: 225/40 R 18 88 W	35/240	-	38/260	-	42/290	-
Rear: 255/35 R 18 90 W	-	41/280	-	42/290	-	49/340
Front: 225/40 R 18 88 Y	35/240	-	35/240	-	38/260	-
Rear: 255/35 R 18 90 Y	-	41/280	-	39/270	-	45/310
Front: 225/35 R 19 88 Y XL	41/280	-	39/270	-	44/300	-
Rear: 255/30 R 19 91 Y XL	-	46/320	-	42/290	-	49/340

More details on the permissible load and weights can be found on page [241](#).

Sports Wagon: tire inflation pressures for the 328i

Tire size	Pressure specifications in psi/kPa					
	Traveling speeds up to a max. of 100 mph / 160 km/h			Traveling speeds including those exceeding 100 mph / 160 km/h		
All pressure specifications in the table are indicated in psi/kilopascal with cold tires. Cold = ambient temperature						
						

without Sports package:

225/50 R 16 92 H M+S	32/220	39/270	32/220	36/250	36/250	44/300
225/50 R 16 92 W						
205/55 R 16 91 H M+S	32/220	39/270	32/220	39/270	39/270	46/320
225/45 R 17 91 H M+S						
225/45 R 17 91 W	33/230	41/280	32/220	39/270	39/270	46/320
225/45 R 17 94 V M+S XL	35/240	42/290	33/230	41/280	41/280	48/330
Front: 225/45 R 17 91 V	33/230	-	32/220	-	39/270	-
Rear: 255/40 R 17 94 V	-	36/250	-	35/240	-	42/290
Front: 225/40 R 18 88 W	36/250	-	32/220	-	39/270	-
Rear: 255/35 R 18 90 W	-	44/300	-	39/270	-	46/320
Front: 225/40 R 18 88 Y	36/250	-	32/220	-	36/250	-
Rear: 255/35 R 18 90 Y	-	44/300	-	36/250	-	44/300
Front: 225/35 R 19 88 Y XL	41/280	-	33/230	-	41/280	-
Rear: 255/30 R 19 91 Y XL	-	48/330	-	41/280	-	48/330



Tire size	Pressure specifications in psi/kPa					
	Traveling speeds up to a max. of 100 mph / 160 km/h		Traveling speeds including those exceeding 100 mph / 160 km/h			
All pressure specifications in the table are indicated in psi/kilopascal with cold tires. Cold = ambient temperature						

with Sports package:

205/55 R 16 91 H M+S						
225/50 R 16 92 H M+S	32/220	39/270	32/220	39/270	39/270	46/320
225/50 R 16 92 W						
225/45 R 17 91 H M+S	33/230	41/280	35/240	42/290	42/290	49/340
225/45 R 17 91 W						
225/45 R 17 94 V M+S XL	35/240	42/290	38/260	45/310	42/290	49/340
Front: 225/45 R 17 91 V	33/230	-	35/240	-	42/290	-
Rear: 255/40 R 17 94 V	-	36/250	-	39/270	-	46/320
Front: 225/40 R 18 88 W	36/250	-	36/250	-	44/300	-
Rear: 255/35 R 18 90 W	-	44/300	-	44/300	-	51/350
Front: 225/40 R 18 88 Y	36/250	-	32/220	-	39/270	-
Rear: 255/35 R 18 90 Y	-	44/300	-	39/270	-	46/320
Front: 225/35 R 19 88 Y XL	41/280	-	36/250	-	42/290	-
Rear: 255/30 R 19 91 Y XL	-	48/330	-	44/300	-	49/340



More details on the permissible load and weights can be found on page [241](#).

Sports Wagon: tire inflation pressures for the 328xi

Tire size	Pressure specifications in psi/kPa					
	Traveling speeds up to a max. of 100 mph / 160 km/h			Traveling speeds including those exceeding 100 mph / 160 km/h		
All pressure specifications in the table are indicated in psi/kilopascal with cold tires. Cold = ambient temperature						
						

without Sports package:

205/55 R 16 91 H M+S						
225/50 R 16 92 H M+S	32/220	39/270	32/220	38/260	36/250	44/300
225/50 R 16 92 W						
225/45 R 17 91 H M+S						
225/45 R 17 91 W	33/230	41/280	32/220	38/260	38/260	45/310
225/45 R 17 94 V M+S XL	35/240	42/290	32/220	39/270	39/270	46/320
Front: 225/45 R 17 91 V	33/230	-	32/220	-	38/260	-
Rear: 255/40 R 17 94 V	-	36/250	-	35/240	-	41/280
Front: 225/40 R 18 88 W	36/250	-	35/240	-	39/270	-
Rear: 255/35 R 18 90 W	-	42/290	-	39/270	-	46/320
Front: 225/40 R 18 88 Y	36/250	-	32/220	-	36/250	-
Rear: 255/35 R 18 90 Y	-	42/290	-	36/250	-	42/290
Front: 225/35 R 19 88 Y XL	39/270	-	35/240	-	39/270	-
Rear: 255/30 R 19 91 Y XL	-	46/320	-	39/270	-	46/320

Tire size	Pressure specifications in psi/kPa					
	Traveling speeds up to a max. of 100 mph / 160 km/h		Traveling speeds including those exceeding 100 mph / 160 km/h			
All pressure specifications in the table are indicated in psi/kilopascal with cold tires. Cold = ambient temperature						
						

with Sports package:

205/55 R 16 91 H M+S						
225/50 R 16 92 H M+S	32/220	39/270	32/220	39/270	38/260	45/310
225/50 R 16 92 W						
225/45 R 17 91 H M+S	33/230	41/280	33/230	41/280	41/280	48/330
225/45 R 17 91 W						
225/45 R 17 94 V M+S XL	35/240	42/290	36/250	44/300	42/290	49/340
Front: 225/45 R 17 91 V	33/230	-	33/230	-	41/280	-
Rear: 255/40 R 17 94 V	-	36/250	-	39/270	-	45/310
Front: 225/40 R 18 88 W	36/250	-	36/250	-	42/290	-
Rear: 255/35 R 18 90 W	-	42/290	-	42/290	-	49/340
Front: 225/40 R 18 88 Y	36/250	-	33/230	-	38/260	-
Rear: 255/35 R 18 90 Y	-	42/290	-	39/270	-	45/310
Front: 225/35 R 19 88 Y XL	39/270	-	38/260	-	42/290	-
Rear: 255/30 R 19 91 Y XL	-	46/320	-	42/290	-	49/340

More details on the permissible load and weights can be found on page [241](#).

Tire identification marks

Knowledge of the labeling on the side of the tire makes it easier to identify and choose the right tires.

Tire size

e.g. 225/45 R 17 91 V

Nominal width in mm

Aspect ratio in %

Radial belt construction

Rim diameter in inches

Load rating, not on ZR tires

Speed code letter, in front of the R on ZR tires

Speed code letter

Q = up to 100 mph or 160 km/h

T = up to 118 mph or 190 km/h

H = up to 131 mph or 210 km/h

V = up to 150 mph or 240 km/h

W = up to 167 mph or 270 km/h

Y = up to 186 mph or 300 km/h

Tire Identification Number

Tires with DOT codes meet the guidelines of the US Department of Transportation.

DOT code:

e.g. DOT xxxx xxx 3208

Manufacturer's code for tire make

Tire size and tire design

Tire age

Tire age

The manufacturing date of tires is contained in the tire coding: DOT ... 3208 means that the tire was manufactured in week 32 of 2008.

BMW recommends that you replace all tires after 6 years at most, even if some tires may last for 10 years.

Uniform Tire Quality Grading

Quality grades can be found where applicable on the tire sidewall between tread shoulder and maximum section width. For example:

Tread wear 200 Traction AA

Temperature A

DOT Quality Grades

Tread wear

Traction AA A B C

Temperature A B C



All passenger car tires must conform to Federal Safety Requirements in addition to these grades. ◀

Tread wear

The tread wear grade is a comparative rating based on the wear rate of the tire when tested under controlled conditions on a specified government test course. For example, a tire graded 150 would wear one and one-half (1 ½) times as well on the government course as a tire graded 100. The relative performance of tires depends upon the actual conditions of their use, however, and may depart significantly from the norm due to variations in driving habits, service practices and differences in road characteristics and climate.

Traction

The traction grades, from highest to lowest, are AA, A, B, and C.

Those grades represent the tire's ability to stop on wet pavement as measured under controlled conditions on specified government test surfaces of asphalt and concrete. A tire marked C may have poor traction performance.



The traction grade assigned to this tire is based on straight-ahead braking traction tests, and does not include acceleration, cornering, hydroplaning, or peak traction characteristics. ◀

Temperature

The temperature grades are A, the highest, B, and C, representing the tire's resistance to the generation of heat and its ability to dissipate

heat when tested under controlled conditions on a specified indoor laboratory test wheel. Sustained high temperature can cause the material of the tire to degenerate and reduce tire life, and excessive temperature can lead to sudden tire failure. The grade C corresponds to a level of performance which all passenger car tires must meet under the Federal Motor Vehicle Safety Standard No. 109. Grades B and A represent higher levels of performance on the laboratory test wheel than the minimum required by law.

⚠ The temperature grade for this tire is established for a tire that is properly inflated and not overloaded. Excessive speed, underinflation, or excessive loading, either separately or in combination, can cause heat buildup and possible tire failure. ◀

RSC – Run-Flat Tires

You will recognize Run-Flat Tires by a circular symbol containing the letters RSC on the side of the tire, refer to page 209.

M+S

Winter and all-season tires. These have better winter properties than summer tires.

XL

Designation for specially reinforced tires.

Tire condition

Inspect your tires frequently for tread wear, signs of damage and for foreign objects lodged in the tread. Check the tread depth.

Minimum tread depth

The tread depth should not drop below 1/8 in/ 3 mm, although, for example, European legislation only specifies a minimum tread depth of 1/16 in/1.6 mm. At tread depths below 1/8 in/ 3 mm there is an increased risk of high-speed hydroplaning, even when only small amounts of water are present on the road surface. When winter tires wear down past a tread depth

of 1/16 in/1.6 mm, they become perceptibly less suitable for winter conditions. In the interest of safety, new tires should be installed.

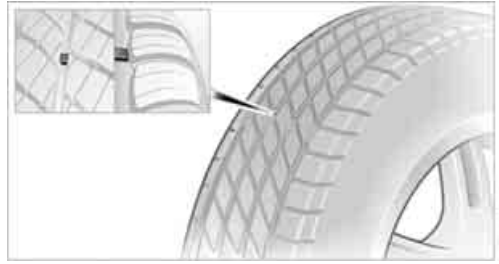

Wear indicators in the base of the tread groove are distributed around the tire's circumference; the letters TWI, for Tread Wear Indicator, on the tire's sidewalls identify tires that incorporate these wear indicators. Once the tire tread has worn down to the wear indicators, the tire has worn to a depth of 1/16 in/1.6 mm.

Wheel/tire damage

Please note that low-profile tires cause wheels, tires and suspension parts to be more susceptible to road hazard and consequential damages.

Unusual vibrations encountered during normal vehicle operation can indicate tire failure or some other vehicle defect. This can, for example, be caused by driving over curbs. The same applies to any other abnormal road behavior, such as pulling severely to the right or left.

⚠ In these cases, reduce speed immediately and have wheels and tires thoroughly checked. To do so, drive carefully to the nearest BMW center or tire shop that works according to BMW repair procedures with correspondingly trained personnel. If necessary, have the vehicle towed there. Otherwise, tire damage can be extremely dangerous for vehicle occupants and other road users. ◀

Tire age

For various reasons, such as the development of brittleness, BMW recommends tire replacement after no more than 6 years, regardless of the actual wear of the tires.

The manufacturing date of tires is contained in the tire coding:
DOT ... 3208 means that the tire was manufactured in week 32 of 2008.

Run-Flat Tires



The symbol identifying Run-Flat Tires is a circle with the letters RSC on the sidewall. Run-Flat Tires comprise a conditionally self-supporting tire and a special rim. The reinforcement in the sidewalls ensures that the tire can continue to be used subject to certain restrictions, even if depressurized.

For information on continuing to drive with a flat tire, refer to Indication of a flat tire, page 84.

New wheels and tires

 Have new wheels and tires installed only by your BMW center or tire shop that works according to BMW repair procedures with correspondingly trained personnel. If this work is not carried out properly, there is a danger of subsequent damage and related safety hazards. Make sure that the new wheels are balanced. ◀

Retreaded tires

 BMW recommends that you do not use retreaded tires, since driving safety may be impaired. The causes for this include potentially different tire casing structures and often wide variations in tire age, which can result in a limited service life. ◀

Correct wheels and tires

When mounting new tires or changing over from summer to winter tires and vice versa, mount Run-Flat Tires for your own safety. In the event of a flat, no spare wheel is available. Your BMW center will be glad to advise you.

 BMW recommends that you use only wheel and tire combinations that BMW has tested and approved for your particular vehicle. Variations in factors such as manufacturing tolerances mean that even wheels and tires with identical official size ratings could actually have different dimensions, which could lead to body contact and thus to severe accidents. If non-approved wheels and tires are used, BMW cannot evaluate their suitability, and therefore cannot guarantee their driving safety. ◀

You can inquire about the right wheel/tire combination at your BMW center.

The correct combination of wheels and tires is also necessary to ensure reliable operation of various vehicle systems such as ABS, DSC or FTM.

To maintain good handling and vehicle response, use only tires of a single brand and tread configuration. After a tire has been damaged, mount the previous wheel and tire combination again as soon as possible.

Wheels with Tire Pressure Monitor TPM electronics

When mounting new tires or changing over from summer to winter tires, or vice versa, only use wheels with TPM electronics; otherwise the Tire Pressure Monitor may not be able to detect a puncture, refer to page 84. Your BMW center will be glad to advise you.

Recommended tire brands

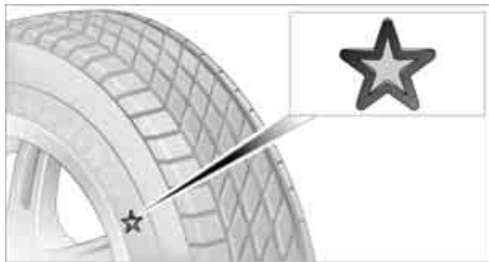

Certain makes of tire are recommended by BMW for each tire size. They are marked with a clearly visible BMW designation on the sidewall of the tire.

When properly used, these tires meet the highest standards in terms of safety and handling characteristics.

Special characteristics of winter tires

BMW recommends winter tires for winter roads or at temperatures below +45°F/+7°C.

Although all-season M+S tires provide better winter traction than summer tires, they generally fail to provide the same levels of cold-weather performance as winter tires.

Pay attention to speed

 Always comply with the speed limit for the winter tires mounted on your car; failure to do so could result in tire damage and accidents. ◀

If the car is capable of speeds higher than that permitted for the winter tires, a label stating the maximum permitted speed for the mounted tires must be displayed in your field of view. Specialist tire dealers and your BMW center can supply these labels.

Storage

Always store wheels and tires in a cool, dry place with as little exposure to light as possible. Always protect tires against all contact with oil, grease and fuels. Do not exceed the maximum tire inflation pressure indicated on the sidewall of the tire.

Swapping wheels between axles

BMW advises against swapping wheels between the front and rear axles, even if all tires have the same size, as this could impair driving characteristics. If the tires are of mixed sizes, swapping wheels between the axles is not permissible.

Snow chains*

Only certain fine-link snow chains have been tested by BMW, classified as safe for use and recommended. Consult your BMW center for more information.

Snow chains must be mounted in pairs and on the rear wheels only. Observe the manufacturer's instructions when mounting snow chains. Do not exceed a speed of 30 mph or 50 km/h.



Do not initialize the Flat Tire Monitor if snow chains are mounted, otherwise the instrument might issue an incorrect reading. When driving with snow chains, you may find it helpful to activate DTC temporarily, refer to page 81. ◀

Under the hood

! Do not work on the car unless you possess the necessary technical knowledge. If you are unfamiliar with the statutory guidelines, have any work on the vehicle performed only by a BMW center or by a workshop that work according to BMW repair procedures with correspondingly trained personnel. If this work is not carried out properly, there is a danger of subsequent damage and related safety hazards. ◀

Hood

Releasing

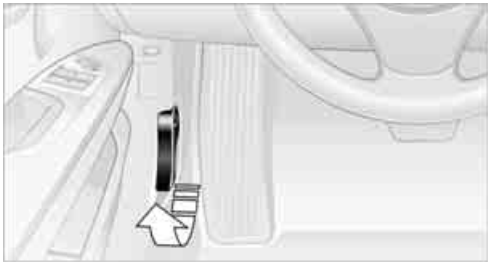

Pull the lever.

Opening



! In order to avoid damage, make sure that the wiper arms are against the windshield before you open the hood. Do not open the engine hood before the engine has cooled down, otherwise injuries may result. ◀

Press the release handle and open the hood.

Closing

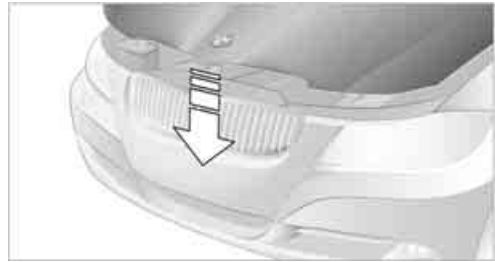

Let the hood drop from a height of approx. 10 in/ 25 cm. It must be clearly heard to engage.

! Make sure that the closing path of the hood is clear, otherwise injuries may result.

If you see any signs while driving your vehicle that the hood is not completely closed, stop at once and close it securely. ◀

Important parts of the engine compartment



- 1 Gasoline engine: expansion tank for coolant, refer to page 215
Diesel engine: the expansion tank is located on the other side of the vehicle
- 2 Washer fluid filler neck for headlamp cleaning system and window washer system, refer to page 59
- 3 Jump-starting connection, refer to page 231
- 4 Filler neck for engine oil, refer to Adding engine oil
- 5 Diesel engine: dipstick for engine oil, refer to Checking oil level

Engine oil

The engine oil consumption is dependent on driving style and driving conditions.

The oil level must be between the two markings on the dipstick.

Diesel engine: checking engine oil level

1. Park the vehicle on a level surface with the engine at operating temperature, i.e. after an uninterrupted drive of at least 6.5 miles/ 10 km.
2. Switch off the engine.
3. After approx. 5 minutes, pull out the dipstick 5 and wipe it off with a lint-free cloth, paper towel or similar material.
4. Carefully push the dipstick all the way back into the measuring tube and pull it out again.

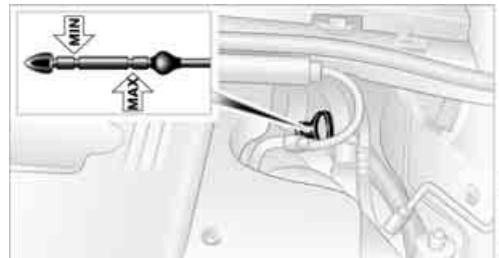

The oil quantity between the two markings on the dipstick is equivalent to approx. 1 US quart/ 1 liter.

 The oil level must not be above the upper marking of the dipstick. Too much oil will harm the engine. ◀

Gasoline engine: checking engine oil level

Your car is equipped with an electronic oil-level monitor.

For a precise measurement and display of the oil level, it is necessary that the engine be at operating temperature, i.e. after uninterrupted driving for at least approx. 6.5 miles/10 km. You can have the oil level displayed while you are driving, or while the vehicle is at a standstill on a level surface and the engine is running.

Display in the instrument cluster



1. Push button **1** in the turn indicator lever up or down repeatedly until the appropriate symbol is shown in the display, accompanied by the word "OIL".
2. Press button **2** in the turn indicator lever. The oil level is checked and the reading displayed.

Possible displays



- 1 Oil level OK
- 2 Oil level is being checked.
This can take about 3 minutes if the car is at a standstill on a level surface, or about 5 minutes while the car is on the move.
- 3 Oil level down to minimum:
Add engine oil as soon as possible, but no more than 1 US quart/1 liter, refer also to Adding engine oil on page 214.
- 4 Oil level is too high.
 Too much oil will harm the engine. Have the vehicle checked without delay. ◀
- 5 The oil level sensor is defective.
Do not add engine oil. You can continue your journey. Note the newly calculated distance remaining to the next oil service, refer to page 71. Have the system checked as soon as possible.

Display via iDrive

iDrive, for operating principle refer to page 16.

1. "Vehicle Info"
2. "Vehicle status"

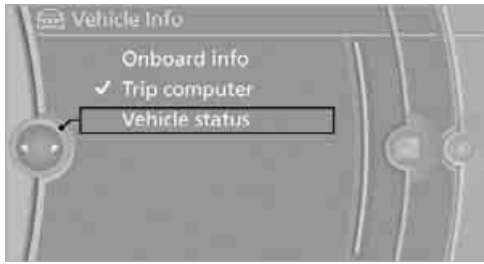

3. "Engine oil level"



Possible messages

- ▷ "Engine oil level OK."
- ▷ "Measurement not possible at this time."
- ▷ "Measuring engine oil level...":
This can take about 3 minutes if the car is at a standstill on a level surface and the engine is running, and about 5 minutes while the car is moving.

If engine oil was added, it may take up to 30 minutes to obtain an oil level reading.

- ▷ "Engine oil level below minimum. Add 1 quart!"
Add engine oil as soon as possible, but no more than 1 US quart/1 liter, refer also to Adding engine oil below.
If the oil level is below the minimum value, add engine oil immediately to avoid engine damage.
- ▷ "Engine oil level too high! Have this checked."

 Too much oil will harm the engine. Have the vehicle checked without delay. ◀

- ▷ "Measurement inactive. Have this checked."
Do not add engine oil. You can continue your journey. Note the newly calculated distance remaining to the next oil service, refer to page 71. Have the system checked as soon as possible.

Adding engine oil

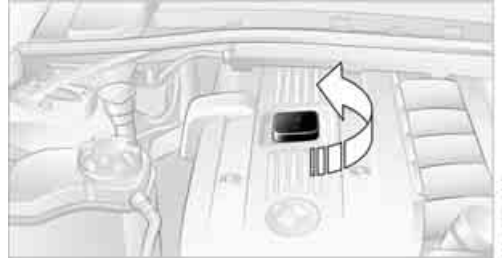

Add a maximum of 1 US quart/1 liter of engine oil no earlier than when a corresponding message appears on the Control Display or, if the car has a diesel engine, when the oil level has dropped to just above the lower marking on the dipstick, refer to page 212.

 Add oil within the next 125 miles/200 km, otherwise the engine could be damaged. ◀

 Keep oils, greases, etc. out of the reach of children and comply with the relevant warnings on the containers. Otherwise, health hazards may result. ◀

Oil change

Have oil changed only at your BMW center or at a workshop that works according to BMW repair procedures with correspondingly trained personnel.

Specified engine oils

The quality of the engine oil selected has critical significance for the operation and service life of an engine. BMW continuously approves specific oils after testing them extensively.

 Your BMW center will be glad to answer any questions regarding the approved oils. ◀

You can also call BMW of North America at 1-800-831-1117 or visit the website www.bmwusa.com to obtain this information.

 Do not use oil additives, as these may cause engine damage. ◀

Alternative oil types

If exceptionally none of the approved oils happens to be available, small quantities of other oils may be used when adding oil between oil changes. However, the corresponding container must be labeled with one of the following oil specifications:

Gasoline engines

- ▷ Preferred: BMW Longlife-01, BMW Longlife-01 FE or BMW Longlife-04
- ▷ Alternatively: BMW Longlife-98, API SM or higher

Diesel engines

BMW Longlife-04

Viscosity ratings

Viscosity is a measure of an oil's flow rating and is categorized in SAE classes.

Selecting the appropriate SAE class depends on the regional climatic conditions in which you normally drive your BMW.

 Approved oils belong to the 0W-40, 0W-30, 5W-40 and 5W-30 SAE classes. ◀

These oils can be used for driving at all outside temperatures.

BMW recommends 

Coolant

 Do not add coolant to the cooling system when the engine is hot. Escaping coolant can cause burns. ◀

Coolant consists of half water and half additive. Not all commercially available additives are suitable for your BMW. Ask your BMW center for suitable additives.

 Only use suitable additives, otherwise engine damage may result. Because additives are harmful to your health, it is important to follow the instructions on the containers. ◀

 Comply with the appropriate environmental protection regulations when disposing of coolant additives. ◀

Checking coolant level

1. Do not open the engine hood before the engine has cooled down.
2. Turn the cap of the expansion tank a little counterclockwise to allow any accumulated pressure to escape, then continue turning to open.
3. The coolant level is correct if it is between the maximum and minimum marks in the filler neck, refer also to the diagram next to the filler neck.



4. If the coolant is low, slowly add coolant up to the specified level; do not overfill.
5. Turn the cap until there is an audible click.
6. Have the reason for the coolant loss eliminated as soon as possible.

Maintenance

BMW Maintenance System



The BMW Maintenance System supports the preservation of the traffic and operating safety of your BMW. The objective is to optimize efforts with respect to minimal vehicle maintenance costs.

If and when you come to sell your BMW, a comprehensive record of servicing will prove a significant benefit.

Condition Based Service CBS

Sensors and special algorithms take the different driving conditions of your BMW into account. Condition Based Service uses this to determine the current and future service requirements. By letting you define a service and maintenance regimen that reflects your own individual requirements, the system builds the basis for trouble-free driving.

On the Control Display, you can have the remaining times or distances for selected maintenance tasks and any legally prescribed dates displayed, refer to page 71:

- ▷ Engine oil
- ▷ Brake pads: separately for front and rear
- ▷ Brake fluid
- ▷ Vehicle check
- ▷ Legally mandated inspections depending on local regulations
- ▷ Diesel particulate filter*

Service data in the remote control

Your vehicle continuously stores service-requirement information in the remote control while you are driving. Your BMW Service Advisor can read out this data from the remote control unit, and propose an optimized maintenance approach. Whenever you take your car in for servicing you should therefore hand your BMW Service Advisor the remote control unit that you last used.

 Make sure that the date is always set correctly, refer to page 74; otherwise the effectiveness of Condition Based Service CBS is not assured. ◀

Service and Warranty Information Booklet for US models and Warranty and Service Guide Booklet for Canadian models

Please consult your Service and Warranty Information Booklet for US models and Warranty and Service Guide Booklet for Canadian models for additional information on service requirements.

 BMW recommends that you have service and repair operations performed at your BMW center.

Take the time to ensure that these service procedures are confirmed by entries in your vehicle's Service and Warranty Information Booklet for US models and Warranty and Service Guide Booklet for Canadian models. These entries verify that your vehicle has received the specified regular maintenance. ◀

Socket for On-Board Diagnosis OBD

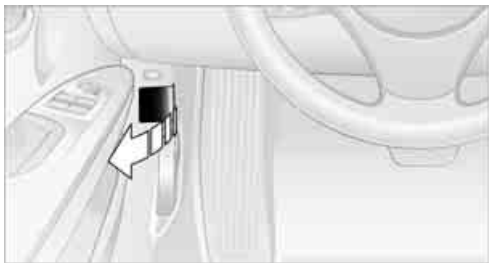

Primary components that make up exhaust emissions can be checked by a device via the OBD socket.

This socket is located on the driver's side to the left, on the bottom of the instrument panel underneath a cover.

Exhaust emission values

SERVICE ENGINE SOON The warning lamp lights up: The exhaust emission values have worsened. Have the car checked as soon as possible.



Canadian models display this warning lamp.

The lamp flashes under certain conditions. This indicates excessive misfiring in the engine. If this happens, you should reduce your speed and visit your nearest BMW center as soon as possible. Severe engine misfiring can quickly lead to serious damage of emissions-related components, especially the catalytic converter.



The warning lamp comes on if the gas cap is not properly tightened and the OBD system assumes that fuel vapor is escaping. If the gas cap is then tightened, the warning lamp should go out within a few days.

Event data recorders

Your vehicle may be equipped with one or several measuring or diagnostic modules or a device for recording or sending certain vehicle data or information. In addition, if you have signed a service contract for BMW Assist, cer-

tain vehicle data may be transmitted or recorded in order to facilitate the corresponding services.

Care

Care products

Regular cleaning and care contributes significantly to the value retention of your BMW.

BMW recommends cleaning and caring for your vehicle with products that are approved by BMW for this purpose.

Your BMW center will be happy to advise you on the products and services available for cleaning and caring for your BMW.

 Original BMW CareProducts have been material tested, laboratory checked and proven in the field, and offer optimal care and protection for your vehicle. ◀

 Do not use cleaners that contain alcohol or solvents as these may result in damage. ◀

 Cleaning agents can contain substances that are dangerous or hazardous to your health. Therefore, follow the warning and safety instructions on the packaging. When cleaning inside the vehicle, always open the doors or windows of the vehicle. In enclosed areas, provide for sufficient ventilation. Only use products designed for cleaning vehicles. ◀

Exterior care

Washing the vehicle

 Especially during the winter months, ensure that the vehicle is washed more frequently. Heavy soiling and road salt can lead to vehicle damage. ◀

 After washing the vehicle, apply the brakes briefly to dry them, otherwise water can reduce braking efficiency over the short term and the brake discs can corrode. ◀

Automatic car washes

Preference should be given to cloth car washes.

Before driving into a car wash, ensure that it is suitable for your BMW. Check the following:

- ▷ Dimensions of your vehicle, refer to page 239
- ▷ If necessary: fold in the exterior mirrors, refer to page 47
- ▷ Maximum permissible tire width

Preparations before driving into an automatic car wash:

- ▷ Unscrew the rod antenna*.
- ▷ Deactivate the rain sensor* to prevent unintentional wiping.
- ▷ Sports Wagon: deactivate the rear window wiper and protect it against damage. If necessary, ask the operator of the car wash about protective measures you should take.
- ▷ Remove additional attachments, e.g. spoiler or telephone antennas, if there is a possibility that they could be damaged.

Automatic transmission

Before driving into an automatic car wash, perform the following steps to ensure that the vehicle can roll:

1. Insert the remote control, even with convenient access, into the ignition lock.
2. Move the selector lever to position N.
3. Release the parking brake.
4. Switch off the engine.
5. Leave the remote control in the ignition lock so that the vehicle can roll.

Steam jets / high-pressure washers

 When using steam jets or high-pressure washers, ensure that you maintain sufficient clearance to the vehicle and do not exceed a temperature of 140 °F /60 °C.

Insufficient clearance or excessive pressure or temperature can lead to component damage or water penetration. Follow the operating instructions of the high-pressure washer. ◀

 When using high-pressure washers, do not spray against the sensors and cam-

eras, e.g. of the Park Distance Control or Rear View Camera, for an extended period and maintain a distance of at least 12 in/30 cm. ◀

Manual car wash

When washing the vehicle by hand, use large quantities of water and car shampoo if necessary. Clean the vehicle with a sponge or washing brush, applying light pressure only.

 Before cleaning the windshield, deactivate the rain sensor or switch off the ignition to prevent unintentional activation of the wipers. ◀

 Observe local regulations pertaining to washing vehicles by hand. ◀

Headlamps

Do not rub them dry and do not use abrasive or corrosive cleaning agents.

Remove contamination, such as insects, by soaking with shampoo or insect remover and then rinsing with plenty of water.

Thaw ice with a windshield de-icer and do not use an ice scraper.

Windows

Clean the inside and outside surfaces of the windows and the mirrors with window cleaner.

 Do not clean the mirrors with cleaners containing quartz. ◀

Wiper blades

Clean with soapy water and replace regularly to avoid streaking.

 Wax and preservative residue and contamination on the window can lead to streaking when operating the windshield wipers, leading to premature wear of the wiper blades and causing the rain sensor to malfunction. ◀

Paintwork care

Regular care contributes to value retention and protects the paintwork against the long-term effects of damaging substances.

Region-specific environmental influences can damage the vehicle paintwork. Therefore, it is important to adapt the frequency and scope of car care accordingly.

Immediately remove very aggressive substances, e.g. spilled fuel, oil, grease, tree resin or bird droppings, to prevent damage to the paintwork.

Repairing paintwork damage

 Immediately repair scratches or similar damage, such as that caused by stones hitting the vehicle, where necessary to prevent rusting. ◀

BMW recommends having paintwork damage repaired by a professional paint repair workshop according to BMW specifications using original BMW paint materials.

Preservation

A preservation treatment is necessary when water no longer beads off of the clean paintwork surface. Only use products for paintwork preservation that contain carnauba or synthetic waxes.

Rubber seals

Treat only with water or rubber care products.

 Do not use silicon-containing care products on rubber seals, otherwise noise and damage could occur. ◀

Chrome parts

Carefully clean vehicle parts, such as the radiator grill, door handles or window frames, with copious quantities of water and a shampoo additive. For additional treatment, use a chrome polish.

Light-alloy wheels

For technical reasons, dust is generated during braking that is deposited on the light-alloy wheels. Remove the dust regularly using acid-free rim cleaner.

 Do not use aggressive, acidic, strongly alkaline and abrasive cleaning agents or

steam jets over 140 °F /60 °C, otherwise damage may occur. ◀

Outside sensors / cameras

 Keep the sensors and cameras on the outside of the vehicle, e.g. Park Distance Control, clean and free of ice to ensure that they remain fully functional. ◀

Interior care

Upholstery / cloth trim

Vacuum regularly with a vacuum cleaner to remove superficial dirt.

To treat severe stains, e.g. from beverages, use a soft sponge or lint-free microfiber cloth in combination with suitable interior cleaners. Follow the instructions on the packaging.

 Clean the upholstery down to the seams using a sweeping motion. Avoid strong rubbing. ◀

 Opened Velcro fasteners on pants or other articles of clothing can damage the seat covers. Ensure that Velcro fasteners are closed. ◀

Leather / leather trim

 The leather used by BMW is a high quality natural product. Slight irregularities in the leather are a typical characteristic of natural leather. ◀

Dust and road grit in the pores and folds of the leather have an abrasive effect, leading to increased wear and causing the leather surface to become brittle prematurely. Therefore, frequently clean the leather of dust using a cloth or vacuum cleaner.

In particular, ensure that light-colored leather is cleaned regularly as it has a tendency to soil more easily.

Treat the leather twice a year using a leather lotion as dirt and grease will gradually attack the leather's protective layer.

Carpets / cargo bay

You can vacuum the carpets and floor mats or clean them with interior cleaner if heavily soiled.

The floor mats can be removed for cleaning. When replacing the mats, ensure that the seat rails do not extend over the floor mats, as this may damage the mats.

Lint on the floor mats occurs for technical reasons and can be removed by vacuuming repeatedly.

Interior plastic parts

- ▷ Imitation leather surfaces
- ▷ Lamp glasses
- ▷ Display pane of instrument cluster
- ▷ Matt parts

Clean with water and solvent-free plastic cleaner if necessary.

Fine wood parts

Clean fine wood trim and fine wood parts with a damp cloth. Wipe dry with a soft cloth.

Safety belts

 Do not clean with cleaning agents as these may destroy the fabric. ◀

Interior sensors / cameras

To clean interior sensors and cameras, use a lint-free cloth moistened with glass cleaner.

Displays

To clean the displays, e.g. of the radio or instrument cluster, use a display cleaning cloth or a soft, non-abrasive, lint-free cloth.

 Avoid applying excessive pressure when cleaning the displays, otherwise damage may occur. ◀

 Do not use chemical or abrasive household cleaning agents. Keep all types of fluid away from the device. Otherwise, surfaces or electrical components may be corroded or damaged. ◀

CD/DVD drives



Do not use a cleaning CD, as it may damage parts of the drive. ◀

Vehicle storage

If your vehicle is to be decommissioned for longer than three months, your BMW center or a workshop that operates according to BMW specifications will be glad to advise you.

Replacing components

Onboard tool kit

Sedan



The onboard tool kit is stored in a compartment on the right-hand side of the cargo bay. Remove the cover.

Sports Wagon



The onboard tool kit is stored in a compartment on the left-hand side underneath the cargo bay floor panel.

Wiper blades

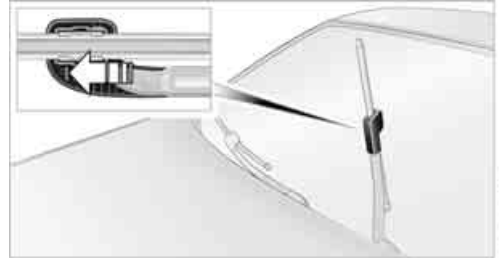

1. Fold up the wiper arm.
2. Remove the cover. To do so, press the hook on the bottom, see arrow.

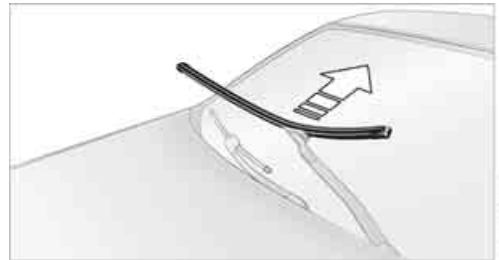

3. Fold the wiper blade upwards.
4. Remove the wiper blade in the direction of the windshield, see arrow.

! To avoid damage, make sure that the wiper arms are against the windshield before you open the engine compartment. ◀

Sports Wagon: changing rear wiper blade



1. Fold up the wiper arm.
2. Pull off the wiper blade, see arrow.
3. Insert the new wiper blade and press it on until it audibly engages.

Lamps and bulbs

Lamps and bulbs make an essential contribution to vehicle safety. They should, therefore, be handled carefully. BMW recommends having your BMW center perform any work that you do not feel competent to perform yourself or that is not described here.

 Never touch the glass of new bulbs with your bare fingers, as even minute amounts of contamination will burn into the bulb's surface and reduce its service life. Use a clean tissue, cloth or something similar, or hold the bulb by its base. ◀

You can obtain a selection of replacement bulbs at your BMW center.

 Only change bulbs while they are cool to the touch, otherwise you could suffer burns. ◀

 When working on electrical systems, always begin by switching off the consumer in question, otherwise short-circuits could result. To avoid possible injury or equipment damage when replacing bulbs, observe any instructions provided by the bulb manufacturer. ◀

For care of the headlamps, please follow the instructions in the chapter entitled 'Care'.

 If the routine for changing a particular bulb is not described here, please contact your BMW center or a workshop that works according to BMW repair procedures with correspondingly trained personnel. ◀

Light-emitting diodes LED

Light-emitting diodes installed behind translucent lenses serve as the light source for many of the controls and displays in your vehicle. These light-emitting diodes, which operate using a concept similar to that applied in conventional lasers, are officially designated as Class 1 light-emitting diodes.

 Do not remove the covers or expose the eyes directly to the unfiltered light source for several hours, otherwise this could cause irritation to the retina. ◀

Xenon lamps*

These bulbs have a very long service life and are highly unlikely to fail. If a xenon bulb fails nevertheless, switch on the fog lamps and continue the journey with great care, provided that local legislation does not prohibit this.

 Have any work on the xenon lamp system, including bulb replacements, performed only by a BMW center or a workshop that works according to BMW repair procedures with correspondingly trained personnel. Otherwise, if such work is carried out improperly, the high voltage in the system presents the danger of fatal injuries. ◀

Replacing parking lamps, roadside parking lamps, and daytime running lamps

H8 bulb, 35 watts

1. Switch off the lamps and take the remote control out of the ignition lock.
2. Turn the cover to the left, see arrow, and remove it.

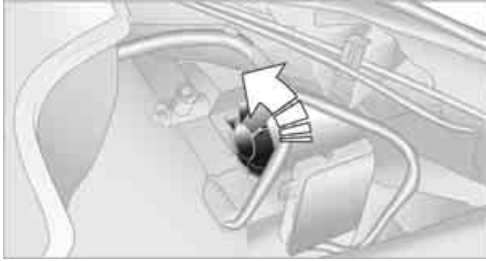

3. Turn the bulb approx. 90°, see arrow, and take it out.



4. Disconnect the plug, change the bulb and reconnect the plug.
5. Insert the bulb and turn it until it stops.
6. Reattach the cover.

Replacing the corner-illuminating lamp*

H3 bulb, 55 watts

1. Switch off the lamps and take the remote control out of the ignition lock.
2. Remove the upper cover from the headlamp. To do so, pull the rubber seal up and

off and unscrew the cover using the screwdriver from the onboard tool kit, see arrow.

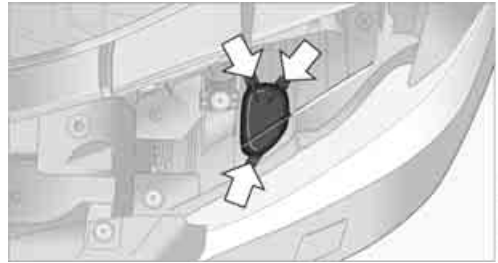

3. Release the wire bracket from the anchor, see arrow, and fold it up.

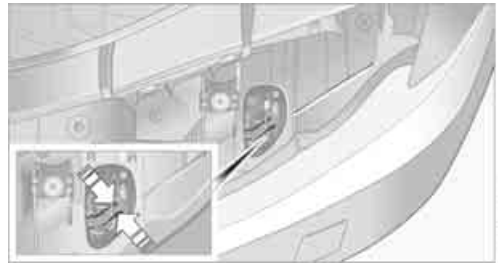

4. Disconnect the plug, change the bulb and reconnect the plug.
5. Insert the bulb.
6. Fold the wire bracket down and engage it.
7. Reattach the cover.

! Be careful when installing the cover, otherwise leaks could occur and cause damage to the headlamp system. ◀

Halogen lamps

H7 bulb, 55 watts

! Always wear gloves and eye protection; the atmosphere within the H7 bulb is pressurized. Otherwise there is a risk of injury if the bulb is damaged. ◀

There are separate headlamp covers for low-beam headlamps and high-beam headlamps.

! Be careful when installing the covers, otherwise leaks could occur and cause damage to the headlamp system. ◀

▶ For checking and adjusting headlamp aim, please contact your BMW center. ◀

Access to the bulbs

The high-beam bulb can be accessed from the engine compartment, whereas the low-beam bulb can be accessed through a flap in the wheel well.

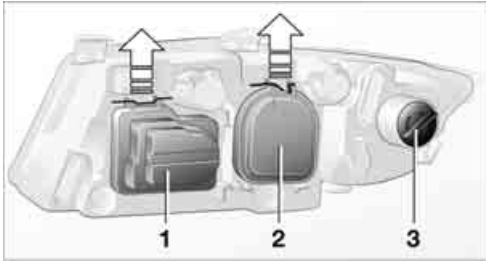

- 1 Cover for high-beam headlamp
- 2 Cover for low-beam headlamp
- 3 Turn signal bulb socket

To remove the covers:

1. Fold the respective wire bracket to the side, see arrows.
2. Flip open the cover and take it out of the guide.

Follow the same steps in reverse order to reattach the covers.

Access through the wheel well

Only for low-beam headlamps and turn signals:

1. Turn the wheel inwards.
2. Open the flap in the wheel well. To do so, turn the fastener counterclockwise using a coin, for example.



Changing low-beam and high-beam bulbs

1. Remove the relevant cover for the headlamp.
2. Disconnect the plug from the bulb.
3. Push the wire bracket to the side out of the mounting, arrow 1, and fold it down, arrow 2.

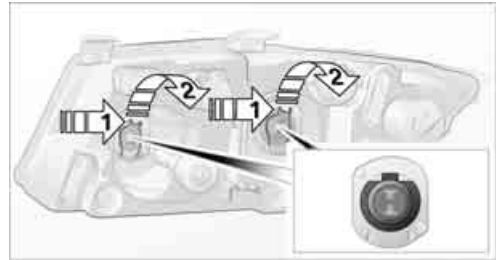

4. Remove the bulb.
5. Insert new bulb as shown in the detail of the illustration above.
6. Fold up the wire bracket and engage it.
7. Connect the plug.
8. Reattach the cover.

Parking lamps, roadside parking lamps

5-watt bulb, W5W

1. Remove the cover for the high-beam headlamp.
2. Pull out the bulb socket, see arrow.

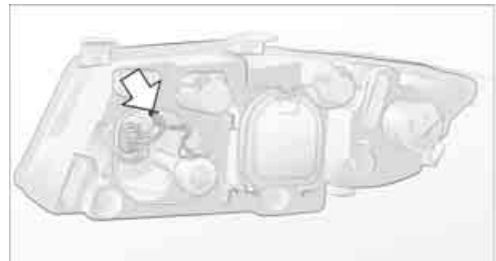

3. Remove and replace the bulb.
4. Insert bulb socket.
5. Reattach the cover.

Turn signals, front

24-watt bulb, PY24W

1. Open the flap in the wheel well, refer to Access through the wheel well on page 225.



2. Rotate turn signal bulb socket **1** to the left and remove.
3. Apply gentle pressure to the bulb while turning it to the left for removal and replacement.
4. Insert turn signal bulb socket **1**.
5. Attach the flap to the wheel well.

Tail lamps

Sedan

- ▷ Brake lamp in the luggage compartment lid: H21W bulb, 21 watts
- ▷ Backup lamp: W16W bulb, 16 watts
- ▷ Other bulbs: P21W bulb, 21 watts

The tail lamps are divided in two parts. One part is in the luggage compartment lid, the other is in the fender.



- 1 Brake lamp
- 2 Roadside parking lamp/tail lamp, LED
- 3 Turn signal, LED

- 4 Backup lamp
- 5 Tail lamp, LED
- 6 Brake lamp

If one of the bulbs **2, 3** or **5** malfunctions, please contact your BMW center or a workshop that works according to BMW repair procedures with correspondingly trained personnel.

Sports Wagon

- ▷ Brake lamp in the tailgate: H21W bulb, 21 watts
- ▷ Backup lamp: W16W bulb, 16 watts
- ▷ Other bulbs: P21W bulb, 21 watts

The tail lamps are divided in two parts. One part is in the tailgate, the other is in the fender.



- 1 Brake lamp
- 2 Roadside parking lamp/tail lamp, LED
- 3 Turn signal, LED
- 4 Backup lamp
- 5 Tail lamp, LED
- 6 Brake lamp

If one of the bulbs **2, 3** or **5** malfunctions, please contact your BMW center or a workshop that works according to BMW repair procedures with correspondingly trained personnel.

Fender-mounted lamps

Sedan

1. Using a screwdriver, pry off the cover in the cargo bay or release the turn-lock fastener by turning it counterclockwise and remove the cover.
2. Loosen the bulb holder at the clip, see arrow, and pull out.

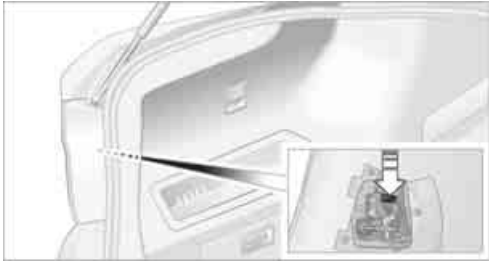

3. Apply gentle pressure to the bulb while turning it to the left for removal and replacement.
4. Re-engage the bulb holder so that it audibly clicks into place.
5. Reattach the cover in the cargo bay.

Sports Wagon

1. Left-hand lamps:
Open the flap on the left-hand side of the cargo bay.
Right-hand lamps:
Open the cargo bay floor panel. Turn the screws on the cover, arrows 1, 90° and take out the cover, arrow 2.

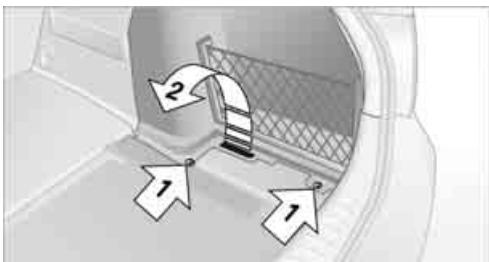

2. Loosen the bulb holder at the clip, see arrow, and pull out.

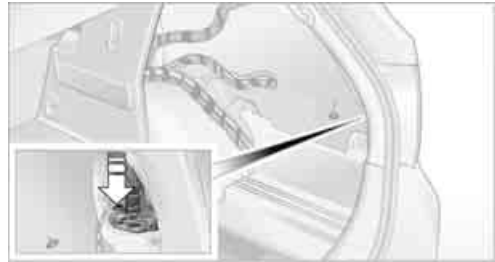

3. Apply gentle pressure to the bulb while turning it to the left for removal and replacement.
4. Re-engage the bulb holder so that it audibly clicks into place.
5. Reattach the cover in the cargo bay.

Lamps in the luggage compartment lid/ tailgate

Sedan



1. Take the warning triangle out of its holder, refer to page 231. Unscrew the holder using the screwdriver from the onboard tool kit.
2. Pry out the plastic plugs in the trim of the luggage compartment lid using a screwdriver and remove the trim.
3. Release the bulb holder at the clip, see arrow, and remove.
4. Apply gentle pressure to the bulb while turning it to the left for removal and replacement.
5. Re-engage the bulb holder so that it audibly clicks into place.

6. Reattach the trim of the luggage compartment lid and the holder for the warning triangle.

Sports Wagon

1. Use a screwdriver to press out the cover at the clips, see arrows, and fold it downward.

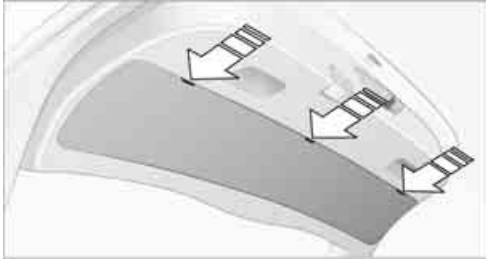

2. Fold away the foam insulating material.
3. Release the bulb holder at the clip, see arrow, and remove.

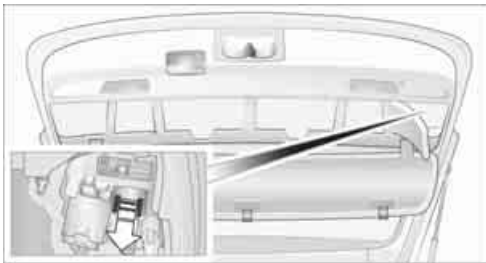

4. Apply gentle pressure to the bulb while turning it to the left for removal and replacement.
5. Re-engage the bulb holder so that it audibly clicks into place.
6. Reattach the trim of the tailgate.

License plate lamp, center brake lamp, parking/tail lamp and turn signal*

These lamps use LED technology for operation. In the event of a malfunction, please contact your BMW center or a workshop that works according to BMW repair procedures with correspondingly trained personnel.

Changing wheels

Your BMW is equipped with Run-Flat Tires as standard. This removes the need to change a wheel immediately in the event of a puncture.

For information on continuing to drive with a damaged tire, refer to Indication of a flat tire on page 84.

The symbol identifying Run-Flat Tires is a circle with the letters RSC on the sidewall, refer to Run-Flat Tires, page 209.

When mounting new tires or changing over from summer to winter tires and vice versa, mount Run-Flat Tires for your own safety. In the event of a flat, no spare wheel is available. Your BMW center will be glad to advise you. Refer also to New wheels and tires, page 209.

 The tools for changing wheels are available as optional accessories from your BMW center. ◀

Jack mounting points

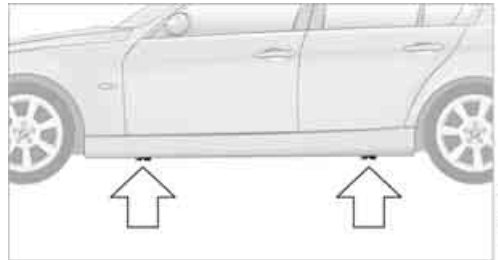

The jacking points are at the positions shown in the illustration.

Vehicle battery

Battery care

The battery is 100% maintenance-free, the electrolyte will last for the life of the battery when the vehicle is operated in a temperate climate. Your BMW center will be glad to advise in all matters concerning the battery.

Charging the battery

Only charge the battery in the vehicle via the terminals in the engine compartment with the engine off. Connections, refer to Jump starting on page 231.

Disposal

 Have old batteries disposed of by your BMW center or hand them in to a recycling center. Maintain the battery in an upright position for transport and storage. Always secure the battery against tipping over during transport. ◀

Power failure

After a temporary power loss, the functioning of some equipment may be limited and require reinitialization. Individual settings may likewise have been lost and will have to be programmed:

- ▷ Time and date
These values must be updated, refer to page 73.
- ▷ Radio
In some cases, stations may have to be stored again, refer to page 145.
- ▷ Navigation system
Operability must be waited for, refer to page 122.
- ▷ Glass roof
It may happen that the roof can only be raised. The system must be initialized. Please contact your BMW center.
- ▷ Panorama glass roof
It may happen that the roof can only be raised. The system must be initialized. Please contact your BMW center.
- ▷ Seat and mirror memory
The positions must be stored again, refer to page 45.
- ▷ Inside rearview mirror with digital compass
The system must be calibrated, refer to page 101.

Fuses



Never attempt to repair a blown fuse and do not replace a defective fuse with a substitute of another color or amperage rating, otherwise this could lead to a circuit overload, ultimately resulting in a fire in the vehicle. ◀



Open the cover in the glove compartment and remove it.

Spare fuses and a pair of plastic forceps are set in holders on the distributor box.

See the rear of the cover for information on fuse assignment.

Giving and receiving assistance

Emergency Request*

Conditions for an Emergency Request:

- ▷ Equipment version with full preparation package mobile phone. This equipment makes it possible to send an Emergency Request even if no mobile phone is paired with the vehicle.
- ▷ BMW Assist is activated. Activating BMW Assist, refer to page 182.
- ▷ Radio readiness is on.
- ▷ The BMW Assist system is logged on to a wireless network.
- ▷ The Emergency Request system is operable.

Once your service contract for BMW Assist expires, the BMW Assist system can be deactivated by a BMW center without you having to visit a workshop. Once the BMW Assist system has been deactivated, Emergency Requests are not possible. The BMW Assist system can be reactivated by a BMW center after a new contract has been signed.

Sending an Emergency Request

1. Briefly press the cover flap to open.



2. Press the SOS button until the LED in the button lights up.

As soon as the voice connection to the BMW Assist Response Center has been established, the LED flashes.

Once the BMW Assist Response Center has received your Emergency Request, the

BMW Assist Response Center contacts you and takes further steps to help you. Even if you are unable to respond, the BMW Assist Response Center will be able to initiate further steps to assist you under certain conditions.

If the circumstances allow this, remain in the vehicle until the connection has been established. You will then be able to provide a detailed description of the situation.

Data for determining the necessary rescue measures are transmitted to the BMW Assist Response Center, e.g. the current position of your vehicle, if it can be determined.

If the LED is flashing but the BMW Assist Response Center cannot be heard over the hands-free system, it is possible that the hands-free system is malfunctioning. You may still be heard by the BMW Assist Response Center, however.

Under certain conditions, an Emergency Request is sent automatically immediately after a severe accident. This Automatic Collision Notification is not affected by the button being pressed.



For technical reasons, the Emergency Request service cannot be guaranteed for the most unfavorable conditions. ◀

Roadside Assistance

The BMW Roadside Assistance is there to assist you around the clock in the event of a breakdown, including on weekends and public holidays.

The phone numbers of the Roadside Assistance in your home country can be found in the Contact brochure.

In vehicles equipped with BMW Assist, you can establish contact with BMW Roadside Assistance for breakdown assistance directly via iDrive, refer to page 186.

First aid pouch*

Some of the articles contained in the first aid pouch have a limited service life. Therefore, check the expiration dates of the contents regularly and replace any items in good time, if necessary.

Sedan



The first aid pouch is located on the right-hand side of the cargo bay in a storage area.

Sports Wagon



The first aid pouch is located in the cargo bay behind the left-hand trim panel.

Warning triangle*

Sedan

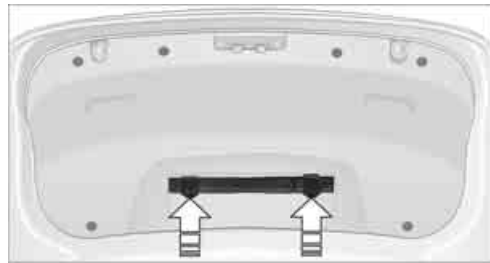

The warning triangle is located in a holder in the luggage compartment lid. Press the tabs to take it out.

Sports Wagon



The warning triangle is located behind the left-hand trim panel in the cargo bay. Press the tab to take it out.

Jump starting

If the car's own battery is flat, your BMW's engine can be started by connecting two jumper cables to another vehicle's battery. You can also use the same method to help start another vehicle. Only use jumper cables with fully-insulated clamp handles.

 Do not touch any electrically live parts when the engine is running, or a fatal accident may occur. Carefully adhere to the following sequence, both to prevent damage to one or both vehicles, and to guard against possible personal injuries. ◀

Preparation

1. Check whether the battery of the other vehicle has a voltage of 12 volts and approximately the same capacitance in Ah. This information can be found on the battery.
2. Switch off the engine of the assisting vehicle.
3. Switch off any consumers in both vehicles.

 There must not be any contact between the bodies of the two vehicles, otherwise there is a danger of shorting. ◀

Connecting jumper cables

 Connect the jumper cables in the correct order, so that no sparks which could cause injury occur. ◀

Your BMW has a jump-starting connection in the engine compartment which acts as the battery's positive terminal, refer also to the Engine compartment overview on page 212. The cap is marked with +.

1. Pull the cap of the BMW jump-starting connection up to remove.



2. Attach one terminal clamp of the plus/+ jumper cable to the positive terminal of the battery or a starting-aid terminal of the vehicle providing assistance.
3. Attach the second terminal clamp of the plus/+ jumper cable to the positive terminal of the battery or a starting-aid terminal of the vehicle to be started.
4. Attach one terminal clamp of the minus/- jumper cable to the negative terminal of the battery or to an engine or body ground of the assisting vehicle.

Your BMW has a special nut as body ground or negative pole.

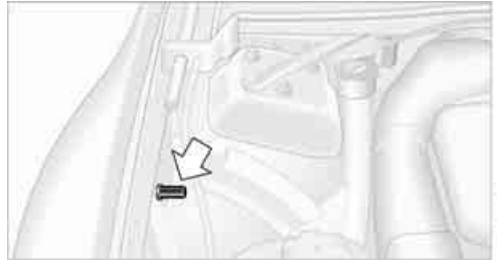

5. Attach the second terminal clamp of the minus/- jumper cable to the negative terminal of the battery or to the engine or body ground of the vehicle to be started.

Starting the engine

1. Start the engine of the donor vehicle and allow it to run for a few minutes at slightly increased idle speed.
2. Start the engine on the other vehicle in the usual way.
If the first start attempt is not successful, wait a few minutes before another attempt in order to allow the discharged battery to recharge.
3. Let the engines run for a few minutes.
4. Disconnect the jumper cables by reversing the above connecting sequence.

If necessary, have the battery checked and recharged.

 Never use spray fluids to start the engine. ◀

Tow-starting, towing away

 Observe the applicable laws and regulations for tow-starting and towing vehicles. ◀

 Do not transport any passengers other than the driver in a vehicle that is being towed. ◀

Using a tow fitting

The screw-in tow fitting must always be carried in the car. It can be screwed in at the front or rear of the BMW.

Sedan: it is stored in the onboard tool kit underneath the cover on the right-hand side of the cargo bay, refer to page 222.

Sports Wagon: it is stored in the onboard tool kit underneath the cover on the left-hand side of the cargo bay, refer to page 222.

 Use only the tow fitting provided with the vehicle and screw it all the way in. Use the tow fitting for towing on paved roads only. Avoid lateral loading of the tow fitting, e.g. do not lift the vehicle by the tow fitting. Otherwise the tow fitting and the vehicle could be damaged. ◀

Access to screw thread

Release the cover panel in the bumper:
Press on the upper part of the cover panel.

Front

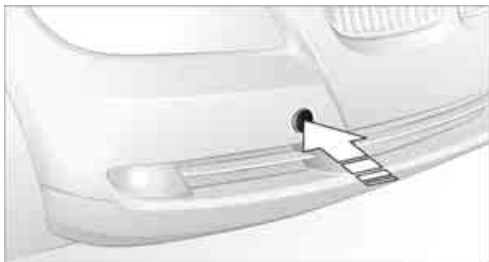

Rear

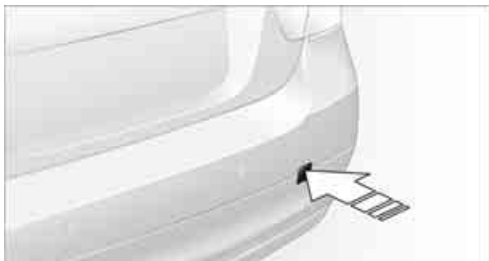

Being towed

 Make sure that the ignition is switched on, refer to page 53, otherwise the low-beam

headlamps, tail lamps, turn signal indicators and windshield wipers may be unavailable.

Power steering assistance is not available when the engine is not running. Thus, braking and steering will require increased effort. Active steering is not active and it will be necessary to turn the steering wheel further. ◀

Manual transmission

Gearshift lever in neutral position.

Automatic transmission

Selector lever in position N.

Changing selector lever positions, refer to page 56.

 Do not exceed a towing speed of 45 mph or 70 km/h and a towing distance of 90 miles/150 km, otherwise the automatic transmission may be damaged. ◀

Towing methods

 Do not lift the vehicle by a tow fitting or body and chassis parts, otherwise damage may result. ◀

With a tow bar

 The towing vehicle must not be lighter than the towed vehicle, otherwise it may be impossible to maintain control. ◀

The tow fittings used should be on the same side on both vehicles. Should it prove impossible to avoid mounting the tow bar at an angle, please observe the following:

- ▷ Clearance and maneuvering capability will be sharply limited during cornering.
- ▷ The tow bar will generate lateral forces if it is attached offset.

 Attach the tow bar to the tow fittings only, as attaching it to other parts of the vehicle could result in damage. ◀

With a tow rope

When starting off in the towing vehicle, make sure that the tow rope is taut.

⚠ To avoid jerking and the associated stresses on vehicle components when towing, always use nylon ropes or nylon straps. Attach the tow rope to the tow fittings only, as attaching it to other parts of the vehicle could result in damage. ◀

With a tow truck: vehicle without xDrive

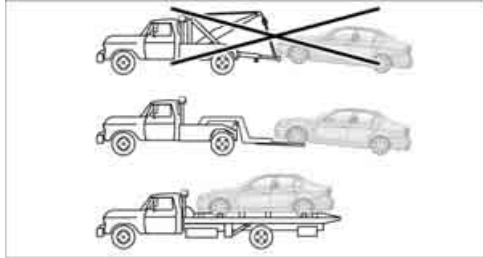

Have the BMW transported with a tow truck with a so-called lift bar or on a flat bed.

Do not tow the vehicle with just the rear axle raised as this may cause the steering to turn.

With a tow truck: vehicle with xDrive

⚠ Do not tow a BMW with xDrive with just the front or rear axle raised, otherwise the wheels could lock up and the transfer case could be damaged. ◀

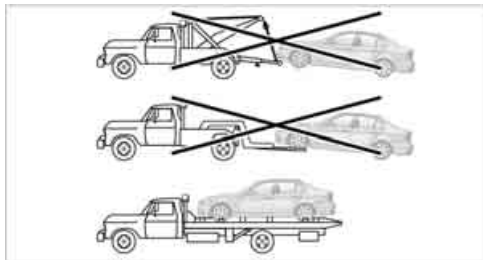

Have the BMW transported on a flatbed surface only.

Tow-starting

Avoid tow-starting the vehicle whenever possible; instead, jump-start the engine, refer to page 231. Vehicles with a catalytic converter should only be tow-started when the engine is cold, vehicles with an automatic transmission cannot be tow-started at all.

1. Switch on hazard warning flashers, comply with local regulations.
2. Switch on the ignition, refer to page 53.
3. Shift into 3rd gear.
4. Have the vehicle tow-started with the clutch depressed and slowly release the clutch. After the engine starts, immediately depress the clutch completely again.
5. Stop at a suitable location, remove the tow bar or rope and switch off the hazard warning flashers.
6. Have the vehicle checked.

▶ With xDrive: do not activate Hill Descent Control HDC when the vehicle is being tow-started, page 82. ◀



Reference

This chapter contains technical data, short commands for the voice activation system and an index that will help you find information most quickly.

Technical data

Engine data

Sedan

		323i (Canada)	328i/xDrive	335i/xDrive	335d
Displacement	cu in/cm ³	152.4/2,497	182.8/2,996	181.8/2,979	182.6/2,993
Number of cylinders		6	6	6	6
Maximum power output	hp	200	230	300	265
at engine speed	rpm	6,000	6,500	5,800	4,200
Maximum torque	lb ft/Nm	180/244	200/270	300/407	425/580
at engine speed	rpm	4,000 - 5,000	2,750	1,400 - 5,000	1,750 - 2,250

Sports Wagon

		328i/xDrive
Displacement	cu in/cm ³	182.8/2,996
Number of cylinders		6
Maximum power output	hp	230
at engine speed	rpm	6,500
Maximum torque	lb ft/Nm	200/270
at engine speed	rpm	2,750

Dimensions

Sedan

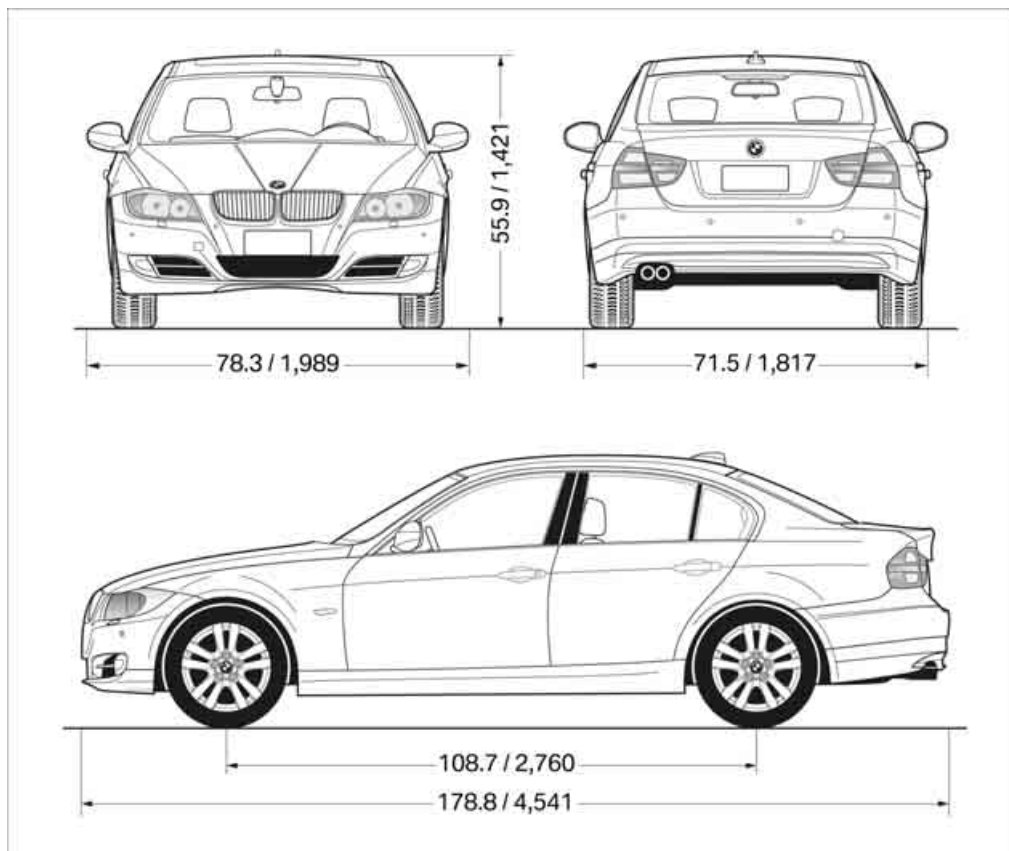

All dimensions given in inches/mm.

Smallest turning circle dia.: 36 ft 1 in/11.0 m, with xDrive: 38 ft 9 in/11.8 m.

Sports Wagon

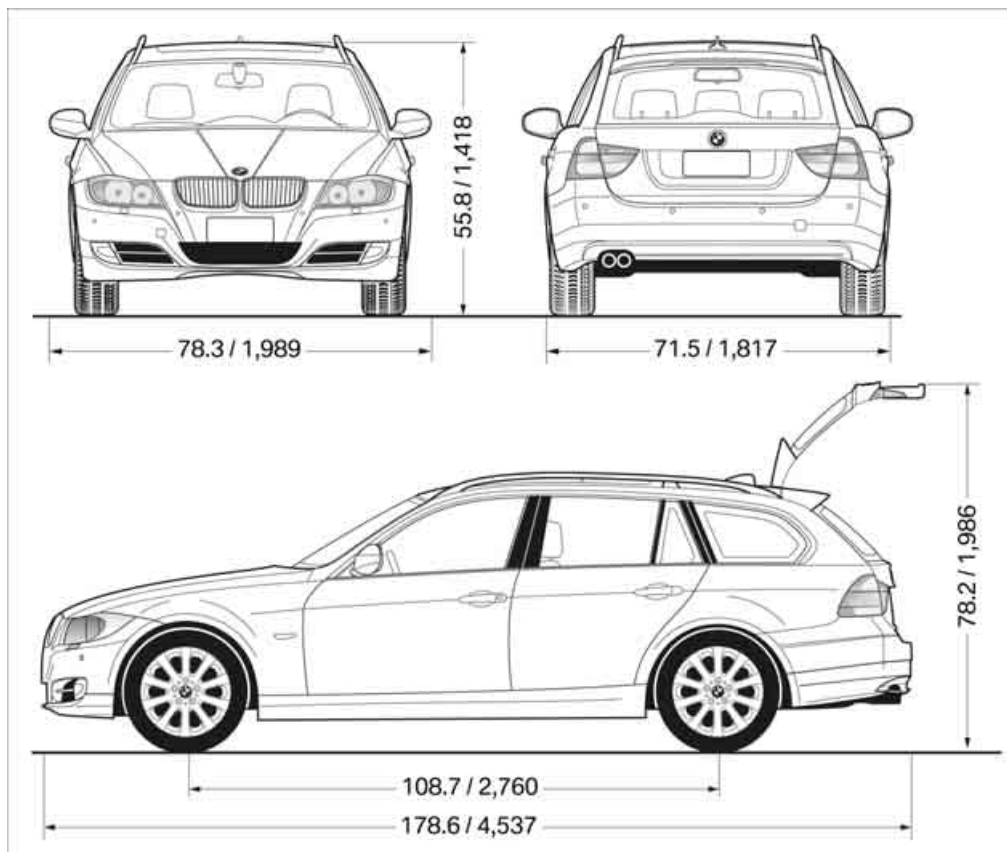

All dimensions given in inches/mm.

Smallest turning circle dia.: 36 ft 1 in/11.0 m, with xDrive: 38 ft 9 in/11.8 m.

Weights

Sedan

		323i (Canada)	328i	328i xDrive
Approved gross weight				
▷ with manual transmission	lbs/kg	4,365/1,980	4,420/2,005	4,663/2,115
▷ with automatic transmission	lbs/kg	4,431/2,010	4,486/2,035	4,707/2,135
Load	lbs/kg	1,014/460	1,014/460	1,014/460
Approved front axle load	lbs/kg	2,105/955	2,127/965	2,304/1,045
Approved rear axle load	lbs/kg	2,425/1,100	2,469/1,120	2,513/1,140
Approved roof load capacity	lbs/kg	165/75	165/75	165/75
Cargo bay capacity	cu ft/l	16.2/460	16.2/460	16.2/460

		335i	335i xDrive	335d
Approved gross weight				
▷ with manual transmission	lbs/kg	4,652/2,110	4,872/2,210	-
▷ with automatic transmission	lbs/kg	4,663/2,115	4,883/2,215	4,883/2,215
Load	lbs/kg	1,014/460	1,014/460	1,014/460
Approved front axle load	lbs/kg	2,238/1,015	2,436/1,105	2,381/1,080
Approved rear axle load	lbs/kg	2,546/1,155	2,546/1,155	2,646/1,200
Approved roof load capacity	lbs/kg	165/75	165/75	165/75
Cargo bay capacity	cu ft/l	15.9/450	15.9/450	15.9/450

Never exceed either the approved axle loads or the gross vehicle weight.

Sports Wagon

		328i	328i xDrive
Approved gross weight			
▷ with manual transmission	lbs/kg	4,630/2,100	4,872/2,210
▷ with automatic transmission	lbs/kg	4,696/2,130	4,916/2,230
Load	lbs/kg	1,058/480	1,058/480
Approved front axle load	lbs/kg	2,127/965	2,326/1,055
Approved rear axle load	lbs/kg	2,646/1,200	2,646/1,200
Approved roof load capacity	lbs/kg	165/75	165/75
Cargo bay capacity	cu ft/l	16.2-48.9/460-1,385	16.2-48.9/460-1,385

Never exceed either the approved axle loads or the gross vehicle weight.

Capacities

			Notes
Fuel tank	US gal/liters	approx. 16.1/61	Fuel grade: page 191
including reserve of			
▷ Gasoline engine	US gal/liters	approx. 2.1/8.0	
▷ Diesel engine	US gal/liters	approx. 1.7/6.5	
Window washer system			For more details: page 59
including headlamp washers	US qt/liters	approx. 6.3/6.0	

Short commands for the voice activation system*

With short commands you can carry out certain functions directly, regardless of which menu

item is selected. Here are the important short commands for the voice activation system.

Useful short commands

Function	Command
Switching on the radio	›Radio on‹
Opening the music collection	›Music collection‹
Tone control	›Tone‹
Selecting the settings	›Settings‹
Opening the computer	›Onboard info‹
Opening the contacts*	›Contacts‹
Displaying the phone book*	›Phonebook‹
Opening BMW Assist*	›B M W Assist‹
Opening the home address*	›Home address‹
Opening destination entry*	›Enter address‹
Opening destination guidance*	›Guidance‹

CD/Multimedia

CD/DVD drive

Function	Command
Playing back a CD	›C D on‹
Selecting a CD	›Select C D‹
Selecting a CD and track	›C D ... track ...‹ e.g. CD 3 track 5
Selecting a track	›C D track ...‹ e.g. track 5
Opening the CD and Multimedia menu	›C D and multimedia‹
CD and DVD	›C D and D V D‹
CD and DVD changer*	›C D and D V D‹
CD and DVD menu	›C D and D V D‹
Playing back a DVD	›D V D on‹

Function	Command
Selecting a DVD	›D V D ...‹
Switching on the DVD changer	›D V D on‹
Entertainment details on the split screen	›Entertainment details‹

Music collection

Function	Command
Calling up the current playback	›Current playback‹
Opening the music collection	›Music collection‹
Playing back the music collection	›Music collection on‹
Searching for music; opening the menu	›Music search‹
Playing back the most frequently played tracks	›Top fifty‹

External devices

Function	Command
Opening external devices	›External devices‹

Tone control

Function	Command
Opening the tone control	›Tone‹

Radio

FM

Function	Command
Calling up the radio	›Radio‹
Switching on the radio	›Radio on‹
Calling up FM	›F M‹
Playing FM	›F M on‹
Opening manual search	›Manual search‹
Calling up a frequency	›Frequency ... megahertz‹ e.g. 93.5 megahertz or frequency 93.5
Selecting the frequency range	›Select frequency‹
Selecting a radio station	›Station ...‹ e.g. W-PLJ
Calling up a station	›Select station‹ e.g. W-PLJ

AM

Function	Command
Calling up AM	›A M‹
Playing AM	›A M on‹
Opening manual search	›Manual search‹
Calling up a frequency	›Frequency ... Kiloherzt‹ e.g. frequency 753 kilohertz or 753 kilohertz

Weather Band

Function	Command
Selecting the Weather Band	›Weather band‹
Switching on the Weather Band	›Weather band on‹
Selecting a Weather Band station	›Select a weather channel‹

Satellite radio

Function	Command
Calling up the satellite radio	›Satellite radio‹
Switching on the satellite radio	›Satellite radio on‹
Selecting a satellite radio channel	›Satellite radio channel ...‹ e.g. channel 2

Presets

Function	Command
Calling up the stored stations	›Presets‹
Choosing a stored station	›Select preset‹
Selecting a stored station	›Preset ...‹ e.g. stored station 2

Telephone

Function	Command
Opening the Telephone menu	›Telephone‹
Displaying the phone book	›Phonebook‹
Redialing	›Redial‹
Displaying accepted calls	›Received calls‹
Dialing a phone number	›Dial number‹
Displaying the list of messages	›Messages‹
Displaying Bluetooth	›Bluetooth devices‹

Navigation

General information

Function	Command
Navigation menu	›Navigation‹
Opening destination entry	›Enter address‹
Opening destination guidance	›Guidance‹
Starting destination guidance	›Start guidance‹
Ending destination guidance	›Stop guidance‹
Opening the home address	›Home address‹
Opening the route criteria	›Route preference‹
Opening the route	›Route information‹
Switching on the voice instructions	›Switch on voice instructions‹
Repeating a voice instruction	›Repeat voice instructions‹
Switching off the voice instructions	›Switch off voice instructions‹
Displaying the address book	›Address book‹
Displaying the last destinations	›Last destinations‹
Opening the traffic bulletins	›Traffic Info‹
Special destinations	›Points of interest‹

Map

Function	Command
Displaying the map	›Map‹
Map facing north	›Map facing north‹
Map in the direction of travel	›Map in direction of travel‹
Perspective map	›Perspective map‹
Automatic scaling of the map*	›Map with automatic scaling‹
Changing the scale	›Map scale‹
Scale ... feet*	›Map scale ... feet‹ e.g. map scale of 100 feet
Scale ... meters*	›Map scale ... meters‹ e.g. map scale of 100 meters
Scale ... kilometers*	›Map scale ... kilometers‹ e.g. map scale of 5 kilometers
Scale ... miles*	›Map scale ... miles‹ e.g. map scale of 5 miles
Scale ... yards*	›Map scale ... yards‹ e.g. map scale of 100 yards

Split screen settings

Function	Command
Split screen	›Switch on splitscreen‹
Switching off the split screen	›Turn off split screen‹
Adapting the split screen	›Split screen content‹
Split screen current position	›Split screen current position‹
Split screen map facing north	›Split screen map facing north‹
Split screen direction of travel	›Split screen map in direction of travel‹
Split screen perspective	›Split screen perspective‹
Automatically scaling the split screen	›Split screen automatic scaling‹
Split screen scale ... feet*	›Split screen scale ... feet‹ e.g. split screen scale of 100 feet
Split screen scale ... meters*	›Split screen scale ... meters‹ e.g. split screen scale of 100 meters
Split screen scale ... kilometers*	›Split screen scale ... kilometers‹ e.g. split screen scale of 5 kilometers
Split screen scale ... miles*	›Split screen scale ... miles‹ e.g. split screen scale of 5 miles
Split screen scale ... yards*	›Split screen scale ... yards‹ e.g. split screen scale of 100 yards
Split screen, computer	›Split screen on board info‹
Split screen, trip computer	›Splitscreen trip computer‹

Contacts

Function	Command
Opening the contacts	›Contacts‹
My contacts	›My contacts‹
New contact	›New contact‹

BMW Assist

Function	Command
Opening BMW Assist	›B M W Assist‹
Opening BMW Search*	›B M W Search‹
Opening the Internet*	›Internet‹

Vehicle information

Function	Command
Opening the computer	›Onboard info‹
Opening the trip computer	›Trip computer‹
Opening the vehicle information	›Vehicle information‹
Opening the vehicle status	›Vehicle status‹

Settings

Vehicle

Function	Command
Opening the main menu	›Main menu‹
Selecting the settings	›Settings‹
Opening the options	›Options‹
Central screen settings	›Central display‹
Opening the time and date settings	›Time and date‹
Opening the language and unit settings	›Language and units‹
Opening the speed limit settings	›Limit‹
Opening the light menu	›Lighting‹
Selecting the door lock	›Door locks‹

Equipment

Function	Command
Selecting the air conditioning	›Climate‹

Everything from A-Z

Index

"..." Identifies Control Display texts used to select individual functions and refers you to the page where these texts can be found.

A

- ABS Antilock Brake System [81](#)
- ACC, refer to Active cruise control [61](#)
- Accident, refer to Sending an Emergency Request [230](#)
- Activated-charcoal filter for automatic climate control [97](#)
- Active cruise control [61](#)
 - indicator lamps [64](#)
 - malfunction [65](#)
 - selecting distance [63](#)
 - sensor [64](#)
- Active steering [87](#)
- Adaptive brake light
 - brake force display [87](#)
- Adaptive Head Light [91](#)
- Additives
 - coolant [215](#)
- Address, entering [123](#), [129](#)
- Address for navigation
 - entering [123](#), [129](#)
- Adjusting temperature inside the car, refer to Automatic climate control [95](#)
- Adjusting the thigh support [42](#)
- Adjusting the tone during audio operation, refer to Tone control [142](#)
- Airbags [88](#)
 - indicator/warning lamp [89](#)
 - sitting safely [41](#)
- Air conditioning mode
 - automatic climate control [95](#)
 - ventilation [97](#)
- Air distribution
 - automatic [95](#)
- Air flow rate [95](#)
- Airing, refer to Ventilation [97](#)
- Air pressure, refer to Tire inflation pressure [195](#)
- Air recirculation, refer to Recirculated-air mode [96](#)
- Air supply
 - automatic climate control [95](#)
 - ventilation [97](#)
- Air vents [94](#)
- AKI, refer to Fuel specifications [191](#)
- Alarm system [33](#)
 - avoiding unintentional alarms [34](#)
 - interior motion sensor [33](#)
 - switching off an alarm [33](#)
 - tilt alarm sensor [33](#)
- Albums of music collection [159](#)
- All-season tires, refer to Winter tires [210](#)
- All-wheel drive, refer to xDrive [82](#)
- AM, waveband [145](#)
- Ambient air, refer to Recirculated-air mode [96](#)
- Antenna for mobile phone [168](#)
- Antifreeze
 - coolant [215](#)
 - washer fluid [59](#)
- Antilock Brake System ABS [81](#)
- Anti-theft alarm system, refer to Alarm system [33](#)
- Anti-theft system [27](#)
- Approved axle loads, refer to Weights [241](#)
- Approved gross vehicle weight, refer to Weights [241](#)
- Armrest, refer to Center armrest [103](#)
- Arrival time, refer to Computer [69](#)
- Ashtray
 - front [104](#)
 - rear [105](#)
- Assistance systems, refer to Driving stability control systems [81](#)
- AUC Automatic recirculated-air control [96](#)
- Audio [142](#)
 - controls [142](#)
 - switching on/off [142](#)
 - tone control [142](#)
 - volume [142](#)
- Audio device, external [103](#)
- Automatic
 - air distribution [95](#)
 - air flow rate [95](#)
 - cruise control [59](#), [61](#)
 - headlamp control [90](#)
- Automatic car washes [218](#)
- Automatic climate control [94](#)
 - automatic air distribution [95](#)
- Automatic curb monitor [47](#)
- Automatic recirculated-air control AUC [96](#)
- Automatic Service Request [185](#)
- Automatic transmission with Steptronic [55](#)
 - interlock [55](#), [56](#)
 - overriding selector lever lock [57](#)
 - shiftlock, refer to Changing selector lever position [56](#)
 - sport program [56](#)
 - towing [232](#)
 - tow-starting [232](#)
- AUTO program for automatic climate control [95](#)

AUX-IN
– port [103](#)
AUX-IN port [161](#)
Average fuel consumption [69](#)
– setting the units [71](#)
Average speed [69](#)
Avoid highways in navigation [133](#)
Avoiding unintentional alarms [34](#)
Axle loads, refer to Weights [241](#)

B

Backrest contour, refer to Lumbar support [43](#)
Backrests, refer to Seat adjustment [42](#)
Backrest width adjustment [43](#)
Back seats
– refer to Rear seats [44](#)
Backup lamps
– replacing bulb [227](#)
Backup lamps, refer to Tail lamps [226](#)
Band-aids, refer to First-aid pouch [231](#)
Bar, refer to Towing methods [233](#)
Base plate for telephone or mobile phone
– refer to Snap-in adapter [177](#)
– refer to Snap-in adapter in the center armrest storage compartment [103](#)
Bass, tone setting [142](#)
Battery [228](#)
– charging [229](#)
– disposal [35](#), [229](#)
– jump starting [231](#)
– remote control [26](#)
– temporary power failure [229](#)
Battery for mobile phone [177](#)
Battery renewal
– remote control [35](#)
– remote control for vehicle [35](#)
Being towed [233](#)
Belts, refer to Safety belts [46](#)

Belt tensioner, refer to Safety belts [46](#)
Beverage holders, refer to Cup holders [104](#)
Blower, refer to Air flow rate [95](#)
Bluetooth, activating/deactivating [170](#)
Bluetooth, refer to separate Owner's Manual
BMW
– car shampoo [220](#)
BMW Assist, activating [182](#)
BMW Advanced Diesel [192](#)
BMW Assist [181](#)
BMW center [186](#)
BMW Homepage [4](#)
BMW Maintenance System [216](#)
BMW Search [182](#)
BMW webpage [4](#)
Bottle holders, refer to Cup holders [104](#)
Brake assist, refer to Dynamic Brake Control DBC [81](#)
Brake fluid, refer to Service requirements [71](#)
Brake force display [87](#)
Brake lamps
– brake force display [87](#)
– replacing bulb [227](#)
Brake pads [114](#)
– breaking in [114](#)
Brake rotors [116](#)
– brakes [114](#)
– breaking in [114](#)
Brakes
– ABS [81](#)
– BMW Maintenance System [216](#)
– brake force display [87](#)
– breaking in [114](#)
– parking brake [54](#)
– service requirements [71](#)
Brakes, refer to Braking safely [116](#)

Brake system [114](#)
– BMW Maintenance System [216](#)
– breaking in [114](#)
– disc brakes [116](#)
Breakdown services, refer to Roadside Assistance [230](#)
Breaking in the clutch [114](#)
Breaking in the differential, refer to Engine and differential [114](#)
Break-in period [114](#)
Brightness of Control Display [78](#)
Bulb changing, refer to Lamps and bulbs [223](#)
Button for starting the engine, refer to Start/stop button [53](#)
Buttons on the steering wheel [11](#)

C

California Proposition 65 warning [6](#)
Call
– accepting [171](#)
– ending [172](#)
– rejecting [172](#)
Calling, refer to Phone numbers, dialing [172](#)
Can holders, refer to Cup holders [104](#)
Capacities [242](#)
Capacity of the cargo bay [241](#)
Car battery, refer to Vehicle battery [228](#)
Car care, refer to Care [218](#)

- Care 218
 - automatic car washes 218
 - care products 218
 - carpets 220
 - CD/DVD drives 221
 - chrome parts 219
 - displays 220
 - exterior 218
 - fine wood parts 220
 - headlamps 219
 - high-pressure washer 218
 - interior 220
 - leather 220
 - light-alloy wheels 219
 - paintwork 219
 - plastic parts 220
 - rubber seals 219
 - safety belts 220
 - sensors and cameras 220
 - upholstery and cloth trim 220
 - washing the car manually 219
 - windows 219
 - wiper blades 219
- Cargo, securing 118
- Cargo bay 107
 - capacity 241
 - convenient access 35
 - folding up the floor panel 109
 - lamp, refer to Interior lamps 93
 - opening from inside 30
 - opening from outside 31
 - partition net 107
 - roll-up cover 107
- Cargo bay lid, refer to Luggage compartment lid/tailgate 30
- Cargo bay net, refer to Partition net 107
- Cargo loading 117
 - securing cargo 118
 - stowing cargo 118
 - vehicle 117
- Car jack
 - jacking points 228
- Car key, refer to Integrated key/remote control 26
- Car phone
 - installation location, refer to Center armrest 103
 - refer to separate Owner's Manual
- Car phone, refer to Telephone 168
- Car radio, refer to Radio 145
- Car shampoo 220
- Car wash 117
- Catalytic converter, refer to Hot exhaust system 115
- CBS Condition Based Service 216
- CD, audio playback 150
- CD changer 150
 - controls 142
 - fast forward/reverse 152
 - installation location 154
 - random play sequence 151
 - selecting a track 150
 - switching on/off 142
 - tone control 142
 - volume 142
- CD player 150
 - controls 142
 - fast forward/reverse 152
 - random play sequence 151
 - selecting a track 150
 - switching on/off 142
 - tone control 142
 - volume 142
- Center armrest 103
- Center brake lamp
 - replacing bulb 228
- Center console, refer to Around the center console 14
- Central locking
 - from inside 30
 - from outside 27
- Central locking system 27
 - convenient access 34
 - hotel function 32
 - setting unlocking characteristics 27
- Changes, technical, refer to For your own safety 5
- Changing bulbs, refer to Lamps and bulbs 223
- Changing the measurement units on the Control Display 71
- Changing wheels 228
- Chassis number, refer to Engine compartment 212
- Check Control 75
- Check Gas Cap 190
- Child-restraint fixing system LATCH 50
- Child-restraint systems 49
- Child-safety lock 52
- Child seats, refer to Transporting children safely 49
- Chrome parts 220
- Chrome polish 220
- Cigarette lighter, refer to Lighter 104
- Cleaning headlamps 58
 - washer fluid 59
- Cleaning your BMW, refer to Care 218
- Clock 67
 - 12h/24h mode 74
 - setting the time and date 74
 - setting time 73
- Closing
 - from inside 30
 - from outside 27
- Clothes hooks 103
- Cockpit 10
- Cold start, refer to Starting the engine 53
- Combined instrument, refer to Instrument cluster 12
- Comfort access, refer to Convenient access 34
- Comfort area, refer to Around the center console 14
- Center console for remote control, refer to Ignition lock 53
- Compass 101

- Computer [69](#)
 - displays on Control Display [69](#)
 - Computer, refer to iDrive [16](#)
 - Concierge service [181](#)
 - Condensation, refer to When the vehicle is parked [117](#)
 - Condition Based Service CBS [216](#)
 - Configuring settings, refer to Personal Profile [26](#)
 - Confirmation signals for locking/unlocking the vehicle [28](#)
 - Congestion
 - refer to Route, bypassing sections [134](#)
 - Connecting vacuum cleaner, refer to Connecting electrical appliances [105](#)
 - Consumption, refer to Average consumption [69](#)
 - Consumption display
 - average consumption [69](#)
 - Energy Control [68](#)
 - Control Center, refer to iDrive [16](#)
 - Control Display, refer to iDrive [16](#)
 - adjusting brightness [78](#)
 - switching on/off [19](#)
 - Controller, refer to iDrive [16](#)
 - Controls and displays [10](#)
 - Control unit, refer to iDrive [16](#)
 - Convenient access [34](#)
 - replacing the battery [35](#)
 - Convenient operation
 - glass roof [28](#)
 - windows [28](#)
 - Coolant [215](#)
 - checking level [215](#)
 - Coolant temperature [68](#)
 - Cooling, maximum [95](#)
 - Cooling fluid, refer to Coolant [215](#)
 - Cooling system, refer to Coolant [215](#)
 - Copyright [2](#)
 - Corner-illuminating lamps
 - replacing bulbs [224](#)
 - Corner-illuminating lamps, refer to Adaptive Head Light [91](#)
 - Cornering lamps, refer to Adaptive Head Light [91](#)
 - Correct tires [209](#)
 - Country codes DVD [152](#)
 - Courtesy lamps, refer to Interior lamps [93](#)
 - Criteria for route [133](#)
 - Cross-hairs in navigation [128](#)
 - Cruise control [59](#)
 - active [61](#)
 - malfunction [61](#)
 - Cruising range [69](#)
 - Cup holders [104](#)
 - Curb weight, refer to Weights [241](#)
 - Current fuel consumption, refer to Energy Control [68](#)
 - Current playback of music collection [158](#)
 - Current position
 - displaying [139](#)
 - Customer Relations [185](#)
- ## D
- Dashboard, refer to Cockpit [10](#)
 - Dashboard, refer to Instrument cluster [12](#)
 - Dashboard lighting, refer to Instrument lighting [92](#)
 - Data, technical [238](#)
 - dimensions [239](#)
 - engine [238](#)
 - weights [241](#)
 - Data transfer [186](#)
 - Date
 - date format [75](#)
 - setting [74](#)
 - Daytime running lamps [91](#)
 - replacing bulbs [223](#)
 - DBC Dynamic Brake Control [81](#)
 - Deactivating front passenger airbags [88](#)
 - Deadlocking, refer to Locking [28](#)
 - Defect
 - door lock [29](#)
 - fuel filler door [190](#)
 - glass roof [37](#)
 - panorama glass roof [39](#)
 - Destination, entering by town/city name [123](#)
 - Destination address
 - entering [123](#), [129](#)
 - Destination for navigation
 - entering by voice [129](#)
 - entering via map [128](#)
 - entry [123](#)
 - home address [126](#)
 - manual entry [123](#)
- Destination guidance [133](#)
 - bypassing a route section [134](#)
 - changing specified route [133](#)
 - continuing [133](#)
 - starting [133](#)
 - voice instructions [134](#)
 - volume of voice instructions [135](#)
- Diesel exhaust fluid [193](#)
- Diesel fuel [191](#)
- Diesel particulate filter [115](#)
- Digital clock [67](#)
- Digital compass [101](#)
- Digital radio, refer to High Definition Radio [146](#)
- Dimensions [239](#)
- Dipstick, engine oil [212](#)
- Directional indicators, refer to Turn signals [57](#)
- Direction instructions, refer to Voice instructions [134](#)
- Directory for navigation, refer to Address book [125](#)
- Displacement, refer to Engine data [238](#)
- Display, refer to iDrive controls [16](#)
 - "Display current location" [139](#)

- Display lighting, refer to Instrument lighting [92](#)
 - Displays
 - on the Control Display [16](#)
 - Displays, refer to Instrument cluster [12](#)
 - Displays and controls [10](#)
 - Disposal
 - coolant [215](#)
 - remote control battery [35](#)
 - vehicle battery [229](#)
 - Distance control, refer to Active cruise control [61](#)
 - Distance remaining to service, refer to Service requirements [71](#)
 - Distance warning, refer to Park Distance Control PDC [80](#)
 - Door key, refer to Remote control with integrated key [26](#)
 - Door lock [29](#)
 - Doors, emergency operation [29](#)
 - DOT Quality Grades [207](#)
 - Draft-free ventilation [97](#)
 - Drinks holders, refer to Cup holders [104](#)
 - Drive-off assistance, refer to Dynamic Stability Control DSC [81](#)
 - Drive-off assistant [83](#)
 - Driving lamps, refer to Parking lamps/low beams [90](#)
 - Driving notes [114](#)
 - Driving off on hills, refer to Drive-off assistant [83](#)
 - Driving stability control systems [81](#)
 - Driving through water [116](#)
 - Driving tips, refer to Driving notes [114](#)
 - Dry air, refer to Cooling function [96](#)
 - DSC Dynamic Stability Control [81](#)
 - DTC Dynamic Traction Control [81](#)
 - indicator/warning lamp [81](#)
 - DVD
 - country codes [152](#)
 - settings [153](#)
 - video playback [152](#)
 - DVD menu [153](#)
 - DVD video [152](#)
 - Dynamic Brake Control DBC [81](#)
 - Dynamic Stability Control DSC
 - indicator/warning lamp [81](#)
 - Dynamic Traction Control DTC
 - indicator/warning lamp [82](#)
- ## E
- Eject button, refer to Buttons on the CD player [142](#)
 - Electrical malfunction
 - door lock [29](#)
 - driver's door [29](#)
 - fuel filler door [190](#)
 - glass roof [37](#)
 - luggage compartment lid [31](#)
 - panorama glass roof [39](#)
 - Electric seat adjustment [42](#)
 - Electric steering wheel lock
 - with convenient access [34](#)
 - Electronic brake-force distribution EBV [81](#)
 - Electronic oil level check [213](#)
 - Electronic Stability Program ESP, refer to Dynamic Stability Control DSC [81](#)
 - Emergency actuation, automatic transmission, refer to Overriding selector lever lock [57](#)
 - Emergency operation
 - fuel filler door, manual release [190](#)
 - Emergency operation, refer to Closing manually
 - glass roof [37](#)
 - panorama glass roof [39](#)
 - Emergency operation, refer to Manual operation
 - door lock [29](#)
 - Emergency release
 - luggage compartment lid from inside [32](#)
 - Emergency Request [230](#)
 - Emergency services, refer to Roadside Assistance [230](#)
 - Energy, saving
 - saving fuel [114](#)
 - Energy-conscious driving, refer to Energy Control [68](#)
 - Energy Control [68](#)
 - Engine
 - breaking in [114](#)
 - data [238](#)
 - overheated, refer to Coolant temperature [68](#)
 - speed [238](#)
 - starting [53](#)
 - starting, convenient access [34](#)
 - switching off [54](#)
 - Engine compartment [212](#)
 - Engine coolant, refer to Coolant [215](#)
 - Engine oil
 - adding [214](#)
 - alternative oil types [215](#)
 - BMW Maintenance System [216](#)
 - capacity [242](#)
 - checking level [212](#)
 - dipstick [212](#)
 - intervals between changes, refer to Service requirements [71](#)
 - Engine output, refer to Engine data [238](#)
 - Engine speed, refer to Engine data [238](#)
 - Engine starting, refer to Starting the engine [53](#)
 - Entry lamps, refer to Interior lamps [93](#)
 - Entry map for destination [128](#)

Environmentally friendly driving, refer to Energy Control **68**
Equalizer, tone setting **143**
Error messages, refer to Check Control **75**
Event data recorders **217**
Exhaust system, refer to Hot exhaust system **115**
Expanding the cargo bay **107**
Exterior mirrors **47**
– adjusting **47**
– automatic dimming feature **48**
– automatic heating **47**
– folding in and out **47**
External audio device **103**
Eyes
– for tow-starting and towing away **233**
– for tying down loads **118**

F

Failure messages, refer to Check Control **75**
Failure of an electrical consumer **229**
False alarm
– avoiding unintentional alarm **34**
– switching off an alarm **33**
Fastening safety belts, refer to Safety belts **46**
Fastest route for navigation **133**
Fast forward
– CD changer **152**
– CD player **152**
Filter
– refer to Microfilter/activated-charcoal filter for automatic climate control **97**
First aid pouch **231**
Fixture for remote control, refer to Ignition lock **53**
Flash when locking/unlocking **28**

Flat tire
– Run-Flat Tires **209**
– Tire Pressure Monitor TPM **84**
Flat Tire Monitor FTM **83**
– indicating a flat tire **84**
– indicator/warning lamp **84**
– initializing the system **83**
– malfunction **84**
– snow chains **83, 210**
– system limits **83**
Flat tires, refer to Tire condition **208**
Fluid reservoir, refer to Washer fluid reservoir **59**
FM, waveband **145**
Fog lamps **92**
– indicator lamp **13, 92**
Folding rear seat backrest **107**
Folding up the floor panel **109**
Footbrake, refer to Braking safely **116**
Footwell lamps, refer to Interior lamps **93**
For your own safety **5**
Four-wheel drive, refer to xDrive **82**
Free memory capacity, music collection **159**
Front airbags **88**
FTM, refer to Flat Tire Monitor **83**
Fuel **191**
– additives **192**
– average consumption **69**
– gauge **68**
– high-quality brands **191**
– quality **191**
– specifications **191**
– tank contents, refer to Capacities **242**
Fuel clock, refer to Fuel gauge **68**
Fuel display, refer to Fuel gauge **68**
Fuel-efficient driving, refer to Energy Control **68**

Fuel filler door **190**
– releasing in the event of electrical malfunction **190**
Fuses **229**

G

Garage door opener, refer to Integrated universal remote control **99**
Gasoline
– refer to Average consumption **69**
Gasoline, refer to Required fuel **191**
Gasoline display, refer to Fuel gauge **68**
Gear indicator, automatic transmission with Steptronic **55**
Gearshift lever
– automatic transmission with Steptronic **56**
– manual transmission **55**
Gearshifts
– automatic transmission with Steptronic **56**
– manual transmission **55**
General driving notes **115**
Glass roof, electric **37**
– closing after electrical malfunction **37**
– convenient operation **28, 29**
– initializing **37**
– opening, closing **37**
– pinch protection system **37**
– power failure **37**
– raising **37**
– remote control **28**
Glove compartment **102**
GPS navigation, refer to Navigation system **122**
Grills **94**
Gross vehicle weight, refer to Weights **241**

H

- Halogen lamps
 - replacing bulbs [224](#)
 - Handbrake, refer to Parking brake [54](#)
 - Hands-free system [14](#)
 - Hazard warning flashers [14](#)
 - HDC Hill Descent Control [82](#)
 - HD radio, refer to High Definition Radio [146](#)
 - Head airbags [88](#)
 - Headlamp control, automatic [90](#)
 - Headlamp cover [224](#)
 - Headlamp flasher [57](#)
 - indicator lamp [11](#), [13](#)
 - Headlamps
 - replacing bulbs [224](#)
 - Head restraints [43](#)
 - rear, removing [44](#)
 - sitting safely [41](#)
 - Heated
 - mirrors [47](#)
 - rear window [97](#)
 - seats [45](#)
 - Heating
 - mirrors [47](#)
 - rear window [97](#)
 - residual heat [96](#)
 - seats [45](#)
 - steering wheel [48](#)
 - Heating and ventilation, refer to Climate [94](#)
 - Heating while at a standstill, refer to Using residual heat [96](#)
 - Heavy loads, refer to Stowing cargo [118](#)
 - Height, refer to Dimensions [239](#)
 - Height adjustment
 - seats [42](#)
 - steering wheel [48](#)
 - High beams [92](#)
 - headlamp flasher [92](#)
 - indicator lamp [13](#)
 - replacing bulbs [224](#)
 - High Definition Radio [146](#)
 - High-pressure washer [218](#), [219](#)
 - High water, refer to Driving through water [116](#)
 - Highways, refer to Route criteria [133](#)
 - Hill Descent Control HDC [82](#)
 - Hills [116](#)
 - Holders for cups [104](#)
 - Homepage BMW [4](#)
 - Hood [211](#)
 - Hooks for shopping bags [108](#)
 - Horn [10](#), [11](#)
 - Hotel function, refer to Locking or unlocking separately [32](#)
 - Hot exhaust system [115](#)
 - Hydraulic brake assist, refer to Dynamic Brake Control DBC [81](#)
 - Hydroplaning [116](#)
- I**
- IBOC, refer to High Definition Radio [146](#)
 - Ice warning, refer to Outside temperature warning [67](#)
 - ID3 tag, refer to Information about the track [151](#)
 - Identification marks
 - Run-Flat Tires [209](#)
 - tire coding [207](#)
 - iDrive [16](#)
 - adjusting brightness [78](#)
 - changing language [78](#)
 - changing settings [78](#)
 - changing units of measure and display format [71](#)
 - controls [16](#)
 - menu guidance [17](#)
 - operating principle [16](#)
 - overview [16](#)
 - setting the date and time [74](#)
 - start menu [17](#)
 - status information [19](#)
 - iDrive operating principle [16](#)
 - Ignition [53](#)
 - switched off [53](#)
 - switched on [53](#)
 - Ignition key, refer to Remote control with integrated key [26](#)
 - Ignition key position 1, refer to Radio readiness [53](#)
 - Ignition key position 2, refer to Ignition on [53](#)
 - Ignition lock [53](#)
 - Imprint [2](#)
 - Indicator and warning lamps [13](#)
 - Tire Pressure Monitor TPM [86](#)
 - Inflation pressure, refer to Tire inflation pressure [195](#)
 - Inflation pressure monitoring, refer to Tire Pressure Monitor TPM [84](#)
 - Initializing
 - after power failure [229](#)
 - compass, refer to Calibrating [101](#)
 - Flat Tire Monitor FTM [83](#)
 - glass roof [37](#)
 - panorama glass roof [39](#)
 - radio, refer to Station, storing [145](#)
 - refer to Setting the time and date [74](#)
 - Installation location
 - CD changer [154](#)
 - navigation DVD drive [122](#)
 - telephone [103](#)
 - Instructions for navigation system, refer to Voice instructions [134](#)
 - Instrument cluster [12](#)
 - Instrument lighting [92](#)
 - Instrument panel, refer to Cockpit [10](#)
 - Integrated key [26](#)
 - Integrated universal remote control [99](#)
 - Interior lamps [93](#)
 - remote control [28](#)
 - Interior motion sensor [33](#)

Interior rearview mirror [48](#)
– automatic dimming feature [48](#)
– compass [101](#)
Interlock, refer to Disengaging the remote control [55](#)
Intermittent mode of the wipers [58](#)
Intersection, entering, navigation [124](#)
iPod, connecting, refer to AUX-IN port [161](#)
iPod, connecting, refer to USB-audio interface [162](#)

J

Jacking points [228](#)
Joystick, refer to iDrive [16](#)
Jumping, refer to Jump starting [231](#)
Jump starting [231](#)

K

Key, refer to Integrated key/remote control [26](#)
Keyless go, refer to Convenient access [34](#)
Keyless opening and closing, refer to Convenient access [34](#)
Key Memory, refer to Personal Profile [26](#)
Kick-down [56](#)
– automatic transmission with Steptronic [56](#)
Knock control [191](#)

L

Lamps
– automatic headlamp control [90](#)
– parking lamps/low beams [90](#)
Lamps and bulbs, replacing bulbs [223](#)
Language, changing on Control Display [78](#)

Lap-and-shoulder belt, refer to Safety belts [46](#)
Lashing eyes, refer to Securing cargo [118](#)
Last destinations [126](#)
LATCH child-restraint fixing system [50](#)
Leather care [220](#)
LED Light-emitting diodes [223](#)
Length, refer to Dimensions [239](#)
License plate lamp, replacing bulb [228](#)
Light-alloy wheels [219](#)
Light-emitting diodes LED [223](#)
Lighter [104](#)
– connecting electrical appliances [105](#)
Lighting
– instruments [92](#)
– lamps and bulbs [223](#)
– vehicle, refer to Lamps [90](#)
Light switch [90](#)
Limit, refer to Speed limit [77](#)
Load [118](#)
Load securing equipment, refer to Securing cargo [118](#)
Lock buttons, doors, refer to Locking [30](#)
Locking
– adjusting confirmation signal [28](#)
– from inside [30](#)
– from outside [28](#)
– without remote control, refer to Convenient access [34](#)
Locking and unlocking doors
– confirmation signals [28](#)
– from inside [30](#)
– from outside [27](#)
Longlife oils
– alternative oil types [215](#)
– approved engine oils [215](#)
Low-beam headlamps [90](#)
– automatic [90](#)
Low beams
– replacing bulbs [224](#)

Lower back support, refer to Lumbar support [43](#)
Luggage compartment lid [30](#)
– convenient access [35](#)
– emergency release [32](#)
– locking or unlocking separately [32](#)
– opening from inside [30](#)
– opening from outside [31](#)
– remote control [28](#)
Luggage rack, refer to Roof-mounted luggage rack [119](#)
Lumbar support [43](#)
LW, waveband [145](#)

M

M+S tires, refer to Winter tires [210](#)
Maintenance, refer to Service Booklet
Maintenance system [216](#)
Malfunction
– automatic transmission with Steptronic [57](#)
– luggage compartment lid [31](#)
– tires [84](#)
Malfunction warnings, refer to Check Control [75](#)
Manual car wash [219](#)
Manual mode, automatic transmission with Steptronic [56](#)
Manual operation
– door lock [29](#)
– driver's door [29](#)
– fuel filler door [190](#)
– glass roof [37](#)
– luggage compartment lid [31](#)
– panorama glass roof [39](#)
– transmission lock, automatic transmission [57](#)
Manual transmission [55](#)
Map display [135](#)
Map for navigation
– changing scale [135](#)
– entering destination [128](#)

Master key, refer to Remote control with integrated key [26](#)

Maximum cooling [95](#)

Maximum speed
– with winter tires [210](#)

Measurements, refer to Dimensions [239](#)

Memory, refer to Seat and mirror memory [45](#)

MENU button [16](#)

Menus, refer to iDrive [16](#)

Microfilter
– BMW Maintenance System [216](#)
– for automatic climate control [97](#)

Microfilter/activated-charcoal filter
– BMW Maintenance System [216](#)

Microphone
– telephone [14](#)
– voice commands [14](#)

Mirror dimming feature [48](#)

Mirrors [47](#)
– automatic curb monitor [47](#)
– exterior mirrors [47](#)
– heating [47](#)
– interior rearview mirror [48](#)
– memory, refer to Seat and mirror memory [45](#)

Mirrors, folding in before entering a car wash [47](#)

Mobile phone
– adjusting volume [171](#)
– connecting, refer to Mobile phone, pairing [168](#)
– installation location, refer to Center armrest [103](#)
– operation via iDrive [171](#)
– pairing [168](#)
– refer to separate Owner's Manual

Mobile phone, installation location, refer to Center armrest [103](#)

Mobile phone, refer to Telephone [168](#)

Mobile phone, refer to the separate Owner's Manual

Modifications, technical, refer to For your own safety [5](#)

Monitor, refer to iDrive controls [16](#)

Monitoring system for tire pressures, refer to Flat Tire Monitor [83](#)

MP3 player, connecting, refer to AUX-IN port [161](#)

MP3 player, connecting, refer to USB-audio interface [162](#)

Multifunctional steering wheel, refer to Buttons on the steering wheel [11](#)

Multifunction switch
– refer to Turn signals/headlamp flasher [57](#)
– refer to Wiper system [58](#)

Multimedia screen, refer to iDrive [16](#)

Music, managing [159](#)

Music, playing [158](#)

Music, storing [157](#)

Music collection [157](#)
– backup [160](#)
– importing [160](#)

Music player, connecting, refer to AUX-IN port [161](#)

Music player, connecting, refer to USB-audio interface [162](#)

Music search [158](#)

N

Navigation announcements, refer to Switching voice instructions on/off [134](#)

Navigation data [122](#)

Navigation drive, location [122](#)

Navigation DVD [122](#)

Navigation system [122](#)
– address book [125](#)
– bypassing a route section [134](#)
– continuing destination guidance [133](#)
– destination entry [123](#)
– displaying current position [139](#)
– entering a destination by voice [129](#)
– entering a destination manually [123](#)
– route list [134](#)
– selecting destination via map [128](#)
– selecting route criteria [133](#)
– special destinations [126](#)
– starting destination guidance [133](#)
– terminating destination guidance [133](#)
– voice instructions [134](#)
– volume adjustment [135](#)

Neck support, refer to Head restraints [43](#)

Nets, refer to Storage compartments [103](#)

New tires [209](#)

North-facing map [135](#)

Nozzles [94](#)

Number of cylinders, refer to Engine data [238](#)

Nylon rope, refer to Tow rope [233](#)

O

OBD socket, refer to Socket for On-Board Diagnosis [217](#)

Octane ratings, refer to Fuel specifications [191](#)

Odometer [67](#)

Oil, refer to Engine oil [212](#)

Oil consumption [212](#)

Oil level [212](#)

Old batteries, refer to Disposal [229](#)

Onboard tool kit [222](#)

Opening and closing
– convenient access [34](#)
– from inside [30](#)
– from outside [27](#)
– using the door lock [29](#)
– via the remote control [27](#)
Options, selecting for navigation [133](#)
Orientation menu, refer to Start menu [17](#)
Outlets
– refer to Ventilation [97](#)
Output, refer to Engine data [238](#)
Outside-air mode
– automatic climate control [96](#)
Outside-temperature display [67](#)
– changing units of measure [71](#)
– in computer [71](#)
Outside temperature warning [67](#)
Overheated engine, refer to Coolant temperature [68](#)
Overriding selector lever lock [57](#)
Overview
– radio control [142](#)

P

Paintwork care [219](#)
Panorama glass roof [38](#)
– closing after electrical malfunction [39](#)
– comfort position [39](#)
– convenient operation [28](#)
– initializing [39](#)
– opening, closing [38](#)
– pinch protection system [39](#)
– power failure [39](#)
– raising [38](#)
– remote control [28](#)
Park assistant, refer to Park Distance Control [80](#)
Park Distance Control PDC [80](#)

Parked car ventilation [97](#)
– preselecting switch-on times [98](#)
– switching on and off directly [98](#)
Parking
– vehicle [54](#)
Parking aid, refer to Park Distance Control PDC [80](#)
Parking brake [54](#)
– indicator lamp [54](#)
Parking lamps [90](#)
– replacing bulbs [223](#), [225](#)
Parking lamps/low beams [90](#)
Particulate filter, refer to Diesel particulate filter [115](#)
Partition net [107](#)
Passenger-side mirror tilt function [47](#)
Pathway lighting [91](#)
Personal Profile [26](#)
Phone book [171](#)
Phone numbers
– dialing [172](#)
Pinch protection system
– glass roof, electric [37](#)
– panorama glass roof [39](#)
– windows [36](#)
Placing a call, refer to telephone owner's manual
Polish [220](#)
Pollen
– refer to Microfilter/activated-charcoal filter for automatic climate control [97](#)
Position, refer to Current position, displaying [139](#)
Postal code, entering for navigation [124](#)
Power failure [229](#)
Power windows [36](#)
– safety switch [36](#)
Power windows, refer to Windows [36](#)
Preheating, refer to Vehicles with diesel engine [54](#)
Pressure, tires [195](#)
Pressure monitoring, tires [83](#)
– Flat Tire Monitor [83](#)

Pressure monitoring of tires, refer to Tire Pressure Monitor TPM [84](#)
Programmable buttons on the steering wheel [11](#)
Protection function, refer to Pinch protection system
– glass roof, electric [37](#)
– panorama glass roof [39](#)
– windows [36](#)
Providing medical assistance, refer to First aid pouch [231](#)
Puncture
– Flat Tire Monitor [83](#)

R

Radio
– controls [142](#)
– High Definition Radio [146](#)
– satellite radio [148](#)
– selecting a waveband [145](#)
– storing stations [145](#)
– switching on/off [142](#)
– tone control [142](#)
– volume [142](#)
– Weather Band, refer to Weather information [148](#)
Radio position, refer to Radio readiness [53](#)
Radio readiness [53](#)
– switched off [53](#)
– switched on [53](#)
Radio-remote key, refer to Remote control with integrated key [26](#)
Rain sensor [58](#)
Rapeseed-oil methyl ester RME [191](#)
Reading lamps [93](#)
Rear lamps, refer to Tail lamps [226](#)
Rear seat backrest, folding [107](#)

- Rear seats
 - adjusting head restraints [44](#)
 - folding [107](#)
 - folding down
 - backrests [106, 107](#)
 - folding head restraint down and up [44](#)
 - Rear ventilation [97](#)
 - Rearview mirror, refer to Mirrors [47](#)
 - Rear window
 - cleaning [59](#)
 - opening [32](#)
 - Rear window blind, refer to Roller sun blinds [102](#)
 - Rear window defroster [97](#)
 - Rear window safety switch [36](#)
 - Rear window wiper [59](#)
 - changing rear wiper blade [223](#)
 - Receiving level of mobile phone, refer to Status information [19](#)
 - Reception
 - quality [146](#)
 - radio station [146](#)
 - Recirculated-air mode [96](#)
 - Recirculation of air, refer to Recirculated-air mode [96](#)
 - Reclining seat, refer to Backrest [42](#)
 - Refueling [190](#)
 - Releasing
 - hood [211](#)
 - Remaining distance, refer to Cruising range [69](#)
 - Remote control [26](#)
 - battery renewal [35](#)
 - convenient access [34](#)
 - garage door opener [99](#)
 - luggage compartment lid [28](#)
 - malfunction [29, 35](#)
 - removing from the ignition lock [53](#)
 - service data [216](#)
 - tailgate [28](#)
 - Replacement remote control [26](#)
 - Replacing bulbs, refer to Lamps and bulbs [223](#)
 - Replacing tires [209](#)
 - Replacing tires, refer to New wheels and tires [209](#)
 - Reporting safety defects [6](#)
 - Reserve warning, refer to Fuel gauge [68](#)
 - Reset, refer to Resetting tone settings [144](#)
 - Residual heat [96](#)
 - Restraint systems
 - for children [49](#)
 - refer to Safety belts [46](#)
 - Reverse
 - CD changer [152](#)
 - CD player [152](#)
 - Reverse gear
 - automatic transmission with Steptronic [56](#)
 - manual transmission [55](#)
 - RME, refer to Rapeseed-oil methyl ester [191](#)
 - Road map [135](#)
 - Roadside
 - Assistance [181, 230](#)
 - Roadside parking lamps [92](#)
 - replacing bulbs [223, 225](#)
 - Roadworthiness test, refer to Service requirements [71](#)
 - Roller blind
 - sun blinds [102](#)
 - Roof load capacity [241](#)
 - Roof-mounted luggage rack [119](#)
 - Rope, refer to Tow-starting, towing away [233](#)
 - Rotary/pushbutton, refer to iDrive [16](#)
 - Route [133, 134](#)
 - bypassing sections [134](#)
 - changing [133, 134](#)
 - changing criteria [133](#)
 - displaying streets or towns/cities [134](#)
 - map display [135](#)
 - selecting [133](#)
 - Route instructions, refer to Destination guidance through voice instructions [134](#)
 - Route map, refer to Map display [135](#)
 - Route section, changing [134](#)
 - Route selection [133](#)
 - RSC Runflat System
 - Component, refer to Run-Flat Tires [209](#)
 - Runflat System Component RSC, refer to Run-Flat Tires [209](#)
 - Run-Flat Tires [209](#)
 - continuing driving with a damaged tire [84](#)
 - flat tire [84](#)
 - Flat Tire Monitor [84](#)
 - new tires [209](#)
 - replacing [209](#)
 - tire inflation pressure [195](#)
 - winter tires [210](#)
- ## S
- Safety-belt height adjustment [46](#)
 - Safety belts [46](#)
 - damage [46](#)
 - indicator/warning lamp [46](#)
 - reminder [46](#)
 - sitting safely [41](#)
 - Safety systems
 - airbags [88](#)
 - Antilock Brake System ABS [81](#)
 - brake system [81](#)
 - driving stability control systems [81](#)
 - Dynamic Stability Control DSC [81](#)
 - safety belts [46](#)
 - Safety tires, refer to Run-Flat Tires [209](#)
 - Satellite radio [148](#)
 - enabling channel [148](#)
 - selecting channel [149](#)
 - storing channel [149](#)

- Saving fuel [114](#)
- Screen, refer to iDrive controls [16](#)
- Screw thread for tow fitting [233](#)
- SDARS, refer to Satellite radio [148](#)
- Seat adjustment
 - electric [42](#)
 - mechanical [42](#)
- Seat and mirror memory [45](#)
- Seat belt reminder, refer to 'Fasten safety belts' reminder [46](#)
- Seat heating [45](#)
- Seats [42](#)
 - adjusting electrically [42](#)
 - adjusting the seats [42](#)
 - heating [45](#)
 - memory, refer to Seat and mirror memory [45](#)
 - saving a setting, refer to Seat and mirror memory [45](#)
 - sitting safely [41](#)
- Securing cargo [110](#)
- Securing the vehicle
 - from inside [30](#)
 - from outside [27](#)
- Selecting distance for active cruise control [63](#)
- Selecting new scale for navigation [135](#)
- Selector lever
 - automatic transmission with Steptronic [56](#)
- Selector lever lock, refer to Changing selector lever positions, shiftlock [56](#)
- Selector lever positions
 - automatic transmission with Steptronic [56](#)
- Service, refer to Roadside Assistance [230](#)
- Service car, refer to Roadside Assistance [230](#)
- Service data in the remote control [216](#)
- Service Interval Display, refer to Condition Based Service CBS [216](#)
- Service Request [185](#)
- Service requirement display, refer to Condition Based Service CBS [216](#)
- Service requirements [71](#)
- Services status [186](#)
- Settings
 - changing on Control Display [78](#)
 - clock, 12h/24h mode [74](#)
 - DVD [153](#)
 - language [78](#)
- Settings and information [70](#)
- Setting times, refer to Preselecting switch-on times [98](#)
- Shifting gears
 - automatic transmission with Steptronic [56](#)
 - manual transmission [55](#)
- Shiftlock
 - automatic transmission, refer to Changing selector lever positions [56](#)
- Short commands for the voice activation system [243](#)
- Short route in navigation, refer to Selecting route [133](#)
- Shuffled, refer to Random
 - CD changer [151](#)
 - CD player [151](#)
- Side airbags [88](#)
- Side window blind, refer to Roller sun blinds [102](#)
- Side windows, refer to Windows [36](#)
- Signal horn, refer to Horn [10](#), [11](#)
- Sitting safely [41](#)
 - with airbags [41](#)
 - with head restraint [41](#)
 - with safety belts [41](#)
- Ski bag [109](#)
- Sliding/tilt sunroof
 - refer to Panorama glass roof [38](#)
- Sliding/tilt sunroof, refer to Glass roof, electric [37](#)
- Slot for remote control [53](#)
- Smokers' package, refer to Ashtray [104](#)
- Snap-in adapter
 - inserting/removing [177](#)
 - use [168](#)
- Snap-in adapter, refer to Center armrest storage compartment [103](#)
- Socket, On-Board Diagnosis OBD [217](#)
- Socket, refer to Connecting electrical appliances [105](#)
- Soot particulate filter, refer to Diesel particulate filter [115](#)
- SOS, refer to Sending an Emergency Request [230](#)
- Sound output for entertainment on/off [142](#)
- Spare fuses, [229](#)
- Spare fuses, refer to Fuses [229](#)
- Special destinations [126](#)
- Speed
 - Run-Flat Tires [84](#)
 - with winter tires [210](#)
- Speed limit [77](#)
- Speed limit warning, refer to Speed limit [77](#)
- Speedometer [12](#)
- Speed Volume [143](#)
- Split rear seat backrest, refer to Expanding the cargo bay [107](#)
- Split screen, refer to Control Display, switching on/off [19](#)
- Split screen content, refer to Display for split screen content, selecting [19](#)
- Spray nozzles, refer to Cleaning windshield and headlamps [58](#)
- Stability control, refer to Driving stability control systems [81](#)

- Start/stop button [53](#)
 - starting the engine [53](#)
 - switching off the engine [54](#)
 - Starting, refer to Starting the engine [53](#)
 - Starting assistance, refer to
 - Jump starting [231](#)
 - Starting difficulties
 - jump starting [231](#)
 - Starting the engine
 - start/stop button [53](#)
 - Start menu [17](#)
 - State/province, for navigation [123](#)
 - Station, selecting
 - radio [145](#)
 - Status of this Owner's Manual at time of printing [5](#)
 - Steam jet [218](#), [219](#)
 - Steering wheel [48](#)
 - adjustment [48](#)
 - buttons on steering wheel [11](#)
 - heating [48](#)
 - lock [53](#)
 - locking with convenient access [34](#)
 - Steering with variable ratio, refer to Active steering [87](#)
 - Steptronic, refer to Automatic transmission with Steptronic [55](#)
 - Storage [221](#)
 - Storage compartments [103](#)
 - Storage nets [108](#)
 - "Store Channel" in radio [149](#)
 - Storing seat positions, refer to Seat and mirror memory [45](#)
 - Storing tires [210](#)
 - Stowage, refer to Storage compartments [103](#)
 - Street, entering, navigation [124](#)
 - Summer tires, refer to Wheels and tires [195](#)
 - Sun blinds [102](#)
 - Surface ice, refer to Outside temperature warning [67](#)
 - SVCD [152](#)
 - SW, waveband [145](#)
 - Switches, refer to Cockpit [10](#)
 - Switching off
 - engine [54](#)
 - Switching off the engine
 - start/stop button [53](#)
 - Switching on
 - audio [142](#)
 - CD changer [142](#)
 - CD player [142](#)
 - radio [142](#)
 - Switching the cooling function on and off [96](#)
 - Switch-on times of parked car ventilation, preselecting [98](#)
 - Symbols [4](#)
 - status information [19](#)
 - traffic bulletins for navigation system [136](#)
- ## T
- Tachometer [67](#)
 - Tailgate [30](#)
 - convenient access [35](#)
 - emergency operation, refer to Opening manually [31](#)
 - opening from inside [30](#)
 - opening from outside [31](#)
 - opening manually [31](#)
 - remote control [28](#)
 - Tailgate, refer to Luggage compartment lid/tailgate [30](#)
 - Tail lamp
 - replacing bulb [228](#)
 - Tail lamps [226](#)
 - replacing bulb [227](#)
 - Tank contents, refer to Capacities [242](#)
 - Technical data [238](#)
 - capacities [242](#)
 - dimensions [239](#)
 - Technical modifications, refer to For your own safety [5](#)
 - Telephone [168](#)
 - installation location, refer to Center armrest [103](#)
 - refer to separate Owner's Manual
 - TeleService, activating [185](#)
 - TeleService Diagnosis [182](#)
 - TeleService Help [182](#)
 - Temperature
 - automatic climate control [95](#)
 - changing unit of measure [71](#)
 - coolant, refer to Coolant temperature [68](#)
 - Temperature display
 - outside temperature [67](#)
 - outside temperature warning [67](#)
 - setting the units [71](#)
 - Tempomat, refer to Cruise control [59](#)
 - Tensioning straps, refer to Securing cargo [118](#)
 - The individual vehicle [5](#)
 - Third brake lamp, refer to Center brake lamp [228](#)
 - Through-loading system [106](#)
 - Through-loading system, refer to Expanding the cargo bay [107](#)
 - Tilt alarm sensor [33](#)
 - Tilt function, passenger-side mirror [47](#)
 - Timer, refer to Preselecting switch-on times [98](#)
 - Tire inflation pressure [195](#)
 - loss [84](#), [85](#)
 - Tire pressure monitoring, refer to Flat Tire Monitor [83](#)
 - Tire Pressure Monitor TPM [84](#)
 - resetting the system [85](#)
 - system limitations [85](#)
 - warning lamp [86](#)
 - Tire puncture, refer to Flat Tire Monitor [84](#)
 - Tire Quality Grading [207](#)

- Tires
 - age [207](#), [208](#)
 - air loss [86](#)
 - breaking in [114](#)
 - changing, refer to Changing wheels [228](#)
 - condition [208](#)
 - damage [208](#)
 - inflation pressure [195](#)
 - labels [207](#)
 - minimum tread depth [208](#)
 - new wheels and tires [209](#)
 - pressure monitoring, refer to Flat Tire Monitor [83](#)
 - pressure monitoring, refer to Tire Pressure Monitor TPM [84](#)
 - puncture [84](#)
 - replacing [209](#)
 - Run-Flat [209](#)
 - size [207](#)
 - storage [210](#)
 - tread depth [208](#)
 - wear indicators, refer to Minimum tread depth [208](#)
 - wheel/tire combination, refer to Correct wheels and tires [209](#)
 - winter tires [210](#)
 - TMC station, refer to Traffic bulletins [136](#)
 - Tone
 - control [142](#)
 - middle setting [144](#)
 - Tools, refer to Onboard tool kit [222](#)
 - Top 50 of music collection [159](#)
 - Torque, refer to Engine data [238](#)
 - Tow bar [233](#)
 - Tow fitting [233](#)
 - screw thread [233](#)
 - Tow fittings for tow-starting and towing away [233](#)
 - Towing [232](#)
 - car with automatic transmission [232](#)
 - methods [233](#)
 - Towing and tow-starting [232](#)
 - Town/city, for navigation [123](#)
 - Tow rope [233](#)
 - Tow-starting [232](#), [234](#)
 - TPM, refer to Tire Pressure Monitor [84](#)
 - Track
 - selecting on CD [150](#)
 - Traction control, refer to Dynamic Stability Control DSC [81](#)
 - Traffic bulletins
 - categories [137](#)
 - Traffic bulletins, filtering [137](#)
 - Traffic bulletins for navigation [136](#)
 - during destination guidance [137](#)
 - in map display [137](#)
 - Traffic jam
 - displaying traffic bulletins [136](#)
 - Transmission
 - automatic transmission with Steptronic [55](#)
 - manual transmission [55](#)
 - overriding selector lever lock for automatic transmission with Steptronic [57](#)
 - Transmission interlock
 - refer to Changing selector lever position [56](#)
 - refer to P Park [56](#)
 - Transporting children safely [49](#)
 - Transport securing devices, refer to Securing cargo [118](#)
 - Travel instructions, refer to Voice instructions [134](#)
 - Tread depth, refer to Minimum tire tread [208](#)
 - Trip-distance counter, refer to Trip odometer [67](#)
 - Triple turn signal activation [58](#)
 - Trip odometer [67](#)
 - Trunk, refer to Cargo bay [107](#)
 - Turning circle, refer to Dimensions [239](#)
 - Turn signal indicators
 - indicator/warning lamp [12](#)
 - replacing bulbs [226](#)
 - triple turn signal [58](#)
 - Turn signals [57](#)
 - TV
 - control elements [142](#)
 - switching on/off [142](#)
 - tone control [142](#)
 - volume [142](#)
 - Tying down loads, refer to Cargo loading [118](#)
- ## U
- Uniform Tire Quality Grading/UTQR [207](#)
 - Units
 - average consumption [71](#)
 - temperature [71](#)
 - Universal garage door opener, refer to Integrated universal remote control [99](#)
 - Universal mobile phone preparation package, refer to separate Owner's Manual
 - Universal remote control [99](#)
 - Unlatching, refer to Unlocking [34](#)
 - Unlocking
 - from inside [30](#)
 - from outside [27](#)
 - luggage compartment lid [35](#)
 - setting unlocking characteristics [27](#)
 - tailgate [35](#)
 - without remote control, refer to Convenient access [34](#)
 - USB-audio interface [162](#)
- ## V
- VCD [152](#)

Vehicle

- battery [228](#)
- breaking in [114](#)
- cargo loading [117](#)
- Identification Number, refer to Engine compartment [212](#)
- measurements, refer to Dimensions [239](#)
- parking [54](#)
- weight [241](#)

Vehicle jack [228](#)

Vehicle position, refer to

- Displaying current position [139](#)

Vehicle storage [221](#)

Ventilation [97](#)

- draft-free [97](#)
- in the rear [97](#)

Ventilation, refer to Climate [94](#)

Ventilation while at a standstill [97](#)

Vents, refer to Ventilation [97](#)

Video menu [152](#)

Video playback [152](#)

Voice, refer to Destination guidance through voice instructions [134](#)

Voice commands

- overview [22](#)
- short commands [243](#)

Voice instructions from navigation system [134](#)

- repeating [135](#)
- switching on/off [134](#)
- volume [135](#)

Volume [142](#)

- audio sources [142](#)
- fuel tank, refer to Capacities [242](#)
- mobile phone [171](#)
- TV [142](#)
- voice instructions [135](#)

Volume balance, tone setting [143](#)

W

Warm

- steering wheel [48](#)

Warning and indicator lamps [13](#)

Warning messages, refer to

- Check Control [75](#)

Warning triangle [231](#)

Washer fluid [59](#)

- content of the reservoir [59](#)

Washer fluid reservoir [59](#)

Waste tray, refer to

- Ashtray [104](#)

Water on roads, refer to

- Driving through water [116](#)

Water penetration [218](#), [219](#)

Waveband on the radio [145](#)

Wear indicators in tires, refer to Minimum tread depth [208](#)

Weather information [148](#)

Weights [241](#)

Welcome lamps [90](#)

Wheel/tire combination, refer to

- Correct wheels and tires [209](#)

Wheelbase, refer to

- Dimensions [239](#)

Wheels, new [209](#)

Wheels and tires [195](#)

Width, refer to

- Dimensions [239](#)

Windows [36](#)

- convenient operation [28](#)
- opening, closing [36](#)
- pinch protection system [36](#)
- rear window [32](#)
- safety switch [36](#)

Windows, indicator on Control Display [16](#)

Windshield

- cleaning [58](#)

Windshield wash [58](#)

- filling capacity, reservoir [242](#)
- nozzles [59](#)
- rear window [59](#)
- reservoir for washer fluid [59](#)
- washer fluid [59](#)

Windshield wiper blades, changing [222](#)

Windshield wipers, refer to

- Wiper system [58](#)

Winter diesel [192](#)

Winter tires [210](#)

- setting speed limit [77](#)
- storage [210](#)

Wiper blade replacement [222](#)

Wiper system [58](#)

Word-matching principle for navigation [133](#)

Work in the engine compartment [211](#)

Wrench/screwdriver, refer to

- Onboard tool kit [222](#)

X

xDrive [82](#)

Xenon lamps

- replacing bulbs [223](#)

Y

Your individual vehicle

- settings, refer to Personal Profile [26](#)

More about BMW

bmwusa.com



The Ultimate
Driving Machine

01 41 2 602 099 ue iDrive

