

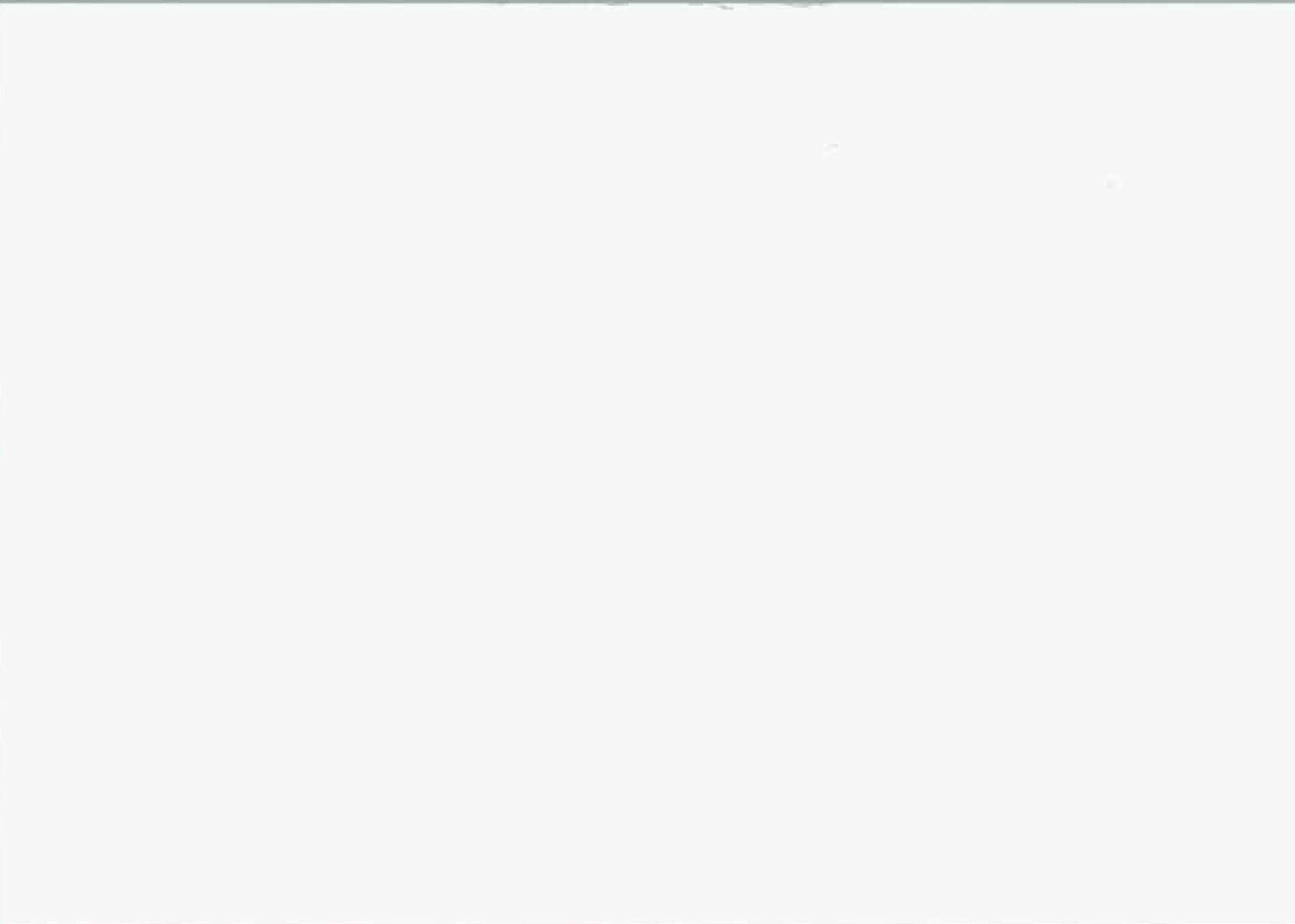

**BUICK**  
PREMIUM AMERICAN  
MOTORCARS



**Regal**





## The 1993 Buick Regal Owner's Manual

Litho in U.S.A.  
Part No. 25603821 B • First Edition

©Copyright General Motors Corporation 1992  
All Rights Reserved

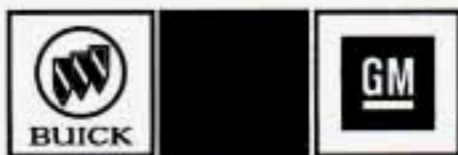

GENERAL MOTORS, GM and the GM Emblem, BUICK, and the BUICK Emblem are registered trademarks of General Motors Corporation.

This manual includes the latest information at the time it was printed. We reserve the right to make changes in the product after that time without further notice. For vehicles first sold in Canada, substitute the name "General Motors of Canada Limited" for Buick Motor Division whenever it appears in this manual.

Please keep this manual in your Buick, so it will be there if you ever need it when you're on the road. If you sell the vehicle, please leave this manual in it so the new owner can use it.



We support voluntary technician certification.

## For Canadian Owners Who Prefer a French Language Manual:

Aux propriétaires canadiens: Vous pouvez vous procurer un exemplaire de ce guide en français chez votre concessionnaire ou à DGN Marketing Services Ltd., 1500 Bonhill Rd., Mississauga, Ontario L5T 1C7.

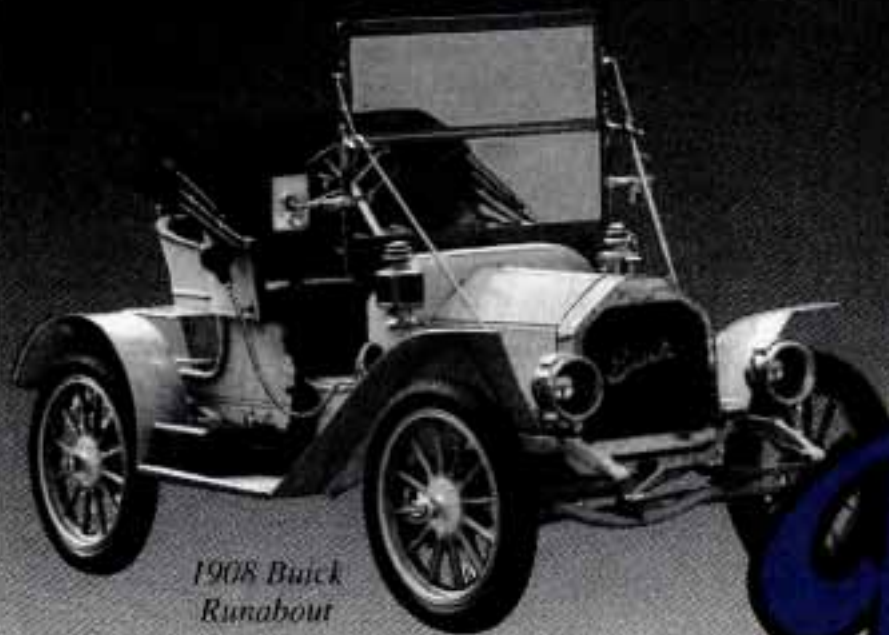

*1908 Buick  
Runabout*

*Buick Motor Division  
provides one of the most dramatic  
and important chapters in the history  
of the American automobile.*

# Buick



*David Dunbar Buick*



*Walter Marr and Thomas Buick*

Buick's chief engineer, Walter L. Marr (left), and Thomas D. Buick, son of founder David Dunbar Buick, drove the first Flint Buick in a successful Flint-Detroit round trip in July 1904.

David Buick was building gasoline engines by 1899, and Marr, his engineer, apparently built the first auto to be called a Buick in 1900. However, Buick traditionally dates its beginnings to 1903. That was the year the company was reorganized, refinanced and moved from Detroit to Flint. Buick has always been a product innovator. Buick engineers developed the

"valve-in-head" engine, a light, powerful and reliable engine which would eventually influence the entire automotive industry.

William C. Durant was instrumental in promoting Buicks across the country using his Durant-Dort Carriage Co. outlets and salespeople as the nucleus of a giant distribution system. He knew the Buick as a "self-seller". If automobiles could be this good, he thought, maybe it was time to switch from the horse and buggy business to automobiles.



*William C. (Billy) Durant*

At the 1905, New York Auto Show, Durant took orders for 1,000 Buicks before the company had built 40. On Buick's success, Durant created a holding company, September 16, 1908. He called it General Motors.

Durant also created a racing team that won 500 racing trophies in 1909 and 1910, including successes at Indianapolis two years before the Indy 500 began.

The success of Buick engines was visible not only on the race track, but in endurance tests across the country and around the world. Buick was the only car to complete a 1,000-mile Chicago-to-New York race in 1906. And a Buick was the first car to travel across South America, driven from Buenos Aires, Argentina, over the Andes to Santiago, Chile in 1914.



*1911 Model 21 Touring Car*

Buick drew plenty of attention because it could climb hills and run through mud like no other car. Buick's endurance and reliability were world famous.

During World War I, Buick built Liberty aircraft engines as well as Red Cross ambulances so successful that one Buick ambulance was awarded the Croix de Guerre by the French government.

As a builder of premier automobiles, Buick was hard hit by the Great Depression. However, new General Manager Harlow H. Curtice created popular new models including the Special and the Roadmaster. Buick sales soon flourished.



*First Buick Factory*

In World War II, Buick built aircraft engines, tanks and other military hardware. This post-war period brought great styling and engineering changes which resulted in increased sales. The torque converter automatic transmission, Dynaflo, was introduced in the 1948 Roadmaster. Buick's famous "portholes" came along in 1949.



*1949 Roadmaster*

A high-compression V-8 engine was introduced in 1953. And Buick's famous vertical pillar "toothy" grille (introduced in 1942), became more massive in the post-war era.



*1953 Skylark*



Motor Trend magazine named the 1962 Buick Special "Car of the Year". The first production V-6 engine was used in the Special.



### *1962 Buick Special*

Built inside the walls of the old buildings in Buick's former Flint complex, which formed the cornerstone of General Motors, Buick City is a state-of-the-art assembly facility with more than 200 robots and other high-tech equipment. It was completed in the fall of 1985.

Buicks are, and will continue to be, premium American motorcars with smooth power, high performance, rich detail and comfortable accommodation.



*Ed Mertz, General Manager, Buick Motor Division*

Our mission is simple:

"Buick will provide Premium American Motorcars backed with services that exceed our customers' expectations, throughout the purchase, ownership, service and repurchase experience."

Buicks are SUBSTANTIAL.

Buicks are DISTINCTIVE.

Buicks are POWERFUL.

Buicks are MATURE.

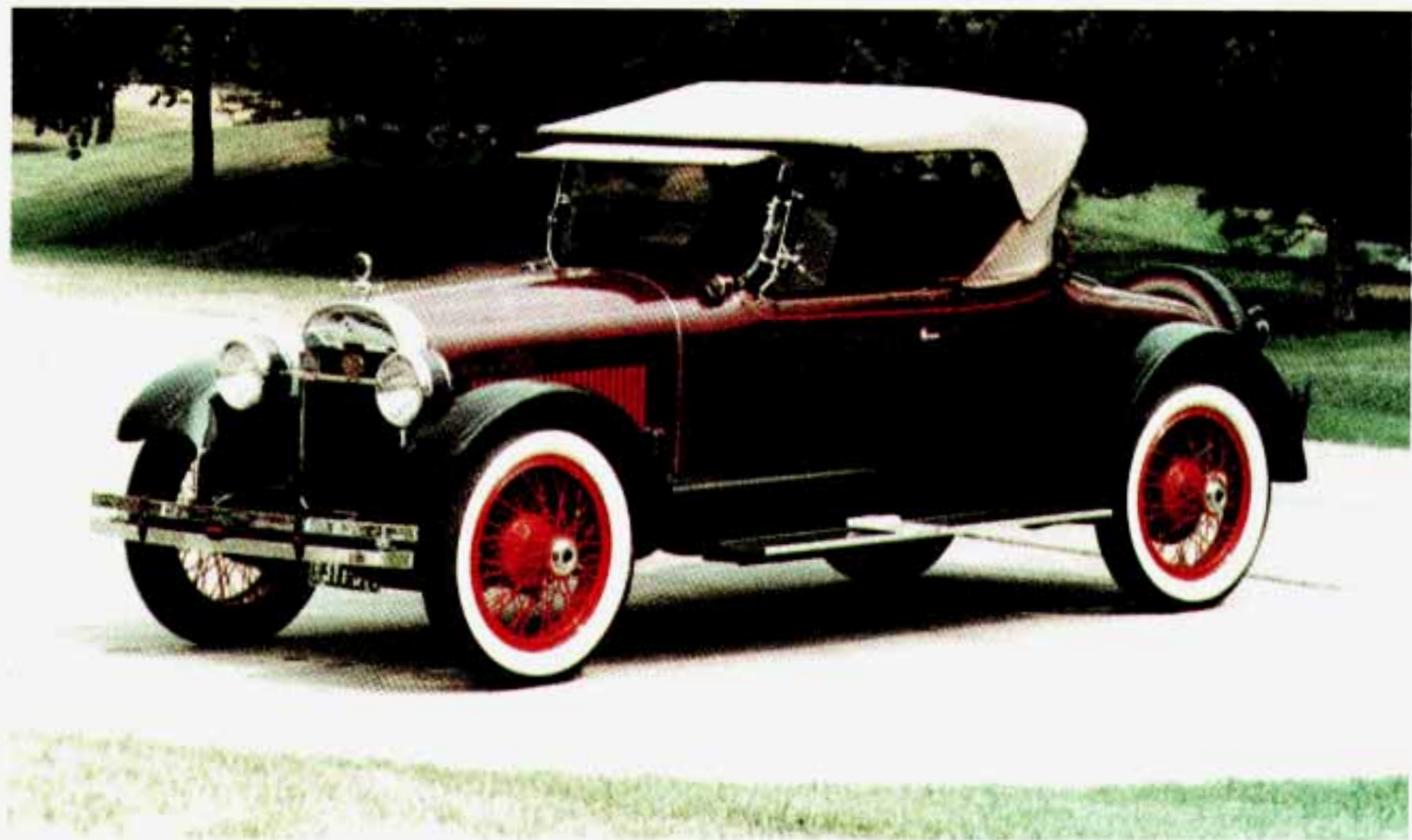

*1923 Sport Roadster*



# Table of Contents

<b>How to Use this Manual</b> .....	10
This part tells you how to use your manual and includes safety and vehicle damage warnings & symbols.13	
<b>Seats and Safety Belts</b> .....	13
This part tells you how to use your seats and safety belts properly.	
<b>Features and Controls</b> .....	57
This part explains how to start and operate your Buick.	
<b>Comfort Controls and Audio Systems</b> .....	109
This part tells you how to adjust the ventilation & comfort controls and how to operate your sound system.	
<b>Your Driving and the Road</b> .....	127
Here you'll find helpful information and tips about the road and how to drive under different conditions.	
<b>Problems on the Road</b> .....	177
This part tells you what to do if you have a problem while driving, such as a flat tire or engine overheating.	
<b>Service and Appearance Care</b> .....	213
Here the manual tells you how to keep your Buick running properly and looking good.	
<b>Maintenance Schedule</b> .....	265
This part tells you when to perform vehicle maintenance and what fluids and lubricants to use.	
<b>Customer Assistance Information</b> .....	285
This part tells you how to contact Buick for assistance and how to get service publications. It also gives you information on "Reporting Safety Defects" on page 287.	
<b>Index</b> .....	293
Here's an alphabetical listing of almost every subject in this manual. You can use it to quickly find something you want to read.	

## How to Use This Manual

Many people read their owner's manual from beginning to end when they first receive their new vehicle. This will help you learn about the features and controls for your vehicle. In this manual, you'll find that pictures and words work together to explain things quickly.

## Safety Warnings and Symbols

You will find a number of safety cautions in this book. We use yellow and the word CAUTION to tell you about things that could hurt you if you were to ignore the warning.



In the yellow caution area, we tell you what the hazard is. Then we tell you what to do to help avoid or reduce the hazard. Please read these cautions. If you don't, you or others could be hurt.

You will also find a red circle with a slash through it in this book.



This safety symbol means "Don't," "Don't do this," or "Don't let this happen."

## Vehicle Damage Warnings

Also, in this book you will find these blue notices:



**NOTICE:**

In the blue notice area, we tell you about something that can damage your vehicle. Many times, this damage would not be covered by your warranty, and it could be costly. But the notice will tell you what to do to help avoid the damage.

When you read other manuals, you might see CAUTION and NOTICE warnings in different colors or in different words. In this manual, we've used the familiar words and colors that Buick has used for years.

You'll also see warning labels on your vehicle. They use the same colors, and the words CAUTION or NOTICE.

## Vehicle Symbols

These are some of the symbols you will find on your vehicle.

For example, these symbols are used on an original battery:

CAUTION  
POSSIBLE  
INJURY



PROTECT  
EYES BY  
SHIELDING



CAUSTIC  
BATTERY  
ACID COULD  
CAUSE  
BURNS



AVOID  
SPARKS OR  
FLAMES



SPARK OR  
FLAME  
COULD  
EXPLODE  
BATTERY



These symbols are important for you and your passengers whenever your vehicle is driven:

DOOR LOCK  
UNLOCK



FASTEN  
SEAT  
BELTS



POWER  
WINDOW



These symbols have to do with your lights:

MASTER  
LIGHTING  
SWITCH



TURN  
SIGNALS

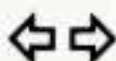

PARKING  
LIGHTS



HAZARD  
WARNING  
FLASHER



LIGHTS OR  
HIGH BEAM



FOG LAMPS



These symbols are on some of your controls:

WINDSHIELD  
WIPER &  
WASHER



WINDSHIELD  
WASHER



WINDSHIELD  
DEFROSTER



REAR  
WINDOW  
DEFOGGER

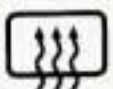

VENTILATING  
FAN



HEADLAMP  
WASHER  
WIPER



These symbols are used on warning and indicator lights:

ENGINE  
COOLANT  
TEMP



BATTERY  
CHARGING  
SYSTEM

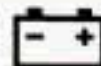

BRAKE



RADIATOR  
COOLANT



FUEL



ENGINE OIL  
PRESSURE



ENGINE OIL  
TEMP

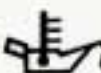

ANTILOCK  
BRAKE



Here are some other symbols you may see:

FUSE



RADIO  
SELECTOR



RADIO  
VOLUME



AIR  
CONDITIONING



TRUNK  
HATCHBACK  
RELEASE



LIGHTER



HORN



SPEAKER





## Part 1 Seats And Safety Belts

Here you'll find information about the seats in your Buick and how to use your safety belts properly. You can also learn about some things you should not do with safety belts.

### Part 1 includes:

Seats and Seat Controls .....	14
Head Restraints .....	17
Safety Belts - They're for Everyone .....	19
Why Safety Belts Work .....	20
Questions Many People Ask About Safety Belts .....	24
How to Wear Safety Belts Properly .....	26
Adults .....	26
Driver Position .....	26
Lap-Shoulder Belt .....	27
Safety Belt Use During Pregnancy .....	33
Passenger Positions .....	34
Children .....	40
Smaller Children and Babies .....	40
Child Restraints .....	42
Larger Children .....	52
Safety Belt Extender .....	55
Checking Your Restraint System .....	55
Replacing Safety Belts After a Crash .....	56

## Seats and Seat Controls

This section tells you about the seats -- how to adjust them, and also about reclining front seatbacks, and head restraints.

### Manual Seat



#### **CAUTION:**

**You can lose control of the vehicle if you try to adjust a manual driver's seat while the vehicle is moving. The sudden movement could startle and confuse you, or make you push a pedal when you don't want to. Adjust the driver's seat only when the vehicle is not moving.**



Move the lever under the front seat to unlock it. Slide the seat to where you want it. Then release the lever and try to move the seat with your body, to make sure the seat is locked into place.



### **Four-Way Manual Seat - Drivers Seat Only (Option)**

If you have this option, you have two levers under the front edge of the seat. The lever near the outer side of the seat unlocks the seat allowing it to slide forward and back. The lever near the center allows you to tilt the seat up or down.

### **Power Seat (Option)**



**Front Control (F):** Raise the front of the seat by holding the switch up. Hold the switch down to lower the front of the seat.

**Center Control (C):** Move the seat forward or back by holding the control to the front or back. Raise or lower the seat by holding the control up or down.

**Rear Control (R):** Raise the rear of the seat by holding the switch up. Hold the switch down to lower the rear of the seat.

## Reclining Front Seatback(s)

To adjust the seatback, lift the lever on the outer side of the seat and move the seatback to where you want it. Release the lever to lock the seatback. Pull up on the lever and the seat will go to an upright position.



But don't have a seatback reclined if your vehicle is moving.



### CAUTION:

Sitting in a reclined position when your vehicle is in motion can be dangerous. Even if you buckle up, your safety belts can't do their job when you're reclined like this.



CAUTION: (Continued)

**CAUTION: (Continued)**

The shoulder belt can't do its job because it won't be against your body. Instead, it will be in front of you. In a crash you could go into it, receiving neck or other injuries.

The lap belt can't do its job either. In a crash the belt could go up over your abdomen. The belt forces would be there, not at your pelvic bones. This could cause serious internal injuries.

For proper protection when the vehicle is in motion, have the seatback upright. Then sit well back in the seat and wear your safety belt properly.

## Head Restraints



Slide the head restraint up or down so that the top of the restraint is closest to the top of your ears.

This position reduces the chance of a neck injury in a crash.

## Front Seatback Latches (Two-Door Models)

The front seatback folds forward to let people get into the back seat.

Your seatback will move back and forth freely, unless you come to a sudden stop. Then it will lock in place.

There's one time the seatback may not fold without some help from you. That's if your vehicle is parked going down a fairly steep hill.



To fold a seatback forward, push the seatback toward the rear as you lift this latch. Then the seatback will fold forward. The latch must be down for the seat to work properly.



### CAUTION:

**If the seatback isn't locked, it could move forward in a sudden stop or crash. That could cause injury to the person sitting there. Always press rearward on the seatback to be sure it is locked in place.**

## Easy Entry Seat Option (Two-Door Models)

The right front seat of your vehicle makes it easy to get in and out of the rear seat.

- When you tilt the right front seatback fully forward, the whole seat will slide forward.
- After someone gets into the rear seat area, move the right front seatback to its original position. Then move the seat rearward until it locks.
- To get out, again tilt the seatback fully forward.



## CAUTION:

If an easy entry right front seat isn't locked, it can move. In a sudden stop or crash, the person sitting there could be injured. After you've used it, be sure to push rearward on an easy entry seat to be sure it is locked.



## Safety Belts: They're For Everyone

This part of the manual tells you how to use safety belts properly. It also tells you some things you should not do with safety belts.



## CAUTION:

Don't let anyone ride where they can't wear a safety belt properly. If you are in a crash and you're not wearing a safety belt, your injuries can be much worse. You can hit things inside the vehicle or be ejected from it. You can be seriously injured or killed. In the same crash, you might not be if you are buckled up. Always fasten your safety belt, and check that your passengers' belts are fastened properly too.

This figure lights up when you turn the key to "Run" or "Start" when your safety belt isn't buckled, and you'll hear a tone, too. It's the reminder to buckle up.

In many states and Canadian provinces, the law says to wear safety belts. Here's why: They work.

You never know if you'll be in a crash. If you do have a crash, you don't know if it will be a bad one.

A few crashes are very mild. In them, you won't get hurt even if you're not buckled up. And some crashes can be so serious, like being hit by a train, that even buckled up a person wouldn't survive. But most crashes are in between. In many of them, people who buckle up can survive and sometimes walk away. Without belts they could be badly hurt or killed.

After 25 years of safety belts in vehicles, the facts are clear. In most crashes buckling up does matter ... a lot!



## Why Safety Belts Work

When you ride in or on anything, you go as fast as it goes.



For example, if the bike is going 10 mph (16 km/h), so is the child.

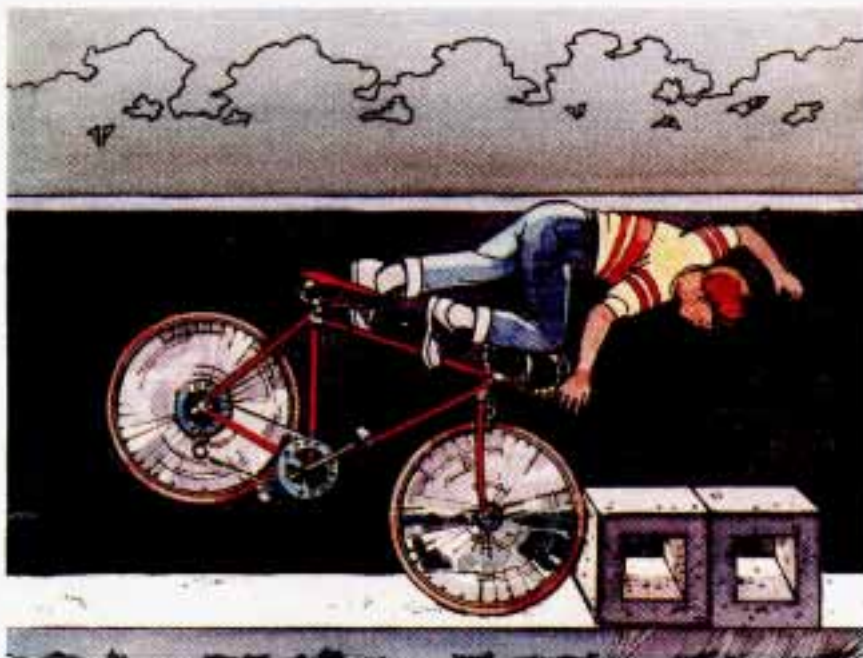

When the bike hits the block, it stops. But the child keeps going!

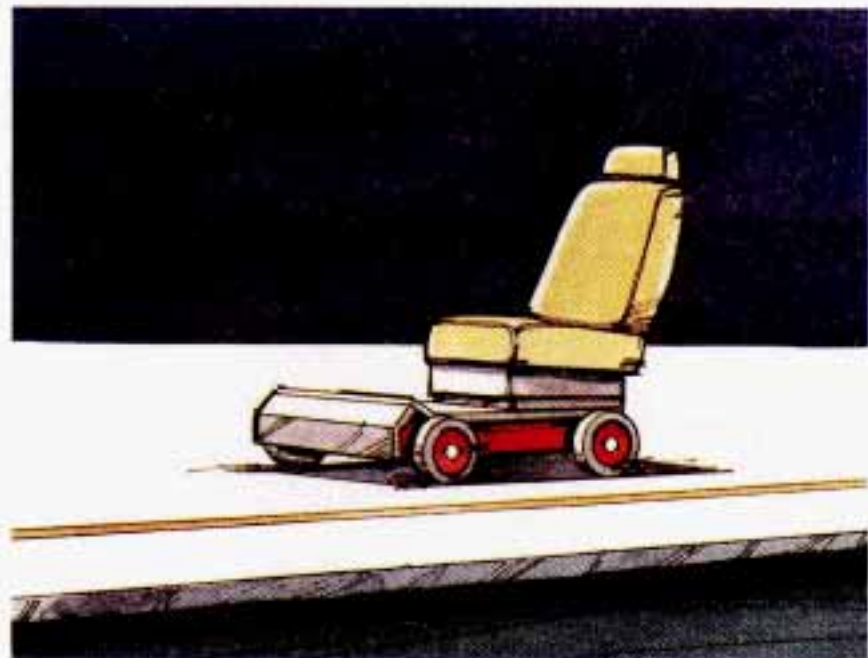

Take the simplest "vehicle." Suppose it's just a seat on wheels.



Put someone on it.

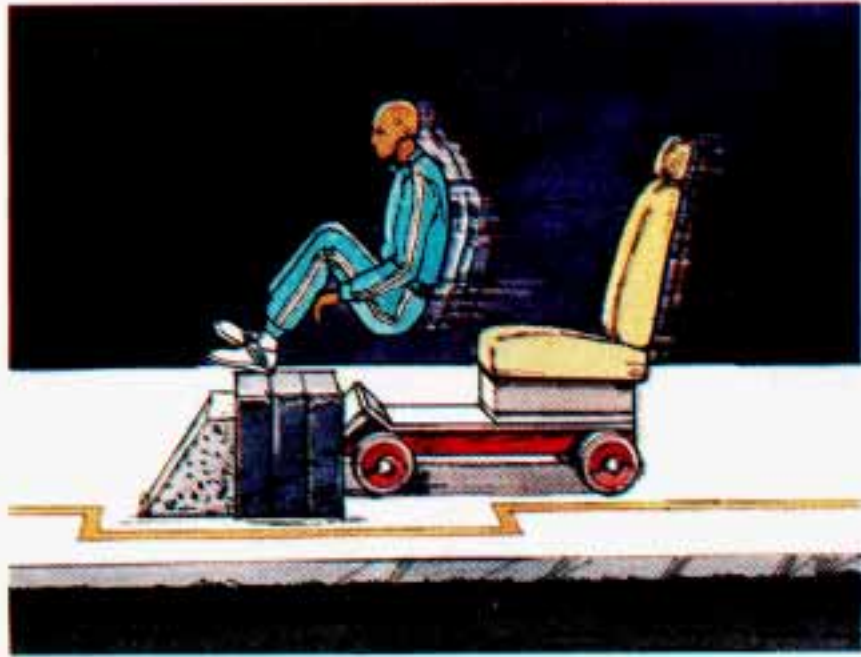

Get it up to speed. Then stop the "car." The rider doesn't stop.





The person keeps going until stopped by something.  
In a real vehicle, it could be the windshield ...



or the instrument panel ...



or the safety belts!

With safety belts, you slow down as the vehicle does. You get more time to stop. You stop over more distance, and your strongest bones take the forces. That's why safety belts make such good sense.

## Here Are Questions Many People Ask About Safety Belts -- and the Answers

**Q:** Won't I be trapped in the vehicle after an accident if I'm wearing a safety belt?

**A:** You could be -- whether you're wearing a safety belt or not. But you can easily unbuckle a safety belt, even if you're upside down. And your chance of being conscious during and after an accident, so you can unbuckle and get out, is much greater if you are belted.

**Q:** Why don't they just put in air bags so people won't have to wear safety belts?

**A:** "Air bags," or Supplemental Inflatable Restraint systems, are in some vehicles today and will be in more of them in the future. But they are supplemental systems only -- so they work with safety belts, not instead of them. Every "air bag" system ever offered for sale has required the use of safety belts. Even if you're in a vehicle that has "air bags," you still have to buckle up to get the

most protection. That's true not only in frontal collisions, but especially in side and other collisions.

**Q:** If I'm a good driver, and I never drive far from home, why should I wear safety belts?

**A:** You may be an excellent driver, but if you're in an accident -- even one that isn't your fault -- you and your passengers can be hurt. Being a good driver doesn't protect you from things beyond your control, such as bad drivers.

Most accidents occur within 25 miles (40 km) of home. And the greatest number of serious injuries and deaths occur at speeds of less than 40 mph (65 km/h).

Safety belts are for everyone.

## Safety Belt Warning Light



When the key is turned to "Run" or "Start," a tone will come on for about eight seconds to remind people to fasten their safety belts, unless the driver's safety belt is buckled. The safety belt light will also come on and stay on until the driver's belt is buckled.



### **CAUTION:**

If your safety belt light ever comes on or stays on after the front doors are closed and the driver's belt is buckled, have your vehicle fixed. If you don't, you might not have the protection you'd need in a crash.

## How To Wear Safety Belts Properly

### Adults

This section is only for people of adult size.

#### CAUTION:

**There are special things to know about safety belts and children. And there are different rules for babies and smaller children. If a child will be riding in your Buick, see the section after this one, called "Children." Follow those rules for everyone's protection.**

First, you'll want to know which restraint systems your vehicle has.

We'll start with the driver position.

## Cars First Sold In Canada

Was your Buick first sold, when new, in Canada? (If it was, a sticker on the driver's door will say "conforms to all applicable Canada motor vehicle..." etc.) If so, then the rest of Part 1 does not apply to your vehicle.

To learn how to use your safety belts, please read the Owner's Manual Safety Belt Supplement. It comes with every new Buick first sold in Canada.

### Driver Position

This section describes the driver's restraint system.

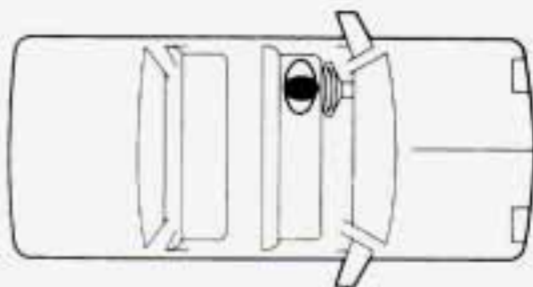

## Automatic Lap-Shoulder Belt



This safety belt is called "automatic" because you don't have to buckle up when you get into your vehicle.



And you don't have to unbuckle when you get out.

Just get into your vehicle. Then close and lock the door. Adjust the seat (to see how, see "Seats" in the Index) so you can sit up straight.

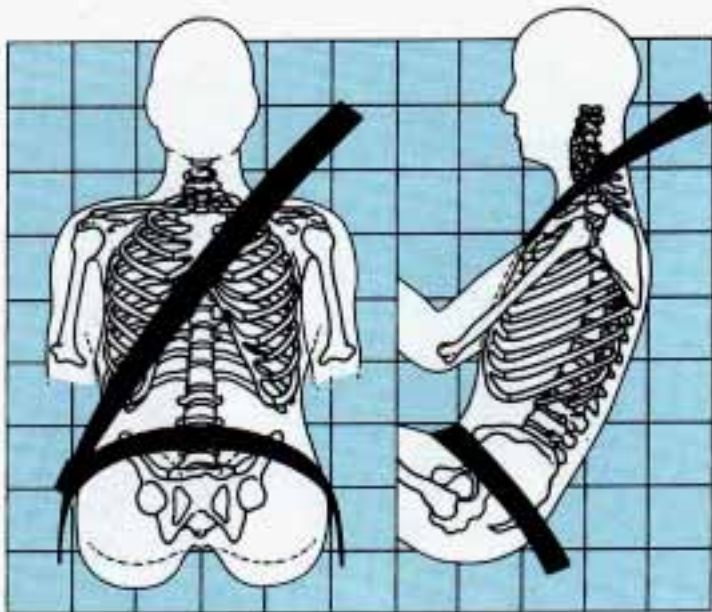

The lap belt should be worn as low on the hips as possible. In a crash, this applies force to the strong

pelvic bones. And you'd be less likely to slide under the lap belt. If you slid under it, the belt would apply force at your abdomen. This could cause serious or even fatal injuries. The shoulder belt should go over the shoulder and across the chest. These parts of the body are best able to take belt restraining forces.

The safety belt locks if there's a sudden stop or a crash.

It's possible that an automatic belt could keep you from fully opening a door. That can happen if the door was slammed shut very hard. Just close the door all the way, then slowly open it. If that doesn't fix it, then your Buick needs service.

We hope you'll always keep your automatic belt buckled. However, you may need to unbuckle it in an emergency. And you would need to unbuckle it to let someone get into the center front seat position, if your

vehicle has one. To unbuckle the automatic belt, just push the button on the buckle.



To reattach the automatic belt:

1. Close and lock the door.
2. Adjust the seat (to see how, see "Seats" in the Index) so you can sit up straight.



3. Pick up the latch plate and pull the belt across you. Don't let it get twisted.
4. Push the latch plate into the buckle until it clicks.

**Q:** What's wrong with this?

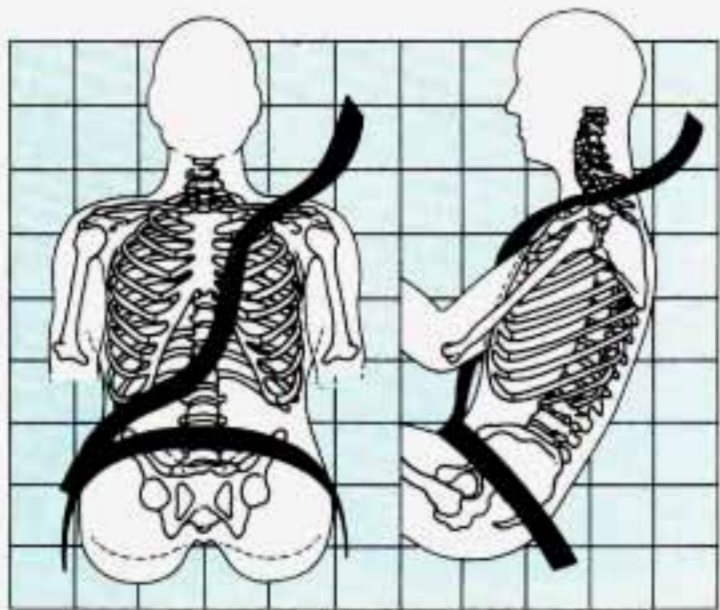

**CAUTION:**

You can be seriously hurt if your shoulder belt is too loose. In a crash you would move forward too much, which could significantly increase injury. The shoulder belt should fit against your body.

**A:** The shoulder belt is too loose. It won't give nearly as much protection this way.



**Q:** What's wrong with this?

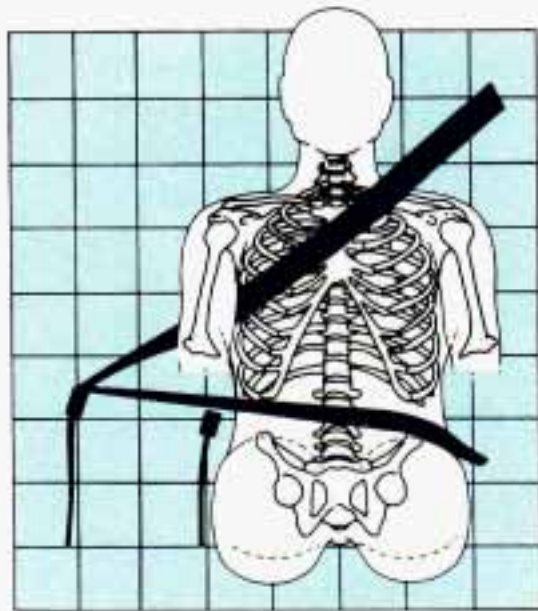

## **CAUTION:**

You can be seriously injured if your belt is buckled in the wrong place like this. In a crash, the belt would go up over your abdomen. The belt forces would be there, not at the pelvic bones. This could cause serious internal injuries. Always buckle your belt into the buckle nearest you.

**A:** The belt is buckled in the wrong place.

**Q:** What's wrong with this?

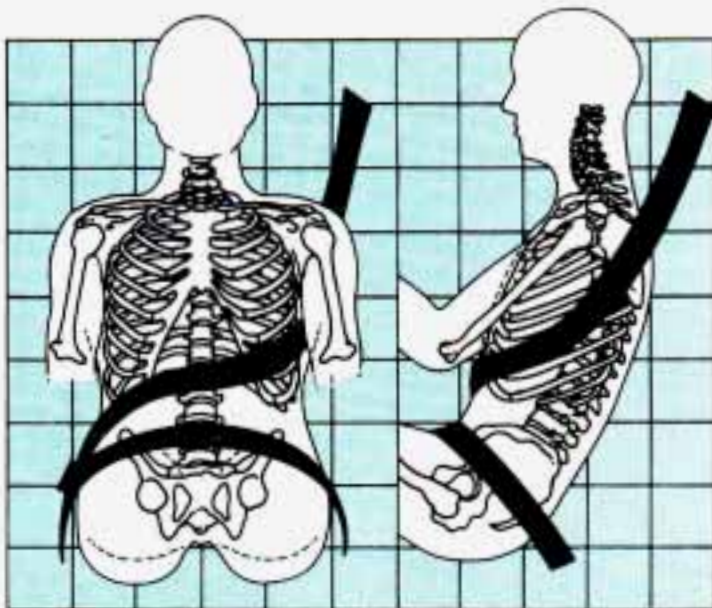

### **CAUTION:**

You can be seriously injured if you wear the shoulder belt under your arm. In a crash, your body would move too far forward, which would increase the chance of head and neck injury. Also, the belt would apply too much force to the ribs, which aren't as strong as shoulder bones. You could also severely injure internal organs like your liver or spleen.

**A:** The shoulder belt is worn under the arm. It should be worn over the shoulder at all times.

**Q:** What's wrong with this?

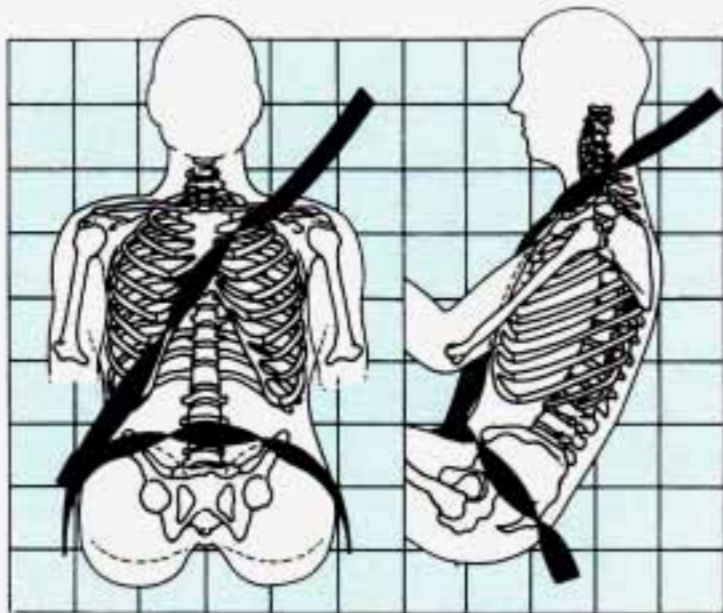

## **CAUTION:**

You can be seriously injured by a twisted belt. In a crash, you wouldn't have the full width of the belt to take impact forces. If a belt is twisted, make it straight so it can work properly, or ask your dealer to fix it.

## **Safety Belt Use During Pregnancy**

Safety belts work for everyone, including pregnant women. Like all occupants, they are more likely to be seriously injured if they don't wear safety belts.

A pregnant woman should wear a lap-shoulder belt, and the lap portion should be worn as low as possible throughout the pregnancy.

**A:** The belt is twisted across the body.

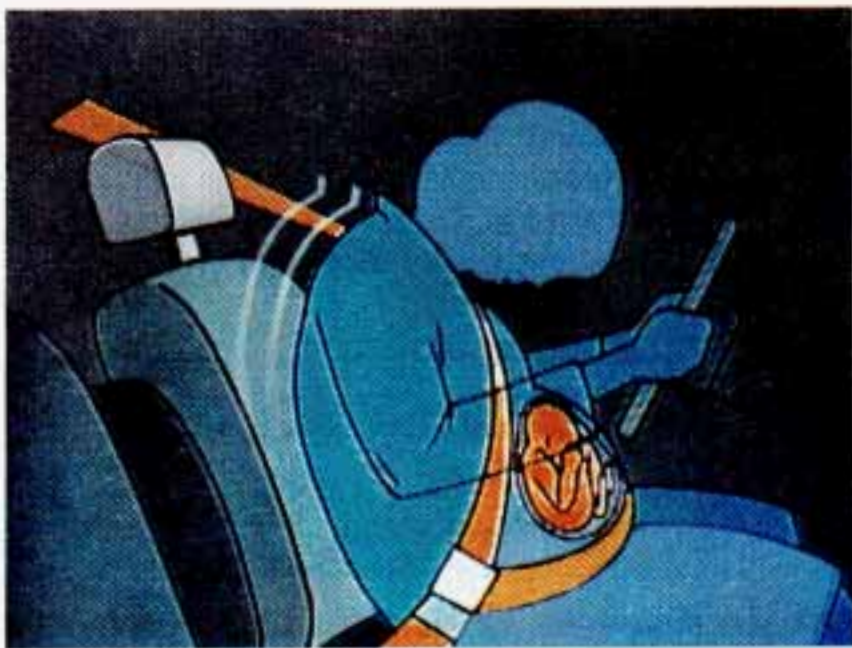

## Right Front Passenger Position

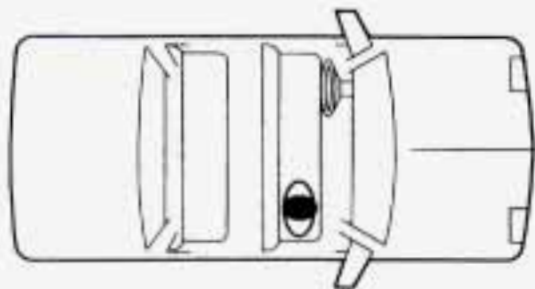

The right front passenger's safety belt works the same way as the driver's safety belt. See "Driver Position," earlier in this part.

The best way to protect the fetus is to protect the mother. When a safety belt is worn properly, it's more likely that the fetus won't be hurt in a crash. For pregnant women, as for anyone, the key to making safety belts effective is wearing them properly.

- Adjust the seat (to see how, see “Seats” in the Index) so you can sit up straight. Move your seat far enough forward that your feet touch the part of the car that is called the “toeboard” (A). That way you’d be less likely to slide under the lap belt in a crash.



## Center Passenger Position

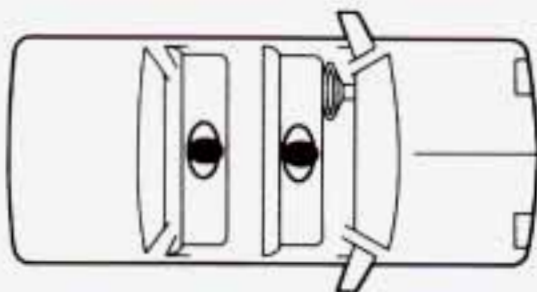



When you sit in a center seating position, you have a lap safety belt, which has no retractor. To make the belt longer, tilt the latch plate and pull it along the belt.

To make the belt shorter, pull its free end as shown until the belt is snug.



Buckle, position and release it the same way as the lap part of a lap-shoulder belt. If the belt isn't long enough, see "Safety Belt Extender" at the end of this section.

Make sure the release button on the buckle faces upward or outward so you would be able to unbuckle it quickly if you ever had to.

## Rear Seat Passengers

It's very important for rear seat passengers to buckle up! Accident statistics show that unbelted people in the rear seat are hurt more often in crashes than those who are wearing safety belts.

Rear passengers who aren't safety belted can be thrown out of the vehicle in a crash. And they can strike others in the vehicle who are wearing safety belts.

## Rear Seat Outside Passenger Positions

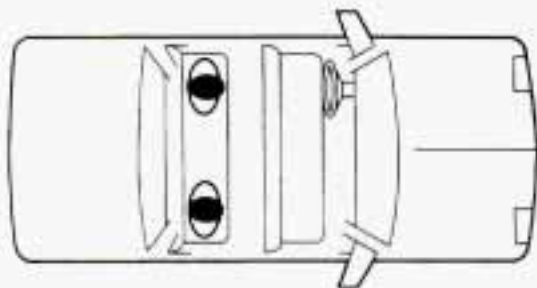

The positions next to the windows have lap-shoulder belts. Here's how to wear one properly.



1. Pick up the latch plate and pull the belt across you. Don't let it get twisted.
2. Push the latch plate into the buckle until it clicks.



If the belt stops before it reaches the buckle, tilt the latch plate and keep pulling until you can buckle it.

If the belt is not long enough, see “Safety Belt Extender” at the end of this section. Make sure the release button on the buckle faces upward or outward so you would be able to unbuckle it quickly if you ever had to.



3. To make the lap part tight, pull down on the buckle end of the belt as you pull up on the shoulder part.



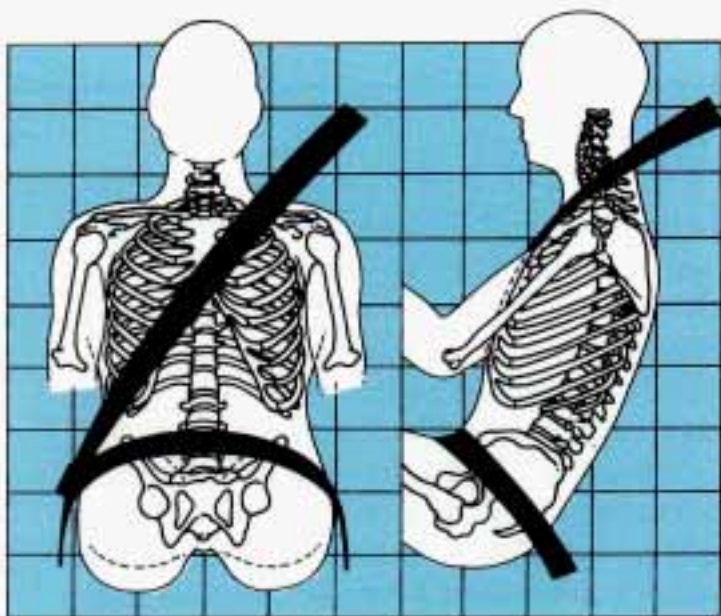

The lap part of the belt should be worn low and snug on the hips, just touching the thighs. In a crash, this applies force to the strong pelvic bones. And you'd be less likely to slide under the lap belt. If you slid under it, the belt would apply force at your abdomen. This could cause serious or even fatal injuries. The shoulder belt should go over the shoulder and across the chest. These parts of the body are best able to take belt restraining forces.

The safety belt locks if there's a sudden stop or a crash.



## CAUTION:

You can be seriously hurt if your shoulder belt is too loose. In a crash you would move forward too much, which could increase injury. The shoulder belt should fit against your body.



- To unlatch the belt, just push the button on the buckle.

## Children



Everyone in a vehicle needs protection! That includes infants and all children smaller than adult size. In fact, the law in every state and Canadian province says children up to some age must be restrained while in a vehicle.

## Smaller Children and Babies



### **CAUTION:**

Smaller children and babies should always be restrained in a child or infant restraint. The instructions for the restraint will say whether it is the right type and size for your child. A very young child's hip bones are so small that a regular belt might not stay low on the hips, as it should. Instead, the belt will likely be over the child's abdomen. In a crash the belt would apply force right on the child's abdomen, which could cause serious or fatal injuries. So, be sure that any child small enough for one is always properly restrained in a child or infant restraint.



## CAUTION:

Never hold a baby in your arms while riding in a vehicle. A baby doesn't weigh much – until a crash. During a crash a baby will become so heavy you can't hold it. For example, in a crash at only 25 mph (40 km/h), a 12-pound (5.5 kg) baby will suddenly become a 240-pound (110 kg) force on your arms. The baby would be almost impossible to hold.



CAUTION: (Continued)

## CAUTION: (Continued)

Secure the baby in an infant restraint.



## Child Restraints

Be sure to follow the instructions for the restraint. You may find these instructions on the restraint itself or in a booklet, or both. These restraints use the belt system in your vehicle, but the child also has to be secured within the restraint to help reduce the chance of personal injury. The instructions that come with the infant or child restraint will show you how to do that.

### Where to Put the Restraint

Accident statistics show that children are safer if they are restrained in the rear rather than the front seat. We at General Motors therefore recommend that you put your child restraint in the rear seat unless the child is an infant and you're the only adult in the vehicle. In that case, you might want to secure the restraint in the front seat where you can keep an eye on the baby.

Wherever you install it, be sure to secure the child restraint properly.



### **CAUTION:**

**An unsecured child restraint can move around in a collision or sudden stop and injure people in the vehicle. Be sure to properly secure any child restraint in your vehicle -- even when no child is in it.**

## Top Strap

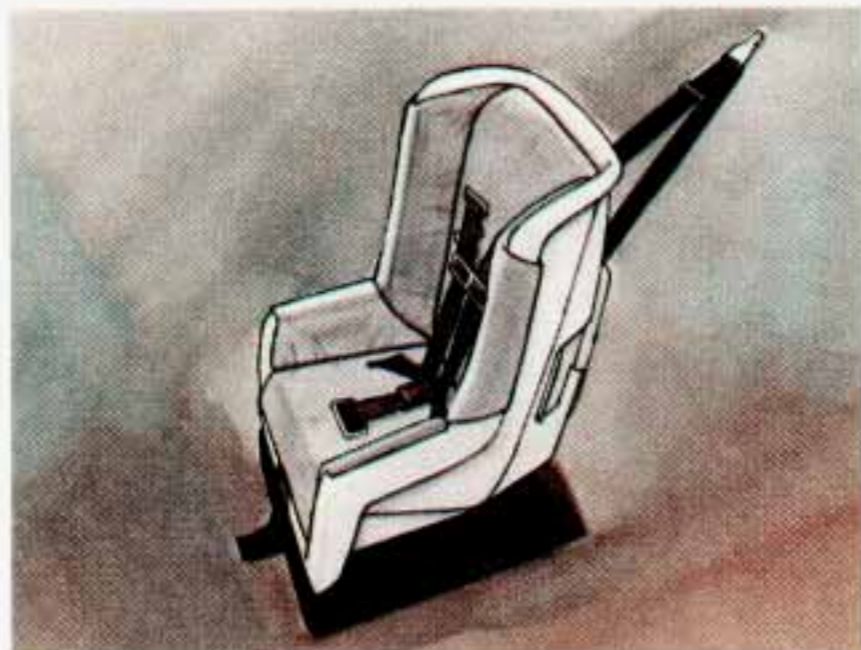

If your child restraint has a top strap, it should be anchored.

If you need to have an anchor installed, you can ask your Buick dealer to put it in for you. If you want to install an anchor yourself, your dealer can tell you how to do it.

Vehicles first sold in Canada have child restraint anchor bracket hardware in the glove box, along with instructions for installing it. This should be used only with a child restraint, and only to secure a child restraint at a rear seating position. Additional anchor brackets for child restraints at the rear seating positions are available at Buick dealerships in Canada.

## Securing a Child Restraint in a Rear Outside Position

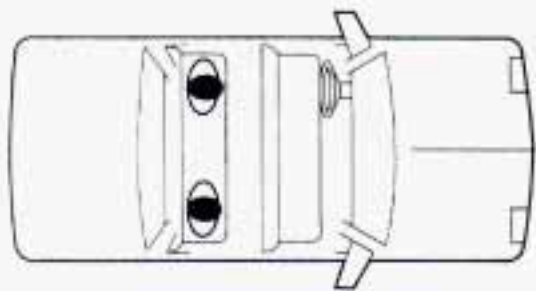

You'll be using the lap-shoulder belt. See the earlier section about the top strap if the child restraint has one.

1. Put the restraint on the seat. Follow the instructions for the child restraint.
2. Secure the child in the child restraint as the instructions say.
3. Pull out the vehicle's safety belt and run the lap part through or around the restraint. The child restraint instructions will show you how. Tilt the latch plate to adjust the belt if needed.

See if the shoulder belt would go in front of the child's face or neck. If so, put it behind the child restraint.

4. Buckle the belt. Make sure the release button faces upward or outward, so you'll be able to unbuckle it quickly if you ever need to.



5. To tighten the belt, pull up on the shoulder belt while you push down on the child restraint.



6. Push and pull the child restraint in different directions to be sure it is secure.

To remove the child restraint, just unbuckle the vehicle's safety belt and let it go back all the way. The safety belt will move freely again and be ready to work for an adult or larger child passenger.

## Securing a Child Restraint in a Center Seat Position

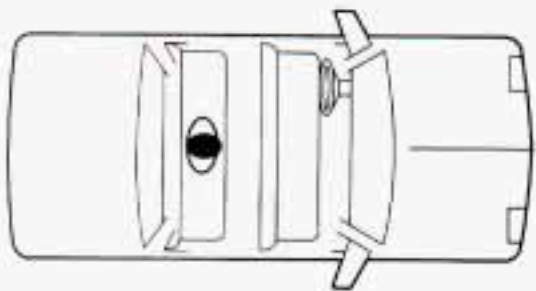

When you secure a child restraint in a center seating position, you'll be using the lap belt.

See the earlier section about the top strap if the child restraint has one.

1. Make the belt as long as possible by tilting the latch plate and pulling it along the belt.





2. Put the restraint on the seat. Follow the instructions for the child restraint.
3. Secure the child in the child restraint as the instructions say.
4. Run the vehicle's safety belt through or around the restraint. The child restraint instructions will show you how.



5. Buckle the belt. Make sure the release button faces upward or outward, so you'll be able to unbuckle it quickly if you ever need to.
6. To tighten the belt, pull its free end while you push down on the child restraint.
7. Push and pull the child restraint in different directions to be sure it is secure. If the child restraint isn't secure, turn the latch plate over and buckle it again. Then see if it is secure. If it isn't, secure the restraint in a different place in the vehicle and contact the child restraint maker for their advice.

To remove the child restraint, just unbuckle the vehicle's safety belt. It will be ready to work for an adult or larger child passenger.

## Securing a Child Restraint in the Right Front Seat

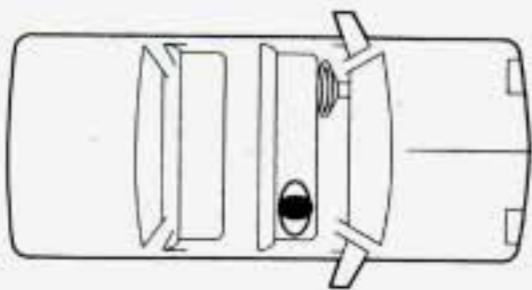

To use a child restraint here, you will need a special infant/child seat attaching belt and the hardware that goes with it. See the earlier section about the top strap if the child restraint has one.

Your dealer can get these and install the hardware for you. It's free. The special belt is GM Part Number 12340286. Your dealer can find the correct hardware in the accessory section of the GM Parts Catalog.



### **CAUTION:**

**Don't use the special infant/child seat attaching hardware in another vehicle. If you do, it may not work well and the child may not be protected properly in a crash. The special hardware is for your vehicle only.**

**Also, don't use the special belt for anything but securing a child restraint in the right front seat. If an adult or older child uses it, the belt won't provide protection and may even increase injury in a crash.**

Once the special hardware is installed, please follow the instructions with it and these steps:

1. Unbuckle the automatic lap-shoulder belt by pushing the button on the buckle.



2. Snap one hook of the infant/child seat attaching belt near the floor at the door side of the seat.



It will stay on the door, ready to be rebuckled for use by adults or older children.

3. Put the belt's special latch plate into the vehicle's safety belt buckle.



4. You can make the belt longer by tilting the buckle and pulling it along the belt.



5. Put the restraint on the seat. Follow the instructions for the child restraint.
6. Secure the child in the child restraint as the instructions say.

7. Run the belt through or around the child restraint.  
The child restraint instructions will show you how.
8. Put the hook on the free end through the slot in the latch plate.



9. To make it tight, pull the belt while you push down on the child restraint. If the belt won't stay tight, switch it end for end.

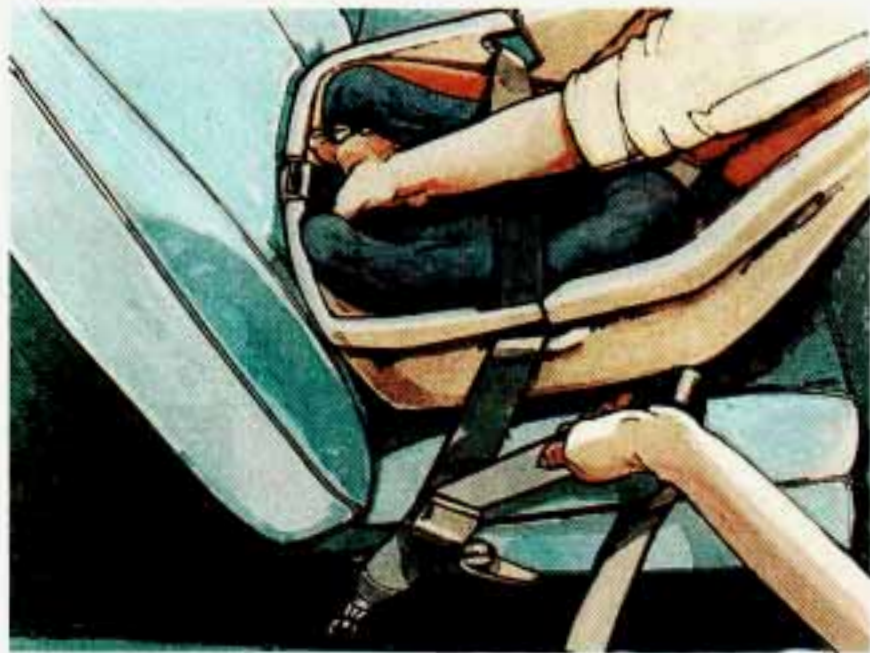

10. Push and pull the child restraint in different directions to be sure it is secure.

### To remove the infant/child seat restraint:

1. Push the button on the safety belt buckle and remove the special latch plate. Leave the latch plate on the special belt.



2. Push the spring on the hook near the door and remove the special belt.

3. Put the belt away in a safe place in your vehicle, so it won't fly around in a crash and injure someone.
4. Remember to reattach the automatic belt again, once the child restraint is removed. Be sure it isn't twisted.

### Larger Children



Children who have outgrown child restraints should wear the vehicle's safety belts.

If you have the choice, a child should sit next to a window so the child can wear a lap-shoulder belt and get the additional restraint a shoulder belt can provide.

Accident statistics show that children are safer if they are restrained in the rear seat. But they need to use the safety belts properly.

- Children who aren't buckled up can be thrown out in a crash.

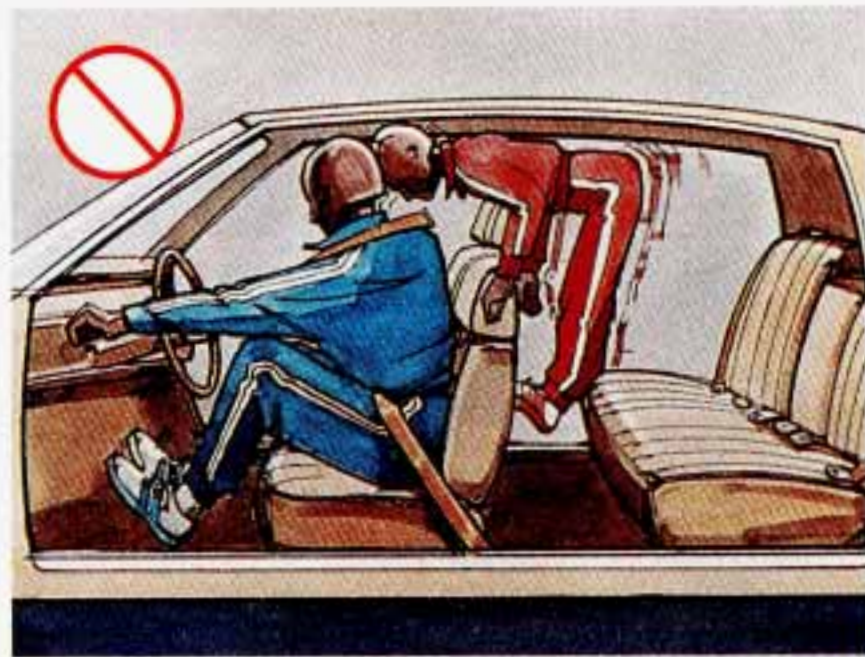

- Children who aren't buckled up can strike other people who are.



## CAUTION:

Never do this.



Here two children are wearing the same belt. The belt can't properly spread the impact forces. In a crash, the two children can be crushed together and seriously injured. A belt must be used by only one person at a time.

**Q:** What if a child is wearing a lap-shoulder belt, but the child is so small that the shoulder belt is very close to the child's face or neck?

**A:** Move the child toward the center of the vehicle, but be sure that the shoulder belt still is on the child's shoulder, so that in a crash the child's upper body would have the restraint that belts provide. If the child is so small that the shoulder belt is still very close to the child's face or neck, you might want to place the child in the center seat position, the one that has only a lap belt.





## CAUTION:

Never do this.



Here a child is sitting in a seat that has a lap-shoulder belt, but the shoulder part is behind the child. If the child wears the belt in this way, in a crash the child might slide under the belt. The belt's force would then be applied right on the child's abdomen. That could cause serious or fatal injuries.

Wherever the child sits, the lap portion of the belt should be worn low and snug on the hips, just touching the child's thighs. This applies belt force to the child's pelvic bones in a crash.

## Safety Belt Extender

If the vehicle's safety belt will fasten around you, you should use it. The automatic lap-shoulder belt has plenty of extra length built in, so it will fasten around almost all people.

But if a safety belt isn't long enough to fasten, your dealer will order you an extender. It's free. When you go in to order it, take the heaviest coat you will wear, so the extender will be long enough for you. The extender will be just for you, and just for the seat in your vehicle that you choose. Don't let someone else use it, and use it only for the seat it is made to fit. To wear it, just attach it to the regular safety belt.

## Checking Your Restraint Systems

Now and then, make sure all your belts, buckles, latch plates, retractors, anchorages and reminder systems are working properly. Look for any loose parts or damage. If you see anything that might keep a restraint system from doing its job, have it repaired.

## Replacing Safety Belts After a Crash

If you've had a crash, do you need new belts?

After a very minor collision, nothing may be necessary. But if the belts were stretched, as they would be if worn during a more severe crash, then you need new belts.

If belts are cut or damaged, replace them. Collision damage also may mean you will have to have safety belt parts, like the retractor, replaced or anchorage locations repaired -- even if the belt wasn't being used at the time of the collision.

**Q:** What's wrong with this?

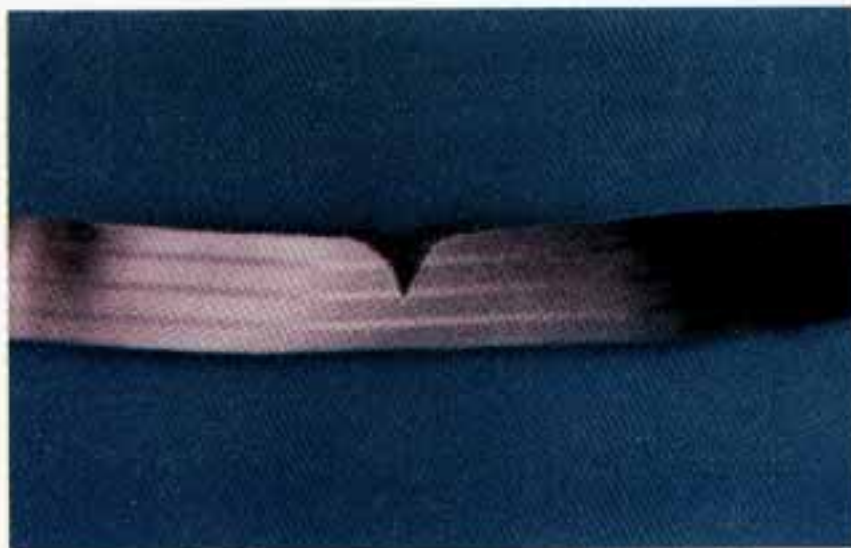

**A:** The belt is torn.



### **CAUTION:**

Torn or frayed belts may not protect you in a crash. They can rip apart under impact forces. If a belt is torn or frayed, get a new one right away.



## Part 2 Features And Controls

Here you can learn about the many standard and optional features on your Buick, and information on starting, shifting and braking. Also explained are the instrument panel and the warning systems that tell you if everything is working properly -- and what to do if you have a problem.

Part 2 includes:

Keys .....	58
Door Locks .....	59
New Vehicle Break-In .....	65
Starting the Engine .....	67
Shifting the Transaxle .....	71
Windows .....	79
Tilt Steering Wheel .....	80
Multi-Function Lever .....	81
Turn and Lane Change Signals .....	81
Headlight High-Low Beam Changer .....	83
Windshield Wiper/Washer .....	84
Cruise Control .....	86
Mirrors .....	94
Instrument Panel .....	99
Speedometer and Odometer .....	99
Warning Lights, Gages and Indicators .....	100

## Keys



### CAUTION:

Leaving young children in a vehicle with the ignition key is dangerous for many reasons. A child or others could be badly injured or even killed.

They could operate power windows or other controls or even make the vehicle move. Don't leave the keys in a vehicle with young children.

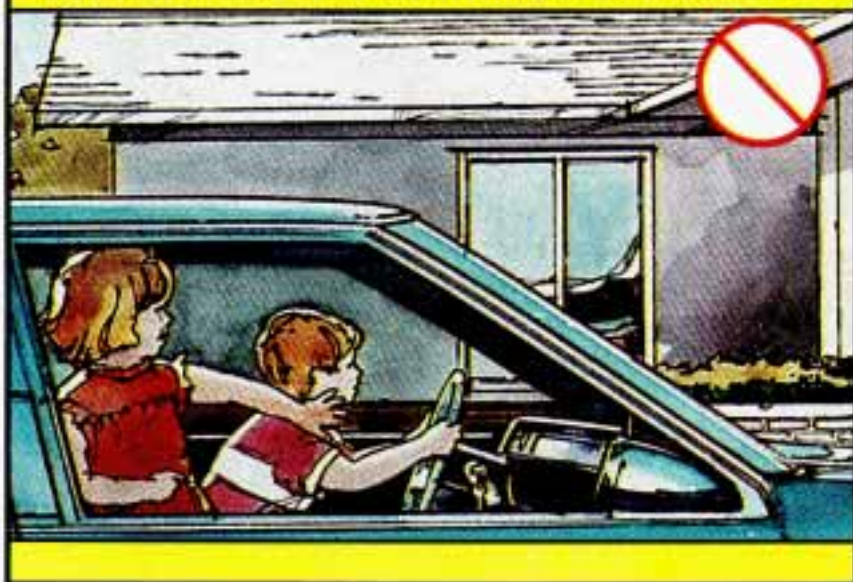

The ignition keys are for the ignition only.



The door keys are for the doors and all other locks.

When a new Regal is delivered, the dealer removes the plugs from the keys, and gives them to the first owner.

Each plug has a code on it that tells your dealer or a qualified locksmith how to make extra keys. Keep the plugs in a safe place. If you lose your keys, you'll be able to have new ones made easily using these plugs.

### **NOTICE:**

**Your Buick has a number of new features that can help prevent theft. But you can have a lot of trouble getting into your vehicle if you ever lock your keys inside. You may even have to damage your vehicle to get in. So be sure you have extra keys.**

## **Door Locks**



### **CAUTION:**

**Unlocked doors can be dangerous.**

**Passengers -- especially children -- can easily open the doors and fall out. When a door is locked, the inside handle won't open it.**

**Outsiders can easily enter through an unlocked door when you slow down or stop your vehicle.**

**This may not be so obvious: You increase the chance of being thrown out of the vehicle in a crash if the doors aren't locked. Wear safety belts properly, lock your doors, and you will be far better off whenever you drive your vehicle.**

There are several ways to lock and unlock your vehicle:



From the outside: Use your door key.

From the inside: To lock the door, move the lock control down.

To unlock the door, move the lock control up.



## Power Door Locks



Push the power door lock switch to lock or unlock all the doors at once.

## Automatic Door Locks

Just close your doors and turn on the ignition. All of your doors will lock when you move your shift lever out of "P" (Park) or "N" (Neutral). Each time you close your doors and turn on the ignition, the doors will lock automatically only once. If someone needs to get out while the vehicle is running, have that person use the manual or power lock. When the door is closed again, it will not lock automatically. Just use the manual or power lock to lock the door again.

## Leaving Your Vehicle

If you are leaving the vehicle, take your keys, open your door and set the locks from inside. Then get out and close the door.

## Remote Trunk Release (Option)

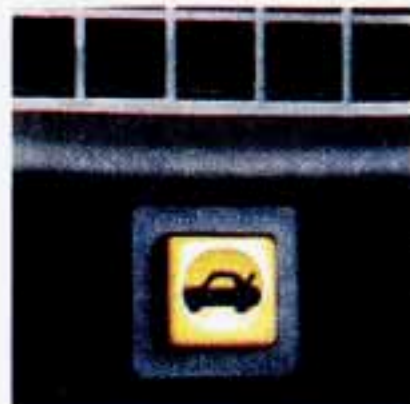

The remote trunk release button is in the glovebox. It works only when the transaxle is in Park.

If you have the Remote Keyless Entry System Option, it will also unlock your trunk.

## Remote Keyless Entry System (Option)



If your Buick has this option, you can lock and unlock your doors or unlock your trunk from up to 30 feet (9 m) away using the key chain transmitter supplied with your vehicle.

Your Remote Keyless Entry System operates on a radio frequency subject to Federal Communications Commission (FCC) Rules. This device complies with Part 15 of the FCC Rules. Operation is subject to the following two conditions: (1) This device may not cause harmful interference, and (2) This device must accept any interference received, including interference that may cause undesired operation.

Should interference to this system occur, try this:

- Check to determine if battery replacement is necessary. See the instructions on battery replacement.
- Check the distance. You may be too far from your vehicle. This product has a maximum range.
- Check the location. Other vehicles or objects may be blocking the signal.
- See your Buick dealer or a qualified technician for service.

Changes or modifications to this system by other than an authorized service facility could void authorization to use this equipment.



## Operation

The driver's door will unlock automatically when **UNLOCK** is pressed. If **UNLOCK** is pressed twice quickly, all doors will unlock. The interior lights will also come on for approximately 40 seconds and go off when the ignition is turned on.

All doors will lock when **DOOR** is pressed.

The trunk will unlock when the opened trunk symbol is pressed, but only when the transaxle is in **PARK**.

## Matching Transmitter(s) To Your Vehicle

Each key chain transmitter is coded to prevent another transmitter from unlocking your vehicle. If a transmitter is lost or stolen, a replacement can be purchased through your dealer. Remember to bring the remaining transmitter with you when you go to your dealer. When the dealer matches the replacement transmitter to your vehicle, the remaining transmitter must also be matched. Once the new transmitter is coded, the lost transmitter will not unlock your vehicle.

You can match a transmitter to as many different vehicles as you own, provided they are equipped with exactly the same model system. (General Motors offers several different models of these systems on their

vehicles.) Each vehicle can have only two transmitters matched to it.

See your dealer to match transmitters to another vehicle.

## Battery Replacement

Under normal use, the batteries in your key chain transmitter should last about two years.

You can tell the batteries are weak if the transmitter won't work at the normal range in any location. If you have to get close to your vehicle before the transmitter works, it's probably time to change the batteries.



For battery replacement, use two Duracell® batteries, type DL-2016, or a similar type.

To replace the batteries:



1. If your transmitter has a screw, remove the screw from the back cover. If there is no screw, carefully pry off the cover by inserting a dime (or similar object) in the slot between the covers and twist.
2. Lift off the front cover, bottom half first.
3. Remove and replace the batteries. Put them in as the direction under the batteries indicate.
4. Replace the front cover. Make sure the cover is on tightly, so water won't get in. Replace the screw in the back cover, if there is one. If there is no screw, snap together.
5. Check the operation of the transmitter.

## Theft

Vehicle theft is big business, especially in some cities. Although your Buick has a number of theft deterrent features, we know that nothing we put on it can make it impossible to steal. However, there are ways you can help.

**Key in the ignition:** If you walk away from your vehicle with the keys inside, it's an easy target for joy riders or professional thieves -- so don't do it.

When you park your Buick and open the driver's door, you'll hear a tone reminding you to remove your key from the ignition and take it with you. Always do this. Your steering wheel will be locked, and so will your ignition and transaxle. And remember to lock the doors.

**Parking at Night:** Park in a lighted spot, close all windows and lock your vehicle. Remember to keep your valuables out of sight. Put them in a storage area, or take them with you.

Parking Lots: If you park in a lot where someone will be watching your vehicle, it's best to lock it up and take your keys. But what if you have to leave your ignition key? What if you have to leave something valuable in your vehicle?

- Put your valuables in a storage area, like your trunk or glove box.
- Lock the glove box.
- Lock all the doors except the driver's.
- Then take the door key with you.

## New Vehicle "Break-In"

### **NOTICE:**

**Your modern Buick doesn't need an elaborate "break-in." But it will perform better in the long run if you follow these guidelines:**

- **Don't drive at any one speed -- fast or slow -- for the first 500 miles (804 km). Don't make full-throttle starts.**
- **Avoid making hard stops for the first 200 miles (322 km) or so. During this time your new brake linings aren't yet broken in. Hard stops with new linings can mean premature wear and earlier replacement. Follow this "breaking-in" guideline every time you get new brake linings.**

## Ignition Key Positions



Your key with the black plastic head operates your ignition lock.

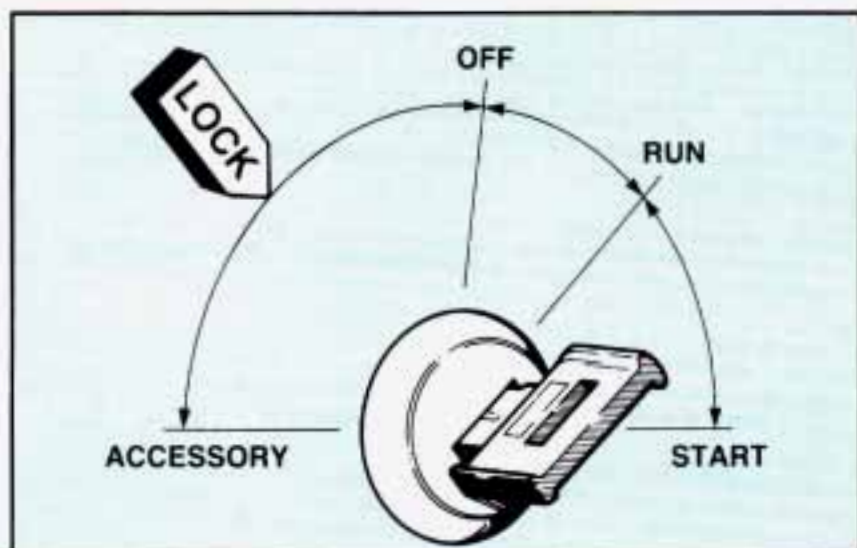

This lock gives you five different positions.

Before you put the key in, your ignition will be in the Lock position. This position locks your ignition, steering wheel and transaxle. It's a theft deterrent feature.

The other positions let you perform these functions:

**ACC:** Accessory lets you use things like the radio and the windshield wipers when the engine is off. To get into "Acc", push in the key and turn it toward you. Your

steering wheel will remain locked, just as it was before you inserted the key.

**OFF:** This position lets you turn off the engine but still turn the steering wheel. It doesn't lock the steering wheel like "Lock." Use "Off" if you must have your car in motion while the engine is off ( example, if your car is being pushed).

**RUN:** This is the position for driving.

**START:** This position starts your engine.

### **NOTICE:**

If your key seems stuck in "Lock" and you can't turn it, be sure it is all the way in. If it is, then turn the steering wheel left and right while you turn the key hard. But turn the key only with your hand. Using a tool to force it could break the key or the ignition switch. If none of this works, then your vehicle needs service.

## **Starting Your Engine**

Engines start differently. The 8th digit of your Vehicle Identification Number (VIN) shows the code letter or number for your engine. You will find the VIN at the top left of your instrument panel. (See "Vehicle Identification Number" in the Index.) Follow the proper steps to start the engine.

Move your shift lever to "P" (Park) or "N" (Neutral). Your engine won't start in any other position -- that's a safety feature. To restart when you're already moving, use "N" (Neutral) only.

### **NOTICE:**

Don't try to shift to "P" (Park) if your Buick is moving. If you do, you could damage the transaxle. Shift to "P" (Park) only when your vehicle is stopped.

To start your 3.1 Liter (Code T) engine:

1. Don't push the accelerator pedal before starting your engine. In some other vehicles you might need to do this, but because of your vehicle's computer systems, you don't.
2. Turn your ignition key to "Start." When the engine starts, let go of the key. The idle speed will go down as your engine gets warm.

**NOTICE:**

Holding your key in "Start" for longer than 15 seconds at a time will cause your battery to be drained much sooner. And the excessive heat can damage your starter motor.

3. If your engine won't start (or starts but then stops), it could be flooded with too much gasoline. Try pushing your accelerator pedal all the way to the floor and holding it there as you hold the key in "Start" for about three seconds. If the vehicle starts briefly but then stops again, do the same thing, but this time keep the pedal down for five or six seconds. This clears the extra gasoline from the engine.

**NOTICE:**

Your engine is designed to work with the electronics in your vehicle. If you add electrical parts or accessories, you could change the way the fuel injection system operates. Before adding electrical equipment, check with your dealer. If you don't, your engine might not perform properly.

If you ever have to have your vehicle towed, see the part of this Manual that tells how to do it without damaging your vehicle. See "Towing Your Vehicle" in the Index.

To start your 3.8 Liter (Code L) engine:

1. Don't push the accelerator pedal before starting your engine. In some other vehicles you might need to do this, but because of your vehicle's computer systems, you don't.
2. Turn your ignition key to "Start." When the engine starts, let go of the key. The idle speed will go down as your engine gets warm.
3. If it doesn't start right away, hold your key in "Start" for about three seconds at a time until your engine starts. Wait about 15 seconds between each try to help avoid draining your battery.

**NOTICE:**

Holding your key in "Start" for longer than 15 seconds at a time will cause your battery to be drained much sooner. And the excessive heat can damage your starter motor.

4. If your engine still won't start (or starts but then stops), it could be flooded with too much gasoline. Try pushing your accelerator pedal all the way to the floor and holding it there as you hold the key in "Start" for about three seconds. If the vehicle starts briefly but then stops again, do the same thing, but this time keep the pedal down for five or six seconds. This clears the extra gasoline from the engine. After waiting about 15 seconds, repeat the normal starting procedure.

**NOTICE:**

Your engine is designed to work with the electronics in your vehicle. If you add electrical parts or accessories, you could change the way the fuel injection system operates. Before adding electrical equipment, check with your dealer. If you don't, your engine might not perform properly.

If you ever have to have your vehicle towed, see the part of this Manual that tells how to do it without damaging your vehicle. See "Towing Your Vehicle" in the Index.

## Driving Through Deep Standing Water

### NOTICE:

If you drive too quickly through deep puddles or standing water, water can come in through your engine's air intake and badly damage your engine. If you can't avoid deep puddles or standing water, drive through them very slowly.

## Engine Block Heater (Canada Only)

In very cold weather, 0°F (-18°C) or colder, the engine block heater can help. You'll get easier starting and better fuel economy during engine warm-up.

To use the block heater:

1. Turn off the engine.
2. Open the hood and unwrap the electrical cord.
3. Plug it into a normal, grounded 110-volt outlet.



### CAUTION:

Plugging the cord into an ungrounded outlet could cause an electrical shock. Also, the wrong kind of extension cord could overheat and cause a fire. You could be seriously injured. Plug the cord into a properly grounded three-prong 110-volt outlet. If the cord won't reach, use a heavy-duty three-prong extension cord rated for at least 15 amps.

### NOTICE:

**After you've used the block heater, be sure to store the cord as it was before, to keep it away from moving engine parts. If you don't, it could be damaged.**

How long should you keep the block heater plugged in? The answer depends on the weather, the kind of oil you have, and some other things. Instead of trying to list everything here, we ask that you contact a Buick dealer in the area where you'll be parking your vehicle. The dealer can give you the best advice for that particular area.



## Automatic Transaxle

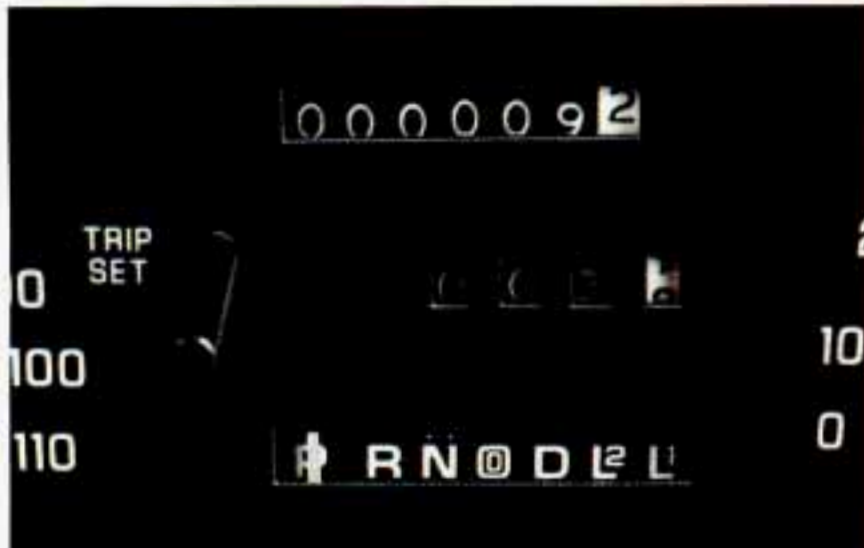

There are several different positions for your shift lever.

- **P (Park)**

This locks your front wheels. It's the best position to use when you start your engine because your vehicle can't move easily.



### CAUTION:

It is dangerous to get out of your vehicle if the shift lever is not fully in "P" (Park) with the parking brake firmly set. Your vehicle can roll.

Don't leave your vehicle when the engine is running unless you have to. If you have left the engine running, the vehicle can move suddenly. You or others could be injured. To be sure your vehicle won't move, when you're on fairly level ground, always set your parking brake and move the shift lever to "P" (Park).

See "Shifting Into "P" (Park)" in the Index. If you are parking on a hill, or if you're pulling a trailer, also see "Parking on Hills" or "Towing a Trailer" in the Index.

- **R (Reverse)**

Use this gear to back up.

## NOTICE:

Shifting to "R" (Reverse) while your vehicle is moving forward could damage your transaxle. Shift to "R" only after your vehicle is stopped.

To rock your vehicle back and forth to get out of snow, ice or sand without damaging your transaxle, see "If You're Stuck: In Sand, Mud, Ice or Snow" in the Index.

- **N (Neutral)**

In this position, your engine doesn't connect with the wheels. To restart when you're already moving, use "N" (Neutral) only.



## CAUTION:

Shifting out of "P" (Park) or "N" (Neutral) while your engine is "racing" (running at high speed) is dangerous. Unless your foot is firmly on the brake pedal, your vehicle could move very rapidly. You could lose control and hit people or objects. Don't shift out of "P" (Park) or "N" (Neutral) while your engine is racing.

## NOTICE:

Damage to your transaxle caused by shifting out of "P" (Park) or "N" (Neutral) with the engine racing isn't covered by your warranty.

- **ⓓ Automatic Overdrive**

This position is for normal driving. If you need more power for passing, and you're:

- Going less than about 35 mph (56 km/h), push your accelerator pedal about halfway down.
- Going about 35 mph (56 km/h) or more, push the accelerator all the way down.

You'll shift down to the next gear and have more power.

- **D (Third Gear)**

This is like ⓓ, but you never go into Overdrive.

Here are some times you might choose "D" instead of ⓓ:

- When driving on hilly, winding roads

- When towing a trailer, so there is less shifting between gears
- When going down a steep hill

## ● 2 (Second Gear)

This position gives you more power but lower fuel economy. You can use "2" on hills. It can help control your speed as you go down steep mountain roads, but then you would also want to use your brakes off and on.

### **NOTICE:**

Don't drive in "2" (Second Gear) for more than 5 miles (8 km), or at speeds over 55 mph (88 km/h), or you can damage your transaxle. Use "D" or "D" as much as possible.

Don't shift into "2" unless you are going slower than 65 mph (105 km/h), or you can damage your engine.

## ● 1 (First Gear)

This position gives you even more power (but lower fuel economy) than "2." You can use it on very steep hills, or in deep snow or mud. If the selector lever is put in "1," the transaxle won't shift into first gear until the vehicle is going slowly enough.

### **NOTICE:**

If your front wheels can't rotate, don't try to drive. This might happen if you were stuck in very deep sand or mud or were up against a solid object. You could damage your transaxle.

Also, if you stop when going uphill, don't hold your vehicle there with only the accelerator pedal. This could overheat and damage the transaxle. Use your brakes or shift into "P" Park to hold your vehicle in position on a hill.

Maximum engine speed is limited when the transaxle is in "D" (Drive) or "N" (Neutral) to protect driveline components from improper operation.

## Pump-to-Set Parking Brake

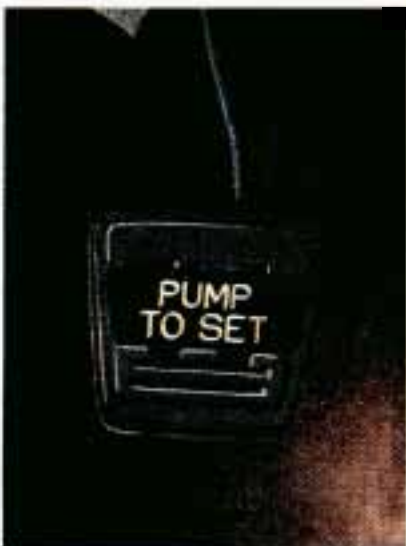

The parking brake uses the brakes on the rear wheels.

### To set the parking brake:

Hold the regular brake pedal down with your right foot. Pump your parking brake pedal several times with your left foot until the pedal feels firm. If the ignition is on, the brake system warning light will come on.

Over time, more pumps may be needed to set the parking brake firmly. If it ever takes more than two full pumps, have the brake system adjusted by your dealer.



### To release the parking brake:

Hold the regular brake pedal down. Pull the brake release lever.

### **NOTICE:**

**Driving with the parking brake on can cause your rear brakes to overheat. You may have to replace them, and you could also damage other parts of your vehicle.**

If you are on a hill: See “Parking on Hills” in the Index. That section shows how to turn your front wheels.

If you are towing a trailer and are parking on any hill: See “Towing a Trailer” in the Index. That section shows what to do first to keep the trailer from moving.

## Shifting Into “P” (Park)



### CAUTION:

It can be dangerous to get out of your vehicle if the shift lever is not fully in “P” (Park) with the parking brake firmly set. Your vehicle can roll. If you have left the engine running, the vehicle can move suddenly. You or others could be injured. To be sure your vehicle won't move, when you're on fairly level ground, use the steps that follow. If you are parking on a hill, or if you're pulling a trailer, also see “Parking On Hills” or “Towing a Trailer” in the Index.

## Steering Column Shift Lever

1. Hold the brake pedal down with your right foot and set the parking brake.
2. Move the shift lever into “P” (Park) position like this:



- Pull the lever toward you.



- Move the lever up as far as it will go.

3. Move the ignition key to "Lock."
4. Remove the key and take it with you. If you can walk away from your vehicle with the ignition key in your hand, your vehicle is in "P" (Park).

### Console Shift Lever

1. Hold the brake pedal down with your right foot and set the parking brake.

2. Move the shift lever into "P" (Park) position like this:

- Hold in the button on the lever, and push the lever all the way toward the front of your vehicle.



3. Move the ignition key to "Lock."
4. Remove the key and take it with you. If you can walk away from your vehicle with the ignition key in your hand, your vehicle is in "P" (Park).

## Leaving Your Vehicle With the Engine Running

### CAUTION:

It can be dangerous to leave your vehicle with the engine running. Your vehicle could move suddenly if the shift lever is not fully in "P" (Park) with the parking brake firmly set. And, if you leave the vehicle with the engine running, it could overheat and even catch fire. You or others could be injured. Don't leave your vehicle with the engine running unless you have to.

If you have to leave your vehicle with the engine running, be sure your vehicle is in "P" (Park) and your parking brake is firmly set before you leave it. After you've moved the shift lever into the "P" (Park) position, hold the regular brake pedal down. Then, see if you can move the shift lever away from "P" (Park) without first pulling it toward you (or, if you have the console shift lever, without first pushing the button). If you can, it means that the shift lever wasn't fully locked into "P" (Park).

## Parking Over Things That Burn



### CAUTION:

Things that can burn could touch hot exhaust parts under your vehicle and ignite. Don't park over papers, leaves, dry grass or other things that can burn.

## Engine Exhaust



### CAUTION:

Engine exhaust can kill. It contains the gas carbon monoxide (CO), which you can't see or smell. It can cause unconsciousness and death.

You might have exhaust coming in if:

- Your exhaust system sounds strange or different.
- Your vehicle gets rusty underneath.
- Your vehicle was damaged in a collision.
- Your vehicle was damaged when driving over high points on the road or over road debris.
- Repairs weren't done correctly.
- Your vehicle or exhaust system had been modified improperly.

If you ever suspect exhaust is coming into your vehicle:

- Drive it only with all the windows down to blow out any CO; and
- Have it fixed immediately.

## Running Your Engine While You're Parked

It's better not to park with the engine running. But if you ever have to, here are some things to know.



### CAUTION:

Idling the engine with the air system control off could allow dangerous exhaust into your vehicle (see the earlier Caution under "Engine Exhaust").

Also, idling in a closed-in place can let deadly carbon monoxide (CO) into your vehicle even if the fan switch is at the highest setting. One place this can happen is a garage. Exhaust -- with CO -- can come in easily. NEVER park in a garage with the engine running.

Another closed-in place can be a blizzard. (See "Blizzard" in the Index.)

CAUTION: (Continued)



**CAUTION: (Continued)**

It can be dangerous to get out of your vehicle if the shift lever is not fully in "P" (Park) with the parking brake firmly set. Your vehicle can roll. Don't leave your vehicle when the engine is running unless you have to. If you've left the engine running, the vehicle can move suddenly. You or others could be injured. To be sure your vehicle won't move, even when you're on fairly level ground, always set your parking brake and move the shift lever to "P" (Park).

Follow the proper steps to be sure your vehicle won't move. See "Shifting Into 'P' (Park)" in the Index.

If you are parking on a hill, or if you're pulling a trailer, also see "Parking on Hills" or "Towing a Trailer" in the Index.

## Power Windows (Option)

Light pressure on the driver's window switch makes the window go down as long as the switch is pressed. Press the switch all the way down and release it to make the window go all the way down. To stop the glass while it is lowering press the "UP" side of the switch. This express-down feature is only available on the driver's window.



You may have a lock out button. Press it to disable the power window switches. This will prevent passengers

from opening and closing the windows. The driver can still control all the windows with the switch in the locked position. Press it again to enable the passenger window switches.

## **Astrorooft (Option)**

The control is on the roof between the windshield and the sunroof. The ignition switch must be in the "RUN" position for the sunroof to operate.

The sunshade can be opened by grasping the handle at the front of the shade and sliding it to the rear. It will open automatically with the sliding glass panel. It must be closed manually.

To open the glass to an angled venting position, press and hold the forward portion of the switch until it stops. To close it, press and hold the rear portion of the switch until it stops.

To open the sliding glass sunroof completely, press and hold the rear portion of the switch. To close the sunroof, press and hold the front portion of the switch until it stops.

The sunroof cannot be operated manually if your car has an electrical power failure.

## **Horn**

To sound the horn, press the center of the steering wheel.

## **Tilt Wheel**

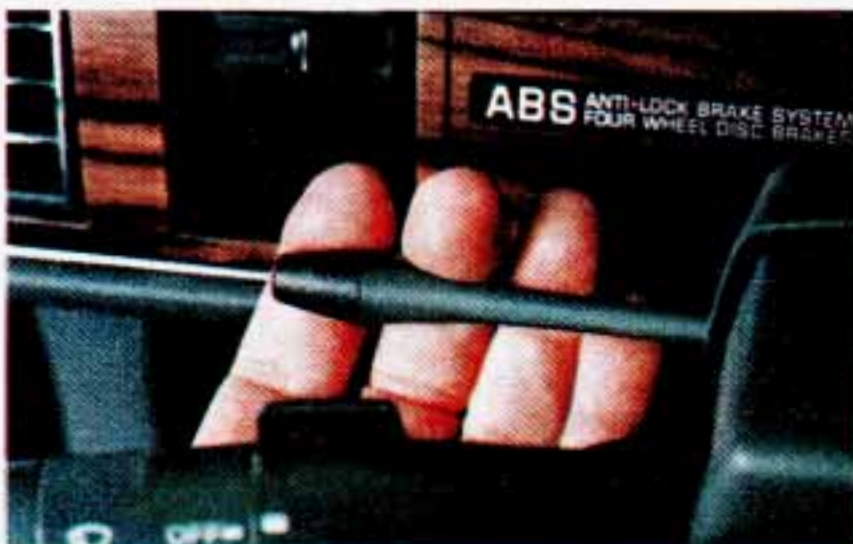

A tilt steering wheel allows you to adjust the steering wheel before you drive.

You can also raise it to the highest level to give your legs more room when you exit and enter the vehicle.

To tilt the wheel, hold the steering wheel and pull the lever. Move the steering wheel to a comfortable level, then release the lever to lock the wheel in place.

## The Turn Signal/Headlight Beam Lever

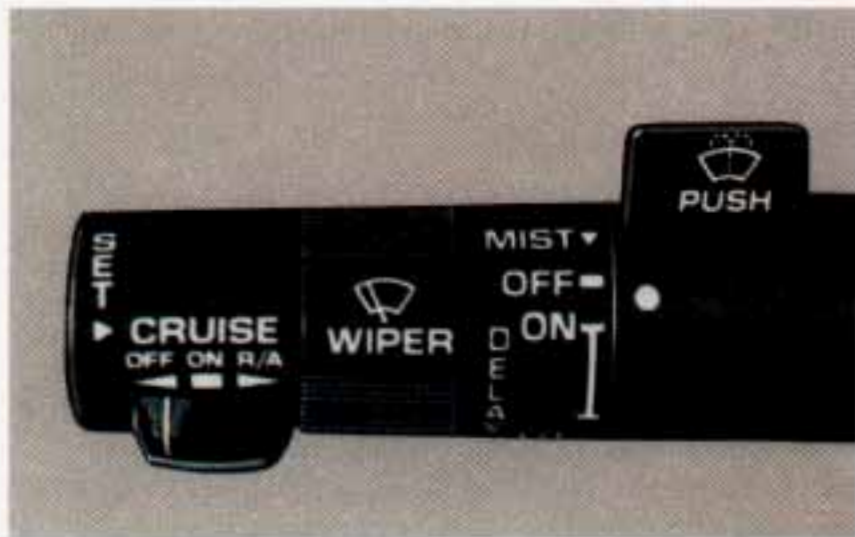

The lever on the left side of the steering column includes your:

- Turn Signal and Lane Change Indicator
- Headlight High-Low Beam & Passing Signal

- Flash-To-Pass Feature
- Windshield Wipers
- Windshield Washer
- Cruise Control (Option)

## Turn Signal and Lane Change Indicator

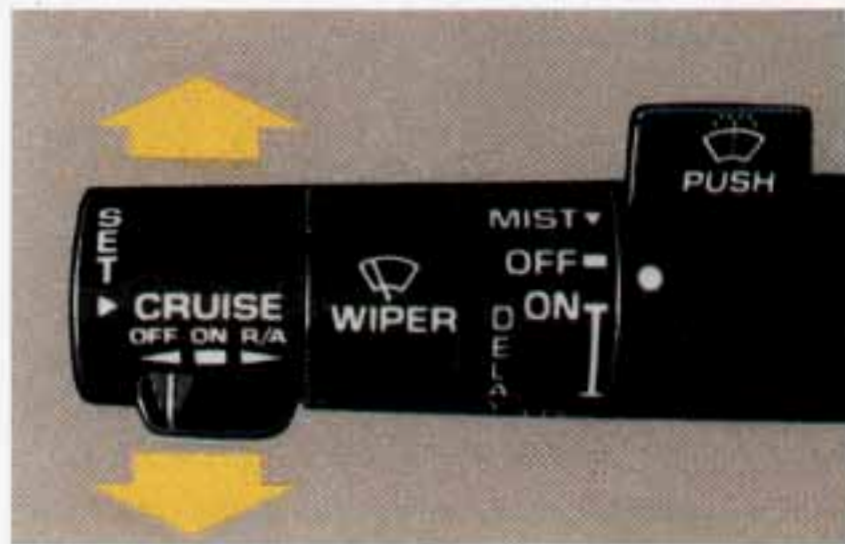

The turn signal has two upward (for Right) and two downward (for Left) positions. These positions allow you to signal a turn or a lane change.

To signal a turn, move the lever all the way up or down. When the turn is finished, the lever will return automatically.

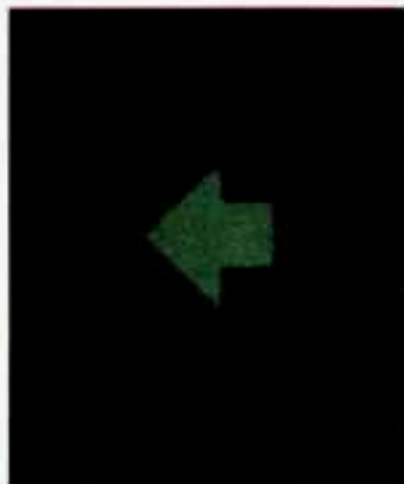

A green arrow on the instrument panel will flash in the direction of the turn or lane change.

To signal a lane change, just raise or lower the lever until the green arrow starts to flash. Hold it there until you complete your lane change. The lever will return by itself when you release it.

As you signal a turn or a lane change, if the arrows don't flash but just stay on, a signal bulb may be burned out and other drivers won't see your turn signal.

If a bulb is burned out, replace it to help avoid an accident. If the green arrows don't go on at all when you signal a turn, check the fuse (see "Fuses" in the Index) and for burned-out bulbs.

### **Turn Signal "ON" Chime**

A chime will sound if your turn signal is left on after having gone 3/4 mile, to remind you to turn your signal off.

### **Operation of Lights**

Although your vehicle's lighting system (headlights, parking lights, fog lamps, side marker lights and taillights) meet all applicable federal lighting requirements, certain states and provinces may apply their own lighting regulations that may require special attention before you operate these lights. For example, some jurisdictions may require that you operate your lower beam lights with fog lamps at all times, or that headlights be turned on whenever you must use your windshield wipers. In addition, most jurisdictions prohibit driving solely with parking lights, especially at dawn or dusk. It is recommended that you check with your own state or provincial highway authority for applicable lighting regulations.

## Headlight High-Low Beam



To change the headlights from low beam to high or high to low, pull the turn signal lever all the way toward you. Then release it. When the high beams are on, this blue light on the instrument panel also will be on.

## Flash-To-Pass Feature

This feature lets you use your high beam headlights to signal a driver in front of you that you want to pass. It works even if your headlights are off.

To use it, pull the headlight beam lever toward you a little (but not so far that you hear a click). When you do:

If your headlights are off: Your high beam headlights will turn on. They'll stay on as long as you hold the lever there. Release the lever to turn them off.

If your headlights are on, but on low beam: The system works normally. Just pull the lever until it clicks. Your headlights will shift to high beam and stay there. To return to low beam, just pull the lever toward you.

If you have fog lamps, they go off whenever the high beams go on. When the high beams go off, the fog lamps will come on again.

## Windshield Wipers

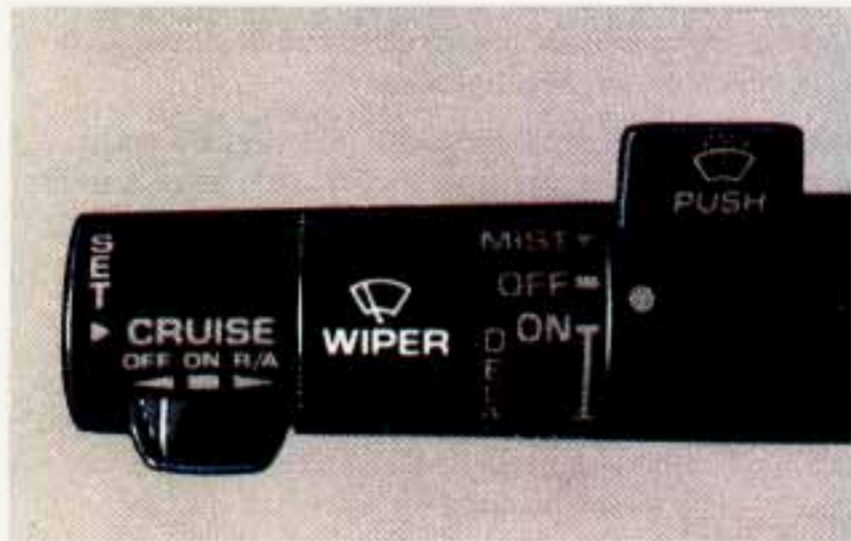

You control the windshield wipers by turning the band marked “WIPER.”

For a single wiping cycle, turn the band to “MIST.” Hold it there until the wipers start, then let go. The wipers will stop after one cycle. If you want more cycles, hold the band on “MIST” longer.

You can set the wiper speed for a long or short delay between wipes. This can be very useful in light rain or snow. Turn the band to choose the delay time. The closer to “LO,” the shorter the delay.

For steady wiping at low speed, turn the band away from you to the “LO” position. For high speed wiping, turn the band further, to “HI.” To stop the wipers, move the band to “OFF.”



### CAUTION:

Damaged wiper blades may prevent you from seeing well enough to drive safely. To avoid damage, be sure to clear ice and snow from the wiper blades before using them. If they're frozen to the windshield, carefully loosen or thaw them. If your blades do become damaged, get new blades or blade inserts.

Heavy snow or ice can overload your wipers. A circuit breaker will stop them until the motor cools. Clear away snow or ice to prevent an overload.

## Windshield Washer

At the top of the multifunction lever there's a paddle with the word "PUSH" on it. To spray washer fluid on the windshield, push the paddle. Unless they are already turned on, the wipers will operate at low speed for several sweeps, then turn off.



### CAUTION:

- Driving without washer fluid can be dangerous. A bad mud splash can block your vision. You could hit another vehicle or go off the road. Check your washer fluid level often.
- In freezing weather, don't use your washer until the windshield is warmed. Otherwise the washer fluid can form ice on the windshield, blocking your vision.

### NOTICE:

- When using concentrated washer fluid, follow the manufacturer's instructions for adding water.
- Don't mix water with ready-to-use washer fluid. Water can cause the solution to freeze and damage your washer fluid tank and other parts of the washer system. Also, water doesn't clean as well as washer fluid.
- Fill your washer fluid tank only 3/4 full when it's very cold. This allows for expansion, which could damage the tank if it is completely full.
- Don't use radiator antifreeze in your windshield washer. It can damage your washer system and paint.

## Cruise Control (Option)



With Cruise Control, you can maintain a speed of about 25 mph (40 km/h) or more without keeping your foot on the accelerator. This can really help on long trips. Cruise Control does not work at speeds below about 25 mph (40 km/h).

When you apply your brakes, the Cruise Control shuts off.



### **CAUTION:**

- Cruise Control can be dangerous where you can't drive safely at a steady speed. So, don't use your Cruise Control on winding roads or in heavy traffic.
- Cruise Control can be dangerous on slippery roads. On such roads, fast changes in tire traction can cause needless wheel spinning, and you could lose control. Don't use Cruise Control on slippery roads.



## To Set Cruise Control



1. Move the Cruise Control switch to "ON."

2. Get up to the speed you want.



3. Push in the set button at the end of the lever and release it. (The "CRUISE" light on the instrument panel will come on.)



### CAUTION:

If you leave your Cruise Control switch on when you're not using Cruise, you might hit a button and go into Cruise when you don't want to. You could be startled and even lose control. Keep the Cruise Control switch "OFF" until you want to use it.

4. Take your foot off the accelerator pedal.

## To Resume a Set Speed

Suppose you set your Cruise Control at a desired speed and then you apply the brake. This, of course, shuts off the Cruise Control. But you don't need to reset it. Once you're going about 25 mph (40 km/h) or more, you can move the Cruise Control switch from "ON" to "Resume/Accelerate" for about half a second.



You'll go right back up to your chosen speed and stay there.



## CAUTION:

If you hold the switch at "Resume/Accelerate" longer than half a second, the vehicle will keep going faster until you release the switch or apply the brake. You could be startled and even lose control. So unless you want to go faster, don't hold the switch at "Resume/Accelerate."

## To Increase Speed While Using Cruise Control

There are two ways to go to a higher speed. Here's the first:

1. Use the accelerator pedal to get to the higher speed.



2. Push the button at the end of the lever, then release the button and the accelerator pedal. You'll now cruise at the higher speed.

Here's the second way to go to a higher speed:



1. Move the Cruise switch from "ON" to "Resume/Accelerate." Hold it there until you get up to the speed you want, and then release the switch.
2. To increase your speed in very small amounts, move the switch to "Resume/Accelerate" for less than half a second and then release it. Each time you do this, your vehicle will go about 1 mph (1.6 km/h) faster.

## To Reduce Speed While Using Cruise Control



1. Push in the button at the end of the lever until you reach the lower speed you want, then release it.
2. To slow down in very small amounts, push the button for less than half a second. Each time you do this, you'll go 1 mph (1.6 km/h) slower.

## Passing Another Vehicle While Using Cruise Control

Use the accelerator pedal to increase your speed. When you take your foot off the pedal, your vehicle will slow down to the Cruise Control speed you set earlier.

## Using Cruise Control on Hills

How well your Cruise Control will work on hills depends upon your speed, load, and the steepness of the hills. When going up steep hills, you may have to step on the accelerator pedal to maintain your speed. When going downhill, you may have to brake or shift to a lower gear to keep your speed down. Of course, applying the brake takes you out of Cruise Control. Many drivers find this to be too much trouble and don't use Cruise Control on steep hills.

## To Get Out of Cruise Control

There are two ways to turn off the Cruise Control:



1. Step lightly on the brake pedal ; OR



2. Move the Cruise switch to "OFF."  
(The "CRUISE" light will go out.)

## To Erase Speed Memory

When you turn off the Cruise Control or the ignition, or shift into "P" (Park) or "N" (Neutral) your Cruise Control set speed memory is erased.

## Lights

The light controls are on the instrument panel.

It controls these light systems:



- Headlights
- Taillights
- Parking Lights
- License Lights
- Sidemarker Lights
- Instrument Panel Lights
- Interior Courtesy Lights

## Headlight “On” Warning

If the light switch is left on you’ll hear a warning tone when you turn the ignition off and open the driver’s door.

## Fog Lights (GS Only Option)



If you have the fog light feature, the control is on the instrument. The parking lights must be on, for the fog lights to work. The fog lights will turn off when you switch to high beam headlights. When you switch back to low beam headlights they will turn back on.

## Daytime Running Lights (Canada Only)

The Canadian Federal Government has decided that “Daytime Running Lights” (DRL) are a useful feature, in that DRL can make your vehicle more visible to pedestrians and other drivers during daylight hours. DRL are required on new vehicles sold in Canada.

Your DRL work with a light sensor on top of the instrument panel. Don’t cover it up.

The low beam headlights will come on at reduced brightness in daylight when:

- The ignition is on
- The headlight switch is off, and
- The parking brake is released.

At dusk, the exterior lights will come on automatically and the low beams will change to full brightness. At dawn, the exterior lights will go out and the low beams will change to the reduced brightness of DRL (if the headlight switch is off). Of course, you may still turn on the headlights any time you need to. To idle your vehicle with the DRL off, set the parking brake while the ignition is in the “Off” or “Lock” position. Then start the vehicle. The DRL will stay off until you release the parking brake.

## Front Seat Reading Lights (Option)

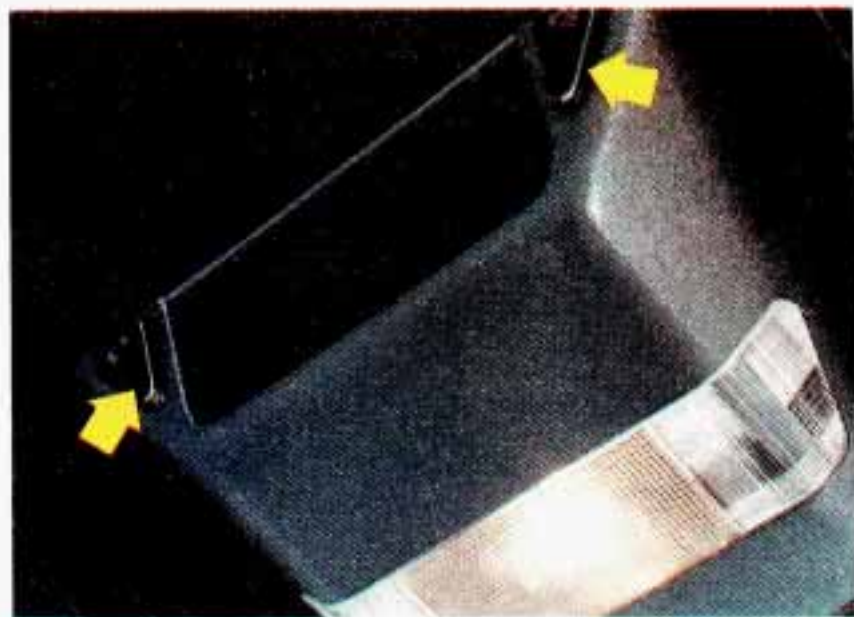

The front seat reading lights are turned on by pressing the switches.



The reading lights on the inside rearview mirror are turned on by pressing the switch.

## Courtesy Lights

When any door is opened, several lights turn on. They make it easy for you to enter and leave the car. The courtesy lights go off when the doors are closed.

The interior courtesy lights can be turned on by sliding the light switch to INT or by sliding the switch to OFF. You can also change the brightness of the instrument panel lights by sliding the switch between OFF and BRT.

The instrument panel lights will come on when a door is opened and closed. The instrument panel lights will automatically go off after approximately 30 seconds, unless the headlights or parking lights have been turned on.

## Mirrors

### Inside Mirror

When you are sitting in a comfortable driving position, adjust the mirror so you can see clearly behind your car. The day-night adjustment allows you to adjust the mirror to avoid glare from the lights behind you.

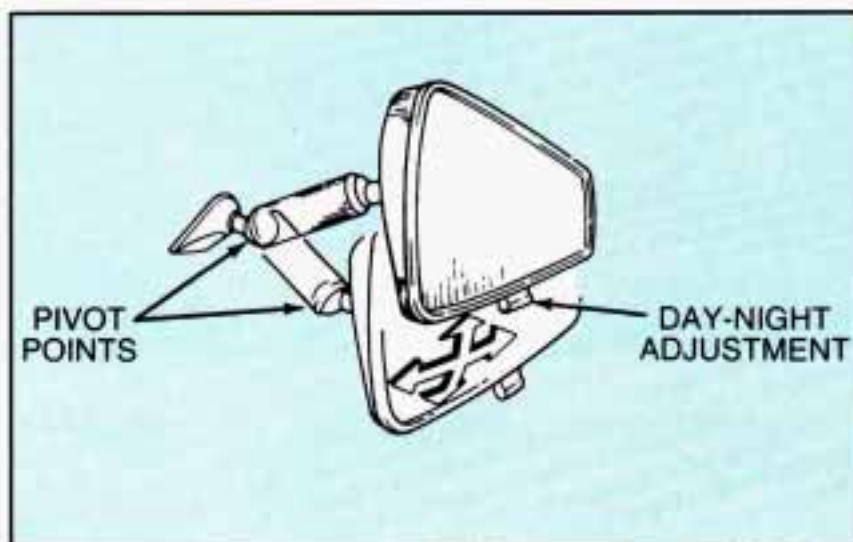



## Outside Mirrors

### Standard



To adjust your left outside mirror move the control located on the driver's door.

Adjust each mirror so you can just see the side of your car and the area behind your car.

### Optional



If your Buick has the electric mirror control, you'll find it on the driver's door.

Move the switch to choose the right or left to mirror. Press any of the four arrows to move the mirror in the desired direction. Adjust each mirror so you can just see the side of your car and the area behind your car.

## Convex Outside Mirror

Your right side mirror is convex.

A convex mirror's surface is curved so you can see more from the driver's seat.



### CAUTION:

If you aren't used to a convex mirror, you can hit another vehicle. A convex mirror can make things (like other vehicles) look farther away than they really are. If you cut too sharply into the right lane, you could hit a vehicle on your right. Check your inside mirror or glance over your shoulder before changing lanes.

## Ashtrays

The front center ashtray can be removed for cleaning.



To remove the rear ashtray for cleaning, press down on the snuffer as you pull the ashtray down and out.



This ashtray can be removed for cleaning.



## **NOTICE:**

**Don't put papers or other flammable things into your ashtrays. Hot cigarettes or other smoking materials could ignite them, causing a damaging fire.**

## **Cigarette Lighter**

It's near the ashtray. To use the cigarette lighter, push it all the way in and let it go. When it's ready, it will pop back by itself.

## **NOTICE:**

**If you hold a cigarette lighter in with your hand while it is heating, it won't be able to back away from the heating element when it's ready. That can make it overheat, damaging the lighter and the heating element.**

### **Storage Armrest (Option)**



The armrest between the front seats opens into a storage area. To open it, press the lever at the front edge and lift the cover. To use the cupholder which is stored inside, pull it up and rotate it forward. You may have an adjustable cup holder.

### **Console (Option)**

A storage area is under the center armrest, and in front of the shift lever.

### **Rear Seat Console and Pass-Through (Option)**



To open the rear seat console, pull the strap handle toward the front of the vehicle. Inside the console, is a storage area and dual cupholders.

The rear seat pass-through can be fully opened after the rear seat console has been opened. This allows you to access the trunk from inside your vehicle.

## Luggage Carrier (Option)

If you have the optional luggage carrier, you can load things on the deck lid of your vehicle. The luggage carrier has slats attached to the deck lid, a rear rail, and tiedowns.

### **NOTICE:**

**Loading cargo that weighs more than 50 lbs (23 kg) on the luggage carrier may damage your vehicle. When you carry large things, never let them hang over the rear or the sides of your vehicle. Load your cargo so that it rests on the slats and does not scratch or damage the vehicle. Put the cargo against the rear rail and fasten it securely to the luggage carrier.**

Don't exceed the maximum vehicle capacity when loading your Buick. For more information on vehicle capacity and loading, see "Loading Your Vehicle" in the Index.

To prevent damage or loss of cargo as you're driving, check now and then to make sure the luggage carrier and cargo are still securely fastened.

## The Instrument Panel: Your Information System



Your instrument panel is designed to let you know at a glance how your car is running. You'll know how fast you're going, how much fuel you're using, and many other things you'll need to now to drive safely and economically.

### Speedometer and Odometer

Your speedometer lets you see your speed in both miles per hour (mph) and kilometers per hour (km/h). Your odometer shows how far your vehicle has been driven, in either miles (used in the U.S.) or kilometers (used in Canada).

Your Buick has a "tamper-resistant odometer." On the standard odometer, if you can see silver lines between

the numbers, probably someone has tried to turn it back. The numbers may not be true.

You may wonder what happens if a car has to have a new odometer installed. If possible, the new one has to be set to the same reading the old one had. If it can't be, then it's set at zero, but a label on the driver's door must show the old reading and when the new one was installed.

## Trip Odometer



A trip odometer can tell you how many miles you have driven since you last set it back to zero. To reset it, push the trip set knob.

## Warning Lights, Gages and Indicators

This section describes the warning lights and gages that may be on your vehicle. The pictures will help you locate them.

Warning lights and gages can signal that something is wrong before it becomes serious enough to cause an expensive repair or replacement. Paying attention to your warning lights and gages could also save you or others from injury.

Warning lights go on when there may be or is a problem with one of your vehicle's functions. As you will see in the details on the next few pages, some warning lights come on briefly when you turn the ignition key just to let you know they're working. If you are familiar with this section, you should not be alarmed when this happens.

Gages can indicate when there may be or is a problem with one of your vehicle's functions. Often gages and warning lights work together to let you know when there's a problem with your vehicle.

When one of the warning lights comes on and stays on when you are driving, or when one of the gages shows there may be a problem, check the section that tells you what to do about it. Please follow the manual's advice. Waiting to do repairs can be costly -- and even dangerous. So please get to know your warning lights and gages. They're a big help.

## Fuel Gage



Your fuel gage shows about how much fuel is in your tank. It works only when the engine is on. When the indicator nears "E," you still have a little fuel left. You need to get more right away.

Here are four concerns some owners have had about the fuel gage. All these situations are normal and indicate nothing wrong with the fuel gage.

- At the gas station, the gas pump shuts off before the gage reads "F".
- It takes more (or less) gas to fill up than the gage indicated. For example, the gage indicated 1/2 full, but it took more -- or less -- than half of the tank's capacity to fill it.
- The gage moves a little when you turn a corner, speed up, or stop your vehicle.
- When you turn the engine off, the gage doesn't go all the way back to "E".

## Low Fuel Light



When your fuel gage reads in the red band, this light will go on. You should get more fuel as soon as you can.

## Brake System Warning Light



Your Buick's hydraulic brake system is divided into two parts. If one part isn't working, the other part can still work and stop you. For good braking, though, you need both parts working well.

If the warning light goes on, there could be a brake problem. Have your brake system inspected right away.

This light should come on as you start the vehicle. If it doesn't come on then, have it fixed so it will be ready to warn you if there's a problem.

This light will also come on when you set your parking brake, and will stay on if your parking brake doesn't release fully. If it stays on after your parking brake is fully released, it means you have a brake problem. If the light comes on while driving, pull off the road and stop carefully. You may notice that the pedal is harder to push. Or, the pedal may go closer to the floor. It may take longer to stop. If the light is still on, have the vehicle towed for service. (See "Towing Your Vehicle" in the Index.)



### CAUTION:

**Your brake system may not be working properly if the brake warning light is on. Driving with the brake warning light on can lead to an accident. If the light is still on after you've pulled off the road and stopped carefully, have the vehicle towed for service.**



## Anti-Lock Brake System Warning Light (Option)

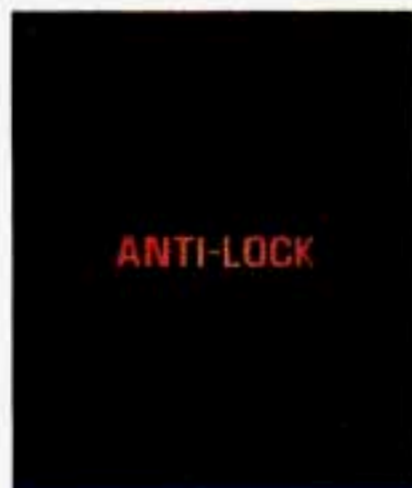

With anti-lock, this light will go on unless you start your engine and it will stay on for three seconds. If the light doesn't come on, have it fixed so it will be ready to warn you if there is a problem.

If the light stays on or comes on when you're driving, stop as soon as possible and turn the key off. Then start the engine to reset the system. If the light still stays on, or comes on again while you're driving, your Buick needs service. Unless the regular brake system warning light is also on, you will still have brakes, but not

anti-lock brakes. If the regular brake system warning light is also on, see "Brake System Warning Light" earlier in this part.

If the anti-lock brake system warning light ever flashes, your anti-lock brake system is still working but needs service as soon as possible.

## Engine Coolant Temperature Gage



This gage shows the engine coolant temperature. If the gage pointer moves into the red area, your engine is too hot!

It means that your engine coolant has overheated. If you have been operating your vehicle under normal driving conditions, you should pull off the road, stop your vehicle and turn off the engine as soon as possible.

## HOT COOLANT CAN BURN YOU BADLY!

In "Problems on the Road," this manual shows what to do. See "Engine Overheating" in the Index.

### Low Coolant Warning Light



If this light comes on, your system is low on coolant and the engine may overheat.

See "Engine Coolant" in the Index and have your vehicle serviced as soon as you can.

### Engine Oil Pressure Gage



You can read your engine oil pressure directly from the gage on your instrument panel.

If the gage reads in the red band and stays there, it means oil isn't going through your engine properly. You could be low on oil, or you might have some other oil problem. Have your vehicle serviced as soon as you can.



## **CAUTION:**

Don't keep driving if the oil pressure is low. If you do, your engine can become so hot that it catches fire. You or others could be burned. Check your oil as soon as possible and have your vehicle serviced.

## **NOTICE:**

Damage to your engine from neglected oil problems can be costly and is not covered by your warranty.

## **Low Oil Warning Light**



When the "LOW OIL" light comes on you should check your engine oil level and add engine oil. See "Engine Oil" in the Index.

## Volts Gage



The "VOLTS" gage shows voltage in the electrical system. The normal range is 11 to 15 volts. If the gage reading stays in either red range, have your Buick dealer check the electrical system.

## Check Gages Light



The "CHECK GAGES" light indicates that there is an engine or electrical problem. If the "TEMP," "OIL" or "VOLTS" gages read properly, there may still be an electrical problem which should be checked by your Buick dealer.

## Malfunction Indicator Lamp (Service Engine Soon Light)



A computer monitors operation of your fuel, ignition and emission control systems. This light should come on when the ignition is on, but the engine is not running, as a check to show you it is working. If it does not come on at all, have it fixed right away. If it stays on, or it comes on while you are driving, the computer is indicating that you have a problem. You should take your vehicle in for service soon.

### **NOTICE:**

If you keep driving your vehicle with this light on, after a while the emission controls won't work as well, your fuel economy won't be as good and your engine may not run as smoothly. This could lead to costly repairs not covered by your warranty.

## Tachometer



The tachometer tells you how fast the engine is running. It shows speed in revolutions per minute (RPM). Do not operate your engine in the red line range. If you do you can cause severe engine damage.



## Part 3 Comfort Controls And Audio Systems

In this part you'll find out how to operate the comfort control systems and audio systems offered with your Buick. Be sure to read about the particular system supplied with your vehicle.

Part 3 includes:

Comfort Control System .....	110
Heater and Defroster .....	111
Air Conditioner .....	111
Rear Window Defogger .....	113
Ventilation .....	112
Audio Systems .....	113
Setting the Clock .....	116, 121
Radio Controls .....	115, 119
Tape Player Controls .....	117, 121
CD Player Controls .....	118
Understanding Radio Reception .....	113
Care of Cassette Tape Player & Tapes .....	123
Care of Compact Discs .....	124
Antenna Care .....	124

## Your Buick Comfort Control System



Fresh air from outside your vehicle flows through your Buick when the car is moving. When the vehicle is not moving, you can get outside air to flow through by selecting any air choice (except the rear window defogger) and the HI fan speed.

### Air Outlets

Adjust the direction of air flow by moving the louvered vents.



### Fan Control

The fan control is used to select the blower speed.



## Temperature Control

Move the TEMP slide control to change the temperature of the air coming through your air outlets.



If you have the optional dual control air conditioner you have a second temperature lever.

The top lever control the temperature for the driver. The lower lever controls the temperature for the front seat passenger. Both use the same mode and fan speed.

## Air Conditioning

The air conditioning has three settings. On very hot days, open the windows long enough to let hot inside air escape. This reduces the amount of work your air

conditioner's compressor will have to do, which should help fuel economy.

### Max

This provides maximum cooling with the least amount of work. This setting recirculates much of the air inside your vehicle so it maximizes your air conditioner's performance and fuel economy.

### Norm

Use for normal cooling on hot days. This setting cools outside air and directs it through the instrument panel outlets.

### Bi-Lv (Bi-Level)

This setting is designed for use on sunny days where the air is only moderately warm or cool. On days like these, the sun may adequately warm your upper body, but your lower body may not be warm enough.

The Bi-level setting directs outside air into your vehicle in two ways. Cool air is directed toward your upper body through the front instrument panel outlets, while slightly warmed air is directed through the heater outlet at your feet.

The air conditioner compressor operates in all Air Conditioning positions, and the Defrost position when the outside temperature is above 40°F (4.5°C).

### Ventilation

For mild outside temperatures, when little heating or cooling is needed, press the VENT button. Air will flow through the instrument panel outlets. Use the air outlets to turn on, adjust and turn off the air flow. Adjust the TEMP lever to control the temperature.

### Heating

When outside temperatures are cold, press the button marked HTR and slide the TEMP lever toward HOT to send heated air through the floor outlets.

### Defog

When your windshield is foggy, press the DEFOG button to direct most of the air flow toward the windshield. When it's 50°F (10°C) or warmer, the system will provide cooled air.

### Defrost



When fog or ice is on the windshield, this setting directs the maximum air flow toward the windshield.

Operate the system in another setting for 30 seconds before pushing this button. This will take moist air out of the system to avoid fogging of the windshield. When it's 50°F (10°C) or warmer the system will provide cooled air.

### Off

When the system is off, the ventilation system will allow air to flow through your Buick when the vehicle is moving.

## Rear Window Defogger (Option)



The lines you see on the rear window warm the glass. Press the button to start warming your window. After 10 minutes, it will go off by itself or pressing the button again during the heating cycle will shut it off. If you need additional warming time, push the button again.

### **NOTICE:**

**Scraping the inside of your rear window could cut and damage the heater. Your warranty would not cover this damage. And don't put decals there; you might have to scrape them off.**

## Audio Systems

Your Delco® audio system has been designed to operate easily and give years of listening pleasure. But you will get the most enjoyment out of it if you acquaint yourself with it first. Find out what your Delco® system can do and how to operate all its controls, to be sure you're getting the most out of the advanced engineering that went into it.

### FM Stereo

FM stereo will give you the best sound. But FM signals will reach only about 10 to 40 miles (16 to 65 km). And, tall buildings or hills can interfere with FM signals, causing the sound to come and go.

### AM

The range for most AM stations is greater than for FM, especially at night. The longer range, however, can cause stations to interfere with each other. AM can pick up noise from things like storms and power lines. Try reducing the treble to reduce this noise.

## AM Stereo

This means the Delco® system can receive C-QUAM® stereo broadcasts. Many AM stations around the country use C-QUAM® to produce stereo, though some do not. (C-QUAM® is a registered trademark of Motorola, Inc.) If your Delco® system can get C-QUAM®, your “STEREO” light will come on when you’re receiving it.



### CAUTION:

Hearing damage from loud noise is almost undetectable until it is too late. Your hearing can adapt to higher volumes of sound. Sound that seems normal can be loud and harmful to your hearing. Take precautions by adjusting the volume control on your radio to a safe sound level before your hearing adapts to it.

To help avoid hearing loss or damage:

- Adjust the volume control to the lowest setting.
- Increase volume slowly until you hear comfortably and clearly.

### NOTICE:

**Before you add any sound equipment to your vehicle -- like a tape player, CB radio, mobile telephone or two-way radio -- be sure you can add what you want. If you can, it's very important to do it properly. Added sound equipment may interfere with the operation of your vehicle's engine, Delco® radio or other systems, and even damage them. And, your vehicle's systems may interfere with the operation of sound equipment that has been added improperly.**

**So, before adding sound equipment, check with your dealer and be sure to check Federal rules covering mobile radio and telephone units.**



## To Play This Radio

### On-Off

Press the OFF-VOL knob to turn the radio on and off. (The radio also goes on/off with the ignition).

### Vol

The volume knob increases and decreases volume when it is held slightly rotated against the spring load.

### Tune

Rotate the tune knob to tune in radio stations. The tune knob increases and decreases station frequency when it is held slightly rotated against the spring load.

### Fade

The fade control moves the sound between the front and rear speakers.

### Bal

The control behind the fade control allows you to balance the sound between the right and left speakers.

### AM/FM

Press the AM/FM button to get AM or FM.

### Seek

Press the SEEK button to go to the next higher station and stay there. Push it again and it will find the next higher station.

## Scan

Press the SCAN button to hear each station for a few seconds. Push it again to stop scanning.

## Pushbuttons

The five pushbuttons let you return to favorite stations. To set the pushbuttons for up to ten stations (5 AM and 5 FM).

- Tune in the desired station.
- Press SET.
- Within 5 seconds, push one of the pushbuttons. Whenever you push that button again, the preset station will return.
- Repeat these steps for each pushbutton.

## Clock

To set the clock,

- Press SET. SET must be lit in VF display before adjusting the clock.
- Within 5 seconds, push and hold the SCAN button until the correct minute appears.
- Push and hold the SEEK button until the correct hour appears.

## Bass

Press the (BAS +) side of the button to increase bass tones and press the (BAS -) side of the button to decrease bass tones. Press the center of the control for the preset bass setting.

## Treble

Press the (TRB +) side of the button to increase treble tones and press the (TRB -) side of the button to decrease treble tones. Press the center of the control for the preset treble setting.



## To Play A Cassette

Your tape player is built to work best with tapes that are 30 to 45 minutes long on each side. Tapes longer than that are so thin they may not work well in this player.

With the radio on, press a tape into the slot marked AUTO REVERSE (tape side goes in first).

Once the tape is playing, use the volume, balance and fade just as you did for the radio. The arrows indicate which side of the tape is being played.

### Program

To go from one side of the tape to the other, press the PROG button.

### Fwd

To advance the tape, press FWD and the tape will rapidly go forward until you press the REV button lightly.

### Rev

To reverse the tape, press REV and the tape will rapidly go backward until you press the FWD button lightly.

### Eject

To remove the tape and switch to the radio, press EJCT button.



## To Play A Compact Disc

Use full -size compact discs. DO NOT use mini-discs that are called singles. They won't eject.

To turn the system on, the radio power must be on.

Insert a disc partway into the slot, label side up. The player will pull it in. The word CD IN will appear in the graphic display. Wait a few seconds and the disc should play.

If the disc comes back out, check whether:

- The disc is upside down.
- It is dirty, scratched, or wet.
- There's too much moisture in the air. (If there is, wait about one hour and try again.)

## **RCL**

Press RCL to see what track is playing. Press it again within 5 seconds to see how long the CD has been playing that track.

The track number also appears when you change the volume or when a new track starts to play.

## **NEXT**

Press NEXT to hear the next track now (instead of waiting until the present track is finished.) If you hold this button, or press it more than once, the disc will advance further.

## **PREV**

If you press and hold the PREV button, or press it more than once, the disc will return to previous tracks.

## **SCAN**

Press SCAN to hear the first ten seconds of each track. Press it again to stop scanning.

## **STOP**

By pressing STOP, the compact disc will stop playing and the radio will play.

## **PLAY**

Pressing PLAY will cause the radio to stop and the compact disc will play, if there is one inserted.

## **COMP**

Pressing the COMP button makes soft and loud passages more equal in volume.

## **EJCT**

By pressing EJECT, the disc will eject and the radio will play. The disc will start at track one when you reinsert it.

Press the OFF-VOL knob or turn the ignition key off to stop the disc player. The disc stays in the player and will resume playing at the point where it stopped.





## To Play This Radio

### On-Off

Press Off-Vol knob to turn the radio on or off when the ignition is on.

### Volume

The volume knob increases and decreases volume when it is held slightly rotated against the spring load.

### Tune

The tune knob increases and decreases station frequency when it is held slightly rotated against the spring load.

### Fade

The fade control fades the sound between your front and rear speakers. It operates like the volume and tune controls.

### Balance

The control behind the fade control allows you to balance the sound between the right and left speakers. It operates like the fade control.

### AM/FM

Press the AM/FM button to select either AM or FM radio band. The band you select will be displayed along with the frequency of the station. If the station is in stereo, a STEREO indicator will also be displayed.

### Seek

Press the SEEK button to search for the next station up the AM or FM radio band. Press it again to go to the next higher station.

## Scan

Press the SCAN button to hear each station for a few seconds. Push it again to stop scanning.

## Pushbuttons

The five buttons can be used to preset ten radio stations (5 AM and 5 FM stations.)

- Tune in the desired station.
- Press SET. (The SET indicator will appear on the screen for five seconds.)
- While the SET indicator is displayed, press one of the five buttons. Whenever you press that button again, the preset station will return.
- Repeat these steps for each of 5 AM and 5 FM stations.

## Loud

Press LD to increase the bass response.

## Mute

Pressing Mute allows you to silence the radio or tape player; press again to listen. During mute, only volume up works.

## Clock

With the ignition on and the radio off, press SET. The set indicator will appear on the display for five seconds.

- During that five seconds, press SCAN to set the minute.
- Press SET again. Within 5 seconds, press SEEK to set the hour.



## To Play A Cassette Player

To turn the system on, the radio power must be on. The radio will play until a cassette is pushed into the cassette entry door (the tape side goes in first). Do not use tapes that are longer than 92 minutes (46 minutes on each side.)

Once the tape is playing, use the volume, balance, and fade controls just like you did for radio.

### **Equalizer**

The EQUALIZER enables you to adjust five separate sound frequencies to your individual taste.

Slide an EQUALIZER control up to emphasize a frequency, down to de-emphasize it. It's best to begin with all the controls in the middle position, then adjust each control as you like.

### **FWD**

Press to advance the tape rapidly. Press again to play the tape. (The radio plays while a tape is advancing.)

### **REV**

Press to reverse the tape rapidly. Press again to play the tape. (The radio plays while a tape is rewinding.)

### **SEEK**

To search for the next selection on the tape, press SEEK then press either FWD or REV. For the SEEK to stop, there must be at least a 4-second gap between selections on the tape.

### **PROG**

Press PROG to change the side of the tape being played. When the ▲ is lit, the selections listed on the top side of the tape are played. When the ▼ is lit, selections listed on the bottom side of the tape are played. When the end of a tape is reached, the other side will then play.

### **□□ Dolby**

Press □□ to remove unwanted noise on tapes.

### **CrO<sub>2</sub>**

When playing high bias chrome or metal tapes, press CrO<sub>2</sub>. This button sets tape bias. When playing standard tapes, press again.

### **EJCT**

Press EJCT to eject the cassette tape from the tape player.

## Steering Wheel Controls

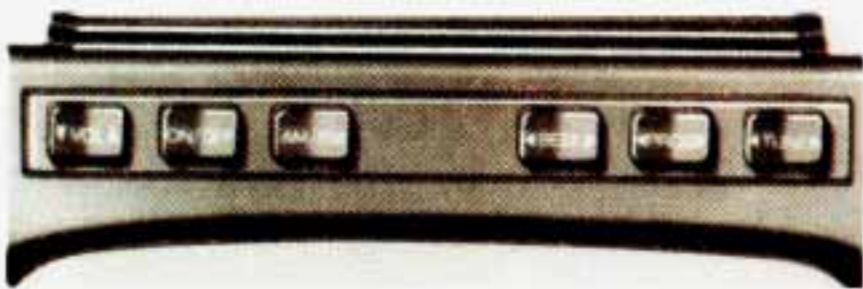

If your car has this feature, you can also control certain functions at the steering wheel.

### **On/Off**

Press ON/OFF to turn the radio on or off.

### **Vol**

To increase or decrease the volume, press VOL ▲ or ▼.

### **AM/FM**

Press this to choose AM or FM.

### **Seek**

Press ◀ to go to a lower frequency station. Press ▶ to go to a higher frequency station.

### **Prog**

Press ◀ or ▶ to hear the stations preset on your radio pushbuttons. Press five times to hear them all.

### **Tune**

Press ◀ or ▶ to tune up or down, only as long as the button is held.

## Care of Your Cassette Tape Player

A tape player that is not cleaned regularly can cause reduced sound quality, ruined cassettes, or a damaged mechanism. Cassette tapes should be stored in their cases away from contaminants, direct sunlight, and extreme heat. If they aren't, they may not operate properly or cause failure of the tape player.

Your tape player should be cleaned regularly each month or after every 15 hours of use. If you notice a reduction in sound quality, try a known good cassette to see if the tape or the tape player is at fault. If this other cassette has no improvement in sound quality, clean the tape player.

Clean your tape player with a wiping-action, non-abrasive cleaning cassette, and follow the directions provided with it.

Cassettes are subject to wear and the sound quality may degrade over time. Always make sure that the cassette tape is in good condition before you have your tape player serviced.



## Care of Your Compact Discs

Handle discs carefully. Store them in their original cases or other protective cases and away from direct sunlight and dust. If the surface of a disc is soiled, dampen a clean, soft cloth in a mild, neutral detergent solution and clean it, wiping from the center to the edge.

Be sure never to touch the signal surface when handling discs. Pick up discs by grasping the outer edges or the edge of the hole and the outer edge.

## Fixed Mast Antenna

The fixed mast antenna can withstand most car washes without being damaged. If the mast should ever become slightly bent, you can straighten it out by hand. If the mast is badly bent, as it might be by vandals, you should replace it.

Check every once in a while to be sure the mast is still tightened to the fender.

If necessary, tighten the antenna with your hand until snug and then use a wrench to tighten it another 1/4 of a turn.

## Power Antenna Mast Care

Your power antenna will look its best and work well if it's cleaned from time to time.

### To Clean the Antenna Mast:

1. Turn on the ignition and radio to raise the antenna to full mast extension.
2. Dampen a clean cloth with mineral spirits or equivalent solvent.

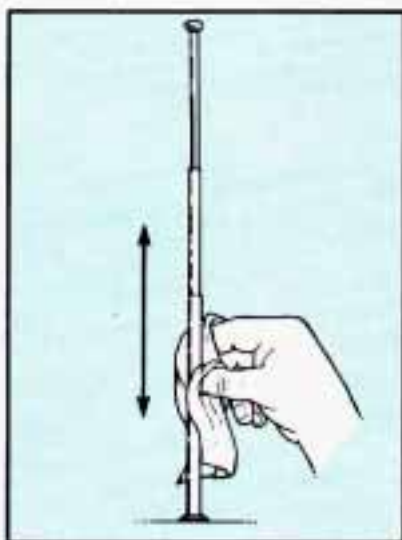

3. Wipe cloth over the mast sections, removing any dirt.

4. Wipe dry with clean cloth before retracting.
5. Make the antenna go up and down by turning the radio or ignition on and off.
6. Then repeat if necessary.

### **NOTICE:**

**Don't lubricate the power antenna. Lubrication could damage it.**

### **NOTICE:**

**Before entering an automatic car wash, turn off your radio to make the power antenna go down. This will prevent the mast from possibly getting damaged. If the antenna does not go down when you turn the radio off, it may be damaged or need to be cleaned. In either case, lower the antenna by hand by carefully pressing the antenna down.**

If the mast portion of your antenna is damaged, you can easily replace it. See your dealer for a replacement kit and follow the instructions in the kit.



*1954 Buick 56C*





## Part 4 Your Driving And The Road

Here you'll find information about driving on different kinds of roads and in varying weather conditions. We've also included many other useful tips on driving.

Part 4 includes:

Road Signs .....	128
Defensive Driving .....	134
Drunken Driving .....	135
Control of a Vehicle .....	138
Braking Tips .....	139
Steering Tip .....	144
Steering in Emergencies .....	145
Passing .....	147
Loss of Control .....	148
Driving at Night .....	149
Driving in the Rain .....	152
Driving in Fog, Mist and Haze .....	154
City Driving .....	156
Freeway Driving .....	157
Driving on a Long Trip .....	159
Hill and Mountain Roads .....	161
Parking on Hills .....	163
Winter Driving .....	166
Towing a Trailer .....	170



## Road Signs

The road signs you see everywhere are coded by color, shape and symbols. It's a good idea to know these codes so that you can quickly grasp the basic meaning or intent of the sign even before you have a chance to read it.

## Color of Road Signs



**RED** means **STOP**. It may also indicate that some movement is not allowed. Examples are **DO NOT ENTER** and **WRONG WAY**.



**YELLOW** indicates a general warning. Slow down and be careful when you see a yellow sign. It may signal a railroad crossing ahead, a no passing zone, or some other potentially dangerous situation. Likewise, a yellow solid line painted on the road means “Don’t Cross.”



**ORANGE** indicates road construction or maintenance. You’ll want to slow down when you see an orange sign, as part of the road may be closed off or torn up. And there may be workers and maintenance vehicles around, too.



**GREEN** is used to guide the driver. Green signs may indicate upcoming freeway exits or show the direction you should turn to reach a particular place.

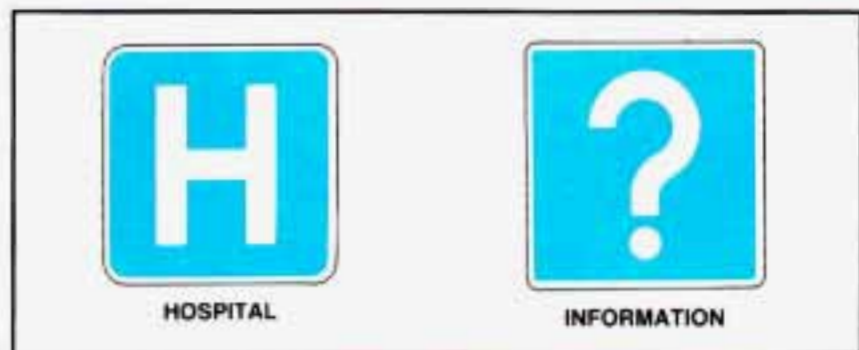

**BLUE** signs with white letters show motorists' services.



**BROWN** signs point out recreation areas or points of historic or cultural interest.

## Shape of Road Signs

The shape of the sign will tell you something, too.



An **OCTAGONAL** (eight-sided) sign means **STOP**. It is always red with white letters.



A **DIAMOND**-shaped sign is a warning of something ahead — for example, a curve, steep hill, soft shoulder, or a narrow bridge.



A **TRIANGLE**, pointed downward, indicates **YIELD**. It assigns the right-of-way to traffic on certain approaches to an intersection.



A **TRIANGULAR** sign also is used on two-lane roads to indicate a **NO PASSING ZONE**. This sign will be on the left side of the roadway.

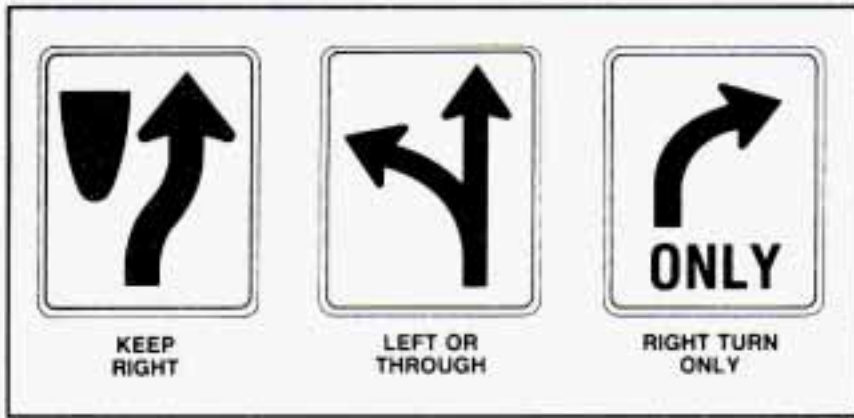

RECTANGULAR (square or oblong) signs show speed limits, parking regulations, give directions, and such information as distances to cities.

## Symbols on Road Signs



There are many international road signs in use today. The basic message of many of these signs is in pictures or graphic symbols. A picture within a circle with a diagonal line across it shows what not to do.



We're all familiar with traffic lights or stop lights. Often green arrows are being used in the lights for improved traffic control. On some multilane roads, green arrows light up, indicating that traffic in one or more lanes can move or make a turn. Green arrows don't mean "go no matter what." You'll still need to proceed with caution, yielding the right of way to pedestrians and sometimes to other vehicles.

Some traffic lights also use red arrows to signify that you must stop before turning on red.

## Traffic Lights

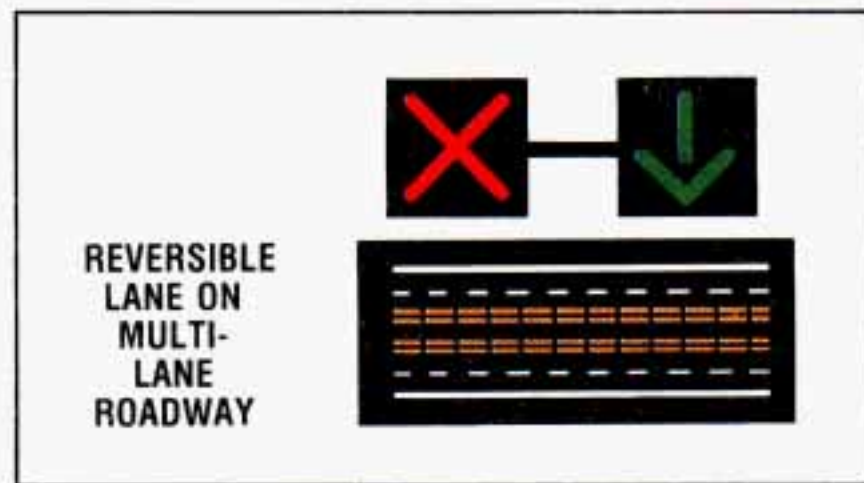
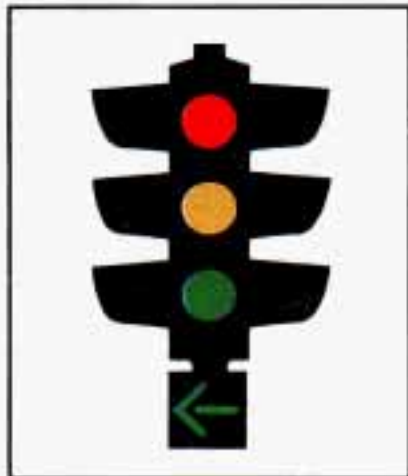

Many city roads and expressways, and even bridges, use reversible-lane traffic control during rush hours. A red X light above a lane means no driving in that lane at that

time. A green arrow means you may drive in that lane. Look for the signs posted to warn drivers what hours and days these systems are in effect.

## Pavement Markings

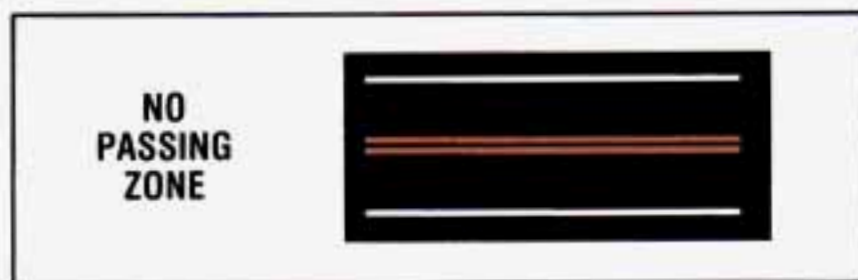

Pavement markings add to traffic signs and signals. They give information to drivers without taking attention from the roadway. A solid yellow line on your side of the road or lane means "don't cross."

## Your Own Signals

Drivers signal to others, too. It's not only more polite, it's safer to let other drivers know what you are doing. And in some places the law requires driver signals.

Turn and lane change signals. Always signal when you plan to turn or change lanes.

If necessary, you can use hand signals out the window: Left arm straight out for a left turn, down for slow or about-to-stop, and up for a right turn.

Slowing down. If time allows, tap the brake pedal once or twice in advance of slowing or stopping. This warns the driver behind you.

Disabled. Your four-way flashers signal that your vehicle is disabled or is a hazard. See "Hazard Warning Flasher" in the Index.

## Traffic Officer

The traffic police officer is also a source of important information. The officer's signals govern, no matter what the traffic lights or other signs say.

The next section discusses some of the road conditions you may encounter.

## Defensive Driving

The best advice anyone can give about driving is: Drive defensively.

Please start with a very important safety device in your Buick: Buckle up. (See "Safety Belts" in the Index.)



Defensive driving really means “be ready for anything.” On city streets, rural roads, or freeways, it means “always expect the unexpected.”

Assume that pedestrians or other drivers are going to be careless and make mistakes. Anticipate what they might do. Be ready for their mistakes.

Expect children to dash out from behind parked cars, often followed by other children. Expect occupants in parked cars to open doors into traffic. Watch for movement in parked cars -- someone may be about to open a door.

Expect other drivers to run stop signs when you are on a through street. Be ready to brake if necessary as you go through intersections. You may not have to use the brake, but if you do, you will be ready.

If you're driving through a shopping center parking lot where there are well-marked lanes, directional arrows, and designated parking areas, expect some drivers to ignore all these markings and dash straight toward one part of the lot.

Pedestrians can be careless. Watch for them. In general, you must give way to pedestrians even if you know you have the right of way.

Rear-end collisions are about the most preventable of accidents. Yet they are common. Allow enough

following distance. It's the best defensive driving maneuver, in both city and rural driving. You never know when the vehicle in front of you is going to brake or turn suddenly.

Here's a final bit of information about defensive driving. The most dangerous time for driving in the U.S. is very early on Sunday morning. In fact, GM Research studies show that the most and the least dangerous times for driving, every week, fall on the same day. That day is Sunday. The most dangerous time is Sunday from 3 a.m. to 4 a.m. The safest time is Sunday from 10 a.m. to 11 a.m. Driving the same distance on a Sunday at 3 a.m. isn't just a little more dangerous than it is at 10 a.m. It's about 134 times more dangerous!

That leads to the next section.

## **Drunken Driving**

Death and injury associated with drinking and driving is a national tragedy. It's the number one contributor to the highway death toll, claiming thousands of victims every year. Alcohol takes away three things that anyone needs to drive a vehicle:

- Judgment
- Muscular Coordination
- Vision

Police records show that half of all motor vehicle-related deaths involve alcohol — a driver, a passenger or someone else, such as a pedestrian, had been drinking. In most cases, these deaths are the result of someone who was drinking and driving. Over 25,000 motor vehicle-related deaths occur each year because of alcohol, and thousands of people are injured.

Just how much alcohol is too much if a person plans to drive? Ideally, no one should drink alcohol and then drive. But if one does, then what's "too much"? It can be a lot less than many might think. Although it depends on each person and situation, here is some general information on the problem.

The Blood Alcohol Content (BAC) of someone who is drinking depends upon four things:

- How much alcohol is in the drink.
- The drinker's body weight.
- The amount of food that is consumed before and during drinking.
- The length of time it has taken the drinker to consume the alcohol.



According to the American Medical Association, a 180-pound (82 kg) person who drinks three 12-ounce (355 ml) bottles of beer in an hour will end up with a BAC of about 0.06 percent. The person would reach the same BAC by drinking three 4-ounce (120 ml) glasses of wine or three mixed drinks if each had 1-1/2 ounces (45 ml) of a liquor like whiskey, gin or vodka.

It's the amount of alcohol that counts. For example, if the same person drank three double martinis (3 ounces or 90 ml of liquor each) within an hour, the person's

BAC would be close to 0.12 percent. A person who consumes food just before or during drinking will have a slightly lower BAC level.



The law in most U.S. states sets the legal limit at a BAC of 0.10 percent. In Canada the limit is 0.08 percent, and in some other countries it's lower than that. The BAC will be over 0.10 percent after three to six drinks (in one hour). Of course, as we've seen, it depends on how

much alcohol is in the drinks, and how quickly the person drinks them.

But it's very important to keep in mind that the ability to drive is affected well below a BAC of 0.10 percent. Research shows that the driving skills of many people are impaired at a BAC approaching 0.05 percent, and that the effects are worse at night. All drivers are impaired at BAC levels above 0.05 percent. Statistics show that the chance of being in an accident increases sharply for drivers who have a BAC of 0.05 percent or above. A driver with a BAC level of 0.06 percent (three beers in one hour for a 180-pound or 82 kg person) has doubled his or her chance of having an accident. At a BAC level of 0.10 percent, the chance of that driver having an accident is six times greater; at a level of 0.15 percent, the chances are twenty-five times greater! And, the body takes about an hour to rid itself of the alcohol in one drink. No amount of coffee or number of cold showers will speed that up.

"I'll be careful" isn't the right answer. What if there's an emergency, a need to take sudden action, as when a child darts into the street? A person with a higher BAC might not be able to react quickly enough to avoid the collision.

There's something else about drinking and driving that many people don't know. Medical research shows that

alcohol in a person's system can make crash injuries worse. That's especially true for brain, spinal cord and heart injuries. That means that if anyone who has been drinking -- driver or passenger -- is in a crash, the chance of being killed or permanently disabled is higher than if that person had not been drinking. And we've already seen that the chance of a crash itself is higher for drinking drivers.



## CAUTION:

**Drinking and then driving is very dangerous. Your reflexes, perceptions, and judgment will be affected by even a small amount of alcohol. You could have a serious -- or even fatal -- accident if you drive after drinking. Please don't drink and drive or ride with a driver who has been drinking. Ride home in a cab; or if you're with a group, designate a driver who will not drink.**

## Control of a Vehicle

You have three systems that make your vehicle go where you want it to go. They are the brakes, the steering and the accelerator. All three systems have to do their work at the places where the tires meet the road.



Sometimes, as when you're driving on snow or ice, it's easy to ask more of those control systems than the tires and road can provide. That means you can lose control of your vehicle.

## Braking

Braking action involves perception time and reaction time.

First, you have to decide to push on the brake pedal. That's perception time. Then you have to bring up your foot and do it. That's reaction time.

Average reaction time is about 3/4 of a second. But that's only an average. It might be less with one driver and as long as two or three seconds or more with another. Age, physical condition, alertness, coordination, and eyesight all play a part. So do alcohol, drugs and frustration. But even in 3/4 of a second, a vehicle moving at 60 mph (100 km/h) travels 66 feet (20 m). That could be a lot of distance in an emergency, so keeping enough space between your vehicle and others is important.

And, of course, actual stopping distances vary greatly with the surface of the road (whether it's pavement or gravel); the condition of the road (wet, dry, icy); tire tread; and the condition of your brakes.

Most drivers treat their brakes with care. Some, however, overwork the braking system with poor driving habits.

- Avoid needless heavy braking. Some people drive in spurts -- heavy acceleration followed by heavy braking -- rather than keeping pace with traffic. This is a mistake. Your brakes may not have time to cool between hard stops. Your brakes will wear out much faster if you do a lot of heavy braking.
- Don't "ride" the brakes by letting your left foot rest lightly on the brake pedal while driving.





## CAUTION:

**"Riding" your brakes can cause them to overheat to the point that they won't work well. You might not be able to stop your vehicle in time to avoid an accident. If you "ride" your brakes, they will get so hot they will require a lot of pedal force to slow you down. Avoid "riding" the brakes.**

## NOTICE:

**"Riding" the brakes wears them out much faster. You would need costly brake replacement much sooner than normal, and it also reduces fuel economy.**

If you keep pace with the traffic and allow realistic following distances, you will eliminate a lot of unnecessary braking. That means better braking and longer brake life.

- If your engine ever stops while you're driving, brake normally but don't pump your brakes. If you do, the pedal may get harder to push down. If your engine stops, you will still have some power brake assist. But you will use it when you brake. Once the power assist is used up, it may take longer to stop and the brake pedal will be harder to push.

## Anti-Lock Brakes (Option)

If your Buick has this system, your Buick has an advanced electronic braking system that will help prevent skidding.

If you have an anti-lock brake system (ABS), the brake pedal will say so. And this light on the instrument panel will go on when you start your vehicle.

When you start your vehicle and begin to drive away, you may hear a momentary motor or clicking noise. And you may even notice that your brake pedal moves a little while this is going on. This is the ABS system testing itself. If you have your foot on the brake pedal, this check won't happen until the vehicle goes about 4 mph (6 km/h) or until you take your foot off the brake pedal.

After an ABS stop, you may hear a clicking noise the next time the vehicle goes about 4 mph (6 km/h).

If there's a problem with the anti-lock brake system, the anti-lock brake system warning light will stay on or flash.

See "Anti-lock Brake System Warning Light" in the Index.



Here's how anti-lock works. Let's say the road is wet. You're driving safely. Suddenly an animal jumps out in front of you.

You slam on the brakes. Here's what happens with ABS.

A computer senses that wheels are slowing down. The computer separately works the brakes at each front wheel and at the rear wheels.

The anti-lock system can change the brake pressure faster than any driver could. The computer is programmed to make the most of available tire and road conditions.



You can steer around the obstacle while braking hard. As you brake, your computer keeps receiving updates on wheel speed and controls braking pressure accordingly.



## CAUTION:

Anti-lock doesn't change the time you need to get your foot up to the brake pedal. If you get too close to the vehicle in front of you, you won't have time to apply your brakes if that vehicle suddenly slows or stops. Always leave enough room up ahead to stop, even though you have anti-lock brakes.

### To Use Anti-Lock:

Don't pump the brakes. Just hold the brake pedal down and let anti-lock work for you. You also may hear a clicking noise as you accelerate after a hard stop.

### Disc Brake Wear Indicators

Your Buick has four-wheel disc brakes.

Disc brake pads have built-in wear indicators that make a high-pitched warning sound when the brake pads are worn and new pads are needed. The sound may come and go or be heard all the time your vehicle is moving (except when you are pushing on the brake pedal firmly).





## **CAUTION:**

The brake wear warning sound means that sooner or later your brakes won't work well. That could lead to an accident. When you hear the brake wear warning sound, have your vehicle serviced.

## **NOTICE:**

Continuing to drive with worn-out brake pads could result in costly brake repair.

Some driving conditions or climates may cause a brake squeal when the brakes are first applied or lightly applied. This does not mean something is wrong with your brakes.

Brake linings should always be replaced as complete axle sets.

## **Brake Pedal Travel**

See your dealer if the brake pedal does not return to normal height, or if there is a rapid increase in pedal travel. This could be a sign of brake trouble.

## **Brake Adjustment**

Every time you make a moderate brake stop, your disc brakes adjust for wear.

If you rarely make a moderate or heavier stop, then your brakes might not adjust correctly. If you drive in that way, then -- very carefully -- make a few moderate brake stops about every 1000 miles (1600 km), so your brakes will adjust properly.

## **Braking in Emergencies**

At some time, nearly every driver gets into a situation that requires hard braking.

If you have anti-lock, you can steer and brake at the same time. However, if you don't have anti-lock, your first reaction -- to hit the brake pedal hard and hold it down -- may be the wrong thing to do. Your wheels can stop rolling. Once they do, the vehicle can't respond to your steering. Momentum will carry it in whatever direction it was headed when the wheels stopped rolling.

That could be off the road, into the very thing you were trying to avoid, or into traffic.

If you don't have anti-lock, use a "squeeze" braking technique. This will give you maximum braking while maintaining steering control. You do this by pushing on the brake pedal with steadily increasing pressure.

In an emergency you will probably want to "squeeze" the brakes hard without locking the wheels. If you hear or feel the wheels sliding, ease off the brake pedal. This will help you retain steering control.

(If you do have anti-lock, it's different: see Index under "Anti-lock Brake System.") In many emergencies, steering can help you more than even the very best braking.

## Steering

### Power Steering

If you lose power steering assist because the engine stops or the system fails to function, you can steer but it will take much more effort.

### Steering Tips

#### Driving on Curves

It's important to take curves at a reasonable speed.

A lot of the "driver lost control" accidents mentioned on the news happen on curves. Here's why:

Experienced driver or beginner, each of us is subject to the same laws of physics when driving on curves. The traction of the tires against the road surface makes it possible for the vehicle to change its path when you turn the front wheels. If there's no traction, inertia will keep the vehicle going in the same direction. If you've ever tried to steer a vehicle on wet ice, you'll understand this.

The traction you can get in a curve depends on the condition of your tires and the road surface, the angle at which the curve is banked, and your speed. While you're in a curve, speed is the one factor you can control.

Suppose you're steering through a sharp curve. Then you suddenly apply the brakes. Both control systems -- steering and braking -- have to do their work where the tires meet the road. Unless you have four-wheel anti-lock brakes, adding the hard braking can demand too much of those places. You can lose control.

The same thing can happen if you're steering through a sharp curve and you suddenly accelerate.

Those two control systems -- steering and acceleration -- can overwhelm those places where the tires meet the road and make you lose control.

What should you do if this ever happens? Let up on the brake or accelerator pedal, steer the vehicle the way you want it to go, and slow down.

Speed limit signs near curves warn that you should adjust your speed. Of course, the posted speeds are based on good weather and road conditions. Under less favorable conditions you'll want to go slower.

If you need to reduce your speed as you approach a curve, do it before you enter the curve, while your front wheels are straight ahead.

Try to adjust your speed so you can "drive" through the curve. Maintain a reasonable, steady speed. Wait to accelerate until you are out of the curve, and then accelerate gently into the straightaway.

When you drive into a curve at night, it's harder to see the road ahead of you because it bends away from the straight beams of your lights. This is one good reason to drive slower.

## **Steering in Emergencies**

There are times when steering can be more effective than braking. For example, you come over a hill and find a truck stopped in your lane, or a car suddenly pulls

out from nowhere, or a child darts out from between parked cars and stops right in front of you. You can avoid these problems by braking -- if you can stop in time. But sometimes you can't; there isn't room. That's the time for evasive action -- steering around the problem.

Your Buick can perform very well in emergencies like these. First apply your brakes -- but, unless you have anti-lock, not enough to lock your wheels. It is better to remove as much speed as you can from a possible collision. Then steer around the problem, to the left or right depending on the space available.

An emergency like this requires close attention and a quick decision. If you are holding the steering wheel at the recommended 9 and 3 o'clock positions, you can turn it a full 180 degrees very quickly without removing either hand. But you have to act fast, steer quickly, and just as quickly straighten the wheel once you have avoided the object. You must then be prepared to steer back to your original lane and then brake to a controlled stop.

Depending on your speed, this can be rather violent for an unprepared driver. This is one of the reasons driving

experts recommend that you use your safety belts and keep both hands on the steering wheel.



The fact that such emergency situations are always possible is a good reason to practice defensive driving at all times.

## Off-Road Recovery

You may find sometime that your right wheels have dropped off the edge of a road onto the shoulder while you're driving.

If the level of the shoulder is only slightly below the pavement, recovery should be fairly easy. Ease off the accelerator and then, if there is nothing in the way, steer so that your vehicle straddles the edge of the pavement. You can turn the steering wheel up to 1/4 turn until the right front tire contacts the pavement edge. Then turn your steering wheel to go straight down the roadway.

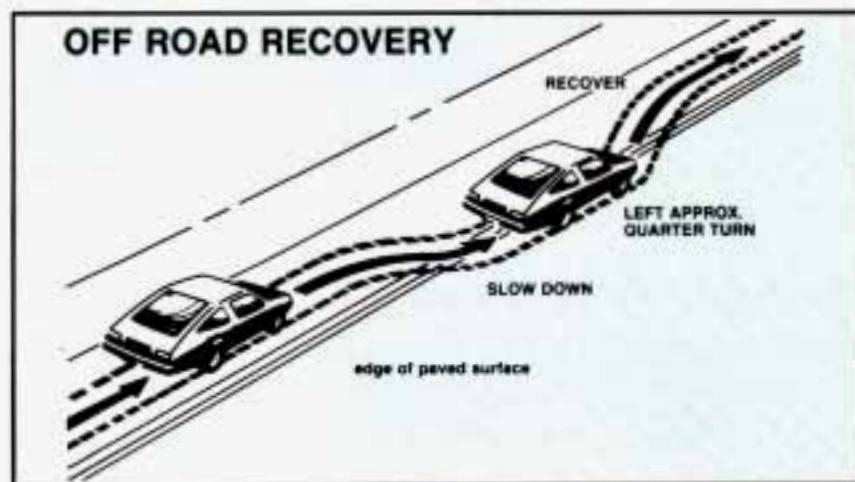

If the shoulder appears to be about four inches (100 mm) or more below the pavement, this difference can cause problems. If there is not enough room to pull entirely onto the shoulder and stop, then follow the same procedures. But if the right front tire scrubs against the side of the pavement, do NOT steer more sharply. With

too much steering angle, the vehicle may jump back onto the road with so much steering input that it crosses over into the oncoming traffic before you can bring it back under control.

Instead, ease off again on the accelerator and steering input, straddle the pavement once more, then try again.

## Passing

The driver of a vehicle about to pass another on a two-lane highway waits for just the right moment, accelerates, moves around the vehicle ahead, then goes back into the right lane again. A simple maneuver?

Not necessarily! Passing another vehicle on a two-lane highway is a potentially dangerous move, since the passing vehicle occupies the same lane as oncoming traffic for several seconds. A miscalculation, an error in judgment, or a brief surrender to frustration or anger can suddenly put the passing driver face to face with the worst of all traffic accidents -- the head-on collision.

So here are some tips for passing:

- "Drive ahead." Look down the road, to the sides, and to crossroads for situations that might affect your passing patterns. If you have any doubt whatsoever about making a successful pass, wait for a better time.

- Watch for traffic signs, pavement markings, and lines. If you can see a sign up ahead that might indicate a turn or an intersection, delay your pass. A broken center line usually indicates it's all right to pass (providing the road ahead is clear). Never cross a solid line on your side of the lane or a double solid line, even if the road seems empty of approaching traffic.
- If you suspect that the driver of the vehicle you want to pass isn't aware of your presence, tap the horn a couple of times before passing.
- Do not get too close to the vehicle you want to pass while you're awaiting an opportunity. For one thing, following too closely reduces your area of vision, especially if you're following a larger vehicle. Also, you won't have adequate space if the vehicle ahead suddenly slows or stops. Keep back a reasonable distance.
- When it looks like a chance to pass is coming up, start to accelerate but stay in the right lane and don't get too close. Time your move so you will be increasing speed as the time comes to move into the other lane. If the way is clear to pass, you will have a "running start" that more than makes up for the distance you would lose by dropping back. And if something happens to cause you to cancel your pass,

you need only slow down and drop back again and wait for another opportunity.

- If other cars are lined up to pass a slow vehicle, wait your turn. But take care that someone isn't trying to pass you as you pull out to pass the slow vehicle. Remember to glance over your shoulder and check the blind spot.
- Check your mirrors, glance over your shoulder, and start your left lane change signal before moving out of the right lane to pass. When you are far enough ahead of the passed vehicle to see its front in your inside mirror, activate your right lane change signal and move back into the right lane. (Remember that your right outside mirror is convex. The vehicle you just passed may seem to be farther away from you than it really is.)
- Try not to pass more than one vehicle at a time on two-lane roads. Reconsider before passing the next vehicle.
- Don't overtake a slowly moving vehicle too rapidly. Even though the brake lights are not flashing, it may be slowing down or starting to turn.
- If you're being passed, make it easy for the following driver to get ahead of you. Perhaps you can ease a little to the right.

## Loss of Control

Let's review what driving experts say about what happens when the three control systems (brakes, steering and acceleration) don't have enough friction where the tires meet the road to do what the driver has asked.

In any emergency, don't give up. Keep trying to steer and constantly seek an escape route or area of less danger.

## Skidding

In a skid, a driver can lose control of the vehicle. Defensive drivers avoid most skids by taking reasonable care suited to existing conditions, and by not "overdriving" those conditions. But skids are always possible.

The three types of skids correspond to your Buick's three control systems. In the braking skid your wheels aren't rolling. In the steering or cornering skid, too much speed or steering in a curve causes tires to slip and lose cornering force. And in the acceleration skid too much throttle causes the driving wheels to spin.

A cornering skid and an acceleration skid are best handled by easing your foot off the accelerator pedal.

If your vehicle starts to slide (as when you turn a corner on a wet, snow- or ice-covered road), ease your foot off

the accelerator pedal as soon as you feel the vehicle start to slide. Quickly steer the way you want the vehicle to go. If you start steering quickly enough, your vehicle will straighten out. As it does, straighten the front wheels.

Of course, traction is reduced when water, snow, ice, gravel, or other material is on the road. For safety, you'll want to slow down and adjust your driving to these conditions. It is important to slow down on slippery surfaces because stopping distance will be longer and vehicle control more limited.

While driving on a surface with reduced traction, try your best to avoid sudden steering, acceleration, or braking (including engine braking by shifting to a lower gear). Any sudden changes could cause the tires to slide. You may not realize the surface is slippery until your vehicle is skidding. Learn to recognize warning clues -- such as enough water, ice or packed snow on the road to make a "mirrored surface" -- and slow down when you have any doubt.

If you have the anti-lock braking system, remember: It helps avoid only the braking skid. If you do not have anti-lock, then in a braking skid (where the wheels are no longer rolling), release enough pressure on the brakes to get the wheels rolling again. This restores steering control. Push the brake pedal down steadily when you

have to stop suddenly. As long as the wheels are rolling, you will have steering control. Steer the way you want to go.

## Driving at Night



Night driving is more dangerous than day driving. One reason is that some drivers are likely to be impaired -- by alcohol or drugs, with night vision problems, or by fatigue.

Here are some tips on night driving.

- Drive defensively. Remember, this is the most dangerous time.
- Don't drink and drive. (See "Drunken Driving" in the Index for more on this problem.)
- Adjust your inside rearview mirror to reduce the glare from headlights behind you.
- Since you can't see as well, you may need to slow down and keep more space between you and other vehicles. It's hard to tell how fast the vehicle ahead is going just by looking at its taillights.
- Slow down, especially on higher speed roads. Your headlights can light up only so much road ahead.
- In remote areas, watch for animals.
- If you're tired, pull off the road in a safe place and rest.

## Night Vision

No one can see as well at night as in the daytime. But as we get older these differences increase. A 50-year-old driver may require at least twice as much light to see the same thing at night as a 20-year-old.

What you do in the daytime can also affect your night vision. For example, if you spend the day in bright sunshine you are wise to wear sunglasses. Your eyes will have less trouble adjusting to night.

But if you're driving, don't wear sunglasses at night. They may cut down on glare from headlights, but they also make a lot of things invisible that should remain visible — such as parked cars, obstacles, pedestrians, or even trains blocking railway crossings. You may want to put on your sunglasses after you have pulled into a brightly-lighted service or refreshment area. Eyes shielded from that glare may adjust more quickly to darkness back on the road. But be sure to remove your sunglasses before you leave the service area.

You can be temporarily blinded by approaching lights. It can take a second or two, or even several seconds, for your eyes to readjust to the dark. When you are faced with severe glare (as from a driver who doesn't lower the high beams, or a vehicle with misaimed headlights), slow down a little. Avoid staring directly into the approaching lights. If there is a line of opposing traffic, make occasional glances over the line of headlights to make certain that one of the vehicles isn't starting to move into your lane. Once you are past the bright lights, give your eyes time to readjust before resuming speed.



## High Beams

If the vehicle approaching you has its high beams on, signal by flicking yours to high and then back to low beam. This is the usual signal to lower the headlight beams. If the other driver still doesn't lower the beams, resist the temptation to put your high beams on. This only makes two half-blinded drivers.

On a freeway, use your high beams only in remote areas where you won't impair approaching drivers. In some places, like cities, using high beams is illegal.

When you follow another vehicle on a freeway or highway, use low beams. True, most vehicles now have day-night mirrors that enable the driver to reduce glare. But outside mirrors are not of this type and high beams from behind can bother the driver ahead.

## A Few More Night Driving Suggestions

Keep your windshield and all the glass on your vehicle clean -- inside and out. Glare at night is made much worse by dirt on the glass. Even the inside of the glass can build up a film caused by dust. Tobacco smoke also makes inside glass surfaces very filmy and can be a vision hazard if it's left there.

Dirty glass makes lights dazzle and flash more than clean glass would, making the pupils of your eyes contract repeatedly. You might even want to keep a cloth and some glass cleaner in your vehicle if you need to clean your glass frequently.

Remember that your headlights light up far less of a roadway when you are in a turn or curve.

Keep your eyes moving; that way, it's easier to pick out dimly lighted objects.

Just as your headlights should be checked regularly for proper aim, so should your eyes be examined regularly. Some drivers suffer from night blindness -- the inability to see in dim light -- and aren't even aware of it.

## Driving in the Rain



Rain and wet roads can mean driving trouble. On a wet road you can't stop, accelerate or turn as well because your tire-to-road traction isn't as good as on dry roads. And, if your tires don't have much tread left, you'll get even less traction.

It's always wise to go slower and be cautious if rain starts to fall while you are driving. The surface may get wet suddenly when your reflexes are tuned for driving on dry pavement.

The heavier the rain, the harder it is to see. Even if your windshield wiper blades are in good shape, a heavy rain can make it harder to see road signs and traffic signals, pavement markings, the edge of the road, and even people walking. Road spray can often be worse for vision than rain, especially if it comes from a dirty road.

So it is wise to keep your wiping equipment in good shape and keep your windshield washer tank filled. Replace your windshield wiper inserts when they show

signs of streaking or missing areas on the windshield, or when strips of rubber start to separate from the inserts.



Driving too fast through large water puddles or even going through some car washes can cause problems, too. The water may affect your brakes. Try to avoid puddles. But if you can't, try to slow down before you hit them.



## **CAUTION:**

**Wet brakes can cause accidents. They won't work well in a quick stop and may cause pulling to one side. You could lose control of the vehicle. After driving through a large puddle of water or a car wash, apply your brake pedal lightly until your brakes work normally.**

## **Hydroplaning**

Hydroplaning is dangerous. So much water can build up under your tires that they can actually ride on the water. This can happen if the road is wet enough and you're going fast enough. When your vehicle is hydroplaning, it has little or no contact with the road.

You might not be aware of hydroplaning. You could drive along for some time without realizing your tires aren't in constant contact with the road. You could find out the hard way: when you have to slow, turn, move out to pass -- or if you get hit by a gust of wind. You could suddenly find yourself out of control.

Hydroplaning doesn't happen often. But it can if your tires haven't much tread or if the pressure in one or

more is low. It can happen if a lot of water is standing on the road. If you can see reflections from trees, telephone poles, or other vehicles, and raindrops “dimple” the water’s surface, there could be hydroplaning.

Hydroplaning usually happens at higher speeds. There just isn’t a hard and fast rule about hydroplaning. The best advice is to slow down when it is raining, and be careful.

### Some Other Rainy Weather Tips

- Turn on your headlights -- not just your parking lights -- to help make you more visible to others.
- Look for hard-to-see vehicles coming from behind. You may want to use your headlights even in daytime if it’s raining hard.
- Besides slowing down, allow some extra following distance. And be especially careful when you pass another vehicle. Allow yourself more clear room ahead, and be prepared to have your view restricted by road spray. If the road spray is so heavy you are actually blinded, drop back. Don’t pass until conditions improve. Going more slowly is better than having an accident.
- Use your defogger if it helps.

- Have good tires with proper tread depth. (See “Tires” in the Index.)

### Driving in Fog, Mist and Haze



Fog can occur with high humidity or heavy frost. It can be so mild that you can see through it for several hundred feet (meters). Or it might be so thick that you can see only a few feet (meters) ahead. It may come suddenly to an otherwise clear road. And it can be a major hazard.

When you drive into a fog patch, your visibility will be reduced quickly. The biggest dangers are striking the vehicle ahead or being struck by the one behind. Try to “read” the fog density down the road. If the vehicle ahead starts to become less clear or, at night, if the taillights are harder to see, the fog is probably thickening. Slow down to give traffic behind you a chance to slow down. Everybody then has a better chance to avoid hitting the vehicle ahead.

A patch of dense fog may extend only for a few feet (meters) or for miles (kilometers); you can’t really tell while you’re in it. You can only treat the situation with extreme care.

One common fog condition -- sometimes called mist or ground fog -- can happen in weather that seems perfect, especially at night or in the early morning in valley and low, marshy areas. You can be suddenly enveloped in thick, wet haze that may even coat your windshield. You can often spot these fog patches or mist layers with your headlights. But sometimes they can be waiting for you as you come over a hill or dip into a shallow valley. Start your windshield wipers and washer, to help clear accumulated road dirt. Slow down carefully.

## **Tips on Driving in Fog**

If you get caught in fog, turn your headlights on low beam, even in daytime. You’ll see -- and be seen -- better. Use your fog lights if your vehicle has them.

Don’t use your high beams. The light will bounce off the water droplets that make up fog and reflect back at you.

Use your defogger. In high humidity, even a light buildup of moisture on the inside of the glass will cut down on your already limited visibility. Run your windshield wipers and washer occasionally. Moisture can build up on the outside glass, and what seems to be fog may actually be moisture on the outside of your windshield.

Treat dense fog as an emergency. Try to find a place to pull off the road. Of course you want to respect another’s property, but you might need to put something between you and moving vehicles -- space, trees, telephone poles, a private driveway, anything that removes you from other traffic.

If visibility is near zero and you must stop but are unsure whether you are away from the road, turn your lights on, start your hazard warning flashers, and sound

your horn at intervals or when you hear approaching traffic.

Pass other vehicles in fog only if you can see far enough ahead to pass safely. Even then, be prepared to delay your pass if you suspect the fog is worse up ahead. If other vehicles try to pass you, make it easy for them.

## City Driving



One of the biggest problems with city streets is the amount of traffic on them. You'll want to watch out for what the other drivers are doing and pay attention to traffic signals.

Here are ways to increase your safety in city driving:

- Know the best way to get to where you are going. Try not to drive around trying to pick out a familiar street or landmark. Get a city map and plan your trip into an unknown part of the city just as you would for a cross-country trip.
- Try to use the freeways that rim and crisscross most large cities. You'll save time and energy. (See the next section, "Freeway Driving.")
- Treat a green light as a warning signal. A traffic light is there because the corner is busy enough to need it. When a light turns green, and just before you start to move, check both ways for vehicles that have not cleared the intersection or may be running the red light.
- Obey all posted speed limits. But remember that they are for ideal road, weather and visibility conditions. You may need to drive below the posted limit in bad weather or when visibility is especially poor.

- Pull to the right (with care) and stop clear of intersections when you see or hear emergency vehicles.

## Freeway Driving



Mile for mile, freeways (also called thruways, parkways, expressways, turnpikes, or superhighways) are the safest of all roads. But they have their own special rules.

The most important advice on freeway driving is: Keep up with traffic and keep to the right. Drive at the same speed most of the other drivers are driving. Too-fast or too-slow driving breaks a smooth traffic flow. Treat the left lane on a freeway as a passing lane.

### Entering the Freeway

At the entrance there is usually a ramp that leads to the freeway. If you have a clear view of the freeway as you drive along the entrance ramp, you should begin to check traffic. Try to determine where you expect to blend with the flow. If traffic is light, you may have no problem. But if it is heavy, find a gap as you move along the entering lane and time your approach. Try to merge into the gap at close to the prevailing speed. Switch on your turn signal, check your rearview mirrors as you move along, and glance over your shoulder as often as necessary. Try to blend smoothly with the traffic flow.

### Driving on the Freeway

Once you are on the freeway, adjust your speed to the posted limit or to the prevailing rate if it's slower. Stay in the right lane unless you want to pass. If you are on a two-lane freeway, treat the right lane as the slow lane and the left lane as the passing lane.

If you are on a three-lane freeway, treat the right lane as the slower-speed through lane, the middle lane as the higher-speed through lane, and the left lane as the passing lane.

Before changing lanes, check your rearview mirrors. Then use your turn signal.

Just before you leave the lane, glance quickly over your shoulder to make sure there isn't another vehicle in your "blind" spot.

If you are moving from an outside to a center lane on a freeway having more than two lanes, make sure another vehicle isn't about to move into the same spot. Look at the vehicles two lanes over and watch for telltale signs: turn signals flashing, an increase in speed, or moving toward the edge of the lane. Be prepared to delay your move.

Once you are moving on the freeway, make certain you allow a reasonable following distance. Expect to move slightly slower at night.

## **Leaving the Freeway**

When you want to leave the freeway, move to the proper lane well in advance. Dashing across lanes at the last minute is dangerous. If you miss your exit do not, under

any circumstances, stop and back up. Drive on to the next exit.

At each exit point is a deceleration lane. Ideally it should be long enough for you to enter it at freeway speed (after signaling, of course) and then do your braking before moving onto the exit ramp.

Unfortunately, not all deceleration lanes are long enough -- some are too short for all the braking. Decide when to start braking. If you must brake on the through lane, and if there is traffic close behind you, you can allow a little extra time and flash your brake lights (in addition to your turn signal) as extra warning that you are about to slow down and exit.

The exit ramp can be curved, sometimes quite sharply.

The exit speed is usually posted. Reduce your speed according to your speedometer, not to your sense of motion. After driving for any distance at higher speeds, you may tend to think you are going slower than you actually are. For example, 40 mph (65 km/h) might seem like only 20 mph (30 km/h). Obviously, this could lead to serious trouble on a ramp designed for 20 mph (30 km/h)!



## Driving a Long Distance

Although most long trips today are made on freeways, there are still many made on regular highways.

Long-distance driving on freeways and regular highways is the same in some ways. The trip has to be planned and the vehicle prepared, you drive at higher-than-city speeds, and there are longer turns behind the wheel. You'll enjoy your trip more if you and your vehicle are in good shape. Here are some tips for a successful long trip.

### Before Leaving on a Long Trip

Make sure you're ready. Try to be well rested. If you must start when you're not fresh -- such as after a day's work -- don't plan to make too many miles that first part of the journey. Wear comfortable clothing and shoes you can easily drive in.

Is your vehicle ready for a long trip? If you keep it serviced and maintained, it's ready to go. If it needs service, have it done before starting out. Of course, you'll find experienced and able service experts in Buick dealerships all across North America. They'll be ready and willing to help if you need it.

Here are some things you can check before a trip:

- Windshield Washer Fluid: Is the reservoir full? Are all windows clean inside and outside?
- Wiper Blades: Are they in good shape?
- Fuel, Engine Oil, Other Fluids: Have you checked all levels?
- Lights: Are they all working? Are the lenses clean?
- Tires: They are vitally important to a safe, trouble-free trip. Is the tread good enough for long-distance driving? Are the tires all inflated to the recommended pressure?
- Weather Forecasts: What's the weather outlook along your route? Should you delay your trip a short time to avoid a major storm system?
- Maps: Do you have up-to-date maps?

### On the Road

Unless you are the only driver, it is good to share the driving task with others. Limit turns behind the wheel to about 100 miles (160 km) or two hours at a sitting. Then, either change drivers or stop for some refreshment like coffee, tea or soft drinks and some limbering up. But do stop and move around. Eat lightly along the way. Heavier meals tend to make some people sleepy.

On two-lane highways or undivided multilane highways that do not have controlled access, you'll want to watch for some situations not usually found on freeways. Examples are: stop signs and signals, shopping centers with direct access to the highway, no passing zones and school zones, vehicles turning left and right off the road, pedestrians, cyclists, parked vehicles, and even animals.

## Highway Hypnosis

Is there actually such a condition as "highway hypnosis"? Or is it just plain falling asleep at the wheel? Call it highway hypnosis, lack of awareness, or whatever.

There is something about an easy stretch of road with the same scenery, along with the hum of the tires on the road, the drone of the engine, and the rush of the wind against the vehicle that can make you sleepy. Don't let it happen to you! If it does, your vehicle can leave the road in less than a second, and you could crash and be injured.

What can you do about highway hypnosis? First, be aware that it can happen.

Then here are some tips:

- Make sure your vehicle is well ventilated, with a comfortably cool interior.
- Keep your eyes moving. Scan the road ahead and to the sides. Check your rearview mirrors frequently and your instruments from time to time. This can help you avoid a fixed stare.
- Wear good sunglasses in bright light. Glare can cause drowsiness. But don't wear sunglasses at night. They will drastically reduce your overall vision at the very time you need all the seeing power you have.
- If you get sleepy, pull off the road into a rest, service, or parking area and take a nap, get some exercise, or both. For safety, treat drowsiness on the highway as an emergency.

As in any driving situation, keep pace with traffic and allow adequate following distances.

## Hill and Mountain Roads



Driving on steep hills or mountains is different from driving in flat or rolling terrain.

If you drive regularly in steep country, or if you're planning to visit there, here are some tips that can make your trips safer and more enjoyable.

- Keep your vehicle in good shape. Check all fluid levels and also the brakes, tires, cooling system and transaxle. These parts can work hard on mountain roads.
- Know how to go down hills. The most important thing to know is this: let your engine do some of the slowing down. Don't make your brakes do it all. Shift to a lower gear when you go down a steep or long hill. That way, you will slow down without excessive use of your brakes.



## **CAUTION:**

**If you don't shift down, your brakes could get so hot that they wouldn't work well. You would then have poor braking or even none going down a hill. You could crash. Shift down to let your engine assist your brakes on a steep downhill slope.**



## **CAUTION:**

**Coasting downhill in "N" (Neutral) or with the ignition off is dangerous. Your brakes will have to do all the work of slowing down. They could get so hot that they wouldn't work well. You could crash. Always have your engine running and your vehicle in gear when you go downhill.**

- Know how to go uphill. You may want to shift down to a lower gear. The lower gears help cool your engine and transaxle, and you can climb the hill better.

- Stay in your own lane when driving on two-lane roads in hills or mountains. Don't swing wide or cut across the center of the road. Drive at speeds that let you stay in your own lane. That way, you won't be surprised by a vehicle coming toward you in the same lane.
- It takes longer to pass another vehicle when you're going uphill. You'll want to leave extra room to pass. If a vehicle is passing you and doesn't have enough room, slow down to make it easier for the other vehicle to get by.
- As you go over the top of a hill, be alert. There could be something in your lane, like a stalled car or an accident.
- You may see highway signs on mountains that warn of special problems. Examples are long grades, passing or no-passing zones, a falling rocks area, or winding roads. Be alert to these and take appropriate action.
- Winter driving can present special problems. See "Winter Driving" in the Index.

## Parking on Hills



Hills and mountains mean spectacular scenery. But please be careful where you stop if you decide to look at the view or take pictures. Look for pull-offs or parking areas provided for scenic viewing.

Another part of this manual tells how to use your parking brake (see "Parking Brake" in the Index). But on a mountain or steep hill, you can do one more thing.

You can turn your front wheels to keep your vehicle from rolling downhill or out into traffic.

Here's how:

## Parking Downhill



Turn your wheels to the right.

You don't have to jam your tires against the curb, if there is a curb. A gentle contact is all you need.

## Parking Uphill



If there is a curb, turn your wheels to the left if the curb is at the right side of your vehicle.



If you're going uphill on a one-way street and you're parking on the left side, your wheels should point to the right.



If there is no curb when you're parking uphill, turn the wheels to the right.

If there is no curb when you're parking uphill on the left side of a one-way street, your wheels should be turned to the left.

## Torque Lock (Automatic Transaxle)

If you are parking on a hill and you don't shift your transaxle into "P" (Park) properly, the weight of the vehicle may put too much force on the parking pawl in the transaxle. You may find it difficult to pull the shift lever out of "P" (Park). This is called "torque lock." To prevent torque lock, always be sure to shift into "P" (Park) properly before you leave the driver's seat. To find out how, see "Shifting Into "P" (Park)" in the Index.

When you are ready to drive, move the shift lever out of "P" (Park) BEFORE you release the parking brake.

If "torque lock" does occur, you may need to have another vehicle push yours a little uphill to take some of the pressure from the transaxle, so you can pull the shift lever out of "P" (Park).

## Winter Driving



Here are some tips for winter driving:

- Have your Buick in good shape for winter. Be sure your engine coolant mix is correct.
- Snow tires can help in loose snow, but they may give you less traction on ice than regular tires. If you do not expect to be driving in deep snow, but may have to travel over ice, you may not want to switch to snow tires at all.

- You may want to put winter emergency supplies in your trunk.

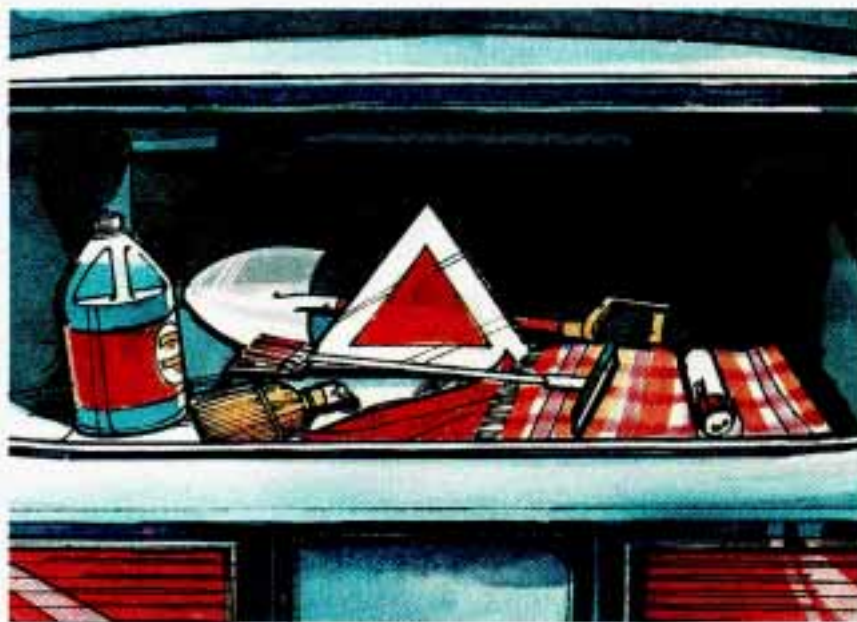

Include an ice scraper, a small brush or broom, a supply of windshield washer fluid, a rag, some winter outer clothing, a small shovel, a flashlight, a red cloth, and a couple of reflective warning triangles. And, if you will be driving under severe conditions, include a small bag of sand, a piece of old carpet or a couple of burlap bags to help provide traction. Be sure you properly secure these items in your vehicle.



## Driving on Snow or Ice

Most of the time, those places where your tires meet the road probably have good traction.

However, if there is snow or ice between your tires and the road, you can have a very slippery situation. You'll have a lot less traction or "grip" and will need to be very careful.



What's the worst time for this? "Wet ice." Very cold snow or ice can be slick and hard to drive on. But wet ice can be even more trouble because it may offer the least traction of all. You can get "wet ice" when it's about freezing (32°F; 0°C) and freezing rain begins to fall. Try to avoid driving on wet ice until salt and sand crews can get there.

Whatever the condition -- smooth ice, packed, blowing or loose snow -- drive with caution. Accelerate gently. Try not to break the fragile traction. If you accelerate too fast, the drive wheels will spin and polish the surface under the tires even more.

Unless you have the anti-lock braking system, you'll want to brake very gently, too. (If you do have anti-lock, see "Anti-lock" in the Index. This system improves your vehicle's ability to make a hard stop on a slippery road.) Whether you have the anti-lock braking system or not, you'll want to begin stopping sooner than you would on dry pavement. Without anti-lock brakes, if you feel your vehicle begin to slide, let up on the brakes a little. Push the brake pedal down steadily to get the most traction you can.

Remember, unless you have anti-lock, if you brake so hard that your wheels stop rolling, you'll just slide. Brake so your wheels always keep rolling and you can still steer.

- Whatever your braking system, allow greater following distance on any slippery road.
- Watch for slippery spots. The road might be fine until you hit a spot that's covered with ice. On an otherwise clear road, ice patches may appear in shaded areas where the sun can't reach: around clumps of trees, behind buildings, or under bridges. Sometimes the surface of a curve or an overpass may remain icy when the surrounding roads are clear. If you see a patch of ice ahead of you, brake before you are on it. Try not to brake while you're actually on the ice, and avoid sudden steering maneuvers.

## If You're Caught in a Blizzard



If you are stopped by heavy snow, you could be in a serious situation. You should probably stay with your vehicle unless you know for sure that you are near help and you can hike through the snow. Here are some things to do to summon help and keep yourself and your passengers safe: Turn on your hazard flashers. Tie a red cloth to your vehicle to alert police that you've been

stopped by the snow. Put on extra clothing or wrap a blanket around you. If you have no blankets or extra clothing, make body insulators from newspapers, burlap bags, rags, floor mats -- anything you can wrap around yourself or tuck under your clothing to keep warm.

You can run the engine to keep warm, but be careful.



## **CAUTION:**

**Snow can trap exhaust gases under your vehicle. This can cause deadly CO (carbon monoxide) gas to get inside. CO could overcome you and kill you. You can't see it or smell it, so you might not know it is in your vehicle. Clear away snow from around the base of your vehicle, especially any that is blocking your exhaust pipe. And check around again from time to time to be sure snow doesn't collect there.**

**Open a window just a little on the side of the vehicle that's away from the wind. This will help keep CO out.**

**CAUTION: (Continued)**

## **CAUTION: (Continued)**



Run your engine only as long as you must. This saves fuel. When you run the engine, make it go a little faster than just idle. That is, push the accelerator slightly. This uses less fuel for the heat that you get and it keeps the battery charged. You will need a well-charged battery to restart the vehicle, and possibly for signaling later on with your headlights. Let the heater run for awhile.

Then, shut the engine off and close the window almost all the way to preserve the heat. Start the engine again and repeat this only when you feel really uncomfortable from the cold. But do it as little as possible. Preserve the fuel as long as you can. To help keep warm, you can get out of the vehicle and do some fairly vigorous exercises every half hour or so until help comes.

## If You're Stuck in Deep Snow

This manual explains how to get the vehicle out of deep snow without damaging it. See "Rocking Your Vehicle" in the Index.

## Towing a Trailer



### **CAUTION:**

**If you don't use the correct equipment and drive properly, you can lose control when you pull a trailer. For example, if the trailer is too heavy, the brakes may not work well -- or even at all. You and your passengers could be seriously injured. Pull a trailer only if you have followed all the steps in this section.**

### **NOTICE:**

**Pulling a trailer improperly can damage your vehicle and result in costly repairs not covered by your warranty. To pull a trailer correctly, follow the advice in this section.**

Your vehicle can tow a trailer. To identify what the vehicle trailering capacity is for your vehicle, you should read the information in "Weight of the Trailer" that appears later in this section. But trailering is different than just driving your vehicle by itself. Trailering means changes in handling, durability, and fuel economy. Successful, safe trailering takes correct equipment, and it has to be used properly.

That's the reason for this section. In it are many time-tested, important trailering tips and safety rules. Many of these are important for your safety and that of your passengers. So please read this section carefully before you pull a trailer.

Load-pulling components such as the engine, transaxle, wheel assemblies, and tires are forced to work harder against the drag of the added weight. The engine is required to operate at relatively higher speeds and under greater loads, generating extra heat. What's more, the

trailer adds considerably to wind resistance, increasing the pulling requirements.

All of that means changes in:

- Handling
- Durability
- Fuel economy

### If You Do Decide To Pull A Trailer

If you do, here are some important points.

- There are many different laws having to do with trailering. Make sure your rig will be legal, not only where you live but also where you'll be driving. A good source for this information can be state or provincial police.
- Consider using a sway control.

You can ask a hitch dealer about sway controls.

- Don't tow a trailer at all during the first 500 miles (800 km) your new vehicle is driven. Your engine, axle or other parts could be damaged.
- Then, during the first 500 miles (800 km) that you tow a trailer, don't drive over 50 mph (80 km/h) and don't make starts at full throttle. This helps your

engine and other parts of your vehicle wear in at the heavier loads.

Three important considerations have to do with weight:

## **Weight of the Trailer**

How heavy can a trailer safely be?

It should never weigh more than 1,000 pounds (450 kg). But even that can be too heavy.

It depends on how you plan to use your rig. For example, speed, altitude, road grades, outside temperature and how much your vehicle is used to pull a trailer are all important. And, it can also depend on any special equipment that you have on your vehicle.

You can ask your dealer for our trailering information or advice, or you can write us at Buick Motor Division, Customer Assistance Center, 902 E. Hamilton Avenue, Flint, MI 48550.

In Canada, write to General Motors of Canada Limited, Customer Assistance Center, 1908 Colonel Sam Drive, Oshawa, Ontario L1H 8P7.

## **Weight of the Trailer Tongue**

The tongue load (A) of any trailer is an important weight to measure because it affects the total capacity weight of your vehicle. The capacity weight includes the

curb weight of the vehicle, any cargo you may carry in it, and the people who will be riding in the vehicle. And if you will tow a trailer, you must subtract the tongue load from your vehicle's capacity weight because your vehicle will be carrying that weight, too. See "Loading Your Vehicle" in the Index for more information about your vehicle's maximum load capacity.

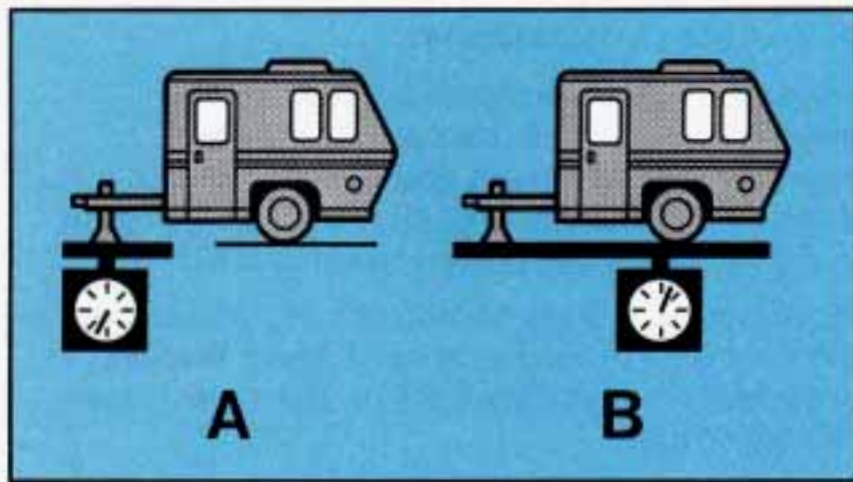

The trailer tongue (A) should weigh 10% of the total loaded trailer weight (B).

After you've loaded your trailer, weigh the trailer and then the tongue, separately, to see if the weights are proper. If they aren't, you may be able to get them right simply by moving some items around in the trailer.

## Total Weight on Your Vehicle's Tires

Be sure your vehicle's tires are inflated to the limit for cold tires. You'll find these numbers on the Certification label at the rear edge of the driver's door (or see "Tire Loading" in the Index). Then be sure you don't go over the GVW limit for your vehicle.

## Hitches

It's important to have the correct hitch equipment. Crosswinds, large trucks going by, and rough roads are a few reasons why you'll need the right hitch. Here are some rules to follow:

- Will you have to make any holes in the body of your vehicle when you install a trailer hitch? If you do, then be sure to seal the holes later when you remove the hitch. If you don't seal them, deadly carbon monoxide (CO) from your exhaust can get into your vehicle (see "Carbon Monoxide" in the Index). Dirt and water can, too.
- The bumpers on your vehicle are not intended for hitches. Do not attach rental hitches or other bumper-type hitches to them. Use only a frame-mounted hitch that does not attach to the bumper.

## Safety Chains

You should always attach chains between your vehicle and your trailer. Cross the safety chains under the tongue of the trailer so that the tongue will not drop to the road if it becomes separated from the hitch. Instructions about safety chains may be provided by the hitch manufacturer or by the trailer manufacturer. Follow the manufacturer's recommendation for attaching safety chains. Always leave just enough slack so you can turn with your rig. And, never allow safety chains to drag on the ground.

## Trailer Brakes

If your trailer weighs more than 1,000 pounds (450 kg) loaded, then it needs its own brakes -- and they must be adequate. Be sure to read and follow the instructions for the trailer brakes so you'll be able to install, adjust and maintain them properly. If your vehicle has anti-lock brakes, do not try to tap into your vehicle's brake system. If you do, both brake systems won't work well, or at all. Even if your vehicle doesn't have anti-lock brakes, don't tap into your vehicle's brake system if the trailer's brake system will use more than 0.02 cubic inch (0.3 cc) of fluid from your vehicle's master cylinder. If it does, both braking systems won't work well. You could even lose your brakes.

- Will the trailer brake parts take 3,000 psi (20 650 kPa) of pressure? If not, the trailer brake system must not be used with your vehicle.
- If everything checks out this far, then make the brake fluid tap at the upper rear master cylinder port. But don't use copper tubing for this. If you do, it will bend and finally break off. Use steel brake tubing.

## Driving with a Trailer

Towing a trailer requires a certain amount of experience. Before setting out for the open road, you'll want to get to know your rig. Acquaint yourself with the feel of handling and braking with the added weight of the trailer. And always keep in mind that the vehicle you are driving is now a good deal longer and not nearly so responsive as your vehicle is by itself.

Before you start, check the trailer hitch and platform, safety chains, electrical connector, lights, tires and mirror adjustment. If the trailer has electric brakes, start your vehicle and trailer moving and then apply the trailer brake controller by hand to be sure the brakes are working. This lets you check your electrical connection at the same time.

During your trip, check occasionally to be sure that the load is secure, and that the lights and any trailer brakes are still working.

## Following Distance

Stay at least twice as far behind the vehicle ahead as you would when driving your vehicle without a trailer. This can help you avoid situations that require heavy braking and sudden turns.

## Passing

You'll need more passing distance up ahead when you're towing a trailer. And, because you're a good deal longer, you'll need to go much farther beyond the passed vehicle before you can return to your lane.

## Backing Up

Hold the bottom of the steering wheel with one hand. Then, to move the trailer to the left, just move that hand to the left. To move the trailer to the right, move your hand to the right. Always back up slowly and, if possible, have someone guide you.

## Making Turns

When you're turning with a trailer, make wider turns than normal. Do this so your trailer won't strike soft shoulders, curbs, road signs, trees, or other objects. Avoid jerky or sudden maneuvers. Signal well in advance.

## Turn Signals When Towing a Trailer

When you tow a trailer, your vehicle has to have a different turn signal flasher and extra wiring. The green arrows on your instrument panel will flash whenever you signal a turn or lane change. Properly hooked up, the trailer lights will also flash, telling other drivers you're about to turn, change lanes or stop.

When towing a trailer, the green arrows on your instrument panel will flash for turns even if the bulbs on the trailer are burned out. Thus, you may think drivers behind you are seeing your signal when they are not. It's important to check occasionally to be sure the trailer bulbs are still working.

## Driving On Grades

Reduce speed and shift to a lower gear **before** you start down a long or steep downgrade. If you don't shift down, you might have to use your brakes so much that they would get hot and no longer work well.

On a long uphill grade, shift down and reduce your speed to around 45 mph (70 km/h) to reduce the possibility of engine and transaxle overheating.

If you are towing a trailer that weighs more than 1,000 pounds ( 450 kg), and you have an automatic transaxle with Overdrive, you may prefer to drive in "D" instead of Overdrive (or, as you need to, a lower gear).



## Parking on Hills

You really should not park your vehicle, with a trailer attached, on a hill. If something goes wrong, your rig could start to move. People can be injured, and both your vehicle and the trailer can be damaged.

But if you ever have to park your rig on a hill, here's how to do it:

1. Apply your regular brakes, but don't shift into "P" (Park) yet.
2. Have someone place chocks under the trailer wheels.
3. When the wheel chocks are in place, release the regular brakes until the chocks absorb the load.
4. Reapply the regular brakes. Then apply your parking brake, and then shift to "P" (Park).
5. Release the regular brakes.

## When You Are Ready to Leave After Parking on a Hill

1. Apply your regular brakes and hold the pedal down while you:
  - Start your engine;
  - Shift into a gear; and
  - Release the parking brake.
2. Let up on the brake pedal.
3. Drive slowly until the trailer is clear of the chocks.
4. Stop and have someone pick up and store the chocks.

## Maintenance When Trailer Towing

Your vehicle will need service more often when you're pulling a trailer. See the Maintenance Schedule for more on this. Things that are especially important in trailer operation are automatic transaxle fluid (don't overfill), engine oil, belt, cooling system, and brake adjustment. Each of these is covered in this manual, and the Index will help you find them quickly. If you're trailering, it's a good idea to review these sections before you start your trip.

Check periodically to see that all hitch nuts and bolts are tight.

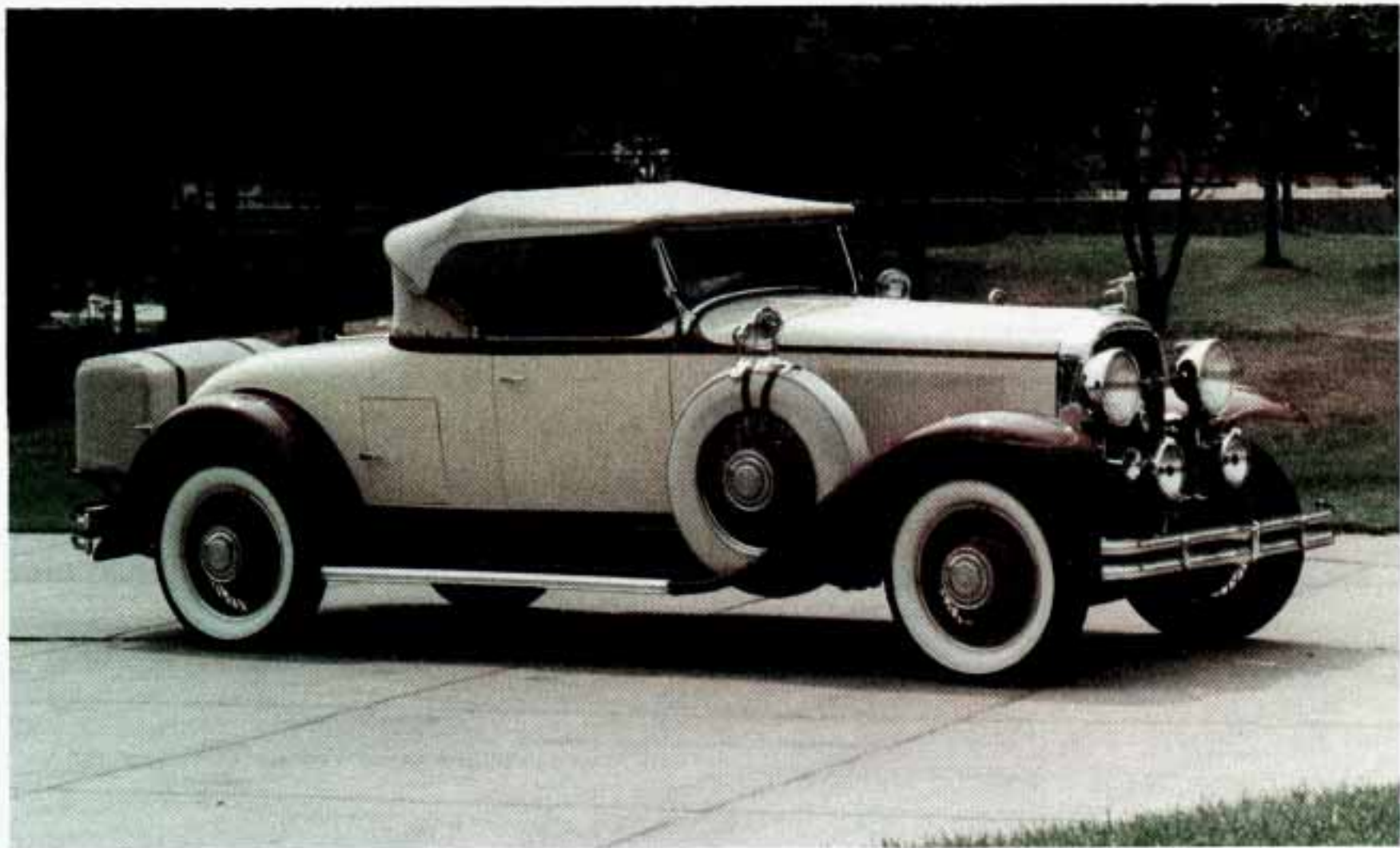

*1931 Buick Model 90*



## Part 5 Problems On The Road

Here you'll find what to do about some problems that can occur on the road.

Part 5 includes:

Hazard Warning Flashers .....	178
Other Warning Devices .....	179
"Jump" Starting .....	180
Towing Your Buick .....	185
Engine Overheating .....	192
If a Tire Goes Flat .....	201
Changing a Flat Tire .....	201
Compact Spare Tire .....	210
If You're Stuck in Sand, Mud, Ice or Snow .....	211



## Hazard Warning Flashers



Your hazard warning flashers let you warn others. They also let police know you have a problem. Your front and rear turn signal lights will flash on and off.



Slide the switch up to make your front and rear turn signal lights flash on and off.

Your hazard warning flashers work no matter what position your key is in, and even if the key isn't in.



To turn off the flashers, slide the switch down. When the hazard warning flashers are on, your turn signals won't work.

## Other Warning Devices

If you carry reflective triangles, you can set one up at the side of the road about 300 feet (100 m) behind your vehicle.

## Jump Starting

If your battery has run down, you may want to use another vehicle and some jumper cables to start your Buick. But please follow the steps below to do it safely.



### CAUTION:

Batteries can hurt you. They can be dangerous because:

- They contain acid that can burn you.
- They contain gas that can explode or ignite.
- They contain enough electricity to burn you.

If you don't follow these steps exactly, some or all of these things can hurt you.

### NOTICE:

Ignoring these steps could result in costly damage to your vehicle that wouldn't be covered by your warranty.

Trying to start your Buick by pushing or pulling it won't work, and it could damage your vehicle.

## To Jump Start Your Buick:

1. Check the other vehicle. It must have a 12-volt battery with a negative ground system.

### NOTICE:

If the other system isn't a 12-volt system with a negative ground, both vehicles can be damaged.

2. Get the vehicles close enough so the jumper cables can reach, but be sure the vehicles aren't touching each other. If they are, it could cause a ground connection you don't want. You wouldn't be able to start your Buick, and the bad grounding could damage the electrical systems.



## CAUTION:

You could be injured if the vehicles roll. Set the parking brake firmly on each vehicle. Put an automatic transaxle in "P" (Park) or a manual transaxle in "N" (Neutral).

3. Turn off the ignition on both vehicles. Turn off all lights that aren't needed, and radios. This will avoid sparks and help save both batteries. And it could save your radio!

## NOTICE:

If you leave your radio on, it could be badly damaged. The repairs wouldn't be covered by your warranty.

4. Open the hoods and locate the batteries.



## CAUTION:

An electric fan can start up even when the engine is not running and can injure you. Keep hands, clothing and tools away from any underhood electric fan.

Find the positive (+) and negative (-) terminals on each battery.

Your Buick has a remote positive (+) jump starting terminal. The terminal is on the same side of the engine compartment as your battery.

You should always use the remote positive (+) terminal instead of the positive (+) terminal on your battery.

To uncover the remote positive (+) terminal, lift the red plastic cap.



## **CAUTION:**

Using a match near a battery can cause battery gas to explode. People have been hurt doing this, and some have been blinded. Use a flashlight if you need more light.

Be sure the battery has enough water. You don't need to add water to the Delco Freedom<sup>®</sup> battery installed in every new GM vehicle. But if a battery has filler caps, be sure the right amount of fluid is there. If it is low, add water to take care of that first. If you don't, explosive gas could be present.

Battery fluid contains acid that can burn you. Don't get it on you. If you accidentally get it in your eyes or on your skin, flush the place with water and get medical help immediately.

5. Check that the jumper cables don't have loose or missing insulation. If they do, you could get a shock. The vehicles could be damaged, too.

Before you connect the cables, here are some basic things you should know. Positive (+) will go to positive (+) and negative (-) will go to negative (-) or a metal engine part. Don't connect (+) to (-) or you'll get a short that would damage the battery and maybe other parts, too.



## **CAUTION:**

Fans or other moving engine parts can injure you badly. Keep your hands away from moving parts once the engines are running.





6. Connect the red positive (+) cable to the positive (+) terminal of the vehicle with the dead battery. Use a remote positive (+) terminal if the vehicle has one.



7. Don't let the other end touch metal. Connect it to the positive (+) terminal of the good battery. Use a remote positive (+) terminal if the vehicle has one.



8. Now connect the black negative (-) cable to the good battery's negative (-) terminal.

Don't let the other end touch anything until the next step. The other end of the negative cable doesn't go to the dead battery. It goes to a heavy unpainted metal part on the engine of the vehicle with the dead battery.

9. Attach the cable at least 18 inches (45 cm) away from the dead battery, but not near engine parts that move. The electrical connection is just as good there, but the chance of sparks getting back to the battery is much less.



10. Now start the vehicle with the good battery and run the engine for a while.

11. Try to start the vehicle with the dead battery.

If it won't start after a few tries, it probably needs service.

12. Remove the cables in reverse order to prevent electrical shorting. Take care that they don't touch each other or any other metal.

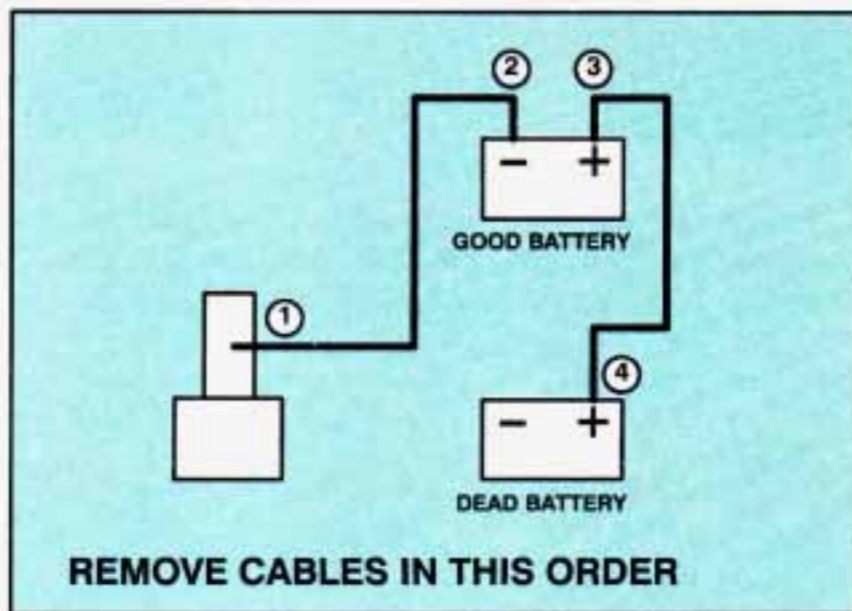

## Towing Your Vehicle

Try to have a GM dealer or a professional towing service tow your Buick. The usual towing equipment is a sling-type (A) or a wheel-lift (B) or car carrier (C) tow truck.

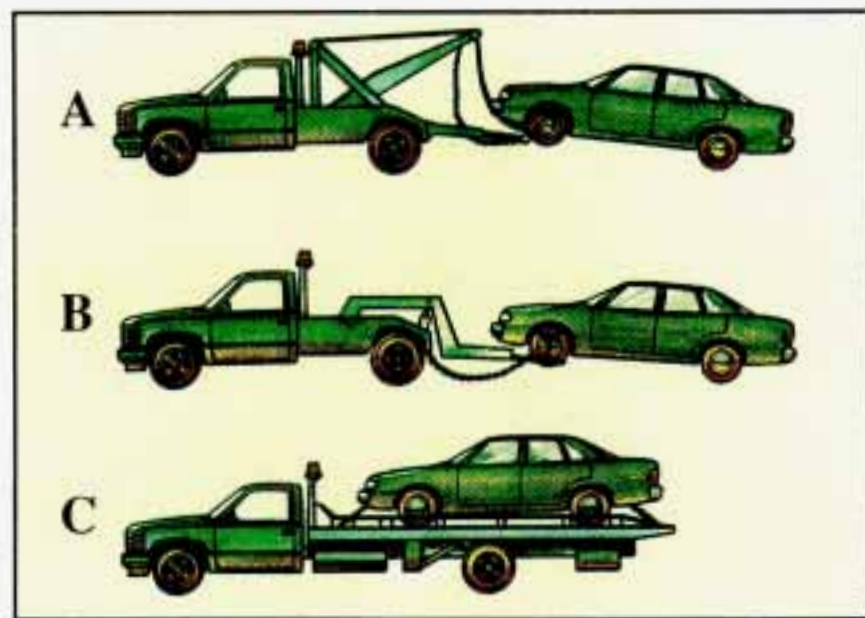

If your vehicle has been changed or modified since it was factory-new by adding aftermarket items like fog lamps, aero skirting, or special tires and wheels, these instructions and illustrations may not be correct.

Before you do anything, turn on the hazard warning flashers.

When you call, tell the towing service:

- That your vehicle has front-wheel drive.
- The make, model, and year of your vehicle.
- Whether you can still move the shift lever.
- If there was an accident, what was damaged.

When the towing service arrives, let the tow operator know that this manual contains detailed towing instructions and illustrations. The operator may want to see them.



## CAUTION:

To help avoid injury to you or others:

- Never let passengers ride in a vehicle that is being towed.
- Never tow faster than safe or posted speeds.
- Never tow with damaged parts not fully secured.
- Never get under your vehicle after it has been lifted by the tow truck.
- Always use separate safety chains on each side when towing a vehicle.
- Never use "J" hooks. Use T-hooks instead.



When your vehicle is being towed, have the ignition key off. The steering wheel should be clamped in a straight-ahead position, with a clamping device designed for towing service. Do not use the vehicle's steering column lock for this. The transaxle should be in Neutral and the parking brake released.

Don't have your vehicle towed on the front wheels, unless you must. If the vehicle must be towed on the front wheels, don't go more than **55 mph (88 Km/h)** or farther than **500 miles (800 km)** or your transaxle will be damaged. If these limits must be exceeded, then the front wheels have to be supported on a dolly.



## CAUTION:

A vehicle can fall from a car carrier if it isn't properly secured. This can cause a collision, serious personal injury and vehicle damage. The vehicle should be tightly secured with chains or steel cables before it is transported.

Don't use substitutes (ropes, leather straps, canvas webbing, etc.) that can be cut by sharp edges underneath the towed vehicle.

## Front Towing Hook-Ups (Custom Sedan Only)



Attach "T" hook chains in front of the wheels into the side slots of the cradle on both sides.

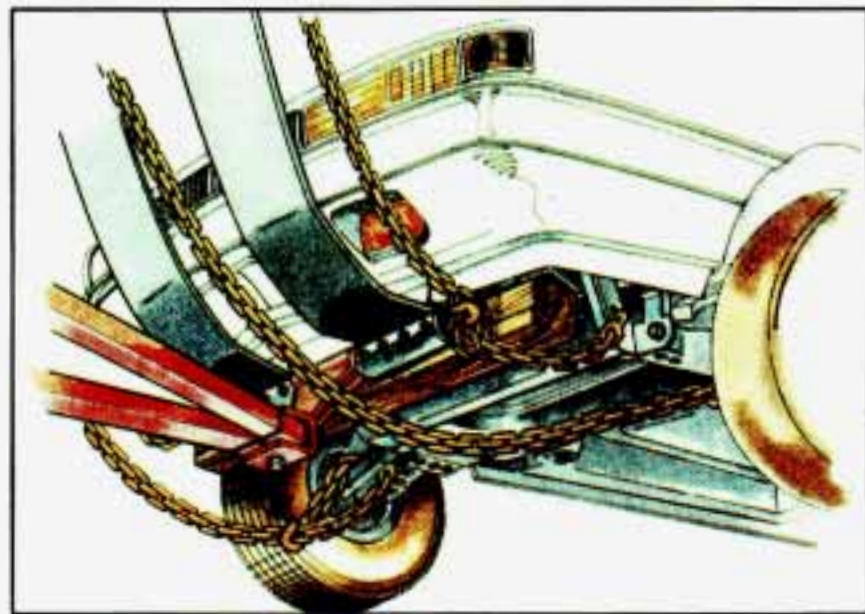

Position a 4" x 4" wood beam across the sling chains against the bottom of the cradle horns. Position the lower sling crossbar against the front of the 4" x 4" wood beam.



Attach a separate safety chain around the outboard end of each lower control arm.

## Front Towing Hook-Ups (Limited Sedan Only)



Attach "T" hook chains in front of the wheel into the side slots in the cradle on both sides.

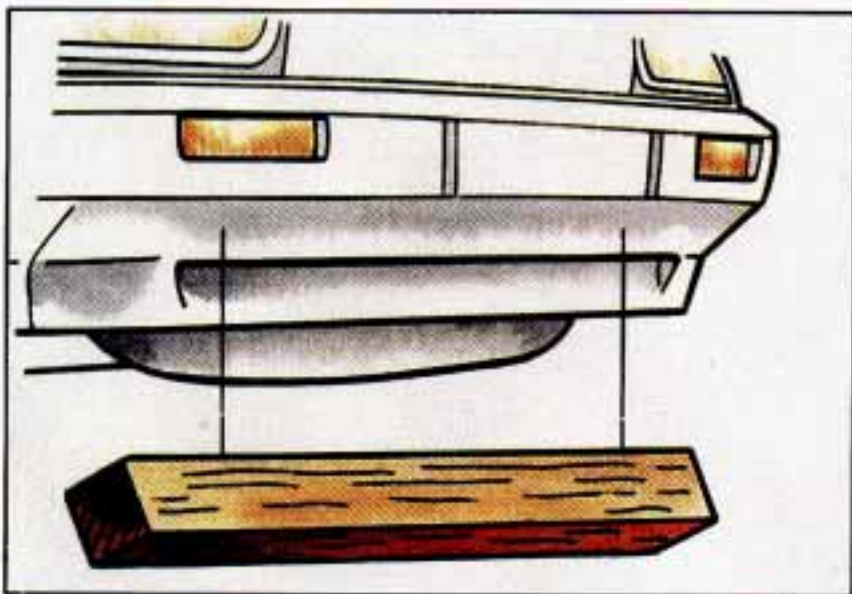

Position a 4" x 4" wood beam across the sling chains and center in the middle of the lower fascia.

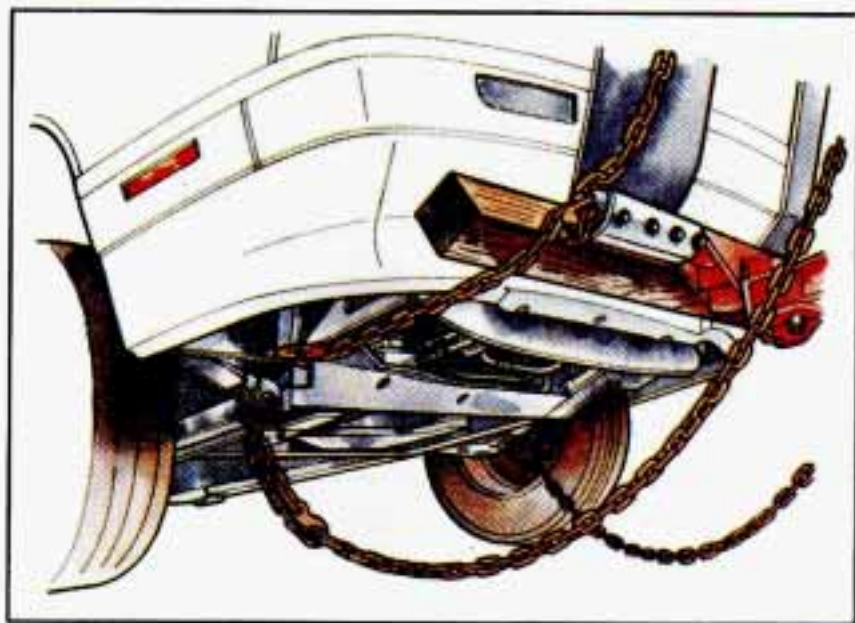

Position the lower sling crossbar against the front of the 4" x 4" wood beam.



Attach a separate safety chain around the outboard end of each lower control arm.

## Rear Towing Hook-Ups (Coupes Only)



Attach "T" hook chains into slots in the bottom of the floor pan just ahead of the rear wheels on both sides.

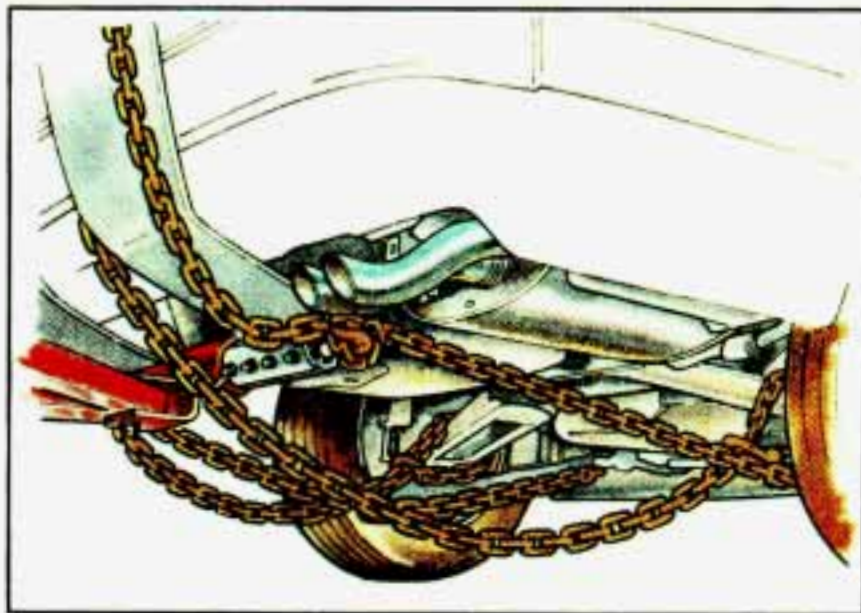

No 4" x 4" wood beam is needed. Position the lower sling crossbar just ahead of the front edge of the rear bumper.



Attach a separate safety chain around the outboard end of each lower control arm.

## Rear Towing Hook-Ups (Limited & Custom Sedans Only)

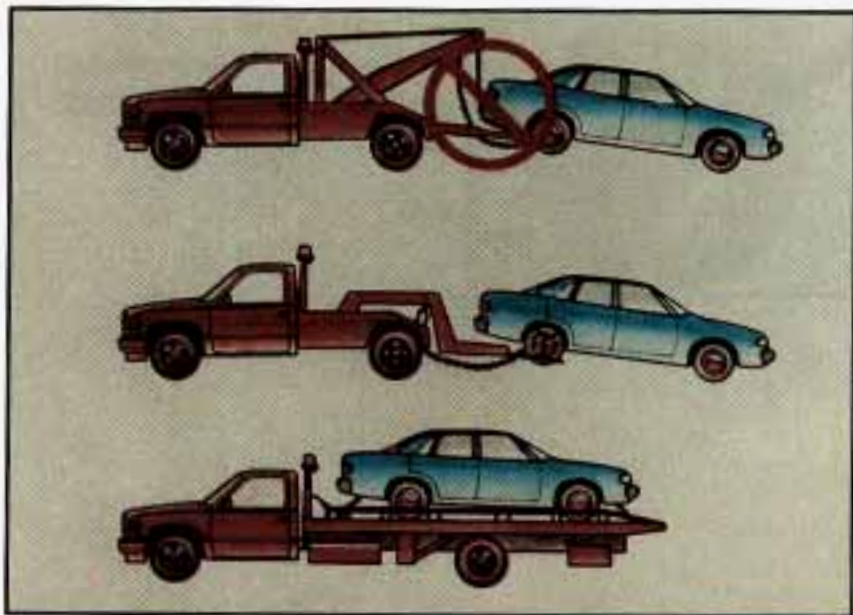

Use wheel lift or car carrier equipment. Additional ramping may be required for car carrier equipment. Use safety chain and wheel straps.

### **NOTICE:**

Do not tow with sling-type equipment or the rear bumper valance will be damaged.

To help avoid damaging a vehicle during a tow over rough surfaces, install a towing dolly beneath the wheels that would otherwise be on the ground during the tow. This will increase the clearance between the wheel-lift equipment and the underbody of the towed vehicle.



## Front Towing Hook-Ups (Coupes Only)

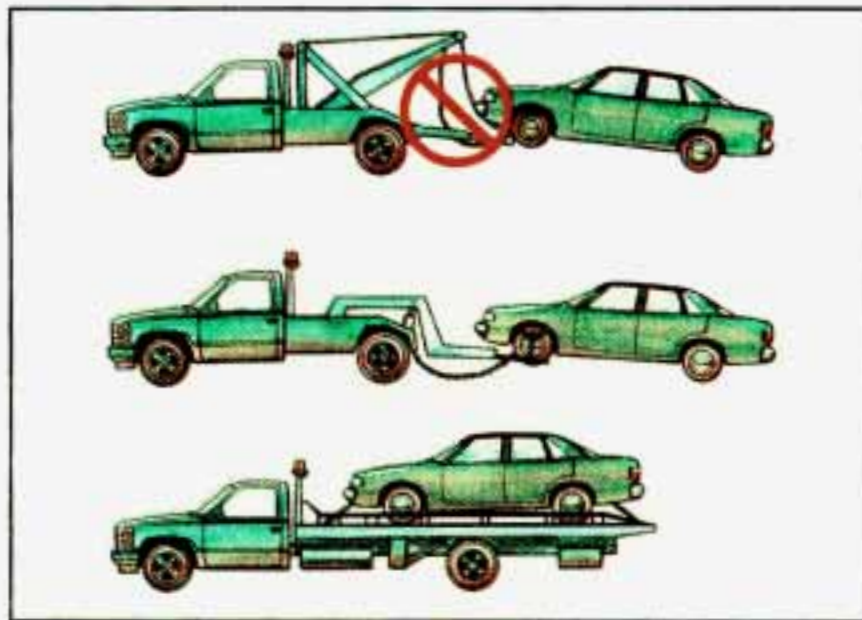

Use wheel lift or car carrier equipment. Additional ramping may be required for car carrier equipment. Use safety chain and wheel straps.

### **NOTICE:**

Do not tow with sling-type equipment or fascia/fog lamp/grille damage will occur.

To help avoid damaging a vehicle during a tow over rough surfaces, install a towing dolly beneath the wheels that would otherwise be on the ground during the tow. This will increase the clearance between the wheel-lift equipment and the underbody of the towed vehicle.

## Engine Overheating

You will find a coolant temperature gage on your Buick's instrument panel.

You may also find a low coolant warning light on your Buick instrument panel.

### If Steam Is Coming From Your Engine:



#### **CAUTION:**

**Steam from an overheated engine can burn you badly, even if you just open the hood. Stay away from the engine if you see or hear steam coming from it. Just turn it off and get everyone away from the vehicle until it cools down. Wait until there is no sign of steam or coolant before opening the hood.**

**If you keep driving when your engine is overheated, the liquids in it can catch fire. You or others could be badly burned. Stop your engine if it overheats, and get out of the vehicle until the engine is cool.**

#### **NOTICE:**

**If your engine catches fire because you keep driving with no coolant, your vehicle can be badly damaged. The costly repairs would not be covered by your warranty.**

### If No Steam Is Coming From Your Engine:

If you get the overheat warning but see or hear no steam, the problem may not be too serious. Sometimes the engine can get a little too hot when you:

- Climb a long hill on a hot day.
- Stop after high speed driving.
- Idle for long periods in traffic.
- Tow a trailer.

If you get the overheat warning with no sign of steam, try this for a minute or so:

1. Turn off your air conditioner.
2. Turn on your heater to full hot at the highest fan speed and open the window as necessary.
3. Try to keep your engine under load (in a drive gear where the engine runs slower).

If you no longer have the overheat warning, you can drive. Just to be safe, drive slower for about ten minutes. If the warning doesn't come back on, you can drive normally.

If the warning continues, pull over, stop, and park your vehicle right away.

If there's still no sign of steam, you can idle the engine for two or three minutes while you're parked, to see if the warning stops. But then, if you still have the warning, **TURN OFF THE ENGINE AND GET EVERYONE OUT OF THE VEHICLE** until it cools down.

You may decide not to lift the hood but to get service help right away.

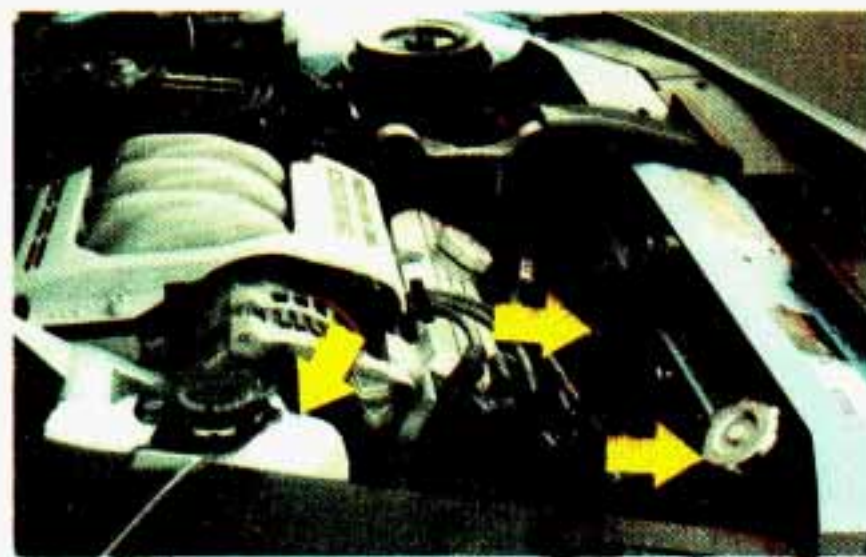

When you decide it's safe to lift the hood, here's what you'll see:

- Coolant recovery tank
- Radiator pressure cap
- Electric engine fan

**⚠ CAUTION:**

An electric fan under the hood can start up even when the engine is not running and can injure you. Keep hands, clothing and tools away from any underhood electric fan.

If the coolant inside the coolant recovery tank is boiling, don't do anything else until it cools down.



The coolant level should be at or above the "COLD". If it isn't, you may have a leak in the radiator hoses, heater hoses, radiator, water pump or somewhere else in the cooling system.

**⚠ CAUTION:**

Heater and radiator hoses, and other engine parts, can be very hot. Don't touch them. If you do, you can be burned.

Don't run the engine if there is a leak. If you run the engine, it could lose all coolant. That could cause an engine fire, and you could be burned. Get any leak fixed before you drive the vehicle.

**NOTICE:**

Engine damage from running your engine without coolant isn't covered by your warranty.

If there seems to be no leak, check to see if the electric engine fan is running. If the engine is overheating, the fan should be running. If it isn't, your vehicle needs service.

## How to Add Coolant to the Coolant Recovery Tank

If you haven't found a problem yet, but the coolant level isn't at or above "COLD" add a 50/50 mixture of clean water (preferably distilled) and a proper antifreeze at the coolant recovery tank. (See "Engine Coolant" in the Index for more information about the proper coolant mix.)



### CAUTION:

Adding only plain water to your cooling system can be dangerous. Plain water, or some other liquid like alcohol, can boil before the proper coolant mix will. Your vehicle's coolant warning system is set for the proper coolant mix. With plain water or the wrong mix, your engine could get too hot but you wouldn't get the overheat warning. Your engine could catch fire and you or others could be burned. Use a 50/50 mix of clean water and a proper antifreeze.

### NOTICE:

In cold weather, water can freeze and crack the engine, radiator, heater core and other parts. Use the recommended coolant.





## **CAUTION:**

**You can be burned if you spill coolant on hot engine parts. Coolant contains ethylene glycol and it will burn if the engine parts are hot enough. Don't spill coolant on a hot engine.**

When the coolant in the coolant recovery tank is at or above "COLD," start your vehicle.

If the overheat warning continues, there's one more thing you can try. You can add the proper coolant mix directly to the radiator, but be sure the cooling system is cool before you do it.



## **CAUTION:**

**Steam and scalding liquids from a hot cooling system can blow out and burn you badly. They are under pressure, and if you turn the radiator pressure cap -- even a little -- they can come out at high speed. Never turn the cap when the cooling system, including the radiator pressure cap, is hot. Wait for the cooling system and radiator pressure cap to cool if you ever have to turn the pressure cap.**



## How to Add Coolant to the Radiator

### **NOTICE:**

Your engine has a specific radiator fill procedure. Failure to follow this procedure could cause your engine to overheat and be severely damaged.



1. You can remove the radiator pressure cap when the cooling system, including the radiator pressure cap and upper radiator hose, is no longer hot.

Turn the pressure cap slowly to the left until it first stops. (Don't press down while turning the pressure cap.)

If you hear a hiss, wait for that to stop. A hiss means there is still some pressure left.

2. Then keep turning the pressure cap, but now push down as you turn it. Remove the pressure cap.



## CAUTION:

You can be burned if you spill coolant on hot engine parts. Coolant contains ethylene glycol and it will burn if the engine parts are hot enough. Don't spill coolant on a hot engine.

After the engine cools, open the coolant air bleed valve or valves.



3.1L V6 (VIN Code T or M): There are two bleed valves. One is located on the thermostat housing. The other is located on the thermostat bypass tube.



3.8L V6 (VIN Code L27): There is one bleed valve. It is located on the thermostat housing.





3. Fill the radiator with the proper mix, up to the base of the filler neck.

If you see a stream of coolant coming from an air bleed valve, close the valve. Otherwise, close the valve(s) after the radiator is filled.

4. Rinse or wipe any spilled coolant from the engine and compartment.



5. Then fill the coolant recovery tank to "COLD."
6. Put the cap back on the coolant recovery tank, but leave the radiator pressure cap off.



7. Start the engine and let it run until you can feel the upper radiator hose getting hot. Watch out for the engine fan(s).

8. By this time the coolant level inside the radiator filler neck may be lower. If the level is lower, add more of the proper mix through the filler neck until the level reaches the base of the filler neck.



9. Then replace the pressure cap. Be sure the arrows on the pressure cap line up like this.

## If a Tire Goes Flat

It's unusual for a tire to "blow out" while you're driving, especially if you maintain your tires properly. If air goes out of a tire, it's much more likely to leak out slowly. But if you should ever have a "blowout," here are a few tips about what to expect and what to do:

If a front tire fails, the flat tire will create a drag that pulls the vehicle toward that side. Take your foot off the accelerator pedal and grip the steering wheel firmly. Steer to maintain lane position, then gently brake to a stop well out of the traffic lane.

A rear blowout, particularly on a curve, acts much like a skid and may require the same correction you'd use in a skid. In any rear blowout, remove your foot from the accelerator pedal. Get the vehicle under control by steering the way you want the vehicle to go. It may be very bumpy and noisy, but you can still steer. Gently brake to a stop, well off the road if possible.

If your tire goes flat, the next section shows how to use your jacking equipment to change a flat tire safely.

## Changing a Flat Tire

If a tire goes flat, avoid further tire and wheel damage by driving slowly to a level place. Turn on your hazard warning flashers.



### **CAUTION:**

**Changing a tire can cause an injury. The vehicle can slip off the jack and roll over you or other people. You and they could be badly injured. Find a level place to change your tire. To help prevent the vehicle from moving:**

- 1. Set the parking brake firmly.**
- 2. Put the shift lever in "P" (Park).**
- 3. Turn off the engine.**

**To be even more certain the vehicle won't move, you can put chocks at the front and rear of the tire farthest away from the one being changed. That would be the tire on the other side of the vehicle, at the opposite end.**



The following steps will tell you how to use the jack and change a tire.



The equipment you'll need is in the trunk.

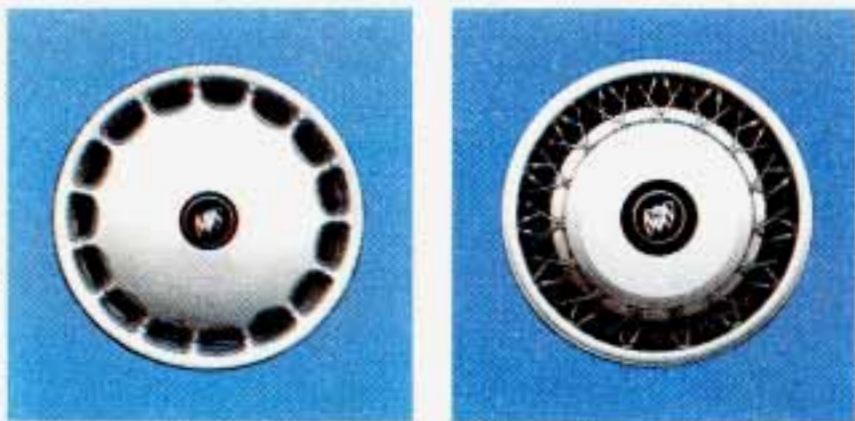

If there is a wheel cover, remove it by using the flat end of the wheel wrench. Pry along the edge of the wheel cover until it comes off. Be careful; the rim edges may be sharp. Don't try to remove it with your bare hands.



If your vehicle has wheel nut cover, remove it to access the wheel nuts.



If your vehicle has wheel nut caps, remove them using the wheel nut wrench.



If you have a Gran Sport Coupe, remove a rocker panel extension section to expose the place where the jack fits. Using the wheel wrench, loosen all the wheel nuts. Don't remove them yet.



Position the jack under the vehicle. Your Buick has a notch on the frame near each of the wheels. Fit the lift head into the notch nearest the wheel with the flat tire.

## NOTICE:

Raising your vehicle with the jack improperly positioned will damage the vehicle or may allow the vehicle to fall off the jack. Be sure to fit the jack lift head into the proper location before raising your vehicle.



## CAUTION:

Getting under a vehicle when it is jacked up is dangerous. If the vehicle slips off the jack, you could be badly injured or killed. Never get under a vehicle when it is supported only by a jack.

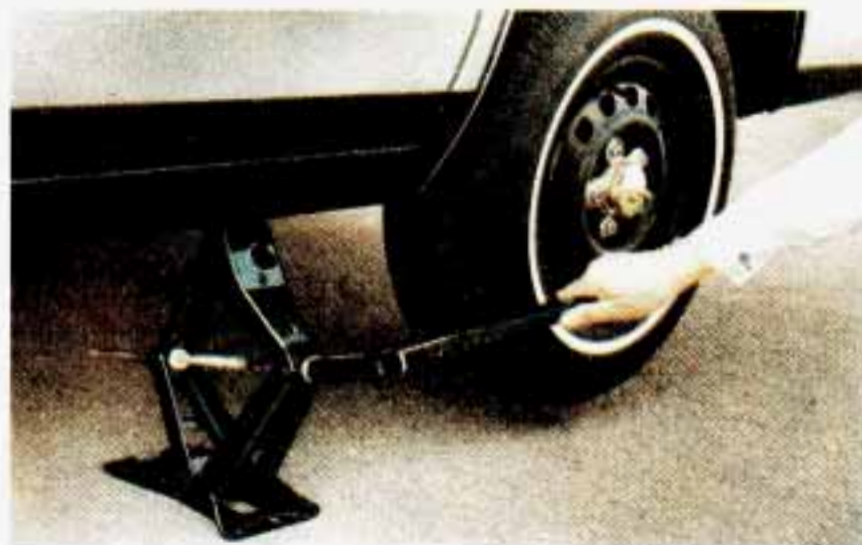

Raise the vehicle by rotating the wheel wrench clockwise. Raise the vehicle far enough off the ground so there is enough room for the spare tire to fit.

Remove all the wheel nuts and take off the flat tire.

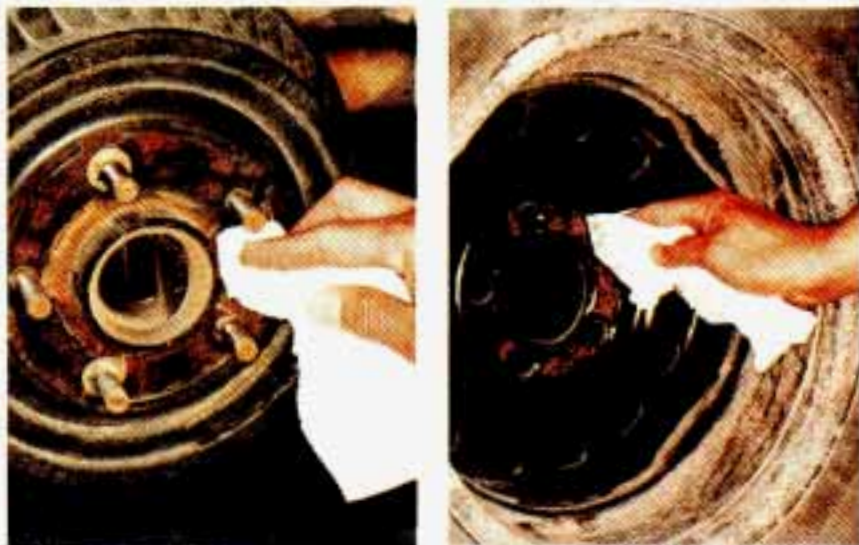

## CAUTION:

Rust or dirt on the wheel, or on the parts to which it is fastened, can make the wheel nuts become loose after a time. The wheel could come off and cause an accident. When you change a wheel, remove any rust or dirt from the places where the wheel attaches to the vehicle. In an emergency, you can use a cloth or a paper towel to do this; but be sure to use a scraper or wire brush later, if you need to, to get all the rust or dirt off.

Remove any rust or dirt from the wheel bolts, mounting surfaces or spare wheel. Place the spare on the wheel mounting surface.





## CAUTION:

Never use oil or grease on studs or nuts. If you do, the nuts might come loose. Your wheel could fall off, causing a serious accident.



Replace the wheel nuts with the rounded end of the nuts toward the wheel. Tighten each nut by hand until the wheel is held against the hub.



Lower the vehicle by rotating the wheel wrench counterclockwise. Lower the jack completely.

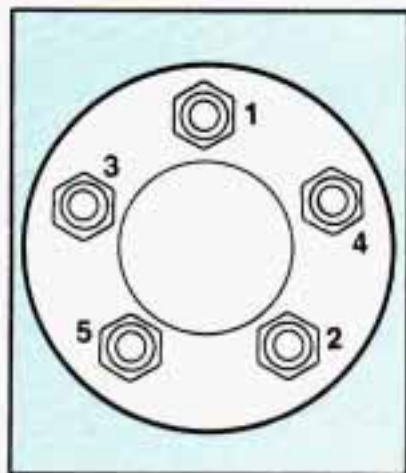

Tighten the wheel nuts firmly in a criss-cross sequence as shown.



## CAUTION:

Incorrect wheel nuts or improperly tightened wheel nuts can cause the wheel to become loose and even come off. This could lead to an accident. Be sure to use the correct wheel nuts. If you have to replace them, be sure to get the right kind.

Stop somewhere as soon as you can and have the nuts tightened with a torque wrench to 100 ft. lbs. (140 N·m).

Don't try to put a wheel cover on your compact spare tire. It won't fit. Store the wheel cover in the trunk until you have the flat tire repaired or replaced.

## NOTICE:

Wheel covers won't fit on your compact spare. If you try to put a wheel cover on your compact spare, you could damage the cover or the spare.

Now put all the equipment back into the trunk.

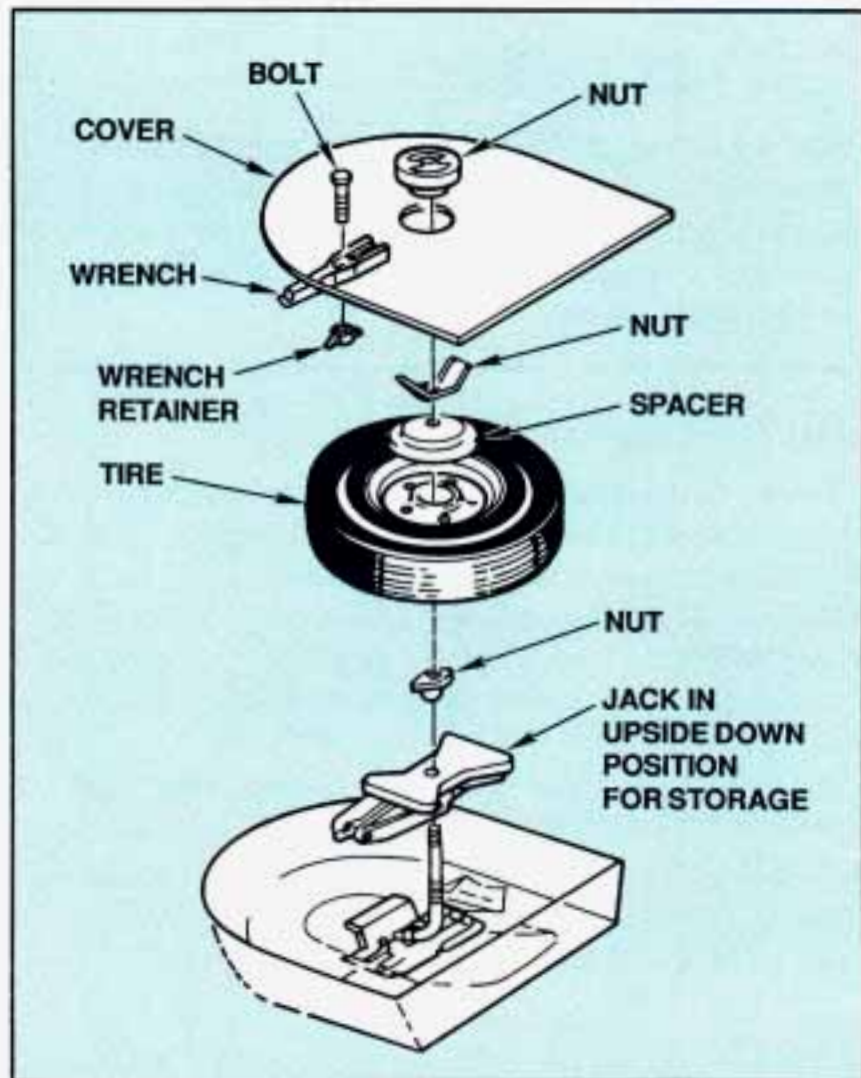



## CAUTION:

Storing a jack, a tire or other equipment in the passenger compartment of the vehicle could cause injury. In a sudden stop or collision, loose equipment could strike someone. Store all these in the proper place.

## Compact Spare Tire

Although the compact spare was fully inflated when your vehicle was new, it can lose air after a time. Check the inflation pressure regularly. It should be 60 psi (420 kPa). The compact spare is made to go up to 3,000 miles (5000 km), so you can finish your trip and have your full-size tire repaired or replaced where you want. Of course, it's best to replace your spare with a full-size tire as soon as you can. Your spare will last longer and be in good shape in case you need it again.

Your anti-lock brake system warning light may come on when you are driving with a compact spare. See "Anti-Lock Brake System Warning Light" in the Index.

## NOTICE:

Don't take your compact spare through an automatic car wash with guide rails. The compact spare can get caught on the rails. That can damage the tire and wheel, and maybe other parts of your vehicle.

Don't use your compact spare on some other vehicle.

And don't mix your compact spare or wheel with other wheels or tires. They won't fit. Keep your spare and its wheel together.

## NOTICE:

Tire chains won't fit your compact spare. Using them will damage your vehicle and destroy the chains too. Don't use tire chains on your compact spare.



## CAUTION:

Storing a jack, a tire, or other equipment in the passenger compartment of the vehicle could cause injury. In a sudden stop or collision, loose equipment could strike someone. Store all these in the proper place.

## If You're Stuck: In Sand, Mud, Ice or Snow

What you don't want to do when your vehicle is stuck is to spin your wheels. The method known as "rocking" can help you get out when you're stuck, but you must use caution.



## CAUTION:

If you let your tires spin at high speed, they can explode and you or others could be injured. And, the transaxle or other parts of the vehicle can overheat. That could cause an engine compartment fire or other damage. When you're stuck, spin the wheels as little as possible. Don't spin the wheels above 35 mph (55 km/h) as shown on the speedometer.

## NOTICE:

Spinning your wheels can destroy parts of your vehicle as well as the tires. If you spin the wheels too fast while shifting your transaxle back and forth, you can destroy your transaxle.

### Rocking your vehicle to get it out:

First, turn your steering wheel left and right. That will clear the area around your front wheels. Then shift back and forth between "R" (Reverse) and a forward gear, spinning the wheels as little as possible. Release the accelerator pedal while you shift, and press lightly on the accelerator pedal when the transaxle is in gear. If that doesn't get you out after a few tries, you may need to be towed out. If you do need to be towed out, see "Towing Your Vehicle" in the Index.



*1957 Buick Super*



## Part 6 Service And Appearance Care

Here you will find information about the care of your Buick. This Part begins with service and fuel information, and then it shows how to check important fluid and lubricant levels. There is also technical information about your vehicle, and a section devoted to its appearance care.

Part 6 includes:

Service Tips .....	214
Fuel .....	215
Hood Release .....	218
Engine Oil .....	220
Air Cleaner .....	225
Automatic Transaxle Fluid .....	226
Engine Coolant .....	228
Power Steering Fluid .....	231
Windshield Washer Fluid .....	232
Brakes .....	233
Battery .....	235
Bulb Replacement .....	236
Loading Your Vehicle .....	238
Tires .....	240
Appearance Care .....	248
Vehicle Identification Number (VIN) .....	256
Fuses and Circuit Breakers .....	257
Capacities and Specifications .....	263

## Service

Your Buick dealer knows your vehicle best and wants you to be happy with it. We hope you'll go to your dealer for all your service needs. You'll get genuine GM parts and GM-trained and supported service people.

We hope you'll want to keep your GM vehicle all GM. Genuine GM parts have one of these marks:



## Doing Your Own Service Work

If you want to do some of your own service work, you'll want to get the proper Buick Service Manual. It tells you much more about how to service your Buick than this manual can. To order the proper service manual, see "Service Publications" in the Index.

You should keep a record with all parts receipts and list the mileage and the date of any service work you perform. See "Maintenance Record" in the Index.



## CAUTION:

**You can be injured if you try to do service work on a vehicle without knowing enough about it.**

- **Be sure you have sufficient knowledge, experience, and the proper replacement parts and tools before you attempt any vehicle maintenance task.**
- **Be sure to use the proper nuts, bolts and other fasteners. "English" and "metric" fasteners can be easily confused. If you use the wrong fasteners, parts can later break or fall off. You could be hurt.**

## NOTICE:

**If you try to do your own service work without knowing enough about it, your vehicle could be damaged.**



## Fuel

Use regular unleaded gasoline rated at 87 octane or higher. It should meet specifications ASTM D4814 in the U.S. and CGSB 3.5-92 in Canada. These fuels should have the proper additives, so you should not have to add anything to the fuel.

In the U.S. and Canada, it's easy to be sure you get the right kind of gasoline (unleaded). You'll see "UNLEADED" right on the pump. And only unleaded nozzles will fit into your vehicle's filler neck.

Be sure the posted octane is at least 87. If the octane is less than 87, you may get a heavy knocking noise when you drive. If it's bad enough, it can damage your engine.

If you're using fuel rated at 87 octane or higher and you still hear heavy knocking, your engine needs service. But don't worry if you hear a little pinging noise when you're accelerating or driving up a hill. That's normal, and you don't have to buy a higher octane fuel to get rid of pinging. It's the heavy, constant knock that means you have a problem.

What about gasoline with blending materials that contain oxygen, such as MTBE or alcohol?

MTBE is "methyl tertiary-butyl ether." Fuel that is no more than 15% MTBE is fine for your vehicle.

Ethanol is ethyl or grain alcohol. Properly-blended fuel that is no more than 10% ethanol is fine for your vehicle.

Methanol is methyl or wood alcohol.

### **NOTICE:**

**Fuel that is more than 5% methanol is bad for your vehicle. Don't use it. It can corrode metal parts in your fuel system and also damage plastic and rubber parts. That damage wouldn't be covered under your warranty. And even at 5% or less, there must be "cosolvents" and corrosion preventers in this fuel to help avoid these problems.**

### Gasolines for Cleaner Air

Your use of gasoline with detergent additives will help prevent deposits from forming in your engine and fuel system. That helps keep your engine in tune and your emission control system working properly. It's good for your vehicle, and you'll be doing your part for cleaner air.

Many gasolines are now blended with materials called oxygenates. General Motors recommends that you use

gasolines with these blending materials, such as MTBE and ethanol. By doing so, you can help clean the air, especially in those parts of the country that have high carbon monoxide levels.

In addition, some gasoline suppliers are now producing reformulated gasolines. These gasolines are specially designed to reduce vehicle emissions. General Motors recommends that you use reformulated gasoline. By doing so, you can help clean the air, especially in those parts of the country that have high ozone levels.

You should ask your service station operators if their gasolines contain detergents and oxygenates, and if they have been reformulated to reduce vehicle emissions.

## **Fuels in Foreign Countries**

If you plan on driving in another country outside the U.S. or Canada, unleaded fuel may be hard to find. Do not use leaded gasoline. If you use even one tankful, your emission controls won't work well or at all. With continuous use, spark plugs can get fouled, the exhaust system can corrode, and your engine oil can deteriorate quickly. Your vehicle's oxygen sensor will be damaged. All of that means costly repairs that wouldn't be covered by your warranty.

To check on fuel availability, ask an auto club, or contact a major oil company that does business in the country where you'll be driving.

You can also write us at the following address for advice. Just tell us where you're going and give your Vehicle Identification Number (VIN).

General Motors of Canada Ltd.  
International Export Sales  
P.O. Box 828  
Oshawa, Ontario L1H 7N1, Canada

## Filling Your Tank



The cap is behind a hinged door on the left side of your vehicle.



While refueling, hang the cap inside the fuel door.  
To take off the cap, turn it slowly to the left (counterclockwise).



### **CAUTION:**

Gasoline vapor is highly flammable. It burns violently, and that can cause very bad injuries. Don't smoke if you're near gasoline or refueling your vehicle. Keep sparks, flames, and smoking materials away from gasoline.



## CAUTION:

If you get gasoline on you and then something ignites it, you could be badly burned. Gasoline can spray out on you if you open the fuel filler cap too quickly. This spray can happen if your tank is nearly full, and is more likely in hot weather. Open the fuel filler cap slowly and wait for any "hiss" noise to stop. Then unscrew the cap all the way.

When you put the cap back on, turn it to the right until you hear a clicking noise.

## NOTICE:

If you need a new cap, be sure to get the right type. Your dealer can get one for you. If you get the wrong type, it may not fit or have proper venting, and your fuel tank and emissions system might be damaged.

## Checking Things Under the Hood

### Hood Release



To open the hood, first pull the handle inside the vehicle. It is located on the floor next to the driver's seat.



Then go to the front of the vehicle and release the secondary hood release. Lift the hood.

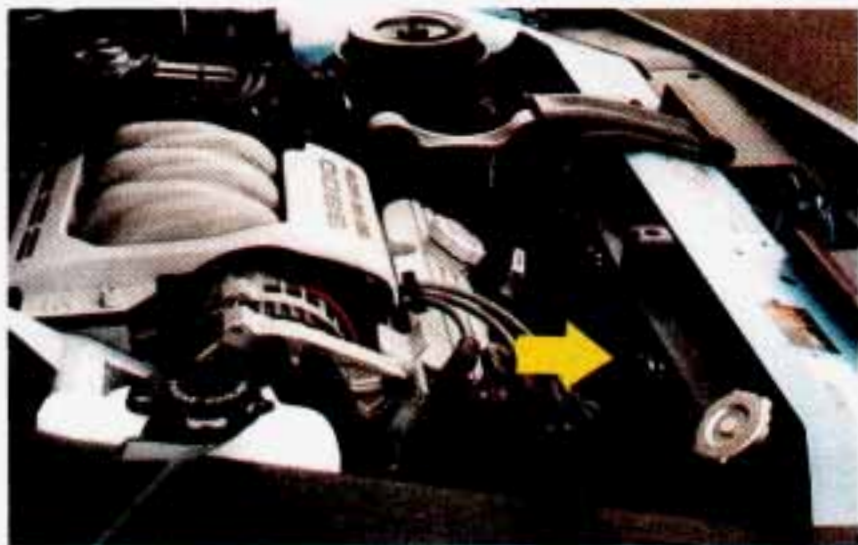

 **CAUTION:**

An electric fan under the hood can start up and injure you even when the engine is not running. Keep hands, clothing and tools away from any underhood electric fan.

 **CAUTION:**

Things that burn can get on hot engine parts and start a fire. These include liquids like gasoline, oil, coolant, brake fluid, windshield washer and other fluids, and plastic or rubber. You or others could be burned. Be careful not to drop or spill things that will burn onto a hot engine.

Before closing the hood, be sure all the filler caps are on properly.

Then just pull the hood down and close it firmly.

## Engine Oil

If the “LOW OIL” light on the instrument panel comes on, it means you need to check your engine oil level right away. You should check your engine oil level regularly, the light is an added reminder.



It's a good idea to check your engine oil every time you get fuel. In order to get an accurate reading, the oil must be warm and the vehicle must be on level ground.



The dipstick is located near the front and center of the engine compartment.

Turn off the engine and give the oil a few minutes to drain back into the oil pan. If you don't, the oil dipstick might not show the actual level.



**To Check Engine Oil:** Pull out the dipstick and clean it with a paper towel or cloth, then push it back in all the way. Remove it again, keeping the tip lower.

**When to Add Oil:** If the oil is at or below the ADD line, then you'll need to add some oil. But you must use the right kind. This section explains what kind of oil to use. For crankcase capacity, see "Capacities and Specifications" in the Index.

## NOTICE:

Don't add too much oil. If your engine has so much oil that the oil level gets above the cross-hatched area that shows the proper operating range, your engine could be damaged.

Just fill it enough to put the level somewhere in the proper operating range. Push the dipstick all the way back in when you're through.

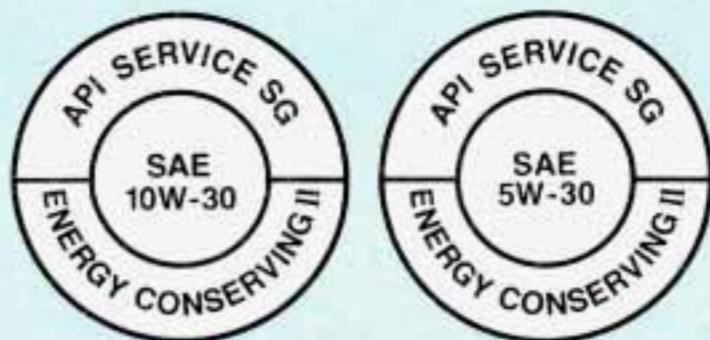

## What Kind of Oil to Use:

Look for three things:

- SG

“SG” must be on the oil container, either by itself or combined with other quality designations, such as “SG/CC,” “SG/CD,” “SF,SG,CC,” etc. These letters show American Petroleum Institute (API) levels of quality.

### NOTICE:

If you use oils that don't have the “SG” designation, you can cause engine damage not covered by your warranty.

- If you have the 3.8L engine use: SAE 10W-30

As shown in the viscosity chart, SAE 10W-30 is best for your vehicle. However, you can use SAE 5W-30 if it's going to be colder than 60°F (16°C) before your next oil change. When it's very cold, below 0°F (-18°C), you should use SAE 5W-30.

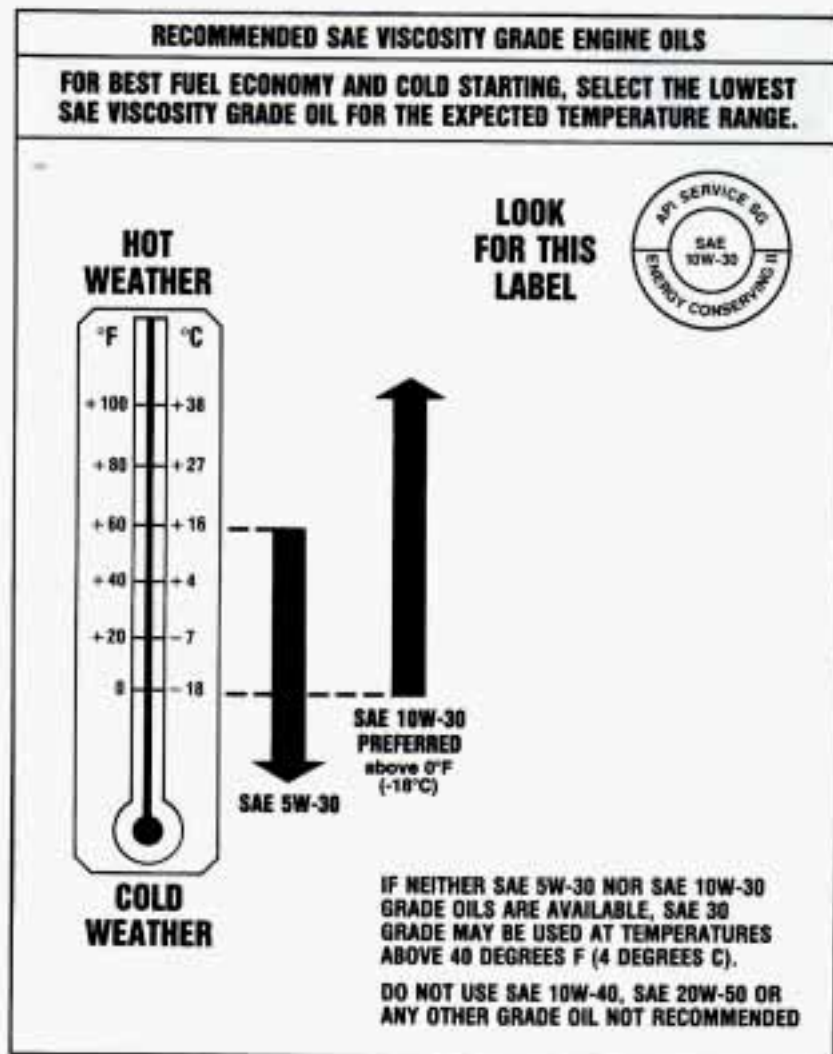



**RECOMMENDED SAE VISCOSITY GRADE ENGINE OILS**

**FOR BEST FUEL ECONOMY AND COLD STARTING, SELECT THE LOWEST SAE VISCOSITY GRADE OIL FOR THE EXPECTED TEMPERATURE RANGE.**

**HOT WEATHER**

**COLD WEATHER**

**LOOK FOR THIS LABEL**

IF NEITHER SAE 5W-30 NOR SAE 10W-30 GRADE OILS ARE AVAILABLE, SAE 30 GRADE MAY BE USED AT TEMPERATURES ABOVE 40 DEGREES F (4 DEGREES C).  
 DO NOT USE SAE 10W-40, SAE 20W-50 OR ANY OTHER GRADE OIL NOT RECOMMENDED

- If you have the 3.1L engine use: SAE 5W-30  
As shown in the viscosity chart, SAE 5W-30 is best for your vehicle. However, you can use SAE 10W-30 if it's going to be 0°F (-18°C) or above.

These numbers on an oil container show its viscosity, or thickness. Do not use other viscosity oils such as SAE 10W-40 or SAE 20W-50.

- Energy Conserving II

Oils with these words on the container will help you save fuel.

This doughnut-shaped logo (symbol) is used on most oil containers to help you select the correct oil.

You should look for this on the oil container, and use **only** those oils that display the logo.

GM Goodwrench<sup>®</sup> oil (in Canada, GM Engine Oil) meets all the requirements for your vehicle.

**Engine Oil Additives:** Don't add anything to your oil. Your Buick dealer is ready to advise if you think something should be added.

**When to Change Engine Oil:** See if any one of these is true for you:

- Most trips are less than 4 miles (6 km).
- It's below freezing outside and most trips are less than 10 miles (16 km).
- The engine is at low speed most of the time (as in door-to-door delivery, or in stop-and-go traffic).
- You tow a trailer often.
- Most trips are through dusty places.

If any one of these is true for your vehicle, then you need to change your oil and filter every 3,000 miles (5 000 km) or 3 months -- whichever comes first.

If none of them is true, change the oil every 7,500 miles (12 500 km) or 12 months -- whichever comes first. Change the filter at the first oil change and at every other oil change after that.

**Engine Block Heater:** An engine block heater can be a big help if you have to park outside in very cold

weather, -20°F (-29°C) or colder. If your vehicle has this option, see "Engine Block Heater" in the Index.

#### What to Do with Used Oil:



#### CAUTION:

**Used engine oil contains things that have caused skin cancer in laboratory animals. Don't let used oil stay on your skin for very long. Clean your skin and nails with soap and water, or a good hand cleaner. Wash or properly throw away clothing or rags containing used engine oil.**

Used oil can be a real threat to the environment. If you change your own oil, be sure to drain all free-flowing oil from the filter before disposal. Don't ever dispose of oil by pouring it on the ground, into sewers, or into streams or bodies of water. Instead, recycle it by taking it to a place that collects used oil. If you have a problem

properly disposing of your used oil, ask your dealer, a service station or a local recycling center for help.

## Air Cleaner



The air cleaner is in the right front area of the engine compartment.

Refer to the Maintenance Schedule to determine when to replace the air filter.

See “Scheduled Maintenance Services” in the Index.



### CAUTION:

Operating the engine with the air cleaner off can cause you or others to be burned. The air cleaner not only cleans the air, it stops flame if the engine backfires. If it isn't there, and the engine backfires, you could be burned. Don't drive with it off, and be careful working on the engine with the air cleaner off.

### NOTICE:

If the air cleaner is off, a backfire can cause a damaging engine fire. And, dirt can easily get into your engine, which will damage it. Always have the air cleaner in place when you're driving.

## Automatic Transaxle Fluid

### When to Check and Change:

A good time to check your automatic transaxle fluid level is when the engine oil is changed. Refer to the Maintenance Schedule to determine when to change your fluid. See “Scheduled Maintenance Services” in the Index.

### How to Check:

Because this operation can be a little difficult, you may choose to have this done at a Buick dealership Service Department.

If you do it yourself, be sure to follow all the instructions here, or you could get a false reading on the dipstick.

### **NOTICE:**

**Too much or too little fluid can damage your transaxle. Too much can mean that some of the fluid could come out and fall on hot engine parts, starting a fire. Be sure to get an accurate reading if you check your transaxle fluid.**

Wait at least 30 minutes before checking the transaxle fluid level if you have been driving:

- When outside temperatures are above 90°F (32°C).
- At high speed for quite a while.
- In heavy traffic -- especially in hot weather.
- While pulling a trailer.

To get the right reading, the fluid should be at normal operating temperature, which is 180°F to 200°F (82°C to 93°C).

Get the vehicle warmed up by driving about 15 miles (24 km) when outside temperatures are above 50°F (10°C). If it's colder than 50°F (10°C), you may have to drive longer.

### To check the fluid level:

- Park your vehicle on a level place.
- Place the shift lever in “P” (Park) with the parking brake applied.
- With your foot on the brake pedal, move the shift lever through each gear range, pausing for about three seconds in each range. Then, position the shift lever in “P” (Park).
- Let the engine run at idle for three to five minutes.

Then, without shutting off the engine, follow these steps:



1. Pull out the dipstick and wipe it with a clean rag or paper towel.

2. Push it back in all the way, wait three seconds and then pull it back out again.



3. Check both sides of the dipstick, and read the lower level. The fluid level must be in the cross-hatched area.
4. If the fluid level is where it should be, push the dipstick back in all the way.

#### **How to Add Fluid:**

Refer to the Maintenance Schedule to determine what kind of transaxle fluid to use. See "Recommended Fluids and Lubricants" in the Index.

If the fluid level is low, add only enough of the proper fluid to bring the level into the cross-hatched area on the dipstick. It doesn't take much fluid, generally less than a pint. Don't overfill. We recommend you use only fluid labeled DEXRON®-IIE, because fluids with that label are made especially for your automatic transaxle.

Damage caused by fluid other than DEXRON®-IIE is not covered by your new vehicle warranty.

- After adding fluid, recheck the fluid level as described under "How to Check."
- When the correct fluid level is obtained, push the dipstick back in all the way.

## Engine Coolant

The following explains your cooling system and how to add coolant when it is low. If you have a problem with engine overheating or if you need to add coolant to your radiator, see "Engine Overheating" in the Index.

The proper coolant for your Buick will:

- Give freezing protection down to  $-34^{\circ}\text{F}$  ( $-37^{\circ}\text{C}$ ).
- Give boiling protection up to  $262^{\circ}\text{F}$  ( $128^{\circ}\text{C}$ ).
- Protect against rust and corrosion.
- Help keep the proper engine temperature.
- Let the warning lights work as they should.

## What to Use:

Use a mixture of one-half clean water (preferably distilled) and one-half antifreeze that meets "GM Specification 1825-M," which won't damage aluminum parts. You can also use a recycled coolant conforming to GM Specification 1825-M with a complete coolant flush and refill. Use GM Engine Coolant Supplement (sealer) with any complete coolant change. If you use these, you don't need to add anything else.



## CAUTION:

**Adding only plain water to your cooling system can be dangerous. Plain water, or some other liquid like alcohol, can boil before the proper coolant mix will. Your vehicle's coolant warning system is set for the proper coolant mix. With plain water or the wrong mix, your engine could get too hot but you wouldn't get the overheat warning. Your engine could catch fire and you or others could be burned. Use a 50/50 mix of clean water and a proper antifreeze.**

## NOTICE:

If you use an improper coolant mix, your engine could overheat and be badly damaged. The repair cost wouldn't be covered by your warranty. Too much water in the mix can freeze and crack the engine, radiator, heater core and other parts.

### Adding Coolant



The 3.1 liter engine has the coolant recovery tank located at the left of the engine compartment.



The 3.8 liter engine has the coolant recovery tank located at the left of the engine compartment.

**To Check Coolant:** When your engine is cold, the coolant level should be at "COLD" or a little higher. When your engine is warm, the level should be up to "HOT," or a little higher.

**LOW  
COOLANT**

If this light comes on, it means you're low on engine coolant. This light comes on, it means you're low on engine coolant (diesel engine only).

**To Add Coolant:** If you need more coolant, add the proper mix at the coolant recovery tank.



### **CAUTION:**

Turning the radiator pressure cap when the engine and radiator are hot can allow steam and scalding liquids to blow out and burn you badly. With the coolant recovery tank, you will almost never have to add coolant at the radiator. Never turn the radiator pressure cap -- even a little -- when the engine and radiator are hot.

Add coolant mix at the recovery tank, but be careful not to spill it.



### **CAUTION:**

You can be burned if you spill coolant on hot engine parts. Coolant contains ethylene glycol, and it will burn if the engine parts are hot enough. Don't spill coolant on a hot engine.



## Radiator Pressure Cap

### **NOTICE:**

Your radiator cap is a 15 psi (105 kPa) pressure-type cap and must be tightly installed to prevent coolant loss and possible engine damage from overheating. Be sure the arrows on the cap line up with the overflow tube on the radiator filler neck.

When you replace your radiator pressure cap, an AC® cap is recommended.

## Thermostat

Engine coolant temperature is controlled by a thermostat in the engine coolant system. The thermostat stops the flow of coolant through the radiator until the coolant reaches a preset temperature.

When you replace your thermostat, an AC® thermostat is recommended.

## Power Steering Fluid



### **How To Check Power Steering Fluid:**

Unscrew the cap and wipe the dipstick with a clean rag. Replace the cap and completely tighten it. Then remove the cap again and look at the fluid level on the dipstick.

- When the engine compartment is hot, the level should be at the "HOT" mark.
- When the engine compartment is cool, the level should be at the "FULL COLD" mark.

### What to Add:

Refer to the Maintenance Schedule to determine what kind of fluid to use. See “Recommended Fluids and Lubricants” in the Index.

### NOTICE:

When adding power steering fluid or making a complete fluid change, always use the proper fluid. Failure to use the proper fluid can cause leaks and damage hoses and seals.

## Windshield Washer Fluid

### To Add:



Open the cap labeled “WASHER FLUID ONLY.” Add washer fluid until the bottle is full.

## NOTICE:

- When using concentrated washer fluid, follow the manufacturer's instructions for adding water.
- Don't mix water with ready-to-use washer fluid. Water can cause the solution to freeze and damage your washer fluid tank and other parts of the washer system. Also, water doesn't clean as well as washer fluid.
- Fill your washer fluid tank only 3/4 full when it's very cold. This allows for expansion, which could damage the tank if it is completely full.
- Don't use radiator antifreeze in your windshield washer. It can damage your washer system and paint.

## Brake Master Cylinder

Your brake master cylinder is here. It is filled with DOT-3 brake fluid.



There are only two reasons why the brake fluid level in your master cylinder might go down. The first is that the brake fluid goes down to an acceptable level during normal brake lining wear. When new linings are put in, the fluid level goes back up. The other reason is that fluid is leaking out of the brake system. If it is, you should have your brake system fixed, since a leak means that sooner or later your brakes won't work well, or

won't work at all. So, it isn't a good idea to "top off" your brake fluid. Adding brake fluid won't correct a leak. If you add fluid when your linings are worn, then you'll have too much fluid when you get new brake linings. You should add (or remove) brake fluid, as necessary, only when work is done on the brake hydraulic system.



### **CAUTION:**

**If you have too much brake fluid, it can spill on the engine. The fluid will burn if the engine is hot enough. You or others could be burned, and your vehicle could be damaged. Add brake fluid only when work is done on the brake hydraulic system.**

When your brake fluid falls to a low level, your brake warning light will come on. See "Brake System Warning Light" in the Index.

### **What to Add:**

When you do need brake fluid, use only DOT-3 brake fluid -- such as Delco Supreme 11® (GM Part No.1052535). Use new brake fluid from a sealed container only.

### **NOTICE:**

- **DOT-5 silicone brake fluid can damage your vehicle. Don't use it.**
- **Don't let someone put in the wrong kind of fluid. For example, just a few drops of mineral-based oil, such as engine oil, in your brake system can damage brake system parts so badly that they'll have to be replaced.**
- **Brake fluid can damage paint, so be careful not to spill brake fluid on your vehicle.**

## **Replacing Brake System Parts**

The braking system on a modern vehicle is complex. Its many parts have to be of top quality and work well together if the vehicle is to have really good braking. Vehicles we design and test have top-quality GM brake parts in them, as your Buick does when it is new. When you replace parts of your braking system -- for example, when your brake linings wear down and you have to have new ones put in -- be sure you get new genuine GM replacement parts. If you don't, your brakes may no longer work properly. For example, if someone puts in brake linings that are wrong for your vehicle, the

balance between your front and rear brakes can change, for the worse. The braking performance you've come to expect can change in many other ways if someone puts in the wrong replacement brake parts.

## Battery

Every new Buick has a Delco Freedom® battery. You never have to add water to one of these. When it's time for a new battery, we recommend a Delco Freedom® battery. Get one that has the catalog number shown on the original battery's label.

## Vehicle Storage

If you're not going to drive your vehicle for 25 days or more, take off the black, negative (-) cable from the battery. This will help keep your battery from running down.

### CAUTION:

Batteries have acid that can burn you and gas that can explode. You can be badly hurt if you aren't careful. See "Jump Starting" in the Index for tips on working around a battery without getting hurt.

Contact your dealer to learn how to prepare your vehicle for longer storage periods.

## Halogen Bulbs



### CAUTION:

Halogen bulbs have pressurized gas inside and can burst if you drop or scratch the bulb. You or others could be injured. Take special care when handling and disposing of halogen bulbs.

## Headlamp Bulb Replacement

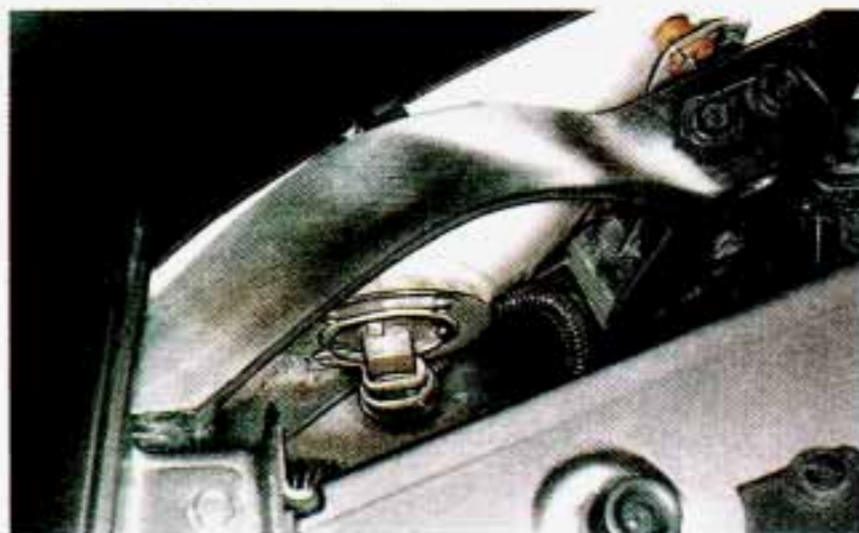

Headlight bulbs can be changed as described by the following procedure.

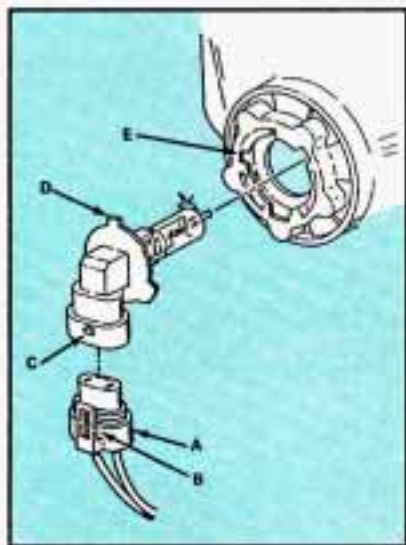

1. Remove the electrical connector (A) from the bulb by raising the lock tab (B) and pulling the connector down and away from the bulb's plastic base (C).

2. Press and turn the plastic base (C) a 1/4 turn counterclockwise and remove from the metal retaining ring (E) by gently pulling back and away from the headlight.

3. Install the new bulb by inserting the smallest tab (D) located on top of the plastic base into the corresponding notch in the metal retaining ring (E). Turn 1/4 turn clockwise until it stops. The small plastic tab should be at the top of the metal ring.
4. Install the electrical connector with slotted grooves toward to the front of vehicle.

### Taillamp Bulb Replacement



Remove the plastic nuts that secure the trunk trim over the taillights area.



1. Remove the plastic wingnuts of the taillamp bulbs you want to replace.
2. Pull the taillight away from body carefully, to avoid scratching the paint or dropping it.



3. Squeeze the bulb socket and turn it 1/4 turn to detach it from the light.



4. Pull the bulb straight out to remove it from its socket. The new bulb must be aligned properly, then push it in the socket. Reinstall the socket, taillight, and rear trunk trim.

## Loading Your Vehicle



TIRE-LOADING INFORMATION					
OCCUPANTS			VEHICLE CAP. WT.		
FRT.	CTR.	RR.	TOTAL	LBS.	KG

MAX. LOADING & GVWR SAME AS VEHICLE  
CAPACITY WEIGHT   XXX   COLD TIRE  
TIRE SIZE                   SPEED   PRESSURE  
  RTG   PSI/KPa

FRT.

RR.

SPA.

IF TIRES ARE HOT, ADD 4PSI/28KPa  
SEE OWNER'S MANUAL FOR ADDITIONAL  
INFORMATION



Two labels on your vehicle show how much weight it may properly carry. The Tire-Loading Information label found on the deck lid, tells you the proper size, speed rating and recommended inflation pressures for the tires on your vehicle. It also gives you important information about the number of people that can be in your vehicle



and the total weight that you can carry. This weight is called the Vehicle Capacity Weight and includes the weight of all occupants, cargo, and all nonfactory-installed options.



MFD BY GENERAL MOTORS CORP  
DATE GVWR GAWR FRT GAWR RR

THIS VEHICLE CONFORMS TO ALL APPLICABLE U.S. FEDERAL MOTOR VEHICLE SAFETY, BUMPER, AND THEFT PREVENTION STANDARDS IN EFFECT ON THE DATE OF MANUFACTURE SHOWN ABOVE.

**GENUINE**

The other label is the Certification label, found on the rear edge of the driver's door. It tells you the gross weight capacity of your vehicle, called the GVWR (Gross Vehicle Weight Rating). The GVWR includes the weight of the vehicle, all occupants, fuel and cargo. Never exceed the GVWR for your vehicle, or the Gross Axle Weight Rating (GAWR) for either the front or rear axle.

And, if you do have a heavy load, you should spread it out. Don't carry more than 167 pounds (76 kilograms) in your trunk .



### **CAUTION:**

**Do not load your vehicle any heavier than the GVWR or the maximum front and rear GAWRs. If you do, parts on your vehicle can break, or it can change the way your vehicle handles. These could cause you to lose control. Also, overloading can shorten the life of your vehicle.**

### **NOTICE:**

**Your warranty does not cover parts or components that fail because of overloading.**

If you put things inside your vehicle -- like suitcases, tools, packages, or anything else -- they will go as fast as the vehicle goes. If you have to stop or turn quickly, or if there is a crash, they'll keep going.



## **CAUTION:**

Things you put inside your vehicle can strike and injure people in a sudden stop or turn, or in a crash.

- Put things in the trunk of your vehicle. In a trunk, put them as far forward as you can. Try to spread the weight evenly.
- Never stack heavier things, like suitcases, inside the vehicle so that some of them are above the tops of the seats.
- When you carry something inside the vehicle, secure it whenever you can.
- Don't leave a seat folded down unless you need to.

## **Tires**

We don't make tires. Your new vehicle comes with high quality tires made by a leading tire manufacturer. These tires are warranted by the tire manufacturers and their warranties are delivered with every new Buick. If your spare tire is a different brand than your road tires, you will have a tire warranty folder from each of these manufacturers.



## **CAUTION:**

Poorly maintained and improperly used tires are dangerous.

- **Overloading your tires can cause overheating as a result of too much friction. You could have an air-out and a serious accident. See "Loading Your Vehicle" in the Index.**
- **Underinflated tires pose the same danger as overloaded tires. The resulting accident could cause serious injury. Check all tires frequently to maintain the recommended pressure. Tire pressure should be checked when your tires are cold.**
- **Overinflated tires are more likely to be cut, punctured, or broken by a sudden impact, such as when you hit a pothole. Keep tires at the recommended pressure.**
- **Worn, old tires can cause accidents. If your tread is badly worn, or if your tires have been damaged, replace them.**

## **Inflation - Tire Pressure**

The Tire-Loading Information label which is on deck lid shows the correct inflation pressures for your tires, when they're cold. "Cold" means your vehicle has been sitting for at least three hours or driven no more than a mile.

## **NOTICE:**

**Don't let anyone tell you that underinflation or overinflation is all right. It's not. If your tires don't have enough air (underinflation) you can get:**

- **Too much flexing**
- **Too much heat**
- **Tire overloading**
- **Bad wear**
- **Bad handling**
- **Bad fuel economy.**

**If your tires have too much air (overinflation), you can get:**

- **Unusual wear**
- **Bad handling**
- **Rough ride**
- **Needless damage from road hazards.**

**When to Check:** Check your tires once a month or more.

Don't forget your compact spare tire. It should be at 60 psi (420 kPa).

**How to Check:** Use a good quality pocket-type gage to check tire pressure. Simply looking at the tires will not tell you the pressure, especially if you have radial tires -- which may look properly inflated even if they're underinflated.

If your tires have valve caps, be sure to put them back on. They help prevent leaks by keeping out dirt and moisture.

## Tire Inspection and Rotation

To make your tires last longer, have them inspected and rotated at the mileages recommended in the Maintenance Schedule. See "Scheduled Maintenance Services" in the Index.

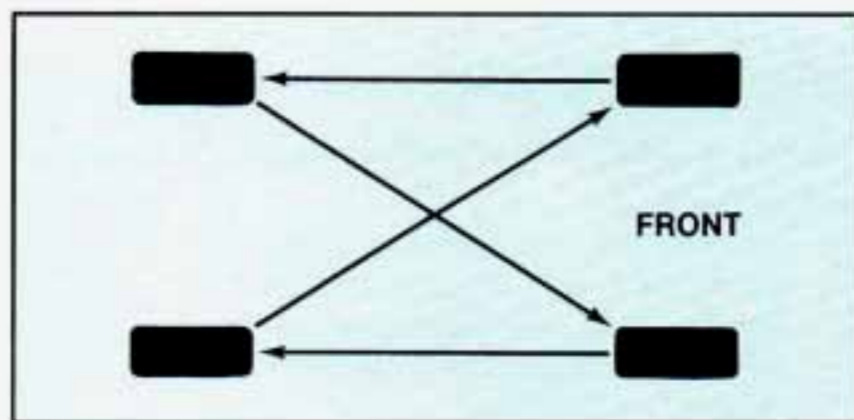

Use this rotation pattern.

After the tires have been rotated, adjust the front and rear inflation pressure as shown on the Tire-Loading Information label. Make certain that all wheel nuts are properly tightened. See "Wheel Nut Torque" in the Index.



## CAUTION:

Rust or dirt on a wheel, or on the parts to which it is fastened, can make wheel nuts become loose after a time. The wheel could come off and cause an accident. When you change a wheel, remove any rust or dirt from places where the wheel attaches to the vehicle. In an emergency, you can use a cloth or a paper towel to do this; but be sure to use a scraper or wire brush later, if you need to, to get all the rust or dirt off. (See "Changing a Flat Tire" in the Index.)

## When It's Time for New Tires

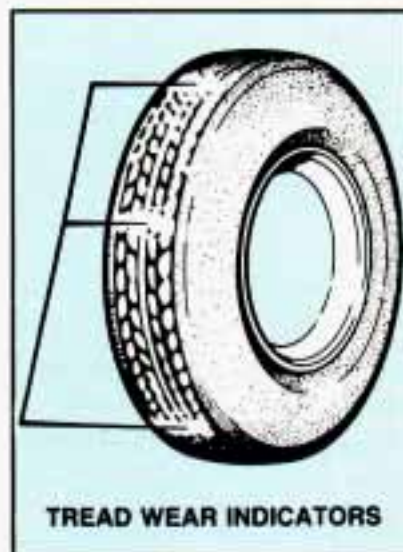

One way to tell when it's time for new tires is to check the treadwear indicators, which will appear when your tires have only  $\frac{2}{32}$  inch (1.6 mm) or less of tread remaining.

You need a new tire if:

- You can see the indicators at three places around the tire.
- You can see cord or fabric showing through the tire's rubber.
- The tread or sidewall is cracked, cut or snagged deep enough to show cord or fabric.
- The tire has a bump, bulge or split.

- The tire has a puncture, cut, or other damage that can't be repaired well because of the size or location of the damage.

## Buying New Tires

To find out what kind and size of tires you need, look at the Tire-Loading Information label.

The tires installed on your vehicle when it was new had a Tire Performance Criteria Specification (TPC Spec) number on each tire's sidewall. When you get new tires, get ones with that same TPC Spec number. That way, your vehicle will continue to have tires that are designed to give proper endurance, handling, speed rating, traction, ride and other things during normal service on your vehicle. If your tires have an all-season tread design, the TPC number will be followed by a "MS" (for mud and snow).

If you ever replace your tires with those not having a TPC Spec number, make sure they are the same size, load range, speed rating and construction type (bias, bias-belted or radial) as your original tires.



## CAUTION:

**Mixing tires could cause you to lose control while driving. If you mix tires of different sizes or types (radial and bias-belted tires), the vehicle may not handle properly, and you could have a crash. Be sure to use the same size and type tires on all wheels.**

**It's all right to drive with your compact spare, though. It was developed for limited use on your vehicle.**

## Uniform Tire Quality Grading

The following information relates to the system developed by the United States National Highway Traffic Safety Administration which grades tires by treadwear, traction and temperature performance. (This applies only to vehicles sold in the United States.)

### Treadwear

The treadwear grade is a comparative rating based on the wear rate of the tire when tested under controlled conditions on a specified government test course. For example, a tire graded 150 would wear one and a half (1

1/2) times as well on the government course as a tire graded 100. The relative performance of tires depends upon the actual conditions of their use, however, and may depart significantly from the norm due to variations in driving habits, service practices and differences in road characteristics and climate.

### **Traction - A, B, C**

The traction grades, from highest to lowest are: A, B, and C. They represent the tire's ability to stop on wet pavement as measured under controlled conditions on specified government test surfaces of asphalt and concrete. A tire marked C may have poor traction performance.

Warning: The traction grade assigned to this tire is based on braking (straight-ahead) traction tests and does not include cornering (turning) traction.

### **Temperature - A, B, C**

The temperature grades are A (the highest), B, and C, representing the tire's resistance to the generation of heat and its ability to dissipate heat when tested under controlled conditions on a specified indoor laboratory test wheel. Sustained high temperature can cause the material of the tire to degenerate and reduce tire life, and excessive temperature can lead to sudden tire failure.

The grade C corresponds to a level of performance which all passenger car tires must meet under the Federal Motor Vehicle Safety Standard No. 109. Grades B and A represent higher levels of performance on the laboratory test wheel than the minimum required by law.

Warning: The temperature grade for this tire is established for a tire that is properly inflated and not overloaded. Excessive speed, underinflation, or excessive loading, either separately or in combination, can cause heat buildup and possible tire failure.

Those grades are molded on the sidewalls of passenger car tires.

While the tires available as standard or optional equipment on General Motors vehicles may vary with respect to these grades, all such tires meet General Motors performance standards and have been approved for use on General Motors vehicles. All passenger type (P Metric) tires must conform to Federal safety requirements in addition to these grades.

### **Wheel Alignment and Tire Balance**

The wheels on your vehicle were aligned and balanced carefully at the factory to give you the longest tire life and best overall performance.

In most cases, you will not need to have your wheels aligned again. However, if you notice unusual tire wear or your vehicle pulling one way or the other, the alignment may need to be reset. If you notice your vehicle vibrating when driving on a smooth road, your wheels may need to be rebalanced.

## Wheel Replacement

Replace any wheel that is bent, cracked or badly rusted. If wheel nuts keep coming loose, the wheel, wheel bolts, and wheel nuts should be replaced. If the wheel leaks air out, replace it (except some aluminum wheels, which can sometimes be repaired). See your Buick dealer if any of these conditions exist.

Your dealer will know the kind of wheel you need.

Each new wheel should have the same load carrying capacity, diameter, width, offset, and be mounted the same way as the one it replaces.

If you need to replace any of your wheels, wheel bolts, or wheel nuts, replace them only with new GM original equipment parts. This way, you will be sure to have the right wheel, wheel bolts, and wheel nuts for your Buick model.



## CAUTION:

**Using the wrong replacement wheels, wheel bolts, or wheel nuts on your vehicle can be dangerous. It could affect the braking and handling of your vehicle, make your tires lose air and make you lose control. You could have a collision in which you or others could be injured. Always use the correct wheel, wheel bolts, and wheel nuts for replacement.**

## NOTICE:

**The wrong wheel can also cause problems with bearing life, brake cooling, speedometer/odometer calibration, headlight aim, bumper height, vehicle ground clearance, and tire or tire chain clearance to the body and chassis.**



## Used Replacement Wheels



### CAUTION:

Putting a used wheel on your vehicle is dangerous. You can't know how it's been used or how many miles it's been driven. It could fail suddenly and cause an accident. If you have to replace a wheel use a new GM original equipment wheel.

## Tire Chains

### NOTICE:

If your Buick has P215/60R16 or P225/60R16 size tires, don't use tire chains; they can damage your vehicle.

If you have other tires, use tire chains only when you must. Use only SAE Class "S" type chains that are the proper size for your tires. Install them on the front tires and tighten them as tightly as possible with the ends securely fastened. Drive slowly and follow the chain manufacturer's instructions. If you can hear the chains contacting your vehicle, stop and retighten them. If the contact continues, slow down until it stops. Driving too fast with chains on will damage your vehicle.

## Appearance Care



### CAUTION:

Cleaning products can be hazardous. Some are toxic. Others can burst into flame if you strike a match or get them on a hot part of the vehicle. Some are dangerous if you breathe their fumes in a closed space. When you use anything in a container to clean your Buick, be sure to follow the instructions. And always open your doors or windows when you're cleaning the inside.

**Never** use these to clean your vehicle:

- Gasoline
- Benzene
- Naphtha
- Carbon Tetrachloride
- Acetone
- Paint Thinner
- Turpentine
- Lacquer Thinner
- Nail Polish Remover

They can all be hazardous -- some more than others -- and they can all damage your vehicle, too.

### NOTICE:

Don't use any of these unless this manual says you can. In many uses, they will damage your vehicle:

- Laundry Soap
- Bleach
- Reducing Agents

## Cleaning the Inside of Your Buick

Use a vacuum cleaner often to get rid of dust and loose dirt. Wipe vinyl with a clean, damp cloth.

Your Buick dealer has two GM cleaners -- a solvent-type spot lifter and a foam-type powdered cleaner. They will clean normal spots and stains very well.

Here are some cleaning tips:

- Always read the instructions on the cleaner label.
- Clean up stains as soon as you can -- before they set.
- Use a clean cloth or sponge, and change to a clean area often. A soft brush may be used if stains are stubborn.

- Use solvent-type cleaners in a well-ventilated area only. If you use them, don't saturate the stained area.
- If a ring forms after spot cleaning, clean the entire area immediately or it will set.

## Using Foam-Type Cleaner on Fabric

- Vacuum and brush the area to remove any loose dirt.
- Always clean a whole trim panel or section. Mask surrounding trim along stitch or welt lines.
- Mix Multi-Purpose Powdered Cleaner following the directions on the container label.
- Use suds only and apply with a clean sponge.
- Don't saturate the material.
- Don't rub it roughly.
- As soon as you've cleaned the section, use a sponge to remove the suds.
- Rinse the section with a clean, wet sponge.
- Wipe off what's left with a slightly damp paper towel or cloth.
- Then dry it immediately with an air hose, a hair dryer or a heat lamp.

### **NOTICE:**

**Be careful with a hair dryer or heat lamp. You could scorch the fabric.**

- Wipe with a clean cloth.

## Using Solvent-Type Cleaner on Fabric

First, see if you have to use solvent-type cleaner at all. Some spots and stains will clean off better with just water and mild soap.

If you need to use it, then:

- Gently scrape excess soil from the trim material with a clean, dull knife or scraper. Use very little cleaner, light pressure and clean cloths (preferably cheesecloth). Cleaning should start at the outside of the stain, "feathering" toward the center. Keep changing to a clean section of the cloth.
- When you clean a stain from fabric, immediately dry the area with an air hose, hair dryer, or heat lamp to help prevent a cleaning ring. (See the previous NOTICE.)

## Special Cleaning Problems

**Greasy or Oily Stains:** Like grease, oil, butter, margarine, shoe polish, coffee with cream, chewing gum, cosmetic creams, vegetable oils, wax crayon, tar and asphalt.

- Carefully scrape off excess stain.
- Then follow the solvent-type instructions above.
- Shoe polish, wax crayon, tar and asphalt will stain if left on a vehicle seat fabric. They should be removed as soon as possible. Be careful, because the cleaner will dissolve them and may cause them to bleed.

**Non-Greasy Stains:** Like catsup, coffee (black), egg, fruit, fruit juice, milk, soft drinks, wine, vomit, urine and blood.

- Carefully scrape off excess stain, then sponge the soiled area with cool water.
- If a stain remains, follow the foam-type instructions above.
- If an odor lingers after cleaning vomit or urine, treat the area with a water/baking soda solution: 1 teaspoon (5 ml) of baking soda to 1 cup (250 ml) of lukewarm water.

- Finally, if needed, clean lightly with solvent-type cleaner.

**Combination Stains:** Like candy, ice cream, mayonnaise, chili sauce and unknown stains.

- Carefully scrape off excess stain, then clean with cool water and allow to dry.
- If a stain remains, clean it with solvent-type cleaner.

## Cleaning Vinyl or Leather

Just use warm water and a clean cloth.

- Rub with a clean, damp cloth to remove dirt. You may have to do it more than once.
- Things like tar, asphalt and shoe polish will stain if you don't get them off quickly. Use a clean cloth and solvent-type vinyl/leather cleaner.

## Cleaning the Top of the Instrument Panel

Use only mild soap and water to clean the top surfaces of the instrument panel. Sprays containing silicones or waxes may cause annoying reflections in the windshield and even make it difficult to see through the windshield under certain conditions.

## Care of Safety Belts

Keep belts clean and dry.



### **CAUTION:**

**Do not bleach or dye safety belts. If you do, it may severely weaken them. In a crash they might not be able to provide adequate protection. Clean safety belts only with mild soap and lukewarm water.**

## Glass

Glass should be cleaned often. GM Glass Cleaner (GM Part No. 1050427) or a liquid household glass cleaner will remove normal tobacco smoke and dust films.

Don't use abrasive cleaners on glass, because they may cause scratches. Avoid placing decals on the inside rear window, since they may have to be scraped off later. If abrasive cleaners are used on the inside of the rear window, an electric defogger element may be damaged. Any temporary license should not be attached across the defogger grid.

## Cleaning the Outside of the Windshield and Wiper Blades

If the windshield is not clear after using the windshield washer, or if the wiper blade chatters when running, wax or other material may be on the blade or windshield.

Clean the outside of the windshield with GM Windshield Cleaner, Bon-Ami Powder® (GM Part No. 1050011). The windshield is clean if beads do not form when you rinse it with water.

Clean the blade by wiping vigorously with a cloth soaked in full strength windshield washer solvent. Then rinse the blade with water.

Wiper blades should be checked on a regular basis and replaced when worn.

## Cleaning the Outside of Your Buick

The paint finish on your vehicle provides beauty, depth of color, gloss retention and durability.

### Washing Your Vehicle

The best way to preserve your vehicle's finish is to keep it clean by washing it often with lukewarm or cold water.

Don't wash your vehicle in the direct rays of the sun. Don't use strong soaps or chemical detergents. Use liquid hand, dish or car washing (non-detergent) soaps. Don't use cleaning agents that contain acid or abrasives. All cleaning agents should be flushed promptly and not allowed to dry on the surface, or they could stain. Dry the finish with a soft, clean chamois or a 100% cotton towel to avoid surface scratches and water spotting.

High pressure vehicle washes may cause water to enter your vehicle.

### **Finish Care**

Occasional waxing or mild polishing of your Buick may be necessary to remove residue from the paint finish. You can get GM approved cleaning products from your dealer. (See "Appearance Care and Materials" in the Index.)

Your Buick has a "basecoat/clearcoat" paint finish. The clearcoat gives more depth and gloss to the colored basecoat.

### **NOTICE:**

**Machine compounding or aggressive polishing on a basecoat/clearcoat paint finish may dull the finish or leave swirl marks.**

### **Aluminum Wheels (If So Equipped)**

Your aluminum wheels have a protective coating similar to the painted surface of your vehicle. Don't use strong soaps, chemicals, chrome polish, or other abrasive cleaners on them because you could damage this coating. After rinsing thoroughly, a wax may be applied.

### **NOTICE:**

**If you have aluminum wheels, don't use an automatic vehicle wash that has hard silicon carbide cleaning brushes. These brushes can take off the protective coating.**

## White Sidewall Tires

Your Buick dealer has a GM White Sidewall Tire Cleaner. You can use a stiff brush with it.

## Weatherstrips

These are places where glass or metal meets rubber. Silicone grease there will make them last longer, seal better, and not stick or squeak. Apply silicone grease with a clean cloth at least every six months.

## Sheet Metal Damage

If your vehicle is damaged and requires sheet metal repair or replacement, make sure the body repair shop applies anti-corrosion material to the parts repaired or replaced to restore corrosion protection.

## Foreign Material

Calcium chloride and other salts, ice melting agents, road oil and tar, tree sap, bird droppings, chemicals from industrial chimneys, and other foreign matter can damage your vehicle's finish if they remain on painted surfaces. Use cleaners that are marked safe for painted surfaces for these stains.

## Finish Damage

Any stone chips, fractures or deep scratches in the finish should be repaired right away. Bare metal will corrode quickly and may develop into a major repair expense.

Minor chips and scratches can be repaired with touch-up materials available from your dealer or other service outlets. Larger areas of finish damage can be corrected in your dealer's body and paint shop.

## Underbody Maintenance

Chemicals used for ice and snow removal and dust control can collect on the underbody. If these are not removed, accelerated corrosion (rust) can occur on the underbody parts such as fuel lines, frame, floor pan, and exhaust system even though they have corrosion protection.

At least every spring, flush these materials from the underbody with plain water. Clean any areas where mud and other debris can collect. Dirt packed in closed areas of the frame should be loosened before being flushed. Your dealer or an underbody vehicle washing system can do this for you.

## Fiberglass Springs

### **NOTICE:**

**Don't use corrosive or acidic cleaning agents, engine degreasers, aluminum cleaning agents or other harsh solvents to clean fiberglass springs; they'll damage the springs.**

## Chemical Paint Spotting

Some weather and atmospheric conditions can create a chemical fallout. Airborne pollutants can fall upon and attack painted surfaces on your vehicle. This damage can take two forms: blotchy, ringlet-shaped discolorations, and small irregular dark spots etched into the paint surface.

Although no defect in the paint job causes this, Buick will repair, at no charge to the owner, the surfaces of new vehicles damaged by this fallout condition within 12 months or 12,000 miles (20 000 km) of purchase, whichever comes first.



## Appearance Care and Maintenance Materials

You can get these from your Buick dealer.

PART NUMBER	SIZE	DESCRIPTION	USAGE
12345343	16 oz. (0.473L)	Magic Mirror Creme Wax	Exterior cleaner and polish
1052277	12 oz. (0.354L)	Spray-A-Squeak	Weather strips
1052863	1 oz. (0.028kg)	Silicone Grease	Stops squeaks
1050172	16 oz. (0.473L)	Tar and Road Oil Remover	Also removes old waxes, polishes
1050173	16 oz. (0.473L)	Chrome Cleaner and Polish	Removes rust and corrosion
1050174	16 oz. (0.473L)	White Sidewall Tire Cleaner	Cleans white and black tires
1050214	32 oz. (0.946L)	Vinyl/Leather Cleaner	Spot and stain removal
1050244	16 oz. (0.473L)	Fabric Cleaner	Spot and stain removal
1050427	23 oz. (0.680L)	Glass Cleaner	Also spot cleans vinyls
1050429	6 lb. (2.72kg)	Multi-Purpose Powdered Cleaner	Cleans vinyl and cloth, also, tires and mats
1052349	12 oz. (0.340kg)	Lubriplate (White Grease)	For hood, trunk, door hinges and latches
1051055	16 oz. (0.473L)	Preservatone	Vinyl Top Dressing
1051398*	8 oz. (0.237L)	Spot Lifter	For cloth
1051515	32 oz. (0.946L)	Washer Solvent	Windshield-washing system
1052870	16 oz. (0.473L)	Wash-Wax (conc.)	Exterior Wash

\* Not recommended for pigskin suede leather.

See Your General Motors Dealers for These Products.

See Your Maintenance Schedule for Other Products.

## Vehicle Identification Number (VIN)



This is the legal identifier for your Buick. It appears on a plate in the front corner of the instrument panel, on the driver's side. You can see it if you look through the windshield from outside your vehicle. The VIN also appears on the Vehicle Certification and Service Parts labels and the certificates of title and registration.

### Engine Identification

The eighth character in your VIN is the engine code for your GM engine. This code will help you identify your engine, specifications, and replacement parts in this section.

## Service Parts Identification Label

You'll find this label on the deck lid. It's very helpful if you ever need to order parts. On this label is:

- Your VIN.
- Its model designation.
- Paint information.
- A list of all production options and special equipment.

Be sure that this label is not removed from the vehicle.

## Add-On Electrical Equipment

### NOTICE:

**Don't add anything electrical to your Buick unless you check with your dealer first. Some electrical equipment can damage your vehicle and the damage wouldn't be covered by your warranty. Some of it can just keep other things from working as they should.**

## Fuses and Circuit Breakers

The wiring circuits in your car are protected from short circuits by a combination of fuses, circuit breakers, and fusible thermal links in the wiring itself. This greatly reduces the chance of fires caused by electrical problems.



This fuse panel is inside the glove box. Pull the cover down for access. Some spare fuses and a fuse puller are included.

Be sure to use the correct fuse. If you ever have a problem on the road and don't have a spare fuse, you can "borrow" one of the correct value. Just pick some feature of your car that you can get along without -- like the radio or cigarette lighter -- and use its fuse, if it is of the value you need. Replace it as soon as you can.

## Fuse Usage

	Amp	Description
1.	10	Radio & Clock
2.	15	Radio & Clock; Instrument Cluster; Passive Restraint Timer
3.	15	Courtesy, Glove Box, Underhood, Trunk, Header Lights; Cigarette Lighter; Lighted Inside Rearview Mirror; Power Door Locks; Power Mirrors
4.	25	Windshield Wiper & Washer
5.	10	Cruise Control; DRL Module; Instrument Cluster; HVAC
6.	15	Brake Lights; ABS Control Module; Chime Module
7.	15	Engine Control Module
8.	20	Taillights; DRL Module
9.	15	Hazard Warning Flasher
10.	10	Rear Defogger Timer Relay; Instrument Cluster; Chime Module; Cruise Control; DRL Module; Lamp Driver Module; ABS Lamp Driver
11.	5	Instrument Panel, Console, Switch Lights
12.	25	Blower Motor
13.	10	Turn Signals
14.		Not Used
15.	10	ABS Control Module
16.		Not Used
17.		Not Used
18.		Not Used

## Electrical Center

### Driver Side — Underhood

	Amp	Description
1.		Not Used
2.		Not Used
3.		Not Used
4.		Not Used
5.		Not Used
6.		Not Used
7.		Not Used
8.	5	ABS Control Module
9.	15	Fog Lights
10.	10	Horn
11.		Not Used
12.		Not Used
13.	60	ABS Controller
14.	50	Exterior Lights
<b>Relay</b>		
15.		Horn
16.		Fog Lights
17.		ABS

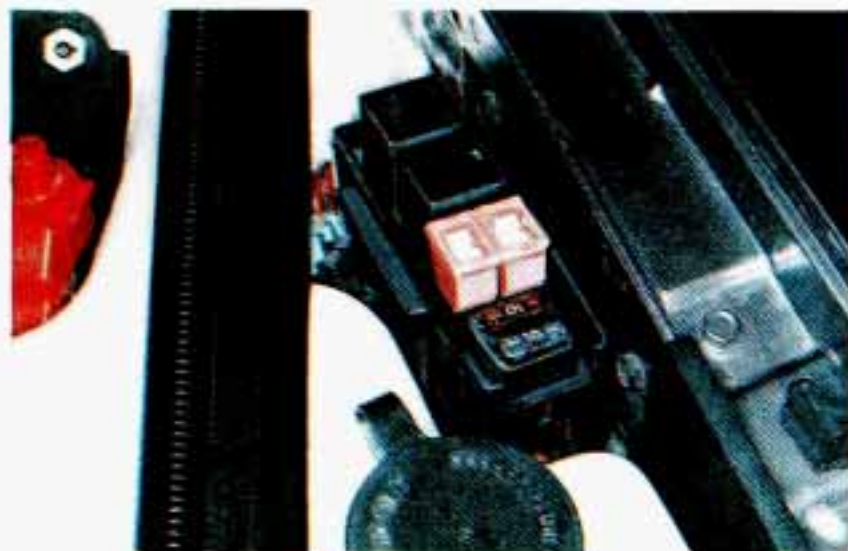

If your car has anti-lock brakes, there is an ABS electrical center under the hood on the driver's side.

## Electrical Center

### Passenger Side — Underhood

	Amp	Description
18.	20	Fuel Injectors (3.8L)
19.	15	Trunk Release
20.	20	ECM; Fuel Pump
21.	10	ECM (3.8L)
22.	3	Cooling Fan Relay (3.8L)
23.		Not Used
24.	10	Direct Ignition System
25.	10	Fuel Injectors (3.1L)
26.		Not Used
27.	15	Ignition
28.	10	TCC; Primary Cooling Fan (3.1L)
<b>Relay</b>		
29.		Fuel Pump
30.		Cooling Fan Control (3.8L)
31.		Secondary Cooling Fan
32.		Primary Cooling Fan
33.		A/C Clutch Coil
<b>Fusible Elements</b>		
34.	60	Starter Solenoid
35.	60	Cooling Fan
36.	60	Blower Motor
37.	60	Cooling Fan
38.	30	Fuse Block

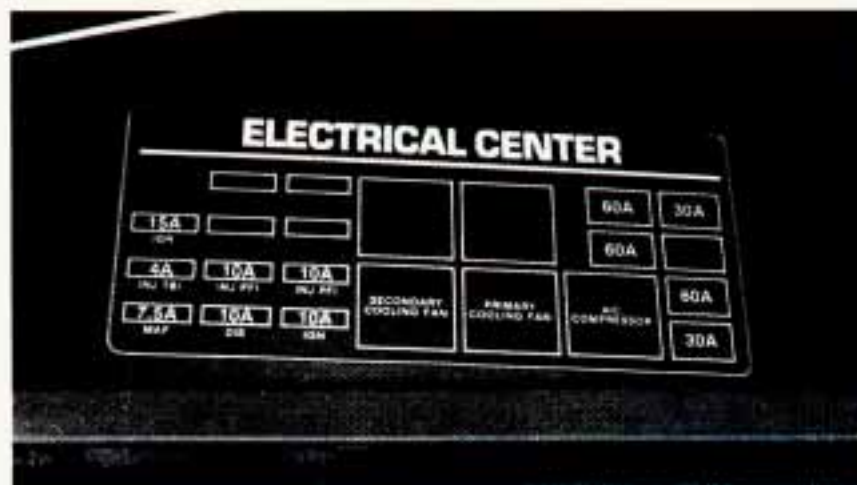

This electrical center is also under the hood on the passenger side.

The fuse chart, below, shows how to tell a blown fuse from a good fuse.

GM PART NO.	RATING	COLOR
12004003	3 AMP	VIOLET
12004005	5 AMP	TAN
12004006	7.5 AMP	BROWN
12004007	10 AMP	RED
12004008	15 AMP	LIGHT BLUE
12004009	20 AMP	YELLOW
12004010	25 AMP	WHITE
12004011	30 AMP	LIGHT GREEN

## Headlights

The headlight wiring is protected by a circuit breaker in the light switch. An electrical overload will cause the lights to go on and off, or in some cases to remain off. If this happens, have your headlight wiring checked right away.

## Windshield Wipers

The windshield wiper motor is protected by a circuit breaker and a fuse. If the motor overheats due to heavy snow, etc., the wiper will stop until the motor cools. If the overload is caused by some electrical problem and not snow, etc., be sure to get it fixed.

## Power Windows and Other Power Options

Circuit breakers in the fuse panel protect the power windows and other power accessories. When the current load is too heavy, the circuit breaker opens and closes, protecting the circuit until the problem is fixed or goes away.

## Regal Dimensions

Inches Unless Otherwise Noted

<b>Overall:</b>	<b>Coupe</b>	<b>Sedan</b>	<b>Interior Rear:</b>	<b>Coupe</b>	<b>Sedan</b>
Length .....	193.6	193.9	Leg Room .....	34.8	36.2
Width .....	72.5	72.5	Head Room .....	37.1	37.8
Height .....	53.0	54.5	Shoulder Room .....	56.8	57.8
Wheelbase .....	107.5	107.5	Hip Room .....	53.1	53.2
Front Tread .....	59.5	59.5			
Rear Tread .....	58.0	58.0			
			<b>Trunk Capacity – Cu. Ft. ...</b>	15.6	15.8
<b>Interior Front:</b>			<b>Passengers:</b>		
Leg Room .....	42.3	42.4	Front .....	3	3
Head Room .....	37.8	38.7	Rear .....	3	3
Shoulder Room .....	57.6	57.8			
Hip Room .....	52.0	52.7	<b>Base Curb Weight – Lbs. ..</b>	3152	3236

## Replaceable Light Bulbs

Application	Number	Application	Number
<b>EXTERIOR</b>		<b>EXTERIOR (continued)</b>	
Headlight		Rear Side Marker – Sedan	24
High Beam	9005	Tail	194
Low Beam	9006	Tail/Stop/Turn	3057
Fog Lamp	H3		
Park/Turn – Coupe	890	<b>INTERIOR</b>	
Park/Turn – Sedan	3157	Ashtray	194
Front Side Marker – Coupe	194NA	Courtesy Lamp –	
Front Side Marker – Sedan	194	Rear Quarter	562
Backup – Coupe	892	Dome	211–2
Backup – Sedan	3057	Dome	561
High Level Stop	3155	Glovebox	1816
High Level Stop – Luggage Rack	891	Luggage Compartment	917
License	194	Reading	24
Rear Side Marker – Coupe	24	Reading Lamp	212–2
		Underhood	561
		Vanity Mirror	558



## Capacities and Specifications

### Engine Code L<sup>1</sup> (L27)<sup>2</sup> 3.8L V-6 SFI

#### Belt Tensions —

Automatically controlled by an idler pulley.  
Tension adjustment should never be necessary.

#### Cooling System Capacity —

11.1 quarts/10.5 liters

#### Crankcase Capacity —

Oil change with filter change —  
4 quarts/3.8 liters

#### Air Conditioning Capacity<sup>4</sup> —

(R12) — 2.25 lbs. (1.02 kilograms)

#### Fuel Tank Capacity —

16.5 gallons/62.7 liters

#### Transaxle —

Automatic Overdrive — Drain & Refill —  
6 quarts/5.7 liters

#### Maintenance Item Part Numbers<sup>3</sup> —

Air Filter — A925C

Fuel Filter — GF579

Oil Filter — PF47

PCV Valve — CV892C

Radiator Cap — RC27

Spark Plug — 41-600, GAP 0.060"

<sup>1</sup> 8th Character of the Vehicle Identification Number.

<sup>2</sup> Made in a GM plant in the United States.

<sup>3</sup> Part numbers are AC type.

<sup>4</sup> **Air Conditioning Refrigerant** – Not all air conditioning refrigerants are the same. If the air conditioning system in your vehicle needs refrigerant, be sure the proper refrigerant is used. If you're not sure ask your Buick dealer.

## Capacities and Specifications

### Engine Code T<sup>1</sup> (LH0)<sup>2</sup> 3.1L V-6 MFI

#### Belt Tensions —

Automatically controlled by an idler pulley.  
Tension adjustment should never be necessary.

#### Cooling System Capacity —

11.9 quarts/12.6 liters

#### Crankcase Capacity —

Oil change with filter change —  
4 quarts/3.8 liters

#### Air Conditioning Capacity<sup>4</sup> —

(R12) — 2.25 lbs. (1.02 kilograms)

#### Fuel Tank Capacity —

16.5 gallons/62.7 liters

#### Transaxle —

Automatic Overdrive — Drain & Refill —  
6 quarts/5.7 liters

#### Maintenance Item Part Numbers<sup>3</sup> —

Air Filter — A1129C

Fuel Filter — GF481

Oil Filter — PF51

PCV Valve — CV892C

Radiator Cap — RC27

Spark Plug — R44LTSM, GAP 0.045"

<sup>1</sup> 8th Character of the Vehicle Identification Number.

<sup>2</sup> Made in a GM plant in the United States.

<sup>3</sup> Part numbers are AC type.

<sup>4</sup> **Air Conditioning Refrigerant** – Not all air conditioning refrigerants are the same. If the air conditioning system in your vehicle needs refrigerant, be sure the proper refrigerant is used. If you're not sure ask your Buick dealer.



## Part 7 Maintenance Schedule

This part covers the maintenance required for your Buick. Your vehicle needs these services to retain its safety, dependability and emission control performance.

Part 7 includes:

Introduction .....	266
A Word About Maintenance .....	266
Your Vehicle and the Environment .....	267
How This Part is Organized .....	267
Section A: Scheduled Maintenance Services .....	268
Using Your Maintenance Schedules .....	268
Selecting the Right Schedule .....	269
Schedule I .....	270
Schedule II .....	272
Explanation of Scheduled Maintenance Services .....	274
Section B: Owner Checks and Services .....	276
At Each Fuel Fill .....	276
At Least Once a Month .....	277
At Least Once a Year .....	277
Section C: Periodic Maintenance Inspections .....	279
Section D: Recommended Fluids and Lubricants .....	280
Section E: Maintenance Record .....	282

**IMPORTANT:**  
KEEP ENGINE OIL  
AT THE PROPER  
LEVEL AND CHANGE AS  
RECOMMENDED



***Protection  
Plan***

**Have you purchased the GM Protection Plan? The Plan supplements your new vehicle warranties. See your Buick dealer for details.**

## **Introduction**

### **A Word About Maintenance**

We at General Motors want to help you keep your vehicle in good working condition. But we don't know exactly how you'll drive it. You may drive very short distances only a few times a week. Or you may drive long distances all the time in very hot, dusty weather. You may use your vehicle in making deliveries. Or you may drive it to work, to do errands or in many other ways.

Because of all the different ways people use their GM vehicles, maintenance needs vary. You may even need more frequent checks and replacements than you will find in the schedules in this part. So please read this part and note how you drive. If you have any questions on how to keep your vehicle in good condition, see your Buick dealer, the place many GM owners choose to have their maintenance work done. Your dealer can be relied upon to use proper parts and practices.

## Your Vehicle and the Environment

Proper vehicle maintenance not only helps to keep your vehicle in good working condition, but also helps the environment. All recommended maintenance procedures are important. Improper vehicle maintenance or the removal of important components can significantly affect the quality of the air we breathe. Improper fluid levels or even the wrong tire inflation can increase the level of emissions from your vehicle. To help protect our environment, and to help keep your vehicle in good condition, please maintain your vehicle properly.

### How This Part is Organized

The remainder of this part is divided into five sections:

“Section A: Scheduled Maintenance Services” shows what to have done and how often. Some of these services can be complex, so unless you are technically qualified and have the necessary equipment, you should let your dealer’s service department or another qualified service center do these jobs.



### CAUTION:

**Performing maintenance work on a vehicle can be dangerous. In trying to do some jobs, you can be seriously injured. Do your own maintenance work only if you have the required know-how and the proper tools and equipment for the job. If you have any doubt, have a qualified technician do the work.**

If you are skilled enough to do some work on your vehicle, you will probably want to get the service information GM publishes. You will find a list of publications and how to get them in this manual. See “Service Publications” in the Index.

“Section B: Owner Checks and Services” tells you what should be checked whenever you stop for fuel. It also explains what you can easily do to help keep your vehicle in good condition.

“Section C: Periodic Maintenance Inspections” explains important inspections that your Buick dealer’s service department or another qualified service center should perform.

“Section D: Recommended Fluids and Lubricants” lists some products GM recommends to help keep your vehicle properly maintained. These products, or their equivalents, should be used whether you do the work yourself or have it done.

“Section E: Maintenance Record” provides a place for you to record the maintenance performed on your vehicle. Whenever any maintenance is performed, be sure to write it down in this section. This will help you determine when your next maintenance should be done. In addition, it is a good idea to keep your maintenance receipts. They may be needed to qualify your vehicle for warranty repairs.

## **Section A: Scheduled Maintenance Services**

### **Using Your Maintenance Schedules**

This section tells you the maintenance services you should have done and when you should schedule them. Your Buick dealer knows your vehicle best and wants you to be happy with it. If you go to your dealer for your service needs, you'll know that GM-trained and supported service people will perform the work using genuine GM parts.

These schedules are for vehicles that:

- carry passengers and cargo within recommended limits. You will find these limits on your vehicle's Tire-Loading Information label. See “Loading Your Vehicle” in the Index.
- are driven on reasonable road surfaces within legal driving limits.
- use the recommended unleaded fuel. See “Fuel” in the Index.

## Selecting the Right Schedule

First you'll need to decide which of the two schedules is right for your vehicle. Here's how to decide which schedule to follow:

### Schedule I

Is any one of these true for your vehicle?

- Most trips are less than 4 miles (6 km).
- Most trips are less than 10 miles (16 km) when outside temperatures are below freezing.

- The engine is at low speed most of the time (as in door-to-door delivery, or in stop-and-go traffic).
- You operate your vehicle in dusty areas.
- You tow a trailer.

If any one (or more) of these is true for your driving, follow Schedule I.

### Schedule II

Follow Schedule II **only** if none of the above conditions is true.

## Scheduled Maintenance Services Schedule I

Follow Schedule I if your car is **MAINLY** driven under one or more of the following conditions:

- When most trips are less than 4 miles (6 kilometers).
- When most trips are less than 10 miles (16 kilometers) and outside temperatures remain below freezing.
- When most trips include extended idling and/or frequent low-speed operation as in stop-and-go traffic.
- Towing a trailer.\*†
- When operating in dusty areas.

Schedule I should also be followed if the car is used for delivery service, police, taxi or other commercial applications.

TO BE SERVICED (See Explanation of Scheduled Maintenance Services Following Schedules I and II)	WHEN TO PERFORM Miles (kilometers) or Months, Whichever Occurs First	MILES (000)															
		3	6	9	12	15	18	21	24	27	30	33	36	39	42	45	48
		KILOMETERS (000)															
Item No.		5	10	15	20	25	30	35	40	45	50	55	60	65	70	75	80
1. Engine Oil & Oil Filter Change*	Every 3 000 mi. (5000 km) or 3 months.	●	●	●	●	●	●	●	●	●	●	●	●	●	●	●	●
2. Chassis Lubrication	Every other oil change		●		●		●		●		●		●		●		●
3. Throttle Body Mounting Bolt Torque*	At 6 000 mi. (10 000 km) only		●														
4. Tire & Wheel Inspection & Rotation	At 6 000 mi. (10 000 km) and then every 15 000 mi. (25 000 km) or as necessary		●					●					●				
5. Engine Accessory Drive Belt(s) Inspection*	Every 30 000 mi. (50 000 km) or 24 months.																
6. Cooling System Service*											●						



TO BE SERVICED (See Explanation of Scheduled Maintenance Services Following Schedules I and II)	WHEN TO PERFORM Miles (kilometers) or Months, Whichever Occurs First	MILES (000)																
		3	6	9	12	15	18	21	24	27	30	33	36	39	42	45	48	
		KILOMETERS (000)																
Item No.		5	10	15	20	25	30	35	40	45	50	55	60	65	70	75	80	
7. Transaxle Service	See Explanation of Scheduled Maintenance Service Following Schedules I and II										•							
8. Spark Plug Replacement*	Every 30 000 mi (50 000 km)										•							
9. Spark Plug Wire Inspection*†											•							
10. Air Cleaner Filter Replacement*												•						
11. Fuel Tank, Cap & Lines Inspection*†												•						

**The services shown in this schedule up to 48 000 miles (80 000 km) should be performed after 48 000 miles at the same intervals.**

\* An Emission Control Service.

† The U.S. Environmental Protection Agency has determined that the failure to perform this maintenance item will not nullify the emission warranty or limit recall liability prior to the completion of vehicle useful life. General Motors, however, urges that all recommended maintenance services be performed at the indicated intervals and the maintenance be recorded in "Section E: Maintenance Record".

## Scheduled Maintenance Services Schedule II

Follow Schedule II ONLY if none of the driving conditions specified in Schedule I apply.

Item No.	TO BE SERVICED (See Explanation of Scheduled Maintenance Services Following Schedules I and II)	WHEN TO PERFORM Miles (kilometers) or Months, Whichever Occurs First	MILES (000)					
			7.5	15	22.5	30	37.5	45
			KILOMETERS (000)					
			12.5	25	37.5	50	62.5	75
1.	Engine Oil Change*	Every 7 500 mi. (12 500 km) or 12 mos.	•	•	•	•	•	•
	Oil Filter Change*	At first and then every other oil change	•		•		•	
2.	Chassis Lubrication	Every 7 500 mi. (12 500 km) or 12 mos.	•	•	•	•	•	•
3.	Throttle Body Mounting Bolt Torque*	At 7 500 mi. (12 500 km) only	•					
4.	Tire & Wheel Inspection & Rotation	At 7 500 mi. (12 500 km) and then every 15 000 mi. (25 000 km) or as necessary	•		•		•	
5.	Engine Accessory Drive Belt(s) Inspection*	Every 30 000 mi. (50 000 km) or 24 mos.				•		
6.	Cooling System Service*					•		

<b>TO BE SERVICED</b> (See Explanation of Scheduled Maintenance Services Following Schedules I and II) <i>Item No.</i>	<b>WHEN TO PERFORM</b> <b>Miles (kilometers) or</b> <b>Months, Whichever</b> <b>Occurs First</b>	<i>MILES (000)</i>					
		7.5	15	22.5	30	37.5	45
		<i>KILOMETERS (000)</i>					
		12.5	25	37.5	50	62.5	75
7. Transaxle Service	See Explanation of Scheduled Maintenance Services Following Schedules I and II				•		
8. Spark Plug Replacement*	Every 30 000 mi. (50 000 km)				•		
9. Spark Plug Wire Inspection*†					•		
10. Air Cleaner Filter Replacement*					•		
11. Fuel Tank, Cap & Lines Inspection*†					•		

**The services shown in this schedule up to 45 000 miles (75 000 km) should be performed after 45 000 miles at the same intervals.**

\* An Emission Control Service.

† The U.S. Environmental Protection Agency has determined that the failure to perform this maintenance item will not nullify the emission warranty or limit recall liability prior to the completion of vehicle useful life. General Motors, however, urges that all recommended maintenance services be performed at the indicated intervals and the maintenance be recorded in "Section E-Maintenance Record".

## Explanation of Scheduled Maintenance Services

Below are explanations of the services listed in Schedule I and Schedule II.

The proper fluids and lubricants to use are listed in Section D. Make sure whoever services your vehicle uses these. All parts should be replaced and all necessary repairs done before you or anyone else drives the vehicle.

NOTE: To determine your engine's displacement and code, see "Engine Identification" in the Index.

1. **Engine Oil and Filter Change\*** -- Always use SG Energy Conserving II oils of proper viscosity. The "SG" designation may be shown alone or in combination with others, such as "SG/CC", "SG/CD" or "SF, SG, CC," etc. To determine the preferred viscosity for your vehicle's engine (e.g., SAE 5W-30 or SAE 10W-30), see "Engine Oil" in the Index.
2. **Chassis Lubrication** -- Lubricate the transaxle shift linkage, parking brake cable guides, underbody contact points and linkage. If your vehicle is equipped with grease fittings, lubricate the suspension and steering linkage.

3. **Throttle Body Mounting Bolt Torque\*** -- Check the torque of the mounting bolts and/or nuts.
4. **Tire and Wheel Rotation and Inspection** -- For proper wear and maximum tire life, rotate your tires following the instructions in this manual. See "Tires, Inspection & Rotation" in the Index. Check the tires for uneven wear or damage. If you see irregular or premature wear, check the wheel alignment. Check for damaged wheels also.
5. **Engine Accessory Drive Belt(s) Inspection** -- Inspect the belt(s) for cracks, fraying, wear and proper tension. Replace as needed.
6. **Cooling System Service\*** -- Drain, flush and refill the system with new or approved recycled coolant conforming to GM Specification 1825M. Keep coolant at the proper mixture as specified. See "Coolant" in the Index. This provides proper freeze protection, corrosion inhibitor level and engine operating temperature.

Inspect hoses and replace if they are cracked, swollen or deteriorated. Tighten screw-type hose clamps. Clean the outside of the radiator and air

\* An Emission Control Service.

† The U.S. Environmental Protection Agency has determined that the failure to perform this maintenance item will not nullify the emission warranty or limit recall liability prior to the completion of vehicle useful life. General Motors, however, urges that all recommended maintenance services be performed at the indicated intervals and the maintenance be recorded in "Section E: Maintenance Record".

conditioning condenser. Wash the pressure cap and neck.

To help ensure proper operation, we recommend a pressure test of both the cooling system and the pressure cap.

7. **Transaxle Service** -- Change both the fluid and filter every 15,000 miles (25 000 km) if the vehicle is mainly driven under one or more of these conditions:

- In heavy city traffic where the outside temperature regularly reaches 90°F (32°C) or higher.
- In hilly or mountainous terrain.
- When doing frequent trailer towing.
- Uses such as found in taxi, police car or delivery service.

If you do not use your vehicle under any of these conditions, change both the fluid and filter every 100,000 miles (160 000 km).

8. **Spark Plug Replacement\*** -- Replace spark plugs with the proper type. See "Specifications Chart" in the Index.
9. **Spark Plug Wire Inspection\*†** -- Inspect for burns, cracks or other damage. Check the boot fit at the distributor and at the spark plugs. Replace wires as needed.
10. **Air Cleaner Filter Replacement\*** -- Replace every 30,000 miles (50 000 km) or more often under dusty conditions. Ask your dealer for the proper replacement intervals for your driving conditions.
11. **Fuel Tank, Cap and Lines Inspection\*†** -- Inspect fuel tank, cap and lines (including fuel rails and injection assembly, if equipped) for damage or leaks. Inspect fuel cap gasket for an even filler neck imprint or any damage. Replace parts as needed. Periodic replacement of the fuel filter is not required.

\* An Emission Control Service.

† The U.S. Environmental Protection Agency has determined that the failure to perform this maintenance item will not nullify the emission warranty or limit recall liability prior to the completion of vehicle useful life. General Motors, however, urges that all recommended maintenance services be performed at the indicated intervals and the maintenance be recorded in "Section E: Maintenance Record".

## Section B: Owner Checks and Services

Listed below are owner checks and services which should be performed at the intervals specified to help ensure the safety, dependability and emission control performance of your vehicle.

Be sure any necessary repairs are completed at once. Whenever any fluids or lubricants are added to your vehicle, make sure they are the proper ones, as shown in Section D.

### At Each Fuel Fill

(It is important for you or a service station attendant to perform these underhood checks at each fuel fill.)

CHECK OR SERVICE	WHAT TO DO
Engine Oil Level	Check the engine oil level and add the proper oil if necessary. See "Engine Oil" in the Index for further details.
Engine Coolant Level	Check the engine coolant level in the coolant recovery tank and add the proper coolant mix if necessary. See "Coolant" in the Index for further details.
Windshield Washer Fluid Level	Check the windshield washer fluid level in the windshield washer tank and add the proper fluid if necessary. See "Windshield Washer Fluid" in the Index for further details.

## At Least Once A Month

CHECK OR SERVICE	WHAT TO DO
Tire Inflation	Check tire inflation. Make sure they are inflated to the pressures specified on the Tire-Loading Information label located on the rear edge of the driver's door. See "Tires" in the Index for further details.

## At Least Once A Year

CHECK OR SERVICE	WHAT TO DO
Key Lock Cylinders	Lubricate the key lock cylinders with the lubricant specified in Section D.
Body Lubrication	Lubricate all body door hinges. Also lubricate all hinges and latches, including those for the hood, glove box door and console door. Section D tells you what to use.

CHECK OR SERVICE	WHAT TO DO
Starter Switch	<p><b>CAUTION:</b> When you are doing this check, the vehicle could move suddenly. If it does, you or others could be injured. Follow the steps below.</p> <ol style="list-style-type: none"><li>1. Before you start, be sure you have enough room around the vehicle.</li><li>2. Firmly apply both the parking brake (see "Parking Brake" in the Index if necessary) and the regular brake.</li></ol> <p>NOTE: Do not use the accelerator pedal, and be ready to turn off the engine immediately if it starts.</p> <ol style="list-style-type: none"><li>3. Try to start the engine in each gear. The starter should work only in "P" (Park) or "N" (Neutral). If the starter works in any other position, your vehicle needs service.</li></ol>

CHECK OR SERVICE	WHAT TO DO
Steering Column Lock	<p>While parked, and with the parking brake set, try to turn the key to "LOCK" in each shift lever position.</p> <ul style="list-style-type: none"> <li>● The key should turn to "LOCK" only when the shift lever is in "P" (Park).</li> <li>● The key should come out only in "LOCK."</li> </ul>

CHECK OR SERVICE	WHAT TO DO
Parking Brake and Automatic Transaxle "P" (Park) Mechanism Check	<div data-bbox="1271 211 1781 619" style="border: 2px solid black; background-color: yellow; padding: 5px;"> <p><b>CAUTION: When you are doing this check, your vehicle could begin to move. You or others could be injured and property could be damaged. Make sure there is room in front of your vehicle in case it begins to roll. Be ready to apply the regular brake at once should the vehicle begin to move.</b></p> </div> <p>Park on a fairly steep hill, with the vehicle facing downhill. Keeping your foot on the regular brake, set the parking brake.</p> <ul style="list-style-type: none"> <li>● To check the parking brake: With the engine running and transaxle in "N" (Neutral), slowly remove foot pressure from the regular brake pedal. Do this until the vehicle is held by the parking brake only.</li> <li>● To check the "P" (Park) mechanism's holding ability: Shift to "P" (Park). Then release all brakes.</li> </ul>



CHECK OR SERVICE	WHAT TO DO
Underbody Flushing	At least every spring, use plain water to flush any corrosive materials from the underbody. Take care to clean thoroughly any areas where mud and other debris can collect.

## Section C: Periodic Maintenance Inspections

Listed below are inspections and services which should be performed at least twice a year (for instance, each spring and fall). You should let your GM dealer's service department or other qualified service center do these jobs. Make sure any necessary repairs are completed at once.

INSPECTION OR SERVICE	WHAT SHOULD BE DONE
Steering, Suspension and Front-Wheel-Drive Axle Boot and Seal Inspection	Inspect the front and rear suspension and steering system for damaged, loose or missing parts, signs of wear, or lack of lubrication. Inspect the power steering lines and hoses for proper hookup, binding, leaks, cracks, chafing, etc. Clean and then inspect the drive axle boot seals for damage, tears or leakage. Replace seals if necessary.
Exhaust System Inspection	Inspect the complete exhaust system. Inspect the body near the exhaust system. Look for broken, damaged, missing or out-of-position parts as well as open seams, holes, loose connections, or other conditions which could cause a heat build-up in the floor pan or could let exhaust fumes into the vehicle. See "Engine Exhaust" in the Index.
Throttle Linkage Inspection	Inspect the throttle linkage for interference or binding, and for damaged or missing parts. Replace parts as needed.

INSPECTION OR SERVICE	WHAT SHOULD BE DONE
Brake System Inspection	<p>Inspect the complete system. Inspect brake lines and hoses for proper hookup, binding, leaks, cracks, chafing, etc. Inspect disc brake pads for wear and rotors for surface condition. Also inspect other brake parts, including calipers, parking brake, etc. Check parking brake adjustment. You may need to have your brakes inspected more often if your driving habits or conditions result in frequent braking.</p> <p>NOTE: A low brake fluid level can indicate worn disc brake pads which may need to be serviced. Also, if the brake system warning light stays on or comes on, something may be wrong with the brake system. See "Brake System Warning Light" in the Index. If your vehicle is equipped with anti-lock brakes and the anti-lock brake system warning light stays on, comes on or flashes, something may be wrong with the anti-lock brake system. See "Anti-Lock Brake System Warning Light" in the Index.</p>

## Section D: Recommended Fluids and Lubricants

NOTE: Fluids and lubricants identified below by name, part number or specification may be obtained from your GM dealer.

USAGE	FLUID/LUBRICANT
Engine Oil	<p>GM Goodwrench Motor Oil or equivalent for API service SG Energy Conserving II oils of the proper viscosity. The "SG" designation may be shown alone or in combination with others, such as "SG/CC," "SG/CD," or "SF,SG,CC," etc. To determine the preferred viscosity for your vehicle's engine, see "Engine Oil" in the Index.</p>
Engine Coolant	<p>50/50 mixture of water (preferably distilled) and good quality ethylene glycol base antifreeze (GM Part No. 1052753 or equivalent) conforming to GM Specification 1825M or approved recycled coolant conforming to GM Specification 1825M.</p>

USAGE	FLUID/LUBRICANT
Hydraulic Brake System	Delco Supreme 11 <sup>®</sup> Brake Fluid (GM Part No. 1052535) or equivalent DOT-3 brake fluid.
Parking Brake Guides	Chassis lubricant meeting requirements of NLGI Grade 2, Category LB or GC-LB (GM Part No. 1052497 or equivalent).
Power Steering System	GM Hydraulic Power Steering Fluid (GM Part No. 1052884) or equivalent.
Automatic Transaxle	DEXRON <sup>®</sup> IIE Automatic Transmission Fluid (GM Part No. 12345881)
Key Lock Cylinders	Lubricate with Multi-Purpose Lubricant (GM Part No. 12345120), synthetic SAE 5W-30 engine oil or silicone lubricant (GM Part No. 1052276 or 1052277).
Automatic Transaxle Shift Linkage	Engine oil.

USAGE	FLUID/LUBRICANT
Chassis Lubrication	Chassis lubricant meeting requirements of NLGI Grade 2, Category LB or GC-LB (GM Part No. 1052497 or equivalent).
Windshield Washer Solvent	GM Optikleen <sup>®</sup> Washer Solvent (GM Part No. 1051515) or equivalent.
Hood Latch Assembly a. Pivots and Spring Anchor b. Release Pawl	a. Engine oil. b. Chassis lubricant meeting requirements of NLGI Grade 2, Category LB or GC-LB (GM Part No. 1052497 or equivalent).
Hood and Door Hinges	Engine oil or Lubriplate Lubricant (GM Part No. 1050109).
Fuel filler Door Hinge and Striker Plunger	Chassis lubricant meeting requirements of NLGI Grade 2, Category LB or GC-LB (GM Part No. 1052497 or equivalent).
Weatherstrips	Dielectric Silicone Grease (GM Part No. 12345579 or equivalent).

See "Specifications Chart" in the Index for recommended replacement filters, valves and spark plugs.

## Section E: Maintenance Record

After the scheduled services are performed, record the date, odometer reading and who performed the service in the columns indicated. When completing the Maintenance Performed column, insert the numbers

from the Schedule I or Schedule II maintenance charts which correspond to the maintenance performed. Also, you should retain all maintenance receipts. Your owner information portfolio is a convenient place to store them.

<b>Maintenance Record</b>			
<b>DATE</b>	<b>ODOMETER READING</b>	<b>SERVICED BY</b>	<b>MAINTENANCE PERFORMED</b>

## Maintenance Record

DATE	ODOMETER READING	SERVICED BY	MAINTENANCE PERFORMED

## Maintenance Record

DATE	ODOMETER READING	SERVICED BY	MAINTENANCE PERFORMED



## Part 8 Customer Assistance Information

Here you will find out how to contact Buick if you need assistance. This Part also tells you how to obtain service publications and how to report any safety defects.

Part 8 includes:

Customer Satisfaction .....	285
Customer Assistance for Hearing/Speech Impaired .....	286
Reporting Safety Defects .....	287
Service Publications .....	288

### Customer Satisfaction Procedure

Your satisfaction and goodwill are important to your dealer and Buick. Normally, any problems with the sales transaction or the operation of your vehicle will be resolved by your dealer's Sales or Service Departments. Sometimes, however, despite the best intentions of all concerned, misunderstandings can occur. If your concern has not been resolved to your satisfaction, the following steps should be taken:

**STEP ONE** -- Discuss your problem with a member of dealership management. Complaints can often be quickly resolved at that level. If the matter has already been reviewed with the Sales, Service, or Parts Manager, contact the owner of the dealership or the General Manager.

**STEP TWO --** If after contacting a member of Dealership Management, it appears your problem cannot be resolved by the dealership without further help, contact the Buick Customer Assistance Center by calling 1-800-521-7300. In Canada, contact GM of Canada Customer Assistance Center in Oshawa by calling 1-800-263-3777 (English) or 1-800-263-7854 (French).

In Mexico, call 254-17-86. In Puerto Rico or U.S. Virgin Islands, call 1-809-763-1315. In all other overseas locations, contact GM International Export Sales in Canada by calling 1-416-644-4112.

For prompt assistance, please have the following information available to give the Customer Assistance Representative:

- Your name, address, telephone number
- Vehicle Identification Number (This is available from the vehicle registration or title, or the plate attached to the left top of the instrument panel and visible through the windshield.)
- Dealership name and location
- Vehicle delivery date and present mileage
- Nature of problem

In order to give your inquiry prompt attention, please call the toll-free number listed above. However, if you wish to write Buick, write to Buick Motor Division, Customer Assistance Center, 902 E. Hamilton Avenue, Flint, MI, 48550. A listing of all Buick Zone Offices and offices outside the U.S. which can assist you can also be found in the warranty booklet.

When contacting Buick, please remember that your problem will likely be resolved in the dealership, using the dealership's facilities, equipment and personnel. That is why we suggest you follow Step One first if you have a problem.

## **Customer Assistance for the Hearing or Speech Impaired**

To assist owners who have hearing difficulties, Buick has installed special TDD (Telecommunication Devices for the Deaf) equipment in its Customer Assistance Center. Any hearing or speech impaired customer who has access to a TDD or a conventional teletypewriter (TTY) can communicate with Buick by dialing: 1-800-TD-BUICK. (TDD users in Canada can dial 1-800-263-3830.)



## **REPORTING SAFETY DEFECTS TO THE UNITED STATES GOVERNMENT**

If you believe that your vehicle has a defect which could cause a crash or could cause injury or death, you should immediately inform the National Highway Traffic Safety Administration (NHTSA), in addition to notifying General Motors.

If NHTSA receives similar complaints, it may open an investigation, and if it finds that a safety defect exists in a group of vehicles, it may order a recall and remedy campaign. However, NHTSA cannot become involved in individual problems between you, your dealer, or General Motors.

To contact NHTSA, you may either call the Auto Safety Hotline toll-free at 1-800-424-9393 (or 366-0123 in the Washington, D.C. area) or write to:

NHTSA, U.S. Department of Transportation  
Washington, D.C. 20590

You can also obtain other information about motor vehicle safety from the Hotline.

## **REPORTING SAFETY DEFECTS TO THE CANADIAN GOVERNMENT**

If you live in Canada, and you believe that your vehicle has a safety defect, you should immediately notify Transport Canada, in addition to notifying General Motors of Canada Limited. You may write to:

Transport Canada at Box 8880  
Ottawa, Ontario K1G 3J2.

## **REPORTING SAFETY DEFECTS TO GENERAL MOTORS**

In addition to notifying NHTSA (or Transport Canada) in a situation like this, we certainly hope you'll notify us. Please call us at 1-800-521-7300, or write:

Buick Motor Division, Customer Assistance Center  
902 E. Hamilton Avenue  
Flint, MI 48550.

In Canada, please call us at 1-800-263-3777 (English) or 1-800-263-7854 (French). Or, write:

General Motors of Canada Limited  
Customer Assistance Center  
1908 Colonel Sam Drive  
Oshawa, Ontario L1H 8P7

## Service Publications

Information on how to obtain Product Service Publications, Subscriptions and Indexes as described below is applicable only in the fifty U.S. states (and the District of Columbia) and only for cars and light trucks with GVWR less than 10,000 pounds (4 536 kg).

In Canada, information pertaining to Product Service Bulletins and Indexes can be obtained by writing to:

General Motors of Canada Limited  
Service Publications Department  
1908 Colonel Sam Dr.  
Oshawa, Ontario L1H 8P7

Buick regularly sends its dealers useful service bulletins about Buick products. Buick monitors product performance in the field. We then prepare bulletins for servicing our products better. Now, you can get these bulletins too.

Bulletins cover various subjects. Some pertain to the proper use and care of your vehicle. Some describe costly repairs. Others describe inexpensive repairs which, if done on time with the latest parts, may avoid future costly repairs. Some bulletins tell a technician how to repair a new or unexpected condition. Others describe a quicker way to fix your vehicle. They can help a technician service your vehicle better.

Most bulletins apply to conditions affecting a small number of cars or trucks. Your Buick dealer or a qualified technician may have to determine if a specific bulletin applies to your vehicle.

You can subscribe to all Buick bulletins. This way you'll get them as they come out. You can wait a while and get an index to the bulletins. You can also get individual bulletins. However, you'll need the index to identify them.

## Subscriptions

You can subscribe to all Buick Product Service Publications (PSP's). This will include bulletins for all cars sold by Buick and will not be limited to PSP's applicable to any particular model. When you buy a subscription, you will receive the PSP's in periodic mailings, shortly after they come out. A subscription costs U.S. \$86.50 (\$106.50 including a special binder) and it entitles you to all PSP's published by Buick during the model year. You can purchase a subscription by sending a check or money order to Service Publications, Post Office Box 1901, Flint, Michigan, 48501, along with the order form located in the following text. You may get additional subscription ordering forms by calling the toll-free number shown in the following text.

## Individual PSP's

If you don't want to buy all the PSP's issued by Buick for all models in the model year, you can buy individual PSP's, such as those which may pertain to a particular model. To do this, you will first need to see our index of PSP's. It provides a variety of information. Here's what you'll find in the index and how you can get one:

### What You'll Find in the Index:

- A list of all PSP's published by Buick in a model year (1989 or later). PSP's covering all models of Buick cars are listed in the same index.
- Ordering information so you can buy the specific PSP's you may want.
- Price information for the PSP's you may want to buy.

## **How You Can Get an Index:**

Indexes are published periodically. Most of the PSP's which could potentially apply to the most recent Buick models will be listed in the most recent publication for that model year. This means you may want to wait until the end of the model year before ordering an index, if you are interested in buying PSP's pertaining to a current model year car or truck.

Some PSP's pertaining to a particular model year vehicle may be published in later years, and these would be listed in the later year's index. When you order an index for a model year that is not over yet, we'll send you the most recently published issue. Check the ordering form for indexes for earlier model years.

Cut out the ordering form, fill it out, and mail it in. We will then see to it that an index is mailed to you. There is no charge for indexes for the 1989-1993 model years.

## **Toll-Free Telephone Number**

If you want an additional ordering form for an index or a subscription, just call toll-free and we'll be happy to send you one. Automated recording equipment will take your name and mailing address. The number to call is 1-800-551-4123.

## **Copies at Participating Dealers**

Copies of Indexes and individual PSP's are at your participating Buick dealer. You can ask to see them.

**A VERY IMPORTANT REMINDER:** These PSP's are meant for technicians. They are not meant for the "do-it-yourselfer." Technicians have the equipment, tools, safety instructions, and know-how to do a job quickly and safely.

## **Buick Service Publications**

You can get these by using the order form:

# BUICK PUBLICATIONS ORDER FORM



NAME \_\_\_\_\_ DATE \_\_\_\_\_

ADDRESS \_\_\_\_\_

CITY \_\_\_\_\_ STATE \_\_\_\_\_ ZIP \_\_\_\_\_

VISA \_\_\_\_\_ MASTERCARD \_\_\_\_\_

CARD NUMBER

EXP. DATE  -  PHONE # (  )

## WHAT'S A PRODUCT SERVICE PUBLICATION?

Product Service Publications (PSPs), are bulletins, letters and articles published for trained dealer service personnel. They describe or recommend diagnostic, maintenance, or repair procedures, parts recommendations or use and care information. The indexes list all PSP's published by Buick in each model year. To review all Product Service Publications (PSP's) for a specific model year vehicle, it is necessary to order the index for that model year and all subsequent model year indexes.

Buick bulletins are intended for use by professional technicians, NOT a "do-it-yourselfer". They are written to inform these technicians of conditions that may occur on some vehicles, or to provide information that could assist in the proper service of a vehicle. Properly trained technicians have the equipment, tools, safety instructions, and know-how to do a job properly and safely. If a condition is described, DO NOT assume that the bulletin applies to your vehicle, or that your vehicle will have that condition. See your Buick dealer for information on whether your vehicle may benefit from the information.

## WHAT'S A CHASSIS SERVICE MANUAL?

Chassis Service Manuals have diagnosis, repair and overhaul information on engines, transmission, axle, suspension, brakes, electrical, steering, etc. 1963 through 1987 model manuals were published in looseleaf format and included all series in a single publication. The 1982 and prior Chassis Service Manuals are published in a bound format and may contain more than one series. The 1988 and later Chassis Service Manuals are published in a bound format for each series. Chassis Service Manuals for certain models prior to 1990 and all 1990 and later models are combined with the respective Body Service Manuals.

## WHAT'S A BODY SERVICE MANUAL?

Body Service Manuals have repair information on trim, seats, windows, doors, etc. These manuals are published in a bound format. Body Service Manuals for certain models prior to 1990 and all 1990 and later models are combined with the respective Chassis Service Manuals.

## WHAT ARE OWNER PUBLICATIONS?

Owner Publications are publications written directly for owners and intended to provide information about their car, such as Owner's Manuals, Maintenance Schedules and Warranty and Owner Assistance Information Booklets. Beginning in 1991, the Maintenance Schedule is included in the Owner's Manual.



## HOW TO ORDER

Fill in order completely including year and model. Enclose check or money order (Sorry no C.O.D. or Purchase Orders). Make check or money order payable only in U.S. Funds to Service Publications. VISA and MASTERCARD also accepted. Indicate card number and expiration date above. Michigan Residents must add 4% sales tax. Canadian and Overseas residents please add 20% for shipping and handling. For additional information and/or phone orders call 1-313-239-5552 from 8 A.M. to 5 P.M. Eastern Time Monday thru Friday. For phone orders have VISA or MASTERCARD ready. All orders will be sent via UPS or First Class U.S. mail postage paid. Sorry, No P.O. Box addresses.

## RUSH DELIVERIES

Two day and overnight service is available for VISA and MASTERCARD orders only. Sorry, NO P.O. Box or APO/FPO addresses. Recipient telephone number is needed with order. Please call for details.

## FOREIGN SHIPMENTS

VISA, MASTERCARD only. Shipping and applicable duty charges to be paid by customer. All pricing in U.S. Funds. If no delivery preference is specified, package will be shipped and charged surface delivery rates.

## SEND ORDER TO:

Service Publications  
P.O. Box 1901  
Flint, MI 48501

Amount of Order	
Mich. Sales Tax	
Michigan Residents Must add 4 % Sales Tax	
Canada/Overseas add 20% s/h	
Total Amount	

\* Service Publications is an Authorized Publication Distributor to Buick Motor Division

**VERY IMPORTANT - PLEASE INCLUDE YEAR AND MODEL**

CHASSIS SERVICE MANUAL	QTY	RETAIL PRICE OF CAR	YEAR OF CAR	MODEL OF CAR	NO. ORDER AVAILABLE
1981 LESABRE/ELECTRA/PARK AVE. SERVICE MANUAL		\$45.00			
1988 CHASSIS SERVICE MANUAL (EXCEPT REGAL)		\$35.00			
1983 THRU 1987 CHASSIS SERVICE MANUAL WITHOUT BRIDGES		\$60.00			#4
1974 THRU 1982 CHASSIS SERVICE MANUAL EXCEPT 1980 OR 1981 SKYLARK, 1982 SKYLARK OR SKYLARK (CENTURY)		\$35.00			1976, 77, 79 *
<b>CHASSIS AND BODY SERVICE MANUAL</b>					
1991 THRU 1990 LE SABRE OR PARK AVE./ULTRA CHASSIS & BODY		\$45.00			
1991 ULTRA SERVICE MANUAL SUPPLEMENT FOR SUPER CHARGER		\$15.50			
1990 LESABRE (ELECTRA/PARK AVE. CHASSIS & BODY SERVICE MANUAL		\$45.00			
1989 THRU 1993 CHASSIS & BODY SERVICE MANUAL ALL SERIES (EXCEPT LE SABRE/ELECTRA/PARK AVE.)		\$35.00			
1988 REGAL CHASSIS & BODY SERVICE MANUAL		\$35.00			
1982 SKYLARK OR 1982 SKYLARK (CENTURY) CHASSIS & BODY SERVICE MANUAL		\$35.00			
1980 OR 1981 SKYLARK CHASSIS & BODY SERVICE MANUAL		\$35.00			
1988, 1989, 1990, 1991, 1992 OR 1993 COMPLETE SET-CHASSIS AND ELECTRICAL SYSTEMS MANUAL AND BODY SERVICE MANUAL FOR ALL SERIES/YEAR		\$465.00			
<b>BODY SERVICE MANUAL</b>					
1989 LESABRE/ELECTRA/PARK AVE. BODY SERVICE MANUAL		\$20.00			
1988 BODY SERVICE MANUAL (EXCEPT REGAL)		\$20.00			
1975 THRU 1987 BODY SERVICE MANUAL		\$20.00			1976, 77, 79 *
<b>GLOVE BOX MATERIAL-Please include year and model</b>					
1975 THRU 1988 OWNERS MANUAL (EXCEPT 1989 LE SABRE/ELECTRA/PARK AVE)		\$ 5.00			
1989 LESABRE OR ELECTRA/PARK AVE. OWNERS MANUAL		\$10.00			
1990 THRU 1993 BUCK OWNERS MANUAL		\$10.00			
1981 THRU 1982 BUCK WARRANTY INFORMATION		\$ 3.50			1982 CAL. GAS
GAS <input type="checkbox"/> DIESEL <input type="checkbox"/> CALIFORNIA <input type="checkbox"/>					
1973 THRU 1980 BUCK MAINTENANCE SCHEDULE		\$ 3.50			
GAS <input type="checkbox"/> DIESEL <input type="checkbox"/> CALIFORNIA <input type="checkbox"/> 1980 TURBO <input type="checkbox"/>					
REATA CONVERTIBLE TOP INSTRUCTION FOLDER		\$ 3.50			
<b>OPEL MANUALS</b>					
1977 THRU 1979 OPEL SERVICE MANUAL		\$20.00			
1972 THRU 1979 OPEL OWNERS MANUAL		\$ 5.00			1974, 75
1977 THRU 1979 OPEL MAINTENANCE SCHEDULE		\$ 3.00			1972 GT, 74 ALL
<b>PRODUCT SERVICE PUBLICATIONS</b>					
1990, 1991, 1992 OR 1993 PSP INDEX (1993 NOT AVAILABLE UNTIL JANUARY, 1993)		N/C			
1992 MODEL YEAR PSP SUBSCRIPTION (NOT AVAILABLE AFTER SEPTEMBER, 1992)		\$66.50			
1993 MODEL YEAR PSP SUBSCRIPTION (NOT AVAILABLE BEFORE OCTOBER, 1992)		\$66.50			
PSP SUBSCRIPTION BINDER		\$20.00			
<b>BULLETIN OR LETTER NUMBER</b>					
INDIVIDUAL					\$ 4.00
PSP					\$ 2.50
					\$ 2.00
					\$ 2.50

\* FOR OUT OF PRINT SERVICE MANUALS  
CONTACT: NATIONAL REPRODUCTIONS INC.  
53 E. LIBERTY  
ANN ARBOR, MI 48104 1-800-465-3782

PRICES GOOD THROUGH 12-31-92



## Part 9 Index

<b>A</b> cc (Ignition Key Position) .....	66	Antilock Brake System .....	140
Adding		Antilock Braking System Warning Light .....	103
Brake Fluid .....	233	Anti-Theft Tips .....	64
Electrical Equipment .....	256	Appearance Care .....	248
Engine Coolant .....	228	Appearance Care and Materials .....	255
Engine Oil .....	220	Armrest, Storage .....	98
Power Steering Fluid .....	231	Ashtrays .....	96
Transaxle Fluid .....	226	Astrorooft .....	80
Windshield Washer Fluid .....	232	Audio Systems .....	113
Additives, Engine Oil .....	223	Automatic Door Locks .....	61
Adjustment, Brake .....	143	Automatic Lap-Shoulder Belt .....	27
Adult Safety Belt Usage .....	26	Automatic Overdrive .....	72
Air Cleaner .....	225	Automatic Safety Belt, Use With Child Restraint .....	42
Air Conditioner .....	110	Automatic Transaxle .....	71
Air Outlets .....	110	Automatic Transaxle Fluid .....	226
Alcohol, Driving Under the Influence of .....	135	Automatic Transaxle Torque Lock .....	165
Alcohol in Gasoline .....	215		
Aluminum Wheels, Cleaning .....	252	<b>B</b> aby, Holding a .....	41
AM Radio Reception .....	113	Battery .....	235
AM Stereo Radio Reception .....	114	Battery Cables, Starting With .....	180
Antenna Care .....	124	Blizzard, If You're Caught in a .....	168
Antifreeze .....	228		

Blood Alcohol Level .....	135
“Blowout,” Tire .....	201
Boat, Towing a .....	170
Brake	
Adjustment .....	143
Fluid .....	233
Lining Replacement, How to Drive After .....	234
Master Cylinder .....	233
Parking .....	74
Pedal Travel .....	143
Brake System, Antilock, Warning Light .....	103
Brake System Warning Light .....	102
Brakes, Trailer .....	173
Brake Wear Indicators, Disc .....	142
Brakes, Antilock .....	140
Braking .....	139
Braking in Emergencies .....	143
Braking if Your Engine Stops .....	140
Break-In, New Vehicle .....	65
Break-In Schedule, When Towing a Trailer .....	170
Bulb Chart .....	262
Bulb Replacement, Headlamp .....	235
Bulb Replacement, Taillamp .....	236
Bulbs, Halogen .....	235
Bulbs, Turn Signal .....	82,262

<b>C</b> amper, Towing a .....	170
Capacities and Specifications .....	263,264
Cap, Radiator Pressure .....	231
Car Jack Instructions .....	201
Carbon Monoxide in Exhaust .....	78
Care, Appearance .....	248
Care, Finish .....	252
Carrier, Luggage .....	99
Cassette Tape Player Care .....	123
Cautions, Safety .....	10
CB Radio, Adding a .....	114
Cellular Telephone, Adding a .....	114
Chains, Tire .....	247
Change the Oil, When to .....	221
Changing a Flat Tire .....	201
Check Gages Light .....	106
Checking	
Brake Fluid .....	233
Engine Coolant .....	228
Engine Oil Level .....	220
Power Steering Fluid .....	231
Safety Belt Systems .....	55
Transaxle Fluid .....	226
Under the Hood .....	218
Windshield Washer Fluid .....	232
Chemical Paint Spotting .....	254



Child Restraints .....	42	Control of a Vehicle .....	138
Children and Safety Belts .....	40	Control, Loss of .....	148
Cigarette Lighter .....	97	Controls, Features and .....	57
Circuit Breakers .....	257	Convex Outside Mirror .....	94
City Driving .....	156	Coolant, Engine .....	228
Cleaner, Air .....	225	Coolant, Engine, Warning Gage .....	103
Cleaning		Coolant, Safety Warnings About .....	195
Aluminum Wheels .....	252	Courtesy Lights .....	94
Fabric .....	249	Covers, How to Remove Wheel .....	203
Glass .....	251	Cruise Control .....	86
Inside of Your Car .....	248	Cruise Control, Change Speed With .....	89
Leather and Vinyl .....	250	Cruise Control, Turning Off .....	91
Outside Of Your Car .....	251	Cruise Control Using on Hills .....	90
Power Antenna .....	124	Curves, Driving on .....	144
Top of the Instrument Panel .....	250	Customer Assistance Information .....	285
Underbody of Your Car .....	253	Customer Assistance for the Hearing and Speech Impaired .....	286
Safety Belts .....	251	Customer Satisfaction Procedure .....	285
Windshield Wiper and Blades .....	251		
Weather Strips .....	253	<b>D</b> (Drive) Third Gear .....	72
White Sidewall Tires .....	253	Ⓢ Automatic Overdrive .....	72
Clock, Setting the .....	116,120	Damage to Finish .....	253
Closed-In Places, Don't Idle in .....	78	Damage to Sheet Metal .....	253
CO in Exhaust .....	78	Damage Warnings .....	11
Color of Road Signs .....	128	Daytime Running Lights .....	92
Comfort Controls and Audio Systems .....	109	Dead Battery .....	180
Compact Disc Care .....	124	Defensive Driving .....	134
Compact Spare Tire .....	210	Defogger, Rear Window .....	113
Contents, Table of .....	9		

Defrost .....	112
Dimensions .....	261
Disc Brake Wear Indicators .....	142
Disposal of Used Oil .....	224
Door Locks .....	59
Down Hills and Mountains, Driving .....	161
Downhill Parking .....	163
Downshifting .....	73
Driving	
At Night .....	149
Defensively .....	134
Drunk .....	135
In a Foreign Country .....	216
In Cities .....	156
In Fog, Mist or Haze .....	154
In Rain .....	152
In Winter .....	166
On Curves .....	144
On Freeways .....	157
On Hill and Mountain Roads .....	161
On a Long Trip .....	159
On Snow or Ice .....	167
Through Deep Standing Water .....	70
Drunken Driving .....	135

<b>E</b> lectric Outside Rearview Mirror Control .....	94
Electrical Equipment, Adding .....	114,256
Emergencies, Braking .....	143
Emergencies on the Road .....	177
Emergencies, Steering in .....	145
Emergency Starting, Discharged Battery .....	180
Emergency Wrecker Towing .....	185
Energy Conserving Oil .....	221
Engine	
Block Heater .....	70,224
Coolant .....	228
Coolant Temperature Warning Gage .....	103
Oil .....	220
Oil Additives .....	223
Oil Pressure Warning Gage .....	104
Oil, When to Change .....	221
Overheating .....	192
Starting .....	67
Warning Light About Need for Service .....	107
Ethanol in Gasoline .....	215
Exhaust .....	78
Expectant Mothers, Use of Safety Belts by .....	33
Expressway Driving .....	157
Extender, Safety Belt .....	55
Exterior Appearance .....	251

<b>F</b> eatures and Controls .....	57
Fetus, Risk To -- From Safety Belt Use .....	33
Fiberglass Springs .....	254
Filling Your Fuel Tank .....	217
Filter, Oil .....	224,263,264
Finish Care .....	252
Finish Damage .....	253
First Gear, When to Use .....	73
Flash-To-Pass .....	83
Flat Tire .....	201
Flooded Engine, Starting a .....	68
<b>F</b> luids	
Brake .....	233
Power Steering .....	231
Transaxle .....	226
Windshield Washer .....	232
Fluid Capacities .....	263,264
FM Stereo Radio Reception .....	113
Fog, Driving in .....	154
Fog Lights .....	92
Foreign Operation .....	216
Francais, Guide En .....	2
Freedom Battery .....	235
Freeway Driving .....	157
French Language Manual .....	2
Front Seatback Latches .....	18
Fuel .....	101,215
Fuel Gage .....	100

Fuel Light, Low .....	101
Fuel Tank, Filling Your .....	217
Fuels in Foreign Countries .....	216
Fuses and Circuit Breakers .....	257

## **G**ages

Engine Coolant Temperature .....	103
Fuel .....	100
Volts .....	106
Gasoline .....	215
Gasoline Tank, Filling Your .....	217
Gear Positions .....	71
Glass Cleaning .....	251
Graphic Symbols .....	12
Guard Against Theft .....	64
Guide En Francais .....	2

<b>H</b> alogen Bulbs .....	235
Hazard Warning Flasher .....	178
Haze, Driving in .....	154
Headlight Bulb Replacement .....	235
Headlight High-Low Beam Switch .....	83
Headlight "On" Warning .....	92
Head Restraints .....	17
Hearing Impaired Customer Assistance .....	286
Heater .....	110

Heater, Engine Block .....	70,224
High Speed, Shifting When Your Engine is Running at ...	72
“Highway Hypnosis” .....	160
Hill and Mountain Roads .....	161
Hills, Parking on .....	163
Hitches, Trailer .....	172
Holding a Baby in Your Car .....	41
Hood, Opening the .....	218
Horn .....	80
Hot Coolant Warning Gage .....	103
Hot Engine, Safety Warnings About .....	193
Hydroplaning .....	153

<b>I</b> ce, Driving on .....	167
Identification Label, Service Parts .....	256
Identification Number, Vehicle .....	256
Idling Your Engine .....	78
If You’re Stuck: In Sand, Mud, Ice or Snow .....	211
Ignition Key Positions .....	66
Indicator, Turn Signal .....	81
Indicators, Disc Brake Wear .....	142
Indicators, Warning Lights and Gages .....	100
Infant Restraint .....	42
Inflation, Tire .....	241
Inside Mirror .....	94
Inspection, Tire .....	242
Instrument Panel .....	99
Interior Cleaning .....	248
Introduction, How to Use this Manual .....	10

<b>J</b> ack, Tire .....	202
Jacking Up the Car .....	202
“Jump” Starting .....	180

<b>K</b> eys .....	58
Keyless Entry System, Remote .....	62
Kilometer Indicator .....	99

<b>L</b> abel, Service Parts Identification .....	256
Lane Change Indicator .....	81
Lap Belt .....	35
Lap-Shoulder Belt Usage by Children .....	54
Latches, Front Seatback .....	18
Leather Cleaning .....	250
Leaving Your Vehicle .....	77
Light Bulbs, Replaceable .....	262
Light, Safety Belt .....	25
Light, Turn Signal Indicator .....	81
Lighter, Cigarette .....	97
Lights	
Daytime Running .....	92
Fog .....	92
Gages and Warning Indicators .....	100
“On” Warning .....	100
Operation .....	91
Reading .....	93
Traffic .....	133
Loading Your Vehicle .....	238

Long Distance Driving .....	159
Loss of Control .....	148
Low Coolant Warning Light .....	110
Low Fuel Light .....	105
Low Oil Pressure, Warning Light .....	110
Luggage Carrier .....	101

## Maintenance

Inspections .....	279
Record .....	282
Schedule .....	256
Underbody .....	253
Malfunction Indicator Lamp .....	107
Manual Seat .....	14
Markings, Pavement .....	134
Master Cylinder, Brake .....	233
Methanol in Gasoline .....	215
Mirrors .....	94
Mist, Driving in .....	154
Mobile Telephone, Adding a .....	114
Mountain Driving .....	161
MTBE in Gasoline .....	215

<b>N</b> (Neutral) Gear Position .....	72
New Vehicle "Break-In" .....	65
Night Driving .....	149
Night Vision .....	150
Notices About Damage .....	2

<b>O</b> ctane Required for Your Car .....	237
Odometer .....	99
Off (Ignition Key Position) .....	67
Off-Road Recovery .....	146
Oil, Change Your Engine .....	221
Oil, Engine .....	220
Oil Pressure Warning Light .....	105
Operation in Foreign Countries .....	216
Outside Mirrors .....	94
Overdrive, Automatic .....	72
Overheated Engine .....	192
Owner Checks and Services .....	276

<b>P</b> (Park) Position .....	71
Paint Spotting .....	254
Park, Shifting Into .....	75
Parking Brake .....	74
Parking on Hills .....	163
Parking Over Things That Burn .....	77
Passing .....	147
Pavement Markings .....	134
Pedal Travel, Brake .....	143
Perception Time, Braking .....	139
Periodic Maintenance Inspections .....	279
Polishing and Waxing .....	252

Power	
Antenna Cleaning	124
Door Locks	61
Mirrors	94
Seat Controls	15
Steering	144
Steering Fluid	231
Windows	79
Pregnancy, Use of Safety Belts During	33
Pressure, Tire	241
Problems on the Road	177
Proper Safety Belt Usage, for Adults	26
Publications Order Form	291
Publications, Service	288
Push-Starting Your Car	180
<b>R</b> (Reverse) Gear Position	71
Racing, Shifting When Your Engine is	79
Radiator Pressure Cap	231
Radiator Overheating	192
Radio, Two-Way, Adding a	114
Radio Systems	113
Rain, Driving in	152
Reaction Time in Braking	139
Reading Lights	93
Rear Seat Console and Pass-Through	98
Rear Window Defogger	113
Reclining Front Seatbacks	16
Recommended Fluids and Lubricants	280
Recovery, Off-Road	146
Recreational Vehicle, Towing a	170
Remote Keyless Entry System	62
Remote Trunk Release	61
Replaceable Light Bulbs	262
Replacing Brake System Parts	234
Replacing Safety Belts	56
Replacing Tires	244
Replacing Wheels	246
Reporting Safety Defects	287
Restarting Your Car When It's Moving	79
Restraint, Child	42
Restraint Systems, Checking Your	55
Restraints, Head	17
Reverse Gear Position	71
"Riding" the Brakes	139
Road Signs	128
Roads, Hill and Mountain	161
Rocking Your Vehicle	170
Rotation, Tire	242
Run (Ignition Key Position)	67
Running Lights, Daytime	92
Running Your Engine While You're Parked	77
<b>S</b> afety Belt Care	251
Safety Belt Extender	55
Safety Belt Reminder Light	25
Safety Belt Replacement	56
Safety Belt Usage by Adults	26

Safety Belt Usage by Children	40	Sheet Metal Damage	253
Safety Belt Use During Pregnancy	33	Shift Lever Positions	71
Safety Belt, Automatic	27	Shifting Into Park	75
Safety Belt, Center Passenger	35	Signaling Turns	81
Safety Belt, Lap	35	Signs, Road	128
Safety Belt, Lap-Shoulder	27	Skidding	148
Safety Belts, Rear Seat Passengers	37	Snow or Ice, Driving on	167
Safety Belts, Right Front Adult Passenger	34	Snowstorm, If You're Caught in a Bad	168
Safety Belts, Too Loose	30	Solvent-Type Cleaner on Fabric	249
Safety Belts, Torn	56	Sound Equipment, Adding	114
Safety Belts, Twisted	33	Spare Tire	210
Safety Belts, Why They Work	20	Specifications Chart	263,264
Safety Cautions	10	Speech Impaired, Customer Assistance for	286
Safety Chains	173	Speed Control	86
Safety Defects, Reporting	287	Speedometer	99
Safety Warnings	10	Stains, Removing	250
Schedule, Maintenance	265	Start (Ignition Key Position)	67
Scheduled Maintenance Services	268	Starting Your Engine	67
Seats and Safety Belts	13	Starting Your Car if the Battery is "Dead"	180
Seat Controls	8	Steam From Hot (Overheated) Engine	192
Second Gear, When to Use	73	Steering	144
Securing A Child Restraint	46,48	Steering in Emergencies	145
Service and Appearance Care	213	Steering Wheel Radio Controls	122
Service Tips	214	Steering Wheel, Tilt	80
"Service Engine Soon" Warning Light	107	Steering Without Power Assist	144
Service Parts Identification Label	256	Stereo Sound Systems	123
Service Publications	288	Storage Armrest	98
Setting the Clock	116,120	Storing Your Car	235
Setting the Trip Odometer	99	Stuck, If Your Ignition Key is	67
Shape of Road Signs	131	Stuck, If Your Car is	211

Subscribing to Buick Service Publications .....	288
Sunroof .....	80
Symbols on Road Signs .....	132
Symbols on Your Car .....	12

<b>T</b> able of Contents .....	9
Tachometer .....	108
Taillight Bulb Replacement .....	236
Tamper-Resistance of Odometer .....	99
Tape Player Care .....	123
Temperature, Engine Coolant Warning Light .....	103
Theft .....	64
Thermostat .....	231
Third Gear, When to Use .....	72
Tilt Steering Wheel .....	82
Time, Setting the .....	116,120
Tire Balance .....	245
Tire Chains .....	247
Tire, Flat .....	201
Tire Inflation .....	241
Tire Inspection and Rotation .....	242
Tire Quality Grading .....	244
Tires .....	240
Tires, When to Replace .....	244
Tires, White Sidewall, Cleaning .....	253
Torn Safety Belts .....	56

Torque Lock (Automatic Transaxle) .....	165
Towing Hook-Ups .....	187
Towing a Trailer .....	170
Towing Your Car .....	185
Trademarks, GM .....	214
Traffic Lights .....	133
Traffic Officer .....	134
Trailer Brakes .....	173
Trailer Towing .....	170
Transaxle, Automatic .....	71
Transaxle Fluid .....	226
Trip Odometer .....	100
Trunk Release, Remote .....	61
Turn Signal and Headlight Beam Lever .....	81
Turn Signal and Lane Change Indicator .....	81
Turn Signal Reminder .....	82
Twisted Safety Belts .....	33
Two Children Wearing the Same Safety Belt .....	54

<b>U</b> nderbody Cleaning .....	253
Uniform Tire Quality Grading .....	244
Unleaded Gasoline .....	215
Uphill Parking .....	164
Upholstery Care .....	250
Used Oil Disposal .....	224
Used Replacement Wheels .....	247



<b>V</b> ehicle Damage, Warnings .....	11	Weight of a Trailer .....	171
Vehicle Identification Number .....	256	Wet Road Driving .....	168
Vehicle Storage .....	235	Wheel Alignment .....	245
Vehicle Symbols .....	12	Wheel Cover Removal .....	203
Ventilation .....	110	Wheel Nut Torque .....	208
Vinyl, Cleaning .....	250	Wheel Replacement .....	246
Volts Gage .....	106	White Sidewall Tire Cleaning .....	253
		Why Wear Safety Belts? .....	20
<b>W</b> arning		Windows, Power .....	79
Devices .....	179	Windshield	
Flasher, Hazard .....	178	Cleaning .....	251
Light, Antilock Brake System .....	103	Washer .....	85
Light, Brake System .....	102	Washer Fluid .....	232
Light, Check Gages .....	106	Wipers .....	84
Light, Engine Coolant Temperature .....	103	Winter Driving .....	166
Light, Engine Oil .....	105	Wire Wheel Cover .....	203
Light, Low Coolant .....	104	Working on Your Car .....	266
Light, Low Fuel .....	101	Worn Tires .....	243
Light, Service Engine Soon .....	107	Wrecker Towing .....	185
Lights, Gages and Indicators on Instrument Panel .....	100		
Warnings, Safety .....	10	<b>Y</b> our Driving and the Road .....	127
Washer, Windshield .....	85	Your Own Signals .....	134
Washing Your Vehicle .....	251	Your Vehicle and the Environment .....	267
Wear Indicators, Disc Brake .....	142		
Weather Strip Cleaning .....	253		

## Fuel Mileage Chart

		MILES PER GALLON																										
		10	11	12	13	14	15	16	17	18	19	20	21	22	23	24	25	26	27	28	29	30	31	32	33	34	35	36
GALLONS PURCHASED	5	50	55	60	65	70	75	80	85	90	95	100	105	110	115	120	125	130	135	140	145	150	155	160	165	170	175	180
	6	60	66	72	78	84	90	96	102	108	114	120	126	132	138	144	150	156	162	168	174	180	186	192	198	204	210	216
	7	70	77	84	91	98	105	112	119	126	133	140	147	154	161	168	175	182	189	196	203	210	217	224	231	238	245	252
	8	80	88	96	104	112	120	128	136	144	152	160	168	176	184	192	200	208	216	224	232	240	248	256	264	272	280	288
	9	90	99	108	117	126	135	144	153	162	171	180	189	198	207	216	225	234	243	252	261	270	279	288	297	306	315	324
	10	100	110	120	130	140	150	160	170	180	190	200	210	220	230	240	250	260	270	280	290	300	310	320	330	340	350	360
	11	110	121	132	143	154	165	176	187	198	209	220	231	242	253	264	275	286	297	308	319	330	341	352	363	374	385	396
	12	120	132	144	156	168	180	192	204	216	228	240	252	264	276	288	300	312	324	336	348	360	372	384	396	408	420	432
	13	130	143	156	169	182	195	208	221	234	247	260	273	286	299	312	325	338	351	364	377	390	403	416	429	442	455	468
	14	140	154	168	182	196	210	224	238	252	266	280	294	308	322	336	350	364	378	392	406	420	434	448	462	476	490	504
	15	150	165	180	195	210	225	240	255	270	285	300	315	330	345	360	375	390	405	420	435	450	465	480	495	510	525	540
	16	160	176	192	208	224	240	256	272	288	304	320	336	352	368	384	400	416	432	448	464	480	496	512	528	544	560	576
	17	170	187	204	221	238	255	272	289	306	323	340	357	374	391	408	425	442	459	476	493	510	527	544	561	578	595	612
	18	180	198	216	234	252	270	288	306	324	342	360	378	396	414	432	450	468	486	504	522	540	558	576	594	612	630	648
19	190	209	228	247	266	285	304	323	342	361	380	399	418	437	456	475	494	513	532	551	570	589	608	627	646	665	684	
20	200	220	240	260	280	300	320	340	360	380	400	420	440	460	480	500	520	540	560	580	600	620	640	660	680	700	720	
21	210	231	252	273	294	315	336	357	378	399	420	441	462	483	504	525	546	567	588	609	630	651	672	693	714	735	756	
22	220	242	264	286	308	330	352	374	396	418	440	462	484	506	528	550	572	594	616	638	660	682	704	726	748	770	792	





THIS MANUAL IS PRINTED ON RECYCLED PAPER USING  
MINIMUM 50% WASTEPAPER, 10% POST CONSUMER WASTE