

# 2011 Buick Lucerne Owner Manual

---

<b>In Brief</b> .....	1-1	Theft-Deterrent Systems .....	3-16
Instrument Panel .....	1-2	Starting and Operating Your Vehicle .....	3-19
Initial Drive Information .....	1-4	Mirrors .....	3-31
Vehicle Features .....	1-15	Object Detection Systems .....	3-35
Performance and Maintenance .....	1-22	Universal Home Remote System .....	3-42
<b>Seats and Restraint System</b> .....	2-1	Storage Areas .....	3-49
Head Restraints .....	2-2	Sunroof .....	3-51
Front Seats .....	2-3	<b>Instrument Panel</b> .....	4-1
Rear Seats .....	2-12	Instrument Panel Overview .....	4-3
Safety Belts .....	2-12	Climate Controls .....	4-16
Child Restraints .....	2-33	Warning Lights, Gauges, and Indicators .....	4-27
Airbag System .....	2-55	Driver Information Center (DIC) .....	4-42
Restraint System Check .....	2-70	Audio System(s) .....	4-67
<b>Features and Controls</b> .....	3-1	<b>Driving Your Vehicle</b> .....	5-1
Keys .....	3-3	Your Driving, the Road, and the Vehicle .....	5-2
Doors and Locks .....	3-9	Towing .....	5-23
Windows .....	3-14		

---

# 2011 Buick Lucerne Owner Manual

---

<b>Service and Appearance Care</b> .....	6-1	<b>Maintenance Schedule</b> .....	7-1
Service .....	6-3	Maintenance Schedule .....	7-2
Fuel .....	6-5	<b>Customer Assistance Information</b> .....	8-1
Checking Things Under the Hood .....	6-12	Customer Assistance and Information .....	8-2
Headlamp Aiming .....	6-49	Reporting Safety Defects .....	8-13
Bulb Replacement .....	6-52	Vehicle Data Recording and Privacy .....	8-16
Windshield Wiper Blade Replacement .....	6-55	<b>Index</b> .....	i-1
Tires .....	6-57		
Appearance Care .....	6-98		
Vehicle Identification .....	6-106		
Electrical System .....	6-107		
Capacities and Specifications .....	6-116		

---



The names, logos, emblems, slogans, vehicle model names, and vehicle body designs appearing in this manual including, but not limited to, GM, the GM logo, BUICK, the BUICK Emblem, and LUCERNE are trademarks and/or service marks of General Motors LLC, its subsidiaries, affiliates, or licensors.

This manual describes features that may or may not be on your specific vehicle either because they are options that you did not purchase or due to changes subsequent to the printing of this owner manual. Please refer to the purchase documentation relating to your specific vehicle to confirm each of the features found on your vehicle. For vehicles first sold in Canada, substitute the name "General Motors of Canada Limited" for Buick Motor Division wherever it appears in this manual.

Keep this manual in the vehicle for quick reference.

Litho in U.S.A.  
Part No. 20827774 B Second Printing

## Canadian Owners

### Propriétaires Canadiens

A French language copy of this manual can be obtained from your dealer or from:

On peut obtenir un exemplaire de ce guide en français auprès du concessionnaire ou à l'adresse suivante:

Helm, Incorporated  
P.O. Box 07130  
Detroit, MI 48207  
1-800-551-4123

Numéro de poste 6438 de langue française

[www.helminc.com](http://www.helminc.com)

## Index

To quickly locate information about the vehicle, use the index in the back of the manual. It is an alphabetical list of what is in the manual and the page number where it can be found.

©2010 General Motors LLC. All Rights Reserved.

## Safety Warnings and Symbols

Warning messages found on vehicle labels and in this manual describe hazards and what to do to avoid or reduce them.

**Danger** indicates a hazard with a high level of risk which will result in serious injury or death.

**Warning** or **Caution** indicates a hazard that could result in injury or death.



### WARNING:

These mean there is something that could hurt you or other people.

**Notice:** This means there is something that could result in property or vehicle damage. This would not be covered by the vehicle's warranty.



A circle with a slash through it is a safety symbol which means “Do Not,” “Do not do this,” or “Do not let this happen.”

## Vehicle Symbols

The vehicle has components and labels that use symbols instead of text. Symbols are shown along with the text describing the operation or information relating to a specific component, control, message, gauge, or indicator.



: This symbol is shown when you need to see your owner manual for additional instructions or information.



: This symbol is shown when you need to see a service manual for additional instructions or information.

## Vehicle Symbol Chart

Here are some additional symbols that may be found on the vehicle and what they mean. For more information on the symbol, refer to the Index.

 : Airbag Readiness Light

 : Air Conditioning

 : Antilock Brake System (ABS)

 : Audio Steering Wheel Controls or OnStar®

 : Brake System Warning Light

 : Charging System

 : Cruise Control

 : Engine Coolant Temperature

 : Exterior Lamps

 : Fog Lamps

 : Fuel Gauge

 : Fuses

 : Headlamp High/Low-Beam Changer

 : LATCH System Child Restraints

 : Malfunction Indicator Lamp

 : Oil Pressure

 : Power

 : Remote Vehicle Start

 : Safety Belt Reminders

 : Tire Pressure Monitor

 : Traction Control

 : Windshield Washer Fluid



# Section 1 In Brief

---

<b>Instrument Panel</b> .....	1-2	<b>Vehicle Features</b> .....	1-15
<b>Initial Drive Information</b> .....	1-4	Radio(s) .....	1-15
Remote Keyless Entry (RKE) System .....	1-4	Satellite Radio .....	1-16
Remote Vehicle Start .....	1-4	Portable Audio Devices (Auxiliary Input or USB Port) .....	1-17
Door Locks .....	1-5	Steering Wheel Controls .....	1-17
Trunk Release .....	1-5	Bluetooth® .....	1-18
Windows .....	1-6	Navigation System .....	1-18
Seat Adjustment .....	1-6	Driver Information Center (DIC) .....	1-18
Memory Features .....	1-8	Cruise Control .....	1-19
Heated Seats .....	1-9	Lane Departure Warning (LDW) .....	1-20
Heated and Ventilated Seats .....	1-9	Side Blind Zone Alert (SBZA) .....	1-20
Head Restraint Adjustment .....	1-10	Ultrasonic Parking Assist .....	1-21
Safety Belts .....	1-10	Power Outlets .....	1-21
Sensing System for Passenger Airbag .....	1-11	Universal Remote System .....	1-21
Mirror Adjustment .....	1-11	<b>Performance and Maintenance</b> .....	1-22
Steering Wheel Adjustment .....	1-12	Traction Control System (TCS) .....	1-22
Interior Lighting .....	1-13	StabiliTrak® System .....	1-22
Exterior Lighting .....	1-13	Tire Pressure Monitor .....	1-22
Windshield Wiper/Washer .....	1-14	Tire Sealant and Compressor Kit .....	1-23
Climate Controls .....	1-14	Engine Oil Life System .....	1-23
		Fuel E85 (85% Ethanol) .....	1-23
		Driving for Better Fuel Economy .....	1-23
		Roadside Assistance Program .....	1-24
		OnStar® .....	1-24

# Instrument Panel

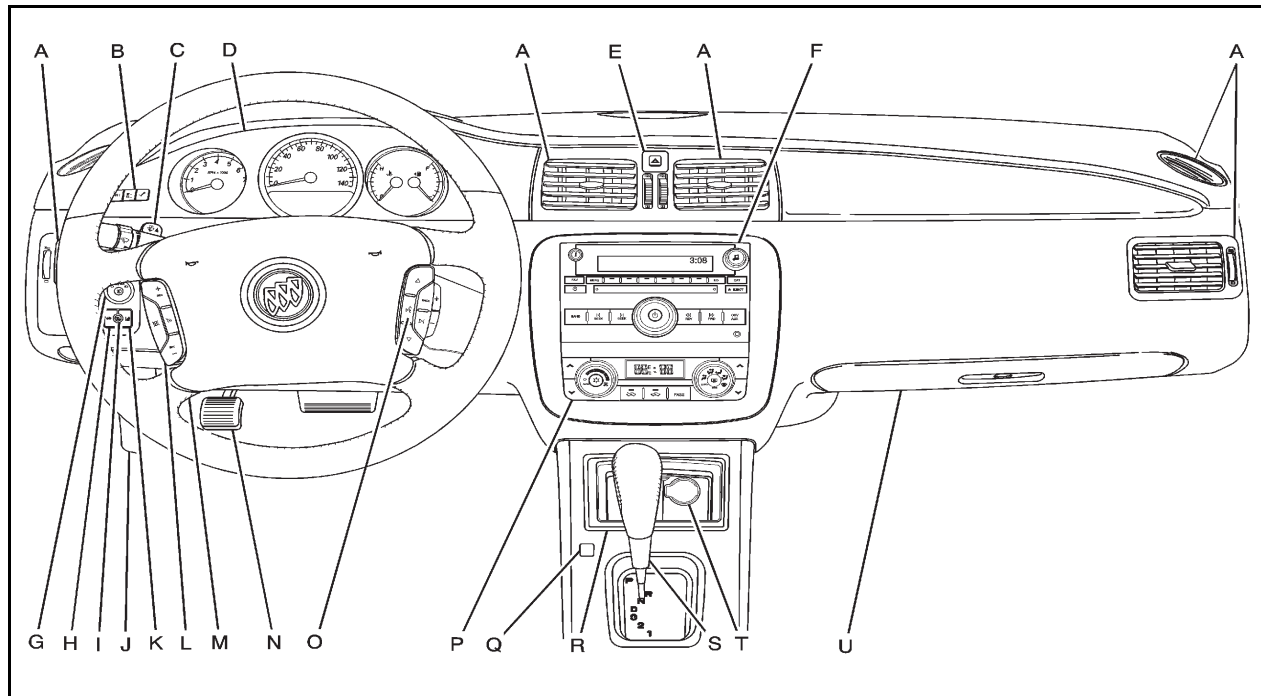



- A. *Outlet Adjustment on page 4-25*
- B. *DIC Operation and Displays on page 4-42*
- C. *Turn Signal/Multifunction Lever on page 4-4*  
*Windshield Wipers on page 4-6*
- D. *Instrument Panel Cluster on page 4-28*
- E. *Hazard Warning Flashers on page 4-3*
- F. *Audio System(s) on page 4-67*
- G. *Exterior Lamps on page 4-10*
- H. *Trunk Release. See Trunk on page 3-12*
  - I. *Instrument Panel Brightness on page 4-12*
- J. *Hood Release on page 6-13*
- K. *Lane Departure Warning (LDW) on page 3-40*
- L. *Cruise Control on page 4-7*  
*Heated Steering Wheel on page 4-4*
- M. *Data Link Connector (DLC) (Out of View). See Malfunction Indicator Lamp on page 4-37*
- N. *Parking Brake on page 3-26*
- O. *Audio Steering Wheel Controls on page 4-94*
- P. *Climate Control System on page 4-16*  
*Dual Automatic Climate Control System on page 4-20*
- Q. *Traction Control System (TCS) on page 5-6*  
*StabiliTrak® System on page 5-5*
- R. *Front Storage Area on page 3-49*
- S. *Shift Lever. See Automatic Transmission Operation on page 3-24*
- T. *Accessory Power Outlet(s) on page 4-15*
- U. *Glove Box on page 3-49*

## Initial Drive Information

This section provides a brief overview about some of the important features that may or may not be on your specific vehicle.

For more detailed information, refer to each of the features which can be found later in this owner manual.

## Remote Keyless Entry (RKE) System

The RKE transmitter is used to remotely lock and unlock the doors from up to 60 m (195 feet) away from the vehicle.

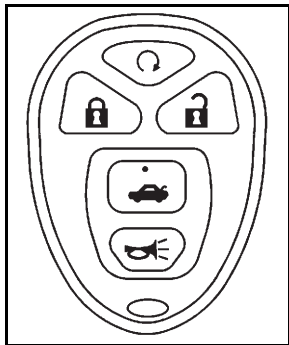

Press  to unlock the driver door. Press again within five seconds to unlock all remaining doors.

Press  to lock all doors.

Lock and unlock feedback can be personalized.

Press and hold  for approximately one second to open the trunk.

Press  and release to locate the vehicle.

Press  and hold for more than two seconds to sound the panic alarm.



Press  again to cancel the panic alarm.

See *Keys on page 3-3* and *Remote Keyless Entry (RKE) System Operation on page 3-4*.

## Remote Vehicle Start

With this feature the engine can be started from outside of the vehicle.

## Starting the Vehicle

1. Aim the RKE transmitter at the vehicle.
2. Press .
3. Immediately after completing Step 2, press and hold  until the turn signal lamps flash.

When the vehicle starts, the parking lamps will turn on and remain on as long as the engine is running. The doors will be locked and the climate control system may come on.

The engine will continue to run for 10 minutes. Repeat the steps for a 10-minute time extension. Remote start can be extended only once.

## Canceling a Remote Start

To cancel a remote start:

- Aim the RKE transmitter at the vehicle and press and hold  until the parking lamps turn off.
- Turn on the hazard warning flashers.
- Turn the ignition on and then back off.

See *Remote Vehicle Start on page 3-7*.

## Door Locks

From the outside, unlock the door using either the key or the RKE transmitter.

From the inside, use the power door lock switches or manual lock knobs located at the top of the door panel near the window.

## Power Door Locks

On vehicles with power door locks, the switches are located on the front doors.

 **(Unlock):** Press to unlock the doors.

 **(Lock):** Remove the key from the ignition and press to lock the doors.

For more information, see:

- *Door Locks on page 3-9.*
- *Power Door Locks on page 3-9.*
- *Remote Keyless Entry (RKE) System Operation on page 3-4.*

## Trunk Release

In addition to the trunk release button on the RKE transmitter, there is a remote release  button located to the left of the steering wheel, next to the instrument panel brightness control. Press to open the trunk.

See *Trunk on page 3-12*.

## Windows

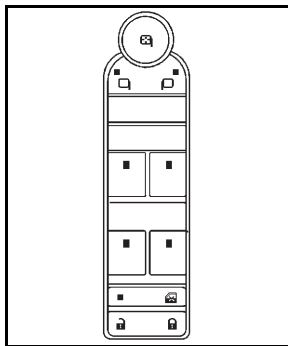

On vehicles with power windows, the switches are on the driver door armrest. Each passenger door has a switch that controls only that window.

Press the switch to lower the window. Pull the switch up to raise it.

For more information, see *Power Windows* on page 3-15.

## Seat Adjustment

### Power Seats

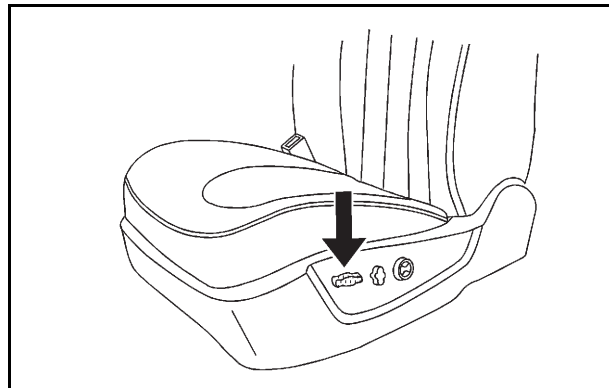

To adjust a power seat:

- Move the seat forward or rearward by sliding the control forward or rearward.
- Raise or lower the front or rear part of the seat cushion by moving the front or rear of the control up or down.
- Raise or lower the entire seat by moving the entire control up or down.

See *Power Seats* on page 2-3.

## Reclining Seatbacks

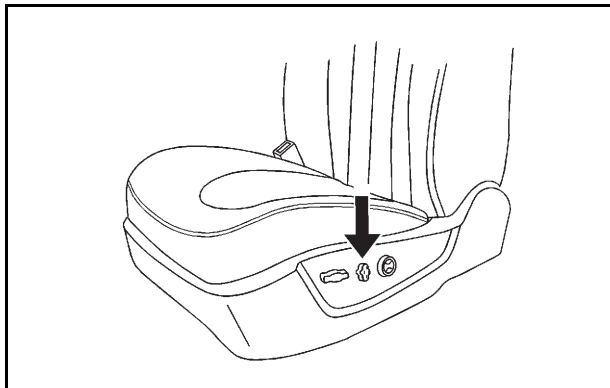

To raise or recline the seatback, tilt the top of the control forward or rearward.

See *Reclining Seatbacks* on page 2-9.

## Lumbar Adjustment

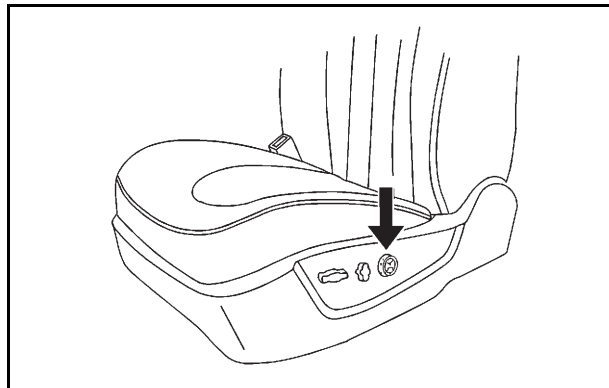

Use the round control on the outboard side of the seat to adjust the lumbar support.

See *Power Lumbar* on page 2-4 for more information.

## Memory Features

On vehicles with the memory feature, the controls on the driver door are used to program and recall memory settings for the driver seat, outside mirrors, and the power steering column, if the vehicle has this feature.

**1:** Saves and recalls for driver 1.

**2:** Saves and recalls for driver 2.

 : Recalls the easy exit driver seat and power steering column positions.

## Storing Memory Positions

To save into memory:

1. Adjust the driver seat, seatback recliner, lumbar, both outside mirrors, and the power steering column, if equipped.
2. Press and hold “1” until two beeps sound.
3. Repeat for a second driver position using “2.”

To recall the memory positions, press and release “1” or “2.” The vehicle must be in P (Park). A single beep will sound. The seat, outside mirrors, and power steering column, if equipped, will move to the positions previously stored for the identified driver.

See *Memory Seat and Mirrors on page 2-7* for more information.

## Easy Exit Positions

The easy exit feature can move the driver seat rearward and the power steering column, if equipped, up and forward to allow extra room to exit the vehicle.

 : Press to recall the easy exit positions. The vehicle must be in P (Park).

See *Memory Seat and Mirrors on page 2-7* and “Easy Exit Recall” and “Easy Exit Setup” under *DIC Vehicle Customization on page 4-58* for more information.

## Heated Seats

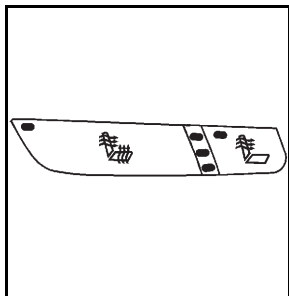

If available, the buttons are on the front doors. To operate, the ignition must be on.

 : Press to heat the seat and seatback.

 : Press to heat the seatback.

For more information, see *Heated Seats on page 2-4*.

## Heated and Ventilated Seats

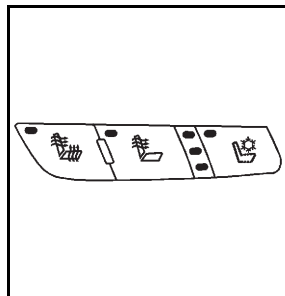

If available, the buttons are on the front doors. To operate, the ignition must be on.

 : Press to heat the seat and seatback.

 : Press to heat the seatback only.

 : Press to cool the seat and seatback.

For more information see *Heated and Ventilated Seats on page 2-6*.

## Head Restraint Adjustment

The vehicle's front seats have adjustable head restraints in the outboard seating positions.

Do not drive until the head restraints for all occupants are installed and adjusted properly.

To achieve a comfortable seating position, change the seatback recline angle as little as necessary while keeping the seat and the head restraint height in the proper position.

For more information see *Head Restraints on page 2-2* and *Power Seats on page 2-3*.

## Safety Belts

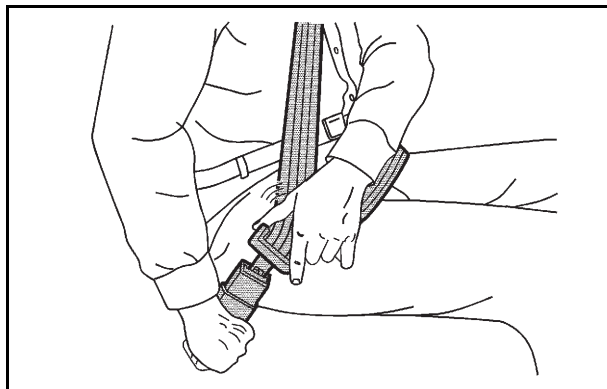

Refer to the following sections for important information on how to use safety belts properly.

- *Safety Belts: They Are for Everyone on page 2-12.*
- *How to Wear Safety Belts Properly on page 2-17.*
- *Lap-Shoulder Belt on page 2-26.*
- *Lap Belt on page 2-32.*
- *Lower Anchors and Tethers for Children (LATCH) on page 2-42.*



## Sensing System for Passenger Airbag

The passenger sensing system will turn off the right front passenger frontal airbag and seat-mounted side impact airbag under certain conditions. The driver airbags and roof-rail airbags are not affected by this.

The passenger airbag status indicator will be visible on the overhead console when the vehicle is started.

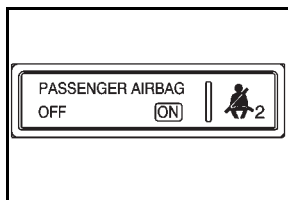

**United States**

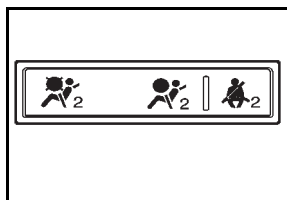

**Canada**

See *Passenger Sensing System* on page 2-64 for important information.

## Mirror Adjustment Exterior Mirrors

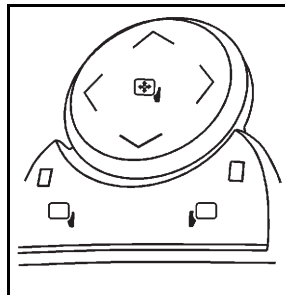

Controls for the outside power mirrors are located on the driver door armrest.

1. Press the left or right side of the selector switch located beneath the control pad to choose the driver or passenger side mirror.
2. Press one of the four arrows located on the control pad to move the mirror in the desired direction.

Manually fold the mirrors inward to prevent damage when going through an automatic car wash. To fold, push the mirror toward the vehicle. Push the mirror outward, to return to its original position.

## Interior Mirror

The vehicle has an automatic dimming inside rearview mirror. Automatic dimming reduces the glare of lights from behind the vehicle. The dimming feature comes on and the indicator light illuminates each time the vehicle is started.

Press the  button, located on the mirror, to turn the dimming feature and compass on or off.

See *Automatic Dimming Rearview Mirror on page 3-31*.

## Steering Wheel Adjustment

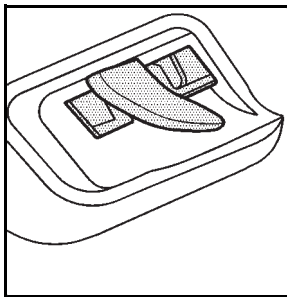

The lever is located on the left side of the steering column.

To adjust the steering wheel:

1. Hold the wheel and pull the lever toward you.
2. Move the steering wheel up or down.
3. Release the lever to lock the wheel in place.

## Power Tilt Wheel and Telescopic Steering Column

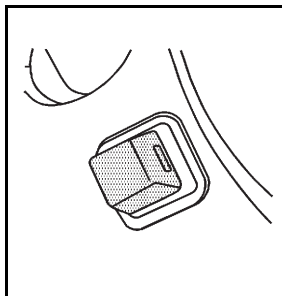

For vehicles with a power tilt control, it is located on the left hand side of the steering column.

To adjust the steering wheel, push the control up, down, forward or backward.

Do not adjust the steering wheel while driving.

See *Tilt Wheel on page 4-3* or *Power Tilt Wheel and Telescopic Steering Column on page 4-4* (If Equipped).

## Interior Lighting

### Courtesy Lamps

When any door is opened, the interior lamps turn on to enter and exit the vehicle. Turn the instrument panel brightness control  located on the left side of the steering wheel, completely clockwise to manually turn on these lamps.

### Front Reading Lamps

The front reading lamps are located on the headliner. Press the button near each lamp to turn them on or off.

For more information on interior lighting, see:

- *Courtesy Lamps on page 4-13.*
- *Instrument Panel Brightness on page 4-12.*
- *Delayed Entry Lighting on page 4-13.*
- *Delayed Exit Lighting on page 4-13.*

## Exterior Lighting

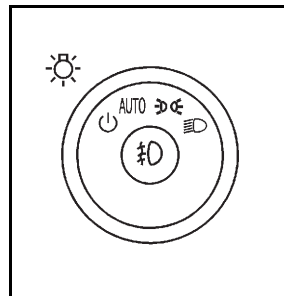

The exterior lamp control is located on the instrument panel to the left of the steering wheel.

 : Turns off the exterior lamps.

**AUTO:** Automatic operation of the headlamps and other exterior lamps.

 : Manual operation of the parking lamps and other exterior lamps.

 : Manual operation of the headlamps and other exterior lamps.

 : Press to turn on the fog lamps.

For more information, see:

- *Exterior Lamps on page 4-10.*
- *Daytime Running Lamps (DRL) on page 4-11.*
- *Fog Lamps on page 4-12.*
- *Wiper Activated Headlamps on page 4-11.*

## Windshield Wiper/Washer

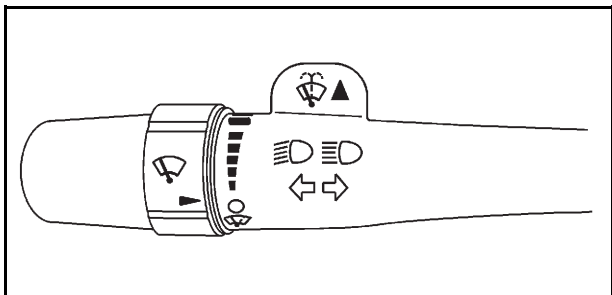

The windshield wiper lever is located on the left side of the steering column.

 : Use for a single wiping cycle.

 : Delays wiping cycle.

 : Slow wipes.

 : Fast wipes.

 : Turns the wipers off.

 : Press and release this paddle, located at the top of the turn signal/multifunction lever, to spray washer fluid on the windshield.

See *Windshield Wipers on page 4-6* and *Windshield Washer on page 4-7*.

## Climate Controls

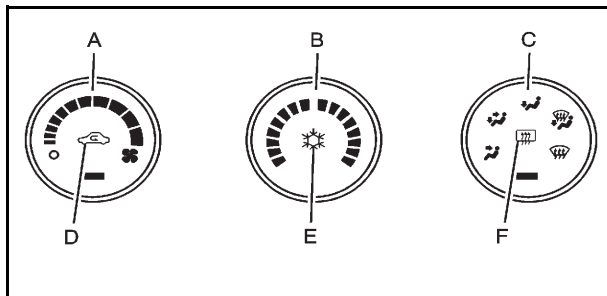

A. Fan Control

B. Temperature Control

C. Air Delivery Mode

Control

D. Air Recirculation

E. Air Conditioning

F. Rear Window Defogger

See *Climate Control System on page 4-16*  
(If Equipped).

This system allows the driver and passenger to control the temperature settings separately.

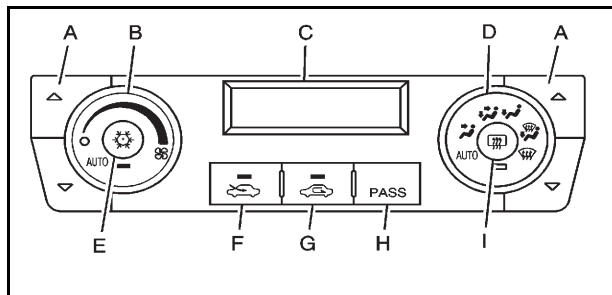

- |  |                         |
|--|-------------------------|
| A. Driver and Passenger Temperature Controls | E. Air Conditioning     |
| B. Fan Control                               | F. Outside Air          |
| C. Display                                   | G. Air Recirculation    |
| D. Air Delivery Mode Control                 | H. PASS                 |
|  | I. Rear Window Defogger |

See *Dual Automatic Climate Control System* on page 4-20 (If Equipped).

## Vehicle Features

### Radio(s)

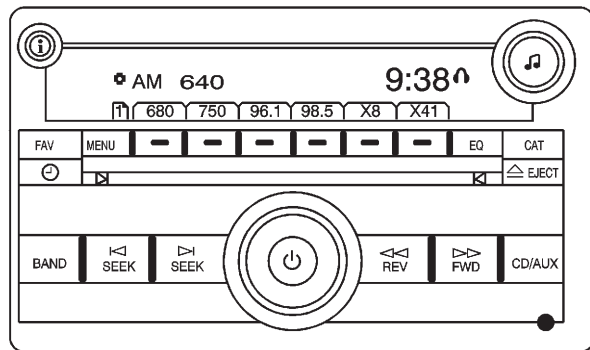

#### Radio with CD (MP3)

**⏻** : Press to turn the system on and off. Turn to increase or decrease the volume.

**BAND**: Press to choose between FM, AM, or XM™, if equipped.

**🎵** : Select radio stations.

**⏮ ⏭** : Seek or scan stations.

**i (XM™ Satellite Radio Service, MP3, and RDS Features):** Press this button to display additional text information related to the current FM-RDS or XM station, or MP3 song. When information is not available, No Info displays.

For more information about these and other radio features, see *Audio System(s) on page 4-67*.

## Storing a Favorite Station



For vehicles with an XM radio, a maximum of 36 stations can be stored as favorites using the six softkeys located below the radio station frequency tabs and by using the radio FAV button. Press FAV to go through up to six pages of favorites, each having six favorite stations available per page. Each page of favorites can contain any combination of AM, FM, or XM stations.

See *Radio(s) on page 4-69*.

## Setting the Clock

To set the time and date for the radio with CD (MP3):

1. Turn the ignition key to ACC/ACCESSORY or ON/RUN.
2. Press  to turn the radio on.

3. Press  and the HR, MIN, MM, DD, YYYY (hour, minute, month, day, and year) displays.
4. Press the softkey located below any one of the tabs that you want to change.
5. Increase or decrease the time or date by turning  clockwise or counterclockwise.

For detailed instructions on setting the clock for your specific audio system, see *Setting the Clock on page 4-68*.

## Satellite Radio

XM is a satellite radio service that is based in the 48 contiguous United States and 10 Canadian provinces. XM satellite radio has a wide variety of programming and commercial-free music, coast to coast, and in digital-quality sound.

A fee is required to receive the XM service.

For more information, refer to:

- [www.xmradio.com](http://www.xmradio.com) or call 1-800-929-2100 (U.S.)
- [www.xmradio.ca](http://www.xmradio.ca) or call 1-877-438-9677 (Canada)

See “XM Satellite Radio Service” under *Radio(s) on page 4-69*.

## Portable Audio Devices (Auxiliary Input or USB Port)

This vehicle may have an auxiliary input jack and a USB port, located on the audio faceplate. External devices such as iPods®, laptop computers, MP3 players, CD changers, USB storage devices, etc. can be connected to the auxiliary input jack using a 3.5 mm (1/8 in) cable or the USB port depending on the audio system.

Press the CD/AUX button to play audio from the portable player.

See “Using the Auxiliary Input Jack” and “Using the USB Port” under *Radio(s)* on page 4-69.

## Steering Wheel Controls

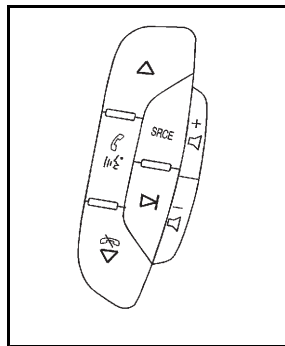

For vehicles with audio steering wheel controls, some audio controls can be adjusted at the steering wheel.

: Press to change favorite radio stations, select tracks on a CD/DVD, or to navigate tracks or folders on an iPod® or USB device.

: Press to silence the vehicle speakers only. Press again to turn the sound on. Press and hold longer than two seconds to interact with OnStar® or Bluetooth systems, if equipped.

+ - : Increases or decreases volume.

: Press to reject an incoming call, or to end a call.

**SRCE:** Press to switch between the radio, CD, and for vehicles with, DVD, front auxiliary, and rear auxiliary.

: Press to seek the next radio station, the next track or chapter while sourced to the CD or DVD slot, or to select tracks and folders on an iPod® or USB device.

For more information, see *Audio Steering Wheel Controls* on page 4-94.

## Bluetooth®

For vehicles with an in-vehicle Bluetooth system, it allows users with a Bluetooth enabled cell phone to make and receive hands-free calls using the vehicle's audio system and controls.

The Bluetooth enabled cell phone must be paired with the in-vehicle Bluetooth system before it can be used in the vehicle. Not all phones will support all functions. For more information visit [www.gm.com/bluetooth](http://www.gm.com/bluetooth).

For more information, see *Bluetooth®* on page 4-86.

## Navigation System

If the vehicle has a navigation system, there is a separate Navigation System Manual that includes information on the radio, audio players, and navigation system.

The navigation system provides detailed maps of most major freeways and roads. After a destination has been set, the system provides turn-by-turn instructions for

reaching the destination. In addition, the system can help locate a variety of points of interest (POIs), such as banks, airports, restaurants, and more.

See the Navigation System Manual for more information.

## Driver Information Center (DIC)

The DIC display is located at the bottom of the instrument panel cluster. It shows the status of many vehicle systems and enables access to the personalization menu.

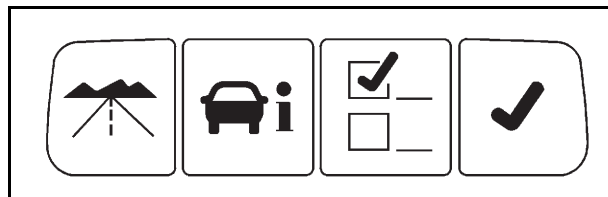

The DIC buttons are located on the instrument panel to the left of the instrument panel cluster.

: Press to scroll through the trip and fuel displays.

: Press to scroll through the vehicle information displays.



 : Press to customize the feature settings on your vehicle. See *DIC Vehicle Customization on page 4-58* for more information.

✓ : Press to reset certain DIC features and to acknowledge DIC warning messages and clear them from the display.

For more information, see *Driver Information Center (DIC) on page 4-42*.

## Vehicle Customization

Some vehicle features can be programmed by using the DIC buttons on the instrument panel to the left of the steering wheel. These features include:

- Language
- Door Lock and Unlock Settings
- Lighting
- Chime Volume
- Memory Settings

See *DIC Vehicle Customization on page 4-58*.

## Cruise Control

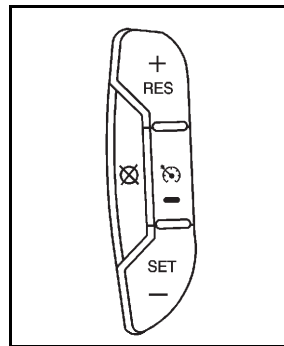

The cruise control buttons are located on the left side of the steering wheel.

 : Press to turn the cruise control on or off.

**+ RES:** Press briefly to make the vehicle resume to a previously set speed, or press and hold to accelerate.

**SET- :** Press to set the speed and activate cruise control or make the vehicle decelerate.

 **(Cancel):** Press to disengage cruise control without erasing the set speed from memory.

For more information, see *Cruise Control on page 4-7*.

## Lane Departure Warning (LDW)

For vehicles with LDW, it is intended to help avoid lane change collisions. It provides a warning if the vehicle is crossing a lane without using a turn signal. LDW uses a camera to detect the lane markings. It only operates at speeds of 56 km (35 mph) or greater.

The warning symbol , located in the instrument panel cluster, appears green if a lane marking is detected. It changes to amber, flashes, and sounds three chimes if the vehicle crosses a detected lane marking and the turn signal is not on.

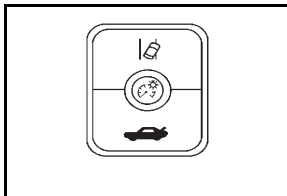

To turn LDW on and off, press the LDW button, located by the exterior headlamp control.

See *Lane Departure Warning (LDW)* on page 3-40 for more information.

## Side Blind Zone Alert (SBZA)

For vehicles with this feature, it may alert you to vehicles located in your side blind zone. When the system detects a vehicle in the side blind zone, an SBZA display will light up in the corresponding outside side mirror indicating that it may not be safe to change lanes.

The system is enabled at every vehicle startup. It can be disabled through the Driver Information Center (DIC).

If the message **SIDE BLIND ZONE SYS.**

**UNAVAILABLE** appears on the DIC, the system has been disabled because the sensor is blocked and cannot detect vehicles in the blind zone. The sensors, located behind the rear quarter panels, may be blocked by mud, dirt, snow, ice, slush, or even heavy rainstorms. The vehicle does not need service.

See *Side Blind Zone Alert (SBZA)* on page 3-36 for more information.

## Ultrasonic Parking Assist

For vehicles with this feature, it uses sensors on the rear bumper to detect objects while parking the vehicle. It operates at speeds less than 8 km/h (5 mph) while in R (Reverse).

Keep the sensors on the vehicle's rear bumper clean to ensure proper operation.

The system can be disabled through the Driver Information Center (DIC).

See *Ultrasonic Rear Parking Assist (URPA)* on page 3-35 for more information.

## Power Outlets

The accessory power outlets can be used to plug in electrical equipment, such as a cell phone or MP3 player.

The vehicle may have up to three power outlets depending on the type of front seat installed. If the vehicle has front bucket seats with a center console, there are two outlets inside the center console storage bin, one accessory power outlet and one USB port outlet. An extra power outlet can be found under the climate control system next to the ashtray.

See *Accessory Power Outlet(s)* on page 4-15.

## Universal Remote System

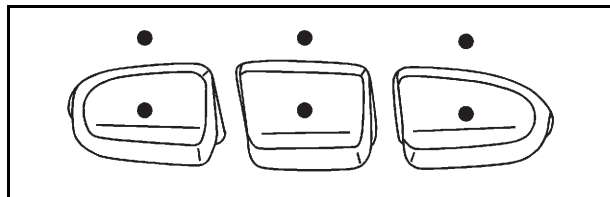



The Universal Home Remote System allows for garage door openers, security systems, and home automation devices to be programmed to work with these buttons in the vehicle.

See *Universal Home Remote System* on page 3-42.

## Performance and Maintenance

### Traction Control System (TCS)

The traction control system limits wheel spin. The system turns on automatically every time the vehicle is started.

- To turn off traction control, press and release  in front of the shift lever.  illuminates and the appropriate DIC message is displayed. See *DIC Warnings and Messages on page 4-49*.
- Press and release the button again to turn on traction control.

For more information, see *Traction Control System (TCS) on page 5-6*.

### StabiliTrak<sup>®</sup> System

The vehicle has a StabiliTrak system that assists with directional control of the vehicle in difficult driving conditions. The system turns on automatically every time the vehicle is started. The system cannot be turned off.

For more information, see *StabiliTrak<sup>®</sup> System on page 5-5*.

### Tire Pressure Monitor

This vehicle may have a Tire Pressure Monitor System (TPMS).

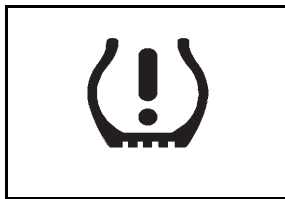

The TPMS warning light alerts you to a significant loss in pressure of one of the vehicles tires.

If the warning light comes on, stop as soon as possible and inflate the tires to the recommended pressure shown on the tire loading information label. See *Loading the Vehicle on page 5-18*. The warning light will remain on until the tire pressure is corrected.

During cooler conditions, the low tire pressure warning light may appear when the vehicle is first started and then turn off. This may be an early indicator that the tire pressures are getting low and the tires need to be inflated to the proper pressure.

The TPMS does not replace normal monthly tire maintenance. It is the driver's responsibility to maintain correct tire pressures.

See *Tire Pressure Monitor System on page 6-65* and *Tire Pressure Monitor Operation on page 6-66*.

## Tire Sealant and Compressor Kit

This vehicle may come with a jack and spare tire or a tire sealant and compressor kit. The kit can be used to seal small punctures in the tread area of the tire.

See *Tire Sealant and Compressor Kit on page 6-80* for complete operating information.

If the vehicle came with a jack and spare tire, see *Changing a Flat Tire on page 6-88*.

## Engine Oil Life System

The engine oil life system calculates engine oil life based on vehicle use and displays a DIC message when it is necessary to change the engine oil and filter. The oil life system should be reset to 100% only following an oil change.

### Resetting the Oil Life System

1. Display the OIL LIFE REMAINING on the DIC.
2. Press and hold the SET/RESET button on the DIC for more than five seconds. The oil life will change to 100%.

See *Engine Oil Life System on page 6-22*.

## Fuel E85 (85% Ethanol)

Vehicles that have a FlexFuel badge and a yellow fuel cap can use either unleaded gasoline or ethanol fuel containing up to 85% ethanol (E85). See *Fuel E85 (85% Ethanol) on page 6-7*. For all other vehicles, use only the unleaded gasoline described under *Gasoline Octane on page 6-6*.

## Driving for Better Fuel Economy

Driving habits can affect fuel mileage. Here are some driving tips to get the best fuel economy possible.

- Avoid fast starts and accelerate smoothly.
- Brake gradually and avoid abrupt stops.
- Avoid idling the engine for long periods of time.
- When road and weather conditions are appropriate, use cruise control, if equipped.
- Always follow posted speed limits or drive more slowly when conditions require.
- Keep vehicle tires properly inflated.
- Combine several trips into a single trip.
- Replace the vehicle's tires with the same TPC Spec number molded into the tire's sidewall near the size.
- Follow recommended scheduled maintenance.

## Roadside Assistance Program

U.S.: 1-800-252-1112

TTY Users: 1-888-889-2438

Canada: 1-800-268-6800

As the owner of a new Buick, you are automatically enrolled in the Roadside Assistance program.

See *Roadside Assistance Program on page 8-7* for more information.

## Roadside Assistance and OnStar

If you have an active OnStar subscription, press the  button and the current GPS location will be sent to an OnStar Advisor who will assess your problem, contact Roadside Assistance, and relay exact location to get you the help you need.

## Online Owner Center

The Online Owner Center is a complimentary service that includes online service reminders, vehicle maintenance tips, online owner manual, special privileges and more.

Sign up today at: [www.buickownercenter.com](http://www.buickownercenter.com) (U.S.) or [www.gm.ca](http://www.gm.ca) (Canada).

## OnStar®

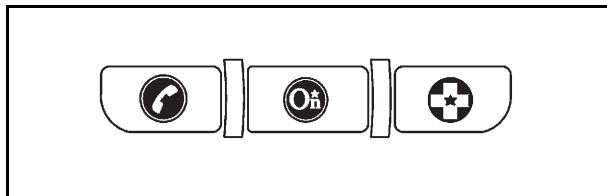



OnStar® uses several innovative technologies and live Advisors to provide a wide range of safety, security, navigation, diagnostics, and calling services.

## Automatic Crash Response

In a crash, built-in sensors can automatically alert an OnStar Advisor who is immediately connected to the vehicle to see if you need help.

## How OnStar Service Works

 : This blue button connects you to a specially trained OnStar Advisor to verify your account information and to answer questions.

 : Push this red emergency button to get priority help from specially trained OnStar Emergency Advisors.

 : Push this button for hands-free, voice-activated calling and to give voice commands for Turn-by-Turn Navigation.

Crisis Assist, Stolen Vehicle Assistance, Vehicle Diagnostics, Remote Door Unlock, Roadside Assistance, Turn-by-Turn Navigation and Hands-Free Calling are available on most vehicles. Not all OnStar services are available on all vehicles. For more information see the OnStar Owner's Guide or visit [www.onstar.com](http://www.onstar.com) (U.S.) or [www.onstar.ca](http://www.onstar.ca) (Canada), contact OnStar at 1-888-4-ONSTAR (1-888-466-7827) or TTY 1-877-248-2080, or push  to speak with an OnStar Advisor 24 hours a day, 7 days a week.

For a full description of OnStar services and system limitations, see the OnStar Owner's Guide in the glove box.

OnStar service is subject to the OnStar Terms and Conditions included in the OnStar Glove Box Kit.

OnStar service requires wireless communication networks and the Global Positioning System (GPS) satellite network. Not all OnStar services are available everywhere or on all vehicles at all times.

OnStar service can't work unless your vehicle is in a place where OnStar has an agreement with a wireless service provider for service in that area, and the wireless service provider has coverage, network capacity, reception, and technology compatible with OnStar service. Service involving location information about your vehicle can't work unless GPS signals are available, unobstructed, and compatible with the OnStar hardware. The vehicle has to have a working electrical system and adequate battery power for the OnStar equipment to operate. OnStar service may not work if the OnStar equipment isn't properly installed or you haven't maintained it and your vehicle is in good working order and in compliance with all government regulations. If you try to add, connect, or modify any equipment or software in your vehicle, OnStar service may not work. Other problems OnStar can't control may prevent service to you, such as hills, tall buildings, tunnels, weather, electrical system design and architecture of your vehicle, damage to important parts of your vehicle in a crash, or wireless phone network congestion or jamming.

See *Radio Frequency Statement on page 8-18* for information regarding Part 15 of the Federal Communications Commission (FCC) rules and Industry Canada Standards RSS-210/220/310.



## OnStar Steering Wheel Controls

This vehicle may have a Talk/Mute button that can be used to interact with OnStar Hands-Free calling. See *Audio Steering Wheel Controls on page 4-94* for more information.

On some vehicles, the mute button can be used to dial numbers into voice mail systems, or to dial phone extensions. See the OnStar Owner's Guide for more information.

## Your Responsibility

Increase the volume of the radio if the OnStar Advisor cannot be heard.

If the light next to the OnStar buttons is red, the system may not be functioning properly. Push  and request a vehicle diagnostic. If the light appears clear (no light is appearing), your OnStar subscription has expired and all services have been deactivated. Push  to confirm that the OnStar equipment is active.



## Section 2 Seats and Restraint System

---

<b>Head Restraints</b> .....	2-2	Lower Anchors and Tethers for Children (LATCH) .....	2-42
<b>Front Seats</b> .....	2-3	Securing a Child Restraint in a Rear Seat Position .....	2-49
Power Seats .....	2-3	Securing a Child Restraint in the Center Front Seat Position .....	2-51
Power Lumbar .....	2-4	Securing a Child Restraint in the Right Front Seat Position .....	2-52
Heated Seats .....	2-4	<b>Airbag System</b> .....	2-55
Heated and Ventilated Seats .....	2-6	Where Are the Airbags? .....	2-57
Memory Seat and Mirrors .....	2-7	When Should an Airbag Inflate? .....	2-60
Reclining Seatbacks .....	2-9	What Makes an Airbag Inflate? .....	2-61
Center Seat .....	2-11	How Does an Airbag Restrain? .....	2-62
<b>Rear Seats</b> .....	2-12	What Will You See After an Airbag Inflates? ...	2-62
Rear Seat Pass-Through Door .....	2-12	Passenger Sensing System .....	2-64
<b>Safety Belts</b> .....	2-12	Servicing Your Airbag-Equipped Vehicle .....	2-68
Safety Belts: They Are for Everyone .....	2-12	Adding Equipment to Your Airbag-Equipped Vehicle .....	2-69
How to Wear Safety Belts Properly .....	2-17	<b>Restraint System Check</b> .....	2-70
Lap-Shoulder Belt .....	2-26	Checking the Restraint Systems .....	2-70
Safety Belt Use During Pregnancy .....	2-31	Replacing Restraint System Parts After a Crash .....	2-71
Lap Belt .....	2-32		
Safety Belt Extender .....	2-33		
<b>Child Restraints</b> .....	2-33		
Older Children .....	2-33		
Infants and Young Children .....	2-36		
Child Restraint Systems .....	2-39		
Where to Put the Restraint .....	2-41		

## Head Restraints

The front seats have adjustable head restraints in the outboard seating positions.

### **WARNING:**

With head restraints that are not installed and adjusted properly, there is a greater chance that occupants will suffer a neck/spinal injury in a crash. Do not drive until the head restraints for all occupants are installed and adjusted properly.

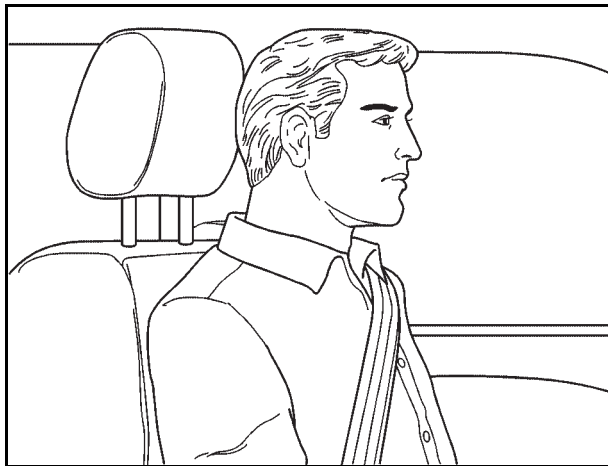

Adjust the head restraint so that the top of the restraint is at the same height as the top of the occupant's head. This position reduces the chance of a neck injury in a crash.

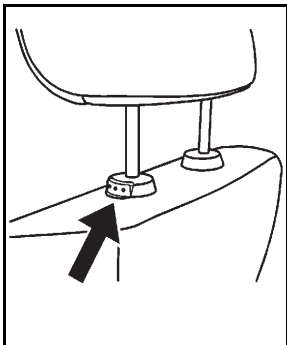

Pull the head restraint up to raise it. To lower the head restraint, press the button, located on the top of the seatback, and push the restraint down.

Push down on the head restraint after the button is released to make sure that it is locked in place.

The head restraints are not designed to be removed.

## Front Seats

### Power Seats

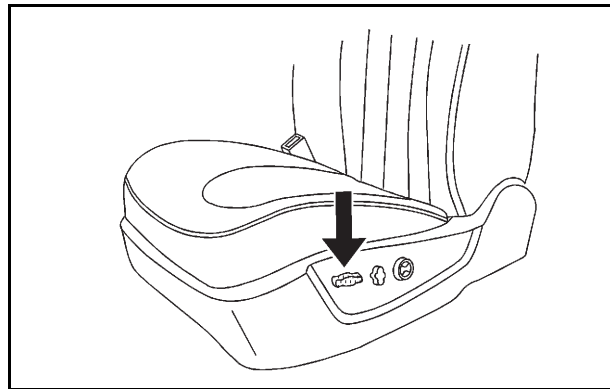

To adjust a power seat:

- Move the seat forward or rearward by sliding the control forward or rearward.
- Raise or lower the front or rear part of the seat cushion by moving the front or rear of the control up or down.
- Raise or lower the entire seat by moving the entire control up or down.

For vehicles with power reclining seatbacks, see “Power Reclining Seatbacks” under *Reclining Seatbacks* on page 2-9.

## Power Lumbar

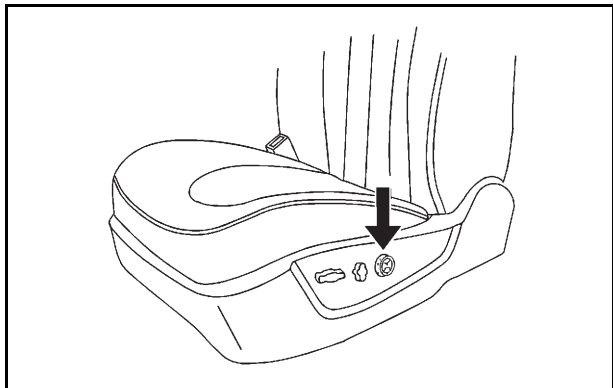

To adjust the power lumbar, if available:

- On vehicles with two-way lumbar, press the top or bottom of the control to increase or decrease lumbar support.

- On vehicles with four-way lumbar, press the front or rear of the control to increase or decrease lumbar support. Press the top or bottom of the control to raise or lower the location of the support in the seatback.

## Heated Seats

### **WARNING:**

If you cannot feel temperature change or pain to the skin, the seat heater may cause burns even at low temperatures. To reduce the risk of burns, people with such a condition should use care when using the seat heater, especially for long periods of time. Do not place anything on the seat that insulates against heat, such as a blanket, cushion, cover, or similar item. This may cause the seat heater to overheat. An overheated seat heater may cause a burn or may damage the seat.

To operate, the ignition must be on.

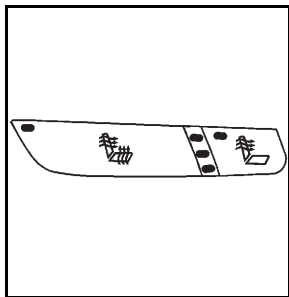

If available, the buttons are on the front doors.

#### Driver Side Buttons Shown

 **(Heated Seat Cushion and Seatback):** Press to heat the seat and seatback.

 **(Heated Seatback):** Press to heat the seatback.

Press the desired button once to turn this feature on at the highest setting. A light on the button turns on to show which feature is on.

The column of three lights near the buttons shows the current temperature setting. With each press of the button, the seat will change to the next lower setting, and then to the off setting. The lights indicate three for the highest setting and one for the lowest.

#### Remote Start Heated Front Seats

During a remote start, the front heated seats can be turned on automatically. They are canceled when the ignition is turned on. Press the button to use the heated seats after the vehicle is started.

The heated seat indicator lights on the button do not turn on during a remote start.

The temperature performance of an unoccupied seat may be reduced. This is normal.

See *Remote Vehicle Start on page 3-7* for more information.

## Heated and Ventilated Seats

### **WARNING:**

If you cannot feel temperature change or pain to the skin, the seat heater may cause burns even at low temperatures. See the Warning under *Heated Seats* on page 2-4.

To operate, the ignition must be on.

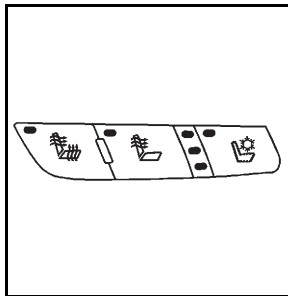

If available, the buttons are on the front doors.

### Driver Side Buttons Shown

 **(Heated Seat Cushion and Seatback):** Press to heat the seat cushion and seatback.

 **(Heated Seatback):** Press to heat the seatback.

 **(Ventilated Seat Cushion and Seatback):** Press to cool the seat cushion and seatback.

Press the desired button once to turn this feature on at the highest setting. A light on the button turns on to show which feature is on.

The column of three lights near the buttons shows the current temperature setting. With each press of the button, the seat will change to the next lower setting, and then to the off setting. The lights indicate three for the highest setting and one for the lowest.

### Remote Start Heated Front Seats

During a remote start, the front heated seats can be turned on automatically. They are canceled when the ignition is turned on. Press the button to use the heated seats after the vehicle is started.

The heated seat indicator lights on the button do not turn on during a remote start.

The temperature performance of an unoccupied seat may be reduced. This is normal.

See *Remote Vehicle Start* on page 3-7 for more information.

## Memory Seat and Mirrors

On vehicles with the memory feature, the controls on the driver door are used to program and recall memory settings for the driver seat, outside mirrors, and the power steering column, if the vehicle has this feature.

**1:** Saves and recalls for driver 1.

**2:** Saves and recalls for driver 2.

 **(Easy Exit Positions):** Recalls the easy exit driver seat and power steering column positions.

## Storing Memory Positions

To save into memory:

1. Adjust the driver seat, seatback recliner, lumbar, both outside mirrors, and the power steering column, if equipped.
2. Press and hold “1” until two beeps sound.
3. Repeat for a second driver position using “2.”

To recall the memory positions, press and release “1” or “2.” The vehicle must be in P (Park). A single beep will sound. The seat, outside mirrors, and power steering column, if equipped, will move to the positions previously stored for the identified driver.

## Memory Remote Recall

The memory feature can recall the driver seat, outside mirrors, and power steering column, if equipped, to stored positions when entering the vehicle.

To activate memory remote recall, unlock the driver door with the Remote Keyless Entry (RKE) transmitter. The driver seat, outside mirrors, and power steering column will move to the memory positions associated with the transmitter used to unlock the vehicle.

The automatic recall feature can be turned on or off using the vehicle customization menu. See “Memory Seat Recall” under *DIC Vehicle Customization on page 4-58* for more information.

To stop recall movement, press one of the memory or power mirror buttons, power seat controls, or the power steering column switch.

If something has blocked the driver seat and/or steering column while recalling a memory position, the recall may stop. Remove the obstruction; then press and hold the appropriate manual control for the memory item that is not recalling for two seconds. Try recalling the memory position again by pressing the appropriate memory button. If the memory position is still not recalling, see your dealer for service.

## Easy Exit Positions

The easy exit feature can move the driver seat rearward and the power steering column, if equipped, up and forward to allow extra room to exit the vehicle.

 : Press to recall the easy exit positions. The vehicle must be in P (Park).

If the easy exit feature is programmed on in the vehicle customization menu, automatic driver seat and power steering column movement occur when the ignition key is removed.

A single beep sounds. The driver seat will move back and the power steering column, if equipped, moves up and forward.

If something has blocked the driver seat while recalling the exit position, the recall may stop. Remove the obstruction; then press and hold the power seat control rearward for two seconds. Try recalling the exit position again. If the exit position is still not recalling, see your dealer for service.

See “Easy Exit Recall” and “Easy Exit Setup” under *DIC Vehicle Customization on page 4-58* for more information.



## Reclining Seatbacks

### **WARNING:**

Sitting in a reclined position when the vehicle is in motion can be dangerous. Even when buckled up, the safety belts cannot do their job when reclined like this.

The shoulder belt cannot do its job because it will not be against your body. Instead, it will be in front of you. In a crash, you could go into it, receiving neck or other injuries.

The lap belt cannot do its job either. In a crash, the belt could go up over your abdomen. The belt forces would be there, not at your pelvic bones. This could cause serious internal injuries.

For proper protection when the vehicle is in motion, have the seatback upright. Then sit well back in the seat and wear the safety belt properly.

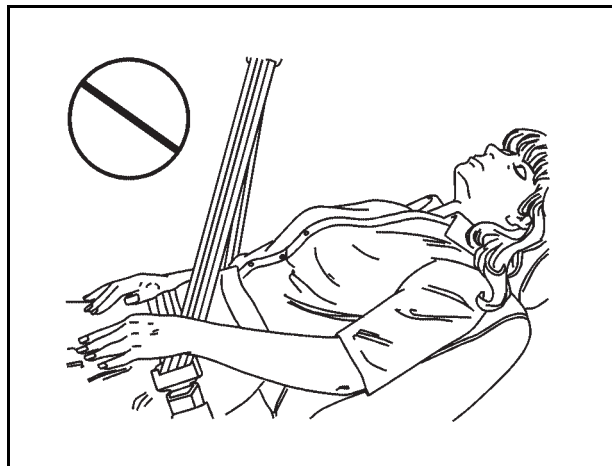

Do not have the seatback reclined if your vehicle is moving.

## Manual Reclining Seatbacks

### **WARNING:**

You can lose control of the vehicle if you try to adjust a manual driver seat while the vehicle is moving. The sudden movement could startle and confuse you, or make you push a pedal when you do not want to. Adjust the driver seat only when the vehicle is not moving.

### **WARNING:**

If either seatback is not locked, it could move forward in a sudden stop or crash. That could cause injury to the person sitting there. Always push and pull on the seatbacks to be sure they are locked.

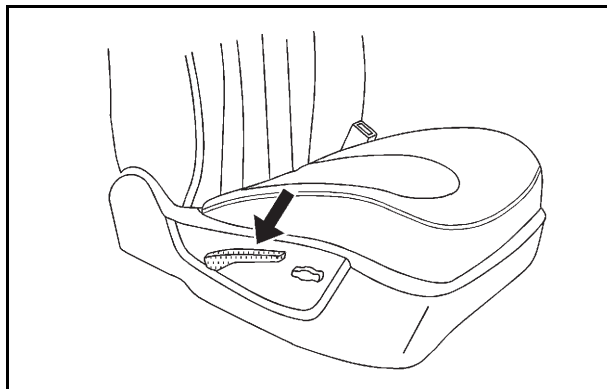

To recline the seatback:

1. Lift the lever.
2. Move the seatback to the desired position, and then release the lever to lock the seatback in place.
3. Push and pull on the seatback to make sure it is locked.

To return the seatback to the upright position:

1. Lift the lever fully without applying pressure to the seatback, and the seatback will return to the upright position.
2. Push and pull on the seatback to make sure it is locked.

## Power Reclining Seatbacks

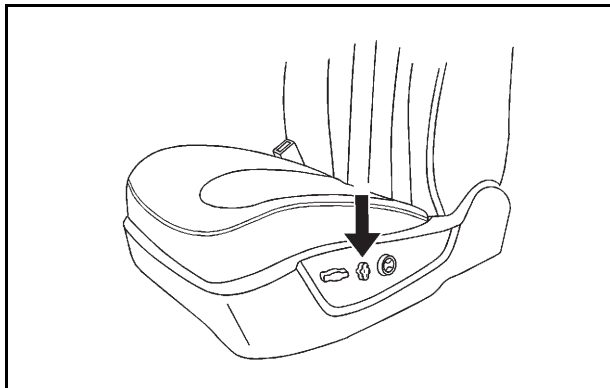

To adjust a power seatback, if equipped:

- Tilt the top of the control rearward to recline.
- Tilt the top of the control forward to raise.

## Center Seat

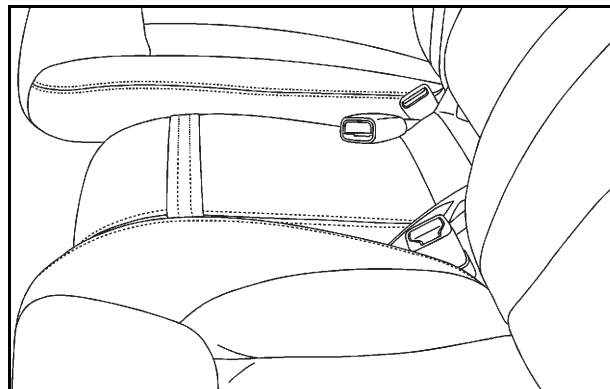

The vehicle may have a front center seat. This seat can be converted to a storage area by lowering the seatback. See *Center Flex Storage Unit* on page 3-49.

## Rear Seats

### Rear Seat Pass-Through Door

The vehicle has a pass-through door that provides access to the trunk from the rear seats. See “Rear Seat Pass-Through Door” under *Trunk on page 3-12*.

## Safety Belts

### Safety Belts: They Are for Everyone

This section of the manual describes how to use safety belts properly. It also describes some things not to do with safety belts.

#### **WARNING:**

Do not let anyone ride where a safety belt cannot be worn properly. In a crash, if you or your passenger(s) are not wearing safety belts, the injuries can be much worse. You can hit things inside the vehicle harder or be ejected from the vehicle. You and your passenger(s) can be seriously injured or killed. In the same crash, you

(Continued)

#### **WARNING: (Continued)**

might not be, if you are buckled up. Always fasten your safety belt, and check that your passenger(s) are restrained properly too.

#### **WARNING:**

It is extremely dangerous to ride in a cargo area, inside or outside of a vehicle. In a collision, people riding in these areas are more likely to be seriously injured or killed. Do not allow people to ride in any area of your vehicle that is not equipped with seats and safety belts. Be sure everyone in the vehicle is in a seat and using a safety belt properly.

This vehicle has indicators as a reminder to buckle the safety belts. See *Safety Belt Reminders on page 4-29* for additional information.

In most states and in all Canadian provinces, the law requires wearing safety belts. Here is why:

You never know if you will be in a crash. If you do have a crash, you do not know if it will be a serious one.

A few crashes are mild, and some crashes can be so serious that even buckled up, a person would not survive. But most crashes are in between. In many of them, people who buckle up can survive and sometimes walk away. Without safety belts, they could have been badly hurt or killed.

After more than 40 years of safety belts in vehicles, the facts are clear. In most crashes buckling up does matter ... a lot!

## Why Safety Belts Work

When you ride in or on anything, you go as fast as it goes.

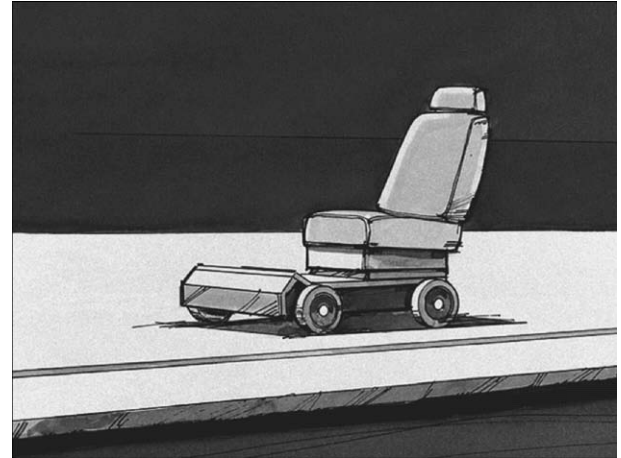

Take the simplest vehicle. Suppose it is just a seat on wheels.

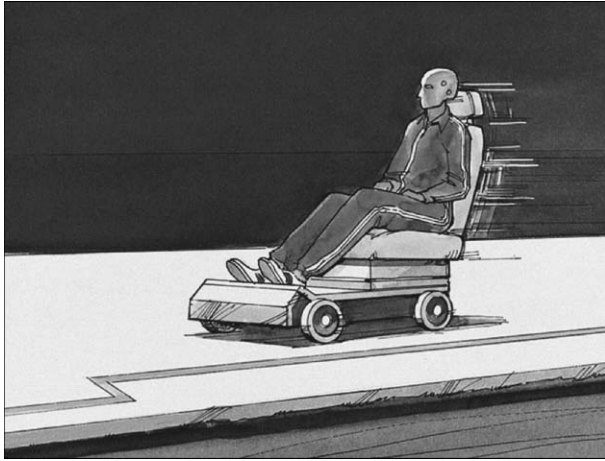

Put someone on it.

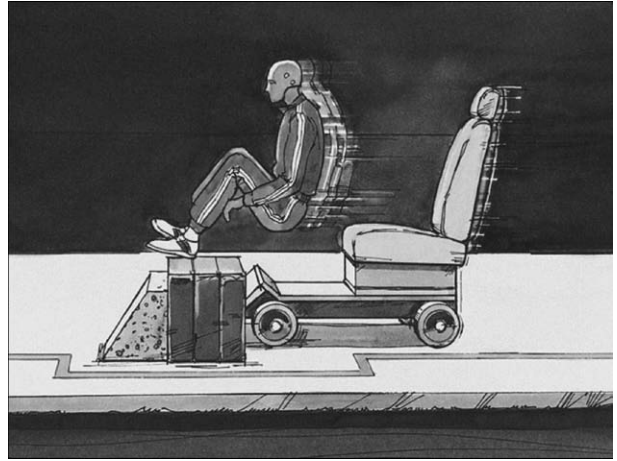

Get it up to speed. Then stop the vehicle. The rider does not stop.



The person keeps going until stopped by something. In a real vehicle, it could be the windshield...

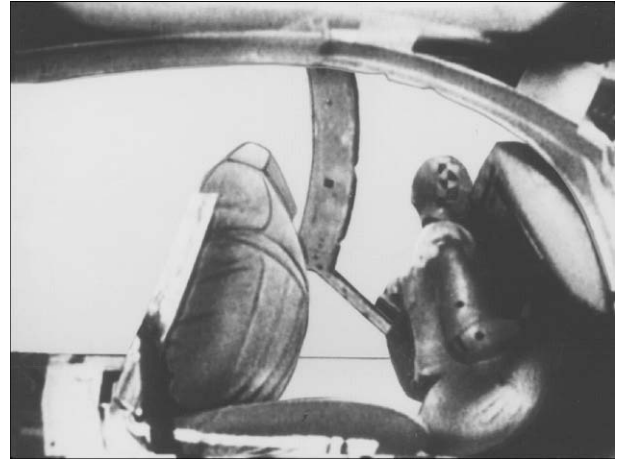

or the instrument panel...



or the safety belts!

With safety belts, you slow down as the vehicle does. You get more time to stop. You stop over more distance, and your strongest bones take the forces. That is why safety belts make such good sense.

## Questions and Answers About Safety Belts

**Q: Will I be trapped in the vehicle after a crash if I am wearing a safety belt?**

**A:** You *could* be — whether you are wearing a safety belt or not. But your chance of being conscious during and after an accident, so you *can* unbuckle and get out, is *much* greater if you are belted. And you can unbuckle a safety belt, even if you are upside down.

**Q: If my vehicle has airbags, why should I have to wear safety belts?**

**A:** Airbags are supplemental systems only; so they work *with* safety belts — not instead of them. Whether or not an airbag is provided, all occupants still have to buckle up to get the most protection. That is true not only in frontal collisions, but especially in side and other collisions.



**Q: If I am a good driver, and I never drive far from home, why should I wear safety belts?**

**A:** You may be an excellent driver, but if you are in a crash — even one that is not your fault — you and your passenger(s) can be hurt. Being a good driver does not protect you from things beyond your control, such as bad drivers.

Most accidents occur within 25 miles (40 km) of home. And the greatest number of serious injuries and deaths occur at speeds of less than 40 mph (65 km/h).

Safety belts are for everyone.

## How to Wear Safety Belts Properly

This section is only for people of adult size.

Be aware that there are special things to know about safety belts and children. And there are different rules for smaller children and infants. If a child will be riding in the vehicle, see *Older Children on page 2-33* or *Infants and Young Children on page 2-36*. Follow those rules for everyone's protection.

It is very important for all occupants to buckle up. Statistics show that unbelted people are hurt more often in crashes than those who are wearing safety belts.

Occupants who are not buckled up can be thrown out of the vehicle in a crash. And they can strike others in the vehicle who are wearing safety belts.

First, before you or your passenger(s) wear a safety belt, there is important information you should know.

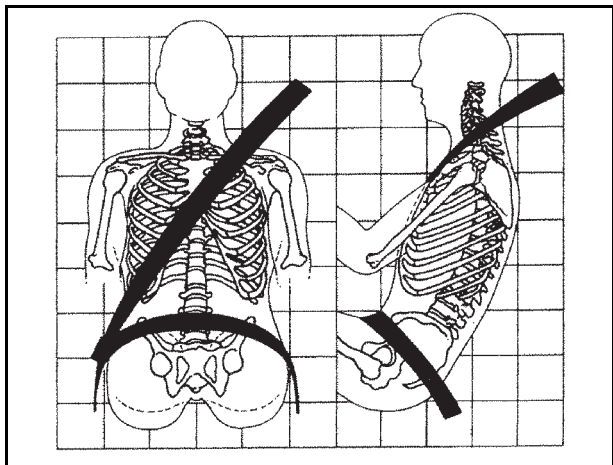

Sit up straight and always keep your feet on the floor in front of you. The lap part of the belt should be worn low and snug on the hips, just touching the thighs.

In a crash, this applies force to the strong pelvic bones and you would be less likely to slide under the lap belt. If you slid under it, the belt would apply force on your abdomen. This could cause serious or even fatal injuries. The shoulder belt should go over the shoulder and across the chest. These parts of the body are best able to take belt restraining forces.

The shoulder belt locks if there is a sudden stop or crash.

**Q: What is wrong with this?**

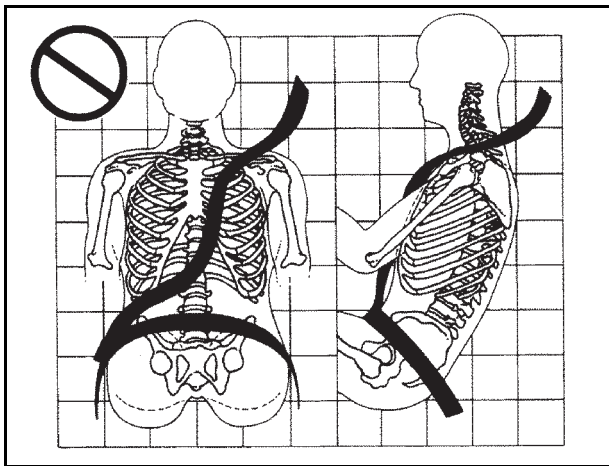

**A:** The shoulder belt is too loose. It will not give as much protection this way.

**⚠ WARNING:**

You can be seriously hurt if the shoulder belt is too loose. In a crash, you would move forward too much, which could increase injury. The shoulder belt should fit snugly against your body.

**Q: What is wrong with this?**

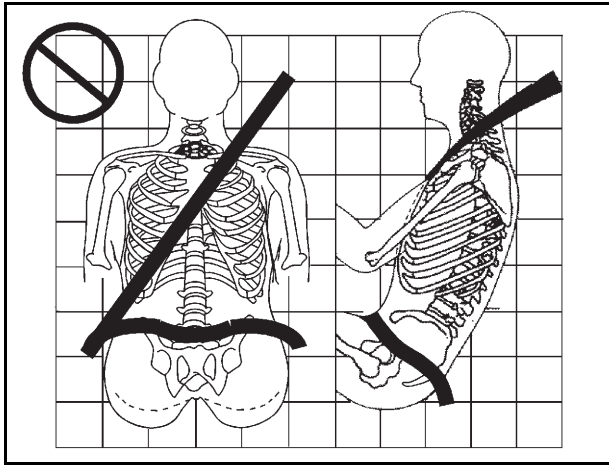

**A: The lap belt is too loose. It will not give nearly as much protection this way.**

**⚠ WARNING:**

You can be seriously hurt if the lap belt is too loose. In a crash, you could slide under the lap belt and apply force on your abdomen. This could cause serious or even fatal injuries. The lap belt should be worn low and snug on the hips, just touching the thighs.

**Q: What is wrong with this?**

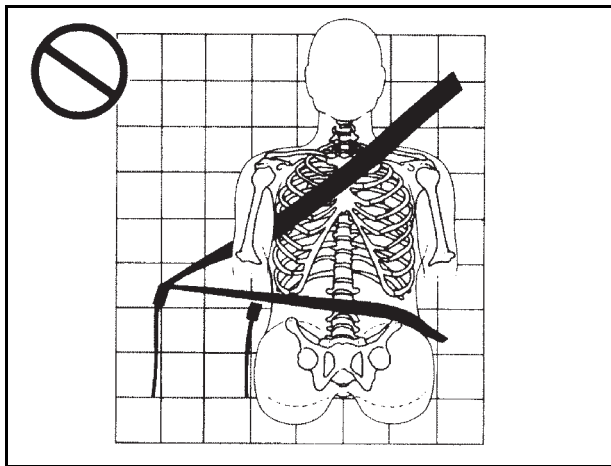

**A: The belt is buckled in the wrong buckle.**

**⚠ WARNING:**

You can be seriously injured if the belt is buckled in the wrong place like this. In a crash, the belt would go up over your abdomen. The belt forces would be there, not on the pelvic bones. This could cause serious internal injuries. Always buckle the belt into the buckle nearest you.

**Q: What is wrong with this?**

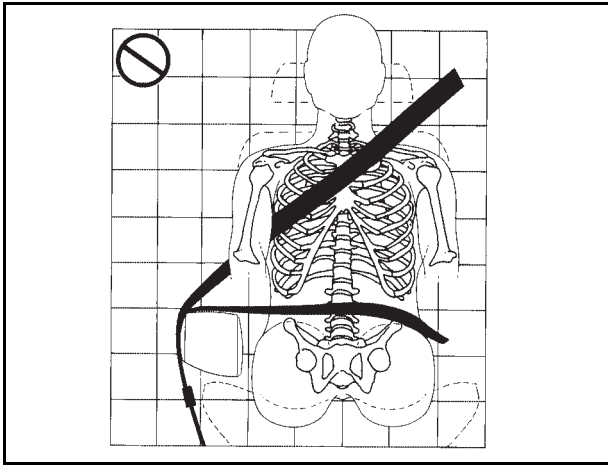

**A: The belt is over an armrest.**

**⚠ WARNING:**

You can be seriously injured if the belt goes over an armrest like this. The belt would be much too high. In a crash, you can slide under the belt. The belt force would then be applied on the abdomen, not on the pelvic bones, and that could cause serious or fatal injuries. Be sure the belt goes under the armrests.

**Q: What is wrong with this?**

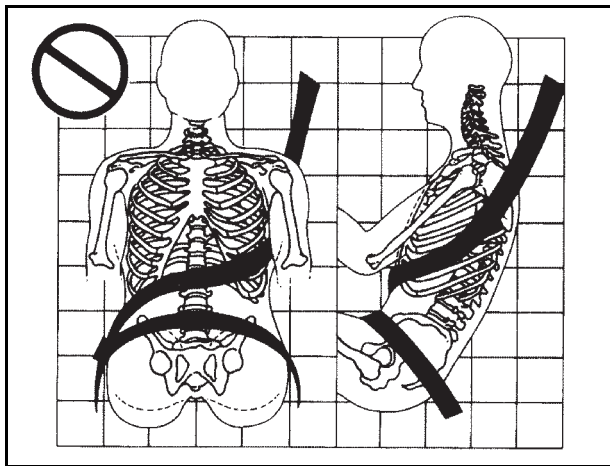

**A:** The shoulder belt is worn under the arm. It should be worn over the shoulder at all times.

**⚠ WARNING:**

You can be seriously injured if you wear the shoulder belt under your arm. In a crash, your body would move too far forward, which would increase the chance of head and neck injury. Also, the belt would apply too much force to the ribs, which are not as strong as shoulder bones. You could also severely injure internal organs like your liver or spleen. The shoulder belt should go over the shoulder and across the chest.

**Q: What is wrong with this?**

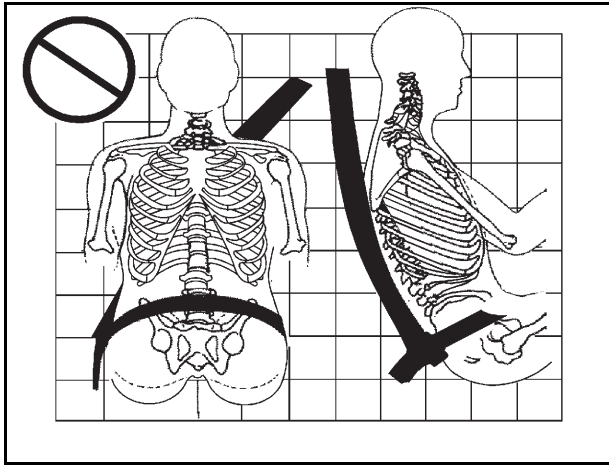

**A: The belt is behind the body.**

**⚠ WARNING:**

You can be seriously injured by not wearing the lap-shoulder belt properly. In a crash, you would not be restrained by the shoulder belt. Your body could move too far forward increasing the chance of head and neck injury. You might also slide under the lap belt. The belt force would then be applied right on the abdomen. That could cause serious or fatal injuries. The shoulder belt should go over the shoulder and across the chest.



Q: What is wrong with this?

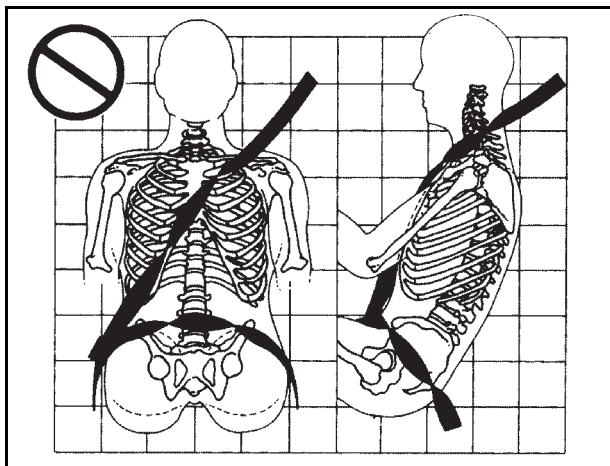

A: The belt is twisted across the body.

**⚠ WARNING:**

You can be seriously injured by a twisted belt. In a crash, you would not have the full width of the belt to spread impact forces. If a belt is twisted, make it straight so it can work properly, or ask your dealer to fix it.

## Lap-Shoulder Belt

All seating positions in the vehicle have a lap-shoulder except for the center front passenger position (if equipped), which has a lap belt. See *Lap Belt on page 2-32* for more information.

The following instructions explain how to wear a lap-shoulder belt properly.

1. Adjust the seat, if the seat is adjustable, so you can sit up straight. To see how, see “Seats” in the Index.
2. Pick up the latch plate and pull the belt across you. Do not let it get twisted.

The lap-shoulder belt may lock if you pull the belt across you very quickly. If this happens, let the belt go back slightly to unlock it. Then pull the belt across you more slowly.

If the shoulder portion of a passenger belt is pulled out all the way, the child restraint locking feature may be engaged. If this happens, just let the belt go back all the way and start again.

Engaging the child restraint locking feature in the right front seating position may affect the passenger sensing system. See *Passenger Sensing System on page 2-64* for more information.

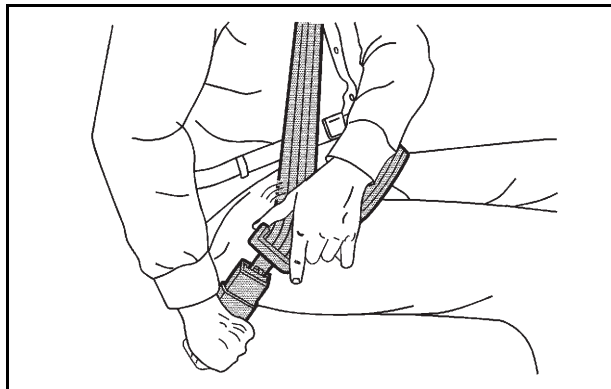

3. Push the latch plate into the buckle until it clicks. If the latch plate will not go fully into the buckle, check if the correct buckle is being used. Pull up on the latch plate to make sure it is secure. If the belt is not long enough, see *Safety Belt Extender on page 2-33*. Position the release button on the buckle so that the safety belt could be quickly unbuckled if necessary.

4. If equipped with a shoulder belt height adjuster, move it to the height that is right for you. See “Shoulder Belt Height Adjuster” later in this section for instructions on use and important safety information.

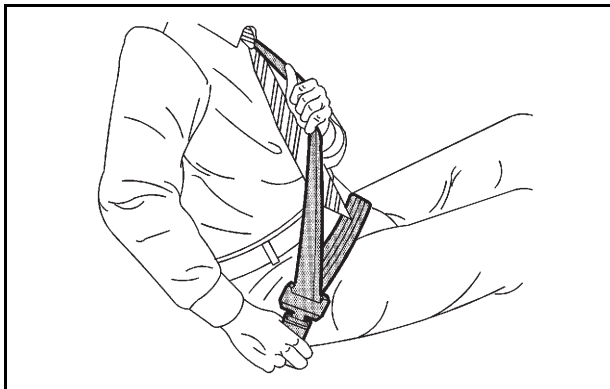

5. To make the lap part tight, pull up on the shoulder belt.

It may be necessary to pull stitching on the safety belt through the latch plate to fully tighten the lap belt on smaller occupants.

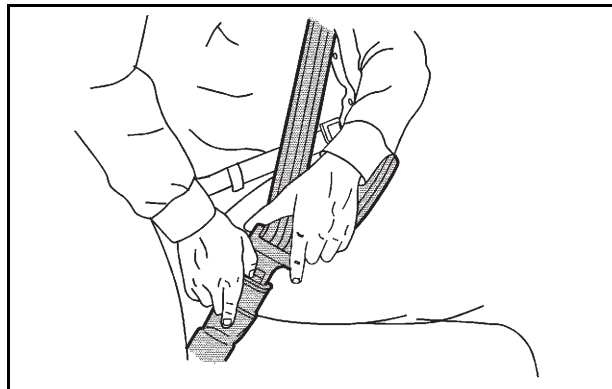

To unlatch the belt, push the button on the buckle. The belt should return to its stowed position. Slide the latch plate up the safety belt webbing when the safety belt is not in use. The latch plate should rest on the stitching near the guide loop on the side wall.

Before a door is closed, be sure the safety belt is out of the way. If a door is slammed against a safety belt, damage can occur to both the belt and the vehicle.

## Shoulder Belt Height Adjuster

The vehicle has a shoulder belt height adjuster for the driver and right front passenger seating positions.

Adjust the height so the shoulder portion of the belt is on the shoulder and not falling off of it. The belt should be close to, but not contacting, the neck. Improper shoulder belt height adjustment could reduce the effectiveness of the safety belt in a crash. See *How to Wear Safety Belts Properly* on page 2-17.

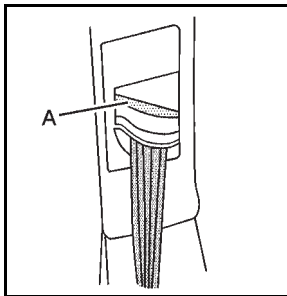

Press the release button (A) and move the height adjuster to the desired position. The adjuster can be moved up by pushing up on the shoulder belt guide.

After the adjuster is set to the desired position, try to move it down without pressing the release button to make sure it has locked into position.

## Safety Belt Pretensioners

This vehicle has safety belt pretensioners for front outboard occupants. Although the safety belt pretensioners cannot be seen, they are part of the safety belt assembly. They can help tighten the safety belts during the early stages of a moderate to severe frontal or near frontal crash if the threshold conditions for pretensioner activation are met. And, if your vehicle has side impact airbags, safety belt pretensioners can help tighten the safety belts in a side crash.

Pretensioners work only once. If the pretensioners activate in a crash, they will need to be replaced, and probably other new parts for the vehicle's safety belt system. See *Replacing Restraint System Parts After a Crash* on page 2-71.

## Rear Safety Belt Comfort Guides

This vehicle may have rear shoulder belt comfort guides for each outside passenger position in the rear seat. If not, they are available through your dealer. The guides may provide added safety belt comfort for older children who have outgrown booster seats and for some adults. When installed the comfort guide positions the shoulder belt away from the neck and head.

Here is how to install a comfort guide to the safety belt:

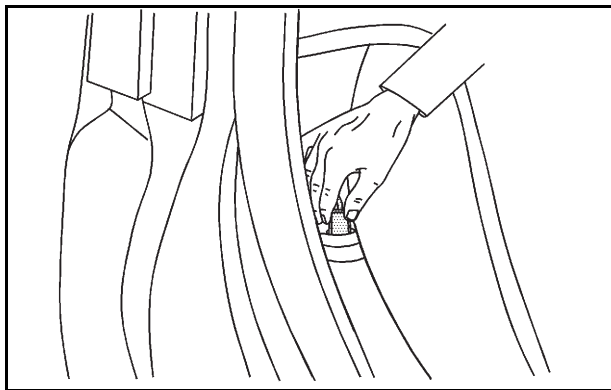

1. Remove the guide from its storage pocket on the rear side of the seatback.

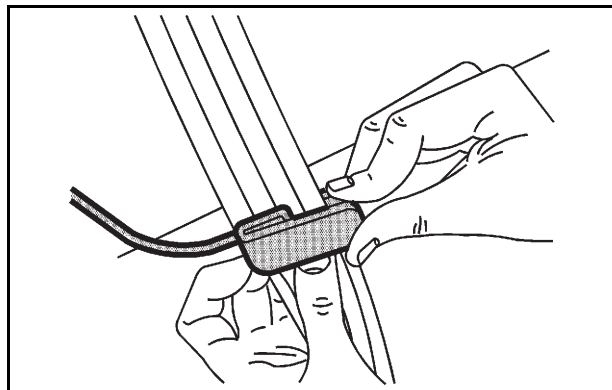

2. Place the guide over the belt, and insert the two edges of the belt into the slots of the guide.

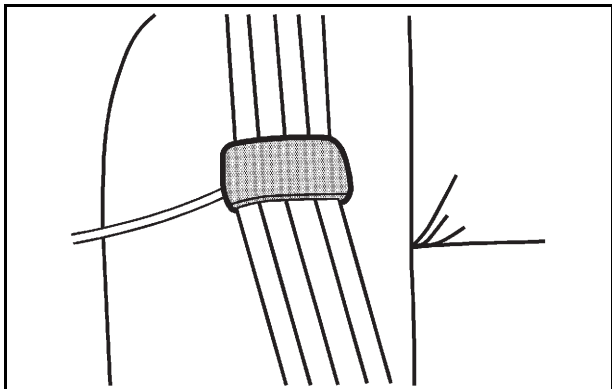

3. Be sure that the belt is not twisted and it lies flat. The elastic cord must be under the belt and the guide on top.

**⚠ WARNING:**

A safety belt that is not properly worn may not provide the protection needed in a crash. The person wearing the belt could be seriously injured. The shoulder belt should go over the shoulder and across the chest. These parts of the body are best able to take belt restraining forces.

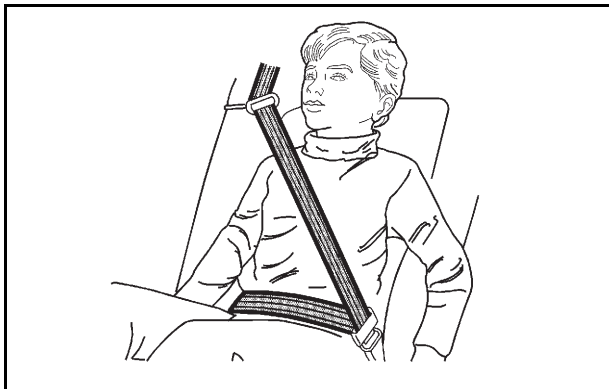

4. Buckle, position, and release the safety belt as described previously in this section. Make sure the shoulder portion of the belt is on the shoulder and not falling off of it. The belt should be close to, but not contacting, the neck.

To remove and store the comfort guide, squeeze the belt edges together so that the safety belt can be removed from the guide. Slide the guide into its storage pocket on the side of the seatback.

## Safety Belt Use During Pregnancy

Safety belts work for everyone, including pregnant women. Like all occupants, they are more likely to be seriously injured if they do not wear safety belts.

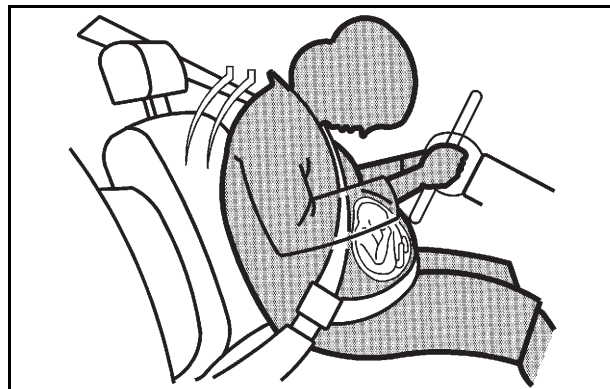

A pregnant woman should wear a lap-shoulder belt, and the lap portion should be worn as low as possible, below the rounding, throughout the pregnancy.

The best way to protect the fetus is to protect the mother. When a safety belt is worn properly, it is more likely that the fetus will not be hurt in a crash. For pregnant women, as for anyone, the key to making safety belts effective is wearing them properly.

## Lap Belt

This part is only for the lap belt. To learn how to wear a lap-shoulder belt, see *Lap-Shoulder Belt* on page 2-26.

The vehicle may have a center seating position. When you sit in the center front seating position, you have a lap safety belt, which has no retractor.

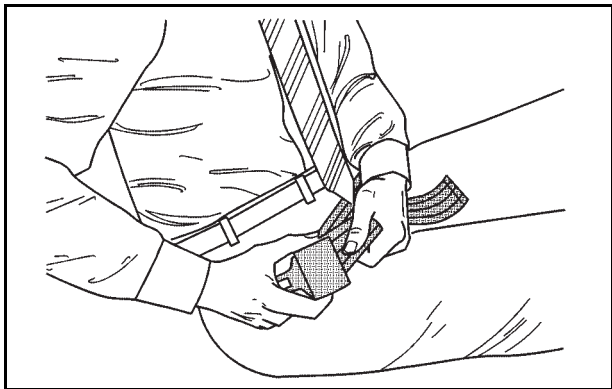

To make the belt longer, tilt the latch plate and pull it along the belt.

Buckle, position and release it the same way as the lap part of a lap-shoulder belt.

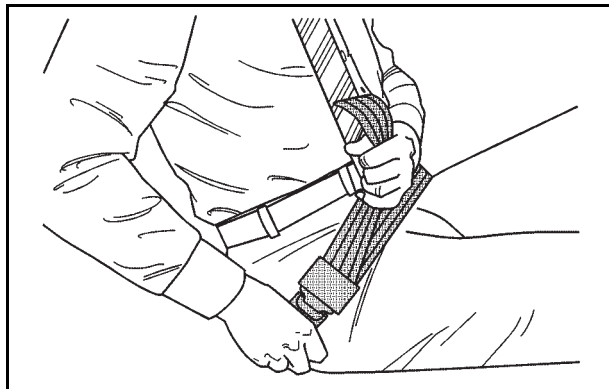

To make the belt shorter, pull its free end as shown until the belt is snug.

If the belt is not long enough, see *Safety Belt Extender* on page 2-33.

Make sure the release button on the buckle is positioned so you would be able to unbuckle the safety belt quickly if necessary.

If you find that the latch plate will not go fully into the buckle, see if you are using the correct buckle. Be sure that the latch plate clicks when inserted into the buckle.



## Safety Belt Extender

If the vehicle's safety belt will fasten around you, you should use it.

But if a safety belt is not long enough, your dealer will order you an extender. When you go in to order it, take the heaviest coat you will wear, so the extender will be long enough for you. To help avoid personal injury, do not let someone else use it, and use it only for the seat it is made to fit. The extender has been designed for adults. Never use it for securing child seats. To wear it, attach it to the regular safety belt. For more information, see the instruction sheet that comes with the extender.

## Child Restraints

### Older Children

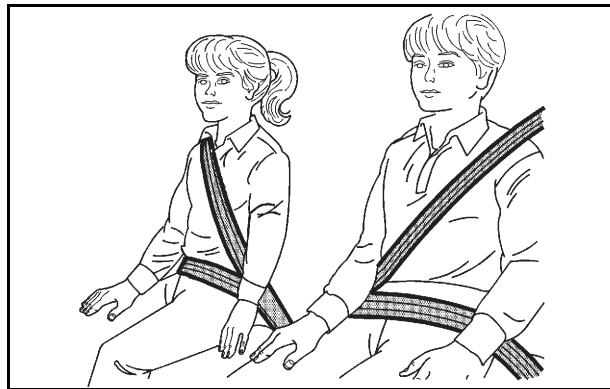

Older children who have outgrown booster seats should wear the vehicle's safety belts.

The manufacturer's instructions that come with the booster seat, state the weight and height limitations for that booster. Use a booster seat with a lap-shoulder belt until the child passes the below fit test:

- Sit all the way back on the seat. Do the knees bend at the seat edge? If yes, continue. If no, return to the booster seat.

- Buckle the lap-shoulder belt. Does the shoulder belt rest on the shoulder? If yes, continue. If no, try using the rear safety belt comfort guide. See “Rear Safety Belt Comfort Guides” under *Lap-Shoulder Belt on page 2-26* for more information. If the shoulder belt still does not rest on the shoulder, then return to the booster seat.
- Does the lap belt fit low and snug on the hips, touching the thighs? If yes, continue. If no, return to the booster seat.
- Can proper safety belt fit be maintained for length of trip? If yes, continue. If no, return to the booster seat.

If you have the choice, a child should sit in a position with a lap-shoulder belt and get the additional restraint a shoulder belt can provide.

**Q: What is the proper way to wear safety belts?**

**A:** An older child should wear a lap-shoulder belt and get the additional restraint a shoulder belt can provide. The shoulder belt should not cross the face or neck. The lap belt should fit snugly below the hips, just touching the top of the thighs. This applies belt force to the child’s pelvic bones in a crash. It should never be worn over the abdomen, which could cause severe or even fatal internal injuries in a crash.

Also see “Rear Safety Belt Comfort Guides” under *Lap-Shoulder Belt on page 2-26*.

According to accident statistics, children and infants are safer when properly restrained in a child restraint system or infant restraint system secured in a rear seating position.

In a crash, children who are not buckled up can strike other people who are buckled up, or can be thrown out of the vehicle. Older children need to use safety belts properly.

 <b>WARNING:</b>
<p>Never do this.</p> <p>Never allow two children to wear the same safety belt. The safety belt can not properly spread the impact forces. In a crash, the two children can be crushed together and seriously injured. A safety belt must be used by only one person at a time.</p>

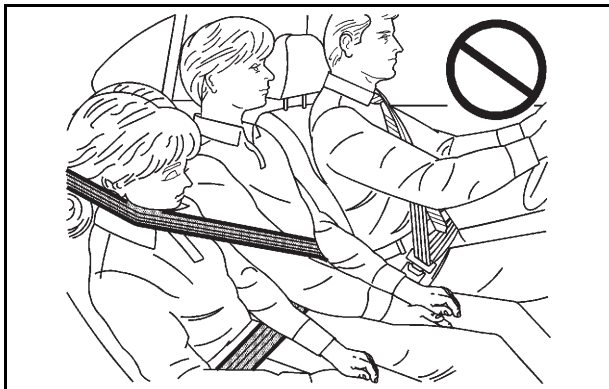

## WARNING: (Continued)

head and neck injury. The child might also slide under the lap belt. The belt force would then be applied right on the abdomen. That could cause serious or fatal injuries. The shoulder belt should go over the shoulder and across the chest.

## ⚠ WARNING:

Never do this.

Never allow a child to wear the safety belt with the shoulder belt behind their back. A child can be seriously injured by not wearing the lap-shoulder belt properly. In a crash, the child would not be restrained by the shoulder belt. The child could move too far forward increasing the chance of

(Continued)



## Infants and Young Children

Everyone in a vehicle needs protection! This includes infants and all other children. Neither the distance traveled nor the age and size of the traveler changes the need, for everyone, to use safety restraints. In fact, the law in every state in the United States and in every Canadian province says children up to some age must be restrained while in a vehicle.

### **WARNING:**

Children can be seriously injured or strangled if a shoulder belt is wrapped around their neck and the safety belt continues to tighten. Never leave children unattended in a vehicle and never allow children to play with the safety belts.

Airbags plus lap-shoulder belts offer protection for adults and older children, but not for young children and infants. Neither the vehicle's safety belt system nor its airbag system is designed for them. Every time infants and young children ride in vehicles, they should have the protection provided by appropriate child restraints.

Children who are not restrained properly can strike other people, or can be thrown out of the vehicle.

### **WARNING:**

Never do this.

Never hold an infant or a child while riding in a vehicle. Due to crash forces, an infant or a child will become so heavy it is not possible to hold it during a crash. For example, in a crash at only 40 km/h (25 mph), a 5.5 kg (12 lb) infant will suddenly become a 110 kg (240 lb) force on a person's arms. An infant should be secured in an appropriate restraint.

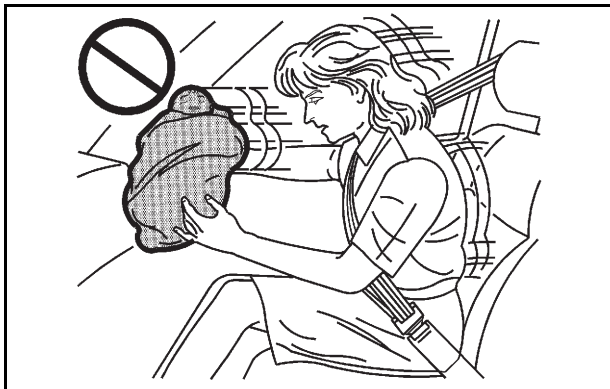

**⚠ WARNING:**

Never do this.

Children who are up against, or very close to, any airbag when it inflates can be seriously injured or killed. Never put a rear-facing child restraint in the right front seat. Secure a rear-facing child restraint in a rear seat. It is also better to secure a forward-facing child restraint in a rear seat.

(Continued)

**WARNING: (Continued)**

If you must secure a forward-facing child restraint in the right front seat, always move the front passenger seat as far back as it will go.



**Q: What are the different types of add-on child restraints?**

**A:** Add-on child restraints, which are purchased by the vehicle's owner, are available in four basic types. Selection of a particular restraint should take into consideration not only the child's weight, height, and age but also whether or not the restraint will be compatible with the motor vehicle in which it will be used.

For most basic types of child restraints, there are many different models available. When purchasing a child restraint, be sure it is designed to be used in a motor vehicle. If it is, the restraint will have a label saying that it meets federal motor vehicle safety standards.

The restraint manufacturer's instructions that come with the restraint state the weight and height limitations for a particular child restraint. In addition, there are many kinds of restraints available for children with special needs.

 **WARNING:**

To reduce the risk of neck and head injury during a crash, infants need complete support. This is because an infant's neck is not fully developed

(Continued)

**WARNING: (Continued)**

and its head weighs so much compared with the rest of its body. In a crash, an infant in a rear-facing child restraint settles into the restraint, so the crash forces can be distributed across the strongest part of an infant's body, the back and shoulders. Infants should always be secured in rear-facing child restraints.

 **WARNING:**

A young child's hip bones are still so small that the vehicle's regular safety belt may not remain low on the hip bones, as it should. Instead, it may settle up around the child's abdomen. In a crash, the belt would apply force on a body area that is unprotected by any bony structure. This alone could cause serious or fatal injuries. To reduce the risk of serious or fatal injuries during a crash, young children should always be secured in appropriate child restraints.

## Child Restraint Systems

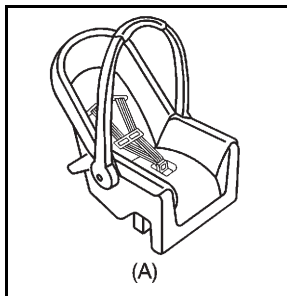

A rear-facing infant seat (A) provides restraint with the seating surface against the back of the infant.

The harness system holds the infant in place and, in a crash, acts to keep the infant positioned in the restraint.

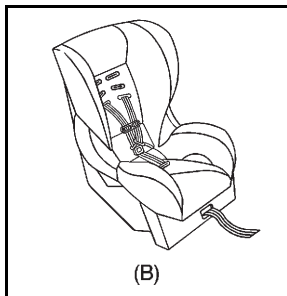

A forward-facing child seat (B) provides restraint for the child's body with the harness.

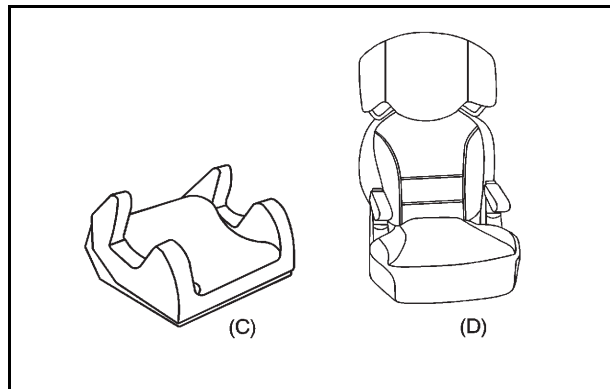

A booster seat (C-D) is a child restraint designed to improve the fit of the vehicle's safety belt system. A booster seat can also help a child to see out the window.

## Securing an Add-On Child Restraint in the Vehicle

### **WARNING:**

A child can be seriously injured or killed in a crash if the child restraint is not properly secured in the vehicle. Secure the child restraint properly in the vehicle using the vehicle safety belt or LATCH system, following the instructions that came with that child restraint and the instructions in this manual.

To help reduce the chance of injury, the child restraint must be secured in the vehicle. Child restraint systems must be secured in vehicle seats by lap belts or the lap belt portion of a lap-shoulder belt, or by the LATCH system. See *Lower Anchors and Tethers for Children (LATCH) on page 2-42* for more information. A child can be endangered in a crash if the child restraint is not properly secured in the vehicle.

When securing an add-on child restraint, refer to the instructions that come with the restraint which may be on the restraint itself or in a booklet, or both, and to this manual. The child restraint instructions are important, so if they are not available, obtain a replacement copy from the manufacturer.

Keep in mind that an unsecured child restraint can move around in a collision or sudden stop and injure people in the vehicle. Be sure to properly secure any child restraint in the vehicle — even when no child is in it.

In some areas, Certified Child Passenger Safety Technicians (CPSTs) are available to inspect and demonstrate how to correctly use and install child restraints. In the U.S., refer to the National Highway Traffic Safety Administration (NHTSA) website to locate the nearest child safety seat inspection station. For CPST availability in Canada, check with Transport Canada or the Provincial Ministry of Transportation office.

## Securing the Child Within the Child Restraint

### **WARNING:**

A child can be seriously injured or killed in a crash if the child is not properly secured in the child restraint. Secure the child properly following the instructions that came with that child restraint.



## Where to Put the Restraint

According to accident statistics, children and infants are safer when properly restrained in a child restraint system or infant restraint system secured in a rear seating position.

We recommend that children and child restraints be secured in a rear seat, including: an infant or a child riding in a rear-facing child restraint; a child riding in a forward-facing child seat; an older child riding in a booster seat; and children, who are large enough, using safety belts.

A label on your sun visor says, "Never put a rear-facing child seat in the front." This is because the risk to the rear-facing child is so great, if the airbag deploys.

### **WARNING:**

A child in a rear-facing child restraint can be seriously injured or killed if the right front passenger airbag inflates. This is because the back of the rear-facing child restraint would be very close to the inflating airbag. A child in a forward-facing child restraint can be seriously

(Continued)

### **WARNING: (Continued)**

injured or killed if the right front passenger airbag inflates and the passenger seat is in a forward position.

Even if the passenger sensing system has turned off the right front passenger frontal airbag, no system is fail-safe. No one can guarantee that an airbag will not deploy under some unusual circumstance, even though it is turned off.

Secure rear-facing child restraints in a rear seat, even if the airbag is off. If you secure a forward-facing child restraint in the right front seat, always move the front passenger seat as far back as it will go. It is better to secure the child restraint in a rear seat.

See *Passenger Sensing System* on page 2-64 for additional information.

 **WARNING:**

A child in a child restraint in the center front seat can be badly injured or killed by the frontal airbags if they inflate. Never secure a child restraint in the center front seat. It is always better to secure a child restraint in a rear seat.

Do not use child restraints in the center front seat position.

When securing a child restraint in a rear seating position, study the instructions that came with your child restraint to make sure it is compatible with this vehicle.

Child restraints and booster seats vary considerably in size, and some may fit in certain seating positions better than others. Always make sure the child restraint is properly secured.

Depending on where you place the child restraint and the size of the child restraint, you may not be able to access adjacent safety belt assemblies or LATCH anchors for additional passengers or child restraints. Adjacent seating positions should not be used if the child restraint prevents access to or interferes with the routing of the safety belt.

Wherever a child restraint is installed, be sure to secure the child restraint properly.

Keep in mind that an unsecured child restraint can move around in a collision or sudden stop and injure people in the vehicle. Be sure to properly secure any child restraint in your vehicle — even when no child is in it.

## **Lower Anchors and Tethers for Children (LATCH)**

The LATCH system holds a child restraint during driving or in a crash. This system is designed to make installation of a child restraint easier. The LATCH system uses anchors in the vehicle and attachments on the child restraint that are made for use with the LATCH system.

Make sure that a LATCH-compatible child restraint is properly installed using the anchors, or use the vehicle's safety belts to secure the restraint, following the instructions that came with that restraint, and also the instructions in this manual. When installing a child restraint with a top tether, you must also use either the lower anchors or the safety belts to properly secure the child restraint. A child restraint must never be installed using only the top tether and anchor.

In order to use the LATCH system in your vehicle, you need a child restraint that has LATCH attachments. The child restraint manufacturer will provide you with instructions on how to use the child restraint and its attachments. The following explains how to attach a child restraint with these attachments in your vehicle.

Not all vehicle seating positions or child restraints have lower anchors and attachments or top tether anchors and attachments.

## Lower Anchors

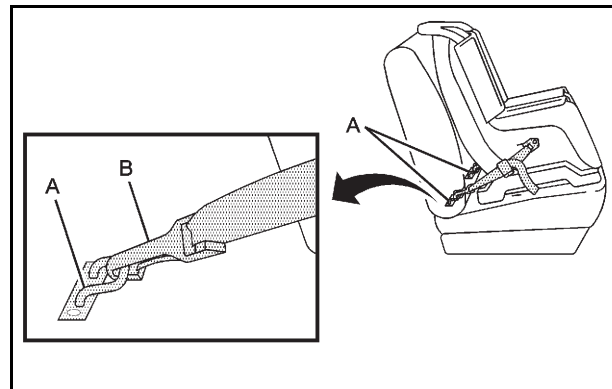

Lower anchors (A) are metal bars built into the vehicle. There are two lower anchors for each LATCH seating position that will accommodate a child restraint with lower attachments (B).

## Top Tether Anchor

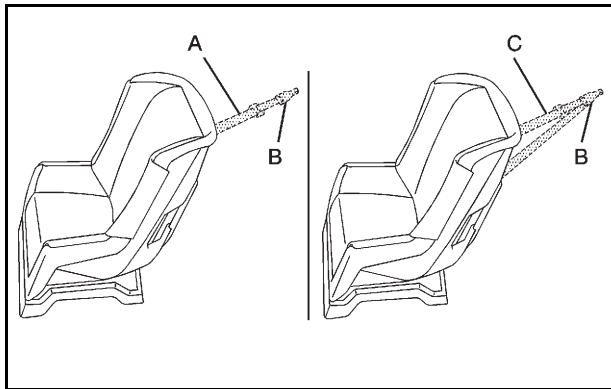

A top tether (A, C) anchors the top of the child restraint to the vehicle. A top tether anchor is built into the vehicle. The top tether attachment (B) on the child restraint connects to the top tether anchor in the vehicle in order to reduce the forward movement and rotation of the child restraint during driving or in a crash.

Your child restraint may have a single tether (A) or a dual tether (C). Either will have a single attachment (B) to secure the top tether to the anchor.

Some child restraints that have a top tether are designed for use with or without the top tether being attached. Others require the top tether always to be attached. In Canada, the law requires that forward-facing child restraints have a top tether, and that the tether be attached. Be sure to read and follow the instructions for your child restraint.

## Lower Anchor and Top Tether Anchor Locations

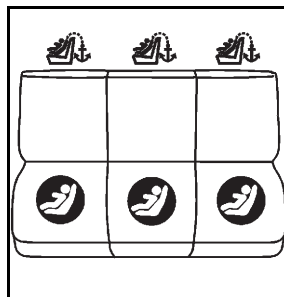

Rear Seat

 (Top Tether Anchor):  
Seating positions with top tether anchors.

 (Lower Anchor):  
Seating positions with two lower anchors.



To assist you in locating the lower anchors, each seating position with lower anchors has two labels, near the crease between the seatback and the seat cushion.



To assist you in locating the top tether anchors, the top tether anchor symbol is located on the cover.

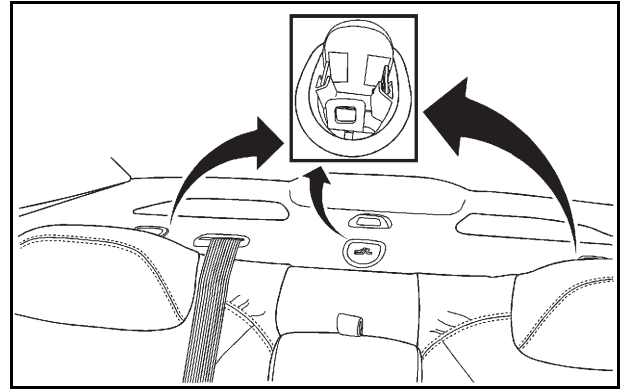

The top tether anchors are located under the covers on the rear seatback filler panel. Flip open the cover to access the anchors. Be sure to use an anchor located on the same side of the vehicle as the seating position where the child restraint will be placed.

Do not secure a child restraint in a position without a top tether anchor if a national or local law requires that the top tether be attached, or if the instructions that come with the child restraint say that the top tether must be attached.

According to accident statistics, children and infants are safer when properly restrained in a child restraint system or infant restraint system secured in a rear seating position. See *Where to Put the Restraint on page 2-41* for additional information.

## Securing a Child Restraint Designed for the LATCH System

### **WARNING:**

If a LATCH-type child restraint is not attached to anchors, the child restraint will not be able to protect the child correctly. In a crash, the child could be seriously injured or killed. Install a LATCH-type child restraint properly using the anchors, or use the vehicle safety belts to secure the restraint, following the instructions that came with the child restraint and the instructions in this manual.

### **WARNING:**

Do not attach more than one child restraint to a single anchor. Attaching more than one child restraint to a single anchor could cause the anchor or attachment to come loose or even break during a crash. A child or others could be injured. To reduce the risk of serious or fatal injuries during a crash, attach only one child restraint per anchor.

### **WARNING:**

Children can be seriously injured or strangled if a shoulder belt is wrapped around their neck and the safety belt continues to tighten. Buckle any unused safety belts behind the child restraint so children cannot reach them. Pull the shoulder belt all the way out of the retractor to set the lock, if the vehicle has one, after the child restraint has been installed.

**Notice:** Do not let the LATCH attachments rub against the vehicle's safety belts. This may damage these parts. If necessary, move buckled safety belts to avoid rubbing the LATCH attachments.

**Do not fold the empty rear seat with a safety belt buckled. This could damage the safety belt or the seat. Unbuckle and return the safety belt to its stowed position, before folding the seat.**

1. Attach and tighten the lower attachments to the lower anchors. If the child restraint does not have lower attachments or the desired seating position does not have lower anchors, secure the child restraint with the top tether and the safety belts. Refer to your child restraint manufacturer instructions and the instructions in this manual.
  - 1.1. Find the lower anchors for the desired seating position.
  - 1.2. Put the child restraint on the seat.
  - 1.3. Attach and tighten the lower attachments on the child restraint to the lower anchors.

2. If the child restraint manufacturer recommends that the top tether be attached, attach and tighten the top tether to the top tether anchor, if equipped. Refer to the child restraint instructions and the following steps:
  - 2.1. Find the top tether anchor.
  - 2.2. Flip open the top tether anchor cover to expose the anchor.
  - 2.3. Route, attach, and tighten the top tether according to your child restraint instructions and the following instructions:

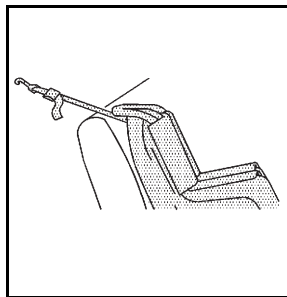

If the position you are using does not have a headrest or head restraint and you are using a single tether, route the tether over the seatback.

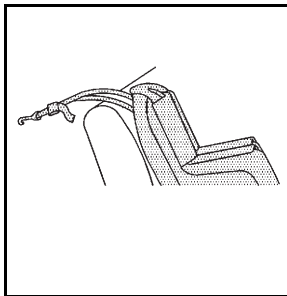

If the position you are using does not have a headrest or head restraint and you are using a dual tether, route the tether over the seatback.

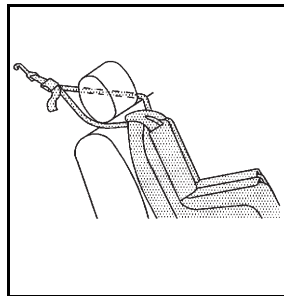

If the position you are using has a fixed headrest or head restraint and you are using a dual tether, route the tether around the headrest or head restraint.

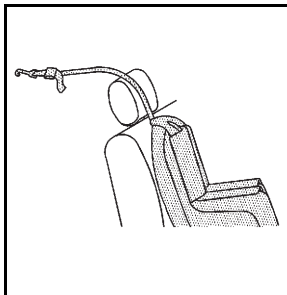

If the position you are using has a fixed headrest or head restraint and you are using a single tether, route the tether over the headrest or head restraint.

3. Before placing a child in the child restraint, make sure it is securely held in place. To check, grasp the child restraint at the LATCH path and attempt to move it side-to-side and back-and-forth. There should be no more than 2.5 cm (1 in) of movement for proper installation.



## Securing a Child Restraint in a Rear Seat Position

When securing a child restraint in a rear seating position, study the instructions that came with the child restraint to make sure it is compatible with this vehicle.

If the child restraint has the LATCH system, see *Lower Anchors and Tethers for Children (LATCH)* on page 2-42 for how and where to install the child restraint using LATCH. If a child restraint is secured in the vehicle using a safety belt and it uses a top tether, see *Lower Anchors and Tethers for Children (LATCH)* on page 2-42 for top tether anchor locations.

Do not secure a child seat in a position without a top tether anchor if a national or local law requires that the top tether be anchored, or if the instructions that come with the child restraint say that the top strap must be anchored.

In Canada, the law requires that forward-facing child restraints have a top tether, and that the tether be attached.

If the child restraint does not have the LATCH system, you will be using the safety belt to secure the child restraint in this position. Be sure to follow the instructions that came with the child restraint. Secure the child in the child restraint when and as the instructions say.

If more than one child restraint needs to be installed in the rear seat, be sure to read *Where to Put the Restraint* on page 2-41.

1. Put the child restraint on the seat.
2. Pick up the latch plate, and run the lap and shoulder portions of the vehicle's safety belt through or around the restraint. The child restraint instructions will show you how.

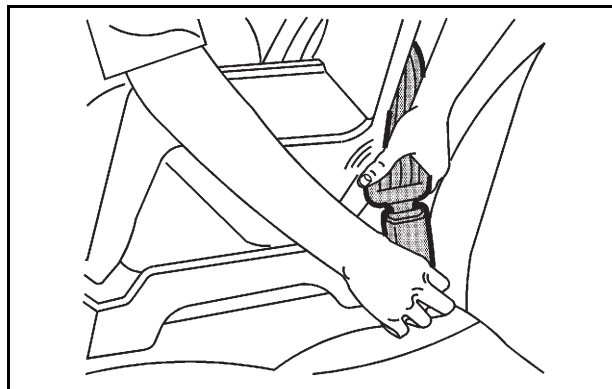

3. Push the latch plate into the buckle until it clicks. Position the release button on the buckle so that the safety belt could be quickly unbuckled if necessary.

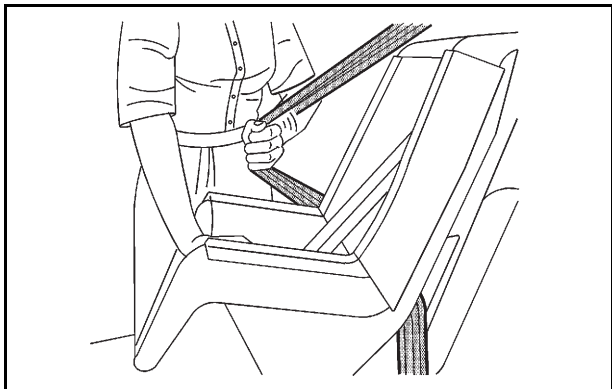

4. Pull the shoulder belt all the way out of the retractor to set the lock. When the retractor lock is set, the belt can be tightened but not pulled out of the retractor.

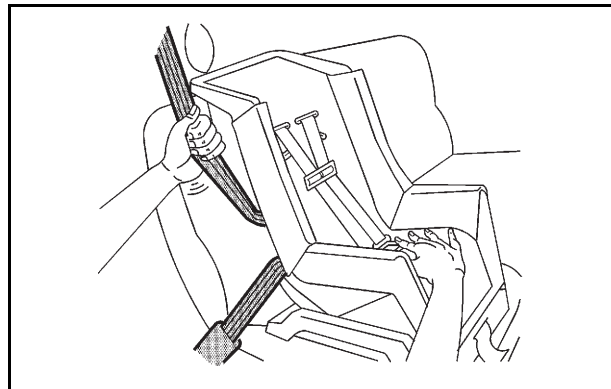

5. To tighten the belt, push down on the child restraint, pull the shoulder portion of the belt to tighten the lap portion of the belt, and feed the shoulder belt back into the retractor. When installing a forward-facing child restraint, it may be helpful to use your knee to push down on the child restraint as you tighten the belt.

Try to pull the belt out of the retractor to make sure the retractor is locked. If the retractor is not locked, repeat Steps 4 and 5.

6. If the child restraint has a top tether, follow the child restraint manufacturer's instructions regarding the use of the top tether. See *Lower Anchors and Tethers for Children (LATCH)* on page 2-42 for more information.
7. Before placing a child in the child restraint, make sure it is securely held in place. To check, grasp the child restraint at the safety belt path and attempt to move it side-to-side and back-and-forth. When the child restraint is properly installed, there should be no more than 2.5 cm (1 in) of movement.

To remove the child restraint, unbuckle the vehicle safety belt and let it return to the stowed position. If the top tether is attached to a top tether anchor, disconnect it.

## Securing a Child Restraint in the Center Front Seat Position

### **WARNING:**

A child in a child restraint in the center front seat can be badly injured or killed by the frontal airbags if they inflate. Never secure a child restraint in the center front seat. It is always better to secure a child restraint in a rear seat.

Do not use child restraints in the center front seat position.

## Securing a Child Restraint in the Right Front Seat Position

This vehicle has airbags. A rear seat is a safer place to secure a forward-facing child restraint. See *Where to Put the Restraint* on page 2-41.

In addition, the vehicle has a passenger sensing system which is designed to turn off the right front passenger frontal airbag and seat-mounted side impact airbag under certain conditions. See *Passenger Sensing System* on page 2-64 and *Passenger Airbag Status Indicator* on page 4-31 for more information, including important safety information.

A label on the sun visor says, "Never put a rear-facing child seat in the front." This is because the risk to the rear-facing child is so great, if the airbag deploys.

### **WARNING:**

A child in a rear-facing child restraint can be seriously injured or killed if the right front passenger airbag inflates. This is because the back of the rear-facing child restraint would be very close to the inflating airbag. A child in a forward-facing child restraint can be seriously injured or killed if the right front passenger airbag inflates and the passenger seat is in a forward position.

Even if the passenger sensing system has turned off the right front passenger frontal airbag, no system is fail-safe. No one can guarantee that an airbag will not deploy under some unusual circumstance, even though it is turned off.

Secure rear-facing child restraints in a rear seat, even if the airbag is off. If you secure a forward-facing child restraint in the right front seat, always move the front passenger seat as far back as it will go. It is better to secure the child restraint in a rear seat.

See *Passenger Sensing System* on page 2-64 for additional information.

If the child restraint has the LATCH system, see *Lower Anchors and Tethers for Children (LATCH)* on page 2-42 for how and where to install the child restraint using LATCH. If a child restraint is secured using a safety belt and it uses a top tether, see *Lower Anchors and Tethers for Children (LATCH)* on page 2-42 for top tether anchor locations.

Do not secure a child seat in a position without a top tether anchor if a national or local law requires that the top tether be anchored, or if the instructions that come with the child restraint say that the top strap must be anchored.

In Canada, the law requires that forward-facing child restraints have a top tether, and that the tether be attached.

You will be using the lap-shoulder belt to secure the child restraint in this position. Follow the instructions that came with the child restraint.

1. Move the seat as far back as it will go before securing the forward-facing child restraint.

When the passenger sensing system has turned off the right front passenger frontal airbag and seat-mounted side impact airbag, the off indicator on the passenger airbag status indicator should light and stay lit when you start the vehicle. See *Passenger Airbag Status Indicator* on page 4-31.

2. Put the child restraint on the seat.
3. Pick up the latch plate, and run the lap and shoulder portions of the vehicle's safety belt through or around the restraint. The child restraint instructions will show you how.

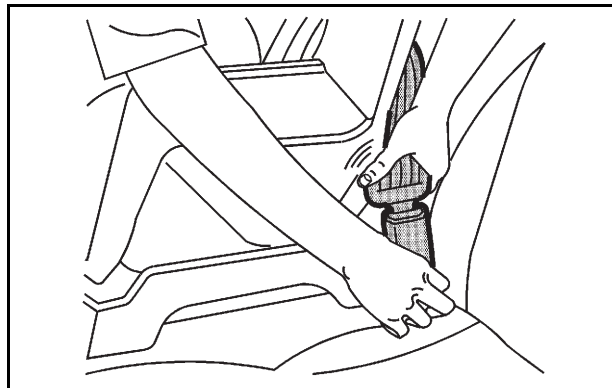

4. Push the latch plate into the buckle until it clicks. Position the release button on the buckle so that the safety belt could be quickly unbuckled if necessary.

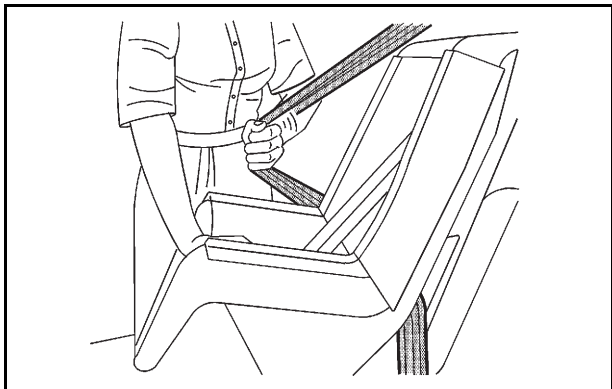

5. Pull the shoulder belt all the way out of the retractor to set the lock. When the retractor lock is set, the belt can be tightened but not pulled out of the retractor.

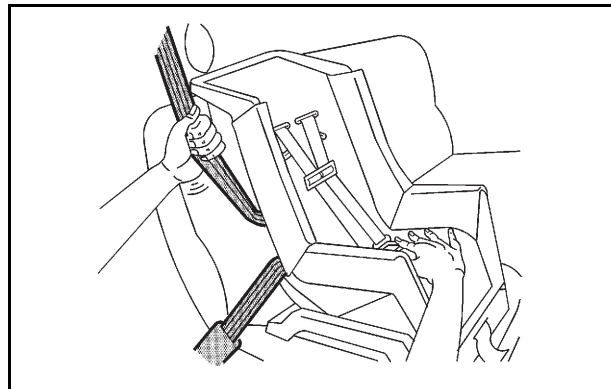

6. To tighten the belt, push down on the child restraint, pull the shoulder portion of the belt to tighten the lap portion of the belt, and feed the shoulder belt back into the retractor. When installing a forward-facing child restraint, it may be helpful to use your knee to push down on the child restraint as you tighten the belt.

Try to pull the belt out of the retractor to make sure the retractor is locked. If the retractor is not locked, repeat Steps 5 and 6.

7. Before placing a child in the child restraint, make sure it is securely held in place. To check, grasp the child restraint at the safety belt path and attempt to move it side-to-side and back-and-forth. When the child restraint is properly installed, there should be no more than 2.5 cm (1 in) of movement.

If the airbags are off, the off indicator in the passenger airbag status indicator will come on and stay on when the vehicle is started.

If a child restraint has been installed and the on indicator is lit, see “If the On Indicator is Lit for a Child Restraint ” under *Passenger Sensing System on page 2-64* for more information.

To remove the child restraint, unbuckle the vehicle safety belt and let it return to the stowed position.

## Airbag System

The vehicle has the following airbags:

- A frontal airbag for the driver.
- A frontal airbag for the right front passenger.
- A seat-mounted side impact airbag for the driver.
- A seat-mounted side impact airbag for the right front passenger.

- A roof-rail airbag for the driver and the passenger seated directly behind the driver.
- A roof-rail airbag for the right front passenger and the passenger seated directly behind the right front passenger.

All of the airbags in your vehicle will have the word AIRBAG embossed in the trim or on an attached label near the deployment opening.

For frontal airbags, the word AIRBAG will appear on the middle part of the steering wheel for the driver and on the instrument panel for the right front passenger.

With seat-mounted side impact airbags, the word AIRBAG will appear on the side of the seatback closest to the door.

With roof-rail airbags, the word AIRBAG will appear along the headliner or trim.

Airbags are designed to supplement the protection provided by safety belts. Even though today's airbags are also designed to help reduce the risk of injury from the force of an inflating bag, all airbags must inflate very quickly to do their job.

Here are the most important things to know about the airbag system:

 **WARNING:**

You can be severely injured or killed in a crash if you are not wearing your safety belt — even if you have airbags. Airbags are designed to work with safety belts, but do not replace them. Also, airbags are not designed to deploy in every crash. In some crashes safety belts are your only restraint. See *When Should an Airbag Inflate?* on page 2-60.

Wearing your safety belt during a crash helps reduce your chance of hitting things inside the vehicle or being ejected from it. Airbags are “supplemental restraints” to the safety belts. Everyone in your vehicle should wear a safety belt properly — whether or not there is an airbag for that person.

 **WARNING:**

Airbags inflate with great force, faster than the blink of an eye. Anyone who is up against, or very close to, any airbag when it inflates can be seriously injured or killed. Do not sit unnecessarily close to any airbag, as you would be if you were sitting on the edge of the seat or leaning forward. Safety belts help keep you in position before and during a crash. Always wear a safety belt, even with airbags. The driver should sit as far back as possible while still maintaining control of the vehicle.

Occupants should not lean on or sleep against the door or side windows in seating positions with seat-mounted side impact airbags and/or roof-rail airbags.



## **WARNING:**

Children who are up against, or very close to, any airbag when it inflates can be seriously injured or killed. Airbags plus lap-shoulder belts offer protection for adults and older children, but not for young children and infants. Neither the vehicle's safety belt system nor its airbag system is designed for them. Young children and infants need the protection that a child restraint system can provide. Always secure children properly in your vehicle. To read how, see *Older Children on page 2-33* or *Infants and Young Children on page 2-36*.



There is an airbag readiness light on the instrument panel cluster, which shows the airbag symbol.

The system checks the airbag electrical system for malfunctions. The light tells you if there is an electrical problem. See *Airbag Readiness Light on page 4-30* for more information.

## **Where Are the Airbags?**



The driver frontal airbag is in the middle of the steering wheel.



The right front passenger frontal airbag is in the instrument panel on the passenger side.



**Driver Side shown, Passenger Side similar**

The seat-mounted side impact airbags for the driver and right front passenger are in the side of the seatbacks closest to the door.



**Driver Side shown, Passenger Side similar**

The roof-rail airbags for the driver, right front passenger, and second row outboard passengers are in the ceiling above the side windows.

**⚠ WARNING:**

If something is between an occupant and an airbag, the airbag might not inflate properly or it might force the object into that person causing severe injury or even death. The path of an inflating airbag must be kept clear. Do not put anything between an occupant and an airbag, and do not attach or put anything on the steering wheel hub or on or near any other airbag covering.

Do not use seat accessories that block the inflation path of a seat-mounted side impact airbag.

Never secure anything to the roof of a vehicle with roof-rail airbags by routing a rope or tie down through any door or window opening. If you do, the path of an inflating roof-rail airbag will be blocked.

## When Should an Airbag Inflate?

Frontal airbags are designed to inflate in moderate to severe frontal or near-frontal crashes to help reduce the potential for severe injuries mainly to the driver's or right front passenger's head and chest. However, they are only designed to inflate if the impact exceeds a predetermined deployment threshold. Deployment thresholds are used to predict how severe a crash is likely to be in time for the airbags to inflate and help restrain the occupants.

Whether your frontal airbags will or should deploy is not based on how fast your vehicle is traveling. It depends largely on what you hit, the direction of the impact, and how quickly your vehicle slows down.

Frontal airbags may inflate at different crash speeds. For example:

- If the vehicle hits a stationary object, the airbags could inflate at a different crash speed than if the vehicle hits a moving object.
- If the vehicle hits an object that deforms, the airbags could inflate at a different crash speed than if the vehicle hits an object that does not deform.

- If the vehicle hits a narrow object (like a pole), the airbags could inflate at a different crash speed than if the vehicle hits a wide object (like a wall).
- If the vehicle goes into an object at an angle, the airbags could inflate at a different crash speed than if the vehicle goes straight into the object.

Thresholds can also vary with specific vehicle design.

Frontal airbags are not intended to inflate during vehicle rollovers, rear impacts, or in many side impacts.

Your vehicle has a seat position sensor which enables the sensing system to monitor the position of the right front passenger's seat. The passenger seat position sensor and passenger safety belt buckle switch provide information that is used to determine if the airbags should deploy at a reduced level or at full deployment.

In addition, your vehicle has a dual-stage driver airbag. Dual-stage airbags adjust the restraint according to crash severity. Your vehicle has electronic frontal sensors, which help the sensing system distinguish between a moderate frontal impact and a more severe frontal impact. For moderate frontal impacts, dual-stage airbags inflate at a level less than full deployment. For more severe frontal impacts, full deployment occurs.

Your vehicle also has a dual-depth passenger airbag that adjusts the restraint according to crash severity, seat location, and safety belt status using electronic frontal sensor(s) and other special sensors which enable the sensing system to monitor the position of the front passenger seat. The passenger airbag inflates to a reduced depth when the passenger seat is in a forward position. For more rearward front seating positions, the passenger airbag may inflate to an increased depth (a full deployment), based on safety belt status and the crash severity measured early in the event. (Always wear your safety belt, even with frontal airbags.)

Your vehicle has seat-mounted side impact and roof-rail airbags. See *Airbag System on page 2-55*. Seat-mounted side impact and roof-rail airbags are intended to inflate in moderate to severe side crashes. Seat-mounted side impact and roof-rail airbags will inflate if the crash severity is above the system's designed threshold level. The threshold level can vary with specific vehicle design.

Seat-mounted side impact and roof-rail airbags are not intended to inflate in frontal impacts, near-frontal impacts, rollovers, or rear impacts. A seat-mounted side impact airbag is intended to deploy on the side of the vehicle that is struck. Both roof-rail airbags will deploy when either side of the vehicle is struck.

In any particular crash, no one can say whether an airbag should have inflated simply because of the damage to a vehicle or because of what the repair costs were. For frontal airbags, inflation is determined by what the vehicle hits, the angle of the impact, and how quickly the vehicle slows down. For seat-mounted side impact and roof-rail airbags, deployment is determined by the location and severity of the side impact.

## **What Makes an Airbag Inflate?**

In a deployment event, the sensing system sends an electrical signal triggering a release of gas from the inflator. Gas from the inflator fills the airbag causing the bag to break out of the cover and deploy. The inflator, the airbag, and related hardware are all part of the airbag module.

Frontal airbag modules are located inside the steering wheel and instrument panel. For vehicles with seat-mounted side impact airbags, there are airbag modules in the side of the front seatbacks closest to the door. For vehicles with roof-rail airbags, there are airbag modules in the ceiling of the vehicle, near the side windows that have occupant seating positions.

## How Does an Airbag Restrain?

In moderate to severe frontal or near frontal collisions, even belted occupants can contact the steering wheel or the instrument panel. In moderate to severe side collisions, even belted occupants can contact the inside of the vehicle.

Airbags supplement the protection provided by safety belts. Frontal airbags distribute the force of the impact more evenly over the occupant's upper body, stopping the occupant more gradually. Seat-mounted side impact and roof-rail airbags distribute the force of the impact more evenly over the occupant's upper body.

But airbags would not help in many types of collisions, primarily because the occupant's motion is not toward those airbags. See *When Should an Airbag Inflate?* on page 2-60 for more information.

Airbags should never be regarded as anything more than a supplement to safety belts.

## What Will You See After an Airbag Inflates?

After the frontal airbags and seat-mounted side impact airbags inflate, they quickly deflate, so quickly that some people may not even realize an airbag inflated.

Roof-rail airbags may still be at least partially inflated for some time after they deploy. Some components of the airbag module may be hot for several minutes. For location of the airbag modules, see *What Makes an Airbag Inflate?* on page 2-61.

The parts of the airbag that come into contact with you may be warm, but not too hot to touch. There may be some smoke and dust coming from the vents in the deflated airbags. Airbag inflation does not prevent the driver from seeing out of the windshield or being able to steer the vehicle, nor does it prevent people from leaving the vehicle.

### **WARNING:**

When an airbag inflates, there may be dust in the air. This dust could cause breathing problems for people with a history of asthma or other breathing trouble. To avoid this, everyone in the vehicle should get out as soon as it is safe to do so. If you have breathing problems but cannot get out of the vehicle after an airbag inflates, then get fresh air by opening a window or a door. If you experience breathing problems following an airbag deployment, you should seek medical attention.

The vehicle has a feature that may automatically unlock the doors, turn on the interior lamps and hazard warning flashers, and shut off the fuel system after the airbags inflate. You can lock the doors, turn off the interior lamps and hazard warning flashers by using the controls for those features.

 **WARNING:**

A crash severe enough to inflate the airbags may have also damaged important functions in the vehicle, such as the fuel system, brake and steering systems, etc. Even if the vehicle appears to be drivable after a moderate crash, there may be concealed damage that could make it difficult to safely operate the vehicle.

Use caution if you should attempt to restart the engine after a crash has occurred.

In many crashes severe enough to inflate the airbag, windshields are broken by vehicle deformation. Additional windshield breakage may also occur from the right front passenger airbag.

- Airbags are designed to inflate only once. After an airbag inflates, you will need some new parts for the airbag system. If you do not get them, the airbag system will not be there to help protect you in another crash. A new system will include airbag modules and possibly other parts. The service manual for your vehicle covers the need to replace other parts.
- The vehicle has a crash sensing and diagnostic module which records information after a crash. See *Vehicle Data Recording and Privacy on page 8-16* and *Event Data Recorders on page 8-16*.
- Let only qualified technicians work on the airbag systems. Improper service can mean that an airbag system will not work properly. See your dealer for service.

## Passenger Sensing System

The vehicle has a passenger sensing system for the right front passenger position. The passenger airbag status indicator will be visible on the overhead console when the vehicle is started.



United States

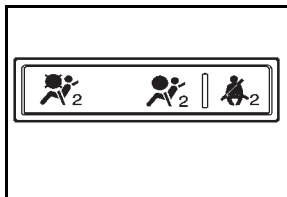

Canada

The words ON and OFF, or the symbol for on and off, are visible during the system check. If you are using remote start, if equipped, to start the vehicle from a distance, you may not see the system check. When the system check is complete, either the word ON or OFF, or the symbol for on or off, will be visible. See *Passenger Airbag Status Indicator* on page 4-31.

The passenger sensing system turns off the right front passenger frontal airbag and seat-mounted side impact airbag under certain conditions. The driver airbags and the roof-rail airbags are not affected by the passenger sensing system.

The passenger sensing system works with sensors that are part of the right front passenger seat. The sensors are designed to detect the presence of a properly-seated occupant and determine if the right front passenger frontal airbag and seat-mounted side impact airbag should be enabled (may inflate) or not.

According to accident statistics, children are safer when properly secured in a rear seat in the correct child restraint for their weight and size.

We recommend that children be secured in a rear seat, including: an infant or a child riding in a rear-facing child restraint; a child riding in a forward-facing child seat; an older child riding in a booster seat; and children, who are large enough, using safety belts.

A label on the sun visor says, "Never put a rear-facing child seat in the front." This is because the risk to the rear-facing child is so great, if the airbag deploys.



 **WARNING:**

A child in a rear-facing child restraint can be seriously injured or killed if the right front passenger airbag inflates. This is because the back of the rear-facing child restraint would be very close to the inflating airbag. A child in a forward-facing child restraint can be seriously injured or killed if the right front passenger airbag inflates and the passenger seat is in a forward position.

Even if the passenger sensing system has turned off the right front passenger frontal airbag and seat-mounted side impact airbag (if equipped), no system is fail-safe. No one can guarantee that an airbag will not deploy under some unusual circumstance, even though the airbag(s) are off.

Secure rear-facing child restraints in a rear seat, even if the airbag(s) are off. If you secure a forward-facing child restraint in the right front seat, always move the front passenger seat as far back as it will go. It is better to secure the child restraint in a rear seat.

The passenger sensing system is designed to turn off the right front passenger airbag and seat-mounted side impact airbag if:

- The right front passenger seat is unoccupied.
- The system determines that an infant is present in a rear-facing infant seat.
- The system determines that a small child is present in a child restraint.
- The system determines that a small child is present in a booster seat.
- A right front passenger takes his/her weight off of the seat for a period of time.
- The right front passenger seat is occupied by a smaller person, such as a child who has outgrown child restraints.
- Or, if there is a critical problem with the airbag system or the passenger sensing system.

When the passenger sensing system has turned off the right front passenger frontal airbag and seat-mounted side impact airbag, the off indicator will light and stay lit to remind you that the airbags are off. See *Passenger Airbag Status Indicator on page 4-31*.

The passenger sensing system is designed to turn on (may inflate) the right front passenger frontal airbag and seat-mounted side impact airbag anytime the system senses that a person of adult size is sitting properly in the right front passenger seat.

When the passenger sensing system has allowed the airbags to be enabled, the on indicator will light and stay lit to remind you that the airbags are active.

For some children who have outgrown child restraints and for very small adults, the passenger sensing system may or may not turn off the right front passenger frontal airbag and seat-mounted side impact airbag, depending upon the person's seating posture and body build. Everyone in the vehicle who has outgrown child restraints should wear a safety belt properly — whether or not there is an airbag for that person.

 **WARNING:**

If the airbag readiness light ever comes on and stays on, it means that something may be wrong with the airbag system. To help avoid injury to yourself or others, have the vehicle serviced right away. See *Airbag Readiness Light* on page 4-30 for more information, including important safety information.

## If the On Indicator is Lit for a Child Restraint

If a child restraint has been installed and the on indicator is lit:

1. Turn the vehicle off.
2. Remove the child restraint from the vehicle.
3. Remove any additional items from the seat such as blankets, cushions, seat covers, seat heaters, or seat massagers.
4. Reinstall the child restraint following the directions provided by the child restraint manufacturer and refer to *Securing a Child Restraint in the Right Front Seat Position* on page 2-52.
5. If, after reinstalling the child restraint and restarting the vehicle, the on indicator is still lit, turn the vehicle off. Then slightly recline the vehicle seatback and adjust the seat cushion, if adjustable, to make sure that the vehicle seatback is not pushing the child restraint into the seat cushion.

Also make sure the child restraint is not trapped under the vehicle head restraint. If this happens, adjust the head restraint. See *Head Restraints* on page 2-2.

6. Restart the vehicle.

If the on indicator is still lit, secure the child in the child restraint in a rear seat position in the vehicle, and check with your dealer.

## If the Off Indicator is Lit for an Adult-Size Occupant



If a person of adult-size is sitting in the right front passenger seat, but the off indicator is lit, it could be because that person is not sitting properly in the seat.

If this happens, use the following steps to allow the system to detect that person and enable the right front passenger frontal airbag and seat-mounted side impact airbag:

1. Turn the vehicle off.
2. Remove any additional material from the seat, such as blankets, cushions, seat covers, seat heaters, or seat massagers.
3. Place the seatback in the fully upright position.
4. Have the person sit upright in the seat, centered on the seat cushion, with legs comfortably extended.
5. Restart the vehicle and have the person remain in this position for two to three minutes after the on indicator is lit.

## Additional Factors Affecting System Operation

Safety belts help keep the passenger in position on the seat during vehicle maneuvers and braking, which helps the passenger sensing system maintain the passenger airbag status. See “Safety Belts” and “Child Restraints” in the Index for additional information about the importance of proper restraint use.

A thick layer of additional material, such as a blanket or cushion, or aftermarket equipment such as seat covers, seat heaters, and seat massagers can affect how well the passenger sensing system operates. We recommend that you not use seat covers or other aftermarket equipment except when approved by GM for your specific vehicle. See *Adding Equipment to Your Airbag-Equipped Vehicle* on page 2-69 for more information about modifications that can affect how the system operates.

 **WARNING:**

Stowing of articles under the passenger seat or between the passenger seat cushion and seatback may interfere with the proper operation of the passenger sensing system.

## Servicing Your Airbag-Equipped Vehicle

Airbags affect how the vehicle should be serviced. There are parts of the airbag system in several places around the vehicle. Your dealer and the service manual have information about servicing the vehicle and the airbag system. To purchase a service manual, see *Service Publications Ordering Information* on page 8-14.

 **WARNING:**

For up to 10 seconds after the ignition is turned off and the battery is disconnected, an airbag can still inflate during improper service. You can be injured if you are close to an airbag when it inflates. Avoid yellow connectors. They are probably part of the airbag system. Be sure to follow proper service procedures, and make sure the person performing work for you is qualified to do so.

## Adding Equipment to Your Airbag-Equipped Vehicle

**Q: Is there anything I might add to or change about the vehicle that could keep the airbags from working properly?**

**A:** Yes. If you add things that change your vehicle's frame, bumper system, height, front end or side sheet metal, they may keep the airbag system from working properly. Changing or moving any parts of the front seats, safety belts, the airbag sensing and diagnostic module, steering wheel, instrument panel, roof-rail airbag modules, ceiling headliner or pillar garnish trim, overhead console, front sensors, side impact sensors, or airbag wiring can affect the operation of the airbag system.

In addition, your vehicle has a passenger sensing system for the right front passenger's position, which includes sensors that are part of the passenger's seat. The passenger sensing system may not operate properly if the original seat trim is replaced with non-GM covers, upholstery or trim, or with GM covers, upholstery or trim designed for a different vehicle. Any object, such as an aftermarket seat heater or a comfort enhancing pad or device,

installed under or on top of the seat fabric, could also interfere with the operation of the passenger sensing system. This could either prevent proper deployment of the passenger airbag(s) or prevent the passenger sensing system from properly turning off the passenger airbag(s). See *Passenger Sensing System on page 2-64*.

If you have any questions about this, you should contact Customer Assistance before you modify your vehicle. The phone numbers and addresses for Customer Assistance are in Step Two of the Customer Satisfaction Procedure in this manual. See *Customer Satisfaction Procedure on page 8-2*.

**Q: Because I have a disability, I have to get my vehicle modified. How can I find out whether this will affect my airbag system?**

**A:** If you have questions, call Customer Assistance. The phone numbers and addresses for Customer Assistance are in Step Two of the Customer Satisfaction Procedure in this manual. See *Customer Satisfaction Procedure on page 8-2*.

In addition, your dealer and the service manual have information about the location of the airbag sensors, sensing and diagnostic module and airbag wiring.

# Restraint System Check

## Checking the Restraint Systems

### Safety Belts

Now and then, check that the safety belt reminder light, safety belts, buckles, latch plates, retractors, and anchorages are all working properly.

Look for any other loose or damaged safety belt system parts that might keep a safety belt system from doing its job. See your dealer to have it repaired. Torn or frayed safety belts may not protect you in a crash. They can rip apart under impact forces. If a belt is torn or frayed, get a new one right away.

Make sure the safety belt reminder light is working. See *Safety Belt Reminders* on page 4-29 for more information.

Keep safety belts clean and dry. See *Care of Safety Belts* on page 6-101.

### Airbags

The airbag system does not need regularly scheduled maintenance or replacement. Make sure the airbag readiness light is working. See *Airbag Readiness Light* on page 4-30 for more information.

**Notice:** If an airbag covering is damaged, opened, or broken, the airbag may not work properly. Do not open or break the airbag coverings. If there are any opened or broken airbag covers, have the airbag covering and/or airbag module replaced. For the location of the airbag modules, see *What Makes an Airbag Inflate?* on page 2-61. See your dealer for service.

## Replacing Restraint System Parts After a Crash

### **WARNING:**

A crash can damage the restraint systems in your vehicle. A damaged restraint system may not properly protect the person using it, resulting in serious injury or even death in a crash. To help make sure your restraint systems are working properly after a crash, have them inspected and any necessary replacements made as soon as possible.

If the vehicle has been in a crash, do you need new safety belts or LATCH system (if equipped) parts?

After a very minor crash, nothing may be necessary. But the safety belt assemblies that were used during any crash may have been stressed or damaged. See your dealer to have the safety belt assemblies inspected or replaced.

If the vehicle has the LATCH system and it was being used during a crash, you may need new LATCH system parts.

New parts and repairs may be necessary even if the safety belt or LATCH system (if equipped), was not being used at the time of the crash.

If an airbag inflates, you will need to replace airbag system parts. See the part on the airbag system earlier in this section.

Have the safety belt pretensioners checked if the vehicle has been in a crash, if the airbag readiness light stays on after the vehicle is started, or while you are driving. See *Airbag Readiness Light on page 4-30*.





## Section 3 Features and Controls

---

<b>Keys</b> .....	3-3	<b>Starting and Operating Your Vehicle</b> .....	3-19
Remote Keyless Entry (RKE) System .....	3-4	New Vehicle Break-In .....	3-19
Remote Keyless Entry (RKE) System Operation .....	3-4	Ignition Positions .....	3-19
Remote Vehicle Start .....	3-7	Retained Accessory Power (RAP) .....	3-21
<b>Doors and Locks</b> .....	3-9	Starting the Engine .....	3-21
Door Locks .....	3-9	Engine Coolant Heater .....	3-23
Power Door Locks .....	3-9	Automatic Transmission Operation .....	3-24
Delayed Locking .....	3-10	Parking Brake .....	3-26
Programmable Automatic Door Locks .....	3-10	Shifting Into Park .....	3-27
Rear Door Security Locks .....	3-11	Shifting Out of Park .....	3-28
Lockout Protection .....	3-11	Parking Over Things That Burn .....	3-29
Trunk .....	3-12	Engine Exhaust .....	3-30
<b>Windows</b> .....	3-14	Running the Vehicle While Parked .....	3-30
Power Windows .....	3-15	<b>Mirrors</b> .....	3-31
Sun Visors .....	3-16	Automatic Dimming Rearview Mirror .....	3-31
<b>Theft-Deterrent Systems</b> .....	3-16	Compass .....	3-32
Content Theft-Deterrent .....	3-16	Outside Power Mirrors .....	3-33
PASS-Key <sup>®</sup> III+ Electronic Immobilizer .....	3-17	Outside Automatic Dimming Mirror .....	3-33
PASS-Key <sup>®</sup> III+ Electronic Immobilizer Operation .....	3-17	Park Tilt Mirrors .....	3-34
		Outside Convex Mirror .....	3-34
		Outside Heated Mirrors .....	3-34

## Section 3 Features and Controls

---

<b>Object Detection Systems</b> .....	3-35	<b>Storage Areas</b> .....	3-49
Ultrasonic Rear Parking Assist (URPA) .....	3-35	Glove Box .....	3-49
Side Blind Zone Alert (SBZA) .....	3-36	Cupholders .....	3-49
Lane Departure Warning (LDW) .....	3-40	Front Storage Area .....	3-49
<b>Universal Home Remote System</b> .....	3-42	Center Console Storage .....	3-49
Universal Home Remote System Operation		Center Flex Storage Unit .....	3-49
(With Three Round LED) .....	3-42	Floor Mats .....	3-50
		Rear Seat Armrest .....	3-51
		Convenience Net .....	3-51
		<b>Sunroof</b> .....	3-51

## Keys

### **WARNING:**

Leaving children in a vehicle with the ignition key is dangerous for many reasons. Children or others could be badly injured or even killed. They could operate the power windows or other controls or even make the vehicle move. The windows will function with the keys in the ignition and children could be seriously injured or killed if caught in the path of a closing window. Do not leave the keys in a vehicle with children.

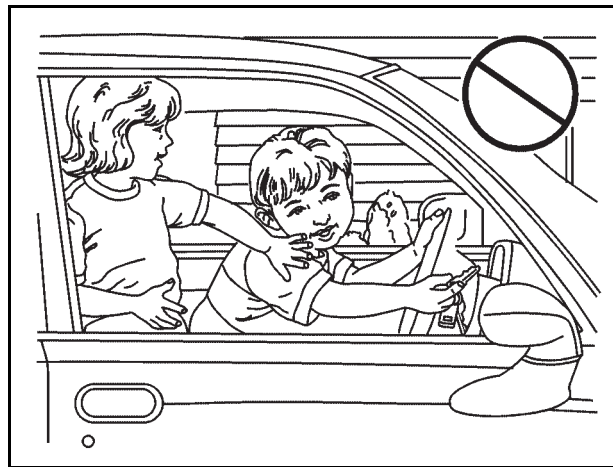

The key can be used for the ignition, the driver's door, and the glovebox lock.

The key has a bar-coded key tag that the dealer or qualified locksmith can use to make new keys. Store this information in a safe place, not in your vehicle.

See your dealer if a replacement key or additional key is needed.

**Notice:** If the keys get locked in the vehicle, it may have to be damaged to get them out. Always carry a spare key.

If you are locked out of your vehicle, contact Roadside Assistance. See *Roadside Assistance Program on page 8-7* for more information.

## Remote Keyless Entry (RKE) System

See *Radio Frequency Statement on page 8-18* for information regarding Part 15 of the Federal Communications Commission (FCC) rules and Industry Canada Standards RSS-210/220/310.

If there is a decrease in the RKE operating range, try this:

- Check the distance. The transmitter may be too far from the vehicle. Stand closer during rainy or snowy weather.
- Check the location. Other vehicles or objects may be blocking the signal. Take a few steps to the left or right, hold the transmitter higher, and try again.
- Check the transmitter's battery. See "Battery Replacement" later in this section.
- If the transmitter is still not working correctly, see your dealer or a qualified technician for service.

## Remote Keyless Entry (RKE) System Operation

The Remote Keyless Entry (RKE) transmitter functions work up to 60 m (195 feet) away from the vehicle.

There are other conditions which can affect the performance of the transmitter. See *Remote Keyless Entry (RKE) System on page 3-4*.

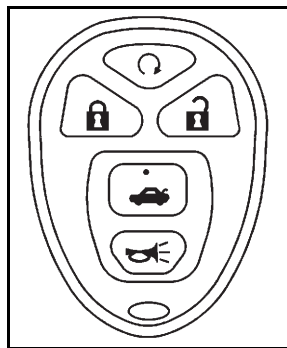



**With Remote Start Shown,  
Without Remote Start  
Similar**

**⌚ (Remote Vehicle Start):** For vehicles with this feature, press to start the engine from outside the vehicle using the RKE transmitter. See *Remote Vehicle Start on page 3-7* for additional information.

 **(Lock):** Press to lock all the doors. If enabled through the Driver Information Center (DIC), the parking lamps flash once to indicate locking has occurred.

If enabled through the DIC, the horn chirps when  is pressed again within five seconds. See *DIC Vehicle Customization on page 4-58* for additional information.



Pressing  may arm the content theft-deterrent system. See *Content Theft-Deterrent on page 3-16*.

 **(Unlock):** Press once to unlock the driver door. If  is pressed again within five seconds, all remaining doors unlock. The interior lamps come on and stay on for 20 seconds or until the ignition is turned on. If enabled through the DIC, the parking lamps flash twice to indicate unlocking has occurred. See *DIC Vehicle Customization on page 4-58*.

Pressing  on the RKE transmitter disarms the content theft-deterrent system. See *Content Theft-Deterrent on page 3-16*.

 **(Remote Trunk Release):** Press and hold for about one second to unlock the trunk. The transmission must be in P (Park).

 **(Vehicle Locator/Panic Alarm):** Press and release to locate the vehicle. The turn signal lamps flash and the horn sounds three times.

Press and hold  for more than two seconds to activate the panic alarm. The turn signal lamps flash and the horn sounds repeatedly for 30 seconds. The alarm turns off when the ignition is moved to ON/RUN or  is pressed again. The ignition must be in LOCK/OFF for the panic alarm to work.

The vehicle comes with two transmitters. Each transmitter will have a number on it, "1" or "2". These numbers correspond to the driver of the vehicle. For example, the memory seat position for driver 1 will be recalled when using the transmitter labeled "1", if enabled through the DIC. See *Memory Seat and Mirrors on page 2-7* and *DIC Vehicle Customization on page 4-58* for more information.

## Programming Transmitters to the Vehicle

Only RKE transmitters programmed to the vehicle will work. If a transmitter is lost or stolen, a replacement can be purchased and programmed through your dealer. When the replacement transmitter is programmed to the vehicle, all remaining transmitters must also be programmed. Any lost or stolen transmitters no longer work once the new transmitter is programmed. Each vehicle can have up to eight transmitters programmed to it. See your dealer for programming new transmitters.

## Battery Replacement

Replace the battery if the REPLACE BATTERY IN REMOTE KEY message appears in the DIC. See “REPLACE BATTERY IN REMOTE KEY” under *DIC Warnings and Messages on page 4-49* for additional information.

**Notice:** When replacing the battery, do not touch any of the circuitry on the transmitter. Static from your body could damage the transmitter.

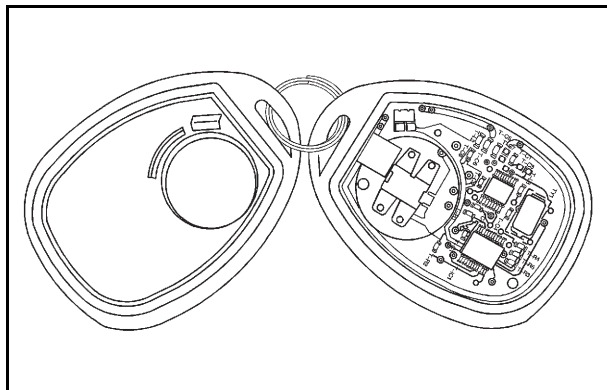

To replace the battery:

1. Separate the transmitter with a flat, thin object, such as a flat head screwdriver.
  - Carefully insert the tool into the notch located along the parting line of the transmitter. Do not insert the tool too far. Stop as soon as resistance is felt.
  - Twist the tool until the transmitter is separated.
2. Remove the old battery. Do not use a metal object.
3. Insert the new battery, positive side facing down. Replace with a CR2032 or equivalent battery.
4. Snap the transmitter back together.

## Remote Vehicle Start

Your vehicle may have a remote starting feature.

This feature allows you to start the engine from outside the vehicle. It may also start the vehicle's heating or air conditioning systems, rear window defogger, and heated seats. See *Heated Seats on page 2-4* and *Heated and Ventilated Seats on page 2-6* for additional information. When the remote start system is active, the climate control system will heat or cool the inside of the vehicle at the setting the vehicle was set to when the vehicle was last turned off. The rear window defogger will be turned on by the climate control system when it is cold outside. If the vehicle has heated seats, they may also turn on when it is cold outside. Cooled seats are not activated during a remote start. Normal operation of the system will return after the key is turned to the ON/RUN position.

Laws in some communities may restrict the use of remote starters. For example, some laws may require a person using the remote start to have the vehicle in view when doing so. Check local regulations for any requirements on remote starting of vehicles.

Do not use the remote start feature if your vehicle is low on fuel. Your vehicle may run out of fuel.

If your vehicle has the remote start feature, the RKE transmitter functions will have an increased range of operation. However, the range may be less while the vehicle is running.

There are other conditions which can affect the performance of the transmitter, see *Remote Keyless Entry (RKE) System on page 3-4* for additional information.

**Ⓚ (Remote Start):** This button will be on the RKE transmitter if you have remote start.

To start the vehicle using the remote start feature:

1. Aim the transmitter at the vehicle.
2. Press and release the transmitter's lock button, then immediately press and hold the transmitter's remote start button until the turn signal lights flash or if the vehicle's lights are not visible, press and hold the remote start button for at least four seconds.

When the vehicle starts, the parking lamps will turn on and remain on while the vehicle is running. The vehicle's doors will be locked.

3. If it is the first remote start since the vehicle has been driven, repeat these steps, while the engine is still running, to extend the engine running time by 10 minutes. Remote start can be extended one time.

After entering the vehicle during a remote start, insert and turn the key to ON/RUN to drive the vehicle.

If the vehicle is left running it will automatically shut off after 10 minutes unless a time extension has been done.

To manually shut off a remote start:

- Aim the RKE transmitter at the vehicle and press the remote start button until the parking lamps turn off.
- Turn on the hazard warning flashers.
- Turn the ignition switch on and then off.

The vehicle can be started remotely two separate times between driving sequences. The engine will run for 10 minutes after each remote start.

Or, you can extend the engine run time by another 10 minutes within the first 10 minute remote start time frame, and before the engine stops.

For example, if the lock button and then the remote start buttons are pressed again after the vehicle has been running for five minutes, 10 minutes are added, allowing the engine to run for 15 minutes.

The additional 10 minutes are considered a second remote vehicle start.

Once two remote starts, or a single remote start with one time extension have been done, the vehicle must be started with the key.

After the key is removed from the ignition, another remote start can be performed.

The vehicle cannot be started remotely if the key is in the ignition, the hood is not closed, or if there is an emission control system malfunction.

## **Remote Start Ready**

If your vehicle does not have the remote vehicle start feature, it may have the remote start ready feature. This feature allows your dealer to add the manufacturer's remote vehicle start feature.

See your dealer if you would like to add the manufacturer's remote vehicle start feature to your vehicle.



# Doors and Locks

## Door Locks

### **WARNING:**

Unlocked doors can be dangerous.

- Passengers, especially children, can easily open the doors and fall out of a moving vehicle. When a door is locked, the handle will not open it. The chance of being thrown out of the vehicle in a crash is increased if the doors are not locked. So, all passengers should wear safety belts properly and the doors should be locked whenever the vehicle is driven.
- Young children who get into unlocked vehicles may be unable to get out. A child can be overcome by extreme heat and can suffer permanent injuries or even death from heat stroke. Always lock the vehicle whenever leaving it.

(Continued)

### **WARNING: (Continued)**

- Outsiders can easily enter through an unlocked door when you slow down or stop the vehicle. Locking the doors can help prevent this from happening.

There are several ways to lock and unlock your vehicle.

From the outside, use either the key or the Remote Keyless Entry (RKE) transmitter.

From the inside, use the power door lock switches or manual lock knobs. The manual lock knobs are located at the top of the door panel near the window.

Push the manual lock knob down to lock the door. To unlock the door, pull up on the knob.

## Power Door Locks

With power door locks, the switches on the front doors can be used to lock and unlock the vehicle.

 **(Unlock):** Press to unlock the doors.

 **(Lock):** Remove the key from the ignition and press to lock the doors.

## Delayed Locking

This feature allows the driver to delay the actual locking of the doors. When the driver power door lock switch is pressed with the key removed from the ignition, and the driver door open, a chime will sound three times to signal that the delayed locking system is active. When all doors have been closed, the doors will lock automatically after several seconds. If any door is opened before this, the timer will reset itself once all the doors have been closed again.

Pressing the driver or passenger power door lock switch again or the RKE transmitter button will override this feature.

## Personal Choice Programming

The delayed locking feature can be turned on or off, using the Driver Information Center (DIC) to program this feature. See “DELAY DOOR LOCK” under *DIC Vehicle Customization on page 4-58*.

## Programmable Automatic Door Locks

Your vehicle is programmed so that, when the doors are closed, the ignition is on, and the shift lever is moved out of P (Park), all the doors will lock. The doors will unlock every time you stop the vehicle and move the shift lever into P (Park).

If someone needs to get out while your vehicle is not in P (Park), have the person use the manual lock knob or power door lock switch. When the door is closed again, it will not lock automatically. Use the manual lock knob or power door lock switch to lock the door.

If your vehicle has a Driver Information Center (DIC), you can choose various lock and unlock settings. For programming information, see *DIC Vehicle Customization on page 4-58*.

## Rear Door Security Locks

Rear door security locks prevent passengers from opening the rear doors from the inside.

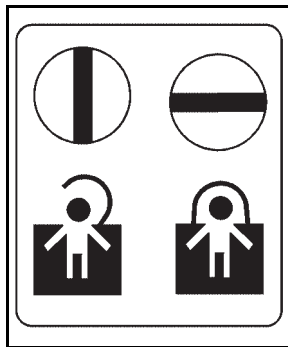

The rear door security locks are located on the inside edge of each rear door. The rear doors must be opened to access them.

To use the lock:

1. Insert the key into the security lock slot and turn it so the slot is in the horizontal position.
2. Close the door.
3. Do the same for the other rear door.

To open a rear door when the security lock is on, do the following:

1. Unlock the door using the Remote Keyless Entry (RKE) transmitter, if the vehicle has one, the power door lock switch, or by lifting the rear door manual lock.
2. Open the door from the outside.

To cancel the rear door security lock:

1. Unlock the door and open it from the outside.
2. Insert the key into the security lock slot and turn it so the slot is in the vertical position.
3. Do the same for the other rear door.

## Lockout Protection

If the key is in the ignition and the power door lock switch is used to lock the doors, all doors will lock and then the driver door will unlock. It is always recommended that the ignition key is removed from the vehicle when locking the doors.

The lockout protection feature can be overridden by holding the power door lock switch for three seconds or longer.

## Trunk

### **WARNING:**

Exhaust gases can enter the vehicle if it is driven with the liftgate, trunk/hatch open, or with any objects that pass through the seal between the body and the trunk/hatch or liftgate. Engine exhaust contains Carbon Monoxide (CO) which cannot be seen or smelled. It can cause unconsciousness and even death.

If the vehicle must be driven with the liftgate, or trunk/hatch open:

- Close all of the windows.
- Fully open the air outlets on or under the instrument panel.
- Adjust the Climate Control system to a setting that brings in only outside air and set the fan speed to the highest setting. See Climate Control System in the Index.
- If the vehicle is equipped with a power liftgate, disable the power liftgate function.

For more information about carbon monoxide, see *Engine Exhaust* on page 3-30.

## Remote Trunk Release



The remote trunk release button  is located on the instrument panel. See *Instrument Panel* on page 1-2.

Press the button to open the trunk. To use this feature, your vehicle must be in P (Park) or N (Neutral).

You can also press the remote trunk release button on the Remote Keyless Entry (RKE) transmitter to open the trunk. See *Remote Keyless Entry (RKE) System Operation* on page 3-4.

## Emergency Trunk Release Handle



**Notice:** Do not use the emergency trunk release handle as a tie-down or anchor point when securing items in the trunk as it could damage the handle. The emergency trunk release handle is only intended to aid a person trapped in a latched trunk, enabling them to open the trunk from the inside.

There is a glow-in-the-dark emergency trunk release handle located inside the trunk near the latch. This handle will glow following exposure to light. Pull the release handle to open the trunk from the inside.

## Rear Seat Pass-Through

Your vehicle has a small door in the rear seat. This door allows you to access the trunk from inside the vehicle.

The rear seat armrest must be down for the pass-through door to open. To release the pass-through door, move the release lever up. To close the door, raise it and push it until it latches.

## Windows

### **WARNING:**

Leaving children, helpless adults, or pets in a vehicle with the windows closed is dangerous. They can be overcome by the extreme heat and suffer permanent injuries or even death from heat stroke. Never leave a child, a helpless adult, or a pet alone in a vehicle, especially with the windows closed in warm or hot weather.

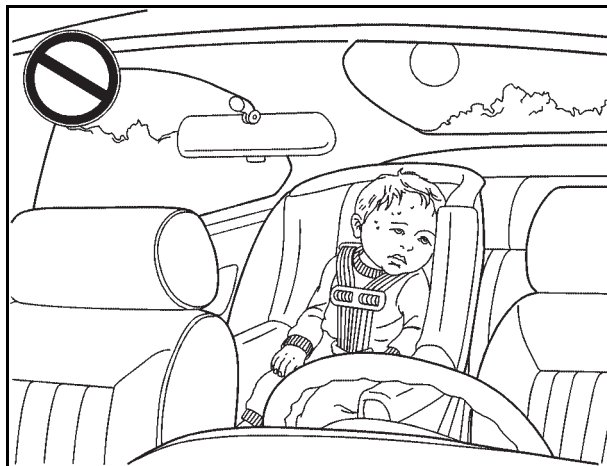

The vehicle aerodynamics are designed to improve fuel economy performance. This may result in a pulsing sound when either rear window is down and the front windows are up. To reduce the sound, open either a front window or the sunroof (if equipped).

## Power Windows

### **WARNING:**

Leaving children in a vehicle with the keys is dangerous for many reasons. Children or others could be badly injured or even killed. They could operate the power windows or other controls or even make the vehicle move. The windows will function and they could be seriously injured or killed if caught in the path of a closing window. Do not leave keys in a vehicle with children.

When there are children in the rear seat use the window lockout button to prevent unintentional operation of the windows.

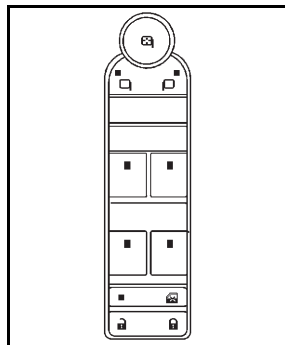

**Driver's Side shown**

The power window switches are located on the driver's door armrest. In addition, each door has a switch for its own window.

The front power window switches operate with one position for up and two positions for down movement and the rear power window switches operate with one position for up and one for down movement.

Your vehicle has Retained Accessory Power (RAP) that allows you to use the power windows once the ignition has been turned off. For more information, see *Retained Accessory Power (RAP)* on page 3-21.

## Express-Down Window

This feature is on the front windows. Press the switch to the second position to activate the express-down feature. To stop the window as it is lowering, press down briefly on the switch again.

## Window Lockout

 **(Window Lockout):** The rear window lockout button is located on the driver's door armrest near the window switches.

Press the right side of this button to disable the rear window controls. The light on the button will come on, indicating the feature is in use. The rear windows still can be raised or lowered using the driver's window switches when the lockout feature is active.

To restore power to the rear windows, press the button again. The light on the button will go out.

## Sun Visors

Pull the visor toward you, or move to the side to help reduce glare.

On vehicles with a lighted vanity mirror, lift the attached cover to use.

## Theft-Deterrent Systems

This vehicle has theft-deterrent features, however, they do not make it impossible to steal.

### Content Theft-Deterrent

Your vehicle may have the optional content theft-deterrent alarm system.

To activate the theft-deterrent system:

1. Open the door.
2. Lock the door with the power door lock switch or the Remote Keyless Entry (RKE) transmitter. If you are using the RKE transmitter, the door does not need to be open.
3. Close all doors.

Once armed, the alarm will go off if someone tries to enter the vehicle without using the RKE transmitter or a key or turns the ignition on with an incorrect key. The horn will sound and the turn signal lamps will flash for about 30 seconds.

When the alarm is armed, the trunk may be opened with the RKE transmitter. The power door lock switches are disabled and the doors remain locked. You must use your RKE transmitter or your key to unlock the doors when the system is armed.



## **Arming with the Power Lock Switch**

The alarm system will arm when you use either power lock switch to lock the doors while any door is open and the key is removed from the ignition. The alarm system will not arm if the truck is open when you use either power lock switch to lock the doors.

## **Arming with the RKE Transmitter**

The alarm system will arm when you use your RKE transmitter to lock the doors, if the key is not in the ignition.

## **Disarming with the RKE Transmitter**

The alarm system will disarm when you use your RKE transmitter to unlock the doors.

The first time a remote unlock command is received, three flashes will be seen and three horn chirps heard to indicate an alarm condition has occurred since last arming.

## **Disarming with Your Key**

The alarm system will disarm when you use your key to unlock the doors or insert your key in the ignition and turn it from the LOCK/OFF position.

## **PASS-Key<sup>®</sup> III+ Electronic Immobilizer**

See *Radio Frequency Statement on page 8-18* for information regarding Part 15 of the Federal Communications Commission (FCC) rules and Industry Canada Standards RSS-210/220/310.

## **PASS-Key<sup>®</sup> III+ Electronic Immobilizer Operation**

Your vehicle is equipped with PASS-Key<sup>®</sup> III+ (Personalized Automotive Security System) theft-deterrent system. PASS-Key<sup>®</sup> III+ is a passive theft-deterrent system.

The system is automatically armed when the key is removed from the ignition.

You do not have to manually arm or disarm the system.

The security light will come on if there is a problem with arming or disarming the theft-deterrent system.

When the PASS-Key<sup>®</sup> III+ system senses that someone is using the wrong key, it prevents the vehicle from starting. Anyone using a trial-and-error method to start the vehicle will be discouraged because of the high number of electrical key codes.

When trying to start the vehicle if the engine does not start and the security light on the instrument panel cluster comes on, there may be a problem with your theft-deterrent system. Turn the ignition off and try again.

If the engine still does not start, and the key appears to be not damaged, try another ignition key. At this time, you may also want to check the fuse, see *Fuses and Circuit Breakers on page 6-108*. If the engine still does not start with the other key, your vehicle needs service. If your vehicle does start, the first key may be faulty. See your dealer who can service the PASS-Key® III+ to have a new key made. In an emergency, contact Roadside Assistance. See *Roadside Assistance Program on page 8-7*.

It is possible for the PASS-Key® III+ decoder to “learn” the transponder value of a new or replacement key. Up to 10 keys may be programmed for the vehicle. The following procedure is for programming additional keys only. If all the currently programmed keys are lost or do not operate, you must see your dealer or a locksmith who can service PASS-Key® III+ to have keys made and programmed to the system.

See your dealer or a locksmith who can service PASS-Key® III+ to get a new key blank that is cut exactly as the ignition key that operates the system.

To program the new key:

1. Verify that the new key has a ⊕ stamped on it.
2. Insert the already programmed key in the ignition and start the engine. If the engine will not start, see your dealer for service.
3. After the engine has started, turn the key to LOCK/OFF, and remove the key.
4. Insert the key to be programmed and turn it to the ON/RUN position within five seconds of the original key being turned to the LOCK/OFF position.  
The security light will turn off once the key has been programmed.
5. Repeat Steps 1 through 4 if additional keys are to be programmed.

If you lose or damage your PASS-Key® III+ key, see your dealer or a locksmith who can service PASS-Key® III+ to have a new key made.

Do not leave the key or device that disarms or deactivates the theft deterrent system in the vehicle.

# Starting and Operating Your Vehicle

## New Vehicle Break-In

**Notice:** The vehicle does not need an elaborate break-in. But it will perform better in the long run if you follow these guidelines:

- Do not drive at any one constant speed, fast or slow, for the first 500 miles (805 km). Do not make full-throttle starts. Avoid downshifting to brake or slow the vehicle.
- Avoid making hard stops for the first 200 miles (322 km) or so. During this time the new brake linings are not yet broken in. Hard stops with new linings can mean premature wear and earlier replacement. Follow this breaking-in guideline every time you get new brake linings.
- Do not tow a trailer during break-in. See *Towing a Trailer on page 5-25* for the trailer towing capabilities of your vehicle and more information.

Following break-in, engine speed and load can be gradually increased.

## Ignition Positions

The ignition has four different positions:

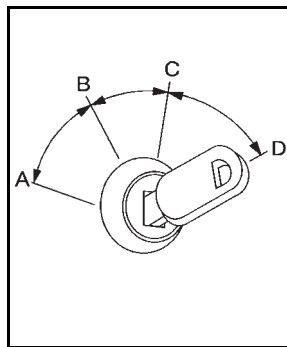

In order to shift out of P (Park), ignition must be in the ON/RUN and the regular brake pedal must be applied.

**Notice:** Using a tool to force the key to turn in the ignition could cause damage to the switch or break the key. Use the correct key, make sure it is all the way in, and turn it only with your hand. If the key cannot be turned by hand, see your dealer.

**A (STOPPING THE ENGINE/LOCK/OFF):** When the vehicle is stopped, turn the ignition switch to LOCK/OFF to turn the engine off. Retained Accessory Power (RAP) will remain active. See *Retained Accessory Power (RAP) on page 3-21*.

This position locks the ignition. It also locks the transmission and steering column. This is the only position in which the ignition key can be inserted or removed.

Do not turn the engine off when the vehicle is moving. This will cause a loss of power assist in the brake and steering systems and disable the airbags.

In an emergency:

1. Brake using a firm and steady pressure. Do not pump the brakes repeatedly. This may deplete power assist, requiring increased brake pedal force.
2. Shift the vehicle to N (Neutral). This can be done while the vehicle is moving. After shifting to N (Neutral), firmly apply the brakes and steer the vehicle to a safe location.
3. Come to a complete stop, shift to P (Park), and turn the ignition to LOCK/OFF. On vehicles with an automatic transmission, the shift lever must be in P (Park) to turn the ignition switch to the LOCK/OFF position.
4. Set the parking brake. See *Parking Brake on page 3-26*.

The steering can bind with the wheels turned off center. If this happens, move the steering wheel from right to left while turning the key to ACC/ACCESSORY. If this doesn't work, then the vehicle needs service.

**B (ACC/ACCESSORY):** This position lets the radio and windshield wipers operate while the engine is off. To use ACC/ACCESSORY, turn the key clockwise.

**C (ON/RUN):** This position can be used to operate electrical accessories and to display some of the warning and indicator lights. The switch stays in this position when the engine is running.

If you leave the key in the ACC/ACCESSORY or ON/RUN position with the engine off, the battery could be drained. You may not be able to start the vehicle if the battery is allowed to drain for an extended period of time.

**D (START):** This position starts the engine. When the engine starts, release the key. The ignition switch returns to ON/RUN for driving.

A warning tone will sound and the Driver Information Center (DIC) will display DRIVER DOOR OPEN when the driver door is opened if the ignition is in LOCK/OFF, ACC/ACCESSORY and the key is in the ignition. See *DIC Warnings and Messages on page 4-49* for more information.

## Retained Accessory Power (RAP)

The following accessories can be used for up to 10 minutes after the engine is turned off.

- Audio System
- Audio Steering Wheel (if equipped)
- Clock
- Power Windows
- Sunroof (if equipped)

Power to these accessories works up to 10 minutes or until the driver door is opened.

The instrument panel cluster lights stay on for a few seconds, then will go out. Once the driver door is opened, the power shuts off to these accessories. The vehicle has a feature designed to protect the battery against drainage. For more information see *Inadvertent Power Battery Saver on page 4-14* and *Electric Power Management on page 4-14*.

## Starting the Engine

Move the shift lever to P (Park) or N (Neutral). The engine will not start in any other position. To restart the engine when the vehicle is already moving, use N (Neutral) only.

**Notice:** Do not try to shift to P (Park) if the vehicle is moving. If you do, you could damage the transmission. Shift to P (Park) only when the vehicle is stopped.

## Starting Procedure

1. With your foot off the accelerator pedal, turn the ignition to START. When the engine starts, let go of the key. The idle speed will slow down as the engine warms. Do not race the engine immediately after starting it. Operate the engine and transmission gently to allow the oil to warm up and lubricate all moving parts.

The vehicle has a Computer-Controlled Cranking System. This feature assists in starting the engine and protects components. If the ignition key is turned to the START position, and then released when the engine begins cranking, the engine will continue cranking for a few seconds or until the vehicle starts. If the engine does not start and the key is held in START, cranking will be stopped after 15 seconds to prevent cranking motor damage. To prevent gear damage, this system also prevents cranking if the engine is already running.

Engine cranking can be stopped by turning the ignition switch to the ACC/ACCESSORY or LOCK/OFF position.

**Notice:** Cranking the engine for long periods of time, by returning the key to the START position immediately after cranking has ended, can overheat and damage the cranking motor, and drain the battery. Wait at least 15 seconds between each try, to let the cranking motor cool down.

2. If the engine does not start after 5-10 seconds, especially in very cold weather (below 0°F or -18°C), it could be flooded with too much gasoline. Try pushing the accelerator pedal all the way to the floor and holding it there as you hold the key in START for up to a maximum of 15 seconds. Wait at least 15 seconds between each try, to allow the cranking motor to cool down.

When the engine starts, let go of the key and accelerator. If the vehicle starts briefly but then stops again, repeat these steps. This clears the extra gasoline from the engine. Do not race the engine immediately after starting it. Operate the engine and transmission gently until the oil warms up and lubricates all moving parts.

**Notice:** The engine is designed to work with the electronics in the vehicle. If you add electrical parts or accessories, you could change the way the engine operates. Before adding electrical equipment, check with your dealer. If you do not, the engine might not perform properly. Any resulting damage would not be covered by the vehicle warranty.

## Engine Coolant Heater

The engine coolant heater can provide easier starting and better fuel economy during engine warm-up in cold weather conditions at or below 0°F (-18°C). Vehicles with an engine coolant heater should be plugged in at least four hours before starting.

### To Use the Engine Coolant Heater

1. Turn off the engine.
2. Open the hood and unwrap the electrical cord.

On vehicles with the 3.9L V6 engine, the coolant heater cord is located on the driver side of the vehicle, near the strut tower. On vehicles with the 4.6L V8 engine, the cord is located on the driver side of the vehicle on the right side of the engine air cleaner. It is between the engine cover and the engine air cleaner.

### **WARNING:**

Plugging the cord into an ungrounded outlet could cause an electrical shock. Also, the wrong kind of extension cord could overheat and cause a fire. You could be seriously injured. Plug the cord into a properly grounded three-prong 110-volt AC outlet. If the cord will not reach, use a heavy-duty three-prong extension cord rated for at least 15 amps.

3. Plug the cord into a normal, grounded 110-volt AC outlet.
4. Before starting the engine, be sure to unplug and store the cord as it was before to keep it away from moving engine parts, and prevent damage.

The length of time the heater should remain plugged in depends on several factors. Ask a dealer in the area where you will be parking the vehicle for the best advice on this.

## Automatic Transmission Operation

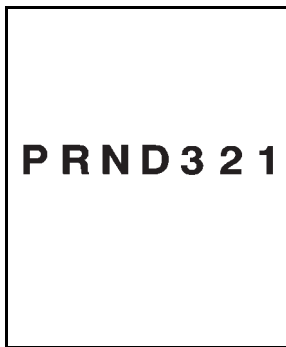

The vehicle may have a shift lever located either on the steering column or on the console between the seats.

**P (Park):** This position locks the front wheels. It is the best position to use when you start the engine because the vehicle cannot move easily.

### **WARNING:**

It is dangerous to get out of the vehicle if the shift lever is not fully in P (Park) with the parking brake firmly set. The vehicle can roll.

Do not leave the vehicle when the engine is running unless you have to. If you have left the engine running, the vehicle can move suddenly. You or others could be injured. To be sure the vehicle will not move, even when you are on fairly level ground, always set the parking brake and move the shift lever to P (Park). See *Shifting Into Park* on page 3-27. If you are pulling a trailer, see *Towing a Trailer* on page 5-25.

Make sure the shift lever is fully in P (Park) before starting the engine. The vehicle has an automatic transmission shift lock control system. You have to fully apply the regular brakes before you can shift from P (Park) while the ignition is in ON/RUN. If you cannot shift out of P (Park), ease pressure on the shift lever and push the shift lever all the way into P (Park) as you maintain brake application. Then move the shift lever into the gear you want. See *Shifting Out of Park* on page 3-28.

**R (Reverse):** Use this gear to back up.



**Notice:** Shifting to R (Reverse) while the vehicle is moving forward could damage the transmission. The repairs would not be covered by the vehicle warranty. Shift to R (Reverse) only after the vehicle is stopped.

To rock the vehicle back and forth to get out of snow, ice, or sand without damaging the transmission, see *If Your Vehicle is Stuck in Sand, Mud, Ice, or Snow on page 5-17*.

**N (Neutral):** In this position, the engine does not connect with the wheels. To restart the engine when the vehicle is already moving, use N (Neutral) only. Also, use N (Neutral) when the vehicle is being towed.

 **WARNING:**

Shifting into a drive gear while the engine is running at high speed is dangerous. Unless your foot is firmly on the brake pedal, the vehicle could move very rapidly. You could lose control and hit people or objects. Do not shift into a drive gear while the engine is running at high speed.

**Notice:** Shifting out of P (Park) or N (Neutral) with the engine running at high speed may damage the transmission. The repairs would not be covered by the vehicle warranty. Be sure the engine is not running at high speed when shifting the vehicle.

**D (Drive):** This position is for normal driving. It provides the best fuel economy. If you need more power for passing, and you are:

- Going less than about 35 mph (55 km/h), push the accelerator pedal about halfway down.
- Going about 35 mph (55 km/h) or more, push the accelerator all the way down.

The transmission will shift down to the next gear and have more power.

Downshifting the transmission in slippery road conditions could result in skidding, see “Skidding” under *Loss of Control on page 5-10*

**3 (Third):** This position is also used for normal driving. It reduces vehicle speed more than D (Drive) without using the brakes. You might choose 3 (Third) instead of D (Drive) when driving on hilly, winding roads, when towing a trailer, so there is less shifting between gears and when going down a steep hill.

**2 (Second):** This position reduces vehicle speed even more than 3 (Third) without using the brakes. You can use 2 (Second) on hills. It can help control vehicle speed as you go down steep mountain roads, but then you would also want to use the brakes off and on.

**Notice:** Driving in 2 (Second) for more than 25 miles (40 km) or at speeds over 55 mph (90 km/h) may damage the transmission. Also, shifting into 2 (Second) at speeds above 65 mph (105 km/h) can cause damage. Drive in 3 (Third) or D (Drive) instead of 2 (Second).

**1 (First):** This position reduces vehicle speed even more than 2 (Second) without using the brakes. You can use it on very steep hills, or in deep snow or mud. If the shift lever is put in 1 (First) while going forward, the transmission will not shift into first gear until the vehicle is going slowly enough.

**Notice:** Spinning the tires or holding the vehicle in one place on a hill using only the accelerator pedal may damage the transmission. The repair will not be covered by the vehicle warranty. If you are stuck, do not spin the tires. When stopping on a hill, use the brakes to hold the vehicle in place.

## Parking Brake

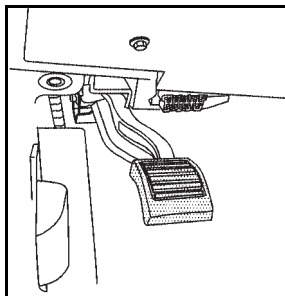

The parking brake pedal is located to the left of the regular brake pedal, near the driver door.

To set the parking brake, hold the regular brake pedal down, then push the parking brake pedal down.

If the ignition is on, the brake system warning light on the instrument panel cluster should come on. If it does not, you need to have the vehicle serviced.

A warning chime will sound if the parking brake is set, the ignition is on, and the vehicle speed is greater than 5 mph (8 km/h). The brake light will come on and stay on until the parking brake is released. See *Brake System Warning Light on page 4-32* for more information.

To release the parking brake, hold the regular brake pedal down, then push the parking brake pedal down. When you lift your foot off the parking brake pedal, the pedal will follow your foot to the released position.

**Notice:** Driving with the parking brake on can overheat the brake system and cause premature wear or damage to brake system parts. Make sure that the parking brake is fully released and the brake warning light is off before driving.

If you are towing a trailer and are parking on any hill, see *Towing a Trailer on page 5-25*.

## Shifting Into Park

### WARNING:

It can be dangerous to get out of the vehicle if the shift lever is not fully in P (Park) with the parking brake firmly set. The vehicle can roll. If you have left the engine running, the vehicle can move suddenly. You or others could be injured. To be sure the vehicle will not move, even when you are on fairly level ground, use the steps that follow. If you are pulling a trailer, see *Towing a Trailer on page 5-25*.

## Steering Column Shift Lever

If the vehicle has a steering column shift lever, use this procedure to shift the vehicle into P (Park):

1. Hold the brake pedal down.
2. Move the shift lever into P (Park) by pulling the shift lever toward you and moving it up as far as it will go.
3. With your foot still holding the brake pedal down, set the parking brake. See *Parking Brake on page 3-26* for more information.
4. Turn the ignition key to LOCK/OFF.
5. Remove the key and take it with you. If you can leave the vehicle with the ignition key in your hand, the vehicle is in P (Park).

## Console Shift Lever

If the vehicle is equipped with a console shift lever, use this procedure to shift the vehicle into P (Park):

1. Hold the brake pedal down.
2. Move the shift lever into P (Park) by pushing the lever all the way toward the front of the vehicle and then to the left.
3. While keeping the brake pedal applied, set the parking brake. See *Parking Brake on page 3-26* for more information.

4. Turn the ignition key to LOCK/OFF.
5. Remove the key and take it with you. If you can leave the vehicle with the ignition key in your hand, the vehicle is in P (Park).

## Leaving the Vehicle With the Engine Running

### **WARNING:**

It can be dangerous to leave the vehicle with the engine running. The vehicle could move suddenly if the shift lever is not fully in P (Park) with the parking brake firmly set. And, if you leave the vehicle with the engine running, it could overheat and even catch fire. You or others could be injured. Do not leave the vehicle with the engine running.

If you have to leave the vehicle with the engine running, be sure your vehicle is in P (Park) and the parking brake is firmly set before you leave it. See *Parking Brake on page 3-26* for more information.

## Torque Lock

Torque lock is when the weight of the vehicle puts too much force on the parking pawl in the transmission. This happens when parking on a hill and shifting the transmission into P (Park) is not done properly and then it is difficult to shift out of P (Park). To prevent torque lock, set the parking brake and then shift into P (Park). To find out how, see “Shifting Into Park” in this section.

If torque lock does occur, your vehicle may need to be pushed uphill by another vehicle to relieve the parking pawl pressure, so you can shift out of P (Park).

## Shifting Out of Park

### Automatic Transmission Shift Lock

This vehicle has an electronic shift lock release system. The shift lock release is designed to:

- Prevent ignition key removal unless the shift lever is in P (Park)
- Prevent movement of the shift lever out of P (Park), unless the ignition is in ON/RUN and the regular brake pedal is applied.

The shift lock is always functional except in the case of a an uncharged or low voltage (less than 9 volt) battery.

If the vehicle has an uncharged battery or a battery with low voltage, try charging or jump starting the battery. See *Jump Starting on page 6-44*.

## Console Shift

If the console shifter cannot be moved out of P (Park)

1. Apply and maintain the regular brakes.
2. Turn the ignition to ON/RUN position. See *Ignition Positions on page 3-19* for more information.
3. Let up on the shift lever and make sure the shift lever is pushed all the way into P (Park).
4. Then, move the shift into the desired gear.

If you still cannot move the shift lever from P (Park), consult your dealer or a professional towing service.

## Column Shift

If the shifter cannot be moved out of P (Park)

1. Apply and maintain the regular brakes.
2. Turn the ignition key to the ON/RUN position. See *Ignition Positions on page 3-19* for more information.

3. Shift out of the P (Park) position to the N (Neutral) position.

4. Then, move the shift into the desired gear.

If you still cannot move the shift lever from P (Park), consult your dealer or a professional towing service.

## Parking Over Things That Burn



### WARNING:

Things that can burn could touch hot exhaust parts under the vehicle and ignite. Do not park over papers, leaves, dry grass, or other things that can burn.

## Engine Exhaust

### **WARNING:**

Engine exhaust contains Carbon Monoxide (CO) which cannot be seen or smelled. Exposure to CO can cause unconsciousness and even death.

Exhaust may enter the vehicle if:

- The vehicle idles in areas with poor ventilation (parking garages, tunnels, deep snow that may block underbody airflow or tail pipes).
- The exhaust smells or sounds strange or different.
- The exhaust system leaks due to corrosion or damage.
- The vehicle exhaust system has been modified, damaged or improperly repaired.
- There are holes or openings in the vehicle body from damage or after-market modifications that are not completely sealed.

(Continued)

### **WARNING: (Continued)**

If unusual fumes are detected or if it is suspected that exhaust is coming into the vehicle:

- Drive it only with the windows completely down.
- Have the vehicle repaired immediately.

Never park the vehicle with the engine running in an enclosed area such as a garage or a building that has no fresh air ventilation.

## Running the Vehicle While Parked

It is better not to park with the engine running. But if you ever have to, here are some things to know.

### **WARNING:**

Idling a vehicle in an enclosed area with poor ventilation is dangerous. Engine exhaust may enter the vehicle. Engine exhaust contains Carbon Monoxide (CO) which cannot be seen or smelled. It can cause unconsciousness and even

(Continued)

## **WARNING: (Continued)**

death. Never run the engine in an enclosed area that has no fresh air ventilation. For more information, see *Engine Exhaust on page 3-30*.

## **WARNING:**

It can be dangerous to get out of the vehicle if the automatic transmission shift lever is not fully in P (Park) with the parking brake firmly set. The vehicle can roll. Do not leave the vehicle when the engine is running unless you have to. If you have left the engine running, the vehicle can move suddenly. You or others could be injured. To be sure the vehicle will not move, even when you are on fairly level ground, always set the parking brake and move the shift lever to P (Park).

Follow the proper steps to be sure the vehicle will not move. See *Shifting Into Park on page 3-27*.

If parking on a hill and pulling a trailer, see *Towing a Trailer on page 5-25*.

## **Mirrors**

### **Automatic Dimming Rearview Mirror**

The vehicle may have an automatic dimming inside rearview mirror with OnStar<sup>®</sup> and/or a compass display. Automatic dimming reduces the glare from the headlamps of the vehicle behind you. The dimming feature comes on and the indicator light illuminates each time the vehicle is started.

Vehicles with OnStar have three additional control buttons located at the bottom of the mirror. See your dealer for more information on the system and how to subscribe to OnStar. See the OnStar<sup>®</sup> owners guide for more information about the services OnStar provides.

 **(On/Off):** Press to turn the dimming feature and/or compass display on or off.

### **Cleaning the Mirror**

Do not spray glass cleaner directly on the mirror. Use a soft towel dampened with water.

## Compass

### Compass Operation

There is a compass display in the upper right corner of the mirror.

### Compass Calibration

Press and hold  to activate the compass calibration mode. CAL displays in the compass window on the mirror.

If after a few seconds the display does not show a compass direction, (N for North for example), there may be a strong magnetic field interfering with the compass. Interference can be caused by a magnetic antenna mount, note pad holder, or similar object. If CAL displays in the compass window, the compass may need to be reset or calibrated.

The compass can be calibrated by driving the vehicle in circles at 5 mph (8 km/h) or less until the display reads a direction.

### Compass Variance

The compass is set to zone eight. If you do not live in zone eight or drive out of the area, the compass variance needs to be changed to the appropriate zone.

To adjust for compass variance:

1. Find your current location and variance zone number on the following zone map.

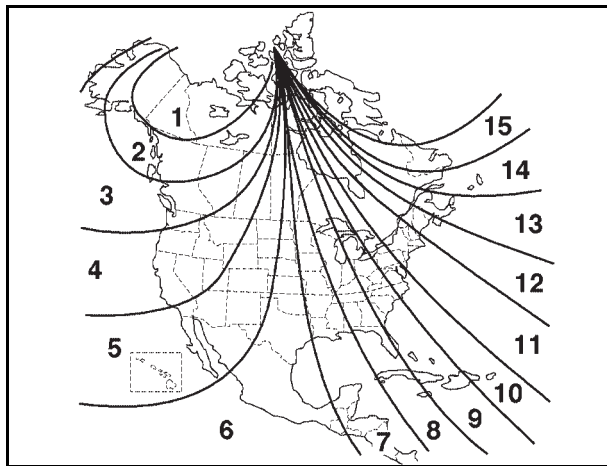

2. Press and hold  until the zone number displays. The number shown is the current zone number.



3. Once the zone number displays, press  repeatedly until the correct zone number displays. Stop pressing the button and the mirror returns to normal operation. If CAL appears in the compass window, the compass may need calibration. See “Compass Calibration” listed previously.

## Outside Power Mirrors

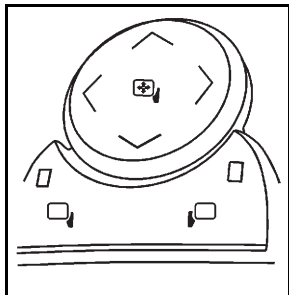

Controls for the outside power mirrors are located on the driver's door armrest.

To adjust the mirror:

1. Press the left or right side of the selector switch located beneath the control pad to choose the driver or passenger side mirror.

2. Press one of the four arrows located on the control pad to move the mirror in the desired direction.
3. Adjust each outside mirror so that a little of the vehicle and the area behind it can be seen.

Manually fold the mirrors inward to prevent damage when going through an automatic car wash. To fold, push the mirror toward the vehicle. Push the mirror outward, to return to its original position.

## Outside Automatic Dimming Mirror

If the vehicle has this feature, the driver side mirror adjusts for the glare of headlamps behind you. This feature is controlled by the on and off settings on the automatic dimming rearview mirror. See *Automatic Dimming Rearview Mirror on page 3-31* for more information.

## Turn Signal Indicator

The vehicle may also have a turn signal indicator on the mirror. An arrow on the outside rearview mirror flashes in the direction of the turn or lane change. See *Turn and Lane-Change Signals on page 4-5* for more information.

## Side Blind Zone Alert (SBZA)

If the vehicle has the Side Blind Zone Alert (SBZA) system, see *Side Blind Zone Alert (SBZA)* on page 3-36.

## Park Tilt Mirrors

If the vehicle has memory mirrors, the outside mirrors have park tilt mirrors. This feature tilts the driver's side and passenger side mirror to a factory programmed position when the vehicle is in R (Reverse). This feature may be useful in allowing you to view the curb when you are parallel parking.

When the vehicle is shifted out of R (Reverse) and either a five second delay has occurred, or the ignition is turned to LOCK/OFF, the driver and passenger side mirrors return to their original position.

See *DIC Vehicle Customization* on page 4-58 for more information.

## Outside Convex Mirror

### **WARNING:**

A convex mirror can make things, like other vehicles, look farther away than they really are. If you cut too sharply into the right lane, you could hit a vehicle on the right. Check the inside mirror or glance over your shoulder before changing lanes.

The passenger side mirror is convex shaped. A convex mirror's surface is curved so more can be seen from the driver seat.

## Outside Heated Mirrors

For vehicles with heated mirrors:

 **(Rear Window Defogger):** Press to heat the mirrors.

See "Rear Window Defogger" under *Climate Control System* on page 4-16 or *Dual Automatic Climate Control System* on page 4-20 for more information.

# Object Detection Systems

## Ultrasonic Rear Parking Assist (URPA)

For vehicles with the Ultrasonic Rear Parking Assist (URPA) system, it operates at speeds less than 8 km/h (5 mph), and assists the driver with parking and avoiding objects while in R (Reverse). The sensors on the rear bumper are used to detect the distance to an object up to 2.5 m (8 ft) behind the vehicle, and at least 25 cm (10 in) off the ground.

### **WARNING:**

The Ultrasonic Rear Parking Assist (URPA) system does not replace driver vision. It cannot detect:

- Objects that are below the bumper, underneath the vehicle, or too close or far from the vehicle.
- Children, pedestrians, bicyclists, or pets.

(Continued)

### **WARNING: (Continued)**

If you do not use proper care before and while backing, vehicle damage, injury, or death could occur. Even with URPA, always check behind the vehicle before backing up. While backing, be sure to look for objects and check the vehicle's mirrors.

## How the System Works

URPA comes on automatically when the shift lever is moved into R (Reverse). A single tone sounds to indicate the system is working.

URPA operates only at speeds less than 8 km/h (5 mph).

An obstacle is indicated by audible beeps. The interval between the beeps becomes shorter as the vehicle gets closer to the obstacle. When the distance is less than 30 cm (12 in) the beeps are continuous.

To be detected, objects must be at least 25 cm (10 in) off the ground and below trunk level. Objects must also be within 2.5 m (8 ft) from the rear bumper. This distance may be less during warmer or humid weather.

The system can be disabled through the Driver Information Center (DIC). See “Park Assist” under *DIC Operation and Displays on page 4-42* for more information.

## When the System Does Not Seem to Work Properly

**SERVICE PARK ASSIST:** If this message occurs, take the vehicle to your dealer to repair the system.

**PARK ASSIST OFF:** If the URPA system does not activate due to a temporary condition, the message displays on the DIC, see *DIC Operation and Displays on page 4-42* for more information. This can occur under the following conditions:

- The driver disables the system.
- The ultrasonic sensors are not clean. Keep the vehicle's rear bumper free of mud, dirt, snow, ice and slush. For cleaning instructions, see *Washing Your Vehicle on page 6-102*.
- A trailer was attached to the vehicle, or a bicycle or an object was hanging out of the trunk during the last drive cycle. Once the object is removed, URPA will return to normal operation.

- A tow bar is attached to the vehicle.
- The vehicle's bumper is damaged. Take the vehicle to your dealer to repair the system.
- Other conditions may affect system performance, such as vibrations from a jackhammer or the compression of air brakes on a very large truck.

If the system is still disabled, after driving forward at least 40 km/h (25 mph), take the vehicle to your dealer.

## Side Blind Zone Alert (SBZA)

The vehicle may have a Side Blind Zone Alert (SBZA) system. Read this entire section before using the system.

### **WARNING:**

SBZA is only a lane changing aid and does not replace driver vision. SBZA does not detect:

- Vehicles outside the side blind zones which may be rapidly approaching.
- Pedestrians, bicyclists, or animals.

(Continued)

## WARNING: (Continued)

Failure to use proper care when changing lanes may result in damage to the vehicle, injury, or death. Always check the outside and rearview mirrors, glance over your shoulder, and use the turn signal before changing lanes.

When the system detects a vehicle in the side blind zone, amber SBZA displays will light up in the side mirrors. This indicates that it may be unsafe to change lanes. Before making a lane change, always check the SBZA display, check the outside and rearview mirrors, look over your shoulder for vehicles and hazards, and use the turn signal.

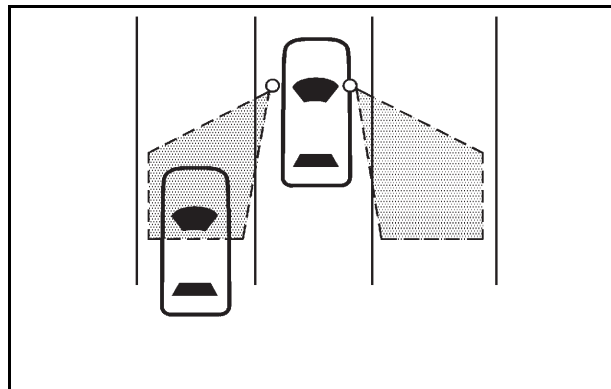

### SBZA Detection Zones

The SBZA sensor covers a zone of approximately one lane over from both sides of the vehicle, 3.5 m (11 ft). This zone starts at each side mirror and goes back approximately 5 m (16 ft). The height of the zone is approximately between 0.5 m (1.5 ft) and 2.0 m (6 ft) off the ground.

The SBZA detection zones do not change if the vehicle is towing a trailer. So be extra careful when changing lanes while towing a trailer.

## How the System Works

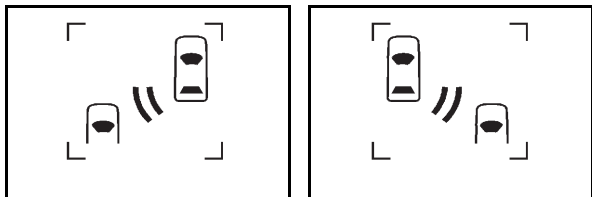

**Left Side Mirror Display**    **Right Side Mirror Display**

When the vehicle is started, both outside mirror displays will briefly come on to indicate that the system is operating. While driving forward, the left or right side mirror SBZA display will light up if a vehicle is detected in that blind zone. If you activate a turn signal and a vehicle has been detected on the same side, the SBZA display will flash to give you extra warning not to change lanes.

SBZA displays do not come on while the vehicle is approaching or passing other vehicles. At speeds greater than 20 mph (32 km/h), SBZA displays may come on when a vehicle you have passed remains in or drops back into the detection zone.

SBZA can be disabled through the Driver Information Center (DIC). See *Driver Information Center (DIC)* on page 4-42 for more information. If the SBZA is disabled by the driver, the SBZA mirror displays will not light up during normal driving.

## When the System Does Not Seem To Work Properly

Occasional missed alerts can occur under normal circumstances and will increase in wet conditions. The system does not need to be serviced due to an occasional missed alert. The number of missed alerts will increase with increased rainfall or road spray.

If the SBZA displays do not light up when the system is on and vehicles are in the blind zone, the system may need service. Take the vehicle to your dealer.

SBZA is designed to ignore stationary objects; however, the system may occasionally light up due to guard rails, signs, trees, shrubs, and other stationary objects. This is normal system operation, the vehicle does not need service.

SBZA does not operate when the left or right corners of the rear bumper are covered with mud, dirt, snow, ice, slush, or in heavy rainstorms. For cleaning instructions, see *Washing Your Vehicle* on page 6-102. If the DIC still displays the SIDE BLIND ZONE SYS. UNAVAILABLE message after cleaning the bumper, see your dealer.

The SBZA displays may remain on if a trailer is attached to the vehicle, or a bicycle or object is extending out to either side of the vehicle.

When SBZA is disabled for any reason other than the driver turning it off, the driver will not be able to turn SBZA back on using the DIC. The SIDE BLIND ZONE ALERT ON option will not be selectable if the conditions for normal system operation are not met. Until normal operating conditions for SBZA are met, you should not rely upon SBZA while driving.

## SBZA Error Messages

The following messages may appear in the DIC:

**SIDE BLIND ZONE ALERT SYSTEM OFF:** This message indicates that the driver has turned the system off.

**SIDE BLIND ZONE SYS. UNAVAILABLE:** This message indicates that the SBZA system is disabled because the sensor is blocked and cannot detect vehicles in the blind zone. The sensor may be blocked by mud, dirt, snow, ice, slush, or even heavy rainstorms. This message may also activate during heavy rain or due to road spray. The vehicle does not need service. For cleaning, see *Washing Your Vehicle on page 6-102*.

**SERVICE SIDE BLIND ZONE ALERT SYSTEM:** If this message appears, both SBZA displays will remain on indicating there is a problem with the SBZA system. If these displays remain on after continued driving, the system needs service. Take the vehicle to your dealer.

## FCC Information

See *Radio Frequency Statement on page 8-18* for information regarding Part 15 of the Federal Communications Commission (FCC) rules and Industry Canada Standards RSS-210/220/310.

Frequency of operation: 24.05GHz – 24.25GHz

Field Strength: Not greater than 2.5V/m peak (0.25V/m average) at a distance of 3 m.

The manufacturer is not responsible for any radio or TV interference caused by unauthorized modifications to this equipment. Such modifications could void the user's authority to operate the equipment.

## Lane Departure Warning (LDW)

The vehicle may have a Lane Departure Warning (LDW) system. Read this entire section before using the system.

### **WARNING:**

The Lane Departure Warning (LDW) system does not steer the vehicle and is only an aid to help you stay in your driving lane. The LDW system may not:

- Provide you with enough time to avoid a lane change collision.
- Be loud enough for you to hear the warning beeps.
- Work properly under bad weather conditions or if the windshield is not kept clean.
- Detect lane markings and will not detect road edges.
- Warn you that your vehicle is crossing a lane marking if the system does not detect the lane marking.

(Continued)

### **WARNING: (Continued)**

LDW will indicate the system is working whenever it detects either the left or right lane marking. So if you depart on the side of the lane that LDW is not detecting, LDW will not warn you.

If you do not carefully maintain your vehicle position within the lane, vehicle damage, injury, or death could occur. Even with LDW, always keep your attention on the road and maintain proper vehicle position within the lane. Always keep the windshield clean and do not use LDW in bad weather conditions.

When the vehicle crosses a detected lane marking, the LDW symbol will flash and you will hear three beeps. LDW will not warn you if the turn signal is on or if you make a sharp maneuver. Before making a lane change, check the vehicle's mirrors, glance over your shoulder for vehicles and hazards, and start the turn signal before changing lanes.



## How the System Works

LDW uses a camera located between the inside rearview mirror and the windshield to detect the lane markings.

 **(Lane Departure Warning):** To turn LDW on and off, press the LDW control, located by the exterior headlamp control. An indicator on the control will light to indicate that LDW is on.

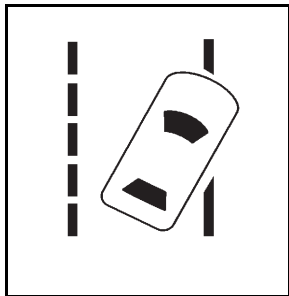

When the vehicle is started, the LDW symbol, located in the instrument panel cluster, will briefly come on to indicate that the light is operational.

LDW only operates at speeds of 35 mph (56 km) or greater. If LDW is turned on when traveling at these speeds, the LDW symbol will appear green if the system detects a left or right lane marking. This symbol will change to amber and flash and three beeps will sound if you cross a detected lane marking without using the turn signal.

If the LDW symbol does not appear, LDW is not currently operating and will not warn you.

To change the volume of the warning chime, see Chime Volume under *DIC Vehicle Customization on page 4-58* for more information.

## When the System Does Not Seem To Work Properly

The LDW symbol will not appear when the system is having difficulty seeing the lines on the road or if the view of the camera on the windshield is blocked with mud, dirt, snow, ice, or slush, if the windshield is damaged, or when weather limits visibility, such as while driving in fog, rain, or snow conditions. This is normal operation, the vehicle does not need service. For cleaning instructions, see *Washing Your Vehicle on page 6-102*.

LDW warnings may occasionally occur due to tar marks, shadows, cracks in the road, or other road imperfections. This is normal system operation, the vehicle does not need service.

## LDW Error Message

**SERVICE LANE DEPARTURE SYSTEM:** This message may appear in the DIC to indicate that LDW is not working properly. If this message remains on after continued driving, the system needs service. Take your vehicle to your dealer.

**LANE DEPARTURE SYSTEM UNAVAILABLE:** This message may appear in the DIC if LDW does not activate due to a temporary condition.

## Universal Home Remote System

See *Radio Frequency Statement on page 8-18* for information regarding Part 15 of the Federal Communications Commission (FCC) rules and Industry Canada Standards RSS-210/220/310.

## Universal Home Remote System Operation (With Three Round LED)

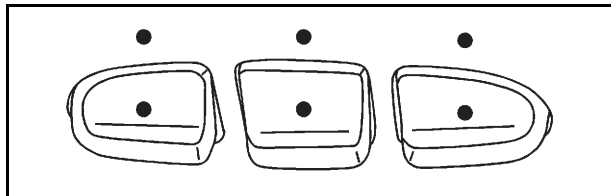

This vehicle may have the Universal Home Remote System. If there are three round Light Emitting Diode (LED) indicator lights above the Universal Home Remote buttons, follow the instructions below.

This system provides a way to replace up to three remote control transmitters used to activate devices such as garage door openers, security systems, and home automation devices.

Do not use this system with any garage door opener that does not have the stop and reverse feature. This includes any garage door opener model manufactured before April 1, 1982.

Read the instructions completely before attempting to program the transmitter. Because of the steps involved, it may be helpful to have another person assist with programming the transmitter.

Be sure to keep the original remote control transmitter for use in other vehicles, as well as, for future programming. Only the original remote control transmitter is needed for Fixed Code programming. The programmed buttons should be erased when the vehicle is sold or the lease ends. See “Erasing Universal Home Remote Buttons” later in this section.

Park the vehicle outside of the garage when programming a garage door. Be sure that people and objects are clear of the garage door or gate that is being programmed.

## **Programming Universal Home Remote — Rolling Code**

For questions or help programming the Universal Home Remote System, call 1-866-572-2728 or go to [learcar2u.com](http://learcar2u.com).

Most garage door openers sold after 1996 are Rolling Code units.

Programming a garage door opener involves time-sensitive actions, so read the entire procedure before starting. Otherwise, the device will time out and the procedure will have to be repeated.

To program up to three devices:

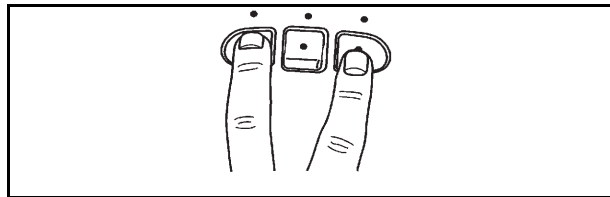

1. From inside the vehicle, press the two outside buttons at the same time for one to two seconds, and immediately release them.

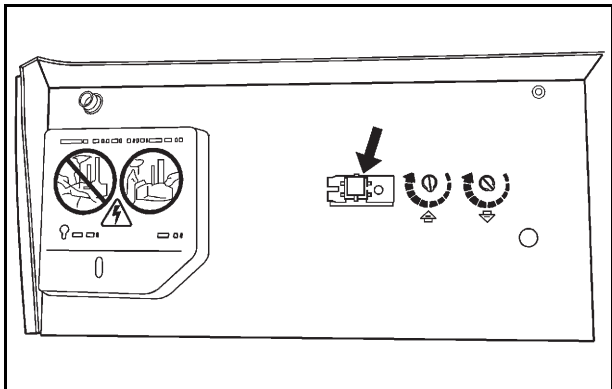

2. Locate in the garage, the garage door opener receiver (motor-head unit). Locate the “Learn” or “Smart” button. It can usually be found where the hanging antenna wire is attached to the motor-head unit and may be a colored button. Press this button. After pressing this button, complete the following steps in less than 30 seconds.

3. Immediately return to the vehicle. Press and hold the Universal Home Remote button that will be used to control the garage door until the garage door moves. The indicator light, above the selected button, should slowly blink. This button may need to be held for up to 20 seconds.
4. Immediately, within one second, release the button when the garage door moves. The indicator light will blink rapidly until programming is complete.
5. Press and release the same button again. The garage door should move, confirming that programming is successful and complete.

To program another Rolling Code device such as an additional garage door opener, a security device, or home automation device, repeat Steps 1 through 5, choosing a different function button in Step 3 than what was used for the garage door opener.

If these instructions do not work, the garage door opener is probably a Fixed Code unit. Follow the Programming instructions that follow for a Fixed Code garage door opener.

## Programming Universal Home Remote — Fixed Code

For questions or help programming the Universal Home Remote System, call 1-866-572-2728 or go to [learcar2u.com](http://learcar2u.com).

Most garage door openers sold before 1996 are Fixed Code units.

Programming a garage door opener involves time-sensitive actions, so read the entire procedure before starting. Otherwise, the device will time out and the procedure will have to be repeated.

To program up to three devices:

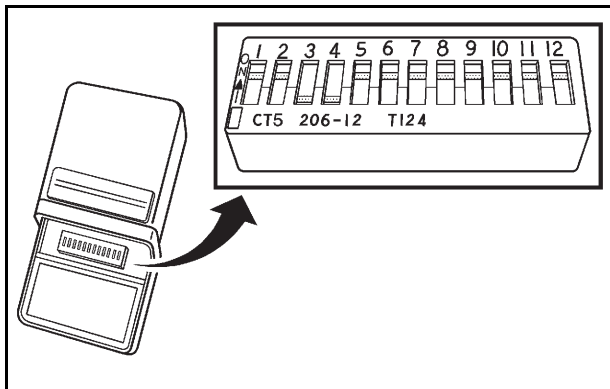

1. To verify that the garage door opener is a Fixed Code unit, remove the battery cover on the hand held transmitter supplied by the manufacturer of

the garage door opener motor. If there are a row of dip switches similar to the graphic above, the garage door opener is a Fixed Code unit. If you do not see a row of dip switches, return to the previous section for Programming Universal Home Remote – Rolling Code.

Your hand held transmitter can have between eight to 12 dip switches depending on the brand of transmitter.

The garage door opener receiver (motor head unit) could also have a row of dip switches that can be used when programming the Universal Home Remote. If the total number of switches on the motor head and hand held transmitter are different, or if the dip switch settings are different, use the dip switch settings on the motor head unit to program the Universal Home Remote. The motor head dip switch settings can also be used when the original hand held transmitter is not available.

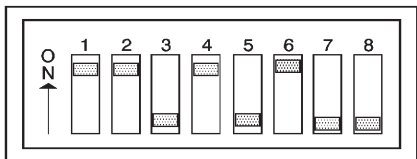

Switch Number	1	2	3	4	5	6	7	8
Switch Position	On	On	Off	On	Off	On	Off	Off
Your Universal Home Remote Button	Left	Left	Right	Left	Right	Left	Right	Right

**Example of Eight Dip Switches with Two Positions**

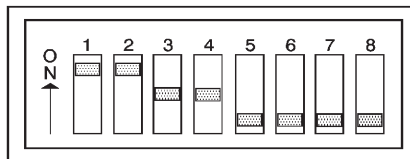

Switch Number	1	2	3	4	5	6	7	8
Switch Position	On	On	Neutral	Neutral	Off	Off	Off	Off
Your Universal Home Remote Button	Left	Left	Middle	Middle	Right	Right	Right	Right

**Example of Eight Dip Switches with Three Positions**

The panel of switches might not appear exactly as they do in the examples above, but they should be similar.

The switch positions on the hand-held transmitter could be labeled, as follows:

- A switch in the up position could be labeled as “Up,” “+,” or “On.”
- A switch in the down position could be labeled as “Down,” “-,” or “Off.”
- A switch in the middle position could be labeled as “Middle,” “0,” or “Neutral.”

2. Write down the eight to 12 switch settings from left to right as follows:

- When a switch is in the up position, write “Left.”
- When a switch is in the down position, write “Right.”
- If a switch is set between the up and down position, write “Middle.”

The switch settings written down in Step 2 now become the button strokes to be entered into the Universal Home Remote in Step 4. Be sure to enter the switch settings written down in Step 2, in order from left to right, into the Universal Home Remote, when completing Step 4.

3. From inside your vehicle, first firmly press all three buttons at the same time for about three seconds. Release the buttons to put the Universal Home Remote into programming mode.

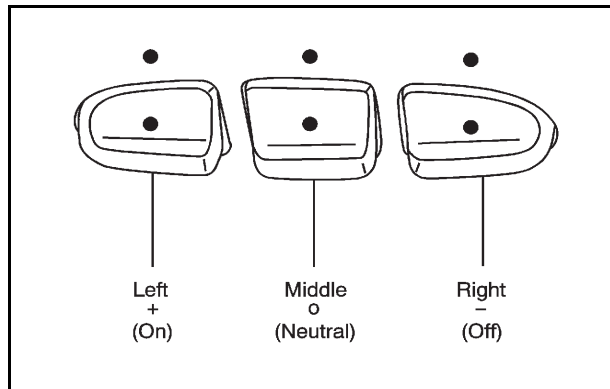

4. The indicator lights will blink slowly. Enter each switch setting from Step 2 into your vehicle's Universal Home Remote. You will have two and one-half minutes to complete Step 4. Now press one button on the Universal Home Remote for each switch setting as follows:

- If you wrote “Left,” press the left button in the vehicle.
- If you wrote “Right,” press the right button in the vehicle.
- If you wrote “Middle,” press the middle button in the vehicle.

5. After entering all of the switch positions, again, firmly press and release all three buttons at the same time. The indicator lights will turn on.
6. Press and hold the button that will be used to control the garage door until the garage door moves. The indicator light above the selected button should slowly blink. This button may need to be held for up to 55 seconds.
7. Immediately release the button when the garage door moves. The indicator light will blink rapidly until programming is complete.
8. Press and release the same button again. The garage door should move, confirming that programming is successful and complete.

To program another Fixed Code device such as an additional garage door opener, a security device, or home automation device, repeat Steps 1-8, choosing a different button in Step 6 than what was used for the garage door opener.

## Using Universal Home Remote

Press and hold the appropriate button for at least half of a second. The indicator light will come on while the signal is being transmitted.

## Reprogramming Universal Home Remote Buttons

Any of the three buttons can be reprogrammed by repeating the instructions.

## Erasing Universal Home Remote Buttons

The programmed buttons should be erased when the vehicle is sold or the lease ends.

To erase either Rolling Code or Fixed Code on the Universal Home Remote device:

1. Press and hold the two outside buttons at the same time for approximately 20 seconds, until the indicator lights, located directly above the buttons, begin to blink rapidly.
2. Once the indicator lights begin to blink, release both buttons. The codes from all buttons will be erased.

For help or information on the Universal Home Remote System, call the customer assistance phone number under *Customer Assistance Offices on page 8-5*.



## Storage Areas

### Glove Box

Lift up the glove box handle to open it. Use the key to lock and unlock the glove box.

### Cupholders

There are cupholders located in the full floor console, or in the front of the center seat console. Cupholders are also located in the rear armrest. Slide the cover back to access the full floor console cupholder. Fold open the front of the console to access the center seat console cupholder.

### Front Storage Area

To access the front storage area, push down and then release. Push up and forward to remove.

## Center Console Storage

If the vehicle has a full floor console it has two storage areas. Lift the left lever located in the front of the armrest lid to access the upper storage tray. Lift the right lever to access the lower storage area. If the vehicle has a center seat console it will have two storage areas. Press the button located on the front of the armrest and lift the armrest cover to access the upper storage area. Pull the strap located behind the cup holder to access the lower storage area.

There may be a USB port available in the center console. See *Radio(s) on page 4-69* for more information.

## Center Flex Storage Unit

This vehicle may have a center flex storage unit that includes a front center seat with a lap belt and an underseat storage compartment. The center seatback can also be used as an armrest. Cupholders are also located at the front edge of the storage unit and can be accessed by folding the compartment forward.

Pull the handle rearward to open a storage compartment and access the accessory power outlet. Pull out to remove.

When not being used, the center seat lap belt can be stored in the underseat storage compartment.

## Floor Mats

### **WARNING:**

If a floor mat is the wrong size or is not properly installed, it can interfere with the accelerator pedal and/or brake pedal. Interference with the pedals can cause unintended acceleration and/or increased stopping distance which can cause a crash and injury. Make sure the floor mat does not interfere with the accelerator or brake pedal.

Use the following guidelines for proper floor mat usage.

- The original equipment floor mats were designed for your vehicle. If the floor mats need replacing, it is recommended that GM certified floor mats be purchased. Non-GM floor mats may not fit properly and may interfere with the accelerator or brake pedal. Always check that the floor mats do not interfere with the pedals.
- Use the floor mat with the correct side up. Do not turn it over.
- Do not place anything on top of the driver side floor mat.

- Use only a single floor mat on the driver side.
- Do not place one floor mat on top of another.

The driver side floor mat is held in place by two hooks.

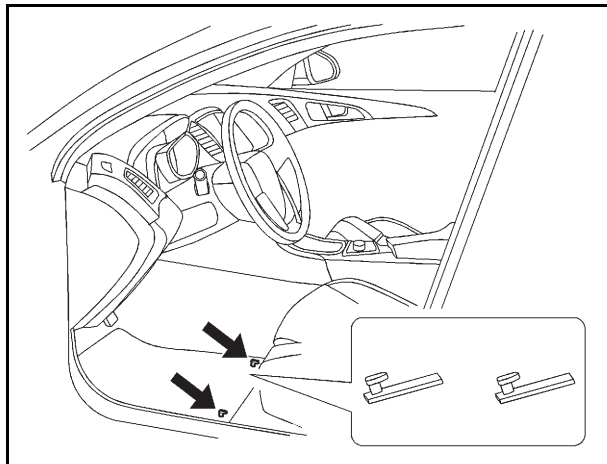

### Removing and Replacing the Floor Mats

1. Pull up on the rear of the mat to remove it from the hooks.
2. Reinstall the floor mat by lining up the openings in the floor mat over the hooks and push it down into position.

3. Make sure the floor mat is properly secured and verify that it does not interfere with the accelerator or brake pedals.

## Rear Seat Armrest

This vehicle has a rear seat armrest with cupholders. Pull the tab on the armrest forward, to access it.

## Convenience Net

Use the convenience net, located in the rear, to store small loads as far forward as possible. The net should not be used to store heavy loads.

## Sunroof

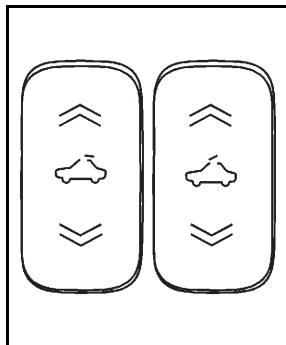

If your vehicle has a power sunroof, the switches are located on the headliner.

To express-open the sunroof press the rear of the driver's side switch to the second detent position, and release. To stop the sunroof from express opening, press the switch again. The sunroof has a comfort stop feature which stops the sunroof from opening to the full-open position. From the comfort stop position, press the rear of the driver's side switch a second time to open the sunroof to the full-open position. If the sunshade is in the closed position, it will open with the sunroof, or it can be opened manually.

To close the sunroof, press the front of the driver side switch to the second detent position, and release.

To vent the sunroof press and hold the back of the passenger side switch until the vent reaches the desired position. Press the front of the passenger side switch to close the sunroof.

If an object is in the path of the sunroof while it is closing, the anti-pinch feature will detect the object and stop the sunroof from closing at the point of the obstruction. The sunroof will then return to the full-open or vent position.

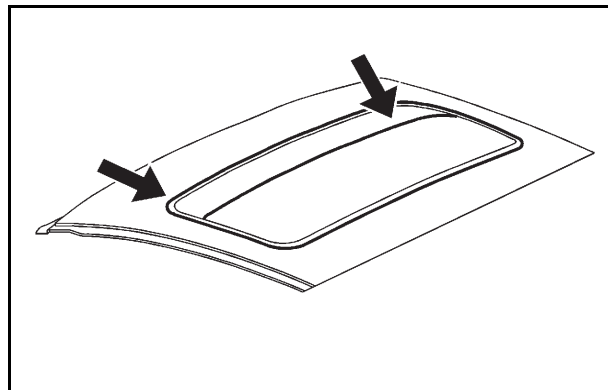

Dirt and debris may collect on the sunroof seal or in the tracks that could cause an issue with sunroof operation, noise or plug the water drainage system. Periodically open the sunroof and remove any obstacles or loose debris. Wipe the sunroof seal and roof sealing area using a clean cloth, mild soap, and water. Do not remove grease from sunroof.

## Section 4 Instrument Panel

---

<b>Instrument Panel Overview</b> .....	4-3	Delayed Exit Lighting .....	4-13
Hazard Warning Flashers .....	4-3	Perimeter Lighting .....	4-13
Horn .....	4-3	Front Reading Lamps .....	4-13
Tilt Wheel .....	4-3	Electric Power Management .....	4-14
Power Tilt Wheel and Telescopic Steering		Inadvertent Power Battery Saver .....	4-14
Column .....	4-4	Battery Run-Down Protection .....	4-15
Heated Steering Wheel .....	4-4	Accessory Power Outlet(s) .....	4-15
Turn Signal/Multifunction Lever .....	4-4	Ashtray(s) .....	4-16
Turn and Lane-Change Signals .....	4-5	<b>Climate Controls</b> .....	4-16
Headlamp High/Low-Beam Changer .....	4-5	Climate Control System .....	4-16
Flash-to-Pass .....	4-5	Dual Automatic Climate Control System .....	4-20
Windshield Wipers .....	4-6	Outlet Adjustment .....	4-25
Windshield Washer .....	4-7	Passenger Compartment Air Filter .....	4-25
Cruise Control .....	4-7	<b>Warning Lights, Gauges, and Indicators</b> .....	4-27
Exterior Lamps .....	4-10	Instrument Panel Cluster .....	4-28
Wiper Activated Headlamps .....	4-11	Speedometer and Odometer .....	4-29
Headlamps on Reminder .....	4-11	Trip Odometer .....	4-29
Daytime Running Lamps (DRL) .....	4-11	Tachometer .....	4-29
Fog Lamps .....	4-12	Safety Belt Reminders .....	4-29
Cornering Lamps .....	4-12	Airbag Readiness Light .....	4-30
Exterior Lighting Battery Saver .....	4-12	Passenger Airbag Status Indicator .....	4-31
Instrument Panel Brightness .....	4-12	Charging System Light .....	4-32
Courtesy Lamps .....	4-13	Brake System Warning Light .....	4-32
Entry Lighting .....	4-13	Antilock Brake System (ABS) Warning Light ...	4-33
Delayed Entry Lighting .....	4-13	Traction Control System (TCS) Warning	
Theater Dimming .....	4-13	Light .....	4-34

## Section 4 Instrument Panel

---

StabiliTrak® Indicator Light .....	4-34	<b>Audio System(s)</b> .....	4-67
Lane Departure Warning (LDW) Light .....	4-35	Setting the Clock .....	4-68
Engine Coolant Temperature Warning Light ....	4-36	Radio(s) .....	4-69
Engine Coolant Temperature Gauge .....	4-36	Using an MP3 .....	4-78
Tire Pressure Light .....	4-37	XM Radio Messages .....	4-84
Malfunction Indicator Lamp .....	4-37	Navigation/Radio System .....	4-85
Oil Pressure Light .....	4-40	Bluetooth® .....	4-86
Security Light .....	4-40	Theft-Deterrent Feature .....	4-94
Front Fog Lamp Light .....	4-40	Audio Steering Wheel Controls .....	4-94
Cruise Control Light .....	4-41	Radio Reception .....	4-97
Highbeam On Light .....	4-41	Backglass Antenna .....	4-97
Fuel Gauge .....	4-41	XM™ Satellite Radio Antenna System .....	4-98
<b>Driver Information Center (DIC)</b> .....	4-42		
DIC Operation and Displays .....	4-42		
DIC Compass .....	4-47		
DIC Warnings and Messages .....	4-49		
DIC Vehicle Customization .....	4-58		

## Instrument Panel Overview

### Hazard Warning Flashers

The hazard warning flashers let you warn others that you have a problem.

The hazard warning flasher button is located in the center of the instrument panel above the radio.

 : Press to make the front and rear turn signal lamps flash on and off. Press the button again to turn the flashers off.

When the hazard warning flashers are on, the turn signals will not work.

### Horn

Press near or on the horn symbols on the steering wheel pad to sound the horn.

### Tilt Wheel

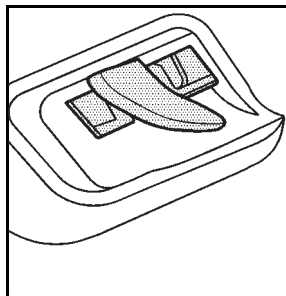

The tilt lever is located on the left side of the steering column.

To adjust the steering wheel:

1. Hold the wheel and pull the lever toward you.
2. Move the steering wheel up or down.
3. Release the lever to lock the wheel in place.

Do not adjust the steering wheel while driving.

## Power Tilt Wheel and Telescopic Steering Column

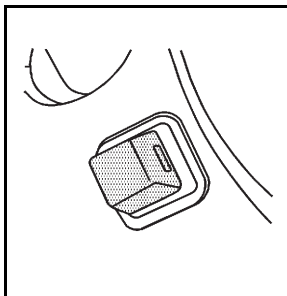

For vehicles with a power tilt control, it is located on the left hand side of the steering column.

To adjust the steering wheel, push the control up, down, forward or backward.

Do not adjust the steering wheel while driving.

## Heated Steering Wheel

For vehicles with a heated steering wheel, the button for this feature is located on the steering wheel.

 : Press to turn the heated steering wheel on or off. A light on the button displays when the feature is turned on.

The steering wheel takes about three minutes to start heating.

## Turn Signal/Multifunction Lever

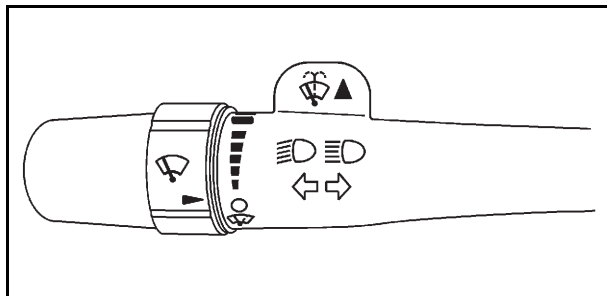

The lever on the left side of the steering column includes the following:

 : Turn and Lane-Change Signals

 : Headlamp High/Low-Beam Changer

 : Windshield Wipers

 : Windshield Washer

Flash-To-Pass Feature.

Information for these features is on the pages following.



## Turn and Lane-Change Signals

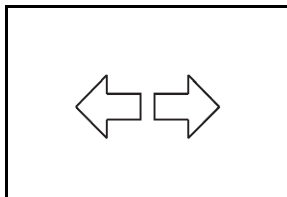

An arrow on the instrument panel cluster flashes in the direction of the turn or lane change.

For vehicles with the side blind zone alert system, an arrow in the outside mirror flashes when the turn signal is used. See *Side Blind Zone Alert (SBZA)* on page 3-36 for more information.

Move the lever all the way up or down to signal a turn.

Raise or lower the lever until the arrow starts to flash to signal a lane change. Hold it there until the lane change is complete. If the lever is briefly pressed and released, the turn signal will flash three times.

The lever returns to its starting position when it is released.

If after signaling a turn or lane change the arrow flashes rapidly or does not come on, a signal bulb may be burned out.

Have the bulbs replaced. If the bulb is not burned out, check the fuse. See *Fuses and Circuit Breakers* on page 6-108.

## Turn Signal On Chime

If the turn signal is left on, a warning chime sounds and the Driver Information Center (DIC) will display TURN SIGNAL ON after driving about a mile as a reminder to turn it off. See *DIC Warnings and Messages* on page 4-49.

## Headlamp High/Low-Beam Changer

To change the headlamps from low beam to high beam, push the turn signal lever away from you. To change from high beam to low beam, pull the turn signal lever toward you.

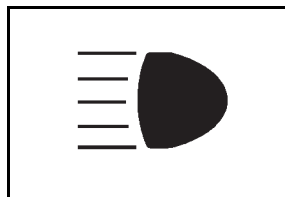

While the high beams are on, this light located on the instrument panel cluster will also be on.

## Flash-to-Pass

This feature lets you use the high-beam headlamps to signal the driver in front of you that you want to pass. It works even if your headlamps are off.

Pull the turn signal lever toward you briefly to flash-to-pass.

If the headlamps are off or on low beam, the high-beam headlamps will turn on. They will stay on as long as you hold the lever toward you and the high-beam indicator on the instrument panel cluster will come on.

## Windshield Wipers

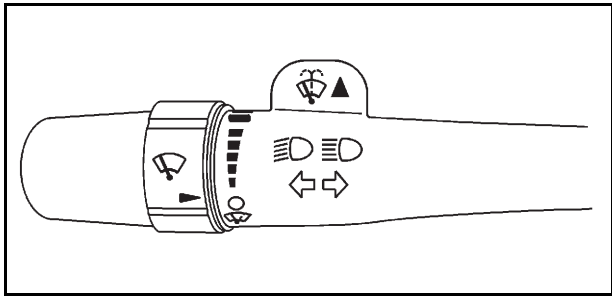

The windshield wiper lever is located on the left side of the steering column.

Turn the band with the wiper symbol on it to control the windshield wipers.

**(Mist):** For a single wiping cycle, hold it on mist until the wipers start, then release. The wipers stop after one wipe. Several wipes, hold the band longer.

**(Delay):** Use to set the delay time between wipe cycles. The wiper speed can be set for a long or short delay between wipes. The closer the band is set to the top of the lever, the shorter the delay.

**(Low Speed):** Slow wipes.

**(High Speed):** Fast wipes.

**(Off):** Turns the wipers off.

Clear ice and snow from the wiper blades before using them. If frozen to the windshield, carefully loosen or thaw them. Damaged blades should be replaced.

Heavy snow or ice can overload the wiper motor. A circuit breaker will stop the motor until it cools.

The vehicle has wiper-activated headlamps. After the windshield wipers have completed eight wipe cycles within four minutes, the headlamps automatically turn on. See *Wiper Activated Headlamps on page 4-11* for more information.

## Windshield Washer

### **WARNING:**

In freezing weather, do not use the washer until the windshield is warmed. Otherwise the washer fluid can form ice on the windshield, blocking your vision.

 **(Washer Fluid):** Press and release this paddle, located at the top of the turn signal/multifunction lever, to spray washer fluid on the windshield. The wipers will clear the windshield and either stop or return to the preset speed. For more washer cycles, press and hold the paddle.

## Cruise Control

With cruise control, you can maintain a speed of about 40 km/h (25 mph) or more without keeping your foot on the accelerator. Cruise control does not work at speeds below about 40 km/h (25 mph).

### **WARNING:**

Cruise control can be dangerous where you cannot drive safely at a steady speed. So, do not use the cruise control on winding roads or in heavy traffic.

Cruise control can be dangerous on slippery roads. On such roads, fast changes in tire traction can cause excessive wheel slip, and you could lose control. Do not use cruise control on slippery roads.

If your vehicle has the Traction Control System (TCS) and the cruise control is on, TCS will begin to limit wheel spin and the cruise control automatically turns off. See *Traction Control System (TCS)* on page 5-6. When road conditions allow you to safely use it again, the cruise control can be turned back on.

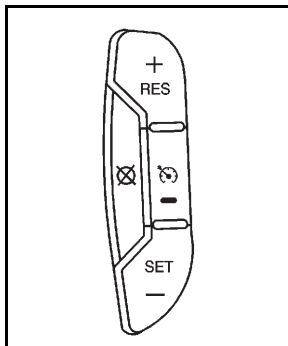

The cruise control buttons are located on left side of the steering wheel.

## Setting Cruise Control

If the cruise button is on when not in use, it could get bumped and go into cruise when not desired. Keep the cruise control switch off when cruise is not being used.

The cruise control light on the instrument panel cluster comes on after the cruise control has been set to the desired speed. See *Instrument Panel Cluster* on page 4-28.

1. Press the button to turn the cruise system on.
2. Get up to the desired speed.
3. Press and release the SET- button located on the steering wheel.
4. Take your foot off the accelerator.

## Resuming a Set Speed

If cruise control is set at a desired speed and then the brakes are applied, the cruise control is disengaged without erasing the set speed from memory.

Once the vehicle speed is 40 km/h (25 mph) or greater, press the +RES button on the steering wheel. The vehicle returns to the previously selected speed and stays there.

(On/Off): Press to turn the cruise control on or off. The indicator is lit when cruise control is on.

+ RES (Resume/Accelerate): Press briefly to make the vehicle resume to a previously set speed, or press and hold to accelerate.

SET- : Press to set the speed and activate cruise control or make the vehicle decelerate.

(Cancel): Press to disengage cruise control without erasing the set speed from memory.

## Increasing Speed While Using Cruise Control

If the cruise control system is already activated,

- Press and hold the +RES button on the steering wheel until the desired speed is reached, then release it.
- To increase vehicle speed in small increments, press the +RES button. Each time this is done, the vehicle goes about 1.6 km/h (1 mph) faster.

## Reducing Speed While Using Cruise Control

If the cruise control system is already activated,

- Press and hold the SET- button on the steering wheel until the lower speed desired is reached, then release it.
- To slow down in small amounts, press the SET- button briefly. Each time this is done, the vehicle goes about 1.6 km/h (1 mph) slower.

## Passing Another Vehicle While Using Cruise Control



Use the accelerator pedal to increase vehicle speed. When you take your foot off the pedal, the vehicle will slow down to the cruise speed you set earlier.

## Using Cruise Control on Hills

How well the cruise control will work on hills depends upon the vehicle speed, load and the steepness of the hills. When going up steep hills, you might have to step on the accelerator pedal to maintain your speed. When going downhill, you might have to brake or shift to a lower gear to keep your speed down. If the brakes are applied the cruise control will turn off.

## Ending Cruise Control

There are three ways to end cruise control:

- To disengage cruise control, step lightly on the brake pedal, or
- Press the  button on the steering wheel.
- To turn off the cruise control, press the  button on the steering wheel.

## Erasing Speed Memory

The cruise control set speed memory is erased from memory by pressing  or if the ignition is turned off.

## Exterior Lamps

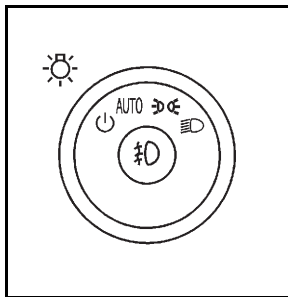

The exterior lamps control is located on the instrument panel to the left of the steering wheel.

It controls the following systems:

- Headlamps
- Taillamps
- Parking Lamps
- License Plate Lamps
- Instrument Panel Lights
- Fog Lamps

The exterior lamps control has four positions:

**⏻ (Off):** Turn the control to this position to turn off the exterior lamps.

**AUTO (Automatic):** Turn the control to this position to automatically turn on the headlamps at normal brightness, together with the following:

- Parking Lamps
- Instrument Panel Lights

**🚗 (Parking Lamps):** Turn the control to this position to turn on the parking lamps together with the following:

- Taillamps
- License Plate Lamps
- Instrument Panel Lights

**🚗 (Headlamps):** Turn the control to this position to turn on the headlamps together with the following lamps listed below. A warning chime sounds if the driver's door is opened while the ignition switch is off and the headlamps are on.

- Parking Lamps
- License Plate Lamps
- Instrument Panel Lights

**🚗 (Fog Lamps):** Push the exterior lamps control in to turn on the fog lamps.

See *Fog Lamps* on page 4-12.

## Wiper Activated Headlamps

This feature activates the headlamps and parking lamps after the windshield wipers are turned on and have completed eight wipe cycles within four minutes.

When the ignition is turned to LOCK/OFF, the wiper-activated headlamps immediately turn off. The wiper-activated headlamps also turn off if the windshield wipers are turned off.

## Headlamps on Reminder

If you leave the exterior lamp buttons for the headlamps or parking lamps on, remove the key from the ignition and open the driver's door, you will hear a continuous warning chime. The chime will turn off when the lamps are turned off.

## Daytime Running Lamps (DRL)

Daytime Running Lamps (DRL) can make it easier for others to see the front of your vehicle during the day. Fully functional daytime running lamps are required on all vehicles first sold in Canada.

A light sensor on top of the instrument panel monitors the exterior light level for the operation of DRL, so be sure it is not covered.

The DRL system makes the low-beam headlamps turn on at reduced brightness in daylight when the following conditions are met:

- The engine is running.
- The exterior lamp button for the headlamps is off.

When the DRL are on, only the low-beam headlamps will be on. The parking lamps, taillamps, sidemarker and other lamps will not be on.

When it is dark enough outside, the low-beam headlamps will come on. The other lamps that turn on with the headlamps will also turn on. When it is bright enough outside, the regular lamps will go off, and the low-beam headlamps change to the reduced brightness of DRL.

To turn off all exterior lighting at night when the vehicle is parked, turn the exterior lamp control to the off position. See *Exterior Lamps on page 4-10* for more information.

The regular headlamp system should be turned on when needed.

## Fog Lamps

The fog lamps button is on the exterior lamps control to the left of the steering column.

 **(Fog Lamps):** Press to turn the fog lamps on or off. A light comes on in the instrument panel cluster when the fog lamps are in use. See *Instrument Panel Cluster on page 4-28*. The ignition must be in the ON/RUN position for the fog lamps to work.

The fog lamps will go off when the headlamps are changed to high-beam.

Some localities have laws that require the headlamps to be on along with the fog lamps.

## Cornering Lamps

For vehicles with this feature, the cornering lamps come on when: the headlamps or parking lamps are on, the vehicle is not in P (Park), and you signal a turn with the turn signal/multifunction lever. They provide more light for cornering.

## Exterior Lighting Battery Saver

If the exterior lamp button has been left on, the exterior lamps will turn off about 10 minutes after the ignition is turned to LOCK/OFF and a door has been opened. This protects against draining the battery if the headlamps or parking lamps are accidentally left on. If the lamps need to be left on for more than 10 minutes, use the exterior lamp control to turn the lamps back on after the ignition is turned to LOCK/OFF and any door is opened.

## Instrument Panel Brightness

 **(Instrument Panel Brightness):** This feature controls the brightness of the instrument panel lights.

The knob for this control is located next to the exterior lamps control.

Push the knob in and release when it pops out. Turn the knob clockwise to increase the brightness of the instrument panel lights and counter clockwise to decrease the brightness. Turning the knob completely clockwise to the detent will turn on the courtesy lamps.



## Courtesy Lamps

When any door is opened, several lamps turn on making it easier for you to enter and exit the vehicle. Turn the instrument panel brightness control completely clockwise to manually turn on these lamps.

## Entry Lighting

If it is dark enough outside when you press the unlock button on the remote keyless entry transmitter, the interior courtesy lamps will turn on and stay on for about 40 seconds. The lamps can be turned off immediately by pressing the lock button on the remote keyless entry transmitter, turning the ignition key to ON/RUN or activating the power door locks.

## Delayed Entry Lighting

The interior lamps will turn on if you open the door when it is dark enough outside. When you close the door with the ignition off, the interior lamps will stay on for up to 25 seconds or until the ignition is turned to an on position. When the lamps turn off as a result of the 25 second timer or the ignition switch being turned on, the lighting will deactivate by way of the theater dimming effect. Locking the doors will override the delayed entry lighting feature and the lamps will turn off right away.

## Theater Dimming

This feature allows for a three to five second fade out of the courtesy lamps instead of immediate turn off.

## Delayed Exit Lighting

If it is dark enough outside when you remove the key from the ignition, the interior lamps will turn on and stay on for about 25 seconds. This will give you time to find the door pull handle or lock switches. Once the key is inserted into the ignition, the exit lighting will be cancelled and the lighting will fade out.

## Perimeter Lighting

If it is dark enough outside when the unlock button on the remote keyless entry transmitter is pressed, the DRL, parking lamps and back-up lamps will come on.

This feature can be programmed on for various amounts of time in seconds for each transmitter.

See *DIC Vehicle Customization on page 4-58* for information on programming.

## Front Reading Lamps

The front reading lamps are located on the headliner. Press the button near each lamp to turn them on or off.

## Electric Power Management

The vehicle has Electric Power Management (EPM) that estimates the battery's temperature and state of charge. It then adjusts the voltage for best performance and extended life of the battery.

When the battery's state of charge is low, the voltage is raised slightly to quickly bring the charge back up. When the state of charge is high, the voltage is lowered slightly to prevent overcharging. If the vehicle has a voltmeter gauge or a voltage display on the Driver Information Center (DIC), you may see the voltage move up or down. This is normal. If there is a problem, an alert will be displayed.

The battery can be discharged at idle if the electrical loads are very high. This is true for all vehicles. This is because the generator (alternator) may not be spinning fast enough at idle to produce all the power that is needed for very high electrical loads.

A high electrical load occurs when several of the following are on, such as: headlamps, high beams, fog lamps, rear window defogger, climate control fan at high speed, heated seats, engine cooling fans, trailer loads, and loads plugged into accessory power outlets.

EPM works to prevent excessive discharge of the battery. It does this by balancing the generator's output and the vehicle's electrical needs. It can increase engine idle speed to generate more power, whenever needed. It can temporarily reduce the power demands of some accessories.

Normally, these actions occur in steps or levels, without being noticeable. In rare cases at the highest levels of corrective action, this action may be noticeable to the driver. If so, a Driver Information Center (DIC) message might be displayed, such as BATTERY SAVER ACTIVE, BATTERY VOLTAGE LOW, or LOW BATTERY. If this message is displayed, it is recommended that the driver reduce the electrical loads as much as possible. See *DIC Warnings and Messages on page 4-49*.

## Inadvertent Power Battery Saver

This feature is designed to protect your vehicle's battery against drainage from the interior lamps, or garage door opener. When the ignition is turned off, the power to these features will automatically turn off after 10 minutes. Power will be restored for an additional 10 minutes if any door is opened, the trunk is opened or the courtesy lamp switch is turned on.

## Battery Run-Down Protection

This feature helps prevent the battery from being drained, if the interior courtesy lamps, reading/map lamps, visor vanity lamps or trunk lamp are accidentally left on. If any of these lamps are left on, they automatically turn off after 10 minutes, if the ignition is off. The lamps will not come back on again until one of the following occurs:

- The ignition is turned on.
- The exterior lamps control is turned off, then on again.

The headlamps will timeout after 10 minutes, if they are manually turned on with the ignition on or off.

## Accessory Power Outlet(s)

Accessory power outlets can be used to plug in electrical equipment, such as a cell phone or MP3 player.

The vehicle may have up to three power outlets depending on the type of front seat installed. If the vehicle has front bucket seats with a center console, there are two outlets inside the center console storage bin, one accessory power outlet and one USB port outlet. An extra accessory power outlet can be found under the climate control system next to the ashtray.

Remove the cover to access and replace when not in use.

### **WARNING:**

Power is always supplied to the outlets. Do not leave electrical equipment plugged in when the vehicle is not in use because the vehicle could catch fire and cause injury or death.

**Notice:** Leaving electrical equipment plugged in for an extended period of time while the vehicle is off will drain the battery. Always unplug electrical equipment when not in use and do not plug in equipment that exceeds the maximum 20 ampere rating.

Certain electrical accessories may not be compatible with the accessory power outlet and could overload vehicle or adapter fuses. If a problem is experienced, see your dealer.

When adding electrical equipment, be sure to follow the proper installation instructions included with the equipment. See *Add-On Electrical Equipment on page 6-107*.

**Notice:** Hanging heavy equipment from the power outlet can cause damage not covered by the vehicle warranty. The power outlets are designed for accessory power plugs only, such as cell phone charge cords.

## Ashtray(s)

**Notice:** If papers, pins, or other flammable items are put in the ashtray, hot cigarettes or other smoking materials could ignite them and possibly damage the vehicle. Never put flammable items in the ashtray.

For vehicles without the floor console, pull the tray located below the climate controls to reveal the ashtray. The ashtray can be removed by pulling on the ledge located at the top of the ashtray.

The vehicles with a full floor console do not have an ashtray. There is a storage bin below the climate control system. For more information, see *Front Storage Area on page 3-49*.

## Climate Controls

### Climate Control System

The heating, cooling, and ventilation for the vehicle can be controlled with this system.

For vehicles with the remote start feature, when activated, the climate control system heats or cools the inside of the vehicle with the settings used before the vehicle was turned off. The heated seats, if the vehicle has them, and the rear window defogger will also be turned on when it is cold outside. The cooled seat setting is not activated during a remote start. Normal operation of the system will return after the key is turned to the ON/RUN position. See *Remote Keyless Entry (RKE) System Operation on page 3-4* for more information.

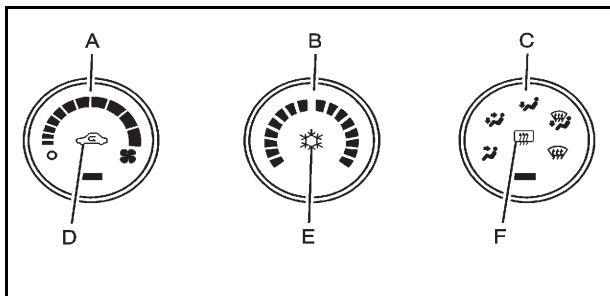

- |                              |                         |
|------------------------------|-------------------------|
| A. Fan Control               | D. Recirculation        |
| B. Temperature Control       | E. Air Conditioning     |
| C. Air Delivery Mode Control | F. Rear Window Defogger |

## Operation

**○ (Off):** Turns the climate control system off. Outside air still enters the vehicle and is directed to the floor. The airflow direction and temperature can be adjusted.

**Temperature Control:** Turn clockwise or counterclockwise to increase or decrease the temperature.

**☪ (Fan Control):** Turn clockwise or counterclockwise to increase or decrease the fan speed. The fan speed is temporarily reduced between the transition to a new mode. The fan will resume when the new mode is complete.

If the airflow seems low when the fan speed is at the highest setting, the passenger compartment air filter may need to be replaced. For more information, see *Passenger Compartment Air Filter* on page 4-25 and *Scheduled Maintenance* on page 7-3.

**Air Delivery Mode Control:** Turn clockwise or counterclockwise to change the direction of the airflow in the vehicle.

To change the current mode, select one of the following:

**☪ (Vent):** Air is directed to the instrument panel outlets.

**☪ (Bi-Level):** Air is divided between the instrument panel outlets and the floor outlets. Slightly cooler air is directed to the instrument panel outlets and warmer air is directed to the floor outlets.

**☪ (Floor):** Air is directed to the floor outlets, with some air directed to the windshield and side window outlets.

If recirculation is selected while in this mode, it stays on for three minutes to reduce windshield fogging.



 **(Floor/Defog):** This clears the windows of fog or moisture. Air is directed to the windshield and side window outlets and to the floor outlets. The system runs the air conditioning compressor unless the outside temperature is near or below freezing.

 **(Defrost):** This mode clears the windshield of fog or frost more quickly. Air is directed to the windshield and side window outlets. The system runs the air conditioning compressor unless the outside temperature is near or below freezing.

 **(Air Conditioning):** Press to turn the air conditioning system on or off. An indicator light below the button comes on to show that this mode is on. Air conditioning can be selected in any mode as long as the fan knob is not in the off position.

On hot days during the vehicle's initial start-up, open the windows to let hot inside air escape; then close them. This helps to reduce the time it takes for the vehicle to cool down. It also helps the system to operate more efficiently.

For quicker cool down on hot days, do the following:

1. Select .
2. Select .
3. Select .
4. Select the coolest temperature.
5. Select the highest fan speed.

The air-conditioning system removes moisture from the air, so a small amount of water might drip under the vehicle while idling or after turning off the engine. This is normal.

 **(Recirculation):** Press to turn the recirculation mode on. An indicator light below the button comes on to show that this mode is on. This mode recirculates and helps to quickly cool the air inside the vehicle. It can be used to prevent outside air and odors from entering the vehicle. This mode cannot be selected while in the defog or defrost modes. If you try to select the recirculation mode, the indicator light flashes three times and turns off.

Operation in this mode during periods of high humidity and cool outside temperatures may result in increased window fogging. If window fogging is experienced, select the defrost mode.

## Rear Window Defogger

The rear window defogger uses a warming grid to remove fog from the rear window.

 **(Rear Window Defogger):** Press to turn the rear window defogger on or off. An indicator light below the button comes on to show that the rear window defogger is on. Be sure to clear as much snow from the rear window as possible.

The rear window defogger only works when the ignition is in ON/RUN. The rear window defogger stays on for about 20 minutes after the button is pressed if traveling at slow speeds. At higher vehicle speeds, the rear defogger may stay on continuously. If turned on again, the defogger only runs for about 10 minutes before turning off. The defogger can be turned off by pressing the button again, by turning the ignition to ACC/ACCESSORY or ON/RUN, or by turning off the engine.

If the vehicle has heated outside rearview mirrors, the mirrors heat to help clear fog or frost from the surface of the mirror when the rear window defogger is on. See *Outside Heated Mirrors* on page 3-34 for more information.

**Notice:** Do not use anything sharp on the inside of the rear window. If you do, you could cut or damage the warming grid, and the repairs would not be covered by the vehicle warranty. Do not attach a temporary vehicle license, tape, a decal, or anything similar to the defogger grid.

## Dual Automatic Climate Control System

The heating, cooling, and ventilation for the vehicle can be controlled with this system.

For vehicles with the remote start feature and it is activated, the climate control system heats or cools the inside of the vehicle, with the settings used before the vehicle was turned off. The heated seats, if the vehicle has them, and the rear window defogger will be turned on by the climate control system when it is cold outside. The cooled seat setting is not activated during a remote start. Normal operation of the system will return after the key is turned to the ON/RUN position. See *Remote Keyless Entry (RKE) System Operation* on page 3-4 for more information.

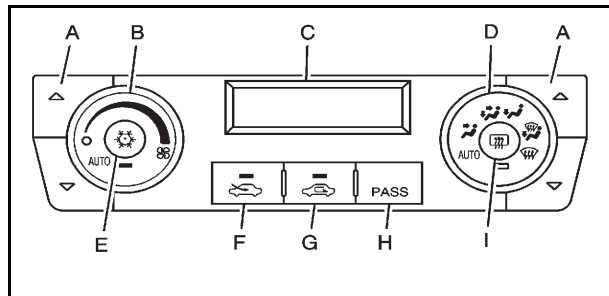

- |  |                         |
|--|-------------------------|
| A. Driver and Passenger Temperature Controls | E. Air Conditioning     |
| B. Fan Control                               | F. Outside Air          |
| C. Display                                   | G. Recirculation        |
| D. Air Delivery Mode Control                 | H. PASS                 |
|  | I. Rear Window Defogger |

### Automatic Operation

**AUTO (Automatic Fan):** When AUTO is selected on the fan control, the system automatically adjusts the fan speed. If the OnStar<sup>®</sup> system is activated when this position is selected, the fan speed will lower.



## AUTO (Automatic Mode)

1. Turn the fan control to AUTO.
2. Turn the mode control to AUTO.
3. Adjust the temperature to a comfortable setting between 68°F (21°C) and 78°F (26°C).

Choosing the coldest or warmest temperature setting will not cause the system to heat or cool any faster. In cold weather, the system starts at reduced fan speeds to avoid blowing cold air into the vehicle until warmer air is available. The system will start out blowing air to the floor, but may change modes automatically as the vehicle warms up to maintain the chosen temperature setting. The length of time needed to warm the interior depends on the outside temperature.

4. Wait a few minutes for the system to automatically regulate. Then adjust the temperature as necessary to find your comfort setting.

Do not cover the solar sensor located in the center of the instrument panel, near the windshield. For more information on the solar sensor, see “Sensors” later in this section.

After the vehicle is started, the display shows the interior temperature settings.

When the ENG/MET (English/metric) button on the Driver Information Center (DIC) is pressed, the display shows readings in Fahrenheit or Celsius. Use the ENG/MET button to toggle between the readings.



**AUTO (Automatic Air Conditioning):** If AUTO is selected on the fan or mode control, the system automatically controls the air conditioning compressor. The A/C compressor runs automatically even at cool outside temperatures in order to dehumidify the air. The A/C indicator light is lit when the system is operating automatically. Press the A/C button on the fan control to turn off the A/C. To clear windows better in defog or defrost modes, the A/C compressor runs automatically in damp cool conditions.



 **(Auto Recirculation):** If AUTO is selected on either the fan or mode control, the system automatically controls the supply of fresh outside air or recirculates the interior air to cool the car faster. The indicator light on the recirculation button will light whenever the system switches to recirculation. You may force outside air by pressing the outside air button. The next time AUTO fan or mode is selected, it will reset back to AUTO operation.

## Manual Operation

 **(Off):** Turns the climate control system off. Outside air still enters the vehicle and is directed to the floor. The airflow direction and temperature can be adjusted.

If the temperature is adjusted while the system is off, the display will light to show the current settings.

  **(Driver Temperature Controls):** Press these buttons next to the fan control to increase or decrease the temperature inside the vehicle.

  **(Passenger Temperature Controls):** Press these buttons next to the mode control to increase or decrease the temperature for the front passenger. If the passenger climate control system is off, pressing one of these buttons turns it on.

 **(Fan Control):** Turn clockwise or counterclockwise to increase or decrease the fan speed. Turning this control completely counterclockwise turns on the automatic fan operation.

If the airflow seems low when the fan speed is at the highest setting, the passenger compartment air filter may need to be replaced. For more information, see *Passenger Compartment Air Filter on page 4-25* and *Scheduled Maintenance on page 7-3*.

**Air Delivery Mode Control:** Turn clockwise or counterclockwise to change the direction of the airflow in the vehicle.

To change the current mode, select one of the following:

 **(Vent):** Air is directed to the instrument panel outlets.

 **(Bi-Level):** Air is divided between the instrument panel outlets and the floor outlets. In automatic operation, cooler air is directed to the upper outlets and warmer air to the floor outlets.

 **(Floor):** Air is directed to the floor outlets, with some air directed to the windshield and side window outlets.



If recirculation is selected while in this mode, it stays on for three minutes to reduce windshield fogging.

 **(Floor/Defog):** This mode clears the windows of fog or moisture. Air is directed to the floor outlets, with some air directed to the windshield and side window outlets. The system turns off recirculation and runs the air-conditioning compressor unless the outside temperature is at or below freezing. The recirculation mode cannot be selected while in the floor/defog mode.

 **(Defrost):** This mode removes fog or frost from the windshield more quickly. Air is directed to the windshield and the side window outlets. The system automatically turns off recirculation and runs the air-conditioning compressor, unless the outside temperature is at or below freezing. Recirculation cannot be selected while in the defrost mode.

 **(Air Conditioning):** Press to turn the air conditioning system on or off and override the automatic system. An indicator light below the button comes on to show that this mode is on.

The air conditioning system removes moisture from the air, so a small amount of water might drip under the vehicle while idling or after turning off the engine. This is normal.

 **(Outside Air):** Press to let outside air enter the vehicle. An indicator light comes on to show this mode is on. Pressing  cancels this mode.

 **(Recirculation):** Press to turn the recirculation mode on. An indicator light below the button comes on to show that this mode is on. This mode recirculates and helps to quickly cool the air inside the vehicle. It can be used to prevent outside air and odors from entering the vehicle. This mode cannot be selected while in the defog or defrost modes. If you try to select the recirculation mode, the indicator light flashes three times and turns off.

Operation in this mode during periods of high humidity and cool outside temperatures may result in increased window fogging. If window fogging is experienced, select the defrost mode.

**PASS (Passenger Climate Control):** Press to turn the passenger climate control systems on or off.

When the passenger climate control system is on, the passenger temperature setting is displayed.

If the PASS button is pressed to turn the passenger temperature setting off, the driver temperature setting controls the temperature for the entire vehicle.

## Sensors

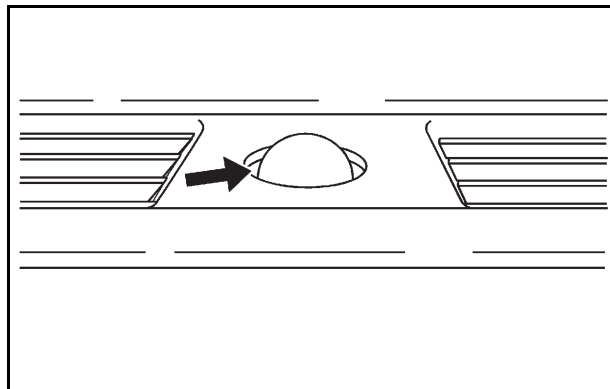

The solar sensor, located in the defrost grille, in the middle of the instrument panel, monitors the solar radiation. Do not cover the solar sensor or the system will not work properly.

There is also an interior temperature sensor located next to the steering wheel that measures the temperature of the air inside the vehicle.

There is also an exterior temperature sensor located behind the front grille. This sensor reads the outside air temperature and helps maintain the temperature inside the vehicle. Any cover on the front of the vehicle could cause a false temperature reading to display.

In order to prevent false temperature readings at startup, the displayed temperature will not change until the following occurs:

- Vehicle speed is above 10 mph (16 km/h) for five minutes.
- Vehicle speed is above 32 mph (51 km/h) for two and a half minutes.

The climate control system uses the information from these sensors to maintain your comfort setting by adjusting the outlet temperature, fan speed, and the air delivery mode. The system may also supply cooler air to the side of the vehicle facing the sun. The recirculation mode will also be used as needed to maintain cool outlet temperatures.

## Rear Window Defogger

The rear window defogger uses a warming grid to remove fog or frost from the rear window.

 **(Rear Defogger):** Press to turn the rear window defogger on or off. An indicator light below the button comes on to show that the rear window defogger is on. Be sure to clear as much snow from the rear window as possible.

The rear window defogger only works when the ignition is in ON/RUN. The rear window defogger stays on for about 20 minutes after the button is pressed if the vehicle is traveling at slower vehicle speeds. At higher vehicle speeds the rear window defogger may stay on continuously. If turned on again, the defogger only runs for about 10 minutes before turning off. The defogger can be turned off by pressing the button again, by turning the ignition to ACC/ACCESSORY or ON/RUN, or by turning off the engine.

The heated outside rearview mirrors will heat to help clear fog or frost from the surface of the mirror when the rear window defogger is on. See *Outside Heated Mirrors* on page 3-34 for more information.

**Notice:** Do not use a razor blade or sharp object to clear the inside rear window. Do not adhere anything to the defogger grid lines in the rear glass. These actions may damage the rear defogger. Repairs would not be covered by your warranty.

## Outlet Adjustment

Use the levers, located in the middle of the front outlets, to change the direction of the airflow. Use the thumbwheel located between the outlets to turn them on and off.

If the vehicle has rear seat outlets, adjust the direction of the airflow using the lever in the center of each outlet.

## Operation Tips

- Clear away any ice, snow, or leaves from the air inlets at the base of the windshield that could block the flow of air into the vehicle.
- Use of non-GM approved hood deflectors can adversely affect the performance of the system.
- Keep the path under the front seats clear of objects to help circulate the air inside the vehicle better.

## Passenger Compartment Air Filter

Outside air is routed through a passenger compartment air filter before entering the vehicle. This filter removes certain particles from the air, including pollen and dust particles. The filter should be replaced as part of routine scheduled maintenance. See *Scheduled Maintenance on page 7-3* for when to replace the filter.

The access panel for the passenger compartment air filter is located under the hood near the windshield, on the passenger's side of the vehicle.

To access the passenger compartment air filter, do the following:

1. Press the tabs back and left to remove the cover.

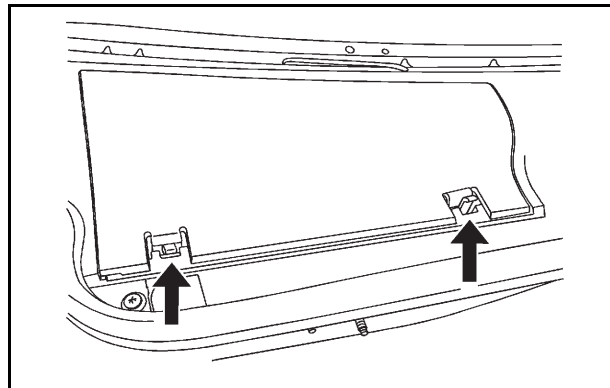

2. Insert a tool behind the push pin located on the inboard side of the air filter compartment to carefully pry the pin out.

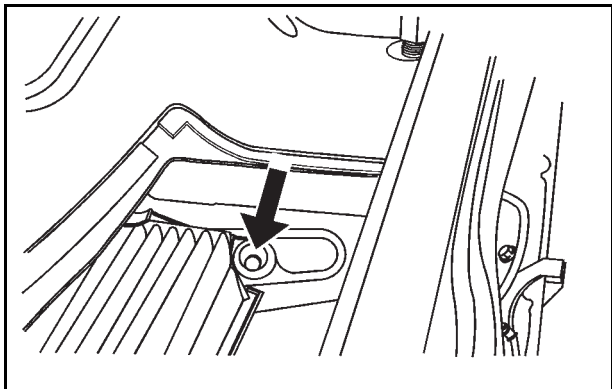

3. To remove the air filter, insert a tool between the air filter and the compartment wall on the outboard side of the vehicle. Then, push in to flatten the pin holding the air filter in place. Gently remove the air filter and any loose debris that may be inside the air filter compartment.

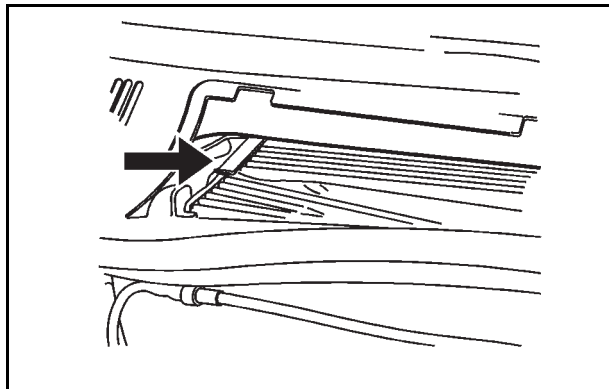

4. Insert the new air filter by pushing until you hear a click. Reinstall the push pin and snap the cover into place.

## Warning Lights, Gauges, and Indicators

Warning lights and gauges can signal that something is wrong before it becomes serious enough to cause an expensive repair or replacement. Paying attention to the warning lights and gauges could prevent injury.

Warning lights come on when there might be or there is a problem with one of the vehicle's functions. Some warning lights come on briefly when the engine is started to indicate they are working.

Gauges can indicate when there might be or there is a problem with one of the vehicle's functions. Often gauges and warning lights work together to indicate a problem with the vehicle.

When one of the warning lights comes on and stays on while driving, or when one of the gauges shows there could be a problem, check the section that explains what to do. Follow this manual's advice. Waiting to do repairs can be costly and even dangerous.





## Speedometer and Odometer

The speedometer shows the vehicle speed in both miles per hour (mph) and kilometers per hour (km/h). The odometer shows how far the vehicle has been driven, in either miles or kilometers.

This vehicle has a tamper resistant odometer.

If the vehicle needs a new odometer installed, the new one can be set to the mileage total of the old odometer. If this is not possible, it is set to zero and a label must be put on the driver's door to show the old mileage reading when the new odometer was installed.

## Trip Odometer

A trip odometer show how far the vehicle has been driven since the odometer was last set to zero. See *Driver Information Center (DIC) on page 4-42* for information on resetting the trip odometer.

## Tachometer

The tachometer displays the engine speed in revolutions per minute (rpm).

## Safety Belt Reminders

### Driver Safety Belt Reminder Light

When the engine is started, a chime sounds for several seconds to remind a driver to fasten the safety belt, unless the driver safety belt is already buckled.



The safety belt light comes on and stays on for several seconds, then flashes for several more.

This chime and light are repeated if the driver remains unbuckled and the vehicle is in motion. If the driver safety belt is already buckled, neither the chime nor the light comes on.

## Passenger Safety Belt Reminder Light

For vehicles equipped with the passenger safety belt reminder light, several seconds after the engine is started, a chime sounds for several seconds to remind the front passenger to buckle their safety belt. The passenger safety belt light, located on the instrument panel, comes on and stays on for several seconds and then flashes for several more.



This chime and light are repeated if the passenger remains unbuckled and the vehicle is in motion.

If the passenger safety belt is buckled, neither the chime nor the light comes on.

The front passenger safety belt warning light and chime may turn on if an object is put on the seat such as a briefcase, handbag, grocery bag, laptop or other electronic device. To turn off the warning light and/or chime, remove the object from the seat or buckle the safety belt.

## Airbag Readiness Light

The system checks the airbag's electrical system for possible malfunctions. If the light stays on it indicates there is an electrical problem. The system check includes the airbag sensor, the pretensioners, the airbag modules, the wiring and the crash sensing and diagnostic module. For more information on the airbag system, see *Airbag System* on page 2-55.



The airbag readiness light flashes for a few seconds when the engine is started. If the light does not come on then, have it fixed immediately.

### **WARNING:**

If the airbag readiness light stays on after the vehicle is started or comes on while driving, it means the airbag system might not be working properly. The airbags in the vehicle might not inflate in a crash, or they could even inflate without a crash. To help avoid injury, have the vehicle serviced right away.

If there is a problem with the airbag system, an airbag Driver Information Center (DIC) message can also come on. See *DIC Warnings and Messages on page 4-49* for more information.

## Passenger Airbag Status Indicator

The vehicle has the passenger sensing system. See *Passenger Sensing System on page 2-64* for important safety information. The overhead console has a passenger airbag status indicator.

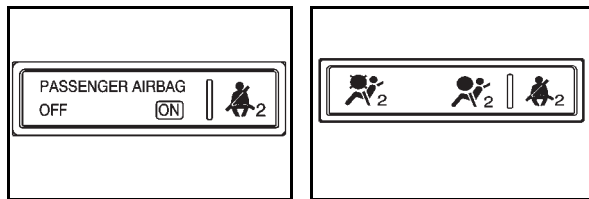

**United States**

**Canada**

When the vehicle is started, the passenger airbag status indicator will light ON and OFF, or the symbol for on and off, for several seconds as a system check.

If you are using remote start to start the vehicle from a distance, if equipped, you may not see the system check.

Then, after several more seconds, the status indicator will light either ON or OFF, or either the on or off symbol, to let you know the status of the right front passenger frontal and seat-mounted side impact airbags.

If the word ON or the on symbol is lit on the passenger airbag status indicator, it means that the right front passenger frontal airbag and seat-mounted side impact airbag are enabled (may inflate).

If the word OFF or the off symbol is lit on the passenger airbag status indicator, it means that the passenger sensing system has turned off the right front passenger frontal and seat-mounted side impact airbag.

If, after several seconds, both status indicator lights remain on, or if there are no lights at all, there may be a problem with the lights or the passenger sensing system. See your dealer for service.

## **WARNING:**

If the airbag readiness light ever comes on and stays on, it means that something may be wrong with the airbag system. To help avoid injury to yourself or others, have the vehicle serviced right away. See *Airbag Readiness Light on page 4-30* for more information, including important safety information.

## Charging System Light



This light comes on briefly when the ignition key is turned to START, but the engine is not running, as a check to show it is working.

If it does not, have the vehicle serviced by your dealer.

The light should go out once the engine starts. If it stays on, or comes on while driving, there could be a problem with the charging system. A charging system message in the Driver Information Center (DIC) can also appear. See *DIC Warnings and Messages on page 4-49* for more information. This light could indicate that there are problems with a generator drive belt, or that there is an electrical problem. Have it checked right away. If the vehicle must be driven a short distance with the light on, turn off accessories, such as the radio and air conditioner.

## Brake System Warning Light

The vehicle brake system consists of two hydraulic circuits. If one circuit is not working, the remaining circuit can still work to stop the vehicle. For normal braking performance, both circuits need to be working.

If the warning light comes on, there is a brake problem. Have the brake system inspected right away.



English



Metric

This light should come on briefly when the engine is started. If it does not come on then, have it fixed so it will be ready to warn if there is a problem.

When the ignition is on, the brake system warning light also comes on when the parking brake is set. The light will stay on if the parking brake does not fully release. If it stays on after the parking brake is fully released, it means there is a brake problem.

 **WARNING:**

The brake system might not be working properly if the brake system warning light is on. Driving with the brake system warning light on can lead to a crash. If the light is still on after the vehicle has been pulled off the road and carefully stopped, have the vehicle towed for service.

If the light comes on while driving, pull off the road and stop carefully. The pedal can be harder to push, or the pedal could go closer to the floor. It could take longer to stop. Try turning off and restarting the vehicle one or two times, if the light is still on, have the vehicle towed for service. See *Towing Your Vehicle on page 5-23*.

## Antilock Brake System (ABS) Warning Light

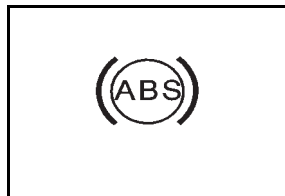

For vehicles with the Antilock Brake System (ABS), this light comes on briefly when the engine is started.

If it does not, have the vehicle serviced by your dealer. If the system is working normally the indicator light then goes off.

If the ABS light stays on, turn the ignition off. If the light comes on while driving, stop as soon as it is safely possible and turn the ignition off. Then start the engine again to reset the system. If the ABS light stays on, or comes on again while driving, the vehicle needs service. If the regular brake system warning light is not on, the vehicle still has brakes, but not antilock brakes.

If the regular brake system warning light is also on, the vehicle does not have antilock brakes and there is a problem with the regular brakes. See *Brake System Warning Light* on page 4-32.

For vehicles with a Driver Information Center (DIC), see *DIC Warnings and Messages* on page 4-49 for all brake related DIC messages.

## Traction Control System (TCS) Warning Light



The Traction Control System (TCS) light comes on briefly when the engine is started.

If it does not, have the vehicle serviced by your dealer. If the system is working normally the indicator light then goes off.

When the system is active, the light flashes while the system is limiting wheel spin or assisting with controlling the vehicle.

If it stays on or comes on while driving a SERVICE TRACTION CONTROL message appears in the Driver Information Center (DIC). This indicates that there could be a problem with the traction control system and the vehicle may need service. When this warning light is on and the SERVICE TRACTION CONTROL message appears on the DIC, the system does not limit wheel spin.

If the traction control system is manually turned off, this light comes on and the TRACTION CONTROL OFF message appears on the DIC.

See *Traction Control System (TCS)* on page 5-6 and *DIC Warnings and Messages* on page 4-49 for more information.

## StabiliTrak<sup>®</sup> Indicator Light



The StabiliTrak Indicator Light comes on briefly while starting the engine.

If it does not, have the vehicle serviced by your dealer. If the system is working normally the indicator light will then go off.

This light may come on while the vehicle is first driven and the STABILITRAK NOT READY message will appear in the Driver Information Center (DIC). See *StabiliTrak® System on page 5-5* for more information.

If the light stays on, or comes on while driving a SERVICE STABILITRAK message will appear in the DIC. This indicates that there may be a problem with the StabiliTrak system and the vehicle may need service. When this warning light is on and the SERVICE STABILITRAK message appears on the DIC, the system will not assist with controlling the vehicle.

When the system is active, the light will flash while the system is assisting with controlling the vehicle.

See *StabiliTrak® System on page 5-5* and *DIC Warnings and Messages on page 4-49* for more information.

## Lane Departure Warning (LDW) Light

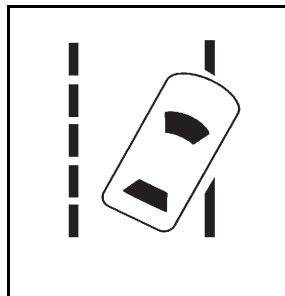

For vehicles with the lane departure warning system, this light briefly comes on green while starting the vehicle.

If it does not, have the vehicle serviced by your dealer. If the system is working normally the indicator light then goes off.

This light also comes on green if the system detects a left or right lane marking. It flashes, changes to amber, and three beeps sound, if a detected lane marking is crossed without using a turn signal. See *Lane Departure Warning (LDW) on page 3-40* for more information.

## Engine Coolant Temperature Warning Light

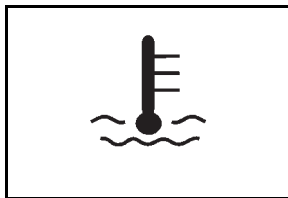

This light comes on briefly while starting the vehicle.

If it does not, have the vehicle serviced by the dealer. If the system is working normally the indicator light goes off.

**Notice:** Driving with the engine coolant temperature warning light on could cause the vehicle to overheat. See *Engine Overheating on page 6-35*. The vehicle's engine could be damaged, and it might not be covered by the vehicle warranty. Never drive with the engine coolant temperature warning light on.

The engine coolant temperature warning light comes on when the engine has overheated.

If this happens pull over and turn off the engine as soon as possible. See *Engine Overheating on page 6-35* for more information.

## Engine Coolant Temperature Gauge

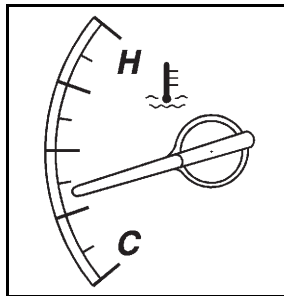

English

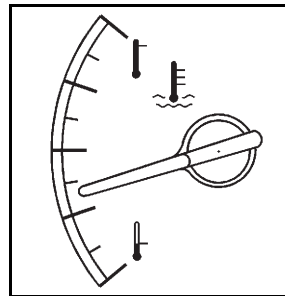

Metric

This gauge shows the engine coolant temperature. If the pointer moves towards the H (United States) or shaded in thermostat symbol area (Canada), the engine is too hot.

A temperature indicator light will turn on and a chime will sound.

If the vehicle has been operating under normal driving conditions, and the temperature indicator light comes on, pull off the road, stop the vehicle and turn off the engine as soon as possible.



## Tire Pressure Light



For vehicles with a Tire Pressure Monitoring System, this light comes on briefly when the engine is started. It provides information about tire pressures and the Tire Pressure Monitoring System.

### When the Light is On Steady

This indicates that one or more of the tires is significantly underinflated.

A tire pressure message in the Driver Information Center (DIC), can accompany the light. See *Driver Information Center (DIC) on page 4-42* for more information. Stop and check the tires as soon as it is safe to do so. If underinflated, inflate to the proper pressure. See *Inflation - Tire Pressure on page 6-64* for more information.

## When the Light Flashes First and Then is On Steady

This indicates that there may be a problem with the Tire Pressure Monitor System. The light flashes for about a minute and stays on steady for the remainder of the ignition cycle. This sequence repeats with every ignition cycle. See *Tire Pressure Monitor Operation on page 6-66* for more information.

## Malfunction Indicator Lamp

A computer system called OBD II (On-Board Diagnostics-Second Generation) monitors operation of the fuel, ignition, and emission control systems. It ensures that emissions are at acceptable levels for the life of the vehicle, helping to produce a cleaner environment.

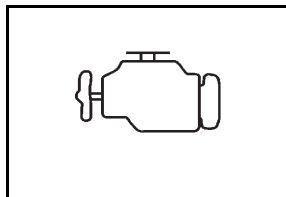

This light should come on when the ignition is on, but the engine is not running, as a check to show it is working. If it does not, have the vehicle serviced by your dealer.

If the Malfunction Indicator Lamp comes on and stays on, while the engine is running, this indicates that there is an OBD II problem and service is required.

Malfunctions often are indicated by the system before any problem is apparent. Being aware of the light can prevent more serious damage to the vehicle. This system assists the service technician in correctly diagnosing any malfunction.

**Notice:** If the vehicle is continually driven with this light on, after a while, the emission controls might not work as well, the vehicle fuel economy might not be as good, and the engine might not run as smoothly. This could lead to costly repairs that might not be covered by the vehicle warranty.

**Notice:** Modifications made to the engine, transmission, exhaust, intake, or fuel system of the vehicle or the replacement of the original tires with other than those of the same Tire Performance Criteria (TPC) can affect the vehicle's emission controls and can cause this light to come on. Modifications to these systems could lead to costly repairs not covered by the vehicle warranty. This could also result in a failure to pass a required Emission Inspection/Maintenance test. See *Accessories and Modifications on page 6-3*.

This light comes on during a malfunction in one of two ways:

**Light Flashing:** A misfire condition has been detected. A misfire increases vehicle emissions and could damage the emission control system on the vehicle. Diagnosis and service might be required.

To prevent more serious damage to the vehicle:

- Reduce vehicle speed.
- Avoid hard accelerations.
- Avoid steep uphill grades.
- If towing a trailer, reduce the amount of cargo being hauled as soon as it is possible.

If the light continues to flash, when it is safe to do so, stop the vehicle. Find a safe place to park the vehicle. Turn the vehicle off, wait at least 10 seconds, and restart the engine. If the light is still flashing, follow the previous steps and see your dealer for service as soon as possible.

**Light On Steady:** An emission control system malfunction has been detected on the vehicle. Diagnosis and service might be required.

The following may correct an emission system malfunction:

- Make sure the fuel cap is fully installed. See *Filling the Tank on page 6-9*. The diagnostic system can determine if the fuel cap has been left off or improperly installed. A loose or missing fuel cap allows fuel to evaporate into the atmosphere. A few driving trips with the cap properly installed should turn the light off.

- Make sure the electrical system is not wet. The system could be wet if the vehicle was driven through a deep puddle of water.
- Make sure to fuel the vehicle with quality fuel. Poor fuel quality causes the engine not to run as efficiently as designed and can cause: stalling after start-up, stalling when the vehicle is changed into gear, misfiring, hesitation on acceleration, or stumbling on acceleration. These conditions might go away once the engine is warmed up.

If one or more of these conditions occurs, change the fuel brand used. It will require at least one full tank of the proper fuel to turn the light off.

See *Gasoline Octane* on page 6-6.

If none of the above have made the light turn off, your dealer can check the vehicle. The dealer has the proper test equipment and diagnostic tools to fix any mechanical or electrical problems that might have developed.

## Emissions Inspection and Maintenance Programs

Some state/provincial and local governments may have programs to inspect the on-vehicle emission control equipment. For the inspection, the emission system test equipment is connected to the vehicle's Data Link Connector (DLC).

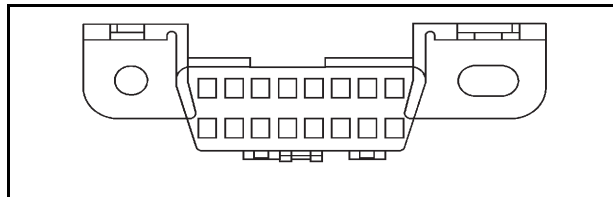

The DLC is under the instrument panel to the left of the steering wheel. See your dealer if assistance is needed.

The vehicle may not pass inspection if:

- the Malfunction Indicator Lamp is on with the engine running, or if the light does not come on when the ignition is turned to ON/RUN while the engine is off.
- the critical emission control systems have not been completely diagnosed by the system. This can happen if the battery has recently been replaced or if the battery has run down. The diagnostic system evaluates critical emission control systems during normal driving. This can take several days of routine driving. If this has been done and the vehicle still does not pass the inspection, your dealer can prepare the vehicle for inspection.

## Oil Pressure Light



### **WARNING:**

Do not keep driving if the oil pressure is low. The engine can become so hot that it catches fire. Someone could be burned. Check the oil as soon as possible and have the vehicle serviced.

**Notice:** Lack of proper engine oil maintenance can damage the engine. The repairs would not be covered by the vehicle warranty. Always follow the maintenance schedule for changing engine oil.

This light comes on briefly while starting the engine. If it does not, have the vehicle serviced by your dealer. If the system is working normally the indicator light then goes off.

If the light comes on and stays on, it means that oil is not flowing through the engine properly. The vehicle could be low on oil and it might have some other system problem.

## Security Light



For information regarding this light and the vehicle's security system, see *Content Theft-Deterrent* on page 3-16.

## Front Fog Lamp Light

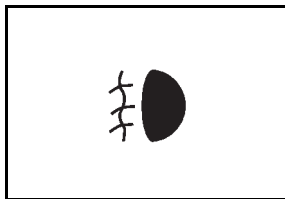

The fog lamp light comes on when the fog lamps are in use.

The light goes out when the fog lamps are turned off. See *Fog Lamps* on page 4-12 for more information.

## Cruise Control Light

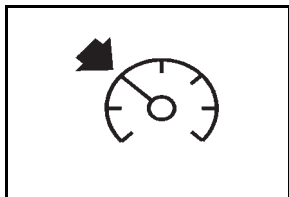

The cruise control light comes on whenever the cruise control is set.

The light goes out when the cruise control is turned off. See *Cruise Control on page 4-7* for more information.

## Highbeam On Light

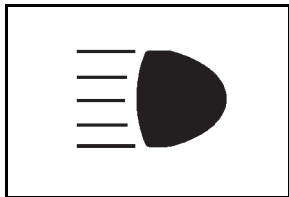

This light comes on when the high-beam headlamps are in use.

See *Headlamp High/Low-Beam Changer on page 4-5* for more information.

## Fuel Gauge

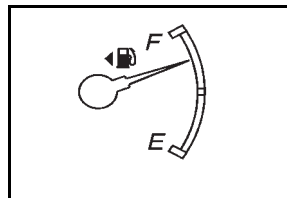

English

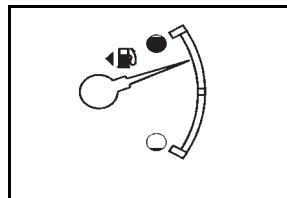

Metric

The fuel gauge shows about how much fuel is in the tank.

An arrow on the fuel gauge indicates the side of the vehicle the fuel door is on.

The gauge works only when the ignition is on. When the indicator moves to the edge of the low fuel warning band, the low fuel warning light comes on and a chime sounds. The vehicle still has a little fuel left, but the vehicles fuel tank should be filled soon.

Here are some things that some owners ask about. None of these show a problem with the fuel gauge:

- At the service station, the gas pump shuts off before the gauge reads full.
- It takes more (or less) fuel to fill up than the gauge indicated. For example, the gauge may have indicated half full, but it took more (or less) than half the tank's capacity to fill it.
- The gauge moves up a little while turning a corner, speeding up or making a hard stop.
- The gauge does not go back to empty when the ignition is turned off.

## Driver Information Center (DIC)

Your vehicle has a Driver Information Center (DIC).

All messages will appear in the DIC display located below the speedometer in the instrument panel cluster. The DIC buttons are located on the instrument panel, to the left of the instrument panel cluster.

The DIC comes on when the ignition is on. After a short delay, the DIC will display the information that was last displayed before the engine was turned off.

The DIC displays trip, fuel, and vehicle system information, and warning messages if a system problem is detected. The bottom line of the DIC shows the shift lever position indicator. See *Automatic Transmission Operation on page 3-24* for more information.

If your vehicle's DIC has these features, the compass direction and the outside air temperature may also display on the DIC when viewing the trip and fuel information. The compass direction appears on the top right corner of the DIC display. The outside air temperature automatically appears in the bottom right corner of the DIC display. If there is a problem with the system that controls the temperature display, the numbers will be replaced with dashes. If this occurs, have the vehicle serviced by your dealer.

The DIC also allows some features to be customized. See *DIC Vehicle Customization on page 4-58* for more information.

## DIC Operation and Displays

The DIC has different displays which can be accessed by pressing the DIC buttons located on the instrument panel, to the left of the instrument panel cluster.

## DIC Buttons

The buttons are the trip/fuel, vehicle information, customization, and set/reset buttons. The button functions are detailed in the following pages.

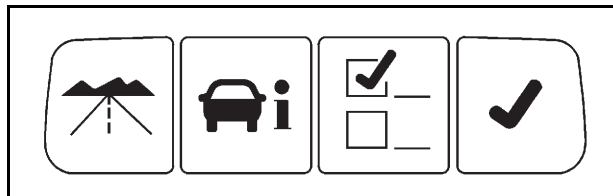

 **(Trip/Fuel):** Press this button to display the odometer, trip odometers, fuel range, average economy, instantaneous economy, and average speed.

 **(Vehicle Information):** Press this button to display the oil life, units, park assist on vehicles with this feature, side blind zone alert on vehicles with this feature, tire pressure readings on vehicles with this feature, and compass zone and compass calibration on vehicles with this feature.

 **(Customization):** Press this button to customize the feature settings on your vehicle. See *DIC Vehicle Customization on page 4-58* for more information.

 **(Set/Reset):** Press this button to set or reset certain functions and to turn off or acknowledge messages on the DIC.

## Trip/Fuel Menu Items

 **(Trip/Fuel):** Press this button to scroll through the following menu items:

### Odometer

Press the trip/fuel button until ODOMETER displays. This display shows the distance the vehicle has been driven in either kilometers (km) or miles (mi).

### Trip A and Trip B

Press the trip/fuel button until TRIP A or TRIP B displays. This display shows the current distance traveled in either kilometers (km) or miles (mi) since the last reset for each trip odometer. Both trip odometers can be used at the same time.

Each trip odometer can be reset to zero separately by pressing the set/reset button while the desired trip odometer is displayed.

The trip odometer has a feature called the retro-active reset. This can be used to set the trip odometer to the number of kilometers (miles) driven since the ignition was last turned on. This can be used if the trip odometer is not reset at the beginning of the trip.

To use the retro-active reset feature, press and hold the set/reset button for at least four seconds. The trip odometer will display the number of kilometers (km) or miles (mi) driven since the ignition was last turned on and the vehicle was moving. Once the vehicle begins moving, the trip odometer will accumulate mileage. For example, if the vehicle was driven 8 km (5 miles) before it is started again, and then the retro-active reset feature is activated, the display will show 8 km (5 miles). As the vehicle begins moving, the display will then increase to 8.2 km (5.1 miles), 8.4 km (5.2 miles), etc.

If the retro-active reset feature is activated after the vehicle is started, but before it begins moving, the display will show the number of kilometers (km) or miles (mi) that were driven during the last ignition cycle.

## Fuel Range

Press the trip/fuel button until FUEL RANGE displays. This display shows the approximate number of remaining kilometers (km) or miles (mi) the vehicle can be driven without refueling.

The fuel range estimate is based on an average of the vehicle's fuel economy over recent driving history and the amount of fuel remaining in the fuel tank. This estimate will change if driving conditions change. For example, if driving in traffic and making frequent stops, this display may read one number, but if the vehicle is driven on a freeway, the number may change even though the same amount of fuel is in the fuel tank.

This is because different driving conditions produce different fuel economies. Generally, freeway driving produces better fuel economy than city driving.

If your vehicle is low on fuel, the FUEL LEVEL LOW message will be displayed. See "FUEL LEVEL LOW" under *DIC Warnings and Messages on page 4-49* for more information.

## Average Economy

Press the trip/fuel button until AVG ECONOMY displays. This display shows the approximate average liters per 100 kilometers (L/100 km) or miles per gallon (mpg). This number is calculated based on the number of L/100 km (mpg) recorded since the last time this menu item was reset. To reset AVG ECONOMY, press and hold the set/reset button. The display will return to zero.

## Instantaneous Economy

Press the trip/fuel button until INST ECONOMY displays. This display shows the current fuel economy at a particular moment and will change frequently as driving conditions change. This display shows the instantaneous fuel economy in liters per 100 kilometers (L/100 km) or miles per gallon (mpg). Unlike average economy, this screen cannot be reset.



## Average Speed

Press the trip/fuel button until AVERAGE SPEED displays. This display shows the average speed of the vehicle in kilometers per hour (km/h) or miles per hour (mph). This average is calculated based on the various vehicle speeds recorded since the last reset of this value. To reset the value, press and hold the set/reset button. The display will return to zero.

## Blank Display

This display shows no information.

## Vehicle Information Menu Items

 **(Vehicle Information):** Press this button to scroll through the following menu items:

### Oil Life

Press the vehicle information button until OIL LIFE REMAINING displays. This display shows an estimate of the oil's remaining useful life. If you see 99% OIL LIFE REMAINING on the display, that means 99% of the current oil life remains. The engine oil life system will alert you to change the oil on a schedule consistent with your driving conditions.

When the remaining oil life is low, the CHANGE ENGINE OIL SOON message will appear on the display. See “CHANGE ENGINE OIL SOON” under *DIC Warnings and Messages* on page 4-49. You should change the oil as soon as possible. See *Engine Oil* on page 6-18. In addition to the engine oil life system monitoring the oil life, additional maintenance is recommended in the Maintenance Schedule in this manual. See *Scheduled Maintenance* on page 7-3 for more information.

Remember, you must reset the OIL LIFE yourself after each oil change. It will not reset itself. Also, be careful not to reset the OIL LIFE accidentally at any time other than when the oil has just been changed. It cannot be reset accurately until the next oil change. To reset the engine oil life system, see *Engine Oil Life System* on page 6-22.

### Units

Press the vehicle information button until UNITS displays. This display allows you to select between Metric or English units of measurement. Once in this display, press the set/reset button to select between ENGLISH or METRIC units.

## Park Assist

If your vehicle has the Ultrasonic Rear Parking Assist (URPA) system, this display allows the system to be turned on or off. Press the vehicle information button until PARK ASSIST displays. Once in this display, press the set/reset button to select between ON or OFF. If you choose ON, the system will be turned on. If you choose OFF, the system will be turned off. The URPA system automatically turns back on after each vehicle start. When the URPA system is turned off and the vehicle is shifted out of PARK (P), the DIC will display the PARK ASSIST OFF message as a reminder that the system has been turned off. See *DIC Warnings and Messages on page 4-49* and *Ultrasonic Rear Parking Assist (URPA) on page 3-35* for more information.

## Side Blind Zone

If your vehicle has the Side Blind Zone Alert (SBZA) system, this display allows the system to be turned on or off. Press the vehicle information button until SIDE BLIND ZONE displays. Once in this display, press the set/reset button to select between ON or OFF. If you choose ON, the system will be turned on. If you choose OFF, the system will be turned off. When the SBZA system is turned off, the DIC will display the SIDE BLIND ZONE ALERT SYSTEM OFF message as a reminder that the system has been turned off. See *DIC Warnings and Messages on page 4-49* and *Side Blind Zone Alert (SBZA) on page 3-36* for more information.

## Tire Pressure

On vehicles with the Tire Pressure Monitor System (TPMS), the pressure for each tire can be viewed in the DIC. The tire pressure will be shown in either pounds per square inch (psi) or kilopascals (kPa). Press the vehicle information button until the DIC displays FRONT TIRES PSI (kPa) LEFT ## RIGHT ##. Press the vehicle information button again until the DIC displays REAR TIRES PSI (kPa) LEFT ## RIGHT ##.

If a low tire pressure condition is detected by the system while driving, a message advising you to check the pressure in a specific tire will appear in the display. See *Inflation - Tire Pressure on page 6-64* and *DIC Warnings and Messages on page 4-49* for more information.

If the tire pressure display shows dashes instead of a value, there may be a problem with your vehicle. If this consistently occurs, see your dealer for service.

## Change Compass Zone

Your vehicle may have this feature. To change the compass zone through the DIC, see *DIC Compass on page 4-47*.

## Calibrate Compass

Your vehicle may have this feature. The compass can be manually calibrated. To calibrate the compass through the DIC, see *DIC Compass on page 4-47*.

## Blank Display

This display shows no information.

## Customization Menu Items

**☰ (Customization):** Press this button to enter the feature settings menu. This display allows you to customize the feature settings on your vehicle. See *DIC Vehicle Customization on page 4-58* for more information.

## DIC Compass

Your vehicle may have a compass in the Driver Information Center (DIC). The information below explains how to operate this feature in the DIC.

If your vehicle has a compass in the mirror, see *Compass on page 3-32*.

## Compass Zone

Your dealer will set the correct zone for your location. If the zone is not set to your location or you drive out of the area, the variance needs to be changed to the appropriate zone.

To adjust for compass variance, use the following procedure:

### Compass Variance (Zone) Procedure

1. Do not set the compass zone when the vehicle is moving. Only set it when the vehicle is in P (Park). Press the vehicle information button until **PRESS ✓ TO CHANGE COMPASS ZONE** displays.

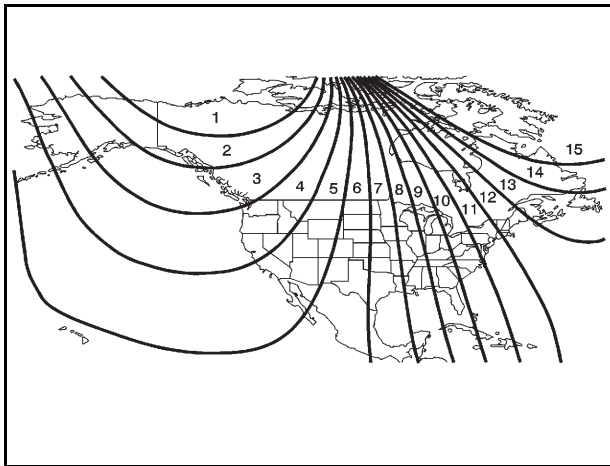

2. Find the vehicle's current location and variance zone number on the map.  
Zones 1 through 15 are available.
3. Press the set/reset button to scroll through and select the appropriate variance zone.
4. Press the trip/fuel button until the vehicle heading, for example, N for North, is displayed in the DIC.
5. If calibration is necessary, calibrate the compass. See "Compass Calibration Procedure" following.

## Compass Calibration

The compass can be manually calibrated. Only calibrate the compass in a magnetically clean and safe location, such as an open parking lot, where driving the vehicle in circles is not a danger. It is suggested to calibrate away from tall buildings, utility wires, manhole covers, or other industrial structures, if possible.

If CAL should ever appear in the DIC display, the compass should be calibrated.

If the DIC display does not show a heading, for example, N for North, or the heading does not change after making turns, there may be a strong magnetic field interfering with the compass. Interference may be caused by a magnetic antenna mount, magnetic note pad holder, or any other magnetic item. Turn off the vehicle, move the magnetic item, then turn on the vehicle and calibrate the compass.

To calibrate the compass, use the following procedure:

### Compass Calibration Procedure

1. Before calibrating the compass, check that the compass zone is set to the variance zone in which the vehicle is located. See "Compass Variance (Zone) Procedure" earlier in this section.

Do not operate any switches such as window, sunroof, climate controls, seats, etc. during the calibration procedure.

2. Press the vehicle information button until **PRESS ✓ TO CALIBRATE COMPASS** displays.
3. Press the set/reset button to start the compass calibration.
4. The DIC will display **CALIBRATING: DRIVE IN CIRCLES**. Drive the vehicle in tight circles at less than 5 mph (8 km/h) to complete the calibration. The DIC will display **CALIBRATION COMPLETE** for a few seconds when the calibration is complete. The DIC display will then return to **PRESS ✓ TO CALIBRATE COMPASS**.

## DIC Warnings and Messages

Messages are displayed on the DIC to notify the driver that the status of the vehicle has changed and that some action may be needed by the driver to correct the condition. Multiple messages may appear one after another. Some messages may not require immediate action, but you can press the set/reset button to acknowledge that you received the message and clear it from the DIC display. Pressing any of the DIC buttons also acknowledges and clears any messages. Some messages cannot be cleared from the DIC display because they are more urgent. These messages require action before they can be cleared. You should take any messages that appear on the display seriously and remember that clearing the messages will only make

the messages disappear, not correct the problem. The following are the possible messages that can be displayed and some information about them.

### **AUTOMATIC LIGHT CONTROL OFF**

This message displays when the automatic headlamps are turned off. See *Exterior Lamps on page 4-10* for more information.

### **AUTOMATIC LIGHT CONTROL ON**

This message displays when the automatic headlamps are turned on. See *Exterior Lamps on page 4-10* for more information.

### **BATTERY SAVER ACTIVE**

This message displays when the system detects that the battery voltage is dropping beyond a reasonable level. The battery saver system starts reducing certain features of the vehicle that you may be able to notice. At the point that the features are disabled, this message is displayed. It means that the vehicle is trying to save the charge in the battery.

Turn off all unnecessary accessories to allow the battery to recharge.

The normal battery voltage range is 11.5 to 15.5 volts.

## CHANGE ENGINE OIL SOON

This message displays when service is required for the vehicle. See your dealer. See *Engine Oil on page 6-18* and *Scheduled Maintenance on page 7-3* for more information.

Acknowledging the CHANGE ENGINE OIL SOON message will not reset the OIL LIFE REMAINING. That must be done at the OIL LIFE screen under the vehicle information menu. See "Oil Life" under *DIC Operation and Displays on page 4-42* and *Engine Oil Life System on page 6-22*.

## DRIVER DOOR OPEN

This message displays when the driver door is not closed properly. Make sure that the door is closed completely.

## ENGINE HOT A/C (Air Conditioning) OFF

This message displays when the engine coolant becomes hotter than the normal operating temperature. To avoid added strain on a hot engine, the air conditioning compressor is automatically turned off. When the coolant temperature returns to normal, the A/C operation automatically resumes. You can continue to drive your vehicle. If this message continues to appear, have the system repaired by your dealer as soon as possible to avoid compressor damage.

## ENGINE OVERHEATED IDLE ENGINE

**Notice:** If you drive your vehicle while the engine is overheating, severe engine damage may occur. If an overheat warning appears on the instrument panel cluster and/or DIC, stop the vehicle as soon as possible. Do not increase the engine speed above normal idling speed. See *Engine Overheating on page 6-35* for more information.

This message displays when the engine coolant temperature is too hot. Stop and allow the vehicle to idle until it cools down.

## ENGINE OVERHEATED STOP ENGINE

**Notice:** If you drive your vehicle while the engine is overheating, severe engine damage may occur. If an overheat warning appears on the instrument panel cluster and/or DIC, stop the vehicle as soon as possible. See *Engine Overheating on page 6-35* for more information.

This message displays along with a continuous chime when the engine has overheated. Stop and turn the engine off immediately to avoid severe engine damage. See *Engine Overheating on page 6-35*.

## **ENGINE POWER IS REDUCED**

This message displays when the vehicle's engine power is reduced. Reduced engine power can affect the vehicle's ability to accelerate. If this message is on, but there is no reduction in performance, proceed to your destination. The performance may be reduced the next time the vehicle is driven. The vehicle may be driven at a reduced speed while this message is on, but acceleration and speed may be reduced. Anytime this message stays on, the vehicle should be taken to your dealer for service as soon as possible.

## **ERROR**

This message displays while viewing the odometer or trip odometers if there is a problem with the instrument panel cluster. See your dealer for service.

## **FUEL LEVEL LOW**

This message displays when your vehicle is low on fuel. Refill the fuel tank as soon as possible. See *Fuel Gauge on page 4-41* and *Filling the Tank on page 6-9* for more information.

## **HOOD OPEN**

If your vehicle has the remote start feature, this message displays when the hood is not closed properly. Make sure that the hood is closed completely. See *Hood Release on page 6-13*.

## **ICE POSSIBLE DRIVE WITH CARE**

This message displays when the outside air temperature is cold enough to create icy road conditions. Adjust your driving accordingly.

## **LANE DEPARTURE SYSTEM UNAVAILABLE**

If your vehicle has the Lane Departure Warning (LDW) system, this message may display if the LDW system does not activate due to a temporary condition. See *Lane Departure Warning (LDW) on page 3-40* for more information.

## **LEFT REAR DOOR OPEN**

This message displays when the driver side rear door is not closed properly. Make sure that the door is closed completely.

## **OIL LEVEL LOW ADD OIL**

On some vehicles, this message displays when the vehicle's engine oil is low. Fill the oil to the proper level as soon as possible. See *Engine Compartment Overview on page 6-14* for the engine oil fill location. Also, see *Engine Oil on page 6-18* for information on the kind of oil to use and the proper oil level.

## OIL PRESSURE LOW STOP ENGINE

**Notice:** If you drive your vehicle while the engine oil pressure is low, severe engine damage may occur. If a low oil pressure warning appears on the instrument panel cluster and/or DIC, stop the vehicle as soon as possible. Do not drive the vehicle until the cause of the low oil pressure is corrected. See *Engine Oil on page 6-18* for more information.

This message displays when the vehicle's engine oil pressure is low. The oil pressure light also appears on the instrument panel cluster. See *Oil Pressure Light on page 4-40*.

Stop the vehicle immediately, as engine damage can result from driving a vehicle with low oil pressure. Have the vehicle serviced by your dealer as soon as possible when this message is displayed.

## PARK ASSIST OFF

If your vehicle has this feature, after the vehicle has been started, this message will remind the driver that the Ultrasonic Rear Parking Assist (URPA) system has been turned off. Press the set/reset button to acknowledge this message and clear it from the DIC display. To turn the URPA system back on, see "Park Assist" under *DIC Operation and Displays on page 4-42*. See *Ultrasonic Rear Parking Assist (URPA) on page 3-35* for more information.

## PASSENGER DOOR OPEN

This message displays when the front passenger door is not closed properly. Make sure that the door is closed completely.

## REMOTE KEY LEARNING ACTIVE

This message displays while you are matching a Remote Keyless Entry (RKE) transmitter to your vehicle. See "Matching Transmitter(s) to Your Vehicle" under *Remote Keyless Entry (RKE) System Operation on page 3-4* and *DIC Operation and Displays on page 4-42* for more information.

## REPLACE BATTERY IN REMOTE KEY

This message displays when the battery in the Remote Keyless Entry (RKE) transmitter needs to be replaced. To replace the battery, see "Battery Replacement" under *Remote Keyless Entry (RKE) System Operation on page 3-4*.

## RIGHT REAR DOOR OPEN

This message displays when the passenger side rear door is not closed properly. Make sure that the door is closed completely.



## **SERVICE A/C (Air Conditioning) SYSTEM**

This message displays when the electronic sensors that control the air conditioning and heating systems are no longer working. Have the climate control system serviced by your dealer if you notice a drop in heating and air conditioning efficiency.

## **SERVICE AIR BAG**

This message displays when there is a problem with the airbag system. Have your vehicle serviced by your dealer immediately. See *Airbag Readiness Light on page 4-30* for more information.

## **SERVICE BATTERY CHARGING SYSTEM**

This message displays when there is a problem with the generator and battery charging systems. Driving with this problem could drain the battery. Turn off all unnecessary accessories. Stop and turn off the vehicle as soon as it is safe to do so. Have the electrical system checked by your dealer immediately.

## **SERVICE BRAKE ASSIST**

This message displays if there is a problem with the brake system. The brake system warning light and the antilock brake system warning light may also be displayed on the instrument panel cluster. See *Brake System Warning Light on page 4-32* and *Antilock Brake System (ABS) Warning Light on page 4-33* for more information. If this happens, stop as soon as possible and turn off the vehicle. Restart the vehicle and check for the message on the DIC display. If the message is displayed or appears again when you begin driving, the brake system needs service. See your dealer as soon as possible. See *Brakes on page 6-39* for more information.

## **SERVICE BRAKE SYSTEM**

This message displays if the ignition is on to inform the driver that the brake fluid level is low. Have the brake system serviced by your dealer as soon as possible. The brake system warning light also appears on the instrument panel cluster when this message appears on the DIC. See *Brake System Warning Light on page 4-32*.

## SERVICE LANE DEPARTURE SYSTEM

If your vehicle has the Lane Departure Warning (LDW) system, this message may display to indicate that the LDW system is not working properly. If this message remains on after continued driving, the system needs service. See your dealer. See *Lane Departure Warning (LDW) on page 3-40* for more information.

## SERVICE PARK ASSIST

If your vehicle has this feature, this message displays if there is a problem with the Ultrasonic Rear Parking Assist (URPA) system. Do not use this system to help you park. See *Ultrasonic Rear Parking Assist (URPA) on page 3-35* for more information. See your dealer for service.

## SERVICE POWER STEERING

Your vehicle may have a speed variable assist steering system. See *Steering on page 5-8*.

This message displays if a problem is detected with the speed variable assist steering system. When this message is displayed, you may notice that the effort required to steer the vehicle decreases or feels lighter, but you will still be able to steer the vehicle.

## SERVICE SIDE BLIND ZONE ALERT SYSTEM

If your vehicle has the Side Blind Zone Alert (SBZA) system and this message displays, both SBZA displays will remain on indicating there is a problem with the SBZA system. If these displays remain on after continued driving, the system needs service. See your dealer. See *Side Blind Zone Alert (SBZA) on page 3-36* for more information.

## SERVICE STABILITRAK

If your vehicle has StabiliTrak<sup>®</sup>, this message displays if there has been a problem detected with StabiliTrak. A warning light also appears on the instrument panel cluster. See *Traction Control System (TCS) Warning Light on page 4-34*. See *StabiliTrak<sup>®</sup> System on page 5-5* for more information.

If this message turns on while you are driving, pull off the road as soon as possible and stop carefully. Try resetting the system by turning the ignition off and then back on. If this message still stays on or turns back on again while you are driving, your vehicle needs service. Have the StabiliTrak System inspected by your dealer as soon as possible.

## SERVICE SUSPENSION SYSTEM

This message displays to indicate that the suspension system is not operating properly. See your dealer for service.

## SERVICE THEFT SYSTEM

This message displays when there is a problem with the theft-deterrent system programmed in the key. A fault has been detected in the system which means that the system is disabled and it is not protecting the vehicle. The vehicle usually restarts; however, you may want to take the vehicle to your dealer before turning off the engine. See *PASS-Key® III+ Electronic Immobilizer on page 3-17* for more information.

## SERVICE TIRE MONITOR SYSTEM

On vehicles with the Tire Pressure Monitor System (TPMS), this message displays if a part on the TPMS is not working properly. The tire pressure light also flashes and then remains on during the same ignition cycle. See *Tire Pressure Light on page 4-37*. Several conditions may cause this message to appear. See *Tire Pressure Monitor Operation on page 6-66* for more information. If the warning comes on and stays on, there may be a problem with the TPMS. See your dealer.

## SERVICE TRACTION CONTROL

This message displays when the Traction Control System (TCS) is not functioning properly. A warning light also appears on the instrument panel cluster. See *Traction Control System (TCS) Warning Light on page 4-34*. See *Traction Control System (TCS) on page 5-6* for more information. Have the TCS serviced by your dealer as soon as possible.

## SERVICE TRANSMISSION

This message displays when there is a problem with the transmission. See your dealer for service.

## SERVICE VEHICLE SOON

This message displays when a non-emissions related malfunction occurs. Have the vehicle serviced by your dealer as soon as possible.

## SIDE BLIND ZONE ALERT SYSTEM OFF

If your vehicle has the Side Blind Zone Alert (SBZA) system, this message displays when the SBZA system has been turned off. See *Side Blind Zone Alert (SBZA) on page 3-36* and *DIC Operation and Displays on page 4-42* for more information.

## **SIDE BLIND ZONE SYS. UNAVAILABLE**

If your vehicle has the Side Blind Zone Alert (SBZA) system, this message displays when the SBZA system is disabled because the sensor is blocked and cannot detect vehicles in your blind zone. The sensor may be blocked by mud, dirt, snow, ice, or slush. This message may also display during heavy rain or due to road spray. It may also come on when driving in isolated areas with no guardrails, trees, or road signs and light traffic. Your vehicle does not need service. For cleaning instructions, see *Washing Your Vehicle on page 6-102*. See *Side Blind Zone Alert (SBZA) on page 3-36* for more information.

## **SPEED LIMITED TO XXX MPH (km/h)**

This message displays when your vehicle speed is limited to 128 km/h (80 mph) because the vehicle detects a problem in the speed variable assist steering, magnetic ride control, or automatic leveling control systems. Have your vehicle serviced by your dealer.

## **STABILITRAK NOT READY**

If your vehicle has StabiliTrak, this message may display and the Traction Control System and StabiliTrak Warning Light on the instrument panel cluster may be on after first driving the vehicle and exceeding 30 km/h (19 mph) for 30 seconds. The StabiliTrak system is not functional until the light has turned off. See *StabiliTrak® System on page 5-5* for more information.

## **STARTING DISABLED SERVICE THROTTLE**

This message displays if the starting of the engine is disabled due to the electronic throttle control system. Have your vehicle serviced by your dealer immediately.

This message only appears while the ignition is in ON/RUN, and will not disappear until the problem is resolved.

This message cannot be acknowledged.

## **THEFT ATTEMPTED**

This message displays if the content theft-deterrent system has detected a break-in attempt while you were away from your vehicle. See *Content Theft-Deterrent on page 3-16* for more information.

## **TIGHTEN GAS CAP**

This message may be displayed if the gas cap is not on, or is not fully tightened. Check the gas cap to ensure that it is on properly. See *Filling the Tank on page 6-9* for more information.

## TIRE LEARNING ACTIVE

On vehicles with the Tire Pressure Monitor System (TPMS), this message displays when the TPMS is re-learning the tire positions on your vehicle. The tire positions must be re-learned after rotating the tires or after replacing a tire or sensor. See *Tire Inspection and Rotation on page 6-70*, *Tire Pressure Monitor System on page 6-65*, and *Inflation - Tire Pressure on page 6-64* for more information.

## TIRE LOW ADD AIR TO TIRE

On vehicles with the Tire Pressure Monitor System (TPMS), this message displays when the pressure in one or more of the vehicle's tires is low. This message also displays LEFT FRT (left front), RIGHT FRT (right front), LEFT RR (left rear), or RIGHT RR (right rear) to indicate the location of the low tire. The low tire pressure warning light will also come on. See *Tire Pressure Light on page 4-37*. If a tire pressure message appears on the DIC, stop as soon as you can. Have the tire pressures checked and set to those shown on the Tire Loading Information label. See *Tires on page 6-57*, *Loading the Vehicle on page 5-18*, and *Inflation - Tire Pressure on page 6-64*. You can receive more than one tire pressure message at a time. To read the other messages that may have been sent at the same time, press the set/reset button. The DIC also shows the tire pressure values. See *DIC Operation and Displays on page 4-42*.

## TRACTION CONTROL OFF

This message displays when the Traction Control System (TCS) is turned off. Adjust your driving accordingly. See *Traction Control System (TCS) on page 5-6* for more information.

## TRACTION CONTROL ON

This message displays when the Traction Control System (TCS) is turned on. See *Traction Control System (TCS) on page 5-6* for more information.

## TRANSMISSION HOT IDLE ENGINE

**Notice:** If you drive the vehicle while the transmission fluid is overheating and the transmission temperature warning is displayed on the instrument panel cluster and/or DIC, you can damage the transmission. This could lead to costly repairs that would not be covered by the warranty. Do not drive the vehicle with overheated transmission fluid or while the transmission temperature warning is displayed.

This message displays when the transmission fluid in your vehicle is too hot. Stop the vehicle and allow it to idle until it cools down. If the warning message continues to display, have the vehicle serviced by your dealer as soon as possible.

## TRUNK OPEN

This message displays when the trunk is not closed completely. Make sure that the trunk is closed completely. See *Trunk on page 3-12*.

## TURN SIGNAL ON

This message displays as a reminder to turn off the turn signal if you drive your vehicle for more than about 1.2 km (0.75 mile) with a turn signal on. See *Turn Signal/Multifunction Lever on page 4-4*.

This message displays and a chime sounds only when the ignition is in ON/RUN. The message will not disappear until the turn signal is manually turned off, or a turn is completed.

## WASHER FLUID LOW ADD FLUID

This message displays when the windshield washer fluid is low. Fill the windshield washer reservoir as soon as possible. See *Engine Compartment Overview on page 6-14* for the location of the windshield washer reservoir. Also, see *Windshield Washer Fluid on page 6-38* for more information.

## DIC Vehicle Customization

Your vehicle has customization capabilities that allow you to program certain features to one preferred setting. Customization features can only be programmed to one setting on the vehicle and cannot be programmed to a preferred setting for two different drivers.

All of the customization options may not be available on your vehicle. Only the options available will be displayed on the DIC.

The default settings for the customization features were set when your vehicle left the factory, but may have been changed from their default state since then.

The customization preferences are automatically recalled.

To change customization preferences, use the following procedure.

## Entering the Feature Settings Menu

1. Turn the ignition on and place the vehicle in P (Park).  
To avoid excessive drain on the battery, it is recommended that the headlamps are turned off.
2. Press the customization button to enter the feature settings menu.

If the menu is not available, FEATURE SETTINGS AVAILABLE IN PARK will display. Before entering the menu, make sure the vehicle is in P (Park).

## Feature Settings Menu Items

The following are customization features that allow you to program settings to the vehicle:

### DISPLAY IN ENGLISH

This feature will only display if a language other than English has been set. This feature allows you to change the language in which the DIC messages appear to English.

Press the customization button until the **PRESS ✓ TO DISPLAY IN ENGLISH** screen appears on the DIC display. Press the set/reset button once to display all DIC messages in English.

## DISPLAY LANGUAGE

This feature allows you to select the language in which the DIC messages will appear.

Press the customization button until the **DISPLAY LANGUAGE** screen appears on the DIC display. Press the set/reset button once to access the settings for this feature. Then press the customization button to scroll through the following settings:

**ENGLISH (default):** All messages will appear in English.

**FRANCAIS:** All messages will appear in French.

**ESPANOL:** All messages will appear in Spanish.

**NO CHANGE:** No change will be made to this feature. The current setting will remain.

To select a setting, press the set/reset button while the desired setting is displayed on the DIC.

## AUTO DOOR LOCK

This feature allows you to select when the vehicle's doors will automatically lock. See *Programmable Automatic Door Locks* on page 3-10 for more information.

Press the customization button until AUTO DOOR LOCK appears on the DIC display. Press the set/reset button once to access the settings for this feature. Then press the customization button to scroll through the following settings:

**SHIFT OUT OF PARK (default):** The doors automatically lock when the doors are closed and the vehicle is shifted out of P (Park).

**AT VEHICLE SPEED:** The doors automatically lock when the vehicle speed is above 5 mph (8 km/h) for three seconds.

**NO CHANGE:** No change will be made to this feature. The current setting will remain.

To select a setting, press the set/reset button while the desired setting is displayed on the DIC.

## AUTO DOOR UNLOCK

This feature allows you to select whether or not to turn off the automatic door unlocking feature. It also allows you to select which doors and when the doors will automatically unlock. See *Programmable Automatic Door Locks on page 3-10* for more information.

Press the customization button until AUTO DOOR UNLOCK appears on the DIC display. Press the set/reset button once to access the settings for this feature. Then press the customization button to scroll through the following settings:

**OFF:** None of the doors will automatically unlock.

**DRIVER AT KEY OUT:** Only the driver's door will unlock when the key is taken out of the ignition.

**DRIVER IN PARK:** Only the driver's door will unlock when the vehicle is shifted into P (Park) .

**ALL AT KEY OUT:** All of the doors will unlock when the key is taken out of the ignition.

**ALL IN PARK (default):** All of the doors will unlock when the vehicle is shifted into P (Park).

**NO CHANGE:** No change will be made to this feature. The current setting will remain.

To select a setting, press the set/reset button while the desired setting is displayed on the DIC.



## REMOTE DOOR LOCK

This feature allows you to select the type of feedback you will receive when locking the vehicle with the Remote Keyless Entry (RKE) transmitter. You will not receive feedback when locking the vehicle with the RKE transmitter if the doors are open. See *Remote Keyless Entry (RKE) System Operation on page 3-4* for more information.

Press the customization button until REMOTE DOOR LOCK appears on the DIC display. Press the set/reset button once to access the settings for this feature. Then press the customization button to scroll through the following settings:

**HORN & LIGHTS OFF:** There will be no feedback when you press the lock button on the RKE transmitter.

**LIGHTS ONLY:** The exterior lamps will flash when you press the lock button on the RKE transmitter.

**HORN ONLY:** The horn will sound on the second press of the lock button on the RKE transmitter.

**HORN & LIGHTS ON (default):** The exterior lamps will flash when you press the lock button on the RKE transmitter, and the horn will sound when the lock button is pressed again within five seconds of the previous command.

**NO CHANGE:** No change will be made to this feature. The current setting will remain.

To select a setting, press the set/reset button while the desired setting is displayed on the DIC.

## REMOTE DOOR UNLOCK

This feature allows you to select the type of feedback you will receive when unlocking the vehicle with the Remote Keyless Entry (RKE) transmitter. You will not receive feedback when unlocking the vehicle with the RKE transmitter if the doors are open. See *Remote Keyless Entry (RKE) System Operation on page 3-4* for more information.

Press the customization button until REMOTE DOOR UNLOCK appears on the DIC display. Press the set/reset button once to access the settings for this feature. Then press the customization button to scroll through the following settings:

**LIGHTS OFF:** The exterior lamps will not flash when you press the unlock button on the RKE transmitter.

**LIGHTS ON (default):** The exterior lamps will flash when you press the unlock button on the RKE transmitter.

**NO CHANGE:** No change will be made to this feature. The current setting will remain.

To select a setting, press the set/reset button while the desired setting is displayed on the DIC.

## DELAY DOOR LOCK

This feature allows you to select whether or not the locking of the vehicle's doors will be delayed. When locking the doors with the power door lock switch and a door is open, this feature will delay locking the doors until five seconds after the last door is closed. You will hear three chimes to signal that the delayed locking feature is in use. The key must be out of the ignition for this feature to work. You can temporarily override delayed locking by pressing the power door lock switch twice or the lock button on the RKE transmitter twice. See *Delayed Locking on page 3-10* for more information.

Press the customization button until DELAY DOOR LOCK appears on the DIC display. Press the set/reset button once to access the settings for this feature. Then press the customization button to scroll through the following settings:

**OFF:** There will be no delayed locking of the vehicle's doors.

**ON (default):** The doors will not lock until five seconds after the last door is closed.

**NO CHANGE:** No change will be made to this feature. The current setting will remain.

To select a setting, press the set/reset button while the desired setting is displayed on the DIC.

## EXIT LIGHTING

This feature allows you to select the amount of time you want the exterior lamps to remain on when it is dark enough outside. This happens after the key is turned from ON/RUN to LOCK/OFF.

Press the customization button until EXIT LIGHTING appears on the DIC display. Press the set/reset button once to access the settings for this feature. Then press the customization button to scroll through the following settings:

**OFF:** The exterior lamps will not turn on.

**30 SECONDS (default):** The exterior lamps will stay on for 30 seconds.

**1 MINUTE:** The exterior lamps will stay on for one minute.

**2 MINUTES:** The exterior lamps will stay on for two minutes.

**NO CHANGE:** No change will be made to this feature. The current setting will remain.

To select a setting, press the set/reset button while the desired setting is displayed on the DIC.

## APPROACH LIGHTING

This feature allows you to select whether or not to have the exterior lights turn on briefly during low light periods after unlocking the vehicle using the Remote Keyless Entry (RKE) transmitter.

Press the customization button until APPROACH LIGHTING appears on the DIC display. Press the set/reset button once to access the settings for this feature. Then press the customization button to scroll through the following settings:

**OFF:** The exterior lights will not turn on when you unlock the vehicle with the RKE transmitter.

**ON (default):** If it is dark enough outside, the exterior lights will turn on briefly when you unlock the vehicle with the RKE transmitter.

The lights will remain on for 20 seconds or until the lock button on the RKE transmitter is pressed, or the vehicle is no longer off. See *Remote Keyless Entry (RKE) System Operation on page 3-4* for more information.

**NO CHANGE:** No change will be made to this feature. The current setting will remain.

To select a setting, press the set/reset button while the desired setting is displayed on the DIC.

## CHIME VOLUME

This feature allows you to select the volume level of the chime.

Press the customization button until CHIME VOLUME appears on the DIC display. Press the set/reset button once to access the settings for this feature. Then press the customization button to scroll through the following settings:

**NORMAL:** The chime volume will be set to a normal level.

**LOUD:** The chime volume will be set to a loud level.

**NO CHANGE:** No change will be made to this feature. The current setting will remain.

There is no default for chime volume. The volume will stay at the last known setting.

To select a setting, press the set/reset button while the desired setting is displayed on the DIC.

## PARK TILT MIRRORS

If your vehicle has this feature, it allows you to select whether or not the outside mirror(s) will automatically tilt down when the vehicle is shifted into R (Reverse). See *Park Tilt Mirrors on page 3-34* for more information.

Press the customization button until PARK TILT MIRRORS appears on the DIC display. Press the set/reset button once to access the settings for this feature. Then press the customization button to scroll through the following settings:

**OFF (default):** Neither outside mirror will be tilted down when the vehicle is shifted into R (Reverse).

**DRIVER MIRROR:** The driver's outside mirror will be tilted down when the vehicle is shifted into R (Reverse).

**PASSENGER MIRROR:** The passenger's outside mirror will be tilted down when the vehicle is shifted into R (Reverse).

**BOTH MIRRORS:** The driver's and passenger's outside mirrors will be tilted down when the vehicle is shifted into R (Reverse).

**NO CHANGE:** No change will be made to this feature. The current setting will remain.

To select a setting, press the set/reset button while the desired setting is displayed on the DIC.

## EASY EXIT RECALL

If your vehicle has this feature, it allows you to select your preference for the automatic easy exit seat feature. See *Memory Seat and Mirrors on page 2-7* for more information.

Press the customization button until EASY EXIT RECALL appears on the DIC display. Press the set/reset button once to access the settings for this feature. Then press the menu up/down button to scroll through the following settings:

**DOOR BUTTON ONLY:** No automatic seat exit recall will occur. The recall will only occur after pressing the easy exit seat button.

**BUTTON AND KEY OUT (default):** If the features are enabled through the EASY EXIT SETUP menu, the driver's seat will move back, and if the vehicle has the power tilt wheel and telescopic steering feature, the power steering column will move up and forward when the key is removed from the ignition or after pressing the easy exit seat button. The automatic easy exit seat movement will only occur one time after the key is removed from the ignition. If the automatic movement has already occurred, and you put the key back in the ignition and remove it again, the seat and steering column will stay in the original exit position, unless a memory recall took place prior to removing the key again.

**NO CHANGE:** No change will be made to this feature. The current setting will remain.

To select a setting, press the set/reset button while the desired setting is displayed on the DIC.

## EASY EXIT SETUP

If your vehicle has this feature, it allows you to select which areas will recall with the automatic easy exit seat feature. It also allows you to turn off the automatic easy exit feature. See *Memory Seat and Mirrors on page 2-7* and “EASY EXIT RECALL” earlier for more information.

Press the customization button until EASY EXIT SETUP appears on the DIC display. Press the set/reset button once to access the settings for this feature. Then press the menu up/down button to scroll through the following settings:

**OFF:** No automatic seat exit will recall.

**SEAT ONLY:** The driver's seat will recall.

**TILT ONLY:** The steering wheel tilt feature will recall.

**TELESCOPE ONLY:** The steering column telescope feature will recall.

**SEAT/TILT:** The driver's seat and the steering wheel tilt feature will recall.

**SEAT/TELESCOPE:** The driver's seat and the steering column telescope feature will recall.

**TILT/TELESCOPE:** The steering wheel tilt and steering column telescope features will recall.

**ALL (default):** The driver's seat and the steering wheel tilt and steering column telescope features will recall, if your vehicle has this option.

**NO CHANGE:** No change will be made to this feature. The current setting will remain.

To select a setting, press the set/reset button while the desired setting is displayed on the DIC.

## MEMORY SEAT RECALL

If your vehicle has this feature, it allows you to select your preference for the remote memory seat recall feature. See *Memory Seat and Mirrors on page 2-7* for more information.

Press the customization button until MEMORY SEAT RECALL appears on the DIC display. Press the set/reset button once to access the settings for this feature. Then press the customization button to scroll through the following settings:

**OFF (default):** No remote memory seat recall will occur.

**ON:** The driver's seat and outside mirrors will automatically move to the stored driving position when the unlock button on the Remote Keyless Entry (RKE) transmitter is pressed. The steering column will also move on vehicles with the power tilt and telescopic steering feature. See *Power Tilt Wheel and Telescopic Steering Column on page 4-4* for more information. See “Relearn Remote Key” under *DIC Operation and Displays on page 4-42* for more information on matching transmitters to driver ID numbers.

**NO CHANGE:** No change will be made to this feature. The current setting will remain.

To select a setting, press the set/reset button while the desired setting is displayed on the DIC.

## REMOTE START

If your vehicle has this feature, it allows you to turn the remote start off or on. The remote start feature allows you to start the engine from outside of the vehicle using the Remote Keyless Entry (RKE) transmitter. See *Remote Vehicle Start on page 3-7* for more information.

Press the customization button until REMOTE START appears on the DIC display. Press the set/reset button once to access the settings for this feature. Then press the customization button to scroll through the following settings:

**OFF:** The remote start feature will be disabled.

**ON (default):** The remote start feature will be enabled.

**NO CHANGE:** No change will be made to this feature. The current setting will remain.

To select a setting, press the set/reset button while the desired setting is displayed on the DIC.

## FACTORY SETTINGS

This feature allows you to set all of the customization features back to their factory default settings.

Press the customization button until FACTORY SETTINGS appears on the DIC display. Press the set/reset button once to access the settings for this feature. Then press the customization button to scroll through the following settings:

**RESTORE ALL (default):** The customization features will be set to their factory default settings.

**DO NOT RESTORE:** The customization features will not be set to their factory default settings.

To select a setting, press the set/reset button while the desired setting is displayed on the DIC.

## EXIT FEATURE SETTINGS

This feature allows you to exit the FEATURE SETTINGS menu.

Press the customization button until FEATURE SETTINGS PRESS ✓ TO EXIT appears on the DIC display. Press the set/reset button to exit the menu.

If you do not exit, pressing the customization button again will return you to the beginning of the FEATURE SETTINGS menu.

## Exiting the Feature Settings Menu

The feature settings menu will be exited when any of the following occurs:

- The vehicle is shifted out of P (Park).
- The vehicle is no longer in ON/RUN.
- The trip/fuel or vehicle information DIC buttons are pressed.
- The end of the feature settings menu is reached and exited.
- A 40 second time period has elapsed with no selection made.

## Audio System(s)

Determine which radio the vehicle has and read the following pages to become familiar with its features.

### **WARNING:**

Taking your eyes off the road for extended periods could cause a crash resulting in injury or death to you or others. Do not give extended attention to entertainment tasks while driving.

This system provides access to many audio and non audio listings.

To minimize taking your eyes off the road while driving, do the following while the vehicle is parked:

- Become familiar with the operation and controls of the audio system.
- Set up the tone, speaker adjustments, and preset radio stations.

For more information, see *Defensive Driving on page 5-2*.









**Notice:** Contact your dealer before adding any equipment.

**Adding audio or communication equipment could interfere with the operation of the engine, radio, or other systems, and could damage them. Follow federal rules covering mobile radio and telephone equipment.**

The vehicle has Retained Accessory Power (RAP). With RAP, the audio system can be played even after the ignition is turned off. See *Retained Accessory Power (RAP) on page 3-21* for more information.



## Setting the Clock

To set the time and date:

1. Turn the ignition key to ACC/ACCESSORY or ON/RUN. Press  to turn the radio on.
2. Press  and the HR, MIN, MM, DD, YYYY (hour, minute, month, day, and year) displays.
3. Press the softkey located below any one of the tabs that you want to change.
4. To increase the time or date do one of the following:
  - Press the softkey located below the selected tab.
  - Press  SEEK, or  FWD.
  - Turn  clockwise.
5. To decrease the time or date do one of the following:
  - Press  SEEK or  REV.
  - Turn  counterclockwise.

The date does not automatically display. To see the date press  while the radio is on. The date with display times out after a few seconds and goes back to the normal radio and time display.

To change the time default setting from 12 hour to 24 hour or to change the date default setting from month/day/year to day/month/year:

1. Press  and then the softkey located below the forward arrow label. Once the time 12H and 24H, and the date MM/DD/YYYY (month, day, and year) and DD/MM/YYYY (day, month, and year) displays.
2. Press the softkey located below the desired option.
3. Press  again to apply the selected default, or let the screen time out.



## Radio(s)

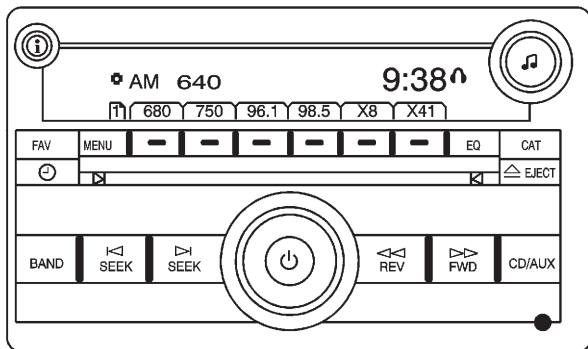

**Radio with CD (MP3) shown, Radio with CD (MP3) and USB Port similar**

The vehicle has one of these radios as its audio system.

## Radio Data System (RDS)

The radio may have RDS. The RDS feature is available for use only on FM stations that broadcast RDS information. This system relies upon receiving specific information from these stations and only works when the information is available. While the radio is tuned to an FM-RDS station, the station name or call letters display. In rare cases, a radio station could broadcast

incorrect information that causes the radio features to work improperly. If this happens, contact the radio station.

## Playing the Radio

**⏻ (Power/Volume):** Press to turn the system on and off. Turn to increase or decrease the volume.

**Speed Compensated Volume (SCV):** Radios with the Speed Compensated Volume (SCV) feature automatically adjust the radio volume to compensate for road and wind noise as the vehicle speeds up or slows down, so that the volume level is consistent.

To activate SCV:

1. Set the radio volume to the desired level.
2. Press the MENU button to display the radio setup menu.
3. Press the softkey under the AUTO VOLUM tab on the radio display.
4. Press the softkey under the desired Speed Compensated Volume setting (OFF, Low, Med, or High) to select the level of radio volume compensation. The display times out after approximately 10 seconds. Each higher setting allows for more radio volume compensation at faster vehicle speeds.

**i (Information):** For vehicles with XM, MP3, WMA, or RDS features, press **i** to display additional text information related to the current FM-RDS or XM station; or CD, MP3, WMA song. Song title information will be displayed on the top line of the display while the artist information will be displayed on the bottom line, if the information is available during XM, CD, MP3, or WMA playback. When information is not available, “No Info” displays.

**Auto Text (Satellite Radio Service, CD, MP3, and WMA features):** If additional information is available for the current song being played, Auto Text will automatically page/scroll the information every three seconds above the FAV presets on the radio display.

To activate Auto Text:

1. Press MENU to display the radio setup menu.
2. Press the softkey under AUTO TXT tab on the radio display.
3. Press the softkey under the ON tab on the radio display.

If **i** is pressed and the song title or artist information is longer than what can be displayed, the extra information will page every three seconds when Auto Text is activated.

## Finding a Station

**BAND:** Press to choose between FM, AM, or XM™ (if equipped).

**🎵 (Tune):** Turn to select radio stations.

**⏪ SEEK:** Press to seek or scan stations with a strong signal in the selected band.

- To seek stations, press and release the ⏪ SEEK button to go to the previous station and stay there.
- To scan stations, press and hold the ⏪ SEEK button for a few seconds until the radio beeps once. The radio goes to a station, plays for a few seconds, then goes to the next station. Press the ⏪ SEEK button again to stop scanning.
- To scan preset stations in the selected band, press and hold the ⏪ SEEK button for four seconds until a double beep sounds. The radio goes to a stored preset, plays for a few seconds, then goes to the next stored preset. Press the ⏪ SEEK button again to stop scanning preset stations.

**↵ SEEK:** Press to seek or scan stations with a strong signal in the selected band.

- To seek stations, press and release the ↵ SEEK button to go to the next station and stay there.
- To scan stations, press and hold the ↵ SEEK button for a few seconds until the radio beeps once. The radio goes to a station, plays for a few seconds, then goes to the next station. Press the ↵ SEEK button again to stop scanning.
- To scan preset stations in the selected band, press and hold the ↵ SEEK button for four seconds until a double beep sounds. The radio goes to a stored preset, plays for a few seconds, then goes to the next stored preset. Press the ↵ SEEK button again to stop scanning preset stations.

## Storing a Radio Station

Drivers are encouraged to set up radio station favorites while the vehicle is in P (Park). Tune to favorite stations using the softkeys, favorites button, and steering wheel controls. See *Defensive Driving on page 5-2*.

**FAV (Favorites):** A maximum of 36 stations can be stored as favorites using the six softkeys located below the radio station frequency tabs and by using the radio favorites page button (FAV button). Press FAV to go through up to six pages of favorites, each having six favorite stations available per page. Each page of favorites can contain any combination of AM, FM, or XM stations.

To setup the number of favorites pages:

1. Press the MENU button to display the radio setup menu.
2. Press the softkey located below the FAV 1-6 tab.
3. Select the desired number of favorites pages by pressing the softkey located below the displayed page numbers.
4. Press the FAV button, or let the menu time out, to return to the original main radio screen showing the radio station frequency tabs and to begin programming favorites.





To store a station as a favorite:

1. Tune to the desired radio station.
2. Press the FAV button to display the page where to store the station.
3. Press and hold one of the six softkeys until a beep sounds.
4. Repeat the steps for each radio station to be stored as a favorite.

## Setting the Tone (Bass/Midrange/Treble)

**BASS/MID/TREB (Bass, Midrange, or Treble):** The radio may display some or all tones such as BASS, MID, and TREB.

To adjust the tone settings:

1. Press the  knob until the tone control tabs display.
2. Press the softkey below the desired tab, then turn the  knob to adjust the highlighted setting. The highlighted setting can also be adjusted by pressing either SEEK arrow, or by pressing the  FWD or  REV buttons.

The radio may be capable of adjusting bass, midrange, or treble to the middle position by pressing the softkey below the BASS, MID, or TREB tab for more than two seconds. The radio beeps once and the level adjusts to the middle position.

The radio may also be capable of adjusting all tone and speaker controls to the middle position by pressing the  knob for more than two seconds until the radio beeps once.



If a station's frequency is weak, or has static, decrease the treble.



**EQ (Equalization):** Press this button to select preset equalization settings.

To return to the manual mode, press the EQ button until Manual displays or start to manually adjust the bass, midrange, or treble by pressing the  knob.

## Adjusting the Speakers (Balance/Fade)

To adjust balance or fade:

1. Press the  knob until the speaker control labels display.
2. Press the softkey under the desired tab, or continue pressing the  knob to highlight the desired tab.
3. Turn the  knob to adjust the highlighted setting. The highlighted setting can also be adjusted by pressing either SEEK arrow.

On some radios, the  FWD and  REV buttons can also be used to adjust the highlighted level.



The radio may be capable of adjusting balance or fade to the middle position by pressing the softkey below the BAL or FADE tab for more than two seconds. The radio beeps once and the level adjusts to the middle position.

The radio may also be capable of adjusting all tone and speaker controls to the middle position by pressing the  knob for more than two seconds until the radio beeps once.

## Finding a Category (CAT) Station (XM Satellite Radio Service Only)

**CAT (Category):** To select and find a desired category:

1. Press the BAND button until the XM frequency displays.
2. Press the CAT button to display the category labels on the radio display. Continue pressing the CAT button until the desired category name displays.
3. Press either of the two softkeys below the desired category tab to immediately tune to the first XM station associated with that category.

4. To go to the previous or to the next XM station within the selected category, do one of the following:
  - Turn the  knob.
  - Press the softkeys below the right or left arrows on the radio display.
  - Press either of the  SEEK or  SEEK buttons.
5. To exit the category search mode, press the FAV button or the BAND button to display the favorites again.

XM categories can be removed through the setup menu. To remove an undesired category:

1. Press the MENU button to display the radio setup menu.
2. Press the softkey below the XM CAT tab.
3. Turn the  knob to display the category to be removed.
4. Press the softkey below the Remove tab until the category name along with the word Removed displays.
5. Repeat the steps to remove additional categories.

Removed categories can be restored by pressing the softkey under the Add tab when a removed category displays or by pressing the softkey below the Restore All tab.

Categories cannot be removed or added while the vehicle is moving faster than 8 km/h (5 mph).

## Radio Messages

**Calibration Error:** Displays if the radio is no longer calibrated properly for the vehicle. The vehicle must be returned to your dealer for service.

**Loc or Locked:** Displays when the THEFTLOCK® system has activated. Take the vehicle to your dealer for service.

If any error occurs repeatedly or if an error cannot be corrected, contact your dealer.

## XM Satellite Radio Service

XM is a satellite radio service that is based in the 48 contiguous United States and 10 Canadian provinces. XM Satellite Radio has a wide variety of programming and commercial-free music, coast-to-coast, and in digital-quality sound. A service fee is required to receive the XM service. If XM Service needs to be reactivated, the radio will display "No Subscription Please Renew" on channel XM1.

For more information, contact XM at [www.xmradio.com](http://www.xmradio.com) or call 1-800-929-2100 in the U.S. and [www.xmradio.ca](http://www.xmradio.ca) or call 1-877-438-9677 in Canada.

## Radio Messages for XM Only

See *XM Radio Messages on page 4-84* later in this section for further detail.

## Loading a CD

Insert a CD partway into the slot, label side up. The player pulls it in and the CD begins playing.

When the CD is inserted, the CD symbol displays. As each new track starts to play, the track number displays.

The CD player can play the smaller 3 inch (8 cm) single CDs with an adapter ring. Full-size CDs and the smaller CDs are loaded in the same manner.

## Ejecting a CD

 **EJECT:** Press to eject the CD. If the CD is not removed, after several seconds, the CD automatically pulls back into the player.

## Playing a CD

If the ignition or radio is turned off with a CD in the player, the CD stays in the player. When the ignition or radio is turned on, the CD starts to play where it stopped, if it was the last selected audio source.

**♪ (Tune):** Turn to select tracks on the CD currently playing.

**⏮ SEEK:** Press to go to the start of the current track, if more than ten seconds have played. Press and hold or press multiple times to continue moving backward through the tracks on the CD.

**⏭ SEEK:** Press to go to the next track. Press and hold or press multiple times to continue moving forward through the tracks on the CD.

**⏪ REV (Reverse):** Press and hold to reverse playback quickly within a track. Sound is heard at a reduced volume and the elapsed time of the track displays. Release to resume playing the track.

**⏩ FWD (Fast Forward):** Press and hold to advance playback quickly within a track. Sound is heard at a reduced volume and the elapsed time of the track displays. Release to resume playing the track.

**RDM (Random):** Tracks can be listened to in random, rather than sequential order.

To use random:

1. Press the softkey below RDM tab until Random Current Disc displays.
2. Press the softkey again to turn off random play.

**BAND:** Press to listen to the radio while a CD is playing. The CD remains inside the radio for future listening.

**CD/AUX (CD/Auxiliary):** Press to play a CD while listening to the radio. The CD icon and a message showing the track number displays when a CD is in the player. Press this button again and the system automatically searches for an auxiliary input device, such as a portable audio player. If a portable audio player is not connected, No Aux Input Device Found may display.

## Playing an MP3 CD-R or CD-RW Disc

For more information, see *Using an MP3 on page 4-78* later in this section.

## CD Messages

**CHECK DISC:** If an error message displays and/or the CD comes out, it could be for one of the following reasons:

- The CD player is very hot. When the temperature returns to normal, the CD should play.
- The road is very rough. When the road becomes smoother, the CD should play.
- The CD is dirty, scratched, wet, or upside down.
- The air is very humid. If so, wait about an hour and try again.
- A problem may have occurred while burning the CD.
- The label could be caught in the CD player.

If the CD is not playing correctly, for any other reason, try a known good CD.

If any error occurs repeatedly or if an error cannot be corrected, contact your dealer. If the radio displays an error message, write it down and provide it to your dealer when reporting the problem.

## Care of CDs

Store CD(s) in their original cases or other protective cases and away from direct sunlight and dust. The CD player scans the bottom of the disc. If the bottom of a CD is damaged it may not play properly or at all. Do not touch the bottom of a CD while handling it. Pick up CDs by grasping the outer edges or the edge of the hole and the outer edge.

If the surface of a CD is dirty, take a soft, lint free cloth or dampen a clean, soft cloth in a mild, neutral detergent solution mixed with water, and clean it. Make sure the wiping process starts from the center to the edge.

## Care of the CD Player

Do not add labels to a CD. Labels could get caught in the CD player. Use a marking pen to write on the top of the CD if a description is needed.

Do not use CD lens cleaners, they could damage the CD player.



**Notice:** If a label is added to a CD, more than one CD is inserted into the slot at a time, or an attempt is made to play scratched or damaged CDs, the CD player could be damaged. While using the CD player, use only CDs in good condition without any label, load one CD at a time, and keep the CD player and the loading slot free of foreign materials, liquids, and debris.

If an error displays, see “CD Messages” earlier in this section.

## Using the Auxiliary Input Jack

The radio system may have a 3.5 mm (1/8 in) auxiliary input jack located on the faceplate. This is not an audio output; do not plug the headphone set into the front auxiliary input jack. An external audio device such as an iPod®, laptop computer, MP3 player, CD changer, etc. can be connected to the auxiliary input jack for use as another audio source.

Drivers are encouraged to set up any auxiliary device while the vehicle is in P (Park). See *Defensive Driving on page 5-2* for more information on driver distraction.

To use a portable audio player, connect a 3.5 mm (1/8 in) cable to the radio's front auxiliary input jack. When a device is connected, press the radio CD/AUX button to begin playing audio from the device over the vehicle speakers.

⏮ (**Power/Volume**): Turn to adjust the volume. Additional volume adjustments may have to be made from the portable device if the volume is too quiet or too loud.

**BAND:** Press to listen to the radio while a portable audio device is playing. The portable audio device continues playing until it is stopped or turned off.

**CD/AUX (CD/Auxiliary):** Press to play a CD while a portable audio device is playing. Press again and the system begins playing audio from the connected portable audio player. If a portable audio player is not connected, No Aux Input Device Found may display.

## Using the USB Port

Radio's with a USB port can control a USB storage device or an iPod® using the radio buttons and knobs. See *Using an MP3 on page 4-78* for information about how to connect and control a USB storage device or an iPod.

## USB Support

The USB connector is located on the front of the radio and uses the USB 2.0 standard.

### USB Supported Devices

- USB Flash Drives
- Portable USB Hard Drives
- Fifth generation or later iPod
- First , Second, or Third generation iPod nano
- iPod touch
- iPod classic

Make sure the iPod has the latest firmware from Apple® for proper operation. iPod firmware can be updated using the latest iTunes® application. See [www.apple.com/itunes](http://www.apple.com/itunes).

For help with identifying your iPod, go to [www.apple.com/support](http://www.apple.com/support).

## Using an MP3

### Format

Radios that have the capability of playing MP3's can play .mp3 files that were recorded onto a CD-R or CD-RW disc. Radios that have a USB port can play .mp3 and .wma files that are stored on a USB storage device as well as AAC files that are stored on an iPod®.

### Compressed Audio

The radio can play discs that contain both uncompressed CD audio and MP3 files.

The CD player reads all MP3 files first, then the uncompressed CD audio files.

### CD-R or CD-RW Supported File and Folder Structure

The radio supports:

- Up to 50 folders.
- Up to 8 folders in depth.
- Up to 50 playlists.
- Up to 255 files.
- Playlists with an .m3u or .wpl extension.
- Files with an .mp3 or .cda file extension.

## USB Supported File and Folder Structure

The radio supports:

- Up to 700 folders.
- Up to 8 folders in depth.
- Up to 65,535 files.
- Folder and file names up to 64 bytes.
- Files with an .mp3 or .wma file extension.
- AAC files stored on an iPod.
- FAT16
- FAT32

### Root Directory

The root directory is treated as a folder. Files are stored in the root directory when the disc or storage device does not contain folders. Files accessed from the root directory of a CD display as F1 ROOT.

### Empty Folder

Folders that do not contain files are skipped, and the player advances to the next folder that contains files.

## Order of Play

Tracks are played in the following order:

- Play begins from the first track in the first playlist and continues sequentially through all tracks in each playlist. When the last track of the last playlist has played, play continues from the first track of the first playlist.
- Play begins from the first track in the first folder and continues sequentially through all tracks in each folder. When the last track of the last folder has played, play continues from the first track of the first folder.

When play enters a new folder, the display does not automatically show the new folder name unless the folder mode has been chosen as the default display. The new track name displays.

## File System and Naming

The song name that displays is the song name that is contained in the ID3 tag. If the song name is not present in the ID3 tag, then the radio displays the file name without the extension (such as .mp3) as the track name.

Track names longer than 32 characters or four pages are shortened. The display does not show parts of words on the last page of text and the extension of the filename is not displayed.

## Preprogrammed Playlists

CDs that have preprogrammed playlists that were created using WinAmp™, MusicMatch™, or Real Jukebox™ software can be accessed, however, there is no playlist editing capability using the radio. These playlists are treated as special folders containing compressed audio song files.



Playlists that have an .m3u or .pls file extension and are stored on a USB device may be supported by the radio with a USB port.



## Playing a CD-R or CD-RW MP3



 **(Tune):** Turn to select MP3 files on the CD currently playing.



 **SEEK:** Press to go to the start of the track, if more than ten seconds have played. Press and hold or press multiple times to continue moving backward through tracks.

 **SEEK:** Press to go to the next track. Press and hold or press multiple times to continue moving forward through tracks.

 **REV (Reverse):** Press and hold to reverse playback quickly. Sound is heard at a reduced volume and the elapsed time of the file displays. Release  REV to resume playing.



 **FWD (Fast Forward):** Press and hold to advance playback quickly. Sound is heard at a reduced volume and the elapsed time of the file displays. Release  FWD to resume playing. The elapsed time of the file displays.

 **(Previous Folder):** Press the softkey below  to go to the first track in the previous folder.

 **(Next Folder):** Press the softkey below  to go to the first track in the next folder.

**RDM (Random):** MP3 files can be listened to on a CD in random, rather than sequential order. To use random:

1. Press the softkey under the RDM tab until Random Current Disc displays to play songs from the current CD in random order.
2. Press the same softkey again to turn off random play.

 **(Music Navigator):** Press the softkey below  to have the files played in order by artist or album. The player scans the disc to sort the files by artist and album ID3 tag information. It can take several minutes to scan the disc depending on the number of files on the disc. The radio may begin playing while it is scanning in the background.

When the scan is finished, the disc begins playing files in order by artist. The current artist playing is shown on the second line of the display. Once all songs by that artist are played, the player moves to the next artist in alphabetical order and begins playing files by that artist.

To listen to files by another artist, press the softkey located below either arrow tab. The disc goes to the next or previous artist in alphabetical order. Continue pressing either softkey below the arrow tab until the desired artist displays.

To change from playback by artist to playback by album:

1. Press the softkey located below the Sort By tab.
2. Press one of the softkeys below the album tab from the sort screen.
3. Press the softkey below the back tab to return to the main music navigator screen.

The album name displays on the second line between the arrows and songs from the current album begins to play. Once all songs from that album have played, the player moves to the next album in alphabetical order on the CD and begins playing MP3 files from that album.

To exit music navigator mode, press the softkey below the Back tab to return to normal MP3 playback.

## Connecting a USB Storage Device or iPod®

The USB Port can be used to control an iPod or a USB storage device.

To connect a USB storage device, connect the device to the USB port located on the front of the radio.

To connect an iPod, connect one end of the USB cable that came with the iPod to the iPod's dock connector and connect the other end to the USB port located on the front of the radio. If the vehicle is on and the USB connection works, "OK to disconnect" and a GM logo may appear on the iPod and iPod appears on the radio's display. The iPod music appears on the radio's display and begins playing.

The iPod charges while it is connected to the vehicle if the vehicle is in the ACC/ACCESSORY or ON/RUN position. When the vehicle is turned off, the iPod automatically powers off and will not charge or draw power from the vehicle's battery.

If you have an older iPod model that is not supported, it can still be used by connecting it to the Auxiliary Input Jack using a standard 3.5 mm (1/8 in) stereo cable. See "Using the Auxiliary Input Jack" earlier for more information.



## Using the Radio to Control a USB Storage Device or iPod



The radio can control a USB storage device or an iPod using the radio buttons and knobs and display song information on the radio's display.

 **(Tune):** Turn to select files.

 **SEEK:** Press to go to the start of the track, if more than ten seconds have played. Press and hold or press multiple times to continue moving backward through tracks.

 **SEEK:** Press to go to the next track. Press and hold or press multiple times to continue moving forward through tracks.

 **REV (Reverse):** Press and hold to reverse playback quickly. Sound is heard at a reduced volume. Release  REV to resume playing. The elapsed time of the file displays.

 **FWD (Fast Forward):** Press and hold to advance playback quickly. Sound is heard at a reduced volume. Release  FWD to resume playing. The elapsed time of the file displays.



 **(Information):** Press to display additional information about the selected track.

## Using Softkeys to Control a USB Storage Device or iPod



The five softkeys below the radio display are used to control the functions listed below.



To use the softkeys:



1. Press the first or fifth softkey below the radio display to display the functions listed below, or press the softkey below the function if it is currently displayed.
2. Press the softkey below the tab with the function on it to use that function.

 **(Pause):** Press the softkey below  to pause the track. The tab appears raised when pause is being used. Press the softkey below  again to resume playback.

**Back:** Press the softkey below the back tab to go back to the main display screen on an iPod, or the root directory on a USB storage device.



 **(Folder View):** Press the softkey below  to view the contents of the current folder on the USB drive. To browse and select files:

1. Press the softkey below .
2. Turn  to scroll through the list of folders.

3. Press  to select the desired folder. If there is more than one folder, repeat Steps 1 and 2 until the desired folder is reached.
4. Turn  to scroll through the files in the selected folder.
5. Press  to select the desired file to be played.

To skip through large lists, the five softkeys can be used to navigate in the following order:





- First softkey, first item in the list.
- Second softkey, 1% through the list each time the softkey is pressed.
- Third softkey, 5% through the list each time the softkey is pressed.
- Fourth softkey, 10% through the list each time the softkey is pressed.
- Fifth softkey, end of the list.

 **(Music Navigator):** Press the softkey below  to view and select a file on an iPod, using the iPod's menu system. Files are sorted by:

- Playlists
- Artists
- Albums

- Genres
- Songs
- Composers

To select files:

1. Press the softkey below .
2. Turn  to scroll through the list of menus.
3. Press  to select the desired menu.
4. Turn  to scroll through the folders or files in the selected menu.
5. Press  to select the desired file to be played.



To skip through large lists, the five softkeys can be used to navigate in the following order:



- First softkey, first item in the list.
- Second softkey, 1% through the list each time the softkey is pressed.
- Third softkey, 5% through the list each time the softkey is pressed.
- Fourth softkey, 10% through the list each time the softkey is pressed.
- Fifth softkey, end of the list.

## Repeat Functionality

To use Repeat:





Press the softkey below  or  to select between Repeat All and Repeat Track.



 (**Repeat All**): Press the softkey below  to repeat all tracks. The tab appears lowered when Repeat All is being used. This is the default mode when a USB storage device or iPod is first connected.



 (**Repeat Track**): Press the softkey below  to repeat one track. The tab appears raised when Repeat Track is being used.

## Shuffle Functionality



To use Shuffle:

Press the softkey below , ,  or  to select between Shuffle Off, Shuffle All Songs/Shuffle Songs, Shuffle Album, or Shuffle Folder.

 (**Shuffle Off**): Press the softkey below  to turn shuffle off. This is the default mode when a USB storage device or iPod is first connected.

 (**Shuffle All Songs / Shuffle Songs**): Press the softkey below  or  to shuffle all songs on the USB storage device or iPod.

 (**Shuffle Album**): Press the softkey below  to shuffle all songs in the current album on an iPod.

 (**Shuffle Folder**): Press the softkey below  to shuffle all songs in the current folder on a USB storage device.

## XM Radio Messages

**XL (Explicit Language Channels):** These channels, or any others, can be blocked at a customer's request, by calling 1-800-929-2100 in the U.S. and 1-877-438-9677 in Canada.

**XM Updating:** The encryption code in the receiver is being updated, and no action is required. This process should take no longer than 30 seconds.

**No XM Signal:** The system is functioning correctly, but the vehicle is in a location that is blocking the XM™ signal. When the vehicle is moved into an open area, the signal should return.

**Loading XM:** The audio system is acquiring and processing audio and text data. No action is needed. This message should disappear shortly.

**Channel Off Air:** This channel is not currently in service. Tune in to another channel.

**Channel Unauth:** This channel is blocked or cannot be received with your XM Subscription package.



**Channel Unavail:** This previously assigned channel is no longer assigned. Tune to another station. If this station was one of the presets, choose another station for that preset button.

**No Artist Info:** No artist information is available at this time on this channel. The system is working properly.

**No Title Info:** No song title information is available at this time on this channel. The system is working properly.

**No CAT Info:** No category information is available at this time on this channel. The system is working properly.

**No Information:** No text or informational messages are available at this time on this channel. The system is working properly.

**No Subscription Please Renew:** XM subscription needs to be reactivated. Contact XM at [www.xmradio.com](http://www.xmradio.com) or call 1-800-929-2100 in the U.S. and [www.xmradio.ca](http://www.xmradio.ca) or call 1-877-438-9677 in Canada.

**CAT Not Found:** There are no channels available for the selected category. The system is working properly.

**XM Theftlocked:** The XM receiver in the vehicle could have previously been in another vehicle. For security purposes, XM receivers cannot be swapped between vehicles. If this message is received after having the vehicle serviced, check with your dealer.

**XM Radio ID:** If tuned to channel 0, this message alternates with the XM™ Radio 8 digit radio ID label. This label is needed to activate the service.

**Unknown:** If this message is received when tuned to channel 0, there could be a receiver fault. Consult with your dealer.

**Check Antenna:** If this message does not clear within a short period of time, the receiver or antenna could have a fault. Consult with your dealer.

**Check XM Receiver:** If this message does not clear within a short period of time, the receiver could have a fault. Consult with your dealer.

**XM Not Available:** If this message does not clear within a short period of time, the receiver could have a fault. Consult with your dealer.

## Navigation/Radio System

For vehicles with a navigation radio system, see the separate Navigation System manual.

## Bluetooth®

For vehicles equipped with Bluetooth capability, the system can interact with many cell phones, allowing:

- Placement and receipt of calls in a hands-free mode.
- Sharing of the cell phone's address book or contact list with the vehicle.

To minimize driver distraction, before driving, and with the vehicle parked:

- Become familiar with the features of the cell phone. Organize the phone book and contact lists clearly and delete duplicate or rarely used entries. If possible, program speed dial or other shortcuts.
- Review the controls and operation of the infotainment system.
- Pair cell phone(s) to the vehicle. The system may not work with all cell phones. See "Pairing a Phone" in this section for more information.
- If the cell phone has voice dialing capability, learn to use that feature to access the address book or contact list. See "Voice Pass-Thru" in this section for more information.
- See "Storing and Deleting Phone Numbers" in this section for more information.

### **WARNING:**

When using a cell phone, it can be distracting to look too long or too often at the screen of the phone or the infotainment (navigation) system. Taking your eyes off the road too long or too often could cause a crash resulting in injury or death. Focus your attention on driving.

Vehicles with a Bluetooth system can use a Bluetooth capable cell phone with a Hands Free Profile to make and receive phone calls. The system can be used while the key is in ON/RUN or ACC/ACCESSORY position. The range of the Bluetooth system can be up to 9.1 m (30 ft). Not all phones support all functions, and not all phones are guaranteed to work with the in-vehicle Bluetooth system. See [www.gm.com/bluetooth](http://www.gm.com/bluetooth) for more information on compatible phones.

## Voice Recognition

The Bluetooth system uses voice recognition to interpret voice commands to dial phone numbers and name tags.

For additional information say “Help” while you are in a voice recognition menu.

**Noise:** Keep interior noise levels to a minimum. The system may not recognize voice commands if there is too much background noise.

**When to Speak:** A short tone sounds after the system responds indicating when it is waiting for a voice command. Wait until the tone and then speak.

**How to Speak:** Speak clearly in a calm and natural voice.

## Audio System

When using the in-vehicle Bluetooth system, sound comes through the vehicle's front audio system speakers and overrides the audio system. Use the audio system volume knob, during a call, to change the volume level. The adjusted volume level remains in memory for later calls. To prevent missed calls, a minimum volume level is used if the volume is turned down too low.

## Bluetooth Controls

Use the buttons located on the steering wheel to operate the in-vehicle Bluetooth system. See *Audio Steering Wheel Controls on page 4-94* for more information.

 **(Push To Talk):** Press to answer incoming calls, to confirm system information, and to start speech recognition.

 **(Phone On Hook):** Press to end a call, reject a call, or to cancel an operation.

## Pairing

A Bluetooth cell phone must be paired to the Bluetooth system and then connected to the vehicle before it can be used. See your cell phone manufacturers user guide for Bluetooth functions before pairing the cell phone. If a Bluetooth phone is not connected, calls will be made using OnStar<sup>®</sup> Hands-Free Calling, if available. Refer to the OnStar owner's guide for more information.

## Pairing Information

- Up to five cell phones can be paired to the Bluetooth system.
- The pairing process is disabled when the vehicle is moving.
- Pairing only needs to be completed once, unless the pairing information on the cell phone changes or the cell phone is deleted from the system.
- Only one paired cell phone can be connected to the Bluetooth system at a time.
- If multiple paired cell phones are within range of the system, the system connects to the first available paired cell phone in the order that they were first paired to the system. To link to a different paired phone, see “Linking to a Different Phone” later in this section.

## Pairing a Phone

1. Press and hold  for two seconds.
2. Say “Bluetooth.”
3. Say “Pair.” The system responds with instructions and a four-digit PIN number. The PIN number is used in Step 5.

4. Start the pairing process on the cell phone that you want to pair. For help with this process, see your cell phone manufacturers user guide.
5. Locate the device named “Your Vehicle” in the list on the cell phone. Follow the instructions on the cell phone to enter the PIN number that was provided in Step 3. After the PIN number is successfully entered, the system prompts you to provide a name for the paired cell phone. This name will be used to indicate which phones are paired and connected to the vehicle, see “Listing All Paired and Connected Phones” later in this section for more information.
6. Repeat Steps 1 through 5 to pair additional phones.



## Listing All Paired and Connected Phones

The system can list all cell phones paired to it. If a paired cell phone is also connected to the vehicle, the system responds with “is connected” after that phone name.

1. Press and hold  for two seconds.
2. Say “Bluetooth.”
3. Say “List.”



## Deleting a Paired Phone

If the phone name you want to delete is unknown, see “Listing All Paired and Connected Phones.”

1. Press and hold   for two seconds.
2. Say “Bluetooth.”
3. Say “Delete.” The system asks for which phone to delete.
4. Say the name of the phone you want to delete.

## Connecting to a Different Phone

To connect to a different cell phone, the Bluetooth system looks for the next available cell phone in the order in which all the available cell phones were paired. Depending on which cell phone you want to connect to, you may have to use this command several times.

1. Press and hold   for two seconds.
2. Say “Bluetooth.”
3. Say “Change phone.”
  - If another cell phone is found, the response will be “<Phone name> is now connected.”
  - If another cell phone is not found, the original phone remains connected.

## Storing and Deleting Phone Numbers

The system can store up to 30 phone numbers as name tags in the Hands Free Directory that is shared between the Bluetooth and OnStar systems.

The following commands are used delete and store phone numbers.



**Store:** This command will store a phone number, or a group of numbers as a name tag.

**Digit Store:** This command allows a phone number to be stored as a name tag by entering the digits one at a time.

**Delete:** This command is used to delete individual name tags.

**Delete All Name Tags:** This command deletes all stored name tags in the Hands Free Calling Directory and the OnStarTurn by Turn Destinations Directory.



### Using the “Store” Command

1. Press and hold   for two seconds.
2. Say “Store.”
3. Say the phone number or group of numbers you want to store all at once with no pauses, then follow the directions given by the system to save a name tag for this number.



## Using the “Digit Store” Command

If an unwanted number is recognized by the system, say “Clear” at any time to clear the last number.

To hear all of the numbers recognized by the system, say “Verify” at any time.

1. Press and hold   for two seconds.
2. Say “Digit Store.”
3. Say each digit, one at a time, that you want to store. After each digit is entered, the system repeats back the digit it heard followed by a tone. After the last digit has been entered, say “Store,” and then follow the directions given by the system to save a name tag for this number.



## Using the “Delete” Command

1. Press and hold   for two seconds.
2. Say “Delete.”
3. Say the name tag you want to delete.

## Using the “Delete All Name Tags” Command

This command deletes all stored name tags in the Hands Free Calling Directory and the OnStarTurn by Turn Destinations Directory.



To delete all name tags:

1. Press and hold   for two seconds.
2. Say “Delete all name tags.”

## Listing Stored Numbers

The list command will list all the stored numbers and name tags.

## Using the “List” Command

1. Press and hold   for two seconds.
2. Say “Directory.”
3. Say “Hands Free Calling.”
4. Say “List.”

## Making a Call



Calls can be made using the following commands.

**Dial or Call:** The dial or call command can be used interchangeably to dial a phone number or a stored name tag.

**Digit Dial:** This command allows a phone number to be dialed by entering the digits one at a time.

**Re-dial:** This command is used to dial the last number used on the cell phone.

### Using the “Dial” or “Call” Command

1. Press and hold   for two seconds.
2. Say “Dial” or “Call.”
3. Say the entire number without pausing or say the name tag.



Once connected, the person called will be heard through the audio speakers.

### Using the “Digit Dial” Command

The digit dial command allows a phone number to be dialed by entering the digits one at a time. After each digit is entered, the system repeats back the digit it heard followed by a tone.



If an unwanted number is recognized by the system, say “Clear” at any time to clear the last number.

To hear all of the numbers recognized by the system, say “Verify” at any time.

1. Press and hold   for two seconds.
2. Say “Digit Dial.”
3. Say each digit, one at a time, that you want to dial. After each digit is entered, the system repeats back the digit it heard followed by a tone. After the last digit has been entered, say “Dial.”

Once connected, the person called will be heard through the audio speakers.





### Using the “Re-dial” Command

1. Press and hold   for two seconds.
2. After the tone, say “Re-dial.”

Once connected, the person called will be heard through the audio speakers.







## Receiving a Call

When an incoming call is received, the audio system mutes and a ring tone is heard in the vehicle.

- Press   to answer the call.
- Press   to ignore a call.





## Call Waiting

Call waiting must be supported on the cell phone and enabled by the wireless service carrier.

- Press   to answer an incoming call when another call is active. The original call is placed on hold.
- Press   again to return to the original call.
- To ignore the incoming call, no action is required.
- Press   to disconnect the current call and switch to the call on hold.

## Three-Way Calling

Three-way calling must be supported on the cell phone and enabled by the wireless service carrier.



1. While on a call, press  .
2. Say “Three-way call.”
3. Use the dial or call command to dial the number of the third party to be called.
4. Once the call is connected, press   to link all the callers together.

## Ending a Call

Press   to end a call.

## Muting a Call

During a call, all sounds from inside the vehicle can be muted so that the person on the other end of the call cannot hear them.

To mute a call, press  , and then say “Mute Call.”

To cancel mute, press  , and then say “Un-mute Call.”

## Transferring a Call

Audio can be transferred between the Bluetooth system and the cell phone.

The cell phone must be paired and connected with the Bluetooth system before a call can be transferred. The connection process can take up to two minutes after the ignition is turned to ON/RUN.

## To Transfer Audio From the Bluetooth System to a Cell Phone

During a call with the audio in the vehicle:

1. Press  .
2. Say “Transfer Call.”



## To Transfer Audio to the Bluetooth System From a Cell Phone

During a call with the audio on the cell phone, press . The audio transfers to the vehicle. If the audio does not transfer to the vehicle, use the audio transfer feature on the cell phone. See your cell phone manufacturers user guide for more information.

## Voice Pass-Thru

Voice pass-thru allows access to the voice recognition commands on the cell phone. See your cell phone manufacturers user guide to see if the cell phone supports this feature.

To access contacts stored in the cell phone:

1. Press and hold  for two seconds.
2. Say "Bluetooth." The system responds "Bluetooth ready," followed by a tone.
3. Say "Voice." The system responds "OK, accessing <phone name>."
  - The cell phone's normal prompt messages will go through its cycle according to the phone's operating instructions.

## Dual Tone Multi-Frequency (DTMF) Tones

The Bluetooth system can send numbers and the numbers stored as name tags during a call. You can use this feature when calling a menu driven phone system. Account numbers can also be stored for use.

## Sending a Number or Name Tag During a Call

1. Press . The system responds "Ready," followed by a tone.
2. Say "Dial."
3. Say the number or name tag to send.

## Clearing the System

Unless information is deleted out of the in-vehicle Bluetooth system, it will be retained indefinitely. This includes all saved name tags in the phone book and phone pairing information. For information on how to delete this information, see the previous sections on Deleting a Paired Phone and Deleting Name Tags.

## Other Information

The Bluetooth® word mark and logos are owned by the Bluetooth® SIG, Inc. and any use of such marks by General Motors is under license. Other trademarks and trade names are those of their respective owners.

See *Radio Frequency Statement on page 8-18* for FCC information.

## Theft-Deterrent Feature

TheftLock® is designed to discourage theft of the vehicle's radio by learning a portion of the Vehicle Identification Number (VIN). The radio does not operate if it is stolen or moved to a different vehicle.

## Audio Steering Wheel Controls

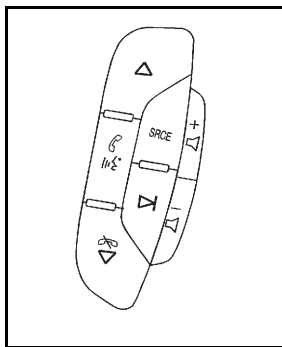

Vehicles with audio steering wheel controls could differ depending on the vehicle's options. Some audio controls can be adjusted at the steering wheel.

**△ / ~~▽~~ (Next / Previous):** Press to select preset or favorite radio stations, select tracks on a CD/DVD, or to navigate an iPod® or USB device.

### Radio

To select preset or favorite radio stations:







Press and release **△** or **~~▽~~** to go to the next or previous radio station stored as a preset or favorite.

## CD/DVD



To select tracks on a CD/DVD:

Press and release  or  to go to the next or previous track.



## Select tracks on an iPod or USB Device (Vehicles without a Navigation System)

1. Press and hold  or  while listening to a song until the contents of the current folder display on the radio display.
2. Press and release  or  to scroll up or down the list, then press and hold  or press  to play the highlighted track.



## Navigating folders on an iPod or USB Device (Vehicles without a Navigation System):

1. Press and hold  or  while listening to a song until the contents of the current folder display on the radio display.
2. Press and hold  to go back to the previous folder list.

3. Press and release  or  to scroll up or down the list.

- To select a folder, press and hold , or press  when the folder is highlighted.
- To go back further in the folder list, press and hold .



## Navigating an iPod or USB Device on the Main Audio Screen (Vehicles with a Navigation System)

Press and release  or  to select the next or previous track within the selected category.

Press and hold  or  to move quickly through the tracks.



Press and release  to move up one track within the selected category.

## Navigating an iPod or USB Device on the Music Navigator Screen (Vehicles with a Navigation System)



Press and release  or  to select the next or previous track within the selected category.

Press and hold  or  to move quickly through the tracks within the selected category.

Press and release  to move up one track within the selected category.

  **(Mute/Push to Talk):** Press to silence the vehicle speakers only. Press again to turn the sound on.

For vehicles with Bluetooth or OnStar<sup>®</sup> systems, press and hold for longer than two seconds to interact with those systems. See *Bluetooth<sup>®</sup> on page 4-86* and the OnStar Owner's Guide for more information.

  **(End):** Press to reject an incoming call, or end a current call.

**SRCE (Source/Voice Recognition):** Press to switch between the radio, CD, and for vehicles with, DVD, front auxiliary, and rear auxiliary.

For vehicles with the navigation system, press and hold this button for longer than one second to initiate voice recognition. See "Voice Recognition" in the Navigation System manual for more information.



 **(Seek):** Press to go to the next radio station while in AM, FM, or XM<sup>™</sup>.

For vehicles with or without a navigation system:



Press  to go to the next track or chapter while sourced to the CD or DVD slot.

Press  to select a track or a folder when navigating folders on an iPod or USB device.

For vehicles with a navigation system:

1. Press and hold  until a beep is heard, to place the radio into SCAN mode, a station will play for five seconds before moving to the next station.
2. To stop the SCAN function, press  again.

While listening to a CD/DVD, press and hold  to quickly move forward through the tracks. Release to stop on the desired track.

+  -  **(Volume):** Press to increase or to decrease the volume.

## Radio Reception

Frequency interference and static can occur during normal radio reception if items such as cell phone chargers, vehicle convenience accessories, and external electronic devices are plugged into the accessory power outlet. If there is interference or static, unplug the item from the accessory power outlet.

### AM

The range for most AM stations is greater than for FM, especially at night. The longer range can cause station frequencies to interfere with each other. For better radio reception, most AM radio stations boost the power levels during the day, and then reduce these levels during the night. Static can also occur when things like storms and power lines interfere with radio reception. When this happens, try reducing the treble on the radio.

### FM Stereo

FM signals only reach about 10 to 40 miles (16 to 65 km). Although the radio has a built-in electronic circuit that automatically works to reduce interference, some static can occur, especially around tall buildings or hills, causing the sound to fade in and out.

## XM™ Satellite Radio Service

XM Satellite Radio Service gives digital radio reception from coast-to-coast in the 48 contiguous United States, and in Canada. Just as with FM, tall buildings or hills can interfere with satellite radio signals, causing the sound to fade in and out. In addition, traveling or standing under heavy foliage, bridges, garages, or tunnels may cause loss of the XM signal for a period of time.

## Cellular Phone Usage

Cellular phone usage may cause interference with the vehicle's radio. This interference may occur when making or receiving phone calls, charging the phone's battery, or simply having the phone on. This interference causes an increased level of static while listening to the radio. If static is received while listening to the radio, unplug the cellular phone and turn it off.

## Backglass Antenna

The AM-FM antenna is integrated with the rear window defogger, located in the rear window. Make sure that the inside surface of the rear window is not scratched and that the lines on the glass are not damaged. If the inside surface is damaged, it could interfere with radio reception. For proper radio reception, the antenna connector needs to be properly attached to the post on the glass.

If a cellular telephone antenna needs to be attached to the glass, make sure that the grid lines for the AM-FM antenna are not damaged. There is enough space between the grid lines to attach a cellular telephone antenna without interfering with radio reception.

**Notice:** Using a razor blade or sharp object to clear the inside rear window can damage the rear window antenna and/or the rear window defogger. Repairs would not be covered by the vehicle warranty. Do not clear the inside rear window with sharp objects.

**Notice:** Do not apply aftermarket glass tinting with metallic film. The metallic film in some tinting materials will interfere with or distort the incoming radio reception. Any damage caused to your backglass antenna due to metallic tinting materials will not be covered by the vehicle warranty.

## **XM™ Satellite Radio Antenna System**

The XM Satellite Radio antenna is located on the roof of the vehicle. Keep the antenna clear of obstructions for clear radio reception.

If the vehicle has a sunroof, the performance of the XM system may be affected if the sunroof is open.

## Section 5 Driving Your Vehicle

---

<b>Your Driving, the Road, and the Vehicle</b> .....	5-2	Driving in Rain and on Wet Roads .....	5-12
Defensive Driving .....	5-2	Before Leaving on a Long Trip .....	5-13
Drunk Driving .....	5-2	Highway Hypnosis .....	5-13
Control of a Vehicle .....	5-3	Hill and Mountain Roads .....	5-14
Braking .....	5-3	Winter Driving .....	5-15
Antilock Brake System (ABS) .....	5-4	If Your Vehicle is Stuck in Sand, Mud, Ice, or Snow .....	5-17
Braking in Emergencies .....	5-5	Rocking Your Vehicle to Get It Out .....	5-17
StabiliTrak <sup>®</sup> System .....	5-5	Loading the Vehicle .....	5-18
Traction Control System (TCS) .....	5-6	<b>Towing</b> .....	5-23
Magnetic Ride Control <sup>™</sup> .....	5-7	Towing Your Vehicle .....	5-23
Steering .....	5-8	Recreational Vehicle Towing .....	5-23
Off-Road Recovery .....	5-9	Towing a Trailer .....	5-25
Passing .....	5-10		
Loss of Control .....	5-10		
Driving at Night .....	5-11		

# Your Driving, the Road, and the Vehicle

## Defensive Driving

Defensive driving means “always expect the unexpected.” The first step in driving defensively is to wear the safety belt. See *Safety Belts: They Are for Everyone* on page 2-12.

### **WARNING:**

Assume that other road users (pedestrians, bicyclists, and other drivers) are going to be careless and make mistakes. Anticipate what they might do and be ready. In addition:

- Allow enough following distance between you and the driver in front of you.
- Focus on the task of driving.

Driver distraction can cause collisions resulting in injury or possible death. These simple defensive driving techniques could save your life.

## Drunk Driving

### **WARNING:**

Drinking and then driving is very dangerous. Your reflexes, perceptions, attentiveness, and judgment can be affected by even a small amount of alcohol. You can have a serious — or even fatal — collision if you drive after drinking. Do not drink and drive or ride with a driver who has been drinking. Ride home in a cab; or if you are with a group, designate a driver who will not drink.

Death and injury associated with drinking and driving is a global tragedy.

Alcohol affects four things that anyone needs to drive a vehicle: judgment, muscular coordination, vision, and attentiveness.

Police records show that almost 40 percent of all motor vehicle-related deaths involve alcohol. In most cases, these deaths are the result of someone who was drinking and driving. In recent years, more than 17,000 annual motor vehicle-related deaths have been associated with the use of alcohol, with about 250,000 people injured.



For persons under 21, it is against the law in every U.S. state to drink alcohol. There are good medical, psychological, and developmental reasons for these laws.

The obvious way to eliminate the leading highway safety problem is for people never to drink alcohol and then drive.

Medical research shows that alcohol in a person's system can make crash injuries worse, especially injuries to the brain, spinal cord, or heart. This means that when anyone who has been drinking — driver or passenger — is in a crash, that person's chance of being killed or permanently disabled is higher than if the person had not been drinking.

## Control of a Vehicle

The following three systems help to control the vehicle while driving — brakes, steering, and accelerator. At times, as when driving on snow or ice, it is easy to ask more of those control systems than the tires and road can provide. Meaning, you can lose control of the vehicle. See *Traction Control System (TCS)* on page 5-6.

Adding non-dealer accessories can affect vehicle performance. See *Accessories and Modifications* on page 6-3.

## Braking

See *Brake System Warning Light* on page 4-32.

Braking action involves perception time and reaction time. Deciding to push the brake pedal is perception time. Actually doing it is reaction time.

Average reaction time is about three-fourths of a second. But that is only an average. It might be less with one driver and as long as two or three seconds or more with another. Age, physical condition, alertness, coordination, and eyesight all play a part. So do alcohol, drugs, and frustration. But even in three-fourths of a second, a vehicle moving at 100 km/h (60 mph) travels 20 m (66 feet). That could be a lot of distance in an emergency, so keeping enough space between the vehicle and others is important.

And, of course, actual stopping distances vary greatly with the surface of the road, whether it is pavement or gravel; the condition of the road, whether it is wet, dry, or icy; tire tread; the condition of the brakes; the weight of the vehicle; and the amount of brake force applied.

Avoid needless heavy braking. Some people drive in spurts, heavy acceleration followed by heavy braking, rather than keeping pace with traffic. This is a mistake. The brakes might not have time to cool between hard stops. The brakes will wear out much faster with a lot of heavy braking. Keeping pace with the traffic and allowing realistic following distances eliminates a lot of unnecessary braking. That means better braking and longer brake life.

If the engine ever stops while the vehicle is being driven, brake normally but do not pump the brakes. If the brakes are pumped, the pedal could get harder to push down. If the engine stops, there will still be some power brake assist but it will be used when the brake is applied. Once the power assist is used up, it can take longer to stop and the brake pedal will be harder to push.

Adding non-dealer accessories can affect vehicle performance. See *Accessories and Modifications on page 6-3*.

## Antilock Brake System (ABS)

This vehicle has the Antilock Brake System (ABS), an advanced electronic braking system that helps prevent a braking skid.

When the engine is started and the vehicle begins to drive away, ABS checks itself. A momentary motor or clicking noise might be heard while this test is going on, and it might even be noticed that the brake pedal moves a little. This is normal.

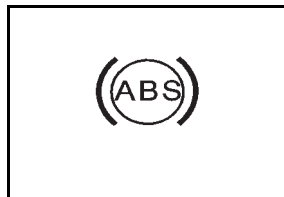

If there is a problem with ABS, this warning light stays on. See *Antilock Brake System (ABS) Warning Light on page 4-33*.

Let us say the road is wet and you are driving safely. Suddenly, an animal jumps out in front of you. You slam on the brakes and continue braking. Here is what happens with ABS:

A computer senses that the wheels are slowing down. If one of the wheels is about to stop rolling, the computer will separately work the brakes at each front wheel and at both rear wheels.

ABS can change the brake pressure to each wheel, as required, faster than any driver could. This can help the driver steer around the obstacle while braking hard.

As the brakes are applied, the computer keeps receiving updates on wheel speed and controls braking pressure accordingly.

Remember: ABS does not change the time needed to get a foot up to the brake pedal or always decrease stopping distance. If you get too close to the vehicle in front of you, there will not be enough time to apply the brakes if that vehicle suddenly slows or stops. Always leave enough room up ahead to stop, even with ABS.

## Using ABS

Do not pump the brakes. Just hold the brake pedal down firmly and let antilock work. The antilock pump or motor operating might be heard and the brake pedal might be felt to pulsate, but this is normal.

## Braking in Emergencies

ABS allows the driver to steer and brake at the same time. In many emergencies, steering can help more than even the very best braking.

## Brake Assist

This vehicle has a Brake Assist feature designed to assist the driver in stopping or decreasing vehicle speed in emergency driving conditions. This feature uses the stability system hydraulic brake control module to supplement the power brake system under conditions where the driver has quickly and forcefully applied the brake pedal in an attempt to quickly stop or slow down the vehicle. The stability system hydraulic brake control module increases brake pressure at each corner of the vehicle until the ABS activates. Minor brake pedal pulsations or pedal movement during this time is normal and the driver should continue to apply the brake pedal as the driving situation dictates. The Brake Assist feature will automatically disengage when the brake pedal is released or brake pedal pressure is quickly decreased.

## StabiliTrak<sup>®</sup> System

The vehicle has a StabiliTrak system which combines antilock brake, traction and stability control systems and helps the driver maintain directional control of the vehicle in most driving conditions. This is accomplished by selectively applying any one of the vehicle's brakes and reducing engine power.

The StabiliTrak system comes on automatically whenever the vehicle is started. The system cannot be turned off.



This light will flash when the system is operating.

The STABILITRAK NOT READY message may be displayed in the Driver Information Center (DIC) and the Traction Control System (TCS)/StabiliTrak warning light on the instrument panel cluster comes on after first driving the vehicle and exceeding 19 mph (30 km/h) for 30 seconds. The StabiliTrak system is off until the light has turned off. This could take up to 15 minutes.

The TCS/StabiliTrak warning light on the instrument panel cluster will flash when the system is operating. See *Traction Control System (TCS) Warning Light on page 4-34* and *StabiliTrak<sup>®</sup> Indicator Light on page 4-34* for more information. The system may be heard or felt while it is working. This is normal.

The SERVICE STABILITRAK message is displayed and the TCS/StabiliTrak warning light on the instrument panel cluster comes on if there is a problem with the system. When this light and the SERVICE STABILITRAK message are on, the system is not working. Adjust your driving accordingly.

## Traction Control System (TCS)

The vehicle has a Traction Control System (TCS) that limits wheel spin. This is especially useful in slippery road conditions. The system operates only if it senses that the front wheels are spinning too much or beginning to lose traction. When this happens, the system works the front brakes and reduces engine power (by closing the throttle and managing engine spark) to limit wheel spin.



The TCS and StabiliTrak<sup>®</sup> light will flash when the system is limiting wheel spin.

The system may be heard or felt while it is working, but this is normal. See *Traction Control System (TCS) Warning Light on page 4-34* for more information.

If the vehicle is in cruise control when TCS begins to limit wheel spin, the cruise control will automatically disengage. The cruise control may be re-engaged when road conditions allow. See *Cruise Control on page 4-7*.

The SERVICE TRACTION CONTROL message in the DIC and the TCS/StabiliTrak warning light comes on if there is a problem with the traction control system. See *DIC Warnings and Messages on page 4-49*.

When this light and the SERVICE TRACTION CONTROL message are on, the system will not limit wheel spin. Adjust your driving accordingly.

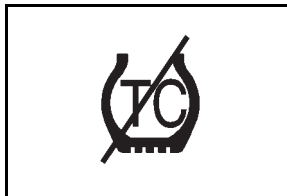

To turn the system off or on, press and release this button located in front of the shift lever.

TCS automatically comes on whenever the vehicle is started. To limit wheel spin, especially in slippery road conditions, always leave the system turned on. TCS can be turned off if needed.

The system can be turned on or off at any time by pressing the TCS button. The DIC will display TRACTION CONTROL OFF when the button is pressed, and part of the traction control system is disabled. The vehicle will still have brake-traction control, but will not be able to use the engine speed management system. System noises may be heard as

a result of the brake-traction control working. If the controller detects excessive wheel spin in this mode, the TCS/StabiliTrak light may blink.

It is recommended to leave the system on for normal driving conditions, but it may be necessary to turn the system off if the vehicle is stuck in sand, mud, ice or snow, and you want to “rock” the vehicle to attempt to free it. See *If Your Vehicle is Stuck in Sand, Mud, Ice, or Snow on page 5-17*.

Adding non-dealer accessories can affect the vehicle's performance. See *Accessories and Modifications on page 6-3* for more information.

## Magnetic Ride Control™

The vehicle may have Magnetic Ride Control that automatically adjusts the ride of the vehicle. The controller receives input from the system to determine the proper ride. If the controller detects a problem within the system, the Driver Information Center (DIC) displays a SERVICE SUSPENSION SYS message. See *DIC Warnings and Messages on page 4-49* for more information. If this message appears, have the vehicle serviced at your dealer.

## Steering

### Power Steering

If power steering assist is lost because the engine stops or the system is not functioning, the vehicle can be steered but it will take more effort.

### Steering Tips

It is important to take curves at a reasonable speed.

Traction in a curve depends on the condition of the tires and the road surface, the angle at which the curve is banked, and vehicle speed. While in a curve, speed is the one factor that can be controlled.

If there is a need to reduce speed, do it before entering the curve, while the front wheels are straight.

Try to adjust the speed so you can drive through the curve. Maintain a reasonable, steady speed. Wait to accelerate until out of the curve, and then accelerate gently into the straightaway.

## Steering in Emergencies

There are times when steering can be more effective than braking. For example, you come over a hill and find a truck stopped in your lane, or a car suddenly pulls out from nowhere, or a child darts out from between parked cars and stops right in front of you. These problems can be avoided by braking — if you can stop in time. But sometimes you cannot stop in time because there is no room. That is the time for evasive action — steering around the problem.

The vehicle can perform very well in emergencies like these. First apply the brakes. See *Braking on page 5-3*. It is better to remove as much speed as possible from a collision. Then steer around the problem, to the left or right depending on the space available.

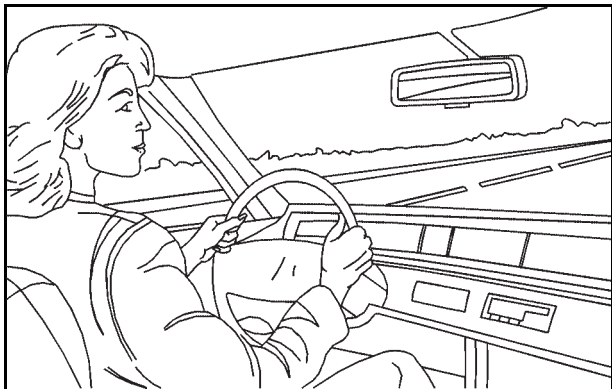

An emergency like this requires close attention and a quick decision. If holding the steering wheel at the recommended 9 and 3 o'clock positions, it can be turned a full 180 degrees very quickly without removing either hand. But you have to act fast, steer quickly, and just as quickly straighten the wheel once you have avoided the object.

The fact that such emergency situations are always possible is a good reason to practice defensive driving at all times and wear safety belts properly.

## Off-Road Recovery

The vehicle's right wheels can drop off the edge of a road onto the shoulder while driving.

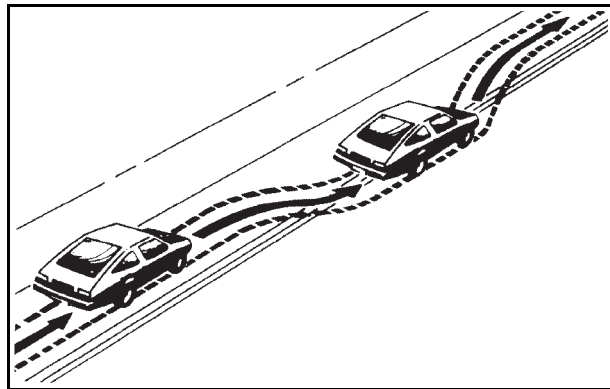

If the level of the shoulder is only slightly below the pavement, recovery should be fairly easy. Ease off the accelerator and then, if there is nothing in the way, steer so that the vehicle straddles the edge of the pavement. Turn the steering wheel 8 to 13 cm (3 to 5 in), about one-eighth turn, until the right front tire contacts the pavement edge. Then turn the steering wheel to go straight down the roadway.

## Passing

Passing another vehicle on a two-lane road can be dangerous. To reduce the risk of danger while passing:

- Look down the road, to the sides, and to crossroads for situations that might affect a successful pass. If in doubt, wait.
- Watch for traffic signs, pavement markings, and lines that could indicate a turn or an intersection. Never cross a solid or double-solid line on your side of the lane.
- Do not get too close to the vehicle you want to pass. Doing so can reduce your visibility.
- Wait your turn to pass a slow vehicle.
- When you are being passed, ease to the right.

## Loss of Control

Let us review what driving experts say about what happens when the three control systems — brakes, steering, and acceleration — do not have enough friction where the tires meet the road to do what the driver has asked.

In any emergency, do not give up. Keep trying to steer and constantly seek an escape route or area of less danger.

## Skidding

In a skid, a driver can lose control of the vehicle. Defensive drivers avoid most skids by taking reasonable care suited to existing conditions, and by not overdriving those conditions. But skids are always possible.

The three types of skids correspond to the vehicle's three control systems. In the braking skid, the wheels are not rolling. In the steering or cornering skid, too much speed or steering in a curve causes tires to slip and lose cornering force. And in the acceleration skid, too much throttle causes the driving wheels to spin.

Remember: Any traction control system helps avoid only the acceleration skid. If the traction control system is off, then an acceleration skid is best handled by easing your foot off the accelerator pedal.

If the vehicle starts to slide, ease your foot off the accelerator pedal and quickly steer the way you want the vehicle to go. If you start steering quickly enough, the vehicle may straighten out. Always be ready for a second skid if it occurs.

Of course, traction is reduced when water, snow, ice, gravel, or other material is on the road. For safety, slow down and adjust your driving to these conditions. It is important to slow down on slippery surfaces because stopping distance will be longer and vehicle control more limited.



While driving on a surface with reduced traction, try your best to avoid sudden steering, acceleration, or braking, including reducing vehicle speed by shifting to a lower gear. Any sudden changes could cause the tires to slide. You may not realize the surface is slippery until the vehicle is skidding. Learn to recognize warning clues — such as enough water, ice, or packed snow on the road to make a mirrored surface — and slow down when you have any doubt.

Remember: Antilock brakes help avoid only the braking skid.

## Driving at Night

Night driving is more dangerous than day driving because some drivers are likely to be impaired — by alcohol or drugs, with night vision problems, or by fatigue.

Night driving tips include:

- Drive defensively.
- Do not drink and drive.
- Reduce headlamp glare by adjusting the inside rearview mirror.

- Slow down and keep more space between you and other vehicles because headlamps can only light up so much road ahead.
- Watch for animals.
- When tired, pull off the road.
- Do not wear sunglasses.
- Avoid staring directly into approaching headlamps.
- Keep the windshield and all glass on your vehicle clean — inside and out.
- Keep your eyes moving, especially during turns or curves.

No one can see as well at night as in the daytime.

But, as we get older, these differences increase.

A 50-year-old driver might need at least twice as much light to see the same thing at night as a 20-year-old.

## Driving in Rain and on Wet Roads

Rain and wet roads can reduce vehicle traction and affect your ability to stop and accelerate. Always drive slower in these types of driving conditions and avoid driving through large puddles and deep-standing or flowing water.

### **WARNING:**

Wet brakes can cause crashes. They might not work as well in a quick stop and could cause pulling to one side. You could lose control of the vehicle.

After driving through a large puddle of water or a car/vehicle wash, lightly apply the brake pedal until the brakes work normally.

Flowing or rushing water creates strong forces. Driving through flowing water could cause the vehicle to be carried away. If this happens, you and other vehicle occupants could drown. Do not ignore police warnings and be very cautious about trying to drive through flowing water.

## Hydroplaning

Hydroplaning is dangerous. Water can build up under your vehicle's tires so they actually ride on the water. This can happen if the road is wet enough and you are going fast enough. When the vehicle is hydroplaning, it has little or no contact with the road.

There is no hard and fast rule about hydroplaning. The best advice is to slow down when the road is wet.

## Other Rainy Weather Tips

Besides slowing down, other wet weather driving tips include:

- Allow extra following distance.
- Pass with caution.
- Keep windshield wiping equipment in good shape.
- Keep the windshield washer fluid reservoir filled.
- Have good tires with proper tread depth. See *Tires on page 6-57*.
- Turn off cruise control.

## Before Leaving on a Long Trip

To prepare your vehicle for a long trip, consider having it serviced by your dealer before departing.

Things to check on your own include:

- *Windshield Washer Fluid*: Reservoir full? Windows clean — inside and outside?
- *Wiper Blades*: In good shape?
- *Fuel, Engine Oil, Other Fluids*: All levels checked?
- *Lamps*: Do they all work and are lenses clean?
- *Tires*: Are treads good? Are tires inflated to recommended pressure?
- *Weather and Maps*: Safe to travel? Have up-to-date maps?

## Highway Hypnosis

Always be alert and pay attention to your surroundings while driving. If you become tired or sleepy, find a safe place to park your vehicle and rest.

Other driving tips include:

- Keep the vehicle well ventilated.
- Keep interior temperature cool.
- Keep your eyes moving — scan the road ahead and to the sides.
- Check the rearview mirror and vehicle instruments often.

## Hill and Mountain Roads

Driving on steep hills or through mountains is different than driving on flat or rolling terrain. Tips for driving in these conditions include:

- Keep the vehicle serviced and in good shape.
- Check all fluid levels and brakes, tires, cooling system, and transmission.
- Going down steep or long hills, shift to a lower gear.

### **WARNING:**

If you do not shift down, the brakes could get so hot that they would not work well. You would then have poor braking or even none going down a hill. You could crash. Shift down to let the engine assist the brakes on a steep downhill slope.

### **WARNING:**

Coasting downhill in N (Neutral) or with the ignition off is dangerous. The brakes will have to do all the work of slowing down and they could get so hot that they would not work well. You would then have poor braking or even none going down a hill. You could crash. Always have the engine running and the vehicle in gear when going downhill.

- Stay in your own lane. Do not swing wide or cut across the center of the road. Drive at speeds that let you stay in your own lane.
- Top of hills: Be alert — something could be in your lane (stalled car, accident).
- Pay attention to special road signs (falling rocks area, winding roads, long grades, passing or no-passing zones) and take appropriate action.

## Winter Driving

### Driving on Snow or Ice

Drive carefully when there is snow or ice between the tires and the road, creating less traction or grip. Wet ice can occur at about 0°C (32°F) when freezing rain begins to fall, resulting in even less traction. Avoid driving on wet ice or in freezing rain until roads can be treated with salt or sand.

Drive with caution, whatever the condition. Accelerate gently so traction is not lost. Accelerating too quickly causes the wheels to spin and makes the surface under the tires slick, so there is even less traction.

Try not to break the fragile traction. If you accelerate too fast, the drive wheels will spin and polish the surface under the tires even more.

The *Traction Control System (TCS)* on page 5-6 improves the ability to accelerate on slippery roads, but slow down and adjust your driving to the road conditions. When driving through deep snow, turn off the traction control system to help maintain vehicle motion at lower speeds.

The *Antilock Brake System (ABS)* on page 5-4 improves vehicle stability during hard stops on a slippery roads, but apply the brakes sooner than when on dry pavement.

Allow greater following distance on any slippery road and watch for slippery spots. Icy patches can occur on otherwise clear roads in shaded areas. The surface of a curve or an overpass can remain icy when the surrounding roads are clear. Avoid sudden steering maneuvers and braking while on ice.

Turn off cruise control, if equipped, on slippery surfaces.

## Blizzard Conditions

Being stuck in snow can be a serious situation. Stay with the vehicle unless there is help nearby. If possible, use the *Roadside Assistance Program on page 8-7*. To get help and keep everyone in the vehicle safe:

- Turn on the *Hazard Warning Flashers on page 4-3*.
- Tie a red cloth to an outside mirror.

### **WARNING:**

Snow can trap engine exhaust under the vehicle. This may cause exhaust gases to get inside. Engine exhaust contains carbon monoxide (CO) which cannot be seen or smelled. It can cause unconsciousness and even death.

If the vehicle is stuck in the snow:

- Clear away snow from around the base of your vehicle, especially any that is blocking the exhaust pipe.
- Check again from time to time to be sure snow does not collect there.

(Continued)

### **WARNING: (Continued)**

- Open a window about 5 cm (2 in) on the side of the vehicle that is away from the wind to bring in fresh air.
- Fully open the air outlets on or under the instrument panel.
- Adjust the Climate Control system to a setting that circulates the air inside the vehicle and set the fan speed to the highest setting. See Climate Control System in the Index.

For more information about carbon monoxide, see *Engine Exhaust on page 3-30*.

Snow can trap exhaust gases under the vehicle. This can cause deadly CO (carbon monoxide) gas to get inside. CO could overcome you and kill you. You cannot see it or smell it, so you might not know it is in the vehicle. Clear away snow from around the base of the vehicle, especially any that is blocking the exhaust.

Run the engine for short periods only as needed to keep warm, but be careful.

To save fuel, run the engine for only short periods as needed to warm the vehicle and then shut the engine off and close the window most of the way to save heat. Repeat this until help arrives but only when you feel really uncomfortable from the cold. Moving about to keep warm also helps.

If it takes some time for help to arrive, now and then when you run the engine, push the accelerator pedal slightly so the engine runs faster than the idle speed. This keeps the battery charged to restart the vehicle and to signal for help with the headlamps. Do this as little as possible to save fuel.

## **If Your Vehicle is Stuck in Sand, Mud, Ice, or Snow**

Slowly and cautiously spin the wheels to free the vehicle when stuck in sand, mud, ice, or snow. See *Rocking Your Vehicle to Get It Out on page 5-17*.

If the vehicle has a traction system, it can often help to free a stuck vehicle. Refer to the vehicle's traction system in the Index. If stuck too severely for the traction system to free the vehicle, turn the traction system off and use the rocking method.

### **WARNING:**

If the vehicle's tires spin at high speed, they can explode, and you or others could be injured. The vehicle can overheat, causing an engine compartment fire or other damage. Spin the wheels as little as possible and avoid going above 55 km/h (35 mph).

For information about using tire chains on the vehicle, see *Tire Chains on page 6-78*.

## **Rocking Your Vehicle to Get It Out**

Turn the steering wheel left and right to clear the area around the front wheels. Turn off any traction or stability system. Shift back and forth between R (Reverse) and a forward gear, spinning the wheels as little as possible. To prevent transmission wear, wait until the wheels stop spinning before shifting gears. Release the accelerator pedal while shifting, and press lightly on the accelerator pedal when the transmission is in gear. Slowly spinning the wheels in the forward and reverse directions causes a rocking motion that could free the vehicle. If that does not get the vehicle out after a few tries, it might need to be towed out. If the vehicle does need to be towed out, see *Towing Your Vehicle on page 5-23*.

## Loading the Vehicle

It is very important to know how much weight your vehicle can carry. Two labels on your vehicle show how much weight it may properly carry, the Tire and Loading Information label and the Vehicle Certification label.

### **WARNING:**

Do not load the vehicle any heavier than the Gross Vehicle Weight Rating (GVWR), or either the maximum front or rear Gross Axle Weight Rating (GAWR). This can cause systems to break and change the way the vehicle handles. This could cause loss of control and a crash. Overloading can also shorten the life of the vehicle.

## Tire and Loading Information Label

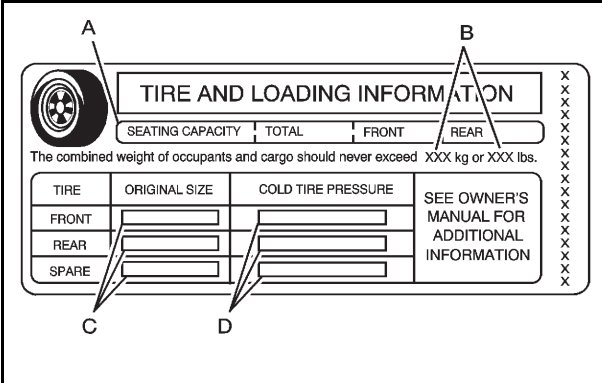

**TIRE AND LOADING INFORMATION**

SEATING CAPACITY TOTAL FRONT REAR

The combined weight of occupants and cargo should never exceed XXX kg or XXX lbs.

TIRE	ORIGINAL SIZE	COLD TIRE PRESSURE	SEE OWNER'S MANUAL FOR ADDITIONAL INFORMATION
FRONT			
REAR			
SPARE			

### Label Example

A vehicle specific Tire and Loading Information label is attached to the vehicle's center pillar (B-pillar). With the driver door open, you will find the label attached below the door lock post (striker). The Tire and Loading Information label lists the number of occupant seating positions (A), and the maximum vehicle capacity weight (B) in kilograms and pounds. The vehicle capacity weight includes the weight of all occupants, cargo, and all nonfactory-installed options.



The Tire and Loading Information label also lists the tire size of the original equipment tires (C) and the recommended cold tire inflation pressures (D). For more information on tires and inflation, see *Tires on page 6-57* and *Inflation - Tire Pressure on page 6-64*.

There is also important loading information on the Certification label. It tells you the Gross Vehicle Weight Rating (GVWR) and the Gross Axle Weight Rating (GAWR) for the front and rear axle, see “Certification Label” later in this section.

### **Steps for Determining Correct Load Limit**

1. Locate the statement “The combined weight of occupants and cargo should never exceed XXX kg or XXX lbs” on your vehicle's placard.
2. Determine the combined weight of the driver and passengers that will be riding in your vehicle.
3. Subtract the combined weight of the driver and passengers from XXX kg or XXX lbs.
4. The resulting figure equals the available amount of cargo and luggage load capacity. For example, if the “XXX” amount equals 1400 lbs and there will be five 150 lb passengers in your vehicle, the amount of available cargo and luggage load capacity is 650 lbs (1400 – 750 (5 x 150) = 650 lbs).
5. Determine the combined weight of luggage and cargo being loaded on the vehicle. That weight may not safely exceed the available cargo and luggage load capacity calculated in Step 4.
6. If your vehicle will be towing a trailer, the load from your trailer will be transferred to your vehicle. Consult this manual to determine how this reduces the available cargo and luggage load capacity for your vehicle.

If your vehicle can tow a trailer, see *Towing a Trailer on page 5-25* for important information on towing a trailer, towing safety rules, and trailering tips.

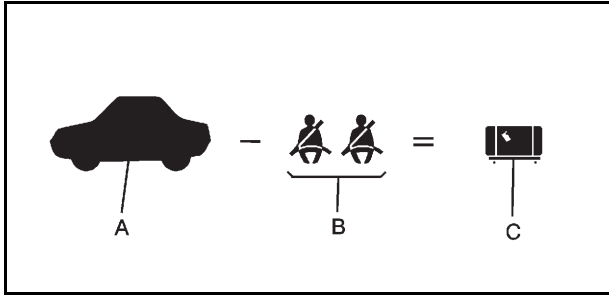

**Example 1**

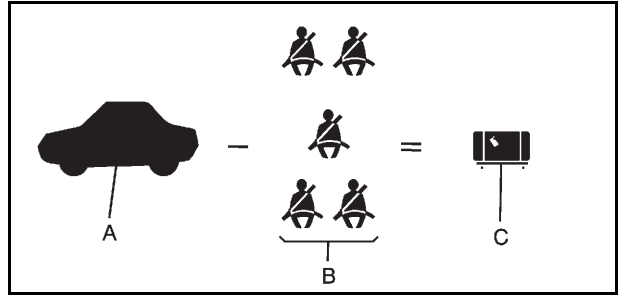

**Example 2**

Item	Description	Total
A	Maximum Vehicle Capacity Weight for Example 1 =	1,000 lbs (453 kg)
B	Subtract Occupant Weight @ 150 lbs (68 kg) × 2 =	300 lbs (136 kg)
C	Available Occupant and Cargo Weight =	700 lbs (317 kg)

Item	Description	Total
A	Maximum Vehicle Capacity Weight for Example 2 =	1,000 lbs (453 kg)
B	Subtract Occupant Weight @ 150 lbs (68 kg) × 5 =	750 lbs (340 kg)
C	Available Cargo Weight =	250 lbs (113 kg)



Never exceed the GVWR for your vehicle or the Gross Axle Weight Rating (GAWR) for either the front or rear axle.

If there is a heavy load, it should be spread out.

 **WARNING:**

Do not load the vehicle any heavier than the Gross Vehicle Weight Rating (GVWR), or either the maximum front or rear Gross Axle Weight Rating (GAWR). This can cause systems to break and change the way the vehicle handles. This could cause loss of control and a crash. Overloading can also shorten the life of the vehicle.

**Notice: Overloading the vehicle may cause damage. Repairs would not be covered by the vehicle warranty. Do not overload the vehicle.**

If things like suitcases, tools, packages, or anything else are put inside the vehicle, they will go as fast as the vehicle goes. If you have to stop or turn quickly, or if there is a crash, they will keep going.

 **WARNING:**

Things inside the vehicle can strike and injure people in a sudden stop or turn, or in a crash.

- Put things in the cargo area of the vehicle. In the cargo area, put them as far forward as possible. Try to spread the weight evenly.
- Never stack heavier things, like suitcases, inside the vehicle so that some of them are above the tops of the seats.
- Do not leave an unsecured child restraint in the vehicle.
- Secure loose items in the vehicle.
- Do not leave a seat folded down unless needed.

# Towing

## Towing Your Vehicle

To avoid damage, the disabled vehicle should be towed with all four wheels off the ground. Consult your dealer or a professional towing service if the disabled vehicle must be towed. See *Roadside Assistance Program on page 8-7*.

To tow the vehicle behind another vehicle for recreational purposes, such as behind a motorhome, see “Recreational Vehicle Towing” following.

## Recreational Vehicle Towing

Recreational vehicle towing means towing the vehicle behind another vehicle – such as behind a motorhome. The two most common types of recreational vehicle towing are known as dinghy towing and dolly towing. Dinghy towing is towing the vehicle with all four wheels on the ground. Dolly towing is towing the vehicle with two wheels on the ground and two wheels up on a device known as a dolly.

Here are some important things to consider before recreational vehicle towing:

- What’s the towing capacity of the towing vehicle? Be sure to read the tow vehicle manufacturer’s recommendations.
- How far will the vehicle be towed? Some vehicles have restrictions on how far and how long they can tow.
- Does the vehicle have the proper towing equipment? See your dealer or trailering professional for additional advice and equipment recommendations.
- Is the vehicle ready to be towed? Just as preparing the vehicle for a long trip, make sure the vehicle is prepared to be towed. See *Before Leaving on a Long Trip on page 5-13*.

## Dinghy Towing

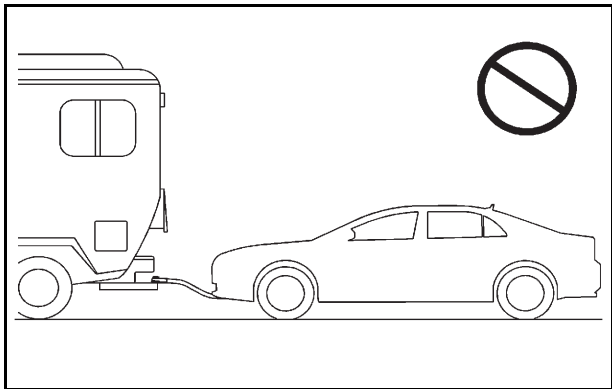

**Notice:** If the vehicle is towed with all four wheels on the ground, the drivetrain components could be damaged. The repairs would not be covered by the vehicle warranty. Do not tow the vehicle with all four wheels on the ground.

The vehicle was not designed to be towed with all four wheels on the ground. Use a dolly if the vehicle must be towed. See “Dolly Towing” later in this section for more information.

## Dolly Towing

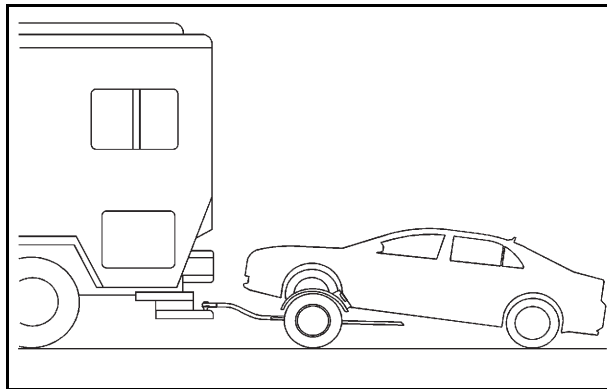

The vehicle can be towed using a dolly. To tow the vehicle using a dolly, follow these steps:

1. Put the front wheels on a dolly.
2. Put the gear shift lever in P (Park).
3. Set the parking brake.
4. Clamp the steering wheel in a straight-ahead position with a clamping device designed for towing.

5. Remove the key from the ignition.
6. Secure the vehicle to the dolly.
7. Release the parking brake.

## Towing a Trailer

### **WARNING:**

The driver can lose control when pulling a trailer if the correct equipment is not used or the vehicle is not driven properly. For example, if the trailer is too heavy, the brakes may not work well — or even at all. The driver and passengers could be seriously injured. The vehicle may also be damaged; the resulting repairs would not be covered by the vehicle warranty. Pull a trailer only if all the steps in this section have been followed. Ask your dealer for advice and information about towing a trailer with the vehicle.

**Notice:** Pulling a trailer improperly can damage the vehicle and result in costly repairs not covered by the vehicle warranty. To pull a trailer correctly, follow the advice in this section and see your dealer for important information about towing a trailer with the vehicle.

The vehicle can tow a trailer if it is equipped with the proper trailer towing equipment. To identify the trailering capacity of the vehicle, read the information in “Weight of the Trailer” that appears later in this section. Trailering is different than just driving the vehicle by itself. Trailering means changes in handling, acceleration, braking, durability and fuel economy. Successful, safe trailering takes correct equipment, and it has to be used properly.

The following information has many time-tested, important trailering tips and safety rules. Many of these are important for the safety of the driver and the passengers. So please read this section carefully before pulling a trailer.

Load-pulling components such as the engine, transmission, axles, wheel assemblies and tires are forced to work harder against the drag of the added weight. The engine is required to operate at relatively higher speeds and under greater loads, generating extra heat. The trailer also adds considerably to wind resistance, increasing the pulling requirements.

## Pulling A Trailer

Here are some important points:

- There are many different laws, including speed limit restrictions, having to do with trailering. Make sure the rig will be legal, not only where you live but also where you will be driving. A good source for this information can be state or provincial police.
- Do not tow a trailer at all during the first 1,000 miles (1600 km) the new vehicle is driven. The engine, transmission or other parts could be damaged. The repairs would not be covered by the vehicle's warranty.
- Then, during the first 500 miles (800 km) that a trailer is towed, do not drive over 50 mph (80 km/h) and do not make starts at full throttle. This helps the engine and other parts of the vehicle wear in at the heavier loads.
- Obey speed limit restrictions when towing a trailer. Do not drive faster than the maximum posted speed for trailers, or no more than 55 mph (90 km/h), to save wear on the vehicle's parts.
- Do not tow a trailer when the outside temperature is above 100°F (38°C).

Three important considerations have to do with weight:

- the weight of the trailer,
- the weight of the trailer tongue
- and the total weight on the vehicle's tires.

## Weight of the Trailer

How heavy can a trailer safely be?

It should never weigh more than 1,000 lbs (454 kg). But even that can be too heavy.

It depends on how the rig is used. For example, speed, altitude, road grades, outside temperature and how much the vehicle is used to pull a trailer are all important. It can depend on any special equipment on the vehicle, and the amount of tongue weight the vehicle can carry. See "Weight of the Trailer Tongue" later in this section for more information.

Maximum trailer weight is calculated assuming only the driver is in the tow vehicle and it has all the required trailering equipment. The weight of additional optional equipment, passengers and cargo in the tow vehicle must be subtracted from the maximum trailer weight.

Ask your dealer for trailering information or advice, or write us at our Customer Assistance Offices. See *Customer Assistance Offices on page 8-5* for more information.



## Weight of the Trailer Tongue

The tongue load (A) of any trailer is an important weight to measure because it affects the total gross weight of the vehicle. The Gross Vehicle Weight (GVW) includes the curb weight of the vehicle, any cargo carried in it, and the people who will be riding in the vehicle. If there are a lot of options, equipment, passengers or cargo in the vehicle, it will reduce the tongue weight the vehicle can carry, which will also reduce the trailer weight the vehicle can tow. If towing a trailer, the tongue load must be added to the GVW because the vehicle will be carrying that weight, too. See *Loading the Vehicle on page 5-18* for more information about the vehicle's maximum load capacity.

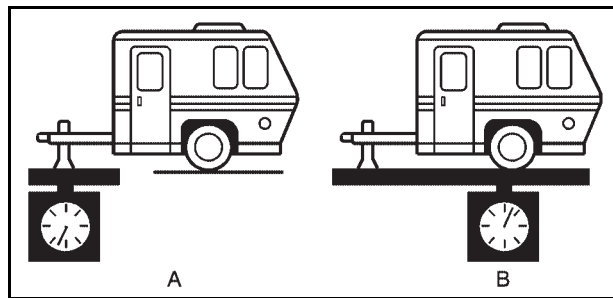

Using a weight-carrying hitch, the trailer tongue (A) should weigh 10 to 15 percent of the total loaded trailer weight (B).

After loading the trailer, weigh the trailer and then the tongue, separately, to see if the weights are proper. If they are not, adjustments might be made by moving some items around in the trailer.

## Total Weight on the Vehicle's Tires

Be sure the vehicle's tires are inflated to the upper limit for cold tires. These numbers can be found on the Certification/Tire label. See *Loading the Vehicle on page 5-18*. Make sure not to go over the GVW limit for the vehicle, including the weight of the trailer tongue.

## Hitches

It is important to have the correct hitch equipment. Crosswinds, large trucks going by and rough roads are a few reasons why the right hitch is needed. Here are some rules to follow:

- The rear bumper on the vehicle is not intended for hitches. Do not attach rental hitches or other bumper-type hitches to it. Use only a frame-mounted hitch that does not attach to the bumper.
- Will any holes be made in the body of the vehicle when the trailer hitch is installed? If there are, then be sure to seal the holes later when the hitch is removed. If the holes are not sealed, dirt, water, and deadly carbon monoxide (CO) from the exhaust can get into the vehicle. See *Engine Exhaust on page 3-30* in the Index for more information.

## Safety Chains

Always attach chains between the vehicle and the trailer. Cross the safety chains under the tongue of the trailer to help prevent the tongue from contacting the road if it becomes separated from the hitch. Instructions about safety chains may be provided by the hitch manufacturer or by the trailer manufacturer. Follow the manufacturer's recommendation for attaching safety chains and do not attach them to the bumper. Always leave just enough slack so the rig can turn. Never allow safety chains to drag on the ground.

## Trailer Brakes

Because the vehicle has antilock brakes, do not try to tap into the vehicle's hydraulic brake system. If you do, both brake systems will not work well, or at all.

Does your trailer have its own brakes? Be sure to read and follow the instructions for the trailer brakes so you will be able to install, adjust and maintain them properly.

## Driving with a Trailer

Towing a trailer requires a certain amount of experience. Get to know the rig before setting out for the open road. Get acquainted with the feel of handling and braking with the added weight of the trailer. And always keep in mind that the vehicle you are driving is now longer and not as responsive as the vehicle is by itself.

Before starting, check all trailer hitch parts and attachments, safety chains, electrical connectors, lamps, tires and mirror adjustments. If the trailer has electric brakes, start the vehicle and trailer moving and then apply the trailer brake controller by hand to be sure the brakes are working. This checks the electrical connection at the same time.

During the trip, check occasionally to be sure that the load is secure, and that the lamps and any trailer brakes are still working.

## Following Distance

Stay at least twice as far behind the vehicle ahead as you would when driving the vehicle without a trailer. This can help to avoid situations that require heavy braking and sudden turns.

## Passing

More passing distance is needed when towing a trailer. Because the rig is longer, it is necessary to go much farther beyond the passed vehicle before returning to the lane.

## Backing Up

Hold the bottom of the steering wheel with one hand. Then, to move the trailer to the left, move that hand to the left. To move the trailer to the right, move your hand to the right. Always back up slowly and, if possible, have someone guide you.

## Making Turns

**Notice: Making very sharp turns while trailering could cause the trailer to come in contact with the vehicle. The vehicle could be damaged. Avoid making very sharp turns while trailering.**

When turning with a trailer, make wider turns than normal. Do this so the trailer will not strike soft shoulders, curbs, road signs, trees or other objects. Avoid jerky or sudden maneuvers. Signal well in advance.

## Turn Signals When Towing a Trailer

The arrows on the instrument panel flash whenever signaling a turn or lane change. Properly hooked up, the trailer lamps also flash, telling other drivers the vehicle is turning, changing lanes or stopping.

When towing a trailer, the arrows on the instrument panel flash for turns even if the bulbs on the trailer are burned out. For this reason you may think other drivers are seeing the signal when they are not. It is important to check occasionally to be sure the trailer bulbs are still working.

## Driving on Grades

**Notice:** Do not tow on steep continuous grades exceeding 9.6 km (6 miles). Extended, higher than normal engine and transmission temperatures may result and damage the vehicle. Frequent stops are very important to allow the engine and transmission to cool.

Reduce speed and shift to a lower gear *before* starting down a long or steep downgrade. If the transmission is not shifted down, the brakes might have to be used so much that they would get hot and no longer work well.

On a long uphill grade, shift down and reduce the vehicle's speed to around 45 mph (70 km/h) to reduce the possibility of the engine and the transmission overheating. If the engine does overheat, see *Engine Overheating on page 6-35*.

## Parking on Hills

### **WARNING:**

Parking the vehicle on a hill with the trailer attached can be dangerous. If something goes wrong, the rig could start to move. People can be injured, and both the vehicle and the trailer can be damaged. When possible, always park the rig on a flat surface.

If parking the rig on a hill:

1. Press the brake pedal, but do not shift into P (Park) yet. Turn the wheels into the curb if facing downhill or into traffic if facing uphill.
2. Have someone place chocks under the trailer wheels.
3. When the wheel chocks are in place, release the brake pedal until the chocks absorb the load.
4. Reapply the brake pedal. Then apply the parking brake and shift the transmission into P (Park).
5. Release the brake pedal.

## Leaving After Parking on a Hill

1. Apply and hold the brake pedal while you:
  - start the engine,
  - shift into a gear, and
  - release the parking brake.
2. Let up on the brake pedal.
3. Drive slowly until the trailer is clear of the chocks.
4. Stop and have someone pick up and store the chocks.

## Maintenance When Trailer Towing

The vehicle needs service more often when pulling a trailer. See *Scheduled Maintenance on page 7-3* for more information. Things that are especially important in trailer operation are automatic transmission fluid, engine oil, belts, cooling system and brake system. It is a good idea to inspect these before and during the trip.

Check periodically to see that all hitch nuts and bolts are tight.

## Engine Cooling When Trailer Towing

The cooling system may temporarily overheat during severe operating conditions. See *Engine Overheating on page 6-35*.

## Changing a Tire When Trailer Towing

If the vehicle gets a flat tire while towing a trailer, be sure to secure the trailer and disconnect it from the vehicle before changing the tire.

 **NOTES**

---

---

---

---

---

---

---

---

---

---

---

---

---

---

---

---

---

---

---

---

---

---

---

---

---

## Section 6 Service and Appearance Care

---

<b>Service</b> .....	6-3	Engine Coolant (4.6L Engine) .....	6-28
Accessories and Modifications .....	6-3	Engine Coolant (3.9L Engine) .....	6-31
California Proposition 65 Warning .....	6-4	Engine Overheating .....	6-35
California Perchlorate Materials		Overheated Engine Protection	
Requirements .....	6-4	Operating Mode .....	6-37
Doing Your Own Service Work .....	6-4	Power Steering Fluid .....	6-37
Adding Equipment to the Outside of the		Windshield Washer Fluid .....	6-38
Vehicle .....	6-5	Brakes .....	6-39
<b>Fuel</b> .....	6-5	Battery .....	6-42
Gasoline Octane .....	6-6	Jump Starting .....	6-44
Gasoline Specifications (U.S. and		<b>Headlamp Aiming</b> .....	6-49
Canada Only) .....	6-6	<b>Bulb Replacement</b> .....	6-52
California Fuel .....	6-6	Halogen Bulbs .....	6-52
Additives .....	6-7	Taillamps, Turn Signal, Stoplamps and	
Fuel E85 (85% Ethanol) .....	6-7	Sidemarker Lamps .....	6-52
Fuels in Foreign Countries .....	6-9	Taillamps and Back-Up Lamps .....	6-54
Filling the Tank .....	6-9	License Plate Lamp .....	6-55
Filling a Portable Fuel Container .....	6-11	Replacement Bulbs .....	6-55
<b>Checking Things Under the Hood</b> .....	6-12	<b>Windshield Wiper Blade Replacement</b> .....	6-55
Hood Release .....	6-13	<b>Tires</b> .....	6-57
Engine Compartment Overview .....	6-14	Tire Sidewall Labeling .....	6-58
Engine Oil .....	6-18	Tire Terminology and Definitions .....	6-61
Engine Oil Life System .....	6-22	Inflation - Tire Pressure .....	6-64
Engine Air Cleaner/Filter .....	6-23	Tire Pressure Monitor System .....	6-65
Automatic Transmission Fluid .....	6-24	Tire Pressure Monitor Operation .....	6-66
Cooling System .....	6-27		

## Section 6 Service and Appearance Care

---

Tire Inspection and Rotation .....	6-70	Weatherstrips .....	6-101
When It Is Time for New Tires .....	6-71	Washing Your Vehicle .....	6-102
Buying New Tires .....	6-72	Cleaning Exterior Lamps/Lenses .....	6-102
Different Size Tires and Wheels .....	6-74	Finish Care .....	6-102
Uniform Tire Quality Grading .....	6-75	Windshield and Wiper Blades .....	6-103
Wheel Alignment and Tire Balance .....	6-76	Aluminum or Chrome-Plated Wheels and Trim .....	6-104
Wheel Replacement .....	6-76	Tires .....	6-105
Tire Chains .....	6-78	Sheet Metal Damage .....	6-105
If a Tire Goes Flat .....	6-78	Finish Damage .....	6-105
Tire Sealant and Compressor Kit .....	6-80	Underbody Maintenance .....	6-105
Tire Sealant and Compressor Kit Storage .....	6-87	Chemical Paint Spotting .....	6-106
Changing a Flat Tire .....	6-88	<b>Vehicle Identification</b> .....	6-106
Removing the Spare Tire and Tools .....	6-89	Vehicle Identification Number (VIN) .....	6-106
Removing the Flat Tire and Installing the Spare Tire .....	6-90	Service Parts Identification Label .....	6-107
Storing a Flat or Spare Tire and Tools .....	6-96	<b>Electrical System</b> .....	6-107
Compact Spare Tire .....	6-97	Add-On Electrical Equipment .....	6-107
<b>Appearance Care</b> .....	6-98	Power Windows and Other Power Options ...	6-107
Interior Cleaning .....	6-98	Fuses and Circuit Breakers .....	6-108
Fabric/Carpet .....	6-99	Underhood Fuse Block .....	6-108
Leather .....	6-100	Rear Underseat Fuse Block .....	6-110
Instrument Panel, Vinyl, and Other Plastic Surfaces .....	6-101	<b>Capacities and Specifications</b> .....	6-116
Care of Safety Belts .....	6-101		



## Service

For service and parts needs, visit your dealer. You will receive genuine GM parts and GM-trained and supported service people.

Genuine GM parts have one of these marks:

**ACDelco**<sup>®</sup>

---

Genuine **GM** | **Parts**

---

**GM** | **Goodwrench**<sup>®</sup>

---

**GM** | **Accessories**

## Accessories and Modifications

When non-dealer accessories are added to the vehicle, they can affect vehicle performance and safety, including such things as airbags, braking, stability, ride and handling, emissions systems, aerodynamics, durability, and electronic systems like antilock brakes, traction control, and stability control. Some of these accessories could even cause malfunction or damage not covered by the vehicle warranty.

Damage to vehicle components resulting from the installation or use of non-GM certified parts, including control module modifications, is not covered under the terms of the vehicle warranty and may affect remaining warranty coverage for affected parts.

GM Accessories are designed to complement and function with other systems on the vehicle. Your GM dealer can accessorize the vehicle using genuine GM Accessories. When you go to your GM dealer and ask for GM Accessories, you will know that GM-trained and supported service technicians will perform the work using genuine GM Accessories.

Also, see *Adding Equipment to Your Airbag-Equipped Vehicle on page 2-69*.

## California Proposition 65 Warning

Most motor vehicles, including this one, contain and/or emit chemicals known to the State of California to cause cancer and birth defects or other reproductive harm. Engine exhaust, many parts and systems, many fluids, and some component wear by-products contain and/or emit these chemicals.

## California Perchlorate Materials Requirements

Certain types of automotive applications, such as airbag initiators, seat belt pretensioners, and lithium batteries contained in Remote Keyless Entry transmitters, may contain perchlorate materials. Special handling may be necessary. For additional information, see [www.dtsc.ca.gov/hazardouswaste/perchlorate](http://www.dtsc.ca.gov/hazardouswaste/perchlorate).

## Doing Your Own Service Work

### **WARNING:**

You can be injured and the vehicle could be damaged if you try to do service work on a vehicle without knowing enough about it.

- Be sure you have sufficient knowledge, experience, the proper replacement parts, and tools before attempting any vehicle maintenance task.
- Be sure to use the proper nuts, bolts, and other fasteners. Metric and English fasteners can be easily confused. If the wrong fasteners are used, parts can later break or fall off. You could be hurt.

If doing some of your own service work, use the proper service manual. It tells you much more about how to service the vehicle than this manual can. To order the proper service manual, see *Service Publications Ordering Information on page 8-14*.

This vehicle has an airbag system. Before attempting to do your own service work, see *Servicing Your Airbag-Equipped Vehicle on page 2-68*.

Keep a record with all parts receipts and list the mileage and the date of any service work performed. See *Maintenance Record on page 7-12*.

## Adding Equipment to the Outside of the Vehicle

Things added to the outside of the vehicle can affect the airflow around it. This can cause wind noise and can affect fuel economy and windshield washer performance. Check with your dealer before adding equipment to the outside of the vehicle.

## Fuel

Use of the recommended fuel is an important part of the proper maintenance of this vehicle. To help keep the engine clean and maintain optimum vehicle performance, we recommend the use of gasoline advertised as TOP TIER Detergent Gasoline.

Look for the TOP TIER label on the fuel pump to ensure gasoline meets enhanced detergency standards developed by auto companies. A list of marketers providing TOP TIER Detergent Gasoline can be found at [www.toptiergas.com](http://www.toptiergas.com).



TOP  
TIER™  
Detergent Gasoline



CATEGORIE  
SUPERIEURE™  
Essences Détergentes

The eighth digit of the Vehicle Identification Number (VIN) shows the code letter or number that identifies the vehicle's engine. The VIN is at the top left of the instrument panel. See *Vehicle Identification Number (VIN) on page 6-106*.

Vehicles that have a FlexFuel badge and a yellow fuel cap can use either unleaded gasoline or ethanol fuel containing up to 85% ethanol (E85). See *Fuel E85 (85% Ethanol) on page 6-7*. For all other vehicles, use only the unleaded gasoline described under *Gasoline Octane on page 6-6*.

## Gasoline Octane

If the vehicle has the 3.9L V6 engine (VIN Code M), use regular unleaded gasoline with a posted octane rating of 87 or higher. If the octane rating is less than 87, an audible knocking noise, commonly referred to as spark knock, might be heard when driving. If this occurs, use a gasoline rated at 87 octane or higher as soon as possible. If heavy knocking is heard when using gasoline rated at 87 octane or higher, the engine needs service.

If the vehicle has the 4.6L V8 engine (VIN Code S), use premium unleaded gasoline with a posted octane rating of 91 or higher. You can also use regular unleaded gasoline rated at 87 octane or higher, but the vehicle's acceleration could be slightly reduced, and a slight audible knocking noise, commonly referred to as spark knock, might be heard. If the octane is less than 87, you might notice a heavy knocking noise when you drive. If this occurs, use a gasoline rated at 87 octane or higher as soon as possible. Otherwise, you could damage the engine. If heavy knocking is heard when using gasoline rated at 87 octane or higher, the engine needs service.

## Gasoline Specifications (U.S. and Canada Only)

At a minimum, gasoline should meet ASTM specification D 4814 in the United States or CAN/CGSB-3.5 or 3.511 in Canada. Some gasolines contain an octane-enhancing additive called methylcyclopentadienyl manganese tricarbonyl (MMT). We recommend against the use of gasolines containing MMT. See *Additives on page 6-7* for additional information.

## California Fuel

If the vehicle is certified to meet California Emissions Standards, it is designed to operate on fuels that meet California specifications. See the underhood emission control label. If this fuel is not available in states adopting California Emissions Standards, the vehicle will operate satisfactorily on fuels meeting federal specifications, but emission control system performance might be affected. The malfunction indicator lamp could turn on and the vehicle might fail a smog-check test. See *Malfunction Indicator Lamp on page 4-37*. If this occurs, return to your authorized dealer for diagnosis. If it is determined that the condition is caused by the type of fuel used, repairs might not be covered by the vehicle warranty.

## Additives

To provide cleaner air, all gasolines in the United States are now required to contain additives that help prevent engine and fuel system deposits from forming, allowing the emission control system to work properly. In most cases, nothing should have to be added to the fuel. However, some gasolines contain only the minimum amount of additive required to meet U.S. Environmental Protection Agency regulations. To help keep fuel injectors and intake valves clean and avoid problems due to dirty injectors or valves, look for gasoline that is advertised as TOP TIER Detergent Gasoline.

For customers who do not use TOP TIER Detergent Gasoline regularly, one bottle of GM Fuel System Treatment PLUS, added to the fuel tank at every engine oil change, can help clean deposits from fuel injectors and intake valves. GM Fuel System Treatment PLUS is the only gasoline additive recommended by General Motors. It is available at your dealer.

Gasolines containing oxygenates, such as ethers and ethanol, and reformulated gasolines might be available in your area. We recommend that you use these gasolines, if they comply with the specifications described earlier. However, E85 (85% ethanol) and other fuels containing more than 10% ethanol must not be used in vehicles that were not designed for those fuels.

**Notice:** This vehicle was not designed for fuel that contains methanol. Do not use fuel containing methanol. It can corrode metal parts in the fuel system and also damage plastic and rubber parts. That damage would not be covered under the vehicle warranty.

Some gasolines that are not reformulated for low emissions can contain an octane-enhancing additive called methylcyclopentadienyl manganese tricarbonyl (MMT); ask the attendant where you buy gasoline whether the fuel contains MMT. We recommend against the use of such gasolines. Fuels containing MMT can reduce spark plug life and affect emission control system performance. The malfunction indicator lamp might turn on. If this occurs, return to your dealer for service.

## Fuel E85 (85% Ethanol)

Vehicles that have a FlexFuel badge and a yellow fuel cap can use either unleaded gasoline or ethanol fuel containing up to 85% ethanol (E85). For all other vehicles, use only the unleaded gasoline described under *Gasoline Octane on page 6-6*.

We encourage the use of E85 in vehicles that are designed to use it. The ethanol in E85 is a “renewable” fuel, meaning it is made from renewable sources such as corn and other crops.

Many service stations will not have an 85% ethanol fuel (E85) pump available. The U.S. Department of Energy has an alternative fuels website ([www.afdc.energy.gov/afdc/locator/stations/](http://www.afdc.energy.gov/afdc/locator/stations/)) that can help you find E85 fuel. Those stations that do have E85 should have a label indicating ethanol content. Do not use the fuel if the ethanol content is greater than 85%.

At a minimum, E85 should meet ASTM Specification D 5798. By definition, this means that fuel labeled E85 will have an ethanol content between 70% and 85%. Filling the fuel tank with fuel mixtures that do not meet ASTM specifications can affect driveability and could cause the malfunction indicator lamp to come on.

To ensure quick starts in the wintertime, the E85 fuel must be formulated properly for your climate according to ASTM specification D 5798. If you have trouble starting on E85, it could be because the E85 fuel is not properly formulated for your climate. If this happens, switching to gasoline or adding gasoline to the fuel tank can improve starting. For good starting and heater efficiency below 0°C (32°F), the fuel mix in the fuel tank should contain no more than 70% ethanol. It is best not to alternate repeatedly between gasoline and E85.

If you do switch fuels, it is recommended that you add as much fuel as possible — do not add less than 11 L (3 gal) when refueling. You should drive the vehicle immediately after refueling for at least 11 km (7 mi) to allow the vehicle to adapt to the change in ethanol concentration.

E85 has less energy per liter (gallon) than gasoline, so you will need to refill the fuel tank more often when using E85 than when you are using gasoline. See *Filling the Tank* on page 6-9.

**Notice: Some additives are not compatible with E85 fuel and can harm the vehicle's fuel system. Do not add anything to E85. Damage caused by additives would not be covered by the vehicle warranty.**

**Notice: This vehicle was not designed for fuel that contains methanol. Do not use fuel containing methanol. It can corrode metal parts in the fuel system and also damage plastic and rubber parts. That damage would not be covered under the vehicle warranty.**

## Fuels in Foreign Countries

Never use leaded gasoline or any other fuel not recommended in the previous text on fuel. Costly repairs caused by use of improper fuel would not be covered by the vehicle warranty.

To check the fuel availability, ask an auto club, or contact a major oil company that does business in the country where you will be driving.

## Filling the Tank

### **WARNING:**

Fuel vapor burns violently and a fuel fire can cause bad injuries. To help avoid injuries to you and others, read and follow all the instructions on the fuel pump island. Turn off the engine when refueling. Do not smoke near fuel or when refueling the vehicle. Do not use cellular phones. Keep sparks, flames, and smoking materials away from fuel. Do not leave the fuel pump unattended when refueling the vehicle. This is against the law in some places. Do not re-enter the vehicle while pumping fuel. Keep children away from the fuel pump; never let children pump fuel.

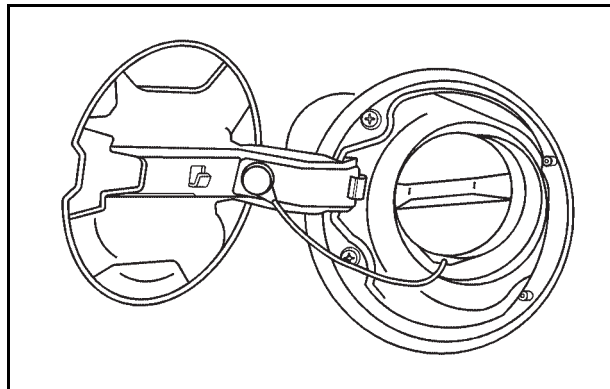

The tethered fuel cap is located behind a hinged fuel door on the driver side of the vehicle. If the vehicle has E85 fuel capability, the fuel cap will be yellow and state that E85 or gasoline can be used. See *Fuel E85 (85% Ethanol)* on page 6-7.

To open the fuel door, push the rearward center edge in and release and it will open.

To remove the fuel cap, turn it slowly to the left (counterclockwise). The fuel cap has a spring in it; if the cap is released too soon, it will spring back to the right.

While refueling, hang the tethered fuel cap from the hook on the fuel door.

 **WARNING:**

Fuel can spray out on you if you open the fuel cap too quickly. If you spill fuel and then something ignites it, you could be badly burned. This spray can happen if the tank is nearly full, and is more likely in hot weather. Open the fuel cap slowly and wait for any hiss noise to stop. Then unscrew the cap all the way.

Be careful not to spill fuel. Do not top off or overfill the tank and wait a few seconds after you have finished pumping before removing the nozzle. Clean fuel from painted surfaces as soon as possible. See *Washing Your Vehicle on page 6-102*.

When replacing the fuel cap, turn it to the right (clockwise) until it clicks. Make sure the cap is fully installed. The diagnostic system can determine if the fuel cap has been left off or improperly installed. This would allow fuel to evaporate into the atmosphere. See *Malfunction Indicator Lamp on page 4-37*.

The TIGHTEN GAS CAP message displays on the Driver Information Center (DIC) if the fuel cap is not properly installed.

 **WARNING:**

If a fire starts while you are refueling, do not remove the nozzle. Shut off the flow of fuel by shutting off the pump or by notifying the station attendant. Leave the area immediately.

**Notice:** If you need a new fuel cap, be sure to get the right type. Your dealer can get one for you. If you get the wrong type, it may not fit properly. This may cause the malfunction indicator lamp to light and may damage the fuel tank and emissions system. See *Malfunction Indicator Lamp on page 4-37*.



## Filling a Portable Fuel Container

### **WARNING:**

Never fill a portable fuel container while it is in the vehicle. Static electricity discharge from the container can ignite the fuel vapor. You can be badly burned and the vehicle damaged if this occurs. To help avoid injury to you and others:

- Dispense fuel only into approved containers.
- Do not fill a container while it is inside a vehicle, in a vehicle's trunk, pickup bed, or on any surface other than the ground.

(Continued)

### **WARNING: (Continued)**

- Bring the fill nozzle in contact with the inside of the fill opening before operating the nozzle. Contact should be maintained until the filling is complete.
- Do not smoke while pumping fuel.
- Do not use a cellular phone while pumping fuel.

## Checking Things Under the Hood

### **WARNING:**

An electric fan under the hood can start up and injure you even when the engine is not running. Keep hands, clothing, and tools away from any underhood electric fan.

### **WARNING:**

Things that burn can get on hot engine parts and start a fire. These include liquids like fuel, oil, coolant, brake fluid, windshield washer and other fluids, and plastic or rubber. You or others could be burned. Be careful not to drop or spill things that will burn onto a hot engine.

## Hood Release

To open the hood:

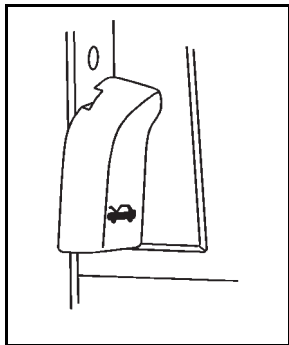

1. Pull the hood release handle inside the vehicle. It is located next to the parking brake pedal near the floor.

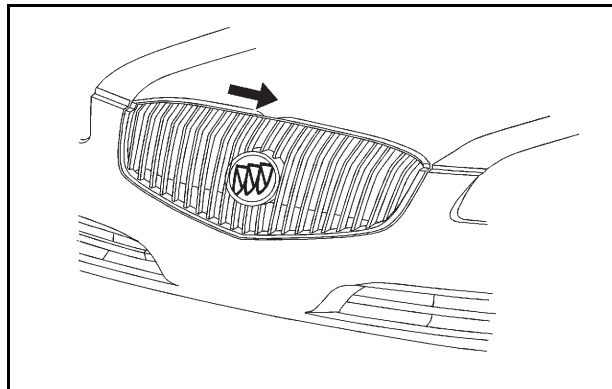

2. Then go to the front of the vehicle and pull the secondary hood release to the right. The hood latch is located under the hood, near the center, at the front edge of the grille.
3. Hold the latch to the right as you lift up on the hood.

Before closing the hood, be sure all the filler caps are on properly. Then just pull the hood down and close it firmly.

## Engine Compartment Overview

When you open the hood on the 3.9L V6 engine, here is what you will see:

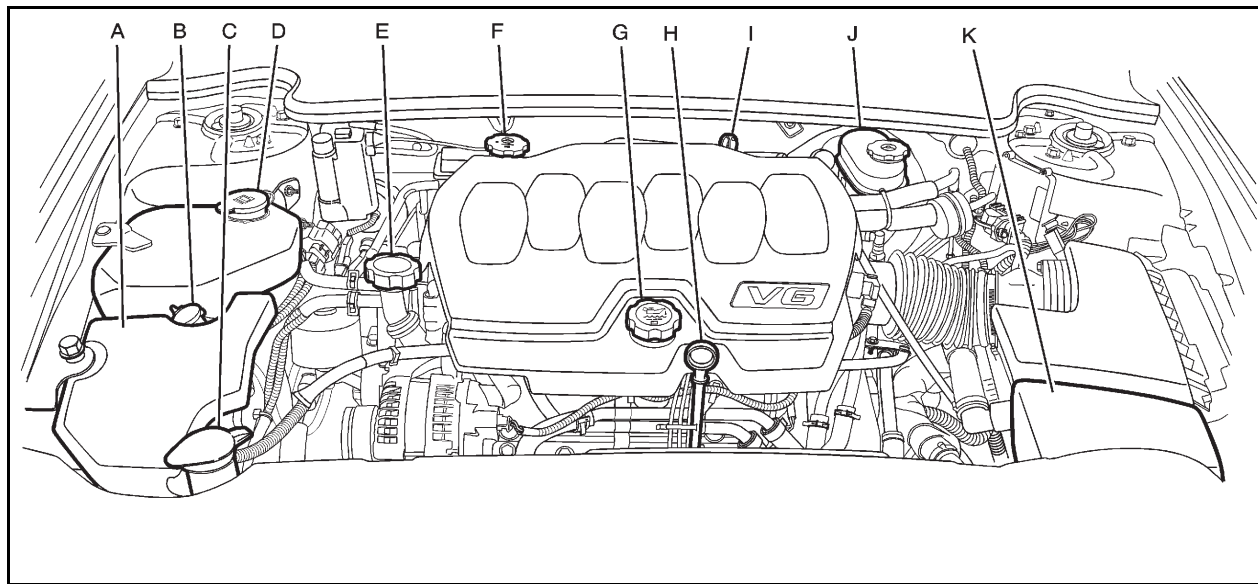

- A. *Underhood Fuse Block on page 6-108.*
- B. *Remote Positive (+) Battery Terminal. See *Jump Starting on page 6-44.**
- C. *Windshield Washer Fluid Reservoir. See “Adding Washer Fluid” under *Windshield Washer Fluid on page 6-38.**
- D. *Engine Coolant Recovery Tank. See *Cooling System on page 6-27.**
- E. *Radiator Pressure Cap. See *Cooling System on page 6-27.**
- F. *Power Steering Fluid Reservoir. See *Power Steering Fluid on page 6-37.**
- G. *Engine Oil Fill Cap. See “When to Add Engine Oil” under *Engine Oil on page 6-18.**
- H. *Engine Oil Dipstick. See “Checking Engine Oil” under *Engine Oil on page 6-18.**
- I. *Automatic Transmission Fluid Dipstick. See “Checking the Fluid Level” under *Automatic Transmission Fluid on page 6-24.**
- J. *Brake Fluid Reservoir. See “Brake Fluid” under *Brakes on page 6-39.**
- K. *Engine Air Cleaner/Filter on page 6-23.*

When you open the hood on the 4.6L V8 engine, here is what you will see:

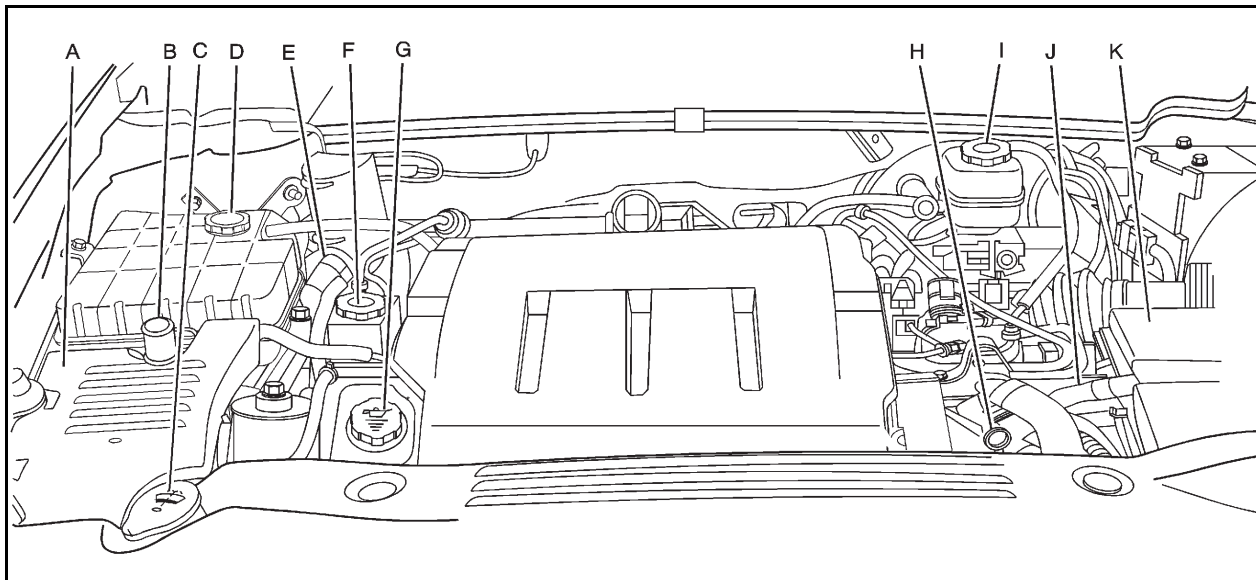

- A. *Underhood Fuse Block on page 6-108.*
- B. *Remote Positive (+) Terminal. See *Jump Starting on page 6-44.**
- C. *Windshield Washer Fluid Reservoir. See “Adding Washer Fluid” under *Windshield Washer Fluid on page 6-38.**
- D. *Engine Coolant Surge Tank and Pressure Cap. See *Cooling System on page 6-27.**
- E. *Remote Negative (-) Terminal. See *Jump Starting on page 6-44.**
- F. *Power Steering Fluid on page 6-37.*
- G. *Engine Oil Fill Cap. See “When to Add Engine Oil” under *Engine Oil on page 6-18.**
- H. *Engine Oil Dipstick. See “Checking Engine Oil” under *Engine Oil on page 6-18.**
- I. *Brake Master Cylinder Reservoir. See “Brake Fluid” under *Brakes on page 6-39.**
- J. *Automatic Transmission Fluid Cap and Dipstick (Out of View). See *Automatic Transmission Fluid on page 6-24.**
- K. *Engine Air Cleaner/Filter on page 6-23.*

## Engine Oil

To ensure proper engine performance and long life, careful attention must be paid to engine oil. Following these simple, but important steps will help protect your investment:

- Always use engine oil approved to the proper specification and of the proper viscosity grade. See “Selecting the Right Engine Oil” in this section.
- Check the engine oil level regularly and maintain the proper oil level. See “Checking Engine Oil” and “When to Add Engine Oil” in this section.
- Change the engine oil at the appropriate time. See *Engine Oil Life System on page 6-22*.
- Always dispose of engine oil properly. See “What to Do with Used Oil” in this section.

## Checking Engine Oil

It is a good idea to check the engine oil level at each fuel fill. In order to get an accurate reading, the vehicle must be on level ground. The engine oil dipstick handle is a yellow loop. See *Engine Compartment Overview on page 6-14* for the location of the engine oil dipstick.

Obtaining an accurate oil level reading is essential:

1. If the engine has been running recently, turn off the engine and allow several minutes for the oil to drain back into the oil pan. Checking the oil level too soon after engine shutoff will not provide an accurate oil level reading.
2. Pull out the dipstick and clean it with a paper towel or cloth, then push it back in all the way. Remove it again, keeping the tip down, and check the level.



## When to Add Engine Oil

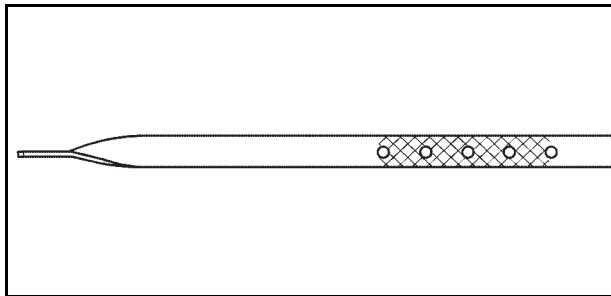

3.9L V6 Engine

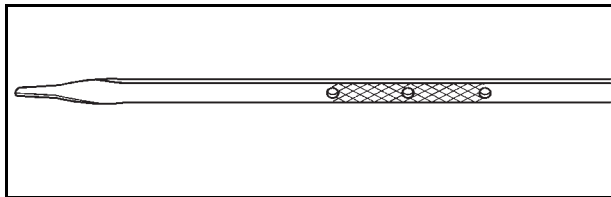

4.6L V8 Engine

If the oil is below the cross-hatched area at the tip of the dipstick, add 1 L (1 qt) of the recommended oil and then recheck the level. See “Selecting the Right Engine Oil” in this section for an explanation of what kind of oil to use. For engine oil crankcase capacity, see *Capacities and Specifications on page 6-116*.

**Notice:** Do not add too much oil. Oil levels above or below the acceptable operating range shown on the dipstick are harmful to the engine. If you find that you have an oil level above the operating range, i.e., the engine has so much oil that the oil level gets above the cross-hatched area that shows the proper operating range, the engine could be damaged. You should drain out the excess oil or limit driving of the vehicle and seek a service professional to remove the excess amount of oil.

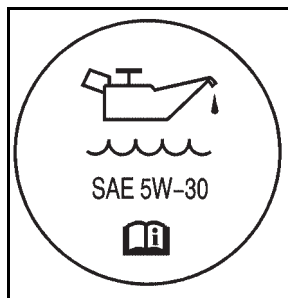

See *Engine Compartment Overview on page 6-14* for the location of the engine oil fill cap.

Add enough oil to put the level somewhere in the proper operating range. Push the dipstick all the way back in when through.

## Selecting the Right Engine Oil

Selecting the right engine oil depends on both the proper oil specification and viscosity grade:

### Specification

Use and ask for engine oils with the dexos™ certification mark. Oils meeting the requirements of the vehicle should have the dexos certification mark on the container. This certification mark indicates that the oil has been approved to the dexos specification.



This vehicle was filled at the factory with dexos-approved engine oil.

**Notice:** Use only engine oil that is approved to the dexos specification or an equivalent engine oil of the appropriate viscosity grade. Engine oils approved to the dexos specification will show the dexos symbol on the container. Failure to use the recommended engine oil or equivalent can result in engine damage not covered by the vehicle warranty. If you are unsure whether the oil is approved to the dexos specification, ask your service provider.

Use of Substitute Engine Oils if dexos is unavailable: In the event that dexos-approved engine oil is not available at an oil change or for maintaining proper oil level, you may use substitute engine oil displaying the API Starburst symbol and of SAE 5W-30 viscosity grade. Use of oils that do not meet the dexos specification, however, may result in reduced performance under certain circumstances.

## Viscosity Grade

SAE 5W-30 is the best viscosity grade for the vehicle. Do not use other viscosity oils such as SAE 10W-30, 10W-40, or 20W-50.

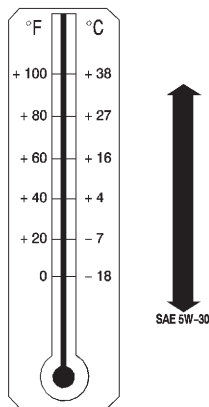

**Cold Temperature Operation:** In an area of extreme cold, where the temperature falls below  $-29^{\circ}\text{C}$  ( $-20^{\circ}\text{F}$ ), an SAE 0W-30 oil should be used. An oil of this viscosity grade will provide easier cold starting for the engine at extremely low temperatures. When selecting an oil of the appropriate viscosity grade, be

sure to always select an oil that meets the required specification, dexos. See “Specification” earlier in this section for more information.

## Engine Oil Additives/Engine Oil Flushes

Do not add anything to the oil. The recommended oils with the dexos specification and displaying the dexos certification mark are all that is needed for good performance and engine protection.

Engine oil system flushes are not recommended and could cause engine damage not covered by the vehicle warranty.

## What to Do with Used Oil

Used engine oil contains certain elements that can be unhealthy for your skin and could even cause cancer. Do not let used oil stay on your skin for very long. Clean your skin and nails with soap and water, or a good hand cleaner. Wash or properly dispose of clothing or rags containing used engine oil. See the manufacturer's warnings about the use and disposal of oil products.

Used oil can be a threat to the environment. If you change your own oil, be sure to drain all the oil from the filter before disposal. Never dispose of oil by putting it in the trash or pouring it on the ground, into sewers, or into streams or bodies of water. Recycle it by taking it to a place that collects used oil.

## Engine Oil Life System

### When to Change Engine Oil

This vehicle has a computer system that indicates when to change the engine oil and filter. This is based on engine revolutions and engine temperature, and not on mileage. Based on driving conditions, the mileage at which an oil change is indicated can vary considerably. For the oil life system to work properly, the system must be reset every time the oil is changed.

When the system has calculated that oil life has been diminished, it indicates that an oil change is necessary. A CHANGE ENGINE OIL SOON message comes on. See *DIC Warnings and Messages on page 4-49*. Change the oil as soon as possible within the next 600 miles (1 000 km). It is possible that, if driving under the best conditions, the oil life system might indicate that an oil change is not necessary for up to a year. The engine oil and filter must be changed at least once a year and, at this time, the system must be reset. Your dealer has trained service people who will perform this work and reset the system. It is also important to check the oil regularly over the course of an oil drain interval and keep it at the proper level.

If the system is ever reset accidentally, the oil must be changed at 3,000 miles (5 000 km) since the last oil change. Remember to reset the oil life system whenever the oil is changed.

### How to Reset the Engine Oil Life System

Reset the system whenever the engine oil is changed so that the system can calculate the next engine oil change. Always reset the engine oil life to 100% after every oil change. It will not reset itself. To reset the system:

1. Display the OIL LIFE REMAINING on the DIC.
2. Press and hold the SET/RESET button on the DIC for more than five seconds. The oil life will change to 100%.

If the CHANGE ENGINE OIL SOON message comes back on when the vehicle is started, the engine oil life system has not been reset. Repeat the procedure.

## Engine Air Cleaner/Filter

See *Engine Compartment Overview* on page 6-14 for the location of the engine air cleaner/filter.

### When to Inspect the Engine Air Cleaner/Filter

Inspect the air cleaner/filter at the scheduled maintenance intervals and replace it at the first oil change after each 50,000 mile (80 000 km) interval. See *Scheduled Maintenance* on page 7-3 for more information. If you are driving in dusty/dirty conditions, inspect the filter at each engine oil change.

### How to Inspect the Engine Air Cleaner/Filter

To inspect the air cleaner/filter, remove the filter from the vehicle and lightly shake the filter to release loose dust and dirt. If the filter remains covered with dirt, a new filter is required.

To inspect or replace the filter:

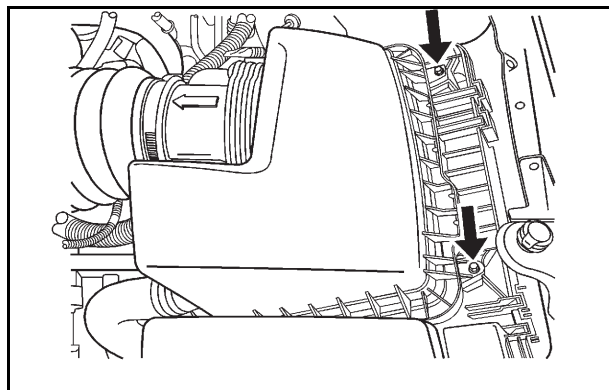

1. Remove the two screws on the top of the engine air cleaner/filter cover.
2. Lift up the outboard side of the cover at an angle while pulling toward you. This is necessary due to the two hinges located on the inboard side of the cover.
3. Remove the engine air cleaner/filter and any loose debris that may be found in the air cleaner base.
4. Inspect or replace the air filter element.

To reinstall the cover:

1. Align the two hinges located on the inboard side of the cover.
2. Push the cover slightly down and towards the engine to engage the tabs in the hinges and align the two screws.
3. Tighten the two screws on the top of the engine air cleaner/filter cover.

 **WARNING:**

Operating the engine with the air cleaner/filter off can cause you or others to be burned. The air cleaner not only cleans the air; it helps to stop flames if the engine backfires. Use caution when working on the engine and do not drive with the air cleaner/filter off.

**Notice:** If the air cleaner/filter is off, dirt can easily get into the engine, which could damage it. Always have the air cleaner/filter in place when you are driving.

## Automatic Transmission Fluid

### When to Check and Change Automatic Transmission Fluid

A good time to check the automatic transmission fluid level is when the engine oil is changed.

Change the fluid and filter at the intervals listed in *Scheduled Maintenance on page 7-3* and be sure to use the transmission fluid listed in *Recommended Fluids and Lubricants on page 7-8*.

### How to Check Automatic Transmission Fluid (3.9L Engine)

Because this operation can be a little difficult, you may choose to have this done at the dealer service department.

If you do it yourself, be sure to follow all the instructions here, or you could get a false reading on the dipstick.

**Notice:** Too much or too little fluid can damage the transmission. Too much can mean that some of the fluid could come out and fall on hot engine parts or exhaust system parts, starting a fire. Too little fluid could cause the transmission to overheat. Be sure to get an accurate reading if checking the transmission fluid.

Wait at least 30 minutes before checking the transmission fluid level if you have been driving:

- When outside temperatures are above 90°F (32°C).
- At high speed for quite a while.
- In heavy traffic — especially in hot weather.
- While pulling a trailer.

To get the right reading, the fluid should be at normal operating temperature, which is 180°F to 200°F (82°C to 93°C).

Get the vehicle warmed up by driving about 15 miles (24 km) when outside temperatures are above 50°F (10°C). If it is colder than 50°F (10°C), you may have to drive longer.

## Checking the Fluid Level

Prepare the vehicle as follows:

1. Park the vehicle on a level place. Keep the engine running.
2. With the parking brake applied, place the shift lever in P (Park).

3. With your foot on the brake pedal, move the shift lever through each gear range, pausing for about three seconds in each range. Then, position the shift lever in P (Park).
4. Let the engine run at idle for three to five minutes.

Then, without shutting off the engine, follow these steps:

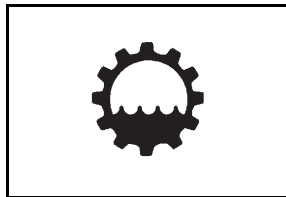

1. For the 3.9L V6 engine, locate the transmission fluid dipstick top which is a round loop with this symbol.

See *Engine Compartment Overview* on page 6-14 for more information on location.

2. Pull out the dipstick and wipe it with a clean rag or paper towel.
3. Push it back in all the way, wait three seconds, and then pull it back out again.

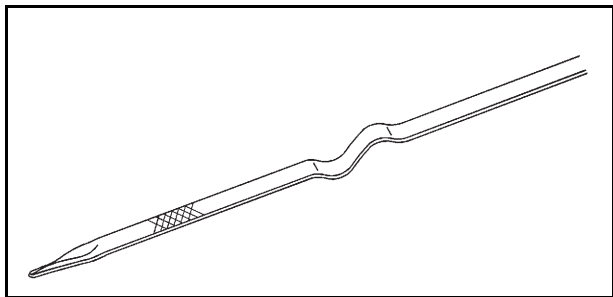

### 3.9L V6 Engine

4. Check both sides of the dipstick and read the lower level. The fluid level must be in the cross-hatched area.
5. If the fluid level is in the acceptable range, push the dipstick back in all the way.

## How to Add Automatic Transmission Fluid

Refer to the Maintenance Schedule to determine what kind of transmission fluid to use. See *Recommended Fluids and Lubricants* on page 7-8.

If the fluid level is low, add only enough of the proper fluid to bring the level into the cross-hatched area on the dipstick.

1. Pull out the dipstick.
2. Using a long-neck funnel, add enough fluid at the dipstick hole to bring it to the proper level.

It does not take much fluid, generally less than one pint (0.5 L). Do not overfill.

**Notice:** Use of the incorrect automatic transmission fluid may damage the vehicle, and the damages may not be covered by the vehicle's warranty. Always use the automatic transmission fluid listed in *Recommended Fluids and Lubricants* on page 7-8.



3. After adding fluid, recheck the fluid level as described under “How to Check Automatic Transmission Fluid” earlier in this section.
4. When the correct fluid level is obtained, push the dipstick back in all the way.

## How to Check Automatic Transmission Fluid (4.6L Engine)

For the 4.6L V8 engine, it is not necessary to check the transmission fluid level. A transmission fluid leak is the only reason for fluid loss. If a leak occurs, take the vehicle to your dealer service department and have it repaired as soon as possible.

## Cooling System

The cooling system allows the engine to maintain the correct working temperature.

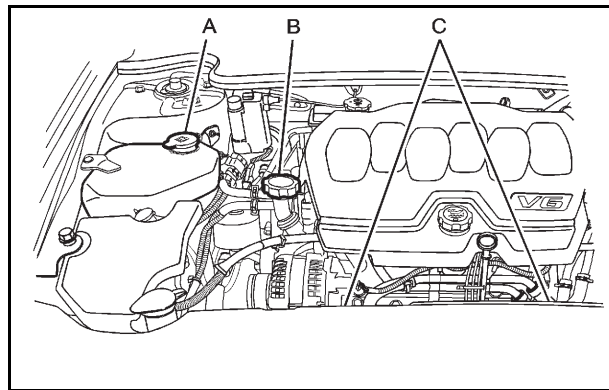

**3.9L Engine**

- A. Coolant Recovery Tank
- B. Radiator Pressure Cap
- C. Electric Engine Cooling Fans

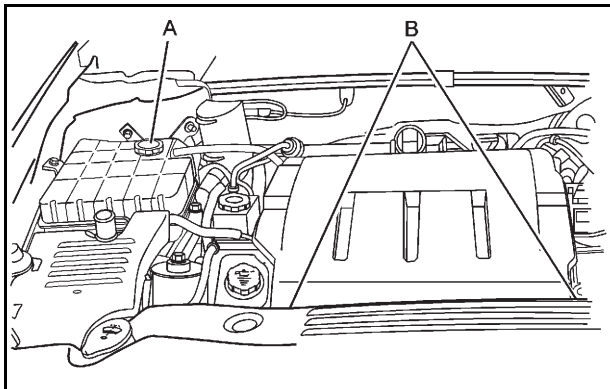

### 4.6L Engine

- A. Coolant Surge Tank with Pressure Cap
- B. Electric Engine Cooling Fans

#### **WARNING:**

An electric engine cooling fan under the hood can start up even when the engine is not running and can cause injury. Keep hands, clothing, and tools away from any underhood electric fan.

#### **WARNING:**

Heater and radiator hoses, and other engine parts, can be very hot. Do not touch them. If you do, you can be burned.

Do not run the engine if there is a leak. If you run the engine, it could lose all coolant. That could cause an engine fire, and you could be burned. Get any leak fixed before you drive the vehicle.

**Notice:** Using coolant other than DEX-COOL<sup>®</sup> can cause premature engine, heater core, or radiator corrosion. In addition, the engine coolant could require changing sooner, at 50 000 km (30,000 mi) or 24 months, whichever occurs first. Any repairs would not be covered by the vehicle warranty. Always use DEX-COOL (silicate-free) coolant in the vehicle.

### Engine Coolant (4.6L Engine)

The cooling system in the vehicle is filled with DEX-COOL<sup>®</sup> engine coolant. This coolant is designed to remain in the vehicle for five years or 150,000 miles (240 000 km), whichever occurs first.

The following explains the cooling system and how to check and add coolant when it is low. If there is a problem with engine overheating, see *Engine Overheating on page 6-35*.

## What to Use

### **WARNING:**

Adding only plain water or some other liquid to the cooling system can be dangerous. Plain water and other liquids, can boil before the proper coolant mixture will. The coolant warning system is set for the proper coolant mixture. With plain water or the wrong mixture, the engine could get too hot but you would not get the overheat warning. The engine could catch fire and you or others could be burned. Use a 50/50 mixture of clean, drinkable water and DEX-COOL coolant.

Use a 50/50 mixture of clean, drinkable water and DEX-COOL<sup>®</sup> coolant. If using this mixture, nothing else needs to be added. This mixture:

- Gives freezing protection down to  $-34^{\circ}\text{F}$  ( $-37^{\circ}\text{C}$ ), outside temperature.
- Gives boiling protection up to  $265^{\circ}\text{F}$  ( $129^{\circ}\text{C}$ ), engine temperature.

- Protects against rust and corrosion.
- Will not damage aluminum parts.
- Helps keep the proper engine temperature.

**Notice:** If an improper coolant mixture is used, the engine could overheat and be badly damaged. The repair cost would not be covered by the vehicle warranty. Too much water in the mixture can freeze and crack the engine, radiator, heater core, and other parts.

**Notice:** If extra inhibitors and/or additives are used in the vehicle's cooling system, the vehicle could be damaged. Use only the proper mixture of the engine coolant listed in this manual for the cooling system. See *Recommended Fluids and Lubricants on page 7-8* for more information.

Never dispose of engine coolant by putting it in the trash, pouring it on the ground, or into sewers, streams or bodies of water. Have the coolant changed by an authorized service center, familiar with legal requirements regarding used coolant disposal. This will help protect the environment and your health.

## Checking Coolant

The vehicle must be on a level surface when checking the coolant level.

Check to see if coolant is visible in the coolant recovery tank. If the coolant inside the coolant recovery tank is boiling, do not do anything else until it cools down. If coolant is visible but the coolant level is not at or above the FULL COLD mark, add a 50/50 mixture of clean, drinkable water and DEX-COOL<sup>®</sup> coolant at the coolant recovery tank, but be sure the cooling system is cool before this is done. See *Engine Coolant (4.6L Engine)* on page 6-28 or *Engine Coolant (3.9L Engine)* on page 6-31 for more information.

If no coolant is visible in the surge tank, add coolant as follows:

### How to Add Coolant to the Surge Tank

#### **WARNING:**

You can be burned if you spill coolant on hot engine parts. Coolant contains ethylene glycol and it will burn if the engine parts are hot enough. Do not spill coolant on a hot engine.

**Notice:** This vehicle has a specific coolant fill procedure. Failure to follow this procedure could cause the engine to overheat and be severely damaged.

#### **WARNING:**

An electric engine cooling fan under the hood can start up even when the engine is not running and can cause injury. Keep hands, clothing, and tools away from any underhood electric fan.

#### **WARNING:**

Steam and scalding liquids from a hot cooling system can blow out and burn you badly. They are under pressure, and if you turn the surge tank pressure cap — even a little — they can come out at high speed. Never turn the cap when the cooling system, including the surge tank pressure cap, is hot. Wait for the cooling system and surge tank pressure cap to cool if you ever have to turn the pressure cap.

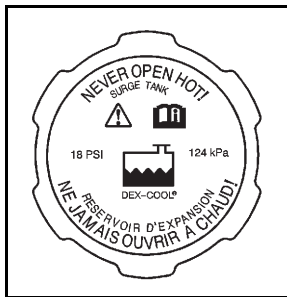

You can remove the coolant surge tank pressure cap when the cooling system, including the coolant surge tank pressure cap and upper radiator hose, is no longer hot.

1. Turn the pressure cap slowly counterclockwise. If you hear a hiss, wait for that to stop. A hiss means there is still some pressure left.
2. Then keep turning the cap and remove it.

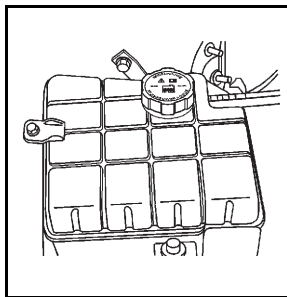

3. Fill the coolant surge tank with the proper mixture to the FULL COLD mark on the side of the coolant surge tank.

4. With the coolant surge tank cap off, start the engine and let it run until you can feel the upper radiator hose getting hot. Watch out for the engine cooling fans.

By this time, the coolant level inside the coolant surge tank may be lower. If the level is lower, add more of the proper mixture to the coolant surge tank until the level reaches the FULL COLD mark on the side of the coolant surge tank.

5. Then replace the cap. Be sure the cap is hand-tight and fully seated.

If coolant is needed, add the proper DEX-COOL<sup>®</sup> coolant mixture at the coolant recovery tank.

**Notice:** If the pressure cap is not tightly installed, coolant loss and possible engine damage may occur. Be sure the cap is properly and tightly secured.

## Engine Coolant (3.9L Engine)

The cooling system in the vehicle is filled with DEX-COOL<sup>®</sup> engine coolant. This coolant is designed to remain in the vehicle for five years or 150,000 miles (240 000 km), whichever occurs first.

The following explains the cooling system and how to check and add coolant when it is low. If there is a problem with engine overheating, see *Engine Overheating on page 6-35*.

## What to Use

### **WARNING:**

Adding only plain water or some other liquid to the cooling system can be dangerous. Plain water and other liquids, can boil before the proper coolant mixture will. The coolant warning system is set for the proper coolant mixture. With plain water or the wrong mixture, the engine could get too hot but you would not get the overheat warning. The engine could catch fire and you or others could be burned. Use a 50/50 mixture of clean, drinkable water and DEX-COOL coolant.

Use a 50/50 mixture of clean, drinkable water and DEX-COOL coolant. If using this mixture, nothing else needs to be added. This mixture:

- Gives freezing protection down to  $-34^{\circ}\text{F}$  ( $-37^{\circ}\text{C}$ ), outside temperature.
- Gives boiling protection up to  $265^{\circ}\text{F}$  ( $129^{\circ}\text{C}$ ), engine temperature.

- Protects against rust and corrosion.
- Will not damage aluminum parts.
- Helps keep the proper engine temperature.

**Notice:** If an improper coolant mixture is used, the engine could overheat and be badly damaged. The repair cost would not be covered by the vehicle warranty. Too much water in the mixture can freeze and crack the engine, radiator, heater core, and other parts.

**Notice:** If extra inhibitors and/or additives are used in the vehicle's cooling system, the vehicle could be damaged. Use only the proper mixture of the engine coolant listed in this manual for the cooling system. See *Recommended Fluids and Lubricants on page 7-8* for more information.

Never dispose of engine coolant by putting it in the trash, pouring it on the ground, or into sewers, streams or bodies of water. Have the coolant changed by an authorized service center, familiar with legal requirements regarding used coolant disposal. This will help protect the environment and your health.

## Checking Coolant

The vehicle must be on a level surface when checking the coolant level.

The coolant level should be at or above the FULL COLD mark when the engine is cold. The coolant level should be above the FULL COLD mark under normal operating conditions. If it is not, you may have a leak in the cooling system.

Check to see if coolant is visible in the coolant recovery tank. If the coolant inside the coolant recovery tank is boiling, do not do anything else until it cools down. If coolant is visible but the coolant level is not at or above the FULL COLD mark, add a 50/50 mixture of clean, drinkable water and DEX-COOL coolant at the coolant recovery tank, but be sure the cooling system is cool before this is done. See Engine Coolant for more information.

## How to Add Coolant to the Recovery Tank

### **WARNING:**

You can be burned if you spill coolant on hot engine parts. Coolant contains ethylene glycol and it will burn if the engine parts are hot enough. Do not spill coolant on a hot engine.

**Notice:** This vehicle has a specific coolant fill procedure. Failure to follow this procedure could cause the engine to overheat and be severely damaged.

If coolant is needed, add the proper DEX-COOL coolant mixture at the coolant recovery tank.

## How to Add Coolant to the Radiator

### **WARNING:**

An electric engine cooling fan under the hood can start up even when the engine is not running and can cause injury. Keep hands, clothing, and tools away from any underhood electric fan.

### **WARNING:**

Steam and scalding liquids from a hot cooling system can blow out and burn you badly. They are under pressure, and if you turn the surge tank pressure cap — even a little — they can come out at high speed. Never turn the cap when the cooling system, including the surge tank pressure cap, is hot. Wait for the cooling system and surge tank pressure cap to cool if you ever have to turn the pressure cap.

If coolant is needed, add the proper mixture directly to the radiator, but be sure the cooling system is cool before this is done.

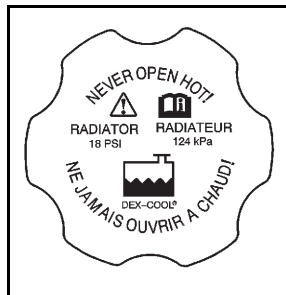

1. You can remove the pressure cap when the cooling system, including the pressure cap and upper radiator hose is no longer hot. Turn the pressure cap slowly counterclockwise.

2. If you hear a hiss, wait for that to stop. A hiss means that there is still some pressure left. Keep turning the pressure cap and remove it.
3. Fill the cooling system with the proper DEX-COOL coolant mixture, up to the base of the filler neck. See *Engine Coolant (4.6L Engine)* on page 6-28 or *Engine Coolant (3.9L Engine)* on page 6-31.
4. Then fill the coolant recovery tank to the COLD FILL line.



5. Install the coolant recovery tank cap and the pressure cap. After a day or two of driving, when the engine is cold, check the coolant level in the recovery tank. If it is low, refill it to the COLD FILL line.

If the coolant in the recovery tank is constantly low, you should have a dealer service department inspect the vehicle for leaks.

**Notice:** If the pressure cap is not tightly installed, coolant loss and possible engine damage may occur. Be sure the cap is properly and tightly secured.

## Engine Overheating

The vehicle has several indicators to warn of engine overheating.

You will find a warning light about a hot engine as well as an engine coolant temperature gauge on the instrument panel cluster.

You may decide not to lift the hood when this warning appears, but instead get service help right away. See *Roadside Assistance Program on page 8-7*.

If you do decide to lift the hood, make sure the vehicle is parked on a level surface.

Then check to see if the engine cooling fans are running. If the engine is overheating, both fans should be running. If they are not, do not continue to run the engine and have the vehicle serviced.

**Notice:** Engine damage from running the engine without coolant is not covered by the warranty.

**Notice:** If the engine catches fire while driving with no coolant, the vehicle can be badly damaged. The costly repairs would not be covered by the vehicle warranty. See *Overheated Engine Protection Operating Mode on page 6-37* for information on driving to a safe place in an emergency.

## If Steam Is Coming From The Engine Compartment

### **WARNING:**

Steam from an overheated engine can burn you badly, even if you just open the hood. Stay away from the engine if you see or hear steam coming from it. Turn it off and get everyone away from the vehicle until it cools down. Wait until there is no sign of steam or coolant before you open the hood.

If you keep driving when the vehicles engine is overheated, the liquids in it can catch fire. You or others could be badly burned. Stop the engine if it overheats, and get out of the vehicle until the engine is cool.

See *Overheated Engine Protection Operating Mode* on page 6-37 for information on driving to a safe place in an emergency.

## If No Steam Is Coming From The Engine Compartment

If an engine overheat warning is displayed but no steam can be seen or heard, the problem may not be too serious. Sometimes the engine can get a little too hot when the vehicle:

- Climbs a long hill on a hot day.
- Stops after high-speed driving.
- Idles for long periods in traffic.
- Tows a trailer.

If the overheat warning is displayed with no sign of steam:

1. Turn the air conditioning off.
2. Turn the heater on to the highest temperature and to the highest fan speed. Open the windows as necessary.
3. In heavy traffic, let the engine idle in N (Neutral) while stopped. If it is safe to do so, pull off the road, shift to P (Park) or N (Neutral) and let the engine idle.

If the temperature overheat gauge is no longer in the overheat zone or an overheat warning no longer displays, the vehicle can be driven. Continue to drive the vehicle slow for about 10 minutes. Keep a safe vehicle distance from the car in front of you. If the warning does not come back on, continue to drive normally.

If the warning continues, pull over, stop, and park the vehicle right away.

If there is no sign of steam, idle the engine for three minutes while parked. If the warning is still displayed, turn off the engine until it cools down. Also, see “Overheated Engine Protection Operating Mode” next in this section.

## Overheated Engine Protection Operating Mode

If an overheated engine condition exists and the message ENGINE OVERHEATED STOP ENGINE is displayed, an overheat protection mode which alternates firing groups of cylinders helps prevent engine damage. In this mode, you will notice a loss in power and engine performance. This operating mode allows the vehicle to be driven to a safe place in an emergency. Driving extended miles (km) and/or towing a trailer in the overheat protection mode should be avoided.

**Notice:** After driving in the overheated engine protection operating mode, to avoid engine damage, allow the engine to cool before attempting any repair. The engine oil will be severely degraded. Repair the cause of coolant loss, change the oil and reset the oil life system. See *Engine Oil* on page 6-18.

## Power Steering Fluid

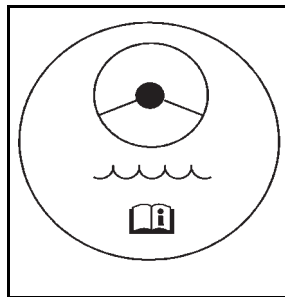

See *Engine Compartment Overview* on page 6-14 for information on the location of the power steering fluid reservoir.

## When to Check Power Steering Fluid

It is not necessary to regularly check power steering fluid unless you suspect there is a leak in the system or you hear an unusual noise. A fluid loss in this system could indicate a problem. Have the system inspected and repaired.

## How to Check Power Steering Fluid

To check the power steering fluid:

1. Turn the key off and let the engine compartment cool down.
2. Wipe the cap and the top of the reservoir clean.
3. Unscrew the cap and wipe the dipstick with a clean rag.
4. Replace the cap and completely tighten it.
5. Remove the cap again and look at the fluid level on the dipstick.

The level should be at the FULL COLD mark.

If necessary, add only enough fluid to bring the level up to the mark.

## What to Use

To determine what kind of fluid to use, see *Recommended Fluids and Lubricants on page 7-8*. Always use the proper fluid.

**Notice:** Use of the incorrect fluid may damage the vehicle and the damages may not be covered by the vehicle's warranty. Always use the correct fluid listed in *Recommended Fluids and Lubricants on page 7-8*.

## Windshield Washer Fluid

### What to Use

When the vehicle needs windshield washer fluid, be sure to read the manufacturer's instructions before use. If the vehicle will be operating in an area where the temperature may fall below freezing, use a fluid that has sufficient protection against freezing.

### Adding Washer Fluid

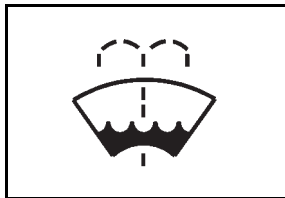

Open the cap with the washer symbol on it. Add washer fluid until the tank is full. See *Engine Compartment Overview on page 6-14* for reservoir location.

### Notice:

- When using concentrated washer fluid, follow the manufacturer's instructions for adding water.
- Do not mix water with ready-to-use washer fluid. Water can cause the solution to freeze and damage the washer fluid tank and other parts of the washer system. Also, water does not clean as well as washer fluid.
- Fill the washer fluid tank only three-quarters full when it is very cold. This allows for fluid expansion if freezing occurs, which could damage the tank if it is completely full.
- Do not use engine coolant (antifreeze) in the windshield washer. It can damage the windshield washer system and paint.

## Brakes

### Brake Fluid

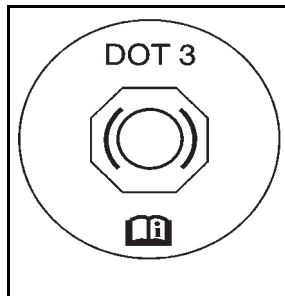

The brake master cylinder reservoir is filled with DOT 3 brake fluid. See *Engine Compartment Overview on page 6-14* for the location of the reservoir.

There are only two reasons why the brake fluid level in the reservoir might go down:

- The brake fluid level goes down because of normal brake lining wear. When new linings are installed, the fluid level goes back up.
- A fluid leak in the brake hydraulic system can also cause a low fluid level. Have the brake hydraulic system fixed, since a leak means that sooner or later the brakes will not work well.

Do not top off the brake fluid. Adding fluid does not correct a leak. If fluid is added when the linings are worn, there will be too much fluid when new brake linings are installed. Add or remove brake fluid, as necessary, only when work is done on the brake hydraulic system.

 **WARNING:**

If too much brake fluid is added, it can spill on the engine and burn, if the engine is hot enough. You or others could be burned, and the vehicle could be damaged. Add brake fluid only when work is done on the brake hydraulic system.

When the brake fluid falls to a low level, the brake warning light comes on. See *Brake System Warning Light on page 4-32*.

## What to Add

Use only new DOT 3 brake fluid from a sealed container. See *Recommended Fluids and Lubricants on page 7-8*.

Always clean the brake fluid reservoir cap and the area around the cap before removing it. This helps keep dirt from entering the reservoir.

 **WARNING:**

With the wrong kind of fluid in the brake hydraulic system, the brakes might not work well. This could cause a crash. Always use the proper brake fluid.

**Notice:**

- **Using the wrong fluid can badly damage brake hydraulic system parts. For example, just a few drops of mineral-based oil, such as engine oil, in the brake hydraulic system can damage brake hydraulic system parts so badly that they will have to be replaced. Do not let someone put in the wrong kind of fluid.**
- **If brake fluid is spilled on the vehicle's painted surfaces, the paint finish can be damaged. Be careful not to spill brake fluid on the vehicle. If you do, wash it off immediately. See *Washing Your Vehicle on page 6-102*.**

## Brake Wear

This vehicle has disc brakes. Disc brake pads have built-in wear indicators that make a high-pitched warning sound when the brake pads are worn and new pads are needed. The sound can come and go or be heard all the time the vehicle is moving, except when applying the brake pedal firmly.

### **WARNING:**

The brake wear warning sound means that soon the brakes will not work well. That could lead to a crash. When the brake wear warning sound is heard, have the vehicle serviced.

### **Notice: Continuing to drive with worn-out brake pads could result in costly brake repair.**

Some driving conditions or climates can cause a brake squeal when the brakes are first applied or lightly applied. This does not mean something is wrong with the brakes.

Properly torqued wheel nuts are necessary to help prevent brake pulsation. When tires are rotated, inspect brake pads for wear and evenly tighten wheel nuts in the proper sequence to torque specifications in *Capacities and Specifications on page 6-116*.

Brake linings should always be replaced as complete axle sets.

## Brake Pedal Travel

See your dealer if the brake pedal does not return to normal height, or if there is a rapid increase in pedal travel. This could be a sign that brake service might be required.

## Brake Adjustment

Every time the brakes are applied, with or without the vehicle moving, the brakes adjust for wear.

## Replacing Brake System Parts

The braking system on a vehicle is complex. Its many parts have to be of top quality and work well together if the vehicle is to have really good braking. The vehicle was designed and tested with top-quality brake parts. When parts of the braking system are replaced — for example, when the brake linings wear down and new ones are installed — be sure to get new approved replacement parts. If this is not done, the brakes might not work properly. For example, if someone puts in brake linings that are wrong for the vehicle, the balance between the front and rear brakes can change — for the worse. The braking performance expected can change in many other ways if the wrong replacement brake parts are installed.

## Battery

Refer to the replacement number on the original battery label when a new battery is needed.

### **DANGER:**

Battery posts, terminals, and related accessories contain lead and lead compounds, chemicals known to the State of California to cause cancer and reproductive harm. Wash hands after handling.

The battery is under the rear seat cushion. To access the battery, see “Removing the Rear Seat Cushion” under *Rear Underseat Fuse Block on page 6-110*. Access to the battery is not necessary to jump start the vehicle. See *Jump Starting on page 6-44*.



**⚠ WARNING:**

A battery that is not properly vented can let sulfuric acid fumes into the area under the rear seat cushion. These fumes can damage the rear seat safety belt systems. You might not be able to see this damage and the safety belts might not provide the protection needed in a crash. If a replacement battery is ever needed, it must be vented in the same manner as the original battery. Always make sure that the vent hose is properly reattached before reinstalling the seat cushion.

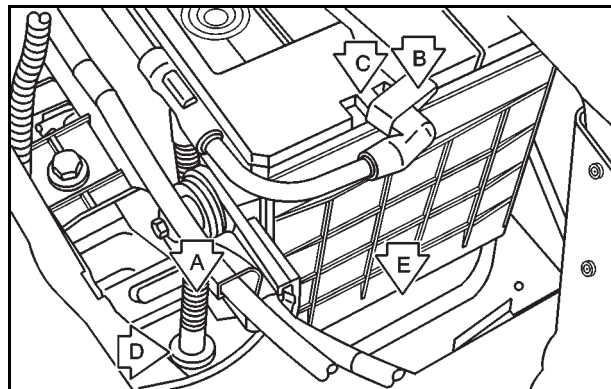

To be sure the vent hose (A) is properly attached, the vent hose connectors (B) must be securely reattached to the vent outlets (C) on each side of the battery and the vent assembly grommet (D) must be secured to the floor pan (E).

## Vehicle Storage

### **WARNING:**

Batteries have acid that can burn you and gas that can explode. You can be badly hurt if you are not careful. See *Jump Starting on page 6-44* for tips on working around a battery without getting hurt.

**Infrequent Usage:** Remove the black, negative (-) cable from the battery to keep the battery from running down.

**Extended Storage:** Remove the black, negative (-) cable from the battery or use a battery trickle charger.

See *Theft-Deterrent Feature on page 4-94* for the audio system.

## Jump Starting

For more information about the vehicle battery, see *Battery on page 6-42*.

If the vehicle's battery has run down, you may want to use another vehicle and some jumper cables to start your vehicle. Be sure to use the following steps to do it safely.

### **WARNING:**

Batteries can hurt you. They can be dangerous because:

- They contain acid that can burn you.
- They contain gas that can explode or ignite.
- They contain enough electricity to burn you.

If you do not follow these steps exactly, some or all of these things can hurt you.

**Notice:** Ignoring these steps could result in costly damage to the vehicle that would not be covered by the warranty.

**Trying to start the vehicle by pushing or pulling it will not work, and it could damage the vehicle.**

1. Check the other vehicle. It must have a 12-volt battery with a negative ground system.

**Notice: Only use a vehicle that has a 12-volt system with a negative ground for jump starting. If the other vehicle does not have a 12-volt system with a negative ground, both vehicles can be damaged.**

2. Get the vehicles close enough so the jumper cables can reach, but be sure the vehicles are not touching each other. If they are, it could cause a ground connection you do not want. You would not be able to start your vehicle, and the bad grounding could damage the electrical systems.

To avoid the possibility of the vehicles rolling, set the parking brake firmly on both vehicles involved in the jump start procedure. Put an automatic transmission in P (Park) or a manual transmission in Neutral before setting the parking brake.

**Notice:** If the radio or other accessories are left on during the jump starting procedure, they could be damaged. The repairs would not be covered by the warranty. Always turn off the radio and other accessories when jump starting the vehicle.

3. Turn off the ignition on both vehicles. Unplug unnecessary accessories plugged into the cigarette lighter or the accessory power outlet(s). Turn off the radio and all lamps that are not needed. This will avoid sparks and help save both batteries. And it could save the radio!
4. Open the hood on the other vehicle and locate the positive (+) and negative (-) terminal locations on that vehicle.

You will not see the battery of your vehicle under the hood. It is located under the rear passenger's seat. You will not need to access the battery for jump starting. The remote positive (+) terminal is for that purpose. See *Engine Compartment Overview on page 6-14* for location.

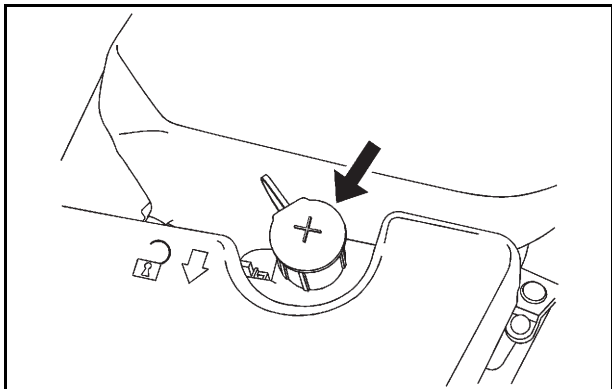

Access the remote positive (+) terminal by removing the cover.

**⚠ WARNING:**

An electric fan can start up even when the engine is not running and can injure you. Keep hands, clothing and tools away from any underhood electric fan.

**⚠ WARNING:**

Using an open flame near a battery can cause battery gas to explode. People have been hurt doing this, and some have been blinded. Use a flashlight if you need more light.

Be sure the battery has enough water. You do not need to add water to the battery installed in your new vehicle. But if a battery has filler caps, be sure the right amount of fluid is there. If it is low, add water to take care of that first. If you do not, explosive gas could be present.

Battery fluid contains acid that can burn you. Do not get it on you. If you accidentally get it in your eyes or on your skin, flush the place with water and get medical help immediately.

 **WARNING:**

Fans or other moving engine parts can injure you badly. Keep your hands away from moving parts once the engine is running.

5. Check that the jumper cables do not have loose or missing insulation. If they do, you could get a shock. The vehicles could be damaged too.

Before you connect the cables, here are some basic things you should know. Positive (+) will go to positive (+) or to a remote positive (+) terminal if the vehicle has one. Negative (-) will go to a heavy, unpainted metal engine part or to a remote negative (-) terminal if the vehicle has one.

Do not connect positive (+) to negative (-) or you will get a short that would damage the battery and maybe other parts too. And do not connect the negative (-) cable to the negative (-) terminal on the dead battery because this can cause sparks.

6. Connect the red positive (+) cable to the positive (+) terminal of the dead battery. Use a remote positive (+) terminal if the vehicle has one.
7. Do not let the other end touch metal. Connect it to the positive (+) terminal of the good battery. Use a remote positive (+) terminal if the vehicle has one.
8. Now connect the black negative (-) cable to the negative (-) terminal of the good battery. Use a remote negative (-) terminal if the vehicle has one.  
Do not let the other end touch anything until the next step. The other end of the negative (-) cable *does not* go to the dead battery. It goes to a heavy, unpainted metal engine part or to a remote negative (-) terminal on the vehicle with the dead battery.
9. Connect the other end of the negative (-) cable at least 18 inches (45 cm) away from the dead battery, but not near engine parts that move. The electrical connection is just as good there, and the chance of sparks getting back to the battery is much less.

10. Now start the vehicle with the good battery and run the engine for a while.
11. Try to start the vehicle that had the dead battery. If it will not start after a few tries, it probably needs service.

**Notice:** If the jumper cables are connected or removed in the wrong order, electrical shorting may occur and damage the vehicle. The repairs would not be covered by the vehicle warranty. Always connect and remove the jumper cables in the correct order, making sure that the cables do not touch each other or other metal.

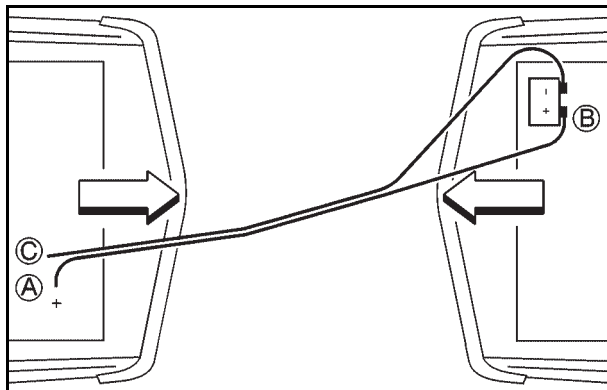

### Jumper Cable Removal

- A. Dead Battery or Remote Positive (+) Terminal
- B. Good Battery or Remote Positive (+) and Remote Negative (-) Terminals
- C. Heavy, Unpainted Metal Engine Part or Remote Negative (-) Terminal

To disconnect the jumper cables from both vehicles, do the following:

1. Disconnect the black negative (-) cable from the vehicle that had the dead battery.
2. Disconnect the black negative (-) cable from the vehicle with the good battery.

3. Disconnect the red positive (+) cable from the vehicle with the good battery.
4. Disconnect the red positive (+) cable from the other vehicle.
5. Return the positive (+) remote terminal cover to its original position.

## Headlamp Aiming

The vehicle has a visual optical headlamp aiming system. The aim of the headlamps have been preset at the factory and should need no further adjustment.

However, if the vehicle is damaged in a crash, the aim of the headlamps may be affected and adjustment may be necessary.

If oncoming vehicles flash their high beams at you, this may mean the vertical aim of your headlamps needs to be adjusted.

It is recommended that the vehicle is taken to your dealer for service if the headlamps need to be adjusted. It is possible however, to re-aim the headlamps as described.

The vehicle should:

- Be placed so the headlamps are 25 ft. (7.6 m) from a light colored wall.
- Have all four tires on a level surface which is level all the way to the wall.
- Be placed so it is perpendicular to the wall.
- Not have any snow, ice or mud on it.
- Be fully assembled and all other work stopped while headlamp aiming is being performed.
- Be normally loaded with a full tank of fuel and one person or 160 lbs (75 kg) sitting on the driver seat.
- Have all tires properly inflated.
- Have the spare tire is in its proper location in the vehicle.

Headlamp aiming is done with the vehicle's low-beam headlamps. The high-beam headlamps will be correctly aimed if the low-beam headlamps are aimed properly.

To adjust the vertical aim:

1. Open the hood. See *Hood Release on page 6-13* for more information.

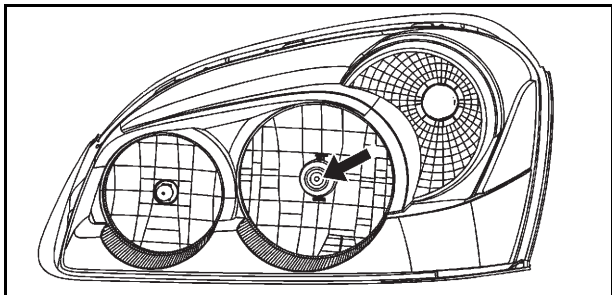

2. Locate the aim dot on the lens of the low-beam headlamp.
3. Record the distance from the ground to the aim dot on the low-beam headlamp.

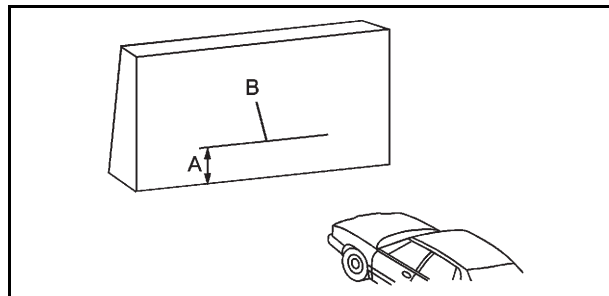

4. At a wall, measure from the ground upward (A) to the recorded distance from Step 3 and mark it.
5. Draw or tape a horizontal line (B) on the wall the width of the vehicle at the height of the mark in Step 4.

**Notice:** Do not cover a headlamp to improve beam cut-off when aiming. Covering a headlamp may cause excessive heat build-up which may cause damage to the headlamp.

6. Turn on the low-beam headlamps and place a piece of cardboard or equivalent in front of the headlamp not being adjusted. Do not place directly on the headlamp. This allows only the beam of light from the headlamp being adjusted to be seen on the flat surface.



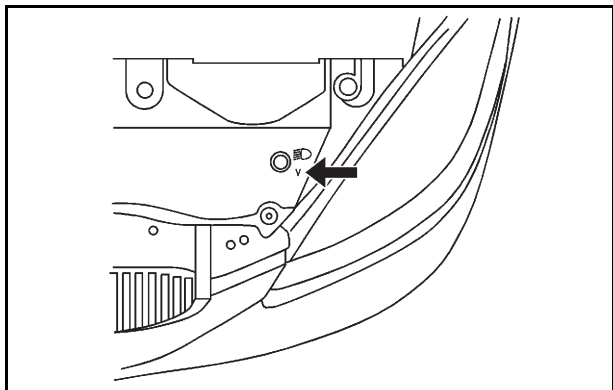

7. Locate the vertical headlamp aiming screws, which are under the hood near each headlamp assembly. The adjustment screw can be turned with a Number 2 Phillips screwdriver.
8. Turn the vertical aiming screw until the headlamp beam is aimed to the horizontal tape line. Turn it clockwise or counterclockwise to raise or lower the angle of the beam.

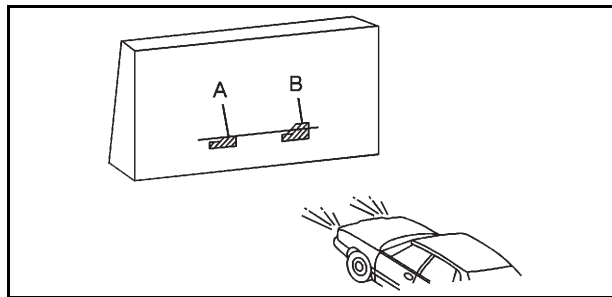

9. Make sure that the light from the headlamp is positioned at the bottom edge of the horizontal tape line. The lamp on the left (A) shows the correct headlamp aim. The lamp on the right (B) shows the incorrect headlamp aim.
10. Repeat Steps 7 through 9 for the opposite headlamp.

## Bulb Replacement

For the proper type of replacement bulbs, see *Replacement Bulbs on page 6-55*.

For any bulb changing procedure not listed in this section, contact your dealer.

## Halogen Bulbs

### **WARNING:**

Halogen bulbs have pressurized gas inside and can burst if you drop or scratch the bulb. You or others could be injured. Be sure to read and follow the instructions on the bulb package.

## Taillamps, Turn Signal, Stoplamps and Sidemarkers Lamps

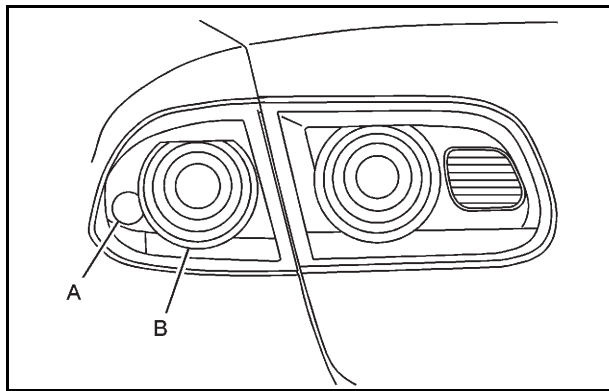

A. Sidemarkers Lamp

B. Stoplamp/Taillamp/Turn Signal Lamp

To replace one of these bulbs:

1. Open the trunk. See *Trunk on page 3-12*.
2. Remove the convenience net.
3. Remove the plastic wing nuts retaining the trunk trim.
4. Pull back the trunk trim.

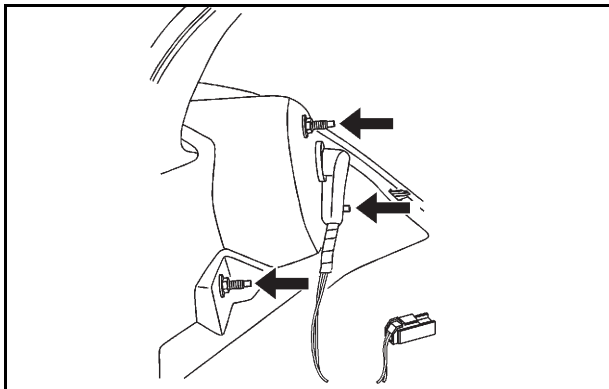

5. Remove the three hex nuts holding the taillamp assembly in place.
6. Pull the taillamp assembly straight out.
7. Turn the bulb socket counterclockwise and pull it straight out to remove it.
8. Pull the old bulb straight out of the socket.
9. Push the new bulb straight in until it clicks.
10. Push the bulb socket in and turn it clockwise to secure it in the taillamp assembly.
11. Push the taillamp assembly straight in to its original location.

When reinstalling the taillamp assembly, make sure the plastic pin on the taillamp assembly lines up and is inserted correctly into the opening of the vehicle.
12. Reinstall the three hex nuts holding the taillamp assembly in place.
13. Put the trunk trim back into place.
14. Reinstall the plastic wing nuts that retain the trunk trim.
15. Put the convenience net back in its original location.

## Taillamps and Back-Up Lamps

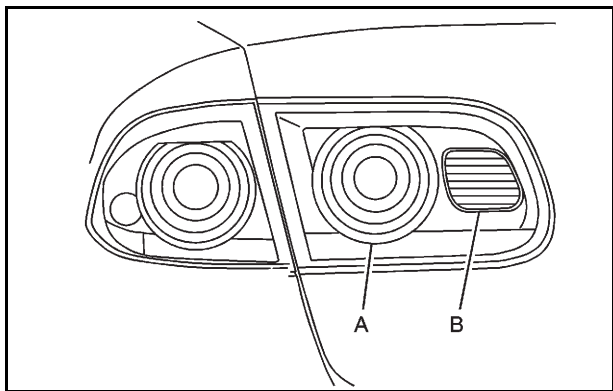

- A. Taillamp
- B. Back-up Lamp

To replace an auxiliary taillamp or back-up lamp bulb:

1. Open the trunk. See *Trunk* on page 3-12.

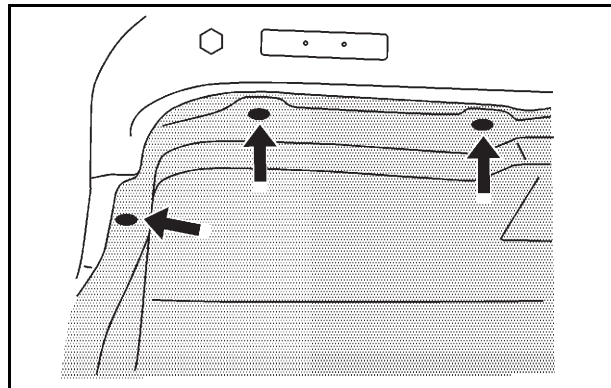

2. Remove the three fasteners from the trunk trim.
3. Pull back the trunk trim to access the bulbs.
4. Turn the bulb socket counterclockwise to remove it.
5. Pull the bulb straight out.
6. Push the bulb straight in until it clicks.

7. Push the bulb socket in and turn it clockwise to secure it.
8. Put the trunk trim and three fasteners back into place.

## License Plate Lamp

To replace one of these bulbs:

1. Remove the license plate.
2. Reach up through the opening above the license plate to access the two license plate lamps.
3. Turn the socket counterclockwise to remove.
4. Grasp the bulb in the socket and pull straight out.
5. Push the bulb straight into the socket until it clicks to secure it.
6. Push the socket in and turn it clockwise to secure it.
7. Reinstall the license plate in its original location.

## Replacement Bulbs

Exterior Lamps	Bulb Number
Back-up Lamp	921LL
Sidemarkers, License Plate Lamp, and Auxiliary Taillamp	194LL
Stoplamp, Taillamp, and Turn Signal Lamp	3057K

For replacement bulbs not listed here, contact your dealer.

## Windshield Wiper Blade Replacement

Windshield wiper blades should be inspected for wear or cracking. See *Scheduled Maintenance on page 7-3*.

It is a good idea to clean or replace the wiper blade assembly on a regular basis or when worn. For proper windshield wiper blade length and type, see *Maintenance Replacement Parts on page 7-10*.

To replace the wiper blade assembly:

1. Turn the ignition to ACC/ACCESSORY with the engine off.
2. Pull the windshield wiper assembly away from the windshield.

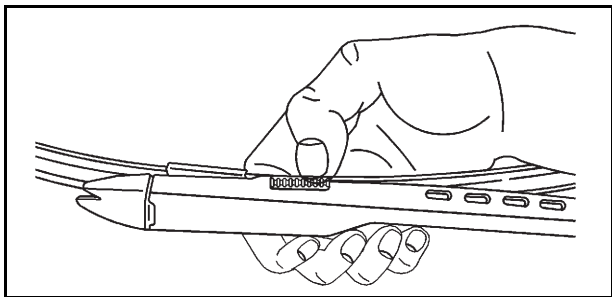

3. Squeeze the tabs on each side of the wiper blade assembly and slide the assembly off the end of the wiper arm.

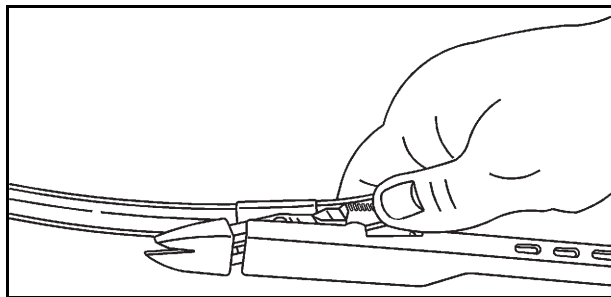

4. Replace the blade assembly with a new one.  
Allowing the wiper blade arm to touch the windshield when no wiper blade is installed could damage the windshield. Any damage that occurs would not be covered by your warranty. Do not allow the wiper blade arm to touch the windshield.
5. Repeat the steps for the other wiper.

## Tires

Your new vehicle comes with high-quality tires made by a leading tire manufacturer. If you ever have questions about your tire warranty and where to obtain service, see your vehicle Warranty booklet for details. For additional information refer to the tire manufacturer.

### **WARNING:**

- Poorly maintained and improperly used tires are dangerous.
- Overloading your tires can cause overheating as a result of too much flexing. You could have a blowout and a serious accident. See *Loading the Vehicle on page 5-18*.
- Under inflated tires pose the same danger as overloaded tires. The resulting crash could cause serious injury. Check all tires frequently to maintain the recommended pressure. Tire pressure should be checked when your tires are cold.

(Continued)

### **WARNING: (Continued)**

- Over inflated tires are more likely to be cut, punctured, or broken by a sudden impact — such as when you hit a pothole. Keep tires at the recommended pressure.
- Worn or old tires can cause a crash. If your tread is badly worn, replace them.
- Replace any tires that have been damaged by impacts with potholes, curbs, etc.
- Improperly repaired tires can cause a crash. Only your dealer or an authorized tire service center should repair, replace, dismount, and mount the tires.
- Do not spin the tires in excess of 55 km/h (35 mph) on slippery surfaces such as snow, mud, ice, etc. Excessive spinning may cause the tires to explode.

## Tire Sidewall Labeling

Useful information about a tire is molded into its sidewall. The examples below show a typical passenger vehicle tire and a compact spare tire sidewall.

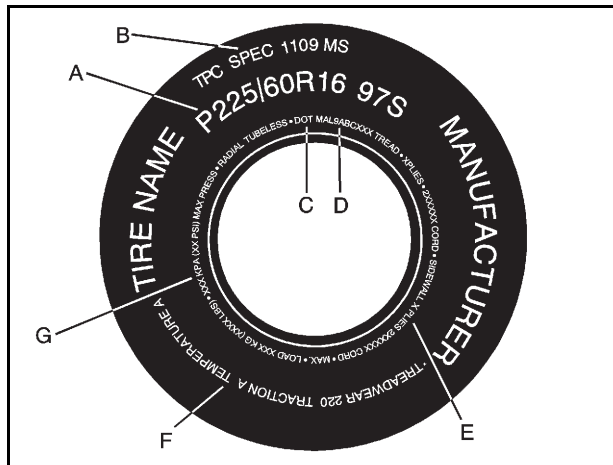

Passenger (P-Metric) Tire Example

**(A) Tire Size:** The tire size is a combination of letters and numbers used to define a particular tire's width, height, aspect ratio,

construction type, and service description. See the "Tire Size" illustration later in this section for more detail.

**(B) TPC Spec (Tire Performance Criteria Specification):** Original equipment tires designed to GM's specific tire performance criteria have a TPC specification code molded onto the sidewall. GM's TPC specifications meet or exceed all federal safety guidelines.

**(C) DOT (Department of Transportation):** The Department of Transportation (DOT) code indicates that the tire is in compliance with the U.S. Department of Transportation Motor Vehicle Safety Standards.

**(D) Tire Identification Number (TIN):** The letters and numbers following DOT (Department of Transportation) code is the Tire Identification Number (TIN). The TIN shows the manufacturer and plant code, tire size, and date the tire was manufactured. The TIN is molded onto both sides of the tire, although only one side may have the date of manufacture.



**(E) Tire Ply Material:** The type of cord and number of plies in the sidewall and under the tread.

**(F) Uniform Tire Quality Grading (UTQG):** Tire manufacturers are required to grade tires based on three performance factors: treadwear, traction, and temperature resistance. For more information see *Uniform Tire Quality Grading on page 6-75*.

**(G) Maximum Cold Inflation Load Limit:** Maximum load that can be carried and the maximum pressure needed to support that load.

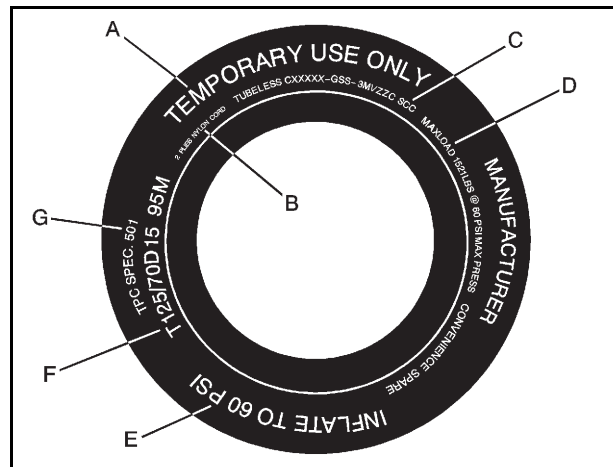

**Compact Spare Tire Example**

**(A) Temporary Use Only:** The compact spare tire or temporary use tire has a tread life of approximately 3,000 miles (5 000 km) and should not be driven at speeds over 65 mph (105 km/h). The compact spare tire is for emergency use when a regular road tire has lost air and gone flat. If your vehicle has a compact spare tire, see *Compact Spare Tire on page 6-97* and *If a Tire Goes Flat on page 6-78*.

**(B) Tire Ply Material:** The type of cord and number of plies in the sidewall and under the tread.

**(C) Tire Identification Number (TIN):** The letters and numbers following the DOT (Department of Transportation) code is the Tire Identification Number (TIN). The TIN shows the manufacturer and plant code, tire size, and date the tire was manufactured. The TIN is molded onto both sides of the tire, although only one side may have the date of manufacture.

**(D) Maximum Cold Inflation Load Limit:** Maximum load that can be carried and the maximum pressure needed to support that load.

**(E) Tire Inflation:** The temporary use tire or compact spare tire should be inflated to 60 psi (420 kPa). For more information on tire pressure and inflation see *Inflation - Tire Pressure on page 6-64*.

**(F) Tire Size:** A combination of letters and numbers define a tire's width, height, aspect ratio, construction type, and service description. The letter T as the first character in the tire size means the tire is for temporary use only.

**(G) TPC Spec (Tire Performance Criteria Specification):** Original equipment tires designed to GM's specific tire performance criteria have a TPC specification code molded onto the sidewall. GM's TPC specifications meet or exceed all federal safety guidelines.

## Tire Size

The following illustration shows an example of a typical passenger vehicle tire size.

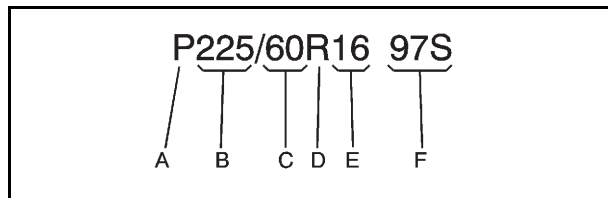

**(A) Passenger (P-Metric) Tire:** The United States version of a metric tire sizing system. The letter P as the first character in the tire size means a passenger vehicle tire engineered to standards set by the U.S. Tire and Rim Association.

**(B) Tire Width:** The three-digit number indicates the tire section width in millimeters from sidewall to sidewall.

**(C) Aspect Ratio:** A two-digit number that indicates the tire height-to-width measurements. For example, if the tire size aspect ratio is 60, as shown in item C of the illustration, it would mean that the tire's sidewall is 60 percent as high as it is wide.

**(D) Construction Code:** A letter code is used to indicate the type of ply construction in the tire. The letter R means radial ply construction; the letter D means diagonal or bias ply construction; and the letter B means belted-bias ply construction.

**(E) Rim Diameter:** Diameter of the wheel in inches.

**(F) Service Description:** These characters represent the load index and speed rating of the tire. The load index represents the load carrying capacity a tire is certified to carry. The speed rating is the maximum speed a tire is certified to carry a load.

## Tire Terminology and Definitions

**Air Pressure:** The amount of air inside the tire pressing outward on each square inch of the tire. Air pressure is expressed in pounds per square inch (psi) or kilopascal (kPa).

**Accessory Weight:** This means the combined weight of optional accessories. Some examples of optional accessories are, automatic transmission, power steering, power brakes, power windows, power seats, and air conditioning.

**Aspect Ratio:** The relationship of a tire's height to its width.

**Belt:** A rubber coated layer of cords that is located between the plies and the tread. Cords may be made from steel or other reinforcing materials.

**Bead:** The tire bead contains steel wires wrapped by steel cords that hold the tire onto the rim.

**Bias Ply Tire:** A pneumatic tire in which the plies are laid at alternate angles less than 90 degrees to the centerline of the tread.

**Cold Tire Pressure:** The amount of air pressure in a tire, measured in pounds per square inch (psi) or kilopascals (kPa) before a tire has built up heat from driving. See *Inflation - Tire Pressure on page 6-64*.

**Curb Weight:** The weight of a motor vehicle with standard and optional equipment including the maximum capacity of fuel, oil, and coolant, but without passengers and cargo.

**DOT Markings:** A code molded into the sidewall of a tire signifying that the tire is in compliance with the U.S. Department of Transportation (DOT) motor vehicle safety standards. The DOT code includes the Tire Identification Number (TIN), an alphanumeric designator which can also identify the tire manufacturer, production plant, brand, and date of production.

**GVWR:** Gross Vehicle Weight Rating. See *Loading the Vehicle on page 5-18*.

**GAWR FRT:** Gross Axle Weight Rating for the front axle. See *Loading the Vehicle on page 5-18*.

**GAWR RR:** Gross Axle Weight Rating for the rear axle. See *Loading the Vehicle on page 5-18*.

**Intended Outboard Sidewall:** The side of an asymmetrical tire, that must always face outward when mounted on a vehicle.

**Kilopascal (kPa):** The metric unit for air pressure.

**Light Truck (LT-Metric) Tire:** A tire used on light duty trucks and some multipurpose passenger vehicles.

**Load Index:** An assigned number ranging from 1 to 279 that corresponds to the load carrying capacity of a tire.

**Maximum Inflation Pressure:** The maximum air pressure to which a cold tire can be inflated. The maximum air pressure is molded onto the sidewall.

**Maximum Load Rating:** The load rating for a tire at the maximum permissible inflation pressure for that tire.

**Maximum Loaded Vehicle Weight:** The sum of curb weight, accessory weight, vehicle capacity weight, and production options weight.

**Normal Occupant Weight:** The number of occupants a vehicle is designed to seat multiplied by 150 lbs (68 kg). See *Loading the Vehicle on page 5-18*.

**Occupant Distribution:** Designated seating positions.

**Outward Facing Sidewall:** The side of an asymmetrical tire that has a particular side that faces outward when mounted on a vehicle. The side of the tire that contains a whitewall, bears white lettering, or bears manufacturer, brand, and/or model name molding that is higher or deeper than the same moldings on the other sidewall of the tire.

**Passenger (P-Metric) Tire:** A tire used on passenger cars and some light duty trucks and multipurpose vehicles.

**Recommended Inflation Pressure:** Vehicle manufacturer's recommended tire inflation pressure as shown on the tire placard. See *Inflation - Tire Pressure on page 6-64* and *Loading the Vehicle on page 5-18*.

**Radial Ply Tire:** A pneumatic tire in which the ply cords that extend to the beads are laid at 90 degrees to the centerline of the tread.

**Rim:** A metal support for a tire and upon which the tire beads are seated.

**Sidewall:** The portion of a tire between the tread and the bead.

**Speed Rating:** An alphanumeric code assigned to a tire indicating the maximum speed at which a tire can operate.

**Traction:** The friction between the tire and the road surface. The amount of grip provided.

**Tread:** The portion of a tire that comes into contact with the road.

**Treadwear Indicators:** Narrow bands, sometimes called wear bars, that show across the tread of a tire when only 1/16 inch (1.6 mm) of tread remains. See *When It Is Time for New Tires on page 6-71*.

**UTQGS (Uniform Tire Quality Grading Standards):** A tire information system that provides consumers with ratings for a tire's traction, temperature, and treadwear. Ratings are determined by tire manufacturers using government testing procedures. The ratings are molded into the sidewall of the tire. See *Uniform Tire Quality Grading on page 6-75*.

**Vehicle Capacity Weight:** The number of designated seating positions multiplied by 150 lbs (68 kg) plus the rated cargo load. See *Loading the Vehicle on page 5-18*.

**Vehicle Maximum Load on the Tire:** Load on an individual tire due to curb weight, accessory weight, occupant weight, and cargo weight.

**Vehicle Placard:** A label permanently attached to a vehicle showing the vehicle's capacity weight and the original equipment tire size and recommended inflation pressure. See "Tire and Loading Information Label" under *Loading the Vehicle on page 5-18*.

## Inflation - Tire Pressure

Tires need the correct amount of air pressure to operate effectively.

**Notice:** Neither tire underinflation nor overinflation is good. Underinflated tires, or tires that do not have enough air, can result in:

- Tire overloading and over-heating which could lead to a blowout.
- Premature or irregular wear.
- Poor handling.
- Reduced fuel economy.

Overinflated tires, or tires that have too much air, can result in:

- Unusual wear.
- Poor handling.
- Rough ride.
- Needless damage from road hazards.

A vehicle specific Tire and Loading Information label is attached to your vehicle. This label shows your vehicle's original equipment tires and the correct inflation pressures for your tires when they are cold. The recommended cold tire inflation pressure, shown on the label, is the minimum amount of air pressure needed to support your vehicle's maximum load carrying capacity.

For additional information regarding how much weight your vehicle can carry, and an example of the Tire and Loading Information label, see *Loading the Vehicle on page 5-18*. How you load your vehicle affects vehicle handling and ride comfort. Never load your vehicle with more weight than it was designed to carry.

### When to Check

Check your tires once a month or more. Do not forget to check the compact spare tire, it should be at 60 psi (420 kPa). For additional information regarding the compact spare tire, see *Compact Spare Tire on page 6-97*.

## How to Check

Use a good quality pocket-type gauge to check tire pressure. You cannot tell if your tires are properly inflated simply by looking at them. Radial tires may look properly inflated even when they are under-inflated. Check the tire's inflation pressure when the tires are cold. Cold means your vehicle has been sitting for at least three hours or driven no more than 1 mile (1.6 km).

Remove the valve cap from the tire valve stem. Press the tire gauge firmly onto the valve to get a pressure measurement. If the cold tire inflation pressure matches the recommended pressure on the Tire and Loading Information label, no further adjustment is necessary. If the inflation pressure is low, add air until you reach the recommended amount.

If you overfill the tire, release air by pushing on the metal stem in the center of the tire valve. Re-check the tire pressure with the tire gauge.

Be sure to put the valve caps back on the valve stems. They help prevent leaks by keeping out dirt and moisture.

## Tire Pressure Monitor System

The Tire Pressure Monitor System (TPMS) uses radio and sensor technology to check tire pressure levels. The TPMS sensors monitor the air pressure in your vehicle's tires and transmit tire pressure readings to a receiver located in the vehicle.

Each tire, including the spare (if provided), should be checked monthly when cold and inflated to the inflation pressure recommended by the vehicle manufacturer on the vehicle placard or tire inflation pressure label. (If your vehicle has tires of a different size than the size indicated on the vehicle placard or tire inflation pressure label, you should determine the proper tire inflation pressure for those tires.)

As an added safety feature, your vehicle has been equipped with a tire pressure monitoring system (TPMS) that illuminates a low tire pressure telltale when one or more of your tires is significantly under-inflated.

Accordingly, when the low tire pressure telltale illuminates, you should stop and check your tires as soon as possible, and inflate them to the proper pressure. Driving on a significantly under-inflated tire causes the tire to overheat and can lead to tire failure. Under-inflation also reduces fuel efficiency and tire tread life, and may affect the vehicle's handling and stopping ability.

Please note that the TPMS is not a substitute for proper tire maintenance, and it is the driver's responsibility to maintain correct tire pressure, even if under-inflation has not reached the level to trigger illumination of the TPMS low tire pressure telltale.

Your vehicle has also been equipped with a TPMS malfunction indicator to indicate when the system is not operating properly. The TPMS malfunction indicator is combined with the low tire pressure telltale. When the system detects a malfunction, the telltale will flash for approximately one minute and then remain continuously illuminated. This sequence will continue upon subsequent vehicle start-ups as long as the malfunction exists.

When the malfunction indicator is illuminated, the system may not be able to detect or signal low tire pressure as intended. TPMS malfunctions may occur for a variety of reasons, including the installation of replacement or alternate tires or wheels on the vehicle that prevent the TPMS from functioning properly. Always check the TPMS malfunction telltale after replacing one or more tires or wheels on your vehicle to ensure that the replacement or alternate tires and wheels allow the TPMS to continue to function properly.

See *Tire Pressure Monitor Operation* on page 6-66 for additional information.

## Federal Communications Commission (FCC) and Industry Canada

See *Radio Frequency Statement* on page 8-18 for information regarding Part 15 of the Federal Communications Commission (FCC) rules and Industry Canada Standards RSS-210/220/310.

## Tire Pressure Monitor Operation

This vehicle may have a Tire Pressure Monitor System (TPMS). The TPMS is designed to warn the driver when a low tire pressure condition exists. TPMS sensors are mounted onto each tire and wheel assembly, excluding the spare tire and wheel assembly. The TPMS sensors monitor the air pressure in the tires and transmits the tire pressure readings to a receiver located in the vehicle.

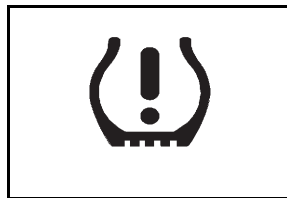

When a low tire pressure condition is detected, the TPMS illuminates the low tire pressure warning light located on the instrument cluster.



If the warning light comes on, stop as soon as possible and inflate the tires to the recommended pressure shown on the tire loading information label. See *Loading the Vehicle on page 5-18*.

A message to check the pressure in a specific tire displays in the Driver Information Center (DIC). The low tire pressure warning light and the DIC warning message come on at each ignition cycle until the tires are inflated to the correct inflation pressure. Using the DIC, tire pressure levels can be viewed by the driver. For additional information and details about the DIC operation and displays see *DIC Operation and Displays on page 4-42* and *DIC Warnings and Messages on page 4-49*.

The low tire pressure warning light may come on in cool weather when the vehicle is first started, and then turn off as the vehicle is driven. This could be an early indicator that the air pressure is getting low and needs to be inflated to the proper pressure.

A Tire and Loading Information label shows the size of the original equipment tires and the correct inflation pressure for the tires when they are cold. See *Loading the Vehicle on page 5-18*, for an example of the Tire and Loading Information label and its location on your vehicle. Also see *Inflation - Tire Pressure on page 6-64*.

Your vehicle's TPMS can warn you about a low tire pressure condition but it does not replace normal tire maintenance. See *Tire Inspection and Rotation on page 6-70* and *Tires on page 6-57*.

**Notice: Tire sealant materials are not all the same. A non-approved tire sealant could damage the TPMS sensors. TPMS sensor damage caused by using an incorrect tire sealant is not covered by the vehicle warranty. Always use only the GM-approved tire sealant available through your dealer or included in the vehicle.**

Factory-installed Tire Inflator Kits use a GM approved liquid tire sealant. Using non-approved tire sealants could damage the TPMS sensors. See *Tire Sealant and Compressor Kit on page 6-80* for information regarding the inflator kit materials and instructions.

## TPMS Malfunction Light and Message

The TPMS will not function properly if one or more of the TPMS sensors are missing or inoperable. When the system detects a malfunction, the low tire pressure warning light flashes for about one minute and then stays on for the remainder of the ignition cycle. A DIC warning message also displays. The malfunction light and DIC warning message come on at each ignition cycle until the problem is corrected. Some of the conditions that can cause these to come on are:

- One of the road tires has been replaced with the spare tire. The spare tire does not have a TPMS sensor. The malfunction light and the DIC message should go off after the road tire is replaced and the sensor matching process is performed successfully. See "TPMS Sensor Matching Process" later in this section.
- The TPMS sensor matching process was not done or not completed successfully after rotating the tires. The malfunction light and the DIC message should go off after successfully completing the sensor matching process. See "TPMS Sensor Matching Process" later in this section.

- One or more TPMS sensors are missing or damaged. The malfunction light and the DIC message should go off when the TPMS sensors are installed and the sensor matching process is performed successfully. See your dealer for service.
- Replacement tires or wheels do not match the original equipment tires or wheels. Tires and wheels other than those recommended could prevent the TPMS from functioning properly. See *Buying New Tires on page 6-72*.
- Operating electronic devices or being near facilities using radio wave frequencies similar to the TPMS could cause the TPMS sensors to malfunction.

If the TPMS is not functioning properly, it cannot detect or signal a low tire condition. See your dealer for service if the TPMS malfunction light and DIC message comes on and stays on.

## TPMS Sensor Matching Process

Each TPMS sensor has a unique identification code. The identification code needs to be matched to a new tire/wheel position after rotating the vehicle's tires or replacing one or more of the TPMS sensors. Also, the TPMS sensor matching process should be performed after replacing a spare tire with a road tire containing the TPMS sensor. The malfunction light and the DIC message should go off at the next ignition cycle. The sensors are matched to the tire/wheel positions, using a TPMS relearn tool, in the following order: driver side front tire, passenger side front tire, passenger side rear tire, and driver side rear. See your dealer for service or to purchase a relearn tool.

There are two minutes to match the first tire/wheel position, and five minutes overall to match all four tire/wheel positions. If it takes longer, the matching process stops and must be restarted.

The TPMS sensor matching process is:

1. Set the parking brake.
2. Turn the ignition to ON/RUN with the engine off.
3. Press the Remote Keyless Entry (RKE) transmitter's lock and unlock buttons at the same time for approximately five seconds. The horn sounds twice to signal the receiver is in relearn mode and TIRE LEARNING ACTIVE message displays on the DIC screen.
4. Start with the driver side front tire.
5. Place the relearn tool against the tire sidewall, near the valve stem. Then press the button to activate the TPMS sensor. A horn chirp confirms that the sensor identification code has been matched to this tire and wheel position.
6. Proceed to the passenger side front tire, and repeat the procedure in Step 5.
7. Proceed to the passenger side rear tire, and repeat the procedure in Step 5.
8. Proceed to the driver side rear tire, and repeat the procedure in Step 5. The horn sounds two times to indicate the sensor identification code has been matched to the driver side rear tire, and the TPMS sensor matching process is no longer active. The TIRE LEARNING ACTIVE message on the DIC display screen goes off.
9. Turn the ignition to LOCK/OFF.
10. Set all four tires to the recommended air pressure level as indicated on the Tire and Loading Information label.

## Tire Inspection and Rotation

We recommend that you regularly inspect your vehicle's tires, including the spare tire, for signs of wear or damage. See *When It Is Time for New Tires on page 6-71* for more information.

Always remove the tires if any of the following statements are true:

- You can see the indicators at three or more places around the tire.
- You can see cord or fabric showing through the tire's rubber.
- The tread or sidewall is cracked, cut, or snagged deep enough to show cord or fabric.
- The tire has a bump, bulge, or split.
- The tire has a puncture, cut, or other damage that cannot be repaired well because of the size or location of the damage.

Tires should be rotated every 12 000 km (7,500 miles). See *Scheduled Maintenance on page 7-3*.

The purpose of a regular tire rotation is to achieve a uniform wear for all tires on the vehicle. This will ensure that your vehicle continues to perform most like it did when the tires were new.

Any time you notice unusual wear, rotate the tires as soon as possible and check wheel alignment. Also check for damaged tires or wheels. See *When It Is Time for New Tires on page 6-71* and *Wheel Replacement on page 6-76*.

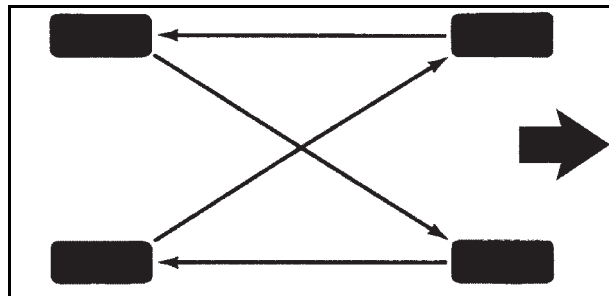

When rotating the vehicle's tires, always use the correct rotation pattern shown here.

Do not include the compact spare tire in the tire rotation.

After the tires have been rotated, adjust the front and rear inflation pressures as shown on the Tire and Loading Information label. See *Inflation - Tire Pressure* on page 6-64 and *Loading the Vehicle* on page 5-18.

Reset the Tire Pressure Monitor System. See *Tire Pressure Monitor Operation* on page 6-66.

Make certain that all wheel nuts are properly tightened. See “Wheel Nut Torque” under *Capacities and Specifications* on page 6-116.

### **WARNING:**

Rust or dirt on a wheel, or on the parts to which it is fastened, can make wheel nuts become loose after time. The wheel could come off and cause an accident. When you change a wheel, remove any rust or dirt from places where the wheel attaches to the vehicle. In an emergency, you can use a cloth or a paper towel to do this; but be sure to use a scraper or wire brush later, if needed, to get all the rust or dirt off. See *Changing a Flat Tire* on page 6-88.

Lightly coat the center of the wheel hub with wheel bearing grease after a wheel change or tire rotation to prevent corrosion or rust build-up. Do not get grease on the flat wheel mounting surface or on the wheel nuts or bolts.

## When It Is Time for New Tires

Various factors, such as maintenance, temperatures, driving speeds, vehicle loading, and road conditions influence when you need new tires.

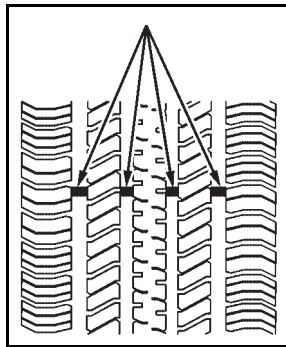

One way to tell when it is time for new tires is to check the treadwear indicators, which will appear when your tires have only 1/16 inch (1.6 mm) or less of tread remaining. See *Tire Inspection and Rotation* on page 6-70 for additional information.

The rubber in tires ages over time, even if they are not being used. This is also true for the spare tire, if your vehicle has one. Multiple conditions affect how fast this aging takes place, including temperatures, loading conditions, and inflation pressure maintenance. Tires will typically need to be replaced due to wear before they may need to be replaced due to age. Consult the tire manufacturer for more information on when tires should be replaced.

## Vehicle Storage

Tires age when stored normally mounted on a parked vehicle. Park a vehicle that will be stored for at least a month in a cool, dry, clean area away from direct sunlight to slow aging. This area should be free of grease, gasoline or other substances that can deteriorate rubber.

Parking for an extended period can cause flat spots on the tires that may result in vibrations while driving. When storing a vehicle for at least a month, remove the tires or raise the vehicle to reduce the weight from the tires.

## Buying New Tires

GM has developed and matched specific tires for your vehicle. The original equipment tires installed on your vehicle, when it was new, were designed to meet General Motors Tire Performance Criteria Specification (TPC Spec) system rating. If you need replacement tires, GM strongly recommends that you get tires with the same TPC Spec rating. This way, your vehicle will continue to have tires that are designed to give the same performance and vehicle safety, during normal use, as the original tires.

GM's exclusive TPC Spec system considers over a dozen critical specifications that impact the overall performance of your vehicle, including brake system performance, ride and handling, traction control, and tire pressure monitoring performance. GM's TPC Spec number is molded onto the tire's sidewall near the tire size. If the tires have an all-season tread design, the TPC Spec number will be followed by an MS for mud and snow. See *Tire Sidewall Labeling on page 6-58* for additional information.

GM recommends replacing tires in sets of four. This is because uniform tread depth on all tires will help keep your vehicle performing most like it did when the tires were new. Replacing less than a full set of tires can affect the braking and handling performance of your vehicle. See *Tire Inspection and Rotation on page 6-70* for information on proper tire rotation.

 **WARNING:**

Tires could explode during improper service. Attempting to mount or dismount a tire could cause injury or death. Only your dealer or authorized tire service center should mount or dismount the tires.

 **WARNING:**

Mixing tires could cause you to lose control while driving. If you mix tires of different sizes, brands, or types (radial and bias-belted tires), the vehicle may not handle properly, and you could have a crash. Using tires of different sizes, brands, or types may also cause damage to your vehicle. Be sure to use the correct size, brand, and type of tires on all wheels. It is all right to drive with your compact spare temporarily, as it was developed for use on your vehicle. See *Compact Spare Tire on page 6-97*.

 **WARNING:**

Using bias-ply tires on the vehicle may cause the wheel rim flanges to develop cracks after many miles of driving. A tire and/or wheel could fail suddenly and cause a crash. Use only radial-ply tires with the wheels on the vehicle.

If you must replace your vehicle's tires with those that do not have a TPC Spec number, make sure they are the same size, load range, speed rating, and construction type (radial and bias-belted tires) as your vehicle's original tires.

Vehicles that have a tire pressure monitoring system could give an inaccurate low-pressure warning if non-TPC Spec rated tires are installed on your vehicle. Non-TPC Spec rated tires may give a low-pressure warning that is higher or lower than the proper warning level you would get with TPC Spec rated tires. See *Tire Pressure Monitor System on page 6-65*.

Your vehicle's original equipment tires are listed on the Tire and Loading Information Label. See *Loading the Vehicle on page 5-18*, for more information about the Tire and Loading Information Label and its location on your vehicle.

## Different Size Tires and Wheels

If you add wheels or tires that are a different size than your original equipment wheels and tires, this may affect the way your vehicle performs, including its braking, ride and handling characteristics, stability, and resistance to rollover. Additionally, if your vehicle has electronic systems such as, antilock brakes, traction control, and electronic stability control, the performance of these systems can be affected.

 **WARNING:**

If different sized wheels are used, there may not be an acceptable level of performance and safety if tires not recommended for those wheels are selected. This increases the chance of a crash and serious injury. Only use GM specific wheel and tire systems developed for the vehicle, and have them properly installed by a GM certified technician.



See *Buying New Tires on page 6-72 and Accessories and Modifications on page 6-3* for additional information.

## **Uniform Tire Quality Grading**

Quality grades can be found where applicable on the tire sidewall between tread shoulder and maximum section width. For example:

### **Treadwear 200 Traction AA Temperature A**

The following information relates to the system developed by the United States National Highway Traffic Safety Administration (NHTSA), which grades tires by treadwear, traction, and temperature performance. This applies only to vehicles sold in the United States. The grades are molded on the sidewalls of most passenger car tires. The Uniform Tire Quality Grading (UTQG) system does not apply to deep tread, winter-type snow tires, space-saver, or temporary use spare tires, tires with nominal rim diameters of 10 to 12 inches (25 to 30 cm), or to some limited-production tires.

While the tires available on General Motors passenger cars and light trucks may vary with respect to these grades, they must also conform to federal safety requirements and additional General Motors Tire Performance Criteria (TPC) standards.

All Passenger Car Tires Must Conform to Federal Safety Requirements In Addition To These Grades.

## **Treadwear**

The treadwear grade is a comparative rating based on the wear rate of the tire when tested under controlled conditions on a specified government test course. For example, a tire graded 150 would wear one and a half (1½) times as well on the government course as a tire graded 100. The relative performance of tires depends upon the actual conditions of their use, however, and may depart significantly from the norm due to variations in driving habits, service practices and differences in road characteristics and climate.

## **Traction – AA, A, B, C**

The traction grades, from highest to lowest, are AA, A, B, and C. Those grades represent the tire's ability to stop on wet pavement as measured under controlled conditions on specified government test surfaces of asphalt and concrete. A tire marked C may have poor traction performance. Warning: The traction grade assigned to this tire is based on straight-ahead braking traction tests, and does not include acceleration, cornering, hydroplaning, or peak traction characteristics.

## **Temperature – A, B, C**

The temperature grades are A (the highest), B, and C, representing the tire's resistance to the generation of heat and its ability to dissipate heat when tested under controlled conditions on a specified indoor laboratory test wheel. Sustained high temperature can cause the material of the tire to degenerate and reduce tire life, and excessive temperature can lead to sudden tire failure. The grade C corresponds to a level of performance which all passenger car tires must meet under the Federal Motor Safety Standard No. 109. Grades B and A represent higher levels of performance on the laboratory test wheel than

the minimum required by law. Warning: The temperature grade for this tire is established for a tire that is properly inflated and not overloaded. Excessive speed, underinflation, or excessive loading, either separately or in combination, can cause heat buildup and possible tire failure.

## **Wheel Alignment and Tire Balance**

The tires and wheels on your vehicle were aligned and balanced carefully at the factory to give you the longest tire life and best overall performance. Adjustments to wheel alignment and tire balancing will not be necessary on a regular basis. However, if you notice unusual tire wear or your vehicle pulling to one side or the other, the alignment might need to be checked. If you notice your vehicle vibrating when driving on a smooth road, the tires and wheels might need to be rebalanced. See your dealer for proper diagnosis.

## **Wheel Replacement**

Replace any wheel that is bent, cracked, or badly rusted or corroded. If wheel nuts keep coming loose, the wheel, wheel bolts, and wheel nuts should be replaced. If the wheel leaks air, replace it (except some aluminum wheels, which can sometimes be repaired). See your dealer if any of these conditions exist.

Your dealer will know the kind of wheel you need.

Each new wheel should have the same load-carrying capacity, diameter, width, offset, and be mounted the same way as the one it replaces.

If you need to replace any of your wheels, wheel bolts, wheel nuts, or Tire Pressure Monitor System (TPMS) sensors, replace them only with new GM original equipment parts. This way, you will be sure to have the right wheel, wheel bolts, wheel nuts, and TPMS sensors for your vehicle.

 **WARNING:**

Using the wrong replacement wheels, wheel bolts, or wheel nuts can be dangerous. It could affect the braking and handling of the vehicle. Tires can lose air, and cause loss of control, causing a crash. Always use the correct wheel, wheel bolts, and wheel nuts for replacement.

**Notice:** The wrong wheel can also cause problems with bearing life, brake cooling, speedometer or odometer calibration, headlamp aim, bumper height, vehicle ground clearance, and tire or tire chain clearance to the body and chassis.

See *Changing a Flat Tire* on page 6-88 for more information.

## Used Replacement Wheels

 **WARNING:**

Replacing a wheel with a used one is dangerous. How it has been used or how far it has been driven may be unknown. It could fail suddenly and cause a crash. When replacing wheels, use a new GM original equipment wheel.

## Tire Chains

### **WARNING:**

If your vehicle has P235/55R17, or P245/50R18 size tires, do not use tire chains. There is not enough clearance.

Tire chains used on a vehicle without the proper amount of clearance can cause damage to the brakes, suspension, or other vehicle parts. The area damaged by the tire chains could cause you to lose control of your vehicle and you or others may be injured in a crash.

Use another type of traction device only if its manufacturer recommends it for use on your vehicle and tire size combination and road conditions. Follow that manufacturer's instructions. To help avoid damage to your vehicle, drive slowly, readjust or remove the device if it is contacting your vehicle, and do not spin your vehicle's wheels.

If you do find traction devices that will fit, install them on the front tires.

**Notice:** If your vehicle has P225/60R16 size tires, use tire chains only where legal and only when you must. Use only SAE Class S-type chains that are the proper size for your tires. Install them on the front tires and tighten them as tightly as possible with the ends securely fastened. Drive slowly and follow the chain manufacturer's instructions. If you can hear the chains contacting your vehicle, stop and retighten them. If the contact continues, slow down until it stops. Driving too fast or spinning the wheels with chains on will damage your vehicle.

### **If a Tire Goes Flat**

It is unusual for a tire to blowout while you are driving, especially if you maintain your vehicle's tires properly. If air goes out of a tire, it is much more likely to leak out slowly. But if you should ever have a blowout, here are a few tips about what to expect and what to do:

If a front tire fails, the flat tire creates a drag that pulls the vehicle toward that side. Take your foot off the accelerator pedal and grip the steering wheel firmly. Steer to maintain lane position, and then gently brake to a stop, well off the road, if possible.

A rear blowout, particularly on a curve, acts much like a skid and may require the same correction you would use in a skid. In any rear blowout remove your foot from the accelerator pedal. Get the vehicle under control by steering the way you want the vehicle to go. It may be very bumpy and noisy, but you can still steer. Gently brake to a stop, well off the road, if possible.

 **WARNING:**

Driving on a flat tire will cause permanent damage to the tire. Re-inflating a tire after it has been driven on while severely underinflated or flat may cause a blowout and a serious crash. Never attempt to re-inflate a tire that has been driven on while severely underinflated or flat. Have your dealer or an authorized tire service center repair or replace the flat tire as soon as possible.

 **WARNING:**

Lifting a vehicle and getting under it to do maintenance or repairs is dangerous without the appropriate safety equipment and training. If a jack is provided with the vehicle, it is designed only for changing a flat tire. If it is used for anything else, you or others could be badly injured or killed if the vehicle slips off the jack. If a jack is provided with the vehicle, only use it for changing a flat tire.

This vehicle may come with a jack and spare tire or a tire sealant and compressor kit. To use the jack and spare tire, see *Changing a Flat Tire on page 6-88*. To use the tire sealant and compressor kit, see *Tire Sealant and Compressor Kit on page 6-80*.

## Tire Sealant and Compressor Kit

### **WARNING:**

Idling a vehicle in an enclosed area with poor ventilation is dangerous. Engine exhaust may enter the vehicle. Engine exhaust contains Carbon Monoxide (CO) which cannot be seen or smelled. It can cause unconsciousness and even death. Never run the engine in an enclosed area that has no fresh air ventilation. For more information, see *Engine Exhaust on page 3-30*.

### **WARNING:**

Overinflating a tire could cause the tire to rupture and you or others could be injured. Be sure to read and follow the tire sealant and compressor kit instructions and inflate the tire to its recommended pressure. Do not exceed the recommended pressure.

### **WARNING:**

Storing the tire sealant and compressor kit or other equipment in the passenger compartment of the vehicle could cause injury. In a sudden stop or collision, loose equipment could strike someone. Store the tire sealant and compressor kit in its original location.

If this vehicle has a tire sealant and compressor kit, there may not be a spare tire, tire changing equipment, and on some vehicles there may not be a place to store a tire.

The tire sealant and compressor can be used to temporarily seal punctures up to 6 mm (¼ in) in the tread area of the tire. It can also be used to inflate an under inflated tire.

If the tire has been separated from the wheel, has damaged sidewalls, or has a large puncture, the tire is too severely damaged for the tire sealant and compressor kit to be effective. See *Roadside Assistance Program on page 8-7*.

Read and follow all of the tire sealant and compressor kit instructions.

The kit includes:

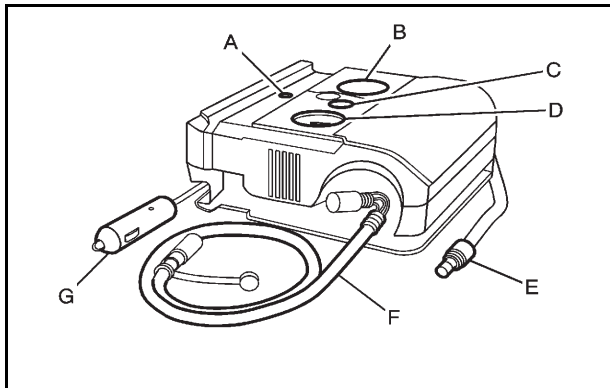

- |  |                                |
|--|--------------------------------|
| A. On/Off Button                                   | D. Pressure Gauge              |
| B. Selector Switch<br>(Sealant/Air or<br>Air Only) | E. Air Only Hose (Black)       |
| C. Pressure Relief Button                          | F. Sealant/Air Hose<br>(Clear) |
|  | G. Power Plug                  |

## Tire Sealant

Read and follow the safe handling instructions on the label adhered to the compressor.

Check the tire sealant expiration date on the sealant canister. The sealant canister should be replaced before its expiration date. Replacement sealant canisters are available at your local dealer. See "Removal and Installation of the Sealant Canister" following.

There is only enough sealant to seal one tire. After usage, the sealant canister and sealant/air hose assembly must be replaced. See "Removal and Installation of the Sealant Canister" following.

## Using the Tire Sealant and Compressor Kit to Temporarily Seal and Inflate a Punctured Tire

Follow the directions closely for correct sealant usage.

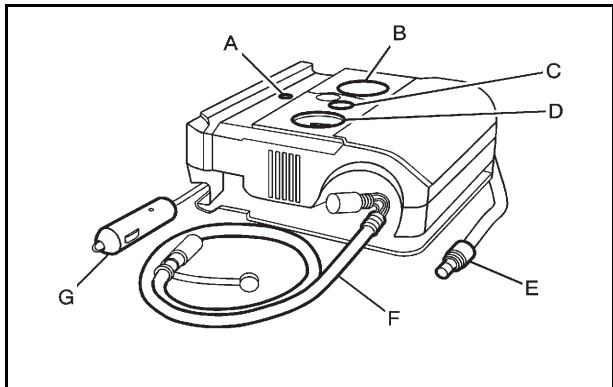

When using the tire sealant and compressor kit during cold temperatures, warm the kit in a heated environment for five minutes. This will help to inflate the tire faster.

If a tire goes flat, avoid further tire and wheel damage by driving slowly to a level place. Turn on the hazard warning flashers. See *Hazard Warning Flashers* on page 4-3.

See *If a Tire Goes Flat* on page 6-78 for other important safety warnings.

Do not remove any objects that have penetrated the tire.

Always do a safety check first. See *If a Tire Goes Flat* on page 6-78. Do not remove any objects that have penetrated the tire.

1. Remove the tire sealant and compressor kit from its storage location. See *Tire Sealant and Compressor Kit Storage* on page 6-87.
2. Unwrap the sealant/air hose (F) and the power plug (G).
3. Place the kit on the ground.  
Make sure the tire valve stem is positioned close to the ground so the hose will reach it.
4. Remove the valve stem cap from the flat tire by turning it counterclockwise.
5. Attach the sealant/air hose (F) onto the tire valve stem. Turn it clockwise until it is tight.
6. Plug the power plug (G) into the accessory power outlet in the vehicle. Unplug all items from other accessory power outlets. See *Accessory Power Outlet(s)* on page 4-15.

If the vehicle has an accessory power outlet, do not use the cigarette lighter.



If the vehicle only has a cigarette lighter, use the cigarette lighter.

Do not pinch the power plug cord in the door or window.

7. Start the vehicle. The vehicle must be running while using the air compressor.
8. Turn the selector switch (B) clockwise to the Sealant + Air position.
9. Press the on/off (A) button to turn the tire sealant and compressor kit on.

The compressor will inject sealant and air into the tire.

The pressure gauge (D) will initially show a high pressure while the compressor pushes the sealant into the tire. Once the sealant is completely dispersed into the tire, the pressure will quickly drop and start to rise again as the tire inflates with air only.

10. Inflate the tire to the recommended inflation pressure using the pressure gauge (D). The recommended inflation pressure can be found on the Tire and Loading Information label. See *Inflation - Tire Pressure on page 6-64*.

The pressure gauge (D) may read higher than the actual tire pressure while the compressor is on. Turn the compressor off to get an accurate pressure reading. The compressor may be turned on/off until the correct pressure is reached.

**Notice: If the recommended pressure cannot be reached after approximately 25 minutes, the vehicle should not be driven farther. The tire is too severely damaged and the tire sealant and compressor kit cannot inflate the tire. Remove the power plug from the accessory power outlet and unscrew the inflating hose from the tire valve. See *Roadside Assistance Program on page 8-7*.**

11. Press the on/off button (A) to turn the tire sealant and compressor kit off.

The tire is not sealed and will continue to leak air until the vehicle is driven and the sealant is distributed in the tire, therefore, Steps 12 through 18 must be done immediately after Step 11.

Be careful while handling the tire sealant and compressor kit as it could be warm after usage.

12. Unplug the power plug (G) from the accessory power outlet in the vehicle.
13. Turn the sealant/air hose (F) counterclockwise to remove it from the tire valve stem.
14. Replace the tire valve stem cap.

15. Replace the sealant/air hose (F), and the power plug (G) back in their original location.

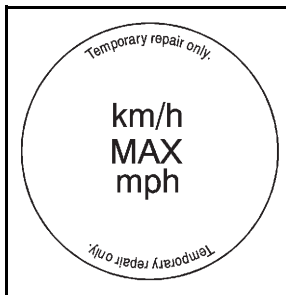

16. If the flat tire was able to inflate to the recommended inflation pressure, remove the maximum speed label from the sealant canister and place it in a highly visible location. Do not exceed the speed on this label until the damaged tire is repaired or replaced.
17. Return the equipment to its original storage location in the vehicle.
18. Immediately drive the vehicle 8 km (5 miles) to distribute the sealant in the tire.
19. Stop at a safe location and check the tire pressure. Refer to Steps 1 through 11 under "Using the Tire Sealant and Compressor Kit without Sealant to Inflate a Tire (Not Punctured)."

If the tire pressure has fallen more than 68 kPa (10 psi) below the recommended inflation pressure, stop driving the vehicle. The tire is too severely damaged and the tire sealant cannot seal the tire. See *Roadside Assistance Program on page 8-7*.

If the tire pressure has not dropped more than 68 kPa (10 psi) from the recommended inflation pressure, inflate the tire to the recommended inflation pressure.

20. Wipe off any sealant from the wheel, tire, and vehicle.
21. Dispose of the used sealant canister and sealant/air hose (F) assembly at a local dealer or in accordance with local state codes and practices.
22. Replace it with a new canister available from your dealer.
23. After temporarily sealing a tire using the tire sealant and compressor kit, take the vehicle to an authorized dealer within a 161 km (100 miles) of driving to have the tire repaired or replaced.

## Using the Tire Sealant and Compressor Kit without Sealant to Inflate a Tire (Not Punctured)

To use the air compressor to inflate a tire with air only and not sealant:

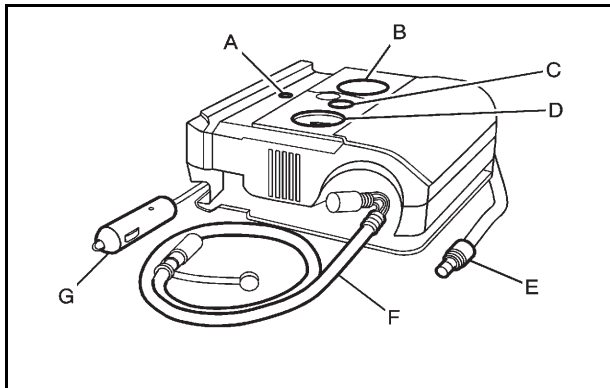

If a tire goes flat, avoid further tire and wheel damage by driving slowly to a level place. Turn on the hazard warning flashers. See *Hazard Warning Flashers* on page 4-3.

See *If a Tire Goes Flat* on page 6-78 for other important safety warnings.

Always do a safety check first. See *If a Tire Goes Flat* on page 6-78. Do not remove any objects that have penetrated the tire.

1. Remove the tire sealant and compressor kit from its storage location. See *Tire Sealant and Compressor Kit Storage* on page 6-87.

2. Unwrap the air only hose (E) and the power plug (G).

3. Place the kit on the ground.

Make sure the tire valve stem is positioned close to the ground so the hose will reach it.

4. Remove the tire valve stem cap from the flat tire by turning it counterclockwise.

5. Attach the air only hose (E) onto the tire valve stem by turning it clockwise until it is tight.

6. Plug the power plug (G) into the accessory power outlet in the vehicle. Unplug all items from other accessory power outlets. See *Accessory Power Outlet(s)* on page 4-15.

If the vehicle has an accessory power outlet, do not use the cigarette lighter.

If the vehicle only has a cigarette lighter, use the cigarette lighter.

Do not pinch the power plug cord in the door or window.

7. Start the vehicle. The vehicle must be running while using the air compressor.
8. Turn the selector switch (B) counterclockwise to the Air Only position.
9. Press the on/off (A) button to turn the compressor on.  
The compressor will inflate the tire with air only.
10. Inflate the tire to the recommended inflation pressure using the pressure gauge (D). The recommended inflation pressure can be found on the Tire and Loading Information label. See *Inflation - Tire Pressure* on page 6-64.  
The pressure gauge (D) may read higher than the actual tire pressure while the compressor is on. Turn the compressor off to get an accurate reading. The compressor may be turned on/off until the correct pressure is reached.
11. Press the on/off button (A) to turn the tire sealant and compressor kit off.  
Be careful while handling the tire sealant and compressor kit as it could be warm after usage.
12. Unplug the power plug (G) from the accessory power outlet in the vehicle.
13. Disconnect the air only hose (E) from the tire valve stem, by turning it counterclockwise, and replace the tire valve stem cap.

14. Replace the air only hose (E) and the power plug (G) and cord back in its original location.
15. Place the equipment in the original storage location in the vehicle.

## Removal and Installation of the Sealant Canister

To remove the sealant canister:

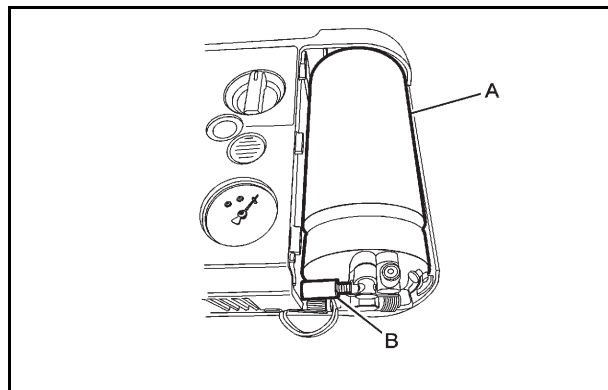

1. Remove the plastic cover.
2. Unscrew the connector (B) from the canister (A).
3. Pull up on the canister (A) to remove it.

4. Replace with a new canister which is available from your dealer.
5. Push the new canister into place.
6. Screw the connector (B) to the canister (A).
7. Slide the plastic cover back on.

## Tire Sealant and Compressor Kit Storage

The tire sealant and compressor kit is located in the trunk.

1. Open the trunk. See *Trunk* on page 3-12
2. Lift the cover.

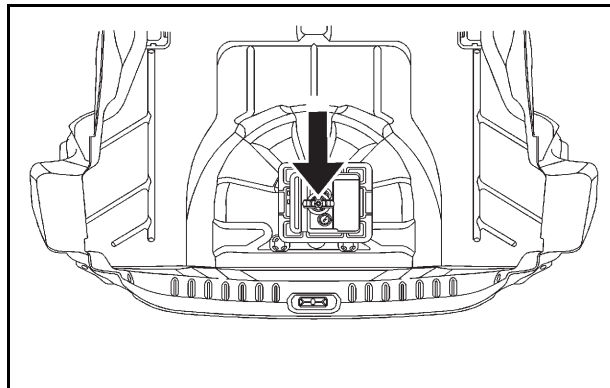

3. Turn the retainer clockwise and remove the tire sealant and compressor kit.

To store the tire sealant and compressor kit, reverse the steps.

## Changing a Flat Tire

If a tire goes flat, avoid further tire and wheel damage by driving slowly to a level place, well off the road, if possible. Turn on the hazard warning flashers. See *Hazard Warning Flashers on page 4-3*.

### **WARNING:**

Changing a tire can be dangerous. The vehicle can slip off the jack and roll over or fall on you or other people. You and they could be badly injured or even killed. Find a level place to change your tire. To help prevent the vehicle from moving:

1. Set the parking brake firmly.
2. Put the shift lever in P (Park).
3. Turn off the engine and do not restart while the vehicle is raised.
4. Do not allow passengers to remain in the vehicle.

To be even more certain the vehicle will not move, you should put blocks at the front and rear of the tire farthest away from the one being changed. That would be the tire, on the other side, at the opposite end of the vehicle.

When the vehicle has a flat tire (B), use the following example as a guide to assist you in the placement of wheel blocks (A).

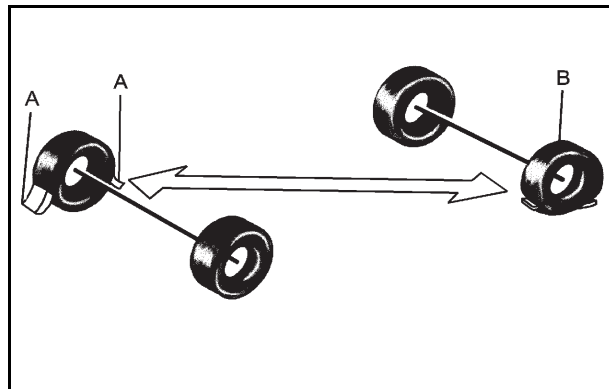

- A. Wheel Block  
B. Flat Tire

The following information explains how to use the jack and change a tire.

## Removing the Spare Tire and Tools

The equipment you will need is located in the trunk.

1. Open the trunk. See *Trunk* on page 3-12.

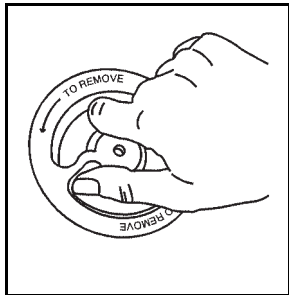

2. Turn the center retainer counterclockwise to remove it.

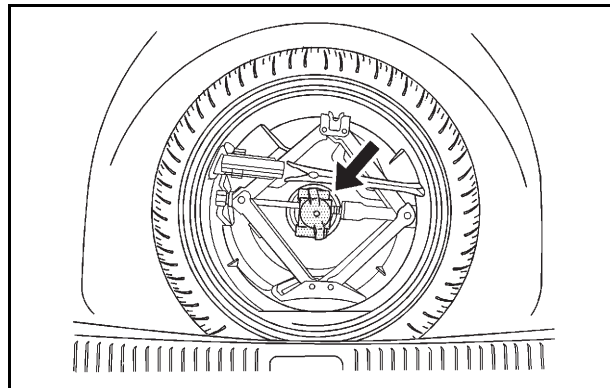

3. Lift and remove the compact spare tire cover.

4. Turn the retainer that secures the jack and wheel wrench counterclockwise and remove the washer.
5. Remove the jack container with the jack and the wheel wrench.
6. Remove the spare tire from the vehicle. See *Compact Spare Tire* on page 6-97.

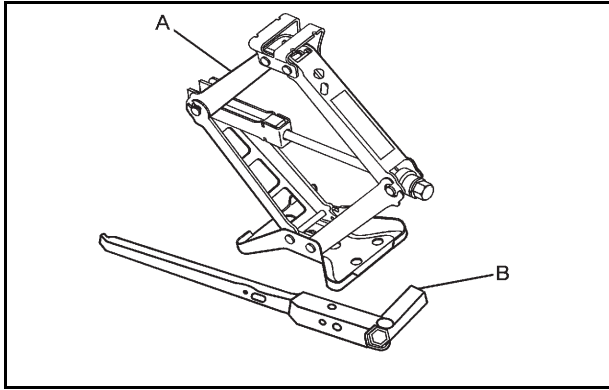

The tools you will be using include the jack (A) and the wheel wrench (B).

## Removing the Flat Tire and Installing the Spare Tire

1. Do a safety check before proceeding. See *Changing a Flat Tire on page 6-88.*

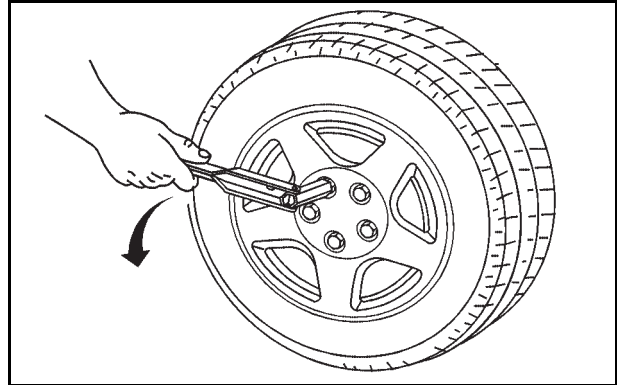

2. Turn the wheel wrench counterclockwise to loosen all the wheel nuts, but do not remove them yet.
3. Turn the jack handle counterclockwise to lower the jack lift head until it fits under the vehicle.  
Turn the jack handle clockwise to raise the jack lift head.



**⚠ WARNING:**

Raising the vehicle with the jack improperly positioned can damage the vehicle and even make the vehicle fall. To help avoid personal injury and vehicle damage, be sure to fit the jack lift head into the proper location before raising the vehicle.

**Notice:** If you position the jack under the rocker molding and attempt to raise the vehicle, you could break the molding and/or cause other damage to your vehicle. Always position the jack so that when the jack head is raised, it will fit firmly in the notch located inboard from the rocker molding.

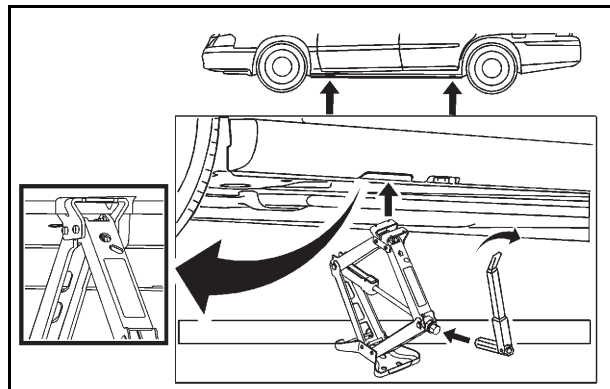

4. Put the jack into the flange in the frame which is located near each wheel well. The flanges are accessible through openings in the plastic trim at the bottom of the vehicle. The front opening is about 8 inches (20 cm) back from the front wheel well. The rear opening is about 3 inches (8 cm) forward from the rear wheel well.

5. Position the jack and raise the jack head until it fits firmly on the ridge in the vehicle's frame nearest the flat tire. Do not raise the vehicle yet.
6. Put the compact spare tire near the flat tire.

**⚠ WARNING:**

Getting under a vehicle when it is jacked up is dangerous. If the vehicle slips off the jack, you could be badly injured or killed. Never get under a vehicle when it is supported only by a jack.

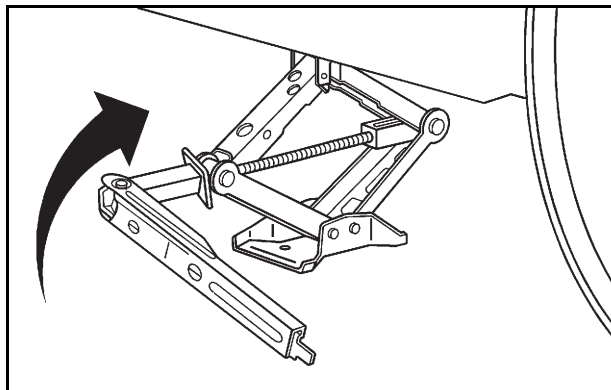

7. Turn the jack handle clockwise to raise the vehicle. Raise the vehicle far enough off the ground for the compact spare tire to fit under the vehicle.

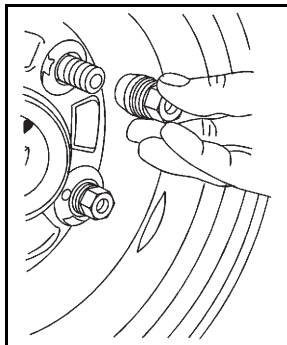

8. Remove all wheel nuts and remove the flat tire.

**⚠ WARNING:**

Rust or dirt on a wheel, or on the parts to which it is fastened, can make wheel nuts become loose after time. The wheel could come off and cause an accident. When changing a wheel, remove any rust or dirt from places where the wheel attaches to the vehicle. In an emergency, use a cloth or a paper towel to do this; but be sure to use a scraper or wire brush later, if needed, to get all the rust or dirt off. See *Changing a Flat Tire* on page 6-88.

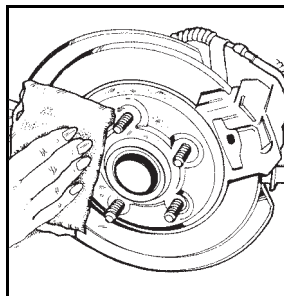

9. Remove any rust or dirt from the wheel bolts, mounting surfaces and spare wheel.

10. Install the compact spare tire.

**⚠ WARNING:**

Never use oil or grease on bolts or nuts because the nuts might come loose. The vehicle's wheel could fall off, causing a crash.

11. Put the wheel nuts back on with the rounded end of the nuts toward the wheel. Turn each nut clockwise by hand until the wheel is held against the hub.

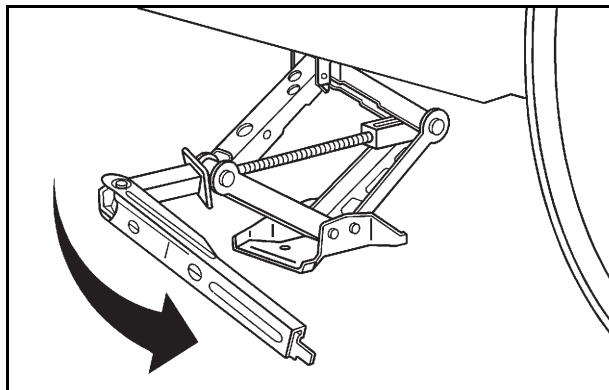

12. Lower the vehicle by turning the jack handle counterclockwise. Lower the jack completely.

**⚠ WARNING:**

Wheel nuts that are improperly or incorrectly tightened can cause the wheels to become loose or come off. The wheel nuts should be tightened with a torque wrench to the proper torque specification after replacing. Follow the torque specification supplied by the aftermarket manufacturer when using accessory locking wheel nuts. See *Capacities and Specifications on page 6-116* for original equipment wheel nut torque specifications.

**Notice:** Improperly tightened wheel nuts can lead to brake pulsation and rotor damage. To avoid expensive brake repairs, evenly tighten the wheel nuts in the proper sequence and to the proper torque specification. See *Capacities and Specifications on page 6-116* for the wheel nut torque specification.

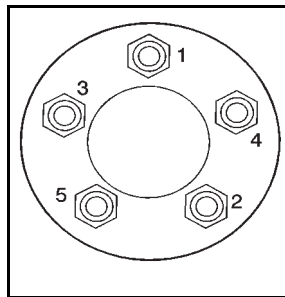

13. Tighten the wheel nuts firmly in a crisscross sequence as shown.

## Storing a Flat or Spare Tire and Tools

### **WARNING:**

Storing a jack, a tire, or other equipment in the passenger compartment of the vehicle could cause injury. In a sudden stop or collision, loose equipment could strike someone. Store all these in the proper place.

After you have put the compact spare tire on your vehicle, you need to store the flat tire in your trunk. Store the flat tire as far forward in the trunk as possible. Store the jack and wheel wrench in their compartment in the trunk. For storage, the jack lift head must be raised until the screw end is even with the edge of the compartment.

To store the compact spare tire and tools:

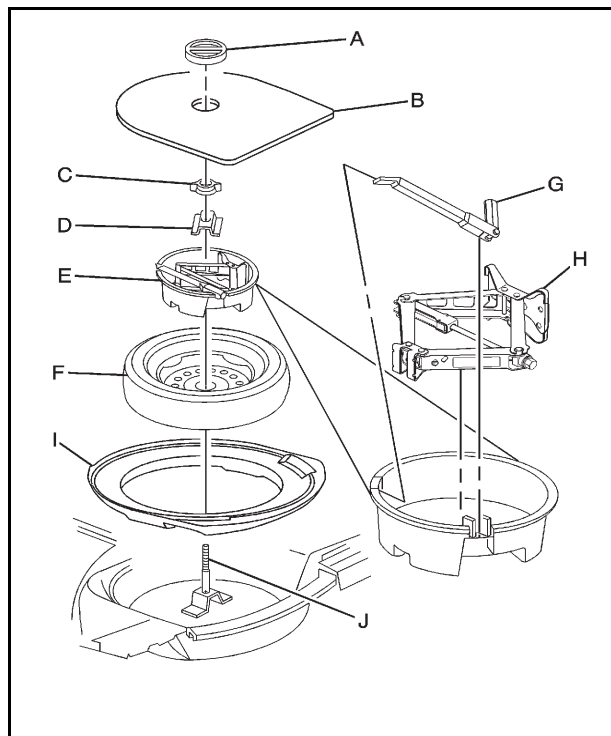

- A. Center Retainer
- B. Compact Spare Tire Cover
- C. Retainer
- D. Washer
- E. Jack Container
- F. Spare Tire
- G. Wheel Wrench
- H. Jack
- I. Foam Insert
- J. Bolt

1. Open the trunk. See *Trunk* on page 3-12.
2. Place the foam insert (I) in the trunk compartment.
3. Reinstall the compact spare tire (F) face down. Line up the wheel center hole with the bolt (J). Then place it on the compartment floor.
4. Insert the jack container (E) into the spare tire (F).
5. Insert the wheel wrench (G) and jack (H) into the center of the compact spare tire making sure to line up the wheel nut hole with the bolt (I) on the compartment floor.
6. Secure the compact spare tire and the jack container (E) with the washer (D) and the retainer (C).
7. Reinstall the compact spare tire cover (B).
8. Secure with the center retainer (A).

The compact spare tire is for temporary use only. Replace the compact spare tire with a full-size tire as soon as you can. See *Compact Spare Tire* on page 6-97.

## Compact Spare Tire

### **WARNING:**

Driving with more than one compact spare tire at a time could result in loss of braking and handling. This could lead to a crash and you or others could be injured. Use only one compact spare tire at a time.

If this vehicle has a compact spare tire it was fully inflated when the vehicle was new, however, it can lose air after a time. Check the inflation pressure regularly. It should be 60 psi (420 kPa).

After installing the compact spare on the vehicle, stop as soon as possible and make sure the spare tire is correctly inflated. The compact spare is made to perform well at speeds up to 65 mph (105 km/h) for distances up to 3,000 miles (5 000 km), so you can finish your trip and have the full-size tire repaired or replaced at your convenience. Of course, it is best to replace the spare with a full-size tire as soon as possible. The spare tire will last longer and be in good shape in case it is needed again.

**Notice:** When the compact spare is installed, do not take the vehicle through an automatic car wash with guide rails. The compact spare can get caught on the rails which can damage the tire, wheel and other parts of the vehicle.

Do not use the compact spare on other vehicles.

Do not mix the compact spare tire or wheel with other wheels or tires. They will not fit. Keep the spare tire and its wheel together.

**Notice:** Tire chains will not fit the compact spare. Using them can damage the vehicle and can damage the chains too. Do not use tire chains on the compact spare.

## Appearance Care

### Interior Cleaning

The interior will continue to look its best if it is cleaned often. Although not always visible, dust and dirt can accumulate on the upholstery. Dirt can damage carpet, fabric, leather, and plastic surfaces. Regular vacuuming is recommended to remove particles from the upholstery. It is important to keep the upholstery from becoming and remaining heavily soiled. Soils should be removed as quickly as possible. The interior may experience extremes of heat that could cause stains to set rapidly.

Lighter colored interiors may require more frequent cleaning. Use care because newspapers and garments that transfer color to home furnishings may also transfer color to the interior.

When cleaning the interior, only use cleaners specifically designed for the surfaces being cleaned. Permanent damage may result from using cleaners on surfaces for which they were not intended. Use glass cleaner only on glass. Remove any accidental over-spray from other surfaces immediately. To prevent over-spray, apply cleaner directly to the cleaning cloth.



**Notice:** Using abrasive cleaners when cleaning glass surfaces on the vehicle, could scratch the glass and/or cause damage to the rear window defogger. When cleaning the glass on the vehicle, use only a soft cloth and glass cleaner.

Many cleaners contain solvents that may become concentrated in the breathing space. Before using cleaners, read and adhere to all safety instructions on the label. While cleaning the interior, maintain adequate ventilation by opening the doors and windows.

Dust may be removed from small buttons and knobs using a small brush with soft bristles.

Products that remove odors from the upholstery and clean the glass can be obtained from your dealer.

Do not clean the vehicle using:

- A knife or any other sharp object to remove a soil from any interior surface.
- A stiff brush. It can cause damage to the interior surfaces.
- Heavy pressure or aggressive rubbing with a cleaning cloth. Use of heavy pressure can damage the interior and does not improve the effectiveness of soil removal.

- Laundry detergents or dishwashing soaps with degreasers can leave residue that streaks and attracts dirt. For liquid cleaners, about 20 drops per gallon (3.78 L) of water is a good guide. Use only mild, neutral-pH soaps.
- Too much cleaner that saturates the upholstery.
- Cleaners that contain solvents can damage the interior.

## Fabric/Carpet

Use a vacuum cleaner with a soft brush attachment frequently to remove dust and loose dirt. A canister vacuum with a beater bar in the nozzle may only be used on floor carpet and carpeted floor mats. For any soil, always try to remove it first with plain water or club soda. Before cleaning, gently remove as much of the soil as possible using one of the following techniques:

- For liquids: gently blot the remaining soil with a paper towel. Allow the soil to absorb into the paper towel until no more can be removed.
- For solid dry soils: remove as much as possible and then vacuum.

To clean:

1. Saturate a lint-free, clean white cloth with water or club soda.
2. Wring the cloth to remove excess moisture.
3. Start on the outside edge of the soil and gently rub toward the center. Continue cleaning, using a clean area of the cloth each time it becomes soiled.
4. Continue to gently rub the soiled area until the cleaning cloth remains clean.
5. If the soil is not completely removed, use a mild soap solution and repeat the cleaning process that was used with plain water.

If any of the soil remains, a commercial fabric cleaner or spot lifter may be necessary. When a commercial upholstery cleaner or spot lifter is to be used, test a small hidden area for colorfastness first. If the locally cleaned area gives any impression that a ring formation may result, clean the entire surface.

After the cleaning process has been completed, a paper towel can be used to blot excess moisture from the fabric or carpet.

## Leather

Leather, and lighter colored leather in particular, will need more frequent cleaning to prevent the buildup of dust, dirt, and colors transferred from other items so that these do not become permanent stains.

To remove dust, a soft cloth dampened with water can be used. If a more thorough cleaning is necessary, a soft cloth dampened with a mild soap solution can be used. Your dealer has a GM approved leather cleaner available that provides superior cleaning performance when used regularly on finished automotive leathers. Allow the leather to dry naturally. Do not use heat, steam, spot lifters or spot removers, or shoe polish on leather. Many commercial leather cleaners and coatings that are sold to preserve and protect leather may permanently change the appearance and feel of the leather and are not recommended. Do not use silicone or wax-based products, or those containing organic solvents to clean the vehicle's interior because they can alter the appearance by increasing the gloss in a non-uniform manner.

## Instrument Panel, Vinyl, and Other Plastic Surfaces

A soft cloth dampened with water may be used to remove dust. If a more thorough cleaning is necessary, a clean soft cloth dampened with a mild soap solution can be used to gently remove dust and dirt. Never use spot lifters or removers on plastic surfaces. Many commercial cleaners and coatings that are sold to preserve and protect soft plastic surfaces may permanently change the appearance and feel of the interior and are not recommended. Do not use silicone or wax-based products, or those containing organic solvents to clean the vehicle's interior because they can alter the appearance by increasing the gloss in a non-uniform manner.

Some commercial products may increase gloss on the instrument panel. The increase in gloss may cause annoying reflections in the windshield and even make it difficult to see through the windshield under certain conditions.

**Notice:** Air fresheners contain solvents that may cause damage to plastics and painted surfaces. Follow the manufacturer's instructions when using air fresheners in the vehicle. If air freshener comes in contact with paint or a plastic surface, blot immediately with a soft cloth. Damage caused by using air fresheners would not be covered by the vehicle warranty.

## Care of Safety Belts

Keep belts clean and dry.

### **WARNING:**

Do not bleach or dye safety belts. It may severely weaken them. In a crash, they might not be able to provide adequate protection. Clean safety belts only with mild soap and lukewarm water.

## Weatherstrips

Silicone grease on weatherstrips will make them last longer, seal better, and not stick or squeak. Apply silicone grease with a clean cloth. During very cold, damp weather frequent application may be required. See *Recommended Fluids and Lubricants* on page 7-8.

## Washing Your Vehicle

The best way to preserve the vehicle's finish is to keep it clean by washing it often.

**Notice:** Certain cleaners contain chemicals that can damage the emblems or nameplates on the vehicle. Check the cleaning product label. If it states that it should not be used on plastic parts, do not use it on the vehicle or damage may occur and it would not be covered by the warranty.

Do not wash the vehicle in direct sunlight. Use a car washing soap. Do not use cleaning agents that are petroleum based or that contain acid or abrasives, as they can damage the paint, metal or plastic on the vehicle. Approved cleaning products can be obtained from your dealer. Follow all manufacturers' directions regarding correct product usage, necessary safety precautions and appropriate disposal of any vehicle care product.

Rinse the vehicle well, before washing and after to remove all cleaning agents completely. If they are allowed to dry on the surface, they could stain.

Dry the finish with a soft, clean chamois or an all-cotton towel to avoid surface scratches and water spotting.

High pressure car washes may cause water to enter the vehicle. Avoid using high pressure washes closer than 12 inches (30 cm) to the surface of the vehicle. Use of power washers exceeding 1,200 psi (8 274 kPa) can result in damage or removal of paint and decals.

## Cleaning Exterior Lamps/Lenses

Use only lukewarm or cold water, a soft cloth and a car washing soap to clean exterior lamps and lenses. Follow instructions under *Washing Your Vehicle* on page 6-102.

## Finish Care

Occasional waxing or mild polishing of the vehicle by hand may be necessary to remove residue from the paint finish. Approved cleaning products can be obtained from your dealer.

If the vehicle has a basecoat/clearcoat paint finish, the clearcoat gives more depth and gloss to the colored basecoat. Always use waxes and polishes that are non-abrasive and made for a basecoat/clearcoat paint finish.

**Notice:** Machine compounding or aggressive polishing on a basecoat/clearcoat paint finish may damage it. Use only non-abrasive waxes and polishes that are made for a basecoat/clearcoat paint finish on the vehicle.

Foreign materials such as calcium chloride and other salts, ice melting agents, road oil and tar, tree sap, bird droppings, chemicals from industrial chimneys, etc., can damage the vehicle's finish if they remain on painted surfaces. Wash the vehicle as soon as possible. If necessary, use non-abrasive cleaners that are marked safe for painted surfaces to remove foreign matter.

Exterior painted surfaces are subject to aging, weather and chemical fallout that can take their toll over a period of years. To help keep the paint finish looking new, keep the vehicle garaged or covered whenever possible.

### **Protecting Exterior Bright Metal Parts**

Bright metal parts should be cleaned regularly to keep their luster. Washing with water is all that is usually needed. However, chrome polish may be used on chrome or stainless steel trim, if necessary.

Use special care with aluminum trim. To avoid damaging protective trim, never use auto or chrome polish, steam or caustic soap to clean aluminum. A coating of wax, rubbed to high polish, is recommended for all bright metal parts.

## **Windshield and Wiper Blades**

Clean the outside of the windshield with glass cleaner.

Clean the rubber blades using a lint free cloth or paper towel soaked with windshield washer fluid or a mild detergent. Wash the windshield thoroughly when cleaning the blades. Bugs, road grime, sap, and a buildup of vehicle wash/wax treatments may cause wiper streaking. Replace the wiper blades if they are worn or damaged.

Wipers can be damaged by:

- Extreme dusty conditions
- Sand and salt
- Heat and sun
- Snow and ice, without proper removal

## Aluminum or Chrome-Plated Wheels and Trim

The vehicle may have either aluminum or chrome-plated wheels.

Keep the wheels clean using a soft clean cloth with mild soap and water. Rinse with clean water. After rinsing thoroughly, dry with a soft clean towel. A wax may then be applied.

**Notice:** Chrome wheels and other chrome trim may be damaged if the vehicle is not washed after driving on roads that have been sprayed with magnesium, calcium or sodium chloride. These chlorides are used on roads for conditions such as ice and dust. Always wash the vehicle's chrome with soap and water after exposure.

**Notice:** Using strong soaps, chemicals, abrasive polishes, cleaners, brushes, or cleaners that contain acid on aluminum or chrome-plated wheels, could damage the surface of the wheel(s). The repairs would not be covered by the vehicle warranty. Use only approved cleaners on aluminum or chrome-plated wheels.

The surface of these wheels is similar to the painted surface of the vehicle. Do not use strong soaps, chemicals, abrasive polishes, abrasive cleaners, cleaners with acid, or abrasive cleaning brushes on them because they could damage the surface. Do not use chrome polish on aluminum wheels.

**Notice:** Using chrome polish on aluminum wheels could damage the wheels. The repairs would not be covered by the vehicle warranty. Use chrome polish on chrome wheels only.

Use chrome polish only on chrome-plated wheels, but avoid any painted surface of the wheel, and buff off immediately after application.

**Notice:** Driving the vehicle through an automatic car wash that has silicone carbide tire cleaning brushes, could damage the aluminum or chrome-plated wheels. The repairs would not be covered by the vehicle warranty. Never drive a vehicle that has aluminum or chrome-plated wheels through an automatic car wash that uses silicone carbide tire cleaning brushes.

## Tires

To clean the tires, use a stiff brush with tire cleaner.

**Notice:** Using petroleum-based tire dressing products on the vehicle may damage the paint finish and/or tires. When applying a tire dressing, always wipe off any overspray from all painted surfaces on the vehicle.

## Sheet Metal Damage

If the vehicle is damaged and requires sheet metal repair or replacement, make sure the body repair shop applies anti-corrosion material to parts repaired or replaced to restore corrosion protection.

Original manufacturer replacement parts will provide the corrosion protection while maintaining the vehicle warranty.

## Finish Damage

Any stone chips, fractures or deep scratches in the finish should be repaired right away. Bare metal will corrode quickly and may develop into major repair expense.

Minor chips and scratches can be repaired with touch-up materials available from your dealer. Larger areas of finish damage can be corrected in your dealer's body and paint shop.

## Underbody Maintenance

Chemicals used for ice and snow removal and dust control can collect on the underbody. If these are not removed, corrosion and rust can develop on the underbody parts such as fuel lines, frame, floor pan, and exhaust system even though they have corrosion protection.

At least every spring, flush these materials from the underbody with plain water. Clean any areas where mud and debris can collect. Dirt packed in close areas of the frame should be loosened before being flushed. Your dealer or an underbody car washing system can do this.

## Chemical Paint Spotting

Some weather and atmospheric conditions can create a chemical fallout. Airborne pollutants can fall upon and attack painted surfaces on the vehicle. This damage can take two forms: blotchy, ring-shaped discolorations, and small, irregular dark spots etched into the paint surface.

Although no defect in the paint job causes this, we will repair, at no charge to the owner, the surfaces of new vehicles damaged by this fallout condition within 12 months or 20 000 km (12,000 mi) of purchase, whichever occurs first.

## Vehicle Identification

### Vehicle Identification Number (VIN)



This legal identifier is in the front corner of the instrument panel, on the driver side. It can be seen through the windshield from outside. The VIN also appears on the Vehicle Certification and Service Parts labels and certificates of title and registration.

### Engine Identification

The eighth character in the VIN is the engine code. This code identifies the vehicle's engine, specifications, and replacement parts. See "Engine Specifications" under *Capacities and Specifications on page 6-116* for the vehicle's engine code.



## Service Parts Identification Label

This label, on the spare tire cover, has the following information:

- Vehicle Identification Number (VIN).
- Model designation.
- Paint information.
- Production options and special equipment.

Do not remove this label from the vehicle.

## Electrical System

### Add-On Electrical Equipment

**Notice:** Do not add anything electrical to the vehicle unless you check with your dealer first. Some electrical equipment can damage the vehicle and the damage would not be covered by the vehicle's warranty. Some add-on electrical equipment can keep other components from working as they should.

Add-on equipment can drain the vehicle battery, even if the vehicle is not operating.

The vehicle has an airbag system. Before attempting to add anything electrical to the vehicle, see *Servicing Your Airbag-Equipped Vehicle* on page 2-68 and *Adding Equipment to Your Airbag-Equipped Vehicle* on page 2-69.

## Power Windows and Other Power Options

Circuit breakers in the rear fuse block protect the power windows and other power accessories. When the current load is too heavy, the circuit breaker opens and closes, protecting the circuit until the problem is fixed or goes away.

## Fuses and Circuit Breakers

The wiring circuits in your vehicle are protected from short circuits by a combination of fuses and circuit breakers. This greatly reduces the chance of fires caused by electrical problems.

Look at the silver-colored band inside the fuse. If the band is broken or melted, replace the fuse. Be sure you replace a bad fuse with a new one of the identical size and rating.

You will find a fuse puller clipped in both of the fuse blocks. Snap the wide end of the fuse puller at the side indentations and pull the fuse out.

The MaxiFuses are located in two fuse blocks, one located in the engine compartment on the passenger's side and the other under the rear seat on the driver's side. If a MaxiFuse should blow, have your vehicle serviced by your dealer immediately.

## Underhood Fuse Block

The underhood fuse block is located on the passenger side of the engine compartment. Remove the fuse cover and secondary service cover to access the fuse block.

**Notice:** Spilling liquid on any electrical component on the vehicle may damage it. Always keep the covers on any electrical component.

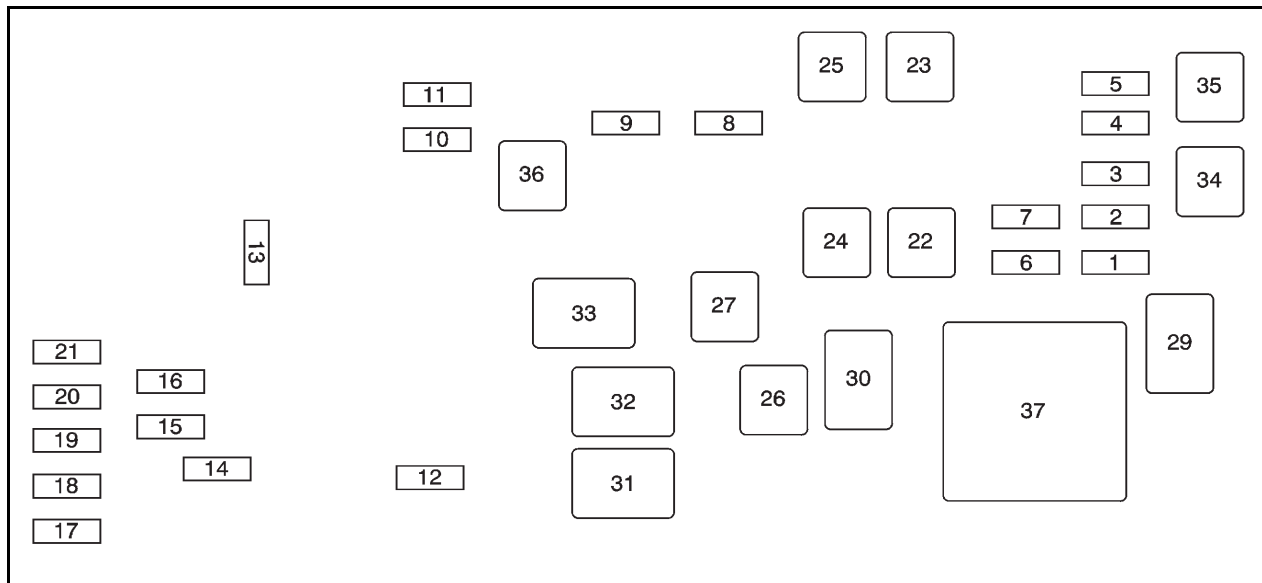

Fuses	Usage
1	Engine Control Module (ECM), Crank
2	Fuel Injectors Odd
3	Fuel Injectors Even
4	Air Conditioning Clutch

Fuses	Usage
5	Air Injection Reactor (AIR) Solenoid
6	Oxygen Sensor
7	Emission Device
8	Transmission, Ignition 1

Fuses	Usage
9	Engine Control Module (ECM), Powertrain Control Module (PCM)
10	Climate Control System, Instrument Panel Cluster Ignition 1
11	Airbag System
12	Horn
13	Windshield Wiper
14	Fog Lamps
15	Right High-Beam Headlamp
16	Left High-Beam Headlamp
17	Left Low-Beam Headlamp
18	Right Low-Beam Headlamp
19	Windshield Washer Pump Motor
20	Left Front Cornering Lamp
21	Right Front Cornering Lamp
22	Air Pump (J-Case)
23	Antilock Brake System (ABS) (J-Case)
24	Starter (J-Case)
25	Antilock Brake System (ABS) Motor (J-Case)

Fuses	Usage
26	Cooling Fan 2 (J-Case)
27	Cooling Fan 1 (J-Case)

Relays	Usage
29	Powertrain
30	Starter
31	Cooling Fan 2
32	Cooling Fan 3
33	Cooling Fan 1
34	Air Conditioning Clutch
35	Air Injection Reactor (AIR) Solenoid
36	Ignition
37	Air Pump

## Rear Underseat Fuse Block

The rear fuse block is located under the rear seat on the driver side. The rear seat cushion must be removed to access the rear fuse block.

## Removing the Rear Seat Cushion

**Notice:** If you touch the exposed wires with the metal on the seat cushion, you could cause a short that could damage the battery and or wires. Avoid contact between the rear seat and the fuse center whenever you remove or reinstall the rear seat. Do not remove covers from any of the covered parts, and do not store anything under the seats.

To remove the rear seat cushion, do the following:

1. Pull up on the front of the cushion to release the front hooks.
2. Pull the cushion up and out toward the front of the vehicle.

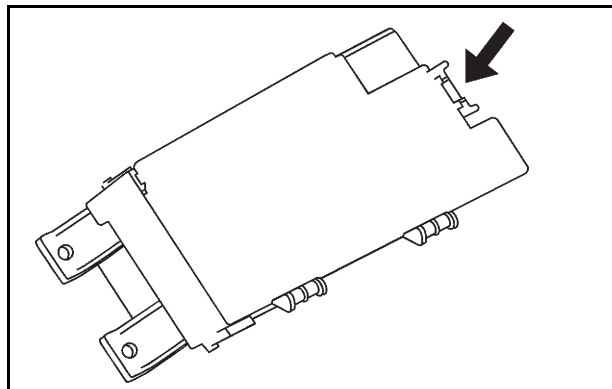

To access the fuse block, pull out and lift up on the cover latch, located at the end of the fuse block, near the battery cable.

To reinstall the rear seat cushion, do the following:

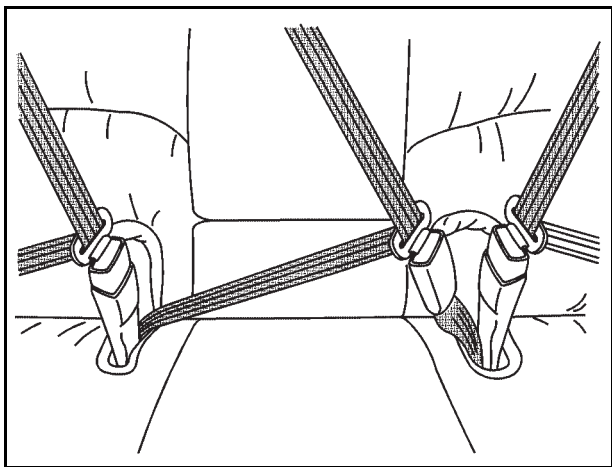

**⚠ WARNING:**

A safety belt that is not properly routed through the seat cushion or is twisted will not provide the protection needed in a crash. If the safety belt has not been routed through the seat cushion at all, it

(Continued)

**WARNING: (Continued)**

will not be there to work for the next passenger. The person sitting in that position could be badly injured. After reinstalling the seat cushion, always check to be sure that the safety belts are properly routed and are not twisted.

1. Buckle the center passenger position safety belt, then route the safety belts through the proper slots in the seat cushion. Do not let the safety belts get twisted.
2. Slide the rear of the cushion up and under the seatback so the rear-locating guides hook into the wire loops on the back frame.
3. With the seat cushion lowered, push rearward and then press down on the seat cushion until the spring locks on both ends engage.
4. Check to make sure the safety belts are properly routed and that no portion of any safety belt is trapped under the seat. Also make sure the seat cushion is secured.

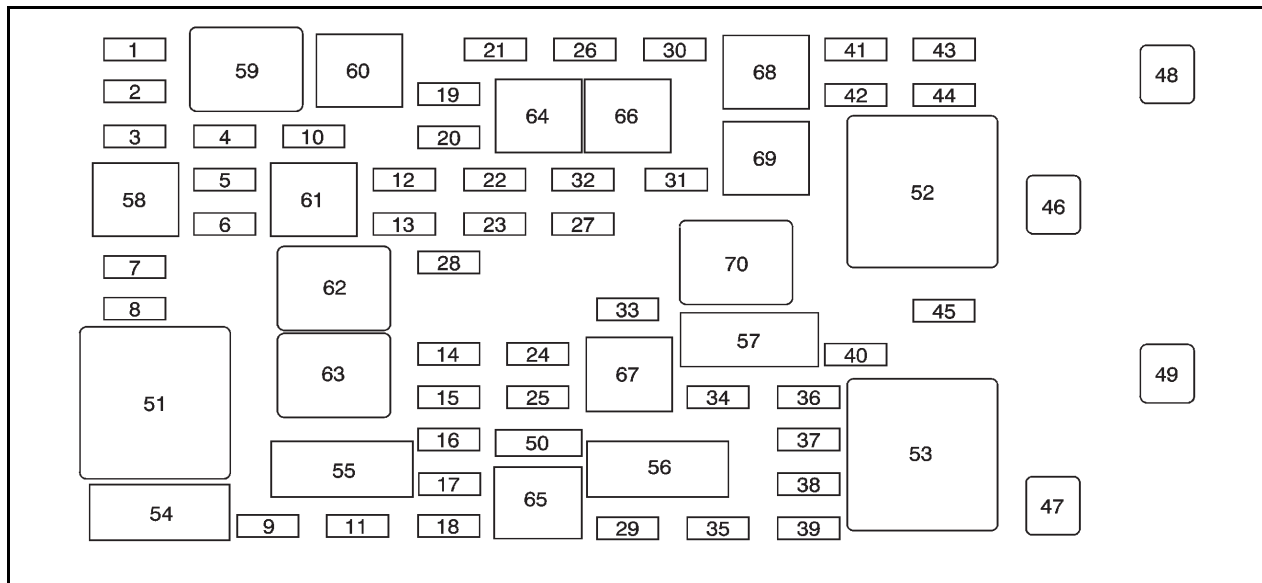

Fuses	Usage
1	Fuel Pump
2	Left Park Lamp
3	Not Used
4	Right Park Lamp

Fuses	Usage
5	Engine Control Module (ECM)/ Transmission Control Module (TCM)
6	Memory Module
7	Not Used

Fuses	Usage
8	Steering Wheel Illumination
9	Front Heated/Cooled Seat Module
10	Run 2 - Heated/Cooled Seats
11	Not Used
12	RPA Module
13	PASS-Key® III System
14	Unlock/Lock Module
15	Magnetic Ride Control
16	Daytime Running Lamps (DRL)
17	Sunroof
18	Body Control Module (BCM) Dim
19	Body Control Module (BCM)
20	Run 1-Heated Steering Wheel
21	Ignition Switch
22	Driver Door Module
23	Not Used
24	Electronic Leveling Control Module
25	Body Control Module (Left Turn Signal)
26	Cigarette Lighter, Auxiliary Power Outlet
27	Not Used

Fuses	Usage
28	Retained Accessory Power 1 (RAP)
29	Passenger Door Module
30	Sensing and Diagnostic Module
31	Accessory Power Outlets
32	Body Control Module (BCM) (Inadvertent)
33	Retained Accessory Power 2 (RAP)
34	CanisterVent Solenoid
35	Body Control Module (Courtesy)
36	Body Control Module (Right Turn Signal)
37	Trunk Release
38	Amplifier, Radio
39	Body Control Module (CHMSL)
40	Body Control Module
41	Not Used
42	OnStar® Module
43	Body Modules
44	Radio
45	Not Used
46	Rear Defogger (J-Case)



<b>Fuses</b>	<b>Usage</b>
47	Electronic Leveling Control Compressor (J-Case)
48	Blower (J-Case)
49	Not Used

<b>Resistor</b>	<b>Usage</b>
50	Terminating Resistor

<b>Relays</b>	<b>Usage</b>
51	Not Used
52	Rear Defogger
53	Electronic Leveling Control Compressor
58	Park Lamps
59	Fuel Pump
60	Not Used
61	Not Used

<b>Relays</b>	<b>Usage</b>
62	Unlock
63	Lock
64	Run
65	Daytime Running Lamps
66	Not Used
67	Trunk Release
68	Not Used
69	Not Used
70	Retained Accessory Power (RAP)

<b>Circuit Breakers</b>	<b>Usage</b>
54	Right Front Seat
55	Left Front Power Seat
56	Power Windows
57	Power Tilt Steering Wheel

## Capacities and Specifications

The following approximate capacities are given in English and metric conversions. See *Recommended Fluids and Lubricants on page 7-8* for more information.

Application	Capacities	
	English	Metric
Air Conditioning Refrigerant R134a	For the air conditioning system refrigerant charge amount, see the refrigerant label located under the hood. See your dealer for more information.	
Engine Cooling System		
3.9L V6 Engine	9.7 qt	9.2 L
4.6L V8 Engine	12.7 qt	12.0 L
Engine Oil with Filter		
3.9L V6 Engine	4.0 qt	3.8 L
4.6L V8 Engine	7.4 qt	7.0 L
Fuel Tank	18.5 gal	70.0 L
Transmission Fluid - Bottom Pan Removal		
3.9L V6 Engine	7.4 qt	7.0 L
4.6L V8 Engine	7.4 qt	7.0 L
Wheel Nut Torque	100 lb ft	140 N•m
All capacities are approximate. When adding, be sure to fill to the approximate level, as recommended in this manual. Recheck fluid level after filling.		

### Engine Specifications

<b>Engine</b>	<b>VIN Code</b>	<b>Transmissions</b>	<b>Spark Plug Gap</b>
3.9L V6 Engine	M	Automatic	0.040 in (1.01 mm)
4.6L V8 Engine	S	Automatic	0.050 in (1.27 mm)



## Section 7 Maintenance Schedule

---

<b>Maintenance Schedule</b> .....	7-2	Recommended Fluids and Lubricants .....	7-8
Introduction .....	7-2	Maintenance Replacement Parts .....	7-10
Scheduled Maintenance .....	7-3	Engine Drive Belt Routing .....	7-11
Owner Checks and Services .....	7-6	Maintenance Record .....	7-12

# Maintenance Schedule

## Introduction

**Notice:** Maintenance intervals, checks, inspections, recommended fluids, and lubricants are necessary to keep this vehicle in good working condition. Damage caused by failure to follow scheduled maintenance might not be covered by the vehicle warranty.

As the vehicle owner, you are responsible for the scheduled maintenance in this section. We recommend having your dealer perform these services. Proper vehicle maintenance helps to keep the vehicle in good working condition, improves fuel economy, and reduces vehicle emissions for better air quality.

Because of all the different ways people use vehicles, maintenance needs vary. The vehicle might need more frequent checks and services. Please read the information under Scheduled Maintenance. To keep the vehicle in good condition, see your dealer.

The maintenance schedule is for vehicles that:

- carry passengers and cargo within recommended limits on the Tire and Loading Information label. See *Loading the Vehicle* on page 5-18.

- are driven on reasonable road surfaces within legal driving limits.
- use the recommended fuel. See *Gasoline Octane* on page 6-6.

### **WARNING:**

Performing maintenance work on a vehicle can be dangerous. In trying to do some jobs, you can be seriously injured. Do your own maintenance work only if you have the required know-how and the proper tools and equipment for the job. If you have any doubt, see your dealer to have a qualified technician do the work. See *Doing Your Own Service Work* on page 6-4.

At your dealer, you can be certain that you will receive the highest level of service available. Your dealer has specially trained service technicians, uses genuine replacement parts, as well as, up-to-date tools and equipment to ensure fast and accurate diagnostics.

The proper replacement parts, fluids, and lubricants to use are listed in *Recommended Fluids and Lubricants* on page 7-8 and *Maintenance Replacement Parts* on page 7-10. We recommend the use of genuine parts from your dealer.

## Rotation of New Tires

To maintain ride, handling, and performance of the vehicle, it is important that the first rotation service for new tires be performed. Tires should be rotated every 12 000 km/7,500 miles. See *Tire Inspection and Rotation* on page 6-70.

## Scheduled Maintenance

### When the Change Engine Oil Soon Message Displays

Change engine oil and filter. See *Engine Oil* on page 6-18. *An Emission Control Service*.

When the CHANGE ENGINE OIL SOON message displays, service is required for the vehicle as soon as possible, within the next 1 000 km/600 miles. If driving under the best conditions, the engine oil life system might not indicate the need for vehicle service for more than a year. The engine oil and filter must be changed at least once a year and the oil life system must be reset. Your dealer has trained service technicians who will perform this work and reset the system. If the engine oil life system is reset accidentally, service the vehicle within 5 000 km/3,000 miles since the last service. Reset the oil life system whenever the oil is changed. See *Engine Oil Life System* on page 6-22.

## Every Engine Oil Change

- Change engine oil and filter. Reset oil life system. See *Engine Oil* on page 6-18 and *Engine Oil Life System* on page 6-22. *An Emission Control Service*.
- Engine coolant level check. See *Engine Coolant (4.6L Engine)* on page 6-28 or *Engine Coolant (3.9L Engine)* on page 6-31.
- Engine cooling system inspection. Visual inspection of hoses, pipes, fittings, and clamps and replacement, if needed.
- Windshield washer fluid level check. See *Windshield Washer Fluid* on page 6-38.
- Windshield wiper blade inspection for wear, cracking, or contamination and windshield and wiper blade cleaning, if contaminated. See *Windshield and Wiper Blades* on page 6-103. Worn or damaged wiper blade replacement. See *Windshield Wiper Blade Replacement* on page 6-55.
- Tire inflation pressures check. See *Inflation - Tire Pressure* on page 6-64.
- Tire wear inspection. See *Tire Inspection and Rotation* on page 6-70.
- Rotate tires if necessary. See *Tire Inspection and Rotation* on page 6-70.

- Fluids visual leak check (or every 12 months, whichever occurs first). A leak in any system must be repaired and the fluid level checked.
- Engine air cleaner filter inspection. See *Engine Air Cleaner/Filter on page 6-23*.
- Brake system inspection (or every 12 months, whichever occurs first).
- Steering and suspension inspection. Visual inspection for damaged, loose, or missing parts or signs of wear.
- Body hinges and latches, key lock cylinders, and rear compartment, hood, glove box door, and console door hinges and latches lubrication. See *Recommended Fluids and Lubricants on page 7-8*. More frequent lubrication may be required when the vehicle is exposed to a corrosive environment. Applying silicone grease on weatherstrips with a clean cloth makes them last longer, seal better, and not stick or squeak.
- Restraint system component check. See *Checking the Restraint Systems on page 2-70*.
- Fuel system inspection for damage or leaks.
- Exhaust system and nearby heat shields inspection for loose or damaged components.

## Additional Required Services

### Every 12 000 km/7,500 Miles

- Rotate tires. Tires should be rotated every 12 000 km/7,500 miles. See *Tire Inspection and Rotation on page 6-70*.

### At Each Fuel Stop

- Engine oil level check. See *Engine Oil on page 6-18*.
- Engine coolant level check. See *Engine Coolant (4.6L Engine) on page 6-28* or *Engine Coolant (3.9L Engine) on page 6-31*.
- Windshield washer fluid level check. See *Windshield Washer Fluid on page 6-38*.

### Once a Month

- Tire inflation pressures check. See *Inflation - Tire Pressure on page 6-64*.
- Tire wear inspection. See *Tire Inspection and Rotation on page 6-70*.
- Sunroof track and seal inspection, if equipped. See *Sunroof on page 3-51*.



## Once a Year

- Starter switch check. See *Owner Checks and Services on page 7-6*.
- Automatic transmission shiftlock control function check. See *Owner Checks and Services on page 7-6*.
- Ignition transmission lock check. See *Owner Checks and Services on page 7-6*.
- Parking brake and automatic transmission P (Park) mechanism check. See *Owner Checks and Services on page 7-6*.
- Accelerator pedal check for damage, high effort, or binding. Replace if needed.
- If the vehicle has a Tire Sealant and Compressor Kit, check the sealant expiration date printed on the instruction label of the kit. See *Tire Sealant and Compressor Kit on page 6-80*.
- Underbody flushing service.
- Hood/Decklid/Liftgate/Liftglass Support Gas Strut Service: Visually inspect gas strut, if equipped, for signs of wear, cracks, or other damage. Check the hold open ability of the gas strut. Contact your dealer if service is required.

## First Engine Oil Change After Every 40 000 km/25,000 Miles

- Passenger compartment air filter replacement (or every 24 months, whichever occurs first). More frequent replacement may be needed if you drive in areas with heavy traffic, areas with poor air quality, or areas with high dust levels. Replacement may also be needed if you notice reduced air flow, windows fogging up, or odors. Your dealer can help you determine when it is the right time to replace the filter.

## First Engine Oil Change After Every 80 000 km/50,000 Miles

- Engine air cleaner filter replacement. See *Engine Air Cleaner/Filter on page 6-23*.
- Automatic transmission fluid change (severe service) for vehicles mainly driven in heavy city traffic in hot weather, in hilly or mountainous terrain, when frequently towing a trailer, or used for taxi, police, or delivery service. See *Automatic Transmission Fluid on page 6-24*.
- Evaporative control system inspection. Check all fuel and vapor lines and hoses for proper hook-up, routing, and condition. Check that the purge valve, if the vehicle has one, works properly.

Replace as needed. *An Emission Control Service. The U.S. Environmental Protection Agency or the California Air Resources Board has determined that the failure to perform this maintenance item will not nullify the emission warranty or limit recall liability prior to the completion of the vehicle's useful life. We, however, urge that all recommended maintenance services be performed at the indicated intervals and the maintenance be recorded.*

### **First Engine Oil Change After Every 160 000 km/100,000 Miles**

- Automatic transmission fluid change (normal service). See *Automatic Transmission Fluid* on page 6-24.
- Spark plug replacement and spark plug wires inspection. *An Emission Control Service.*

### **First Engine Oil Change After Every 240 000 km/150,000 Miles**

- Engine cooling system drain, flush, and refill (or every five years, whichever occurs first). See *Engine Coolant (4.6L Engine)* on page 6-28 or *Engine Coolant (3.9L Engine)* on page 6-31. *An Emission Control Service.*
- Engine drive belts inspection for fraying, excessive cracks, or obvious damage (or every 10 years, whichever occurs first). Replace, if needed.

## **Owner Checks and Services**

### **Starter Switch Check**

#### **WARNING:**

When you are doing this inspection, the vehicle could move suddenly. If the vehicle moves, you or others could be injured.

1. Before starting this check, be sure there is enough room around the vehicle.
2. Firmly apply both the parking brake and the regular brake. See *Parking Brake* on page 3-26.  
Do not use the accelerator pedal, and be ready to turn off the engine immediately if it starts.
3. Try to start the engine in each gear. The vehicle should start only in P (Park) or N (Neutral). If the vehicle starts in any other position, contact your dealer for service.

## Automatic Transmission Shift Lock Control Function Check

### **WARNING:**

When you are doing this inspection, the vehicle could move suddenly. If the vehicle moves, you or others could be injured.

1. Before starting this check, be sure there is enough room around the vehicle. It should be parked on a level surface.
2. Firmly apply the parking brake. See *Parking Brake on page 3-26*.

Be ready to apply the regular brake immediately if the vehicle begins to move.

3. With the engine off, turn the ignition to ON/RUN, but do not start the engine. Without applying the regular brake, try to move the shift lever out of P (Park) with normal effort. If the shift lever moves out of P (Park), contact your dealer for service.

## Ignition Transmission Lock Check

While parked, and with the parking brake set, try to turn the ignition to LOCK/OFF in each shift lever position.

- The ignition should turn to LOCK/OFF only when the shift lever is in P (Park).
- The ignition key should come out only in LOCK/OFF.

Contact your dealer if service is required.

## Parking Brake and Automatic Transmission P (Park) Mechanism Check

### **WARNING:**

When you are doing this check, the vehicle could begin to move. You or others could be injured and property could be damaged. Make sure there is room in front of the vehicle in case it begins to roll. Be ready to apply the regular brake at once should the vehicle begin to move.

Park on a fairly steep hill, with the vehicle facing downhill. Keeping your foot on the regular brake, set the parking brake.

- To check the parking brake's holding ability: With the engine running and the transmission in N (Neutral), slowly remove foot pressure from the regular brake pedal. Do this until the vehicle is held by the parking brake only.
- To check the P (Park) mechanism's holding ability: With the engine running, shift to P (Park). Then release the parking brake followed by the regular brake.

Contact your dealer if service is required.

## Recommended Fluids and Lubricants

Fluids and lubricants identified below by name, part number, or specification can be obtained from your dealer.

Usage	Fluid/Lubricant
Engine Oil	The engine requires engine oil approved to the dexos specification. Oils meeting this specification can be identified with the dexos certification mark. Look for and use only an engine oil that displays the dexos certification mark of the proper viscosity grade. See <i>Engine Oil on page 6-18</i> .
Engine Coolant	50/50 mixture of clean, drinkable water and use only DEX-COOL Coolant. See <i>Engine Coolant (4.6L Engine) on page 6-28</i> or <i>Engine Coolant (3.9L Engine) on page 6-31</i> .
Hydraulic Brake System	DOT 3 Hydraulic Brake Fluid (GM Part No. 88862806, in Canada 88862807).

<b>Usage</b>	<b>Fluid/Lubricant</b>
Windshield Washer	Optikleen® Washer Solvent.
Parking Brake Cable Guides	Chassis Lubricant (GM Part No. 12377985, in Canada 88901242) or lubricant meeting requirements of NLGI #2, Category LB or GC-LB.
Power Steering System	GM Power Steering Fluid (GM Part No. 89021184, in Canada 89021186).
Automatic Transmission	DEXRON®-VI Automatic Transmission Fluid.
Key Lock Cylinders	Multi-Purpose Lubricant, Superlube (GM Part No. 12346241, in Canada 10953474).

<b>Usage</b>	<b>Fluid/Lubricant</b>
Hood Latch Assembly, Secondary Latch, Pivots, Spring Anchor, and Release Pawl	Lubriplate Lubricant Aerosol (GM Part No. 12346293, in Canada 992723) or lubricant meeting requirements of NLGI #2, Category LB or GC-LB.
Hood and Door Hinges	Multi-Purpose Lubricant, Superlube (GM Part No. 12346241, in Canada 10953474).
Weatherstrip Conditioning	Weatherstrip Lubricant (GM Part No. 3634770, in Canada 10953518) or Dielectric Silicone Grease (GM Part No. 12345579, in Canada 992887).

## Maintenance Replacement Parts

Replacement parts identified below by name, part number, or specification can be obtained from your dealer.

### Maintenance Replacement Parts

Part	GM Part Number	ACDelco Part Number
Engine Air Cleaner/Filter	22676970	A1627C
Engine Oil Filter		
3.9L V6 Engine	89017342	PF61
4.6L V8 Engine	89017342	PF61
Passenger Compartment Air Filter	15811562	CF138
Spark Plugs		
3.9L V6	12591131	41-100
4.6L V8	12571535	41-987
Wiper Blades		
Driver Side – 23.6 in (60.0 cm)	20831845	—
Passenger Side – 20.8 in (53.0 cm)	20831846	—

## Engine Drive Belt Routing

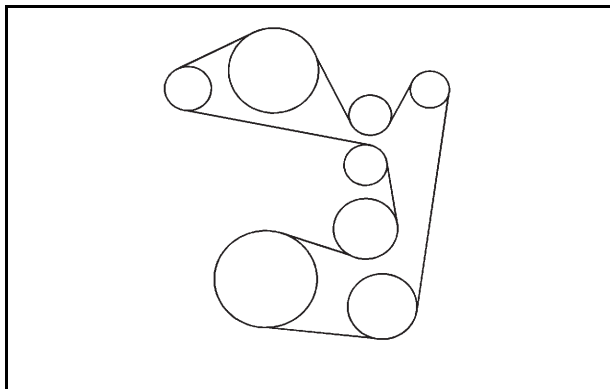

3.9L V6 Engine

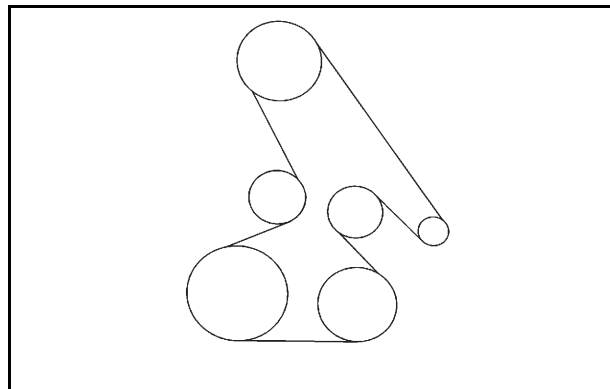

4.6L V8 Engine

## Maintenance Record

After the scheduled services are performed, record the date, odometer reading, who performed the service, and the type of services performed in the boxes provided. Retain all maintenance receipts.

### Maintenance Record

Date	Odometer Reading	Serviced By	Services Performed



**Maintenance Record (cont.)**

<b>Date</b>	<b>Odometer Reading</b>	<b>Serviced By</b>	<b>Services Performed</b>

### Maintenance Record (cont.)

Date	Odometer Reading	Serviced By	Services Performed

## Section 8 Customer Assistance Information

---

<b>Customer Assistance and Information</b> .....	8-2	<b>Reporting Safety Defects</b> .....	8-13
Customer Satisfaction Procedure .....	8-2	Reporting Safety Defects to the United States	
Online Owner Center .....	8-4	Government .....	8-13
Customer Assistance for Text Telephone (TTY)		Reporting Safety Defects to the Canadian	
Users .....	8-5	Government .....	8-14
Customer Assistance Offices .....	8-5	Reporting Safety Defects to General Motors ...	8-14
GM Mobility Reimbursement Program .....	8-6	Service Publications Ordering Information ....	8-14
Roadside Assistance Program .....	8-7	<b>Vehicle Data Recording and Privacy</b> .....	8-16
Scheduling Service Appointments .....	8-9	Event Data Recorders .....	8-16
Courtesy Transportation Program .....	8-9	OnStar® .....	8-17
Collision Damage Repair .....	8-11	Navigation System .....	8-18
		Radio Frequency Identification (RFID) .....	8-18
		Radio Frequency Statement .....	8-18

# Customer Assistance and Information

## Customer Satisfaction Procedure

Your satisfaction and goodwill are important to your dealer and to Buick. Normally, any concerns with the sales transaction or the operation of your vehicle will be resolved by your dealer's sales or service departments. Sometimes, however, despite the best intentions of all concerned, misunderstandings can occur. If your concern has not been resolved to your satisfaction, the following steps should be taken:

**STEP ONE:** Discuss your concern with a member of dealership management. Normally, concerns can be quickly resolved at that level. If the matter has already been reviewed with the sales, service, or parts manager, contact the owner of the dealership or the general manager.

**STEP TWO:** If after contacting a member of dealership management, it appears your concern cannot be resolved by the dealership without further help, in the U.S., call 1-800-521-7300. In Canada, contact General Motors of Canada Customer Communication Centre at 1-800-263-3777 (English) or 1-800-263-7854 (French).

We encourage you to call the toll-free number in order to give your inquiry prompt attention. Have the following information available to give the Customer Assistance representative:

- Vehicle Identification Number. This is available from the vehicle registration or title, or the plate at the top left of the instrument panel and visible through the windshield.
- Dealership name and location.
- Vehicle delivery date and present mileage.

When contacting Buick, remember that your concern will likely be resolved at a dealer's facility. That is why we suggest following Step One first.

**STEP THREE — U.S. Owners:** Both General Motors and your dealer are committed to making sure you are completely satisfied with your new vehicle. However, if you continue to remain unsatisfied after following the procedure outlined in Steps One and Two, you can file with the Better Business Bureau (BBB) Auto Line<sup>®</sup> Program to enforce your rights.

The BBB Auto Line Program is an out of court program administered by the Council of Better Business Bureaus to settle automotive disputes regarding vehicle repairs or the interpretation of the New Vehicle Limited Warranty. Although you may be required to resort to this informal dispute resolution program prior to filing a court action, use of the program is free of charge and your case will generally be heard within 40 days. If you do not agree with the decision given in your case, you may reject it and proceed with any other venue for relief available to you.

You may contact the BBB Auto Line Program using the toll-free telephone number or write them at the following address:

BBB Auto Line Program  
Council of Better Business Bureaus, Inc.  
4200 Wilson Boulevard  
Suite 800  
Arlington, VA 22203-1838  
Telephone: 1-800-955-5100  
[www.dr.bbb.org/goauto](http://www.dr.bbb.org/goauto)

This program is available in all 50 states and the District of Columbia. Eligibility is limited by vehicle age, mileage, and other factors. General Motors reserves the right to change eligibility limitations and/or discontinue its participation in this program.

**STEP THREE — Canadian Owners:** In the event that you do not feel your concerns have been addressed after following the procedure outlined in Steps One and Two, General Motors of Canada Limited wants you to be aware of its participation in a no-charge Mediation/ Arbitration program. General Motors of Canada Limited has committed to binding arbitration of owner disputes involving factory-related vehicle service claims. The program provides for the review of the facts involved by an impartial third party arbiter, and may include an informal hearing before the arbiter. The program is designed so that the entire dispute settlement process, from the time you file your complaint to the final decision, should be completed in approximately 70 days. We believe our impartial program offers advantages over courts in most jurisdictions because it is informal, quick, and free of charge.

For further information concerning eligibility in the Canadian Motor Vehicle Arbitration Plan (CAMVAP), call toll-free 1-800-207-0685, or call the General Motors Customer Communication Centre, 1-800-263-3777 (English), 1-800-263-7854 (French), or write to:

Mediation/Arbitration Program  
c/o Customer Communication Centre  
General Motors of Canada Limited  
Mail Code: CA1-163-005  
1908 Colonel Sam Drive  
Oshawa, Ontario L1H 8P7

Your inquiry should be accompanied by the Vehicle Identification Number (VIN).

## Online Owner Center

### **Buick Owner Center (U.S.)** **[www.buickownercenter.com](http://www.buickownercenter.com)**

Information and services customized for your specific vehicle — all in one convenient place.

- Digital owner manual, warranty information, and more
- Store online service and maintenance records
- Buick dealer locator for service nationwide
- Exclusive privileges and offers

- Recall notices for your specific vehicle
- OnStar and GM Cardmember Services Earnings summaries

### **Other Helpful Links:**

Buick — [www.buick.com](http://www.buick.com)

Buick Merchandise — [www.buickmerchandise.com](http://www.buickmerchandise.com)

Help Center — [www.buick.com/pages/mds/helpcenter/faq.do](http://www.buick.com/pages/mds/helpcenter/faq.do)

- FAQ (Frequently Asked Questions)
- Contact Us

### **My GM Canada (Canada) [www.gm.ca](http://www.gm.ca)**

My GM Canada is a password-protected section of [www.gm.ca](http://www.gm.ca) where you can save information on GM vehicles, get personalized offers, and use handy tools and forms with greater ease.

Here are a few of the valuable tools and services you will have access to:

- My Showroom: Find and save information on vehicles and current offers in your area.
- My Dealers: Save details such as address and phone number for each of your preferred GM dealers.

- My Driveway: Access quick links to parts and service estimates, check trade-in values, or schedule a service appointment by adding the vehicles you own to your driveway profile.
- My Preferences: Manage your profile and use tools and forms with greater ease.

To sign up, visit the My GM.ca section within [www.gm.ca](http://www.gm.ca).

## Customer Assistance for Text Telephone (TTY) Users

To assist customers who are deaf, hard of hearing, or speech-impaired and who use Text Telephones (TTYs), Buick has TTY equipment available at its Customer Assistance Center. Any TTY user can communicate with Buick by dialing: 1-800-832-8425. TTY users in Canada can dial 1-800-263-3830.

## Customer Assistance Offices

Buick encourages customers to call the toll-free number for assistance. However, if a customer wishes to write or e-mail Buick, the letter should be addressed to:

### United States

Buick Customer Assistance Center  
P.O. Box 33136  
Detroit, MI 48232-5136  
[www.Buick.com](http://www.Buick.com)

1-800-521-7300

1-800-832-8425 (For Text Telephone devices (TTYs))

Roadside Assistance: 1-800-252-1112

From Puerto Rico:

1-800-496-9992 (English)

1-800-496-9993 (Spanish)

From U.S. Virgin Islands:

1-800-496-9994

## Canada

General Motors of Canada Limited  
Customer Communication Centre, Mail Code:  
CA1-163-005  
1908 Colonel Sam Drive  
Oshawa, Ontario L1H 8P7  
www.gm.ca

1-800-263-3777 (English)  
1-800-263-7854 (French)  
1-800-263-3830 (For Text Telephone devices  
(TTYs))  
Roadside Assistance: 1-800-268-6800

## All Overseas Locations

Please contact the local General Motors Business Unit.

### Mexico, Central America and Caribbean Islands/Countries (Except Puerto Rico and U.S. Virgin Islands)

General Motors de Mexico, S. de R.L. de C.V.  
Customer Assistance Center  
Av. Ejercito Nacional #843  
Col. Granada  
C.P. 11520, Mexico, D.F.  
01-800-466-0818  
Long Distance: 011-52-53 29 0818

## GM Mobility Reimbursement Program



This program is available to qualified applicants for cost reimbursement of eligible aftermarket adaptive equipment required for your vehicle, such as hand controls or a wheelchair/scooter lift for the vehicle.

For more information on the limited offer, visit [www.gmmobility.com](http://www.gmmobility.com) or call the GM Mobility Assistance Center at 1-800-323-9935. Text telephone (TTY) users, call 1-800-833-9935.

General Motors of Canada also has a Mobility Program. Call 1-800-GM-DRIVE (463-7483) for details. TTY users call 1-800-263-3830.



## Roadside Assistance Program

For U.S.-purchased vehicles, call **1-800-252-1112**;  
(Text Telephone (TTY): **1-888-889-2438**).

For Canadian-purchased vehicles, call **1-800-268-6800**.

Service is available 24 hours a day, 365 days a year.

### Calling for Assistance

When calling Roadside Assistance, have the following information ready:

- Your name, home address, and home telephone number
- Telephone number of your location
- Location of the vehicle
- Model, year, color, and license plate number of the vehicle
- Odometer reading, Vehicle Identification Number (VIN), and delivery date of the vehicle
- Description of the problem

## Coverage

Services are provided up to 5 years/160 000 km (100,000 miles), whichever comes first.

In the U.S., anyone driving the vehicle is covered. In Canada, a person driving the vehicle without permission from the owner is not covered.

Roadside Assistance is not a part of the New Vehicle Limited Warranty. Buick and General Motors of Canada Limited reserve the right to make any changes or discontinue the Roadside Assistance program at any time without notification.

Buick and General Motors of Canada Limited reserve the right to limit services or payment to an owner or driver if they decide the claims are made too often, or the same type of claim is made many times.

### Services Provided

- **Emergency Fuel Delivery:** Delivery of enough fuel for the vehicle to get to the nearest service station.
- **Lock-Out Service:** Service to unlock the vehicle if you are locked out. A remote unlock may be available if you have OnStar<sup>®</sup>. For security reasons, the driver must present identification before this service is given.

- **Emergency Tow From a Public Road or Highway:** Tow to the nearest Buick dealer for warranty service, or if the vehicle was in a crash and cannot be driven. Assistance is also given when the vehicle is stuck in sand, mud, or snow.
- **Flat Tire Change:** Service to change a flat tire with the spare tire. The spare tire, if equipped, must be in good condition and properly inflated. It is the owner's responsibility for the repair or replacement of the tire if it is not covered by the warranty.
- **Battery Jump Start:** Service to jump start a dead battery.

## Services Not Included in Roadside Assistance

- Impound towing caused by violation of any laws.
- Legal fines.
- Mounting, dismounting, or changing of snow tires, chains, or other traction devices.
- Towing or services for vehicles driven on a non-public road or highway.

## Services Specific to Canadian-Purchased Vehicles

- **Fuel delivery:** Reimbursement is approximately \$5 Canadian. Diesel fuel delivery may be restricted. Propane and other fuels are not provided through this service.
- **Lock-Out Service:** Vehicle registration is required.
- **Trip Routing Service:** Detailed maps of North America are provided when requested either with the most direct route or the most scenic route. There is a six request limit per year. Additional travel information is also available. Allow three weeks for delivery.
- **Trip Interruption Benefits and Assistance:** Must be over 250 kilometers from where your trip was started to qualify. General Motors of Canada Limited requires pre-authorization, original detailed receipts, and a copy of the repair orders. Once authorization has been received, the Roadside Assistance advisor will help you make arrangements and explain how to receive payment.

- **Alternative Service:** If assistance cannot be provided right away, the Roadside Assistance advisor may give permission to get local emergency road service. You will receive payment, up to \$100, after sending the original receipt to Roadside Assistance. Mechanical failures may be covered, however any cost for parts and labor for repairs not covered by the warranty are the owner responsibility.

## Scheduling Service Appointments

When the vehicle requires warranty service, contact the dealer and request an appointment. By scheduling a service appointment and advising the service consultant of your transportation needs, the dealer can help minimize your inconvenience.

If the vehicle cannot be scheduled into the service department immediately, keep driving it until it can be scheduled for service, unless, of course, the problem is safety related. If it is, please call the dealership, let them know this, and ask for instructions.

If the dealer requests you to bring the vehicle for service, you are urged to do so as early in the work day as possible to allow for the same-day repair.

## Courtesy Transportation Program

To enhance your ownership experience, we and our participating dealers are proud to offer Courtesy Transportation, a customer support program for vehicles with the Bumper-to-Bumper (Base Warranty Coverage period in Canada), extended powertrain, and/or hybrid-specific warranties in both the U.S. and Canada.

Several Courtesy Transportation options are available to assist in reducing inconvenience when warranty repairs are required.

Courtesy Transportation is not a part of the New Vehicle Limited Warranty. A separate booklet entitled "Warranty and Owner Assistance Information" furnished with each new vehicle provides detailed warranty coverage information.

## Transportation Options

Warranty service can generally be completed while you wait. However, if you are unable to wait, GM helps to minimize inconvenience by providing several transportation options. Depending on the circumstances, the dealer can offer one of the following:

### Shuttle Service

Shuttle service is the preferred means of offering Courtesy Transportation. Dealers may provide shuttle service to get you to your destination with minimal interruption of your daily schedule. This includes one-way or round-trip shuttle service within reasonable time and distance parameters of the dealer's area.

### Public Transportation or Fuel Reimbursement

If the vehicle requires overnight warranty repairs, and public transportation is used instead of the dealer's shuttle service, the expense must be supported by original receipts and can only be up to the maximum amount allowed by GM for shuttle service. In addition, for U.S. customers, should you arrange transportation through a friend or relative, limited reimbursement for reasonable fuel expenses may be available. Claim amounts should reflect actual costs and be supported by original receipts. See the dealer for information regarding the allowance amounts for reimbursement of fuel or other transportation costs.

## Courtesy Rental Vehicle

The dealer may arrange to provide you with a courtesy rental vehicle or reimburse you for a rental vehicle that you obtain if the vehicle is kept for an overnight warranty repair. Rental reimbursement will be limited and must be supported by original receipts. This requires that you sign and complete a rental agreement and meet state/provincial, local, and rental vehicle provider requirements. Requirements vary and may include minimum age requirements, insurance coverage, credit card, etc. You are responsible for fuel usage charges and may also be responsible for taxes, levies, usage fees, excessive mileage, or rental usage beyond the completion of the repair.

It may not be possible to provide a like vehicle as a courtesy rental.

### Additional Program Information

All program options, such as shuttle service, may not be available at every dealer. Please contact the dealer for specific information about availability. All Courtesy Transportation arrangements will be administered by appropriate dealer personnel.

*General Motors reserves the right to unilaterally modify, change, or discontinue Courtesy Transportation at any time and to resolve all questions of claim eligibility pursuant to the terms and conditions described herein at its sole discretion.*

## **Collision Damage Repair**

If your vehicle is involved in a collision and it is damaged, have the damage repaired by a qualified technician using the proper equipment and quality replacement parts. Poorly performed collision repairs diminish your vehicle's resale value, and safety performance can be compromised in subsequent collisions.

### **Collision Parts**

Genuine GM Collision parts are new parts made with the same materials and construction methods as the parts with which your vehicle was originally built. Genuine GM Collision parts are your best choice to ensure that your vehicle's designed appearance, durability, and safety are preserved. The use of Genuine GM parts can help maintain your GM New Vehicle Limited Warranty.

Recycled original equipment parts may also be used for repair. These parts are typically removed from vehicles that were total losses in prior crashes. In most cases, the parts being recycled are from undamaged sections of the vehicle. A recycled original equipment GM part may be an acceptable choice to maintain your vehicle's

originally designed appearance and safety performance; however, the history of these parts is not known. Such parts are not covered by your GM New Vehicle Limited Warranty, and any related failures are not covered by that warranty.

Aftermarket collision parts are also available. These are made by companies other than GM and may not have been tested for your vehicle. As a result, these parts may fit poorly, exhibit premature durability/corrosion problems, and may not perform properly in subsequent collisions. Aftermarket parts are not covered by your GM New Vehicle Limited Warranty, and any vehicle failure related to such parts is not covered by that warranty.

### **Repair Facility**

GM also recommends that you choose a collision repair facility that meets your needs before you ever need collision repairs. Your dealer may have a collision repair center with GM-trained technicians and state-of-the-art equipment, or be able to recommend a collision repair center that has GM-trained technicians and comparable equipment.

## Insuring Your Vehicle

Protect your investment in your GM vehicle with comprehensive and collision insurance coverage. There are significant differences in the quality of coverage afforded by various insurance policy terms. Many insurance policies provide reduced protection to your GM vehicle by limiting compensation for damage repairs by using aftermarket collision parts. Some insurance companies will not specify aftermarket collision parts. When purchasing insurance, we recommend that you ensure that your vehicle will be repaired with GM original equipment collision parts. If such insurance coverage is not available from your current insurance carrier, consider switching to another insurance carrier.

If your vehicle is leased, the leasing company may require you to have insurance that ensures repairs with Genuine GM Original Equipment Manufacturer (OEM) parts or Genuine Manufacturer replacement parts. Read your lease carefully, as you may be charged at the end of your lease for poor quality repairs.

## If a Crash Occurs

If there has been an injury, call emergency services for help. Do not leave the scene of a crash until all matters have been taken care of. Move the vehicle only if its position puts you in danger, or you are instructed to move it by a police officer.

Give only the necessary information to police and other parties involved in the crash.

For emergency towing see *Roadside Assistance Program* on page 8-7.

Gather the following information:

- Driver's name, address, and telephone number
- Driver's license number
- Owner's name, address, and telephone number
- Vehicle license plate number
- Vehicle make, model, and model year
- Vehicle Identification Number (VIN)
- Insurance company and policy number
- General description of the damage to the other vehicle

Choose a reputable repair facility that uses quality replacement parts. See "Collision Parts" earlier in this section.

If the airbag has inflated, see *What Will You See After an Airbag Inflates?* on page 2-62.

## Managing the Vehicle Damage Repair Process

In the event that your vehicle requires damage repairs, GM recommends that you take an active role in its repair. If you have a pre-determined repair facility of choice, take your vehicle there, or have it towed there. Specify to the facility that any required replacement collision parts be original equipment parts, either new Genuine GM parts or recycled original GM parts. Remember, recycled parts will not be covered by your GM vehicle warranty.

Insurance pays the bill for the repair, but you must live with the repair. Depending on your policy limits, your insurance company may initially value the repair using aftermarket parts. Discuss this with your repair professional, and insist on Genuine GM parts. Remember, if your vehicle is leased, you may be obligated to have the vehicle repaired with Genuine GM parts, even if your insurance coverage does not pay the full cost.

If another party's insurance company is paying for the repairs, you are not obligated to accept a repair valuation based on that insurance company's collision policy repair limits, as you have no contractual limits with that company. In such cases, you can have control of the repair and parts choices as long as the cost stays within reasonable limits.

## Reporting Safety Defects

### Reporting Safety Defects to the United States Government

If you believe that your vehicle has a defect which could cause a crash or could cause injury or death, you should immediately inform the National Highway Traffic Safety Administration (NHTSA) in addition to notifying General Motors.

If NHTSA receives similar complaints, it may open an investigation, and if it finds that a safety defect exists in a group of vehicles, it may order a recall and remedy campaign. However, NHTSA cannot become involved in individual problems between you, your dealer, or General Motors.

To contact NHTSA, you may call the Vehicle Safety Hotline toll-free at 1-888-327-4236 (TTY: 1-800-424-9153); go to <http://www.safercar.gov>; or write to:

Administrator, NHTSA  
1200 New Jersey Avenue, S.E.  
Washington, D.C. 20590

You can also obtain other information about motor vehicle safety from <http://www.safercar.gov>.

## Reporting Safety Defects to the Canadian Government

If you live in Canada, and you believe that your vehicle has a safety defect, notify Transport Canada immediately, and notify General Motors of Canada Limited. Call them at 1-800-333-0510 or write to:

Transport Canada  
Road Safety Branch  
2780 Sheffield Road  
Ottawa, Ontario K1B 3V9

## Reporting Safety Defects to General Motors

In addition to notifying NHTSA (or Transport Canada) in a situation like this, please notify General Motors.

Call 1-800-521-7300, or write:

Buick Customer Assistance Center  
P.O. Box 33136  
Detroit, MI 48232-5136

In Canada, call 1-800-263-3777 (English) or 1-800-263-7854 (French), or write:

General Motors of Canada Limited  
Customer Communication Centre, Mail Code:  
CA1-163-005  
1908 Colonel Sam Drive  
Oshawa, Ontario L1H 8P7

## Service Publications Ordering Information

### Service Manuals

Service Manuals have the diagnosis and repair information on the engines, transmission, axle, suspension, brakes, electrical, steering, body, etc.

### Service Bulletins

Service Bulletins give additional technical service information needed to knowledgeably service General Motors cars and trucks. Each bulletin contains instructions to assist in the diagnosis and service of the vehicle.



## Owner Information

Owner publications are written specifically for owners and intended to provide basic operational information about the vehicle. The Owner Manual includes the Maintenance Schedule for all models.

In-Portfolio: Includes a Portfolio, Owner Manual, and Warranty Booklet.

RETAIL SELL PRICE: \$35.00 (U.S.) plus handling and shipping fees.

Without Portfolio: Owner Manual only.

RETAIL SELL PRICE: \$25.00 (U.S.) plus handling and shipping fees.

## Current and Past Models

Technical Service Bulletins and Manuals are available for current and past model GM vehicles.

**ORDER TOLL FREE: 1-800-551-4123**  
**Monday - Friday 8:00 AM - 6:00 PM**  
**Eastern Time**

For Credit Card Orders Only  
(VISA-MasterCard-Discover), visit Helm, Inc. at:  
[www.helminc.com](http://www.helminc.com).

Or write to:

Helm, Incorporated  
P.O. Box 07130  
Detroit, MI 48207

Prices are subject to change without notice and without incurring obligation. Allow ample time for delivery.

All listed prices are quoted in U.S. funds. Make checks payable in U.S. funds.

## Vehicle Data Recording and Privacy

Your GM vehicle has a number of sophisticated computers that record information about the vehicle's performance and how it is driven. For example, your vehicle uses computer modules to monitor and control engine and transmission performance, to monitor the conditions for airbag deployment and deploy airbags in a crash, and, if so equipped, to provide antilock braking to help the driver control the vehicle. These modules may store data to help your dealer technician service your vehicle. Some modules may also store data about how you operate the vehicle, such as rate of fuel consumption or average speed. These modules may also retain the owner's personal preferences, such as radio pre-sets, seat positions, and temperature settings.

## Event Data Recorders

This vehicle has an Event Data Recorder (EDR). The main purpose of an EDR is to record, in certain crash or near crash-like situations, such as an airbag deployment or hitting a road obstacle, data that will assist in understanding how a vehicle's systems performed. The EDR is designed to record data related to vehicle dynamics and safety systems for a short period of time, typically 30 seconds or less. The EDR in this vehicle is designed to record such data as:

- How various systems in your vehicle were operating
- Whether or not the driver and passenger safety belts were buckled/fastened
- How far, if at all, the driver was pressing the accelerator and/or brake pedal
- How fast the vehicle was traveling

This data can help provide a better understanding of the circumstances in which crashes and injuries occur.

**Important:** EDR data is recorded by your vehicle only if a non-trivial crash situation occurs; no data is recorded by the EDR under normal driving conditions and no personal data (e.g., name, gender, age, and crash location) is recorded. However, other parties, such as law enforcement, could combine the EDR data with the type of personally identifying data routinely acquired during a crash investigation.

To read data recorded by an EDR, special equipment is required, and access to the vehicle or the EDR is needed. In addition to the vehicle manufacturer, other parties, such as law enforcement, that have the special equipment, can read the information if they have access to the vehicle or the EDR.

GM will not access this data or share it with others except: with the consent of the vehicle owner or, if the vehicle is leased, with the consent of the lessee; in response to an official request of police or similar government office; as part of GM's defense of litigation through the discovery process; or, as required by law. Data that GM collects or receives may also be used for GM research needs or may be made available to others for research purposes, where a need is shown and the data is not tied to a specific vehicle or vehicle owner.

## OnStar®

If your vehicle is equipped with an active OnStar system, that system may also record data in crash or near crash-like situations. The OnStar Terms and Conditions provides information on data collection and use and is available in the OnStar glove box kit, at [www.onstar.com](http://www.onstar.com) (U.S.) or [www.onstar.ca](http://www.onstar.ca) (Canada), or by pressing the  button and speaking to an advisor.

## Navigation System

If the vehicle has a navigation system, use of the system may result in the storage of destinations, addresses, telephone numbers, and other trip information. Refer to the navigation system operating manual for information on stored data and for deletion instructions.

## Radio Frequency Identification (RFID)

RFID technology is used in some vehicles for functions such as tire pressure monitoring and ignition system security, as well as in connection with conveniences such as key fobs for remote door locking/unlocking and starting, and in-vehicle transmitters for garage door openers. RFID technology in GM vehicles does not use or record personal information or link with any other GM system containing personal information.

## Radio Frequency Statement

This vehicle has systems that operate on a radio frequency that comply with Part 15 of the Federal Communications Commission (FCC) rules and with Industry Canada Standards RSS-210/220/310.

Operation is subject to the following two conditions:

1. The device may not cause interference.
2. The device must accept any interference received, including interference that may cause undesired operation of the device.

Changes or modifications to any of these systems by other than an authorized service facility could void authorization to use this equipment.

## A

Accessories and Modifications .....	6-3	Antilock Brake System (ABS) .....	5-4
Accessory Power .....	3-21	Warning Light .....	4-33
Accessory Power Outlets .....	4-15	Appearance Care	
Add-On Electrical Equipment .....	6-107	Aluminum or Chrome-Plated Wheels .....	6-104
Additives, Fuel .....	6-7	Care of Safety Belts .....	6-101
Air Cleaner/Filter, Engine .....	6-23	Chemical Paint Spotting .....	6-106
Air Conditioning .....	4-16	Cleaning Exterior Lamps/Lenses .....	6-102
Air Filter, Passenger Compartment .....	4-25	Fabric/Carpet .....	6-99
Airbag		Finish Care .....	6-102
Adding Equipment to Your Airbag-Equipped		Finish Damage .....	6-105
Vehicle .....	2-69	Instrument Panel, Vinyl, and Other Plastic	
Airbag System		Surfaces .....	6-101
How Does an Airbag Restrain? .....	2-62	Interior Cleaning .....	6-98
Passenger Sensing System .....	2-64	Leather .....	6-100
Servicing Your Airbag-Equipped Vehicle .....	2-68	Sheet Metal Damage .....	6-105
What Makes an Airbag Inflate? .....	2-61	Tires .....	6-105
What Will You See After an Airbag Inflates? .....	2-62	Underbody Maintenance .....	6-105
When Should an Airbag Inflate? .....	2-60	Washing Your Vehicle .....	6-102
Where Are the Airbags? .....	2-57	Weatherstrips .....	6-101
Airbags		Windshield and Wiper Blades .....	6-103
Passenger Status Indicator .....	4-31	Ashtray(s) .....	4-16
Readiness Light .....	4-30	Assistance Program, Roadside .....	8-7
System Check .....	2-55	Audio System .....	4-67
Antenna		Audio Steering Wheel Controls .....	4-94
Backglass .....	4-97	Navigation/Radio System, see Navigation	
Antenna, XM™ Satellite Radio Antenna System ...	4-98	Manual .....	4-85
		Radio Reception .....	4-97

Audio System (cont.)	
Setting the Clock .....	4-68
Theft-Deterrent Feature .....	4-94
XM™ Satellite Radio Antenna System .....	4-98
Audio System(s) .....	4-69
Automatic Transmission	
Fluid .....	6-24
Operation .....	3-24

## B

Backglass Antenna .....	4-97
Battery .....	6-42
Electric Power Management .....	4-14
Exterior Lighting Battery Saver .....	4-12
Inadvertent Power Saver .....	4-14
Run-Down Protection .....	4-15
Belt Routing, Engine .....	7-11
Bluetooth® .....	4-86
Brake	
Emergencies .....	5-5
Brakes .....	6-39
Antilock .....	5-4
Parking .....	3-26
System Warning Light .....	4-32
Braking .....	5-3
Braking in Emergencies .....	5-5
Break-In, New Vehicle .....	3-19

Bulb Replacement .....	6-55
Fog Lamps .....	4-12
Halogen Bulbs .....	6-52
Headlamp Aiming .....	6-49
Headlamps .....	6-52
License Plate Lamps .....	6-55
Taillamps and Back-Up Lamps .....	6-54
Taillamps, Turn Signal, Stoplamps and Sidemarker Lamps .....	6-52
Buying New Tires .....	6-72

## C

Calibration .....	2-12, 3-32, 4-47
California	
Perchlorate Materials Requirements .....	6-4
Warning .....	6-4
California Fuel .....	6-6
Canadian Owners .....	iii
Capacities and Specifications .....	6-116
Carbon Monoxide	
Engine Exhaust .....	3-30
Trunk .....	3-12
Winter Driving .....	5-15
Care of	
Safety Belts .....	6-101
CD, MP3 .....	4-78
Center Console Storage .....	3-49

Center Flex Storage Unit .....	3-49	Cleaning (cont.)	
Center Seat .....	2-11	Interior .....	6-98
Chains, Tire .....	6-78	Leather .....	6-100
Charging		Tires .....	6-105
System Light .....	4-32	Underbody Maintenance .....	6-105
Check		Washing Your Vehicle .....	6-102
Engine Light .....	4-37	Weatherstrips .....	6-101
Checking Things Under the Hood .....	6-12	Windshield and Wiper Blades .....	6-103
Chemical Paint Spotting .....	6-106	Climate Control System .....	4-16
Child Restraints		Outlet Adjustment .....	4-25
Infants and Young Children .....	2-36	Climate Control Systems	
Lower Anchors and Tethers for Children .....	2-42	Dual Automatic .....	4-20
Older Children .....	2-33	Climate Controls .....	1-14
Securing a Child Restraint in a Rear Seat		Clock, Setting .....	4-68
Position .....	2-49	Collision Damage Repair .....	8-11
Securing a Child Restraint in the Center Front		Compact Spare Tire .....	6-97
Seat Position .....	2-51	Compass .....	2-12, 3-32, 4-47
Securing a Child Restraint in the Right Front		Compressor Kit, Tire Sealant .....	6-80
Seat Position .....	2-52	Content Theft-Deterrent .....	3-16
Systems .....	2-39	Control of a Vehicle .....	5-3
Circuit Breakers .....	6-108	Convenience Net .....	3-51
Cleaning		Coolant	
Aluminum or Chrome-Plated Wheels .....	6-104	Engine .....	6-28, 6-31
Exterior Lamps/Lenses .....	6-102	Engine Temperature Gauge .....	4-36
Fabric/Carpet .....	6-99	Engine Temperature Warning Light .....	4-36
Finish Care .....	6-102	Cooling System .....	6-27
Instrument Panel, Vinyl, and Other Plastic		Cornering Lamps .....	4-12
Surfaces .....	6-101	Courtesy Lamps .....	4-13

Courtesy Transportation Program .....	8-9
Cruise Control .....	4-7
Light .....	4-41
Cupholders .....	3-49
Customer Assistance .....	8-5
Offices .....	8-5
Text Telephone (TTY) Users .....	8-5
Customer Information	
Service Publications Ordering Information .....	8-14
Customer Satisfaction Procedure .....	8-2

## D

Damage Repair, Collision .....	8-11
Data Recorders, Event .....	8-16
Daytime Running Lamps (DRL) .....	4-11
Defensive Driving .....	5-2
Delayed Entry Lighting .....	4-13
Delayed Exit Lighting .....	4-13
Delayed Locking .....	3-10
DIC Compass .....	4-47
Disc, MP3 .....	4-78
Doing Your Own Service Work .....	6-4

Door	
Delayed Locking .....	3-10
Locks .....	3-9
Power Locks .....	3-9
Programmable Automatic Door Locks .....	3-10
Rear Door Security Locks .....	3-11
Drive Belt Routing, Engine .....	7-11
Driver Information Center (DIC) .....	4-42
DIC Operation and Displays .....	4-42
DIC Vehicle Customization .....	4-58
DIC Warnings and Messages .....	4-49
Driving	
At Night .....	5-11
Before a Long Trip .....	5-13
Defensive .....	5-2
Drunk .....	5-2
Highway Hypnosis .....	5-13
Hill and Mountain Roads .....	5-14
In Rain and on Wet Roads .....	5-12
Loss of Control .....	5-10
Off-Road Recovery .....	5-9
Rocking Your Vehicle to Get it Out .....	5-17
Winter .....	5-15
Driving for Better Fuel Economy .....	1-23
Dual Automatic Climate Control System .....	4-20



## E

E85 Fuel .....	6-7
EDR .....	8-16
Electrical Equipment, Add-On .....	6-107
Electrical System	
Fuses and Circuit Breakers .....	6-108
Power Windows and Other Power Options .....	6-107
Rear Underseat Fuse Block .....	6-110
Underhood Fuse Block .....	6-108
Electronic Immobilizer	
PASS-Key® III+ .....	3-17
Electronic Immobilizer Operation	
PASS-Key® III+ .....	3-17
Engine	
Air Cleaner/Filter .....	6-23
Check and Service Engine Soon Light .....	4-37
Compartment Overview .....	6-14
Coolant .....	6-28, 6-31
Coolant Heater .....	3-23
Coolant Temperature Gauge .....	4-36
Coolant Temperature Warning Light .....	4-36
Cooling System .....	6-27
Drive Belt Routing .....	7-11
Exhaust .....	3-30
Oil .....	6-18

Engine (cont.)	
Overheated Protection Operating Mode .....	6-37
Overheating .....	6-35
Starting .....	3-21
Engine Oil	
Life System .....	6-22
Entry Lighting .....	4-13
Event Data Recorders .....	8-16
Extender, Safety Belt .....	2-33
Exterior Lamps .....	4-10
Exterior Lighting Battery Saver .....	4-12

## F

Filter,	
Engine Air Cleaner .....	6-23
Finish Damage .....	6-105
Flash-to-Pass .....	4-5
Flashers, Hazard Warning .....	4-3
Flat Tire .....	6-78
Changing .....	6-88
Flat Tire, Storing .....	6-96
Floor Mats .....	3-50
Fluid	
Automatic Transmission .....	6-24
Power Steering .....	6-37
Windshield Washer .....	6-38

Fog Lamps	
Bulb Replacement .....	4-12
Front Fog Lamps	
Light .....	4-40
Front Reading Lamps .....	4-13
Front Storage Area .....	3-49
Fuel .....	6-5
Additives .....	6-7
California Fuel .....	6-6
E85 (85% Ethanol) .....	6-7
Filling a Portable Fuel Container .....	6-11
Filling the Tank .....	6-9
Fuels in Foreign Countries .....	6-9
Gasoline Octane .....	6-6
Gasoline Specifications .....	6-6
Gauge .....	4-41
Fuel Economy	
Driving .....	1-23
Fuses	
Fuses and Circuit Breakers .....	6-108
Rear Underseat Fuse Block .....	6-110
Underhood Fuse Block .....	6-108

## G

Garage Door Opener .....	3-42
Gasoline	
Octane .....	6-6
Specifications .....	6-6
Gauges	
Engine Coolant Temperature .....	4-36
Fuel .....	4-41
Speedometer .....	4-29
Tachometer .....	4-29
Trip Odometer .....	4-29
Glove Box .....	3-49
GM Mobility Reimbursement Program .....	8-6

## H

Halogen Bulbs .....	6-52
Hazard Warning Flashers .....	4-3
Head Restraints .....	2-2
Headlamps	
Aiming .....	6-49
Bulb Replacement .....	6-52
Daytime Running Lamps (DRL) .....	4-11
Exterior Lamps .....	4-10
Flash-to-Pass .....	4-5
High/Low Beam Changer .....	4-5
On Reminder .....	4-11
Wiper Activated .....	4-11

Heated	
Steering Wheel .....	4-4
Heated Seats .....	2-4, 2-6
Heater .....	4-16
Engine Coolant .....	3-23
Highbeam On Light .....	4-41
Highway Hypnosis .....	5-13
Hill and Mountain Roads .....	5-14
Hood	
Checking Things Under .....	6-12
Release .....	6-13
Horn .....	4-3
How to Wear Safety Belts Properly .....	2-17

## I

Ignition Positions .....	3-19
Inadvertent Power Battery Saver .....	4-14
Infants and Young Children, Restraints .....	2-36
Inflation - Tire Pressure .....	6-64
Instrument Panel	
Brightness .....	4-12
Instrument Panel Cluster .....	4-28
Integrated Trailer Brake Control System (ITBC) ....	5-25
Introduction .....	7-2

## J

Jump Starting .....	6-44
---------------------	------

## K

Keyless Entry	
Remote (RKE) System .....	3-4
Keys .....	3-3

## L

Labeling, Tire Sidewall .....	6-58
Lamps	
Cornering .....	4-12
Courtesy .....	4-13
Daytime Running (DRL) .....	4-11
Exterior Lighting Battery Saver .....	4-12
Front Reading .....	4-13
License Plate .....	6-55
Malfunction Indicator .....	4-37
Taillamps and Back-Up .....	6-54
Lane Departure Warning .....	3-40
Lane Departure Warning Light .....	4-35
Lap Belt .....	2-32
Lap-Shoulder Belt .....	2-26
LATCH System for Child Restraints .....	2-42
Lighting	
Delayed Entry .....	4-13
Delayed Exit .....	4-13
Entry .....	4-13
Perimeter .....	4-13
Theater Dimming .....	4-13

Lights	
Airbag Readiness .....	4-30
Antilock Brake System (ABS) Warning .....	4-33
Brake System Warning .....	4-32
Charging System .....	4-32
Cruise Control .....	4-41
Engine Coolant Temperature Warning .....	4-36
Exterior Lamps .....	4-10
Flash-to-Pass .....	4-5
Front Fog Lamps .....	4-40
High/Low Beam Changer .....	4-5
Highbeam On .....	4-41
Lane Departure Warning .....	4-35
Oil Pressure .....	4-40
On Reminder .....	4-11
Passenger Airbag Status Indicator .....	4-31
Safety Belt Reminders .....	4-29
Security .....	4-40
StabiliTrak <sup>®</sup> Indicator .....	4-34
Tire Pressure .....	4-37
Traction Control System (TCS) Warning .....	4-34
Loading Your Vehicle .....	5-18
Locks	
Delayed Locking .....	3-10
Door .....	3-9
Lockout Protection .....	3-11
Locks (cont.)	
Power Door .....	3-9
Programmable Automatic Door Locks .....	3-10
Rear Door Security Locks .....	3-11
Loss of Control .....	5-10
Lower Anchors and Tethers for Children .....	2-42
Lumbar	
Power Controls .....	2-4
<b>M</b>	
Magnetic Ride Control .....	5-7
Maintenance Schedule	
Maintenance Record .....	7-12
Maintenance Replacement Parts .....	7-10
Owner Checks and Services .....	7-6
Recommended Fluids and Lubricants .....	7-8
Scheduled Maintenance .....	7-3
Malfunction Indicator Lamp .....	4-37
Memory Seat and Mirrors .....	2-7
Message	
DIC Warnings and Messages .....	4-49
Mirrors	
Automatic Dimming Rearview .....	3-31
Manual Rearview Mirror with Compass and Temperature .....	2-12
Outside Automatic Dimming Mirror .....	3-33
Outside Convex Mirror .....	3-34

Mirrors (cont.)	
Outside Heated Mirrors .....	3-34
Outside Power Mirrors .....	3-33
Park Tilt .....	3-34
MP3 .....	4-78

## N

Navigation System, Privacy .....	8-18
Navigation/Radio System, see Navigation	
Manual .....	4-85
Net, Convenience .....	3-51
New Vehicle Break-In .....	3-19

## O

Object Detection, Side Blind Zone Alert (SBZA) ...	3-36
Odometer .....	4-29
Trip .....	4-29
Off-Road	
Recovery .....	5-9
Oil	
Engine .....	6-18
Engine Oil Life System .....	6-22
Pressure Light .....	4-40
Older Children, Restraints .....	2-33
Online Owner Center .....	8-4
OnStar, Privacy .....	8-17
OnStar <sup>®</sup> System .....	1-24

Operation, Universal Home Remote System .....	3-42
Outlet Adjustment .....	4-25
Outlets	
Accessory Power .....	4-15
Outside	
Automatic Dimming Mirror .....	3-33
Convex Mirror .....	3-34
Heated Mirrors .....	3-34
Power Mirrors .....	3-33
Overheated Engine Protection Operating Mode ....	6-37
Owner Checks and Services .....	7-6
Owners, Canadian .....	iii

## P

Paint, Damage .....	6-105
Park	
Shifting Into .....	3-27
Shifting Out of .....	3-28
Park Aid .....	3-35
Park Tilt Mirrors .....	3-34
Parking	
Assist .....	3-35
Brake .....	3-26
Over Things That Burn .....	3-29
PASS-Key <sup>®</sup> III+ Electronic Immobilizer .....	3-17
PASS-Key <sup>®</sup> III+ Electronic Immobilizer	
Operation .....	3-17

Passenger Airbag Status Indicator .....	4-31
Passenger Compartment Air Filter .....	4-25
Passenger Sensing System .....	2-64
Passing .....	5-10
Perchlorate Materials Requirements, California .....	6-4
Perimeter Lighting .....	4-13
Phone	
Bluetooth® .....	4-86
Power	
Door Locks .....	3-9
Electrical System .....	6-107
Lumbar Controls .....	2-4
Retained Accessory (RAP) .....	3-21
Seat .....	2-3
Steering Fluid .....	6-37
Tilt Wheel and Telescopic Steering Column .....	4-4
Windows .....	3-15
Pregnancy, Using Safety Belts .....	2-31
Privacy .....	8-16
Navigation System .....	8-18
OnStar .....	8-17
Radio Frequency Identification (RFID) .....	8-18
Program	
Courtesy Transportation .....	8-9
Programmable Automatic Door Locks .....	3-10
Proposition 65 Warning, California .....	6-4

## R

Radio Frequency	
Identification (RFID) .....	8-18
Statement .....	8-18
Radio(s) .....	4-69
Radios	
Navigation/Radio System, see Navigation	
Manual .....	4-85
Reception .....	4-97
Setting the Clock .....	4-68
Theft-Deterrent .....	4-94
Rear Door Security Locks .....	3-11
Rear Seat Armrest .....	3-51
Rearview Mirror with Compass and	
Temperature .....	2-12
Rearview Mirrors	
Automatic Dimming .....	3-31
Reclining Seatbacks .....	2-9
Recommended Fluids and Lubricants .....	7-8
Recreational Vehicle Towing .....	5-23
Reimbursement Program, GM Mobility .....	8-6
Remote Keyless Entry (RKE) System .....	3-4
Remote Vehicle Start .....	3-7
Removing the Flat Tire and Installing the	
Spare Tire .....	6-90
Removing the Spare Tire and Tools .....	6-89
Replacement Bulbs .....	6-55

Replacement Parts	
Maintenance .....	7-10
Reporting Safety Defects	
Canadian Government .....	8-14
General Motors .....	8-14
U.S. Government .....	8-13
Restraint System Check	
Checking the Restraint Systems .....	2-70
Replacing Restraint System Parts After a Crash .....	2-71
Restraints	
Where to Put .....	2-41
Retained Accessory Power (RAP) .....	3-21
Roadside Assistance Program .....	8-7
Rocking Your Vehicle to Get it Out .....	5-17
Roof	
Sunroof .....	3-51
Running the Vehicle While Parked .....	3-30

## S

Safety Belts	
Care of .....	6-101
Extender .....	2-33
How to Wear Safety Belts Properly .....	2-17
Lap Belt .....	2-32
Lap-Shoulder Belt .....	2-26

Safety Belts (cont.)	
Reminders .....	4-29
Safety Belts Are for Everyone .....	2-12
Use During Pregnancy .....	2-31
Safety Defects Reporting	
Canadian Government .....	8-14
General Motors .....	8-14
U.S. Government .....	8-13
Safety Warnings and Symbols .....	iv
Scheduled Maintenance .....	7-3
Scheduling Appointments .....	8-9
Sealant Kit, Tire .....	6-80
Seats	
Center Seat .....	2-11
Head Restraints .....	2-2
Heated and Ventilated Seats .....	2-6
Heated Seats .....	2-4
Memory, Mirrors .....	2-7
Power Lumbar .....	2-4
Power Seats .....	2-3
Reclining Seatbacks .....	2-9
Securing a Child Restraint	
Center Front Seat Position .....	2-51
Rear Seat Position .....	2-49
Right Front Seat Position .....	2-52
Security	
Light .....	4-40

Service .....	6-3
Accessories and Modifications .....	6-3
Adding Equipment to the Outside of the Vehicle ...	6-5
Doing Your Own Work .....	6-4
Engine Soon Light .....	4-37
Parts Identification Label .....	6-107
Publications Ordering Information .....	8-14
Scheduling Appointments .....	8-9
Servicing Your Airbag-Equipped Vehicle .....	2-68
Setting the Clock .....	4-68
Sheet Metal Damage .....	6-105
Shifting	
Out of Park .....	3-28
Shifting Into Park .....	3-27
Side Blind Zone Alert .....	3-36
Signals, Turn and Lane-Change .....	4-5
Spare Tire	
Compact .....	6-97
Installing .....	6-90
Removing .....	6-89
Storing .....	6-96
Specifications and Capacities .....	6-116
Speedometer .....	4-29
StabiliTrak® Indicator Light .....	4-34
StabiliTrak® System .....	5-5
Start Vehicle, Remote .....	3-7
Starting the Engine .....	3-21

Steering .....	5-8
Heated Wheel .....	4-4
Steering Wheel Controls, Audio .....	4-94
Steering Wheel, Power Tilt Wheel and Telescopic	
Steering Column .....	4-4
Steering Wheel, Tilt Wheel .....	4-3
Storage Areas	
Center Console .....	3-49
Center Flex Storage Unit .....	3-49
Convenience Net .....	3-51
Cupholders .....	3-49
Front Storage Area .....	3-49
Glove Box .....	3-49
Rear Seat Armrest .....	3-51
Storing the Tire Sealant and Compressor Kit .....	6-87
Stuck in Sand, Mud, Ice, or Snow .....	5-17
Sun Visors .....	3-16
Sunroof .....	3-51

## T

Tachometer .....	4-29
Taillamps	
Back-Up Lamps .....	6-54
Turn Signal, Stoplamps and Sidemarker	
Lamps .....	6-52
Telescopic Steering Column, Power Tilt Wheel .....	4-4
Text Telephone (TTY) Users .....	8-5



Theater Dimming .....	4-13	Tires (cont.)	
Theft-Deterrent Feature .....	4-94	Sidewall Labeling .....	6-58
Theft-Deterrent Systems .....	3-16	Storing a Flat or Spare Tire and Tools .....	6-96
Content Theft-Deterrent .....	3-16	Terminology and Definitions .....	6-61
PASS-Key® III+ Electronic Immobilizer .....	3-17	Uniform Tire Quality Grading .....	6-75
PASS-Key® III+ Electronic Immobilizer		Wheel Alignment and Tire Balance .....	6-76
Operation .....	3-17	Wheel Replacement .....	6-76
Tilt Wheel .....	4-3	When It Is Time for New Tires .....	6-71
Time, Setting .....	4-68	Towing	
Tires .....	6-57	Recreational Vehicle .....	5-23
Aluminum or Chrome-Plated Wheels,		Towing a Trailer .....	5-25
Cleaning .....	6-104	Your Vehicle .....	5-23
Buying New Tires .....	6-72	Traction	
Chains .....	6-78	Control System (TCS) .....	5-6
Changing a Flat Tire .....	6-88	Control System Warning Light .....	4-34
Cleaning .....	6-105	Magnetic Ride Control .....	5-7
Compact Spare .....	6-97	StabiliTrak® System .....	5-5
Different Size .....	6-74	Transmission	
If a Tire Goes Flat .....	6-78	Fluid, Automatic .....	6-24
Inflation - Tire Pressure .....	6-64	Transmission Operation, Automatic .....	3-24
Inspection and Rotation .....	6-70	Transportation Program, Courtesy .....	8-9
Installing the Spare Tire .....	6-90	Trip Odometer .....	4-29
Pressure Light .....	4-37	Trunk .....	3-12
Pressure Monitor Operation .....	6-66	Turn and Lane-Change Signals .....	4-5
Pressure Monitor System .....	6-65	Turn Signal/Multifunction Lever .....	4-4
Removing the Flat Tire .....	6-90		
Removing the Spare Tire and Tools .....	6-89		
Sealant and Compressor Kit .....	6-80, 6-87		

## U

Ultrasonic Rear Parking Assist (URPA) .....	3-35
Uniform Tire Quality Grading .....	6-75
Universal Home Remote System .....	3-42
Operation .....	3-42

## V

Vehicle	
Control .....	5-3
Identification Number (VIN) .....	6-106
Loading .....	5-18
Remote Start .....	3-7
Running While Parked .....	3-30
Symbols .....	iv
Vehicle Customization, DIC .....	4-58
Vehicle Data Recording and Privacy .....	8-16
Vehicle Identification	
Service Parts Identification Label .....	6-107
Ventilated Seats .....	2-6
Ventilation Adjustment .....	4-25
Visors .....	3-16

## W

Warning Lights, Gauges, and Indicators .....	4-27
Warnings	
DIC Warnings and Messages .....	4-49
Hazard Flashers .....	4-3
Safety and Symbols .....	iv
Wheels	
Alignment and Tire Balance .....	6-76
Different Size .....	6-74
Replacement .....	6-76
When It Is Time for New Tires .....	6-71
Where to Put the Restraint .....	2-41
Windows .....	3-14
Power .....	3-15
Windshield	
Washer .....	4-7
Washer Fluid .....	6-38
Wiper Blade Replacement .....	6-55
Wiper Blades, Cleaning .....	6-103
Wipers .....	4-6
Winter Driving .....	5-15
Wiper Activated Headlamps .....	4-11

## X

XM Radio Messages .....	4-84
XM™ Satellite Radio	
Antenna .....	4-98