

# 2005 Chevrolet Corvette Owner Manual

<b>Seats and Restraint Systems</b> .....	1-1	Driver Information Center (DIC) .....	3-47
Front Seats .....	1-2	Audio System(s) .....	3-76
Safety Belts .....	1-7	<b>Driving Your Vehicle</b> .....	4-1
Child Restraints .....	1-21	Your Driving, the Road, and Your Vehicle .....	4-2
Airbag System .....	1-40	Towing .....	4-37
Restraint System Check .....	1-51	<b>Service and Appearance Care</b> .....	5-1
<b>Features and Controls</b> .....	2-1	Service .....	5-3
Keys .....	2-3	Fuel .....	5-5
Doors and Locks .....	2-10	Checking Things Under the Hood .....	5-10
Windows .....	2-16	Rear Axle .....	5-43
Theft-Deterrent Systems .....	2-18	Bulb Replacement .....	5-44
Starting and Operating Your Vehicle .....	2-19	Windshield Wiper Blade Replacement .....	5-48
Mirrors .....	2-34	Tires .....	5-51
OnStar <sup>®</sup> System .....	2-40	Appearance Care .....	5-75
HomeLink <sup>®</sup> Transmitter .....	2-41	Vehicle Identification .....	5-85
Storage Areas .....	2-46	Electrical System .....	5-86
Roof Panel .....	2-50	Capacities and Specifications .....	5-94
Convertible Top .....	2-55	<b>Maintenance Schedule</b> .....	6-1
Vehicle Personalization .....	2-66	Maintenance Schedule .....	6-2
<b>Instrument Panel</b> .....	3-1	<b>Customer Assistance and Information</b> .....	7-1
Instrument Panel Overview .....	3-4	Customer Assistance and Information .....	7-2
Climate Controls .....	3-24	Reporting Safety Defects .....	7-10
Warning Lights, Gages, and Indicators .....	3-31	<b>Index</b> .....	1



GENERAL MOTORS, GM, the GM Emblem, CHEVROLET, the CHEVROLET Emblem, the name CORVETTE and the CORVETTE Emblem are registered trademarks of General Motors Corporation.

This manual includes the latest information at the time it was printed. We reserve the right to make changes after that time without further notice. For vehicles first sold in Canada, substitute the name "General Motors of Canada Limited" for Chevrolet Motor Division whenever it appears in this manual.

Keep this manual the vehicle, so it will be there if it is needed when on the road. If the vehicle is sold, leave this manual in it.

## Canadian Owners

A French language copy of this manual can be obtained from your dealer or from:

Helm, Incorporated  
P.O. Box 07130  
Detroit, MI 48207

## How to Use This Manual

Many people read the owner manual from beginning to end when they first receive their new vehicle. If this is done, it can help you learn about the features and controls for the vehicle. Pictures and words work together in the owner manual to explain things.

## Index

A good place to quickly locate information about the vehicle is the Index in the back of the manual. It is an alphabetical list of what is in the manual and the page number where it can be found.

## Safety Warnings and Symbols

There are a number of safety cautions in this book. We use a box and the word CAUTION to tell about things that could hurt you if you were to ignore the warning.



 **CAUTION:**

**These mean there is something that could hurt you or other people.**

In the caution area, we tell you what the hazard is. Then we tell you what to do to help avoid or reduce the hazard. Please read these cautions. If you do not, you or others could be hurt.

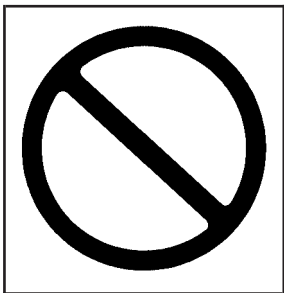

You will also find a circle with a slash through it in this book. This safety symbol means “Do Not,” “Do Not do this” or “Do Not let this happen.”

## Vehicle Damage Warnings

Also, in this manual you will find these notices:

**Notice:** These mean there is something that could damage your vehicle.

A notice tells about something that can damage the vehicle. Many times, this damage would not be covered by your vehicle’s warranty, and it could be costly. But the notice will tell what to do to help avoid the damage.

When you read other manuals, you might see CAUTION and NOTICE warnings in different colors or in different words.

There are also warning labels on the vehicle. They use the same words, CAUTION or NOTICE.































## Vehicle Symbols

The vehicle has components and labels that use symbols instead of text. Symbols are shown along with the text describing the operation or information relating to a specific component, control, message, gage, or indicator.

If you need help figuring out a specific name of a component, gage, or indicator, reference the following topics:

- Seats and Restraint Systems in Section 1
- Features and Controls in Section 2
- Instrument Panel Overview in Section 3
- Climate Controls in Section 3
- Warning Lights, Gages, and Indicators in Section 3
- Audio System(s) in Section 3
- Engine Compartment Overview in Section 5

These are some examples of symbols that may be found on the vehicle:

CAUTION POSSIBLE INJURY		LATCH BOTH LAP AND SHOULDER BELTS TO PROTECT OCCUPANT DO NOT TWIST SAFETY BELT WHEN ATTACHING	 	MASTER LIGHTING SWITCH		ENGINE COOLANT TEMP		FUSE BOX ACCESS	
PROTECT EYES BY SHIELDING		FASTEN SEAT BELTS		AIR BAG		BATTERY CHARGING SYSTEM		ENGINE COOLANT FAN	
CAUSTIC BATTERY ACID COULD CAUSE BURNS		MOVE SEAT FULLY REARWARD SECURE CHILD SEAT		DO NOT INSTALL A REAR-FACING CHILD RESTRAINT IN THIS SEATING POSITION		HAZARD WARNING FLASHER		FUEL	
AVOID SPARKS OR FLAMES		PULL BELT OUT COMPLETELY THEN SECURE CHILD SEAT		DO NOT INSTALL A FORWARD-FACING CHILD RESTRAINT IN THIS SEATING POSITION		DAYTIME RUNNING LAMPS		OWNER'S MANUAL	
SPARK OR FLAME COULD EXPLODE BATTERY		POWER WINDOW		DOOR LOCK UNLOCK		ANTI-LOCK BRAKES		SERVICE MANUAL	
				TURN SIGNALS		COOLANT			
				PARKING LAMPS		ENGINE OIL PRESSURE			
				FOG LAMPS					



# Section 1 Seats and Restraint Systems

---

<b>Front Seats</b> .....	1-2	Child Restraint Systems .....	1-27
Manual Seats .....	1-2	Top Strap .....	1-30
Six-Way Power Seats .....	1-2	Lower Anchorages and Top Tethers for Children (LATCH System) .....	1-31
Power Lumbar and Side Bolsters .....	1-3	Securing a Child Restraint Designed for the LATCH System .....	1-32
Heated Seats .....	1-4	Securing a Child Restraint in the Passenger Seat Position .....	1-35
Reclining Seatbacks .....	1-4	<b>Airbag System</b> .....	1-40
Seatback Latches .....	1-6	Where Are the Airbags? .....	1-42
<b>Safety Belts</b> .....	1-7	When Should an Airbag Inflate? .....	1-45
Safety Belts: They Are for Everyone .....	1-7	What Makes an Airbag Inflate? .....	1-46
Questions and Answers About Safety Belts .....	1-11	How Does an Airbag Restrain? .....	1-46
How to Wear Safety Belts Properly .....	1-12	What Will You See After an Airbag Inflates? .....	1-46
Driver Position .....	1-12	Airbag Off Switch .....	1-48
Safety Belt Use During Pregnancy .....	1-19	Servicing Your Airbag-Equipped Vehicle .....	1-51
Passenger Position .....	1-20	<b>Restraint System Check</b> .....	1-51
Safety Belt Pretensioners .....	1-20	Checking Your Restraint Systems .....	1-51
Safety Belt Extender .....	1-20	Replacing Restraint System Parts After a Crash .....	1-52
<b>Child Restraints</b> .....	1-21		
Older Children .....	1-21		
Infants and Young Children .....	1-24		

## Front Seats

### Manual Seats



To move a manual passenger seat, pull up the bar located under the front of the seat to unlock it. Slide the seat to where you want it and release the bar. Then try to move the seat with your body to make sure it is locked into place.

### Six-Way Power Seats

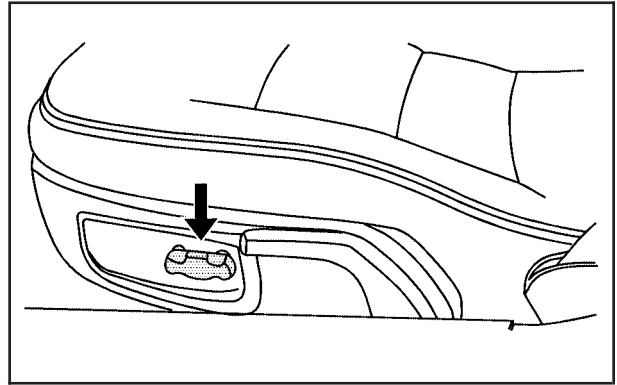

The control for the power driver seat is located on the outboard side of the seat cushion. Your vehicle may have a passenger power seat.

- Move the front of the control up or down to adjust the front portion of the cushion.
- Move the rear of the control up or down to adjust the rear portion of the cushion.
- Slide the seat control forward or rearward to move the entire seat forward or rearward.

Your preferred seat position can be stored and recalled if you have the memory option. See *Memory* on page 2-66.



## Power Lumbar and Side Bolsters

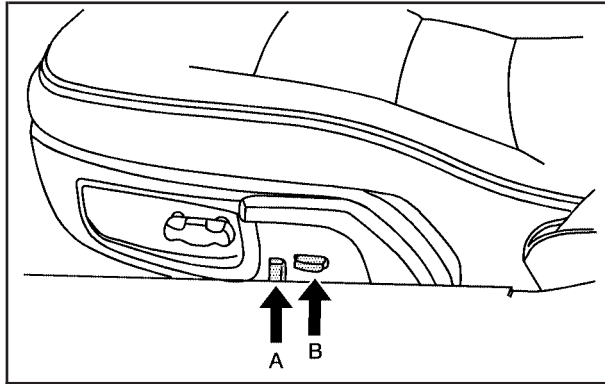

Your vehicle may have power lumbar and side bolsters. The switches are located on the outboard side of the seat cushion.

Use the power seat control to move the seat to the proper position. See *Six-Way Power Seats on page 1-2*.

Use the vertical lumbar switch (A) to adjust support in the seatback. Press the switch forward to increase support. Press the switch rearward to decrease support.

Use the horizontal switch (B) to adjust the side bolsters. Pull up the switch to move the wings of the seatback in closer to your body. Push down the switch to move the wings away from your body.

Keep in mind that as your seating position changes, as it may during long trips, so should the position of your lumbar support. Adjust the seat as needed.

## Heated Seats

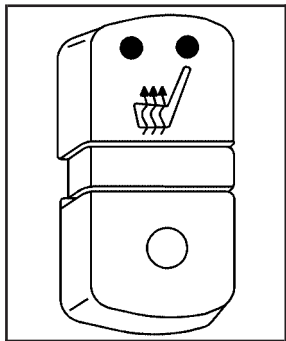

If your vehicle is equipped with heated seats, the buttons are located on the center console.

There is one button for each seat. Each button has three settings: high, low, and off.

To turn on the heated seats, press the top of the button once. The seat will heat to the high setting. Press the top of the button again to switch to the low setting. The lights at the top of the button will indicate which setting it is in. Press the bottom of the button to turn the system off.

The heated seats can only be used when the ignition is on. When the vehicle is off, the heated seats will turn off.

## Reclining Seatbacks

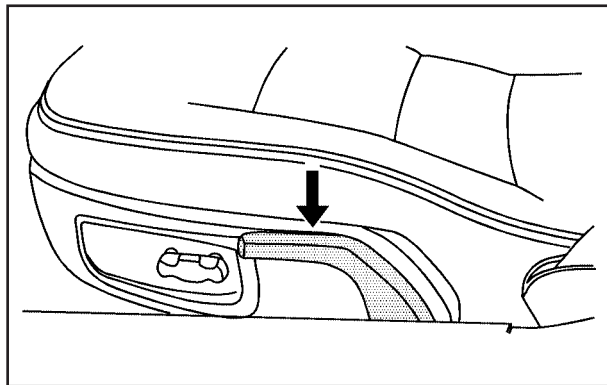

The lever for the reclining seatback is located on the outboard side of each seat.

To adjust the seatback, lean slightly forward to lift your weight off the seatback. Pull completely up on the lever until it stops, and lean back to position the seatback to where you want it. Release the lever to lock the seatback into place.



But do not have a seatback reclined if your vehicle is moving.

## **⚠ CAUTION:**

Sitting in a reclined position when your vehicle is in motion can be dangerous. Even if you buckle up, your safety belts can not do their job when you are reclined like this.

The shoulder belt can not do its job because it will not be against your body. Instead, it will be in front of you. In a crash you could go into it, receiving neck or other injuries.

The lap belt can not do its job either. In a crash the belt could go up over your abdomen. The belt forces would be there, not at your pelvic bones. This could cause serious internal injuries.

For proper protection when the vehicle is in motion, have the seatback upright. Then sit well back in the seat and wear your safety belt properly.

## Seatback Latches



Both seatbacks fold forward to give you access to the rear area. To fold a seatback forward, lift this latch, which is located on top of the backside of the seat, and pull the seatback forward. The seatback will lock down in this position.

To unlock, lift up on the latch and push the seatback rearward. When you return the seatback to its original position, make sure the seatback is locked in place.

### **CAUTION:**

**If the seatback is not locked, it could move forward in a sudden stop or crash. That could cause injury to the person sitting there. Always press rearward on the seatback to be sure it is locked.**

# Safety Belts

## Safety Belts: They Are for Everyone

This part of the manual tells you how to use safety belts properly. It also tells you some things you should not do with safety belts.

### CAUTION:

Do not let anyone ride where he or she can not wear a safety belt properly. If you are in a crash and you are not wearing a safety belt, your injuries can be much worse. You can hit things inside the vehicle or be ejected from it. You can be seriously injured or killed. In the same crash, you might not be if you are buckled up. Always fasten your safety belt, and check that your passenger's belt is fastened properly too.

### CAUTION:

It is extremely dangerous to ride in a cargo area, inside or outside of a vehicle. In a collision, people riding in these areas are more likely to be seriously injured or killed. Do not allow people to ride in any area of your vehicle that is not equipped with seats and safety belts. Be sure everyone in your vehicle is in a seat and using a safety belt properly.



Your vehicle has a light that comes on as a reminder to buckle up. See *Safety Belt Reminder Light* on page 3-33.

In most states and all Canadian provinces, the law says to wear safety belts. Here's why: *They work.*

You never know if you'll be in a crash. If you do have a crash, you don't know if it will be a bad one.

A few crashes are mild, and some crashes can be so serious that even buckled up a person wouldn't survive. But most crashes are in between. In many of them, people who buckle up can survive and sometimes walk away. Without belts they could have been badly hurt or killed.

After more than 30 years of safety belts in vehicles, the facts are clear. In most crashes buckling up does matter...a lot!

## Why Safety Belts Work

When you ride in or on anything, you go as fast as it goes.

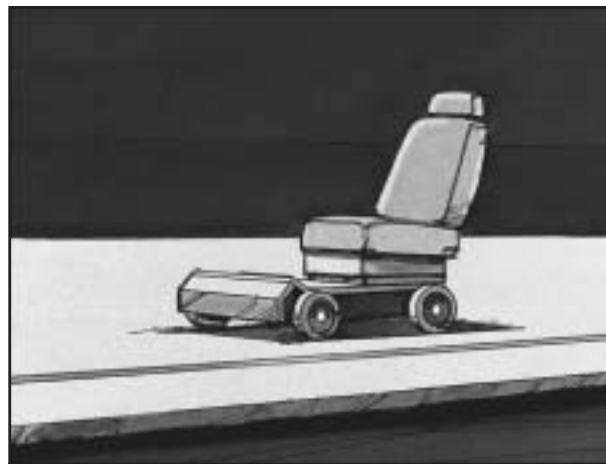

Take the simplest vehicle. Suppose it's just a seat on wheels.



Put someone on it.

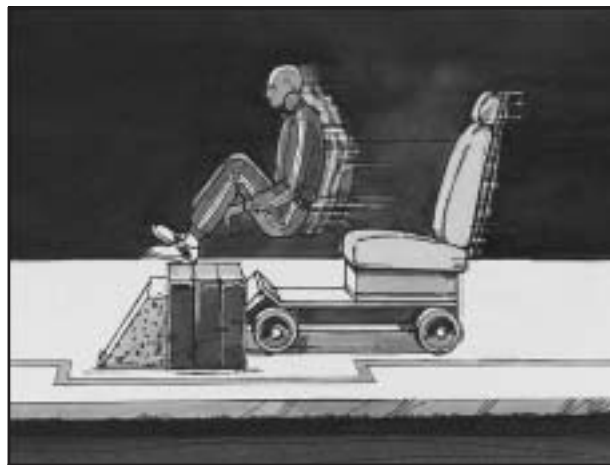

Get it up to speed. Then stop the vehicle. The rider doesn't stop.



The person keeps going until stopped by something. In a real vehicle, it could be the windshield...



or the instrument panel...





or the safety belts!

With safety belts, you slow down as the vehicle does. You get more time to stop. You stop over more distance, and your strongest bones take the forces. That's why safety belts make such good sense.

## Questions and Answers About Safety Belts

**Q:** Won't I be trapped in the vehicle after an accident if I'm wearing a safety belt?

**A:** You *could* be — whether you're wearing a safety belt or not. But you can unbuckle a safety belt, even if you're upside down. And your chance of being conscious during and after an accident, so you *can* unbuckle and get out, is *much* greater if you are belted.

**Q:** If my vehicle has airbags, why should I have to wear safety belts?

**A:** Airbags are in many vehicles today and will be in most of them in the future. But they are supplemental systems only; so they work *with* safety belts — not instead of them. Every airbag system ever offered for sale has required the use of safety belts. Even if you're in a vehicle that has airbags, you still have to buckle up to get the most protection. That's true not only in frontal collisions, but especially in side and other collisions.

**Q:** If I'm a good driver, and I never drive far from home, why should I wear safety belts?

**A:** You may be an excellent driver, but if you're in an accident — even one that isn't your fault — you and your passenger can be hurt. Being a good driver doesn't protect you from things beyond your control, such as bad drivers.

Most accidents occur within 25 miles (40 km) of home. And the greatest number of serious injuries and deaths occur at speeds of less than 40 mph (65 km/h).

Safety belts are for everyone.

## How to Wear Safety Belts Properly

This part is only for people of adult size.

Be aware that there are special things to know about safety belts and children. And there are different rules for smaller children and babies. If a child will be riding in your vehicle, see *Older Children on page 1-21* or *Infants and Young Children on page 1-24*. Follow those rules for everyone's protection.

First, you will want to know which restraint systems your vehicle has.

We will start with the driver position.

## Driver Position

### Lap-Shoulder Belt

The driver has a lap-shoulder belt. Here is how to wear it properly.

1. Close the door.
2. Adjust the seat so you can sit up straight. To see how, see "Seats" in the Index.

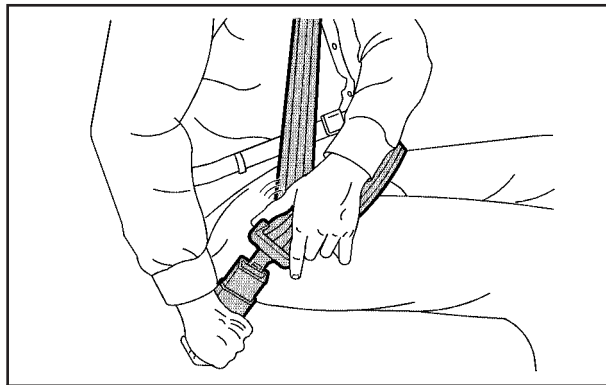

3. Pick up the latch plate and pull the belt across you. Do not let it get twisted.

The lap-shoulder belt may lock if you pull the belt across you very quickly. If this happens, let the belt go back slightly to unlock it. Then pull the belt across you more slowly.

4. Push the latch plate into the buckle until it clicks.  
Pull up on the latch plate to make sure it is secure. When the shoulder belt is pulled out all the way, it will lock. If it does, let it go back all the way and start again.

If the belt is not long enough, see *Safety Belt Extender* on page 1-20.

Make sure the release button on the buckle is positioned so you would be able to unbuckle the safety belt quickly if you ever had to.

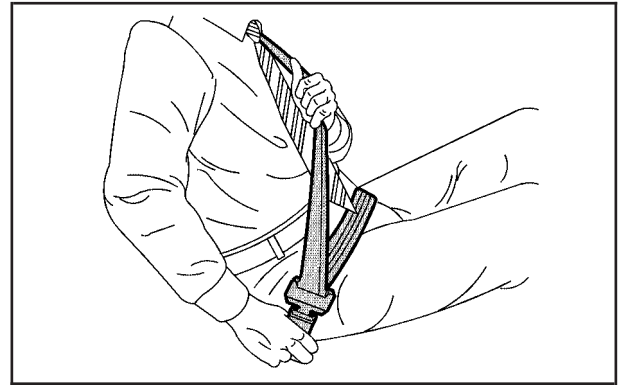

5. To make the lap part tight, pull down on the buckle end of the belt as you pull up on the shoulder belt.

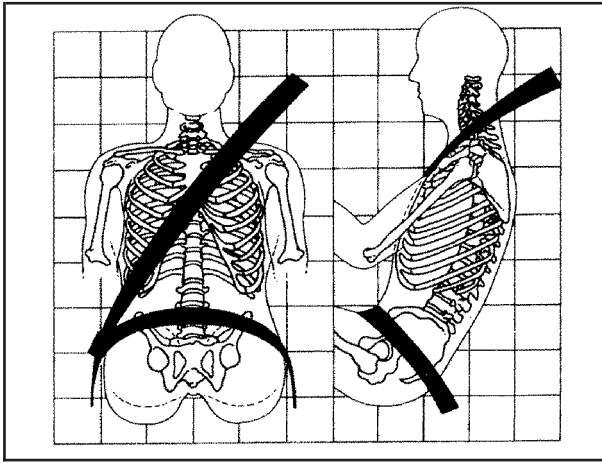

The lap part of the belt should be worn low and snug on the hips, just touching the thighs. In a crash, this applies force to the strong pelvic bones. And you would be less likely to slide under the lap belt. If you slid under it, the belt would apply force at your abdomen. This could cause serious or even fatal injuries. The shoulder belt should go over the shoulder and across the chest. These parts of the body are best able to take belt restraining forces.

The safety belt locks if there is a sudden stop or crash, or if you pull the belt very quickly out of the retractor.

**Q:** What is wrong with this?

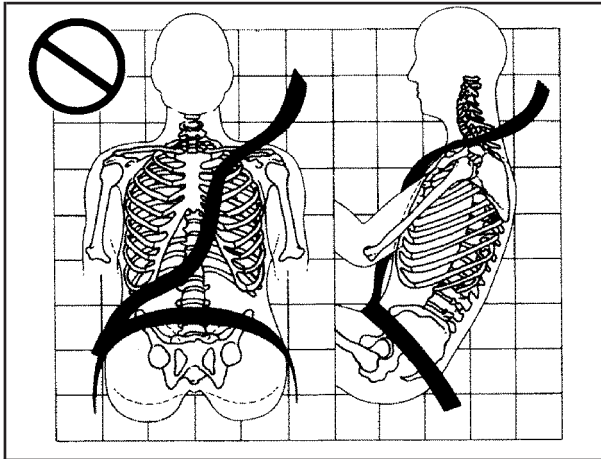

**A:** The shoulder belt is too loose. It will not give nearly as much protection this way.

**⚠ CAUTION:**

You can be seriously hurt if your shoulder belt is too loose. In a crash, you would move forward too much, which could increase injury. The shoulder belt should fit against your body.

**Q:** What is wrong with this?

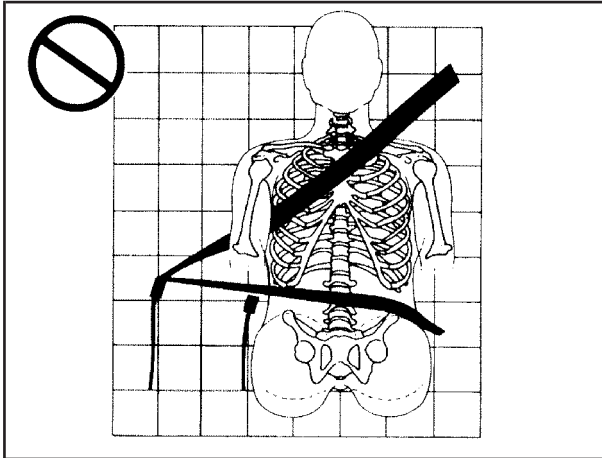

**A:** The belt is buckled in the wrong place.

**⚠ CAUTION:**

You can be seriously injured if your belt is buckled in the wrong place like this. In a crash, the belt would go up over your abdomen. The belt forces would be there, not at the pelvic bones. This could cause serious internal injuries. Always buckle your belt into the buckle nearest you.

**Q:** What is wrong with this?

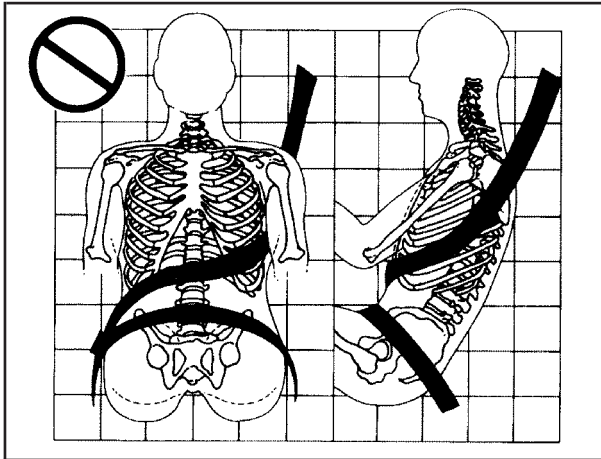

**A:** The shoulder belt is worn under the arm. It should be worn over the shoulder at all times.

**⚠ CAUTION:**

You can be seriously injured if you wear the shoulder belt under your arm. In a crash, your body would move too far forward, which would increase the chance of head and neck injury. Also, the belt would apply too much force to the ribs, which are not as strong as shoulder bones. You could also severely injure internal organs like your liver or spleen.

**Q:** What is wrong with this?

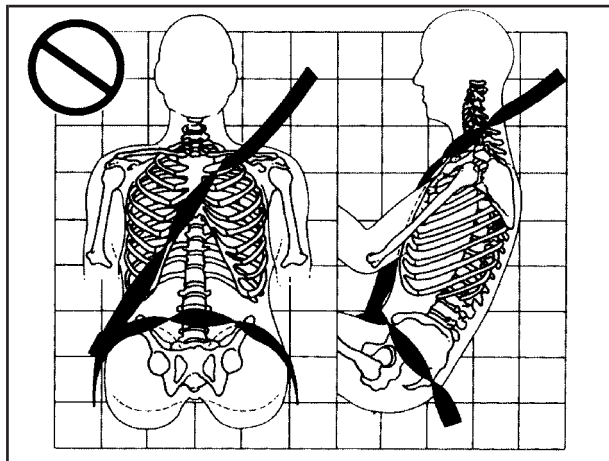

**A:** The belt is twisted across the body.

**⚠ CAUTION:**

You can be seriously injured by a twisted belt. In a crash, you would not have the full width of the belt to spread impact forces. If a belt is twisted, make it straight so it can work properly, or ask your dealer to fix it.



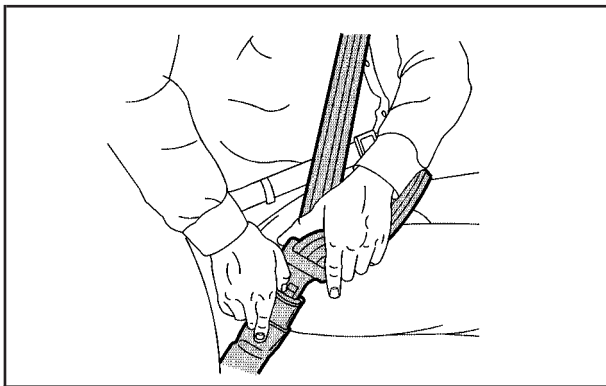

To unlatch the belt, just push the button on the buckle. The belt should go back out of the way.

Before you close the door, be sure the belt is out of the way. If you slam the door on it, you can damage both the belt and your vehicle.

## Safety Belt Use During Pregnancy

Safety belts work for everyone, including pregnant women. Like all occupants, they are more likely to be seriously injured if they do not wear safety belts.

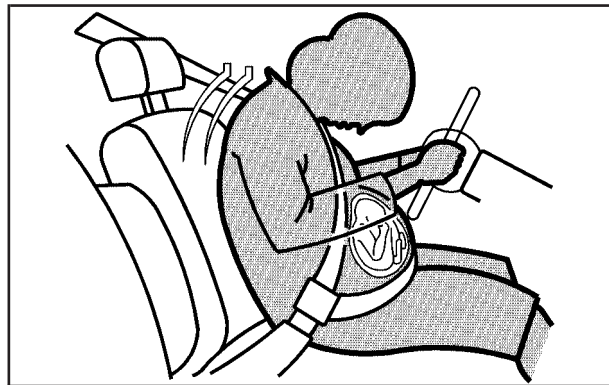

A pregnant woman should wear a lap-shoulder belt, and the lap portion should be worn as low as possible, below the rounding, throughout the pregnancy.

The best way to protect the fetus is to protect the mother. When a safety belt is worn properly, it is more likely that the fetus will not be hurt in a crash. For pregnant women, as for anyone, the key to making safety belts effective is wearing them properly.

## Passenger Position

The passenger's safety belt works the same way as the driver's safety belt. See *Driver Position on page 1-12*.

## Safety Belt Pretensioners

Your vehicle has safety belt pretensioners. They are on the buckle end of the safety belts for the driver and right front passenger. They help the safety belts reduce a person's forward movement in a moderate to severe frontal and near frontal crash.

Pretensioners work only once. If they activate in a crash, you will need to get new ones, and probably other new parts for your safety belt system. See *Replacing Restraint System Parts After a Crash on page 1-52*.

## Safety Belt Extender

If the vehicle's safety belt will fasten around you, you should use it.

But if a safety belt is not long enough, your dealer will order you an extender. It is free. When you go in to order it, take the heaviest coat you will wear, so the extender will be long enough for you. To help avoid personal injury, do not let someone else use it, and use it only for the seat it is made to fit. The extender has been designed for adults. Never use it for securing child seats. To wear it, just attach it to the regular safety belt. For more information, see the instruction sheet that comes with the extender.

# Child Restraints

## Older Children

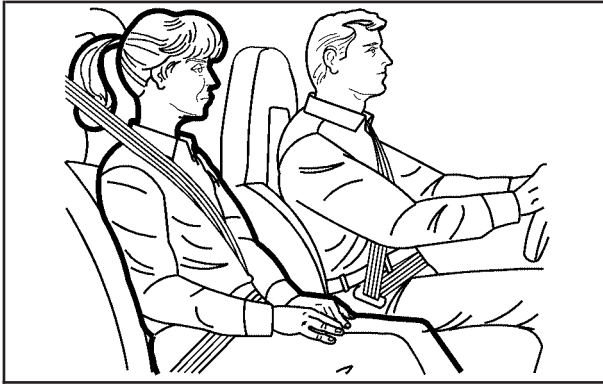

Older children who have outgrown booster seats should wear the vehicle's safety belts.

**Q:** What is the proper way to wear safety belts?

**A:** If possible, an older child should wear a lap-shoulder belt and get the additional restraint a shoulder belt can provide. The shoulder belt should not cross the face or neck. The lap belt should fit snugly below the hips, just touching the top of the thighs. It should never be worn over the abdomen, which could cause severe or even fatal internal injuries in a crash.

In a crash, children who are not buckled up can strike other people who are buckled up, or can be thrown out of the vehicle. Older children need to use safety belts properly.



**⚠ CAUTION:**

Never do this.

Here two children are wearing the same belt. The belt can not properly spread the impact forces. In a crash, the two children can be crushed together and seriously injured. A belt must be used by only one person at a time.

- Q:** What if a child is wearing a lap-shoulder belt, but the child is so small that the shoulder belt is very close to the child's face or neck?
- A:** Move the child toward the center of the vehicle, but be sure that the shoulder belt still is on the child's shoulder, so that in a crash the child's upper body would have the restraint that belts provide.



**⚠ CAUTION:**

**Never do this.**

**Here a child is sitting in a seat that has a lap-shoulder belt, but the shoulder part is behind the child. If the child wears the belt in this way, in a crash the child might slide under the belt. The belt's force would then be applied right on the child's abdomen. That could cause serious or fatal injuries.**

The lap portion of the belt should be worn low and snug on the hips, just touching the child's thighs. This applies belt force to the child's pelvic bones in a crash.

## Infants and Young Children

Everyone in a vehicle needs protection! This includes infants and all other children. Neither the distance traveled nor the age and size of the traveler changes the need, for everyone, to use safety restraints. In fact, the law in every state in the United States and in every Canadian province says children up to some age must be restrained while in a vehicle.

Every time infants and young children ride in vehicles, they should have the protection provided by appropriate restraints. Young children should not use the vehicle's adult safety belts alone, unless there is no other choice. Instead, they need to use a child restraint.

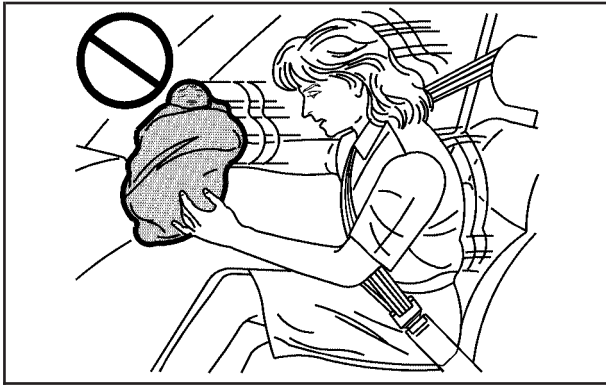

### CAUTION:

**People should never hold a baby in their arms while riding in a vehicle. A baby does not weigh much — until a crash. During a crash a baby will become so heavy it is not possible to hold it. For example, in a crash at only 25 mph (40 km/h), a 12 lb (5.5 kg) baby will suddenly become a 240 lb (110 kg) force on a person's arms. A baby should be secured in an appropriate restraint.**

 **CAUTION:**

**Children who are up against, or very close to, any airbag when it inflates can be seriously injured or killed. Airbags plus lap-shoulder belts offer protection for adults and older children, but not for young children and infants. Neither the vehicle's safety belt system nor its airbag system is designed for them. Young children and infants need the protection that a child restraint system can provide.**

**Q: What are the different types of add-on child restraints?**

**A:** Add-on child restraints, which are purchased by the vehicle's owner, are available in four basic types. Selection of a particular restraint should take into consideration not only the child's weight, height and age but also whether or not the restraint will be compatible with the motor vehicle in which it will be used.

For most basic types of child restraints, there are many different models available. When purchasing a child restraint, be sure it is designed to be used in a motor vehicle. If it is, the restraint will have a label saying that it meets federal motor vehicle safety standards.

The restraint manufacturer's instructions that come with the restraint state the weight and height limitations for a particular child restraint. In addition, there are many kinds of restraints available for children with special needs.

 **CAUTION:**

**Newborn infants need complete support, including support for the head and neck. This is necessary because a newborn infant's neck is weak and its head weighs so much compared with the rest of its body. In a crash, an infant in a rear-facing seat settles into the restraint, so the crash forces can be distributed across the strongest part of an infant's body, the back and shoulders. Infants always should be secured in appropriate infant restraints.**

 **CAUTION:**

**The body structure of a young child is quite unlike that of an adult or older child, for whom the safety belts are designed. A young child's hip bones are still so small that the vehicle's regular safety belt may not remain low on the hip bones, as it should. Instead, it may settle up around the child's abdomen. In a crash, the belt would apply force on a body area that is unprotected by any bony structure. This alone could cause serious or fatal injuries. Young children always should be secured in appropriate child restraints.**



## Child Restraint Systems

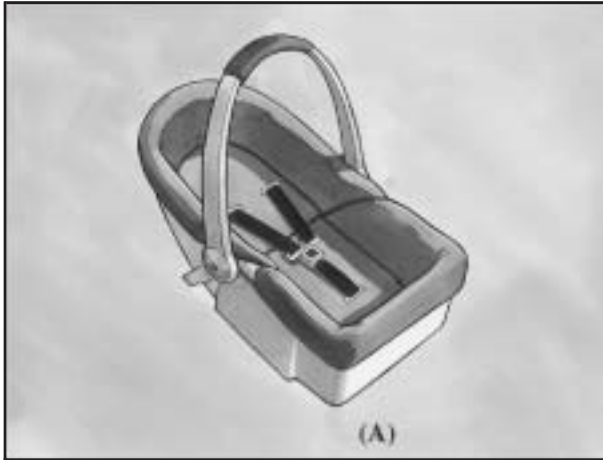

An infant car bed (A), a special bed made for use in a motor vehicle, is an infant restraint system designed to restrain or position a child on a continuous flat surface. Make sure that the infant's head rests toward the center of the vehicle.

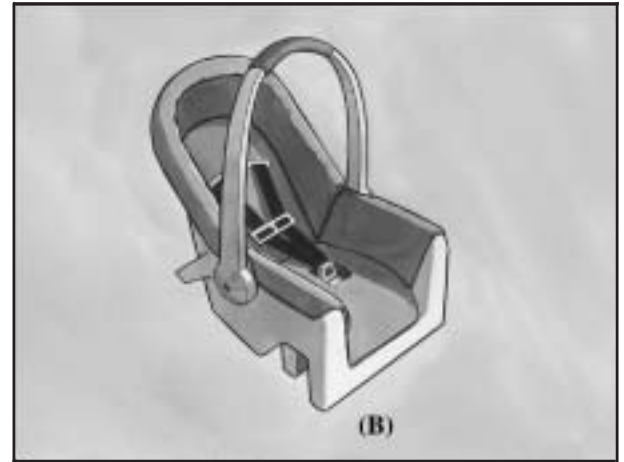

A rear-facing infant seat (B) provides restraint with the seating surface against the back of the infant. The harness system holds the infant in place and, in a crash, acts to keep the infant positioned in the restraint.

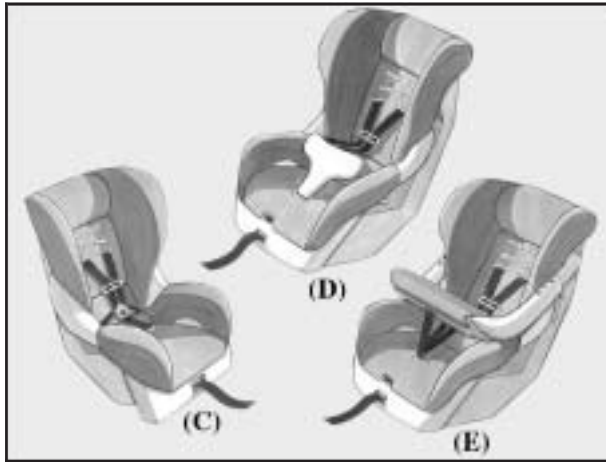

A forward-facing child seat (C-E) provides restraint for the child's body with the harness and also sometimes with surfaces such as T-shaped or shelf-like shields.

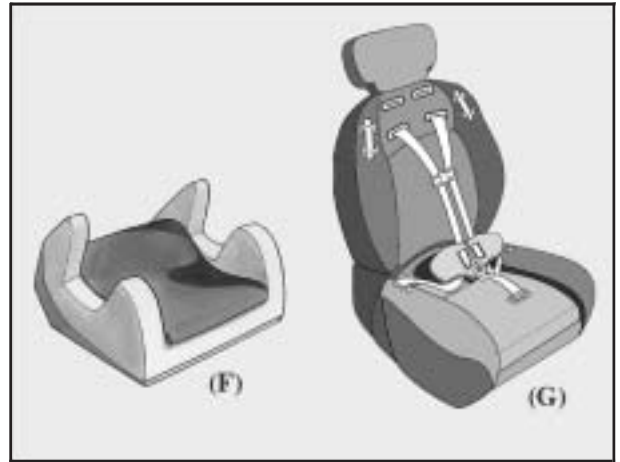

A booster seat (F-G) is a child restraint designed to improve the fit of the vehicle's safety belt system. Some booster seats have a shoulder belt positioner, and some high-back booster seats have a five-point harness. A booster seat can also help a child to see out the window.

**Q: How do child restraints work?**

**A:** A child restraint system is any device designed for use in a motor vehicle to restrain, seat, or position children. A built-in child restraint system is a permanent part of the motor vehicle. An add-on child restraint system is a portable one, which is purchased by the vehicle's owner.

For many years, add-on child restraints have used the adult belt system in the vehicle. To help reduce the chance of injury, the child also has to be secured within the restraint. The vehicle's belt system secures the add-on child restraint in the vehicle, and the add-on child restraint's harness system holds the child in place within the restraint.

One system, the three-point harness, has straps that come down over each of the infant's shoulders and buckle together at the crotch. The five-point harness system has two shoulder straps, two hip straps and a crotch strap. A shield may take the place of hip straps. A T-shaped shield has shoulder straps that are attached to a flat pad which rests low against the child's body. A shelf- or armrest-type shield has straps that are attached to a wide, shelf-like shield that swings up or to the side.

When choosing a child restraint, be sure the child restraint is designed to be used in a vehicle. If it is, it will have a label saying that it meets federal motor vehicle safety standards.

Then follow the instructions for the restraint. You may find these instructions on the restraint itself or in a booklet, or both. These restraints use the belt system in your vehicle, but the child also has to be secured within the restraint to help reduce the chance of personal injury. When securing an add-on child restraint, refer to the instructions that come with the restraint which may be on the restraint itself or in a booklet, or both, and to this manual. The child restraint instructions are important, so if they are not available, obtain a replacement copy from the manufacturer.

The child restraint must be secured properly in the passenger seat. If you want to secure a rear-facing child restraint in the passenger's seat, turn off the passenger's airbag. See *Airbag Off Switch on page 1-48* and *Securing a Child Restraint in the Passenger Seat Position on page 1-35* for more on this, including important safety information.

 **CAUTION:**

**A child in a rear-facing child restraint can be seriously injured or killed if the passenger's airbag inflates. This is because the back of the rear-facing child restraint would be very close to the inflating airbag. Be sure to turn off the airbag before using a rear-facing child restraint in the passenger seat position.**

Keep in mind that an unsecured child restraint can move around in a collision or sudden stop and injure people in the vehicle. Be sure to properly secure any child restraint in your vehicle – even when no child is in it.

## Top Strap

Some child restraints have a top strap, or “top tether,” which can help hold the child restraint during a crash. For it to work, a top strap must be properly anchored to the vehicle. Some child restraints with a top strap are designed to be used whether or not the top strap is anchored. Others require that the top strap be anchored. Also, a national or local law may require that the top strap be anchored.

If your child restraint top strap must be anchored, then do not use the restraint in this vehicle, because in it, a top strap cannot be properly anchored.

## Lower Anchorages and Top Tethers for Children (LATCH System)

Your vehicle has the LATCH system. You will find anchors for the passenger seat. This system, designed to make installation of child restraints easier, does not use the vehicle's safety belts. Instead, it uses vehicle anchors and child restraint attachments to secure the restraints. Some restraints also use another vehicle anchor to secure a top tether strap.

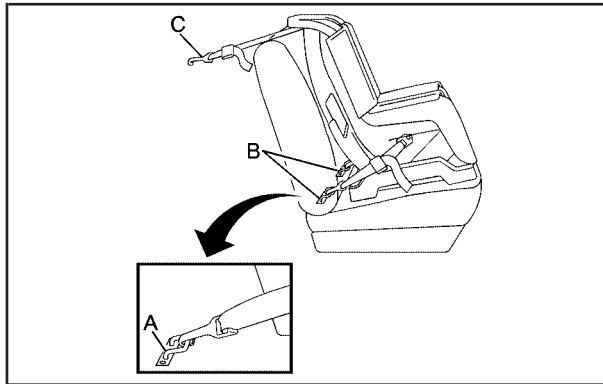

- A. Lower Anchorage
- B. Lower Anchorage
- C. Top Tether

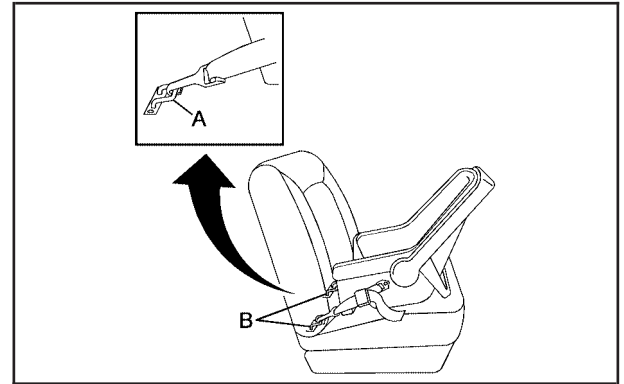

- A. Lower Anchorage
- B. Lower Anchorage

In order to use the LATCH system in your vehicle, you need a child restraint designed for that system.

To assist you in locating the lower anchors for this child restraint system, each seating position with the LATCH system has a label on the seatback at each lower anchor position.



The labels are located near the base of the passenger seat.

### CAUTION:

If a LATCH-type child restraint is not attached to its anchorage points, the restraint will not be able to protect the child correctly. In a crash, the child could be seriously injured or killed. Make sure that a LATCH-type child restraint is properly installed using the anchorage points, or use the vehicle's safety belts to secure the restraint, following the instructions that came with that restraint, and also the instructions in this manual.

## Securing a Child Restraint Designed for the LATCH System

Your vehicle has airbags. There is an airbag off switch in the glove box you can use to turn off the passenger's frontal airbag and side impact airbag (if equipped). See *Airbag Off Switch* on page 1-48 for more on this including important safety information.

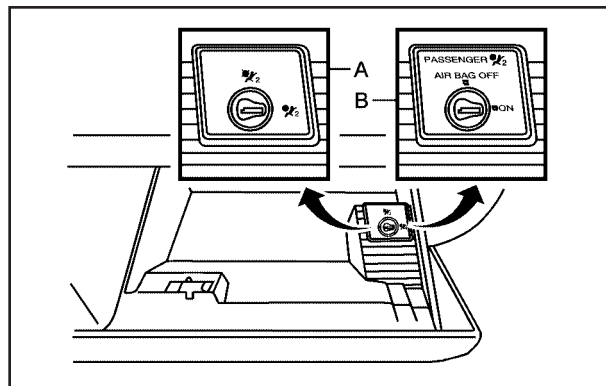

- A. Canadian Switch
- B. United States Switch

Unless the passenger's airbag or airbags have been turned off, *never* put a rear-facing child restraint in this vehicle. Here is why:

 **CAUTION:**

A child in a rear-facing child restraint can be seriously injured or killed if the passenger's airbag inflates. This is because the back of the rear-facing child restraint would be very close to the inflating airbag. Do not use a rear-facing child restraint in this vehicle unless the passenger's frontal airbag and side impact airbag (if equipped) have been turned off.

**CAUTION: (Continued)**

**CAUTION: (Continued)**

Even though the airbag off switch is designed to turn off the passenger's frontal airbag and side impact airbag (if equipped), no system is fail-safe, and no one can guarantee that an airbag will not deploy under some unusual circumstance, even though it is turned off. We recommend that rear-facing child restraints be transported in vehicles with a rear seat that will accommodate a rear-facing child restraint, whenever possible.

If you need to secure a forward-facing child restraint in the passenger seat, always move the passenger seat as far back as it will go.

 **CAUTION:**

**If the airbag readiness light ever comes on when you have turned off the passenger's frontal airbag and side impact airbag (if equipped), it means that something may be wrong with the airbag system. The passenger's frontal airbag and side impact airbag (if equipped) could inflate even though the switch is off. If this ever happens, do not let anyone whom the national government has identified as a member of a passenger airbag risk group sit in the passenger's position (for example, do not secure a rear-facing child restraint in your vehicle) until you have your vehicle serviced. See *Airbag Off Switch on page 1-48*.**

There are no top strap anchors in your vehicle. Do not secure a child seat in your vehicle if a national or local law requires that the top strap be anchored, or if the instructions that come with the restraint say that the top strap must be anchored.

1. Your vehicle has airbags. See *Airbag Off Switch on page 1-48*. If your child restraint is forward-facing, always move the seat as far back as it will go before securing it in this seat. See *Manual Seats on page 1-2* or *Six-Way Power Seats on page 1-2*. Never use a rear-facing child restraint in this seat unless the airbag is off.
2. Find the LATCH anchorages in the passenger seat. See *Lower Anchorages and Top Tethers for Children (LATCH System) on page 1-31*.
3. Put the child restraint on the seat.
4. Attach and tighten the LATCH attachments on the child restraint to the LATCH anchorages in the vehicle. The child restraint instructions will show you how. See *Top Strap on page 1-30* if your child restraint has one.
5. Push and pull the child restraint in different directions to be sure it is secure.

To remove the child restraint, simply unhook the top tether from the top tether anchorage and then disconnect the LATCH anchorages.



Turn on the passenger's airbag or airbags when you remove the child restraint from the vehicle unless the person who will be sitting there is a member of a passenger airbag risk group. See *Airbag Off Switch on page 1-48*.

**⚠ CAUTION:**

If the passenger's frontal airbag and side impact airbag (if equipped) are turned off for a person who is not in a risk group identified by the national government, that person will not have the extra protection of an airbag. In a crash, an airbag will not be able to inflate and help protect the person sitting there. Do not turn off the passenger's frontal airbag and side impact airbag (if equipped) unless the person sitting there is in a risk group. See *Airbag Off Switch on page 1-48* for more on this, including important safety information.

## Securing a Child Restraint in the Passenger Seat Position

Your vehicle has airbags. There is an airbag off switch in the glove box you can use to turn off the passenger's frontal airbag and side impact airbag (if equipped). See *Airbag Off Switch on page 1-48* for more on this including important safety information.

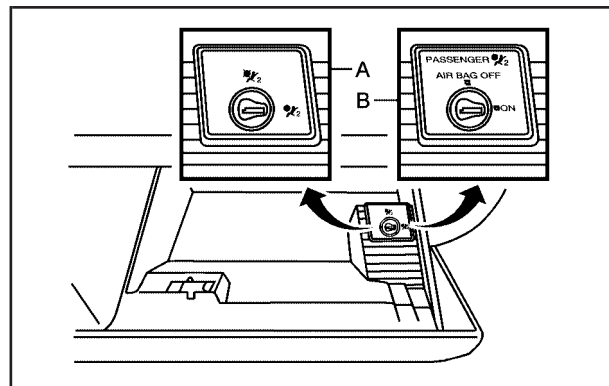

- A. Canadian Switch
- B. United States Switch

Unless the passenger's airbag or airbags have been turned off, *never* put a rear-facing child restraint in this vehicle. Here is why:

 **CAUTION:**

A child in a rear-facing child restraint can be seriously injured or killed if the passenger's airbag inflates. This is because the back of the rear-facing child restraint would be very close to the inflating airbag. Do not use a rear-facing child restraint in this vehicle unless the passenger's frontal airbag and side impact airbag (if equipped) have been turned off.

**CAUTION: (Continued)**

**CAUTION: (Continued)**

Even though the airbag off switch is designed to turn off the passenger's frontal airbag and side impact airbag (if equipped), no system is fail-safe, and no one can guarantee that an airbag will not deploy under some unusual circumstance, even though it is turned off. We recommend that rear-facing child restraints be transported in vehicles with a rear seat that will accommodate a rear-facing child restraint, whenever possible.

If you need to secure a forward-facing child restraint in the passenger seat, always move the passenger seat as far back as it will go.

 **CAUTION:**

**If the airbag readiness light ever comes on when you have turned off the passenger's frontal airbag and side impact airbag (if equipped), it means that something may be wrong with the airbag system. The passenger's frontal airbag and side impact airbag (if equipped) could inflate even though the switch is off. If this ever happens, do not let anyone whom the national government has identified as a member of a passenger airbag risk group sit in the passenger's position (for example, do not secure a rear-facing child restraint in your vehicle) until you have your vehicle serviced. See *Airbag Off Switch* on page 1-48.**

If your child restraint is equipped with the LATCH system, see *Lower Anchorages and Top Tethers for Children (LATCH System)* on page 1-31. See *Top Strap* on page 1-30 if the child restraint has one.

There are no top strap anchors in your vehicle. Do not secure a child seat in your vehicle if a national or local law requires that the top strap be anchored, or if the instructions that come with the restraint say that the top strap must be anchored.

If your child restraint does not have the LATCH system you will be using the lap-shoulder belt to secure the child restraint in this position. Be sure to follow the instructions that came with the child restraint. Secure the child in the child restraint when and as the instructions say.

1. Your vehicle has airbags. See *Airbag Off Switch* on page 1-48. If your child restraint is forward-facing, always move the seat as far back as it will go before securing it in this seat. See *Manual Seats* on page 1-2 or *Six-Way Power Seats* on page 1-2. Never use a rear-facing child restraint in this seat unless the airbag is off.
2. Put the child restraint on the seat.
3. Pick up the latch plate, and run the lap and shoulder portions of the vehicle's safety belt through or around the restraint. The child restraint instructions will show you how.

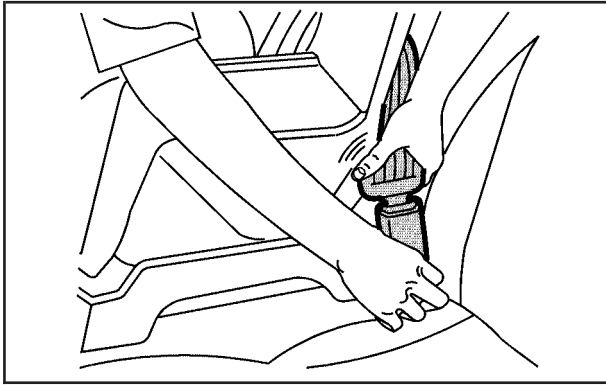

4. Buckle the belt. Make sure the release button is positioned so you would be able to unbuckle the safety belt quickly if you ever had to.

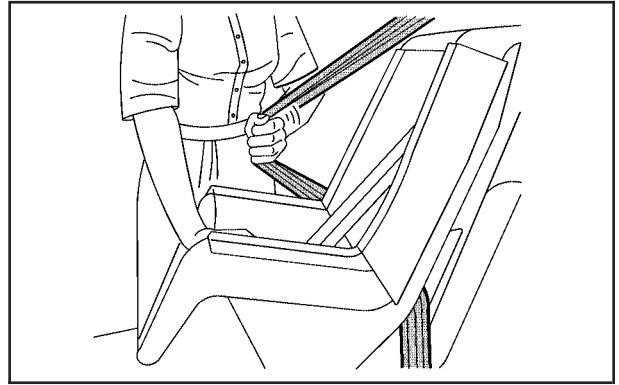

5. Pull the rest of the shoulder belt all the way out of the retractor to set the lock.

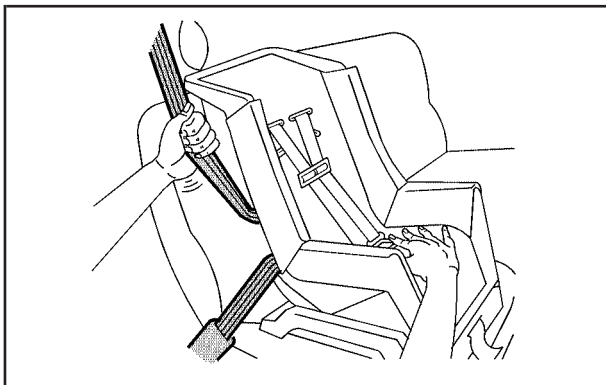

6. To tighten the belt, push down on the child restraint, pull the shoulder portion of the belt to tighten the lap portion of the belt and feed the shoulder belt back into the retractor. You may find it helpful to use your knee to push down on the child restraint as you tighten the belt.
7. Push and pull the child restraint in different directions to be sure it is secure.

To remove the child restraint, just unbuckle the vehicle's safety belt and let it go back all the way. The safety belt will move freely again and be ready to work for an adult or larger child passenger.

Turn on the passenger's airbag or airbags when you remove the child restraint from the vehicle unless the person who will be sitting there is a member of a passenger airbag risk group. See *Airbag Off Switch on page 1-48*.

**⚠ CAUTION:**

**If the passenger's frontal airbag and side impact airbag (if equipped) are turned off for a person who is not in a risk group identified by the national government, that person will not have the extra protection of an airbag. In a crash, an airbag will not be able to inflate and help protect the person sitting there. Do not turn off the passenger's frontal airbag and side impact airbag (if equipped) unless the person sitting there is in a risk group. See *Airbag Off Switch on page 1-48* for more on this, including important safety information.**

## Airbag System

Your vehicle has a frontal airbag for the driver, another frontal airbag for the passenger. Your vehicle may also have a side impact airbag for the driver, and another side impact airbag for the passenger.

Frontal airbags are designed to help reduce the risk of injury from the force of an inflating frontal airbag. But these airbags must inflate very quickly to do their job and comply with federal regulations.

Here are the most important things to know about the airbag system:

### CAUTION:

**You can be severely injured or killed in a crash if you are not wearing your safety belt — even if you have airbags. Wearing your safety belt during a crash helps reduce your chance of hitting things inside the vehicle or being ejected from it. Airbags are designed to work with safety belts but do not replace them.**

**CAUTION: (Continued)**

### **CAUTION: (Continued)**

**Frontal airbags for the driver and right front passenger are designed to deploy only in moderate to severe frontal and near frontal crashes. They are not designed to inflate in rollover, rear or low-speed frontal crashes, or in many side crashes. And, for some unrestrained occupants, frontal airbags may provide less protection in frontal crashes than more forceful airbags have provided in the past.**

**Side impact airbags for the driver and right front passenger are designed to inflate only in moderate to severe crashes where something hits the side of your vehicle. They are not designed to inflate in frontal, in rollover or in rear crashes.**

**Everyone in your vehicle should wear a safety belt properly — whether or not there is an airbag for that person.**

 **CAUTION:**

Both frontal and side impact airbags inflate with great force, faster than the blink of an eye. If you are too close to an inflating airbag, as you would be if you were leaning forward, it could seriously injure you. Safety belts help keep you in position for airbag inflation before and during a crash. Always wear your safety belt, even with frontal airbags. The driver should sit as far back as possible while still maintaining control of the vehicle. Front occupants should not lean on or sleep against the door.

 **CAUTION:**

Anyone who is up against, or very close to, any airbag when it inflates can be seriously injured or killed. Airbags plus lap-shoulder belts offer the best protection for adults, but not for young children and infants. Neither the vehicle's safety belt system nor its airbag system is designed for them. Young children and infants need the protection that a child restraint system can provide. Always secure children properly in your vehicle. To read how, see *Older Children on page 1-21* and *Infants and Young Children on page 1-24*.



There is an airbag readiness light on the instrument panel cluster, which shows the airbag symbol.

The system checks the airbag electrical system for malfunctions. The light tells you if there is an electrical problem. See *Airbag Readiness Light* on page 3-34 for more information.

## Where Are the Airbags?



The driver's frontal airbag is in the middle of the steering wheel.





The passenger's frontal airbag is in the instrument panel on the passenger's side.

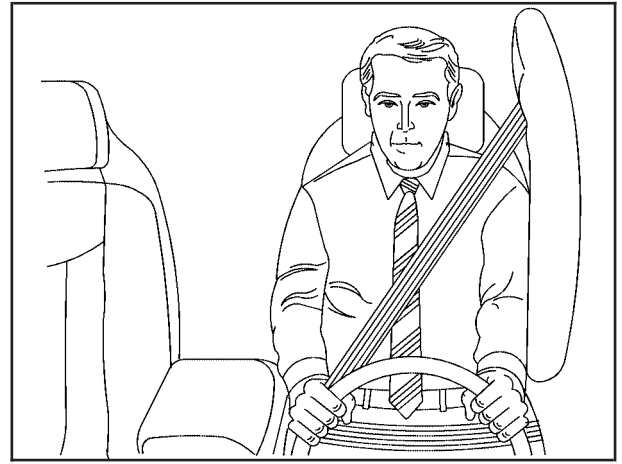

If your vehicle has a side impact airbag for the driver, it is in the side of the driver's seatback closest to the door.



If your vehicle has a side impact airbag for the right front passenger, it is in the side of the passenger's seatback closest to the door.

**⚠ CAUTION:**

If something is between an occupant and an airbag, the airbag might not inflate properly or it might force the object into that person causing severe injury or even death. The path of an inflating airbag must be kept clear. Do not put anything between an occupant and an airbag, and do not attach or put anything on the steering wheel hub or on or near any other airbag covering. Do not let seat covers block the inflation path of a side impact airbag.

## When Should an Airbag Inflate?

The driver's and passenger's frontal airbags are designed to inflate in moderate to severe frontal or near-frontal crashes. But they are designed to inflate only if the impact exceeds a predetermined deployment threshold. Deployment thresholds take into account a variety of desired deployment and non-deployment events and are used to predict how severe a crash is likely to be in time for the airbags to inflate and help restrain the occupants. Whether your frontal airbags will or should deploy is not based on how fast your vehicle is traveling. It depends largely on what you hit, the direction of the impact and how quickly your vehicle slows down.

If your vehicle goes straight into a wall that does not move or deform, the threshold level is about 9 to 15 mph (14 to 24 km/h). (The threshold level can vary, however, with specific vehicle design, so that it can be somewhat above or below this range.)

Airbags may inflate at different crash speeds. For example:

- If the vehicle hits a stationary object, the airbag could inflate at a different crash speed than if the object were moving.
- If the object deforms, the airbag could inflate at a different crash speed than if the object does not deform.

- If the vehicle hits a narrow object (like a pole) the airbag could inflate at a different crash speed than if the vehicle hits a wide object (like a wall).
- If the vehicle goes into an object at an angle the airbag could inflate at a different crash speed than if the vehicle goes straight into the object.

The frontal airbags (driver and passenger) are not intended to inflate during vehicle rollovers, rear impacts, or in many side impacts because inflation would not likely help the occupants.

Side impact airbags are designed to inflate in moderate to severe side crashes. A side impact airbag will inflate if the crash severity is above the system's designed "threshold level." The threshold level can vary with specific vehicle design. Side impact airbags are not designed to inflate in frontal or near-frontal impacts, rollovers or rear impacts, because inflation would not likely help the occupant. A side impact airbag will only deploy on the side of the vehicle that is struck.

In any particular crash, no one can say whether an airbag should have inflated simply because of the damage to a vehicle or because of what the repair costs were. For frontal airbags, inflation is determined by the angle of the impact and how quickly the vehicle slows down in frontal and near-frontal impacts. For side impact airbags, inflation is determined by the location and severity of the impact.

## What Makes an Airbag Inflate?

In an impact of sufficient severity, the airbag sensing system detects that the vehicle is in a crash. For both frontal and side impact airbags, the sensing system triggers a release of gas from the inflator, which inflates the airbag. The inflator, the airbag and related hardware are all part of the airbag modules inside the steering wheel, the instrument panel, and the side of the front seatbacks closest to the door.

## How Does an Airbag Restrain?

In moderate to severe frontal or near frontal collisions, even belted occupants can contact the steering wheel or the instrument panel. In moderate to severe side collisions, even belted occupants can contact the inside of the vehicle. Airbags supplement the protection provided by safety belts. Airbags distribute the force of the impact more evenly over the occupant's upper body, stopping the occupant more gradually. But a frontal airbag would not help you in many types of collisions, including rollovers, rear impacts, and many side impacts, primarily because an occupant's motion is not toward a frontal airbag. A side impact airbag would not help you in many types of collisions, including frontal or near frontal collisions, rollovers, and rear impacts, primarily because

an occupant's motion is not toward a side airbag. Airbags should never be regarded as anything more than a supplement to safety belts, and then only in moderate to severe frontal or near-frontal collisions for frontal airbags, and only in moderate to severe side collisions for side impact airbags.

## What Will You See After an Airbag Inflates?

After the airbag inflates, it quickly deflates, so quickly that some people may not even realize the airbag inflated. Some components of the airbag module will be hot for a short time. These components include the steering wheel hub for the driver's frontal airbag and the instrument panel for the passenger's frontal airbag. For vehicles with side impact airbags, the side of the seatback closest to the driver's and/or passenger's door will be hot. The parts of the bag that come into contact with you may be warm, but not too hot to touch. There will be some smoke and dust coming from the vents in the deflated airbags. Airbag inflation does not prevent the driver from seeing or being able to steer the vehicle, nor does it stop people from leaving the vehicle.

 **CAUTION:**

**When an airbag inflates, there is dust in the air. This dust could cause breathing problems for people with a history of asthma or other breathing trouble. To avoid this, everyone in the vehicle should get out as soon as it is safe to do so. If you have breathing problems but can not get out of the vehicle after an airbag inflates, then get fresh air by opening a window or a door. If you experience breathing problems following an airbag deployment, you should seek medical attention.**

In many crashes severe enough to inflate an airbag, windshields are broken by vehicle deformation. Additional windshield breakage may also occur from the passenger's airbag.

- Airbags are designed to inflate only once. After an airbag inflates, you will need some new parts for your airbag system. If you do not get them, the airbag system will not be there to help protect you in another crash. A new system will include airbag modules and possibly other parts. The service manual for your vehicle covers the need to replace other parts.
- Your vehicle is equipped with a crash sensing and diagnostic module which records information after a crash. See *Vehicle Data Collection and Event Data Recorders* on page 7-9.
- Let only qualified technicians work on your airbag system. Improper service can mean that an airbag system will not work properly. See your dealer for service.

**Notice:** If you damage the covering for the driver's or the passenger's airbag, or the airbag covering on the driver's and passenger's seatback, the airbag may not work properly. You may have to replace the airbag module in the steering wheel, both the airbag module and the instrument panel for the passenger's airbag, or both the airbag module and seatback for the driver's and passenger's side impact airbag. Do not open or break the airbag coverings.

## Airbag Off Switch

Your vehicle has a switch in the glove box that you can use to turn off the passenger's frontal airbag and side impact airbag (if equipped).

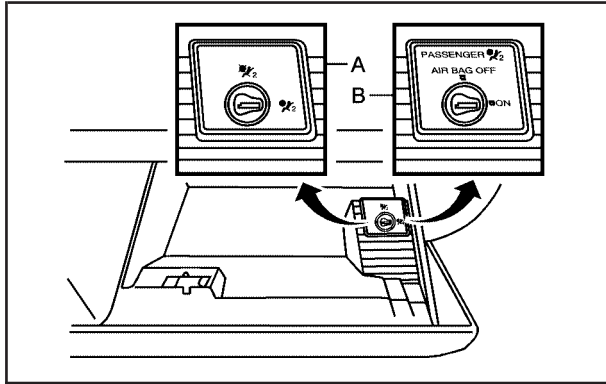

- A. Canadian Switch
- B. United States Switch

This switch should only be turned to the off position if the person in the passenger's position is a member of a passenger risk group identified by the national government as follows:

**Infant.** *An infant (less than 1 year old) must ride in the front seat because:*

- *my vehicle has no rear seat;*
- *my vehicle has a rear seat too small to accommodate a rear-facing infant seat; or*
- *the infant has a medical condition which, according to the infant's physician, makes it necessary for the infant to ride in the front seat so that the driver can constantly monitor the child's condition.*

**Child age 1 to 12.** *A child age 1 to 12 must ride in the front seat because:*

- *my vehicle has no rear seat;*
- *although children ages 1 to 12 ride in the rear seat(s) whenever possible, children ages 1 to 12 sometimes must ride in the front because no space is available in the rear seat(s) of my vehicle; or*
- *the child has a medical condition which, according to the child's physician, makes it necessary for the child to ride in the front seat so that the driver can constantly monitor the child's condition.*

**Medical Condition.** A passenger has a medical condition which, according to his or her physician:

- causes the passenger airbag to pose a special risk for the passenger; and
- makes the potential harm from the passenger airbag in a crash greater than the potential harm from turning off the airbag and allowing the passenger, even if belted, to hit the dashboard or windshield in a crash.

**⚠ CAUTION:**

If the passenger's frontal airbag and side impact airbag (if equipped) are turned off for a person who is not in a risk group identified by the national government, that person will not have the extra protection of an airbag. In a crash, an airbag will not be able to inflate and help protect the person sitting there. Do not turn off the passenger's frontal airbag and side impact airbag (if equipped) unless the person sitting there is in a risk group.



United States

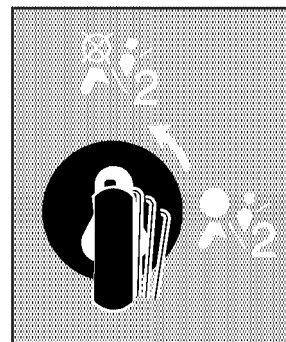

Canada

To turn off the passenger's airbag or airbags, insert your vehicle key into the switch, push in, and move the switch to the off position.

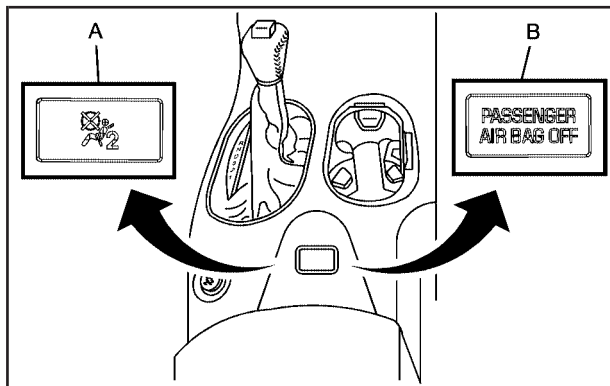

A. Canadian Light

B. United States Light

The airbag off light on the center console will light to let you know that the passenger's airbag or airbags are off. The light will stay lit to remind you that the airbag or airbags are off. The passenger's airbag or airbags will remain off until you turn the switch to the on position.



**United States**

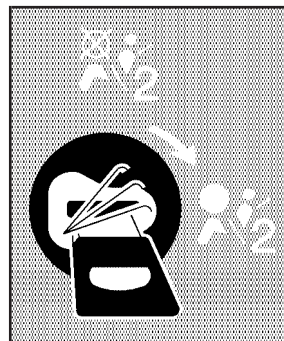

**Canada**

To turn the passenger's airbag or airbags back on, insert your vehicle key into the switch, push in, and move the switch to the on position.



## Servicing Your Airbag-Equipped Vehicle

Airbags affect how your vehicle should be serviced. There are parts of the airbag system in several places around your vehicle. You do not want the system to inflate while someone is working on your vehicle. Your dealer and the service manual have information about servicing your vehicle and the airbag system. To purchase a service manual, see *Service Publications Ordering Information on page 7-11*.

### **CAUTION:**

**For up to 10 seconds after the vehicle is turned off and the battery is disconnected, an airbag can still inflate during improper service. You can be injured if you are close to an airbag when it inflates. Avoid yellow wires, wires wrapped with yellow tape or yellow connectors. They are probably part of the airbag system. Be sure to follow proper service procedures, and make sure the person performing work for you is qualified to do so.**

The airbag system does not need regular maintenance.

## Restraint System Check

### Checking Your Restraint Systems

Now and then, make sure the safety belt reminder light and all your belts, buckles, latch plates, retractors and anchorages are working properly. Look for any other loose or damaged safety belt system parts. If you see anything that might keep a safety belt system from doing its job, have it repaired.

Torn or frayed safety belts may not protect you in a crash. They can rip apart under impact forces. If a belt is torn or frayed, get a new one right away.

Also look for any opened or broken airbag covers, and have them repaired or replaced. (The airbag system does not need regular maintenance.)

## Replacing Restraint System Parts After a Crash

### CAUTION:

**A crash can damage the restraint systems in your vehicle. A damaged restraint system may not properly protect the person using it, resulting in serious injury or even death in a crash. To help make sure your restraint systems are working properly after a crash, have them inspected and any necessary replacements made as soon as possible.**

If you have had a crash, do you need new belts or LATCH system parts?

After a very minor collision, nothing may be necessary. But if the belts were stretched, as they would be if worn during a more severe crash, then you need new parts.

If the LATCH system was being used during a more severe crash, you may need new LATCH system parts.

If belts are cut or damaged, replace them. Collision damage also may mean you will need to have LATCH system, safety belt or seat parts repaired or replaced. New parts and repairs may be necessary even if the belt or LATCH system was not being used at the time of the collision.

If an airbag inflates, you will need to replace airbag system parts. See the part on the airbag system earlier in this section.

If the frontal airbags inflate, you will also need to replace the driver's and right front passenger's safety belt buckle assembly. Be sure to do so. Then the new buckle assembly will be there to help protect you in a collision.

After a crash you may need to replace the driver and front passenger's safety belt buckle assemblies, even if the frontal airbags have not deployed. The driver and front passenger's safety belt buckle assemblies contain the safety belt pretensioners. Have your safety belt pretensioners checked if your vehicle has been in a collision, or if your airbag readiness light stays on after you start your vehicle or while you are driving. See *Airbag Readiness Light* on page 3-34.

## Section 2 Features and Controls

---

<b>Keys</b> .....	2-3	Engine Coolant Heater .....	2-23
Keyless Access System .....	2-4	Automatic Transmission Operation .....	2-24
Keyless Access System Operation .....	2-5	Manual Transmission Operation .....	2-26
<b>Doors and Locks</b> .....	2-10	Parking Brake .....	2-29
Door Locks .....	2-10	Shifting Into Park (P) (Automatic Transmission) ...	2-29
Power Door Locks .....	2-12	Shifting Out of Park (P) (Automatic Transmission) .....	2-31
Automatic Door Locks .....	2-13	Parking Your Vehicle (Manual Transmission) ....	2-31
Programmable Automatic Door Unlock .....	2-13	Parking Over Things That Burn .....	2-32
Lockout Protection .....	2-13	Engine Exhaust .....	2-32
Hatch/Trunk .....	2-14	Running Your Engine While You Are Parked (Automatic Transmission) .....	2-33
<b>Windows</b> .....	2-16	<b>Mirrors</b> .....	2-34
Power Windows .....	2-17	Manual Rearview Mirror .....	2-34
Sun Visors .....	2-18	Automatic Dimming Rearview Mirror with OnStar <sup>®</sup> and Compass .....	2-34
<b>Theft-Deterrent Systems</b> .....	2-18	Automatic Dimming Rearview Mirror with Compass .....	2-36
Theft-Deterrent System .....	2-18	Outside Power Heated Mirrors .....	2-38
<b>Starting and Operating Your Vehicle</b> .....	2-19	Outside Automatic Dimming Mirror .....	2-39
New Vehicle Break-In .....	2-19	Outside Convex Mirror .....	2-39
Front Air Dam .....	2-20	<b>OnStar<sup>®</sup> System</b> .....	2-40
Ignition Positions .....	2-20		
Retained Accessory Power (RAP) .....	2-21		
Starting Your Engine .....	2-21		
Racing or Other Competitive Driving .....	2-22		

## Section 2 Features and Controls

---

<b>HomeLink® Transmitter</b> .....	2-41	<b>Roof Panel</b> .....	2-50
Programming the HomeLink® Transmitter .....	2-42	Removing the Roof Panel .....	2-50
<b>Storage Areas</b> .....	2-46	Storing the Roof Panel .....	2-53
Glove Box .....	2-46	Installing the Roof Panel .....	2-54
Cupholder(s) .....	2-46	<b>Convertible Top</b> .....	2-55
Center Console Storage Area .....	2-46	Convertible Top (Manual) .....	2-55
Floor Mats .....	2-46	Convertible Top (Power) .....	2-62
Rear Storage Area .....	2-47	<b>Vehicle Personalization</b> .....	2-66
Convenience Net .....	2-49	Memory .....	2-66
Cargo Cover .....	2-49		

## Keys

### CAUTION:

Leaving children unattended in a vehicle is dangerous, but it is even more dangerous if the keyless access transmitter is also left in the vehicle. A child or others could be badly injured or even killed.

They could operate the power windows or other controls or even make the vehicle move.

Do not leave the keyless access transmitter in a vehicle with children.



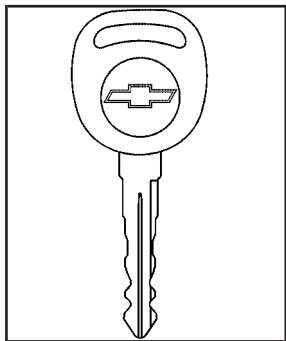

There is a key that works the glove box, the center console and can open the hatch/trunk lid if vehicle power is lost. See *Hatch/Trunk* on page 2-14 for more information.

This key can also be used to turn on/off the passenger's airbags. See *Airbag Off Switch* on page 1-48.

Your vehicle has a keyless access system with pushbutton start. See *Ignition Positions* on page 2-20 for information on starting the vehicle.

**Notice:** Your vehicle has a number of features that can help prevent theft. You can have a lot of trouble getting into your vehicle if you ever lose your transmitters and/or key. You may even have to damage your vehicle to get in. So be sure you have a spare transmitter and/or key.

In an emergency, contact Chevrolet Roadside Assistance. See *Roadside Assistance Program* on page 7-6.

## Keyless Access System

Your vehicle has a Keyless Access System that operates on a radio frequency subject to Federal Communications Commission (FCC) Rules and with Industry Canada.

This device complies with Part 15 of the FCC Rules. Operation is subject to the following two conditions: (1) this device may not cause harmful interference, and (2) this device must accept any interference received, including interference that may cause undesired operation.

This device complies with RSS-210 of Industry Canada. Operation is subject to the following two conditions: (1) this device may not cause interference, and (2) this device must accept any interference received, including interference that may cause undesired operation of the device.

Changes or modifications to this system by other than an authorized service facility could void authorization to use this equipment.

If you ever notice a decrease in the remote keyless entry transmitter range, try doing one of the following:

- Check the distance. You may be too far from your vehicle. You may need to stand closer during rainy or snowy weather.
- Check the location. Other vehicles or objects may be blocking the signal. Take a few steps to the left or right, hold the transmitter higher, and try again.
- Check to determine if battery replacement is necessary. See “Battery Replacement” under *Keyless Access System Operation on page 2-5*.
- Check to make sure that an electronic device such as a cellular phone or lap top computer is not causing interference.
- If you’re still having trouble, see your dealer or a qualified technician for service.

## Keyless Access System Operation

Your vehicle has a keyless access system that allows you to lock and unlock your doors, unlock your hatch/trunk lid and disarm or arm your theft-deterrent system. The range distance is as much as 100 feet (30 m) away.

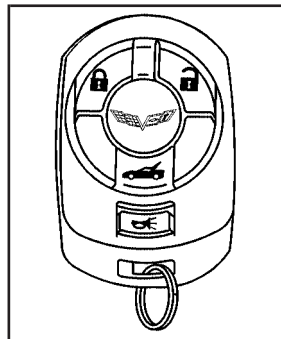



Your vehicle comes standard with two transmitters, and up to four can be matched to your vehicle. See “Matching Transmitter(s) to Your Vehicle” later in this section.

 **(Lock):** Press this button to lock the doors. The light on the door will flash once. If this button is pressed two times, the doors will lock, the light will flash and the horn will sound.

 **(Unlock):** Press this button to unlock the driver's door. The light on the door will flash two times. Press the button two times within 10 seconds to unlock both doors. If it is dark enough outside, your interior lamps will come on.

Your memory settings may also be recalled when you press the unlock button on the keyless access transmitter. See *Memory on page 2-66* for more information.

 **(Hatch/Trunk):** Press this button to open the hatch/trunk lid while the engine is turned off. If the engine is running the shifter needs to be in PARK (P) for an automatic transmission or NEUTRAL with the parking brake set for a manual transmission. See *Parking Brake on page 2-29*.

 **(Panic):** Press this button to sound the vehicle alarm. Press any other button on the keyless access transmitter to stop the vehicle alarm.

## Matching Transmitter(s) to Your Vehicle

Each keyless access transmitter is coded to allow only transmitters programmed to your vehicle, to work. If a transmitter is lost or stolen, a replacement can be purchased and programmed through your GM dealer. Your GM dealer can reprogram your vehicle so lost or stolen transmitters no longer work with your vehicle. Each vehicle can have a maximum of four transmitters matched to it.

To match a new transmitter to your vehicle when you have a recognized transmitter (two recognized transmitters are required for Canadian owners), do the following:

1. The vehicle must be off.
2. Have the recognized and new, unrecognized transmitters on your person.
3. Go to the rear of the vehicle and insert the vehicle key into the key cylinder located above the license plate. See *Hatch/Trunk on page 2-14* for more information on the key cylinder.
4. Open the trunk.
5. Turn the key five times within five seconds.
6. The DIC will display READY FOR FOB #X, where X can be 2, 3 or 4.



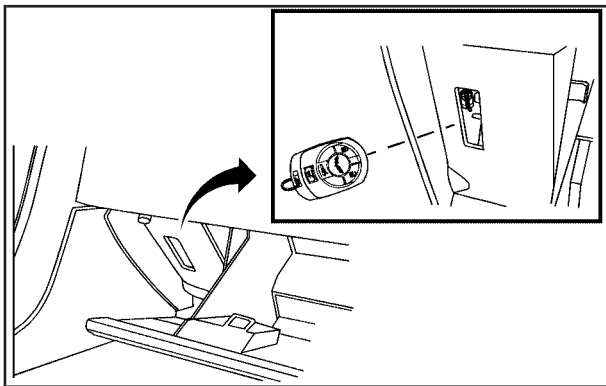

7. Place the new, unrecognized transmitter in the glove box transmitter pocket with the buttons facing towards the passenger's side.
8. Once the transmitter is programmed, a beep will sound. The DIC will display READY FOR #X, where X can be 3 or 4, or MAX # FOBS LEARNED.
9. Press the ACC button (ignition switch).

The Canadian immobilizer standard requires Canadian owners to see their GM dealer for matching new transmitters when a recognized transmitter is not available. United States owners are permitted to match a new transmitter to their vehicle when a recognized transmitter is not available. The procedure will require three ten minutes cycles to complete the matching process. Do the following:

1. The vehicle must be off.

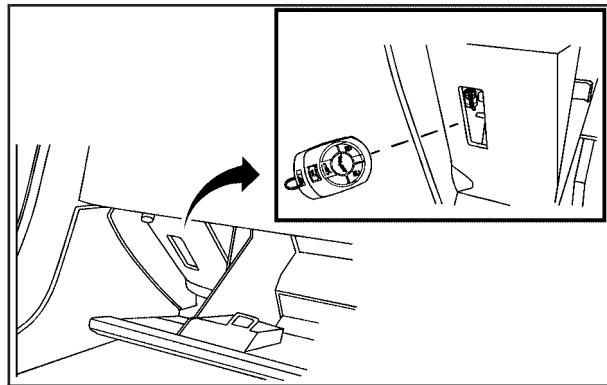

2. Place the new, unrecognized transmitter in the glove box transmitter pocket with the buttons facing towards the passenger's side.

3. Go to the rear of the vehicle and insert the vehicle key into the key cylinder located above the license plate. See *Hatch/Trunk on page 2-14* for more information on the key cylinder.
4. Open the trunk.
5. Turn the key five times within five seconds.
6. The DIC message will display OFF-ACCESORY TO LEARN.
7. Press the ACC button (ignition switch).
8. The DIC will read WAIT 10 MINUTES and will count down to zero, one minute at a time.
9. The DIC will display OFF-ACCESSORY TO LEARN again.
10. Press the ACC button (ignition switch).
11. The DIC will read WAIT 10 MINUTES and will count down to zero, one minute at a time.
12. The DIC will display OFF-ACCESSORY TO LEARN again.

13. Press the ACC button (ignition switch).
14. The DIC will read WAIT 10 MINUTES and will count down to zero, one minute at a time.
15. A beep will sound and the DIC will read READY FOR FOB #1. At this time, all previously known transmitters have been erased.
16. Once the transmitter is recognized and programmed, a beep will sound and the DIC will display READY FOR FOB #2.

If you have additional transmitters to program, take transmitter 1 out of the transmitter pocket and place transmitter 2 in the pocket. This can be done repeatedly until up to four transmitters have been programmed. The DIC will then display MAX # FOBS LEARNED and will exit the programming mode.

When you are done programming transmitters, press the ACC button (ignition switch).

## Battery Replacement

Under normal use, the battery in your keyless access transmitter should last about three years.

You can tell the battery is weak if the transmitter will not work at the normal range in any location. If you have to get close to your vehicle before the transmitter works, it is probably time to change the battery.

A weak battery may also cause the DIC to display NO FOBS DETECTED when you try to start the vehicle. If this happens, place the transmitter in the glove box transmitter pocket with the buttons facing towards the passenger's side. Then, with the vehicle in PARK (P) for an automatic transmission press the break pedal and the START button, or if your vehicle has a manual transmission, press the clutch and the START button. Although this will start the vehicle, it is recommended that you replace the transmitter battery as soon as possible. The DIC may display FOB BATTERY LOW.

**Notice:** When replacing the battery, use care not to touch any of the circuitry. Static from your body transferred to these surfaces may damage the transmitter.

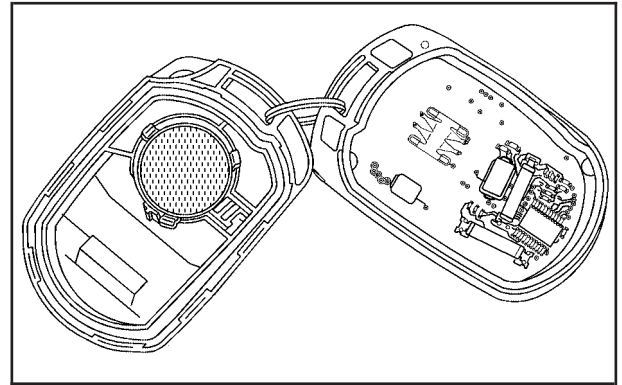

1. Insert a coin or similar object into the slot on the back of the transmitter and gently pry apart the front and back.
2. Gently pull the battery out of the transmitter.
3. Put the new battery in the transmitter, positive (+) side down. Use a battery, type CR2032, or equivalent.
4. Reassemble the transmitter. Make sure to put it together so water will not get in.
5. Test the transmitter.

# Doors and Locks

## Door Locks

### CAUTION:

**Unlocked doors can be dangerous.**

- **Passengers — especially children — can easily open the doors and fall out of a moving vehicle. When a door is locked it will not open. You increase the chance of being thrown out of the vehicle in a crash if the doors are not locked. So, wear safety belts properly and lock the doors whenever you drive.**
- **Young children who get into unlocked vehicles may be unable to get out. A child can be overcome by extreme heat and can suffer permanent injuries or even death from heat stroke. Always lock your vehicle whenever you leave it.**
- **Outsiders can easily enter through an unlocked door when you slow down or stop your vehicle. Locking your doors can help prevent this from happening.**

There are several ways to lock and unlock your vehicle.

From the outside, press the lock or unlock button on the keyless access transmitter. When you have the transmitter with you, you may also unlock and open the door by squeezing the door handle sensor. You do not have to press the unlock button on the transmitter. You will be able to open the door when you press the door handle sensor and the vehicle recognizes your keyless access transmitter. When the passenger door is opened first, the driver's door will also unlock.

From the inside, use the power door lock switch located at the top of the door panel near both windows. See *Power Door Locks on page 2-12*.

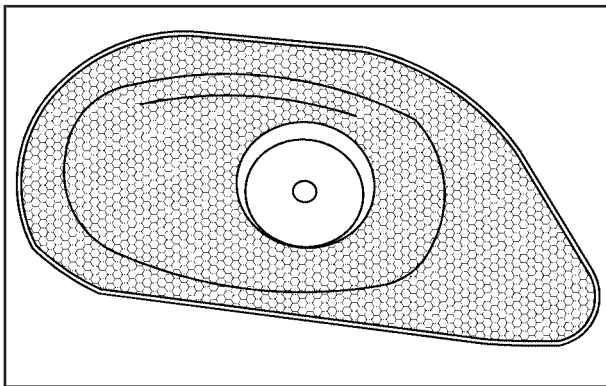

To open a door from the inside, press the button in front of the door handle and push the door open. You will hear a tone when the button is pressed.

If power to the vehicle or the keyless access transmitter is lost, there are two ways to open the door.

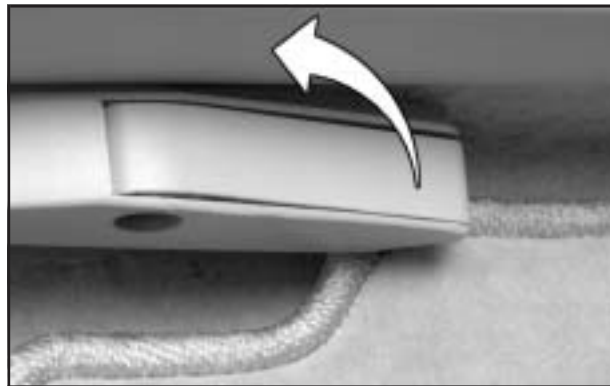

From inside the vehicle, use the door release handle located on the floor next to each seat. Pull the handle up to unlock and unlatch the door.

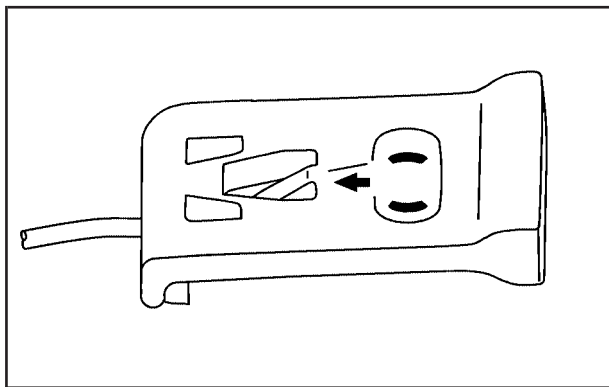

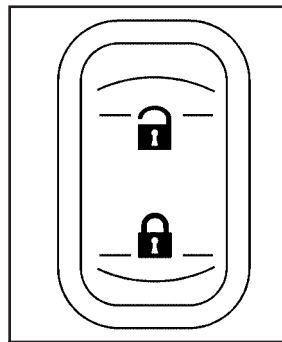

From outside the vehicle, use the door release tab located on the carpet inside the trunk on the driver's side of the vehicle. Pull the tab to unlock and unlatch the driver's door. See *Hatch/Trunk* on page 2-14 for information on opening the trunk during a loss of power.

## Power Door Locks



The power door lock switches are located on the door panels.

 **(Unlock):** Press this part of the switch to unlock the doors.

 **(Lock):** Press this part of the switch to lock the doors.

There is an indicator light on the rear of the door near the window.

When lock is pressed, a beep will sound. If the door is closed when lock is pressed, the light will come on for a few seconds, then turn off. If the door is open when lock is pressed, the light will stay on.

When unlock is pressed, a beep will sound. If the door is closed when unlock is pressed, the light will flash two times. If the door is open when unlock is pressed, the light will flash.

## Automatic Door Locks

Your vehicle is programmed so that, when the doors are closed, the ignition is on and the shift lever is moved out of PARK (P) for automatic transmissions, or when vehicle speed becomes faster than 8 mph (13 kph) for manual transmissions, all the doors will lock.

If someone needs to get out while the vehicle is running or not in PARK (P), have the person use the power door unlock switch. When the door is closed again, the doors will lock either when your foot is removed from the brake or the vehicle speed becomes faster than 8 mph (13 km/h).

## Programmable Automatic Door Unlock

Your vehicle is programmed so that when the shift lever is moved into PARK (P) for automatic transmission vehicles or when the ignition is turned off or is in Retained Accessory Power (RAP) for manual transmission vehicles, both doors will unlock.

With the vehicle stopped and the engine running, door unlocking can be programmed through prompts displayed on the Driver Information Center (DIC). These prompts allow the driver to choose various unlock settings. For programming information, see *DIC Vehicle Personalization on page 3-67*.

## Lockout Protection

Your vehicle can be programmed to sound the horn three times and unlock the driver's door when both doors are closed and there is a keyless access transmitter inside the vehicle. When the driver's door is opened, the key in reminder chime will sound continuously. The vehicle will remain locked only when at least one transmitter has been removed from the vehicle and both doors are closed. See *DIC Vehicle Personalization on page 3-67*.

## Hatch/Trunk

### CAUTION:

It can be dangerous to drive with the hatch/trunk lid open because carbon monoxide (CO) gas can come into your vehicle. You can not see or smell CO. It can cause unconsciousness and even death. If you must drive with the hatch/trunk lid open or if electrical wiring or other cable connections must pass through the seal between the body and the hatch/trunk lid:

- Make sure all other windows are shut.
- Turn the fan on your heating or cooling system to its highest speed and select the control setting that will force outside air into your vehicle. See *Dual Automatic Climate Control System on page 3-24*.
- If you have air outlets on or under the instrument panel, open them all the way.



See *Engine Exhaust on page 2-32*.

**Notice:** Closing the hatch/trunk lid forcefully or from the sides can cause damage to the glass, the defogger or the weather stripping. Be sure objects will fit in the hatch/trunk area before closing the hatch/trunk lid. When closing the hatch/trunk lid, gently pull down from the center.

**Notice:** Do not store heavy or sharp objects in the rear storage compartments located in the hatch/trunk area. If you do, the objects could damage the underbody.

## Hatch/Trunk Lid Release

There are several ways to release the hatch/trunk lid. If your vehicle has an automatic transmission, the shift lever must be in PARK (P). For manual transmissions, the parking brake must be set. See *Parking Brake on page 2-29*.

-  **(Hatch/Trunk):** Press the hatch/trunk lid release button located on the instrument panel to the left of the steering wheel.
-  **(Hatch/Trunk):** Press the hatch/trunk lid release button on the keyless access transmitter. See *Keyless Access System on page 2-4*.
- Squeeze the hatch/trunk release button located on the rear of the hatch/trunk lid above the license plate, as long as you have your transmitter with you.



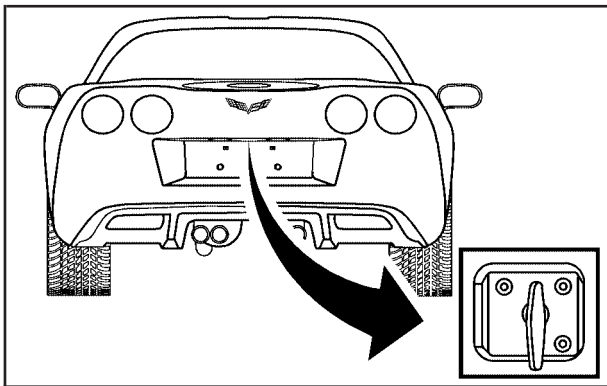

If your vehicle has lost battery power, open the hatch/trunk using the vehicle key. The key lock cylinder is located on the rear of the hatch/trunk lid above the license plate. Turn the vehicle key clockwise in the lock.

If your vehicle has a convertible top and has lost battery power, you can also use the emergency trunk release handle to open the trunk. See “Emergency Trunk Release Handle” following.

## Emergency Trunk Release Handle (Convertible Only)

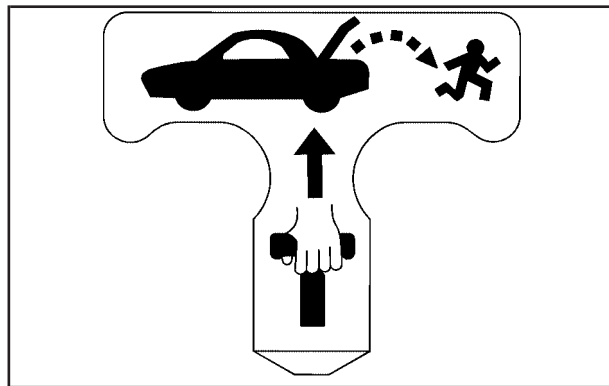

**Notice:** Using the emergency trunk release handle as a tie-down or anchor point when securing items in the trunk may damage it. Use the emergency trunk release handle only to help you open the trunk lid.

There is a glow-in-the-dark emergency trunk release handle located on the rear wall of the trunk below the latch. This handle will glow following exposure to light. Pull the release handle down to open the trunk from the inside.

## Windows

### CAUTION:

Leaving children, helpless adults, or pets in a vehicle with the windows closed is dangerous. They can be overcome by the extreme heat and suffer permanent injuries or even death from heat stroke. Never leave a child, a helpless adult, or a pet alone in a vehicle, especially with the windows closed in warm or hot weather.



## Power Windows

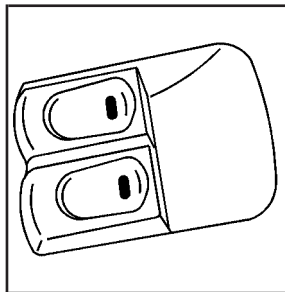

The power window switches are located on each door.

Pull up on the front of the switch to raise the window. Press down on the front of the switch to lower the window.

Your vehicle has Retained Accessory Power (RAP) that allows you to use the power windows when the ignition is off. For more information, see *Retained Accessory Power (RAP)* on page 2-21.

## Power Window Initialize

After a power reconnect such as battery replacement, the window index-up feature will not function until the system is initialized. Once power is restored, do the following:

1. Close the door.
2. Raise the window by pulling up the switch.
3. Hold the up switch for three seconds after the window is closed. Release the switch.
4. Hold the up switch again for three seconds and release.

## Express-Down Window

This feature is on both power windows. Press the front of the switch to the second position to activate the express-down feature. If you want to stop the window as it is lowering, press the switch again.

## Window Indexing

This feature automatically lowers the window a small amount when the door is opened. Then, when the door is closed, the window will raise to its full up position.

## Sun Visors

To block out glare, you can swing down the visors. You can also swing them to the side.

## Lighted Visor Vanity Mirrors

Pull down the sun visor and lift the cover to expose the lighted vanity mirror. When the cover is lifted, the lamps will come on automatically, even if the ignition is off.

## Theft-Deterrent Systems

Vehicle theft is big business, especially in some cities. Although your vehicle has a number of theft-deterrent features, we know that nothing we put on it can make it impossible to steal.

## Theft-Deterrent System

Your vehicle is equipped with a theft-deterrent alarm system.

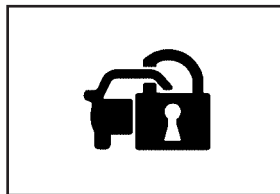

With this system, the security light will flash when the door is open and locked with the power door lock switch.

If this light is on continuously while the engine is running, your vehicle needs service.

## Arming the System

Use one of the three following items listed here to arm the system:

- Press the lock button on the keyless access transmitter.
- Open the door. Lock the door with the power door lock switch. The security light should flash. Remove the keyless access transmitter from inside the vehicle and close the door. The security light will stop flashing and stay on. After 30 seconds, the light should turn off.
- The vehicle can be programmed to automatically lock the doors and arm the theft-deterrent system when you exit the vehicle. See *DIC Vehicle Personalization on page 3-67*.

Now, if a door or the trunk lid is opened without the keyless access transmitter, the alarm will go off. Your horn will sound for two minutes, then it will go off to save battery power. Your vehicle will not start without a keyless transmitter present.

The theft-deterrent system will not arm if you lock the driver's door with the power door lock switch after the doors are closed.

If your passenger stays in the vehicle when you leave with the keyless access transmitter, have the passenger lock the vehicle after the doors are closed. This way the alarm will not arm, and your passenger will not set it off.

## Testing the Alarm

Do the following to test the system:

1. Make sure the trunk lid is latched.
2. Lower the window on the driver's door.
3. Manually arm the system.
4. Close the doors and wait 30 seconds.
5. Reach through the open window and manually pull the release lever on the floor.
6. Turn off the alarm by pressing the unlock button on the transmitter.

If the alarm is inoperative, check to see if the horn works. If not, check the horn fuse. See *Fuses and Circuit Breakers on page 5-87*. If the horn works, but the alarm doesn't go off, see your dealer.

## Disarming the System

Always use your keyless access transmitter to unlock a door either by pressing the unlock button on the transmitter or by squeezing the door handle sensor while you have the transmitter with you. Unlocking a door any other way will set off the alarm. If your alarm sounds, press the unlock button on the keyless access transmitter to disarm it.

## Starting and Operating Your Vehicle

### New Vehicle Break-In

**Notice:** Your vehicle does not need an elaborate break-in. But it will perform better in the long run if you follow these guidelines:

- Keep your speed at 55 mph (88 km/h) or less for the first 500 miles (805 km).
- Do not drive at any one speed — fast or slow — for the first 500 miles (805 km). Do not make full-throttle starts.
- Avoid making hard stops for the first 200 miles (322 km) or so. During this time your new brake linings are not yet broken in. Hard stops with new linings can mean premature wear and earlier replacement. Follow this breaking-in guideline every time you get new brake linings.

## Front Air Dam

Your vehicle is equipped with a front air dam which has minimal ground clearance.

Under normal operation, the air dam will occasionally contact some road surfaces (speed bumps, driveway ramps, etc.). This can be heard inside the vehicle as a scraping noise. This is normal and does not indicate a problem.

Use care when approaching bumps or objects on road surfaces and avoid them when possible.

## Ignition Positions

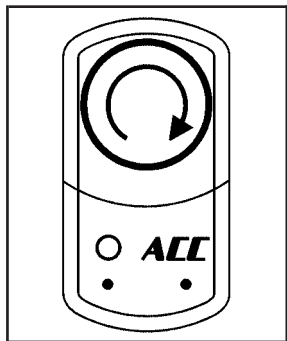

Your vehicle has an electronic keyless ignition with pushbutton start.

**Q (START):** Press this button while your foot is on the brake for an automatic transmission, or while pressing in the clutch for a manual transmission, to start the engine. The keyless access transmitter must be in the vehicle for the ignition to work.

**O ACC (OFF/ACCESSORY):** When the engine is on or in accessory mode, press this button to turn the engine off and place the vehicle in RAP. See "Retained Accessory Power (RAP)" later for more information.

When the engine is off, press this button to place the vehicle in accessory mode. ACCESSORY MODE ON will display on the Driver Information Center (DIC). This mode allows you to use things like the radio and the windshield wipers while the engine is off. Use accessory mode if you must have your vehicle in motion while the engine is off, for example, if your vehicle is being pushed or towed.

After being in accessory mode for about 20 minutes, the vehicle will automatically enter RAP or OFF, depending on if the doors are opened or closed.

## Retained Accessory Power (RAP)

With RAP, your power windows and the audio system will continue to work for up to 10 minutes after the engine is turned off or until either door is opened. If a door is opened, the power windows and audio system will shut off.

## Starting Your Engine

Move your shift lever to PARK (P) or NEUTRAL (N) for an automatic transmission, or your vehicle can be started in NEUTRAL (N) or any other gear as long as the clutch is depressed for a manual transmission. To restart when you are already moving, use NEUTRAL (N) only.

The keyless access transmitter must be in the vehicle for the ignition to work.

**Notice:** Do not try to shift to PARK (P) if your vehicle is moving. If you do, you could damage the transmission. Shift to PARK (P) only when your vehicle is stopped.

1. For an automatic transmission, with your foot on the brake pedal, press the START button. For a manual transmission, while pressing in the clutch, press the START button. When the engine begins cranking, let go of the button. The idle speed will go down as your engine gets warm.

If the battery in the keyless access transmitter is weak, the DIC will display FOB BATTERY LOW. You can still drive the vehicle. See “Battery Replacement” under *Keyless Access System Operation on page 2-5* for more information.

2. If the engine does not start and no DIC message is displayed, wait 15 seconds before trying again.

**Notice:** Your engine is designed to work with the electronics in your vehicle. If you add electrical parts or accessories, you could change the way the engine operates. Before adding electrical equipment, check with your dealer. If you do not, your engine might not perform properly.

## Stopping Your Engine

If your vehicle has an automatic transmission, move the shift lever to PARK (P) and press the ACC button. If the shifter is not in PARK (P), the vehicle will go into accessory mode and the DIC will display SHIFT TO PARK. Once the shifter is moved to PARK (P), the vehicle will turn off.

If your vehicle has a manual transmission, move the shift lever to REVERSE (R) and press the ACC button. If the shifter is not in REVERSE (R), the vehicle will go into accessory mode and the DIC will display SHIFT TO REVERSE. Once the shifter is moved to REVERSE (R), the vehicle will turn off.

If the keyless access transmitter is not detected while going to off, the DIC will display NO FOB – OFF OR RUN?.

See *DIC Warnings and Messages on page 3-53* for more information.

**Notice:** If you do not put a manual transmission in REVERSE (R) before exiting your vehicle, the battery will drain and could be damaged. Always put a manual transmission in REVERSE (R) before shutting off the engine and exiting the vehicle.

## Racing or Other Competitive Driving

See your warranty book before using your vehicle for racing or other competitive driving.

**Notice:** If you use your vehicle for racing or other competitive driving, the engine may use more oil than it would with normal use. Low oil levels can damage the engine. Be sure to check the oil level often during racing or other competitive driving and keep the level at or near 1 quart (1 L) above the upper mark that shows the proper operating range on the engine oil dipstick. For information on how to add oil, see *Engine Oil on page 5-14*. After the competitive driving, remove excess oil so that the level on the dipstick is not above the upper mark that shows the proper operating range.

Vehicles with the Z51 performance package have greaseable outer ends on both of the rear toe-links. Under normal use, lubrication should be performed as described in the maintenance schedule. See *Scheduled Maintenance on page 6-4* and *Recommended Fluids and Lubricants on page 6-11*. If you use the vehicle for racing, lubrication should be performed at the end of each racing day. See your dealer for lubrication and make sure any needed repairs are made at once. Proper procedures for performing these services can be found in the service manual. See *Service Publications Ordering Information on page 7-11*.



## Engine Coolant Heater

If your vehicle has this feature, in very cold weather, 0°F (-18°C) or colder, the engine coolant heater can help. You will get easier starting and better fuel economy during engine warm-up. Usually, the coolant heater should be plugged in a minimum of four hours prior to starting your vehicle. At temperatures above 32°F (0°C), use of the coolant heater is not required.

### To Use The Engine Coolant Heater

1. Turn off the engine.
2. Open the hood and unwrap the electrical cord.  
The electrical cord is located on the driver's side of the engine compartment, in front of the coolant surge tank.
3. Plug it into a normal, grounded 110-volt AC outlet.

### CAUTION:

**Plugging the cord into an ungrounded outlet could cause an electrical shock. Also, the wrong kind of extension cord could overheat and cause a fire. You could be seriously injured. Plug the cord into a properly grounded three-prong 110-volt AC outlet. If the cord will not reach, use a heavy-duty three-prong extension cord rated for at least 15 amps.**

4. Before starting the engine, be sure to unplug and store the cord as it was before to keep it away from moving engine parts. If you do not it could be damaged.

How long should you keep the coolant heater plugged in? The answer depends on the outside temperature, the kind of oil you have, and some other things. Instead of trying to list everything here, we ask that you contact your dealer in the area where you will be parking your vehicle. The dealer can give you the best advice for that particular area.

## Automatic Transmission Operation

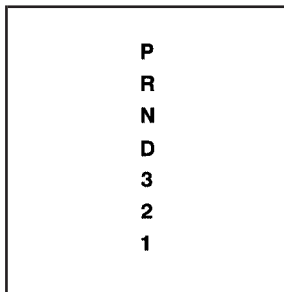

There are several different positions for your shift lever.

**PARK (P):** This position locks your rear wheels. It is the best position to use when you start your engine because your vehicle cannot move easily.

### **CAUTION:**

It is dangerous to get out of your vehicle if the shift lever is not fully in **PARK (P)** with the parking brake firmly set. Your vehicle can roll.

Do not leave your vehicle when the engine is running unless you have to. If you have left the engine running, the vehicle can move suddenly. You or others could be injured. To be sure your vehicle will not move, even when you are on fairly level ground, always set your parking brake and move the shift lever to **PARK (P)**. See *Shifting Into Park (P) (Automatic Transmission)* on page 2-29.

Be sure the shift lever is fully in **PARK (P)** before starting the engine. Your vehicle has an automatic transmission shift lock control system.

You have to fully apply your regular brakes before you can shift from PARK (P) when the vehicle is running. If you cannot shift out of PARK (P), ease pressure on the shift lever – push the shift lever all the way into PARK (P) and release the shift lever button as you maintain brake application. Then press the shift lever button and move the shift lever into the gear you wish. See *Shifting Out of Park (P) (Automatic Transmission)* on page 2-31.

**REVERSE (R):** Use this gear to back up.

**Notice:** Shifting to REVERSE (R) while your vehicle is moving forward could damage the transmission. The repairs would not be covered by your warranty. Shift to REVERSE (R) only after your vehicle is stopped.

To rock your vehicle back and forth to get out of snow, ice or sand without damaging your transmission, see *If You Are Stuck: In Sand, Mud, Ice or Snow* on page 4-31.

**NEUTRAL (N):** In this position, your engine does not connect with the wheels. To restart when you are already moving, use NEUTRAL (N) only. Also, use NEUTRAL (N) when your vehicle is being towed.

## CAUTION:

**Shifting into a drive gear while your engine is running at high speed is dangerous. Unless your foot is firmly on the brake pedal, your vehicle could move very rapidly. You could lose control and hit people or objects. Do not shift into a drive gear while your engine is running at high speed.**

**Notice:** Shifting out of PARK (P) or NEUTRAL (N) with the engine running at high speed may damage the transmission. The repairs would not be covered by your warranty. Be sure the engine is not running at high speed when shifting your vehicle.

**AUTOMATIC OVERDRIVE (D):** This position is for normal driving.

**THIRD (3):** This position is also used for normal driving. However, it offers more power and lower fuel economy than AUTOMATIC OVERDRIVE (D).

Here are some times you might choose THIRD (3) instead of AUTOMATIC OVERDRIVE (D):

- When driving on hilly, winding roads.
- When going down a steep hill.

**SECOND (2):** This position gives you more power but lower fuel economy than THIRD (3). You can use SECOND (2) on hills. It can help control your speed as you go down steep mountain roads, but then you would also want to use your brakes off and on.

If you manually select SECOND (2) when you start the vehicle, the transmission will drive, and stay, in second gear. You may use this feature for reducing torque to the rear wheels when you are trying to start your vehicle from a stop on slippery road surfaces, or for preventing the transmission from downshifting into FIRST (1) in situations where a downshift would be undesirable.

**FIRST (1):** This position gives you even more power, but lower fuel economy, than SECOND (2). You can use it on very steep hills, in deep snow or mud. If the shift lever is put in FIRST (1), the transmission will not shift into first gear until the vehicle is going slowly enough.

**Notice:** Spinning the tires or holding the vehicle in one place on a hill using only the accelerator pedal may damage the transmission. If you are stuck, do not spin the tires. When stopping on a hill, use the brakes to hold the vehicle in place.

Maximum engine speed is limited to protect driveline components from improper operation.

## Manual Transmission Operation

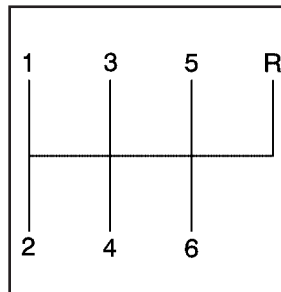

This is the shift pattern for the six-speed manual transmission.

Here is how to operate your transmission:

**FIRST (1):** Press the clutch pedal and shift into FIRST (1). Then slowly let up on the clutch pedal as you press the accelerator pedal.

You can shift into FIRST (1) when you are going less than 40 mph (64 km/h). If you come to a complete stop and it is hard to shift into FIRST (1), put the shift lever in NEUTRAL and let up on the clutch. Press the clutch pedal back down. Then shift into FIRST (1).

**SECOND (2):** Press the clutch pedal as you let up on the accelerator pedal and shift into SECOND (2). Then, slowly let up on the clutch pedal as you press the accelerator pedal.

### THIRD (3), FOURTH (4), FIFTH (5) and SIXTH (6):

Shift into THIRD (3), FOURTH (4), FIFTH (5) and SIXTH (6) the same way you do for SECOND (2). Slowly let up on the clutch pedal as you press the accelerator pedal.

To stop, let up on the accelerator pedal and press the brake pedal. Just before the vehicle stops, press the clutch pedal and the brake pedal, and shift to NEUTRAL.

**NEUTRAL:** Use this position when you start or idle your engine. Your shift lever is in NEUTRAL when it is centered in the shift pattern, not in any gear.

**REVERSE (R):** To back up, press down the clutch pedal and shift into REVERSE (R). Just apply pressure to get the lever past FIFTH (5) and SIXTH (6) into REVERSE (R). Let up on the clutch pedal slowly while pressing the accelerator pedal.

Your six-speed manual transmission has a feature that allows you to safely shift into REVERSE (R) while the vehicle is rolling at less than 3 mph (5 km/h). You will be locked out if you try to shift into REVERSE (R) while your vehicle is moving faster than 3 mph (5 km/h). If you have turned your ignition off the shifter must be shifted to REVERSE (R), enabling the vehicle to be turned off. Otherwise, the vehicle will remain in accessory mode.

## Shift Speeds (Manual Transmission)

### CAUTION:

If you skip a gear when you downshift, you could lose control of your vehicle. You could injure yourself or others. Don't shift down more than one gear at a time when you downshift.

This chart shows when to shift to the next higher gear for the best fuel economy.

Manual Transmission Recommended Shift Speeds in mph (km/h)					
Engine	Acceleration Shift Speed				
	1 to 2	2 to 3	3 to 4	4 to 5	5 to 6
All Engines	15 (24)	25 (40)	40 (64)	45 (72)	50 (80)

If your engine speed drops below 900 rpm, or if the engine is not running smoothly, you should downshift to the next lower gear. You may have to downshift two or more gears to keep the engine running smoothly or for good engine performance.

**Notice:** When shifting gears, do not move the shift lever around unnecessarily. This may damage the transmission. Shift directly into the next gear.

## One to Four Shift Light (Manual Transmission)

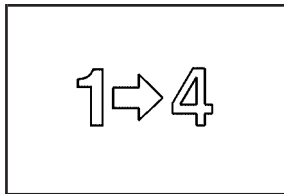

When this light comes on, you can only shift from FIRST (1) to FOURTH (4) instead of FIRST (1) to SECOND (2).

You must complete the shift into FOURTH (4) to turn off this feature. This helps you get the best possible fuel economy.

After shifting to FOURTH (4), you may downshift to a lower gear if you prefer.

**Notice:** Forcing the shift lever into any gear except FOURTH (4) when the 1 TO 4 SHIFT light comes on may damage the transmission. Shift only from FIRST (1) to FOURTH (4) when the light comes on.

This light will come on when:

- The engine coolant temperature is higher than 169°F (76°C),
- you are going 15 to 19 mph (24 to 31 km/h) and
- you are 21 percent throttle or less.

## Downshifting (Manual Transmission)

Do not downshift into the gear shown below at a speed greater than shown in the table:

FIRST (1)	50 mph (80 km/h)
SECOND (2)	74 mph (119 km/h)
THIRD (3)	101 mph (163 km/h)
FOURTH (4)	130 mph (209 km/h)

**Notice:** If you skip more than one gear when you downshift, or if you race the engine when you release the clutch pedal while downshifting, you could damage the engine, clutch, driveshaft or the transmission. Do not skip gears or race the engine when downshifting.

The six-speed transmission has a spring that centers the shift lever near THIRD (3) and FOURTH (4). This spring helps you know which gear you are in when you are shifting. Be careful when shifting from FIRST (1) to SECOND (2) or downshifting from SIXTH (6) to FIFTH (5). The spring will try to pull the shift lever toward FOURTH (4) and THIRD (3). Make sure you move the lever into SECOND (2) or FIFTH (5). If you let the shift lever move in the direction of the pulling, you may end up shifting from FIRST (1) to FOURTH (4) or from SIXTH (6) to THIRD (3).

## Parking Brake

The parking brake lever is located to the right of the center console.

To set the parking brake, hold the brake pedal down. Pull the parking brake lever up. If the ignition is on, the brake system warning light will come on.

To release the parking brake, hold the brake pedal down. Then push the release button in as you move the parking brake lever all the way down.

**Notice:** Driving with the parking brake on can overheat the brake system and cause premature wear or damage to brake system parts. Verify that the parking brake is fully released and the brake warning light is off before driving.

## Shifting Into Park (P) (Automatic Transmission)

### CAUTION:

**It can be dangerous to get out of your vehicle if the shift lever is not fully in PARK (P) with the parking brake firmly set. Your vehicle can roll. If you have left the engine running, the vehicle can move suddenly. You or others could be injured. To be sure your vehicle will not move, even when you are on fairly level ground, use the steps that follow.**

1. Hold the brake pedal down with your right foot and set the parking brake.
2. Move the shift lever into PARK (P) by holding in the button on the lever and pushing the lever all the way toward the front of the vehicle.
3. Turn the ignition off.

## Leaving Your Vehicle With the Engine Running (Automatic Transmission)

### CAUTION:

**It can be dangerous to leave your vehicle with the engine running. Your vehicle could move suddenly if the shift lever is not fully in PARK (P) with the parking brake firmly set. And, if you leave the vehicle with the engine running, it could overheat and even catch fire. You or others could be injured. Do not leave your vehicle with the engine running.**

If you have to leave your vehicle with the engine running, be sure your vehicle is in PARK (P) and your parking brake is firmly set before you leave it. After you have moved the shift lever into PARK (P), hold down the regular brake pedal. See if you can move the shift lever away from PARK (P) without first pulling it toward you. If you can, it means that the shift lever was not fully locked into PARK (P).

## Torque Lock (Automatic Transmission)

If you are parking on a hill and you do not shift your transmission into PARK (P) properly, the weight of the vehicle may put too much force on the parking pawl in the transmission. You may find it difficult to pull the shift lever out of PARK (P). This is called “torque lock.” To prevent torque lock, set the parking brake and then shift into PARK (P) properly before you leave the driver’s seat. To find out how, see “Shifting Into PARK (P)” listed previously in this section.

When you are ready to drive, move the shift lever out of PARK (P) before you release the parking brake.

If torque lock does occur, you may need to have another vehicle push yours a little uphill to take some of the pressure from the transmission parking pawl, so you can pull the shift lever out of PARK (P).



## Shifting Out of Park (P) (Automatic Transmission)

Your vehicle has an automatic transmission shift lock control system which locks the shift lever in PARK (P) when the ignition is off. In addition, you have to fully apply your regular brake before you can shift from PARK (P) when the ignition is on. See *Automatic Transmission Operation on page 2-24*.

If you cannot shift out of PARK (P), ease pressure on the shift lever and push the shift lever all the way into PARK (P) and release the shift lever button as you maintain brake application. Then press the shift lever button and move the shift lever into the gear you wish.

If you ever hold the brake pedal down but still cannot shift out of PARK (P), try this:

1. Put the vehicle in accessory mode.
2. Apply and hold the brake until the end of Step 4.
3. Shift to NEUTRAL (N).
4. Start the engine and then shift to the drive gear you want.
5. Have your vehicle inspected by your dealer as soon as possible.

## Parking Your Vehicle (Manual Transmission)

Before you get out of your vehicle, move the shift lever into REVERSE (R) and firmly apply the parking brake. Once the shift lever has been placed into REVERSE (R) with the clutch pedal pressed in, you can turn the ignition off and release the clutch. If you attempt to exit the vehicle without being in REVERSE (R), the Driver Information Center (DIC) will display SHIFT TO REVERSE and a chime will sound.

**Notice:** If you do not put a manual transmission in REVERSE (R) before exiting your vehicle, the battery will drain and could be damaged. Always put a manual transmission in REVERSE (R) before shutting off the engine and exiting the vehicle.

## Parking Over Things That Burn

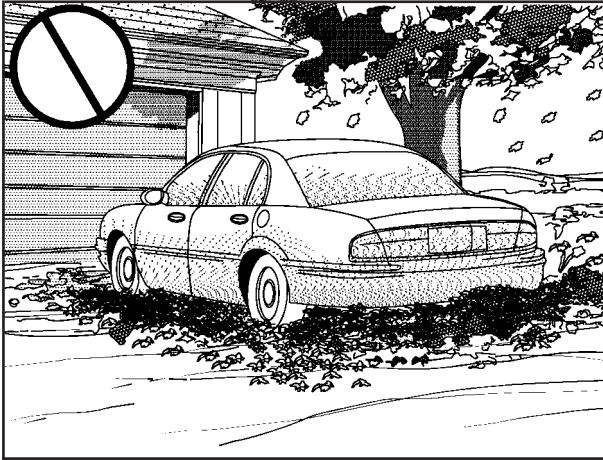

### CAUTION:

Things that can burn could touch hot exhaust parts under your vehicle and ignite. Do not park over papers, leaves, dry grass or other things that can burn.

## Engine Exhaust

### CAUTION:

Engine exhaust can kill. It contains the gas carbon monoxide (CO), which you cannot see or smell. It can cause unconsciousness and death.

You might have exhaust coming in if:

- Your exhaust system sounds strange or different.
- Your vehicle gets rusty underneath.
- Your vehicle was damaged in a collision.
- Your vehicle was damaged when driving over high points on the road or over road debris.
- Repairs were not done correctly.
- Your vehicle or exhaust system had been modified improperly.

If you ever suspect exhaust is coming into your vehicle:

- Drive it only with all the windows down to blow out any CO; and
- Have your vehicle fixed immediately.

## Running Your Engine While You Are Parked (Automatic Transmission)

It's better not to park with the engine running. But if you ever have to, here are some things to know.

### CAUTION:

Idling the engine with the climate control system off could allow dangerous exhaust into your vehicle. See the earlier caution under *Engine Exhaust on page 2-32*.

Also, idling in a closed-in place can let deadly carbon monoxide (CO) into your vehicle even if the climate control fan is at the highest setting. One place this can happen is a garage. Exhaust — with CO — can come in easily. NEVER park in a garage with the engine running.

Another closed-in place can be a blizzard. See *Winter Driving on page 4-27*.

### CAUTION:

It can be dangerous to get out of your vehicle if the shift lever is not fully in PARK (P) with the parking brake firmly set. Your vehicle can roll. Do not leave your vehicle when the engine is running unless you have to. If you have left the engine running, the vehicle can move suddenly. You or others could be injured. To be sure your vehicle will not move, even when you are on fairly level ground, always set your parking brake and move the shift lever to PARK (P).

Follow the proper steps to be sure your vehicle won't move. See *Shifting Into Park (P) (Automatic Transmission) on page 2-29*.

# Mirrors

## Manual Rearview Mirror

When you are sitting in a comfortable driving position, adjust the mirror so you can see clearly behind your vehicle. Grip the mirror in the center to move it up or down and side to side. The day/night control, located at the bottom of the mirror, lessens glare from the headlamps behind your vehicle when in the night position. Turn the control to the right for the night position and to the left for the day position.

Two buttons under the rearview mirror control map lamps. Push each button to turn each map lamp on or off.

## Automatic Dimming Rearview Mirror with OnStar<sup>®</sup> and Compass

The vehicle may have an automatic dimming rearview mirror with OnStar<sup>®</sup>, a compass and map lamps. Three OnStar<sup>®</sup> buttons are at the bottom of the mirror. See *OnStar<sup>®</sup> System on page 2-40* for more information the services OnStar<sup>®</sup> provides.

## Mirror Operation

The mirror automatically changes to reduce glare from headlamps behind you. A time delay feature prevents rapid changing from the day to night positions while driving under lights and through traffic.

 **(On/Off):** The automatic dimming feature is automatically activated when the vehicle is started. The automatic dimming feature is turned on or off by pressing this button located on the lower part of the mirror. Press and hold the button for up to three seconds to turn this feature on or off.

 **(Indicator Light):** This light will turn on when the automatic dimming feature is active.

## Map Lamps

The mirror has map lamps located at the bottom of the mirror. To manually turn the lamps on or off, press the button next to each lamp.

## Compass Operation

The mirror has an eight-point compass display in the bottom of the mirror face.

When the ignition and the compass feature are on, the compass will show two character boxes for approximately two seconds. After two seconds, the mirror will display the current compass heading. For example, NE is displayed for north-east.

## Compass Calibration

If after two seconds the display does not show a compass heading, there may be a strong magnetic field interfering with the compass. Such interference may be caused by a magnetic antenna mount, note pad holder or similar object. If the letter C appears in the compass window, the compass needs calibration.

The mirror compass can be calibrated by driving the vehicle in circles at 5 mph (8 km/h) or less until the display reads a direction.

The compass can be placed in calibration mode by pressing and holding the left map light button until a C appears on the compass display.

## Compass Variance

Compass variance is the difference between earth's magnetic north and true geographic north. If the mirror is not adjusted for compass variance, your compass could give false readings.

The mirror is set in zone eight upon leaving the factory. It will be necessary to adjust the compass to compensate for compass variance if you live outside zone eight. Under certain circumstances, such as a long distance, cross-country trip, it will be necessary to adjust the compass variance.

To adjust for compass variance, do the following:

1. Find your current location and variance zone number on the zone map that follows.

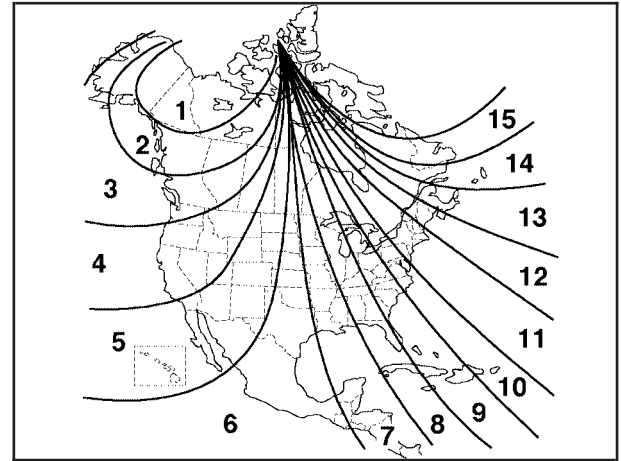

2. Press and hold the left map light button until a zone number appears on the display.
3. Once the zone number appears on the display, press the on/off button quickly until you reach the correct zone number. Stop pressing the button and the mirror will return to normal operation. If C appears in the compass window, the compass may need calibration. See "Compass Calibration" listed previously.

## Cleaning the Mirror

When cleaning the mirror, use a paper towel or similar material dampened with glass cleaner. Do not spray glass cleaner directly on the mirror as that may cause the liquid cleaner to enter the mirror housing.

## Automatic Dimming Rearview Mirror with Compass

If the vehicle has this feature, an automatic dimming mirror automatically dims to the proper level to minimize glare at night from lights behind your vehicle.

The mirror also includes a compass display in the upper right corner of the mirror face.

 **(On/Off):** This is the on/off button.

## Automatic Dimming Mirror Operation

The automatic dimming mirror function is turned on each time the ignition is started. A light near the on/off button will come on to indicate the automatic dimming is on.

Press the on/off button for about six seconds to manually turn the automatic dimming function on or off.

## Compass Display

Press the on/off button, located to the far left, briefly to turn the compass display on or off.

If the display reads CAL, the compass needs to be calibrated. For more information, see “Compass Calibration” later in this section.

To adjust between Fahrenheit and Celsius:

1. Press and hold the on/off button for approximately four seconds until either a flashing °F, or °C appears.
2. Press the button again to change the display to the desired unit of measurement. After approximately four seconds of inactivity, the new unit will be locked in and the compass/temperature display will return.

If an abnormal temperature reading is displayed for an extended period of time, please consult your dealer. Under certain circumstances, a delay in updating the temperature is normal.

## Compass Variance

Compass variance is the difference between earth's magnetic north and true geographic north. If not adjusted to account for compass variance, the mirror's compass could give false readings. The mirror is set in zone eight upon leaving the factory. It will be necessary to adjust the compass to compensate for compass variance if you live outside of zone eight. Under certain circumstances, as during a long distance cross-country trip, it will also be necessary to adjust for compass variance.

To adjust for compass variance do the following:

1. Find your current location and variance zone number on the following zone map.

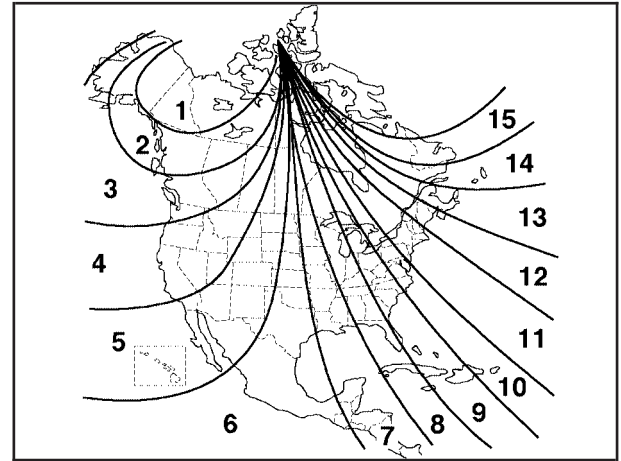

2. Press and hold the on/off button until a Z and a zone number appears in the display. The compass is now in zone mode.
3. Keep pressing the on/off button until the desired zone number appears in the display. Release the button. After approximately four seconds of inactivity, the new zone number will be locked in and the compass/temperature display will return.
4. Calibrate the compass as described below.

## Compass Calibration

The compass may need calibration if one of the following occurs:

- After approximately five seconds, the display does not show a compass heading (N for North, for example), there may be a strong magnetic field interfering with the compass. Such interference may be caused by a magnetic antenna mount, magnetic note pad holder, or a similar magnetic item.
- The compass does not display the correct heading and the compass zone variance is set correctly.

In order to calibrate, CAL must be displayed in the mirror compass windows. If CAL is not displayed, push the on/off button for approximately 12 seconds or until CAL is displayed.

The compass can be calibrated by driving the vehicle in circles at 5 mph (8 km/h) or less until the display reads a direction.

## Cleaning the Mirror

When cleaning the mirror, use a paper towel or similar material dampened with glass cleaner. Do not spray glass cleaner directly on the mirror as that may cause the liquid cleaner to enter the mirror housing.

## Outside Power Heated Mirrors

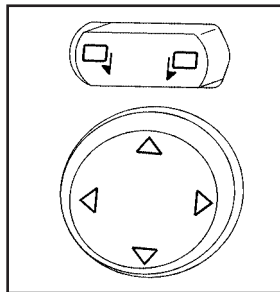

The controls for the outside power mirrors are located on the driver's door.

Move the top selector control to the left or right to select either the driver's or passenger's mirror. To adjust the direction of the mirror, use the arrows on the round four-way control. Adjust each outside mirror so that a little of the vehicle and the area behind it can be seen while sitting in a comfortable, driving position. Keep the control in the center position when not adjusting either outside mirror.

If the vehicle has the memory feature, a preferred mirror position can be stored. See *Memory on page 2-66*.



Both mirrors are heated to rid them of snow, ice, or condensation. They will heat when the rear window defogger is turned on. See “Rear Window Defogger” under *Dual Automatic Climate Control System* on page 3-24.

Both mirrors can manually be folded inward by pulling them toward the vehicle. This feature may be useful when going through a car wash or a confined space. Push the mirrors away from the vehicle, to the normal position, before driving.

## Outside Automatic Dimming Mirror

If your vehicle has this feature, the driver's side outside mirror will adjust for the glare of headlamps behind you. This feature is controlled by the on and off setting on the inside mirror.

## Outside Convex Mirror

### CAUTION:

**A convex mirror can make things (like other vehicles) look farther away than they really are. If you cut too sharply into the right lane, you could hit a vehicle on your right. Check your inside mirror or glance over your shoulder before changing lanes.**

The passenger's side mirror is convex. A convex mirror's surface is curved so more can be seen from the driver's seat. It also makes things look farther away than they really are.

## OnStar<sup>®</sup> System

OnStar<sup>®</sup> uses global positioning system (GPS) satellite technology, wireless communications, and call centers to provide you with a wide range of safety, security, information, and convenience services.

A complete OnStar<sup>®</sup> user's guide and the terms and conditions of the OnStar<sup>®</sup> Subscription Service Agreement are included in the vehicle's glove box literature. For more information, visit [www.onstar.com](http://www.onstar.com) or [www.onstarcanada.com](http://www.onstarcanada.com). Contact OnStar<sup>®</sup> at 1-888-4-ONSTAR (1-888-466-7827), or press the OnStar<sup>®</sup> button to speak to an OnStar<sup>®</sup> advisor 24 hours a day, 7 days a week.

Terms and conditions of the Subscription Service Agreement can be found at [www.onstar.com](http://www.onstar.com) or [www.onstarcanada.com](http://www.onstarcanada.com).

## OnStar<sup>®</sup> Services

For new vehicles equipped with OnStar<sup>®</sup>, the Safe and Sound Plan is included for the first year. You can extend this plan beyond the first year, or upgrade to the Directions and Connections Plan to meet your needs. For more information, press the OnStar<sup>®</sup> button to speak with an advisor.

## Safe and Sound Plan

- Automatic Notification of Airbag Deployment
- Emergency Services
- Roadside Assistance
- Stolen Vehicle Tracking
- AccidentAssist
- Remote Door Unlock/Vehicle Alert
- Remote Diagnostics
- Online Concierge

## Directions and Connections Plan

- All Safe and Sound Plan Services
- Driving Directions
- RideAssist
- Information and Convenience Services

## OnStar® Personal Calling

As an OnStar® subscriber, the Personal Calling capability is available if your hand-held cell phone is lost, forgotten, or has a low battery. It is a hands-free wireless phone that is integrated into the vehicle. Calls can be placed nationwide using simple voice commands with no additional contracts and no additional roaming charges. To find out more about OnStar® Personal Calling, refer to the OnStar® user's guide in the vehicle's glove box or visit [www.onstar.com](http://www.onstar.com) or [www.onstarcanada.com](http://www.onstarcanada.com); or speak with an OnStar® advisor by pressing the OnStar® button or by calling 1-888-4-ONSTAR (1-888-466-7827).

## OnStar® Virtual Advisor

Virtual Advisor is a feature of OnStar® Personal Calling that uses minutes to access up-to-date weather and traffic reports for your area, news and sports updates, stock quotes, entertainment and more. You are also able to listen and reply to your E-mail through your vehicle's audio system. Customize your information profile at [www.myonstar.com](http://www.myonstar.com). See the OnStar® user's guide for more information.

## HomeLink® Transmitter

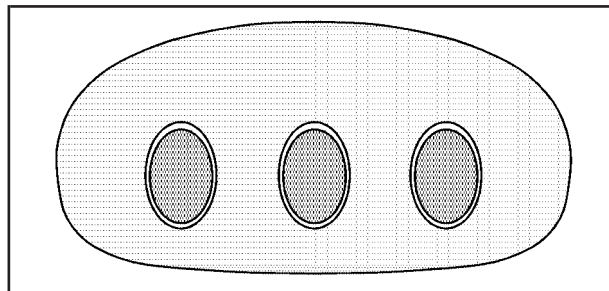

If your vehicle has this feature, the control buttons are located on the driver's sun visor.

HomeLink®, a combined universal transmitter and receiver, provides a way to replace up to three hand-held transmitters used to activate devices such as gate operators, garage door openers, entry door locks, security systems and home lighting. Additional Homelink® information can be found on the internet at [www.homelink.com](http://www.homelink.com) or by calling 1-800-355-3515.

The HomeLink® transmitter operates on a radio frequency subject to Federal Communications Commission (FCC) Rules and with Industry Canada.

This device complies with Part 15 of the FCC Rules. Operation is subject to the following two conditions:

1. This device may not cause harmful interference.
2. This device must accept any interference received, including interference that may cause undesired operation.

This device complies with RSS-210 of Industry Canada. Operation is subject to the following two conditions:

1. This device may not cause harmful interference.
2. This device must accept any interference received, including interference that may cause undesired operation of the device.

Changes or modifications to this system by other than an authorized service facility could void authorization to use this equipment.

## Programming the HomeLink<sup>®</sup> Transmitter

Do not use the HomeLink<sup>®</sup> Transmitter with any garage door opener that does not have the “stop and reverse” feature. This includes any garage door opener model manufactured before April 1, 1982. If you have a newer garage door opener with rolling codes, please be sure to follow Steps 6 through 8 to complete the programming of your HomeLink<sup>®</sup> Transmitter.

Read the instructions completely before attempting to program the HomeLink<sup>®</sup> Transmitter. Because of the steps involved, it may be helpful to have another person available to assist you in programming the transmitter.

Keep the original transmitter for use in other vehicles as well as for future HomeLink<sup>®</sup> programming. It is also recommended that upon the sale of the vehicle, the programmed HomeLink<sup>®</sup> buttons should be erased for security purposes. Refer to “Erasing HomeLink<sup>®</sup> Buttons” or, for assistance, contact HomeLink<sup>®</sup> on the internet at: [www.homelink.com](http://www.homelink.com) or by calling 1-800-355-3515.

Be sure that people and objects are clear of the garage door or gate operator you are programming. When programming a garage door, it is advised to park outside of the garage.

It is recommended that a new battery be installed in your hand-held transmitter for quicker and more accurate transmission of the radio frequency.

## Programming HomeLink®

Your vehicle's engine should be turned off while programming the transmitter. Follow these steps to program up to three channels:

1. Press and hold down the two outside buttons, releasing only when the indicator light begins to flash, after 20 seconds. Do not hold down the buttons for longer than 30 seconds and do not repeat this step to program a second and/or third transmitter to the remaining two HomeLink® buttons.
2. Position the end of your hand-held transmitter about 1 to 3 inches (3 to 8 cm) away from the HomeLink® buttons while keeping the indicator light in view.
3. Simultaneously press and hold both the desired button on HomeLink® and the hand-held transmitter button. Do not release the buttons until Step 4 has been completed.

Some entry gates and garage door openers may require you to substitute Step 3 with the procedure noted in "Gate Operator and Canadian Programming" later in this section.

4. The indicator light will flash slowly at first and then rapidly after HomeLink® successfully receives the frequency signal from the hand-held transmitter. Release both buttons.
5. Press and hold the newly-trained HomeLink® button and observe the indicator light.

If the indicator light stays on constantly, programming is complete and your device should activate when the HomeLink® button is pressed and released.

To program the remaining two HomeLink® buttons, begin with Step 2 under "Programming HomeLink®." Do not repeat Step 1 as this will erase all of the programmed channels.

If the indicator light blinks rapidly for two seconds and then turns to a constant light, continue with Steps 6 through 8 following to complete the programming of a rolling-code equipped device (most commonly, a garage door opener).

6. Locate in the garage, the garage door opener receiver (motor-head unit). Locate the "Learn" or "Smart" button. This can usually be found where the hanging antenna wire is attached to the motor-head unit.

7. Firmly press and release the “Learn” or “Smart” button. The name and color of the button may vary by manufacturer.

You will have 30 seconds to start Step 8.

8. Return to the vehicle. Firmly press and hold the programmed HomeLink<sup>®</sup> button for two seconds, then release. Repeat the press/hold/release sequence a second time, and depending on the brand of the garage door opener (or other rolling code device), repeat this sequence a third time to complete the programming.

HomeLink<sup>®</sup> should now activate your rolling-code equipped device.

To program the remaining two HomeLink<sup>®</sup> buttons, begin with Step 2 of “Programming HomeLink<sup>®</sup>.” You do not want to repeat Step 1, as this will erase all previous programming.

## Gate Operator and Canadian Programming

Canadian radio-frequency laws require transmitter signals to “time out” or quit after several seconds of transmission. This may not be long enough for HomeLink<sup>®</sup> to pick up the signal during programming. Similarly, some U.S. gate operators are manufactured to “time out” in the same manner.

If you live in Canada, or you are having difficulty programming a gate operator by using the “Programming HomeLink<sup>®</sup>” procedures (regardless of where you live), replace Step 3 under “Programming HomeLink<sup>®</sup>” with the following:

Continue to press and hold the HomeLink<sup>®</sup> button while you press and release every two seconds (cycle) your hand-held transmitter until the frequency signal has been successfully accepted by HomeLink<sup>®</sup>. The indicator light will flash slowly at first and then rapidly. Proceed with Step 4 under “Programming HomeLink<sup>®</sup>” to complete.

## Using HomeLink®

Press and hold the appropriate HomeLink® button for at least half of a second. The indicator light will come on while the signal is being transmitted.

## Erasing HomeLink® Buttons

To erase programming from the three buttons do the following:

1. Press and hold down the two outside buttons until the indicator light begins to flash, after 20 seconds. Do not hold the two outside buttons for longer than 30 seconds.
2. Release both buttons.

HomeLink® is now in the train (learning) mode and can be programmed at any time beginning with Step 2 under “Programming HomeLink®” shown earlier in this section.

Individual buttons cannot be erased, but they can be reprogrammed. See “Reprogramming a Single HomeLink® Button” following this section.

## Reprogramming a Single HomeLink® Button

To program a device to HomeLink® using a HomeLink® button previously trained, follow these steps:

1. Press and hold the desired HomeLink® button. Do not release the button.
2. The indicator light will begin to flash after 20 seconds. While still holding the HomeLink® button, proceed with Step 2 under “Programming HomeLink®” shown earlier in this section.

## Resetting Defaults

To reset HomeLink® to default settings do the following:

1. Hold down the two outside buttons for about 20 seconds until the indicator light begins to flash.
2. Continue to hold both buttons until the HomeLink® indicator light turns off.
3. Release both buttons.

For questions or comments, contact HomeLink® at 1-800-355-3515, or on the internet at [www.homelink.com](http://www.homelink.com).

## Storage Areas

### Glove Box

To open the glove box, lift up on the lever. The glove box is lockable. The glove box has a light inside.

### Cupholder(s)

There are two cupholders located on the center console next to the shift lever. To open it, place your thumb on the left side of the lid and slide the handle to the right.

### Center Console Storage Area

To use this storage area, pull up the lid on the driver's side front edge of the console and swing it to the passenger's side.

You can use the key to lock and unlock the console. Do not leave the key in the lock, or it could be damaged when the driver sits down.

## Floor Mats

The floor mats are specially designed to remain in position under your feet and out of reach of the accelerator pedal. The driver's side floor mat is held in place by two locator hooks and the passenger's side is held in place by one.

Be sure that the driver's side floor mat is properly placed on the floor so that it does not block the movement of the accelerator pedal.

### How to Remove and Replace the Floor Mats

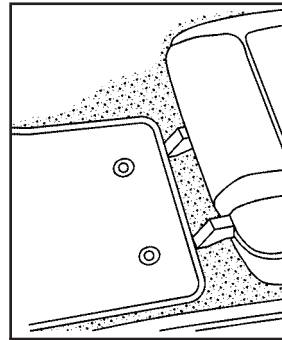

To remove the floor mats, pull up on the rear of the mat to disconnect from the locator hooks.

To reinstall the floor mats, line up the openings in the floor mat over the locator hooks and push down into place.



## Rear Storage Area

There are two rear storage compartments in the floor of the rear hatch/trunk area.

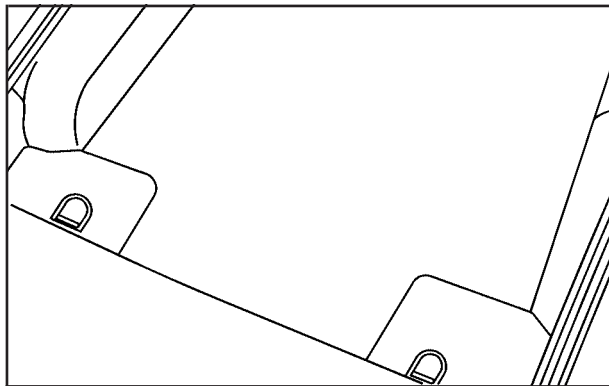

Convertible

Your vehicle will be equipped with two storage compartment lids.

To access a storage compartment, pull up to open the lid. The lids are not removable.

**Notice:** Do not store heavy or sharp objects in the rear storage compartments located in the hatch/trunk area. If you do, the objects could damage the underbody.

## Rear Trunk Partition

For vehicles equipped with the power convertible top option only, there is a trunk partition to keep cargo from getting in the way of the convertible top. The trunk partition must be in place for the top to move. Your vehicle has an indicator that will not allow you to remove the convertible top if the trunk partition is not properly in place.

The trunk partition is a flat carpeted board with a horizontal flap that can be attached to the top of the trunk to divide the storage compartment or stored flat when not in use.

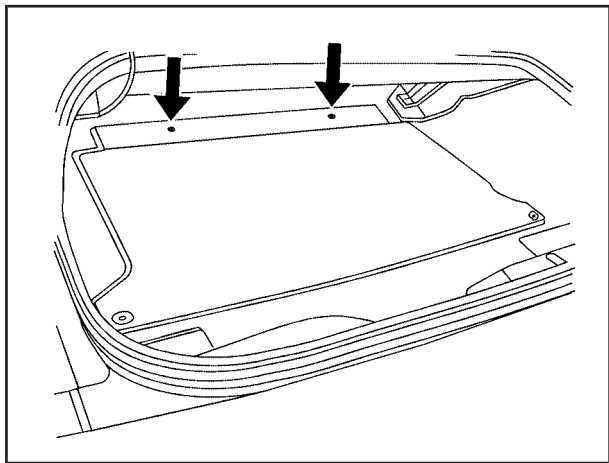

To install the trunk partition, secure the partition onto the retainers located on the floor of the trunk towards the front of the compartment.

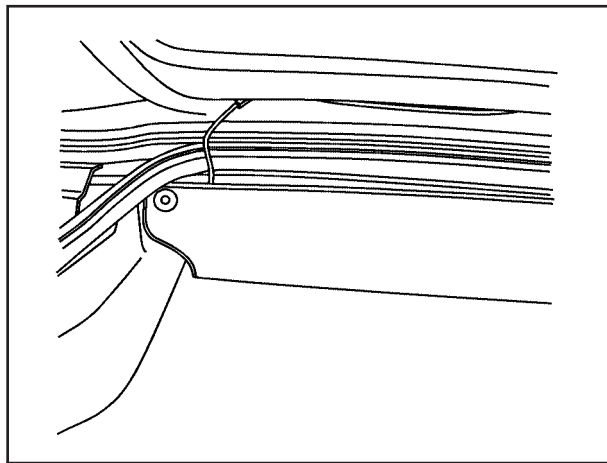

Then pull the divider up and then snap the divider onto the snaps on either side of the trunk.

## Convenience Net

If your vehicle has this feature you will see it on the back wall of the rear area of the vehicle.

Put small loads, like grocery bags, in the net. It can help keep them from falling over during sharp turns or quick starts and stops. The convenience net is not for larger, heavier loads.

You can unhook the net and place it in one of the rear storage compartments when you are not using it.

## Cargo Cover

If your vehicle has this feature, the security shade can provide hidden storage in the rear area of the vehicle. The shade is also helpful in blocking the glare from the removable roof when it is stored in the rear compartment.

## Using the Cargo Cover



1. Hook the elastic loops on the front corners (A) of the shade to the T-nuts located on the front corners of the rear hatch frame.
2. Hook the elastic loops on the rear corners (B) of the shade to the hooks recessed inside the rear hatch frame, near the rear corners.

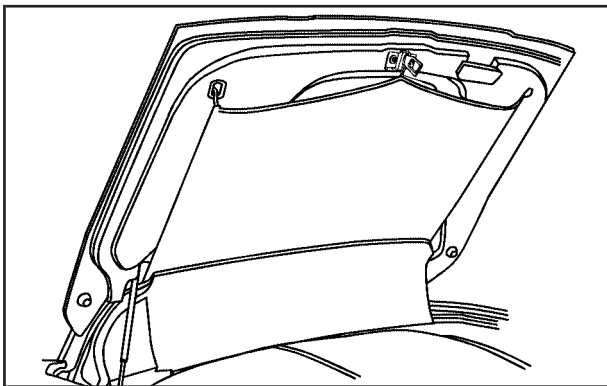

3. Grasp the loop at the rear center of the shade and wrap around the striker assembly.

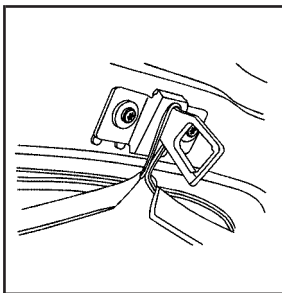

4. Push the loop to the top of the striker (base plate).

## Roof Panel

The vehicle may have a removable roof panel. Follow the procedures listed when removing or installing it.

### Removing the Roof Panel

#### CAUTION:

Do not try to remove a roof panel while the vehicle is moving. Trying to remove the roof panel while the vehicle is moving could cause an accident. The panel could fall into the vehicle and cause you to lose control, or it could fly off and strike another vehicle. You or others could be injured. Remove the roof panel only when the vehicle is parked.

Until you are sure you can remove the panel alone, have someone help you.

**Notice:** If you drop or rest a roof panel on its edges, the roof panel, paint and/or weatherstripping may be damaged. Always place the roof panel in the stowage receivers after removing it from the vehicle.

1. Park on a level surface and set the parking brake. Shift an automatic transmission into PARK (P). Shift a manual transmission into NEUTRAL.
2. Make sure the ignition is OFF.
3. Lower both sun visors.
4. Open the rear hatch and remove any items that may interfere with proper storage of the roof panel.
5. Lower the windows.

There are two release latches on the front of the roof panel and one rear release latch on the back of the roof panel.

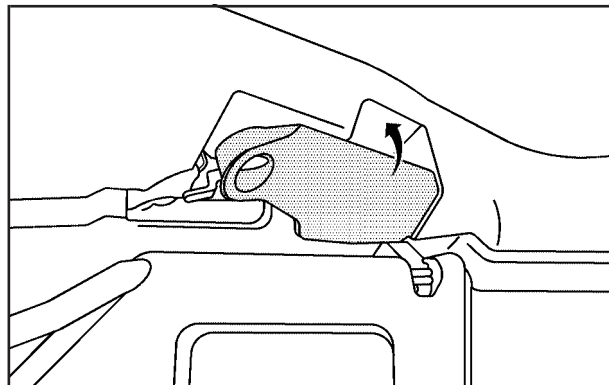

#### **Driver's Side Front Roof Panel Release Latch**

6. To unlock the release latches on the front of the roof panel, grasp each handle with your fingers and pull it outward.

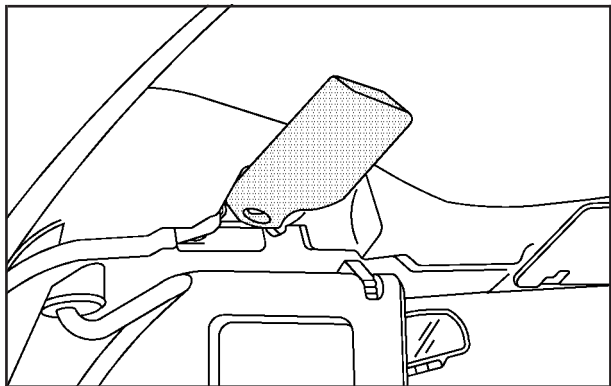

### Driver's Side Rear Roof Panel Release Hatch

The driver's side handle moves toward the driver's door. The passenger's side handle moves toward the passenger's door.

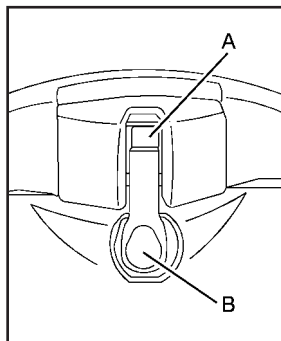

7. To unlock the rear of the roof panel's rear release latch, press the back of the release handle (B). Then press the button on the front of the release handle, (A) with your thumb.

Pull down the latch lever with your fingers.

8. Stand on one side of the vehicle, and if necessary, have someone stand on the other side. Together, carefully lift the front edge of the roof panel up and forward.
9. When the roof panel is loosened from the vehicle, one person should grasp the roof panel as close to the center as possible and lift it away from the vehicle.

## Storing the Roof Panel

### CAUTION:

If a roof panel is not stored properly, it could be thrown about the vehicle in a crash or sudden maneuver. People in the vehicle could be injured. Whenever you store a roof panel in the vehicle, always be sure that it is stored securely in the proper location.

**Notice:** If you drop or rest a roof panel on its edges, the roof panel, paint and/or weatherstripping may be damaged. Always place the roof panel in the storage receivers after removing it from the vehicle.

1. Turn the roof panel so that the front edge of the panel is facing the storage area.

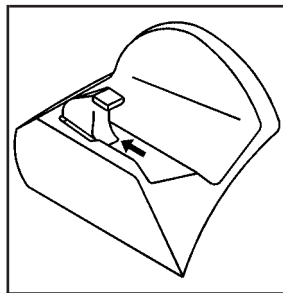

2. Insert the roof panel so that the outside front edges line up between the receiver covers. Push forward on the roof panel until it stops.

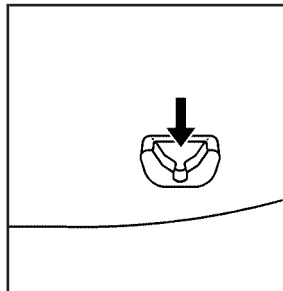

3. Gently place the roof panel down so that the back pins on the roof panel drop into the receivers in the back of the storage area.

## Installing the Roof Panel

### **CAUTION:**

**An improperly attached roof panel may fall into or fly off the vehicle. You or others could be injured. After installing the roof panel, always check that it is firmly attached by pushing up on the underside of the panel. Check now and then to be sure the roof panel is firmly in place.**

***Notice:*** If you drop or rest a roof panel on its edges, the roof panel, paint and/or weatherstripping may be damaged. Always place the roof panel in the storage receivers after removing it from the vehicle.

In most cases, it makes it easier if two people re-install the roof panel.

1. Park on a level surface and set the parking brake. Shift an automatic transmission into PARK (P). Shift a manual transmission into NEUTRAL.
2. Check that the front release latches and the rear release latch on the vehicle's roof opening are in their opened positions before attempting to install the roof panel.
3. If the roof panel is stored in the rear storage area of the vehicle, grasp the rear edge of the roof panel with both hands and gently lift it up and remove it from the storage area.
4. Carefully place the roof panel over the top of the vehicle.
5. Position the rear edge of the roof panel to the weatherstrip on the back of the roof opening. Then align and fit the pins at the rear of the roof panel inside the openings in the rear overhead weatherstrip. Gently lower the front edge of the roof panel to the front of the roof opening.



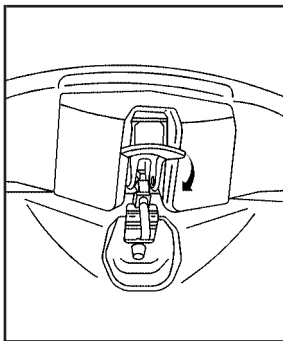

6. Push up on the handle of the rear roof release handle to latch its hook in the closed position.

7. Turn the front release handles inward so that they latch to the closed position.
8. Grasp and tug the roof panel up and down and side-to-side to ensure the roof panel is securely installed.

## Convertible Top

### Convertible Top (Manual)

For care and cleaning of the convertible top, see *Convertible Top on page 5-81* under “Service and Appearance Care”. High pressure car washes may cause water to enter the vehicle.

If the vehicle has this feature, the following procedures explain the proper operation of the manual convertible top.

The parts of the manual convertible top that are used when lowering and raising it are:

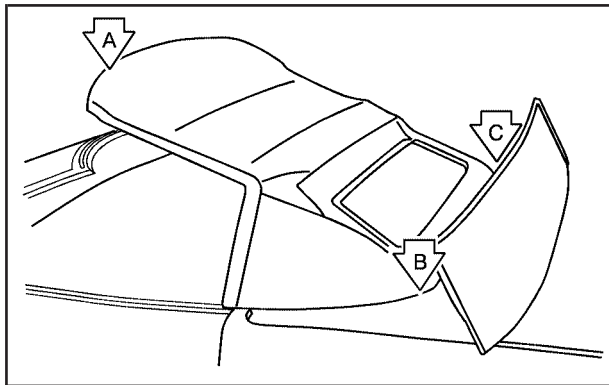

- A. Front Edge of the Convertible Top
- B. Rear Edge of the Convertible Top
- C. Tonneau Cover

**Notice:** Leaving the convertible top down and exposing the interior of your vehicle to outdoor conditions may cause damage. Always close the convertible top if leaving your vehicle outdoors.

**Notice:** Lowering the convertible top when there are objects in the storage area could damage it or break the glass rear window. Always verify that no objects are in the storage area before lowering the convertible top.

**Notice:** Lowering the top if it is damp, wet, or dirty can cause stains, mildew, and damage to the inside of your vehicle. Dry off the top before lowering it.

**Notice:** If you lower the top on your vehicle in cold weather (0°F/-18°C or lower), you may damage top components. Do not lower the convertible top in cold weather.

**Notice:** If you raise or lower the convertible top while the vehicle is in motion, you could damage the top or the top mechanism. The repairs would not be covered by your warranty. Always put an automatic transmission in PARK (P) or a manual transmission in NEUTRAL before raising or lowering the convertible top.

When exiting a vehicle with a manual transmission, put the vehicle into REVERSE (R) and turn the vehicle off.

## Lowering the Manual Convertible Top

1. Park on a level surface and set the parking brake. Shift an automatic transmission into PARK (P). Shift a manual transmission into NEUTRAL.
2. Make sure the ignition is OFF.
3. Make sure the trunk is closed and that the cargo divider in the rear storage area is in the fastened upright position.

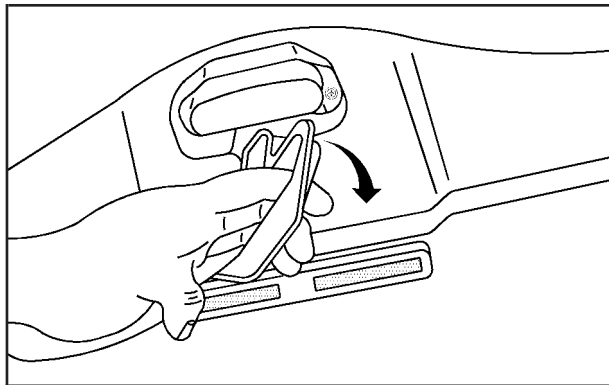

4. The convertible top front latch, located above the inside rearview mirror, must be unlocked. Pull the convertible top front latch down and turn it clockwise to unlock it.

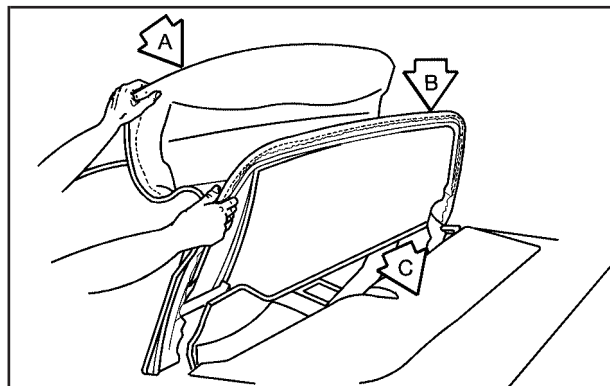

5. Lift upward on the front edge (A) of the convertible top off of the windshield frame. Then lift upward on the rear edge (B) of the convertible top so it is vertical to the tonneau cover (C). The front edge (A) and rear edge (B) should be straight up and locked.

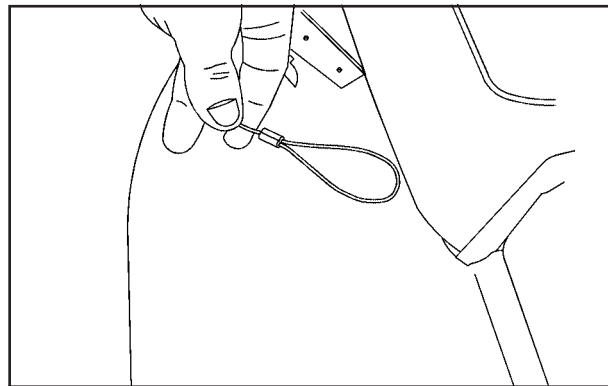
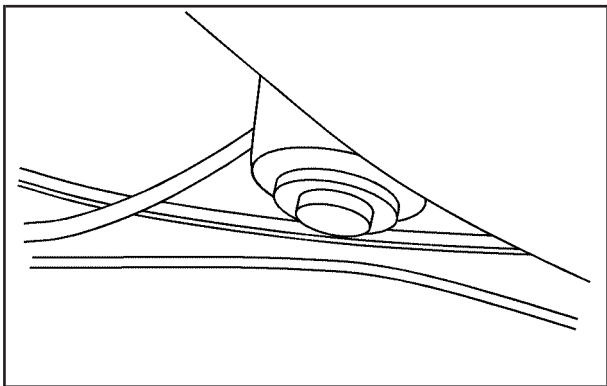

6. Tilt the driver's seatback forward and press the storage compartment release button located on the underside of the tonneau cover (C) behind the driver's seat. Then raise the tonneau cover (C). If the tonneau cover does not release and three chimes are heard, check to make sure the trunk lid is closed. Also, the cover will not release if the vehicle alarm is turned on.

After pressing the release button, the driver's and passenger's door glass should retract to the full-down position.

If the vehicle has lost battery power, the tonneau cover (C) can still be opened using the manual release cable.

The cable is located underneath the carpeting behind the passenger seat, in the center of the vehicle. When using the manual release, first open the doors to prevent damage to the seals. To access the cable, lift and pull back the carpeting. Then pull the cable to release the tonneau cover.

**Notice:** If you lower the convertible top into the storage compartment and the rear edge of the top is not in the full-down position, you could damage the top. Always verify that the rear edge of the convertible top is in the full-down position before lowering the top into the storage compartment.

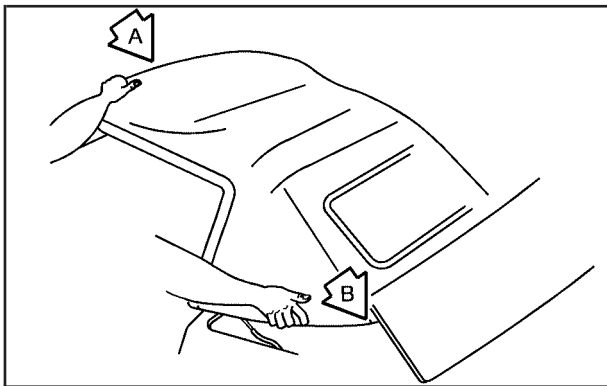

7. Push forward on the front edge (A) of the convertible top to allow the rear edge (B) of the convertible top to be moved to its full-down position.

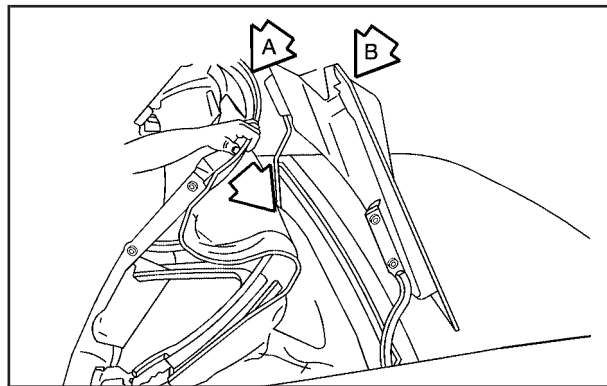

8. Then move the top rearward to its fully-stored position.
9. After the top is stored, apply one even push on the center of the front edge (A) of the convertible top to assure that the top is fully retracted.
10. Close the tonneau cover (B) by pressing down on it with a swift, firm motion.

## Raising the Manual Convertible Top

1. Park on a level surface, set the parking brake firmly and shift an automatic transmission into PARK (P). Shift a manual transmission into NEUTRAL.
2. Lower both windows.
3. Make sure the ignition is OFF.
4. Tilt the driver's seat forward and press the tonneau cover release button, or use the manual release cable if battery power has been lost. See step six under "Lowering the Manual Convertible Top" earlier in this section.

After pressing the release button, the driver and passenger door glass should retract to the full-down position, if they have not already been lowered.

5. Lift the tonneau cover.

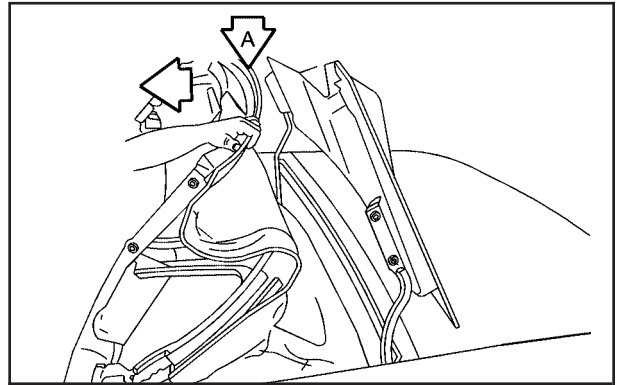

6. Pull the convertible top up by firmly gripping the front edge (A) near the center and applying a brisk upward and forward motion to get the top in the full-up position.

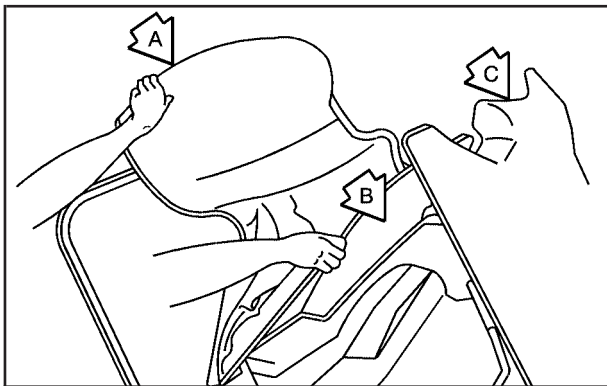

7. Lift the rear edge (B) of the convertible top to its full-up position by first raising the front edge (A).
8. Close the tonneau cover (C) by pushing it down with a swift, firm motion.
9. Lower the rear edge (B) of the convertible top by first slightly pushing the front edge (A) of the convertible top forward.
10. Push the front edge (A) of the convertible top down from the outside of the vehicle, or pull the front edge (A) of the convertible top down from the center pull-down handle located in the inside of the vehicle.

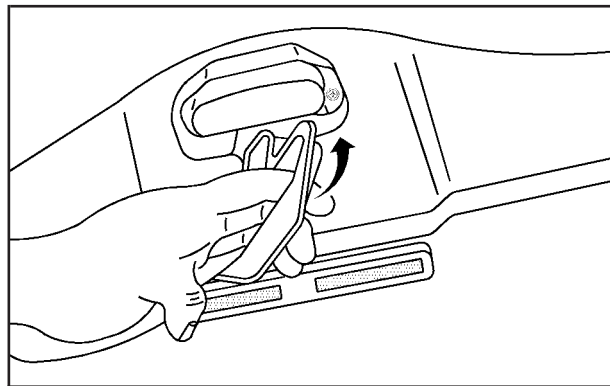

11. Pull the top front latch handle down and turn it counterclockwise to lock the convertible top.

## Convertible Top (Power)

For care and cleaning of the convertible top see *Convertible Top on page 5-81* under “Service and Appearance Care”. High pressure car washes may cause water to enter the vehicle.

To operate the power convertible top use the following steps.

**Notice:** Leaving the convertible top down and exposing the interior of your vehicle to outdoor conditions may cause damage. Always close the convertible top if leaving your vehicle outdoors.

**Notice:** Lowering the convertible top when there are objects in the storage area could damage it or break the glass rear window. Always verify that no objects are in the storage area before lowering the convertible top.

**Notice:** Lowering the top if it is damp, wet, or dirty can cause stains, mildew, and damage to the inside of your vehicle. Dry off the top before lowering it.

**Notice:** If you lower the top on your vehicle in cold weather (0°F/-18°C or lower), you may damage top components. Do not lower the convertible top in cold weather.

**Notice:** If you raise or lower the convertible top while the vehicle is in motion, you could damage the top or the top mechanism. The repairs would not be covered by your warranty. Always put an automatic transmission in PARK (P) or a manual transmission in NEUTRAL before raising or lowering the convertible top.

**Notice:** If you do not put a manual transmission in REVERSE (R) before exiting your vehicle, the battery will drain and could be damaged. Always put a manual transmission in REVERSE (R) before shutting off the engine and exiting the vehicle.

When exiting a vehicle with a manual transmission, put the vehicle into REVERSE (R) and turn the vehicle off.



## Lowering the Power Convertible Top

1. Park on a level surface and set the parking brake. The vehicle must be running or in ACC. Shift an automatic transmission into PARK (P). Shift a manual transmission into NEUTRAL.
2. Make sure the trunk is closed and that the trunk partition in the rear storage area is in the fastened, upright position, and that no objects are forward of the divider.

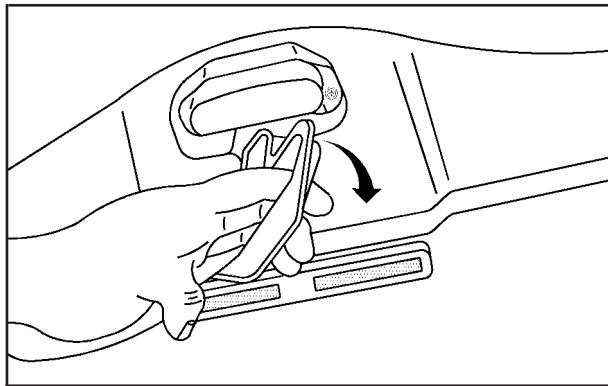

3. Release the convertible top front latch, located above the inside rearview mirror, by pulling and turning it clockwise toward the driver's door. The windows will automatically lower.

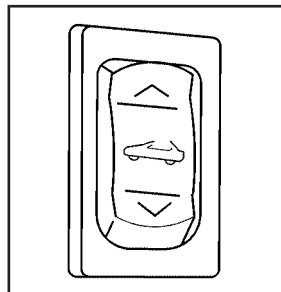

4. Push and hold the bottom of the power convertible top button, located to the left of the steering wheel, on the instrument panel.

The windows will automatically lower and the convertible top will lower into the rear of the vehicle. A chime will sound when the convertible top has lowered completely. If the radio is on the sound may be muted for a brief time.

If the convertible top is operated multiple times, the engine should be running to prevent drain on the vehicle's battery. Under certain conditions, the Driver Information Center (DIC) may display a message regarding the power convertible top. See *DIC Warnings and Messages on page 3-53* for more information.

## Raising the Power Convertible Top

**Notice:** If you raise or lower the convertible top while the vehicle is in motion, you could damage the top or the top mechanism. The repairs would not be covered by your warranty. Always put an automatic transmission in PARK (P) or a manual transmission in NEUTRAL before raising or lowering the convertible top.

**Notice:** If you do not put a manual transmission in REVERSE (R) before exiting your vehicle, the battery will drain and could be damaged. Always put a manual transmission in REVERSE (R) before shutting off the engine and exiting the vehicle.

When exiting a vehicle with a manual transmission, put the vehicle into REVERSE (R) and turn the vehicle off.

1. Park on a level surface and set the parking brake. the vehicle must be running or in ACC. Shift an automatic transmission into PARK (P). Shift a manual transmission into NEUTRAL.
2. Make sure the trunk lid is closed and the trunk partition in the rear storage area is in the fastened, upright position, and that no objects are forward of the divider.

3. Push and hold the top of the power convertible button. The top will raise and the windows will lower if they were in the raised position. A chime will sound when the top is raised completely.
4. After the convertible top is completely raised, release the power convertible top button. If the button is pressed again within five seconds the windows will raise.
5. Pull the convertible front top latch down and turn it counterclockwise to lock the convertible top.

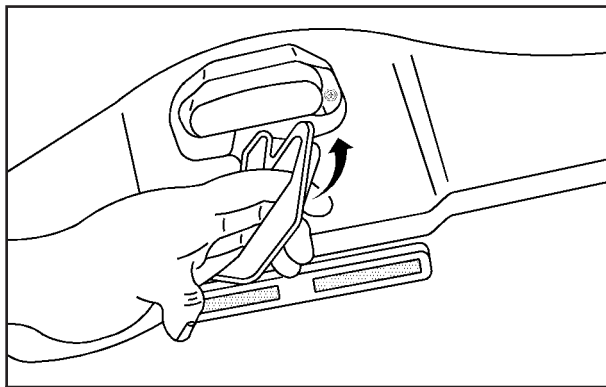

If the radio is on the sound may be muted for a brief time.

If the vehicle has lost power, the convertible top can still be raised by releasing pressure on the hydraulic pump, located in the engine compartment on the passenger side of the vehicle, by using the following steps.

1. Raise the hood to the engine compartment.

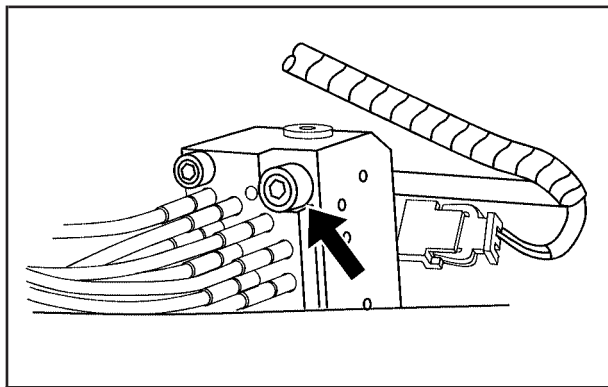

2. Locate the pressure release bolt on the front side of the hydraulic pump.

3. Use the wrench, attached to the inboard side of the hydraulic pump, and turn the pressure release bolt counterclockwise one revolution, to relieve pressure to the hydraulic pump. This will allow you to manually raise the convertible top.
4. Then follow the steps under raising the manual convertible top. See “Convertible Top (Manual)” under *Convertible Top (Manual)* on page 2-55 or *Convertible Top (Power)* on page 2-62

When power is restored to the vehicle, the hydraulic bolt must be tightened, by turning it clockwise. The power convertible top button can then be used to lower or raise the convertible top.

If the power convertible top is operated multiple times, the engine should be running to prevent drain on the vehicle’s battery. Under certain conditions, the Driver Information Center (DIC) may display a message regarding the power top. See *DIC Warnings and Messages* on page 3-53 for more information.

# Vehicle Personalization

## Memory

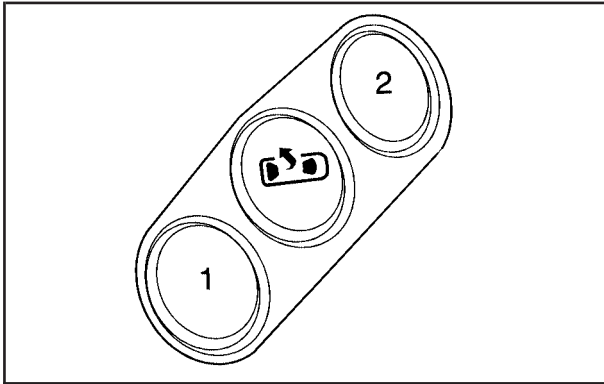

If your vehicle has this feature, memory can program and recall the settings for the driver's seating position. The controls for this feature are located on the driver's door.

The numbers on the back of the keyless access transmitters, 1 and 2, correspond to the numbers on the memory buttons.

To program each button, use the following steps:

1. Adjust the settings for the driver's seat position, both outside mirrors and the telescopic steering column position to a comfortable driving position.
2. Press and hold button 1 until two beeps are heard, then release the button.

Your settings are now programmed.

A second seating, mirror and telescopic steering column position can be programmed by repeating the above steps and pressing button 2 for driver 2.

To recall a memory position, do one of the following:

- If you have an automatic transmission vehicle, press and release the desired button 1 or 2 while the vehicle is in PARK (P).

A single beep will sound and the memory position will be recalled after a brief delay.

If the vehicle is not in PARK (P), three beeps will sound and the memory position will not be recalled.

- If you have a manual transmission vehicle, press and release the desired button 1 or 2. If the vehicle is on, the parking brake needs to be set to recall the memory position.

A single beep will sound and the memory position will be recalled after a brief delay.

If the vehicle is on and the parking brake is not set, three beeps will sound and the memory position will not be recalled.

If your vehicle has the Auto Memory Recall feature and it is turned on in the Driver Information Center (DIC), the seat, mirrors and telescopic steering column position will automatically adjust to their programmed positions when the engine is started. See "Auto Memory Recall" under *DIC Vehicle Personalization on page 3-67* for more information.

To stop recall movement of the memory feature at any time, press one of the power seat controls, power mirror control buttons, memory buttons, or the telescopic steering column switch.

## Easy Exit Seat

Two personalized exit positions can also be programmed to allow for an easy exit or entry into the vehicle. The controls for this memory function are located on the driver's door.

 **(Easy Exit Seat):** This button is used to program and recall the desired driver's seat exit position.

To program an exit position, use the following steps:

1. Recall the desired driving position by pressing button 1 or 2.

The seat will move to the programmed memory position.

2. Position the seat and the telescopic steering column position to a comfortable exit position.

3. Press and hold the exit button until two beeps sound.

Your exit position is now programmed.

A second exit position can be programmed by repeating the above steps and pressing the other memory button.

To recall an exit position, do one of the following:

- If you have an automatic transmission vehicle, press and release the exit button while the vehicle is in PARK (P).

One beep will sound and the exit position for the currently identified driver will be recalled.

- If you have a manual transmission vehicle, press and release the exit button. If the vehicle is on, the parking brake needs to be set to recall the memory position.

One beep will sound and the exit position for the currently identified driver will be recalled.

If your vehicle has the Auto Exit Recall feature and it is turned on in the DIC, automatic seat and telescopic steering column movement to the exit position will occur when you use the keyless access transmitter to unlock your vehicle or when you turn the engine off and open the driver's door. See "Auto Exit Recall" under *DIC Vehicle Personalization on page 3-67* for more information.



## Section 3 Instrument Panel

---

<b>Instrument Panel Overview</b> .....	3-4	Battery Run-Down Protection .....	3-19
Hazard Warning Flashers .....	3-6	Head-Up Display (HUD) .....	3-19
Other Warning Devices .....	3-6	Accessory Power Outlets .....	3-23
Horn .....	3-6	Ashtrays and Cigarette Lighter .....	3-24
Tilt Wheel .....	3-7	<b>Climate Controls</b> .....	3-24
Turn Signal/Multifunction Lever .....	3-8	Dual Automatic Climate Control System .....	3-24
Turn and Lane-Change Signals (Auto Signal) .....	3-8	Outlet Adjustment .....	3-29
Headlamp High/Low-Beam Changer .....	3-9	Passenger Compartment Air Filter .....	3-30
Flash-to-Pass .....	3-9	<b>Warning Lights, Gages, and Indicators</b> .....	3-31
Windshield Wipers .....	3-9	Instrument Panel Cluster .....	3-32
Windshield Washer .....	3-10	Speedometer and Odometer .....	3-33
Cruise Control .....	3-11	Tachometer .....	3-33
Exterior Lamps .....	3-14	Safety Belt Reminder Light .....	3-33
Wiper Activated Headlamps .....	3-15	Airbag Readiness Light .....	3-34
Headlamps on Reminder .....	3-15	Airbag Off Light .....	3-35
Daytime Running Lamps (DRL) .....	3-15	Voltmeter Gage .....	3-36
Fog Lamps .....	3-16	One-to-Four Shift Light (Manual Transmission) .....	3-37
Twilight Sentinel® .....	3-17	Brake System Warning Light .....	3-37
Exterior Lighting Battery Saver .....	3-18	Anti-Lock Brake System Warning Light .....	3-38
Instrument Panel Brightness .....	3-18	Traction Control System (TCS) Warning Light .....	3-39
Courtesy Lamps .....	3-18	Active Handling System Light .....	3-39
Entry/Exit Lighting .....	3-18	Engine Coolant Temperature Gage .....	3-40
Reading Lamps .....	3-18	Tire Pressure Light .....	3-41

## Section 3 Instrument Panel

---

Malfunction Indicator Lamp .....	3-41	<b>Audio System(s)</b> .....	3-76
Engine Oil Pressure Gage .....	3-44	Setting the Time .....	3-76
Security Light .....	3-45	Radio with CD .....	3-76
Fog Lamp Light .....	3-45	Navigation/Radio System .....	3-94
Lights On Reminder .....	3-46	Theft-Deterrent Feature .....	3-94
Highbeam On Light .....	3-46	Radio Reception .....	3-95
Fuel Gage .....	3-46	Care of Your CDs .....	3-95
<b>Driver Information Center (DIC)</b> .....	3-47	Care of Your CD Player .....	3-95
DIC Controls and Displays .....	3-48	Diversity Antenna System .....	3-95
DIC Warnings and Messages .....	3-53	XM™ Satellite Radio Antenna System .....	3-95
Other Messages .....	3-66		
DIC Vehicle Personalization .....	3-67		





# Instrument Panel Overview

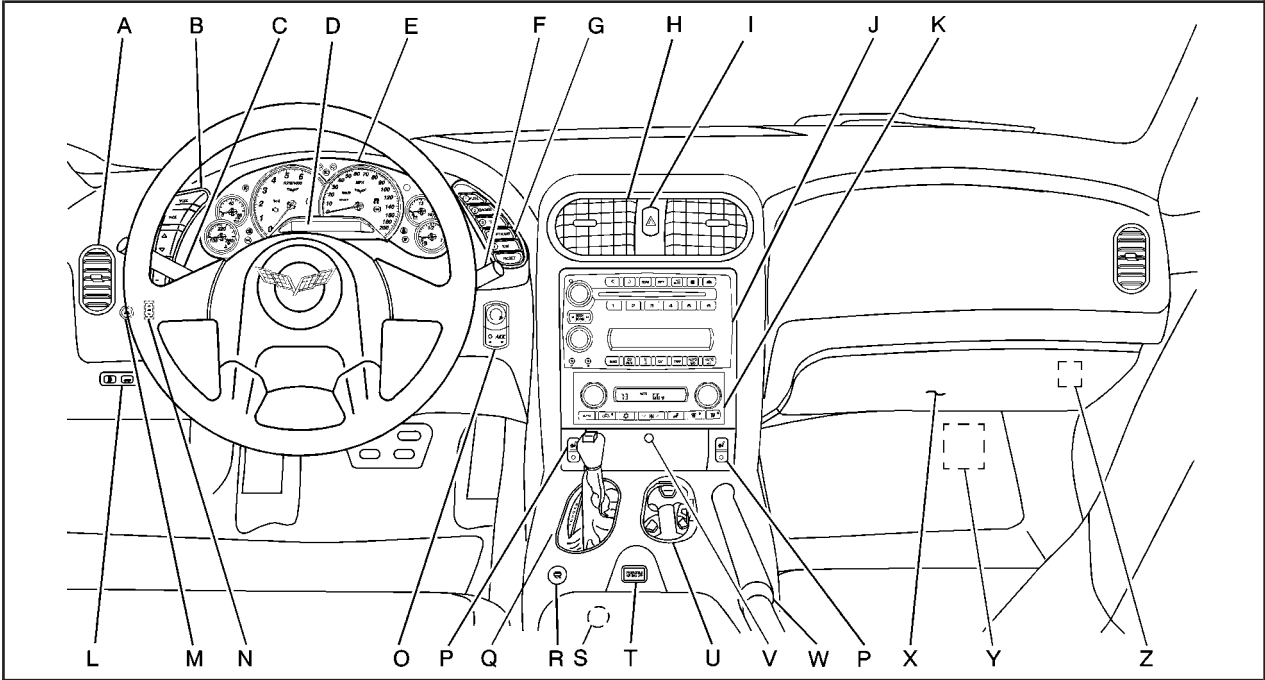

The main components of your instrument panel are the following:

- A. Air Outlet. See *Outlet Adjustment on page 3-29.*
- B. Head-Up Display Controls. See *Head-Up Display (HUD) on page 3-19.*
- C. Turn Signal/Multifunction Lever. See *Turn Signal/Multifunction Lever on page 3-8.* Cruise Control. See *Cruise Control on page 3-11.* Fog Lamps. See *Fog Lamps on page 3-16.* Headlamp Controls. See *Exterior Lamps on page 3-14.*
- D. Driver Information Center (DIC). See *Driver Information Center (DIC) on page 3-47.*
- E. Instrument Panel Cluster. See *Instrument Panel Cluster on page 3-32.*
- F. Windshield Wiper/Washer Lever. See *Windshield Wipers on page 3-9* and *Windshield Washer on page 3-10.*
- G. Driver Information Center (DIC) Controls. See *DIC Controls and Displays on page 3-48.*
- H. Center Air Outlets. See *Outlet Adjustment on page 3-29.*
- I. Hazard Warning Flasher Button. See *Hazard Warning Flashers on page 3-6.*
- J. Audio System. See *Audio System(s) on page 3-76.*
- K. Climate Controls. See *Dual Automatic Climate Control System on page 3-24.*
- L. Fuel Door Release Button. See *Filling Your Tank on page 5-7.* Hatch/Trunk Release Button. See "Hatch/Trunk Lid Release" under *Hatch/Trunk on page 2-14.*
- M. Instrument Panel Brightness Control. See *Instrument Panel Brightness on page 3-18.*
- N. Power Folding Top Switch. See *Convertible Top (Manual) on page 2-55* or *Convertible Top (Power) on page 2-62.*
- O. Ignition Switch. See *Ignition Positions on page 2-20.*
- P. Heated Seat Controls. See *Heated Seats on page 1-4.*
- Q. Shift Lever (Automatic Shown). See *Automatic Transmission Operation on page 2-24* or *Manual Transmission Operation on page 2-26.*
- R. Active Handling Button. See *Active Handling System on page 4-10.*
- S. Accessory Power Outlet. See *Accessory Power Outlets on page 3-23.*
- T. Airbag Off Light. See *Airbag Off Light on page 3-35.*
- U. Instrument Panel Cupholder. See *Cupholder(s) on page 2-46.*

- V. Ashtray and Cigarette Lighter. See *Ashtrays and Cigarette Lighter* on page 3-24.
- W. Parking Brake. See *Parking Brake* on page 2-29.
- X. Glove Box. See *Glove Box* on page 2-46.
- Y. Instrument Panel Fuse Block. See *Instrument Panel Fuse Block* on page 5-88.
- Z. Airbag Off Switch. See *Airbag Off Switch* on page 1-48.

## Hazard Warning Flashers

Your hazard warning flashers let you warn others. They also let police know you have a problem. Your front and rear turn signal lamps will flash on and off.

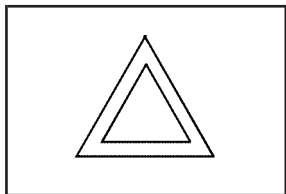

The hazard warning flasher button is located near the center of the instrument panel.

Your hazard warning flashers work no matter what mode the ignition is in, even if the ignition is turned off.

Press the button to make the front and rear turn signal lamps flash on and off. Press the button again to turn the flashers off.

When the hazard warning flashers are on, your turn signals will not work.

## Other Warning Devices

If you carry reflective triangles, you can set them up at the side of the road about 300 feet (100 m) behind your vehicle.

## Horn

Press near or on the horn symbols on your steering wheel pad to sound the horn.

## Tilt Wheel

A tilt wheel allows you to adjust the steering wheel before you drive. You can raise it to the highest level to give your legs more room when you exit and enter the vehicle.

The lever that allows you to tilt the steering wheel is located on the left side of the steering column.



To tilt the wheel, hold the steering wheel and pull the lever toward you. Then move the wheel to a comfortable position and release the lever to lock the wheel in place.

## Telescopic Steering Column

If your vehicle has this feature, the telescopic steering column will allow you to adjust the distance the steering wheel is from the instrument panel.

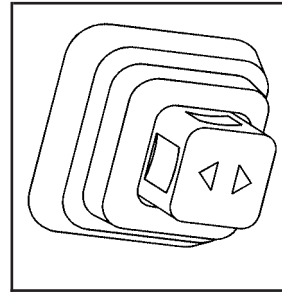

The telescopic steering column switch is located on the right side of the steering column.





To operate the telescopic steering column, push the switch forward and the wheel will move away from you. Pull the switch rearward and the wheel will move toward you.

The telescopic steering column position can be stored with your memory settings. See *Memory* on page 2-66 for more information.

## Turn Signal/Multifunction Lever



The lever on the left side of the steering column includes the following:

-  Turn and Lane-Change Signals. See *Turn and Lane-Change Signals (Auto Signal)* on page 3-8
-  Headlamp High/Low-Beam Changer. See *Headlamp High/Low-Beam Changer* on page 3-9
-  Fog Lamps. See *Fog Lamps* on page 3-16
- Flash-to-Pass Feature. See *Flash-to-Pass* on page 3-9.
-  Cruise Control. See *Cruise Control* on page 3-11.
-  Exterior Lamps Control. See *Exterior Lamps* on page 3-14.

## Turn and Lane-Change Signals (Auto Signal)

The turn signal has two upward (for right) and two downward (for left) positions. These positions allow you to signal a turn or a lane change.

To signal a turn, move the multifunction lever all the way up or down. When the turn is finished, the lever will return automatically.

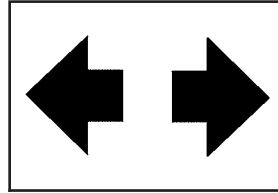

An arrow on the instrument panel cluster will flash in the direction of the turn or lane change.

To signal a lane change, just raise or lower the lever until the arrow starts to flash. Release the lever and the turn signal will automatically flash three times. If more flashes are desired, continue to hold the lever.

If you signal a turn or a lane change and the arrows flash faster than normal, a signal bulb may be burned out.

If a bulb is burned out, replace it to help avoid an accident. If the arrows do not go on at all when you signal a turn, check the fuses and check for burned-out bulbs. See *Fuses and Circuit Breakers* on page 5-87.

## Turn Signal on Chime

A chime will remind you if you leave the turn signal on for more than three-quarters of a mile (1.2 km) of driving.

If you need to leave the turn signal on for more than three-quarters of a mile (1.2 km), turn off the signal and then turn it back on.

## Headlamp High/Low-Beam Changer

To change the headlamps from low beam to high or high to low, push the turn signal lever all the way forward.

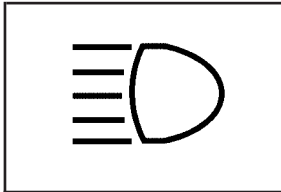

While the high beams are on, this light on the instrument panel cluster also will be on. To change the headlamps from high to low, pull the lever rearward.

## Flash-to-Pass

To use the flash-to-pass feature, momentarily pull the turn signal lever toward you. The high-beam indicator will flash to indicate to the other driver that you intend to pass. If the low-beam headlamps are off and you have the optional fog lamps on, the fog lamps will flash.

## Windshield Wipers





Use the lever located on the right side of the steering column to operate the windshield wipers.

 **(High Speed):** Move the lever to this position for steady wiping at high speed.

 **(Low Speed):** Move the lever to this position for steady wiping at low speed.

 **(Delay):** Move the lever to this position to set a delay between wipes.

 **(Delay Adjustment):** Move the lever to this position to choose a delayed wiping cycle. Turn the intermittent adjust band down for a longer delay or up for a shorter delay. The wiper speed can only be manually adjusted when the lever is in this position.

 **(Speed Sensitive Wipers):** Move the lever to this position for speed sensitive operation. When you select this position, the delay will change with your vehicle's speed. The delay will decrease as you go faster and increase when you go slower.

 **(Off):** Move the lever to this position to turn off the windshield wipers.

 **(Mist):** Move the lever all the way down to mist and release for a single wiping cycle. The windshield wipers will stop after one wipe. If you want more wipes, hold the band on mist longer.

Heavy snow or ice can overload the wipers. If this occurs, a circuit breaker will stop the wipers until the motor cools. So, be sure to clear any ice and snow from the windshield wiper blades before using them. If the wiper blades are frozen to the windshield, carefully loosen them or warm the windshield before turning the wipers on. If your blades do become worn or damaged, get new blades or blade inserts.

## Windshield Washer

The lever on the right side of the steering column also controls the windshield washer. There is a button at the end of the lever. To spray washer fluid on the windshield, press the button and hold it. The washer will spray until you release the button. The wipers will continue to clear the window for about six seconds after the button is released and then stop or return to your preset speed.

### **CAUTION:**

**In freezing weather, do not use your washer until the windshield is warmed. Otherwise the washer fluid can form ice on the windshield, blocking your vision.**

If the fluid in the windshield washer fluid reservoir is low, the message CHECK WASHER FLUID will appear on the Driver Information Center (DIC) display. It will take 15 seconds after the bottle is refilled for this message to turn off. For information on the correct washer fluid to use, see *Windshield Washer Fluid* on page 5-34 and *Recommended Fluids and Lubricants* on page 6-11.



## Cruise Control

Your vehicle is equipped with cruise control.

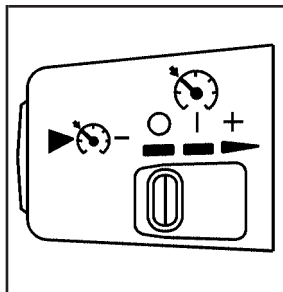

○ **(Off):** This position turns the system off.

| **(On):** This position activates the system.

**+ (Resume/Accelerate):** Move the lever to this symbol to make the vehicle accelerate or resume to a previously set speed.

**Ⓢ (Set):** Press this button to set the speed.

With cruise control, you can maintain a speed of about 25 mph (40 km/h) or more without keeping your foot on the accelerator. This can really help on long trips. Cruise control does not work at speeds below about 25 mph (40 km/h).

Cruise control will not work if your parking brake is set, or if the master cylinder brake fluid level is low.

If you apply your brakes, the cruise control will shut off.

### **CAUTION:**

**Cruise control can be dangerous where you cannot drive safely at a steady speed. So, do not use your cruise control on winding roads or in heavy traffic.**

**Cruise control can be dangerous on slippery roads. On such roads, fast changes in tire traction can cause needless wheel spinning, and you could lose control. Do not use cruise control on slippery roads.**

If your vehicle is in cruise control when the traction control system (if equipped) begins to limit wheel spin, the cruise control will automatically disengage. See *Traction Control System (TCS)* on page 4-9. When road conditions allow you to safely use it again, you may turn cruise control back on.

## Setting Cruise Control

### CAUTION:

If you leave your cruise control on when you are not using cruise, you might hit a button and go into cruise when you do not want to. You could be startled and even lose control. Keep the cruise control switch off until you want to use cruise control.

1. Move the cruise control switch to on.
2. Get up to the speed you want.
3. Press in the set button at the end of the lever and release it.
4. Take your foot off the accelerator pedal.

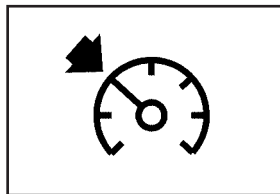

The cruise symbol on the instrument panel will illuminate when the cruise control is engaged.

### Resuming a Set Speed

Suppose you set your cruise control at a desired speed and then you apply the brake. This, of course, disengages the cruise control. But you don't need to reset it.

Once you're going about 25 mph (40 km/h) or more, you can move the cruise control switch briefly from on to resume/accelerate.

You'll go right back up to your chosen speed and stay there.

If you hold the switch at resume/accelerate the vehicle will keep going faster until you release the switch or apply the brake. So unless you want to go faster, don't hold the switch at resume/accelerate.

## **Increasing Speed While Using Cruise Control**

There are two ways to go to a higher speed:

- Use the accelerator pedal to get to the higher speed. Press the set button at the end of the lever, then release the button and the accelerator pedal. You'll now cruise at the higher speed. If the accelerator pedal is held longer than 60 seconds, cruise control will turn off.
- Move the cruise switch from on to resume/accelerate. Hold it there until you get up to the speed you want, and then release the switch. To increase your speed in very small amounts, move the switch briefly to resume/accelerate. Each time you do this, your vehicle will go about 1 mph (1.6 km/h) faster.

## **Reducing Speed While Using Cruise Control**

- Press and hold the set button until you reach the lower speed you want, then release it.
- To slow down in very small amounts, briefly press the set button. Each time you do this, you'll go about 1 mph (1.6 km/h) slower.

## **Passing Another Vehicle While Using Cruise Control**

Use the accelerator pedal to increase your speed. When you take your foot off the pedal, your vehicle will slow down to the cruise control speed you set earlier.

## **Using Cruise Control on Hills**

How well your cruise control will work on hills depends upon your speed, load and the steepness of the hills. When going up steep hills, you may want to step on the accelerator pedal to maintain your speed. When going downhill, you may have to brake or shift to a lower gear to keep your speed down. Of course, applying the brake takes you out of cruise control. Many drivers find this to be too much trouble and don't use cruise control on steep hills.

## **Ending Cruise Control**

To end a cruise control session, step lightly on the brake pedal. If your vehicle has a manual transmission, lightly tapping the clutch will also end a cruise control session.

Stepping on the brake or clutch pedal will end the current cruise control session only. Move the cruise control switch to off to turn the system completely off.

## Erasing Speed Memory

When you turn off the cruise control or the ignition, your cruise control set speed memory is erased.

## Exterior Lamps



The exterior lamp control is located to the left of the steering wheel on the multifunction lever.

 **(Exterior Lamp Control):** Turn the band with this symbol on it to operate the exterior lamps.

The exterior lamp band has four positions:

 **(Off):** Turning the band to this position turns off all lamps.

**AUTO (Automatic):** Turning the band to this position sets the exterior lamps in automatic mode. AUTO mode will turn the exterior lamps on and off depending on how much light is available outside the vehicle.

To override AUTO mode, turn the control to off.

To reset to AUTO mode turn the control to exterior lamps and then back to AUTO. Automatic mode will also reset when your vehicle is turned off and then back on again when the control is left in the AUTO position.

 **(Parking Lamp):** Turning the band to this position turns on the parking lamps together with the following:

- Sidemarkers Lamps
- Taillamps
- License Plate Lamps
- Instrument Panel Lights

The parking brake indicator light will come on and stay on when the parking lamps are on with the engine off and the ignition to ACC.

 **(Headlamps):** Turning the control to this position turns on the headlamps, together with the previously listed lamps and lights.

## Wiper Activated Headlamps

This feature activates the headlamps and parking lamps after the windshield wipers have been in use for approximately 15 seconds and deactivates and returns to ambient lighting conditions 15 seconds after the wipers are turned off.

If the exterior lamp control has been turned off or is in the parking lamp position while the wiper control is active in any position, the HEADLAMPS SUGGESTED message will appear on the Driver Information Center (DIC).

When the ignition is turned off, the wiper-activated headlamps will immediately turn off.

## Headlamps on Reminder

A warning chime will sound if the exterior lamp control is left on in either the headlamp or parking lamp position and the driver's door is opened with the ignition off.

## Daytime Running Lamps (DRL)

Daytime Running Lamps (DRL) can make it easier for others to see the front of your vehicle during the day. DRL can be helpful in many different driving conditions, but they can be especially helpful in the short periods after dawn and before sunset. Fully functional daytime running lamps are required on all vehicles first sold in Canada.

The DRL system will make the front turn signal lamps come on when the following conditions are met:

- It is still daylight and the ignition is on,
- the exterior lamp control is in the off position and
- the transmission is not in PARK (P).

When DRL are on, only the front turn signal lamps will be on. No other exterior lamps such as the parking lamps, taillamps, etc. will be on when the DRL are being used. Your instrument panel will not be lit up either.

When it is dark enough outside, the front turn signal lamps will turn off and normal low-beam headlamps will turn on.

When it is bright enough outside, the regular lamps will go off, and the front turn signal lamps will take over. If you start your vehicle in a dark garage, the automatic headlamp system will come on immediately. Once you leave the garage, it will take approximately one minute for the automatic headlamp system to change to DRL if it is light outside. During that delay, your instrument panel cluster may not be as bright as usual. Make sure your instrument panel brightness knob is in the full bright position. See *Instrument Panel Brightness on page 3-18* for more information.

If it is dark enough outside and the exterior lamp control is off, a HEADLAMPS SUGGESTED message will display on the Driver's Information Center (DIC). This message informs the driver that turning on the exterior lamps is recommended.

Turning the exterior lamp control to off a second time, or turning on the headlamps will remove the HEADLAMPS SUGGESTED message. If the parking lamps or the fog lamps were turned on instead, the HEADLAMPS SUGGESTED message will continue to be displayed.

As with any vehicle, you should turn on the regular headlamp system when you need it.

## Fog Lamps

Use fog lamps for better vision in foggy or misty conditions.

The fog lamps control is located on the multifunction lever next to the exterior lamp control.

 **(Fog Lamps):** Turning the band to this position will turn the fog lamps on.

When you turn the fog lamps on, the fog lamp light will appear on the instrument panel cluster to indicate that the fog lamps and the parking lamps are on.

If you turn the high-beam headlamps on, the fog lamps will turn off. They will turn on again when you switch to low-beam headlamps.

The ignition must be on for the fog lamps to operate.

## Twilight Sentinel®

Twilight Sentinel® can turn your lamps on and off for you. A light sensor on top of the instrument panel makes the Twilight Sentinel® work, so be sure it is not covered.

With Twilight Sentinel®, you will see the following happen:

- When it is dark enough outside, the front turn signal lamps (DRL) will go off, and the headlamps and parking lamps will come on. The other lamps that come on with headlamps will also come on.
- When it is bright enough outside, the headlamps will go off, and the front turn signal lamps (DRL) will come on, as long as the exterior lamp switch is in the AUTO position.

If you start your vehicle in a dark garage, the automatic headlamp system will come on immediately. Once you leave the garage, it will take about one minute for the automatic headlamp system to change to DRL if it is light outside. During that delay, your instrument panel cluster may not be as bright as usual. Make sure your instrument panel brightness control is in full bright position. See *Instrument Panel Brightness on page 3-18*.

You can idle the vehicle with the lamps off, even when it is dark outside.

After starting the vehicle, turn the exterior lamp control band on the multifunction lever to off and then release it. The lamps will remain off until you turn the control band to off again.

Twilight Sentinel® also provides exterior illumination as you leave the vehicle. If Twilight Sentinel® has turned on the lamps when you turn off the ignition, your lamps will remain on until:

- The exterior lamp switch is moved from off to the parking lamp position, or
- a delay time that you select has elapsed.

See “Personal Options” under *DIC Vehicle Personalization on page 3-67* to select the delay time that you want. You can also select no delay time.

If you turn off the ignition with the exterior lamp switch in the parking lamp or headlamp position, the Twilight Sentinel® delay will not occur. The lamps will turn off as soon as the switch is turned off.

As with any vehicle, you should turn on the regular headlamp system when you need it.

## Exterior Lighting Battery Saver

If the manual parking lamps or headlamps have been left on, the exterior lamps will turn off as soon as the ignition is turned off or RAP is active. This protects against draining the battery in case you have accidentally left the headlamps or parking lamps on. The battery saver does not work if the headlamps are turned on after the ignition switch is turned to off.

If you need to leave the lamps on, use the exterior lamp control to turn the lamps back on.

## Instrument Panel Brightness

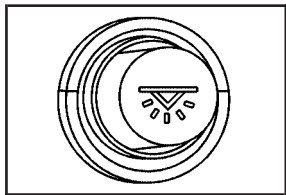

The knob for this feature is located on the left side of the instrument panel.

Turn the knob clockwise to brighten the lights or counterclockwise to dim them. During the day, this knob will adjust the instrument panel brightness and at night will adjust all interior lighting.

Be sure not to have this knob turned all the way down with the lamps on during the day. Your Driver Information Center (DIC) may not be visible.

## Courtesy Lamps

When any door or the hatch/trunk lid is opened, the interior lamps will go on unless it is bright outside.

You can also turn the courtesy lamps on and off by pressing the instrument panel brightness knob.

## Entry/Exit Lighting

With entry lighting, the interior lamps will come on when entering the vehicle. The interior lamps will come on for about 20 seconds when the engine is off.

You can turn exit and entry lighting off by quickly turning the courtesy lamps on and off.

## Reading Lamps

Your inside rearview mirror includes two reading lamps. The lamps will go on when a door is opened. When the doors are closed, each lamp can be turned on individually by pressing the switch for that lamp.



## Battery Run-Down Protection

Your vehicle has a feature to help prevent you from draining the battery in case the underhood lamp, vanity mirror lamps, cargo lamps, reading lamps, console or glove box lamps are accidentally left on. If you leave any of these lamps on, they will automatically time-out after about 20 minutes. To reset it, all of the above lamps must be turned off or the ignition key on.

## Head-Up Display (HUD)

### CAUTION:

**If the HUD image is too bright, or too high in your field of view, it may take you more time to see things you need to see when it is dark outside. Be sure to keep the HUD image dim and placed low in your field of view.**

If your vehicle is equipped with the Head-Up Display (HUD), you can see some of the driver information that appears on your instrument panel cluster.

The information may be displayed in English or metric units and appears as an image focused out toward the front of your vehicle. The HUD consists of the following information:

- Speedometer
- Turn Signal Indicators
- High-Beam Indicator Symbol
- Tachometer
- Oil and Temperature Gages
- Shift Light (Performance SHIFT Light)  
This light is used for performance driving to indicate that the vehicle's best performance level has been reached to shift the transmission into the next higher gear. The SHIFT light will display at an engine speed of about 6,250 rpm, just prior to reaching the engine fuel cut-off mode.
- Check Gages Warning
- Engine Coolant Temperature Gage
- Transmission Oil Temperature Gage
- Engine Oil Temperature Gage
- Engine Oil Pressure Gage
- G-Force Gage
- Audio Functions, Street Mode Only
- Navigation, Only with Navigation Radio, Street Mode Only
- Check Gages Warning

There are three HUD modes that you can choose to view in the HUD display. By pressing the MODE button, you can scroll through these modes in the following order:

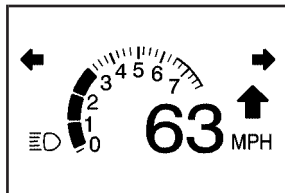

Street Mode supports audio and navigation functions with your choice of tachometer settings.

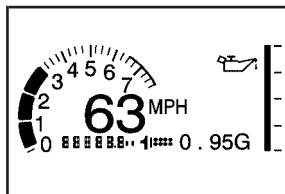

Track Mode 1 supports the G-Force gage and minor gages with a circular tachometer.

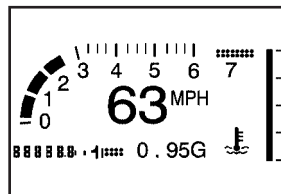

Track Mode 2 supports G-Force gages and minor gages with a linear tachometer.

When you have chosen the desired HUD display, release the MODE button.

Within each mode, the display, can be further customized by pressing the PAGE button. Pressing this button in each mode will turn off and on the following:

- Street Mode — No tachometer, circular tachometer and linear tachometer.
- Track Modes 1 and 2 — No minor gage, coolant temperature, transmission oil temperature, engine oil temperature and engine oil pressure.

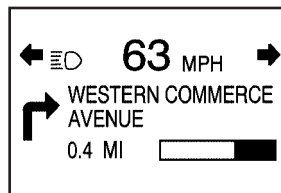

If your vehicle is equipped with a navigation radio, many of the turn-by-turn navigation features will also be displayed on the HUD if you are in Street Mode.

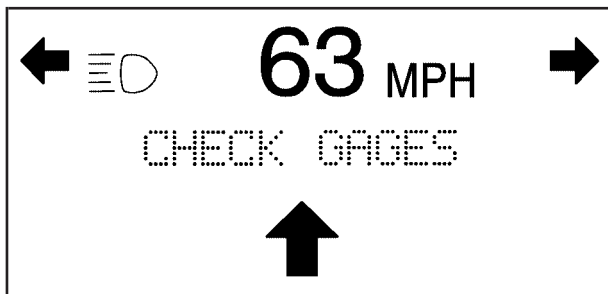

Be sure to continue scanning your displays, controls and driving environment just as you would in a vehicle without HUD. If you never look at your instrument panel cluster, you may not see something important, such as a warning light. Under important warning conditions, the CHECK GAGES warning will illuminate in the HUD. View your Driver Information Center (DIC) for more information.

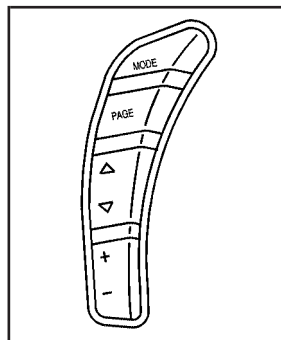

The HUD controls are located to the left of the steering wheel.

To adjust the HUD so you can see it properly, do the following:

1. Start your engine and press the HUD dimmer control all the way up by pressing the (+) button.

The brightness of the HUD image is determined by the light conditions in the direction your vehicle is facing and where you have the HUD dimmer control set. If you are facing a dark object or a heavily shaded area, your HUD may anticipate that you are entering a dark area and may begin to dim.

It is possible for sunlight to enter the HUD making it difficult to see the image. The display will return to normal when the sunlight is no longer entering the HUD.

2. Adjust the seat to a comfortable driving position. If you change your seat position later, you may have to re-adjust your HUD.

3. Press the up or down arrows to center the HUD image in your view.

The HUD image can only be adjusted up and down, not side-to-side.

4. Press the dimmer control downward until the HUD image is no brighter than necessary.

To turn HUD off, press and hold the (–) button until the HUD display turns off.

If the sun comes out or it becomes cloudy, you may need to adjust the HUD brightness again using the dimmer control. Polarized sunglasses could make the HUD image harder to see.

The HUD information can be displayed in one of six languages including English, Spanish, French, German, Italian or Japanese. The speedometer can be displayed in either English or Metric units.

To change the language and unit selections, see “OPTION” under *DIC Controls and Displays* on page 3-48.

Clean the inside of the windshield as needed to remove any dirt or film that reduces the sharpness or clarity of the HUD image.

To clean the HUD, spray household glass cleaner on a soft, clean cloth. Wipe the HUD lens gently, then dry it. Do not spray cleaner directly on the lens because the cleaner could leak into the unit.

If the ignition is on and you can't see the HUD image, check to see if:

- Something is covering the HUD unit.
- The HUD dimmer control is adjusted properly.
- The HUD image is adjusted to the proper height.
- Ambient light is low, in the direction your vehicle is facing.
- A fuse is blown. See *Fuses and Circuit Breakers* on page 5-87.

Keep in mind that your windshield is part of the HUD system. If you ever have to have your windshield replaced, be sure to get one that is designed for HUD or your HUD image may look blurred and out of focus.

## Accessory Power Outlets

The accessory power outlet can be used to connect electrical equipment such as a cellular phone or CB radio.

The accessory power outlet is located inside the center console storage compartment, on the forward left side.

To use the outlet, remove the tethered cap. When not using it, always cover the outlet with the protective cap.

**Notice:** Leaving electrical equipment on for extended periods will drain the battery. Always turn off electrical equipment when not in use and do not plug in equipment that exceeds the maximum amperage rating.

Certain electrical accessories may not be compatible with the accessory power outlet and could result in blown vehicle or adapter fuses. If you experience a problem, see your dealer for additional information on accessory power outlets.

**Notice:** Adding any electrical equipment to your vehicle may damage it or keep other components from working as they should. The repairs would not be covered by your warranty. Check with your dealer before adding electrical equipment.

When adding electrical equipment, be sure to follow the installation instructions included with the equipment.

We recommend that you see a qualified technician or your dealer for the proper installation of your equipment.

**Notice:** Improper use of the power outlet can cause damage not covered by your warranty. Do not hang any type of accessory or accessory bracket from the plug because the power outlets are designed for accessory power plugs only.

## Ashtrays and Cigarette Lighter

The ashtray and cigarette lighter are located on the instrument panel, in front of the shift lever. To use the ashtray, press on the indentation at the top of the door.

**Notice:** If you put papers or other flammable items in the ashtray, hot cigarettes or other smoking materials could ignite them and possibly damage your vehicle. Never put flammable items in the ashtray.

Loose objects, such as paper clips, can lodge behind and beneath the ashtray lid and prevent movement of the lid. You should avoid putting small, loose objects near the ashtray.

To use the cigarette lighter, push it in all the way and let go. When it is ready, it will pop back out by itself.

**Notice:** Holding a cigarette lighter in while it is heating will not allow the lighter to back away from the heating element when it is hot. Damage from overheating may occur to the lighter or heating element, or a fuse could be blown. Do not hold a cigarette lighter in while it is heating. Do not use anything other than the cigarette lighter in the heating element.

## Climate Controls

### Dual Automatic Climate Control System

With this system you can control the heating, cooling and ventilation for your vehicle.

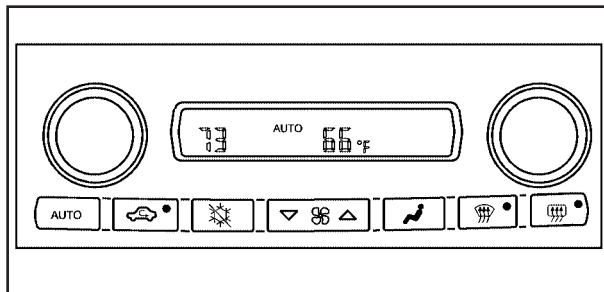

When your vehicle is first started, the display will show the driver's temperature setting, the outside temperature, the fan speed and the air delivery, for about 10 seconds.

The outside temperature is shown in the center of the display. The digital display will show the readings in Fahrenheit or Celsius. See "Personal Options" under *DIC Vehicle Personalization on page 3-67* for information on changing your display.

## Automatic Operation

**AUTO (Automatic):** Press the AUTO button to place the entire system in the automatic mode. When automatic operation is active, the system will automatically control the inside temperature, the air delivery mode and the fan speed.

After a ten second display of the current settings, the word AUTO, the driver's temperature setting and the outside temperature will be shown. The system will operate to achieve your comfort set temperature as quickly as possible. The AUTO control system works best with the windows up and the removable roof installed or the convertible top up.

1. Press the AUTO button.
2. Adjust the temperature to a comfortable setting between 60°F (16°C) and 90°F (32°C). Choosing the coldest or warmest temperature setting will not cause the system to heat or cool any faster. A setting of 73°F (23°C) is suggested.

In cold weather, the system will start at reduced fan speeds to avoid blowing cold air into your vehicle until warmer air is available. The system will start out blowing air at the floor but may change modes automatically as the vehicle warms up to maintain the chosen temperature setting.

The length of time needed for warm up will depend on the outside temperature and the length of time that has elapsed since your vehicle was last driven.

3. Wait for the system to regulate. This may take from 10 to 30 minutes. Then adjust the temperature, if necessary.

Do not cover the solar sensor located in the center of the instrument panel, near the windshield. For more information on the solar sensor, see "Sensor" later in this section.

## Manual Operation

**Driver Power/Temperature:** Press the driver temperature knob on the driver side of the climate control panel to turn the climate control system off. This is the only setting that completely shuts off the fan. The digital display will show only the outside temperature. You can still adjust the driver and the passenger set temperature and the air intake mode when the climate control is off.

**Passenger Power/Temperature:** Press the passenger temperature knob on the passenger side of the climate control panel to turn the passenger's climate control system on or off. Turn the knob to increase or decrease the temperature for the passenger. If the passenger's climate control system is off, the driver's temperature knob will control the temperature for the entire vehicle.

 **(MODE):** Press this button to manually lock in the current air delivery setting and to stop the automatic mode control. Pressing the MODE button will delete AUTO from the digital display and the mode graphics will be shown. To change the setting, press the MODE button again. The AUTO button must be pressed to return to the automatic mode selection.

To change the current mode, select one of the following:

 **(Vent):** This mode directs most of the air to the instrument panel outlets, with a very small amount of air directed to the floor outlets.

 **(Bi-Level):** This mode directs about half of the air to the instrument panel outlets, and directs the remaining air to the floor outlets. Cooler air is directed to the upper outlets and warmer air to the floor outlets.

 **(Floor):** This mode directs most of the air to the floor outlets with some air directed to the side window defogger outlets and some air directed toward the windshield.

The MODE button can also be used to select the defog mode. Information on defogging and defrosting can be found later in this section.

 **(Fan):** Press the button with the fan symbol to manually increase or decrease the fan speed. Keep pressing the up or down arrow on this switch until the desired fan speed appears on the display.

Pressing the arrows will delete AUTO from the digital display. The fan graphics with the fan speed bars will be shown. To increase the fan speed so that more air flows into the vehicle, press the up arrow on the fan switch. To decrease the fan speed and airflow, press the down arrow. The AUTO button must be pressed to return to the automatic fan control.

If the airflow seems low when the fan speed is at the highest setting, the passenger compartment air filter may need to be replaced. For more information, see *Passenger Compartment Air Filter on page 3-30* and *Scheduled Maintenance on page 6-4*.

 **(Recirculation):** Press this button to turn the recirculation mode on or off. When the climate control system is in recirculation mode an indicator light will come on. This mode prevents outside air from entering your vehicle. It can be used to prevent outside air and odors from entering your vehicle and to help cool the air inside your vehicle more quickly. Recirculation mode is not available in defrost or defog mode.



 **(Air Conditioning Off):** Press this button to turn the air conditioning compressor off. Press AUTO to return to automatic operation. When in AUTO, the air conditioning compressor will come on automatically, as needed.

Air conditioning does not operate at temperatures below about 35°F to 40°F (2°C to 4°C). In temperatures above 40°F (4°C), the air conditioning cannot be turned off in defrost and defog, as it helps to remove moisture from the vehicle. It also helps to keep the windows clear.

You may notice a slight change in engine performance when the air-conditioning compressor shuts off and turns on again. This is normal. The system is designed to make adjustments to help with fuel economy while still maintaining the selected temperature.

On hot days, open the windows to let hot inside air escape; then close them. This helps to reduce the time it takes for your vehicle to cool down. It also helps the system to operate more efficiently.

For quick cool down on hot days press the AUTO button and adjust the temperature to a cool, comfortable setting. To achieve maximum cool down, do the following:

1. Select the vent mode.
2. Select recirculation mode.
3. Select the A/C on.
4. Select the coolest temperature.
5. Select the highest fan speed.

Using these settings together for long periods of time may cause the air inside of your vehicle to become too dry. To prevent this from happening, after the air in your vehicle has cooled, turn the recirculation mode off.

The air conditioning system removes moisture from the air, so you may sometimes notice a small amount of water dripping underneath your vehicle while idling or after turning off the engine. This is normal.

## Sensors

The solar sensor on your vehicle monitors the solar radiation and uses the information to maintain the selected temperature when operating in AUTO mode by initiating needed adjustments to the temperature, the fan speed and the air delivery system. The system may also supply cooler air to the side of the vehicle facing the sun. The recirculation mode will also be activated, as necessary. Do not cover the solar sensor located on the top of the instrument panel near the windshield or the system will not work properly.

There is also a sensor located behind the front bumper. This sensor reads the outside air temperature and helps to maintain the temperature inside the vehicle. Any cover on the front of the vehicle could give a false reading in the temperature.

If the outside temperature goes up, the displayed temperature will not change until:

- The vehicle's speed is above 10 mph (16 km/h) five minutes.
- The vehicle's speed is above 32 mph (52 km/h) for two and a half minutes.

These delays prevent false readings. If the temperature goes down, the outside temperature will be shown when you start the vehicle. If it has been turned off for less than three hours, the temperature will be recalled from the previous vehicle operation.

There is also an inside temperature sensor located to the left of the ignition switch. The automatic climate control system uses this sensor to receive information, so if you block or cover it, the system will not function properly.

## Defogging and Defrosting

Fog on the inside of windows is a result of high humidity and moisture condensing on the cool window glass. This can be minimized if the climate control system is used properly. There are two modes to clear fog or frost from your windshield. Use the floor/defog mode to clear the windows of fog or moisture and warm the passengers. Use defrost to remove fog or frost from the windshield more quickly. To prevent fogging on

the inside of the windows in modes other than floor/defog and defrost, make sure the air conditioning compressor is on and recirculation mode is off.

Press the mode button until the defog mode appears on the display.

 **(Floor/Defog):** This mode directs the air equally between the windshield and the floor outlets with a small amount to the side window outlets. When you select this mode, the system turns off recirculation and runs the air-conditioning compressor unless the outside temperature is at or below freezing. The recirculation mode cannot be selected while in the defog mode.

 **(Defrost):** Pressing this button directs most of the air to the windshield, with a small amount directed to the side window outlets. The light on the button will come on and the digital display will show the defrost mode symbol and fan speed when the front defrost mode is being used. In this mode, the system will automatically turn off the recirculation and run the air-conditioning compressor, unless the outside temperature is at or below freezing. Recirculation cannot be selected while in the defrost mode. Pressing this button again will return the system to the last operating mode.

For severe ice conditions, turn the driver's temperature knob to 90°F (32°C) while in defrost mode.

Do not drive the vehicle until all the windows are clear.

## Rear Window Defogger

The rear window defogger uses a warming grid to remove fog or frost from the rear window.

The rear window defogger will only work when the engine is running.

 **(Rear Window Defogger):** Press this button to turn the rear window defogger on. Be sure to clear as much snow from the rear window as possible. An indicator light in the button will come on to let you know that the rear window defogger is activated.

The rear window defogger will turn off about 10 minutes after the button is pressed when traveling less than 30 mph (48 km/h). If turned on again, the defogger will only run for about five minutes before turning off. The defogger can also be turned off by pressing the button again or by turning off the engine.

Your vehicle has heated outside rearview mirrors. The mirrors will heat to help clear fog or frost from the surface of the mirrors when the rear window defog button is pressed.

If your vehicle is equipped with the power convertible top, the rear window defogger and heated mirrors are automatically disabled when the power convertible top is moving or down.

**Notice:** Don't use anything sharp on the inside of the rear window. If you do, you could cut or damage the warming grid, and the repairs wouldn't be covered by your warranty. Do not attach a temporary vehicle license, tape, a decal or anything similar to the defogger grid.

## Outlet Adjustment

Use the tab located on the air outlets to change the direction of the airflow.

### Operation Tips

- Clear away any ice, snow or leaves from the air inlets at the base of the windshield that may block the flow of air into your vehicle.
- Use of non-GM approved hood deflectors may adversely affect the performance of the system.
- Keep the area around the base of the instrument panel console and air path under the seats clear of objects to help circulate the air inside of your vehicle more effectively.

## Passenger Compartment Air Filter

The passenger compartment air filter removes certain odor and particles from the air including pollen and dust particles. Reductions in airflow, which may occur more often in dusty areas, indicate that the filter may need to be replaced. See *Scheduled Maintenance on page 6-4* for information on how often to replace the filter.

The passenger compartment air filter is located on the passenger side of the engine compartment near the battery. See *Engine Compartment Overview on page 5-12*.

To check or replace the air filter, do the following:

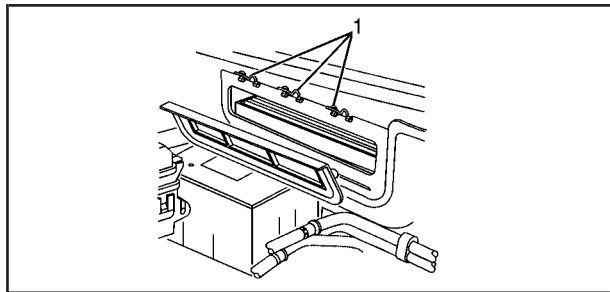

1. Disengage the passenger compartment air filter housing cover retainer clips (1).

2. Remove the passenger compartment air filter housing cover.

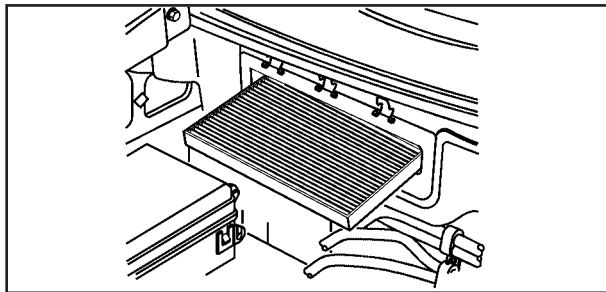

3. Remove the passenger compartment air filter from the housing.
4. Insert the new filter into the housing.
5. Reinstall the passenger compartment air filter housing cover.
6. Engage the passenger compartment air filter housing cover retainer clips.

## Warning Lights, Gages, and Indicators

This part describes the warning lights and gages that may be on your vehicle. The pictures will help you locate them.

Warning lights and gages can signal that something is wrong before it becomes serious enough to cause an expensive repair or replacement. Paying attention to your warning lights and gages could also save you or others from injury.

Warning lights come on when there may be or is a problem with one of your vehicle's functions. As you will see in the details on the next few pages, some warning lights come on briefly when you start the engine just to let you know they are working. If you are familiar with this section, you should not be alarmed when this happens.

Gages can indicate when there may be or is a problem with one of your vehicle's functions. Often gages and warning lights work together to let you know when there is a problem with your vehicle.

When one of the warning lights comes on and stays on when you are driving, or when one of the gages shows there may be a problem, check the section that tells you what to do about it. Please follow this manual's advice. Waiting to do repairs can be costly — and even dangerous. So please get to know your warning lights and gages. They are a big help.

Your vehicle has a Driver Information Center that works along with the warning lights and gages. See *Driver Information Center (DIC) on page 3-47*.

## Instrument Panel Cluster

Your instrument panel cluster and Driver Information Center (DIC) are designed to let you know at a glance how the vehicle is running. You will know how fast you are going, about how much fuel you have left and many other things you will need to know to drive safely and economically. The instrument panel cluster indicator warning lights, gages and DIC messages are explained on the following pages.

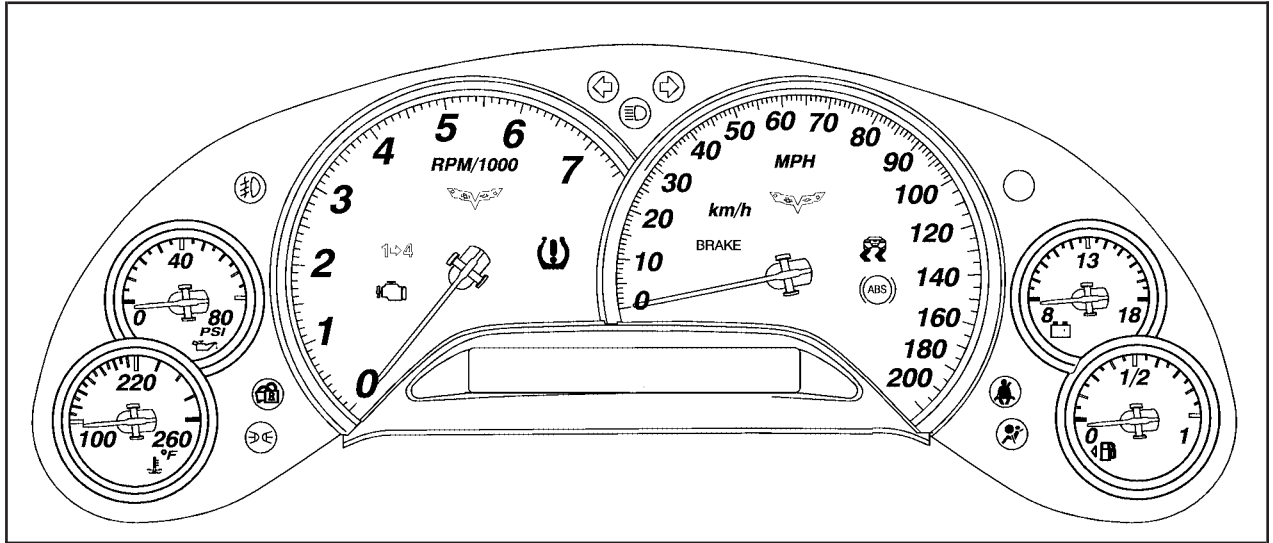

United States shown, Canada similar

## Speedometer and Odometer

Your speedometer lets you see your speed in either miles per hour (mph) or kilometers per hour (km/h). For more information see “Personal Options” under *DIC Vehicle Personalization on page 3-67*.

To read the odometer with the ignition off, turn on the parking lamps.

You may wonder what happens if your vehicle needs a new odometer installed. The mileage total of the new odometer will be set to the original miles (kilometers) of the old odometer. See your dealer if the odometer must be replaced in your vehicle.

## Tachometer

The tachometer displays the engine speed in thousands of revolutions per minute (rpm).

**Notice:** Fuel will shut off at about 6600 rpm. If you continue to drive your vehicle at the fuel shut off rpm, you could damage your engine. Be sure to operate your vehicle below the fuel shut off rpm or reduce your rpm quickly when the fuel shuts off.

## Safety Belt Reminder Light

When the ignition is turned on, a chime will be provided for several seconds to remind people to buckle their safety belts. The driver safety belt light will also be provided and stay on for several seconds, then it will flash for several more. You should buckle your seat belt.



This chime and light will be repeated if the driver remains unbuckled and the vehicle is in motion.

If the driver's belt is buckled, neither the chime nor the light will be provided.

## Airbag Readiness Light

There is an airbag readiness light on the instrument panel, which shows a deployed airbag symbol. The system checks the airbag's electrical system for malfunctions. The light tells you if there is an electrical problem. The system check includes the airbag modules, the wiring and the diagnostic module. For more information on the airbag system, see *Airbag System* on page 1-40.



This light will come on when you start your vehicle, and it will flash for a few seconds. Then the light should go out. This means the system is ready.

If the airbag readiness light stays on after you start the vehicle or comes on when you are driving, your airbag system may not work properly. Have your vehicle serviced right away.

### CAUTION:

**If the airbag readiness light stays on after you start your vehicle, it means the airbag system may not be working properly. The airbags in your vehicle may not inflate in a crash, or they could even inflate without a crash. To help avoid injury to yourself or others, have your vehicle serviced right away if the airbag readiness light stays on after you start your vehicle.**

The airbag readiness light should flash for a few seconds when you turn the vehicle on. If the light does not come on then, have it fixed so it will be ready to warn you if there is a problem.



## Airbag Off Light

When you turn off the passenger's frontal airbag and side impact airbags (if equipped), an indicator on the center console will light and stay lit to remind you that the airbag or airbags have been turned off. This light will go off when you turn the airbag or airbags on. See *Airbag Off Switch* on page 1-48 for more on this, including important safety information.

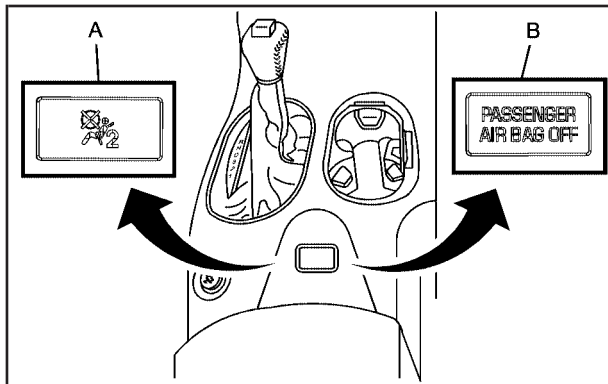

A. Canadian Light

B. United States Light

### CAUTION:

If the passenger's frontal airbag and side impact airbag (if equipped) are turned off for a person who is not in a risk group identified by the national government, that person will not have the extra protection of an airbag. In a crash, an airbag will not be able to inflate and help protect the person sitting there. Do not turn off the passenger's frontal airbag and side impact airbag (if equipped) unless the person sitting there is in a risk group. See *Airbag Off Switch* on page 1-48 for more on this, including important safety information.

## CAUTION:

If the airbag readiness light ever comes on when you have turned off the passenger's frontal airbag and side impact airbag (if equipped), it means that something may be wrong with the airbag system. The passenger's frontal airbag and side impact airbag (if equipped) could inflate even though the switch is off. If this ever happens, do not let anyone whom the national government has identified as a member of a passenger airbag risk group sit in the passenger's position (for example, do not secure a rear-facing child restraint in your vehicle) until you have your vehicle serviced. See *Airbag Off Switch on page 1-48*.

## Voltmeter Gage

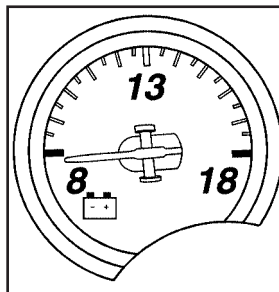

The voltmeter shows the voltage output of your battery. When the engine is running, it shows the voltage output of the charging system.

The reading will change as the rate of charge changes (with engine speed, for example), but if the voltmeter reads at 9 volts or below, your instrument panel cluster and other systems may shut down. The Driver Information Center (DIC) will read BATTERY VOLTAGE LOW when your vehicle is at 10 volts or below. Have it checked right away. Driving with the voltmeter reading at 10 volts or below could drain your battery and disable your vehicle.

## One-to-Four Shift Light (Manual Transmission)

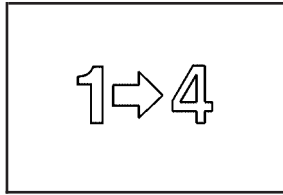

When this light comes on, you can only shift from FIRST (1) to FOURTH (4) instead of FIRST (1) to SECOND (2).

You must complete the shift into FOURTH (4) to turn off this feature. This helps you get the best possible fuel economy.

After shifting to FOURTH (4), you may downshift to a lower gear if you prefer.

**Notice:** Forcing the shift lever into any gear except FOURTH (4) when the 1 TO 4 SHIFT light comes on may damage the transmission. Shift only from FIRST (1) to FOURTH (4) when the light comes on.

This light will come on when:

- The engine coolant temperature is higher than 169°F (76°C),
- you are going 15 to 19 mph (24 to 31 km/h) and
- you are 21 percent throttle or less.

## Brake System Warning Light

Your vehicle's hydraulic brake system is divided into two parts. If one part is not working, the other part can still work and stop you. For good braking, though, you need both parts working well.

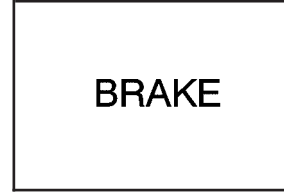

United States

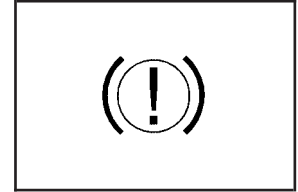

Canada

This light should come on when you start the engine. If it does not come on then, have it fixed so it will be ready to warn you if there is a problem.

If this warning light stays on after you start the engine, the parking brake may still be set or there could be a brake problem. Refer to *Parking Brake on page 2-29* to see if it is set. If the parking brake is not set, have your brake system inspected right away.

If the light comes on while you are driving and you have a CHECK BRAKE FLUID message showing on the DIC, pull off the road and stop carefully. You may notice that the pedal is harder to push. Or, the pedal may go closer to the floor. It may take longer to stop. If the light is still on, have the vehicle towed for service. See *Towing Your Vehicle on page 4-37*.

### CAUTION:

**Your brake system may not be working properly if the brake system warning light is on. Driving with the brake system warning light on can lead to an accident. If the light is still on after you have pulled off the road and stopped carefully, have the vehicle towed for service.**

## Anti-Lock Brake System Warning Light

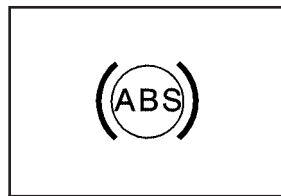

With the anti-lock brake system, the light will come on when your engine is started and may stay on for several seconds. That is normal.

If the light stays on, turn the ignition off. Or, if the light comes on when you are driving, stop as soon as possible and turn the ignition off. Then start the engine again to reset the system. If the light still stays on, or comes on again while you are driving, your vehicle needs service. If the regular brake system warning light is not on, you still have brakes, but you do not have anti-lock brakes. If the regular brake system warning light is also on, you do not have anti-lock brakes and there is a problem with your regular brakes. See "SERVICE ANTILOCK BRAKES" under *DIC Warnings and Messages on page 3-53*.

The anti-lock brake system warning light will come on briefly when you turn the ignition on. This is normal. If the light does not come on then, have it fixed so it will be ready to warn you if there is a problem.

## Traction Control System (TCS) Warning Light

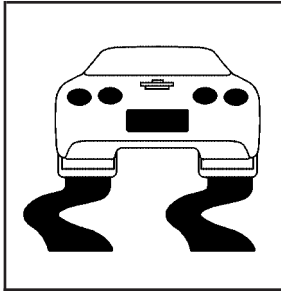

This light should come on briefly as you start the engine. If the light does not come on then, have it fixed so it will be ready to warn you if there is a problem.

If it stays on, or comes on and the DIC shows a **SERVICE TRACTION SYSTEM** message when you are driving, there is a problem with your TCS system and your vehicle needs service. When this light is on, the system will not limit wheel spin. Adjust your driving accordingly. If the driver turns off the Traction Control System by pressing the button on the console, the TCS system light will come on and the **TRACTION SYSTEM OFF** message will show on the DIC.

## Active Handling System Light

The Active Handling System light will come on briefly as you start the engine. If the light does not come on then, have it fixed so it will be ready to warn you if there is a problem. This light will also come on when the **ACTIVE HANDLING CALIBRATING** message is displayed in the Driver Information Center (DIC).

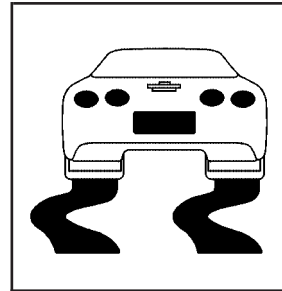

If the light stays on or comes on while you are driving, a chime sounds and a **SERVICE ACTIVE HANDLING SYSTEM** message appears on the DIC, there is a problem with your Active Handling System and your vehicle needs service.

The driver can acknowledge this message by pressing the **RESET** button. When the **SERVICE ACTIVE HANDLING SYSTEM** message is displayed, the Active Handling System will not assist you in controlling the vehicle. You should have the system serviced as soon as possible. Adjust your driving accordingly.

When the system is working, you will see the ACTIVE HANDLING message displayed in the DIC. You may also feel or hear the system working. This is normal.

If the driver turns off the Active Handling System by pressing the button on the console for five seconds, the Active Handling System light will come on, a chime will sound, and the TRACTION SYSTEM AND ACTIVE HANDLING – OFF message will be displayed in the DIC. The Traction Control System will also be turned off. See *DIC Warnings and Messages on page 3-53* for more information.

If the Active Handling System and the Traction Control System are off, pressing the console button momentarily will turn both systems on. The DIC will display the TRACTION SYSTEM AND ACTIVE HANDLING – ON message, the instrument cluster light will be off, and a chime will sound. See *DIC Warnings and Messages on page 3-53* for more information.

## Engine Coolant Temperature Gage

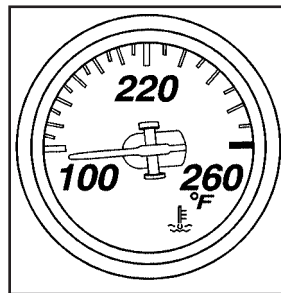

United States

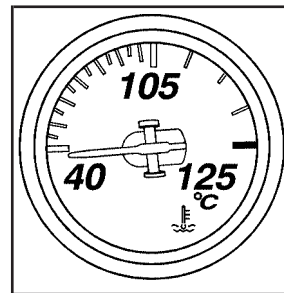

Canada

This gage shows the engine coolant temperature. If the gage pointer moves into the shaded area, your engine is too hot.

This means that your engine coolant has overheated. If you have been operating your vehicle under normal driving conditions, you should pull off the road, stop your vehicle and turn off the engine as soon as possible.

See *Engine Overheating on page 5-25* for more information.

## Tire Pressure Light

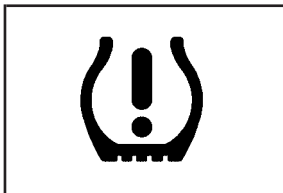

This light should come on briefly as you start the engine. It will then come on only when a flat or low tire pressure condition exists.

See *Tire Pressure Monitor System* on page 5-61 for more information.

## Malfunction Indicator Lamp

### Check Engine Light

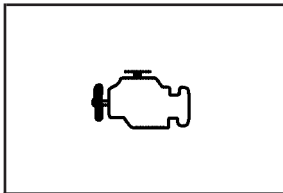

Your vehicle is equipped with a computer which monitors operation of the fuel, ignition, and emission control systems.

This system is called OBD II (On-Board Diagnostics-Second Generation) and is intended to assure that emissions are at acceptable levels for the life of the vehicle, helping to produce a cleaner environment. The CHECK ENGINE light comes on to indicate that there is a problem and service is required. Malfunctions often will be indicated by the system before any problem is apparent. This may prevent more serious damage to your vehicle. This system is also designed to assist your service technician in correctly diagnosing any malfunction.

**Notice:** If you keep driving your vehicle with this light on, after awhile, your emission controls may not work as well, your fuel economy may not be as good, and your engine may not run as smoothly. This could lead to costly repairs that may not be covered by your warranty.

**Notice:** Modifications made to the engine, transmission, exhaust, intake, or fuel system of your vehicle or the replacement of the original tires with other than those of the same Tire Performance Criteria (TPC) can affect your vehicle's emission controls and may cause this light to come on. Modifications to these systems could lead to costly repairs not covered by your warranty. This may also result in a failure to pass a required Emission Inspection/Maintenance test.

This light should come on briefly, as a check to show you it is working, as you start the engine. If the light does not come on, have it repaired. This light will also come on during a malfunction in one of two ways:

- **Light Flashing** — A misfire condition has been detected. A misfire increases vehicle emissions and may damage the emission control system on your vehicle. Diagnosis and service may be required.
- **Light On Steady** — An emission control system malfunction has been detected on your vehicle. Diagnosis and service may be required.

## If the Light Is Flashing

The following may prevent more serious damage to your vehicle:

- Reducing vehicle speed
- Avoiding hard accelerations
- Avoiding steep uphill grades

If the light stops flashing and remains on steady, see “If the Light Is On Steady” following.

If the light continues to flash, when it is safe to do so, stop the vehicle. Find a safe place to park your vehicle. Turn the engine off, wait at least 10 seconds and restart the engine. If the light remains on steady, see “If the Light Is On Steady” following. If the light is still flashing, follow the previous steps, and see your dealer for service as soon as possible.

## If the Light Is On Steady

You also may be able to correct the emission system malfunction by considering the following:

Did you recently put fuel into your vehicle?

If so, reinstall the fuel cap, making sure to fully install the cap. See *Filling Your Tank on page 5-7*. The diagnostic system can determine if the fuel cap has been left off or improperly installed. A loose or missing fuel cap will allow fuel to evaporate into the atmosphere. A few driving trips with the cap properly installed should turn the light off.

Did you just drive through a deep puddle of water?

If so, your electrical system may be wet. The condition will usually be corrected when the electrical system dries out. A few driving trips should turn the light off.



Have you recently changed brands of fuel?

If so, be sure to fuel your vehicle with quality fuel. See *Gasoline Octane on page 5-5*. Poor fuel quality will cause your engine not to run as efficiently as designed. You may notice this as stalling after start-up, stalling when you put the vehicle into gear, misfiring, hesitation on acceleration, or stumbling on acceleration. (These conditions may go away once the engine is warmed up.) This will be detected by the system and cause the light to turn on.

If you experience one or more of these conditions, change the fuel brand you use. It will require at least one full tank of the proper fuel to turn the light off.

If none of the above steps have made the light turn off, your dealer can check the vehicle. Your dealer has the proper test equipment and diagnostic tools to fix any mechanical or electrical problems that may have developed.

## Emissions Inspection and Maintenance Programs

Some state/provincial and local governments have or may begin programs to inspect the emission control equipment on your vehicle. Failure to pass this inspection could prevent you from getting a vehicle registration.

Here are some things you need to know to help your vehicle pass an inspection:

Your vehicle will not pass this inspection if the CHECK ENGINE light is on or not working properly.

To perform a Check Engine light bulb check with the keyless ignition, make sure the transmitter fob is in the passenger compartment. See *Ignition Positions on page 2-20*. Press the bottom of the ACC button on the instrument panel and hold the button down for five seconds. The instrument panel, including the Check Engine light, will light up and the ignition will be on, but the engine will not start — if you press the bottom of the ACC button only briefly, less than five seconds, the accessory mode will be turned on, but not the ignition. After the bulb check, be sure to press and release the ACC button again to turn the ignition off and avoid draining the vehicle's battery.

Your vehicle will not pass this inspection if the OBD (on-board diagnostic) system determines that critical emission control systems have not been completely diagnosed by the system. The vehicle would be considered not ready for inspection. This can happen if you have recently replaced your battery or if your battery has run down. The diagnostic system is designed to evaluate critical emission control systems during normal driving. This may take several days of routine driving. If you have done this and your vehicle still does not pass the inspection for lack of OBD system readiness, your GM dealer can prepare the vehicle for inspection.

## Engine Oil Pressure Gage

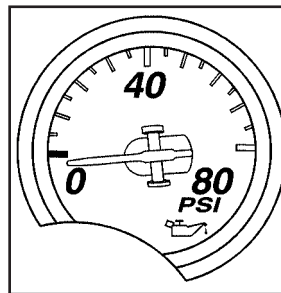

United States

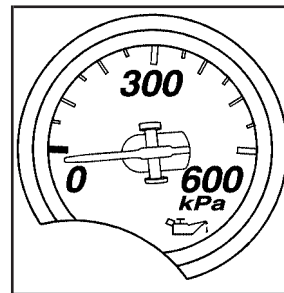

Canada

The engine oil pressure gage shows the engine oil pressure in psi (pounds per square inch) or kPa (kilopascals) when the engine is running.

Oil pressure should be 20 to 80 psi (140 to 550 kPa). In certain situations such as long, extended idles on hot days, it could read as low as 6 psi (40 kPa) and still be considered normal. It may vary with engine speed, outside temperature and oil viscosity, but readings above the shaded area show the normal operating range. Readings in the shaded area tell you that the engine is low on oil, or that you might have some other oil problem. See *Engine Oil* on page 5-14.

The engine oil pressure can also be displayed using the GAGES button on the Driver Information Center (DIC). See *Driver Information Center (DIC)* on page 3-47.

**⚠ CAUTION:**

Do not keep driving if the oil pressure is low. If you do, your engine can become so hot that it catches fire. You or others could be burned. Check your oil as soon as possible and have your vehicle serviced.

**Notice:** Lack of proper engine oil maintenance may damage the engine. The repairs would not be covered by your warranty. Always follow the maintenance schedule in this manual for changing engine oil.

## Security Light

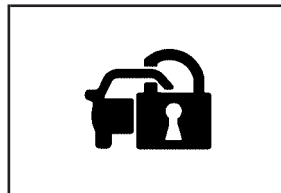

For information regarding this light, see *Theft-Deterrent Systems* on page 2-18.

## Fog Lamp Light



The fog lamps light will come on when the fog lamps are in use.

The light will go out when the fog lamps are turned off. See *Fog Lamps* on page 3-16 for more information.

## Lights On Reminder

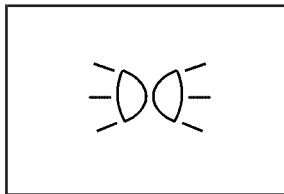

This light comes on whenever the parking lamps are on.

See *Headlamps on Reminder* on page 3-15 for more information.

## Highbeam On Light

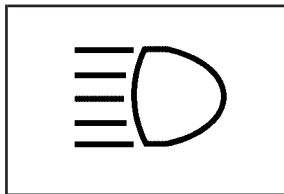

This light comes on whenever the high-beam headlamps are on.

See *Headlamp High/Low-Beam Changer* on page 3-9 for more information.

## Fuel Gage

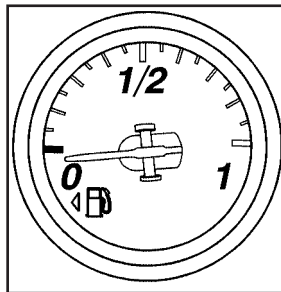

United States

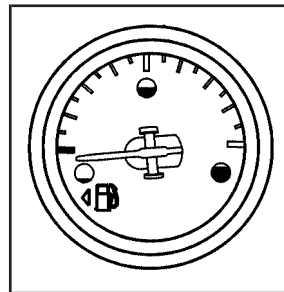

Canada

Your fuel gage tells you about how much fuel you have left when the engine is on.

When the needle approaches the low fuel symbol, a chime will sound and LOW FUEL will appear on the Driver Information Center (DIC) display. At this time, you still have a little fuel left, but you should get more soon.

Press the RESET button to acknowledge a DIC message(s). Pressing the RESET button will also turn off a DIC message but the LOW FUEL message will come on again in 10 minutes if you have not added fuel to the vehicle.

Here are five things that some owners ask about. All these things are normal and do not indicate that anything is wrong with the fuel gage.

- At the gas station, the gas pump shuts off before the gage reads the full symbol.
- It takes more (or less) fuel to fill up than the gage reads. For example, the gage reads half full, but it took more (or less) than half of the tank's capacity to fit it.
- The gage pointer may move while cornering, braking or speeding up.
- The gage may not indicate the tank is empty when the ignition is turned off.
- The gage reading may change slightly within the first several minutes after starting the vehicle.

See *DIC Controls and Displays* on page 3-48 for more information.

## Driver Information Center (DIC)

The Driver Information Center (DIC) gives you the status of many of your vehicle's systems. It is also used to display driver personalization features and warning/status messages. The DIC display is located on the instrument panel cluster below the speedometer and tachometer, directly above the steering column. The DIC buttons are located on the instrument panel, to the right of the instrument panel cluster.

The DIC comes on when the ignition is turned on. After displaying CORVETTE BY CHEVROLET, the DIC will display the current driver and the information that was last displayed before the engine was turned off.

If a problem is detected, a warning message will appear on the DIC display. Be sure to take any message that appears on the display seriously and remember that clearing the message will only make the message disappear, not correct the problem.

## DIC Controls and Displays

The Driver Information Center (DIC) has different modes which can be accessed by pressing the following buttons located on the instrument panel, to the right of the instrument panel cluster.

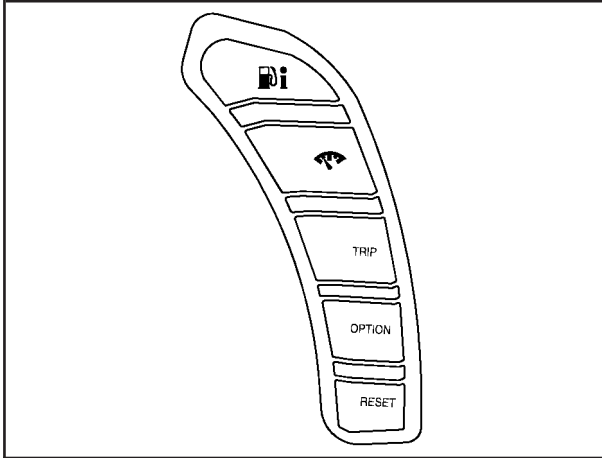

**Fuel i (Fuel):** Press this button to display fuel information such as fuel economy and range.

**Gages:** Press this button to display gage information like oil pressure and temperature, coolant temperature, automatic transmission fluid temperature (if equipped), battery voltage and front/rear tire pressures.

**TRIP:** Press this button to display your total and trip miles, the elapsed time function, your average speed and the engine oil life.

**OPTION:** Press this button to choose personal options that are available on your vehicle, depending on the options your vehicle is equipped with, such as door locks, easy entry seats and language.

**RESET:** Press this button, used along with the other buttons, to reset system functions, select personal options and turn off or acknowledge messages on the DIC.

## FUEL Button

The fuel button displays average fuel economy and instantaneous fuel economy, calculated for your specific driving conditions, and range information.

**Average Fuel Economy:** The average fuel economy is viewed as a long-term approximation of your overall driving conditions. You should reset the average fuel economy display every time you refuel. If you press the RESET button in this mode while you are driving, the system will reset this display and begin figuring fuel economy from that point in time.

Press the fuel button to display average fuel economy, such as:

- AVERAGE FUEL ECONOMY 20.1 MPG or
- AVERAGE FUEL ECONOMY 5.3 L/100 km

**Instantaneous Fuel Economy:** Instantaneous fuel economy reflects only the fuel economy that the vehicle has right now and will change frequently as driving conditions change. Unlike average fuel economy, this menu item cannot be reset.

Press the fuel button again to display instantaneous fuel economy, such as:

- INSTANT FUEL ECONOMY 20.1 MPG or
- INSTANT FUEL ECONOMY 5.3 L/100 km

**Fuel Range:** The range calculates the remaining distance you can drive without refueling. It is based on fuel economy and the fuel remaining in the tank.

Press the fuel button again to display the range, such as:

- RANGE 30 MI or
- RANGE 48 km

If the LOW FUEL warning is displayed or if RANGE is less than 40 miles (64 km), the display will read RANGE LOW.

The fuel economy data used to determine fuel range is an average of recent driving conditions. As your driving conditions change, this data is gradually updated automatically.

## GAGES Button

The gages button displays oil pressure, oil temperature, coolant temperature, transmission fluid temperature (automatic transmission only), battery voltage, and tire pressure information.

**Oil Pressure:** This display shows the oil pressure.

Press the gages button to display the oil pressure, such as:

- OIL PRESSURE 40 PSI or
- OIL PRESSURE 276 kPa

**Oil Temperature:** This display shows the oil temperature.

Press the gages button again to display the oil temperature, such as:

- OIL TEMPERATURE 234°F or
- OIL TEMPERATURE 112°C

If the oil temperature is low, the display will show OIL TEMPERATURE LOW. If the oil temperature is high, the display will show OIL TEMPERATURE HIGH.

**Coolant Temperature:** This display shows the engine coolant temperature.

Press the gages button again to display the coolant temperature, such as:

- COOLANT TEMPERATURE 123°F or
- COOLANT TEMPERATURE 51°C

If the coolant temperature is low, the display will show COOLANT TEMPERATURE LOW. If the coolant temperature is high, the display will show COOLANT TEMPERATURE HIGH.

**Transmission Fluid Temperature:** If you have an automatic transmission vehicle, this display shows the automatic transmission fluid temperature.

Press the gages button again to display the automatic transmission fluid temperature, such as:

- TRANS FLUID TEMP 123°F or
- TRANS FLUID TEMP 51°C

If the transmission fluid temperature is low, the display will show TRANS FLUID TEMP LOW. If the transmission fluid temperature is high, the display will show TRANS FLUID TEMP HIGH.

**Battery Voltage:** This display shows the current battery voltage.

Press the gages button again to display the battery voltage, such as:

- BATTERY VOLTAGE 13.5 VOLTS



**Tire Pressure:** This display shows the tire pressure for each tire.

Press the gages button again to display the tire pressure for the front tires, such as:

- FRONT TIRE PRESSURES L 34 PSI R 33 PSI or
- FRONT TIRE PRESSURES L 234 kPa R 228 kPa

Press the gages button again to display the tire pressure for the rear tires, such as:

- REAR TIRE PRESSURES L 34 PSI R 33 PSI or
- REAR TIRE PRESSURES L 234 kPa R 228 kPa

Tire pressure is not available until the vehicle has reached a speed of 15 mph (24 km/h) or more.

## TRIP Button

The TRIP button displays the odometer, trip distance, elapsed time, average speed, and oil life remaining information.

**Odometer:** The odometer shows how far your vehicle has been driven in either miles or kilometers. Press the TRIP button to display odometer readings, such as:

- ODOMETER 12345 MI or
- ODOMETER 20008 km

Without the keys in the ignition, you can also display the odometer by turning on the parking lamps.

**Trip Odometers:** There are two trip odometers. Press the TRIP button to display TRIP ODOMETER A readings and press the button again to display TRIP ODOMETER B readings, such as:

- TRIP ODOMETER A 130.5 MI or
- TRIP ODOMETER A 209.9 km
- TRIP ODOMETER B 300.5 MI or
- TRIP ODOMETER B 483.5 km

Both of the trip odometers can be used simultaneously. TRIP A could be used to track the distance to a destination. TRIP B could be used to track maintenance periods. The trip odometers can be reset by pressing the RESET button on the DIC.

There is also a miles since last ignition feature that displays the number of miles (kilometers) driven since you last started the vehicle. Press and hold the RESET button for three seconds, then release it. The miles (kilometers) since the last ignition cycle will be set into the trip odometer.

**Elapsed Timer:** Press the TRIP button until ELAPSED TIMER is displayed, such as ELAPSED TIMER .00.

When the ignition is in ON, the DIC can be used as a stopwatch. The display can show hours, minutes and seconds. The elapsed time indicator will record up to 23 hours, 59 minutes and 59 seconds, then it will reset to zero and continue counting. The display appears as ELAPSED TIMER .00 in the elapsed time function.

You can start or stop the elapsed time by pressing the RESET button. To reset the elapsed time to zero, press the RESET button for three seconds while the timer is displayed.

Pressing and holding the RESET button for at least 10 seconds will reset the timer display to the time since last ignition cycle.

**Average Speed:** Press the TRIP button until the average speed is displayed, such as:

- AVERAGE SPEED 62 MPH or
- AVERAGE SPEED 100 km/h

Press and hold the RESET button to reset to 0.0 mph.

**Engine Oil Life:** Press the TRIP button until the engine oil life is displayed, such as OIL LIFE REMAINING 89%.

This is an estimate of the engine oil's remaining useful life. It will show 100% when the system is reset after an oil change. It will alert you to change your oil on a schedule consistent with your driving conditions.

When the remaining oil life is low, the system will alert you with the message CHANGE ENGINE OIL.

Remember, you must reset the engine oil life system yourself after each oil change. It will not reset itself. To reset the system, press and hold the RESET button for three seconds. Also, be careful not to reset the engine oil life system accidentally at any time other than when the oil has just been changed. It cannot be reset accurately until the next oil change.

See “How to Reset the Engine Oil Life System” under *Engine Oil Life System on page 5-18, Scheduled Maintenance on page 6-4 and Engine Oil on page 5-14* for more information.

## OPTION Button

The OPTION button allows you to access the PERSONAL OPTIONS menu and customize the personalization settings on your vehicle. See *DIC Vehicle Personalization on page 3-67* for more information.

## RESET Button

The RESET button, used along with other buttons, will reset system functions and turn off or acknowledge messages on the DIC.

## DIC Warnings and Messages

The following messages and warnings may appear in the DIC display. The DIC display area is located in the instrument panel cluster below the speedometer and tachometer, directly above the steering column. You may receive more than one message at a time. Messages will appear one behind the other. To acknowledge a message and remove it from the display, press the RESET button. You may scroll through the messages that may have been sent at the same time. The message center is continuously updated with the vehicle performance status.

### **ABS ACTIVE (Anti-Lock Brake System**

**Active):** When your anti-lock system is adjusting brake pressure to help avoid a braking skid, the ABS ACTIVE message will be displayed.

Slippery road conditions may exist if this message is displayed, so adjust your driving accordingly. The message will stay on for a few seconds after the system stops adjusting brake pressure.

**ACTIVE HANDLING:** Your vehicle is equipped with a computer controlled system to assist the driver in controlling the vehicle in difficult driving conditions. You may feel or hear the system working and see the ACTIVE HANDLING message displayed in the DIC. This message will stay on for a few seconds following the active handling event. This is normal when the system is operating. See *Active Handling System on page 4-10* and *Braking on page 4-6*.

**ACTIVE HANDLING CALIBRATING:** This message will display and the active handling system light on the instrument panel cluster will be on while the system is calibrating after exceeding 19 mph (30 km/h) for 10 seconds. See *Active Handling System Light on page 3-39*. The Active Handling System is not functional yet. The Active Handling System performance is affected until the next message ACTIVE HANDLING READY is displayed. The Active Handling System is off until the ACTIVE HANDLING READY message is displayed. See *Active Handling System on page 4-10* for more information.

**ACTIVE HANDLING READY:** If you receive this message, the system has completed the functional check of the Active Handling System. See *Active Handling System on page 4-10* for more information.

**ACTIVE HANDLING WARMING UP:** When you first start your vehicle during cold winter weather, and begin to drive away (up to 6 mph (10 km/h)), the message ACTIVE HANDLING WARMING UP may be displayed in the DIC. This is normal. You can acknowledge this message by pressing the RESET button. The Active Handling System performance is affected until the next message ACTIVE HANDLING READY is displayed in the DIC. See *Active Handling System on page 4-10* for more information.

**ATTACH TRUNK PARTITION:** If your vehicle has a power convertible top, this message will appear and a chime will sound if the trunk partition is not in place. Open the hatch/trunk and make sure the trunk partition is secure and no objects are on the trunk partition. See *Rear Storage Area on page 2-47* for more information.

**BATTERY SAVER ACTIVE:** When the vehicle has detected that the battery voltage is dropping beyond a reasonable point, the BATTERY SAVER ACTIVE message will display. The battery saver system will start reducing certain features of the vehicle that you may not be able to notice. At the point that features are disabled, this message is displayed. It means that the vehicle is trying to save the charge in the battery. Turn off unnecessary accessories to allow the battery to recharge.

**CHANGE ENGINE OIL:** This message will appear when the life of the engine oil has expired. See *Scheduled Maintenance on page 6-4*. After an oil change, the engine oil life system must be reset. See “Engine Oil Life” under *DIC Controls and Displays on page 3-48*. Also, see *Engine Oil on page 5-14* and *Engine Oil Life System on page 5-18* for more information.

**CHECK BRAKE FLUID:** This message will appear, a chime will sound and the brake system warning light on the instrument panel cluster will be on if the ignition is on to inform the driver that the brake fluid level is low. See *Brake System Warning Light on page 3-37*. Have the brake system serviced by your GM dealer as soon as possible. See *Brakes on page 5-35*.

**CHECK COOLANT LEVEL:** This message will appear when there is a low level of engine coolant. Have the cooling system serviced by your GM dealer as soon as possible. See *Engine Coolant on page 5-22*.

**CHECK GAS CAP:** If the gas cap has not been fully tightened, this message will appear. You should check your gas cap to ensure that it is on properly. Once tightened, it will take at least one overnight park to reset or clear this message. If there is a CHECK GAS CAP message and a malfunction indicator lamp on in the instrument panel cluster, you may need to see your GM dealer for service. See *Malfunction Indicator Lamp on page 3-41* for more information.

**CHECK OIL LEVEL:** Press the RESET button to acknowledge that you have read the message and to remove it from the display. The message will reappear every 10 minutes until this condition changes. Once the vehicle senses a change in the engine oil level, the light will remain off.

You will hear two chimes when this message is displayed. If this message appears after starting your engine, your engine oil level may be too low. You may need to add oil. See *Engine Overheating on page 5-25*.

**CLOSE TRUNK TO MOVE TOP:** This message will display and a chime will sound if the trunk is open while you are trying to operate the convertible top. Make sure the trunk is closed before operating the convertible top. See *Convertible Top (Manual) on page 2-55* or *Convertible Top (Power) on page 2-62*.

**COMPETITIVE DRIVING MODE:** When the Competitive Driving mode is selected, this message will be displayed in the DIC and a short chime will sound. The instrument panel cluster light will not be on when the Competitive Driving mode is selected. The Traction Control System will not be operating while in the Competitive Driving mode. You should adjust your driving accordingly.

**COOLANT OVER TEMPERATURE:** You will hear a chime when this message is displayed. To acknowledge the warning, press the RESET button. After you press

the RESET button, a message will be displayed and you will hear a chime every minute until this condition changes. If you do not press the RESET button, the message will remain on the digital display until the condition changes.

If the engine coolant exceeds 255°F (124°C), this message is displayed. If you have been operating your vehicle under normal driving conditions, you should pull off the road, stop your vehicle and turn off the engine as soon as possible. You can monitor the coolant temperature with the GAGES button on the DIC or the engine coolant gage on the instrument panel cluster. See *Engine Overheating on page 5-25*.

**CRUISE DISENGAGED:** This message will momentarily appear when you disengage the cruise control system by stepping on the brake on an automatic transmission vehicle or the clutch on a manual transmission vehicle or by turning off the cruise control switch. See *Cruise Control on page 3-11* for more information.

**ENGINE DRAG CONTROL ACTIVE:** This message displays when engine drag control is active. When driving in a lower gear in rainy, snowy or icy conditions, and then letting up on the accelerator or downshifting, the rear wheels may begin to slip and this message appears. This message will stay on for a few seconds following the engine drag control event.

**ENGINE OVERHEATED – STOP ENGINE:** This message will appear along with a continuous chime when the engine has overheated. Stop and turn the engine off immediately to avoid severe engine damage. See *Engine Overheating on page 5-25*.

**ENGINE PROTECTION REDUCE ENGINE RPM:** You will hear multiple chimes when this message is displayed. This message will remain displayed and active until the issue is resolved.

If the engine oil temperature exceeds 320°F (160°C), this message is displayed. You should check the engine coolant temperature and engine oil level. If your engine is too hot, see *Engine Overheating on page 5-25*. Your vehicle may need service, so see your GM dealer. You can monitor the oil temperature with the gages button on the DIC.

**HEADLAMPS SUGGESTED:** If it is dark enough outside and the headlamps and Twilight Sentinel® controls are off, this message will display. This message informs the driver that turning on the exterior lamps is recommended. It has become dark enough outside to require the headlamps and/or other exterior lamps.

**HIGH TIRE PRESSURE:** To acknowledge the warning, press the RESET button. After you press the RESET button, a message will reappear every 10 minutes until this condition changes. This message indicates that

the pressure in one of your tires is higher than 42 psi (290 kPa). Next to the HIGH TIRE PRESSURE message, you can see either LEFT FRONT, RIGHT FRONT, LEFT REAR or RIGHT REAR to indicate to you which tire is higher than 42 psi (290 kPa). You can receive more than one tire pressure message at a time. To read other messages that may have been sent at the same time, press the RESET button. If a tire pressure message appears on the DIC, stop as soon as you can. Have the tire pressures checked and set to those shown on your Tire Loading Information Label. See *Extended Mobility Tires on page 5-56* and *Inflation - Tire Pressure on page 5-58*.

**HOT ENGINE AIR CONDITIONING OFF:** This message displays when the engine coolant becomes hotter than the normal operating temperature. To avoid added strain on a hot engine, the air conditioning compressor is automatically turned off. When the coolant temperature returns to normal, the A/C operation will automatically resume. You can continue to drive your vehicle. If this message continues to appear, have the system repaired by your GM dealer as soon as possible to avoid compressor damage.

**ICE POSSIBLE:** This message displays when the outside air temperature is cold enough to create icy road conditions.

**LOW FUEL:** This message displays when the fuel tank is less than 10 percent full and the display is turned off. A multiple chime will also sound when this message is displayed. See *Fuel Gage on page 3-46*.

**LOW OIL PRESSURE:** If this message appears while the engine is running, stop the engine and do not operate it until the cause of low oil pressure is corrected. Severe damage to the engine can result. A multiple chime will sound when this message is displayed. See *Engine Oil on page 5-14*.

**LOW TIRE PRESSURE:** You will hear multiple chimes and the tire pressure light on the instrument panel cluster will come on when this message is displayed. See *Tire Pressure Light on page 3-41*. To acknowledge the warning, press the RESET button. After you press the RESET button, a message will appear every 10 minutes until this condition changes. This message indicates that the pressure in one of your tires is less than 24 psi (164 kPa). Next to the LOW TIRE PRESSURE message, you can see either LEFT FRONT, RIGHT FRONT, LEFT REAR or RIGHT REAR to indicate to you which tire is low on pressure. You can receive more than one tire pressure message at a time. To read other messages that may have been sent at the same time, press the RESET

button. If a tire pressure message appears on the DIC, stop as soon as you can. Have the tire pressures checked and set to those shown on your Tire Loading Information Label. See *Extended Mobility Tires on page 5-56* and *Tire Pressure Monitor System on page 5-61*.

 **CAUTION:**

**When the LOW TIRE PRESSURE or TIRE FLAT message is displayed on the Driver Information Center, your vehicle's handling capabilities will be reduced during severe maneuvers. The active handling system will be affected. See *Active Handling System on page 4-10*. If you drive too fast, you could lose control of your vehicle. You or others could be injured. Do not drive over 55 mph (90 km/h) when the LOW TIRE PRESSURE or TIRE FLAT message is displayed. Drive cautiously and check your tire pressures as soon as you can.**

**MAXIMUM SPEED 80 MPH (129 km/h):** To acknowledge the warning, press the RESET button. After you press the RESET button, a message will reappear every 10 minutes until this condition changes.

This message indicates that a malfunction is present in the selective real time damping system. The vehicle speed will be limited to a value determined by the vehicle when the shock absorber system has failed and the shocks are in their full soft mode. Have your vehicle serviced by your GM dealer as soon as possible.

**NO FOBS DETECTED:** This message is displayed if the vehicle does not detect the presence of a keyless access transmitter when you have attempted to start the vehicle or a vehicle door has just closed. The following conditions may cause this message to appear:

- Driver-added equipment, such as two-way radios or power inverters, is causing interference. Try moving the keyless access transmitter away from these devices when starting the vehicle.
- The vehicle is experiencing Electro-Magnetic Interference (EMI). Some locations, such as airports and some gas stations, have EMI fields which may interfere with your keyless access transmitter. If moving the transmitter to different locations within the vehicle does not help, place the transmitter in the glove box transmitter pocket with the buttons facing to the right and then press the START button.

**NO FOB - OFF OR RUN?:** This message is displayed and a chime will sound when you turn off the engine, but the vehicle does not detect a keyless access transmitter in the vehicle. The vehicle will remain in ACCESSORY until OFF or START has been pressed or five minutes has expired. If you select OFF, the vehicle cannot be started again without a keyless access transmitter in the vehicle.

**OPTIONS UNAVAILABLE:** This message is displayed for a few seconds if a keyless access transmitter that is not labelled 1 or 2 is used and you try to personalize the features on your vehicle by pressing the OPTION button. The personalization system will not recognize the transmitter and the DIC will not display the current driver number or the menus used to set personalizations. The personalization features will then be set to the default states. See *DIC Vehicle Personalization on page 3-67* for more information.

**PRESS BRAKE TO START ENGINE (Automatic Transmission Only):** This message is displayed if you try to start the engine by pressing the keyless ignition start button without having the brake pressed. The brake needs to be pressed when starting the engine. See *Ignition Positions on page 2-20* for more information.



**REDUCED ENGINE POWER:** You will hear multiple chimes when this message is displayed. To acknowledge that you have read the message and to remove it from the display, press the RESET button. The message will reappear every five minutes until this condition changes.

If the Driver Information Center (DIC) displays the REDUCED ENGINE POWER message and the CHECK ENGINE light comes on, a noticeable reduction in the vehicle's performance may occur. If the REDUCED ENGINE POWER message is displayed but there is no reduction in performance, proceed to your destination. The performance may be reduced the next time the vehicle is driven.

The vehicle may be driven at a reduced speed while the REDUCED ENGINE POWER message is displayed, but acceleration and speed may be reduced. Anytime the CHECK ENGINE light stays on, the vehicle should be taken to your GM dealer as soon as possible for diagnosis and repair.

Also, see *Malfunction Indicator Lamp on page 3-41*. If the REDUCED ENGINE POWER message is displayed in combination with the COOLANT OVER TEMPERATURE message, see *Engine Overheating on page 5-25*.

**SERVICE ACTIVE HANDLING SYSTEM:** If the SERVICE ACTIVE HANDLING SYSTEM message is displayed, there is a problem with your Active Handling System and your vehicle needs service. See your GM dealer. The instrument cluster light will also be on and a chime will sound. When this message is displayed, the system is not working. Adjust your driving accordingly. See *Active Handling System on page 4-10* for more information.

**SERVICE AIR CONDITIONING:** This message displays when the electronic sensors that control the air conditioning and heating systems are no longer working. Have the climate control system serviced by your GM dealer if you notice a drop in heating and air conditioning efficiency.

**SERVICE ANTILOCK BRAKES:** If the SERVICE ANTILOCK BRAKES message is displayed when you are driving, stop as soon as possible and turn the ignition off. Then start the engine again to reset the system. If the message stays on, or comes back on again while you are driving, your vehicle is in need of service. See your GM dealer. If the anti-lock brake system warning light is on and the regular brake system warning light is not on, you still have brakes, but do not have anti-lock brakes. If the regular brake system light is also on, you do not have anti-lock brakes and there is a problem with your brakes. See *Anti-Lock Brake System Warning Light on page 3-38* and *Brake System Warning Light on page 3-37*.

If the SERVICE ANTILOCK BRAKES message is being displayed, your Traction Control System and the Active Handling System will also be disabled. The Driver Information Center will scroll three messages: SERVICE ANTILOCK BRAKES, SERVICE TRACTION SYSTEM and SERVICE ACTIVE HANDLING, and the instrument cluster lights will be illuminated along with a chime. The driver can acknowledge these messages by pressing the RESET button. When the service message is displayed the computer controlled systems will not assist the driver and you should have the system repaired by your GM dealer as soon as possible. Adjust your driving accordingly.

**SERVICE CHARGING SYSTEM:** Press the RESET button to acknowledge that you have read the message and to remove it from the display. The message will reappear every 10 minutes until this condition changes. You will hear multiple chimes when this message is displayed.

If this message comes on while you are driving, you may have a problem with the electrical charging system. It could indicate that you have a loose or broken drive belt or another electrical problem. Have it checked right away by your GM dealer. Driving while this warning message is on could drain your battery.

If you must drive a short distance with the message on, be certain to turn off your accessories, such as the radio and air conditioner.

**SERVICE COLUMN LOCK (Manual Transmission Only):** This message may display if the system that controls the locking and unlocking of the steering column does not work properly. Have the vehicle towed to your GM dealer for service.

**SERVICE ELECTRICAL SYSTEM:** This message displays if an electrical problem has occurred within the Powertrain Control Module (PCM). Have your vehicle serviced by your GM dealer.

**SERVICE FUEL SYSTEM:** This message displays if the Powertrain Control Module (PCM) has detected a problem within the fuel system. Have your vehicle serviced by your GM dealer. This message will also be displayed when the cluster is not getting fuel information from the PCM.

**SERVICE RIDE CONTROL:** This message is used to indicate to the driver that the Selective Ride Control system has detected a malfunction and that the system must be serviced. See your GM dealer. The SERVICE RIDE CONTROL message will always come on when a failure is detected by the Selective Ride Control system. If a fault is present in the Selective Ride Control system which causes the shocks to be in their full soft condition, the SERVICE RIDE CONTROL, SHOCKS INOPERATIVE and MAXIMUM SPEED 80 MPH (129 km/h) will display together.

**SERVICE TIRE MONITOR:** If this message comes on, a part on the Tire Pressure Monitor (TPM) is not working properly. If you drive your vehicle while any of the four sensors are missing or inoperable, the warning will come on in about 60 minutes. A sensor would be missing, for example, if you put different wheels on your vehicle without transferring the sensors. If the warning comes on and stays on, there may be a problem with the TPM. See your GM dealer.

**SERVICE TRACTION SYSTEM:** If the SERVICE TRACTION SYSTEM message is displayed when you are driving, there is a problem with your Traction Control System and your vehicle is in need of service. See your GM dealer. When this message is displayed, the system will not limit wheel spin. Adjust your driving accordingly.

The instrument cluster car icon will also be illuminated and a chime will sound. The driver can acknowledge both messages by pressing the RESET button two times. When the service messages are displayed, the computer controlled systems will not assist the driver in controlling the vehicle. Have the system repaired by your GM dealer as soon as possible. Adjust your driving accordingly.

**SERVICE TRANSMISSION:** If this message appears, there is a problem with the transmission. See your GM dealer for service.

**SERVICE VEHICLE SOON:** If this message appears on the DIC along with a chime, there may be an electrical or another system problem with your vehicle. Have your vehicle checked by your GM dealer if this message keeps appearing.

**SET PARK BRAKE FOR SEAT RECALL:** If you have a manual transmission vehicle, this message displays if you try to recall the memory positions when the ignition is on and the parking brake is not set. If the vehicle is on, you must set the parking brake in order for the memory positions to recall. See *Memory on page 2-66* for more information.

**SET PARK BRAKE TO MOVE TOP:** If you have a manual transmission vehicle, this message will display and a chime will sound if you try to operate the power convertible top without first setting the parking brake. Set the parking brake before trying to operate the power convertible top. See *Convertible Top (Manual) on page 2-55* or *Convertible Top (Power) on page 2-62* for more information.

**SHIFT TO PARK:** If you have an automatic transmission vehicle, this message indicates that the vehicle is not in PARK (P) when the engine is being turned off. The vehicle will be in ACCESSORY. Once the shifter is moved to PARK (P), the vehicle will turn off.

**SHIFT TO PARK OR SET PARK BRAKE FOR TOP:** If you have an automatic transmission vehicle, this message will display and a chime will sound if you try to operate the power convertible top without first shifting

into PARK (P) or setting the parking brake. Either shift the vehicle into PARK (P) or set the parking brake before trying to operate the power convertible top. See *Convertible Top (Manual) on page 2-55* or *Convertible Top (Power) on page 2-62* for more information.

**SHIFT TO REVERSE:** If you have a manual transmission vehicle, this message indicates that the vehicle is not in REVERSE (R) when the engine is being turned off. The vehicle will be in ACCESSORY. Once the shifter is moved to REVERSE (R), the vehicle will turn off.

**SHOCKS INOPERATIVE:** To acknowledge that you have read the message and to remove it from the display, press the RESET button. The message will reappear every 10 minutes until this condition changes.

This message indicates that a malfunction is present in the Selective Ride Control system which is causing the shocks to be in their full soft mode. This is a warning to the driver that the vehicle handling may be affected. Have your vehicle serviced by your GM dealer as soon as possible.

**TIRE FLAT:** You will hear two chimes when this message is displayed followed by the message **MAXIMUM SPEED 55 MPH (90 km/h)**. Also, the tire pressure light on the instrument panel cluster will come on. See *Tire Pressure Light on page 3-41*. If this message appears, do not drive your vehicle above this limit. The next message to appear is **REDUCED HANDLING**. The active handling system will intervene more quickly when a flat tire has been detected. Adjust your driving accordingly. To acknowledge these warnings, press the **RESET** button. After you press the **RESET** button, a message will reappear every 10 minutes until this condition changes. This message indicates that the pressure in one of your tires is lower than 10 psi (68 kPa). Next to the **TIRE FLAT** message, you can see either **LEFT FRONT**, **RIGHT FRONT**, **LEFT REAR** or **RIGHT REAR** to indicate to you which tire is flat. You can receive more than one tire pressure message at a time. To read other messages that may have been sent at the same time, press the **RESET** button. If a tire pressure message appears on the DIC, stop as soon as you can. Have the tire pressures checked and set to those shown on your Tire Loading Information Label. See *Extended Mobility Tires on page 5-56* and *Inflation - Tire Pressure on page 5-58*.

 **CAUTION:**

**When the **LOW TIRE PRESSURE** or **TIRE FLAT** message is displayed on the Driver Information Center, your vehicle's handling capabilities will be reduced during severe maneuvers. If you drive too fast, you could lose control of your vehicle. You or others could be injured. Don't drive over 55 mph (90 km/h) when the **LOW TIRE PRESSURE** or **TIRE FLAT** message is displayed. Drive cautiously and check your tire pressures as soon as you can.**

**TOO COLD TO MOVE TOP:** This message displays and a chime sounds when the power convertible top button is pressed and the power convertible top pump motor temperature is below -4°F (-20°C). Wait for the power convertible top pump motor to warm up before using the power convertible top.

**TOP MOTOR OVER TEMPERATURE:** This message displays and a chime sounds when the power convertible top button is pressed and the power convertible top pump motor temperature is over 221°F (105°C). Wait for the power convertible top pump motor to cool down before using the power convertible top.

**TOP NOT SECURE:** This message displays and a chime sounds when the power convertible top button is released before the top open or close operation is complete or if the top is closed without the header latch engaged. Press and hold the convertible top button to fully open or close the top, and make sure that the header latch is engaged after the top is closed.

### **TRACTION SYSTEM AND ACTIVE**

**HANDLING – OFF:** By pressing the Active Handling System console button for five seconds, the driver can turn the Traction Control and Active Handling Systems off. The message TRACTION SYSTEM AND ACTIVE HANDLING – OFF will be displayed in the DIC, the instrument panel cluster light will be on and a chime will sound. You can acknowledge this message by pressing the RESET button. The anti-lock brake systems remains on with the Traction Control and Active Handling Systems off. You should adjust your driving accordingly.

### **TRACTION SYSTEM AND ACTIVE**

**HANDLING – ON:** If the Traction Control and Active Handling Systems are off, pressing the Active Handling System console button momentarily will turn both systems on. The message TRACTION SYSTEM AND ACTIVE HANDLING – ON will be displayed temporarily in the DIC, the instrument panel cluster light will be off and a chime will sound.

**TRACTION SYSTEM ACTIVE:** When your Traction Control System is limiting wheel spin, the TRACTION SYSTEM ACTIVE message will be displayed. Slippery road conditions may exist if this message is displayed, so adjust your driving accordingly. The message will stay on for a few seconds after the Traction Control System stops limiting wheel spin.

**TRACTION SYSTEM – OFF:** You will hear a single quick tone when this message is displayed and the traction control system warning light on the instrument panel cluster will come on. See *Traction Control System (TCS) Warning Light on page 3-39*. This message comes on and stays on when the Active Handling System console button is pressed to turn the system off. To acknowledge this message, press the RESET button.

**TRACTION SYSTEM – ON:** You will hear a single quick tone when this message is displayed. This message is displayed when you decide to turn on the Traction Control System by pressing the Active Handling System console button on the console. This message will shut off automatically on its own.

**TRANSMISSION HOT IDLE ENGINE:** You will hear four chimes when this message is displayed. To acknowledge this warning, press the RESET button. After you press the RESET button, the message will be displayed every 10 minutes until the condition changes. If you do not press the RESET button, the message remains on the display until the condition changes.

If the transmission fluid temperature rises above 270°F (132°C) or rises rapidly, this message is displayed. The transmission may shift gears or apply the torque converter clutch to reduce the fluid temperature. Driving aggressively or driving on long hills can cause the transmission fluid temperature to be higher than normal. If this message appears, you may continue to drive at a slower speed. You should also monitor the transmission fluid temperature and allow it to cool to at

least 230°F (110°C). The transmission fluid temperature can be monitored with the gages button on the DIC. See *Automatic Transmission Fluid* on page 5-21. You should also check the engine coolant temperature. If it is also hot, see *Engine Overheating* on page 5-25.

If the TRANSMISSION HOT IDLE ENGINE message is displayed during normal vehicle operation on flat roads, your vehicle may need service. See your GM dealer for an inspection.

**TURN SIGNAL ON:** If a turn signal is left on for three-quarters of a mile (1.2 km), this message will appear on the display and you will hear a chime. Move the turn signal/multifunction lever to the off position. To acknowledge this message, press the RESET button.

**UNLATCH HEADER TO MOVE TOP:** This message will display and a chime will sound if you try to lower the convertible top without first unlocking the top. Move the latch handle to unlock the convertible top. See *Convertible Top (Manual)* on page 2-55 or *Convertible Top (Power)* on page 2-62.

## Other Messages

Here are more messages that you can receive on your Driver Information Center (DIC). To acknowledge a message and read another message that may have come on at the same time, press the RESET button.

- ACCESSORY MODE ON
- BATTERY VOLTAGE HIGH  
See *Voltmeter Gage on page 3-36*.
- BATTERY VOLTAGE LOW  
See *Voltmeter Gage on page 3-36*.
- CHECK WASHER FLUID  
See *Windshield Washer Fluid on page 5-34*.
- CRUISE SET TO XXX MPH (XXX km/h)  
See “Cruise Control” under *Turn Signal/Multifunction Lever on page 3-8*.
- DRIVER DOOR AJAR
- FOB AUTOLEARN WAIT XX MINUTES  
See “Matching Transmitter(s) to Your Vehicle” under *Keyless Access System Operation on page 2-5*.
- FOB BATTERY LOW  
See “Battery Replacement” under *Keyless Access System Operation on page 2-5*.
- HATCH AJAR (Coupe)
- INTRUSION SENSOR OFF, if equipped
- INTRUSION SENSOR ON, if equipped
- KNOWN FOB  
See “Matching Transmitter(s) to Your Vehicle” under *Keyless Access System Operation on page 2-5*.
- MAXIMUM NUMBER OF FOBS LEARNED  
See “Matching Transmitter(s) to Your Vehicle” under *Keyless Access System Operation on page 2-5*.
- OFF-ACCESSORY TO LEARN  
See “Matching Transmitter(s) to Your Vehicle” under *Keyless Access System Operation on page 2-5*.
- PASSENGER DOOR AJAR
- READY FOR FOB #X  
See “Matching Transmitter(s) to Your Vehicle” under *Keyless Access System Operation on page 2-5*.
- TONNEAU AJAR (Convertible)
- TRUNK AJAR (Convertible)
- UPSHIFT NOW  
See *Manual Transmission Operation on page 2-26*.



## DIC Vehicle Personalization

Many features on your vehicle can be personalized. This means that the operation of these features can be set to operate differently depending on who is driving the vehicle. See “Personal Options” later in this section for the features that you can personalize.

The personalization settings for other features are automatically updated and saved as the driver adjusts them. These include the following settings and presets:

- The radio presets, tone, volume, fade, balance, equalization (EQ) settings and source (radio or CD)
- The last climate control setting
- The Head-Up Display (HUD) position and dimming level, if equipped
- The instrument panel cluster dimming level and last selected DIC display

Separate personalization settings are saved for two different drivers. One of the keyless access transmitters is assigned to driver 1. The other is assigned to driver 2. The back of the keyless access transmitters are labelled 1 or 2 to correspond to each driver.

The current driver’s preferences are recalled when one of the following occurs:

- The lock or unlock button on the keyless access transmitter, labelled 1 or 2, is pressed.
- The appropriate memory button, 1 or 2, located on the driver’s door is pressed. See *Memory on page 2-66* for more information.
- A valid keyless access transmitter is detected upon opening the driver’s door.

If more than one valid keyless access transmitter is detected upon opening the driver’s door, the driver preferences for the lowest driver number will be recalled.

If a keyless access transmitter that is not labelled 1 or 2 is used, the personalization system will not recognize the transmitter. The Driver Information Center (DIC) will not display a current driver number and the features that are normally programmed through the DIC will be set to the default states. Also, if the OPTION button is pressed, the DIC does not display the menus used to set personalizations, but instead displays OPTIONS UNAVAILABLE for a few seconds.

## Entering the Personal Options Menu

To enter the personal options menu, use the following steps:

1. If you have an automatic transmission vehicle, turn the vehicle on with the shift lever in PARK (P).  
If you have a manual transmission vehicle, turn the vehicle on with the parking brake set.
2. Press the OPTION button and you will enter the PERSONAL OPTIONS menu.  
The DIC will display the current driver number (1 or 2) for a few seconds and then will display instructions on which buttons to use for setting the personalizations. The RESET button is used to select a setting for a particular feature. The OPTION button is used to move to the next feature.
3. Press the OPTION button while the instruction screen is displayed to enter the first personalization menu item.
4. Once you have cycled through all of the personal options, pressing the OPTION button a final time exits the personal options menu. In addition, if no button is pressed within 45 seconds, the DIC will exit the personal options menu.

## Personal Options

The following options are available for programming:

**Display Units:** This option allows you to choose the measurement units.

Press the OPTION button until DISPLAY UNITS appears on the display, then press the RESET button to scroll through the following modes:

- ENGLISH (default)
- METRIC

If you choose ENGLISH, all information will be displayed in English units.

If you choose METRIC, all information will be displayed in metric units.

When the mode you want is selected, press the OPTION button to set your choice and advance to the next personal option.

**Auto Memory Recall (Automatic Transmission only):**

If your automatic transmission vehicle has the memory package, you may have this option. This option allows the driver's seat, the telescopic steering column, if equipped, and the outside rearview mirrors to automatically move to the current driver's set position when the engine starts.

Press the OPTION button until AUTO MEMORY RECALL appears on the display, then press the RESET button to scroll through the following modes:

- YES
- NO (default)

If you choose YES, the driver's seat, the outside rearview mirrors and the telescopic steering column, if equipped, positions are recalled when you turn the ignition on.

If you choose NO, this option will turn off.

When the mode you want is selected, press the OPTION button to set your choice and advance to the next personal option.

**Auto Exit Recall:** If your vehicle has the memory package, you may have this option. This option allows the driver's seat and telescopic steering column, if equipped, to automatically move to the current driver's exit position when one of the following occurs:

- The vehicle is turned off or in Retained Accessory Power (RAP) or ACCESSORY mode and the driver's door is opened.
- The vehicle is turned off or in RAP and the unlock button on the keyless access transmitter is pressed.

Press the OPTION button until AUTO EXIT RECALL appears on the display, then press the RESET button to scroll through the following modes:

- YES
- NO (default)

If you choose YES, when you turn the ignition off and open the driver's door or press the unlock button on the keyless access transmitter, the seat and the telescopic steering wheel, if equipped, will return to their stored exit positions for an easy exit or an easy entrance when returning to the vehicle.

The seat and steering wheel will only return to the stored driving position if you press the appropriate memory button or activate the auto memory recall feature.

If you choose NO, this option will turn off.

When the mode you want is selected, press the OPTION button to set your choice and advance to the next personal option.

**Approach Lights:** This option briefly turns on the parking lamps, the front fog lamps and the back-up lamps during low light periods when the keyless access transmitter is used to unlock the vehicle.

Press the OPTION button until APPROACH LIGHTS appears on the display, then press the RESET button to scroll through the following modes:

- OFF
- ON (default)

If you choose OFF, this option will turn off.

If you choose ON, the parking lamps, the front fog lamps, and the back-up lamps will come on for 20 seconds during low light periods when all of the following occurs:

- You press the unlock button on the keyless access transmitter.
- Both of the doors are closed.
- The vehicle is off or in RAP.

The lamps remain on for 20 seconds or until a door is opened, the lock button on the keyless access transmitter is pressed or the vehicle is no longer off or in RAP.

See *Keyless Access System on page 2-4* for more information.

When the mode you want is selected, press the OPTION button to set your choice and advance to the next personal option.

**Twilight Delay:** This option allows you to set the amount of time you want the parking lamps and front fog lamps to remain on after you exit the vehicle. This will occur when the vehicle is off or in RAP and the headlamps are on due to the automatic headlamp system. The parking lamps and front fog lamps will remain on until the driver selected time expires, the exterior lamp control is activated or the vehicle is no longer off or in RAP.

Press the OPTION button until TWILIGHT DELAY appears on the display, then press the RESET button to scroll through the following modes:

- OFF
- 15 S
- 30 S (default)
- 90 S

If you choose OFF, this option will turn off.

If you choose 15 S, the twilight delay time will be set to 15 seconds.

If you choose 30 S, the twilight delay time will be set to 30 seconds.

If you choose 90 S, the twilight delay time will be set to 90 seconds.

When the mode you want is selected, press the OPTION button to set your choice and advance to the next personal option.

**Flash at Unlock:** This option activates the front and rear turn signals for two short flashes when the unlock or hatch/trunk button on the keyless access transmitter is pressed. The lamps will also flash when OnStar<sup>®</sup>, if equipped, unlocks the doors. This will only occur when the vehicle is off.

Press the OPTION button until FLASH AT UNLOCK appears on the display, then press the RESET button to scroll through the following modes:

- YES (default)
- NO

If you choose YES, the front and rear turn signals will flash twice when you press the unlock button or the hatch/trunk button on the keyless access transmitter or when OnStar<sup>®</sup>, if equipped, unlocks the doors.

If you choose NO, this option will turn off.

When the mode you want is selected, press the OPTION button to set your choice and advance to the next personal option.

**Flash at Lock:** This option activates the front and rear turn signals for one long flash when the lock button on the keyless access transmitter is pressed. The lamps will also flash when OnStar<sup>®</sup>, if equipped, locks the doors. This will only occur when the vehicle is off. If the lock button on the keyless access transmitter is pressed again within five seconds, the horn will sound regardless of which setting you have selected.

Press the OPTION button until FLASH AT LOCK appears on the display, then press the RESET button to scroll through the following modes:

- YES (default)
- NO

If you choose YES, the front and rear turn signals will flash once when you press the lock button on the keyless access transmitter or when OnStar<sup>®</sup>, if equipped, locks the doors.

If you choose NO, this option will turn off.

When the mode you want is selected, press the OPTION button to set your choice and advance to the next personal option.

**FOB Reminder:** This option chirps the horn three times when the driver's door is closed and there is a keyless access transmitter inside the interior of the vehicle. This will only occur when the vehicle is off.

Press the OPTION button until FOB REMINDER appears on the display, then press the RESET button to scroll through the following modes:

- YES
- NO (default)

If you choose YES, the horn will chirp three times when a keyless access transmitter is inside of the vehicle while the ignition is turned off and the driver's door is closed.

If you choose NO, this option will turn off.

When the mode you want is selected, press the OPTION button to set your choice and advance to the next personal option.

**Passive Door Locking:** This option allows you to select whether the doors automatically lock when the ignition is turned off, the keyless access transmitter has been removed from the interior of the vehicle, and the doors have been closed for eight seconds. If a keyless access transmitter is left inside of the vehicle, the doors will not lock. You may temporarily disable the passive door locking feature by pressing a door unlock switch for three seconds while a door is

open. Passive door locking will then remain disabled until a door lock switch is pressed or until the power mode transitions from the off power mode.

Press the OPTION button until PASSIVE DOOR LOCKING appears on the display, then press the RESET button to scroll through the following modes:

- OFF (default)
- SILENT
- HORN

If you choose OFF, this option will turn off.

If you choose SILENT, the doors will automatically lock eight seconds after you turn the ignition off, remove the keyless access transmitter from the interior of the vehicle, and close both doors.

If you choose HORN, the doors will automatically lock and the horn will chirp eight seconds after you turn the ignition off, remove the keyless access transmitter from the interior of the vehicle, and close both doors.

If you are parking in a quiet area and do not want the horn to sound when the doors lock, press the lock button on the keyless access transmitter immediately after removing it from the interior and closing the doors. This will lock the doors and cancel the passive locking for this ignition cycle.

When the mode you want is selected, press the OPTION button to set your choice and advance to the next personal option.

**Passive Door Unlock:** This option allows you to select which doors will automatically unlock when you approach and open the driver's door with your keyless access transmitter. See *Door Locks on page 2-10* for more information.

Press the OPTION button until PASSIVE DOOR UNLOCK appears on the display, then press the RESET button to scroll through the following modes:

- DRIVER (default)
- BOTH

If you choose DRIVER, only the driver's door will automatically unlock when you approach and open the driver's door with your keyless access transmitter.

If you choose BOTH, both doors will automatically unlock when you approach and open the driver's door with your keyless access transmitter.

**Auto Unlock:** This option allows you to select whether the driver's door, both doors or neither door automatically unlocks when the shift lever is moved into PARK (P) for automatic transmission vehicles or when the ignition is turned off or is in RAP for manual transmission vehicles.

Press the OPTION button until AUTO UNLOCK appears on the display, then press the RESET button to scroll through the following modes:

- OFF
- DRIVER
- BOTH (default)

If you choose OFF, this option will turn off.

If you choose DRIVER, on automatic transmission vehicles, the driver's door will automatically unlock when the shift lever is moved into PARK (P). On manual transmission vehicles, the driver's door will automatically unlock when the ignition is turned off or is in RAP.

If you choose BOTH, on automatic transmission vehicles, both doors will automatically unlock when the shift lever is moved into PARK (P). On manual transmission vehicles, both doors will automatically unlock when the ignition is turned off or is in RAP.

When the mode you want is selected, press the OPTION button to set your choice and advance to the next personal option.

**Language:** This option allows you to select the language the DIC, the Head-Up Display (HUD), if equipped, and the radio uses to display messages. Each language mode will be displayed in its own language. For example, English will be displayed as ENGLISH, Spanish as ESPANOL, etc. If your vehicle has the navigation system, you will not have the Japanese language mode.

Press the OPTION button until LANGUAGE appears on the display, then press the RESET button to scroll through the following modes:

- ENGLISH (default)
- GERMAN
- FRENCH
- ITALIAN
- SPANISH
- JAPANESE

If you choose a language that you do not understand, press the OPTION and RESET buttons for five seconds. The DIC will begin displaying all of the various languages one by one for as long as the buttons are pressed. When the desired language is displayed, release the buttons and the DIC will set to this language.

When the mode you want is selected, press the OPTION button to set your choice and advance to the next personal option.

**Personalize Name:** This option allows you to type in a name or greeting that will appear on the DIC display whenever the corresponding keyless access transmitter (1 or 2) is used or one of the memory buttons (1 or 2) located on the driver's door is pressed.

Press the OPTION button until PERSONALIZE NAME appears on the display, then press the RESET button to scroll through the following modes:

- YES
- NO (default)

If you choose YES, you can type in a name that will appear on the DIC display.

To program a name, use the following procedure:

1. Enter the PERSONAL OPTIONS menu and select the driver number (1 or 2) that you would like to program by following the instructions listed previously under "Entering the Personal Options Menu".
2. Press the OPTION button until the PERSONALIZE NAME option appears on the display.
3. Select YES under PERSONALIZE NAME by pressing the RESET button.
4. Press the OPTION button and a cursor will display where you can insert a letter.



5. Press the OPTION button again until the letter you want is displayed. To scroll through the letters faster and without a beeping noise, keep the OPTIONS button depressed. There is a complete alphabet and a blank space available.
6. Then press the RESET button to select the letter of your choice and proceed on to the next space to the right.

If you make a mistake and would like to clear or replace a letter, perform the following steps:

- 6.1. Press the RESET button to reach the letter you would like to change.
- 6.2. Press the OPTION button to scroll through the letter choices.
- 6.3. Press the RESET button to select the letter and proceed on to the next space to the right.

7. Repeat Steps 5 and 6 until the name or greeting you want is complete. After the name or greeting is complete, keep pressing the RESET button until the display turns blank and exits out of this option. You can program up to 20 characters.

If you choose NO, this option will turn off.

If a customized name or greeting is not programmed, the DIC display will show Driver 1 or Driver 2 to correspond with either the number on the back of the keyless access transmitter (1 or 2) that is being used or to the memory button (1 or 2) that is pressed.

PERSONALIZE NAME is the last option available to program in the PERSONAL OPTIONS menu. Pressing the OPTION button after this setting will exit you from the PERSONAL OPTIONS menu. The last item you were in prior to entering PERSONAL OPTIONS will then display on the DIC.

## Audio System(s)

**Notice:** Before adding any sound equipment to your vehicle, like a tape player, CB radio, mobile telephone, or two-way radio, make sure that it can be added by checking with your dealer. Also, check federal rules covering mobile radio and telephone units. If sound equipment can be added, it is very important to do it properly. Added sound equipment may interfere with the operation of your vehicle's engine, radio, or other systems, and even damage them. Your vehicle's systems may interfere with the operation of sound equipment that has been added improperly.

Figure out which audio system is in your vehicle, find out what your audio system can do, and how to operate all of its controls.

Your vehicle may have a feature called Retained Accessory Power (RAP). With RAP, the audio system can be played even after the ignition is turned off. See *Retained Accessory Power (RAP)* on page 2-21 for more information.

## Setting the Time

Press the H or the M button to enter clock mode. Press and hold H until the correct hour appears on the display. Press and hold M until the correct minute appears on the display.

## Radio with CD

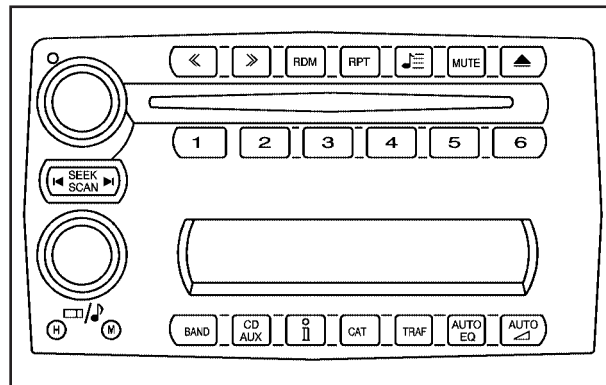

**Radio with CD shown, Radio with Six-Disc CD similar**

Your vehicle has seven Bose® amplified speakers. See your GM dealer for details.

## Radio Data System (RDS)

The audio system has a Radio Data System (RDS). RDS features are available for use only on FM stations that broadcast RDS information.

With RDS, the radio can do the following:

- Seek to stations broadcasting the selected type of programming
- Receive announcements concerning local and national emergencies
- Display messages from radio stations
- Seek to stations with traffic announcements

This system relies upon receiving specific information from these stations and will only work when the information is available. In rare cases, a radio station may broadcast incorrect information that will cause the radio features to work improperly. If this happens, contact the radio station.

While the radio is tuned to an RDS station, the station name or call letters will appear on the display. RDS stations may also provide the time of day, a program type (PTY) for current programming, and the name of the program being broadcast.

## XM™ Satellite Radio Service

If your vehicle has XM™, XM™ is a satellite radio service that is based in the 48 contiguous United States. XM™ offers 100 coast to coast channels including music, news, sports, talk, and children's programming. XM™ provides digital quality audio and text information that includes song title and artist name. A service fee is required in order to receive the XM™ service. For more information, contact XM™ at [www.xmradio.com](http://www.xmradio.com) or call 1-800-852-XXXM (9696).

## Playing the Radio

**Top Knob (Power/Volume):** Press this knob to turn the system on and off. Turn this knob to increase or to decrease the volume.

**i (Information):** For RDS, press this button to change what appears on the display while using RDS. The display options are station name, RDS station frequency, PTY, and the name of the program (if available).

For XM™ (if equipped), press the information button while in XM™ mode to retrieve four different categories of information related to the current song or channel: Artist, Song Title, Category or PTY, Channel Number/Channel Name.

To change the default on the display, press the information button until you see the display you want, then hold the button for two seconds. The radio will produce one beep and the selected display will now be the default.

**AUTO**  **(Automatic Volume):** With automatic volume, the audio system will adjust automatically to make up for road and wind noise as you drive by increasing the volume as vehicle speed increases.

Set the volume at the desired level. Press this button to select MIN, MED, or MAX. AVOL will appear on the display. Each higher setting will provide more volume compensation at faster vehicle speeds. To turn automatic volume off, press this button until AVOL OFF appears on the display.

If your vehicle has the Bose<sup>®</sup> audio system, it includes Bose AudioPilot<sup>®</sup> noise compensation technology. When turned on, AudioPilot<sup>®</sup> continuously adjusts the audio system to compensate for background noise, so that your music always sounds the same at the set volume level. This feature is most effective at lower radio volume settings where background noise can affect how well you hear the music being played through your vehicle's audio system. At higher volume settings, where the music is much louder than the background noise, there may be little or no adjustments by AudioPilot<sup>®</sup>.



To use AudioPilot<sup>®</sup>, set the radio volume to your desired level. Turn AudioPilot<sup>®</sup> on by pressing the automatic volume button until AVOL ON appears on the display. As you increase vehicle speed, the background noise in your vehicle will increase. AudioPilot<sup>®</sup> will adjust your audio system's output for the background noise it hears. To turn AudioPilot<sup>®</sup> off, press the automatic volume button until AVOL OFF appears on the display. For additional information on AudioPilot<sup>®</sup>, please visit [www.bose.com](http://www.bose.com).



**MUTE:** Press this button to silence the system. Press this button again to turn the sound on.

This button is not available on the Radio with Six-Disc CD.

## Finding a Station

**BAND:** Press this button to switch between FM1, FM2, AM, or XM1 or XM2 (if equipped). The display will show the selection.

 /  **(Tune):** Turn this knob to select radio stations.

 **SEEK** : Press the right or the left arrow to go to the next or to the previous station and stay there.

The radio will only seek stations with a strong signal that are in the selected band.

◀ **SCAN** ▶: Press and hold either arrow for two seconds until FREQUENCY SCAN appears on the display. The radio will go to a station, play for a few seconds, then go on to the next station. Press either arrow again to stop scanning.

To scan preset stations, press and hold either arrow for four seconds until PSCAN appears on the display. The radio will go to the first preset station, play for a few seconds, then go on to the next preset station. Press either scan arrow again or one of the pushbuttons to stop scanning presets.

The radio will only scan stations with a strong signal that are in the selected band.

## Setting Preset Stations

Up to 30 stations (six FM1, six FM2, and six AM, six XM1 and six XM2 (if equipped)), can be programmed on the six numbered pushbuttons, by performing the following steps:

1. Turn the radio on.
2. Press BAND to select FM1, FM2, AM, or XM1 or XM2.
3. Tune in the desired station.

4. Press AUTO EQ to select the equalization.
5. Press and hold one of the six numbered pushbuttons until you hear a beep. Whenever that numbered pushbutton is pressed, the station that was set will return and the equalization that was selected will be stored for that pushbutton.
6. Repeat the steps for each pushbutton.

## Setting the Tone (Bass/Treble)

 **(Bass/Treble/Midrange):** Press this knob to select BASS, MIDRANGE, or TREBLE. Turn the knob to increase or to decrease. If a station is weak or noisy, decrease the treble.

**AUTO EQ (Automatic Equalization):** Press this button to select customized equalization settings designed for country/western, jazz, talk, pop, rock, and classical. Selecting CUSTOM or changing bass or treble, returns the EQ to the manual bass and treble settings.

The radio will save separate AUTO EQ settings for each preset and source.

If the radio is equipped with the Bose audio system, the equalization settings are EQ1 through EQ7 and CUSTOM.

## Adjusting the Speakers (Balance/Fade)

 **(Balance):** To adjust the balance between the right and the left speakers, press this knob until BALANCE appears on the display. Turn the knob to move the sound toward the right or the left speakers.

 **(Fade):** To adjust the fade between the front and the rear speakers, press this until FADE appears on the display. Turn the knob to move the sound toward the front or the rear speakers.

## Finding a Category Station (RDS and XM™)

To select and find a desired PTY perform the following:

1. Press the CAT button to select a category. TYPE and a category will appear on the display.
2. Once the desired category is displayed, press one of the SEEK arrows to take you to the category's first station.
3. To go to another station within that category and the category is displayed, press the CAT button once. If the PTY is not displayed, press the CAT button twice to display the category and then to go to another station.

If PTY times out and is no longer on the display, go back to Step 1.

If both category and TRAF are on, the radio will search for stations with the selected category and traffic announcements.

If the radio cannot find the desired category, NONE will appear on the display and the radio will return to the last station you were listening to.

**SCAN:** Scan the stations within a category by performing the following:

1. Press the CAT button to select a category. TYPE and a category will appear on the display.
2. Once the desired category is displayed, press and hold either SCAN arrow until you hear a beep, and the radio will begin scanning the stations in the category.
3. Press either SCAN arrow to stop scanning.

If both category and TRAF are on, the radio will scan for stations with the selected category and traffic announcements.

**BAND (Alternate Frequency):** Alternate frequency allows the radio to switch to a stronger station with the same category. To turn alternate frequency on, press and hold BAND for two seconds. AF ON will appear on the display. The radio may switch to stations with a stronger frequency.

To turn alternate frequency off, press and hold BAND again for two seconds. AF OFF will appear on the display. The radio will not switch to other stations.

This function does not apply for XM™ Satellite Radio Service.

## Setting Preset Category's (RDS Only)

Up to 12 PTYs (six FM1 and six FM2), can be programmed on the six numbered pushbuttons, by performing the following steps:

1. Press BAND to select FM1 or FM2.
2. Press the CAT button to activate program type select mode. TYPE and a category will appear on the display.
3. Press and hold one of the six numbered pushbuttons until you hear a beep. Whenever that numbered pushbutton is pressed, the category that was set will return.
4. Repeat the steps for each pushbutton.

## RDS Messages

**ALERT!:** Alert warns of local or national emergencies. When an alert announcement comes on the current radio station, ALERT! will appear on the display. You will hear the announcement, even if the volume is low or a CD is playing. If a CD is playing, play will stop during the announcement. Alert announcements cannot be turned off.

ALERT! will not be affected by tests of the emergency broadcast system. This feature is not supported by all RDS stations.

**i (Information):** If the current station has a message, the information symbol will appear on the display. Press this button to see the message. The message may display the artist, song title, call in phone numbers, etc.

If the entire message is not displayed, parts of the message will appear every three seconds. To scroll through the message, press and release the INFO button. A new group of words will appear on the display after every press of the button. Once the complete message has been displayed, the information symbol will disappear from the display until another new message is received. The last message can be displayed by pressing the INFO button. You can view the last message until a new message is received or a different station is tuned to.

When a message is not available from a station, NO INFO will appear on the display.

**TRAF (Traffic):** If TRAF appears on the display, the tuned station broadcasts traffic announcements and when a traffic announcement comes on the tuned radio station you will hear it.

If the station does not broadcast traffic announcements, press the TRAF button and the radio will seek to a station that does. When a station that broadcasts traffic announcements is found, the radio will stop seeking and TRAF will appear on the display. If no station is found that broadcasts traffic announcements, NO TRAFFIC will appear on the display.

If TRAF is on the display, press the TRAF button to turn off the traffic announcements.

The radio will play the traffic announcement even if the volume is low. The radio will interrupt the play of a CD if the last tuned station broadcasts traffic announcements.

This function does not apply to XM™ Satellite Radio Service.

## Radio Messages

**CAL ERR (Calibration Error):** The audio system has been calibrated for your vehicle from the factory. If CAL ERR appears on the display, it means that the radio has not been configured properly for your vehicle and must be returned to your GM dealer for service.

**LOCKED:** This message is displayed when the THEFTLOCK® system has locked up. Take the vehicle to your GM dealer for service.

If any error occurs repeatedly or if an error cannot be corrected, contact your GM dealer. If the radio displays an error message, write it down and provide it to your GM dealer when reporting the problem.



## XM™ Radio Messages

Radio Display Message	Condition	Action Required
XL (Explicit Language Channels)	XL on the radio display, after the channel name, indicates content with explicit language.	These channels, or any others, can be blocked at a customer's request, by calling 1-800-852-XXXM (9696).
Updating	Updating encryption code	The encryption code in the receiver is being updated, and no action is required. This process should take no longer than 30 seconds.
No Signal	Loss of signal	The system is functioning correctly, but the vehicle is in a location that is blocking the XM™ signal. When you move into an open area, the signal should return.
Loading XM	Acquiring channel audio (after 4 second delay)	The audio system is acquiring and processing audio and text data. No action is needed. This message should disappear shortly.
CH Off Air	Channel not in service	This channel is not currently in service. Tune to another channel.
CH Unavail	Channel no longer available	This previously assigned channel is no longer assigned. Tune to another station. If this station was one of the presets, choose another station for that preset button.
No Info	Artist Name/Feature not available	No artist information is available at this time on this channel. The system is working properly.
No Info	Song/Program Title not available	No song title information is available at this time on this channel. The system is working properly.

## XM™ Radio Messages (cont'd)

Radio Display Message	Condition	Action Required
No Info	Category Name not available	No category information is available at this time on this channel. The system is working properly.
No Info	No Text/Informational message available	No text or informational messages are available at this time on this channel. The system is working properly.
Not Found	No channel available for the chosen category	There are no channels available for the selected category. The system is working properly.
XM Locked	Theft lock active	The XM™ receiver in the vehicle may have previously been in another vehicle. For security purposes, XM™ receivers cannot be swapped between vehicles. If this message is received after having your vehicle serviced, check with your GM dealer.
Radio ID	Radio ID label (channel 0)	If tuned to channel 0, this message will alternate with the XM™ Radio 8 digit radio ID label. This label is needed to activate the service.
Unknown	Radio ID not known (should only be if hardware failure)	If this message is received when tuned to channel 0, there may be a receiver fault. Consult with your GM dealer.
Chk XMRCvr	Hardware failure	If this message does not clear within a short period of time, your receiver may have a fault. Consult with your GM dealer.

## Playing a CD (Single CD Player)

Insert a CD partway into the slot, label side up. The player will pull it in and the CD should begin playing.

If the ignition or radio is turned off with a CD in the player, it will stay in the player. When the ignition or radio is turned on, the CD will start playing where it stopped, if it was the last selected audio source.



When a CD is inserted, CD and the CD symbol will appear on the display. As each new track starts to play the track number will appear on the display.

The CD player can play the smaller 3 inch (8 cm) single CDs with an adapter ring. Full-size CDs and the smaller CDs are loaded in the same manner.

If playing a CD-R the sound quality may be reduced due to CD-R quality, the method of recording, the quality of the music that has been recorded, and the way the CD-R has been handled. There may be an increase in skipping, difficulty in finding tracks, and/or difficulty in loading and ejecting. If these problems occur try a known good CD.

Do not add paper labels to CDs, they could get caught in the CD player.

If an error appears on the display, see “CD Messages” later in this section.

 /  (**Tune**): Turn this knob to go to the next or previous track.

 (**Reverse**): Press and hold this button to reverse the current track.

 (**Fast Forward**): Press and hold this button to fast forward through the current track.

**RDM (Random)**: Press this button to hear the tracks in random, rather than sequential, order. RANDOM DISC will appear on the display. Press this button again to turn off random play.

**RPT (Repeat)**: Press this button to hear a track over again. REPEAT will appear on the display. Press this button again to turn off repeat play.

**MUTE**: Press this button to silence the system. Press this button again to turn the sound on.

 (**SEEK**): Press the left arrow to go to the start of the current track if more than eight seconds have played. Press the right arrow to go to the start of the next track. If either arrow is held or pressed more than once, the player will continue moving backward or forward through the CD.

**BAND:** Press this button to listen to the radio when a CD is playing. The inactive CD will remain safely inside the radio for future listening.

**CD AUX (Auxiliary):** Press this button to play a CD when listening to the radio. CD will appear on the display when a CD is in the player. If your system is equipped with a remote playback device, pressing this button a second time will allow the remote device to play.

**AUTO EQ (Automatic Equalization):** Press AUTO EQ to select the equalization setting while playing a CD. The equalization will be stored whenever a CD is played. For more information on AUTO EQ, see “AUTO EQ” listed previously in this section.

 **(Eject):** Press this button to eject the CD. EJECT may be activated with either the ignition or radio off.

## Playing a CD(s) (Six-Disc CD Player)

If the ignition or radio is turned off, with a CD in the player, it will stay in the player. When the ignition or radio is turned on, the CD will start playing where it stopped, if it was the last selected audio source.

When a CD is inserted, the CD symbol will appear on the CD. As each new track starts to play, the track number will appear on the display.

The CD player can play the smaller 3 inch (8 cm) single CDs with an adapter ring. Full-size CDs and the smaller CDs are loaded in the same manner.

If playing a CD-R the sound quality may be reduced due to CD-R quality, the method of recording, the quality of the music that has been recorded, and the way the CD-R has been handled. There may be an increase in skipping, difficulty in finding tracks, and/or difficulty in loading and ejecting. If these problems occur try a known good CD.

Do not add paper labels to CDs, they could get caught in the CD player.

If an error appears on the display, see “CD Messages” later in this section.

 **(Load):** Press this button to load CDs into the CD player. This CD player will hold up to six CDs.

To insert one CD, do the following:

1. Turn the ignition on.
2. Press and release the load button.
3. Load a CD. Insert the CD partway into the slot, label side up. The player will pull the CD in.

To insert multiple CDs, do the following:

1. Turn the ignition on.
2. Press and hold the load button for two seconds.  
You will hear a beep and LOAD ALL DISC will appear on the display.
3. When INSERT CD # appears on the display, load a CD. Insert the CD partway into the slot, label side up. The player will pull the CD in.  
Once the CD is loaded you can load another CD. The CD player takes up to six CDs. Do not try to load more than six.

To load more than one CD but less than six, complete Steps 1 through 3. When finished loading CDs, press the load button to cancel the loading function. The radio will begin to play the last CD loaded.

If more than one CD has been loaded, a number for each CD will appear on the display.

## Playing a Specific Loaded CD

For every CD loaded, a number will appear on the display. To play a specific CD, first press the CD AUX button, then press the numbered pushbutton that corresponds to the CD.

If an error appears on the display, see “CD Messages” later in this section.

 **(Eject):** Press this button to eject CD(s).

To eject the CD that is currently playing, press and release this button.

To eject multiple CDs, do the following:

1. Press and hold the eject button for two seconds.  
You will hear a beep and EJECT ALL will appear on the display.
2. When REMOVE CD # appears on the display, the CD will eject and can be removed.  
To stop ejecting the CDs, press the load or the eject button.

If the CD is not removed, after 25 seconds, the CD will be automatically pulled back into the player. If CD is pushed back into the player, before the 25 second time period is complete, the player will sense an error and will try to eject the CD several times before stopping.

Do not repeatedly press the eject button to eject a CD after you have tried to push it in manually. The player's 25-second eject timer will reset at each press of eject, causing the player to not eject the CD until the 25-second time period has elapsed.

 **(Tune):** Turn this knob to go to the next or previous track.

 **(Reverse):** Press and hold this button to reverse the current track.



 **(Fast Forward):** Press and hold this button to fast forward through the current track.



**RDM (Random):** Press this button to hear the tracks in random, rather than sequential, order, on one CD or all of the loaded CDs. RANDOM will appear on the display. Press this button again to turn off random play.

To use random, do one of the following:

- To play the tracks on the CD you are listening to in random order, press and release the RDM button. RANDOM DISC will appear on the display. Press RDM again to turn off random play.
- To play the tracks on all of the CDs that are loaded in random order, press and hold RDM for more than two seconds. RANDOM ALL DISCS will appear on the display. Press RDM again to turn off random play.

**RPT (Repeat):** Press this button to hear a track over again. REPEAT will appear on the display. Press this button again to turn off repeat play.

 **SEEK** : Press the left arrow to go to the start of the current track, if more than ten seconds have played. Press the right arrow to go to the next track. If either arrow is held or pressed more than once, the player will continue moving backward or forward through the CD.

 **SCAN** : To scan one CD, press and hold either SCAN arrow for more than two seconds until SCAN appears on the display and you hear a beep. The radio will go to the next track, play for 10 seconds, then go on to the next track. Press either SCAN arrow again, to stop scanning.

To scan all loaded CDs, press and hold either SCAN arrow for more than four seconds until CD SCAN appears on the display and you hear a beep. Use this feature to listen to 10 seconds of the first track of each loaded CD. Press either SCAN arrow again, to stop scanning.

**BAND:** Press this button to listen to the radio when a CD is playing. The inactive CD(s) will remain safely inside the radio for future listening.

**CD AUX (Auxiliary):** Press this button to play a CD when listening to the radio. CD will appear on the display when a CD is in the player. If your system is equipped with a remote playback device, pressing this button a second time will allow the remote device to play.

**AUTO EQ (Automatic Equalization):** Press AUTO EQ to select the equalization setting while playing a CD. The equalization will be stored whenever a CD is played. For more information on AUTO EQ, see “AUTO EQ” listed previously in this section.

## Using an MP3 CD

### MP3 Format

This MP3 player will accept MP3 files that were recorded on an up to 700 MB CD-R CD. The files can be recorded with the following fixed bit rates: 32 kbps, 40 kbps, 56 kbps, 64 kbps, 80 kbps, 96 kbps, 112 kbps, 128 kbps, 160 kbps, 192 kbps, 224 kbps, 256 kbps, and 320 kbps or a variable bit rate. Song title, artist name, and album will be available when recorded using ID3 tags versions 1 and 2.

The player will be able to read and play a maximum of 50 folders, 50 playlists, 10 sessions, and 255 files. Long file, folder, or playlist names or a combination of a large number of files and folders or playlists may cause the player to be unable to play up to the maximum number of files, folders, playlists, or sessions.

If you wish to play large numbers of files, folders, playlists or sessions minimize the length of the file, folder or playlist name. You can also play an MP3 CD that was recorded using no file folders. The system can support up to 11 folders in depth, though, keep the depth of the folders to a minimum in order to keep down the complexity and confusion in trying to locate a particular folder during playback. If a CD contains more than the maximum of 50 folders, 50 playlists, 10 sessions, and 255 files the player will let you access and navigate up to the maximum, but all items over the maximum will be ignored.

### Root Directory

The root directory will be treated as a folder. If the root directory has compressed audio files, the directory will be displayed as F1 ROOT. All files contained directly under the root directory will be accessed prior to any root directory folders. However, playlists (Px) will always be accessed before root folders or files.

### Empty Directory or Folder

If a root directory or a folder exists somewhere in the file structure that contains only folders/subfolders and no compressed files directly beneath them, the player will advance to the next folder in the file structure that contains compressed audio files and the empty folder will not be displayed or numbered.

## No Folder

When the CD contains only compressed files, the files will be located under the root folder. The next and previous folder functions will have no function on a CD that was recorded without folders or playlists.

When displaying the name of the folder the radio will display ROOT.

When the CD contains only playlists and compressed audio files, but no folders, all files will be located under the root folder. The folder down and the folder up buttons will search playlists (Px) first and then go to the root folder. When the radio displays the name of the folder the radio will display ROOT.

## Order of Play

Tracks will be played in the following order:

- Play will begin from the first track in the first playlist and will continue sequentially through all tracks in each playlist. When the last track of the last playlist has been played, play will continue from the first track of the first playlist.
- If the CD does not contain any playlists, then play will begin from the first track under the root directory. When all tracks from the root directory have been played, play will continue from files according to their numerical listing. After playing the last track from the last folder, play will begin again at the first track of the first folder or root directory.

When play enters a new folder, the display will not automatically show the new folder name unless you have chosen the folder mode as the default display. See the information button later in this section for more information. The new track name will appear on the display.

## File System and Naming

The song name that will be displayed will be the song name that is contained in the ID3 tag. If the song name is not present in the ID3 tag, then the radio will display the file name without the extension (such as .mp3) as the track name.

Track names longer than 32 characters or 4 pages will be shortened. The display will not show parts of words on the last page of text and the extension of the filename will not be displayed.

## Preprogrammed Playlists

You can access preprogrammed playlists which were created by WinAmp™, MusicMatch™, or Real Jukebox™ software, however, you will not have editing capability. These playlists will be treated as special folders containing compressed audio song files.



## Playing an MP3

Insert a CD partway into the slot, label side up. The player will pull it in, and **READING** will appear on the display. The CD should begin playing and the CD symbol will appear on the display.

If the ignition or radio is turned off with a CD in the player it will stay in the player. When the ignition or radio is turned on, the CD will start to play where it stopped, if it was the last selected audio source.



As each new track starts to play, the track number will appear on the display.

The CD player can play the smaller 3 inch (8 cm) single CDs with an adapter ring. Full-size CDs and the smaller CDs are loaded in the same manner.

If playing a CD-R the sound quality may be reduced due to CD-R quality, the method of recording, the quality of the music that has been recorded, and the way the CD-R has been handled. There may be an increase in skipping, difficulty in finding tracks, and/or difficulty in loading and ejecting. If these problems occur try a known good CD.

Do not add paper labels to CDs, they could get caught in the CD player.

If an error appears on the display, see “CD Messages” later in this section.

 /  **(Tune):** Turn this knob to go to the next or previous track.

 **(Previous Folder):** Press this button to go to the first track in the previous folder. Press and hold this button to reverse through the current track.

 **(Next Folder):** Press this pushbutton to go to the first track in the next folder. Press and hold this button to fast forward the current track.

**RDM (Random):** Press this button to hear the tracks in random, rather than sequential, order. **RANDOM** will appear on the display. Press this button again to turn off random play.

**RPT (Repeat):** Press this button to hear a track over again. **REPEAT** will appear on the display. Press this button again to turn off repeat play.

**MUTE:** Press this button to silence the system. Press this button again to turn the sound on.

This button is not available on the Radio with Six-Disc CD.

◀ **SEEK** ▶: Press the left arrow to go to the start of the current track, if more than ten seconds have played. Press the right arrow to go to the next track. If either arrow is held or pressed more than once, the player will continue moving backward or forward through the CD.

**i (Information):** Press this button to display the artist name and album contained in the ID3 tag.

**BAND:** Press this button to listen to the radio when a CD is playing. The inactive CD will remain safely inside the radio for future listening.

**CD AUX (Auxiliary):** Press this button to play a CD when listening to the radio. The CD symbol will appear on the display when a CD is loaded.

▲ **(Eject):** Press this button to eject a CD. Eject may be activated with either the ignition or radio off.

## Using (Song List) Mode (Single CD, MP3, and Six-Disc CD)

This feature is capable of saving 20 track selections. To save tracks into the song list feature, perform the following steps:

1. Turn the CD player on and load it with at least one CD.
2. Check to see that the CD player is not in song list mode. S-LIST should not appear on the display. If S-LIST is present, press the SONG LIST button to turn it off.
3. Select the desired CD by pressing the numbered pushbutton and then use the SEEK right arrow to locate the track to be saved. The track will begin to play.
4. Press and hold the SONG LIST button to save the track into memory. When SONG LIST is pressed, one beep will be heard immediately.
5. Repeat Steps 3 and 4 for saving other selections.

S-LIST FULL will appear on the display if you try to save more than 20 selections.

To play the song list, press the SONG LIST button. The recorded tracks will begin to play in the order they were saved.

Seek through the song list by using the SEEK arrows. Seeking past the last saved track will return to the first saved track.

To delete tracks from the song list, perform the following steps:

1. Turn the CD player on.
2. Press the SONG LIST button to turn song list on. S-LIST will appear on the display.
3. Press either SEEK arrow to select the desired track to be deleted.
4. Press and hold the SONG LIST button for two seconds. When SONG LIST is pressed, one beep will be heard immediately.

After a track has been deleted, the remaining tracks are moved up the list. When another track is added to the song list, the track will be added to the end of the list.

To delete the entire song list, perform the following steps:

1. Turn the CD player on.
2. Press the SONG LIST button to turn song list on. S-LIST will appear on the display.
3. Press and hold the SONG LIST button for more than four seconds. One beep will be heard. S-LIST EMPTY will appear on the display indicating the song list has been deleted.

If a CD is ejected, and the song list contains saved tracks from that CD, those tracks are automatically deleted from the song list. Any tracks saved to the song list again are added to the bottom of the list.

To end song list mode, press the SONG LIST button. One beep will be heard and S-LIST will be removed from the display.

## CD Messages

**CHECK CD:** If this message appears on the display and/or the CD comes out, it could be for one of the following reasons:

- It is very hot. When the temperature returns to normal, the CD should play.
- You are driving on a very rough road. When the road becomes smoother, the CD should play.
- The CD is dirty, scratched, wet, or upside down.
- The air is very humid. If so, wait about an hour and try again.
- There may have been a problem while burning the CD.
- The label may be caught in the CD player.

If the CD is not playing correctly, for any other reason, try a known good CD.

If any error occurs repeatedly or if an error cannot be corrected, contact your GM dealer. If the radio displays an error message, write it down and provide it to your GM dealer when reporting the problem.

## Navigation/Radio System

Your vehicle may have a navigation radio system that includes Radio Data System (RDS) with Program Type (PTY) selections that will seek out the kind of music you want to listen to and XM™ Satellite Radio Service capabilities (if equipped). The radio can also communicate with the navigation system to broadcast announcements on traffic, weather, and emergency alert communications. For information on how to use this system, see the “Navigation System” manual.

## Theft-Deterrent Feature

THEFTLOCK® is designed to discourage theft of your vehicle’s radio. The feature works automatically by learning a portion of the Vehicle Identification Number (VIN). If the radio is moved to a different vehicle, it will not operate and LOCKED will appear on the display.

With THEFTLOCK® activated, the radio will not operate if stolen.

## Radio Reception

### AM

The range for most AM stations is greater than for FM, especially at night. The longer range, however, can cause stations to interfere with each other. AM can pick up noise from things like storms and power lines. Try reducing the treble to reduce this noise.

### FM

FM stereo will give you the best sound, but FM signals will reach only about 10 to 40 miles (16 to 65 km). Tall buildings or hills can interfere with FM signals, causing the sound to come and go.

## Care of Your CDs

Handle CDs carefully. Store them in their original cases or other protective cases and away from direct sunlight and dust. If the surface of a CD is soiled, dampen a clean, soft cloth in a mild, neutral detergent solution and clean it, wiping from the center to the edge.

Be sure never to touch the side without writing when handling CDs. Pick up CDs by grasping the outer edges or the edge of the hole and the outer edge.

## Care of Your CD Player

The use of CD lens cleaners for CD players is not advised, due to the risk of contaminating the lens of the CD optics with lubricants internal to the CD mechanism.

## Diversity Antenna System

The AM-FM antenna is a hidden self tuning system. It optimizes the AM and FM signals relative to the vehicle's position and radio station source. No maintenance or adjustments are needed.

## XM™ Satellite Radio Antenna System

The XM™ Satellite Radio antenna is located on the roof or on the trunk lid of your vehicle. Keep this antenna clear of snow and ice build up for clear radio reception.



## Section 4 Driving Your Vehicle

---

<b>Your Driving, the Road, and Your Vehicle</b> .....	4-2	Driving in Rain and on Wet Roads .....	4-19
Defensive Driving .....	4-2	City Driving .....	4-22
Drunken Driving .....	4-2	Freeway Driving .....	4-23
Control of a Vehicle .....	4-5	Before Leaving on a Long Trip .....	4-24
Braking .....	4-6	Highway Hypnosis .....	4-25
Anti-Lock Brake System (ABS) .....	4-7	Hill and Mountain Roads .....	4-25
Braking in Emergencies .....	4-8	Winter Driving .....	4-27
Traction Control System (TCS) .....	4-9	If You Are Stuck: In Sand, Mud, Ice or Snow .....	4-31
Active Handling System .....	4-10	Rocking Your Vehicle to Get It Out .....	4-32
Limited-Slip Rear Axle .....	4-12	Loading Your Vehicle .....	4-32
Selective Ride Control .....	4-12	<b>Towing</b> .....	4-37
Steering .....	4-13	Towing Your Vehicle .....	4-37
Off-Road Recovery .....	4-15	Recreational Vehicle Towing .....	4-37
Passing .....	4-15	Towing a Trailer .....	4-37
Loss of Control .....	4-16		
Driving at Night .....	4-18		

# Your Driving, the Road, and Your Vehicle

## Defensive Driving

The best advice anyone can give about driving is: Drive defensively.

Please start with a very important safety device in your vehicle: Buckle up. See *Safety Belts: They Are for Everyone* on page 1-7.

Defensive driving really means “be ready for anything.” On city streets, rural roads, or freeways, it means “always expect the unexpected.”

Assume that pedestrians or other drivers are going to be careless and make mistakes. Anticipate what they might do. Be ready for their mistakes.

Rear-end collisions are about the most preventable of accidents. Yet they are common. Allow enough following distance. It is the best defensive driving maneuver, in both city and rural driving. You never know when the vehicle in front of you is going to brake or turn suddenly.

Defensive driving requires that a driver concentrate on the driving task. Anything that distracts from the driving task — such as concentrating on a cellular telephone call, reading, or reaching for something on the floor — makes

proper defensive driving more difficult and can even cause a collision, with resulting injury. Ask a passenger to help do things like this, or pull off the road in a safe place to do them yourself. These simple defensive driving techniques could save your life.

## Drunken Driving

Death and injury associated with drinking and driving is a national tragedy. It is the number one contributor to the highway death toll, claiming thousands of victims every year.

Alcohol affects four things that anyone needs to drive a vehicle:

- Judgment
- Muscular Coordination
- Vision
- Attentiveness

Police records show that almost half of all motor vehicle-related deaths involve alcohol. In most cases, these deaths are the result of someone who was drinking and driving. In recent years, more than 16,000 annual motor vehicle-related deaths have been associated with the use of alcohol, with more than 300,000 people injured.



Many adults — by some estimates, nearly half the adult population — choose never to drink alcohol, so they never drive after drinking. For persons under 21, it is against the law in every U.S. state to drink alcohol. There are good medical, psychological and developmental reasons for these laws.

The obvious way to eliminate the leading highway safety problem is for people never to drink alcohol and then drive. But what if people do? How much is “too much” if someone plans to drive? It is a lot less than many might think. Although it depends on each person and situation, here is some general information on the problem.

The Blood Alcohol Concentration (BAC) of someone who is drinking depends upon four things:

- The amount of alcohol consumed
- The drinker's body weight
- The amount of food that is consumed before and during drinking
- The length of time it has taken the drinker to consume the alcohol

According to the American Medical Association, a 180 lb (82 kg) person who drinks three 12 ounce (355 ml) bottles of beer in an hour will end up with a BAC of about 0.06 percent. The person would reach the

same BAC by drinking three 4 ounce (120 ml) glasses of wine or three mixed drinks if each had 1-1/2 ounces (45 ml) of liquors like whiskey, gin, or vodka.



It is the amount of alcohol that counts. For example, if the same person drank three double martinis (3 ounces or 90 ml of liquor each) within an hour, the person's BAC would be close to 0.12 percent. A person who consumes food just before or during drinking will have a somewhat lower BAC level.

There is a gender difference, too. Women generally have a lower relative percentage of body water than men. Since alcohol is carried in body water, this means that a woman generally will reach a higher BAC level than a man of her same body weight will when each has the same number of drinks.

The law in most U.S. states, and throughout Canada, sets the legal limit at 0.08 percent. In some other countries, the limit is even lower. For example, it is 0.05 percent in both France and Germany. The BAC limit for all commercial drivers in the United States is 0.04 percent.

The BAC will be over 0.10 percent after three to six drinks (in one hour). Of course, as we have seen, it depends on how much alcohol is in the drinks, and how quickly the person drinks them.

But the ability to drive is affected well below a BAC of 0.10 percent. Research shows that the driving skills of many people are impaired at a BAC approaching 0.05 percent, and that the effects are worse at night. All drivers are impaired at BAC levels above 0.05 percent.

Statistics show that the chance of being in a collision increases sharply for drivers who have a BAC of 0.05 percent or above. A driver with a BAC level of 0.06 percent has doubled his or her chance of having a collision. At a BAC level of 0.10 percent, the chance of this driver having a collision is 12 times greater; at a level of 0.15 percent, the chance is 25 times greater!

The body takes about an hour to rid itself of the alcohol in one drink. No amount of coffee or number of cold showers will speed that up. "I will be careful" is not the right answer. What if there is an emergency, a need to take sudden action, as when a child darts into the street? A person with even a moderate BAC might not be able to react quickly enough to avoid the collision.

There is something else about drinking and driving that many people do not know. Medical research shows that alcohol in a person's system can make crash injuries worse, especially injuries to the brain, spinal cord, or heart. This means that when anyone who has been drinking — driver or passenger — is in a crash, that person's chance of being killed or permanently disabled is higher than if the person had not been drinking.

 **CAUTION:**

**Drinking and then driving is very dangerous. Your reflexes, perceptions, attentiveness, and judgment can be affected by even a small amount of alcohol. You can have a serious — or even fatal — collision if you drive after drinking. Please do not drink and drive or ride with a driver who has been drinking. Ride home in a cab; or if you are with a group, designate a driver who will not drink.**

## Control of a Vehicle

You have three systems that make your vehicle go where you want it to go. They are the brakes, the steering, and the accelerator. All three systems have to do their work at the places where the tires meet the road.

Sometimes, as when you are driving on snow or ice, it is easy to ask more of those control systems than the tires and road can provide. That means you can lose control of your vehicle. See *Traction Control System (TCS)* on page 4-9 and *Active Handling System* on page 4-10.

## Braking

Braking action involves perception time and reaction time.

First, you have to decide to push on the brake pedal. That is perception time. Then you have to bring up your foot and do it. That is reaction time.

Average reaction time is about three-fourths of a second. But that is only an average. It might be less with one driver and as long as two or three seconds or more with another. Age, physical condition, alertness, coordination and eyesight all play a part. So do alcohol, drugs and frustration. But even in three-fourths of a second, a vehicle moving at 60 mph (100 km/h) travels 66 feet (20 m). That could be a lot of distance in an emergency, so keeping enough space between your vehicle and others is important.

And, of course, actual stopping distances vary greatly with the surface of the road (whether it is pavement or gravel); the condition of the road (wet, dry, icy); tire tread; the condition of your brakes; the weight of the vehicle and the amount of brake force applied.

Avoid needless heavy braking. Some people drive in spurts — heavy acceleration followed by heavy braking — rather than keeping pace with traffic. This is a mistake. Your brakes may not have time to cool between hard stops. Your brakes will wear out much faster if you do a lot of heavy braking. If you keep pace with the traffic and allow realistic following distances, you will eliminate a lot of unnecessary braking. That means better braking and longer brake life.

If your engine ever stops while you are driving, brake normally but do not pump your brakes. If you do, the pedal may get harder to push down. If your engine stops, you will still have some power brake assist. But you will use it when you brake. Once the power assist is used up, it may take longer to stop and the brake pedal will be harder to push.

## Anti-Lock Brake System (ABS)

Your vehicle has anti-lock brakes. ABS is an advanced electronic braking system that will help prevent a braking skid.

When you start your engine and begin to drive away, your anti-lock brake system will check itself. You may hear a momentary motor or clicking noise while this test is going on, and you may even notice that your brake pedal moves a little. This is normal.

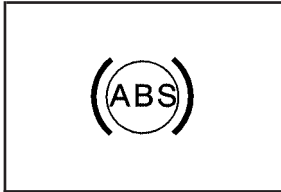

If there is a problem with the anti-lock brake system, this warning light will stay on. See *Anti-Lock Brake System Warning Light* on page 3-38.



Let us say the road is wet and you are driving safely. Suddenly, an animal jumps out in front of you. You slam on the brakes and continue braking. Here is what happens with ABS:

A computer senses that wheels are slowing down. If one of the wheels is about to stop rolling, the computer will separately work the brakes at each wheel.

The anti-lock system can change the brake pressure faster than any driver could. The computer is programmed to make the most of available tire and road conditions. This can help you steer around the obstacle while braking hard.



As you brake, your computer keeps receiving updates on wheel speed and controls braking pressure accordingly.

Remember: Anti-lock does not change the time you need to get your foot up to the brake pedal or always decrease stopping distance. If you get too close to the vehicle in front of you, you will not have time to apply your brakes if that vehicle suddenly slows or stops. Always leave enough room up ahead to stop, even though you have anti-lock brakes.

### **Using Anti-Lock**

Do not pump the brakes. Just hold the brake pedal down firmly and let anti-lock work for you. You may hear a motor or clicking noise and feel the brake pedal move a little during a stop, but this is normal.

### **Braking in Emergencies**

With anti-lock, you can steer and brake at the same time. In many emergencies, steering can help you more than even the very best braking.

## Traction Control System (TCS)

Your vehicle has a traction control system called TCS that limits wheel spin. This is especially useful in slippery road conditions. The system operates only if it senses that the rear wheels are spinning too much or are beginning to lose traction. When this happens, the system works the rear brakes and reduces engine power (by closing the throttle and managing engine spark) to limit wheel spin.

The TRACTION SYSTEM ACTIVE message will come on when the TCS system is limiting wheel spin. See *DIC Warnings and Messages on page 3-53*. You may feel or hear the system working, but this is normal.

If your vehicle is in cruise control when the TCS system begins to limit wheel spin, the cruise control will automatically disengage. When road conditions allow you to safely use it again, you may re-engage the cruise control. See *Turn Signal/Multifunction Lever on page 3-8*.

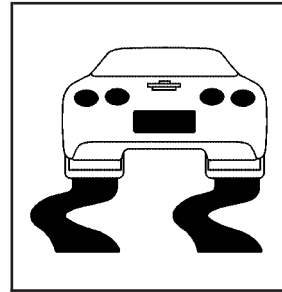

The SERVICE TRACTION SYSTEM message and the TCS warning light will come on to let you know if there is a problem with your TCS system. See *DIC Warnings and Messages on page 3-53*.

When this light and the SERVICE TRACTION SYSTEM message are on, the system will not limit wheel spin. Adjust your driving accordingly.

The TCS system automatically comes on whenever you start your vehicle. To limit wheel spin, especially in slippery road conditions, you should always leave the system on. But you can turn the TCS system off if you ever need to.

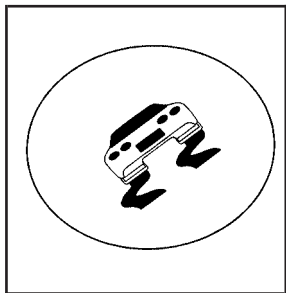

To turn the system off, press the button located on the console. You can turn the system on or off at any time by pressing the ACTIVE HANDLING button. The DIC will display the appropriate message when you push the button.

## Active Handling System

The Active Handling System is a computer controlled system that helps the driver maintain directional control of the vehicle in difficult driving conditions. This is accomplished by selectively applying any one of the vehicle's brakes.

When you first start your vehicle during cold winter weather and begin to drive away, the message ACTIVE HANDLING WARMING UP may be displayed in the DIC. This is normal. You can acknowledge this message by pressing the RESET button. The Active Handling System performance is affected until the message, ACTIVE HANDLING READY, is displayed in the DIC.

The ACTIVE HANDLING CALIBRATING message may be displayed in the DIC and the instrument panel cluster light will be on after exceeding 18 mph (30 km/h) for 10 seconds. The Active Handling System is off until the ACTIVE HANDLING READY message is displayed. This could take up to 15 minutes.

The ACTIVE HANDLING message will come on when the system is operating. See *DIC Warnings and Messages on page 3-53* for more information. You may also feel or hear the system working. This is normal.

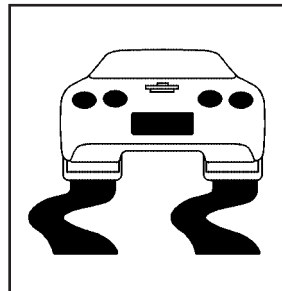

The SERVICE ACTIVE HANDLING message will be displayed, the instrument cluster light will come on, and a chime will sound to let you know if there is a problem with the system. See *DIC Warnings and Messages on page 3-53* for more information.

When this light and the SERVICE ACTIVE HANDLING message are on, the system is not operational. Adjust your driving accordingly.



The Active Handling System comes on automatically whenever you start your vehicle. To help maintain directional control of the vehicle, you should always leave the system on. You can turn the system off if you ever need to. If you turn the Active Handling System off, the Traction Control System will also be turned off. Adjust your driving accordingly.

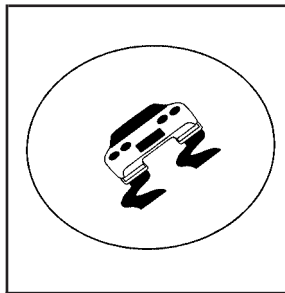

To turn the system off, press the ACTIVE HANDLING button on the console for five seconds. You can turn the system on and off at any time by pressing the button. The DIC will display the appropriate message when you push the button.

If the Tire Pressure Monitor (TPM) system detects a flat tire and the Driver Information Center (DIC) displays TIRE FLAT, or if the TPM system is malfunctioning and the DIC displays SERVICE TIRE MONITOR, the Active Handling System will be affected as follows:

- The Active Handling System cannot be turned off by the driver.
- If the Active Handling System is off, it will be turned on automatically.

- Competitive Driving Mode is unavailable.
- The Active Handling System will feel different in aiding and maintaining directional control.

## Competitive Driving Mode

The driver can select this optional handling mode by pressing the ACTIVE HANDLING button on the console two times within a five second time period. A chime will sound and COMPETITIVE DRIVING MODE will be displayed in the DIC. Competitive Driving Mode allows the driver to have full control of the rear wheels while the Active Handling System helps steer the vehicle by selective brake application. The instrument cluster light will not be on. The Traction Control System will not be operating. Adjust your driving accordingly.

When you press the ACTIVE HANDLING button again, or turn the ignition to ACC, the Active Handling and Traction Control Systems will be on. The TRACTION SYSTEM AND ACTIVE HANDLING-ON message will be displayed temporarily in the DIC and a chime will be heard.

## Limited-Slip Rear Axle

Your limited-slip rear axle can give you additional traction on snow, mud, ice, sand or gravel. It works like a standard axle most of the time, but when one of the rear wheels has no traction and the other does, this feature will allow the wheel with traction to move the vehicle.

## Selective Ride Control

You may have a ride control system on your vehicle called Magnetic Selective Ride Control. The system provides the following performance benefits:

- Reduced Impact Harshness
- Improved Road Isolation
- Improved High-Speed Stability
- Improved Handling Response
- Better Control of Body Ride Motions

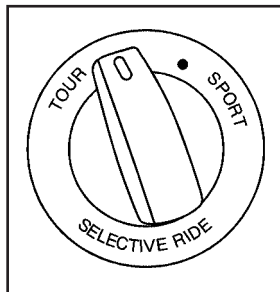

This knob is located on the center console. Turn it to select the suspension of your choice.

**TOUR:** Use for normal city and highway driving. This setting provides a smooth, soft ride.

**SPORT:** Use where road conditions or personal preference demand more control. This setting provides more “feel”, or response to the road conditions.

You can select a setting at any time. Based on road conditions, steering wheel angle and your vehicle speed, the system automatically adjusts to provide the best ride and handling. Select a new setting whenever driving conditions change.

There are three Driver Information Center (DIC) messages that are displayed when a malfunction occurs with the Selective Ride Control system. Refer to *DIC Warnings and Messages on page 3-53*.

## Steering

### Power Steering

If you lose power steering assist because the engine stops or the system is not functioning, you can steer but it will take much more effort.

### Magnetic Speed Variable Assist Steering

Your vehicle is equipped with a steering system that continuously adjusts the effort you feel when steering at all vehicle speeds. It provides ease when parking, yet a firm, solid feel at highway speeds.

### Steering Tips Driving on Curves

It is important to take curves at a reasonable speed.

A lot of the “driver lost control” accidents mentioned on the news happen on curves. Here is why:

Experienced driver or beginner, each of us is subject to the same laws of physics when driving on curves. The traction of the tires against the road surface makes it possible for the vehicle to change its path when you turn the front wheels. If there is no traction, inertia will keep the vehicle going in the same direction. If you have ever tried to steer a vehicle on wet ice, you will understand this.

The traction you can get in a curve depends on the condition of your tires and the road surface, the angle at which the curve is banked, and your speed. While you are in a curve, speed is the one factor you can control.

Suppose you are steering through a sharp curve. Then you suddenly accelerate. Both control systems — steering and acceleration — have to do their work where the tires meet the road. Adding the sudden acceleration can demand too much of those places. You can lose control. See *Traction Control System (TCS) on page 4-9*.

What should you do if this ever happens? Ease up on the accelerator pedal, steer the vehicle the way you want it to go, and slow down.

Speed limit signs near curves warn that you should adjust your speed. Of course, the posted speeds are based on good weather and road conditions. Under less favorable conditions you will want to go slower.

If you need to reduce your speed as you approach a curve, do it before you enter the curve, while your front wheels are straight ahead.

Try to adjust your speed so you can “drive” through the curve. Maintain a reasonable, steady speed. Wait to accelerate until you are out of the curve, and then accelerate gently into the straightaway.

## Steering in Emergencies

There are times when steering can be more effective than braking. For example, you come over a hill and find a truck stopped in your lane, or a car suddenly pulls out from nowhere, or a child darts out from between parked cars and stops right in front of you. You can avoid these problems by braking — if you can stop in time. But sometimes you cannot; there is not room. That is the time for evasive action — steering around the problem.

Your vehicle can perform very well in emergencies like these. First apply your brakes.

See *Braking on page 4-6*. It is better to remove as much speed as you can from a possible collision. Then steer around the problem, to the left or right depending on the space available.

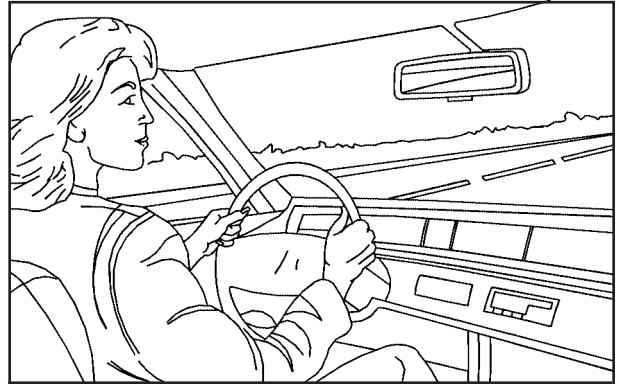

An emergency like this requires close attention and a quick decision. If you are holding the steering wheel at the recommended 9 and 3 o'clock positions, you can turn it a full 180 degrees very quickly without removing either hand. But you have to act fast, steer quickly, and just as quickly straighten the wheel once you have avoided the object.

The fact that such emergency situations are always possible is a good reason to practice defensive driving at all times and wear safety belts properly.

## Off-Road Recovery

You may find that your right wheels have dropped off the edge of a road onto the shoulder while you're driving.

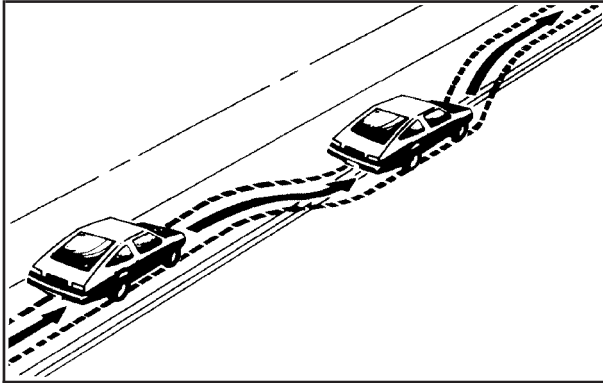

If the level of the shoulder is only slightly below the pavement, recovery should be fairly easy. Ease off the accelerator and then, if there is nothing in the way, steer so that your vehicle straddles the edge of the pavement. You can turn the steering wheel up to one-quarter turn until the right front tire contacts the pavement edge. Then turn your steering wheel to go straight down the roadway.

## Passing

The driver of a vehicle about to pass another on a two-lane highway waits for just the right moment, accelerates, moves around the vehicle ahead, then goes back into the right lane again. A simple maneuver?

Not necessarily! Passing another vehicle on a two-lane highway is a potentially dangerous move, since the passing vehicle occupies the same lane as oncoming traffic for several seconds. A miscalculation, an error in judgment, or a brief surrender to frustration or anger can suddenly put the passing driver face to face with the worst of all traffic accidents — the head-on collision.

So here are some tips for passing:

- Drive ahead. Look down the road, to the sides and to crossroads for situations that might affect your passing patterns. If you have any doubt whatsoever about making a successful pass, wait for a better time.
- Watch for traffic signs, pavement markings and lines. If you can see a sign up ahead that might indicate a turn or an intersection, delay your pass. A broken center line usually indicates it is all right to pass, providing the road ahead is clear. Never cross a solid line on your side of the lane or a double solid line, even if the road seems empty of approaching traffic.

- Do not get too close to the vehicle you want to pass while you are awaiting an opportunity. For one thing, following too closely reduces your area of vision, especially if you are following a larger vehicle. Also, you will not have adequate space if the vehicle ahead suddenly slows or stops. Keep back a reasonable distance.
- When it looks like a chance to pass is coming up, start to accelerate but stay in the right lane and do not get too close. Time your move so you will be increasing speed as the time comes to move into the other lane. If the way is clear to pass, you will have a running start that more than makes up for the distance you would lose by dropping back. And if something happens to cause you to cancel your pass, you need only slow down and drop back again and wait for another opportunity.
- If other vehicles are lined up to pass a slow vehicle, wait your turn. But take care that someone is not trying to pass you as you pull out to pass the slow vehicle. Remember to glance over your shoulder and check the blind spot.
- Check your mirrors, glance over your shoulder, and start your left lane change signal before moving out of the right lane to pass. When you are far enough ahead of the passed vehicle to see its front

in your inside mirror, activate your right lane change signal and move back into the right lane. Remember that your right outside mirror is convex. The vehicle you just passed may seem to be farther away from you than it really is.

- Try not to pass more than one vehicle at a time on two-lane roads. Reconsider before passing the next vehicle.
- Do not overtake a slowly moving vehicle too rapidly. Even though the brake lamps are not flashing, it may be slowing down or starting to turn.
- If you are being passed, make it easy for the following driver to get ahead of you. Perhaps you can ease a little to the right.

## Loss of Control

Let us review what driving experts say about what happens when the three control systems — brakes, steering, and acceleration — do not have enough friction where the tires meet the road to do what the driver has asked.

In any emergency, do not give up. Keep trying to steer and constantly seek an escape route or area of less danger.

## Skidding

In a skid, a driver can lose control of the vehicle. Defensive drivers avoid most skids by taking reasonable care suited to existing conditions, and by not overdriving those conditions. But skids are always possible.

The three types of skids correspond to your vehicle's three control systems. In the braking skid, your wheels are not rolling. In the steering or cornering skid, too much speed or steering in a curve causes tires to slip and lose cornering force. And in the acceleration skid, too much throttle causes the driving wheels to spin.

A cornering skid is best handled by easing your foot off the accelerator pedal.

Remember: Any traction control system helps avoid only the acceleration skid. If your traction control system is off, then an acceleration skid is also best handled by easing your foot off the accelerator pedal.

If your vehicle starts to slide, ease your foot off the accelerator pedal and quickly steer the way you want the vehicle to go. If you start steering quickly enough, your vehicle may straighten out. Always be ready for a second skid if it occurs.

Of course, traction is reduced when water, snow, ice, gravel, or other material is on the road. For safety, you will want to slow down and adjust your driving to these conditions. It is important to slow down on slippery surfaces because stopping distance will be longer and vehicle control more limited.

While driving on a surface with reduced traction, try your best to avoid sudden steering, acceleration, or braking, including engine braking by shifting to a lower gear. Any sudden changes could cause the tires to slide. You may not realize the surface is slippery until your vehicle is skidding. Learn to recognize warning clues — such as enough water, ice, or packed snow on the road to make a mirrored surface — and slow down when you have any doubt.

Remember: Any anti-lock brake system (ABS) helps avoid only the braking skid.

## Driving at Night

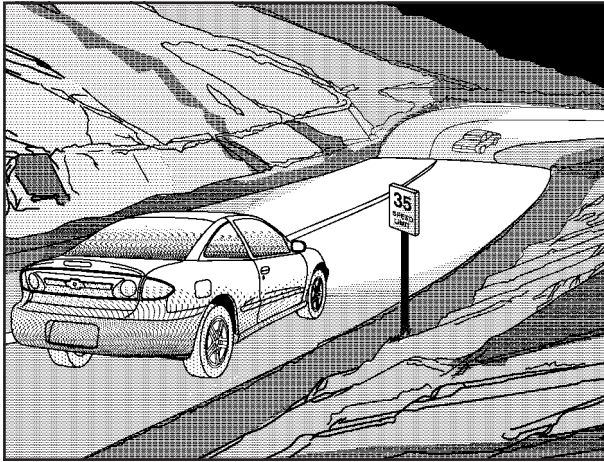

Night driving is more dangerous than day driving. One reason is that some drivers are likely to be impaired — by alcohol or drugs, with night vision problems, or by fatigue.

Here are some tips on night driving.

- Drive defensively.
- Do not drink and drive.
- Adjust your inside rearview mirror to reduce the glare from headlamps behind you.
- Since you cannot see as well, you may need to slow down and keep more space between you and other vehicles.
- Slow down, especially on higher speed roads. Your headlamps can light up only so much road ahead.
- In remote areas, watch for animals.
- If you are tired, pull off the road in a safe place and rest.

No one can see as well at night as in the daytime. But as we get older these differences increase. A 50-year-old driver may require at least twice as much light to see the same thing at night as a 20-year-old.

What you do in the daytime can also affect your night vision. For example, if you spend the day in bright sunshine you are wise to wear sunglasses. Your eyes will have less trouble adjusting to night. But if you are driving, do not wear sunglasses at night. They may cut down on glare from headlamps, but they also make a lot of things invisible.



You can be temporarily blinded by approaching headlamps. It can take a second or two, or even several seconds, for your eyes to re-adjust to the dark. When you are faced with severe glare, as from a driver who does not lower the high beams, or a vehicle with misaimed headlamps, slow down a little. Avoid staring directly into the approaching headlamps.

Keep your windshield and all the glass on your vehicle clean — inside and out. Glare at night is made much worse by dirt on the glass. Even the inside of the glass can build up a film caused by dust. Dirty glass makes lights dazzle and flash more than clean glass would, making the pupils of your eyes contract repeatedly.

Remember that your headlamps light up far less of a roadway when you are in a turn or curve. Keep your eyes moving; that way, it is easier to pick out dimly lighted objects. Just as your headlamps should be checked regularly for proper aim, so should your eyes be examined regularly. Some drivers suffer from night blindness — the inability to see in dim light — and are not even aware of it.

## Driving in Rain and on Wet Roads

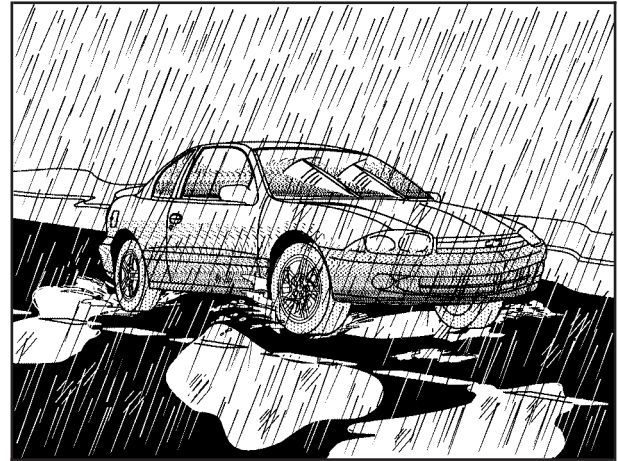

Rain and wet roads can mean driving trouble. On a wet road, you cannot stop, accelerate, or turn as well because your tire-to-road traction is not as good as on dry roads. And, if your tires do not have much tread left, you will get even less traction. It is always wise to go slower and be cautious if rain starts to fall while you are driving. The surface may get wet suddenly when your reflexes are tuned for driving on dry pavement.

The heavier the rain, the harder it is to see. Even if your windshield wiper blades are in good shape, a heavy rain can make it harder to see road signs and traffic signals, pavement markings, the edge of the road, and even people walking.

It is wise to keep your windshield wiping equipment in good shape and keep your windshield washer tank filled with washer fluid. Replace your windshield wiper inserts when they show signs of streaking or missing areas on the windshield, or when strips of rubber start to separate from the inserts.

Driving too fast through large water puddles or even going through some car washes can cause problems, too. The water may affect your brakes. Try to avoid puddles. But if you cannot, try to slow down before you hit them.

 **CAUTION:**

**Wet brakes can cause accidents. They will not work as well in a quick stop and may cause pulling to one side. You could lose control of the vehicle.**

**After driving through a large puddle of water or a car wash, apply your brake pedal lightly until your brakes work normally.**

## Hydroplaning

Hydroplaning is dangerous. So much water can build up under your tires that they can actually ride on the water. This can happen if the road is wet enough and you are going fast enough. When your vehicle is hydroplaning, it has little or no contact with the road.

Hydroplaning does not happen often. But it can if your tires do not have much tread or if the pressure in one or more is low. It can happen if a lot of water is standing on the road. If you can see reflections from trees, telephone poles, or other vehicles, and raindrops dimple the water's surface, there could be hydroplaning.

Hydroplaning usually happens at higher speeds. There just is not a hard and fast rule about hydroplaning. The best advice is to slow down when it is raining.

## Driving Through Deep Standing Water

**Notice:** If you drive too quickly through deep puddles or standing water, water can come in through your engine's air intake and badly damage your engine. Never drive through water that is slightly lower than the underbody of your vehicle. If you cannot avoid deep puddles or standing water, drive through them very slowly.

## Driving Through Flowing Water

### CAUTION:

**Flowing or rushing water creates strong forces. If you try to drive through flowing water, as you might at a low water crossing, your vehicle can be carried away. As little as six inches of flowing water can carry away a smaller vehicle. If this happens, you and other vehicle occupants could drown. Do not ignore police warning signs, and otherwise be very cautious about trying to drive through flowing water.**

## Some Other Rainy Weather Tips

- Besides slowing down, allow some extra following distance. And be especially careful when you pass another vehicle. Allow yourself more clear room ahead, and be prepared to have your view restricted by road spray.
- Have good tires with proper tread depth. See *Tires* on page 5-51.

## City Driving



One of the biggest problems with city streets is the amount of traffic on them. You will want to watch out for what the other drivers are doing and pay attention to traffic signals.

Here are ways to increase your safety in city driving:

- Know the best way to get to where you are going. Get a city map and plan your trip into an unknown part of the city just as you would for a cross-country trip.
- Try to use the freeways that rim and crisscross most large cities. You will save time and energy. See *Freeway Driving on page 4-23*.
- Treat a green light as a warning signal. A traffic light is there because the corner is busy enough to need it. When a light turns green, and just before you start to move, check both ways for vehicles that have not cleared the intersection or may be running the red light.

## Freeway Driving



Mile for mile, freeways—also called thruways, parkways, expressways, turnpikes, or superhighways — are the safest of all roads. But they have their own special rules.

The most important advice on freeway driving is: Keep up with traffic and keep to the right. Drive at the same speed most of the other drivers are driving. Too-fast or too-slow driving breaks a smooth traffic flow. Treat the left lane on a freeway as a passing lane.

At the entrance, there is usually a ramp that leads to the freeway. If you have a clear view of the freeway as you drive along the entrance ramp, you should begin to check traffic. Try to determine where you expect to blend with the flow. Try to merge into the gap at close to the prevailing speed. Switch on your turn signal, check your mirrors, and glance over your shoulder as often as necessary. Try to blend smoothly with the traffic flow.

Once you are on the freeway, adjust your speed to the posted limit or to the prevailing rate if it is slower. Stay in the right lane unless you want to pass.

Before changing lanes, check your mirrors. Then use your turn signal.

Just before you leave the lane, glance quickly over your shoulder to make sure there is not another vehicle in your blind spot.

Once you are moving on the freeway, make certain you allow a reasonable following distance.

Expect to move slightly slower at night.

When you want to leave the freeway, move to the proper lane well in advance. If you miss your exit, do not, under any circumstances, stop and back up. Drive on to the next exit.

The exit ramp can be curved, sometimes quite sharply. The exit speed is usually posted. Reduce your speed according to your speedometer, not to your sense of motion. After driving for any distance at higher speeds, you may tend to think you are going slower than you actually are.

## Before Leaving on a Long Trip

Make sure you are ready. Try to be well rested. If you must start when you are not fresh — such as after a day's work — do not plan to make too many miles that first part of the journey. Wear comfortable clothing and shoes you can easily drive in.

Is your vehicle ready for a long trip? If you keep it serviced and maintained, it is ready to go. If it needs service, have it done before starting out. Of course, you will find experienced and able service experts in GM dealerships all across North America. They will be ready and willing to help if you need it.

Here are some things you can check before a trip:

- *Windshield Washer Fluid:* Is the reservoir full? Are all windows clean inside and outside?
- *Wiper Blades:* Are they in good shape?
- *Fuel, Engine Oil, Other Fluids:* Have you checked all levels?
- *Lamps:* Are they all working? Are the lenses clean?
- *Tires:* They are vitally important to a safe, trouble-free trip. Is the tread good enough for long-distance driving? Are the tires all inflated to the recommended pressure?
- *Weather Forecasts:* What is the weather outlook along your route? Should you delay your trip a short time to avoid a major storm system?
- *Maps:* Do you have up-to-date maps?

## Highway Hypnosis

Is there actually such a condition as highway hypnosis? Or is it just plain falling asleep at the wheel? Call it highway hypnosis, lack of awareness, or whatever.

There is something about an easy stretch of road with the same scenery, along with the hum of the tires on the road, the drone of the engine, and the rush of the wind against the vehicle that can make you sleepy. Do not let it happen to you! If it does, your vehicle can leave the road in less than a second, and you could crash and be injured.

What can you do about highway hypnosis? First, be aware that it can happen.

Then here are some tips:

- Make sure your vehicle is well ventilated, with a comfortably cool interior.
- Keep your eyes moving. Scan the road ahead and to the sides. Check your rearview mirrors and your instruments frequently.
- If you get sleepy, pull off the road into a rest, service, or parking area and take a nap, get some exercise, or both. For safety, treat drowsiness on the highway as an emergency.

## Hill and Mountain Roads



Driving on steep hills or mountains is different from driving in flat or rolling terrain.

If you drive regularly in steep country, or if you are planning to visit there, here are some tips that can make your trips safer and more enjoyable.

- Keep your vehicle in good shape. Check all fluid levels and also the brakes, tires, cooling system, and transmission. These parts can work hard on mountain roads.
- Know how to go down hills. The most important thing to know is this: let your engine do some of the slowing down. Shift to a lower gear when you go down a steep or long hill.

 **CAUTION:**

**If you do not shift down, your brakes could get so hot that they would not work well. You would then have poor braking or even none going down a hill. You could crash. Shift down to let your engine assist your brakes on a steep downhill slope.**

 **CAUTION:**

**Coasting downhill in NEUTRAL (N) or with the ignition off is dangerous. Your brakes will have to do all the work of slowing down. They could get so hot that they would not work well. You would then have poor braking or even none going down a hill. You could crash. Always have your engine running and your vehicle in gear when you go downhill.**

- Know how to go uphill. You may want to shift down to a lower gear. The lower gears help cool your engine and transmission, and you can climb the hill better.
- Stay in your own lane when driving on two-lane roads in hills or mountains. Do not swing wide or cut across the center of the road. Drive at speeds that let you stay in your own lane.
- As you go over the top of a hill, be alert. There could be something in your lane, like a stalled car or an accident.
- You may see highway signs on mountains that warn of special problems. Examples are long grades, passing or no-passing zones, a falling rocks area, or winding roads. Be alert to these and take appropriate action.



## Winter Driving



Here are some tips for winter driving:

- Have your vehicle in good shape for winter.
- You may want to put winter emergency supplies in your vehicle.

Also see *Tires* on page 5-51.



Include an ice scraper, a small brush or broom, a supply of windshield washer fluid, a rag, some winter outer clothing, a small shovel, a flashlight, a red cloth, and a couple of reflective warning triangles. And, if you will be driving under severe conditions, include a small bag of sand, a piece of old carpet or a couple of burlap bags to help provide traction. Be sure you properly secure these items in your vehicle.

## Driving On Snow or Ice

Most of the time, those places where your tires meet the road probably have good traction.

However, if there is snow or ice between your tires and the road, you can have a very slippery situation. You will have a lot less traction, or grip, and will need to be very careful.

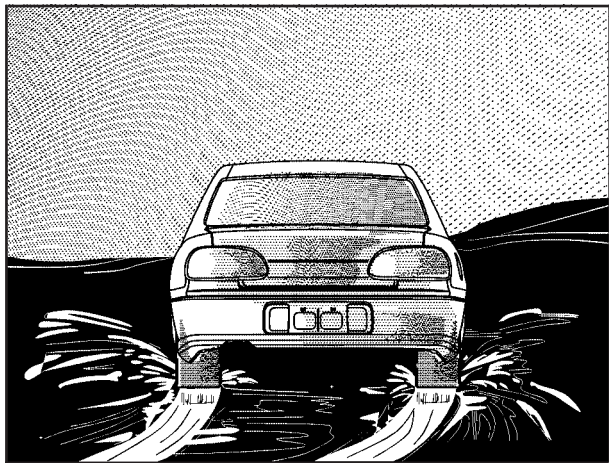

What is the worst time for this? Wet ice. Very cold snow or ice can be slick and hard to drive on.

But wet ice can be even more trouble because it may offer the least traction of all. You can get wet ice when it is about freezing (32°F; 0°C) and freezing rain begins to fall. Try to avoid driving on wet ice until salt and sand crews can get there.

Whatever the condition — smooth ice, packed, blowing or loose snow — drive with caution.

Traction control improves your ability to accelerate when driving on a slippery road. Even though your vehicle has a traction control system, you will want to slow down and adjust your driving to the road conditions. Under certain conditions, you may want to turn the traction control system off, such as when driving through deep snow and loose gravel, to help maintain vehicle motion at lower speeds. See *Traction Control System (TCS)* on page 4-9. The Active Handling System may also activate. See *Active Handling System* on page 4-10.

Your anti-lock brakes improve your vehicle's stability when you make a hard stop on a slippery road. Even though you have the anti-lock braking system, you will want to begin stopping sooner than you would on dry pavement. See *Anti-Lock Brake System (ABS)* on page 4-7.

- Allow greater following distance on any slippery road.
- Watch for slippery spots. The road might be fine until you hit a spot that is covered with ice. On an otherwise clear road, ice patches may appear in shaded areas where the sun cannot reach, such as around clumps of trees, behind buildings, or under bridges. Sometimes the surface of a curve or an overpass may remain icy when the surrounding roads are clear. If you see a patch of ice ahead of you, brake before you are on it. Try not to brake while you are actually on the ice, and avoid sudden steering maneuvers.

## If You Are Caught in a Blizzard

If you are stopped by heavy snow, you could be in a serious situation. You should probably stay with your vehicle unless you know for sure that you are near help and you can hike through the snow. Here are some things to do to summon help and keep yourself and your passengers safe:

- Turn on your hazard flashers.
- Tie a red cloth to your vehicle to alert police that you have been stopped by the snow.
- Put on extra clothing or wrap a blanket around you. If you do not have blankets or extra clothing, make body insulators from newspapers, burlap bags, rags, floor mats — anything you can wrap around yourself or tuck under your clothing to keep warm.

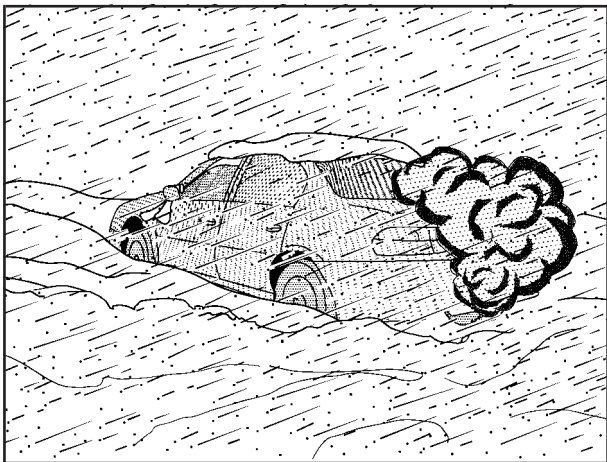

You can run the engine to keep warm, but be careful.

**⚠ CAUTION:**

Snow can trap exhaust gases under your vehicle. This can cause deadly CO (carbon monoxide) gas to get inside. CO could overcome you and kill you. You cannot see it or smell it, so you might not know it is in your vehicle. Clear away snow from around the base of your vehicle, especially any that is blocking your exhaust pipe. And check around again from time to time to be sure snow does not collect there.

**Open a window just a little on the side of the vehicle that is away from the wind. This will help keep CO out.**

Run your engine only as long as you must. This saves fuel. When you run the engine, make it go a little faster than just idle. That is, push the accelerator slightly. This uses less fuel for the heat that you get and it keeps the battery charged. You will need a well-charged battery to restart the vehicle, and possibly for signaling later on with your headlamps. Let the heater run for a while.

Then, shut the engine off and close the window almost all the way to preserve the heat. Start the engine again and repeat this only when you feel really uncomfortable from the cold. But do it as little as possible. Preserve the fuel as long as you can. To help keep warm, you can get out of the vehicle and do some fairly vigorous exercises every half hour or so until help comes.

## If You Are Stuck: In Sand, Mud, Ice or Snow

In order to free your vehicle when it is stuck, you will need to spin the wheels, but you do not want to spin your wheels too fast. The method known as rocking can help you get out when you are stuck, but you must use caution.

### CAUTION:

**If you let your tires spin at high speed, they can explode, and you or others could be injured. And, the transmission or other parts of the vehicle can overheat. That could cause an engine compartment fire or other damage. When you are stuck, spin the wheels as little as possible. Do not spin the wheels above 35 mph (55 km/h) as shown on the speedometer.**

**Notice:** Spinning your wheels can destroy parts of your vehicle as well as the tires. If you spin the wheels too fast while shifting your transmission back and forth, you can destroy your transmission.

For more information about using tire chains on your vehicle, see *Tire Chains* on page 5-69.

## Rocking Your Vehicle to Get It Out

First, turn your steering wheel left and right. That will clear the area around your front wheels. You should turn your TCS System off. See *Traction Control System (TCS) on page 4-9*. Then shift back and forth between REVERSE (R) and a forward gear, spinning the wheels as little as possible. For a manual transmission, shift slowly between either FIRST (1) or SECOND (2) and REVERSE (R), allowing the wheels to stop before shifting into gear. Release the accelerator pedal while you shift, and press lightly on the accelerator pedal when the transmission is in gear. By slowly spinning your wheels in the forward and reverse directions, you will cause a rocking motion that may free your vehicle. If that does not get you out after a few tries, you may need to be towed out. If you do need to be towed out, see *Towing Your Vehicle on page 4-37*.

## Loading Your Vehicle

It is very important to know how much weight your vehicle can carry. This weight is called the vehicle capacity weight and includes the weight of all occupants, cargo and all nonfactory-installed options. Two labels on your vehicle show how much weight it may properly carry, the Tire and Loading Information label and the Certification label.

### CAUTION:

**Do not load your vehicle any heavier than the Gross Vehicle Weight Rating (GVWR), or either the maximum front or rear Gross Axle Weight Rating (GAWR). If you do, parts on your vehicle can break, and it can change the way your vehicle handles. These could cause you to lose control and crash. Also, overloading can shorten the life of your vehicle.**

## Tire and Loading Information Label

The diagram shows a rectangular label with a tire icon on the left. The title "TIRE AND LOADING INFORMATION" is centered at the top. Below the title is a row of five boxes labeled "SEATING CAPACITY", "TOTAL", "FRONT", "CENTR", and "REAR". Below this row is a line of text: "The combined weight of occupants and cargo should never exceed XXX kg or XXX lbs." Below the text is a table with three columns: "ORIGINAL TIRE SIZE", "COLD TIRE INFLATION PRESSURE", and "SEE OWNER'S MANUAL FOR ADDITIONAL INFORMATION". The table has three rows: "FRONT", "REAR", and "SPARE". Callout A points to the tire icon, B points to the title, C points to the "ORIGINAL TIRE SIZE" column, and D points to the "COLD TIRE INFLATION PRESSURE" column.

ORIGINAL TIRE SIZE	COLD TIRE INFLATION PRESSURE	SEE OWNER'S MANUAL FOR ADDITIONAL INFORMATION
	FRONT	
	REAR	
	SPARE	

**Label Example**

A vehicle specific Tire and Loading Information label is attached to the center pillar (B-pillar) of your vehicle. With the driver's door open, you will find the label attached below the door latch. This label shows the number of occupant seating positions (A), and the maximum vehicle capacity weight (B) in kilograms and pounds.

The Tire and Loading Information label also shows the size of the original equipment tires (C) and the recommended cold tire inflation pressures (D). For more information on tires and inflation see *Tires on page 5-51* and *Inflation - Tire Pressure on page 5-58*.

There is also important loading information on the vehicle Certification label. It tells you the Gross Vehicle Weight Rating (GVWR) and the Gross Axle Weight Rating (GAWR) for the front and rear axle. See "Certification Label" later in this section.

### Steps for Determining Correct Load Limit

1. Locate the statement "The combined weight of occupants and cargo should never exceed XXX kg or XXX pounds" on your vehicle's placard.
2. Determine the combined weight of the driver and passengers that will be riding in your vehicle.
3. Subtract the combined weight of the driver and passengers from XXX kilograms or XXX pounds.

4. The resulting figure equals the available amount of cargo and luggage load capacity. For example, if the “XXX” amount equals 1400 lbs and there will be five 150 lb passengers in your vehicle, the amount of available cargo and luggage load capacity is 650 lbs (1400 – 750 (5 x 150) = 650 lbs).
5. Determine the combined weight of luggage and cargo being loaded on the vehicle. That weight may not safely exceed the available cargo and luggage load capacity calculated in Step 4.
6. If your vehicle will be towing a trailer, the load from your trailer will be transferred to your vehicle. Consult this manual to determine how this reduces the available cargo and luggage load capacity of your vehicle.  
Your vehicle is neither designed nor intended to tow a trailer.

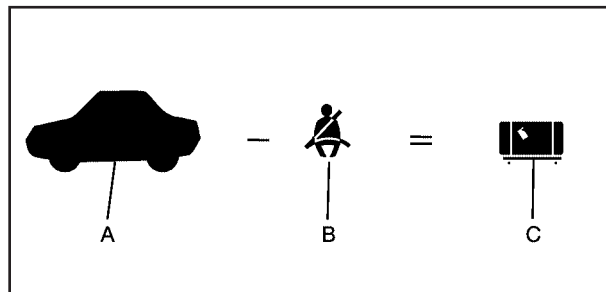

**Example 1**

Item	Description	Total
A	Vehicle Capacity Weight for Example 1 =	400 lbs (181 kg)
B	Subtract Occupant Weight @ 150 lbs (68 kg) x 1 =	150 lbs (68 kg)
C	Available Occupant and Cargo Weight =	250 lbs (113 kg)



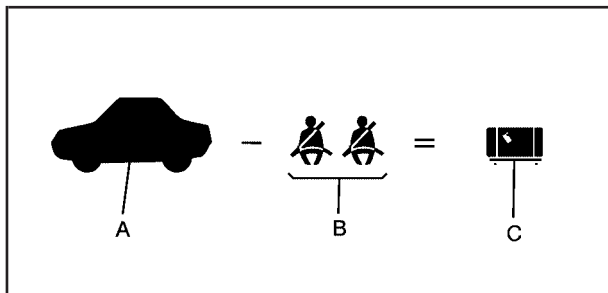

**Example 2**

Item	Description	Total
A	Vehicle Capacity Weight for Example 2 =	400 lbs (181 kg)
B	Subtract Occupant Weight @ 150 lbs (68 kg) x 2 =	300 lbs (136 kg)
C	Available Cargo Weight =	100 lbs (45 kg)

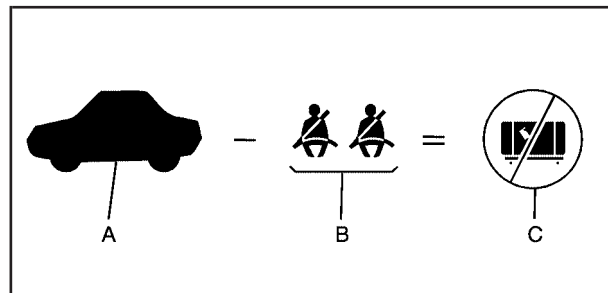

**Example 3**

Item	Description	Total
A	Vehicle Capacity Weight for Example 3 =	400 lbs (181 kg)
B	Subtract Occupant Weight @ 200 lbs (91 kg) x 2 =	400 lbs (181 kg)
C	Available Cargo Weight =	0 lbs (0 kg)

Refer to your vehicle's tire and loading information label for specific information about your vehicle's capacity weight and seating positions. The combined weight of the driver, passengers and cargo should never exceed your vehicle's capacity weight.

## Certification Label

MFD BY GENERAL MOTORS CORP

DATE GVWR GAWR FRT GAWR RR

THIS VEHICLE CONFORMS TO ALL APPLICABLE U.S. FEDERAL MOTOR VEHICLE SAFETY, BUMPER, AND THEFT PREVENTION STANDARDS IN EFFECT ON THE DATE OF MANUFACTURE SHOWN ABOVE.

200 TYPE: PASS CAR

**EXAMPLE**

A vehicle specific Certification label is attached to the rear edge of the driver's door. It tells you the gross weight capacity of your vehicle, called the Gross Vehicle Weight Rating (GVWR). The GVWR includes the weight of the vehicle, all occupants, fuel and cargo. Never exceed the GVWR for your vehicle, or the Gross Axle Weight Rating (GAWR) for either the front or rear axle.

And, if you do have a heavy load, you should spread it out. Do not carry more than 100 lbs (45 kg) in the rear area of your vehicle.

## CAUTION:

Do not load your vehicle any heavier than the Gross Vehicle Weight Rating (GVWR), or either the maximum front or rear Gross Axle Weight Rating (GAWR). If you do, parts on your vehicle can break, and it can change the way your vehicle handles. These could cause you to lose control and crash. Also, overloading can shorten the life of your vehicle.

**Notice:** Overloading your vehicle may cause damage. Repairs would not be covered by your warranty. Do not overload your vehicle.

If you put things inside your vehicle — like suitcases, tools, packages or anything else — they will go as fast as the vehicle goes. If you have to stop or turn quickly, or if there is a crash, they will keep going.

## CAUTION:

Things you put inside your vehicle can strike and injure people in a sudden stop or turn, or in a crash.

- Put things in the rear area of your vehicle. Try to spread the weight evenly.
- Never stack heavier things, like suitcases, inside the vehicle so that some of them are above the tops of the seats.
- Do not leave an unsecured child restraint in your vehicle.
- When you carry something inside the vehicle, secure it whenever you can.

## Towing

### Towing Your Vehicle

Consult your dealer or a professional towing service if you need to have your disabled vehicle towed. See *Roadside Assistance Program on page 7-6*.

### Recreational Vehicle Towing

Recreational vehicle towing means towing your vehicle behind another vehicle — such as behind a motorhome. The two most common types of recreational vehicle towing are known as “dinghy towing” (towing your vehicle with all four wheels on the ground) and “dolly towing” (towing your vehicle with two wheels on the ground and two wheels up on a device known as a “dolly”).

Your vehicle was not designed to be towed with any of its wheels on the ground. If your vehicle must be towed, see “Towing Your Vehicle” earlier in this section.

### Towing a Trailer

Your Corvette is neither designed nor intended to tow a trailer.



## Section 5 Service and Appearance Care

---

<b>Service</b> .....	5-3	Engine Overheating .....	5-25
Doing Your Own Service Work .....	5-4	Overheated Engine Protection	
Adding Equipment to the Outside of Your		Operating Mode .....	5-27
Vehicle .....	5-4	Cooling System .....	5-28
<b>Fuel</b> .....	5-5	Power Steering Fluid .....	5-33
Gasoline Octane .....	5-5	Windshield Washer Fluid .....	5-34
Gasoline Specifications .....	5-5	Brakes .....	5-35
California Fuel .....	5-5	Battery .....	5-38
Additives .....	5-5	Jump Starting .....	5-39
Fuels in Foreign Countries .....	5-6	<b>Rear Axle</b> .....	5-43
Filling Your Tank .....	5-7	<b>Bulb Replacement</b> .....	5-44
Filling a Portable Fuel Container .....	5-9	High Intensity Discharge (HID) Lighting .....	5-44
<b>Checking Things Under the Hood</b> .....	5-10	Halogen Bulbs .....	5-44
Hood Release .....	5-10	Headlamps, Front Turn Signal, and	
Engine Compartment Overview .....	5-12	Parking Lamps .....	5-45
Engine Oil .....	5-14	Sidemarker Lamps .....	5-46
Engine Oil Life System .....	5-18	Taillamps, Turn Signal, and Stoplamps .....	5-47
Engine Air Cleaner/Filter .....	5-19	Replacement Bulbs .....	5-48
Automatic Transmission Fluid .....	5-21	<b>Windshield Wiper Blade Replacement</b> .....	5-48
Manual Transmission Fluid .....	5-21	<b>Tires</b> .....	5-51
Hydraulic Clutch .....	5-22	Tire Sidewall Labelling .....	5-52
Engine Coolant .....	5-22	Tire Terminology and Definitions .....	5-54
Coolant Surge Tank Pressure Cap .....	5-25		

## Section 5 Service and Appearance Care

---

Extended Mobility Tires .....	5-56	Finish Care .....	5-80
Inflation - Tire Pressure .....	5-58	Windshield and Wiper Blades .....	5-80
Tire Pressure Monitor System .....	5-61	Removable Roof Panel .....	5-81
Tire Rotation .....	5-63	Convertible Top .....	5-81
When It Is Time for New Tires .....	5-63	Aluminum Wheels .....	5-82
Buying New Tires .....	5-64	Tires .....	5-82
Uniform Tire Quality Grading .....	5-65	Finish Damage .....	5-83
Wheel Alignment and Tire Balance .....	5-66	Underbody Maintenance .....	5-83
Wheel Replacement .....	5-66	Fiberglass Springs .....	5-83
Tire Chains .....	5-69	Chemical Paint Spotting .....	5-83
Lifting Your Vehicle .....	5-70	Vehicle Care/Appearance Materials .....	5-84
If a Tire Goes Flat .....	5-74	<b>Vehicle Identification</b> .....	5-85
<b>Appearance Care</b> .....	5-75	Vehicle Identification Number (VIN) .....	5-85
Fabric/Carpet .....	5-75	Service Parts Identification Label .....	5-85
Coated Moldings .....	5-77	<b>Electrical System</b> .....	5-86
Leather .....	5-77	Add-On Electrical Equipment .....	5-86
Instrument Panel .....	5-77	Headlamp Wiring .....	5-86
Interior Plastic Components .....	5-77	Windshield Wiper Fuses .....	5-86
Cargo Cover and Convenience Net .....	5-78	Power Windows and Other Power Options .....	5-86
Glass Surfaces .....	5-78	Fuses and Circuit Breakers .....	5-87
Care of Safety Belts .....	5-78	Instrument Panel Fuse Block .....	5-88
Weatherstrips .....	5-78	Engine Compartment Fuse Block .....	5-91
Washing Your Vehicle .....	5-79	<b>Capacities and Specifications</b> .....	5-94
Cleaning Exterior Lamps/Lenses .....	5-79		

## Service

Your dealer knows your vehicle best and wants you to be happy with it. We hope you will go to your dealer for all your service needs. You will get genuine GM parts and GM-trained and supported service people.

We hope you will want to keep your GM vehicle all GM. Genuine GM parts have one of these marks:

***ACDelco***

---

**GM Parts**

---

**GM  
Goodwrench**

---

**GM Accessories**

## California Proposition 65 Warning

Most motor vehicles, including this one, contain and/or emit chemicals known to the State of California to cause cancer and birth defects or other reproductive harm. Engine exhaust, many parts and systems (including some inside the vehicle), many fluids, and some component wear by-products contain and/or emit these chemicals.

## Doing Your Own Service Work

If you want to do some of your own service work, you will want to use the proper service manual. It tells you much more about how to service your vehicle than this manual can. To order the proper service manual, see *Service Publications Ordering Information on page 7-11*.

Your vehicle has an airbag system. Before attempting to do your own service work, see *Servicing Your Airbag-Equipped Vehicle on page 1-51*.

You should keep a record with all parts receipts and list the mileage and the date of any service work you perform. See *Maintenance Record on page 6-15*.

### CAUTION:

**You can be injured and your vehicle could be damaged if you try to do service work on a vehicle without knowing enough about it.**

- **Be sure you have sufficient knowledge, experience, the proper replacement parts and tools before you attempt any vehicle maintenance task.**
- **Be sure to use the proper nuts, bolts and other fasteners. English and metric fasteners can be easily confused. If you use the wrong fasteners, parts can later break or fall off. You could be hurt.**

## Adding Equipment to the Outside of Your Vehicle

Things you might add to the outside of your vehicle can affect the airflow around it. This may cause wind noise and affect windshield washer performance. Check with your dealer before adding equipment to the outside of your vehicle.



## Fuel

Use of the recommended fuel is an important part of the proper maintenance of your vehicle.

### Gasoline Octane

Use premium unleaded gasoline with a posted octane of 91 or higher for best performance. You may also use middle grade or regular unleaded gasoline rated at 87 octane or higher, but your vehicle's acceleration may be slightly reduced. If the octane is less than 87, you may get a heavy knocking noise when you drive. If this occurs, use a gasoline rated at 87 octane or higher as soon as possible. Otherwise, you might damage your engine.

### Gasoline Specifications

It is recommended that gasoline meet specifications which were developed by automobile manufacturers around the world and contained in the World-Wide Fuel Charter which is available from the Alliance of Automobile Manufacturers at [www.autoalliance.org/fuel\\_charter.htm](http://www.autoalliance.org/fuel_charter.htm). Gasoline meeting these specifications could provide improved driveability and emission control system performance compared to other gasoline.

## California Fuel

If your vehicle is certified to meet California Emission Standards (see the underhood emission control label), it is designed to operate on fuels that meet California specifications. If this fuel is not available in states adopting California emissions standards, your vehicle will operate satisfactorily on fuels meeting federal specifications, but emission control system performance may be affected. The malfunction indicator lamp may turn on and your vehicle may fail a smog-check test. See *Malfunction Indicator Lamp on page 3-41*. If this occurs, return to your authorized GM dealer for diagnosis. If it is determined that the condition is caused by the type of fuel used, repairs may not be covered by your warranty.

### Additives

To provide cleaner air, all gasolines in the United States are now required to contain additives that will help prevent engine and fuel system deposits from forming, allowing your emission control system to work properly. In most cases, you should not have to add anything to your fuel. However, some gasolines contain only the minimum amount of additive required to meet U.S. Environmental Protection Agency regulations.

General Motors recommends that you buy gasolines that are advertised to help keep fuel injectors and intake valves clean. If your vehicle experiences problems due to dirty injectors or valves, try a different brand of gasoline. Also, your GM dealer has additives that will help correct and prevent most deposit-related problems.

Gasolines containing oxygenates, such as ethers and ethanol, and reformulated gasolines may be available in your area to contribute to clean air. General Motors recommends that you use these gasolines, particularly if they comply with the specifications described earlier.

**Notice:** Your vehicle was not designed for fuel that contains methanol. Do not use fuel containing methanol. It can corrode metal parts in your fuel system and also damage the plastic and rubber parts. That damage would not be covered under your warranty.

Some gasolines that are not reformulated for low emissions may contain an octane-enhancing additive called methylcyclopentadienyl manganese tricarbonyl (MMT); ask the attendant where you buy gasoline whether the fuel contains MMT. General Motors does not recommend the use of such gasolines. Fuels containing MMT can reduce the life of spark plugs and the performance of the emission control system may be affected. The malfunction indicator lamp may turn on. If this occurs, return to your authorized GM dealer for service.

## Fuels in Foreign Countries

If you plan on driving in another country outside the United States or Canada, the proper fuel may be hard to find. Never use leaded gasoline or any other fuel not recommended in the previous text on fuel. Costly repairs caused by use of improper fuel would not be covered by your warranty.

To check the fuel availability, ask an auto club, or contact a major oil company that does business in the country where you will be driving.

## Filling Your Tank

### CAUTION:

Fuel vapor burns violently and a fuel fire can cause bad injuries. To help avoid injuries to you and others, read and follow all the instructions on the pump island. Turn off your engine when you are refueling. Do not smoke if you are near fuel or refueling your vehicle. Keep sparks, flames and smoking materials away from fuel. Do not leave the fuel pump unattended when refueling your vehicle — this is against the law in some places. Keep children away from the fuel pump; never let children pump fuel.

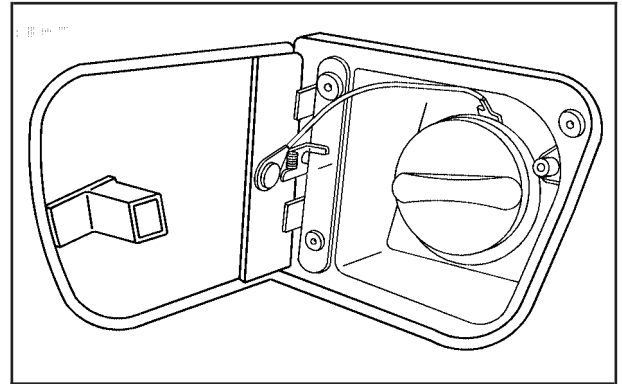

The tethered fuel cap is located behind a hinged fuel door on the driver's side of the vehicle.

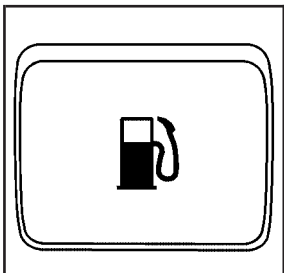

The fuel door release button is located on the instrument panel to the left of the steering wheel. Push the button to release the fuel door.



There is also a manual fuel door release tab. It is located against the upper trim in the rear compartment on the driver's side of the vehicle. Pull the tab to release the fuel door.

To remove the fuel cap, turn it slowly to the left (counterclockwise). The fuel cap has a spring in it; if the cap is released too soon, it will spring back to the right.

While refueling, let the cap hang by the tether below the fuel fill opening.

**⚠ CAUTION:**

**If you spill fuel and then something ignites it, you could be badly burned. Fuel can spray out on you if you open the fuel cap too quickly. This spray can happen if your tank is nearly full, and is more likely in hot weather. Open the fuel cap slowly and wait for any hiss noise to stop. Then unscrew the cap all the way.**

Be careful not to spill fuel. Do not top off or overfill the tank and wait a few seconds after you have finished pumping before removing the nozzle. Clean fuel from painted surfaces as soon as possible. See *Washing Your Vehicle* on page 5-79.

When replacing the fuel cap, turn it to the right (clockwise) until it clicks. Make sure the cap is fully installed. The diagnostic system can determine if the fuel cap has been left off or improperly installed. This would allow fuel to evaporate into the atmosphere. See *Malfunction Indicator Lamp on page 3-41*.

 **CAUTION:**

If a fire starts while you are refueling, do not remove the nozzle. Shut off the flow of fuel by shutting off the pump or by notifying the station attendant. Leave the area immediately.

**Notice:** If you need a new fuel cap, be sure to get the right type. Your dealer can get one for you. If you get the wrong type, it may not fit properly. This may cause your malfunction indicator lamp to light and may damage your fuel tank and emissions system. See *Malfunction Indicator Lamp on page 3-41*.

## Filling a Portable Fuel Container

 **CAUTION:**

Never fill a portable fuel container while it is in your vehicle. Static electricity discharge from the container can ignite the gasoline vapor. You can be badly burned and your vehicle damaged if this occurs. To help avoid injury to you and others:

- Dispense gasoline only into approved containers.
- Do not fill a container while it is inside a vehicle, in a vehicle's trunk, pickup bed or on any surface other than the ground.
- Bring the fill nozzle in contact with the inside of the fill opening before operating the nozzle. Contact should be maintained until the filling is complete.
- Do not smoke while pumping gasoline.

## Checking Things Under the Hood

### CAUTION:

An electric fan under the hood can start up and injure you even when the engine is not running. Keep hands, clothing and tools away from any underhood electric fan.

### CAUTION:

Things that burn can get on hot engine parts and start a fire. These include liquids like fuel, oil, coolant, brake fluid, windshield washer and other fluids, and plastic or rubber. You or others could be burned. Be careful not to drop or spill things that will burn onto a hot engine.

## Hood Release

To open the hood, do the following:

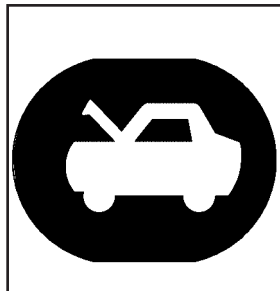

1. Pull the hood release lever with this symbol on it. It is located inside the vehicle below the instrument panel on the driver's side.

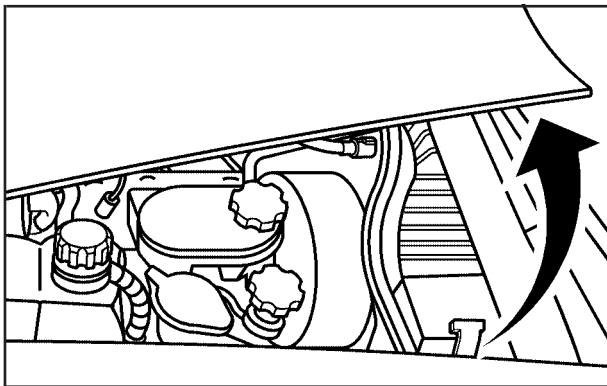

2. Go to the side of the vehicle and pull up on the rear edge of the hood, near the windshield.

Before closing the hood, be sure all the filler caps are on properly. Then, just pull the hood down and close it firmly.

## Engine Compartment Overview

If you are facing the front of your vehicle, when you open the hood, here is what you will see:

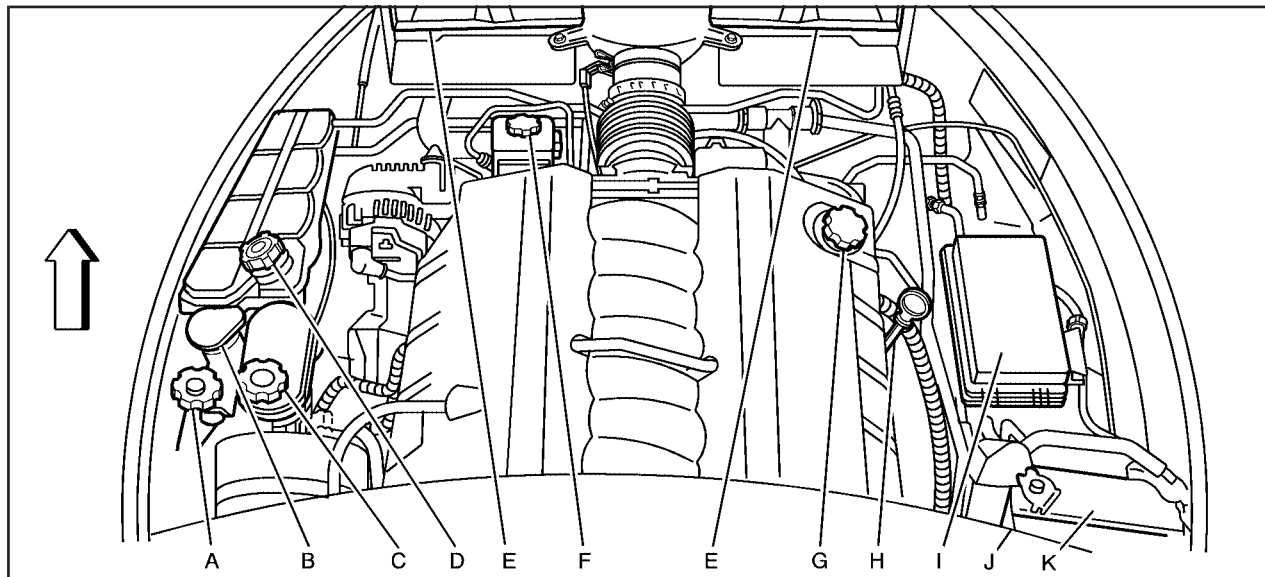



- A. Clutch Master Cylinder Reservoir (If Equipped). See *Hydraulic Clutch on page 5-22*.
- B. Windshield Washer Fluid Reservoir. See “Adding Washer Fluid” under *Windshield Washer Fluid on page 5-34*.
- C. Brake Fluid Reservoir. See “Brake Fluid” under *Brakes on page 5-35*.
- D. Coolant Surge Tank and Pressure Cap. See *Engine Coolant on page 5-22*.
- E. Engine Air Cleaner/Filters. See *Engine Air Cleaner/Filter on page 5-19*.
- F. Power Steering Fluid Reservoir. See *Power Steering Fluid on page 5-33*.
- G. Engine Oil Fill Cap. See “When to Add Engine Oil” under *Engine Oil on page 5-14*.
- H. Engine Oil Dipstick. See “Checking Engine Oil” under *Engine Oil on page 5-14*.
- I. Engine Compartment Fuse Block. See *Engine Compartment Fuse Block on page 5-91*.
- J. Passenger Compartment Air Filter (Out of View). See *Passenger Compartment Air Filter on page 3-30*.
- K. Battery. See *Battery on page 5-38*.

## Engine Oil

If the LOW OIL LEVEL message on the Driver Information Center comes on, it means you need to check your engine oil level right away. For more information, see *Driver Information Center (DIC)* on page 3-47.

You should check your engine oil level regularly; this is an added reminder.

## Checking Engine Oil

It is a good idea to check your engine oil level every time you get fuel. In order to get an accurate reading, the oil must be warm and the vehicle must be on level ground.

The engine oil dipstick handle is a yellow loop. See *Engine Compartment Overview* on page 5-12 for the location of the engine oil dipstick.

1. Turn off the engine and give the oil a few minutes to drain back into the oil pan. If you do not do this, the oil dipstick might not show the actual level.
2. Pull out the dipstick and clean it with a paper towel or a cloth, then push it back in all the way. Remove it again, keeping the tip down.

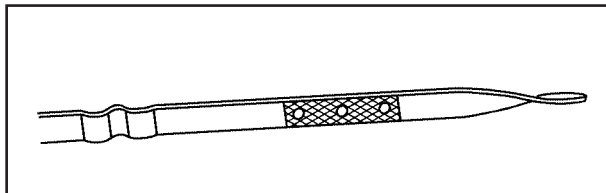

## When to Add Engine Oil

If the oil is below the cross-hatched area at the tip of the dipstick, you will need to add at least one quart of oil. But you must use the right kind. This section explains what kind of oil to use. For engine oil crankcase capacity, see *Capacities and Specifications* on page 5-94.

See *Racing or Other Competitive Driving* on page 2-22 for additional information on engine oil.

**Notice:** Do not add too much oil. If your engine has so much oil that the oil level gets above the cross-hatched area that shows the proper operating range, your engine could be damaged.

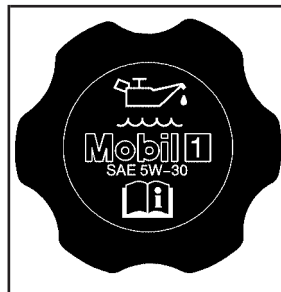

See *Engine Compartment Overview* on page 5-12 for the location of the engine oil fill cap.

Be sure to add enough oil to put the level somewhere in the proper operating range. Push the dipstick all the way back in when you are through.

## What Kind of Engine Oil to Use

Look for two things:

- GM4718M

Your vehicle's engine requires a special oil meeting GM Standard GM4718M. Oils meeting this standard may be identified as synthetic. However, not all *synthetic* oils will meet this GM standard. You should look for and use only an oil that meets GM Standard GM4718M.

**Notice:** If you use oils that do not have the GM4718M Standard designation, you can cause engine damage not covered by your warranty.

**RECOMMENDED SAE VISCOSITY GRADE ENGINE OILS**

**HOT  
WEATHER**

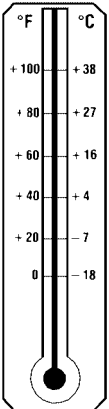

**COLD  
WEATHER**

LOOK  
FOR THIS  
SYMBOL  
AND GM STANDARD  
GM4718M



SAE 5W-30



**DO NOT USE SAE 10W-40, SAE 20W-50 OR ANY OTHER VISCOSITY GRADE OIL NOT RECOMMENDED**

- SAE 5W-30

As shown in the viscosity chart, SAE 5W-30 is best for your vehicle.

These numbers on an oil container show its viscosity, or thickness. Do not use other viscosity oils such as SAE 20W-50.



Oils meeting these requirements should also have the starburst symbol on the container. This symbol indicates that the oil has been certified by the American Petroleum Institute (API).

You should look for this on the oil container, and use *only* those oils that are identified as meeting GM Standard GM4718M and have the starburst symbol on the front of the oil container.

Your vehicle's engine is filled at the factory with a Mobil 1<sup>®</sup> synthetic oil, which meets all requirements for your vehicle.

Substitute Engine Oil: When adding oil to maintain engine oil level, oil meeting GM Standard GM4718M may not be available. You can add substitute oil designated SAE 5W-30 with the starburst symbol at all temperatures. Substitute oil not meeting GM Standard GM4718M should not be used for an oil change.

## Engine Oil Additives

Do not add anything to your oil. The recommended oils with the starburst symbol that meet GM Standard GM4718M are all you will need for good performance and engine protection.

# Engine Oil Life System

## When to Change Engine Oil

Your vehicle has a computer that lets you know when to change your engine oil and filter. This is based on engine revolutions and engine temperature, and not on mileage. Based on driving conditions, the mileage at which an oil change will be indicated can vary considerably. For the oil life system to work properly, you must reset the system every time the oil is changed.

When the system has calculated that oil life has been diminished, it will indicate that an oil change is necessary. A CHANGE OIL SOON message will come on. Change your oil as soon as possible within the next 600 miles (1 000 km). It is possible that, if you are driving under the best conditions, the oil life system may not indicate that an oil change is necessary for over a year. However, your engine oil and filter must be changed at least once a year and at this time the system must be reset. Your dealer has GM-trained service people who will perform this work using genuine GM parts and reset the system. It is also important to check your oil regularly and keep it at the proper level.

If the system is ever reset accidentally, you must change your oil at 3,000 miles (5 000 km) since your last oil change. Remember to reset the oil life system whenever the oil is changed.

## How to Reset the Engine Oil Life System

The Engine Oil Life System calculates when to change your engine oil and filter based on vehicle use. Anytime your oil is changed, reset the system so it can calculate when the next oil change is required. If a situation occurs where you change your oil prior to a CHANGE OIL SOON message being turned on, reset the system.

To reset the CHANGE OIL SOON message after an oil change, do the following:

1. Press the TRIP button so the OIL LIFE percentage is displayed.
2. Press RESET and hold for two seconds. OIL LIFE REMAIN 100% will appear.

If the CHANGE OIL SOON message comes back on when you start your vehicle, the engine oil life system has not reset. Repeat the procedure.

## What to Do with Used Oil

Used engine oil contains certain elements that may be unhealthy for your skin and could even cause cancer. Do not let used oil stay on your skin for very long. Clean your skin and nails with soap and water, or a good hand cleaner. Wash or properly dispose of clothing or rags containing used engine oil. See the manufacturer's warnings about the use and disposal of oil products.

Used oil can be a threat to the environment. If you change your own oil, be sure to drain all the oil from the filter before disposal. Never dispose of oil by putting it in the trash, pouring it on the ground, into sewers, or into streams or bodies of water. Instead, recycle it by taking it to a place that collects used oil. If you have a problem properly disposing of your used oil, ask your dealer, a service station or a local recycling center for help.

## Engine Air Cleaner/Filter

See *Engine Compartment Overview* on page 5-12 for the location of the engine air cleaner/filters.

**Notice:** If you spray water into the engine air cleaner/filter intake and water enters the engine air cleaner/filter housing, you could damage your vehicle's engine. The repairs would not be covered by your warranty. Do not spray water into the engine air cleaner/filter and/or housing.

If you are cleaning your vehicle with the hood open, take care not to spray water directly into either end of the air cleaner/filter housing as this could damage your vehicle's engine.

## When to Inspect the Engine Air Cleaner/Filters

Inspect the air cleaner/filters at the Maintenance II intervals and replace at the first oil change after 50,000 miles (83 000 km). See *Scheduled Maintenance on page 6-4* for more information. If you are driving in dusty/dirty conditions, inspect the filters at each engine oil change.

## How to Inspect the Engine Air Cleaner/Filters

To inspect the air cleaner/filters, remove the filters from the vehicle and lightly shake the filters to release loose dust and dirt. If the filters remain caked with dirt, new filters are required.

To inspect or replace the engine air cleaner/filters, do the following:

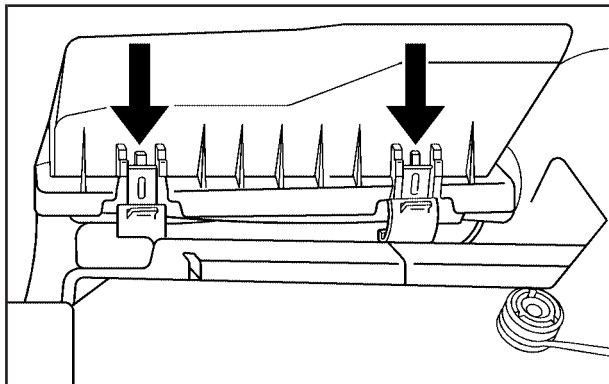

1. Pull the latches on each side of the cover to open, then move the latches up and out of the way.
2. Push the air cleaner/filter cover toward the front of the vehicle and then pull it up and away.

3. Inspect or replace the filter. See *Normal Maintenance Replacement Parts* on page 6-13.
4. Reverse Steps 1 and 2 to replace the air cleaner/filter cover.
5. Repeat the procedure for the second air cleaner/filter.

### CAUTION:

Operating the engine with the air cleaner/filter off can cause you or others to be burned. The air cleaner not only cleans the air; it helps to stop flame if the engine backfires. If it is not there and the engine backfires, you could be burned. Do not drive with it off, and be careful working on the engine with the air cleaner/filter off.

**Notice:** If the air cleaner/filter is off, a backfire can cause a damaging engine fire. And, dirt can easily get into your engine, which will damage it. Always have the air cleaner/filter in place when you are driving.



## Automatic Transmission Fluid

### How to Check

It is not necessary to check the transmission fluid level. A transmission fluid leak is the only reason for fluid loss. If a leak occurs, take the vehicle to your dealer service department and have it repaired as soon as possible.

There is a special procedure for checking and changing the transmission fluid. Because this procedure is difficult, you should have this done at your dealer service department. Contact your dealer for additional information or the procedure can be found in the service manual. To purchase a service manual, see *Service Publications Ordering Information on page 7-11*.

**Notice: Use of automatic transmission fluid labeled other than DEXRON®-III, Approved for the H-Specification, may damage your vehicle, and the damages may not be covered by your warranty. Always use automatic transmission fluid labeled DEXRON®-III, Approved for the H-Specification.**

Change both the fluid and filter every 50,000 miles (80 000 km) if the vehicle is mainly driven under one of these conditions:

- In heavy city traffic where the outside temperature regularly reaches 90°F (32°C) or higher.
- In hilly or mountainous terrain.
- High performance operation.

If you do not use your vehicle under one of these conditions, change the fluid and filter every 100,000 miles (166 000 km).

See *Scheduled Maintenance on page 6-4* for the proper service intervals for the transmission fluid and filter.

## Manual Transmission Fluid

It is not necessary to check the manual transmission fluid level. A transmission fluid leak is the only reason for fluid loss. If a leak occurs, take the vehicle to the dealership service department and have it repaired as soon as possible. You may also have your fluid level checked by your dealer or service center when you have your oil changed. See *Recommended Fluids and Lubricants on page 6-11* for the proper fluid to use.

## Hydraulic Clutch

It is not necessary to regularly check clutch fluid unless you suspect there is a leak in the system. Adding fluid will not correct a leak.

A fluid loss in this system could indicate a problem. Have the system inspected and repaired.

### When to Check and What to Use

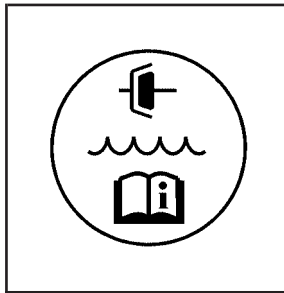

The hydraulic clutch fluid reservoir cap has this symbol on it. See *Engine Compartment Overview* on page 5-12 for reservoir location.

Refer to the Maintenance Schedule to determine how often you should check the fluid level in your clutch master cylinder reservoir and for the proper fluid to use. See *Owner Checks and Services* on page 6-8 and *Recommended Fluids and Lubricants* on page 6-11.

## How to Check and Add Fluid

Make sure the fluid level is at the MIN line on the side of the reservoir. If it is not, remove the cap and add the proper fluid until the level reaches the MIN line.

## Engine Coolant

The cooling system in your vehicle is filled with DEX-COOL<sup>®</sup> engine coolant. This coolant is designed to remain in your vehicle for five years or 150,000 miles (240 000 km), whichever occurs first, if you add only DEX-COOL<sup>®</sup> extended life coolant.

The following explains your cooling system and how to add coolant when it is low. If you have a problem with engine overheating, see *Engine Overheating* on page 5-25.

A 50/50 mixture of clean, drinkable water and DEX-COOL<sup>®</sup> coolant will:

- Give freezing protection down to -34°F (-37°C).
- Give boiling protection up to 265°F (129°C).
- Protect against rust and corrosion.
- Help keep the proper engine temperature.
- Let the warning lights and gauges work as they should.

**Notice:** Using coolant other than DEX-COOL<sup>®</sup> may cause premature engine, heater core or radiator corrosion. In addition, the engine coolant may require changing sooner, at 30,000 miles (50 000 km) or 24 months, whichever occurs first. Any repairs would not be covered by your warranty. Always use DEX-COOL<sup>®</sup> (silicate-free) coolant in your vehicle.

## What to Use

Use a mixture of one-half *clean, drinkable water* and one-half DEX-COOL<sup>®</sup> coolant which will not damage aluminum parts. If you use this coolant mixture, you do not need to add anything else.

## CAUTION:

Adding only plain water to your cooling system can be dangerous. Plain water, or some other liquid such as alcohol, can boil before the proper coolant mixture will. Your vehicle's coolant warning system is set for the proper coolant mixture. With plain water or the wrong mixture, your engine could get too hot but you would not get the overheat warning. Your engine could catch fire and you or others could be burned. Use a 50/50 mixture of clean, drinkable water and DEX-COOL<sup>®</sup> coolant.

**Notice:** If you use an improper coolant mixture, your engine could overheat and be badly damaged. The repair cost would not be covered by your warranty. Too much water in the mixture can freeze and crack the engine, radiator, heater core and other parts.

If you have to add coolant more than four times a year, have your dealer check your cooling system.

**Notice:** If you use the proper coolant, you do not have to add extra inhibitors or additives which claim to improve the system. These can be harmful.

## Checking Coolant



The engine coolant surge tank is located toward the rear of the engine compartment on the driver's side of the vehicle. See *Engine Compartment Overview* on page 5-12 for more information on location.

### CAUTION:

Turning the surge tank pressure cap when the engine and radiator are hot can allow steam and scalding liquids to blow out and burn you badly. Never turn the surge tank pressure cap — even a little — when the engine and radiator are hot.

The vehicle must be on a level surface. When your engine is cold, the coolant level should be at the FULL COLD mark. The FULL COLD mark is on the front of the coolant surge tank. Do not overfill the surge tank. Too much coolant can result in an overflow when the fluid is hot.

## Adding Coolant

If you need more coolant, add the proper DEX-COOL<sup>®</sup> coolant mixture *at the surge tank*, but only when the engine is cool.

### CAUTION:

**You can be burned if you spill coolant on hot engine parts. Coolant contains ethylene glycol, and it will burn if the engine parts are hot enough. Do not spill coolant on a hot engine.**

When replacing the pressure cap, make sure it is hand-tight.

## Coolant Surge Tank Pressure Cap

**Notice:** If the pressure cap is not tightly installed, coolant loss and possible engine damage may occur. Be sure the cap is properly and tightly secured.

See *Engine Compartment Overview* on page 5-12 for information on location.

## Engine Overheating

You will find an engine coolant temperature gage on the instrument panel cluster and a COOLANT OVER TEMPERATURE message on the Driver Information Center (DIC). See *Engine Coolant Temperature Gage* on page 3-40 and *DIC Warnings and Messages* on page 3-53.

## If Steam Is Coming From Your Engine

### CAUTION:

Steam from an overheated engine can burn you badly, even if you just open the hood. Stay away from the engine if you see or hear steam coming from it. Just turn it off and get everyone away from the vehicle until it cools down. Wait until there is no sign of steam or coolant before you open the hood.

If you keep driving when your engine is overheated, the liquids in it can catch fire. You or others could be badly burned. Stop your engine if it overheats, and get out of the vehicle until the engine is cool.

See *Overheated Engine Protection Operating Mode on page 5-27* for information on driving to a safe place in an emergency.

**Notice:** If your engine catches fire because you keep driving with no coolant, your vehicle can be badly damaged. The costly repairs would not be covered by your warranty. See *Overheated Engine Protection Operating Mode on page 5-27* for information on driving to a safe place in an emergency.

## If No Steam Is Coming From Your Engine

If you get an engine overheat warning but see or hear no steam, the problem may not be too serious. Sometimes the engine can get a little too hot when you:

- Climb a long hill on a hot day.
- Stop after high-speed driving.
- Idle for long periods in traffic.

If you get the overheat warning with no sign of steam, try this for a minute or so:

1. In heavy traffic, let the engine idle in NEUTRAL (N) while stopped. If it is safe to do so, pull off the road, shift to PARK (P) or NEUTRAL (N) and let the engine idle.
2. Turn on your heater to full hot at the highest fan speed and open the windows as necessary.

If you no longer have the overheat warning, you can drive. Just to be safe, drive slower for about 10 minutes. If the warning does not come back on, you can drive normally.

If the warning continues and you are not stopped, pull over, stop, and park your vehicle right away.

If there is still no sign of steam, you can idle the engine for three minutes while you are parked. If you still have the warning, *turn off the engine and get everyone out of the vehicle* until it cools down. Also, see “Overheated Engine Protection Operating Mode” later in this section.

You may decide not to lift the hood but to get service help right away.

## Overheated Engine Protection Operating Mode

If an overheated engine condition exists and the messages COOLANT OVER TEMPERATURE and REDUCED ENGINE POWER are displayed, along with the Check Engine light, an overheat protection mode which alternates firing groups of cylinders helps prevent engine damage. In this mode, you will notice a loss in power and engine performance. This operating mode allows your vehicle to be driven to a safe place in an emergency; you may drive up to 50 miles (80 km).

**Notice:** After driving in the overheated engine protection operating mode, to avoid engine damage, allow the engine to cool before attempting any repair. The engine oil will be severely degraded. Repair the cause of coolant loss, change the oil and reset the oil life system. See *Engine Oil on page 5-14*.

## Cooling System

When you decide it is safe to lift the hood, here is what you will see:

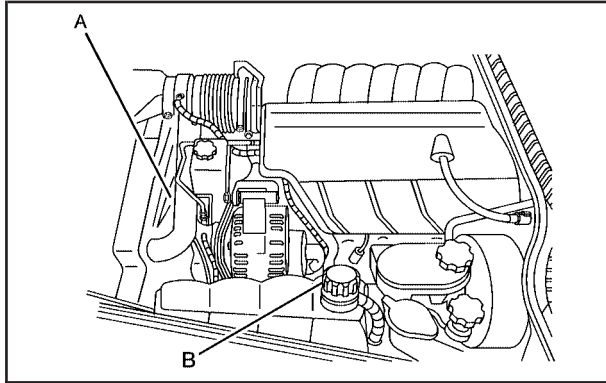

- A. Electric Engine Cooling Fan
- B. Coolant Surge Tank with Pressure Cap

### CAUTION:

**An electric engine cooling fan under the hood can start up even when the engine is not running and can injure you. Keep hands, clothing and tools away from any underhood electric fan.**

If the coolant inside the coolant surge tank is boiling, do not do anything else until it cools down. The vehicle should be parked on a level surface.

The coolant level should be at the FULL COLD mark on the front of the coolant surge tank. If it is not, you may have a leak at the pressure cap or in the radiator hoses, heater hoses, radiator, water pump or somewhere else in the cooling system.



 **CAUTION:**

Heater and radiator hoses, and other engine parts, can be very hot. Do not touch them. If you do, you can be burned.

Do not run the engine if there is a leak. If you run the engine, it could lose all coolant. That could cause an engine fire, and you could be burned. Get any leak fixed before you drive the vehicle.

If there seems to be no leak, with the engine on, check to see if the electric engine cooling fan is running. If the engine is overheating, the fan should be running. If it is not, your vehicle needs service.

**Notice:** Engine damage from running your engine without coolant is not covered by your warranty. See *Overheated Engine Protection Operating Mode on page 5-27* for information on driving to a safe place in an emergency.

**Notice:** Using coolant other than DEX-COOL<sup>®</sup> may cause premature engine, heater core or radiator corrosion. In addition, the engine coolant may require changing sooner, at 30,000 miles (50 000 km) or 24 months, whichever occurs first. Any repairs would not be covered by your warranty. Always use DEX-COOL<sup>®</sup> (silicate-free) coolant in your vehicle.

## How to Add Coolant to the Coolant Surge Tank

If you have not found a problem yet, check to see if coolant is visible in the surge tank. If coolant is visible but the coolant level is not at the FULL COLD mark on the front of the coolant surge tank, add a 50/50 mixture of *clean, drinkable water* and DEX-COOL<sup>®</sup> coolant at the coolant surge tank, but be sure the cooling system, including the coolant surge tank pressure cap, is cool before you do it. See *Engine Coolant on page 5-22* for more information.

If no coolant is visible in the surge tank, add coolant as follows:

 **CAUTION:**

Steam and scalding liquids from a hot cooling system can blow out and burn you badly. They are under pressure, and if you turn the coolant surge tank pressure cap — even a little — they can come out at high speed. Never turn the cap when the cooling system, including the coolant surge tank pressure cap, is hot. Wait for the cooling system and coolant surge tank pressure cap to cool if you ever have to turn the pressure cap.

 **CAUTION:**

Adding only plain water to your cooling system can be dangerous. Plain water, or some other liquid such as alcohol, can boil before the proper coolant mixture will. Your vehicle's coolant warning system is set for the proper coolant mixture. With plain water or the wrong mixture, your engine could get too hot but you would not get the overheat warning. Your engine could catch fire and you or others could be burned. Use a 50/50 mixture of clean, drinkable water and DEX-COOL<sup>®</sup> coolant.

**Notice:** In cold weather, water can freeze and crack the engine, radiator, heater core and other parts. Use the recommended coolant and the proper coolant mixture.

**⚠ CAUTION:**

**You can be burned if you spill coolant on hot engine parts. Coolant contains ethylene glycol and it will burn if the engine parts are hot enough. Do not spill coolant on a hot engine.**



1. You can remove the coolant surge tank pressure cap when the cooling system, including the coolant surge tank pressure cap and upper radiator hose,

is no longer hot. Turn the pressure cap slowly counterclockwise about one-quarter turn and then stop.

If you hear a hiss, wait for that to stop. A hiss means there is still some pressure left.

2. Then keep turning the pressure cap slowly, and remove it.



3. Fill the coolant surge tank with the proper mixture until the level inside stabilizes at the FULL COLD mark on the front of the surge tank.



4. With the coolant surge tank pressure cap off, start the engine and let it run until you can feel the upper radiator hose getting hot. Watch out for the engine cooling fan.

By this time, the coolant level inside the coolant surge tank may be lower. If the level is lower, add more of the proper mixture to the coolant surge tank until the level stabilizes at the FULL COLD mark on the coolant surge tank.

5. Then replace the pressure cap. Be sure the pressure cap is hand-tight and fully seated.

Check the level in the surge tank when the system has cooled down. If the coolant is not at the proper level, repeat Steps 1 through 4, then reinstall the pressure cap. If the coolant is not at the proper level when the system cools down again, see your dealer.

## Power Steering Fluid

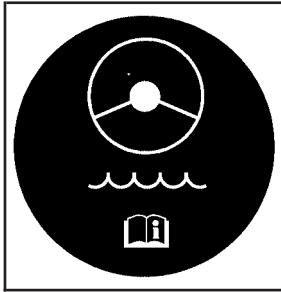

See *Engine Compartment Overview* on page 5-12 for reservoir location.

### When to Check Power Steering Fluid

It is not necessary to regularly check power steering fluid unless you suspect there is a leak in the system or you hear an unusual noise. A fluid loss in this system could indicate a problem. Have the system inspected and repaired.

## How to Check Power Steering Fluid

To check the power steering fluid, do the following:

1. Turn the key off and let the engine compartment cool down.
2. Wipe the cap and the top of the reservoir clean.
3. Unscrew the cap and wipe the dipstick with a clean rag.
4. Replace the cap and completely tighten it.
5. Remove the cap again and look at the fluid level on the dipstick. There are markings on both sides of the dipstick.

The level should be at the FULL COLD mark. If necessary, add only enough fluid to bring the level up to the mark.

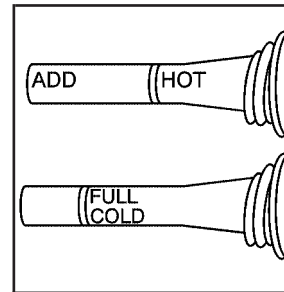

When the engine compartment is hot, the level should be at the HOT mark. When the engine compartment is cool, the level should be at the FULL COLD mark.

## What to Use

To determine what kind of fluid to use, see *Recommended Fluids and Lubricants on page 6-11*. Always use the proper fluid. Failure to use the proper fluid can cause leaks and damage hoses and seals.

## Windshield Washer Fluid

### What to Use

When you need windshield washer fluid, be sure to read the manufacturer's instructions before use. If you will be operating your vehicle in an area where the temperature may fall below freezing, use a fluid that has sufficient protection against freezing.

## Adding Washer Fluid

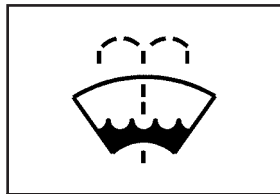

Open the cap with the washer symbol on it. Add washer fluid until the tank is full. See *Engine Compartment Overview on page 5-12* for reservoir location.

### Notice:

- **When using concentrated washer fluid, follow the manufacturer's instructions for adding water.**
- **Do not mix water with ready-to-use washer fluid. Water can cause the solution to freeze and damage your washer fluid tank and other parts of the washer system. Also, water does not clean as well as washer fluid.**
- **Fill your washer fluid tank only three-quarters full when it is very cold. This allows for expansion if freezing occurs, which could damage the tank if it is completely full.**
- **Do not use engine coolant (antifreeze) in your windshield washer. It can damage your washer system and paint.**

# Brakes

## Brake Fluid

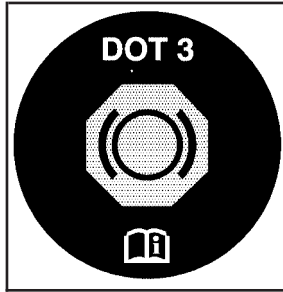

Your brake master cylinder reservoir is filled with DOT-3 brake fluid. See *Engine Compartment Overview* on page 5-12 for the location of the reservoir.

There are only two reasons why the brake fluid level in the reservoir might go down. The first is that the brake fluid goes down to an acceptable level during normal brake lining wear. When new linings are put in, the fluid level goes back up. The other reason is that fluid is leaking out of the brake system. If it is, you should have your brake system fixed, since a leak means that sooner or later your brakes will not work well, or will not work at all.

So, it is not a good idea to top off your brake fluid. Adding brake fluid will not correct a leak. If you add fluid when your linings are worn, then you will have too much fluid when you get new brake linings. You should add or remove brake fluid, as necessary, only when work is done on the brake hydraulic system.

### CAUTION:

**If you have too much brake fluid, it can spill on the engine. The fluid will burn if the engine is hot enough. You or others could be burned, and your vehicle could be damaged. Add brake fluid only when work is done on the brake hydraulic system. See “Checking Brake Fluid” in this section.**

Refer to the Maintenance Schedule to determine when to check your brake fluid. See *Scheduled Maintenance* on page 6-4.

## Checking Brake Fluid

You can check the brake fluid without taking off the cap. Look at the brake fluid reservoir. The fluid level should be above the MIN mark on the reservoir. If it is not, have your brake system checked to see if there is a leak.

After work is done on the brake hydraulic system, make sure the level is between the MIN and MAX marks.

### What to Add

When you do need brake fluid, use only DOT-3 brake fluid. Refer to *Recommended Fluids and Lubricants on page 6-11*. Use new brake fluid from a sealed container only.

Always clean the brake fluid reservoir cap and the area around the cap before removing it. This will help keep dirt from entering the reservoir.

### CAUTION:

**With the wrong kind of fluid in your brake system, your brakes may not work well, or they may not even work at all. This could cause a crash. Always use the proper brake fluid.**

#### **Notice:**

- **Using the wrong fluid can badly damage brake system parts. For example, just a few drops of mineral-based oil, such as engine oil, in your brake system can damage brake system parts so badly that they will have to be replaced. Do not let someone put in the wrong kind of fluid.**
- **If you spill brake fluid on your vehicle's painted surfaces, the paint finish can be damaged. Be careful not to spill brake fluid on your vehicle. If you do, wash it off immediately. See *Appearance Care on page 5-75*.**



## Brake Wear

Your vehicle has four-wheel disc brakes.

Disc brake pads have built-in wear indicators that make a high-pitched warning sound when the brake pads are worn and new pads are needed. The sound may come and go or be heard all the time your vehicle is moving, except when you are pushing on the brake pedal firmly.

### CAUTION:

**The brake wear warning sound means that soon your brakes will not work well. That could lead to an accident. When you hear the brake wear warning sound, have your vehicle serviced.**

**Notice:** Continuing to drive with worn-out brake pads could result in costly brake repair.

Some driving conditions or climates may cause a brake squeal when the brakes are first applied or lightly applied. This does not mean something is wrong with your brakes.

Brake linings should always be replaced as complete axle sets.

## Brake Pedal Travel

See your dealer if the brake pedal does not return to normal height, or if there is a rapid increase in pedal travel. This could be a sign of brake trouble.

## Brake Adjustment

As you make brake stops, your disc brakes automatically adjust for wear.

## Replacing Brake System Parts

The braking system on a vehicle is complex. Its many parts have to be of top quality and work well together if the vehicle is to have really good braking. Your vehicle was designed and tested with top-quality GM brake parts. When you replace parts of your braking system — for example, when your brake linings wear down and you need new ones put in — be sure you get new approved GM replacement parts. If you do not, your brakes may no longer work properly. For example, if someone puts in brake linings that are wrong for your vehicle, the balance between your front and rear brakes can change — for the worse. The braking performance you have come to expect can change in many other ways if someone puts in the wrong replacement brake parts.

## Battery

Your vehicle has a maintenance free battery. When it is time for a new battery, get one that has the replacement number shown on the original battery's label. We recommend an ACDelco® replacement battery.

For battery replacement, see your dealer or the service manual. To purchase a service manual, see *Service and Owner Publications* in *Service Publications Ordering Information* on page 7-11.

**Warning:** Battery posts, terminals and related accessories contain lead and lead compounds, chemicals known to the State of California to cause cancer and reproductive harm. Wash hands after handling.

## Vehicle Storage

If you are not going to drive your vehicle for 25 days or more, remove the black, negative (-) cable from the battery. This will help keep your battery from running down.

### CAUTION:

**Batteries have acid that can burn you and gas that can explode. You can be badly hurt if you are not careful. See *Jump Starting* on page 5-39 for tips on working around a battery without getting hurt.**

Also, for your audio system, see *Theft-Deterrent Feature* on page 3-94.

## Jump Starting

If your battery has run down, you may want to use another vehicle and some jumper cables to start your vehicle. Be sure to use the following steps to do it safely.

### CAUTION:

**Batteries can hurt you. They can be dangerous because:**

- They contain acid that can burn you.
- They contain gas that can explode or ignite.
- They contain enough electricity to burn you.

If you do not follow these steps exactly, some or all of these things can hurt you.

**Notice:** If you try to start your vehicle by pushing or pulling it, you could damage your vehicle. Do not push or pull your vehicle to start it; instead, use the jump starting procedure in this manual to start your vehicle when the battery has run down.

1. Check the other vehicle. It must have a 12-volt battery with a negative ground system.

**Notice:** If the other vehicle's system is not a 12-volt system with a negative ground, both vehicles can be damaged. Only use vehicles with 12-volt systems with negative grounds to jump start your vehicle.

2. Get the vehicles close enough so the jumper cables can reach, but be sure the vehicles are not touching each other. If they are, it could cause a ground connection you do not want. You would not be able to start your vehicle, and the bad grounding could damage the electrical systems.

To avoid the possibility of the vehicles rolling, set the parking brake firmly on both vehicles involved in the jump start procedure. Put an automatic transmission in PARK (P) or a manual transmission in NEUTRAL before setting the parking brakes.

**Notice:** If you leave your radio or other accessories on during the jump starting procedure, they could be damaged. The repairs would not be covered by your warranty. Always turn off your radio and other accessories when jump starting your vehicle.

3. Turn off the ignition on both vehicles. Unplug unnecessary accessories plugged into the cigarette lighter or the accessory power outlet. Turn off the radio and all lamps that are not needed. This will avoid sparks and help save both batteries. And it could save the radio!
4. Open the hoods and locate the batteries. Find the positive (+) and negative (-) terminal locations on each vehicle. See *Engine Compartment Overview on page 5-12* for more information on the location of the positive (+) terminal on your vehicle's battery. Your vehicle also has a remote positive (+) terminal, which can be accessed by opening the cover of the engine compartment fuse block, and can be used to jump start your vehicle. See *Engine Compartment Overview on page 5-12* for the location of the engine compartment fuse block.

 **CAUTION:**

**An electric fan can start up even when the engine is not running and can injure you. Keep hands, clothing and tools away from any underhood electric fan.**

 **CAUTION:**

**Using a match near a battery can cause battery gas to explode. People have been hurt doing this, and some have been blinded. Use a flashlight if you need more light.**

**Be sure the battery has enough water. You do not need to add water to the battery installed in your new vehicle. But if a battery has filler caps, be sure the right amount of fluid is there. If it is low, add water to take care of that first. If you do not, explosive gas could be present.**

**Battery fluid contains acid that can burn you. Do not get it on you. If you accidentally get it in your eyes or on your skin, flush the place with water and get medical help immediately.**

**⚠ CAUTION:**

Fans or other moving engine parts can injure you badly. Keep your hands away from moving parts once the engine is running.

5. Check that the jumper cables do not have loose or missing insulation. If they do, you could get a shock. The vehicles could be damaged too.

Before you connect the cables, here are some basic things you should know. Positive (+) will go to positive (+) or to a remote positive (+) terminal if the vehicle has one. Negative (-) will go to a heavy, unpainted metal engine part or to a remote negative (-) terminal if the vehicle has one.

Do not connect positive (+) to negative (-) or you will get a short that would damage the battery and maybe other parts too. And do not connect the negative (-) cable to the negative (-) terminal on the dead battery because this can cause sparks.

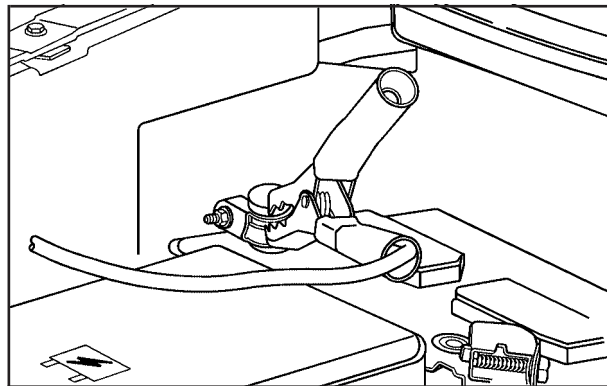

6. Connect the red positive (+) cable to the positive (+) terminal of the dead battery. Use a remote positive (+) terminal if the vehicle has one.
7. Do not let the other end touch metal. Connect it to the positive (+) terminal of the good battery. Use a remote positive (+) terminal if the vehicle has one.

8. Now connect the black negative (-) cable to the negative (-) terminal of the good battery. Use a remote negative (-) terminal if the vehicle has one.  
Do not let the other end touch anything until the next step. The other end of the negative (-) cable *does not* go to the dead battery. It goes to a heavy, unpainted metal engine part or to a remote negative (-) terminal on the vehicle with the dead battery.
9. Connect the other end of the negative (-) cable at least 18 inches (45 cm) away from the dead battery, but not near engine parts that move. The electrical connection is just as good there, and the chance of sparks getting back to the battery is much less.
10. Now start the vehicle with the good battery and run the engine for a while.
11. Try to start the vehicle that had the dead battery. If it will not start after a few tries, it probably needs service.

**Notice:** If the jumper cables are removed in the wrong order, electrical shorting may occur and damage the vehicle. The repairs would not be covered by your warranty. Remove the jumper cables in the correct order, making sure that the cables do not touch each other or other metal.

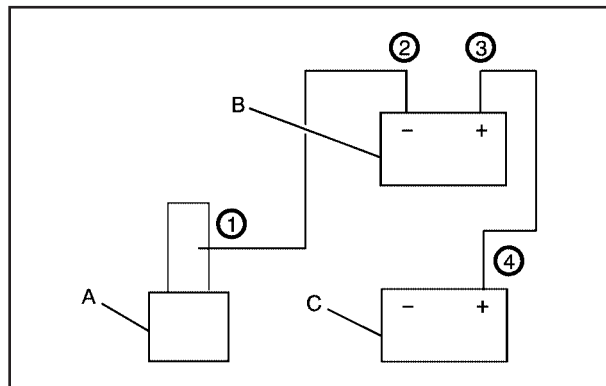

### Jumper Cable Removal

- A. Heavy, Unpainted Metal Engine Part
- B. Good Battery
- C. Dead Battery

To disconnect the jumper cables from both vehicles, do the following:

1. Disconnect the black negative (-) cable from the vehicle that had the dead battery.
2. Disconnect the black negative (-) cable from the vehicle with the good battery.
3. Disconnect the red positive (+) cable from the vehicle with the good battery.
4. Disconnect the red positive (+) cable from the other vehicle.

## Rear Axle

### When to Check Lubricant

It is not necessary to regularly check rear axle fluid unless you suspect there is a leak or you hear an unusual noise. A fluid loss could indicate a problem. Have it inspected and repaired.

### How to Check Lubricant

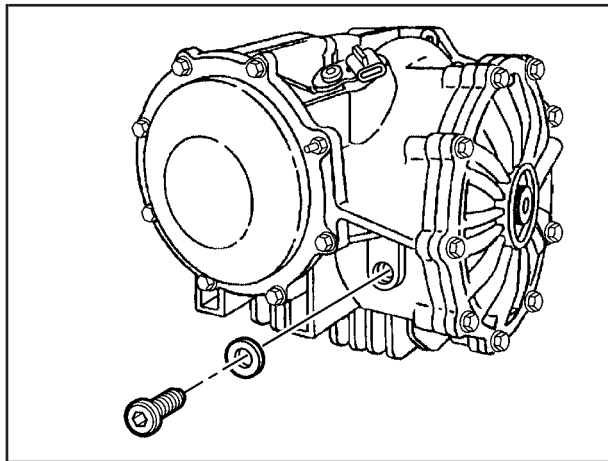

To get an accurate reading, the vehicle should be on a level surface.

If the level is below the bottom of the filler plug hole, you will need to add some lubricant. Add enough lubricant to raise the level to the bottom of the filler plug hole.

### What to Use

To add lubricant when the level is low, use SAE 75W-90 Synthetic Axle Lubricant (GM Part No. U.S. 12378261, in Canada 10953455) meeting GM Specification 9986115. To completely refill after draining, add 4 ounces (118 ml) of Limited-Slip Axle Lubricant Additive (GM Part No. U.S. 1052358, in Canada 992694). Then fill to the bottom of the filler plug hole with the Synthetic Gear Lubricant.

## Bulb Replacement

For the proper type of replacement bulbs, see *Replacement Bulbs on page 5-48*.

For any bulb changing procedure not listed in this section, contact your dealer.

## High Intensity Discharge (HID) Lighting

### CAUTION:

**The low beam high intensity discharge lighting system operates at a very high voltage. If you try to service any of the system components, you could be seriously injured. Have your dealer or a qualified technician service them.**

Your vehicle has HID low-beam headlamps. After your vehicle's HID headlamp bulb has been replaced, you may notice that the beam is a slightly different shade than it was originally. This is normal.

## Halogen Bulbs

### CAUTION:

**Halogen bulbs have pressurized gas inside and can burst if you drop or scratch the bulb. You or others could be injured. Be sure to read and follow the instructions on the bulb package.**



## Headlamps, Front Turn Signal, and Parking Lamps

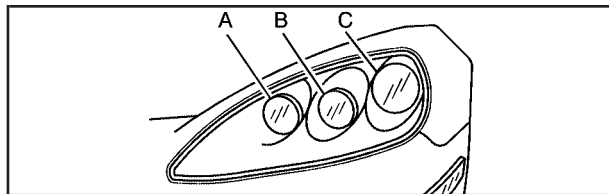

- A. High-beam Headlamp
- B. Low-beam Headlamp
- C. Front Parking/Turn Signal

If the low-beam headlamp needs to be replaced, you will need to see your dealer. See *High Intensity Discharge (HID) Lighting* on page 5-44 for more information.

To replace a high-beam or front parking/turn signal bulb, do the following:

1. Turn the wheel to allow access to the wheel well.

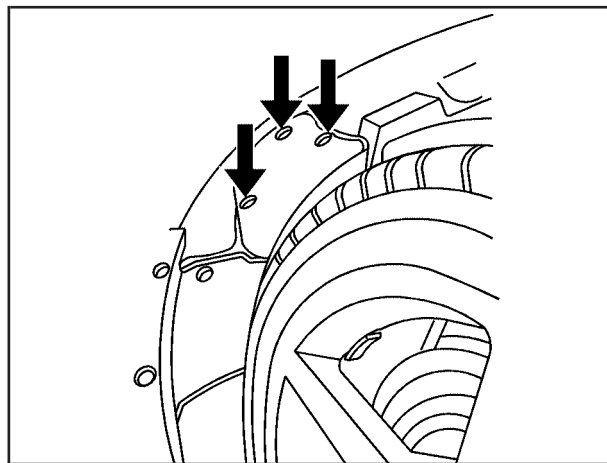

2. Access the high-beam or front parking/turn signal bulbs by removing the access panel. To do this, remove the three outer fasteners and flip back the cover.
3. Remove the outer cover to expose the high-beam headlamp bulb socket once the access cover has been removed.

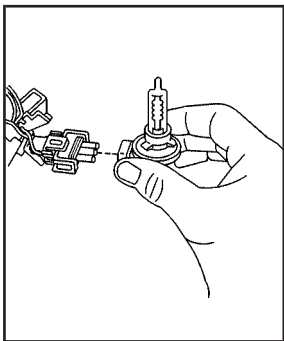

4. Remove the headlamp bulb by releasing the outer tabs from the socket.

## Sidemarker Lamps

To replace a front sidemarker bulb, do the following:

1. Turn the wheel to allow access to the wheel well.

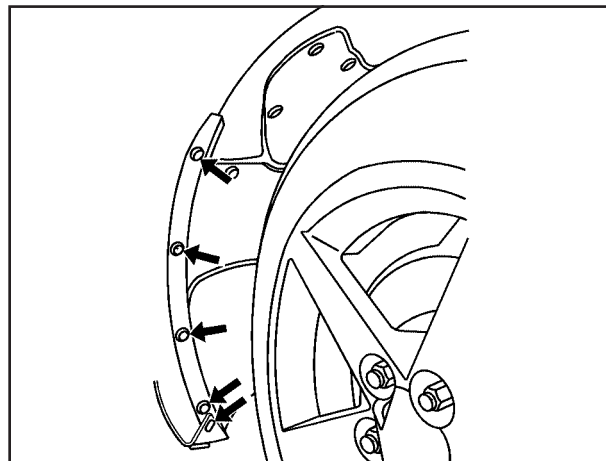

5. Remove the front parking/turn signal bulb by turning the bulb socket counterclockwise.
6. Replace the high-beam headlamp bulb with a new bulb and reattach to the bulb socket.  
Replace the front parking/turn signal bulb by turning the bulb socket clockwise.
7. Reverse the Steps 2 through 4 to reinstall.

2. Remove the five fasteners along the outer edge of the wheel well.
3. Pull back the wheel well trim.
4. Reach in and locate the sidemarker bulb.
5. Remove the bulb socket by turning it counterclockwise.

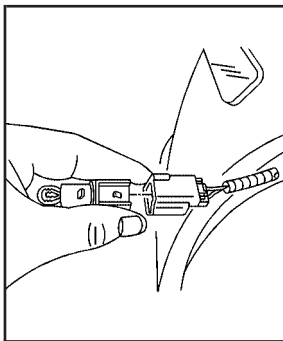

6. Remove the bulb by pushing in on the tab on the bulb socket and then remove the bulb.

7. Replace with a new bulb.
8. Replace the bulb socket by turning it clockwise into the bulb assembly.
9. Replace the fasteners into the wheel well trim.  
When replacing the fasteners, the two largest fasteners will be replaced in the two bottom positions of the wheel well trim. If not, you will find that the fasteners do not fit properly.

## Taillamps, Turn Signal, and Stoplamps

To replace a stoplamp, taillamp/turn signal bulb, do the following:

1. Remove the screw from the top of the lamp assembly.

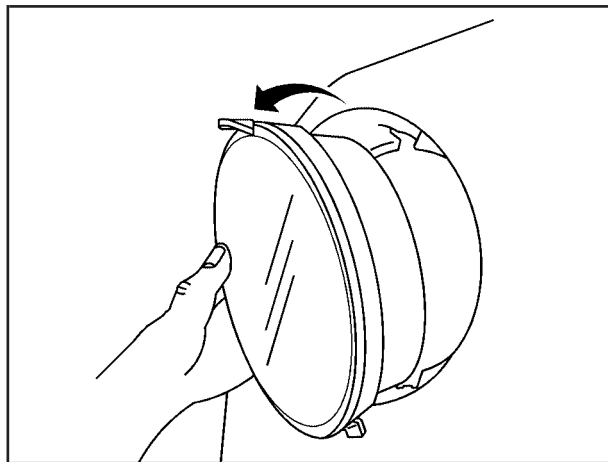

2. Tilt out the lamp assembly.

3. Turn the bulb socket one-quarter turn counterclockwise and pull it out.
4. Pull the bulb straight out to remove it from the socket.
5. Push the new bulb in the bulb socket until it snaps into place.
6. Reinstall the lamp assembly by first lining up the tabs on the bottom of the lamp assembly with the tabs in the vehicle, then slide it in.
7. Replace the screw at the top of the lamp assembly.

## Replacement Bulbs

Exterior Lamp	Bulb Number
Front Parking/Turn Signal	5702KA
Headlamp, High-Beam	H9
Sidemarkers	W3W
Stoptail/Tailamp/Turn Signal	3057KX

For replacement bulbs not listed here, contact your dealer.

## Windshield Wiper Blade Replacement

Windshield wiper blades should be inspected each time maintenance is performed. See “Wiper Blade Check” under *Scheduled Maintenance on page 6-4* for more information.

Replacement blades come in different types and are removed in different ways. For the proper type and length, see *Normal Maintenance Replacement Parts on page 6-13*.

It is a good idea to clean or replace the wiper blade assembly every six months.

**Notice:** Allowing the wiper blade arm to touch the windshield when no wiper blade is installed could damage the windshield. Any damage that occurs would not be covered by your warranty. Do not allow the wiper blade arm to touch the windshield.

To remove the wiper blade assembly, do the following:

1. Open the hood to gain access to the windshield wipers.
2. Lift the wiper arm until it locks into a vertical position.

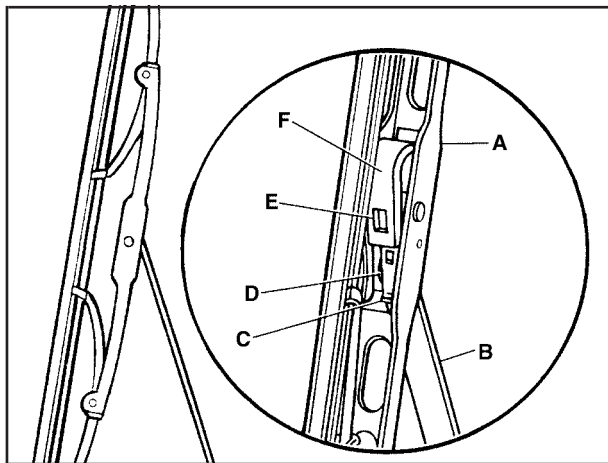

A. Blade Assembly  
B. Arm Assembly  
C. Locking Tab

D. Blade Pivot  
E. Hook Slot  
F. Arm Hook

3. Press down on the blade assembly pivot locking tab (C). Pull down on the blade assembly (A) to release it from the wiper arm hook (F).
4. Remove the insert from the blade assembly (A). The insert has two notches at one end that are locked by the bottom claws of the blade assembly. At the notch end, pull the insert from the blade assembly.

To install the new wiper insert:

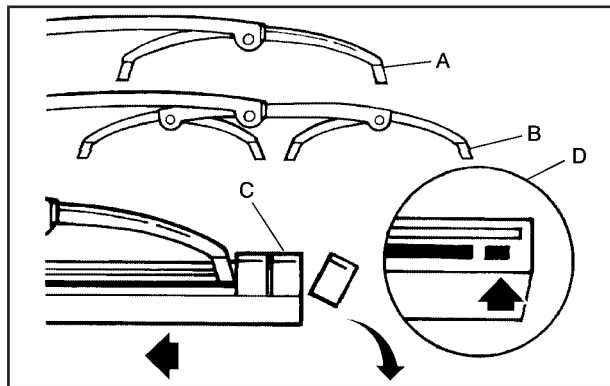

1. Slide the insert (D), notched end last, into the end with the two blade claws (A). Slide the insert all the way through the blade claws at the opposite end (B). Plastic caps (C) will be forced off as the insert is fully installed.
2. Be sure the notches are locked by the bottom claws. Make sure that all other claws are properly locked on both sides of the insert slots.
3. Put the blade assembly pivot in the wiper arm hook. Pull up until the pivot locking tab locks in the hook slot.

4. Carefully lower the wiper arm and blade assembly onto the windshield.

Installation guide:

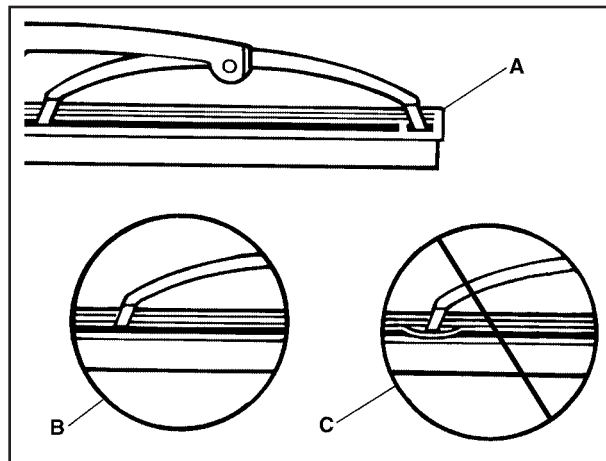

- A. Claw in Notch  
B. Correct Installation  
C. Incorrect Installation

## Tires

Your new vehicle comes with high-quality tires made by a leading tire manufacturer. If you ever have questions about your tire warranty and where to obtain service, see your GM Warranty booklet for details. For additional information refer to the tire manufacturer's booklet included with your vehicle's Owner's Manual.

### CAUTION:

- **Poorly maintained and improperly used tires are dangerous.**
- **Overloading your tires can cause overheating as a result of too much friction. You could have an air-out and a serious accident. See *Loading Your Vehicle* on page 4-32.**
- **Underinflated tires pose the same danger as overloaded tires. The resulting accident could cause serious injury. Check all tires frequently to maintain the recommended pressure. Tire pressure should be checked when your tires are cold.**
- **Overinflated tires are more likely to be cut, punctured or broken by a sudden impact — such as when you hit a pothole. Keep tires at the recommended pressure.**
- **Worn, old tires can cause accidents. If your tread is badly worn, or if your tires have been damaged, replace them.**

**See *Inflation - Tire Pressure* on page 5-58, for inflation pressure adjustment for high speed driving.**

## Winter Tires

If you expect to drive on snow or ice covered roads often, you may want to get winter tires for your vehicle. All season tires provide good overall performance on most surfaces but they may not offer the traction you would like or the same level of performance as winter tires on snow or ice covered roads.

See your dealer for details regarding winter tire availability and proper tire selection. Also, see *Buying New Tires on page 5-64*

If you choose to use winter tires:

- Use tires of the same brand and tread type on all four wheel positions.
- Use only radial ply tires of the same size, load range, and speed rating as the original equipment tires.

Winter tires with the same speed rating as your original equipment tires may not be available for H, V, W and ZR speed rated tires. If you choose winter tires with a lower speed rating, never exceed the tire's maximum speed capability.

## Tire Sidewall Labelling

Useful information about a tire is molded into its sidewall. The example below shows a typical passenger (p-metric) tire sidewall.

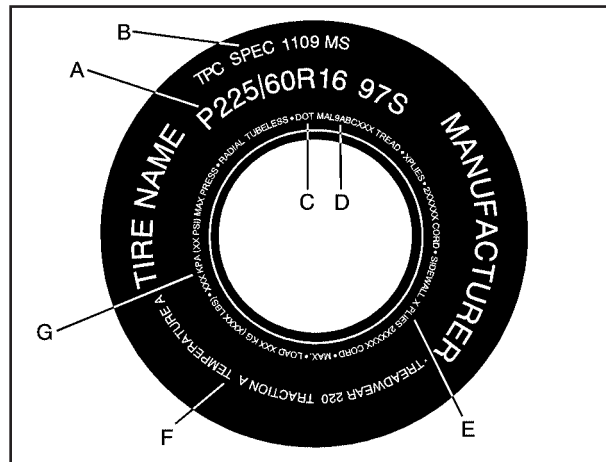

**Passenger (P-Metric) Tire Example**

**(A) Tire Size:** The tire size is a combination of letters and numbers used to define a particular tire's width, height, aspect ratio, construction type and service description. See the "Tire Size" illustration later in this section for more detail.



## **(B) TPC Spec (Tire Performance Criteria**

**Specification):** Original equipment tires designed to GM's specific tire performance criteria have a TPC specification code molded onto the sidewall. GM's TPC specifications meet or exceed all federal safety guidelines.

**(C) DOT (Department of Transportation):** The Department of Transportation (DOT) code indicates that the tire is in compliance with the U.S. Department of Transportation Motor Vehicle Safety Standards.

**(D) Tire Identification Number (TIN):** The letters and numbers following DOT code are the Tire Identification Number (TIN). The TIN shows the manufacturer and plant code, tire size, and date the tire was manufactured. The TIN is molded onto both sides of the tire, although only one side may have the date of manufacture.

**(E) Tire Ply Material:** The type of cord and number of plies in the sidewall and under the tread.

**(F) Uniform Tire Quality Grading (UTQG):** Tire manufacturers are required to grade tires based on three performance factors: treadwear, traction and temperature resistance. For more information see *Uniform Tire Quality Grading on page 5-65*.

**(G) Maximum Cold Inflation Load Limit:** Maximum load that can be carried and the maximum pressure needed to support that load.

## **Tire Size**

The following illustration shows an example of a typical passenger (p-metric) vehicle tire size.

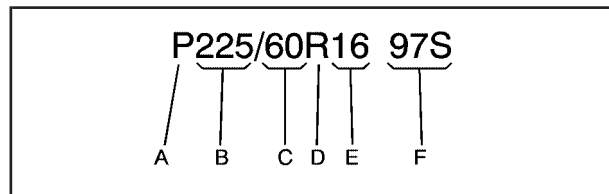

**(A) Passenger (P-Metric) Tire:** The United States version of a metric tire sizing system. The letter P as the first character in the tire size means a passenger vehicle tire engineered to standards set by the U. S. Tire and Rim Association.

**(B) Tire Width:** The three-digit number indicates the tire section width in millimeters from sidewall to sidewall.

**(C) Aspect Ratio:** A two-digit number that indicates the tire height-to-width measurements. For example, if the tire size aspect ratio is 60, as shown in item C of the illustration, it would mean that the tire's sidewall is 60 percent as high as it is wide.

**(D) Construction Code:** A letter code is used to indicate the type of ply construction in the tire. The letter R means radial ply construction; the letter D means diagonal or bias ply construction; and the letter B means belted-bias ply construction.

**(E) Rim Diameter:** Diameter of the wheel in inches.

**(F) Service Description:** These characters represent the load range and speed rating of the tire. The load index represents the load carry capacity a tire is certified to carry. The load index can range from 1 to 279. The speed rating is the maximum speed a tire is certified to carry a load. Speed ratings range from A to Z.

## Tire Terminology and Definitions

**Air Pressure:** The amount of air inside the tire pressing outward on each square inch of the tire. Air pressure is expressed in pounds per square inch (psi) or kiloPascal (kPa).

**Accessory Weight:** This means the combined weight of optional accessories. Some examples of optional accessories are, automatic transmission, power steering, power brakes, power windows, power seats, and air conditioning.

**Aspect Ratio:** The relationship of a tire's height to its width.

**Belt:** A rubber coated layer of cords that is located between the plies and the tread. Cords may be made from steel or other reinforcing materials.

**Bead:** The tire bead contains steel wires wrapped by steel cords that hold the tire onto the rim.

**Bias Ply Tire:** A pneumatic tire in which the plies are laid at alternate angles less than 90 degrees to the centerline of the tread.

**Cold Inflation Pressure:** The amount of air pressure in a tire, measured in pounds per square inch (psi) or kilopascals (kPa) before a tire has built up heat from driving. See *Inflation - Tire Pressure on page 5-58*.

**Curb Weight:** This means the weight of a motor vehicle with standard and optional equipment including the maximum capacity of fuel, oil and coolant, but without passengers and cargo.

**DOT Markings:** A code molded into the sidewall of a tire signifying that the tire is in compliance with the U.S. Department of Transportation (DOT) motor vehicle safety standards. The DOT code includes the Tire Identification Number (TIN), an alphanumeric designator which can also identify the tire manufacturer, production plant, brand and date of production.

**GVWR:** Gross Vehicle Weight Rating, see *Loading Your Vehicle on page 4-32*.

**GAWR FRT:** Gross Axle Weight Rating for the front axle, see *Loading Your Vehicle on page 4-32*.

**GAWR RR:** Gross Axle Weight Rating for the rear axle, see *Loading Your Vehicle on page 4-32*.

**Intended Outboard Sidewall:** The side of an asymmetrical tire, that must always face outward when mounted on a vehicle.

**KiloPascal (kPa):** The metric unit for air pressure.

**Light Truck (LT-Metric) Tire:** A tire used on light duty trucks and some multipurpose passenger vehicles.

**Load Index:** An assigned number ranging from 1 to 279 that corresponds to the load carrying capacity of a tire.

**Maximum Inflation Pressure:** The maximum air pressure to which a cold tire may be inflated. The maximum air pressure is molded onto the sidewall.

**Maximum Load Rating:** The load rating for a tire at the maximum permissible inflation pressure for that tire.

**Maximum Loaded Vehicle Weight:** The sum of curb weight; accessory weight; vehicle capacity weight; and production options weight.

**Normal Occupant Weight:** The number of occupants a vehicle is designed to seat multiplied by 150 lbs (68 kg). See *Loading Your Vehicle on page 4-32*.

**Occupant Distribution:** Designated seating positions.

**Outward Facing Sidewall:** The side of an asymmetrical tire that has a particular side that faces outward when mounted on a vehicle. The side of the tire that contains a whitewall, bears white lettering or bears manufacturer, brand, and/or model name molding that is higher or deeper than the same moldings on the other sidewall of the tire.

**Passenger (P-Metric) Tire:** A tire used on passenger cars and some light duty trucks and multipurpose vehicles.

**Recommended Inflation Pressure:** Vehicle manufacturer's recommended tire inflation pressure and shown on the tire placard. See *Inflation - Tire Pressure on page 5-58* and *Loading Your Vehicle on page 4-32*.

**Radial Ply Tire:** A pneumatic tire in which the ply cords that extend to the beads are laid at 90 degrees to the centerline of the tread.

**Rim:** A metal support for a tire and upon which the tire beads are seated.

**Sidewall:** The portion of a tire between the tread and the bead.

**Speed Rating:** An alphanumeric code assigned to a tire indicating the maximum speed at which a tire can operate.

**Traction:** The friction between the tire and the road surface. The amount of grip provided.

**Tread:** The portion of a tire that comes into contact with the road.

**Treadwear Indicators:** Narrow bands, sometimes called “wear bars,” that show across the tread of a tire when only 1/16 inch (1.6 mm) of tread remains. See *When It Is Time for New Tires on page 5-63*.

**UTQGS (Uniform Tire Quality Grading Standards):** A tire information system that provides consumers with ratings for a tire’s traction, temperature, and treadwear. Ratings are determined by tire manufacturers using government testing procedures. The ratings are molded into the sidewall of the tire. See *Uniform Tire Quality Grading on page 5-65*.

**Vehicle Capacity Weight:** The number of designated seating positions multiplied by 150 lbs (68 kg) plus the rated cargo load. See *Loading Your Vehicle on page 4-32*.

**Vehicle Maximum Load on the Tire:** Load on an individual tire due to curb weight, accessory weight, occupant weight, and cargo weight.

**Vehicle Placard:** A label permanently attached to a vehicle showing the vehicle’s capacity weight and the original equipment tire size and recommended inflation pressure. See “Tire and Loading Information Label” under *Loading Your Vehicle on page 4-32*.

## Extended Mobility Tires

Your vehicle, when new, had Goodyear Extended Mobility Tires (EMT). There’s no spare tire, no tire changing equipment and no place to store a tire in the vehicle. Extended Mobility Tires perform so well without any air that a Tire Pressure Monitor (TPM) is used to alert you if a tire has lost pressure.

If a tire goes flat, you won’t need to stop on the side of the road to change the tire. You can just keep on driving. The shorter the distance you drive and the slower the speed, the greater the chance that the tire will not have to be replaced. If you drive on a deflated EMT for 25 miles (80 km) or less and at speeds of 55 mph (90 km/h) or less, there is a good chance that the tire can be repaired. The tire can operate effectively with no air pressure for up to 100 miles (320 km) at speeds up to 55 mph (90 km/h), but the tire would then have to be replaced. When a tire is filled with air, it provides a cushion between the road and the wheel.

Because you won't have this cushion when driving on a deflated tire, try to avoid potholes that could damage your wheel and require replacement of it.

Some road hazards can damage a tire beyond repair. This damage could occur even before you've driven on the tire in a deflated condition. When a tire has been damaged, or if you've driven any distance on a deflated EMT, check with an authorized Goodyear EMT Service Center to determine whether the tire can be repaired or should be replaced. To maintain your vehicle's extended mobility feature, all replacement tires must be Extended Mobility Tires. As soon as possible, contact the nearest authorized GM or Goodyear EMT servicing facility for inspection and repair or replacement. To locate the nearest GM or Goodyear EMT servicing facility, call Roadside Assistance. For phone numbers and Roadside Assistance details see *Roadside Assistance Program* on page 7-6. You may also contact Goodyear, for the nearest authorized EMT servicing facility, by calling 1-800-789-9878.

 **CAUTION:**

**Extended mobility tires are constructed differently than other tires and could explode during improper service. You or others could be injured or killed if you attempt to repair, replace, dismount, or mount a extended mobility tire. Let only an authorized EMT Service Center repair, replace, dismount and mount extended mobility tires.**

The valve stems on your extended mobility tires have sensors that are part of the Tire Pressure Monitor (TPM). See *Tire Pressure Monitor System* on page 5-61. The TPM sensors contain batteries which are designed to last for 10 years under normal driving conditions. See your dealer if you ever need to have a wheel replaced, or if the sensors ever need replacement.

**Notice:** Using liquid sealants can damage the tire valves and tire pressure monitor sensors in your extended mobility tires. This damage would not be covered by warranty. Don't use liquid sealants in your extended mobility tires.

## Inflation - Tire Pressure

Tires need the correct amount of air pressure to operate effectively.

**Notice:** Do not let anyone tell you that under-inflation or over-inflation is all right. It is not. If your tires do not have enough air (under-inflation), you can get the following:

- Too much flexing
- Too much heat
- Tire overloading
- Premature or irregular wear
- Poor handling
- Reduced fuel economy

If your tires have too much air (over-inflation), you can get the following:

- Unusual wear
- Poor handling
- Rough ride
- Needless damage from road hazards

A Tire and Loading Information label is attached to the vehicle's center pillar, below the driver's door latch. This label lists your vehicle's original equipment tires and shows the correct inflation pressures for your tires when they are cold. The recommended cold tire inflation pressure, shown on the label, is the minimum amount of air pressure needed to support your vehicle's maximum load carrying capacity.

For additional information regarding how much weight your vehicle can carry, and an example of the tire and loading information label, see *Loading Your Vehicle on page 4-32*. How you load your vehicle affects vehicle handling and ride comfort, never load your vehicle with more weight than it was designed to carry.

### When to Check

Check your tires once a month or more.

## How to Check

Use a good quality pocket-type gage to check tire pressure. You cannot tell if your tires are properly inflated simply by looking at them. Radial tires may look properly inflated even when they're under-inflated. Check the tire's inflation pressure when the tires are cold. Cold means your vehicle has been sitting for at least three hours or driven no more than 1 mile (1.6 km).

Remove the valve cap from the tire valve stem. Press the tire gage firmly onto the valve to get a pressure measurement. If the cold tire inflation pressure matches the recommended pressure on the Tire and Loading Information label, no further adjustment is necessary. If the inflation pressure is low, add air until you reach the recommended amount.

If you overfill the tire, release air by pushing on the metal stem in the center of the tire valve. Re-check the tire pressure with the tire gage.

Be sure to put the valve caps back on the valve stems. They help prevent leaks by keeping out dirt and moisture.

## Tire Pressure Monitor System

Your vehicle has a Tire Pressure Monitor (TPM) that sends tire pressure information to the Driver Information Center (DIC). Using the DIC control buttons, the driver is able to check tire pressure levels in all four tires. See *Tire Pressure Monitor System on page 5-61* and *DIC Controls and Displays on page 3-48* for additional information.

## High Speed Operation

### CAUTION:

**Driving at high speeds, 100 mph (160 km/h) or higher, puts an additional strain on tires. Sustained high-speed driving, causes excessive heat build up and can cause sudden tire failure. You could have a crash and you or others could be killed. Some high-speed rated tires require inflation pressure adjustment for high speed operation. When speed limits and road conditions are such, that a vehicle can be driven at high speeds, make sure the tires are rated for high speed operation, in excellent condition and set to the correct cold tire inflation pressure for the vehicle load.**

If you will be driving your vehicle at speeds of 175 mph (282 km/h) or higher, where it is legal, set the cold inflation pressure to the maximum inflation pressure shown on the tire sidewall, or 38 psi (265 kPa), whichever is lower. See the example following. When you end this high-speed driving, return the tires to the cold inflation pressure shown on the Tire and Loading Information label. See *Loading Your Vehicle on page 4-32*.

Example:

You will find the maximum load and inflation pressure molded on the tire's sidewall, in small letters, near the rim flange. It will read something like this: Maximum load 690 kg (1521 lbs) 300 kPa (44 psi) Max. Press.

For this example, you would set the inflation pressure for high-speed driving at 38 psi (265 kPa).

Racing or other competitive driving may affect the warranty coverage of your vehicle. See your warranty booklet for more information.



## Tire Pressure Monitor System

The Tire Pressure Monitor (TPM) System on your vehicle, uses radio and sensor technology to check tire pressure levels. Sensors, mounted on each tire and wheel assembly transmit tire pressure readings to a receiver located in the vehicle. The TPM sensors transmit tire pressure readings once every 60 seconds while the vehicle is being driven and once every 60 minutes when the vehicle is stationary for more than 15 minutes. Using the Driver Information Center (DIC), tire pressure levels can be viewed by the driver. The TPM system also uses the DIC to warn the driver when air pressure, in one or more tires, falls below 24 psi (164 kPa) or is above 42 psi (290 kPa). For additional information and details about the DIC operation and displays see *DIC Controls and Displays on page 3-48* and *DIC Warnings and Messages on page 3-53*.

A low tire pressure warning light also appears on the instrument panel cluster when a low tire condition exists. The low tire pressure warning light will be shown each time the engine is started and stay on until the low tire condition is corrected.

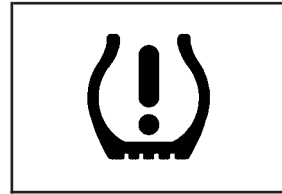

When the tire pressure monitoring system warning light is lit, one or more of your tires is significantly under-inflated.

You should stop and check your tires as soon as possible, and inflate them to the proper pressure as indicated on the vehicle's tire information placard.

Driving on a significantly under-inflated tire causes the tire to overheat and can lead to tire failure. Under-inflation also reduces fuel efficiency and tire tread life, and may affect the vehicle's handling and stopping ability. Each tire, including the spare, should be checked monthly when cold and set to the recommended inflation pressure as specified in the vehicle placard and owner's manual.

The Tire and Loading Information Label (tire information placard) is on the rear edge of the driver's door, below the door latch. This label shows the size of your vehicle's original tires and the correct inflation pressure for your vehicle's tires when they are cold. See *Loading Your Vehicle on page 4-32*.

Your vehicle's TPM system can alert you about a low or high tire pressure condition but it does not replace normal tire maintenance. See *Inflation - Tire Pressure on page 5-58* and *When It Is Time for New Tires on page 5-63*.

Each TPM sensor has a unique identification code that is matched to one of the four tire positions on your vehicle. The tire and wheel assembly positions are, left front (LF); right front (RF); right rear (RR) and left rear (LR). Any time you rotate your vehicle's tires or replace one or more TPM sensors, the identification codes will need to be matched to the new tire and wheel position. The TPM matching process is performed in a specific sequence and time limit. A special tool is also required. See your dealer for service.

The SERVICE TIRE MONITOR message is displayed when the TPM system is malfunctioning. For example, one or more TPM sensors may be inoperable or missing. Also, the active handling system will be affected, see *Active Handling System on page 4-10*. See your dealer for service.

The TPM system operates on a radio frequency subject to Federal Communications Commission (FCC) Rules and with Industry and Science Canada.

This device complies with Part 15 of the FCC Rules and with RSS-210 of Industry and Science Canada.

Operation is subject to the following two conditions:

(1) This device may not cause harmful interference, and  
(2) this device must accept any interference received including interference that may cause undesired operation of the device.

Changes or modifications to this system by other than an authorized service facility could void authorization to use this equipment.

## Tire Rotation

The tires on your vehicle are different sizes front to rear. Due to this, your tires should not be rotated. Each tire and wheel should be used only in the position it is in.

## When It Is Time for New Tires

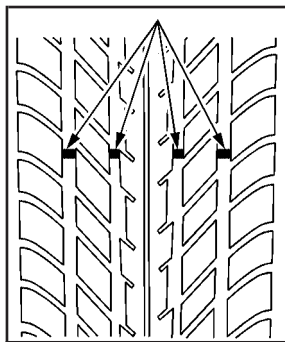

One way to tell when it's time for new tires is to check the treadwear indicators, which will appear when your tires have only 1/16 inch (1.6 mm) or less of tread remaining.

You need a new tire if any of the following statements are true:

- You can see the indicators at three or more places around the tire.
- You can see cord or fabric showing through the tire's rubber.
- The tread or sidewall is cracked, cut or snagged deep enough to show cord or fabric.
- The tire has a bump, bulge or split.
- The tire has a puncture, cut or other damage that can't be repaired well because of the size or location of the damage.

## Buying New Tires

To find out what kind and size of tires you need, look at the Tire and Loading Information label. For information about this label and where to find it, see *Loading Your Vehicle* on page 4-32.

The tires installed on your vehicle when it was new had a Tire Performance Criteria Specification (TPC Spec) number on each tire's sidewall. When you get new tires, GM recommends that you get tires with that same TPC Spec number. That way your vehicle will continue to have tires that are designed to give proper endurance, handling, speed rating, load range, traction, ride, tire pressure monitoring system performance and other things during normal service on your vehicle. If your tires have an all-season tread design, the TPC number will be followed by an "MS" (for mud and snow).

Whenever you replace your tires with those not having a TPC Spec number, make sure they are the same size, load range, speed rating and construction type (bias, bias-belted or radial) as your original tires.

If you replace your vehicle's tires with those not having a TPC Spec number, the tire pressure monitoring system may give an inaccurate low-pressure warning. Non-TPC Spec tires may give a low-pressure warning that is higher or lower than the proper warning level you would get with TPC Spec numbered tires.

### CAUTION:

**Mixing tires could cause you to lose control while driving. If you mix tires of different sizes (other than those originally installed on your vehicle) or types (radial and bias-belted tires), the vehicle may not handle properly, and you could have a crash. Using tires of different sizes (other than those originally installed on your vehicle) may also cause damage to your vehicle. Be sure to use the correct size and type tires on all four wheels.**

### CAUTION:

**If you use bias-ply tires on your vehicle, the wheel rim flanges could develop cracks after many miles of driving. A tire and/or wheel could fail suddenly, causing a crash. Use only radial-ply tires with the wheels on your vehicle.**

## Uniform Tire Quality Grading

Quality grades can be found where applicable on the tire sidewall between tread shoulder and maximum section width. For example:

### **Treadwear 200 Traction AA Temperature A**

The following information relates to the system developed by the United States National Highway Traffic Safety Administration, which grades tires by treadwear, traction and temperature performance. (This applies only to vehicles sold in the United States.)

The grades are molded on the sidewalls of most passenger car tires. The Uniform Tire Quality Grading system does not apply to deep tread, winter-type snow tires, space-saver or temporary use spare tires, tires with nominal rim diameters of 10 to 12 inches (25 to 30 cm), or to some limited-production tires.

While the tires available on General Motors passenger cars and light trucks may vary with respect to these grades, they must also conform to federal safety requirements and additional General Motors Tire Performance Criteria (TPC) standards.

## Treadwear

The treadwear grade is a comparative rating based on the wear rate of the tire when tested under controlled conditions on a specified government test course. For example, a tire graded 150 would wear one and a half (1.5) times as well on the government course as a tire graded 100. The relative performance of tires depends upon the actual conditions of their use, however, and may depart significantly from the norm due to variations in driving habits, service practices and differences in road characteristics and climate.

### **Traction – AA, A, B, C**

The traction grades, from highest to lowest, are AA, A, B, and C. Those grades represent the tire's ability to stop on wet pavement as measured under controlled conditions on specified government test surfaces of asphalt and concrete. A tire marked C may have poor traction performance. Warning: The traction grade assigned to this tire is based on straight-ahead braking traction tests, and does not include acceleration, cornering, hydroplaning, or peak traction characteristics.

## Temperature – A, B, C

The temperature grades are A (the highest), B, and C, representing the tire's resistance to the generation of heat and its ability to dissipate heat when tested under controlled conditions on a specified indoor laboratory test wheel. Sustained high temperature can cause the material of the tire to degenerate and reduce tire life, and excessive temperature can lead to sudden tire failure. The grade C corresponds to a level of performance which all passenger car tires must meet under the Federal Motor Vehicle Safety Standard No. 109. Grades B and A represent higher levels of performance on the laboratory test wheel than the minimum required by law.

Warning: The temperature grade for this tire is established for a tire that is properly inflated and not overloaded. Excessive speed, underinflation, or excessive loading, either separately or in combination, can cause heat buildup and possible tire failure.

## Wheel Alignment and Tire Balance

The wheels on your vehicle were aligned and balanced carefully at the factory to give you the longest tire life and best overall performance.

If you notice unusual tire wear or your vehicle pulling one way or the other, the alignment may need to be reset. If you notice your vehicle vibrating when driving on a smooth road, your wheels may need to be rebalanced.

## Wheel Replacement

Replace any wheel that is bent, cracked, or badly rusted or corroded. If wheel nuts keep coming loose, the wheel, wheel bolts and wheel nuts should be replaced. If the wheel leaks air, replace it (except some aluminum wheels, which can sometimes be repaired). See your dealer if any of these conditions exist.

Your dealer will know the kind of wheel you need.

Each new wheel should have the same load-carrying capacity, diameter, width, offset and be mounted the same way as the one it replaces.

If you need to replace any of your wheels, wheel bolts or wheel nuts, replace them only with new GM original equipment parts. This way, you will be sure to have the right wheel, wheel bolts and wheel nuts for your vehicle.

 **CAUTION:**

Using the wrong replacement wheels, wheel bolts or wheel nuts on your vehicle can be dangerous. It could affect the braking and handling of your vehicle, make your tires lose air and make you lose control. You could have a collision in which you or others could be injured. Always use the correct wheel, wheel bolts and wheel nuts for replacement.

**Notice:** The wrong wheel can also cause problems with bearing life, brake cooling, speedometer or odometer calibration, headlamp aim, bumper height, vehicle ground clearance and tire clearance to the body and chassis.

 **CAUTION:**

Rust or dirt on a wheel, or on the parts to which it is fastened, can make wheel nuts become loose after a time. The wheel could come off and cause a crash. When you change a wheel, remove any rust or dirt from places where the wheel attaches to the vehicle. In an emergency, you can use a cloth or a paper towel to do this; but be sure to use a scraper or wire brush later, if you need to, to get all the rust or dirt off.

 **CAUTION:**

Never use oil or grease on studs or the threads of the wheel nuts. If you do, the wheel nuts might come loose and the wheel could fall off, causing a crash.

 **CAUTION:**

Incorrect wheel nuts or improperly tightened wheel nuts can cause the wheel to become loose and even come off. This could lead to a crash. Be sure to use the correct wheel nuts. If you have to replace them, be sure to get new GM original equipment wheel nuts.

***Notice:*** Improperly tightened wheel nuts can lead to brake pulsation and rotor damage. To avoid expensive brake repairs, evenly tighten the wheel nuts in the proper sequence and to the proper torque specification.



## Used Replacement Wheels

### CAUTION:

Putting a used wheel on your vehicle is dangerous. You can't know how it's been used or how far it's been driven. It could fail suddenly and cause a crash. If you have to replace a wheel, use a new GM original equipment wheel.

## Tire Chains

### CAUTION:

Do not use tire chains. There is not enough clearance. Tire chains used on a vehicle without the proper amount of clearance can cause damage to the brakes, suspension or other vehicle parts. The area damaged by the tire chains could cause you to lose control of your vehicle and you or others may be injured in a crash. Use another type of traction device only if its manufacturer recommends it for use on your vehicle and tire size combination and road conditions. Follow that manufacturer's instructions. To help avoid damage to your vehicle, drive slowly, re-adjust or remove the device if it is contacting your vehicle, and do not spin your wheels. If you do find traction devices that will fit, install them on the rear tires.

## Lifting Your Vehicle

### CAUTION:

Lifting a vehicle can cause an injury. The vehicle can slip off the jack and roll over you or other people. You and they could be badly injured. Find a level place to lift your vehicle.

To help prevent the vehicle from moving:

1. Set the parking brake firmly.
2. Put an automatic transmission shift lever in PARK (P), or shift a manual transmission to FIRST (1) or REVERSE (R).
3. Turn off the engine.

To be even more certain the vehicle won't move, you can put blocks in front of and behind the wheels.

### CAUTION:

Getting under a vehicle when it is jacked up is dangerous. If the vehicle slips off the jack, you could be badly injured or killed. Never get under a vehicle when it is supported only by a jack.

### CAUTION:

Raising your vehicle with the jack improperly positioned can damage the vehicle and even make the vehicle fall. To help avoid personal injury and vehicle damage, be sure to place the jack in the proper location before raising the vehicle.

If you ever use a jack to lift your vehicle, follow the instructions that came with the jack, and be sure to use the correct lifting points to avoid damaging your vehicle.

**Notice:** Lifting your vehicle improperly can damage your vehicle and result in costly repairs not covered by your warranty. To lift your vehicle properly, follow the advice in this part.

To help prevent vehicle damage:

- Be sure to place a block or pad between the jack and the vehicle.
- Make sure the jack you're using spans at least two crossmember ribs.
- Lift only in the areas shown in the following pictures.

For additional information, see your dealer and the Chevrolet Corvette service manual.

## Lifting From the Front

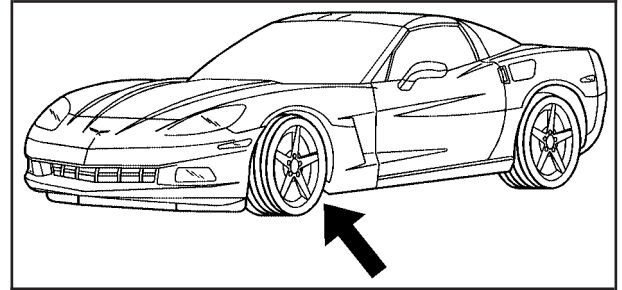

The front lifting points can be accessed from either side of your vehicle, behind the front tires.

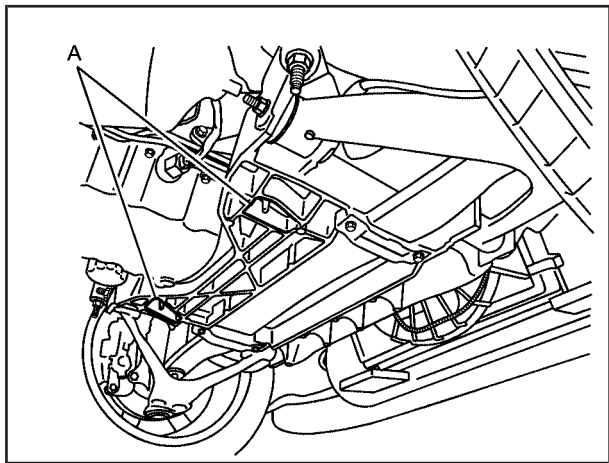

1. Locate the front lifting points (A), according to the illustration shown.
2. Be sure to place a block or pad between the jack and the vehicle.

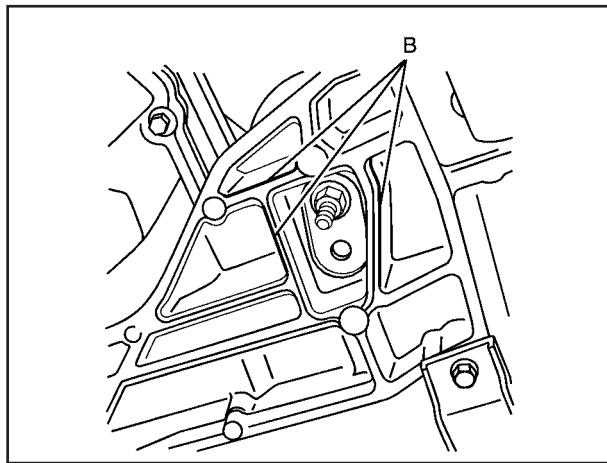

3. Lift the vehicle with the jack, making sure the jack spans at least two of the crossmember ribs (B).

## Lifting From the Rear

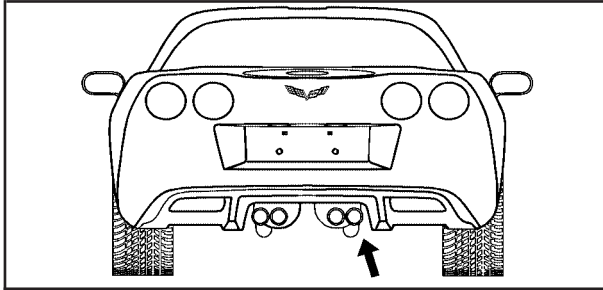

The rear lifting points can be accessed from the rear of the vehicle, on either the driver's or passenger's side.

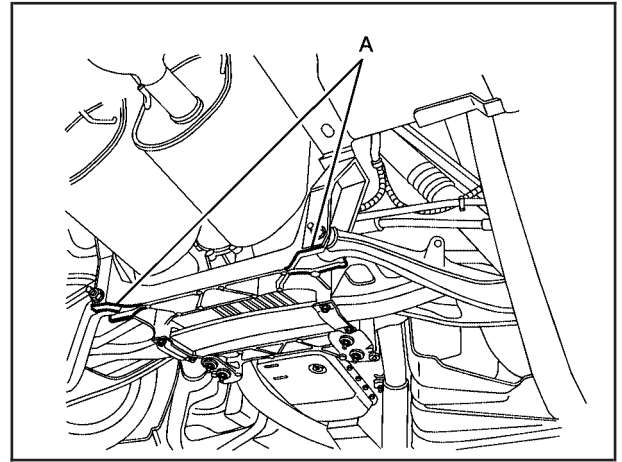

1. Locate the rear lifting points (A), according to the illustration shown.
2. Be sure to place a block or pad between the jack and the vehicle.

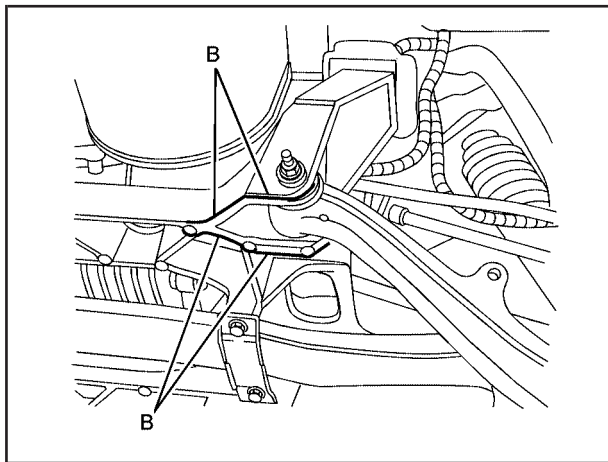

3. Lift the vehicle with the jack, making sure the jack spans at least two of the crossmember ribs (B).

For more information, see *Doing Your Own Service Work* on page 5-4.

## If a Tire Goes Flat

Your Corvette has no spare tire, no tire changing equipment and no place to store a tire.

It's unusual for a tire to "blow out" while you're driving, especially if you maintain your tires properly. See *Tires* on page 5-51. If air goes out of a tire, it's much more likely to leak out slowly.

Your vehicle has Extended Mobility Tires (EMT), so you will not need to stop on the side of the road to change a flat tire. EMT tires can operate effectively with no air pressure. If you drive on a deflated EMT for 25 miles (80 km) or less and at speeds of 55 mph (90 km/h) or less, there is a good chance that the tire can be repaired. Contact the nearest authorized Chevrolet or Goodyear EMT servicing facility, as soon as possible, to have the flat tire inspected and repaired or replaced. For more information, see *Extended Mobility Tires* on page 5-56.

### CAUTION:

**Special tools and procedures are required to service an Extended Mobility Tire (EMT). If these special tools and procedures are not used you or others could be injured and your vehicle could be damaged. Always be sure the proper tools and procedures, as described in the service manual, are used.**

To order a service manual, see *Service Publications Ordering Information* on page 7-11.

## Appearance Care

Cleaning products can be hazardous. Some are toxic. Other cleaning products can burst into flames if a match is struck near them or if they get on a hot part of the vehicle. Some are dangerous if their fumes are inhaled in an enclosed space. When anything from a container is used to clean the vehicle, be sure to follow the manufacturer's warnings and instructions. Always open the doors or windows of the vehicle when cleaning the inside.

Never use these to clean the vehicle:

- Gasoline
- Benzene
- Naphtha
- Carbon Tetrachloride
- Acetone
- Paint Thinner
- Turpentine
- Lacquer Thinner
- Nail Polish Remover

They can all be hazardous — some more than others — and they can all damage the vehicle, too.

Do not use any of these products unless this manual says you can. In many uses, these will damage the vehicle:

- Alcohol
- Laundry Soap
- Bleach
- Reducing Agents

## Fabric/Carpet

Use a vacuum cleaner often to get rid of dust and loose dirt. Wipe vinyl, leather, plastic, and painted surfaces with a clean, damp cloth.

GM-approved cleaning products can be obtained from your dealer.

Here are some cleaning tips:

- Always read the instructions on the cleaner label.
- Clean up stains as soon as you can before they set.
- Carefully scrape off any excess stain.
- Use a clean cloth or sponge, and change to a clean area often. A soft brush may be used if stains are stubborn.
- To avoid forming a ring on fabric after spot cleaning, clean the entire area immediately or it will set.

Most stains can be removed with club soda water. To clean, use the following instructions:

1. For liquids: blot with a clean, soft, white cloth. For solids: remove as much as possible and then vacuum or brush.
2. Apply club soda water to a clean, soft, white cloth. Do not over-saturate; the cloth should not drip water.
3. Clean the entire area. Avoid getting the fabric too wet.
4. Start cleaning from the seams into the stain to avoid a ring effect.
5. Continue cleaning, using a clean area of the cloth each time it becomes soiled.
6. When the stain is removed, blot the cleaned area with another dry, clean, soft, white cloth.

## **Using Cleaner on Fabric**

1. First, try the cleaner on an area of the fabric that is not easily seen to make sure the cleaner does not affect the color of the fabric.
2. For liquids: blot with a clean, soft, white cloth. For solids: remove as much as possible and then vacuum or brush.
3. Spray a small amount of the cleaner onto a clean soft, white, cloth. Do not apply spray directly to the fabric.
4. Start cleaning from the seams into the stain to avoid a ring effect.
5. Continue cleaning, using a clean area of the cloth each time it becomes soiled.
6. When the stain is removed, blot the cleaned area with another dry, clean, soft, white cloth.
7. If the cleaner leaves a ring effect, follow up with the club soda water instructions given earlier in this section.



## Special Fabric Cleaning Problems

Stains caused by such things as catsup, black coffee, egg, fruit, fruit juice, milk, soft drinks, vomit, urine, and blood can be removed using the club soda water instructions given earlier in this section. If an odor lingers after cleaning vomit or urine, treat the area with a water and baking soda solution: 1 teaspoon (5 ml) of baking soda to 1 cup (250 ml) of lukewarm water. Let dry.

Stains caused by oil and grease can be cleaned with an approved GM cleaner and a clean, white cloth.

1. Carefully scrape off excess stain.
2. Clean with cool water and allow to dry completely.
3. If a stain remains, follow the “Using Cleaner on Fabric” instructions described earlier.

## Coated Moldings

These moldings are around the hatch opening in the rear area.

- When lightly soiled, wipe with a sponge or soft lint-free cloth dampened with water.
- When heavily soiled, use warm soapy water.

## Leather

Use a soft cloth with lukewarm water and a mild soap or saddle soap and wipe dry with a soft cloth. Then, let the leather dry naturally. Do not use heat to dry.

- For stubborn stains, use a leather cleaner.
- Never use oils, varnishes, solvent-based or abrasive cleaners, furniture polish, or shoe polish on leather.
- Soiled or stained leather should be cleaned immediately. If dirt is allowed to work into the finish, it can harm the leather.

## Instrument Panel

Use only mild soap and water to clean the top surfaces of the instrument panel. Sprays containing silicones or waxes may cause annoying reflections in the windshield and even make it difficult to see through the windshield under certain conditions.

## Interior Plastic Components

Use only a mild soap and water solution on a soft cloth or sponge. Commercial cleaners may affect the surface finish.

## Cargo Cover and Convenience Net

Wash with warm water and mild detergent, rinse with cold water and tumble dry on low. Do not use chlorine bleach.

## Glass Surfaces

Glass should be cleaned often. GM Glass Cleaner or a liquid household glass cleaner will remove normal tobacco smoke and dust films on interior glass. See *Vehicle Care/Appearance Materials* on page 5-84.

**Notice:** If you use abrasive cleaners when cleaning glass surfaces on your vehicle, you could scratch the glass and/or cause damage to the rear window defogger and the integrated radio antenna. When cleaning the glass on your vehicle, use only a soft cloth and glass cleaner.

## Care of Safety Belts

Keep belts clean and dry.

### CAUTION:

**Do not bleach or dye safety belts. If you do, it may severely weaken them. In a crash, they might not be able to provide adequate protection. Clean safety belts only with mild soap and lukewarm water.**

## Weatherstrips

Silicone grease on weatherstrips will make them last longer, seal better, and not stick or squeak. Apply silicone grease with a clean cloth. During very cold, damp weather frequent application may be required. See *Recommended Fluids and Lubricants* on page 6-11.

## Washing Your Vehicle

The paint finish on the vehicle provides beauty, depth of color, gloss retention, and durability.

The best way to preserve the vehicle's finish is to keep it clean by washing it often with lukewarm or cold water.

Do not wash the vehicle in the direct rays of the sun. Use a car washing soap. Do not use strong soaps or chemical detergents. Be sure to rinse the vehicle well, removing all soap residue completely. GM-approved cleaning products can be obtained from your dealer. See *Vehicle Care/Appearance Materials* on page 5-84. Do not use cleaning agents that are petroleum based, or that contain acid or abrasives. All cleaning agents should be flushed promptly and not allowed to dry on the surface, or they could stain. Dry the finish with a soft, clean chamois or an all-cotton towel to avoid surface scratches and water spotting.

**Notice:** If you drive your vehicle through an automatic car wash that does not have enough clearance for the wide rear tires and wheels, you could damage your vehicle. Verify with the manager of the car wash that your vehicle will fit before entering the car wash or use a touchless car wash.

High pressure car washes may cause water to enter the vehicle.

If you are cleaning your vehicle with the hood open, take care not to spray water directly into either end of the air cleaner/filter housing as this could damage your vehicle's engine. See *Engine Air Cleaner/Filter* on page 5-19 for more information.

## Cleaning Exterior Lamps/Lenses

Use only lukewarm or cold water, a soft cloth and a car washing soap to clean exterior lamps and lenses. Follow instructions under *Washing Your Vehicle* on page 5-79.

## Finish Care

Occasional waxing or mild polishing of the vehicle by hand may be necessary to remove residue from the paint finish. GM-approved cleaning products can be obtained from your dealer. See *Vehicle Care/Appearance Materials on page 5-84*.

The vehicle has a “basecoat/clearcoat” paint finish. The clearcoat gives more depth and gloss to the colored basecoat. Always use waxes and polishes that are non-abrasive and made for a basecoat/clearcoat paint finish.

**Notice: Machine compounding or aggressive polishing on a basecoat/clearcoat paint finish may damage it. Use only non-abrasive waxes and polishes that are made for a basecoat/clearcoat paint finish on your vehicle.**

Foreign materials such as calcium chloride and other salts, ice melting agents, road oil and tar, tree sap, bird droppings, chemicals from industrial chimneys, etc., can damage the vehicle’s finish if they remain on painted surfaces. Wash the vehicle as soon as possible. If necessary, use non-abrasive cleaners that are marked safe for painted surfaces to remove foreign matter.

Exterior painted surfaces are subject to aging, weather, and chemical fallout that can take their toll over a period of years. To help keep the paint finish looking new, keep the vehicle in a garage or covered whenever possible.

## Windshield and Wiper Blades

If the windshield is not clear after using the windshield washer, or if the wiper blade chatters when running, wax, sap, or other material may be on the blade or windshield.

Clean the outside of the windshield with a glass cleaning liquid or powder and water solution. The windshield is clean if beads do not form when it is rinsed with water.

Grime from the windshield will stick to the wiper blades and affect their performance. Clean the blade by wiping vigorously with a cloth soaked in full-strength windshield washer solvent. Then rinse the blade with water.

Check the wiper blades and clean them as necessary; replace blades that look worn.

## Removable Roof Panel

**Notice:** If you use a glass treatment and/or conditioner that contains ethyl alcohol or ethyl sulfate on the roof panel, you could damage the panel. The repairs would not be covered by your warranty. Only use a GM-approved glass cleaner on the roof panel.

Special care is necessary when cleaning, removing, and/or storing the roof panel.

- Flush with water to remove dust and dirt, then dry the panel.
- Clean a transparent roof panel with GM Glass Cleaner. Leave the cleaner on the panel for one minute, then wipe the panel with a soft, lint-free cloth. Do not use glass cleaner on a painted roof panel.
- Do not use abrasive cleaning materials on either type of panel.

If water drops are frequently allowed to dry on the roof panel, impurities in the water will adhere to the top. These impurities may etch or mar the finish. When the panel gets wet, dry it off.

## Convertible Top

The vehicle's convertible top should be cleaned often. However, high pressure car washes may cause water to enter your vehicle.

When you hand wash the top, do it in partial shade. Use a mild soap, lukewarm water and a soft sponge. A chamois or cloth may leave lint on the top, and a brush can chafe the threads in the top fabric. Do not use detergents, harsh cleaners, solvents or bleaching agents.

Wet the entire vehicle and wash the top evenly to avoid spots or rings. Let the soap remain on the fabric for a few minutes. When the top is really dirty, use a mild foam-type cleaner. Thoroughly rinse the entire vehicle, then let the top dry in direct sunlight.

To protect the convertible top:

- After you wash the vehicle, make sure the top is completely dry before you lower it.
- Do not get any cleaner on the vehicle's painted finish; it could leave streaks.
- If you decide to go through an automatic car wash, ask the manager if the equipment could damage your top.

## Aluminum Wheels

**Notice:** If you use strong soaps, chemicals, abrasive polishes, cleaners, brushes, or cleaners that contain acid on aluminum or chrome-plated wheels, you could damage the surface of the wheel(s). The repairs would not be covered by your warranty. Use only GM-approved cleaners on aluminum or chrome-plated wheels.

Keep the wheels clean using a soft clean cloth with mild soap and water. Rinse with clean water. After rinsing thoroughly, dry with a soft clean towel. A wax may then be applied.

**Notice:** Using chrome polish on aluminum wheels could damage the wheels. The repairs would not be covered by your warranty. Use chrome polish on chrome wheels only.

The surface of these wheels is similar to the painted surface of the vehicle. Do not use strong soaps, chemicals, abrasive polishes, abrasive cleaners, cleaners with acid, or abrasive cleaning brushes on them because the surface could be damaged. Do not use chrome polish on aluminum wheels.

**Notice:** If you drive your vehicle through an automatic car wash that has silicone carbide tire cleaning brushes, you could damage the aluminum or chrome-plated wheels. The repairs would not be covered by your warranty. Never drive a vehicle equipped with aluminum or chrome-plated wheels through an automatic car wash that uses silicone carbide tire cleaning brushes.

Do not take the vehicle through an automatic car wash that has silicone carbide tire cleaning brushes. These brushes can also damage the surface of these wheels.

## Tires

To clean the tires, use a stiff brush with tire cleaner.

**Notice:** Using petroleum-based tire dressing products on your vehicle may damage the paint finish and/or tires. When applying a tire dressing, always wipe off any overspray from all painted surfaces on your vehicle.

## Finish Damage

Any stone chips, fractures or deep scratches in the finish should be repaired right away.

Minor chips and scratches can be repaired with touch-up materials available from your dealer or other service outlets. Larger areas of finish damage can be corrected in your dealer's body and paint shop.

## Underbody Maintenance

Chemicals used for ice and snow removal and dust control can collect on the underbody. If these are not removed, corrosion and rust can develop on the underbody parts such as fuel lines, frame, floor pan, and exhaust system even though they have corrosion protection.

At least every spring, flush these materials from the underbody with plain water. Clean any areas where mud and debris can collect. Dirt packed in close areas of the frame should be loosened before being flushed. Your GM dealer or an underbody car washing system can do this for you.

## Fiberglass Springs

**Notice:** If you use acidic or corrosive cleaning products, engine degreasers or aluminum cleaning agents on fiberglass springs, you may damage the springs. The repairs would not be covered by your warranty. Use only approved cleaners when cleaning your vehicle's fiberglass springs.

## Chemical Paint Spotting

Some weather and atmospheric conditions can create a chemical fallout. Airborne pollutants can fall upon and attack painted surfaces on the vehicle. This damage can take two forms: blotchy, ring-shaped discolorations, and small, irregular dark spots etched into the paint surface.

Although no defect in the paint job causes this, GM will repair, at no charge to the owner, the surfaces of new vehicles damaged by this fallout condition within 12 months or 12,000 miles (20 000 km) of purchase, whichever occurs first.

## Vehicle Care/Appearance Materials

See your GM dealer for more information on purchasing the following products.

Description	Usage
Polishing Cloth Wax-Treated	Interior and exterior polishing cloth.
Tar and Road Oil Remover	Removes tar, road oil, and asphalt.
Chrome Cleaner and Polish	Use on chrome or stainless steel.
White Sidewall Tire Cleaner	Removes soil and black marks from whitewalls.
Vinyl Cleaner	Cleans vinyl tops, upholstery, and convertible tops.
Glass Cleaner	Removes dirt, grime, smoke and fingerprints.
Chrome and Wire Wheel Cleaner	Removes dirt and grime from chrome wheels and wire wheel covers.
Finish Enhancer	Removes dust, fingerprints, and surface contaminants. Spray on and wipe off.
Swirl Remover Polish	Removes swirl marks, fine scratches, and other light surface contamination.

Description	Usage
Cleaner Wax	Removes light scratches and protects finish.
Foaming Tire Shine Low Gloss	Cleans, shines, and protects in one step. No wiping necessary.
Wash Wax Concentrate	Medium foaming shampoo. Cleans and lightly waxes. Biodegradable and phosphate free.
Spot Lifter	Quickly removes spots and stains from carpets, vinyl, and cloth upholstery.
Odor Eliminator	Odorless spray odor eliminator used on fabrics, vinyl, leather and carpet.
See your General Motors parts department for these products. See <i>Recommended Fluids and Lubricants</i> on page 6-11.	



# Vehicle Identification

## Vehicle Identification Number (VIN)



This is the legal identifier for your vehicle. It appears on a plate in the front corner of the instrument panel, on the driver's side. You can see it if you look through the windshield from outside your vehicle. The VIN also appears on the Vehicle Certification and Service Parts labels and the certificates of title and registration.

## Engine Identification

The eighth character in your VIN is the engine code. This code will help you identify your engine, specifications and replacement parts.

## Service Parts Identification Label

You will find this label on the inside of the glove box. It is very helpful if you ever need to order parts. On this label, you will find the following:

- VIN
- Model designation
- Paint information
- Production options and special equipment

Be sure that this label is not removed from the vehicle.

# Electrical System

## Add-On Electrical Equipment

**Notice:** Don't add anything electrical to your vehicle unless you check with your dealer first. Some electrical equipment can damage your vehicle and the damage wouldn't be covered by your warranty. Some add-on electrical equipment can keep other components from working as they should.

Your vehicle has an air bag system. Before attempting to add anything electrical to your vehicle, see *Servicing Your Airbag-Equipped Vehicle on page 1-51*.

## Headlamp Wiring

The headlamp wiring is protected by fuses. An electrical overload will cause the lamps to remain off. If this happens, have your headlamp wiring checked right away.

## Windshield Wiper Fuses

The windshield wiper motor is protected by a fuse and an internal circuit breaker. If the motor overheats due to heavy snow, etc., the wiper will stop until the motor cools. If the overload is caused by some electrical problem and not snow, etc., be sure to get it fixed.

## Power Windows and Other Power Options

Circuit breakers protect the power seats, power windows, and other power accessories. When the current load is too heavy, the circuit breaker opens and closes, protecting the circuit until the problem is fixed or goes away.

## Fuses and Circuit Breakers

The wiring circuits in your vehicle are protected from short circuits by a combination of J-Case fuses, mini-fuses and circuit breakers. This greatly reduces the chance of fires caused by electrical problems.

Look at the silver-colored band inside the fuse. If the band is broken or melted, replace the fuse. Be sure you replace a bad fuse with a new one of the identical size and rating.

If you ever have a problem on the road and do not have a spare fuse, you can borrow one that has the same amperage. Just pick some feature of your vehicle that you can get along without – like the radio or cigarette lighter – and use its fuse, if it is the correct amperage. Replace it as soon as you can.

## Instrument Panel Fuse Block

The instrument panel fuse block is located on the passenger's side of the vehicle, under the instrument panel and under the toe-board.

Remove the carpet and toe-board covering to access the fuse block by pulling at the top of each corner of the panel. Then turn the fuse block door knob counterclockwise and pull the door to access the fuses.

You can remove fuses using the fuse puller.

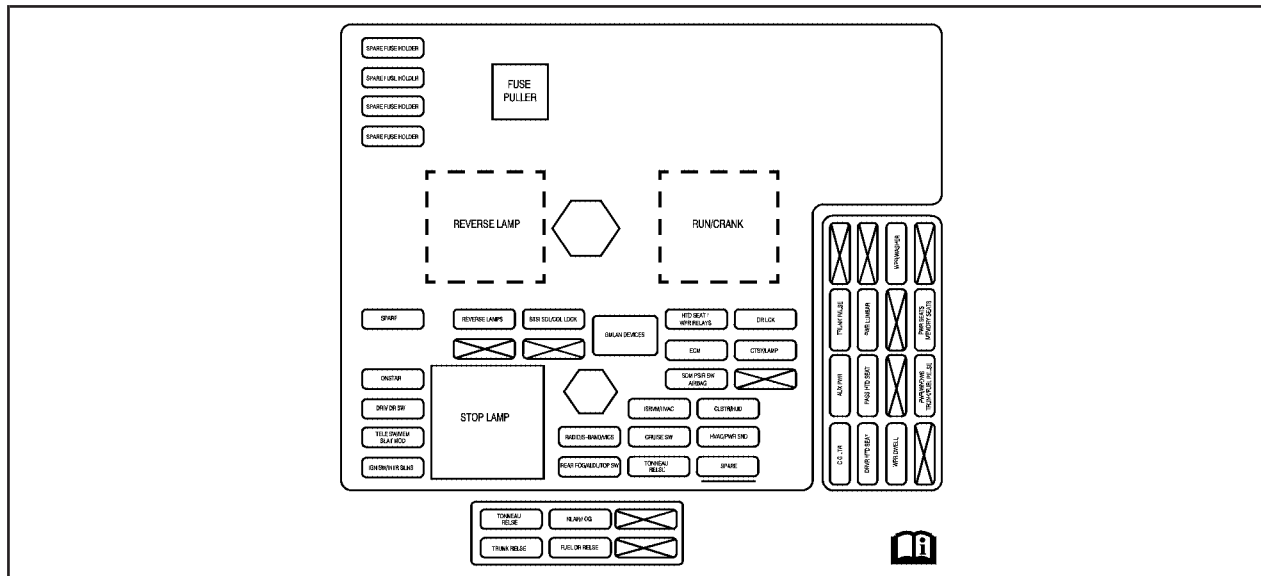

<b>Fuses</b>	<b>Usage</b>
SPARE FUSE HOLDER	Spare Fuse Holder
SPARE FUSE HOLDER	Spare Fuse Holder
SPARE FUSE HOLDER	Spare Fuse Holder
SPARE FUSE HOLDER	Spare Fuse Holder
SPARE	Spare
ONSTAR	OnStar®
DRIV DR SW	Driver Door Switch
TELE SW/MEM SEAT MOD	Telescope Switch, Memory Seat Module
IGN SW/INTR SENS	Ignition Switch, Intrusion Sensor
REVERSE LAMP	Reverse Lamp
REVERSE LAMPS	Reverse Lamps
Blank	Not Used
STOP LAMP	Stop Lamp
BTSI SOL/COL LOCK	Brake Transmission Shift Interlock, Column Lock
BLANK	Not Used

<b>Fuses</b>	<b>Usage</b>
RADIO/S-BAND/VICS	Radio, S-Band, VICS
REAR FOG/ALDL/TOP SW	Rear Fog Lamp, Assembly Line Diagnostic Link Connector, Convertible Top Switch
GMLAN DEVICES	GMLAN Devices
ISRVM/ HVAC	Electric Inside Rearview Mirror, Heating Ventilation, Air Conditioning
CRUISE SW	Cruise Control Switch
TONNEAU RELSE	Tonneau Release
RUN/CRANK	Run/Crank Relay
HTD SEAT/WPR RELAYS	Heated Seat, Wiper Relays
ECM	Engine Control Module
SDM PSIR SW AIRBAG	SDM/PSIR Switch (Airbag)
CLSTR/HUD	Cluster, Heads-Up Display
HVAC/PWR SND	Heating, Ventilation/Air Conditioning, Power Sounder
SPARE	Spare
DR LCK	Door Locks
CTSY/LAMP	Courtesy Lamp
BLANK	Not Used

<b>Fuses</b>	<b>Usage</b>
TONNEAU RELSE	Tonneau Release
TRUNK RELSE	Trunk Release
REAR/ FOG	Rear Fog Lamps
FUEL DR RELSE	Fuel Door Release
BLANK	Not Used
BLANK	Not Used

<b>Fuses</b>	<b>Usage</b>
CIG LTR	Cigarette Lighter
DRVR HTD SEAT	Driver's Heated Seat
WPR DWELL	Wiper Dwell
BLANK	Not Used
AUX PWR	Auxiliary Power
PASS HTD SEAT	Passenger's Heated Seat
BLANK	Not Used

<b>Fuses</b>	<b>Usage</b>
PWR WNDWS/FUEL RELSE	Power Windows, Fuel Door Release
TRUNK RELSE	Trunk Release
PWR LUMBAR	Power Lumbar
BLANK	Not Used
PWR SEATS MEMORY SEATS	Power Seats, Memory Seats
BLANK	Not Used
BLANK	Not Used
WPR/WASHER	Windshield Wiper/Washer
BLANK	Not Used

## Engine Compartment Fuse Block

There is one fuse block in the engine compartment located on the passenger's side of the vehicle. See *Engine Compartment Overview* on page 5-12 for more information on location.

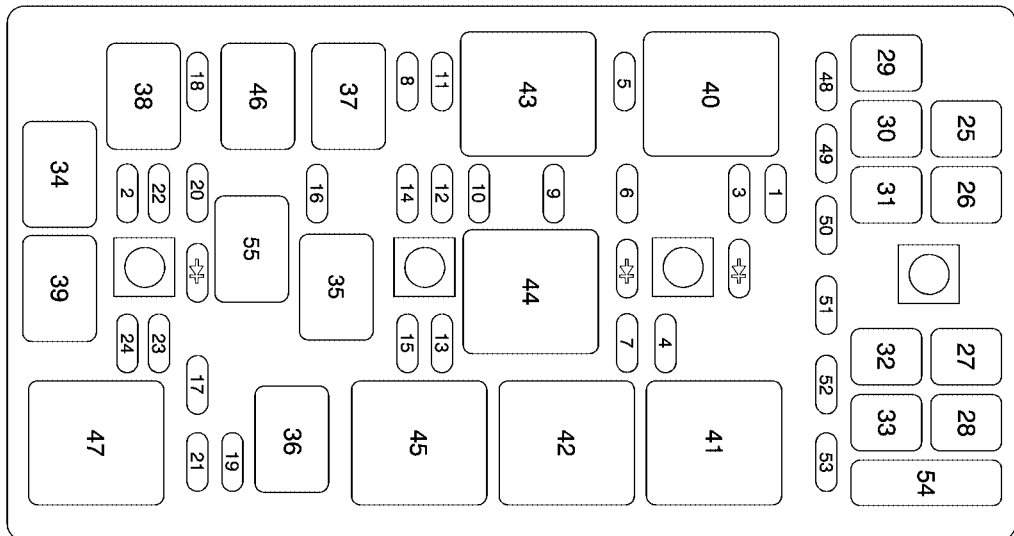

Fuse	Usage
1	Transmission Control Module/Transmission
2	Horn, Alternator Sense
3	Anti-lock Brakes/Real Time Damping
4	Wiper
5	Stoplamps/Back-Up Lamps
6	O2 Sensor
7	Battery Main 5
8	Park Lamps
9	Powertrain Relay Input/Electronic Throttle Control
10	Manual Transmission Solenoids
11	Engine Control Module/Transmission Control Module/Easy Key Module
12	Odd Numbered Fuel Injectors
13	Real Time Damping
14	Canister Purge Solenoid, Mass Air Flow Sensor
15	Air Conditioner Compressor
16	Even Numbered Fuel Injectors
17	Windshield Washer

Fuse	Usage
18	Headlamp Washer
19	Right Low-Beam
20	Fuel Pump
21	Left Low-Beam
22	Front Fog Lamp
23	Right High-Beam
24	Left High-Beam



J-Style Fuses	Usage
25	Cooling Fan
26	Battery Main 3
27	Anti-Lock Brake System
28	Heating/Ventilation/Air Conditioning Blower
29	Battery Main 2
30	Starter
31	Audio Amplifier
32	Blank
33	Battery Main 1



Micro-Relays	Usage
34	Horn
35	Air Conditioning Compressor
36	Windshield Washer
37	Park, Position Lamps
38	Front Fog Lamp
39	High Beam
46	Headlamp Washer
55	Fuel Pump

Mini-Relays	Usage
40	Rear Defog
41	Windshield Wiper High/Low
42	Windshield Wiper Run/Accessory
43	Crank
44	Powertrain Ignition 1
45	Windshield Wiper On/Off
47	Low Beam

Spare Fuses	Usage
48	Spare
49	Spare
50	Spare
51	Spare
52	Spare
53	Spare
54	Fuse Puller

Diodes	Usage
	Diode 1
	Wiper
	Diode 2

## Capacities and Specifications

The following approximate capacities are given in English and metric conversions.

See *Recommended Fluids and Lubricants* on page 6-11 for more information.

Application	Capacities	
	English	Metric
Air Conditioning Refrigerant R134a	1.4 lbs	0.64 kg
Automatic Transmission	11.4 quarts	10.8 L
Cooling System	12.6 quarts	11.9 L
Engine Oil with Filter	5.5 quarts	5.2 L
Fuel Tank	18.0 gallons	68.0 L
Manual Transmission (Overhaul)	4.1 quarts	3.8 L
Rear Axle	1.8 quarts	1.7 L
Wheel Nut Torque	100 ft lb	140 N•m

All capacities are approximate. When adding, be sure to fill to the appropriate level, as recommended in this manual. Recheck fluid level after filling

### Engine Specifications

Engine	VIN Code	Transmission	Spark Plug Gap	Firing Order
6.0L V8 (LS2)	U	Automatic Manual	0.040 inch (1.016 mm)	1-8-7-2-6-5-4-3

### Engine Data

Engine	Horsepower	Torque	Displacement	Compression Ratio
6.0L V8 (LS2)	400 @ 6000 rpm	400 ft lb @ 4400 rpm	6.0 L	10.9:1

## Section 6 Maintenance Schedule

---

<b>Maintenance Schedule</b> .....	6-2	Owner Checks and Services .....	6-8
Introduction .....	6-2	At Each Fuel Fill .....	6-8
Maintenance Requirements .....	6-2	At Least Once a Month .....	6-9
Your Vehicle and the Environment .....	6-2	At Least Once a Year .....	6-9
Using Your Maintenance Schedule .....	6-3	Recommended Fluids and Lubricants .....	6-11
Scheduled Maintenance .....	6-4	Normal Maintenance Replacement Parts .....	6-13
Additional Required Services .....	6-6	Engine Drive Belt Routing .....	6-14
Maintenance Footnotes .....	6-7	Maintenance Record .....	6-15

## Maintenance Schedule

### Introduction

**Important:** Keep engine oil at the proper level and change as recommended.



*Have you purchased the GM Protection Plan? The Plan supplements your new vehicle warranties. See your Warranty and Owner Assistance booklet or your dealer for details.*

## Maintenance Requirements

**Notice:** Maintenance intervals, checks, inspections, replacement parts and recommended fluids and lubricants as prescribed in this manual are necessary to keep your vehicle in good working condition. Any damage caused by failure to follow scheduled maintenance may not be covered by warranty.

### Your Vehicle and the Environment

Proper vehicle maintenance not only helps to keep your vehicle in good working condition, but also helps the environment. All recommended maintenance is important. Improper vehicle maintenance can even affect the quality of the air we breathe. Improper fluid levels or the wrong tire inflation can increase the level of emissions from your vehicle. To help protect our environment, and to keep your vehicle in good condition, be sure to maintain your vehicle properly.

## Using Your Maintenance Schedule

We at General Motors want to help you keep your vehicle in good working condition. But we do not know exactly how you will drive it. You may drive very short distances only a few times a week. Or you may drive long distances all the time in very hot, dusty weather. You may use your vehicle in making deliveries. Or you may drive it to work, to do errands or in many other ways.

Because of all the different ways people use their vehicles, maintenance needs vary. You may need more frequent checks and replacements. So please read the following and note how you drive. If you have any questions on how to keep your vehicle in good condition, see your GM Goodwrench<sup>®</sup> dealer.

This schedule is for vehicles that:

- carry passengers and cargo within recommended limits. You will find these limits on the tire and loading information label. See *Loading Your Vehicle* on page 4-32.
- are driven on reasonable road surfaces within legal driving limits.
- use the recommended fuel. See *Gasoline Octane* on page 5-5.

The services in *Scheduled Maintenance* on page 6-4 should be performed when indicated. See *Additional Required Services* on page 6-6 and *Maintenance Footnotes* on page 6-7 for further information.

### CAUTION:

**Performing maintenance work on a vehicle can be dangerous. In trying to do some jobs, you can be seriously injured. Do your own maintenance work only if you have the required know-how and the proper tools and equipment for the job. If you have any doubt, see your GM Goodwrench<sup>®</sup> dealer to have a qualified technician do the work.**

Some maintenance services can be complex. So, unless you are technically qualified and have the necessary equipment, you should have your GM Goodwrench<sup>®</sup> dealer do these jobs.

When you go to your GM Goodwrench<sup>®</sup> dealer for your service needs, you will know that GM-trained and supported service technicians will perform the work using genuine GM parts.

If you want to purchase service information, see *Service Publications Ordering Information* on page 7-11.

*Owner Checks and Services on page 6-8* tells you what should be checked, when to check it and what you can easily do to help keep your vehicle in good condition.

The proper replacement parts, fluids and lubricants to use are listed in *Recommended Fluids and Lubricants on page 6-11* and *Normal Maintenance Replacement Parts on page 6-13*. When your vehicle is serviced, make sure these are used. All parts should be replaced and all necessary repairs done before you or anyone else drives the vehicle. We recommend the use of genuine GM parts.

## Scheduled Maintenance

When the CHANGE OIL SOON message comes on, it means that service is required for your vehicle. Have your vehicle serviced as soon as possible within the next 600 miles (1 000 km). It is possible that, if you are driving under the best conditions, the engine oil life system may not indicate that vehicle service is necessary for over a year. However, your engine oil and filter must be changed at least once a year and at this time the system must be reset. Your GM Goodwrench<sup>®</sup> dealer has GM-trained service technicians who will perform this work using genuine GM parts and reset the system.

If the engine oil life system is ever reset accidentally, you must service your vehicle within 3,000 miles (5 000 km) since your last service. Remember to reset the oil life system whenever the oil is changed. See *Engine Oil Life System on page 5-18* for information on the Engine Oil Life System and resetting the system.

When the CHANGE OIL SOON message appears, certain services, checks and inspections are required. Required services are described in the following for "Maintenance I" and "Maintenance II." Generally, it is recommended that your first service be Maintenance I, your second service be Maintenance II and that you alternate Maintenance I and Maintenance II thereafter. However, in some cases, Maintenance II may be required more often.

**Maintenance I** — Use Maintenance I if the message comes on within 10 months since the vehicle was purchased or Maintenance II was performed.

**Maintenance II** — Use Maintenance II if the previous service performed was Maintenance I. Always use Maintenance II whenever the message comes on 10 months or more since the last service or if the message has not come on at all for one year.

## Scheduled Maintenance

Service	Maintenance I	Maintenance II
Change engine oil and filter. See <i>Engine Oil on page 5-14</i> . Reset oil life system. See <i>Engine Oil Life System on page 5-18</i> . An <i>Emission Control Service</i> .	•	•
Visually check for any leaks or damage. See <i>footnote (g)</i> .	•	•
Inspect engine air cleaner filter. If necessary, replace filter. See <i>Engine Air Cleaner/Filter on page 5-19</i> . An <i>Emission Control Service</i> . See <i>footnotes † and (k)</i> .		•
Check tire inflation pressures and tire wear. See <i>Tires on page 5-51</i> .	•	•
Inspect brake system. See <i>footnote (a)</i> .	•	•
Check engine coolant and windshield washer fluid levels and add fluid as needed.	•	•
Perform any needed additional services. See “Additional Required Services” in this section.	•	•
Inspect suspension and steering components. See <i>footnote (b)</i> .		•
Inspect engine cooling system. See <i>footnote (c)</i> .		•
Inspect wiper blades. See <i>footnote (d)</i> .		•
Inspect restraint system components. See <i>footnote (e)</i> .		•
Lubricate body components. See <i>footnote (f)</i> .		•
Replace passenger compartment air filter. See <i>footnote (j)</i> .		•

## Additional Required Services

The following services should be performed at the first maintenance service (I or II) after the indicated miles (kilometers) shown for each item.

### Additional Required Services

<b>Service and Miles (Kilometers)</b>	<b>25,000 (41 500)</b>	<b>50,000 (83 000)</b>	<b>75,000 (125 000)</b>	<b>100,000 (166 000)</b>	<b>125,000 (207 500)</b>	<b>150,000 (240 000)</b>
Inspect fuel system for damage or leaks.	•	•	•	•	•	•
Inspect exhaust system for loose or damaged components.	•	•	•	•	•	•
Replace engine air cleaner filter. See <i>Engine Air Cleaner/Filter on page 5-19. An Emission Control Service.</i>		•		•		•
Change automatic transmission fluid and filter (severe service). See <i>footnote (h).</i>		•		•		•
Change automatic transmission fluid and filter (normal service).				•		
Replace spark plugs and inspect spark plug wires. <i>An Emission Control Service.</i>				•		
Engine cooling system service (or every 5 years, whichever occurs first). <i>An Emission Control Service. See footnote (i).</i>						•
Inspect engine accessory drive belt. <i>An Emission Control Service.</i>						•



## Maintenance Footnotes

† *The U.S. Environmental Protection Agency or the California Air Resources Board has determined that the failure to perform this maintenance item will not nullify the emission warranty or limit recall liability prior to the completion of the vehicle's useful life. We, however, urge that all recommended maintenance services be performed at the indicated intervals and the maintenance be recorded.*

(a) *Visually inspect brake lines and hoses for proper hook-up, binding, leaks, cracks, chafing, etc. Inspect disc brake pads for wear and rotors for surface condition. Inspect other brake parts, including calipers, parking brake, etc.*

(b) *Visually inspect front and rear suspension and steering system for damaged, loose or missing parts or signs of wear. Inspect power steering lines and hoses for proper hook-up, binding, leaks, cracks, chafing, etc. If you have the Z51 performance package, lubricate the outer ends of both rear toe-links.*

(c) *Visually inspect hoses and have them replaced if they are cracked, swollen or deteriorated. Inspect all pipes, fittings and clamps; replace with genuine GM parts as needed. To help ensure proper operation, a pressure test of the cooling system and pressure cap and cleaning the outside of the radiator and air conditioning condenser is recommended at least once a year.*

(d) *Visually inspect wiper blades for wear or cracking. Replace blade inserts that appear worn or damaged or that streak or miss areas of the windshield.*

(e) *Make sure the safety belt reminder light and all your belts, buckles, latch plates, retractors and anchorages are working properly. Look for any other loose or damaged safety belt system parts. If you see anything that might keep a safety belt system from doing its job, have it repaired. Have any torn or frayed safety belts replaced. Also look for any opened or broken airbag coverings, and have them repaired or replaced. (The airbag system does not need regular maintenance.)*

(f) *Lubricate all key lock cylinders and body door hinges. Lubricate all hinges and latches, including those for the hood, rear compartment, console door and any folding seat hardware. More frequent lubrication may be required when exposed to a corrosive environment. Applying silicone grease on weatherstrips with a clean cloth will make them last longer, seal better and not stick or squeak.*

(g) *A fluid loss in any vehicle system could indicate a problem. Have the system inspected and repaired and the fluid level checked. Add fluid if needed.*

(h) *Change automatic transmission fluid and filter if the vehicle is mainly driven under one or more of these conditions:*

- *In heavy city traffic where the outside temperature regularly reaches 90°F (32°C) or higher.*
- *In hilly or mountainous terrain.*
- *Uses such as high performance operation.*

(i) *Drain, flush and refill cooling system. This service can be complex; you should have your dealer perform this service. See Engine Coolant on page 5-22 for what to use. Inspect hoses. Clean radiator, condenser, pressure cap and filler neck. Pressure test the cooling system and pressure cap.*

(j) *If you drive regularly under dusty conditions, the filter may require replacement more often.*

(k) *If you drive regularly under dusty conditions, inspect the filter at each engine oil change.*

## Owner Checks and Services

These owner checks and services should be performed at the intervals specified to help ensure the safety, dependability and emission control performance of your vehicle. Your GM Goodwrench® dealer can assist you with these checks and services.

Be sure any necessary repairs are completed at once. Whenever any fluids or lubricants are added to your vehicle, make sure they are the proper ones, as shown in *Recommended Fluids and Lubricants on page 6-11.*

## At Each Fuel Fill

*It is important to perform these underhood checks at each fuel fill.*

### Engine Oil Level Check

Check the engine oil level and add the proper oil if necessary. See *Engine Oil on page 5-14* for further details.

**Notice:** It is important to check your oil regularly and keep it at the proper level. Failure to keep your engine oil at the proper level can cause damage to your engine not covered by your warranty.

### Engine Coolant Level Check

Check the engine coolant level and add DEX-COOL® coolant mixture if necessary. See *Engine Coolant on page 5-22* for further details.

### Windshield Washer Fluid Level Check

Check the windshield washer fluid level in the windshield washer tank and add the proper fluid if necessary.

## At Least Once a Month

### Tire Inspection and Inflation Check

Visually inspect your tires for wear and make sure tires are inflated to the correct pressures. See *Tires on page 5-51* for further details.

## At Least Once a Year

### Starter Switch Check

#### CAUTION:

When you are doing this inspection, the vehicle could move suddenly. If the vehicle moves, you or others could be injured.

1. Before you start, be sure you have enough room around the vehicle.
2. Firmly apply both the parking brake and the regular brake. See *Parking Brake on page 2-29* if necessary.

Do not use the accelerator pedal, and be ready to turn off the engine immediately if it starts.

3. On automatic transmission vehicles, try to start the engine in each gear. The starter should work only in PARK (P) or NEUTRAL (N). If the starter works in any other position, contact your GM Goodwrench® dealer for service.
4. On manual transmission vehicles, put the shift lever in NEUTRAL, push the clutch pedal down halfway, and try to start the engine. The starter should work only when the clutch pedal is pushed down all the way to the floor. If the starter works when the clutch is not pushed all the way down, contact your GM Goodwrench dealer for service.

### Automatic Transmission Shift Lock Control System Check

#### CAUTION:

When you are doing this inspection, the vehicle could move suddenly. If the vehicle moves, you or others could be injured.

1. Before you start, be sure you have enough room around the vehicle. It should be parked on a level surface.

2. Firmly apply the parking brake. See *Parking Brake* on page 2-29 if necessary.  
Be ready to apply the regular brake immediately if the vehicle begins to move.
3. With the engine off and without applying the regular brake, try to move the shift lever out of PARK (P) with normal effort. If the shift lever moves out of PARK (P), contact your GM Goodwrench® dealer for service.

## Parking Brake and Automatic Transmission Park (P) Mechanism Check

### CAUTION:

**When you are doing this check, your vehicle could begin to move. You or others could be injured and property could be damaged. Make sure there is room in front of your vehicle in case it begins to roll. Be ready to apply the regular brake at once should the vehicle begin to move.**

Park on a fairly steep hill, with the vehicle facing downhill. Keeping your foot on the regular brake, set the parking brake.

- To check the parking brake's holding ability: With the engine running and transmission in NEUTRAL (N), slowly remove foot pressure from the regular brake pedal. Do this until the vehicle is held by the parking brake only.
- To check the PARK (P) mechanism's holding ability: With the engine running, shift to PARK (P). Then release the parking brake followed by the regular brake.

Contact your GM Goodwrench® dealer if service is required.

## Underbody Flushing Service

At least every spring, use plain water to flush any corrosive materials from the underbody. Take care to clean thoroughly any areas where mud and other debris can collect.

## Recommended Fluids and Lubricants

Fluids and lubricants identified below by name, part number or specification may be obtained from your dealer.

Usage	Fluid/Lubricant
Engine Oil	The engine requires a special engine oil meeting GM Standard GM4718M. Oils meeting this standard may be identified as synthetic, and should also be identified with the American Petroleum Institute Certified for Gasoline Engines starburst symbol. However, not all synthetic API oils with the starburst symbol will meet this GM standard. You should look for and use only an oil that meets GM Standard GM4718M. GM Goodwrench <sup>®</sup> oil meets all the requirements for your vehicle. For the proper viscosity, see <i>Engine Oil on page 5-14</i> .

Usage	Fluid/Lubricant
Engine Coolant	50/50 mixture of clean, drinkable water and use only DEX-COOL <sup>®</sup> Coolant. See <i>Engine Coolant on page 5-22</i> .
Hydraulic Brake System	Delco Supreme 11 Brake Fluid or equivalent DOT-3 brake fluid.
Windshield Washer Solvent	GM Optikleen <sup>®</sup> Washer Solvent.
Hydraulic Clutch System	Hydraulic Clutch Fluid. Use only GM Part No. U.S. 88958860, in Canada 88901244, Super DOT-4 brake fluid.
Power Steering System	GM Power Steering Fluid (GM Part No. U.S. 89021184, in Canada 89021186).
Chassis Lubrication (Rear Toe-Link Outer Ends with Z51 Option)	Chassis Lubricant (GM Part No. U.S. 12377985, in Canada 88901242) or lubricant meeting requirements of NLGI #2, Category LB or GC-LB.

Usage	Fluid/Lubricant
Manual Transmission	DEXRON®-III Automatic Transmission Fluid. Look for "Approved for the H-Specification" on the label.
Automatic Transmission	DEXRON®-III Automatic Transmission Fluid. Look for "Approved for the H-Specification" on the label.
Key Lock Cylinders	Multi-Purpose Lubricant, Superlube (GM Part No. U.S. 12346241, in Canada 10953474).
Rear Axle (Limited-Slip Differential)	SAE 75W-90 Synthetic Axle Lubricant (GM Part No. U.S. 12378261, in Canada 10953455) meeting GM Specification 9986115. With a complete drain and refill add 4 ounces (118 ml) of Limited-Slip Axle Lubricant Additive (GM Part No. U.S. 1052358, in Canada 992694) where required. See <i>Rear Axle on page 5-43</i> .

Usage	Fluid/Lubricant
Hood Latch Assembly, Secondary Latch, Pivots, Spring Anchor and Release Pawl	Lubriplate Lubricant Aerosol (GM Part No. U.S. 12346293, in Canada 992723) or lubricant meeting requirements of NLGI #2, Category LB or GC-LB.
Hood and Door Hinges	Multi-Purpose Lubricant, Superlube (GM Part No. U.S. 12346241, in Canada 10953474).
Weatherstrip Conditioning	Dielectric Silicone Grease (GM Part No. U.S. 12345579, in Canada 992887).

## Normal Maintenance Replacement Parts

Replacement parts identified below by name, part number, or specification can be obtained from your GM dealer.

<b>Part</b>	<b>GM Part Number</b>	<b>AC Delco® Part Number</b>
Engine Air Cleaner/Filter	25042562	A917C
Engine Oil Filter	88984215	PF44
Passenger Compartment Air Filter Element	10345066	—
Spark Plug	12571164	41-985
Windshield Wiper Blade (Shepherd's Hook Type) 22 inches (55.9 cm)	22143943	—

# Engine Drive Belt Routing

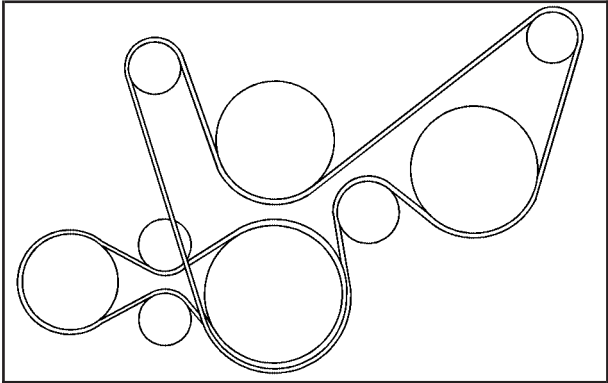



# Maintenance Record

After the scheduled services are performed, record the date, odometer reading, who performed the service and the type of services performed in the boxes provided. See *Maintenance Requirements on page 6-2* in this section. Any additional information from *Owner Checks and Services on page 6-8* can be added on the following record pages. Also, you should retain all maintenance receipts.

## Maintenance Record

Date	Odometer Reading	Serviced By	Maintenance I or Maintenance II	Services Performed



### Maintenance Record (cont'd)

Date	Odometer Reading	Serviced By	Maintenance I or Maintenance II	Services Performed



## Section 7 Customer Assistance and Information

---

<b>Customer Assistance and Information</b> .....	7-2	<b>Reporting Safety Defects</b> .....	7-10
Customer Satisfaction Procedure .....	7-2	Reporting Safety Defects to the United States	
Online Owner Center .....	7-3	Government .....	7-10
Customer Assistance for Text Telephone		Reporting Safety Defects to the Canadian	
(TTY) Users .....	7-4	Government .....	7-11
Customer Assistance Offices .....	7-4	Reporting Safety Defects to	
GM Mobility Reimbursement Program .....	7-5	General Motors .....	7-11
Roadside Assistance Program .....	7-6	Service Publications Ordering Information .....	7-11
Courtesy Transportation .....	7-7		
Vehicle Data Collection and Event Data			
Recorders .....	7-9		

# Customer Assistance and Information

## Customer Satisfaction Procedure

Your satisfaction and goodwill are important to your dealer and to Chevrolet. Normally, any concerns with the sales transaction or the operation of your vehicle will be resolved by your dealer's sales or service departments. Sometimes, however, despite the best intentions of all concerned, misunderstandings can occur. If your concern has not been resolved to your satisfaction, the following steps should be taken:

**STEP ONE:** Discuss your concern with a member of dealership management. Normally, concerns can be quickly resolved at that level. If the matter has already been reviewed with the sales, service or parts manager, contact the owner of the dealership or the general manager.

**STEP TWO:** If after contacting a member of dealership management, it appears your concern cannot be resolved by the dealership without further help, contact the Chevrolet Customer Assistance Center by calling 1-800-222-1020. In Canada, contact GM of Canada Customer Communication Centre by calling 1-800-263-3777 (English) or 1-800-263-7854 (French).

We encourage you to call the toll-free number in order to give your inquiry prompt attention. Please have the following information available to give the Customer Assistance Representative:

- Vehicle Identification Number (VIN). This is available from the vehicle registration or title, or the plate at the top left of the instrument panel and visible through the windshield.
- Dealership name and location.
- Vehicle delivery date and present mileage (kilometers).

When contacting Chevrolet, please remember that your concern will likely be resolved at a dealer's facility. That is why we suggest you follow Step One first if you have a concern.

**STEP THREE:** Both General Motors and your dealer are committed to making sure you are completely satisfied with your new vehicle. However, if you continue to remain unsatisfied after following the procedure outlined in Steps One and Two, you should file with the BBB Auto Line Program to enforce any additional rights you may have. Canadian owners refer to your Warranty and Owner Assistance Information booklet for information on the Canadian Motor Vehicle Arbitration Plan (CAMVAP).

The BBB Auto Line Program is an out of court program administered by the Council of Better Business Bureaus to settle automotive disputes regarding vehicle repairs or the interpretation of the New Vehicle Limited Warranty. Although you may be required to resort to this informal dispute resolution program prior to filing a court action, use of the program is free of charge and your case will generally be heard within 40 days. If you do not agree with the decision given in your case, you may reject it and proceed with any other venue for relief available to you.

You may contact the BBB Auto Line Program using the toll-free telephone number or write them at the following address:

BBB Auto Line Program  
Council of Better Business Bureaus, Inc.  
4200 Wilson Boulevard  
Suite 800  
Arlington, VA 22203-1838  
Telephone: 1-800-955-5100

This program is available in all 50 states and the District of Columbia. Eligibility is limited by vehicle age, mileage, and other factors. General Motors reserves the right to change eligibility limitations and/or discontinue its participation in this program.

## Online Owner Center

The Owner Center is a resource for your GM ownership needs. Specific vehicle information can be found in one place.

### The Online Owner Center allows you to:

- Get e-mail service reminders.
- Access information about your specific vehicle, including tips and videos and an electronic version of this owner's manual (United States only).
- Keep track of your vehicle's service history and maintenance schedule.
- Find GM dealers for service nationwide.
- Receive special promotions and privileges only available to members (United States only).

Refer to the web for updated information.

To register your vehicle, visit [www.MyGMLink.com](http://www.MyGMLink.com) (United States) or My GM Canada within [www.gmcanada.com](http://www.gmcanada.com) (Canada).

## **Customer Assistance for Text Telephone (TTY) Users**

To assist customers who are deaf, hard of hearing, or speech-impaired and who use Text Telephones (TTYs), Chevrolet has TTY equipment available at its Customer Assistance Center. Any TTY user can communicate with Chevrolet by dialing: 1-800-833-CHEV (2438). (TTY users in Canada can dial 1-800-263-3830.)

## **Customer Assistance Offices**

Chevrolet encourages customers to call the toll-free number for assistance. If a U.S. customer wishes to write to Chevrolet, the letter should be addressed to Chevrolet's Customer Assistance Center.

## **United States — Customer Assistance**

Chevrolet Motor Division  
Chevrolet Customer Assistance Center  
P.O. Box 33170  
Detroit, MI 48232-5170

1-800-222-1020  
1-800-833-2438 (For Text Telephone devices (TTYs)  
Roadside Assistance: 1-800-CHEV-USA (243-8872)  
Fax Number: 313-381-0022

From Puerto Rico:

1-800-496-9992 (English)  
1-800-496-9993 (Spanish)  
Fax Number: 313-381-0022

From U.S. Virgin Islands:

1-800-496-9994  
Fax Number: 313-381-0022



## **Canada — Customer Assistance**

General Motors of Canada Limited  
Customer Communication Centre, 163-005  
1908 Colonel Sam Drive  
Oshawa, Ontario L1H 8P7  
1-800-263-3777 (English)  
1-800-263-7854 (French)  
1-800-263-3830 (For Text Telephone devices (TTYs))  
Roadside Assistance: 1-800-268-6800

## **Overseas — Customer Assistance**

Please contact the local General Motors Business Unit.

## **Mexico, Central America and Caribbean Islands/Countries (Except Puerto Rico and U.S. Virgin Islands) — Customer Assistance**

General Motors de Mexico, S. de R.L. de C.V.  
Customer Assistance Center  
Paseo de la Reforma # 2740  
Col. Lomas de Bezares  
C.P. 11910, Mexico, D.F.  
01-800-508-0000  
Long Distance: 011-52-53 29 0 800

## **GM Mobility Reimbursement Program**

This program, available to qualified applicants, can reimburse you up to \$1,000 toward eligible aftermarket driver's or passenger's adaptive equipment you may require for your vehicle, such as hand controls and wheelchair/scooter lifts.

The offer is available for a limited period of time from the date of vehicle purchase/lease. For more details, or to determine your vehicle's eligibility, visit [gmmobility.com](http://gmmobility.com) or call the GM Mobility Assistance Center at 1-800-323-9935. Text telephone (TTY) users, call 1-800-833-9935.

GM of Canada also has a Mobility Program. Call 1-800-GM-DRIVE (463-7483) for details. TTY users call 1-800-263-3830.

## Roadside Assistance Program

As the owner of a new Chevrolet vehicle, you are automatically enrolled in the Chevrolet Roadside Assistance program. This value-added service is intended to provide you with peace of mind as you drive in the city or travel the open road. Call Chevrolet's Roadside Assistance at 1-800-CHEV-USA, (1-800-243-8872) 24 hours a day, 365 days a year to speak with a Chevrolet Roadside Assistance representative.

We will provide the following services during the Bumper-to-Bumper warranty period, at no expense to you:

- **Fuel Delivery:** Delivery of enough fuel (\$5 maximum) for the customer to get to the nearest service station.
- **Lock-out Service (identification required):** Replacement keys or locksmith service will be covered at no charge if you are unable to gain entry into your vehicle. Delivery of the replacement key will be covered within 10 miles (16 km).
- **Emergency Tow:** Tow to the nearest dealership for warranty service or in the event of a vehicle-disabling accident. Assistance provided when the vehicle is mired in sand, mud, or snow.

- **Flat Tire Change:** Installation of a spare tire will be covered at no charge. The customer is responsible for the repair or replacement of the tire if not covered by a warrantable failure.
- **Jump Start:** No-start occurrences which require a battery jump start will be covered at no charge.
- **Dealer Locator Service**

In many instances, mechanical failures are covered under Chevrolet's Bumper-to-Bumper warranty. However, when other services are utilized, our Roadside Assistance Representatives will explain any payment obligations you might incur.

For prompt and efficient assistance when calling, please provide the following to the Roadside Assistance Representative:

- Your name, home address, and home telephone number.
- Telephone number of your location.
- Location of the vehicle.
- Model, year, color, and license plate number.
- Mileage, Vehicle Identification Number (VIN), and delivery date of the vehicle.
- Description of the problem.

While we hope you never have the occasion to use our service, it is added security while traveling for you and your family. Remember, we are only a phone call away. Chevrolet Roadside Assistance: 1-800-CHEV-USA (1-800-234-8872), text telephone (TTY) users, call 1-888-889-2438.

Chevrolet reserves the right to limit services or reimbursement to an owner or driver when, in Chevrolet's judgement, the claims become excessive in frequency or type of occurrence.

Roadside Assistance is not part of or included in the coverage provided by the New Vehicle Limited Warranty. Chevrolet reserves the right to make any changes or discontinue the Roadside Assistance program at any time without notification.

## **Canadian Roadside Assistance**

Vehicles purchased in Canada have an extensive roadside assistance program accessible from anywhere in Canada or the United States. Please refer to the Warranty and Owner Assistance Information book.

## **Courtesy Transportation**

Chevrolet has always exemplified quality and value in its offering of motor vehicles. To enhance your ownership experience, we and our participating dealers are proud to offer Courtesy Transportation, a customer support program for new vehicles.

The Courtesy Transportation program is offered to retail purchase/lease customers in conjunction with the Bumper-to-Bumper coverage provided by the New Vehicle Limited Warranty. Several transportation options are available when warranty repairs are required. This will reduce your inconvenience during warranty repairs.

## **Scheduling Service Appointments**

When your vehicle requires warranty service, you should contact your dealer and request an appointment. By scheduling a service appointment and advising your service consultant of your transportation needs, your dealer can help minimize your inconvenience.

If your vehicle cannot be scheduled into the service department immediately, keep driving it until it can be scheduled for service, unless, of course, the problem is safety-related. If it is, please call your dealership, let them know this, and ask for instructions.

If the dealer requests that you simply drop the vehicle off for service, you are urged to do so as early in the work day as possible to allow for same day repair.

## **Transportation Options**

Warranty service can generally be completed while you wait. However, if you are unable to wait, Chevrolet helps minimize your inconvenience by providing several transportation options. Depending on the circumstances, your dealer can offer you one of the following:

### **Shuttle Service**

Participating dealers can provide you with shuttle service to get you to your destination with minimal interruption of your daily schedule. This includes a one way or round trip shuttle service to a destination up to 10 miles (16 km) from the dealership.

### **Public Transportation or Fuel Reimbursement**

If your vehicle requires overnight warranty repairs, reimbursement of up to a five-day maximum may be available for the use of public transportation such as a taxi or bus. In addition, should you arrange transportation through a friend or relative, reimbursement for reasonable fuel expenses of up to a five-day maximum may be available. Claim amounts should reflect actual costs and be supported by original receipts.

## **Courtesy Rental Vehicle**

Your dealer may arrange to provide you with a courtesy rental vehicle or reimburse you for a rental vehicle that you obtain if your vehicle is kept for a warranty repair. Reimbursement will be limited to a maximum of \$30.00 a day and must be supported by receipts. This requires that you sign and complete a rental agreement and meet state, local and rental vehicle provider requirements. Requirements vary and may include minimum age requirements, insurance coverage, credit card, etc. You are responsible for fuel usage charges and may also be responsible for taxes, levies, usage fees, excessive mileage or rental usage beyond the completion of the repair.

Generally it is not possible to provide a like-vehicle as a courtesy rental.

## **Additional Program Information**

Courtesy Transportation is available during the Bumper-to-Bumper warranty coverage period, but it is not part of the New Vehicle Limited Warranty. A separate booklet entitled "Warranty and Owner Assistance Information" furnished with each new vehicle provides detailed warranty coverage information.

Courtesy Transportation is available only at participating GM dealers and all program options, such as shuttle service, may not be available at every dealer. Please contact your GM dealer for specific information about availability. All Courtesy Transportation arrangements will be administered by appropriate dealer personnel.

**Canadian Vehicles:** For warranty repairs during the Complete Vehicle Coverage period of the General Motors of Canada New Vehicle Limited Warranty, alternative transportation may be available under the Courtesy Transportation Program. Please consult your dealer for details.

General Motors reserves the right to unilaterally modify, change or discontinue Courtesy Transportation at any time and to resolve all questions of claim eligibility pursuant to the terms and conditions described herein at its sole discretion.

## Vehicle Data Collection and Event Data Recorders

Your vehicle, like other modern motor vehicles, has a number of sophisticated computer systems that monitor and control several aspects of the vehicle's performance. Your vehicle uses on-board vehicle computers to monitor emission control components to optimize fuel economy, to monitor conditions for airbag deployment and, if so equipped, to provide anti-lock braking and to help the driver control the vehicle in difficult driving situations. Some information may be stored during regular operations to facilitate repair of detected malfunctions; other information is stored only in a crash event by computer systems, such as those commonly called event data recorders (EDR).

In a crash event, computer systems, such as the Airbag Sensing and Diagnostic Module (SDM) in your vehicle may record information about the condition of the vehicle and how it was operated, such as data related to engine speed, brake application, throttle position, vehicle speed, safety belt usage, airbag readiness, airbag performance, and the severity of a collision. This information has been used to improve vehicle crash performance and may be used to improve crash performance of future vehicles and driving safety. Unlike the data recorders on many airplanes, these on-board systems do not record sounds, such as conversation of vehicle occupants.

To read this information, special equipment is needed and access to the vehicle or the device that stores the data is required. GM will not access information about a crash event or share it with others other than:

- with the consent of the vehicle owner or, if the vehicle is leased, with the consent of the lessee,
- in response to an official request of police or similar government office,
- as part of GM's defense of litigation through the discovery process, or
- as required by law.

In addition, once GM collects or receives data, GM may:

- use the data for GM research needs,
- make it available for research where appropriate confidentiality is to be maintained and need is shown, or
- share summary data which is not tied to a specific vehicle with non-GM organizations for research purposes.

Others, such as law enforcement, may have access to the special equipment that can read the information if they have access to the vehicle or the device that stores the data.

If your vehicle is equipped with OnStar<sup>®</sup>, please check the OnStar<sup>®</sup> subscription service agreement or manual for information on its operations and data collection.

## Reporting Safety Defects

### Reporting Safety Defects to the United States Government

If you believe that your vehicle has a defect which could cause a crash or could cause injury or death, you should immediately inform the National Highway Traffic Safety Administration (NHTSA), in addition to notifying General Motors.

If NHTSA receives similar complaints, it may open an investigation, and if it finds that a safety defect exists in a group of vehicles, it may order a recall and remedy campaign. However, NHTSA cannot become involved in individual problems between you, your dealer, or General Motors.

To contact NHTSA, you may either call the Auto Safety Hotline toll-free at 1-800-424-9393 (or 366-0123 in the Washington, D.C. area) or write to:

NHTSA, U.S. Department of Transportation  
Washington, D.C. 20590

You can also obtain other information about motor vehicle safety from the hotline.

## **Reporting Safety Defects to the Canadian Government**

If you live in Canada, and you believe that your vehicle has a safety defect, you should immediately notify Transport Canada, in addition to notifying General Motors of Canada Limited. You may write to:

Transport Canada  
330 Sparks Street  
Tower C  
Ottawa, Ontario K1A 0N5

## **Reporting Safety Defects to General Motors**

In addition to notifying NHTSA (or Transport Canada) in a situation like this, we certainly hope you will notify General Motors. Please call the Chevrolet Customer Assistance Center at 1-800-222-1020, or write:

Chevrolet Motor Division  
Chevrolet Customer Assistance Center  
P.O. Box 33170  
Detroit, MI 48232-5170

In Canada, please call us at 1-800-263-3777 (English) or 1-800-263-7854 (French). Or, write:

General Motors of Canada Limited  
Customer Communication Centre, 163-005  
1908 Colonel Sam Drive  
Oshawa, Ontario L1H 8P7

## **Service Publications Ordering Information**

### **Service Manuals**

Service Manuals have the diagnosis and repair information on engines, transmission, axle suspension, brakes, electrical, steering, body, etc.

### **Transmission, Transaxle, Transfer Case Unit Repair Manual**

This manual provides information on unit repair service procedures, adjustments, and specifications for GM transmissions, transaxles, and transfer cases.

## Service Bulletins

Service Bulletins give technical service information needed to knowledgeable service General Motors cars and trucks. Each bulletin contains instructions to assist in the diagnosis and service of your vehicle.

In Canada, information pertaining to Product Service Bulletins can be obtained by contacting your General Motors dealer or by calling 1-800-GM-DRIVE (1-800-463-7483).

## Owner's Information

Owner publications are written specifically for owners and intended to provide basic operational information about the vehicle. The owner's manual will include the Maintenance Schedule for all models.

In-Portfolio: Includes a Portfolio, Owner's Manual, and Warranty Booklet.

RETAIL SELL PRICE: \$35.00

Without Portfolio: Owner's Manual only.

RETAIL SELL PRICE: \$25.00

## Current and Past Model Order Forms

Service Publications are available for current and past model GM vehicles. To request an order form, please specify year and model name of the vehicle.

**ORDER TOLL FREE: 1-800-551-4123**  
**Monday-Friday 8:00 AM - 6:00 PM**  
**Eastern Time**

For Credit Card Orders Only  
(VISA-MasterCard-Discover), visit Helm, Inc. on the World Wide Web at: [www.helminc.com](http://www.helminc.com)

Or you can write to:

Helm, Incorporated  
P.O. Box 07130  
Detroit, MI 48207

Prices are subject to change without notice and without incurring obligation. Allow ample time for delivery.

Note to Canadian Customers: All listed prices are quoted in U.S. funds. Canadian residents are to make checks payable in U.S. funds.



# A

Accessory Power Outlets .....	3-23	Appearance Care (cont.)	
Active Handling System .....	4-10	Chemical Paint Spotting .....	5-83
Active Handling System Light .....	3-39	Cleaning Exterior Lamps/Lenses .....	5-79
Additives, Fuel .....	5-5	Coated Moldings .....	5-77
Add-On Electrical Equipment .....	5-86	Convertible Top .....	5-81
Air Cleaner/Filter, Engine .....	5-19	Fabric/Carpet .....	5-75
Air Conditioning .....	3-24	Fiberglass Springs .....	5-83
Air Dam, Front .....	2-20	Finish Care .....	5-80
Airbag		Finish Damage .....	5-83
Off Light .....	3-35	Glass Surfaces .....	5-78
Readiness Light .....	3-34	Instrument Panel .....	5-77
Airbag Sensing and Diagnostic Module (SDM) .....	7-9	Interior Plastic Components .....	5-77
Airbag System .....	1-40	Leather .....	5-77
Airbag Off Switch .....	1-48	Removable Roof Panel .....	5-81
How Does an Airbag Restrain? .....	1-46	Tires .....	5-82
Servicing Your Airbag-Equipped Vehicle .....	1-51	Underbody Maintenance .....	5-83
What Makes an Airbag Inflate? .....	1-46	Vehicle Care/Appearance Materials .....	5-84
What Will You See After an Airbag Inflates? ....	1-46	Washing Your Vehicle .....	5-79
When Should an Airbag Inflate? .....	1-45	Weatherstrips .....	5-78
Where Are the Airbags? .....	1-42	Windshield and Wiper Blades .....	5-80
Antenna, Diversity Antenna System .....	3-95	Ashtrays .....	3-24
Antenna, XM™ Satellite Radio Antenna System .....	3-95	Audio System(s) .....	3-76
Anti-Lock Brake System (ABS) .....	4-7	Care of Your CD Player .....	3-95
Anti-Lock Brake, System Warning Light .....	3-38	Care of Your CDs .....	3-95
Appearance Care .....	5-75	Diversity Antenna System .....	3-95
Aluminum Wheels .....	5-82	Navigation/Radio System .....	3-94
Care of Safety Belts .....	5-78	Radio with CD .....	3-76
Cargo Covered Convenience Net .....	5-78	Setting the Time .....	3-76
		Theft-Deterrent Feature .....	3-94

Audio System(s) (cont.)	
Understanding Radio Reception .....	3-95
XM™ Satellite Radio Antenna System .....	3-95
Automatic Transmission	
Fluid .....	5-21
Operation .....	2-24

## B

Battery .....	5-38
Exterior Lighting Battery Saver .....	3-18
Run-Down Protection .....	3-19
Before Leaving on a Long Trip .....	4-24
Brake	
Anti-Lock Brake System (ABS) .....	4-7
Emergencies .....	4-8
Parking .....	2-29
System Warning Light .....	3-37
Brakes .....	5-35
Braking .....	4-6
Braking in Emergencies .....	4-8
Break-In, New Vehicle .....	2-19
Bulb Replacement .....	5-44
Halogen Bulbs .....	5-44
Headlamps, Front Turn Signal, and Parking Lamps .....	5-45
High Intensity Discharge (HID) Lighting .....	5-44
Replacement Bulbs .....	5-48
Sidemarker Lamps .....	5-46

Bulb Replacement (cont.)	
Taillamps, Turn Signal, and Stoplamps .....	5-47
Buying New Tires .....	5-64

## C

California Fuel .....	5-5
Canadian Owners .....	iii
Capacities and Specifications .....	5-94
Carbon Monoxide .....	2-14, 2-32, 4-27, 4-37
Care of	
Safety Belts .....	5-78
Your CD Player .....	3-95
Your CDs .....	3-95
Cargo Cover .....	2-49
Center Console Storage Area .....	2-46
Chains, Tire .....	5-69
Check	
Engine Light .....	3-41
Checking Things Under the Hood .....	5-10
Chemical Paint Spotting .....	5-83
Child Restraints	
Child Restraint Systems .....	1-27
Infants and Young Children .....	1-24
Lower Anchorages and Top Tethers for Children (LATCH System) .....	1-31
Older Children .....	1-21
Securing a Child Restraint Designed for the LATCH System .....	1-32

Child Restraints (cont.)		
Securing a Child Restraint in the Passenger		
Seat Position .....	1-35	
Top Strap .....	1-30	
Cigarette Lighter .....	3-24	
Cleaning		
Aluminum Wheels .....	5-82	
Cargo Covered Convenience Net .....	5-78	
Coated Moldings .....	5-77	
Convertible Top .....	5-81	
Exterior Lamps/Lenses .....	5-79	
Fabric/Carpet .....	5-75	
Fiberglass Springs .....	5-83	
Finish Care .....	5-80	
Glass Surfaces .....	5-78	
Instrument Panel .....	5-77	
Interior Plastic Components .....	5-77	
Leather .....	5-77	
Removable Roof Panel .....	5-81	
Tires .....	5-82	
Underbody Maintenance .....	5-83	
Washing Your Vehicle .....	5-79	
Weatherstrips .....	5-78	
Windshield and Wiper Blades .....	5-80	
Climate Control System		
Air Filter, Passenger Compartment .....	3-30	
Dual Automatic .....	3-24	
Outlet Adjustment .....	3-29	
Clutch, Hydraulic .....	5-22	
Control of a Vehicle .....	4-5	
Convenience Net .....		2-49
Convertible Top .....		2-55, 2-62
Coolant		
Engine Temperature Gage .....		3-40
Heater, Engine .....		2-23
Surge Tank Pressure Cap .....		5-25
Cooling System .....		5-28
Courtesy Lamps .....		3-18
Cruise Control Lever .....		3-11
Cupholder(s) .....		2-46
Customer Assistance Information		
Courtesy Transportation .....		7-7
Customer Assistance for Text Telephone		
(TTY) Users .....		7-4
Customer Assistance Offices .....		7-4
Customer Satisfaction Procedure .....		7-2
GM Mobility Reimbursement Program .....		7-5
Reporting Safety Defects to General Motors ....		7-11
Reporting Safety Defects to the Canadian		
Government .....		7-11
Reporting Safety Defects to the United		
States Government .....		7-10
Roadside Assistance Program .....		7-6
Service Publications Ordering Information .....		7-11
		<b>D</b>
Daytime Running Lamps .....		3-15
Defensive Driving .....		4-2

Diversity Antenna System .....	3-95
Doing Your Own Service Work .....	5-4
Door	
Locks .....	2-10
Power Door Locks .....	2-12
Driver	
Position, Safety Belt .....	1-12
Driver Information Center (DIC) .....	3-47
DIC Controls and Displays .....	3-48
DIC Vehicle Personalization .....	3-67
DIC Warnings and Messages .....	3-53
Other Messages .....	3-66
Driving	
At Night .....	4-18
City .....	4-22
Defensive .....	4-2
Drunken .....	4-2
Freeway .....	4-23
Hill and Mountain Roads .....	4-25
In Rain and on Wet Roads .....	4-19
Racing or Other Competitive Driving .....	2-22
Rocking Your Vehicle to Get it Out .....	4-32
Winter .....	4-27
Dual Automatic Climate Control System .....	3-24

## E

### Electrical System

Add-On Equipment .....	5-86
Engine Compartment Fuse Block .....	5-91

Electrical System (cont.)	
Fuses and Circuit Breakers .....	5-87
Headlamp Wiring .....	5-86
Instrument Panel Fuse Block .....	5-88
Power Windows and Other Power Options .....	5-86
Windshield Wiper Fuses .....	5-86
Engine	
Air Cleaner/Filter .....	5-19
Battery .....	5-38
Check and Service Engine Soon Light .....	3-41
Coolant .....	5-22
Coolant Heater .....	2-23
Coolant Temperature Gage .....	3-40
Drive Belt Routing .....	6-14
Engine Compartment Overview .....	5-12
Exhaust .....	2-32
Oil .....	5-14
Oil Pressure Gage .....	3-44
Overheated Protection Operating Mode .....	5-27
Overheating .....	5-25
Racing or Other Competitive Driving .....	2-22
Starting .....	2-21
Entry/Exit Lighting .....	3-18
Event Data Recorders (EDR) .....	7-9
Extended Mobility Tires .....	5-56
Extender, Safety Belt .....	1-20
Exterior Lamps .....	3-14
Exterior Lighting Battery Saver .....	3-18

## F

Filter	
Engine Air Cleaner .....	5-19
Finish Damage .....	5-83
Flash-to-Pass .....	3-9
Flat Tire .....	5-74
Floor Mats .....	2-46
Fluid	
Automatic Transmission .....	5-21
Manual Transmission .....	5-21
Power Steering .....	5-33
Windshield Washer .....	5-34
Fog Lamp Light .....	3-45
Fog Lamps .....	3-16
Front Air Dam .....	2-20
Fuel .....	5-5
Additives .....	5-5
California Fuel .....	5-5
Filling a Portable Fuel Container .....	5-9
Filling Your Tank .....	5-7
Fuels in Foreign Countries .....	5-6
Gage .....	3-46
Gasoline Octane .....	5-5
Gasoline Specifications .....	5-5
Fuses	
Engine Compartment Fuse Block .....	5-91
Fuses and Circuit Breakers .....	5-87
Instrument Panel Fuse Block .....	5-88
Windshield Wiper .....	5-86

## G

Gage	
Engine Coolant Temperature .....	3-40
Engine Oil Pressure .....	3-44
Fuel .....	3-46
Speedometer .....	3-33
Tachometer .....	3-33
Voltmeter Gage .....	3-36
Garage Door Opener .....	2-41
Gasoline	
Octane .....	5-5
Specifications .....	5-5
Glove Box .....	2-46
GM Mobility Reimbursement Program .....	7-5

## H

Hatch/Trunk .....	2-14
Hazard Warning Flashers .....	3-6
Headlamp Wiring .....	5-86
Headlamps	
Bulb Replacement .....	5-44
Daytime Running Lamps .....	3-15
Flash-to-Pass .....	3-9
Halogen Bulbs .....	5-44
Headlamps, Front Turn Signal, and Parking Lamps .....	5-45
High Intensity Discharge (HID) Lighting .....	5-44

Headlamps (cont.)	
High/Low Beam Changer .....	3-9
On Reminder .....	3-15
Sidemarkers Lamps .....	5-46
Wiper Activated .....	3-15
Head-Up Display (HUD) .....	3-19
Heated Seats .....	1-4
Heater .....	3-24
Highbeam On Light .....	3-46
Highway Hypnosis .....	4-25
Hill and Mountain Roads .....	4-25
HomeLink® Transmitter .....	2-41
HomeLink® Transmitter, Programming .....	2-42
Hood	
Checking Things Under .....	5-10
Release .....	5-10
Horn .....	3-6
How to Use This Manual .....	iii
How to Wear Safety Belts Properly .....	1-12
Hydraulic Clutch .....	5-22

## I

Ignition Positions .....	2-20
Infants and Young Children, Restraints .....	1-24
Inflation -- Tire Pressure .....	5-58
Installing the Roof Panel .....	2-54

Instrument Panel	
Brightness .....	3-18
Cluster .....	3-32
Overview .....	3-4

## J

Jump Starting .....	5-39
---------------------	------

## K

Keyless Access System .....	2-4
Keyless Access System, Operation .....	2-5
Keys .....	2-3

## L

Labelling, Tire Sidewall .....	5-52
Lamps	
Battery Run-Down Protection .....	3-19
Courtesy .....	3-18
Exterior .....	3-14
Exterior Lighting Battery Saver .....	3-18
Fog .....	3-16
Reading .....	3-18
Twilight Sentinel® .....	3-17

LATCH System	
Child Restraints .....	1-31
Securing a Child Restraint Designed for the LATCH System .....	1-32
Latches, Seatback .....	1-6
Lifting Your Vehicle, Tires .....	5-70
Light	
Active Handling System .....	3-39
Airbag Off .....	3-35
Airbag Readiness .....	3-34
Anti-Lock Brake System Warning .....	3-38
Brake System Warning .....	3-37
Fog Lamp .....	3-45
Highbeam On .....	3-46
Lights On Reminder .....	3-46
Malfunction Indicator .....	3-41
One-to-Four Shift .....	3-37
Safety Belt Reminder .....	3-33
Security .....	3-45
TCS Warning Light .....	3-39
Tire Pressure .....	3-41
Traction Control System (TCS) Warning .....	3-39
Lighting	
Entry/Exit .....	3-18
Limited-Slip Rear Axle .....	4-12
Lockout Protection .....	2-13
Locks	
Door .....	2-10
Lockout Protection .....	2-13

Locks (cont.)	
Power Door .....	2-12
Loss of Control .....	4-16
Lumbar	
Power and Side Bolsters .....	1-3

## M

Maintenance Schedule	
Additional Required Services .....	6-6
At Each Fuel Fill .....	6-8
At Least Once a Month .....	6-9
At Least Once a Year .....	6-9
Introduction .....	6-2
Maintenance Footnotes .....	6-7
Maintenance Record .....	6-15
Maintenance Requirements .....	6-2
Normal Maintenance Replacement Parts .....	6-13
Owner Checks and Services .....	6-8
Recommended Fluids and Lubricants .....	6-11
Scheduled Maintenance .....	6-4
Using Your .....	6-3
Your Vehicle and the Environment .....	6-2
Malfunction Indicator Light .....	3-41
Manual Seats .....	1-2
Manual Transmission	
Fluid .....	5-21
Operation .....	2-26
Memory .....	2-66

Message	
DIC Warnings and Messages .....	3-53
Mirrors	
Automatic Dimming Rearview with Compass ....	2-36
Automatic Dimming Rearview with OnStar®	
and Compass .....	2-34
Manual Rearview Mirror .....	2-34
Outside Automatic Dimming Mirror .....	2-39
Outside Convex Mirror .....	2-39
Outside Power Heated Mirrors .....	2-38
MyGMLink.com .....	7-3

## N

Navigation/Radio System .....	3-94
New Vehicle Break-In .....	2-19
Normal Maintenance Replacement Parts .....	6-13

## O

Odometer .....	3-33
Off-Road Recovery .....	4-15
Oil	
Engine .....	5-14
Engine Oil Pressure Gage .....	3-44
Older Children, Restraints .....	1-21
One-to-Four Shift Light .....	3-37
Online Owner Center .....	7-3
OnStar® System .....	2-40

Other Warning Devices .....	3-6
Outlet Adjustment .....	3-29
Outside	
Automatic Dimming Mirror .....	2-39
Convex Mirror .....	2-39
Power Heated Mirrors .....	2-38
Overheated Engine Protection Operating Mode ....	5-27
Owner Checks and Services .....	6-8
Owners, Canadian .....	iii

## P

Park (P)	
Shifting Into .....	2-29
Shifting Out of .....	2-31
Parking	
Brake .....	2-29
Over Things That Burn .....	2-32
Parking Your Vehicle .....	2-31
Passenger Compartment Air Filter .....	3-30
Passenger Position, Safety Belts .....	1-20
Passing .....	4-15
Power	
Accessory Outlets .....	3-23
Door Locks .....	2-12
Electrical System .....	5-86
Lumbar and Side Bolsters .....	1-3
Retained Accessory (RAP) .....	2-21
Six-Way Seats .....	1-2



Power (cont.)	
Steering Fluid .....	5-33
Windows .....	2-17
Pretensioners, Safety Belt .....	1-20
Programming the HomeLink® Transmitter .....	2-42

## Q

Questions and Answers About Safety Belts .....	1-11
--	------

## R

Radios .....	3-76
Care of Your CD Player .....	3-95
Care of Your CDs .....	3-95
Navigation/Radio System .....	3-94
Radio with CD .....	3-76
Setting the Time .....	3-76
Theft-Deterrent .....	3-94
Understanding Reception .....	3-95
Reading Lamps .....	3-18
Rear Axle .....	5-43
Limited-Slip .....	4-12
Rear Storage Area .....	2-47
Rearview Mirror, Automatic Dimming with Compass .....	2-36
Rearview Mirror, Automatic Dimming with OnStar® and Compass .....	2-34

Rearview Mirrors .....	2-34
Reclining Seatbacks .....	1-4
Recommended Fluids and Lubricants .....	6-11
Recreational Vehicle Towing .....	4-37
Removing the Roof Panel .....	2-50
Replacement Bulbs .....	5-48
Reporting Safety Defects	
Canadian Government .....	7-11
General Motors .....	7-11
United States Government .....	7-10
Restraint System Check	
Checking Your Restraint Systems .....	1-51
Replacing Restraint System Parts After a Crash .....	1-52
Restraint Systems	
Checking .....	1-51
Replacing Parts .....	1-52
Retained Accessory Power (RAP) .....	2-21
Roadside	
Assistance Program .....	7-6
Rocking Your Vehicle to Get it Out .....	4-32
Roof Panel .....	2-50
Installing the Roof Panel .....	2-54
Removing the Roof Panel .....	2-50
Storing the Roof Panel .....	2-53
Routing, Engine Drive Belt .....	6-14
Running Your Engine While You Are Parked .....	2-33

# S

Safety Belt		
Pretensioners .....	1-20	
Reminder Light .....	3-33	
Safety Belts		
Care of .....	5-78	
Driver Position .....	1-12	
How to Wear Safety Belts Properly .....	1-12	
Passenger Position .....	1-20	
Questions and Answers About Safety Belts .....	1-11	
Safety Belt Extender .....	1-20	
Safety Belt Use During Pregnancy .....	1-19	
Safety Belts Are for Everyone .....	1-7	
Safety Warnings and Symbols .....	iii	
Scheduled Maintenance .....	6-4	
Seatback Latches .....	1-6	
Seats		
Heated Seats .....	1-4	
Manual .....	1-2	
Power Lumbar and Side Bolsters .....	1-3	
Reclining Seatbacks .....	1-4	
Seatback Latches .....	1-6	
Six-Way Power Seats .....	1-2	
Securing a Child Restraint		
Designed for the LATCH System .....	1-32	
Passenger Seat Position .....	1-35	
Security Light .....	3-45	
Selective Ride Control .....	4-12	
Service .....	5-3	
Adding Equipment to the Outside of Your Vehicle .....	5-4	
Doing Your Own Work .....	5-4	
Engine Soon Light .....	3-41	
Publications Ordering Information .....	7-11	
Servicing Your Airbag-Equipped Vehicle .....	1-51	
Setting the Time .....	3-76	
Shifting Into Park (P) .....	2-29	
Shifting Out of Park (P) .....	2-31	
Signals, Turn and Lane-Change .....	3-8	
Specifications, Capacities .....	5-94	
Speedometer .....	3-33	
Starting Your Engine .....	2-21	
Steering .....	4-13	
Steering Wheel, Tilt Wheel .....	3-7	
Storage Areas		
Center Console Storage Area .....	2-46	
Convenience Net .....	2-49	
Cupholder(s) .....	2-46	
Glove Box .....	2-46	
Rear Storage Area .....	2-47	
Storing the Roof Panel .....	2-53	
Stuck in Sand, Mud, Ice or Snow .....	4-31	
Sun Visors .....	2-18	

## T

Tachometer .....	3-33
Taillamps	
Turn Signal, and Stoplamps .....	5-47
TCS Warning Light .....	3-39
Theft-Deterrent, Radio .....	3-94
Theft-Deterrent System .....	2-18
Theft-Deterrent Systems .....	2-18
Tilt Wheel .....	3-7
Tire	
Pressure Light .....	3-41
Tires .....	5-51
Aluminum Wheels, Cleaning .....	5-82
Buying New Tires .....	5-64
Chains .....	5-69
Cleaning .....	5-82
Extended Mobility .....	5-56
If a Tire Goes Flat .....	5-74
Inflation -- Tire Pressure .....	5-58
Lifting Your Vehicle .....	5-70
Pressure Monitor System .....	5-61
Rotation .....	5-63
Tire Sidewall Labelling .....	5-52
Tire Terminology and Definitions .....	5-54
Uniform Tire Quality Grading .....	5-65
Wheel Alignment and Tire Balance .....	5-66
Wheel Replacement .....	5-66
When It Is Time for New Tires .....	5-63

Top Strap .....	1-30
Towing	
Recreational Vehicle .....	4-37
Towing a Trailer .....	4-37
Your Vehicle .....	4-37
Traction	
Active Handling System .....	4-10
Control System (TCS) .....	4-9
Control System Warning Light .....	3-39
Limited-Slip Rear Axle .....	4-12
Selective Ride Control .....	4-12
Transmission	
Fluid, Automatic .....	5-21
Fluid, Manual .....	5-21
One-to-Four Shift Light .....	3-37
Transmission Operation, Automatic .....	2-24
Transmission Operation, Manual .....	2-26
Trunk/Hatch .....	2-14
Turn and Lane-Change Signals .....	3-8
Turn Signal/Multifunction Lever .....	3-8
Twilight Sentinel® .....	3-17

## U

Understanding Radio Reception .....	3-95
Uniform Tire Quality Grading .....	5-65

## V

Vehicle	
Control .....	4-5
Damage Warnings .....	iv
Parking Your .....	2-31
Symbols .....	iv
Vehicle Data Collection and Event Data	
Recorders .....	7-9
Vehicle Identification	
Number (VIN) .....	5-85
Service Parts Identification Label .....	5-85
Vehicle Personalization	
DIC .....	3-67
Memory .....	2-66
Ventilation Adjustment .....	3-29
Visors .....	2-18
Voltmeter Gage .....	3-36

## W

Warning Lights, Gages and Indicators .....	3-31
Warnings	
DIC Warnings and Messages .....	3-53
Hazard Warning Flashers .....	3-6
Other Warning Devices .....	3-6

Warnings (cont.)	
Safety and Symbols .....	iii
Vehicle Damage .....	iv
Wheels	
Alignment and Tire Balance .....	5-66
Replacement .....	5-66
Windows .....	2-16
Power .....	2-17
Windshield	
Wiper Blades, Cleaning .....	5-80
Windshield Washer .....	3-10
Fluid .....	5-34
Windshield Wiper	
Blade Replacement .....	5-48
Fuses .....	5-86
Windshield Wipers .....	3-9
Winter Driving .....	4-27
Wiper Activated Headlamps .....	3-15

## X

XM™ Satellite Radio Antenna System .....	3-95
--	------

## Y

Your Vehicle and the Environment .....	6-2
--	-----