

2010 Chevrolet Camaro Owner Manual

Keys, Doors and Windows	1-1
Keys and Locks	1-2
Doors	1-8
Vehicle Security	1-10
Exterior Mirrors	1-12
Interior Mirrors	1-13
Windows	1-14
Roof	1-16
Seats and Restraints	2-1
Head Restraints	2-2
Front Seats	2-3
Rear Seats	2-6
Safety Belts	2-6
Airbag System	2-21
Child Restraints	2-35
Storage	3-1
Storage Compartments	3-1
Additional Storage Features	3-1

Instruments and Controls	4-1
Instrument Panel Overview	4-4
Controls	4-6
Warning Lights, Gages, and Indicators	4-9
Information Displays	4-27
Vehicle Messages	4-30
Vehicle Personalization	4-38
OnStar System	4-42
Universal Remote System	4-45
Lighting	5-1
Exterior Lighting	5-1
Interior Lighting	5-5
Lighting Features	5-6
Infotainment System	6-1
Introduction	6-1
Radio	6-8
Audio Players	6-14
Phone	6-22

Climate Controls	7-1
Climate Control Systems	7-1
Air Vents	7-3
Driving and Operating	8-1
Driving Information	8-2
Starting and Operating	8-16
Engine Exhaust	8-25
Automatic Transmission	8-26
Manual Transmission	8-30
Brakes	8-31
Ride Control Systems	8-34
Cruise Control	8-38
Object Detection Systems	8-41
Fuel	8-43
Towing	8-48
Conversions and Add-Ons	8-55
Vehicle Care	9-1
General Information	9-2
Vehicle Checks	9-4
Headlamp Aiming	9-34

Bulb Replacement	9-37
Electrical System	9-41
Wheels and Tires	9-48
Jump Starting	9-84
Towing	9-87
Appearance Care	9-88
Service and Maintenance	10-1
General Information	10-1
Scheduled Maintenance	10-2
Recommended Fluids, Lubricants, and Parts	10-7
Maintenance Records ...	10-10

Technical Data	11-1
Vehicle Identification	11-1
Vehicle Data	11-2
Customer Information	12-1
Customer Information	12-1
Reporting Safety Defects	12-13
Vehicle Data Recording and Privacy	12-14
Index	i-1

Introduction



GENERAL MOTORS, GM, the GM Emblem, CHEVROLET, the CHEVROLET Emblem, the name Camaro and the Camaro Emblem are registered trademarks of General Motors Corporation.

This manual includes the latest information at the time it was printed. GM reserves the right to make changes after that time without further notice. For vehicles first sold in Canada, substitute the name "General Motors of Canada Limited" for Chevrolet Motor Division wherever it appears in this manual.

This manual describes features that may or may not be on your specific vehicle.

Read this manual from beginning to end to learn about the vehicle's features and controls. Pictures, symbols, and words work together to explain vehicle operation.

Keep this manual in the vehicle for quick reference.

Canadian Vehicle Owners

Canadian Owners (Propriétaires Canadiens)

A French language copy of this manual can be obtained from your dealer/retailer or from:

On peut obtenir un exemplaire de ce guide en français auprès du concessionnaire ou à l'adresse suivante:

Helm, Incorporated
P.O. Box 07130
Detroit, MI 48207

1-800-551-4123

Numéro de poste 6438
de langue française
www.helminc.com

Using this Manual

To quickly locate information about the vehicle use the Index in the back of the manual. It is an alphabetical list of what is in the manual and the page number where it can be found.

Danger, Warnings, and Cautions

Warning messages found on vehicle labels and in this manual describe hazards and what to do to avoid or reduce them.

Danger indicates a hazard with a high level of risk which will result in serious injury or death.

Warning or **Caution** indicates a hazard that could result in injury or death.

WARNING

These mean there is something that could hurt you or other people.

Notice: This means there is something that could result in property or vehicle damage. This would not be covered by the vehicle's warranty.



A circle with a slash through it is a safety symbol which means "Do Not," "Do not do this" or "Do not let this happen."

Symbols

The vehicle has components and labels that use symbols instead of text. Symbols are shown along with the text describing the operation or information relating to a specific component, control, message, gage, or indicator.

 : This symbol is shown when you need to see your owner manual for additional instructions or information.

 : This symbol is shown when you need to see a service manual for additional instructions or information.

Vehicle Symbol Chart

Here are some additional symbols that may be found on the vehicle and what they mean. For more information on the symbol, refer to the index.

 : Airbag Readiness Light

 : Air Conditioning

 : Antilock Brake System (ABS)

 : Audio Steering Wheel Controls or OnStar®

 : Brake System Warning Light

 : Charging System

 : Cruise Control

 : Engine Coolant Temperature

 : Exterior Lamps

 : Fog Lamps

 : Fuel Gage

 : Fuses

 : Headlamp High/Low-Beam Changer

 : LATCH System Child Restraints

 : Malfunction Indicator Lamp

 : Oil Pressure

 : Power

 : Remote Vehicle Start

 : Safety Belt Reminders

 : Tire Pressure Monitor

 : Traction Control

 : Windshield Washer Fluid

Keys, Doors and Windows

Keys and Locks

Keys	1-2
Remote Keyless Entry (RKE) System	1-3
Remote Keyless Entry (RKE) System Operation	1-3
Remote Vehicle Start	1-5
Door Locks	1-6
Power Door Locks	1-7
Lockout Protection	1-8

Doors

Trunk	1-8
-------------	-----

Vehicle Security

Vehicle Security	1-10
Anti-Theft Alarm System	1-10
Immobilizer	1-11
Immobilizer Operation	1-11

Exterior Mirrors

Convex Mirrors	1-12
Power Mirrors	1-12
Heated Mirrors	1-12
Automatic Dimming Mirror	1-12

Interior Mirrors

Manual Rearview Mirror	1-13
Automatic Dimming Rearview Mirror	1-13

Windows

Windows	1-14
Power Windows	1-14
Sun Visors	1-16

Roof

Sunroof	1-16
---------------	------

Keys and Locks

Keys

WARNING

Leaving children in a vehicle with the ignition key is dangerous for many reasons, children or others could be badly injured or even killed. They could operate the power windows or other controls or even make the vehicle move. The windows will function with the keys in the ignition and children could be seriously injured or killed if caught in the path of a closing window. Do not leave the keys in a vehicle with children.



The key, that is part of the Remote Keyless Entry (RKE) transmitter, can be used for the ignition and all locks.



Press the button on the RKE transmitter to extend the key. Press the button and the key blade to retract the key.

See your dealer/retailer if a new key is needed.

Notice: If you ever lock your keys in the vehicle, you may have to damage the vehicle to get in. Be sure you have spare keys.

If you are locked out of the vehicle, see *Roadside Assistance Program* on page 12-6 or *OnStar® System* on page 4-42.

Remote Keyless Entry (RKE) System

See *Radio Frequency Statement (US, Can)* on page 12-15 for information regarding Part 15 of the Federal Communications Commission (FCC) Rules and RSS-210/211 of Industry and Science Canada.

Changes or modifications to this system by other than an authorized service facility could void authorization to use this equipment.

If there is a decrease in the RKE operating range, try this:

- Check the distance. The transmitter may be too far from the vehicle. Stand closer during rainy or snowy weather.
- Check the location. Other vehicles or objects may be blocking the signal. Take a few steps to the left or right, hold the transmitter higher, and try again.

- Check the transmitter's battery. See "Battery Replacement" later in this section.
- If the transmitter is still not working correctly, see your dealer/retailer or a qualified technician for service.

Remote Keyless Entry (RKE) System Operation

If available, the Remote Keyless Entry (RKE) transmitter will work up to 65 feet (20 m) away from the vehicle.

Other conditions can affect the performance of the transmitter. See *Remote Keyless Entry (RKE) System* on page 1-3.



RKE without Remote Start Shown

The following may be available:

🔒 (Lock): Press to lock all doors.

The turn signal indicators may flash and/or the horn may sound to indicate locking, see "Remote Feedback" under *Vehicle Personalization* on page 4-38.

If the passenger door is open when **🔒** is pressed, all doors lock.

1-4 Keys, Doors and Windows

If the driver door is open when  is pressed, all doors lock except the driver door, if enabled through the vehicle personalization.

Pressing  may also arm the theft-deterrent system. See *Anti-Theft Alarm System on page 1-10*.



 **(Unlock):** Press to unlock the driver door or all doors, see “Remote Unlock” under *Vehicle Personalization on page 4-38*.



The turn signal indicators may flash and/or the horn may sound to indicate unlocking, see “Remote Feedback” under *Vehicle Personalization on page 4-38*.

Pressing  will disarm the theft-deterrent system. See *Anti-Theft Alarm System on page 1-10*.

 **(Remote Trunk Release):**
Press and hold to unlock the trunk.

 **(Vehicle Locator/Panic Alarm):**
Press and release one time to locate the vehicle. The exterior lamps flash and the horn chirps.

Press and hold  for at least two seconds to sound the panic alarm. The horn sounds and the turn signals flash until  is pressed again or the key is placed in the ignition and turned to ON/RUN.

 **(Remote Vehicle Start):** For vehicles with this feature, press  and then  to start the engine from outside the vehicle using the RKE transmitter. See *Remote Vehicle Start on page 1-5* for additional information.

Programming Transmitters to the Vehicle

Only RKE transmitters programmed to this vehicle will work. If a transmitter is lost or stolen, a replacement can be purchased and programmed through your dealer/retailer. When the replacement transmitter is programmed to this vehicle, all remaining transmitters must also be reprogrammed. Any lost or stolen transmitters will no longer work once the new transmitter is programmed.

Battery Replacement

Replace the battery if the Replace Battery in Remote Key message displays in the DIC. See “Replace Battery in Remote Key” under *Key and Lock Messages on page 4-33*.

The battery is not rechargeable. See your dealer/retailer to replace the battery.

Remote Vehicle Start

Your vehicle may have this feature which allows you to start the engine from outside the vehicle.

Ⓚ (Remote Vehicle Start): This button will be on the RKE transmitter if you have remote start.

To enable and disable remote start, see “Remote Start” under *Vehicle Personalization on page 4-38*.



During a remote start the climate control system will turn on with the fan speed, air delivery mode, and temperature settings that the system was set when the vehicle was last turned off. If the fan is set to O (off), the climate control system will not turn on.

Laws in some local communities may restrict the use of remote starters. For example, some laws may require a person using remote start to have the vehicle in view. Check local regulations for any requirements.

There are other conditions which can affect the performance of the transmitter, see *Remote Keyless Entry (RKE) System on page 1-3* for additional information.

Starting the Engine Using Remote Start

To start the engine using the remote start feature:

1. Press  on the RKE transmitter.
2. Press and hold  for about two seconds. The turn signal lamps will flash to confirm the vehicle has been started. The parking lamps will turn on and remain on as long as the engine is running. The vehicle's doors will be locked.

3. The key must be inserted and turned to ON/RUN before driving.

The engine will shut off after 10 minutes unless a time extension is done or the key is inserted and turned to ON/RUN.

Extending Engine Run Time

For a 10 minute extension, repeat Steps 1 and 2 while the engine is still running. The remote start can only be extended once.

When the remote start is extended, the second 10 minutes will start immediately.

For example, if the vehicle has been running for five minutes, and 10 minutes are added, the engine will run for a total of 15 minutes.

A maximum of two remote starts or remote start attempts are allowed between ignition cycles.

1-6 Keys, Doors and Windows

The vehicle's ignition switch must be turned to ON/RUN and then back to LOCK/OFF using the key before the remote start procedure can be used again.

Shutting the Engine Off After a Remote Start

To shut off the engine:

- Press  until the parking lamps turn off.
- Turn on the hazard warning flashers.
- Insert the key and turn it to ON/RUN and then back to LOCK/OFF.

Conditions in Which Remote Start Will Not Work

The remote start will not operate if:

- The key is in the ignition.
- The hood is not closed.
- The hazard warning flashers are on.
- There is an emission control system malfunction.
- The engine coolant temperature is too high.
- The oil pressure is low.
- Two remote vehicle starts have already been used.
- The vehicle is not in P (Park).

Door Locks



Unlocked doors can be dangerous.

- Passengers, especially children, can easily open the doors and fall out of a moving vehicle. The chance of being thrown out of the vehicle in a crash is increased if the doors are not locked. So, all passengers should wear safety belts properly and the doors should be locked whenever the vehicle is driven.

(Continued)

WARNING (Continued)

- Young children who get into unlocked vehicles may be unable to get out. A child can be overcome by extreme heat and can suffer permanent injuries or even death from heat stroke. Always lock the vehicle whenever leaving it.
- Outsiders can easily enter through an unlocked door when you slow down or stop your vehicle. Locking your doors can help prevent this from happening.

Manual Door Locks

Lock the doors from inside the vehicle by pressing down the button on the top of the door.

The doors can also be unlocked from the inside by pulling the door handle. Pulling the door handle again unlatches the door.

Unlock the door from the outside by turning the key counterclockwise.

Lock all doors from the outside by turning the key clockwise.

The door lock cylinder turns freely when either the wrong key is used, or the correct key is not fully inserted. The free turning door lock feature prevents the lock from being forced open.

To reset the lock, turn it to the vertical position with the correct key fully inserted. Remove the key and insert it again.

If this does not reset the lock, turn the key half-way around in the cylinder and repeat the reset procedure.

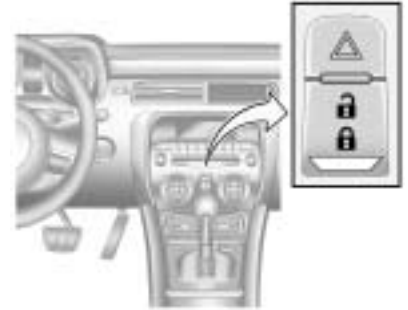
Power Door Locks

The power door lock switch is on the center console.

🔓 (Unlock): Press to unlock both doors.

🔒 (Lock): Press to lock both doors.

To program the power door locks, see *Vehicle Personalization* on page 4-38.

Lockout Protection

The vehicle can be programmed to prevent lockout if set in personalization.

If the driver door is open and the RKE lock button is pressed, the driver door will not lock. When the driver door is opened, and the key is in the ignition, a reminder chime sounds continuously. The vehicle remains locked only when both doors are closed. See *Vehicle Personalization on page 4-38*.

Doors

Trunk

WARNING

Exhaust gases can enter the vehicle if it is driven with the liftgate, trunk/hatch open, or with any objects that pass through the seal between the body and the trunk/hatch or liftgate. Engine exhaust contains Carbon Monoxide (CO) which cannot be seen or smelled. It can cause unconsciousness and even death.

(Continued)

WARNING (Continued)

If the vehicle must be driven with the liftgate, or trunk/hatch open:

- Close all of the windows.
- Fully open the air outlets on or under the instrument panel.
- Adjust the Climate Control system to a setting that brings in only outside air and set the fan speed to the highest setting. See Climate Control System in the Index.
- If the vehicle has a power liftgate, disable the power liftgate function.

For more information about carbon monoxide, see *Engine Exhaust on page 8-25*.

Remote Trunk Release

To open the trunk from the outside the vehicle, press the  button on the Remote Keyless Entry (RKE) transmitter.

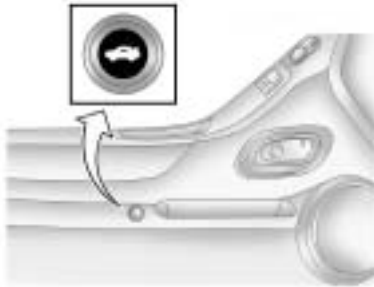

From inside the vehicle, press the  button located on the driver door.

Emergency Trunk Release Handle

Notice: Do not use the emergency trunk release handle as a tie-down or anchor point when securing items in the trunk as it could damage the handle. The emergency trunk release handle is only intended to aid a person trapped in a latched trunk, enabling them to open the trunk from the inside.



There is an emergency trunk release handle located inside the trunk on the trunk latch. On some vehicles, the release handle can be accessed by folding the rear seat center seatback. See *Rear Seats* on page 2-6. Pull the release handle to open the trunk from the inside.

Vehicle Security

Vehicle theft is big business, especially in some cities. This vehicle has theft-deterrent features, however, they do not make it impossible to steal.

Anti-Theft Alarm System

This vehicle has an anti-theft alarm system.



The security light is located on the instrument panel.

Arming the System

To arm the system, press  on the RKE transmitter.

The alarm automatically arms after about 30 seconds. The security light, located on the instrument panel, flashes.

Disarming the System

To disarm the system, do one of the following:

- Press  on the RKE transmitter.
- Turn the ignition to ON/RUN.

The security light stays on for approximately one second when the vehicle is disarming.

If the system is armed when there are people inside of the vehicle, pulling the door handle from the inside one time will unlock the door. Pulling the handle a second time will unlatch the door.

How the System Alarm is Activated

To activate the system if it is armed, open any door, the trunk or hood. The horn will sound and the hazard warning flashers will flash.

How to Turn Off the System Alarm

To turn off the system alarm, do one of the following:

- Press  on the RKE transmitter.
- Turn the ignition to ON/RUN.

The theft-deterrent system is disarmed when the alarm is turned off.

How to Detect a Tamper Condition

If the horn sounds and the turn signal lamps flash three times when  is pressed, an attempted break-in has occurred while the system was armed. The vehicle may also display a message on the DIC. See *Anti-Theft Alarm System Messages* on page 4-35 for more information.

Immobilizer

See *Radio Frequency Statement (US, Can)* on page 12-15 for information regarding Part 15 of the Federal Communications Commission (FCC) Rules and RSS-210/211 of Industry and Science Canada.

Immobilizer Operation

This vehicle has a passive theft-deterrent system.

The system does not have to be manually armed or disarmed.

The vehicle is automatically immobilized when the key is removed from the ignition.

The system is automatically disarmed when the vehicle is started with the correct key. The key uses a transponder that matches an immobilizer control unit in the vehicle and automatically disarms the system. Only the correct key starts the vehicle. The vehicle may not start if the key is damaged.



The immobilizer light, located in the instrument panel cluster, comes on if there is a problem with arming or disarming the theft-deterrent system. See *Immobilizer Light* on page 4-26.

When trying to start the vehicle, the immobilizer light comes on briefly when the ignition is turned on.

If the engine does not start and the immobilizer light stays on there is a problem with the system. Turn the ignition off and try again.

If the engine still does not start, and the key appears to be undamaged, try another ignition key.

If the engine still does not start and the light continues to stay on try another key.

If the engine still does not start with the other key, the vehicle needs service. If the vehicle does start, the first key may be damaged. See your dealer/retailer who can service the theft-deterrent system and have a new key made.

Do not leave the key or device that disarms or deactivates the theft deterrent system in the vehicle.

Exterior Mirrors

Convex Mirrors

WARNING

A convex mirror can make things, like other vehicles, look farther away than they really are. If you cut too sharply into the right lane, you could hit a vehicle on the right. Check the inside mirror or glance over your shoulder before changing lanes.

The passenger side mirror is convex shaped. A convex mirror's surface is curved so more can be seen from the driver seat.

Power Mirrors



Vehicles with outside power mirrors have controls located on the driver door armrest.

To adjust each mirror:

1. Press the switch to select the driver or passenger side mirror.
2. Press one of the four sides on the  (control pad) to adjust the mirror.

3. Adjust each outside mirror so that a little of the vehicle and the area behind it can be seen.

Heated Mirrors

For vehicles with heated mirrors:

(Rear Window Defogger):

Press to heat the mirrors.

See “Rear Window Defogger” under *Climate Control Systems* on page 7-1 for more information.

Automatic Dimming Mirror

Vehicles with automatic dimming outside mirrors will adjust for the glare of headlamps behind you.

Interior Mirrors

Manual Rearview Mirror

Adjust the inside rearview mirror for a clear view of the area behind your vehicle. To avoid glare of the headlamps from behind, push the tab forward for daytime and pull it for nighttime use.

Vehicles with OnStar have additional control buttons located at the bottom of the mirror. See your dealer/retailer for more information on the system and how to subscribe to OnStar. See *OnStar® System on page 4-42* for more information about the services OnStar provides.

Automatic Dimming Rearview Mirror

Vehicles with an automatic dimming inside rearview mirror reduces the glare from the headlamps of the vehicle behind you. The dimming feature comes on and the indicator light illuminates each time the vehicle is started.

Vehicles with OnStar have three additional control buttons located at the bottom of the mirror. See your dealer/retailer for more information on the system and how to subscribe to OnStar. See *OnStar® System on page 4-42* for more information about the services OnStar provides.

 **(On/Off):** Press to turn the dimming feature and/or compass display on or off.

Cleaning the Mirror

Do not spray glass cleaner directly on the mirror. Use a soft towel dampened with water.

Windows

WARNING

Leaving children, helpless adults, or pets in a vehicle with the windows closed is dangerous. They can be overcome by the extreme heat and suffer permanent injuries or even death from heat stroke. Never leave a child, a helpless adult, or a pet alone in a vehicle, especially with the windows closed in warm or hot weather.



Power Windows



The power window switches located on the driver door control all windows. The window switches on the passenger door are only for that window. Push the front of the switch down to open the window. Pull the switch up to close it.

The switches work when the ignition is in ON/RUN, ACC/ACCESSORY, or in Retained Accessory Power (RAP). See *Retained Accessory Power (RAP)* on page 8-19.

Window Indexing

This automatically lowers the window a small amount when the door is opened. When the door is closed, the window will raise fully.

If the vehicle loses power or the window freezes, this feature may not work. From outside the vehicle, close the door and push the window inward so that the glass goes under the molding.

If the “Open, Then Close Driver Window” or “Open, Then Close Passenger Window” messages are displayed on the Driver Information Center (DIC), follow the procedure for Programming the Power Windows later in this section. See also *Driver Information Center (DIC) on page 4-27*.

Express Window Operation

The front window switches have an express-up or down feature that lowers or raises the window without holding the switch. Pull the switch up or press it down all the way and release it. Stop the window by pressing or pulling the switch.

Express Window Anti-Pinch Feature

When express-up is active, the window will auto-reverse if there is an obstruction or severe icing. The window returns to normal operation after the obstruction or condition is removed.

WARNING

If express override is activated, the window will not reverse automatically. You or others could be injured and the window could be damaged. Before you use express override, make sure that all people and obstructions are clear of the window path.

Express Window Anti-Pinch Override

The anti-pinch feature can be overridden by holding the window switch all the way down. The window will lower for as long as the switch is held. Once the switch is released, the express mode is re-activated. In this mode, the window can still close on an object in its path. Use care when using the override mode.

1-16 Keys, Doors and Windows

Programming the Power Windows

If the battery on the vehicle has been recharged, disconnected, or is not working, you will need to reprogram each front power window for the express-up feature to work. Before reprogramming, replace or recharge the vehicle's battery.

To program each front window, follow these steps:

1. With the ignition in ACC/ACCESSORY, ON/RUN, or when Retained Accessory Power (RAP) is active, close all doors.
2. Press and hold the power window switch until the window is fully open.

3. Pull the power window switch up until the window is fully closed.
4. Continue holding the switch up for approximately two seconds after the window is completely closed.

The window is now reprogrammed. Repeat the process for the other windows.

Sun Visors

Pull the sun visor toward you or move it to the side to reduce glare.

Roof

Sunroof

On vehicles with a sunroof, the switch is located on the overhead console.

The sunroof only operates when the ignition is in ON/RUN, ACC/ACCESSORY, or if Retained Accessory Power (RAP) is active. See *Retained Accessory Power (RAP)* on page 8-19.

Express Sunroof Operation

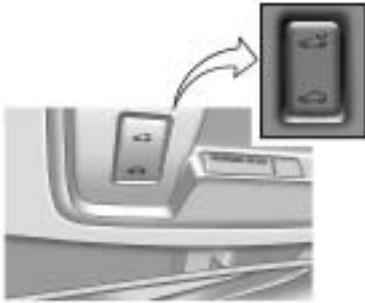

The sunroof can be opened without holding the switch down. Push the switch in the open direction until the second pause. The sunroof will fully open.

To stop the sunroof from moving, press either the open or close sunroof switch.

Press and release the back of the switch to open the sunroof to the vent position. Press it again to express-open the sunroof. To stop the sunroof from opening, press the switch again.

A deflector automatically raises when the sunroof is opened and retracts while the sunroof closes.

If the sunshade is closed, it opens automatically when the sunroof opens past the vented position.

Notice: Forcing the sunshade forward of the sliding glass panel may cause damage and the sunroof may not operate properly. Always close the glass panel before closing the sunshade.

To close the sunroof, press the front of the switch and hold it until the sunroof is closed. The sunroof will stop if the switch is released. Close the sunshade by hand.

The sunroof glass panel cannot be opened or closed if the vehicle has an electrical failure.

Seats and Restraints

Head Restraints

Head Restraints2-2

Front Seats

Seat Adjustment2-3
 Power Seat Adjustment2-4
 Reclining Seatbacks2-4
 Seatback Latches2-5
 Heated Front Seats2-6

Rear Seats

Rear Seats2-6

Safety Belts

Safety Belts2-6
 How to Wear Safety Belts
 Properly2-10
 Lap-Shoulder Belt2-16
 Safety Belt Use During
 Pregnancy2-19

Safety Belt Extender2-20
 Safety System Check2-20
 Safety Belt Care2-20
 Replacing Safety Belt
 System Parts After
 a Crash2-21

Airbag System

Airbag System2-21
 Where Are the Airbags?2-23
 When Should an Airbag
 Inflate?2-25
 What Makes an Airbag
 Inflate?2-26
 How Does an Airbag
 Restrain?2-27
 What Will You See After
 an Airbag Inflates?2-27
 Passenger Sensing
 System2-28
 Servicing the
 Airbag-Equipped Vehicle2-32
 Adding Equipment to
 the Airbag-Equipped
 Vehicle2-33
 Airbag System Check2-34
 Replacing Airbag System
 Parts After a Crash2-34

Child Restraints

Older Children2-35
 Infants and Young
 Children2-37
 Child Restraint Systems2-39
 Where to Put the
 Restraint2-41
 Lower Anchors and
 Tethers for Children
 (LATCH System)2-43
 Replacing LATCH System
 Parts After a Crash2-48
 Securing Child Restraints
 (Rear Seat)2-48
 Securing Child Restraints
 (Right Front Seat)2-50

Head Restraints

The vehicle's front seats have adjustable head restraints in the outboard seating positions.

WARNING

With head restraints that are not installed and adjusted properly, there is a greater chance that occupants will suffer a neck/spinal injury in a crash. Do not drive until the head restraints for all occupants are installed and adjusted properly.



Adjust the head restraint so that the top of the restraint is at the same height as the top of the occupant's head. This position reduces the chance of a neck injury in a crash.



Pull the head restraint up to raise it. To lower the head restraint, press the button, located on the top of the seatback, and push the restraint down.

Push down on the head restraint after the button is released to make sure that it is locked in place.

The vehicle's head restraints are not designed to be removed.

Front Seats

Seat Adjustment

 **WARNING**

You can lose control of the vehicle if you try to adjust a manual driver's seat while the vehicle is moving. The sudden movement could startle and confuse you, or make you push a pedal when you do not want to. Adjust the driver's seat only when the vehicle is not moving.

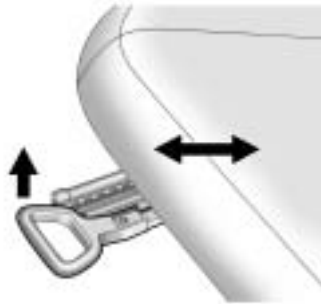

To adjust a manual seat:

1. Lift the handle under the seat to unlock it.
2. Slide the seat and release the handle.
3. Try to move the seat to be sure it is locked in place.

Seat Height Adjustment



To manually raise or lower the seat, move the lever repeatedly upward or downward.

2-4 Seats and Restraints

Power Seat Adjustment



- Move the seat forward or rearward by moving the control forward or rearward.
- Move the whole seat up or down by moving the control up or down.
- Tilt the seat by turning the control forward or rearward.

Reclining Seatbacks

WARNING

You can lose control of the vehicle if you try to adjust the seat while the vehicle is moving. The sudden movement could startle and confuse you, or make you push a pedal when you do not want to. Adjust the driver's seat only when the vehicle is not moving.



WARNING

Sitting in a reclined position when the vehicle is in motion can be dangerous. Even when buckled up, the safety belts cannot do their job when reclined like this.

The shoulder belt cannot do its job because it will not be against your body. Instead, it will be in front of you. In a crash, you could go into it, receiving neck or other injuries.

The lap belt cannot do its job either. In a crash, the belt could go up over your abdomen. The belt forces would be there, not at your pelvic bones. This could cause serious internal injuries.

For proper protection when the vehicle is in motion, have the seatback upright. Then sit well back in the seat and wear the safety belt properly.

Power Reclining Seatbacks



On vehicles with power reclining seatbacks the control is located on the outboard side of the seat.

- To recline the seatback, move the control toward the rear of the vehicle.
- To raise the seatback, move the control toward the front of the vehicle.

Seatback Latches



To access the rear seats pull up on the latch, located on the rear of the driver or front passenger seatback. Fold the seatback forward.

WARNING

If either seatback is not locked, it could move forward in a sudden stop or crash. That could cause injury to the person sitting there. Always push and pull on the seatbacks to be sure they are locked.

Lift the seatback to return it to the upright position. Push and pull on the seatback to make sure it is locked.

Heated Front Seats

On vehicles with heated front seats, the controls are on the center console. The engine must be running.

 **(Heated Seat):** Press to turn on the heated seat.

A light indicates that the feature is working. The number of lights shows the level of heat selected: one or two for a low or high setting. Press the button to cycle through the temperature settings and to turn the heated seat feature off.

Rear Seats

The rear seat has two designated seating positions and can be folded for more cargo space. Fold only when the vehicle is parked.

To fold the seatback down:

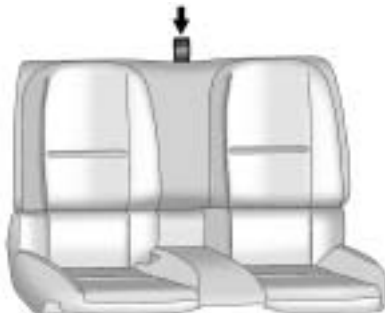

1. Pull on the strap located on the top of the of the rear seatback.
2. Fold the seatback down.

Lift the seatback up to raise it, and push it back to lock it into place. Make sure the safety belt is not twisted or caught in the seatback.

Safety Belts

This section of the manual describes how to use safety belts properly. It also describes some things not to do with safety belts.

WARNING

Do not let anyone ride where a safety belt cannot be worn properly. In a crash, if you or your passenger(s) are not wearing safety belts, the injuries can be much worse. You can hit things inside the vehicle harder or be ejected from the vehicle. You and your passenger(s) can be seriously injured or killed. In the same crash, you might not be, if you are buckled up. Always fasten your safety belt, and check that your passenger(s) are restrained properly too.

WARNING

It is extremely dangerous to ride in a cargo area, inside or outside of a vehicle. In a collision, people riding in these areas are more likely to be seriously injured or killed. Do not allow people to ride in any area of your vehicle that is not equipped with seats and safety belts. Be sure everyone in your vehicle is in a seat and using a safety belt properly.

This vehicle has indicators as a reminder to buckle the safety belts. See *Safety Belt Reminders on page 4-16* for additional information.

In most states and in all Canadian provinces, the law requires wearing safety belts. Here is why:

You never know if you will be in a crash. If you do have a crash, you do not know if it will be a serious one.

A few crashes are mild, and some crashes can be so serious that even buckled up, a person would not survive. But most crashes are in between. In many of them, people who buckle up can survive and sometimes walk away. Without safety belts they could have been badly hurt or killed.

After more than 40 years of safety belts in vehicles, the facts are clear. In most crashes buckling up does matter... a lot!

Why Safety Belts Work

When you ride in or on anything, you go as fast as it goes.



Take the simplest vehicle. Suppose it is just a seat on wheels.

2-8 Seats and Restraints

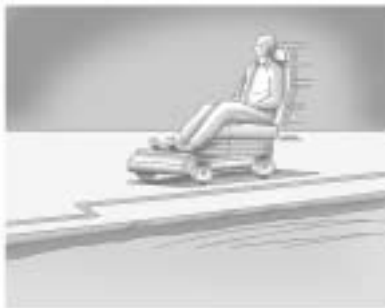

Put someone on it.



Get it up to speed. Then stop the vehicle. The rider does not stop.



The person keeps going until stopped by something. In a real vehicle, it could be the windshield...



or the instrument panel...



or the safety belts!

With safety belts, you slow down as the vehicle does. You get more time to stop. You stop over more distance, and your strongest bones take the forces. That is why safety belts make such good sense.

Questions and Answers About Safety Belts

Q: Will I be trapped in the vehicle after a crash if I am wearing a safety belt?

A: You *could* be — whether you are wearing a safety belt or not. But your chance of being conscious during and after an accident, so you *can* unbuckle and get out, is *much* greater if you are belted. And you can unbuckle a safety belt, even if you are upside down.

Q: If my vehicle has airbags, why should I have to wear safety belts?

A: Airbags are supplemental systems only; so they work *with* safety belts — not instead of them. Whether or not an airbag is provided, all occupants still have to buckle up to get the most protection. That is true not only in frontal collisions, but especially in side and other collisions.

2-10 Seats and Restraints

Q: If I am a good driver, and I never drive far from home, why should I wear safety belts?

A: You may be an excellent driver, but if you are in a crash — even one that is not your fault — you and your passenger(s) can be hurt. Being a good driver does not protect you from things beyond your control, such as bad drivers.

Most accidents occur within 25 miles (40 km) of home. And the greatest number of serious injuries and deaths occur at speeds of less than 40 mph (65 km/h).

Safety belts are for everyone.

How to Wear Safety Belts Properly

This section is only for people of adult size.

Be aware that there are special things to know about safety belts and children. And there are different rules for smaller children and infants. If a child will be riding in the vehicle, see *Older Children* on page 2-35 or *Infants and Young Children* on page 2-37. Follow those rules for everyone's protection.

It is very important for all occupants to buckle up. Statistics show that unbelted people are hurt more often in crashes than those who are wearing safety belts.

Occupants who are not buckled up can be thrown out of the vehicle in a crash. And they can strike others in the vehicle who are wearing safety belts.

First, before you or your passenger(s) wear a safety belt, there is important information you should know.

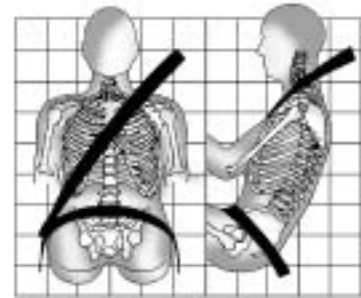

Sit up straight and always keep your feet on the floor in front of you. The lap part of the belt should be worn low and snug on the hips, just touching the thighs.

In a crash, this applies force to the strong pelvic bones and you would be less likely to slide under the lap belt. If you slid under it, the belt would apply force on your abdomen. This could cause serious or even fatal injuries. The shoulder belt should go over the shoulder and across the chest. These parts of the body are best able to take belt restraining forces.

The shoulder belt locks if there is a sudden stop or crash.

Q: What is wrong with this?

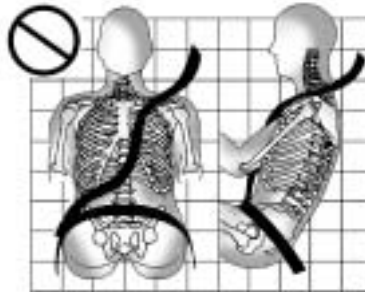

A: The shoulder belt is too loose.
It will not give as much protection this way.

⚠ WARNING

You can be seriously hurt if your shoulder belt is too loose. In a crash, you would move forward too much, which could increase injury. The shoulder belt should fit snugly against your body.

2-12 Seats and Restraints

Q: What is wrong with this?



A: The lap belt is too loose.
It will not give nearly as
much protection this way.

WARNING

You can be seriously hurt if your lap belt is too loose. In a crash, you could slide under the lap belt and apply force on your abdomen. This could cause serious or even fatal injuries. The lap belt should be worn low and snug on the hips, just touching the thighs.

Q: What is wrong with this?

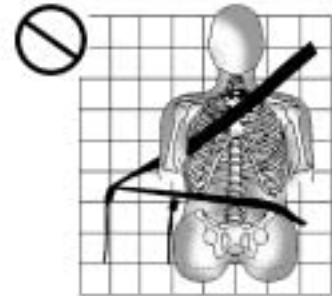

A: The belt is buckled in the wrong
buckle.

⚠ WARNING

You can be seriously injured if your belt is buckled in the wrong place like this. In a crash, the belt would go up over your abdomen. The belt forces would be there, not on the pelvic bones. This could cause serious internal injuries. Always buckle your belt into the buckle nearest you.

Q: What is wrong with this?

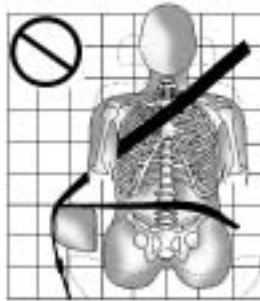

A: The belt is over an armrest.

⚠ WARNING

You can be seriously injured if your belt goes over an armrest like this. The belt would be much too high. In a crash, you can slide under the belt. The belt force would then be applied on the abdomen, not on the pelvic bones, and that could cause serious or fatal injuries. Be sure the belt goes under the armrests.

2-14 Seats and Restraints

Q: What is wrong with this?

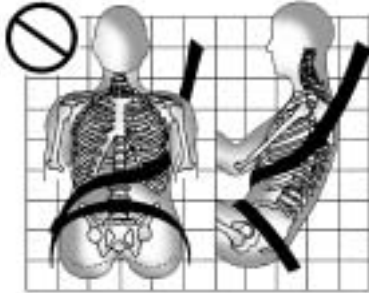

A: The shoulder belt is worn under the arm. It should be worn over the shoulder at all times.

WARNING

You can be seriously injured if you wear the shoulder belt under your arm. In a crash, your body would move too far forward, which would increase the chance of head and neck injury. Also, the belt would apply too much force to the ribs, which are not as strong as shoulder bones. You could also severely injure internal organs like your liver or spleen. The shoulder belt should go over the shoulder and across the chest.

Q: What is wrong with this?

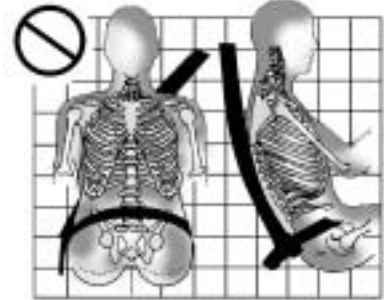

A: The belt is behind the body.

⚠ WARNING

You can be seriously injured by not wearing the lap-shoulder belt properly. In a crash, you would not be restrained by the shoulder belt. Your body could move too far forward increasing the chance of head and neck injury. You might also slide under the lap belt. The belt force would then be applied right on the abdomen. That could cause serious or fatal injuries. The shoulder belt should go over the shoulder and across the chest.

Q: What is wrong with this?

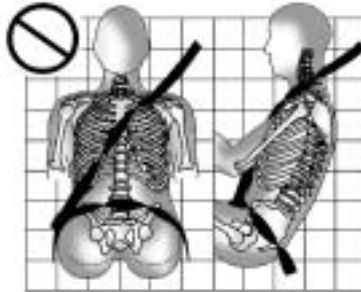

A: The belt is twisted across the body.

⚠ WARNING

You can be seriously injured by a twisted belt. In a crash, you would not have the full width of the belt to spread impact forces. If a belt is twisted, make it straight so it can work properly, or ask your dealer/retailer to fix it.

2-16 Seats and Restraints

Lap-Shoulder Belt

All seating positions in the vehicle have a lap-shoulder belt.

The following instructions explain how to wear a lap-shoulder belt properly.



1. If the seat has a safety belt guide, and the safety belt is not routed through the guide, snap the guide around the belt webbing. Be sure the belt is not twisted.

2. Adjust the seat, if the seat is adjustable, so you can sit up straight. To see how, see "Seats" in the Index.



3. Pick up the latch plate and pull the belt across you. Do not let it get twisted.
The lap-shoulder belt may lock if you pull the belt across you very quickly. If this happens, let the belt go back slightly to unlock it. Then pull the belt across you more slowly.
If the shoulder portion of a passenger belt is pulled out all the way, the child restraint

locking feature may be engaged. If this happens, let the belt go back all the way and start again.



4. Push the latch plate into the buckle until it clicks.
Pull up on the latch plate to make sure it is secure. If the belt is not long enough, see *Safety Belt Extender on page 2-20*.
Position the release button on the buckle so that the safety belt could be quickly unbuckled if necessary.

5. To make the lap part tight, pull up on the shoulder belt. It may be necessary to pull stitching on the safety belt through the latch plate to fully tighten the lap belt on smaller occupants.



To unlatch the belt, push the button on the buckle. The belt should return to its stowed position.

Before a door is closed, be sure the safety belt is out of the way. If a door is slammed against a safety belt, damage can occur to both the safety belt and the vehicle.

Safety Belt Pretensioners

This vehicle has safety belt pretensioners for the front outboard occupants. Although the safety belt pretensioners cannot be seen, they are part of the safety belt assembly. They can help tighten the safety belts during the early stages of a moderate to severe frontal or near frontal crash if the threshold conditions for pretensioner activation are met. And, if the vehicle has side impact airbags, safety belt pretensioners can help tighten the safety belts in a side crash.

Pretensioners work only once. If the pretensioners activate in a crash, they will need to be replaced, and probably other new parts for the vehicle's safety belt system. See *Replacing Safety Belt System Parts After a Crash* on page 2-21.

Rear Safety Belt Comfort Guides

Rear shoulder belt comfort guides may provide added safety belt comfort for older children who have outgrown booster seats and for some adults. When installed on a shoulder belt, the comfort guide positions the shoulder belt away from the neck and head.

There is one guide for each outboard passenger position in the rear seat.

2-18 Seats and Restraints

Here is how to install a comfort guide to the safety belt:



1. Pull the elastic cord out from between the edge of the seatback and the interior body to remove the guide from its storage clip.



2. Place the guide over the belt and insert the two edges of the belt into the slots of the guide.

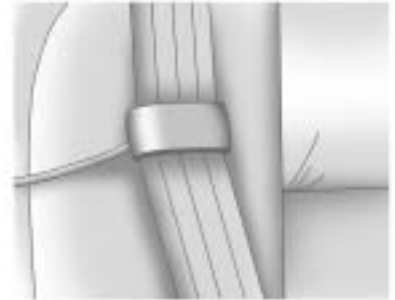

3. Be sure that the belt is not twisted and it lies flat. The elastic cord must be under the belt and the guide on top.

⚠ WARNING

A safety belt that is not properly worn may not provide the protection needed in a crash. The person wearing the belt could be seriously injured. The shoulder belt should go over the shoulder and across the chest. These parts of the body are best able to take belt restraining forces.



4. Buckle, position, and release the safety belt as described previously in this section. Make sure that the shoulder belt crosses the shoulder.

To remove and store the comfort guide, squeeze the belt edges together so that the safety belt can be removed from the guide. Slide the guide onto the clip, leaving only the loop of the elastic cord exposed.

Properly secure the guide before folding the seatback.

Safety Belt Use During Pregnancy

Safety belts work for everyone, including pregnant women. Like all occupants, they are more likely to be seriously injured if they do not wear safety belts.



A pregnant woman should wear a lap-shoulder belt, and the lap portion should be worn as low as possible, below the rounding, throughout the pregnancy.

2-20 Seats and Restraints

The best way to protect the fetus is to protect the mother. When a safety belt is worn properly, it is more likely that the fetus will not be hurt in a crash. For pregnant women, as for anyone, the key to making safety belts effective is wearing them properly.

Safety Belt Extender

If the vehicle's safety belt will fasten around you, you should use it.

But if a safety belt is not long enough, your dealer/retailer will order you an extender. When you go in to order it, take the heaviest coat you will wear, so the extender will be long enough for you. To help avoid personal injury, do not let someone else use it, and use it only for the seat it is made to fit. The extender has been designed for adults. Never use it for securing child seats. To wear it, attach it to the regular safety belt. For more information, see the instruction sheet that comes with the extender.

Safety System Check

Now and then, check that the safety belt reminder light, safety belts, buckles, latch plates, retractors and anchorages are working properly. Look for any other loose or damaged safety belt system parts that might keep a safety belt system from doing its job. See your dealer/retailer to have it repaired. Torn or frayed safety belts may not protect you in a crash. They can rip apart under impact forces. If a belt is torn or frayed, get a new one right away.

Make sure the safety belt reminder light is working. See *Safety Belt Reminders on page 4-16* for more information.

Keep safety belts clean and dry. See *Safety Belt Care on page 2-20*.

Safety Belt Care

Keep belts clean and dry.



Do not bleach or dye safety belts. It may severely weaken them. In a crash, they might not be able to provide adequate protection. Clean safety belts only with mild soap and lukewarm water.

Replacing Safety Belt System Parts After a Crash

WARNING

A crash can damage the safety belt system in the vehicle. A damaged safety belt system may not properly protect the person using it, resulting in serious injury or even death in a crash. To help make sure the safety belt systems are working properly after a crash, have them inspected and any necessary replacements made as soon as possible.

After a minor crash, replacement of safety belts may not be necessary. But the safety belt assemblies that were used during any crash may have been stressed or damaged. See your dealer/retailer to have the safety belt assemblies inspected or replaced.

New parts and repairs may be necessary even if the safety belt system was not being used at the time of the crash.

Have the safety belt pretensioners checked if the vehicle has been in a crash, or if the airbag readiness light stays on after you start the vehicle or while you are driving. See *Airbag Readiness Light* on page 4-17.

Airbag System

The vehicle has the following airbags:

- A frontal airbag for the driver.
- A frontal airbag for the right front passenger.
- A seat-mounted side impact airbag for the driver.
- A seat-mounted side impact airbag for the right front passenger.

The vehicle may also have the following airbags:

- A roof-rail airbag for the driver and the passenger seated directly behind the driver.
- A roof-rail airbag for the right front passenger and the passenger seated directly behind the right front passenger.

2-22 Seats and Restraints

All of the airbags in your vehicle will have the word AIRBAG embossed in the trim or on an attached label near the deployment opening.

For frontal airbags, the word AIRBAG will appear on the middle part of the steering wheel for the driver and on the instrument panel for the right front passenger.

With seat-mounted side impact airbags, the word AIRBAG will appear on the side of the seatback closest to the door.

With roof-rail airbags, the word AIRBAG will appear along the headliner or trim.

Airbags are designed to supplement the protection provided by safety belts. Even though today's airbags are also designed to help reduce the risk of injury from the force of an inflating bag, all airbags must inflate very quickly to do their job.

Here are the most important things to know about the airbag system:

WARNING

You can be severely injured or killed in a crash if you are not wearing your safety belt — even if you have airbags. Airbags are designed to work with safety belts, but do not replace them. Also, airbags are not designed to deploy in every crash. In some crashes safety belts are your only restraint. See *When Should an Airbag Inflate?* on page 2-25.

Wearing your safety belt during a crash helps reduce your chance of hitting things inside the vehicle or being ejected from it. Airbags are “supplemental restraints” to the safety belts. Everyone in your vehicle should wear a safety belt properly — whether or not there is an airbag for that person.

WARNING

Airbags inflate with great force, faster than the blink of an eye. Anyone who is up against, or very close to, any airbag when it inflates can be seriously injured or killed. Do not sit unnecessarily close to the airbag, as you would be if you were sitting on the edge of your seat or leaning forward. Safety belts help keep you in position before and during a crash. Always wear your safety belt, even with airbags. The driver should sit as far back as possible while still maintaining control of the vehicle.

Occupants should not lean on or sleep against the door or side windows in seating positions with seat-mounted side impact airbags and/or roof-rail airbags.

⚠ WARNING

Children who are up against, or very close to, any airbag when it inflates can be seriously injured or killed. Airbags plus lap-shoulder belts offer protection for adults and older children, but not for young children and infants. Neither the vehicle's safety belt system nor its airbag system is designed for them. Young children and infants need the protection that a child restraint system can provide. Always secure children properly in your vehicle. To read how, see *Older Children on page 2-35* or *Infants and Young Children on page 2-37*.



There is an airbag readiness light on the instrument panel, which shows the airbag symbol.

The system checks the airbag electrical system for malfunctions. The light tells you if there is an electrical problem. See *Airbag Readiness Light on page 4-17* for more information.

Where Are the Airbags?

The driver frontal airbag is in the middle of the steering wheel.

2-24 Seats and Restraints



The right front passenger frontal airbag is in the instrument panel on the passenger side.



**Driver Side shown,
Passenger Side similar**

The seat-mounted side impact airbags for the driver and right front passenger are in the side of the seatbacks closest to the door.



**Driver Side shown,
Passenger Side similar**

If the vehicle has roof-rail airbags for the driver, right front passenger, and second row outboard passengers, they are in the ceiling above the side windows.

 **WARNING**

If something is between an occupant and an airbag, the airbag might not inflate properly or it might force the object into that person causing severe injury or even death. The path of an inflating airbag must be kept clear. Do not put anything between an occupant and an airbag, and do not attach or put anything on the steering wheel hub or on or near any other airbag covering.

Do not use seat accessories that block the inflation path of a seat-mounted side impact airbag.

Never secure anything to the roof of a vehicle with roof-rail airbags by routing a rope or tie down through any door or window opening. If you do, the path of an inflating roof-rail airbag will be blocked.

When Should an Airbag Inflate?

Frontal airbags are designed to inflate in moderate to severe frontal or near-frontal crashes to help reduce the potential for severe injuries mainly to the driver's or right front passenger's head and chest. However, they are only designed to inflate if the impact exceeds a predetermined deployment threshold. Deployment thresholds are used to predict how severe a crash is likely to be in time for the airbags to inflate and help restrain the occupants.

Whether the frontal airbags will or should deploy is not based on how fast your vehicle is traveling. It depends largely on what you hit, the direction of the impact, and how quickly your vehicle slows down.

Frontal airbags may inflate at different crash speeds. For example:

- If the vehicle hits a stationary object, the airbags could inflate at a different crash speed than if the vehicle hits a moving object.
- If the vehicle hits an object that deforms, the airbags could inflate at a different crash speed than if the vehicle hits an object that does not deform.
- If the vehicle hits a narrow object (like a pole), the airbags could inflate at a different crash speed than if the vehicle hits a wide object (like a wall).
- If the vehicle goes into an object at an angle, the airbags could inflate at a different crash speed than if the vehicle goes straight into the object.

Thresholds can also vary with specific vehicle design.

Frontal airbags are not intended to inflate during vehicle rollovers, rear impacts, or in many side impacts.

2-26 Seats and Restraints

In addition, the vehicle has dual-stage frontal airbags. Dual-stage airbags adjust the restraint according to crash severity. Your vehicle has electronic frontal sensors, which help the sensing system distinguish between a moderate frontal impact and a more severe frontal impact. For moderate frontal impacts, dual-stage airbags inflate at a level less than full deployment. For more severe frontal impacts, full deployment occurs.

Your vehicle has seat-mounted side impact airbags. Your vehicle may or may not have roof-rail airbags. See *Airbag System on page 2-21*. Seat-mounted side impact and roof-rail airbags are intended to inflate in moderate to severe side crashes. In addition, these roof-rail airbags are intended to inflate in a severe frontal impact. Seat-mounted side impact and roof-rail airbags will inflate if the crash severity is above

the system's designed threshold level. The threshold level can vary with specific vehicle design.

Seat-mounted side impact airbags are not intended to inflate in frontal impacts, near-frontal impacts, rollovers, or rear impacts. A seat-mounted side impact airbag is intended to deploy on the side of the vehicle that is struck. Roof-rail airbags are intended to deploy on both sides in some high threshold frontal impacts.

In any particular crash, no one can say whether an airbag should have inflated simply because of the damage to a vehicle or because of what the repair costs were. For frontal airbags, inflation is determined by what the vehicle hits, the angle of the impact, and how quickly the vehicle slows down. For seat-mounted side impact and roof-rail airbags, deployment is determined by the location and severity of the side impact.

What Makes an Airbag Inflate?

In a deployment event, the sensing system sends an electrical signal triggering a release of gas from the inflator. Gas from the inflator fills the airbag causing the bag to break out of the cover and deploy. The inflator, the airbag, and related hardware are all part of the airbag module.

Frontal airbag modules are located inside the steering wheel and instrument panel. For vehicles with seat-mounted side impact airbags, there are airbag modules in the side of the front seatbacks closest to the door. For vehicles with roof-rail airbags, there are airbag modules in the ceiling of the vehicle, near the side windows that have occupant seating positions.

How Does an Airbag Restrain?

In moderate to severe frontal or near frontal collisions, even belted occupants can contact the steering wheel or the instrument panel. In moderate to severe side collisions, even belted occupants can contact the inside of the vehicle.

Airbags supplement the protection provided by safety belts. Frontal airbags distribute the force of the impact more evenly over the occupant's upper body, stopping the occupant more gradually. Seat-mounted side impact and roof-rail airbags distribute the force of the impact more evenly over the occupant's upper body.

But airbags would not help in many types of collisions, primarily because the occupant's motion is not toward those airbags. See *When Should an Airbag Inflate?* on page 2-25 for more information.

Airbags should never be regarded as anything more than a supplement to safety belts.

What Will You See After an Airbag Inflates?

After the frontal airbags and seat-mounted side impact airbags inflate, they quickly deflate, so quickly that some people may not even realize an airbag inflated. Roof-rail airbags may still be at least partially inflated for some time after they deploy. Some components of the airbag module may be hot for several minutes. For location of the airbag modules, see *What Makes an Airbag Inflate?* on page 2-26.

The parts of the airbag that come into contact with you may be warm, but not too hot to touch. There may be some smoke and dust coming from the vents in the deflated airbags. Airbag inflation does not prevent the driver from seeing out of the windshield or being able to steer the vehicle, nor does it prevent people from leaving the vehicle.

WARNING

When an airbag inflates, there may be dust in the air. This dust could cause breathing problems for people with a history of asthma or other breathing trouble. To avoid this, everyone in the vehicle should get out as soon as it is safe to do so. If you have breathing problems but cannot get out of the vehicle after an airbag inflates, then get fresh air by opening a window or a door. If you experience breathing problems following an airbag deployment, you should seek medical attention.

The vehicle has a feature that may automatically unlock the doors, turn the interior lamps on, and turn the hazard warning flashers on when the airbags inflate. You can lock the doors, turn the interior lamps off, and turn the hazard warning flashers off by using the controls for those features.

2-28 Seats and Restraints

In many crashes severe enough to inflate the airbag, windshields are broken by vehicle deformation. Additional windshield breakage may also occur from the right front passenger airbag.

- Airbags are designed to inflate only once. After an airbag inflates, you will need some new parts for the airbag system. If you do not get them, the airbag system will not be there to help protect you in another crash. A new system will include airbag modules and possibly other parts. The service manual for your vehicle covers the need to replace other parts.
- The vehicle has a crash sensing and diagnostic module which records information after a crash. See *Vehicle Data Recording and Privacy on page 12-14* and *Event Data Recorders on page 12-14*.
- Let only qualified technicians work on the airbag systems. Improper service can mean that an airbag system will not work properly. See your dealer/retailer for service.

Passenger Sensing System

The vehicle has a passenger sensing system for the right front passenger position. The passenger airbag status indicator will be visible on the overhead console when the vehicle is started.



United States



Canada

The words ON and OFF, or the symbol for on and off, will be visible during the system check.

If you are using remote start to start the vehicle from a distance, if equipped, you may not see the system check. When the system check is complete, either the word ON or OFF, or the symbol for on or off, will be visible. See *Passenger Airbag Status Indicator on page 4-18*.

The passenger sensing system will turn off the right front passenger frontal airbag under certain conditions. The driver airbags and roof-rail airbags (if equipped) are not affected by the passenger sensing system.

The passenger sensing system works with sensors that are part of the right front passenger seat. The sensors are designed to detect the presence of a properly-seated occupant and determine if the right front passenger frontal airbag should be enabled (may inflate) or not.

According to accident statistics, children are safer when properly secured in a rear seat in the correct child restraint for their weight and size.

We recommend that children be secured in a rear seat, including: an infant or a child riding in a rear-facing child restraint; a child riding in a forward-facing child seat; an older child riding in a booster seat; and children, who are large enough, using safety belts.

A label on the sun visor says, "Never put a rear-facing child seat in the front." This is because the risk to the rear-facing child is so great, if the airbag deploys.

 **WARNING**

A child in a rear-facing child restraint can be seriously injured or killed if the right front passenger airbag inflates. This is because the back of the rear-facing child restraint would be very close to the inflating airbag. A child in a forward-facing child restraint can be seriously injured or killed if the right front passenger airbag inflates and the passenger seat is in a forward position.

Even if the passenger sensing system has turned off the right front passenger frontal airbag, no system is fail-safe. No one can guarantee that an airbag will not deploy under some unusual circumstance, even though the airbag is turned off.

(Continued)

WARNING (Continued)

Secure rear-facing child restraints in a rear seat, even if the airbag is off. If you secure a forward-facing child restraint in the right front seat, always move the front passenger seat as far back as it will go. It is better to secure the child restraint in a rear seat.

The passenger sensing system is designed to turn off the right front passenger frontal airbag if:

- The right front passenger seat is unoccupied.
- The system determines that an infant is present in a rear-facing infant seat.
- The system determines that a small child is present in a child restraint.
- The system determines that a small child is present in a booster seat.

2-30 Seats and Restraints

- A right front passenger takes his/her weight off of the seat for a period of time.
- The right front passenger seat is occupied by a smaller person, such as a child who has outgrown child restraints.
- Or, if there is a critical problem with the airbag system or the passenger sensing system.

When the passenger sensing system has turned off the right front passenger frontal airbag, the off indicator will light and stay lit to remind you that the airbag is off. See *Passenger Airbag Status Indicator* on page 4-18.

The passenger sensing system is designed to turn on (may inflate) the right front passenger frontal airbag anytime the system senses that a person of adult size is sitting properly in the right front passenger seat. When the passenger sensing system has allowed the airbag to be enabled, the on indicator will light and stay lit to remind you that the airbag is active.

For some children who have outgrown child restraints and for very small adults, the passenger sensing system may or may not turn off the right front passenger frontal airbag, depending upon the person's seating posture and body build. Everyone in the vehicle who has outgrown child restraints should wear a safety belt properly — whether or not there is an airbag for that person.

WARNING

If the airbag readiness light ever comes on and stays on, it means that something may be wrong with the airbag system. To help avoid injury to yourself or others, have the vehicle serviced right away. See *Airbag Readiness Light* on page 4-17 for more information, including important safety information.

If the On Indicator is Lit for a Child Restraint

If a child restraint has been installed and the on indicator is lit:

1. Turn the vehicle off.
2. Remove the child restraint from the vehicle.
3. Remove any additional items from the seat such as blankets, cushions, seat covers, seat heaters, or seat massagers.

4. Reinstall the child restraint following the directions provided by the child restraint manufacturer and refer to *Securing Child Restraints (Rear Seat)* on page 2-48 or *Securing Child Restraints (Right Front Seat)* on page 2-50.
5. If, after reinstalling the child restraint and restarting the vehicle, the on indicator is still lit, turn the vehicle off. Then slightly recline the vehicle seatback and adjust the seat cushion, if adjustable, to make sure that the vehicle seatback is not pushing the child restraint into the seat cushion.
6. Restart the vehicle.
If the on indicator is still lit, secure the child in the child restraint in a rear seat position in the vehicle, and check with your dealer/retailer.

If the Off Indicator is Lit for an Adult-Size Occupant



If a person of adult-size is sitting in the right front passenger seat, but the off indicator is lit, it could be because that person is not sitting properly in the seat.

If this happens, use the following steps to allow the system to detect that person and enable the right front passenger frontal airbag:

1. Turn the vehicle off.
2. Remove any additional material from the seat, such as blankets, cushions, seat covers, seat heaters, or seat massagers.
3. Place the seatback in the fully upright position.
4. Have the person sit upright in the seat, centered on the seat cushion, with legs comfortably extended.
5. Restart the vehicle and have the person remain in this position for two to three minutes after the on indicator is lit.

2-32 Seats and Restraints

Additional Factors Affecting System Operation

Safety belts help keep the passenger in position on the seat during vehicle maneuvers and braking, which helps the passenger sensing system maintain the passenger airbag status. See “Safety Belts” and “Child Restraints” in the Index for additional information about the importance of proper restraint use.

A thick layer of additional material, such as a blanket or cushion, or aftermarket equipment such as seat covers, seat heaters, and seat massagers can affect how well the passenger sensing system operates. We recommend that you not use seat covers or other aftermarket equipment except when approved by GM for your specific vehicle. See *Adding Equipment to the Airbag-Equipped Vehicle* on

page 2-33 for more information about modifications that can affect how the system operates.

The passenger sensing system may turn on the passenger airbag when liquid soaks into the seat. If this happens, the on indicator will be lit.

If the passenger seat gets wet, dry the seat immediately. If the airbag readiness light is lit, do not install a child restraint or allow anyone to occupy the seat. See *Airbag Readiness Light* on page 4-17 for important safety information.

WARNING

Stowing of articles under the passenger seat or between the passenger seat cushion and seatback may interfere with the proper operation of the passenger sensing system.

Servicing the Airbag-Equipped Vehicle

Airbags affect how the vehicle should be serviced. There are parts of the airbag system in several places around the vehicle. Your dealer/retailer and the service manual have information about servicing the vehicle and the airbag system. To purchase a service manual, see *Service Publications Ordering Information* on page 12-12.

WARNING

For up to 10 seconds after the ignition is turned off and the battery is disconnected, an airbag can still inflate during improper service. You can be injured if you are close to an airbag when it inflates. Avoid yellow connectors. They are probably part of the airbag system. Be sure to follow proper service procedures, and make sure the person performing work for you is qualified to do so.

Adding Equipment to the Airbag-Equipped Vehicle

- Q:** Is there anything I might add to or change about the vehicle that could keep the airbags from working properly?
- A:** Yes. If you add things that change the vehicle's frame, bumper system, height, front end or side sheet metal, they may keep the airbag system from working properly. Changing or moving any parts of the front seats, safety belts, the airbag sensing and diagnostic module, steering wheel, instrument panel, roof-rail airbag modules, ceiling headliner or pillar garnish trim, front sensors, side impact sensors, or airbag wiring can affect the operation of the airbag system.

In addition, the vehicle has a passenger sensing system for the right front passenger position, which includes sensors that are part of the passenger seat. The passenger sensing system may not operate properly if the original seat trim is replaced with non-GM covers, upholstery or trim, or with GM covers, upholstery or trim designed for a different vehicle. Any object, such as an aftermarket seat heater or a comfort enhancing pad or device, installed under or on top of the seat fabric, could also interfere with the operation of the passenger sensing system. This could either prevent proper deployment of the passenger airbag(s) or prevent the passenger sensing system from properly turning off the passenger airbag(s). See *Passenger Sensing System* on page 2-28.

If you have questions, call Customer Assistance. The phone numbers and addresses for Customer Assistance are in Step Two of the Customer Satisfaction Procedure in this manual. See *Customer Satisfaction Procedure* on page 12-1.

- Q:** Because I have a disability, I have to get my vehicle modified. How can I find out whether this will affect my airbag system?

A: If you have questions, call Customer Assistance. The phone numbers and addresses for Customer Assistance are in Step Two of the Customer Satisfaction Procedure in this manual. See *Customer Satisfaction Procedure* on page 12-1.

2-34 Seats and Restraints

In addition, your dealer/retailer and the service manual have information about the location of the airbag sensors, sensing and diagnostic module and airbag wiring.

Airbag System Check

The airbag system does not need regularly scheduled maintenance or replacement. Make sure the airbag readiness light is working. See *Airbag Readiness Light on page 4-17* for more information.

Notice: If an airbag covering is damaged, opened, or broken, the airbag may not work properly. Do not open or break the airbag coverings. If there are any opened or broken airbag covers, have the airbag covering and/or airbag module replaced. For the location of the airbag modules, see *What Makes an Airbag Inflate?* on page 2-26. See your dealer/retailer for service.

Replacing Airbag System Parts After a Crash

WARNING

A crash can damage the airbag systems in your vehicle. A damaged airbag system may not work properly and may not protect you and your passenger(s) in a crash, resulting in serious injury or even death. To help make sure your airbag systems are working properly after a crash, have them inspected and any necessary replacements made as soon as possible.

If an airbag inflates, you will need to replace airbag system parts. See your dealer/retailer for service.

If the airbag readiness light stays on after the vehicle is started or comes on when you are driving, the airbag system may not work properly. Have the vehicle serviced right away. See *Airbag Readiness Light on page 4-17* for more information.

Child Restraints

Older Children



Older children who have outgrown booster seats should wear the vehicle's safety belts.

The manufacturer's instructions that come with the booster seat, state the weight and height limitations for that

booster. Use a booster seat with a lap-shoulder belt until the child passes the below fit test:

- Sit all the way back on the seat. Do the knees bend at the seat edge? If yes, continue. If no, return to the booster seat.
- Buckle the lap-shoulder belt. Does the shoulder belt rest on the shoulder? If yes, continue. If no, try using the rear safety belt comfort guide. See "Rear Safety Belt Comfort Guides" under *Lap-Shoulder Belt* on page 2-16 for more information. If the shoulder belt still does not rest on the shoulder, then return to the booster seat.
- Does the lap belt fit low and snug on the hips, touching the thighs? If yes, continue. If no, return to the booster seat.
- Can proper safety belt fit be maintained for the length of the trip? If yes, continue. If no, return to the booster seat.

Q: What is the proper way to wear safety belts?

A: An older child should wear a lap-shoulder belt and get the additional restraint a shoulder belt can provide. The shoulder belt should not cross the face or neck. The lap belt should fit snugly below the hips, just touching the top of the thighs. This applies belt force to the child's pelvic bones in a crash. It should never be worn over the abdomen, which could cause severe or even fatal internal injuries in a crash.

Also see "Rear Safety Belt Comfort Guides" under *Lap-Shoulder Belt* on page 2-16.

According to accident statistics, children and infants are safer when properly restrained in a child restraint system or infant restraint system secured in a rear seating position.

2-36 Seats and Restraints

In a crash, children who are not buckled up can strike other people who are buckled up, or can be thrown out of the vehicle. Older children need to use safety belts properly.

WARNING

Never do this.

Never allow two children to wear the same safety belt. The safety belt can not properly spread the impact forces. In a crash, the two children can be crushed together and seriously injured. A safety belt must be used by only one person at a time.



WARNING

Never do this.

Never allow a child to wear the safety belt with the shoulder belt behind their back. A child can be seriously injured by not wearing the lap-shoulder belt properly. In a crash, the child would not be restrained by the shoulder belt. The child could move too far

(Continued)

WARNING (Continued)

forward increasing the chance of head and neck injury. The child might also slide under the lap belt. The belt force would then be applied right on the abdomen. That could cause serious or fatal injuries. The shoulder belt should go over the shoulder and across the chest.



Infants and Young Children

Everyone in a vehicle needs protection! This includes infants and all other children. Neither the distance traveled nor the age and size of the traveler changes the need, for everyone, to use safety restraints. In fact, the law in every state in the United States and in every Canadian province says children up to some age must be restrained while in a vehicle.

⚠ WARNING

Children can be seriously injured or strangled if a shoulder belt is wrapped around their neck and the safety belt continues to tighten. Never leave children unattended in a vehicle and never allow children to play with the safety belts.

Airbags plus lap-shoulder belts offer protection for adults and older children, but not for young children and infants. Neither the vehicle's safety belt system nor its airbag system is designed for them. Every time infants and young children ride in vehicles, they should have the protection provided by appropriate child restraints.

Children who are not restrained properly can strike other people, or can be thrown out of the vehicle.

⚠ WARNING

Never do this.
Never hold an infant or a child while riding in a vehicle. Due to crash forces, an infant or a child will become so heavy it is not possible to hold it during a crash.

(Continued)

WARNING (Continued)

For example, in a crash at only 40 km/h (25 mph), a 5.5 kg (12 lb) infant will suddenly become a 110 kg (240 lb) force on a person's arms. An infant should be secured in an appropriate restraint.



2-38 Seats and Restraints

WARNING

Never do this.

Children who are up against, or very close to, any airbag when it inflates can be seriously injured or killed. Never put a rear-facing child restraint in the right front seat. Secure a rear-facing child restraint in a rear seat. It is also better to secure a forward-facing child restraint in a rear seat. If you must secure a forward-facing child restraint in the right front seat, always move the front passenger seat as far back as it will go.



Q: What are the different types of add-on child restraints?

A: Add-on child restraints, which are purchased by the vehicle's owner, are available in four basic types. Selection of a particular restraint should take into consideration not only the child's weight, height, and age but also whether or not the restraint will be compatible with the motor vehicle in which it will be used.

For most basic types of child restraints, there are many different models available. When purchasing a child restraint, be sure it is designed to be used in a motor vehicle. If it is, the restraint will have a label saying that it meets federal motor vehicle safety standards.

The restraint manufacturer's instructions that come with the restraint state the weight and height limitations for a particular child restraint. In addition, there are many kinds of restraints available for children with special needs.

⚠ WARNING

To reduce the risk of neck and head injury during a crash, infants need complete support. This is because an infant's neck is not fully developed and its head weighs so much compared with the rest of its body. In a crash, an infant in a rear-facing child restraint settles into the restraint, so the crash forces can be distributed across the strongest part of an infant's body, the back and shoulders. Infants should always be secured in rear-facing child restraints.

⚠ WARNING

A young child's hip bones are still so small that the vehicle's regular safety belt may not remain low on the hip bones, as it should. Instead, it may settle up around the child's abdomen. In a crash, the belt would apply force on a body area that is unprotected by any bony structure. This alone could cause serious or fatal injuries. To reduce the risk of serious or fatal injuries during a crash, young children should always be secured in appropriate child restraints.

Child Restraint Systems**(A) Rear-Facing Infant Seat**

A rear-facing infant seat (A) provides restraint with the seating surface against the back of the infant.

The harness system holds the infant in place and, in a crash, acts to keep the infant positioned in the restraint.



(B) Forward-Facing Child Seat

A forward-facing child seat (B) provides restraint for the child's body with the harness.

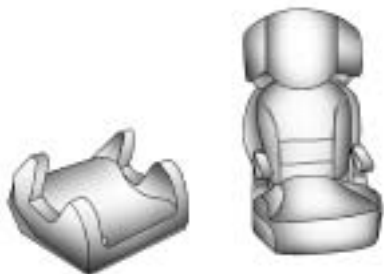

(C) Booster Seats

A booster seat (C) is a child restraint designed to improve the fit of the vehicle's safety belt system. A booster seat can also help a child to see out the window.

Securing an Add-On Child Restraint in the Vehicle

WARNING

A child can be seriously injured or killed in a crash if the child restraint is not properly secured in the vehicle. Secure the child restraint properly in the vehicle using the vehicle's safety belt or LATCH system, following the instructions that came with that child restraint and the instructions in this manual.

To help reduce the chance of injury, the child restraint must be secured in the vehicle. Child restraint systems must be secured in vehicle seats by lap belts or the lap belt portion of a lap-shoulder belt, or by the LATCH system. See *Child Restraint Systems on page 2-39* for more information. Children can be endangered in a crash if the child restraint is not properly secured in the vehicle.

When securing an add-on child restraint, refer to the instructions that come with the restraint which may be on the restraint itself or in a booklet, or both, and to this manual. The child restraint instructions are important, so if they are not available, obtain a replacement copy from the manufacturer.

Keep in mind that an unsecured child restraint can move around in a collision or sudden stop and injure people in the vehicle. Be sure to properly secure any child restraint in the vehicle — even when no child is in it.

Securing the Child Within the Child Restraint

WARNING

A child can be seriously injured or killed in a crash if the child is not properly secured in the child restraint. Secure the child properly following the instructions that came with that child restraint.

Where to Put the Restraint

According to accident statistics, children and infants are safer when properly restrained in a child restraint system or infant restraint system secured in a rear seating position.

We recommend that children and child restraints be secured in a rear seat, including: an infant or a child riding in a rear-facing child restraint; a child riding in a forward-facing child seat; an older child riding in a booster seat; and children, who are large enough, using safety belts.

2-42 Seats and Restraints

A label on the sun visor says, “Never put a rear-facing child restraint in the front.” This is because the risk to the rear-facing child is so great, if the airbag deploys.

WARNING

A child in a rear-facing child restraint can be seriously injured or killed if the right front passenger airbag inflates. This is because the back of the rear-facing child restraint would be very close to the inflating airbag. A child in a forward-facing child restraint can be seriously injured or killed if the right front passenger airbag inflates and the passenger seat is in a forward position.

(Continued)

WARNING (Continued)

Even if the passenger sensing system has turned off the right front passenger frontal airbag, no system is fail-safe. No one can guarantee that an airbag will not deploy under some unusual circumstance, even though it is turned off.

Secure rear-facing child restraints in a rear seat, even if the airbag is off. If you secure a forward-facing child restraint in the right front seat, always move the front passenger seat as far back as it will go. It is better to secure the child restraint in a rear seat.

See *Passenger Sensing System* on page 2-28 for additional information.

When securing a child restraint in a rear seating position, study the instructions that came with the child restraint to make sure it is compatible with this vehicle.

Wherever a child restraint is installed, be sure to secure the child restraint properly.

Keep in mind that an unsecured child restraint can move around in a collision or sudden stop and injure people in the vehicle. Be sure to properly secure any child restraint in the vehicle — even when no child is in it.

Lower Anchors and Tethers for Children (LATCH System)

The LATCH system holds a child restraint during driving or in a crash. This system is designed to make installation of a child restraint easier. The LATCH system uses anchors in the vehicle and attachments on the child restraint that are made for use with the LATCH system.

Make sure that a LATCH-compatible child restraint is properly installed using the anchors, or use the vehicle's safety belts to secure the restraint, following the instructions that came with that restraint, and also the instructions in this manual. When installing a child restraint with

a top tether, you must also use either the lower anchors or the safety belts to properly secure the child restraint. A child restraint must never be installed using only the top tether and anchor.

In order to use the LATCH system in your vehicle, you need a child restraint that has LATCH attachments. The child restraint manufacturer will provide you with instructions on how to use the child restraint and its attachments. The following explains how to attach a child restraint with these attachments in your vehicle.

Not all vehicle seating positions or child restraints have lower anchors and attachments or top tether anchors and attachments.

Lower Anchors

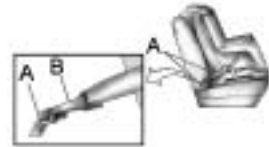

Lower anchors (A) are metal bars built into the vehicle. There are two lower anchors for each LATCH seating position that will accommodate a child restraint with lower attachments (B).

2-44 Seats and Restraints

Top Tether Anchor

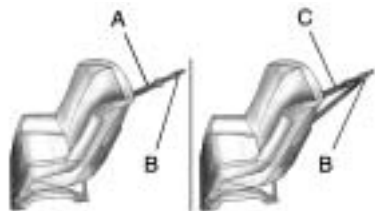

A top tether (A, C) anchors the top of the child restraint to the vehicle. A top tether anchor is built into the vehicle. The top tether attachment (B) on the child restraint connects to the top tether anchor in the vehicle in order to reduce the forward movement and rotation of the child restraint during driving or in a crash.

Your child restraint may have a single tether (A) or a dual tether (C). Either will have a single attachment (B) to secure the top tether to the anchor.

Some child restraints that have a top tether are designed for use with or without the top tether being attached. Others require the top tether always to be attached. In Canada, the law requires that forward-facing child restraints have a top tether, and that the tether be attached. Be sure to read and follow the instructions for your child restraint.

If the child restraint does not have a top tether, one can be obtained, in kit form, for many child restraints. Ask the child restraint manufacturer whether or not a kit is available.

Lower Anchor and Top Tether Anchor Locations

Rear Seat



 **(Top Tether Anchor):** Seating positions with top tether anchors.

 **(Lower Anchor):** Seating positions with two lower anchors.



To assist you in locating the lower anchors, each seating position with lower anchors has two labels, near the crease between the seatback and the seat cushion.



To assist you in locating the top tether anchors, the top tether anchor symbol is located on the cover of the anchor.



The top tether anchors are located on the rear seatback filler panel. Be sure to use an anchor located on the same side of the vehicle as the seating position where the child restraint will be placed.

Do not secure a child restraint in a position without a top tether anchor if a national or local law requires that the top tether be attached, or if the instructions that come with the child restraint say that the top tether must be attached.

According to accidents statistics, children and infants are safer when properly restrained in a child restraint system or infant restraint system secured in a rear seating position. See *Where to Put the Restraint on page 2-41* for additional information.

Securing a Child Restraint Designed for the LATCH System

WARNING

If a LATCH-type child restraint is not attached to anchors, the child restraint will not be able to protect the child correctly. In a crash, the child could be seriously injured or killed. Install a LATCH-type child restraint properly using the anchors, or use the vehicle's safety belts to secure the restraint, following the instructions that came with the child restraint and the instructions in this manual.

WARNING

Do not attach more than one child restraint to a single anchor. Attaching more than one child restraint to a single anchor could cause the anchor or attachment to come loose or even break during a crash. A child or others could be injured. To reduce the risk of serious or fatal injuries during a crash, attach only one child restraint per anchor.

WARNING

Children can be seriously injured or strangled if a shoulder belt is wrapped around their neck and the safety belt continues to tighten. Buckle any unused safety belts behind the child restraint so children cannot reach them. Pull the shoulder belt all the way out of the retractor to set the lock, if your vehicle has one, after the child restraint has been installed.

Notice: Do not let the LATCH attachments rub against the vehicle's safety belts. This may damage these parts. If necessary, move buckled safety belts to avoid rubbing the LATCH attachments.

Do not fold the empty rear seat with a safety belt buckled. This could damage the safety belt or the seat. Unbuckle and return the safety belt to its stowed position, before folding the seat.

1. Attach and tighten the lower attachments to the lower anchors. If the child restraint does not have lower attachments or the desired seating position does not have lower anchors, secure the child restraint with the top tether and the safety belts. Refer to your child restraint manufacturer instructions and the instructions in this manual.
 - 1.1. Find the lower anchors for the desired seating position.
 - 1.2. Put the child restraint on the seat.
 - 1.3. Attach and tighten the lower attachments on the child restraint to the lower anchors.

2. If the child restraint manufacturer recommends that the top tether be attached, attach and tighten the top tether to the top tether anchor, if equipped. Refer to the child restraint instructions and the following steps:
 - 2.1. Find the top tether anchor.
 - 2.2. Route, attach, and tighten the top tether according to your child restraint instructions and the following instructions:



If the position you are using does not have a headrest or head restraint and you are using a single tether, route the tether over the seatback.



If the position you are using does not have a headrest or head restraint and you are using a dual tether, route the tether over the seatback.

3. Push and pull the child restraint in different directions to be sure it is secure.

Replacing LATCH System Parts After a Crash

 **WARNING**

A crash can damage the LATCH system in the vehicle. A damaged LATCH system may not properly secure the child restraint, resulting in serious injury or even death in a crash. To help make sure the LATCH system is working properly after a crash, see your dealer/retailer to have the system inspected and any necessary replacements made as soon as possible.

If the vehicle has the LATCH system and it was being used during a crash, new LATCH system parts may be needed.

New parts and repairs may be necessary even if the LATCH system was not being used at the time of the crash.

Securing Child Restraints (Rear Seat)

When securing a child restraint in a rear seating position, study the instructions that came with the child restraint to make sure it is compatible with this vehicle.

If the child restraint has the LATCH system, see *Lower Anchors and Tethers for Children (LATCH System)* on page 2-43 for how and where to install your child restraint using LATCH. If a child restraint is secured in the vehicle using a safety belt and it uses a top tether, see *Lower Anchors and Tethers for Children (LATCH System)* on page 2-43 for top tether anchor locations.

Do not secure a child restraint in a position without a top tether anchor if a national or local law requires that the top tether be anchored, or if the instructions that come with the child restraint say that the top strap must be anchored.

If the child restraint does not have the LATCH system, you will be using the safety belt to secure the child restraint in this position. Be sure to follow the instructions that came with the child restraint. Secure the child in the child restraint when and as the instructions say.

If more than one child restraint needs to be installed in the rear seat, be sure to read *Where to Put the Restraint* on page 2-41.

1. Put the child restraint on the seat.
2. Pick up the latch plate, and run the lap and shoulder portions of the vehicle's safety belt through or around the restraint. The child restraint instructions will show you how.



3. Push the latch plate into the buckle until it clicks.
Position the release button on the buckle so that the safety belt could be quickly unbuckled if necessary.



4. Pull the rest of the shoulder belt all the way out of the retractor to set the lock.



5. To tighten the belt, push down on the child restraint, pull the shoulder portion of the belt to tighten the lap portion of the belt, and feed the shoulder belt back into the retractor. When installing a forward-facing child restraint, it may be helpful to use your knee to push down on the child restraint as you tighten the belt.

2-50 Seats and Restraints

6. If the child restraint has a top tether, follow the child restraint manufacturer's instructions regarding the use of the top tether. See *Lower Anchors and Tethers for Children (LATCH System)* on page 2-43 for more information.
7. Push and pull the child restraint in different directions to be sure it is secure.

To remove the child restraint, unbuckle the vehicle safety belt and let it return to the stowed position. If the top tether is attached to a top tether anchor, disconnect it.

Securing Child Restraints (Right Front Seat)

This vehicle has airbags. A rear seat is a safer place to secure a forward-facing child restraint. See *Where to Put the Restraint* on page 2-41

In addition, the vehicle has a passenger sensing system which is designed to turn off the right front passenger frontal airbag under certain conditions. See *Passenger Sensing System* on page 2-28 and *Passenger Airbag Status Indicator* on page 4-18 for more information, including important safety information.

A label on the sun visor says, "Never put a rear-facing child seat in the front." This is because the risk to the rear-facing child is so great, if the airbag deploys.

WARNING

A child in a rear-facing child restraint can be seriously injured or killed if the right front passenger airbag inflates. This is because the back of the rear-facing child restraint would be very close to the inflating airbag. A child in a forward-facing child restraint can be seriously injured or killed if the right front passenger airbag inflates and the passenger seat is in a forward position.

Even if the passenger sensing system has turned off the right front passenger frontal airbag, no system is fail-safe. No one can guarantee that an airbag will not deploy under some unusual circumstance, even though it is turned off.

(Continued)

WARNING (Continued)

Secure rear-facing child restraints in a rear seat, even if the airbag is off. If you secure a forward-facing child restraint in the right front seat, always move the front passenger seat as far back as it will go. It is better to secure the child restraint in a rear seat.

See *Passenger Sensing System* on page 2-28 for additional information.

If the child restraint has the LATCH system, see *Lower Anchors and Tethers for Children (LATCH System)* on page 2-43 for how and

where to install the child restraint using LATCH. If a child restraint is secured using a safety belt and it uses a top tether, see *Lower Anchors and Tethers for Children (LATCH System)* on page 2-43 for top tether anchor locations.

Do not secure a child seat in a position without a top tether anchor if a national or local law requires that the top tether be anchored, or if the instructions that come with the child restraint say that the top strap must be anchored.

In Canada, the law requires that forward-facing child restraints have a top tether, and that the tether be attached.

You will be using the lap-shoulder belt to secure the child restraint in this position. Follow the instructions that came with the child restraint.

1. Move the seat as far back as it will go before securing the forward-facing child restraint.

When the passenger sensing system has turned off the right front passenger frontal airbag, the off indicator on the passenger airbag status indicator should light and stay lit when the vehicle is started. See *Passenger Airbag Status Indicator* on page 4-18.

2. Put the child restraint on the seat.

If the seat has a safety belt guide, remove the safety belt from the guide by unsnapping the guide on the seat. Do not secure the child restraint with the safety belt routed through the guide.

2-52 Seats and Restraints

3. Pick up the latch plate, and run the lap and shoulder portions of the vehicle's safety belt through or around the restraint. The child restraint instructions will show you how.



4. Push the latch plate into the buckle until it clicks.
Position the release button on the buckle, so that the safety belt could be quickly unbuckled if necessary.



5. Pull the rest of the shoulder belt all the way out of the retractor to set the lock.



6. To tighten the belt, push down on the child restraint, pull the shoulder portion of the belt to tighten the lap portion of the belt and feed the shoulder belt back into the retractor. When installing a forward-facing child restraint, it may be helpful to use your knee to push down on the child restraint as you tighten the belt.
7. Push and pull the child restraint in different directions to be sure it is secure.

If the airbag is off, the off indicator in the passenger airbag status indicator will come on and stay on when the vehicle is started.

If a child restraint has been installed and the on indicator is lit, see “If the On Indicator is Lit for a Child Restraint” under *Passenger Sensing System on page 2-28* for more information.

To remove the child restraint, unbuckle the vehicle safety belt and let it return to the stowed position.

If the seat has a safety belt guide, return the safety belt into the guide by snapping the guide around the webbing.

Storage

Storage Compartments

Glove Box	3-1
Center Console Storage	3-1

Additional Storage Features

Convenience Net	3-1
-----------------------	-----

Storage Compartments

Glove Box

Open the glove box by lifting up on the lever. Use the key to lock and unlock the glove box.

Center Console Storage

To open, lift the latch on the front edge.

There is an Accessory Power Outlet (APO) and an optional USB/audio jack located in the storage area. See *Power Outlets on page 4-9* and *Auxiliary Devices on page 6-16* for more information.

Additional Storage Features

Convenience Net

For vehicles with a convenience net located inside the trunk, it can be used to secure loose items.

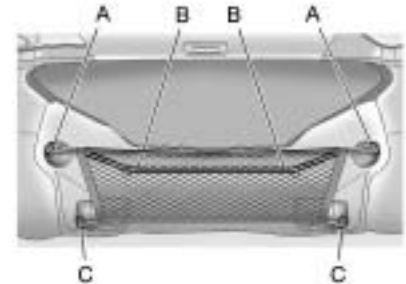

The upper (A) and lower (C) hooks on each side of the trunk opening are provided to attach the net.

Install the opening of the net at the top and over the two middle hooks (B).

Instruments and Controls

Instrument Panel Overview

Instrument Panel Overview4-4

Controls

Steering Wheel Adjustment4-6
 Steering Wheel Controls4-6
 Horn4-7
 Windshield Wiper/Washer4-7
 Compass4-8
 Clock4-8
 Power Outlets4-9

Warning Lights, Gages, and Indicators

Warning Lights, Gages, and Indicators4-9
 Instrument Cluster4-10
 Speedometer4-11
 Odometer4-11
 Trip Odometer4-11
 Tachometer4-11
 Fuel Gage4-11
 Engine Oil Pressure Gage4-12

Engine Oil
 Temperature Gage4-13
 Engine Coolant
 Temperature Gage4-14
 Transmission
 Temperature Gage4-14
 Voltmeter Gage4-15
 Safety Belt Reminders4-16
 Airbag Readiness Light4-17
 Passenger Airbag Status
 Indicator4-18
 Charging System Light4-19
 Malfunction
 Indicator Lamp4-19
 Brake System Warning
 Light4-22
 Antilock Brake System
 (ABS) Warning Light4-23
 Traction Off Light4-23
 Traction Control System
 (TCS)/StabiliTrak[®] Light4-24
 Traction Control System
 (TCS) OFF/StabiliTrak[®] OFF
 Light4-24
 Tire Pressure Light4-24
 Engine Oil Pressure Light4-25
 Immobilizer Light4-26
 Fog Lamp Light4-26
 Taillamp Indicator Light4-26
 Cruise Control Light4-26

Information Displays

Driver Information
 Center (DIC)4-27

Vehicle Messages

Battery Voltage and
 Charging Messages4-30
 Brake System Messages4-31
 Compass Messages4-31
 Cruise Control Messages4-31
 Door Ajar Messages4-31
 Engine Cooling System
 Messages4-32
 Engine Oil Messages4-32
 Engine Power Messages4-33
 Fuel System Messages4-33
 Key and Lock Messages4-33
 Lamp Messages4-33
 Object Detection System
 Messages4-34
 Ride Control System
 Messages4-34
 Airbag System Messages4-35
 Safety Belt Messages4-35
 Anti-Theft Alarm System
 Messages4-35
 Service Vehicle Messages4-35
 Tire Messages4-36
 Transmission Messages4-36
 Vehicle Reminder
 Messages4-37

4-2 Instruments and Controls

Vehicle Speed Messages	4-37
Vehicle Messages	4-37
Window Messages	4-37

Vehicle Personalization

Vehicle Personalization	4-38
-------------------------------	------

OnStar System

OnStar® System	4-42
----------------------	------

Universal Remote System

Universal Remote System	4-45
Universal Remote System Programming	4-45
Universal Remote System Operation	4-48

Instrument Panel Overview

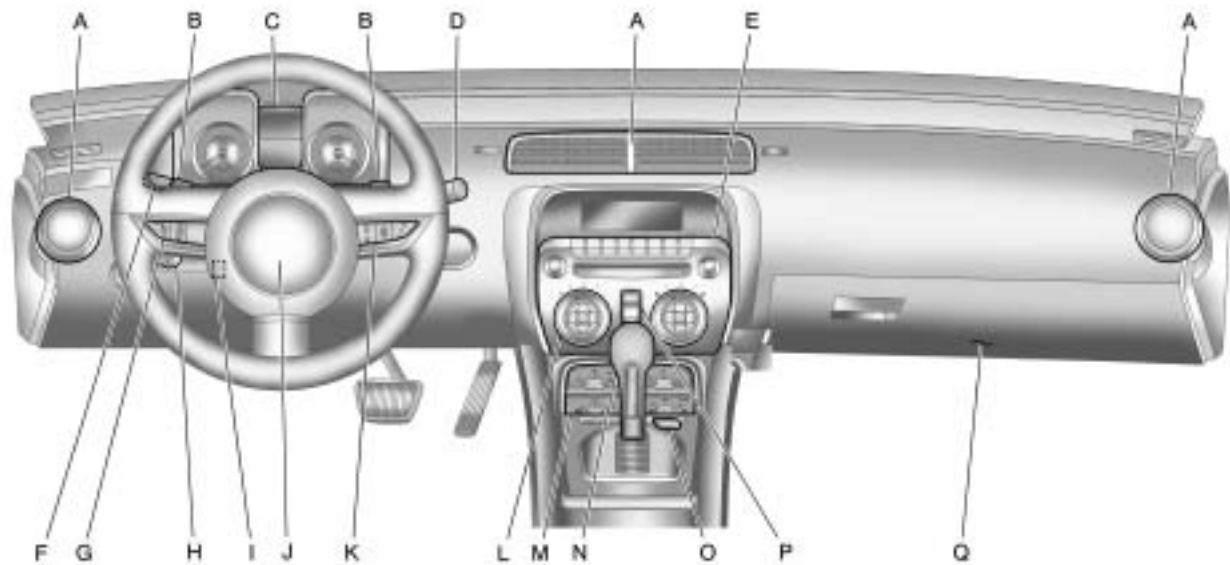

- A. *Air Vents on page 7-3.*
- B. *Driver Shift Controls (If Equipped). See Automatic Transmission on page 8-26.*
- C. *Instrument Cluster on page 4-10.*
- D. *Windshield Wiper/Washer on page 4-7.*
- E. *AM-FM Radio on page 6-8.*
- F. *Turn and Lane-Change Signals on page 5-4. Headlamp High/Low-Beam Changer on page 5-2. Flash-to-Pass on page 5-3. Driver Information Center (DIC) on page 4-27 (If Equipped).*
- G. *Cruise Control on page 8-38.*
- H. *Exterior Lamp Controls on page 5-1. Front Fog Lamps on page 5-5 (If Equipped). Instrument Panel Illumination Control on page 5-5.*
- I. *Steering Wheel Adjustment on page 4-6.*
- J. *Horn on page 4-7.*
- K. *Steering Wheel Controls on page 4-6.*
- L. *Climate Control Systems on page 7-1.*
- M. *Transmission Temperature Gage on page 4-14. Voltmeter Gage on page 4-15. Engine Oil Temperature Gage on page 4-13. Engine Oil Pressure Gage on page 4-12.*
- N. *Shift Lever. See Shifting Into Park on page 8-21.*
- O. *Power Outlets on page 4-9.*
- P. *Hazard Warning Flashers on page 5-4. Power Door Locks on page 1-7.*
- Q. *Glove Box on page 3-1.*

Controls

Steering Wheel Adjustment

A tilt and telescope wheel lets the steering wheel be adjusted.



The lever is on the outboard side of the steering column.

To adjust the steering wheel, pull the lever down. Then move the steering wheel up or down or



backward or forward into a comfortable position. Pull the lever up to lock the steering wheel in place.



Do not adjust the tilt lever while driving.

Steering Wheel Controls



For vehicles with audio steering wheel controls, some audio controls can be adjusted at the steering wheel.

 /  (**Push to Talk**): For vehicles with OnStar® or Bluetooth® systems, press to interact with those systems. See *OnStar® System on page 4-42* and *Bluetooth (Overview) on page 6-22* or *Bluetooth (Infotainment Controls) on page 6-23* or *Bluetooth (Voice Recognition) on page 6-26* for more information.

 /  (**End Call / Mute**): Press to reject an incoming call, or end a current call. Press to silence the vehicle speakers while using the infotainment system. Press again to turn the sound on.

 **SRC**  (**Toggle Switch**): Press to select an audio source.

Toggle up or down to select the next or previous favorite radio station or CD/MP3 track.

+  - (**Volume**): Press + or - to increase or decrease the volume.

Horn

Press near or on the horn symbols on the steering wheel pad to sound the horn.

Windshield Wiper/Washer

The windshield wiper/washer lever is located on the inboard side of the steering column.



Push up or pull down on the lever to place it in one of the following positions.

 **(Mist):** For a single wiping cycle. The lever returns to its starting position when released. For more cycles, hold the lever down before releasing it.

 **(Off):** Turns the wipers off.

-- **(Intermittent):** Move the lever to choose a delayed wiping cycle.

For vehicles with the variable intermittent feature, the time between wipes can be adjusted.

Turn the  band for a longer or shorter delay interval.

— **(Low):** Slow wipes.

== **(High):** Fast wipes.

Windshield Washer: Pull the lever toward you to spray washer fluid on the windshield. The spray continues until the lever is released. The wipers will run a few times. See *Washer Fluid* on page 9-26 for information on filling the windshield washer fluid reservoir.

WARNING

In freezing weather, do not use your washer until the windshield is warmed. Otherwise the washer fluid can form ice on the windshield, blocking your vision.

Clear ice and snow from the wiper blades before using them. If the wiper blades are frozen to the windshield, gently loosen or thaw them. If they become damaged, install new blades or blade inserts. See *Wiper Blade Replacement* on page 9-33.

Heavy snow or ice can overload the wiper motor. A circuit breaker will stop the motor until it cools down.

Compass

The vehicle may have a compass display on the Driver Information Center (DIC). The compass is an OnStar compass and receives its heading and other information from OnStar. See *OnStar® System on page 4-42* for more information about the OnStar system.

Clock

The infotainment system controls are used to access the time and date settings through the menu system. See *Operation on page 6-4* for information about how to use the menu system.

Setting the Time and Date

1. Press the CONFIG button.
2. Select Time and Date Settings.
3. Select Set Time or Set Date.
4. Turn the MENU/SELECT knob to adjust the highlighted value.
5. Press the MENU/SELECT knob to select the next value.
6. To save the time or date and return to the Time and Date Settings menu, press the  BACK button at any time or press MENU/SELECT knob after adjusting the minutes or year.

Setting the 12/24 Hour Format

1. Press the CONFIG button.
2. Select Time and Date Settings.
3. Highlight 12/24 Hour Format.
4. Press the MENU/SELECT knob to select the 12 hour or 24 hour display format.

Setting the Month & Day Format

1. Press the CONFIG button.
2. Select Time and Date Settings.
3. Highlight Month & Day Format.
4. Press the MENU/SELECT knob to select MM/DD (month/day) or DD/MM (day/month).

Setting the Auto Time Adjust

1. Press the CONFIG button.
2. Select Time and Date Settings.
3. Highlight Auto Time Adjust.
4. Press the MENU/SELECT knob to turn Auto Time Adjust on or off.

Power Outlets

The vehicle has two accessory power outlets; one is located below the climate control system and the other is inside the center storage console.

The accessory power outlets do not work when the key is removed from the ignition and the driver door is opened, this helps to preserve the battery life of the vehicle.

Certain power accessory plugs may not be compatible to the accessory power outlet and could result in blown vehicle or adapter fuses. If you experience a problem, see your dealer/retailer for additional information on the accessory power plugs.

Notice: Adding any electrical equipment to the vehicle can damage it or keep other components from working as they should. The repairs would not be covered by the vehicle warranty. Each outlet is rated to a maximum output of 120W. Usage of equipment exceeding an amperage rating of 20A may require fuse replacement. Check with your dealer/retailer before adding electrical equipment.

When adding electrical equipment, be sure to follow the proper installation instructions included with the equipment.

Notice: Improper use of the power outlet can cause damage not covered by the warranty. Do not hang any type of accessory or accessory bracket from the plug because the power outlets are designed for accessory power plugs only.

Warning Lights, Gages, and Indicators

Warning lights come on when there could be a problem with a vehicle function. Some warning lights come on briefly when the engine is started to indicate they are working.

Gages can indicate when there could be a problem with a vehicle function. Often gages and warning lights work together to indicate a problem with the vehicle.

When one of the warning lights comes on and stays on while driving, or when one of the gages shows there may be a problem, check the section that explains what to do. Follow this manual's advice. Waiting to do repairs can be costly and even dangerous.

Instrument Cluster



United States Uplevel Automatic Transmission Shown, Canada and Manual Transmission similar

Speedometer

The speedometer shows the vehicle's speed in both kilometers per hour (km/h) and miles per hour (mph).

Odometer

The odometer shows how far the vehicle has been driven, in either kilometers or miles.

This vehicle has a tamper-resistant odometer. If the vehicle needs a new odometer installed, the new one is set to the mileage of the old odometer. If this is not possible, it is set at zero and a label is put on the driver's door to show the old mileage reading.

Trip Odometer

The trip odometer shows how far the vehicle has been driven since the trip odometer was last set to zero.

Set the odometer using the Driver Information Center (DIC).

To set the trip odometer to zero, press and hold the SET button while the trip odometer display is showing.

Tachometer

The tachometer displays the engine speed in revolutions per minute (rpm).

Fuel Gage

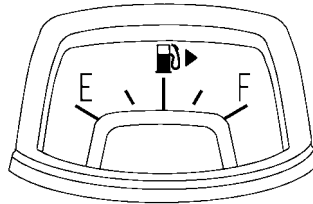

United States

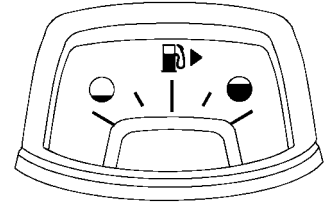

Canada

When the ignition is on, the fuel gage shows about how much fuel the vehicle has left in the fuel tank.

An arrow on the fuel gage indicates which side of the vehicle the fuel door is located.

The gage indicates empty before the vehicle is out of fuel, to show that the vehicle's fuel tank should be filled soon.

4-12 Instruments and Controls

When the fuel tank is low on fuel, a Fuel Level Low message will appear on the Driver Information Center (DIC). For more information see *Fuel System Messages* on page 4-33.

Here are some situations that can occur with the fuel gage. None of these indicate a problem with the fuel gage.

- At the gas station, the fuel pump shuts off before the gage reads full.
- It takes a little more or less fuel to fill up than the fuel gage indicated. For example, the gage may have indicated the tank was half full, but it actually took a little more or less than half the tank's capacity to fill the tank.
- The pointer on the fuel gage is on empty when the ignition is off.

Engine Oil Pressure Gauge

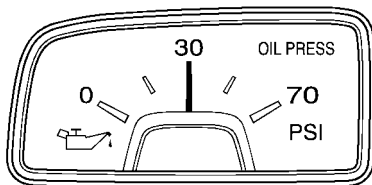

United States

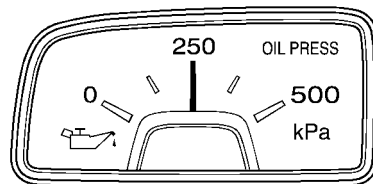

Canada

The oil pressure gage, located in front of the shifter, shows the engine oil pressure in psi (pounds per square inch) when the engine is running. Canadian vehicles indicate pressure in kPa (kilopascals).

Oil pressure may vary with engine speed, outside temperature and oil viscosity, but readings above the low pressure zone indicate the normal operating range. When the oil pressure reaches the low pressure zone, a message appears in the Driver Information Center (DIC).

See *Engine Oil Messages* on page 4-32 and *Engine Oil* on page 9-10 for more information.

WARNING

Do not keep driving if the oil pressure is low. The engine can become so hot that it catches fire. Someone could be burned. Check the oil as soon as possible and have the vehicle serviced.

Notice: Lack of proper engine oil maintenance can damage the engine. The repairs would not be covered by the vehicle warranty. Always follow the maintenance schedule in this manual for changing engine oil.

A reading in the low pressure zone can be caused by a dangerously low oil level or some other problem causing low oil pressure. Check the oil as soon as possible.

Engine Oil Temperature Gage

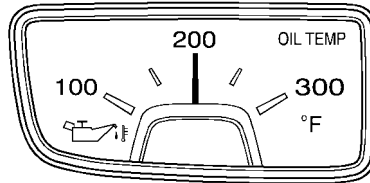

United States

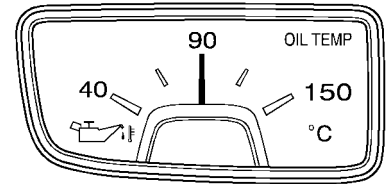

Canada

This gage, located in front of the shifter, shows the engine oil temperature.

If the gage pointer moves into the red area, it means that the engine oil has overheated. If the vehicle has been operated under normal driving conditions, pull off the road, stop the vehicle and turn off the engine as soon as possible.

See *Engine Oil* on page 9-10 for more information.

Engine Coolant Temperature Gage

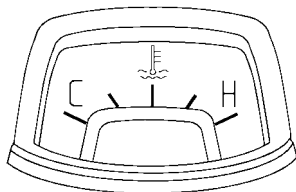

United States

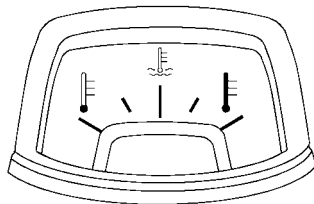

Canada

This gage shows the engine coolant temperature.

If the gage pointer moves towards the H, the engine is too hot.

This reading indicates the same thing as the warning message. It means that the engine coolant has overheated. If the vehicle has been operating under normal driving conditions, pull off the road, stop the vehicle, and turn off the engine as soon as possible. See *Engine Overheating* on page 9-24 for more information.

Transmission Temperature Gage

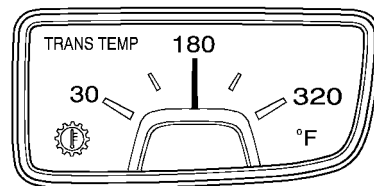

United States

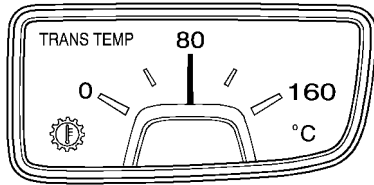

Canada

This gage, located in front of the shifter, shows the transmission oil temperature when the ignition is on. If the gage is reading in the red area and/or a message appears in the DIC, the vehicle must be stopped and the cause checked. One possible cause is a low level in the transmission.

For information on the DIC messages see *Transmission Messages on page 4-36*.

Notice: If the vehicle is driven with the transmission temperature gage above the normal operating range, the transmission can be damaged. This could lead to costly repairs that would not be covered by the vehicle warranty. Do not drive the vehicle while the transmission temperature gage reading is above normal. See your dealer/retailer for service.

Voltmeter Gage

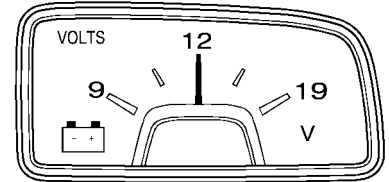

United States Version Shown, Canada Similar

This gage, located in front of the shifter, shows the battery's state of charge in DC volts.

When the engine is running, but the ignition is on, this gage shows the condition of the charging system. The vehicle's charging system regulates voltage based on the state of charge of the battery. It is normal for the voltmeter to fluctuate.

4-16 Instruments and Controls

Readings between the low and high warning zones indicate the normal operating range.

Readings in the low warning zone can occur when a large number of electrical accessories are operating in the vehicle and the engine is left idling for an extended period.

If there is a problem with the battery charging system, a message appears in the Driver Information Center (DIC) and/or the charging system light comes on. See *Battery Voltage and Charging Messages on page 4-30* and *Charging System Light on page 4-19* for more information.

However, readings in either warning zone can indicate a possible problem in the electrical system. Have the vehicle serviced as soon as possible.

Safety Belt Reminders

Driver Safety Belt Reminder Light

There is a driver safety belt reminder light on the instrument panel cluster.



When the engine is started this light and a chime come on and stay on for several seconds to remind drivers to fasten their safety belts. The light also begins to flash.

This cycle repeats if the driver remains unbuckled and the vehicle is moving.

If the driver safety belt is already buckled, neither the light nor chime come on.

Passenger Safety Belt Reminder Light



The passenger safety belt reminder light is located on the overhead console.

When the engine is started, this light and the chime come on and stay on for several seconds to remind the passenger to fasten their safety belt. The light also begins to flash.

This cycle repeats if the passenger remains unbuckled and the vehicle is moving.

If the passenger safety belt is buckled, neither the chime nor the light comes on.

The front passenger safety belt warning light and chime may turn on if an object is put on the seat such as a briefcase, handbag, grocery bag, laptop or other electronic device. To turn off the warning light and or chime, remove the object from the seat or buckle the safety belt

Airbag Readiness Light

This light shows if there is an electrical problem. The system check includes the airbag sensor, the pretensioners, the airbag modules, the wiring and the crash sensing and diagnostic module.

For more information on the airbag system, see *Airbag System on page 2-21*.



The airbag readiness light comes on and stays on for several seconds when the vehicle is started. Then the light goes out.

If it stays on after the vehicle has been started or comes on while driving, the airbag system may not work properly. Have the vehicle serviced right away.

WARNING

If the airbag readiness light stays on after the vehicle is started or comes on while driving, it means the airbag system might not be working properly. The airbags in the vehicle might not inflate in a crash, or they could even inflate without a crash. To help avoid injury, have the vehicle serviced right away.

4-18 Instruments and Controls

Passenger Airbag Status Indicator

The vehicle has a passenger sensing system. See *Passenger Sensing System on page 2-28* for important safety information. The overhead console has a passenger airbag status indicator.



United States



Canada

When the vehicle is started, the passenger airbag status indicator will light ON and OFF, or the symbol for on and off, for several seconds as a system check. If you are using remote start to start your vehicle from a distance, if equipped, you may not see the system check. Then, after several seconds, the status indicator will light either ON or OFF, or either the on or off symbol to let you know the status of the right front passenger frontal airbag.

If the word ON or the on symbol is lit on the passenger airbag status indicator, it means that the right front passenger frontal airbag is enabled (may inflate).

If the word OFF or the off symbol is lit on the passenger airbag status indicator, it means that the passenger sensing system has turned off the right front passenger frontal airbag.

If, after several seconds, both status indicator lights remain on, or if there are no lights at all, there may be a problem with the lights or the passenger sensing system. See your dealer/retailer for service.

WARNING

If the airbag readiness light ever comes on and stays on, it means that something may be wrong with the airbag system. To help avoid injury to yourself or others, have the vehicle serviced right away. See *Airbag Readiness Light on page 4-17* for more information, including important safety information.

Charging System Light

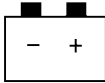

The charging system light comes on briefly when the ignition is turned on but the engine is not running, as a check to show the light is working. It should go out when the engine is started.

If the light stays on, or comes on while driving, there may be a problem with the electrical charging system. Have it checked by your dealer/retailer. Driving while this light is on could drain the battery.

When this light comes on, the Driver Information Center (DIC) also displays a message.

See *Battery Voltage and Charging Messages on page 4-30*.

If a short distance must be driven with the light on, be sure to turn off all accessories, such as the radio and air conditioner.

Malfunction Indicator Lamp

Check Engine Light

A computer system called OBD II (On-Board Diagnostics-Second Generation) monitors operation of the fuel, ignition, and emission control systems. It ensures that emissions are at acceptable levels for the life of the vehicle, helping to produce a cleaner environment.



This light comes on when the ignition is on, but the engine is not running, as a check to show it

is working. If it does not, have the vehicle serviced by your dealer/retailer.

If the check engine light comes on and stays on, while the engine is running, this indicates that there is an OBD II problem and service is required.

Malfunctions often are indicated by the system before any problem is apparent. Being aware of the light can prevent more serious damage to the vehicle. This system assists the service technician in correctly diagnosing any malfunction.

Notice: If the vehicle is continually driven with this light on, after a while, the emission controls might not work as well, the vehicle's fuel economy might not be as good, and the engine might not run as smoothly. This could lead to costly repairs that might not be covered by the vehicle warranty.

4-20 Instruments and Controls

Notice: Modifications made to the engine, transmission, exhaust, intake, or fuel system of the vehicle or the replacement of the original tires with other than those of the same Tire Performance Criteria (TPC) can affect the vehicle's emission controls and can cause this light to come on. Modifications to these systems could lead to costly repairs not covered by the vehicle warranty. This could also result in a failure to pass a required Emission Inspection/Maintenance test. See *Accessories and Modifications on page 9-3*.

This light comes on during a malfunction in one of two ways:

Light Flashing: A misfire condition has been detected. A misfire increases vehicle emissions and could damage the emission control system on the vehicle. Diagnosis and service might be required.

The following can prevent more serious damage to the vehicle:

- Reduce vehicle speed.
- Avoid hard accelerations.
- Avoid steep uphill grades.

If the light continues to flash, when it is safe to do so, stop the vehicle. Find a safe place to park the vehicle. Turn the engine off, wait at least 10 seconds, and restart the engine. If the light is still flashing, follow the previous steps and see your dealer/retailer for service as soon as possible.

Light On Steady: An emission control system malfunction has been detected on the vehicle. Diagnosis and service might be required.

An emission system malfunction might be corrected by:

- Make sure the fuel cap is fully installed. See *Filling the Tank on page 8-46*. The diagnostic system can determine if the fuel cap has been left off or improperly installed. A loose or missing fuel cap allows fuel to evaporate into the atmosphere. A few driving trips with the cap properly installed should turn the light off.
- If the vehicle has been driven through a deep puddle of water, the vehicle's electrical system might be wet. The condition is usually corrected when the electrical system dries out. A few driving trips should turn the light off.

- Make sure to fuel the vehicle with quality fuel. Poor fuel quality causes the engine not to run as efficiently as designed and can cause: stalling after start-up, stalling when the vehicle is changed into gear, misfiring, hesitation on acceleration, or stumbling on acceleration. These conditions might go away once the engine is warmed up.

If one or more of these conditions occurs, change the fuel brand used. It will require at least one full tank of the proper fuel to turn the light off.

See *Gasoline Specifications* on page 8-44.

If none of the above have made the light turn off, your dealer/retailer can check the vehicle. The dealer/retailer has the proper test equipment and diagnostic tools to fix any mechanical or electrical problems that might have developed.

Emissions Inspection and Maintenance Programs

Some state/provincial and local governments have or might begin programs to inspect the emission control equipment on the vehicle. Failure to pass this inspection could prevent getting a vehicle registration.

Here are some things to know to help the vehicle pass an inspection:

- The vehicle will not pass this inspection if the check engine light is on with the engine running, or if the key is in ON/RUN and the light is not on.
- The vehicle will not pass this inspection if the OBD II (on-board diagnostic) system determines that critical emission control systems have not been completely diagnosed by the system. The vehicle would be considered not ready for

inspection. This can happen if the battery has recently been replaced or if the battery has run down. The diagnostic system is designed to evaluate critical emission control systems during normal driving. This can take several days of routine driving. If this has been done and the vehicle still does not pass the inspection for lack of OBD II system readiness, your dealer/retailer can prepare the vehicle for inspection.

4-22 Instruments and Controls

Brake System Warning Light

The vehicle's hydraulic brake system is divided into two parts. If one part is not working, the other part can still work and stop the vehicle. For good braking both parts need to work well.

If the warning light comes on, there is a brake problem. Have the brake system inspected right away.

BRAKE



United States

Canada

If the vehicle has antilock brakes, this light should come on when the key is turned to START. If it does not come on, have it fixed so it will be ready to warn if there is a problem.

When the ignition is on, the brake system warning light also comes on when parking brake is set. The light stays on if the parking brake does not fully release. If it stays on after the parking brake is fully released, it means the vehicle has a brake problem.

If, while driving, the light comes on and a brake message comes on the Driver Information Center (DIC), pull off the road and stop carefully. The pedal could be harder to push or the pedal can go closer to the floor. It could take longer to stop. If the light is still on, have the vehicle towed for service. See *Antilock Brake System (ABS) Warning Light on page 4-23* and *Driving Characteristics and Towing Tips on page 8-49*.

WARNING

The brake system might not be working properly if the brake system warning light is on. Driving with the brake system warning light on can lead to a crash. If the light is still on after the vehicle has been pulled off the road and carefully stopped, have the vehicle towed for service.

The Brake message remains on until the menu button is pressed. The brake light remains until the problem is fixed. See *Brake System Messages on page 4-31* for more information.

Antilock Brake System (ABS) Warning Light



The Antilock Brake System (ABS) light comes on briefly when the engine is started.

If the light does not come on, have it fixed so it will be ready to warn if there is a problem.

If the ABS light stays on, turn the ignition off.

If the light comes on while driving, stop as soon as it is safely possible and turn the ignition off. Then start the engine again to reset the system.

If the ABS light stays on, or comes on again while driving, the vehicle needs service. A chime may also sound when the light comes on steady.

If the ABS light is the only light on, the vehicle has regular brakes, but the antilock brakes are not functioning.

If both lights are on, the vehicle's antilock brakes are not functioning and there is a problem with the regular brakes. See your dealer/retailer for service.

See *Brake System Warning Light on page 4-22*.

See *Brake System Messages on page 4-31* for all brake related DIC messages.

Traction Off Light



This light comes on when the Traction Control System (TCS) has been turned off by pressing and releasing the traction control button.

This light also comes on and the system turns off if there is a problem with the TCS.

If the light comes on and stays on for an extended period of time while the system is turned on, the vehicle needs service.

See *Traction Control System (TCS) on page 8-34* and *StabiliTrak System on page 8-36* for more information.

Traction Control System (TCS)/StabiliTrak[®] Light



The StabiliTrak system or the Traction Control System (TCS) indicator/warning light comes on briefly while starting the engine.

If it does not, have the vehicle serviced by your dealer/retailer. If the system is working normally the indicator light will then go off.

The indicator/warning light flashes while the StabiliTrak or TCS system is working to control the vehicle on a low traction surface.

If the TCS indicator/warning light comes on and stays on while driving, the vehicle needs service.

See *Competitive Driving Mode on page 8-37*, *Traction Control System (TCS) on page 8-34* and *StabiliTrak System on page 8-36* for more information

Traction Control System (TCS) OFF/StabiliTrak[®] OFF Light



This light comes on when the StabiliTrak system is turned off. If the Traction Control System (TCS) is off, wheel spin is not limited. If the StabiliTrak system is off, the system does not assist in controlling the vehicle. Turn on the TCS and the StabiliTrak system and the warning light turns off.

For SS models, if this light is on, the vehicle is in Competitive Mode. A warning also appears in the DIC for StabiliTrak Competitive Mode. See *Ride Control System Messages on page 4-34* for more information.

See *Traction Control System (TCS) on page 8-34* and *StabiliTrak System on page 8-36* for more information

Tire Pressure Light



For vehicles with a tire pressure light, this light comes on briefly when the engine is started and provides information about tire pressures and the Tire Pressure Monitoring System.

When the Light is On Steady

This indicates that one or more of the tires are significantly underinflated.

A tire pressure message in the Driver Information Center (DIC), can accompany the light. See *Tire Messages on page 4-36* for more information. Stop and check the tires as soon as it is safe to do so.

If underinflated, inflate to the proper pressure. See *Tire Pressure on page 9-54* for more information.

When the Light Flashes First and Then is On Steady

This indicates that there may be a problem with the Tire Pressure Monitor System. The light flashes for about a minute and stays on steady for the remainder of the ignition cycle. This sequence repeats with every ignition cycle. See *Tire Pressure Monitor Operation on page 9-57* for more information.

Engine Oil Pressure Light

WARNING

Do not keep driving if the oil pressure is low. The engine can become so hot that it catches fire. Someone could be burned. Check the oil as soon as possible and have the vehicle serviced.

Notice: Lack of proper engine oil maintenance can damage the engine. The repairs would not be covered by the vehicle warranty. Always follow the maintenance schedule in this manual for changing engine oil.

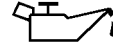

The oil pressure light should come on briefly as the engine is started. If it does not come on have the vehicle serviced by your dealer/retailer.

If the light comes on and stays on, it means that oil is not flowing through the engine properly. The vehicle could be low on oil and might have some other system problem. See your dealer/retailer.

Immobilizer Light



The immobilizer light should come on briefly as the engine is started. If it does not come on have the vehicle serviced by your dealer/retailer. If the system is working normally the indicator light will go off.

This light comes on when the ignition is turned from OFF to ON and stays on if the vehicle is immobilized. This happens when an incorrect key or an unprogrammed key is used to start the vehicle.

If the light stays on and the engine does not start, there could be a problem with the theft-deterrent system. See *Immobilizer Operation on page 1-11* for more information.

Fog Lamp Light



The fog lamp light comes on when the fog lamps are in use.

The light goes out when the fog lamps are turned off. See *Front Fog Lamps on page 5-5* for more information.

Taillamp Indicator Light



This light comes on when the taillamps are on.

Cruise Control Light



This light is white when the cruise control is set and will be green when the system is active.

The light goes out when the cruise control is turned off. See *Cruise Control on page 8-38* for more information.

Information Displays

Driver Information Center (DIC)

The vehicle may have a Driver Information Center (DIC). The DIC displays information about your vehicle. It also displays warning messages if a system problem is detected. See *Vehicle Messages on page 4-37* for more information. All messages appear in the DIC display located in the center of the instrument panel cluster.

The vehicle may also have features that can be customized through the controls on the radio. See *Vehicle Personalization on page 4-38* for more information.

DIC Operation and Displays

The DIC has different displays which can be accessed by using the DIC buttons located on the turn signal lever located on the left side of the steering wheel. The DIC displays trip, fuel, vehicle system information, and warning messages if a system problem is detected.

The bottom of the DIC display shows what position the shift lever is in (Automatic Transmission Only), the odometer, and the direction the vehicle is driving.

DIC Buttons



MENU: Press this button to get to the Trip/Fuel Menu and the Vehicle Information Menu.

△ ▽ (Thumbwheel): Use the thumbwheel to scroll through the items in each menu.

SET (Set/Clear): Use this button to set or clear the menu item when it is displayed.

4-28 Instruments and Controls

Trip/Fuel Menu Items

Press the MENU button on the turn signal lever until Trip/Fuel Information Menu is displayed. Use the thumbwheel to scroll through the following menu items:

- Digital Speedometer
- Trip 1
- Trip 2
- Fuel Range
- Average Fuel Economy
- Average Vehicle Speed
- OnStar Turn by Turn
- Blank

Digital Speedometer

The speedometer shows how fast the vehicle is moving in either miles per hour (mph) or kilometers per hour (km/h). The speedometer cannot be reset.

Trip 1 and Trip 2

The Trip display shows the current distance traveled, in either miles (mi) or kilometers (km), since the last reset for the trip odometer. The trip odometer can be reset to zero by pressing the trip reset stem or the SET button while the trip odometer display is showing.

Fuel Range

The Fuel Range display shows the approximate distance the vehicle can be driven without refueling. The fuel range estimate is based on an average of the vehicle's fuel economy over recent driving history and the amount of fuel remaining in the fuel tank. Fuel range cannot be reset.

Average Fuel Economy

The Average Fuel Economy display shows the approximate average miles per gallon (mpg) or liters per 100 kilometers (L/100 km). This number is calculated based on the number of mpg (L/100 km) recorded since the last time this menu item was reset. The fuel economy can be reset by pressing the SET button while the Average Fuel Economy display is showing.

Average Vehicle Speed

The Average Vehicle Speed display shows the average speed of the vehicle in miles per hour (mph) or kilometers per hour (km/h). This average is calculated based on the various vehicle speeds recorded since the last reset of this value. The average speed can be reset by pressing the SET button while the Average Vehicle Speed display is showing.

OnStar Turn by Turn

This display is used for the OnStar Turn by Turn guidance. See *OnStar® System on page 4-42* for more information.

Blank Display

This display shows no information.

Vehicle Information Menu Items

Press the MENU button on the turn signal lever until Vehicle Information Menu is displayed. Use the thumbwheel to scroll through the following menu items:

- Unit
- Tire Pressure
- Remaining Oil Life
- Coolant Temp
- Battery Voltage
- Speed Warning

Unit

Move the thumbwheel up or down to switch between US or Metric when the Unit display is active. Press SET to confirm the setting. This will change the displays on the cluster and DIC to either English (US) or metric measurements.

Tire Pressure

The display will show a vehicle with the approximate pressures of all four tires. Tire pressure is displayed in either pounds per square inch (psi) or in kilopascal (kPa). See *Tire Pressure Monitor System on page 9-56* and *Tire Pressure Monitor Operation on page 9-57* for more information.

Remaining Oil Life

This display shows an estimate of the oil's remaining useful life. If Remaining Oil Life 99% is displayed, that means 99% of the current oil life remains.

When the remaining oil life is low, the CHANGE ENGINE OIL SOON message will appear on the display. See *Engine Oil Messages on page 4-32*. The oil should be changed as soon as possible. See *Engine Oil on page 9-10*. In addition to the engine oil life system monitoring the oil life, additional maintenance is recommended in the Maintenance Schedule in this manual. See *Scheduled Maintenance on page 10-2* for more information.

Remember, the Oil Life display must be reset after each oil change. It will not reset itself. Also, be careful not to reset the Oil Life display accidentally at any time other than when the oil has just been changed. It cannot be reset accurately until the next oil change. To reset the engine oil life system press the SET button while the Oil Life display is active. See *Engine Oil Life System on page 9-13*.

4-30 Instruments and Controls

Coolant Temperature

This display shows the temperature of the engine cooling system fluid in either degrees Fahrenheit (°F) or degrees Celsius (°C).

Battery Voltage

This display, available on some vehicles, shows the current battery voltage. If the voltage is in the normal range, the value will display. For example, the display may read Battery Voltage 15.0 Volts. The vehicle's charging system regulates voltage based on the state of the battery. The battery voltage can fluctuate while viewing this information on the DIC. This is normal. See *Charging System Light on page 4-19* for more information.

If there is a problem with the battery charging system, the DIC will display a message. See *Battery Voltage and Charging Messages on page 4-30*.

Speed Warning

Speed Warning allows the driver to set a speed that they do not want to exceed. To set the Speed Warning press SET when Speed Warning is displayed.

Compass

The vehicle may have a compass display in the Driver Information Center (DIC). See *Compass on page 4-8* for more information.

Vehicle Messages

Battery Voltage and Charging Messages

Battery Saver Active

This message displays when the vehicle has detected that the battery voltage is dropping beyond a reasonable point. The battery saver system starts reducing certain features of the vehicle that you may be able to notice. At the point that features are disabled, this message is displayed. It means that the vehicle is trying to save the charge in the battery. Turn off unnecessary accessories to allow the battery to recharge.

Low Battery

This message is displayed when the battery voltage is low. See *Battery on page 9-29* for more information.

Service Battery Charging System

This message is displayed when there is a fault in the battery charging system. Take the vehicle to your dealer/retailer for service.

Brake System Messages

Brake Fluid Low

This message is displayed when the brake fluid level is low, see *Brake Fluid on page 9-28*.

Release Parking Brake

This message is displayed as a reminder that the parking brake is on. Release it before you attempt to drive.

Compass Messages

Service Compass

This message is displayed when the compass needs service. Take the vehicle to your dealer/retailer for service.

Cruise Control Messages

Apply Brakes Before Cruise

If this message displays when attempting to activate cruise control, apply the brake and then try again.

Cruise Set to XXX

This message will display when the cruise control is set and it will show the speed it was set to. See *Cruise Control on page 8-38* for more information.

Door Ajar Messages

Driver Door Open

This message will display when the driver door is open. Close the door completely.

Hood Open

This message will display when the hood is open. Close the hood completely.

Passenger Door Open

This message will display when the passenger door is open. Close the door completely.

Trunk Open

This message will display when the trunk is open. Close the trunk completely.

Engine Cooling System Messages

A/C Off Due to High Engine Temp

This message displays when the engine coolant becomes hotter than the normal operating temperature.

To avoid added strain on a hot engine, the air conditioning compressor automatically turns off. When the coolant temperature returns to normal, the air conditioning compressor turns back on. You can continue to drive your vehicle.

If this message continues to appear, have the system repaired by your dealer/retailer as soon as possible to avoid damage to the engine.

Coolant Level Low Add Coolant

This message will display if the coolant is low, see *Engine Coolant* on page 9-19.

Engine Overheated — Idle Engine

This message displays when the engine coolant temperature is too hot. Stop and allow the vehicle to idle until it cools down.

Engine Overheated — Stop Engine

This message displays and a continuous chime sounds if the engine cooling system reaches unsafe temperatures for operation. Stop and turn off the vehicle as soon as it is safe to do so to avoid severe damage. This message clears when the engine has cooled to a safe operating temperature.

High Coolant Temperature

This message displays if the coolant temperature is hot, see *Engine Overheating* on page 9-24.

Engine Oil Messages

Change Engine Oil Soon

This message displays when the engine oil needs to be changed. When you change the engine oil, be sure to reset the CHANGE ENGINE OIL SOON message. See *Engine Oil Life System* on page 9-13 and *Driver Information Center (DIC)* on page 4-27 for information on how to reset the message. See *Engine Oil* on page 9-10 and *Scheduled Maintenance* on page 10-2 for more information.

Engine Oil Hot, Idle Engine

This message displays when the engine oil temperature is too hot. Stop and allow the vehicle to idle until it cools down.

Engine Oil Low – Add Oil

This message displays when the engine oil level is too low. Check the oil level. See *Engine Oil* on page 9-10.

Oil Pressure Low – Stop Engine

This message displays if low oil pressure levels occur. Stop the vehicle as soon as safely possible and do not operate it until the cause of the low oil pressure has been corrected. Check the oil as soon as possible and have your vehicle serviced by your dealer/retailer.

Engine Power Messages

Engine Power Is Reduced

This message displays when the vehicle's engine power is reduced. Reduced engine power can affect the vehicle's ability to accelerate. If this message is on, but there is no reduction in performance, proceed to your destination. The performance may be reduced the next time the vehicle is driven. The vehicle may be driven at a reduced speed while

this message is on, but maximum acceleration and speed may be reduced. Anytime this message stays on, the vehicle should be taken to your dealer/retailer for service as soon as possible.

Fuel System Messages

Fuel Level Low

This message displays when the vehicle is low on fuel. Refuel as soon as possible

Tighten Gas Cap

This message displays when the fuel cap is not on tight. Tighten the fuel cap.

Change Fuel Filter

This message displays when the fuel needs to be replaced. Take the vehicle to your dealer/retailer for service.

Key and Lock Messages

Number Of Keys Programmed

This message displays when programming new keys to the vehicle.

Replace Battery In Remote Key

This message displays when the battery in the Remote Keyless Entry (RKE) transmitter needs to be replaced.

Lamp Messages

Automatic Light Control On

This message is displayed when the automatic light control has been turned on. See *Automatic Headlamp System* on page 5-3.

Automatic Light Control Off

This message is displayed when the automatic light control has been turned off. See *Automatic Headlamp System* on page 5-3.

Left Front Turn Indicator Failure

This message is displayed if the turn signal bulb needs to be replaced. See *Headlamps, Front Turn Signal and Parking Lamps (Base Vehicle)* on page 9-37 or *Headlamps, Front Turn Signal and Parking Lamps (Up-Level Vehicle)* on page 9-38 and *Replacement Bulbs* on page 9-41 for more information.

Left Rear Turn Indicator Failure

This message is displayed if the turn signal bulb needs to be replaced. See *Taillamps, Turn Signal, and Stoplamps* on page 9-40 and *Replacement Bulbs* on page 9-41 for more information.

Right Front Turn Indicator Failure

This message is displayed if the turn signal bulb needs to be replaced. See *Headlamps, Front Turn Signal and Parking Lamps (Base Vehicle)* on page 9-37 or *Headlamps, Front Turn Signal and Parking Lamps (Up-Level Vehicle)* on page 9-38 and *Replacement Bulbs* on page 9-41 for more information.

Right Rear Turn Indicator Failure

This message is displayed if the turn signal bulb needs to be replaced. See *Taillamps, Turn Signal, and Stoplamps* on page 9-40 and *Replacement Bulbs* on page 9-41 for more information.

Turn Signal On

This message is displayed if the turn signal has been left on. Turn off the turn signal.

Object Detection System Messages

Park Assist Off

This message is displayed when the park assist has been turned off. See *Ultrasonic Parking Assist* on page 8-41.

Service Park Assist

This message is displayed if there is a problem with the park assist. Take the vehicle to your dealer/retailer for service.

Ride Control System Messages

StabiliTrak Competitive Mode (V8 Engine Only)

This message displays when competitive mode is selected. See *Competitive Driving Mode* on page 8-37 for more information.

Service Traction Control

This message displays when there is a problem with the Traction Control System (TCS). When this message is displayed, the system will not limit wheel spin. Adjust your driving accordingly. See your dealer/retailer for service.

Service StabiliTrak

This message displays if there is a problem with the StabiliTrak[®] system. If this message appears, try to reset the system. Stop; turn off the engine and remove the key from the ignition; open and close the driver door and wait for at least one minute. During this time you should notice the lights on the cluster turn off. After a minute has passed start the engine again. If this message still comes on, it means there is a problem. See your dealer/retailer for service. The vehicle is safe to drive, however, you do not have the benefit of StabiliTrak, so reduce your speed and drive accordingly.

Airbag System Messages

Service Airbag

This message is displayed if there is a problem with the airbag system. Take the vehicle to your dealer/retailer for service.

Safety Belt Messages

Buckle Seatbelt

This message displays as a reminder when the safety belt is not buckled.

Anti-Theft Alarm System Messages

Theft Attempted

This message displays if the vehicle detects a tamper condition.

Service Vehicle Messages

Service AC System

This message is displayed if there is a problem with the air conditioning system. Take the vehicle to your dealer/retailer for service.

Service Power Steering

This message is displayed if there is a problem with the power steering system. Take the vehicle to your dealer/retailer for service.

Service Vehicle Soon

This message is displayed if there is a problem with the vehicle. Take the vehicle to your dealer/retailer for service.

Tire Messages

Check XXX Tire Pressure

This message displays if the vehicle detects low pressure in one or more tires. The tire with the low pressure will be shown in the message. Check the tire pressures.

Service Tire Monitor System

This message displays if there is a problem with the Tire Pressure Monitor System (TPMS). See *Tire Pressure Monitor Operation on page 9-57* for more information.

Tire Learning Active

This message displays when the system is learning new tires. See *Tire Pressure Monitor Operation on page 9-57* for more information.

Tire Pressure System Reset

This message displays when resetting the TPMS. See *Tire Pressure Monitor Operation on page 9-57* for more information.

Transmission Messages

1 – 4 Shift

This message displays when you can only shift from 1 (First) to 4 (Fourth) instead of 1 (First) to 2 (Second). See *Manual Transmission on page 8-30* for more information.

Press Clutch To Start

This message displays when attempting to start a vehicle with a manual transmission without pressing on the clutch pedal.

Service Transmission

This message displays if there is a problem with the transmission. See your dealer/retailer.

Shift Denied

This message displays when attempting to use the automatic transmission manual mode to shift to too low of a gear. See *Manual Mode on page 8-29* for more information.

Shift To Park

This message displays when the transmission needs to be shifted to park. This may appear when attempting to remove the key from the ignition if the vehicle is not in P (Park).

Transmission Hot – Idle Engine

This message displays and a chime sounds if the transmission fluid in the vehicle gets hot. Driving with the transmission fluid temperature high can cause damage to the vehicle. Stop the vehicle and let it idle to allow the transmission to cool. This message clears when the fluid temperature reaches a safe level.

Vehicle Reminder Messages

Ice Possible Drive With Care

This message is displayed when ice conditions are possible.

Turn Wiper Control to Intermittent First

This message is displayed when attempting to adjust the intermittent wiper speed without intermittent selected on the wiper control. See *Windshield Wiper/Washer* on page 4-7.

Vehicle Speed Messages

Driver Selected Speed Limit Exceeded

This message is displayed when the vehicle speed is greater than the set speed. See “Speed Warning” under *Driver Information Center (DIC)* on page 4-27.

Vehicle Messages

Messages are displayed on the DIC to notify the driver that the status of the vehicle has changed and that some action may be needed by the driver to correct the condition. Multiple messages may appear one after another.

Some messages may not require immediate action. For those you can press SET to acknowledge that you received the messages and to clear them. Some messages cannot be cleared because they are more urgent. These messages require action. You should take any messages that appear on the display seriously and remember that clearing the messages will only make the messages disappear, not correct the problem. Possible messages that can be displayed and some information about them, grouped by subject, are in the following information.

Window Messages

Open, Then Close Driver Window

This message is displayed when the window needs to be reprogrammed. If the vehicle's battery has been recharged or disconnected, you will need to reprogram each front window for the express up feature to work. See *Power Windows* on page 1-14 for more information.

Open, Then Close Passenger Window

This message is displayed when the window needs to be reprogrammed. If the vehicle's battery has been recharged or disconnected, you will need to reprogram each front window for the express up feature to work. See *Power Windows* on page 1-14 for more information.

Vehicle Personalization

The audio system controls are used to access the personalization menus for customizing vehicle features.

CONFIG (Configuration): Press to access the Configuration Settings Menu.

MENU / SELECT Knob: Press the center of this knob to enter the menus and select menu items. Turn the knob to scroll through the menus.

⬅ **BACK:** Press to exit or move backwards in a menu.

Entering the Personalization Menus

1. Press the CONFIG button to access the Configuration Settings menu.
2. Turn the MENU / SELECT knob to highlight Vehicle Settings.
3. Press the center of the MENU / SELECT knob to select the Vehicle Settings menu.

The following list of menu items will be available:

- Climate and Air Quality
- Comfort and Convenience
- Collision/Detection Systems
- Language
- Lighting
- Power Door Locks
- Remote Lock/Unlock/Start
- Return to Factory Settings

Turn the MENU / SELECT knob to highlight the menu. Press the knob to select it. Each of the menus is detailed in the following information.

Climate and Air Quality

Select the Climate and Air Quality menu and the following will be displayed:

- Remote Start Heated Seats

Remote Start Heated Seats

When on, this feature will turn the heated seats on when using remote start.

Press the MENU / SELECT knob when Remote Start Heated Seats is highlighted. Turn the knob to select On or Off. Press the knob to confirm and go back to the last menu.

Comfort and Convenience

Select the Comfort and Convenience menu and the following will be displayed:

- Chime Volume
- Personalization by Driver

Chime Volume

This allows the selection of the chime volume level.

Press the MENU / SELECT knob when Chime Volume is highlighted. Turn the knob to select Normal or High. Press the knob to confirm and go back to the last menu.

Personalization by Driver

This allows the selection of if the personalization settings are specific to each driver or the same no matter which key was used to enter and start the vehicle.

Press the MENU / SELECT knob when Personalization by Driver is highlighted. Turn the knob to select On or Off. Press the knob to confirm and go back to the last menu.

Collision/Detection Systems

Select the Collision/Detection Systems menu and the following will be displayed:

- Park Assist

Park Assist

This allows the Ultrasonic Parking Assist feature to be turned on or off.

Press the MENU / SELECT knob when Park Assist is highlighted. Turn the knob to select On or Off. Press the knob to confirm and go back to the last menu.

Language

Select the Language menu and the following will be displayed:

- English
- French
- Spanish

Turn the MENU / SELECT knob to select the language. Press the knob to confirm and go back to the last menu.

Lighting

Select the Lighting menu and the following will be displayed:

- Exit Lighting
- Vehicle Locator Lights

4-40 Instruments and Controls

Exit Lighting

This allows the selection of how long the exterior lamps stay on when leaving the vehicle when it is dark outside.

Press the MENU / SELECT knob when Exit Lighting is highlighted. Turn the knob to select Off, 30 Seconds, 1 Minute, or 2 Minutes. Press the knob to confirm and go back to the last menu.

Vehicle Locator Lights

This allows the vehicle locator lights to be turned on or off.

Press the MENU / SELECT knob when Vehicle Locator Lights is highlighted. Turn the knob to select On or Off. Press the knob to confirm and go back to the last menu.

Power Door Locks

Select Power Door Locks and the following will be displayed:

- Unlocked Door Anti Lock Out
- Auto Door Unlock
- Delayed Door Lock

Unlocked Door Anti Lock Out

When on, this feature will keep the driver's door from locking when the door is open. If off is selected, the Delayed Door Lock menu will be available.

Press the MENU / SELECT knob when Auto Door Unlock is highlighted. Turn the knob to select On or Off. Press the knob to confirm and go back to the last menu.

Auto Door Unlock

This allows selection of which of the doors will automatically unlock when the vehicle is shifted into P (Park) (automatic transmission) or when the key is removed from the ignition (manual transmission).

Press the MENU / SELECT knob when Auto Door Unlock is highlighted. Turn the knob to select All Doors, Driver Door, or Off. Press the knob to confirm and go back to the last menu.

Delayed Door Lock

When on, this feature will delay the locking of the doors. If you want to override the delay you can press the power door lock on the driver's door.

Press the MENU / SELECT knob when Delayed Door Lock is highlighted. Turn the knob to select On or Off. Press the knob to confirm and go back to the last menu.

Remote Lock/Unlock/Start

Select Remote Lock/Unlock/Start and the following will be displayed:

- Unlock Feedback (Lights)
- Locking Feedback
- Door Unlock Options
- Remote Vehicle Start

Unlock Feedback (Lights)

When on, the exterior lamps will flash when unlocking the vehicle with the RKE transmitter.

Press the MENU / SELECT knob when Unlock Feedback (Lights) is highlighted. Turn the knob to select Flash Lights or Off. Press the knob to confirm and go back to the last menu.

Locking Feedback

This allows selection of what type of feedback is given when unlocking the vehicle with the RKE transmitter.

Press the MENU / SELECT knob when Locking Feedback is highlighted. Turn the knob to select Lights and Horn, Lights Only, Horn Only, or Off. Press the knob to confirm and go back to the last menu.

Door Unlock Options

This allows selection of which doors will unlock when pressing the unlock button on the RKE transmitter.

Press the MENU / SELECT knob when Door Unlock Options is highlighted. Turn the knob to select All Doors or Driver Door Only. Press the knob to confirm and go back to the last menu.

Remote Vehicle Start

This allows the Remote Vehicle Start to be turned on or off, if the vehicle has this feature.

Press the MENU / SELECT knob when Remote Vehicle Start is highlighted. Turn the knob to select On or Off. Press the knob to confirm and go back to the last menu.

Return to Factory Settings

Select Return to Factory Settings to return all of the vehicle personalization to the default settings. Turn the knob to select Yes or No. Press the knob to confirm and go back to the last menu.

OnStar System

OnStar® System



OnStar uses several innovative technologies and live advisors to provide a wide range of safety, security, information, and convenience services. If the airbags deploy, the system is designed to make an automatic call to OnStar Emergency advisors who can request emergency services be sent to your location. If the keys are locked in the vehicle, call OnStar at 1-888-4-ONSTAR to have a signal sent to unlock the doors.

OnStar Hands-Free Calling, including 30 trial minutes good for 60 days, is available on most vehicles. OnStar Turn-by-Turn Navigation service, with one trial route, is available on most vehicles. Press the OnStar button to have an OnStar advisor contact Roadside Service.

OnStar service is provided subject to the OnStar Terms and Conditions included in the OnStar Subscriber glove box literature.

Some services such as Remote Door Unlock or Stolen Vehicle Location Assistance may not be available until the owner of the vehicle registers with OnStar. After the first prepaid year, contact OnStar to select a monthly or annual subscription payment plan. If a payment plan is not selected, the OnStar system and all services, including airbag notification and

emergency services, may be deactivated and no longer available. For more information visit www.onstar.com (U.S.) or www.onstar.ca (Canada), or press the OnStar button to speak with an advisor.

Not all OnStar services are available on all vehicles. To check if this vehicle is able to provide the services described below, or for a full description of OnStar services and system limitations, see the OnStar Owner's Guide in the glove box or visit www.onstar.com (U.S.) or www.onstar.ca (Canada), contact OnStar at 1-888-4-ONSTAR (1-888-466-7827) or TTY 1-877-248-2080, or press the OnStar button to speak with an OnStar advisor 24 hours a day, 7 days a week.

OnStar Services Available with the Safe & Sound Plan

- Automatic Notification of Airbag Deployment
- Advanced Automatic Crash Notification (AACN) (If equipped)
- Link to Emergency Services
- Roadside Assistance
- Stolen Vehicle Location Assistance
- Remote Door Unlock/Vehicle Alert
- OnStar Vehicle Diagnostic Email
- GM Goodwrench On Demand Diagnostics
- OnStar Hands-Free Calling with 30 trial minutes
- OnStar Virtual Advisor (U.S. Only)

OnStar Services Included with Directions & Connections Plan

- All Safe and Sound Plan Services
- OnStar Turn-by-Turn Navigation (If equipped) or Driving Directions - Advisor delivered
- RideAssist
- Information and Convenience Services

OnStar Hands-Free Calling

OnStar Hands-Free Calling allows eligible OnStar subscribers to make and receive calls using voice commands. Hands-Free Calling is fully integrated into the vehicle, and can be used with OnStar Pre-Paid Minute Packages. Most vehicles include 30 trial minutes good for 60 days. Hands-Free Calling can also be linked to a Verizon Wireless service plan in the U.S. or a Bell Mobility service

plan in Canada, depending on eligibility. To find out more, refer to the OnStar Owner's Guide in the vehicle's glove box, visit www.onstar.com or www.onstar.ca, or speak with an OnStar advisor by pressing the OnStar button or calling 1-888-4-ONSTAR (1-888-466-7827).

OnStar Turn-by-Turn Navigation

Vehicles with the OnStar Turn-by-Turn Navigation system can provide voice-guided driving directions. Press the OnStar button to have an OnStar advisor locate a business or address and download driving directions to the vehicle. Voice-guided directions to the desired destination will play through the audio system speakers. See the OnStar Owner's Guide for more information.

4-44 Instruments and Controls

OnStar Virtual Advisor

OnStar Virtual Advisor is a feature of OnStar Hands-Free Calling that uses minutes to access location-based weather, local traffic reports, and stock quotes. Press the phone button and give a few simple voice commands to browse through the various topics. See the OnStar Owner's Guide for more information. This feature is only available in the continental U.S.

OnStar Steering Wheel Controls

This vehicle may have a Talk/Mute button that can be used to interact with OnStar Hands-Free Calling. See *Steering Wheel Controls on page 4-6* for more information.

On some vehicles, the mute button can be used to dial numbers into voice mail systems, or to dial phone extensions. See the OnStar Owner's Guide for more information.

How OnStar Service Works

The OnStar system can record and transmit vehicle information. This information is automatically sent to an OnStar Call Center when the OnStar button is pressed, the emergency button is pressed, or if the airbags or AACN system deploy. This information usually includes the vehicle's GPS location and, in the event of a crash, additional information regarding the crash that the vehicle was involved in (e.g. the direction from which the vehicle was hit). When the Virtual Advisor feature of OnStar Hands-Free Calling is used, the vehicle also sends OnStar the vehicle's GPS location so they can provide services where it is located.

OnStar service cannot work unless the vehicle is in a place where OnStar has an agreement with a wireless service provider for service

in that area. OnStar service also cannot work unless the vehicle is in a place where the wireless service provider OnStar has hired for that area has coverage, network capacity and reception when the service is needed, and technology that is compatible with the OnStar service. Not all services are available everywhere, particularly in remote or enclosed areas, or at all times.

Location information about the vehicle is only available if the GPS satellite signals are unobstructed and available.

The vehicle must have a working electrical system, including adequate battery power, for the OnStar equipment to operate. There are other problems OnStar cannot control that may prevent OnStar from providing OnStar service at any particular time or place.

Some examples are damage to important parts of the vehicle in a crash, hills, tall buildings, tunnels, weather or wireless phone network congestion.

Your Responsibility

Increase the volume of the radio if the OnStar advisor cannot be heard. If the light next to the OnStar buttons is red, the system may not be functioning properly. Press the OnStar button and request a vehicle diagnostic. If the light appears clear (no light is appearing), your OnStar subscription has expired and all services have been deactivated. Press the OnStar button to confirm that the OnStar equipment is active.

Universal Remote System

See *Radio Frequency Statement (US, Can)* on page 12-15 for information regarding Part 15 of the Federal Communications Commission (FCC) Rules and RSS-210/211 of Industry and Science Canada.

Universal Remote System Programming



If there is one square Light Emitting Diode (LED) indicator light next to the Universal Home Remote buttons, follow the instructions below.

This system provides a way to replace up to three remote control transmitters used to activate devices such as garage door openers, security systems, and home automation devices.

Do not use the Universal Home Remote with any garage door opener that does not have the stop and reverse feature. This includes any garage door opener model manufactured before April 1, 1982.

Read the instructions completely before attempting to program the Universal Home Remote. Because of the steps involved, it may be helpful to have another person available to assist you with programming the Universal Home Remote.

Keep the original hand-held transmitter for use in other vehicles as well as for future Universal Home Remote programming.

4-46 Instruments and Controls

It is also recommended that upon the sale of the vehicle, the programmed Universal Home Remote buttons should be erased for security purposes. See “Erasing Universal Home Remote Buttons” later in this section.

When programming a garage door, park outside of the garage. Park directly in line with and facing the garage door opener motor-head or gate motor-head. Be sure that people and objects are clear of the garage door or gate that is being programmed.

It is recommended that a new battery be installed in your hand-held transmitter for quicker and more accurate transmission of the radio-frequency signal.

Programming the Universal Home Remote System

For questions or help programming the Universal Home Remote System, call 1-800-355-3515 or go to www.homelink.com.

Programming a garage door opener involves time-sensitive actions, so read the entire procedure before starting. Otherwise, the device will time out and the procedure will have to be repeated.

To program up to three devices:

1. Hold the end of your hand-held transmitter about 3 to 8 cm (1 to 3 inches) away from the Universal Home Remote buttons while keeping the indicator light in view. The hand-held transmitter was supplied by the manufacturer of your garage door opener receiver (motor-head unit).

2. At the same time, press and hold both the hand-held transmitter button and one of the three Universal Home Remote buttons to be used to operate the garage door. Do not release the Universal Home Remote button or the hand-held transmitter button until the indicator light changes from a slow to a rapidly flashing light. You now may release both buttons.

Some entry gates and garage door openers may require substitution of Step 2 with the procedure noted in “Gate Operator and Canadian Programming” later in this section.

3. Press and hold for five seconds the newly-trained Universal Home Remote button (selected button from Step 2) while observing the indicator light and garage door activation.

- If the indicator light stays on continuously or the garage door starts to move when the Universal Home Remote button is pressed and released, then the programming is complete. There is no need to continue programming Steps 4 through 6.
- If the Universal Home Remote indicator light blinks rapidly for two seconds, then turns to a constant light and the garage door does not move, continue with the programming Steps 4 through 6.

It may be helpful to have another person to assist with the remaining Steps 4 through 6.



4. After Steps 1 through 3 have been completed, locate inside the garage the garage door opener receiver (motor-head unit). Locate the “Learn” or “Smart” button. The name and color of the button may vary by manufacturer.
5. Firmly press and release the “Learn” or “Smart” button. After you press this button, you will have 30 seconds to complete Step 6.

6. Immediately return to the vehicle. Firmly press and hold for two seconds the Universal Home Remote button, selected in Step 2 to control the garage door, and then release it. If the garage door does not move or the garage door lamp does not flash, press and hold the same button a second time for two seconds, and then release it. Again, if the door does not move or the garage door lamp does not flash, press and hold the same button a third time for two seconds, and then release.

The Universal Home Remote should now activate the garage door.

To program the remaining two Universal Home Remote buttons, begin with Step 1 of “Programming the Universal Home Remote System”.

Gate Operator and Canadian Programming

If you have questions or need help programming the Universal Home Remote System, call 1-800-355-3515 or go to www.homelink.com.

Canadian radio-frequency laws require transmitter signals to time out or quit after several seconds of transmission. This may not be long enough for Universal Home Remote to pick up the signal during programming. Similarly, some U.S. gate operators are manufactured to time out in the same manner.

If you live in Canada, or you are having difficulty programming a gate operator or garage door opener by using the "Programming Universal Home Remote" procedures, regardless of where you live, replace Step 2 under "Programming Universal Home Remote" with the following:

2. Continue to press and hold the Universal Home Remote button while you press and release every two seconds (cycle) the hand-held transmitter button until the frequency signal has been successfully accepted by the Universal Home Remote. The Universal Home Remote indicator light will flash slowly at first and then rapidly. Proceed with Step 3 under "Programming Universal Home Remote" to complete.

Universal Remote System Operation

Using Universal Home Remote

Press and hold the appropriate Universal Home Remote button for at least half of a second. The indicator light will come on while the signal is being transmitted.

Erasing Universal Home Remote Buttons

All programmed buttons should be erased when the vehicle is sold or the lease ends.

To erase all programmed buttons on the Universal Home Remote device:

1. Press and hold down the two outside buttons until the indicator light begins to flash, after 10 seconds.
2. Release both buttons.

Reprogramming a Single Universal Home Remote Button

To reprogram any of the three Universal Home Remote buttons:

1. Press and hold the desired Universal Home Remote button. Do not release the button.
2. The indicator light will begin to flash after 20 seconds. Without releasing the button, proceed with Step 1 of the section "Programming Universal Home Remote".

For help or information on the Universal Home Remote System, call the customer assistance phone number under *Customer Assistance Offices on page 12-3*.

Lighting

Exterior Lighting

Exterior Lamp Controls	5-1
Headlamp High/Low-Beam Changer	5-2
Flash-to-Pass	5-3
Daytime Running Lamps (DRL)	5-3
Automatic Headlamp System	5-3
Hazard Warning Flashers	5-4
Turn and Lane-Change Signals	5-4
Front Fog Lamps	5-5

Interior Lighting

Instrument Panel Illumination Control	5-5
Dome Lamps	5-6

Lighting Features

Entry Lighting	5-6
Theater Dimming	5-6
Battery Load Management	5-6
Battery Power Protection	5-7

Exterior Lighting

Exterior Lamp Controls



The exterior lamps control is located on the instrument panel, on the outboard side of the steering wheel.

It controls the following systems:

- Headlamps
- Sidemarkers Lamps
- Parking Lamps
- Taillamps
- License Plate Lamps

- Instrument Panel Lights
- Fog Lamps
- Daytime Running Lamps (DRL)

The exterior lamps control has four positions:

○ (Off): Briefly turn to this position to turn the automatic light control off or on again. When released, the control returns to the AUTO position.

AUTO (Automatic): Turns the headlamps on automatically at normal brightness, together with the following:

- Parking Lamps
- Taillamps
- Sidemarkers Lamps
- License Plate Lamps
- Instrument Panel Lights

AUTO also controls the Daytime Running Lamps (DRL), see *Daytime Running Lamps (DRL)* on page 5-3.

5-2 Lighting

 **(Parking Lamps):** Turns the parking lamps on together with the following:

- Taillamps
- Sidemarker Lamps
- License Plate Lamps
- Instrument Panel Lights

A warning chime sounds if the driver's door is opened when the ignition switch is off and the parking lamps are on.

 **(Headlamps):** Turns the headlamps on together with the following lamps listed below.

- Parking Lamps
- Taillamps
- Sidemarker Lamps
- License Plate Lamps
- Instrument Panel Lights

A warning chime sounds if the driver's door is opened when the ignition switch is off and the headlamps are on.

 **(Front Fog Lamps):** Push the fog lamps button in to turn the fog lamps on or off. The fog lamps come on together with the following:

- Parking Lamps
- Taillamps
- Sidemarker Lamps
- License Plate Lamps
- Instrument Panel Lights

See *Front Fog Lamps on page 5-5.*

Headlamp High/Low-Beam Changer

 **Headlamp High/Low Beam**

Changer: Push the turn and lane change lever away from you to turn the high beams on.

Pull the lever towards you to return to low beams.



This indicator light turns on in the instrument panel cluster when the high beam headlamps are on.

Flash-to-Pass

The flash-to-pass feature works with the low-beams or daytime running lamps (DRL) on or off.

To flash the high beams, pull the turn signal/lane change lever all the way towards you. Then release it.

Daytime Running Lamps (DRL)

Daytime Running Lamps (DRL) can make it easier for others to see the front of your vehicle during the day. Fully functional daytime running lamps are required on all vehicles first sold in Canada.

A light sensor on top of the instrument panel makes the DRL work, so be sure it is not covered.

The DRL system will make the low-beam headlamps come on at a reduced brightness or for vehicles with High Intensity Discharge

(HID) headlamps, the dedicated DRL lights will come on when the following conditions are met:

- The ignition is in the ON/RUN position.
- The exterior lamps control is in AUTO, or has been briefly turned to OFF to turn the automatic light control on again.
- The engine is running.

When the DRL are on, the headlamps, taillamps, sidemarker, instrument panel and other lamps will not be on.

The headlamps automatically change from DRL to the regular headlamps depending on the darkness of the surroundings. The other lamps that come on with the headlamps will also come on.

When it is bright enough outside, the headlamps will go off and the DRL will come on.

To turn the DRL lamps off or on again, turn the exterior lamps control to the off position and then release. For vehicles first sold in Canada, the DRL lamps cannot be turned off.

The regular headlamp system should be turned on when needed.

Automatic Headlamp System

When it is dark enough outside and the headlamp switch is in AUTO, the automatic headlamp system will turn on the headlamps at the normal brightness along with other lamps such as the taillamps, sidemarker, parking lamps, license plate lamps, and the instrument panel lights. The radio lights will also be dim.

To turn off the automatic headlamp system, turn the exterior lamps switch to the off position and then release. For vehicles first sold in Canada, the transmission must be in the P (Park) position, before the automatic headlamp system can be turned off.

5-4 Lighting

The vehicle has a light sensor located on the top of the instrument panel. Do not cover this sensor or the system will come on whenever the ignition is on.

The system may also turn on the headlamps when driving through a parking garage, heavy overcast weather, or a tunnel. This is normal.

There is a delay in the transition between the daytime and nighttime operation of the Daytime Running Lamps (DRL) and the automatic headlamp systems so that driving under bridges or bright overhead street lights does not affect the system. The DRL and automatic headlamp system will only be affected when the light sensor sees a change in lighting lasting longer than the delay.

If the vehicle is started in a dark garage, the automatic headlamp system comes on immediately. If it is light outside when the vehicle leaves the garage, there will be a slight delay before the automatic headlamp system changes to the DRL. During that delay, the instrument panel cluster may not be as bright as usual. Make sure the instrument panel brightness control is in the full bright position. See *Instrument Panel Illumination Control* on page 5-5.

Hazard Warning Flashers

 **Hazard Warning Flasher:** Press this button located on the instrument panel near the audio system, to make the front and rear turn signal lamps flash on and off. This warns others that you are having trouble. Press again to turn the flashers off.

Turn and Lane-Change Signals



An arrow on the instrument panel cluster flashes in the direction of the turn or lane change.

Move the lever all the way up or down to signal a turn.

Raise or lower the lever until the arrow starts to flash to signal a lane change. Hold it there until the lane change is completed. If the lever is briefly pressed and released, the turn signal flashes three times.

The lever returns to its starting position whenever it is released.

If after signaling a turn or lane change the arrow flashes rapidly or does not come on, a signal bulb might be burned out.

Have the bulbs replaced. If the bulb is not burned out, check the fuse. See *Electrical System Overload* on page 9-41.

Front Fog Lamps

For vehicles with front fog lamps, the button is located on the exterior lamp control, on the outboard side of the steering wheel.

The ignition must be turned to ON/RUN to turn on the fog lamps.

 : Press to turn the fog lamps on or off. An indicator light on the instrument panel cluster comes on when the fog lamps are on.

The fog lamps come on together with the parking and sidemarker lamps.

If the high-beam headlamps are turned on, the fog lamps will turn off. If the high-beam headlamps are turned off, the fog lamps will turn back on again. For vehicles with High Intensity Discharge (HID) headlamps, the Daytime Running Lamps (DRL) replace the fog lamps.

Some localities have laws that require the headlamps to be on along with the fog lamps.

Interior Lighting

Instrument Panel Illumination Control

This feature controls the brightness of the instrument panel lights. The thumbwheel is located next to the exterior lamp control.

 **(Instrument Panel Brightness):** Turn the thumbwheel up or down to brighten or dim the instrument panel lights.

Dome Lamps

The dome lamp buttons are located in the overhead console.

To change the settings, press the following:

 **(Off):** Turns the lamp off, even when a door is open.

 **(Door):** The lamp comes on automatically when a door is opened.

 **(On):** Turns the dome lamp on.

Lighting Features

Entry Lighting

The lamps inside the vehicle come on when any door is opened. They stay on about 20 seconds and when all of the doors have been closed or the ignition is turned to ON/RUN they gradually fade out. They also come on when the unlock symbol button is pressed on the Remote Keyless Entry (RKE) system transmitter.

The lamps inside the vehicle stay on for about 20 seconds after the key is removed from the ignition to provide light as you exit.

Theater Dimming

This feature allows for a three to five second fade out of the courtesy lamps instead of immediately turning off.

Battery Load Management

The vehicle has Electric Power Management (EPM) that estimates the battery's temperature and state of charge. It then adjusts the voltage for best performance and extended life of the battery.

When the battery's state of charge is low, the voltage is raised slightly to quickly bring the charge back up. When the state of charge is high, the voltage is lowered slightly to prevent overcharging. If the vehicle has a voltmeter gage or a voltage display on the Driver Information Center (DIC), you may see the voltage move up or down. This is normal. If there is a problem, an alert will be displayed.

The battery can be discharged at idle if the electrical loads are very high. This is true for all vehicles. This is because the generator (alternator) may not be spinning fast enough at idle to produce all the power that is needed for very high electrical loads.

A high electrical load occurs when several of the following are on, such as: headlamps, high beams, fog lamps, rear window defogger, climate control fan at high speed, heated seats, engine cooling fans, trailer loads, and loads plugged into accessory power outlets.

EPM works to prevent excessive discharge of the battery. It does this by balancing the generator's output and the vehicle's electrical needs. It can increase engine idle speed to generate more power, whenever needed. It can temporarily reduce the power demands of some accessories.

Normally, these actions occur in steps or levels, without being noticeable. In rare cases at the

highest levels of corrective action, this action may be noticeable to the driver. If so, a Driver Information Center (DIC) message might be displayed, such as BATTERY SAVER ACTIVE, BATTERY VOLTAGE LOW, or LOW BATTERY. If one of these messages display, it is recommended that the driver reduce the electrical loads as much as possible. See *Driver Information Center (DIC)* on page 4-27.

Battery Power Protection

This feature shuts off the dome lamps if they are left on for more than 10 minutes when the ignition is in LOCK/OFF. This helps to prevent the battery from running down.

Infotainment System

Introduction

Introduction6-1
 Theft-Deterrent Feature6-2
 Overview6-2
 Operation6-4

Radio

AM-FM Radio6-8
 Satellite Radio6-10
 Radio Reception6-13
 Backglass Antenna6-13
 Satellite Radio Antenna6-14

Audio Players

CD Player6-14
 Auxiliary Devices6-16

Phone

Bluetooth (Overview)6-22
 Bluetooth
 (Infotainment Controls)6-23
 Bluetooth
 (Voice Recognition)6-26

Introduction

Read the following pages to become familiar with the infotainment system features.

 **WARNING**

Taking your eyes off the road for extended periods could cause a crash resulting in injury or death to you or others. Do not give extended attention to entertainment tasks while driving.

This system provides access to many audio and non audio listings.

To minimize taking your eyes off the road while driving, do the following while the vehicle is parked:

- Become familiar with the operation and controls of the audio system.
- Set up the tone, speaker adjustments, and preset radio stations.

For more information, see *Defensive Driving* on page 8-2.

Notice: Contact your dealer/retailer before adding any equipment.

Adding audio or communication equipment could interfere with the operation of the vehicle's engine, radio, or other systems, and could damage them. Follow federal rules covering mobile radio and telephone equipment.

The vehicle has Retained Accessory Power (RAP). With RAP, the infotainment system can play even after the ignition is turned off. See *Retained Accessory Power (RAP)* on page 8-19 for more information.

6-2 Infotainment System

Theft-Deterrent Feature

The theft-deterrent feature works by learning a portion of the Vehicle Identification Number (VIN) to the infotainment system. The system does not operate if it is stolen or moved to a different vehicle.

Overview

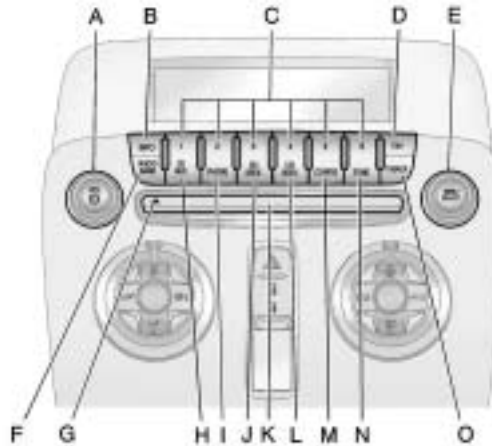

A. VOL

- Press: Turns the system on or off.
- Turn: Adjusts the volume.

B. INFO

- Radio: Shows available information about the current station.
- CD/MP3: Shows available information about the current track.

C. Buttons 1 - 6

- Radio: Saves and selects favorite stations.

D. FAV

- Radio: Opens the favorites list.

E. MENU/SELECT

- Press: Opens the menus and selects menu items.
- Turn: Highlights menu items or sets values while in a menu. Manually selects radio stations while listening to the radio.

F. RADIO/BAND

- Changes the band while listening to the radio.
- Selects the radio when listening to a different audio source.

G.  CD Eject

- Removes CD from slot.

H. CD/AUX

- Selects between the CD player or a connected external audio source.

I. PHONE

- Opens the phone main menu.
- Mutes the audio system.

J.  SEEK

- Radio: Seeks the previous station.
- CD: Selects the previous track or rewinds within a track.

K. CD Slot

- Insert a CD.

L.  SEEK

- Radio: Seeks the next station.
- CD: Selects the next track or fast forwards within a track.

M. CONFIG

- Opens the settings menu.

N. TONE

- Opens the tone menu.

O.  BACK

- Menu: Moves one level back.
- Character Input: Deletes the last character.

6-4 Infotainment System

Operation

Controls

The infotainment system is operated by using the pushbuttons, multifunction knobs, and menus that are shown on the display, and steering wheel controls, if equipped.

Turning the System On or Off

 **VOL (Power/Volume):** Press to turn the system on and off.

Automatic Off

If the infotainment system has been turned on after the ignition is turned off, the system turns off automatically after ten minutes.

Volume Control

 **VOL (Power/Volume):** Turn to adjust the volume.

PHONE: For vehicles with OnStar[®], press and hold PHONE to mute the infotainment system. Press and hold PHONE again, or turn the  VOL to cancel mute.

For vehicles without OnStar[®], press PHONE to mute the infotainment system. Press PHONE again, or turn the  VOL to cancel mute.

Menu System

Controls

The MENU/SELECT knob and the  BACK button are used to navigate the menu system.

MENU/SELECT: Press to:

- Enter the menu system.
- Select or activate the highlighted menu option.
- Confirm a set value.
- Switch a system setting on or off.

Turn to:

- Highlight a menu option.
- Select a value.

 **BACK:** Press to:

- Exit a menu.
- Return from a submenu screen to the previous menu screen.
- Delete the last character in a sequence.

Selecting a Menu Option

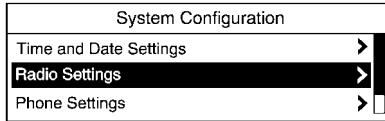

1. Turn the MENU/SELECT knob to move the highlighted bar.
2. Press the MENU/SELECT knob to select the highlighted option.

Submenus

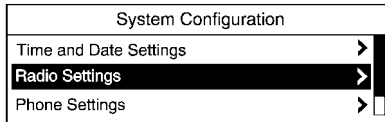

An arrow on the right-hand edge of the menu indicates that it has a submenu with other options.

Activating a Setting

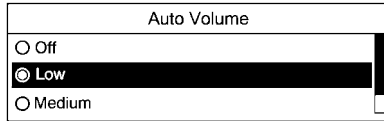

1. Turn the MENU/SELECT knob to highlight the setting.
2. Press the MENU/SELECT knob to activate the setting.

Setting a Value

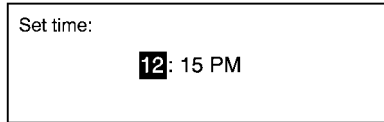

1. Turn the MENU/SELECT knob to change the current value of the setting.
2. Press the MENU/SELECT knob to confirm the setting.

Turning a Function On or Off

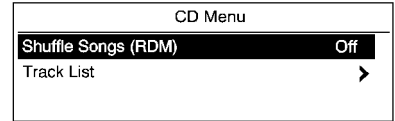

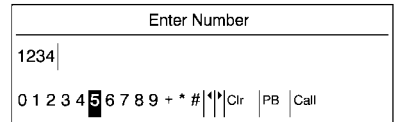

1. Turn the MENU/SELECT knob to highlight the function.
2. Press the MENU/SELECT knob to turn the function on or off.

Entering a Character Sequence



1. Turn the MENU/SELECT knob to highlight the character.
2. Press the MENU/SELECT knob to select the character.

6-6 Infotainment System

Press the  BACK button to delete the last character or press and hold  BACK to delete the entire character sequence.

Audio Settings

The audio settings can be set for each radio band and each audio player source.

To adjust the audio setting, press the TONE button and select the audio setting. Press the  BACK button to go back to the Tone Settings menu.

To quickly reset an audio setting value to 0:

1. Highlight the option.
2. Press and hold the MENU/SELECT knob until the value changes to 0.

Adjusting the Treble, Midrange, and Bass

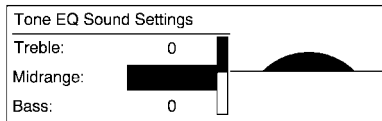

1. Select Treble, Midrange, or Bass.
2. Select the value.

Adjusting the Fader and Balance

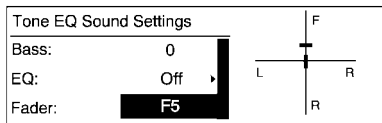

1. Select Fader or Balance.
2. Select the value.

Adjusting the EQ (Equalizer)

For vehicles that have an equalizer:

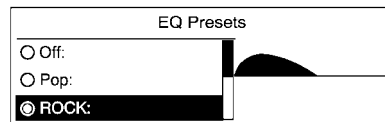

1. Select EQ.
2. Select the setting.

System Settings

Configuring the Number of Favorite Pages

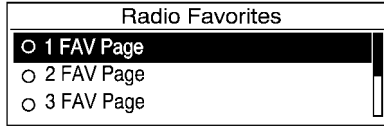

To configure the number of available favorite pages:

1. Press the CONFIG button.
2. Select Radio Settings.
3. Select Radio Favorites.
4. Select the number of available favorite pages.
5. Press the  BACK button to go back to the System Configuration menu.

Auto Volume

The auto volume feature automatically adjusts the radio volume to compensate for road and wind noise as the vehicle speeds up or slows down, so that the volume level is consistent

The level of volume compensation can be selected, or the auto volume feature can be turned off.

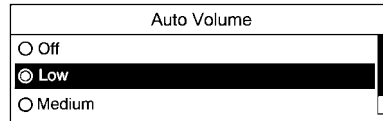

1. Press the CONFIG button.
2. Select Radio Settings.
3. Select Auto Volume.
4. Select the setting
5. Press the  BACK button to go back to the System Configuration menu.

Maximum Startup Volume

The maximum volume played when the radio is first turned on can be set.

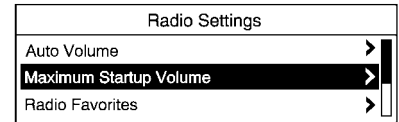

1. Press the CONFIG button.
2. Select Radio Settings.
3. Select Maximum Startup Volume.
4. Select the setting
5. Press the  BACK button to go back to the System Configuration menu.

Radio

AM-FM Radio

Control Buttons

The buttons used to control the radio are:

RADIO/BAND: Press to turn the radio on and choose between AM, FM, and XM™, if equipped.

◀◀ SEEK/ ▶▶ SEEK: Press to search for stations.

FAV: Press to open the favorites list.

1-6: Press to select preset stations.

MENU/SELECT: Turn to manually search for stations.

RDS (Radio Data System)

The radio may have RDS. The RDS feature is available for use only on FM stations that broadcast RDS information. This feature only works when the information from the radio station is available. In rare cases, a radio station could broadcast incorrect information that causes the radio features to work improperly. If this happens, contact the radio station.

While the radio is tuned to an FM-RDS station, the station name or call letters display.

Radio Menus

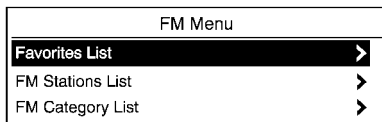

Radio menus are available for AM, FM and XM, if equipped.

Press the MENU/SELECT knob to open the main radio menu for that frequency.

Selecting a Band

Press the RADIO/BAND button to choose AM, FM, or XM™, if equipped. The last station that was playing starts playing again.

Selecting a Station

Seek Tuning

Briefly press **◀◀ SEEK** or **▶▶ SEEK** to automatically search for the next available station. If a station is not found, the radio switches to a more sensitive search level. If a station still is not found, the frequency that was last active begins to play.

Press and hold **◀◀ SEEK** or **▶▶ SEEK** until the station on the display is reached, then release the button.

Manual Tuning

Turn the MENU/SELECT knob to select the frequency on the display.

Favorites List

1. Press the MENU/SELECT knob.
2. Select Favorites List.
3. Select the station.

Station Lists

1. Press the MENU/SELECT knob.
2. Select AM or FM Station List.
All receivable stations in the current reception area are displayed. If no station list has been created an automatic station search is done.
3. Select the station.

Updating Station & Category Lists

If stations stored in the station list can no longer be received.

1. Press the MENU/SELECT knob.
2. Select Update AM or FM Station List, if the station stored in the station list are no longer received. A station search will be completed and the first station in the updated list will play.

To cancel the station search, press the MENU/SELECT knob.

Category Lists

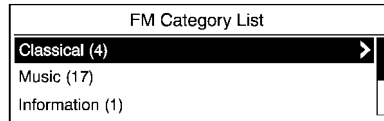

Most stations that broadcast an RDS PTY code specify the type of programming transmitted. Some stations change the PTY code depending on the content.

The system stores the RDS stations, sorted by program type, in the FM category list.

To search for a programming type determined by station:

1. Select FM category list. A list of all programming types available displays.
2. Select the programming type.
A list of stations that transmit programming of the selected type displays.
3. Select the station.

The category lists are updated when the corresponding station lists are updated.

Storing and Retrieving Favorites

Stations from all bands can be stored in the favorite lists in any order.

Up to six stations can be stored in each favorite page and the number of available favorite pages can be set.

Storing a Station as a Favorite

To store the station to a position in the list, press the corresponding numeric button 1-6 until the station can be heard again.

Retrieving Stations

Press the FAV button to open a favorite page or to switch to another favorite page. Briefly press one of the 1-6 buttons to retrieve the station.

Satellite Radio

Vehicles with an XM™ Satellite Radio tuner and a valid XM Satellite Radio subscription can receive XM programming.

XM Satellite Radio Service

XM is a satellite radio service that is based in the 48 contiguous United States and 10 Canadian provinces. XM Satellite Radio has a wide variety of programming and commercial-free music, coast-to-coast, and in digital-quality sound. During your trial or when you subscribe, you will get unlimited access to XM Radio Online for when you are not in the vehicle. A service fee is required to receive the XM service. For more information, contact XM at www.xmradio.com or call 1-800-929-2100 in the U.S. and www.xmradio.ca or call 1-877-438-9677 in Canada.

Control Buttons

The buttons used to control the XM radio are:

RADIO/BAND: Press to turn the radio on and choose between AM, FM, and XM™, if equipped.

◀ SEEK / ▶ SEEK: Press to search for stations.

FAV: Press to open the favorites list.

1-6: Press to select preset stations.

MENU/SELECT: Turn to search for stations.

Selecting the XM Band

Press the RADIO/BAND button to choose between the AM, FM, and XM bands. The last station played in that band begins to play when that band is selected.

XM Categories

XM stations are organized in categories.

Removing or Adding Categories

1. Press the CONFIG button.
2. Select XM Categories.
3. Turn the MENU/SELECT knob to highlight the category.
4. Press the MENU/SELECT knob to remove or add the category.

Selecting an XM Station

XM stations can be selected by using **◀◀ SEEK**, **▶▶ SEEK**, the MENU/SELECT knob, or the menu system.

To select an XM station using **◀◀ SEEK** or **▶▶ SEEK**, do one of the following:

- Press and release **◀◀ SEEK** or **▶▶ SEEK** to go to the previous or next station.
- Press and hold **◀◀ SEEK** or **▶▶ SEEK** to scroll through the previous or next stations until the station is reached.

To select an XM station using the MENU/SELECT knob:

1. Turn the MENU/SELECT knob to highlight an XM station.
2. Press the MENU/SELECT knob to select the station, or leave the station highlighted.

To select a station using the menu:

1. Press the MENU/SELECT knob.
2. Select XM Stations List.
3. Select the station.

Selecting a Station by Category

1. Press the MENU/SELECT knob.
2. Select XM Category List.
A list of all programing types available displays.
3. Select the programing type.
4. Select the station.

Storing and Retrieving Favorites

Stations from all bands can be stored in any order in the favorite pages.

Up to six stations can be stored in each favorite page and the number of available favorite pages can be set.

Storing a Station as a Favorite

To store the station to a position in the list, press and hold the corresponding 1-6 button until the station can be heard again.

6-12 Infotainment System

Retrieving stations

Press the FAV button to open a favorite page or to switch to another favorite page. Briefly press one of the 1-6 buttons to retrieve the station.

XM Messages

XL (Explicit Language Channels):

These channels, or any others, can be blocked by request, by calling 1-800-852-XXMM (9696).

XM Updating: The encryption code is being updated, no action is required.

Loading XM: The audio system is acquiring and processing audio and text data, no action is needed.

Channel Off Air: This channel is not currently in service.

Channel Unauth: This channel is blocked or cannot be received with the XM Subscription package.

Channel Unavail: This previously assigned channel is no longer assigned.

No Artist Info: No artist information is available.

No Title Info: No song title information is available.

No CAT Info: No category information is available.

No Information: No text or informational messages are available.

No XM Signal: The vehicle may be in a location that where the XM signal is being blocked. When the vehicle is moved, the signal should return.

CAT Not Found: There are no channels available for the selected category.

XM Theftlocked: The XM receiver in the vehicle may have been in another vehicle. XM receivers cannot be swapped between vehicles. If this message is received after having the vehicle serviced, check with your dealer/retailer.

XM Radio ID: If tuned to channel 0, this message alternates with the XM Radio 8 digit radio ID label. This label is needed to activate the service.

Unknown: If this message is received when tuned to channel 0, there could be a receiver fault. Consult with your dealer/retailer.

Check XM Receiver: If this message does not clear within a short period of time, the receiver could have a fault. Consult with your dealer/retailer.

XM Not Available: If this message does not clear within a short period of time, the receiver could have a fault. Consult with your dealer/retailer.

Radio Reception

Frequency interference and static can occur during normal radio reception if items such as cell phone chargers, vehicle convenience accessories, and external electronic devices are plugged into the accessory power outlet. If there is interference or static, unplug the item from the accessory power outlet.

FM

FM signals only reach about 16 to 65 km (10 to 40 miles). Although the radio has a built-in electronic circuit that automatically works to reduce interference, some static can occur, especially around tall buildings or hills, causing the sound to fade in and out.

AM

The range for most AM stations is greater than for FM, especially at night. The longer range can cause station frequencies to interfere with each other. For better radio reception, most AM radio stations boost the power levels during the day, and then reduce these levels during the night. Static can also occur when things like storms and power lines interfere with radio reception. When this happens, try reducing the treble on the radio.

XM™ Satellite Radio Service

XM Satellite Radio Service gives digital radio reception from coast-to-coast in the 48 contiguous United States, and in Canada. Just as with FM, tall buildings or hills can interfere with satellite radio signals, causing the sound to fade in and out. In addition, traveling or standing under heavy foliage, bridges, garages, or tunnels may cause loss of the XM signal for a period of time.

Cellular Phone Usage

Cellular phone usage may cause interference with the vehicle's radio. This interference may occur when making or receiving phone calls, charging the phone's battery, or simply having the phone on. This interference can cause an increased level of static while listening to the radio. If static is received while listening to the radio, unplug the cellular phone and turn it off.

Backglass Antenna

The AM-FM antenna is integrated with the rear window defogger, located in the rear window. Make sure that the inside surface of the rear window is not scratched and that the lines on the glass are not damaged. If the inside surface is damaged, it could interfere with radio reception. For proper radio reception, the antenna connector needs to be properly attached to the post on the glass.

6-14 Infotainment System

If a cellular telephone antenna needs to be attached to the glass, make sure that the grid lines for the AM-FM antenna are not damaged. There is enough space between the grid lines to attach a cellular telephone antenna without interfering with radio reception.

Notice: Using a razor blade or sharp object to clear the inside rear window can damage the rear window antenna and/or the rear window defogger. Repairs would not be covered by the vehicle warranty. Do not clear the inside rear window with sharp objects.

Notice: Do not apply aftermarket glass tinting with metallic film. The metallic film in some tinting materials will interfere with or distort the incoming radio reception. Any damage caused to your backglass antenna due to metallic tinting materials will not be covered by the vehicle warranty.

Satellite Radio Antenna

For vehicles with XM™ Satellite Radio Service, the antenna is located on the decklid of the vehicle. Keep the antenna clear of obstructions for clear radio reception.

Audio Players

CD Player

The CD player can play audio CDs and MP3 CDs.

The CD player will not play 8 cm (3 inches) CDs.

Care of CDs

Sound quality can be reduced due to disc quality, recording method, quality of the music recorded, and how the disc has been handled. Handle discs carefully and store them in their original cases or other protective cases away from direct sunlight and dust. If the bottom surface of a disc is damaged, the disc may not play properly or at all. Do not touch the bottom surface of a disc while handling it; this could damage the surface. Pick up discs by grasping the outer edges or the edge of the hole and the outer edge.

If the bottom surface of a disc is dirty, take a soft lint free cloth, or dampen a clean soft cloth in a mild neutral detergent solution mixed with water, and clean it. Wipe the disc from the center to the outer edge.

Care of the CD Player

Do not add a label to a disc, as it could get caught in the CD player. If a label is needed, label the top of the recorded disc with a marking pen.

Do not use disc lens cleaners because they could contaminate the lens of the disc optics and damage the CD player.

Notice: If a label is added to a CD, or more than one CD is inserted into the slot at a time, or an attempt is made to play scratched or damaged CDs, the CD player could be damaged. While using the CD player, use only CDs in good condition without any label, load one CD at a time, and keep the CD player and the loading slot free of foreign materials, liquids, and debris.

Control Buttons

The buttons used to control the CD player are:

CD/AUX: Press to choose between the CD and AUX player.

◀ SEEK / ▶ SEEK: Press to select tracks or to fast forward or rewind within a track.

MENU/SELECT: Turn to select tracks.

INFO: Press to display additional information about the CD that may be available.

△ (Eject): Press to remove the CD.

Inserting a CD

With the printed side facing up, insert a disc into the CD slot until it is drawn in.

Removing a CD

Press the **△** button.

The disc is pushed out of the CD slot.

If the disc is not removed after it is ejected, it is pulled back in after a few seconds.

Playing a CD or MP3 CD

Press the CD/AUX button if there is a disc in the player, it begins playing.

Information about the disc and current track is shown on the display depending on the data stored.

Selecting a CD Track

Using the control buttons:

Press **◀ SEEK** or **▶ SEEK** to select the previous or next track.

Turn the MENU/SELECT knob counterclockwise or clockwise to select the previous or next track.

6-16 Infotainment System

Using the CD Menu:

1. Press the MENU/SELECT knob.
2. Select Tracks list.
3. Select the track.

Playing Tracks in Random Order

Press the MENU/SELECT knob and then set Shuffle Songs to On.

Fast Forward and Rewind

Press and hold ►► SEEK or ◀◀ SEEK to fast forward or rewind within the current track.

Selecting an MP3 Track

Using the control buttons:

Press ◀◀ SEEK or ►► SEEK to select the previous or next track.

Turn the MENU/SELECT knob counterclockwise or clockwise to select the previous or next track.

Using the CD Menu:

1. Press the MENU/SELECT knob.
2. Select Playlists / Folders.
3. Select the play list or folder.
4. Select the track.

Searching for MP3 Tracks

It is normal for the search feature to take some time to display the information after reading the disc due to the amount of information stored on the disc. The infotainment system automatically switches to FM while the disc is being read.

Tracks can be searched by:

- Playlists
- Artists
- Albums
- Song Titles
- Genres
- Folder View

To search for tracks:

1. Press the MENU/SELECT knob.
2. Select Search.
3. Select: Playlists, Artists, Albums, Song Titles, Genres, or Folder View.
4. Select the track.

Auxiliary Devices

The AUX Input allows portable devices to connect to the vehicle using the 3.5mm (1/8 inch) input jack, the USB port, if equipped, or Bluetooth® wireless technology, if equipped.

Portable devices are controlled by using the menu system described in *Operation on page 6-4*.

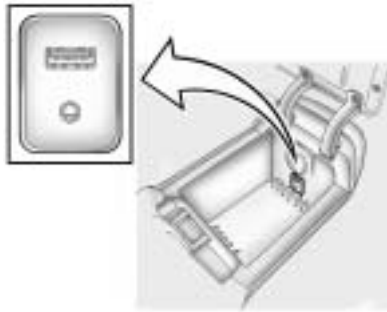

The AUX input is located in the center console.

3.5mm Jack

Connect a 3.5 mm (1/8 inch) cable to the auxiliary input jack to use a portable audio player.

Playback of an audio device that is connected to the 3.5mm jack can only be controlled using the controls on the device.

Adjusting the Volume

Turn the VOL  knob to adjust the volume of the Infotainment system after the volume level has been set on the portable audio device.

USB Port

For vehicles with a USB port, the following devices may be connected and controlled by the infotainment system.

- iPod's
- PlaysForSure Devices (PFD)
- USB Drives
- Zune's

Connecting and Controlling an iPod™

Not all iPod's can be controlled by the Infotainment System.

Connecting an iPod

Connect the iPod to the USB port using the cable that came with the device.

Searching For a Track

Tracks can be searched for by:

- Playlists
- Artists
- Albums
- Song Titles
- Podcasts
- Genres
- Audiobooks
- Composers

To search for tracks:

1. Press the MENU/SELECT knob.
2. Select Search.
3. Select: Playlists, Artists, Albums, Song Titles, Podcasts, Genres, Audiobooks, or Composers.
4. Select the track.

Shuffle

Press the MENU/SELECT knob and set Shuffle Songs (Random) to On or Off, then press the ↩ BACK button to return the main screen.

On: Plays tracks in the current folder in random order.

Off: Plays tracks in the current folder in sequential order.

Repeat

Press the MENU/SELECT knob and set Repeat to On or Off, then press the ↩ BACK button to return the main screen.

On: Repeats the current track.

Off: Playback starts from the beginning of the current track after the last track finishes.

Connecting and Controlling a PlaysForSure Device (PFD) or Zune™

Connecting a PFD or Zune

Connect the PFD or Zune to the USB port using the cable that came with the device.

Searching For a Track

Tracks can be searched for by:

- Playlists
- Artists
- Albums
- Song Titles
- Podcasts
- Genres

To search for tracks:

1. Press the MENU/SELECT knob.
2. Select Search.
3. Select: Playlists, Artists, Albums, Song Titles, Podcasts, or Genres
4. Select the track.

Shuffle Functionality

Press the MENU/SELECT knob and set Shuffle Songs (Random) to On or Off.

On: Plays current tracks in random order.

Off: Plays current tracks in sequential order.

Repeat Functionality

Press the MENU/SELECT knob and set Repeat to On or Off.

Repeat On: Repeats the current track.

Repeat Off: Playback starts from the beginning of the current track after the last track finishes.

Connecting and Controlling a USB Drive

The infotainment system can only play back .mp3 and .wma files from a USB drive.

Only the first 10,000 songs are recognized on the device.

When a device is not supported, the message “No supported data found. You can safely disconnect the device” appears.

Connecting a USB Drive

Connect the USB drive to the USB port using the cable that came with the device.

Searching For a Track

It is normal for the search feature to take some time to display the information after reading the disc due to the amount of information stored on the disc.

Files that do not have any meta data stored in the ID3 tag display as Unknown.

Tracks can be searched for by:

- Playlists*
- Artists
- Albums
- Song Titles
- Genres
- Folder View

*This only displays if a playlist is found on the device.

To search for tracks:

1. Press the MENU/SELECT knob.
2. Select Search.
3. Select: Playlists, Artists, Albums, Song Titles, Genres, or Folder View.
4. Select the track.

Shuffle Functionality

Press the MENU/SELECT knob and set Shuffle Songs (Random) to On or Off.

On: Plays current tracks in random order.

Off: Plays current tracks in sequential order.

Repeat Functionality

Press the MENU/SELECT knob and set Repeat to On or Off.

Repeat On: Repeats the current track.

Repeat Off: Playback starts from the beginning of the current track after the last track finishes.

Connecting a Bluetooth® Device

Before a Bluetooth device can be connected to the infotainment system, it must first be paired to the system. Not all Bluetooth devices can be paired to the infotainment system. Before pairing the Bluetooth device, become familiar with its user guide for Bluetooth functions. The system only connects to Bluetooth devices that support A2DP (Advanced Audio Distribution Profile) version 1.2.

6-20 Infotainment System

Pairing Information:

- Up to five devices can be paired to the system.
- The pairing process is disabled when the vehicle is moving.
- The infotainment system automatically links with the first available paired device in the order the device was paired.
- Only one paired device can be connected to the infotainment system at a time.
- Pairing should only need to be completed once, unless changes to the pairing information have been made or the device is deleted.

Bluetooth Setup Menu

The Bluetooth Setup menu can be accessed with or without a device attached to the USB port.

To select the Bluetooth Setup menu when a device is attached to the USB port and active:

1. Press the MENU/SELECT knob while in the iPod, Zune, PFD, or USB device main menu.
2. Select Bluetooth Music Setup.

To select the Bluetooth Music Setup menu when a device is not attached to the USB port, or when a device is attached to the USB port but not active:

1. Press the CD/AUX button until AUX is the active source.
2. Press the MENU/SELECT knob.
3. Select Bluetooth Music Setup.

To select the Bluetooth Music Setup menu when a Bluetooth device is connected and active:

1. Press the MENU/SELECT knob.
2. Select Bluetooth Music Setup.

Pairing a Device

1. Select Connect To New Device from the Bluetooth Music Setup menu.
2. The system asks a series of Yes/No questions to determine what type of device is being paired.
3. After the system determines what type of Bluetooth device is being paired, the Bluetooth device will need to be put into discovery mode.

4. Some devices may require a PIN number in order to complete the pairing process. Locate the device named “GMusicConnect” in the list on the Bluetooth device and follow the instructions on the device to enter the four digit PIN number provided by the Infotainment System.

Connecting to a Device

Once a device is paired to the Infotainment System, it can be connected to the Infotainment System.

To connect a paired device when no other device is connected to the Infotainment System:

1. Select the Select Device option from the Bluetooth Music Setup menu.
2. Select the new device.

To connect a paired device when another device is connected to the Infotainment System:

1. Select the Select Device option from the Bluetooth Music Setup menu.
2. Select the new device.
3. The active device is disconnected from the system and the new device is connected.

Removing a Device

1. Select Remove Device from the Bluetooth Music Setup menu.
2. Select the device.
3. The device is removed from the system.

Before connecting to the removed device again, it will need to be paired to the Infotainment System.

Changing the Default PIN

To change the default PIN:

1. Select Change Default PIN from the Bluetooth Music Setup menu.
2. Select one of the pre-defined PIN numbers, or select Other to create a PIN.

To create a PIN:

1. Select the length of the PIN number.
2. Enter the character sequence.

Messages

The following messages may appear on the infotainment screen.

Poor Bluetooth Signal Quality:





This message displays when the Bluetooth signal strength is low.

This Feature is Unavailable

While Vehicle is Moving: This message displays when an action is not allowed while the vehicle is moving.

Controlling a Bluetooth® Device

Bluetooth devices that support AVRCP (Audio/Video Remote Control Profile) version 1.0 may be able to be controlled by the Infotainment System.

Press and release  SEEK/
 SEEK to skip tracks. Press and hold  SEEK/ SEEK to fast forward or fast reverse within a track.

Other Information

The Bluetooth® word mark and logos are owned by the Bluetooth® SIG, Inc. and any use of such marks by General Motors is under license. Other trademarks and trade names are those of their respective owners.

See *Radio Frequency Statement (US, Can)* on page 12-15 for FCC information.

Phone



Bluetooth (Overview)



Vehicles with a Bluetooth system can use a Bluetooth capable cell phone with a Hands Free Profile. The infotainment system and voice recognition are used to control the system. The system can be used while in ON/RUN or ACC/ACCESSORY. The range of the Bluetooth system can be up to 9.1 m (30 ft.). Not all phones support all functions and not all phones work with the Bluetooth system. See www.gm.com/bluetooth for more information about compatible phones.

Bluetooth Controls

Use the buttons located on the infotainment system and the steering wheel to operate the Bluetooth system.

Steering Wheel Controls

 /  (**Push To Talk**): Press to answer incoming calls, to confirm system information, and to start voice recognition.

 /  (**End Call / Mute**): Press to end a call, reject a call, or to cancel an operation.

Infotainment System Controls

MENU/SELECT: Press and turn to navigate the menu screens. See *Operation on page 6-4* for more information.

PHONE: Press to enter the Phone main menu.

CONFIG: Press to enter the System Configuration menu.

Voice Recognition

The voice recognition system is used to interpret commands that control the system and dial phone numbers.

Noise: The system may not recognize voice commands if there is too much background noise.

When to Speak: A tone sounds to indicate that the system is ready for a voice command. Wait for the tone and then speak.

How to Speak: Speak clearly in a calm and natural voice.

Audio System

When using the Bluetooth system, sound comes through the vehicle's front audio system speakers and overrides the audio system. Use the audio system volume knob, during a call, to change the volume level. The adjusted volume level remains in memory for later calls. The system maintains a minimum volume level.

Other Information

The Bluetooth® word mark and logos are owned by the Bluetooth® SIG, Inc. and any use of such marks by General Motors is under license. Other trademarks and trade names are those of their respective owners.

See *Radio Frequency Statement (US, Can)* on page 12-15 for FCC information.

Bluetooth (Infotainment Controls)

Pairing

A Bluetooth enabled cell phone must be paired to the Bluetooth system first and then connected to the vehicle before it can be used. See the cell phone manufacturer user guide for Bluetooth functions before pairing the cell phone. If a Bluetooth phone is not connected, calls will be made using OnStar® Hands-Free

Calling, if available. Refer to the OnStar owner's guide for more information.

The pairing process can be started by using the voice recognition system or the controls on the infotainment system.

Pairing Information:

- Up to five cell phones can be paired to the Bluetooth system.
- The pairing process is disabled when the vehicle is moving.
- The Bluetooth system automatically links with the first available paired cell phone in the order the phone was paired.
- Only one paired cell phone can be connected to the Bluetooth system at a time.
- Pairing should only need to be completed once, unless changes to the pairing information have been made or the phone is deleted.

6-24 Infotainment System

To link to a different paired phone, see [Linking to a Different Phone](#) later in this section.

Pairing a Phone

1. Press the CONFIG button.
2. Select Phone Settings.
3. Select Bluetooth
4. Select Pair Device (Phone)
5. Start the Pairing process on the cell phone that will be paired to the vehicle. Reference the cell phone manufacturer user guide for information on this process.

Locate the device named "General Motors" in the list on the cell phone and follow the instructions on the cell phone to enter the four digit PIN number that appears on the infotainment display.

6. The system prompts for a name for the phone. Use a name that best describes the phone. This name will be used to indicate which phone is connected. The system then confirms the name provided.
7. The system responds "<Phone name> has been successfully paired" after the pairing process is complete.
8. Repeat Steps 1 through 7 for additional phones to be paired.

Listing All Paired and Connected Phones

1. Press the CONFIG button.
2. Select Phone Settings.
3. Select the Bluetooth submenu.
4. Select Device List submenu.

Deleting a Paired Phone

1. Press the CONFIG button.
2. Select Phone Settings.
3. Select the Bluetooth submenu.

4. Select Device List submenu.
5. Select the phone to be deleted and then follow the on screen prompts.

Linking to a Different Phone

1. Press the CONFIG button.
2. Select Phone Settings.
3. Select the Bluetooth submenu.
4. Select Device List submenu.
5. Select the new phone and then follow the on screen prompts.

Making a Call

1. Press the PHONE button twice.
2. Select Enter number.
3. Enter the character sequence. See "Entering a Character Sequence" in the *Operation on page 6-4* for more information.
4. Select Call to start dialing the number.

Accepting or Declining an Incoming Call

When an incoming call is received, the infotainment system mutes and a ring tone is heard in the vehicle.

Accepting a Call

Turn the MENU/SELECT knob to “Answer” and press the MENU/SELECT knob to accept the incoming call.

Declining a Call

Turn the MENU/SELECT knob to “Decline” and press the MENU/SELECT knob to decline the incoming call.

Call Waiting

Call waiting must be supported on the Bluetooth phone and enabled by the wireless service carrier to work.

Accepting a Call

Turn the MENU/SELECT knob to “Answer” and press the MENU/SELECT knob to accept the incoming call.

Declining a Call

Turn the MENU/SELECT knob to “Decline” and press the MENU/SELECT knob to decline the incoming call.

Switching Between Calls

To switch between calls:

1. Press the MENU/SELECT knob.
2. Select Switch Call from the menu.

Conference Calling

Conference calling must be supported on the Bluetooth phone and enabled by the wireless service carrier to work.

To start a conference while in a current call:

1. Press the MENU/SELECT knob and select Enter Number.
2. Enter the character sequence then select call. See “Entering a Character Sequence” in the *Operation on page 6-4* for more information.
3. After the call has been placed, press the MENU/SELECT knob and choose Merge Calls.
4. To add more callers to the conference call, repeat steps 1 through 3. The number of callers that can be added are limited by your wireless service carrier.

Ending a Call

Press the MENU/SELECT knob and select Hang Up.

Muting a Call

To Mute a Call

Press the MENU/SELECT knob and select Mute Call.

To Cancel Mute

Press the MENU/SELECT knob and deselect Mute Call.

Dual Tone Multi-Frequency (DTMF) Tones

The in-vehicle Bluetooth system can send numbers during a call. This is used when calling a menu driven phone system.

1. Press the MENU/SELECT knob and select Enter Number.
2. Enter the character sequence. See "Entering a Character Sequence" in the *Operation on page 6-4* for more information.

Bluetooth (Voice Recognition)

Pairing

A Bluetooth cell phone must be paired to the Bluetooth system and then connected to the vehicle before it can be used. See the cell phone manufacturer user guide for Bluetooth functions before pairing the cell phone. If a Bluetooth phone is not connected, calls will be made using OnStar[®] Hands-Free Calling, if available. Refer to the OnStar owner's guide for more information.

The pairing process can be started by using the voice recognition system or the controls on the infotainment system.



Pairing Information:

- Up to five cell phones can be paired to the Bluetooth system.
- The pairing process is disabled when the vehicle is moving.

- The Bluetooth system links with the first available paired cell phone in the order the phone was paired.
- Only one paired cell phone can be connected to the Bluetooth system at a time.
- Pairing should only need to be completed once, unless changes to the pairing information have been made or the phone is deleted.

To link to a different paired phone, see Linking to a Different Phone later in this section.

Pairing a Phone

1. Press  . The system responds "Ready" followed by a tone.
2. Say "Bluetooth". The system responds "Bluetooth ready" followed by a tone.

3. Say "Pair". The system responds with instructions and a four-digit PIN number. The PIN number will be used in Step 4.
4. Start the Pairing process on the cell phone that will be paired to the vehicle. Reference the cell phone manufacturer user guide for information on this process.
 Locate the device named "General Motors" in the list on the cell phone and follow the instructions on the cell phone to enter the four-digit PIN number that was provided in Step 3.
5. The system prompts for a name for the phone. This name will be used to indicate which phone is connected. The system confirms the name.

6. The system responds "<Phone name> has been successfully paired" after the pairing process is complete.
7. Repeat Steps 1 through 7 for additional phones to be paired.

Listing All Paired and Connected Phones

1. Press . The system responds "Ready" followed by a tone.
2. Say "Bluetooth". The system responds "Bluetooth ready" followed by a tone.
3. Say "List". The system lists all the paired Bluetooth devices. The system will respond "is connected" if a phone is connected to the vehicle.

Deleting a Paired Phone

1. Press . The system responds "Ready" followed by a tone.
2. Say "Bluetooth". The system responds "Bluetooth ready" followed by a tone.
3. Say "Delete". The system asks which phone to delete followed by a tone.
4. Say the name of the phone to be deleted. If the phone name is unknown, use the "List" command for a list of all paired phones. The system responds "Would you like to delete <phone name>? Yes or No" followed by a tone.
5. Say "Yes" to delete the phone. The system responds "OK, deleting <phone name>".

6-28 Infotainment System

Linking to a Different Phone

1. Press . The system responds “Ready” followed by a tone.
2. Say “Bluetooth”. The system responds “Bluetooth ready” followed by a tone.
3. Say “Change phone”. The system responds “Please wait while I search for other phones”.
 - If another phone is found, the response will be “<Phone name> is now connected”.
 - If another phone is not found, the original phone remains connected.

Storing Name Tags

The system can store up to thirty phone numbers as name tags that are shared between the Bluetooth and OnStar systems.

The system uses the following commands to store and retrieve phone numbers:

- Store
- Digit Store
- Directory

Using the Store Command

The store command allows a phone number to be stored without entering the digits individually.



1. Press . The system responds “Ready” followed by a tone.
2. Say “Store”. The system responds “Store, number please” followed by a tone.

3. Say the complete phone number to be stored at once with no pauses.
 - If the system recognizes the number the response is “OK, Storing”.
 - If the system does not recognize the phone number, the response is “Store <Phone number>”. “Please say yes or no”. If the number is correct, say “Yes”. If the number is not correct, say “No”. The system will ask for the number again.
4. After the system stores the phone number, it responds “Please say the name tag” followed by a tone.

5. Say a name tag for the phone number. The name tag is recorded and the system responds "About to store <name tag>. Does that sound OK?".
 - If the name tag does not sound correct, say "No" and repeat Step 5.
 - If the name tag sounds correct, say "Yes" and the name tag is stored. After the number is stored the system returns to the main menu.

Using the Digit Store Command

The digit store command allows a phone number to be stored by entering the digits individually.



1. Press  . The system responds "Ready" followed by a tone.

2. Say "Digit Store". The system responds "Please say the first digit to store" followed by a tone.
3. Say the first digit to be stored. The system will repeat back the digit it heard followed by a tone. Continue entering digits until the number to be stored is complete.
 - If an unwanted number is recognized by the system, say "Clear" at any time to clear the last number.
 - To hear all of the numbers recognized by the system, say "Verify" at any time.
4. After the complete number has been entered, say "Store". The system responds "Please say the name tag" followed by a tone.

5. Say a name tag for the phone number. The name tag is recorded and the system responds "About to store <name tag>. Does that sound OK?".
 - If the name tag does not sound correct, say "No" and repeat Step 5.
 - If the name tag sounds correct, say "Yes" and the name tag is stored. After the number is stored the system returns to the main menu.

Using the Directory Command

The directory command lists all of the name tags stored by the system. To use the directory command:

1. Press  . The system responds "Ready" followed by a tone.
2. Say "Directory". The system responds "Directory" and lists all stored name tags. The system returns to the main menu when the list is complete.

6-30 Infotainment System

Deleting Name Tags

The system uses the following commands to delete name tags:

- Delete
- Delete all name tags

Using the Delete Command

The delete command is used to delete specific name tags.

To delete name tags:



1. Say "Delete". The system responds "Delete, please say the name tag" followed by a tone.
2. Say the name tag to be deleted. The system responds "Would you like to delete, <name tag>? Please say yes or no".
 - If the name tag is correct, say "Yes" to delete the name tag. The system responds "OK, deleting <name tag>, returning to the main menu."

- If the name tag is incorrect, say "No". The system responds "No. OK, let's try again, please say the name tag."

Using the Delete All Name Tags Command

The delete all name tags command deletes all stored phone book name tags and route name tags for OnStar if stored.

To delete all name tags:

1. Press  . The system responds "Ready" followed by a tone.
2. Say "Delete all name tags". The system responds "You are about to delete all name tags stored in your phone directory

and your route destination directory. Are you sure you want to do this? Please say yes or no."



- Say "Yes" to delete all name tags.
- Say "No" to cancel the function and return to the main menu.

Making a Call



Calls can be made using the following commands:

- Dial
- Digit Dial
- Call
- Re-dial



Using the Dial Command

1. Press  . The system responds “Ready” followed by a tone.
2. Say “Dial”. The system responds “Dial using <phone name>.” “Number please” followed by a tone.
3. Say the entire number without pausing.
 - If the system recognizes the number, it responds “OK, Dialing” and dials the number.
 - If the system does not recognize the number, it confirms the numbers followed by a tone. If the number is correct, say “Yes”. The system responds “OK, Dialing” and dials the number. If the number is not correct, say “No”. The system will ask for the number again.

Using the Digit Dial Command

1. Press  . The system responds “Ready” followed by a tone.
2. Say “Digit Dial”. The system responds “Digit dial using <phone name>, please say the first digit to dial” followed by a tone.
3. Say the digits to be dialed one at a time. The system repeats back the digit it heard followed by a tone.
4. Continue entering digits until the number to be dialed is complete. After the whole number has been entered, say “Dial”. The system responds “OK, Dialing” and dials the number.
 - If an unwanted number is recognized by the system, say “Clear” at any time to clear the last number.
 - To hear all of the numbers recognized by the system, say “Verify” at any time.



Using the Call Command

1. Press  . The system responds “Ready” followed by a tone.
2. Say “Call”. The system responds “Call using <phone name>.” Please say the name tag” followed by a tone.
3. Say the name tag of the person to call.
 - If the system recognizes the name tag it responds “OK, calling, <name tag>” and dials the number.
 - If the system does not recognize the name tag, it confirms the name tag followed by a tone. If the name tag is correct, say “Yes”. The system responds “OK, calling, <name tag>” and dials the number. If the name tag is not correct, say “No”. The system will ask for the name tag again.

6-32 Infotainment System

Once connected, the person called will be heard through the audio speakers.





Using the Re-dial Command

1. Press  . The system responds “Ready” followed by a tone.
2. After the tone, say “Re-dial”. The system responds “Re-dial using <phone name>” and dials the last number called from the connected Bluetooth phone.

Once connected, the person called will be heard through the audio speakers.







Receiving a Call

When an incoming call is received, the audio system mutes and a ring tone is heard in the vehicle.

- Press   to answer the call.
- Press   to ignore a call.



Call Waiting



Call waiting must be supported on the Bluetooth phone and enabled by the wireless service carrier to work.

- Press   to answer an incoming call when another call is active. The original call is placed on hold.
- Press   again to return to the original call.
- To ignore the incoming call, no action is required.
- Press   to disconnect the current call and switch to the call on hold.

Three-Way Calling

Three-Way Calling must be supported on the Bluetooth phone and enabled by the wireless service carrier to work.

1. While on a call press  . The system responds “Ready” followed by a tone.

2. Say “Three-way call”. The system responds “Three-way call, please say dial or call”.
3. Use the dial or call command to dial the number of the third party to be called.
4. Once the call is connected, press   to link all the callers together.



Ending a Call

Press   to end a call.

Muting a Call

During a call, all sounds from inside the vehicle can be muted so that the person on the other end of the call cannot hear them.

To Mute a call

1. Press  . The system responds “Ready” followed by a tone.
2. Say “Mute Call”. The system responds “Call muted”.

To Cancel Mute

1. Press . The system responds "Ready" followed by a tone.
2. After the tone, say "Mute Call". The system responds "Resuming call".

Transferring a Call

Audio can be transferred between the in-vehicle Bluetooth system and the cell phone.

To Transfer Audio to the Cell Phone

During a call with the audio in the vehicle:

1. Press . The system responds "Ready" followed by a tone.
2. Say "Transfer Call." The system responds "Transferring call" and the audio transfers to the cell phone.

To Transfer Audio to the In-Vehicle Bluetooth System

The cell phone must be paired and connected with the Bluetooth system before a call can be transferred. The connection process can take up to two minutes after the key is turned to ON/RUN or ACC/ACCESSORY.

During a call with the audio on the cell phone, press . The audio transfers to the vehicle.

Voice Pass-Thru

Voice Pass-Thru allows access to the voice recognition commands on the cell phone. See the cell phone manufacturer user guide to see if the cell phone supports this feature.



To access contacts stored in the cell phone:

1. Press . The system responds "Ready" followed by a tone.
2. Say "Bluetooth". The system responds "Bluetooth ready" followed by a tone.
3. Say "Voice". The system responds "OK, accessing <phone name>".
 - The cell phone's normal prompt messages will go through its cycle according to the phone's operating instructions.

Dual Tone Multi-Frequency (DTMF) Tones



The in-vehicle Bluetooth system can send numbers and the numbers stored as name tags during a call. Use this feature when calling a menu driven phone system. Account numbers can also be stored for use.

Sending a Number During a Call

1. Press  . The system responds “Ready” followed by a tone.
2. Say “Dial”. The system responds “Say a number to send tones” followed by a tone.
3. Say the number to send.
 - If the system recognizes the number it responds “OK, Sending Number” and the dial tones are sent and the call continues.

- If the system does not recognize the number it responds “Dial Number, please say yes or no?” followed by a tone. If the number is correct, say “Yes”. The system responds “OK, Sending Number” and the dial tones are sent and the call continues.

Sending a Stored Name Tag During a Call

1. Press  . The system responds “Ready” followed by a tone.
2. Say “Send name tag.” The system responds “Say a name tag to send tones” followed by a tone.
3. Say the name tag to send.
 - If the system recognizes the number it responds “OK, Sending <name tag>” and the dial tones are sent and the call continues.

- If the system does not recognize the name tag it responds “Dial <name tag>, please say yes or no?” followed by a tone. If the name tag is correct, say “Yes”. The system responds “OK, Sending <name tag>” and the dial tones are sent and the call continues.

Clearing the System

Unless information is deleted out of the in-vehicle Bluetooth system, it will be retained indefinitely. This includes all saved name tags in the phonebook and phone pairing information. For information on how to delete this information, see the above sections on Deleting a Paired Phone and Deleting Name Tags.

Climate Controls

Climate Control Systems

Climate Control Systems7-1

Air Vents

Air Vents7-3

Climate Control Systems

The heating, cooling, defrosting, and ventilation for the vehicle can be controlled with this system.

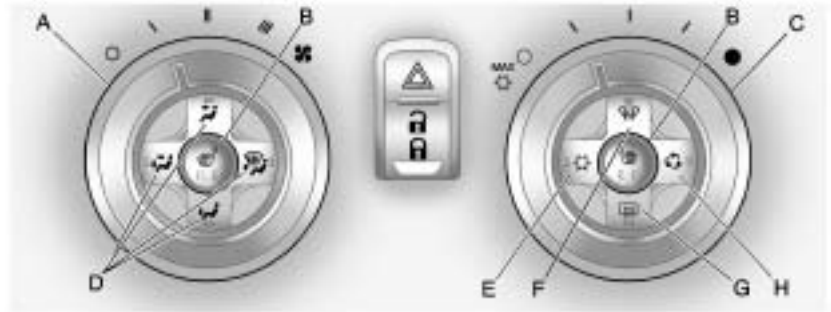

- A. Fan Control
- B. Heated Seats
- C. Temperature Control
- D. Air Delivery Mode Controls
- E. Air Conditioning
- F. Defrost
- G. Rear Window Defogger
- H. Recirculation

 (**Fan Control**): Turn to increase or decrease the fan speed. Turn the knob to O to turn the fan off.

Temperature Control: Turn to increase or decrease the temperature inside the vehicle. Maximum cooling occurs when the temperature knob is turned to MAX  and the air conditioning system is turned on.

7-2 Climate Controls

Air Delivery Mode Control:

To change the current mode, select one of the following:

 **(Vent):** Air is directed to the instrument panel outlets.

 **(Bi-Level):** Air is directed to the instrument panel outlets and the floor outlets.

 **(Floor):** Air is directed to the floor outlets.

 **(Defog):** Clears the windows of fog or moisture. Air is directed to the windshield and floor outlets.

 **(Defrost):** Clears the windshield of fog or frost more quickly. Air is directed to the windshield and side window outlets.

For best results, clear all snow and ice from the windshield before defrosting.

Do not drive the vehicle until all the windows are clear.

Air Conditioning

 **(Air Conditioning):** Press to turn the air conditioning on or off. An indicator light turns on. If the fan is turned off or the outside temperature falls below freezing, the air conditioning will not work.

The air conditioning might automatically come on when  is selected.

 **(Recirculation):** Press to turn on the recirculation. An indicator light comes on. Air is recirculated inside the vehicle. It helps to quickly cool the air inside the vehicle or prevent outside air and odors from entering.

Operation in the recirculation mode while the air conditioner is off increases humidity and may cause the windows to fog.



Recirculation is not available in the defrost or defog modes.

Rear Window Defogger

 **(Rear Defogger):** Press to turn the rear window defogger on or off. The rear window defogger turns off automatically after about 12 minutes. It can also be turned off by turning the ignition to ACC/ACCESSORY or LOCK/OFF. If turned on again it runs for about 6 minutes before turning off. At higher vehicle speeds, the rear defogger can stay on continuously.

Do not drive the vehicle until all the windows are clear.

Notice: Do not use a razor blade or sharp object to clear the inside rear window. Do not adhere anything to the defogger grid lines in the rear glass. These actions may damage the rear defogger. Repairs would not be covered by your warranty.

 /  **(Heated Seats):** Press to turn on or off. See *Heated Front Seats* on page 2-6.

Passenger Compartment Air Filter

The passenger compartment air filter removes most of the pollen and dust from the air that enters the vehicle. The filter will need to be replaced periodically. See *Scheduled Maintenance on page 10-2*.

Using the climate control system without an air filter installed is not recommended. Water or other debris could enter the system and result in leaks or noises. Always install a new filter when removing the old filter.

Air Vents

Use the air outlets located in the center and on the side of the instrument panel to direct the airflow. Use the thumbwheels near the center air outlets to direct airflow to the left or right.

Operation Tips

- In defog or defrost mode, warm air flows from the some air outlets. To improve side window defogging or defrosting, direct side air outlets towards the side windows.
- Clear away any ice, snow, or leaves from air inlets at the base of the windshield that could block the flow of air into the vehicle.

- Keep the path under the front seats clear of objects to help circulate the air inside of the vehicle more effectively.
- Use of non-GM approved hood deflectors can adversely affect the performance of the system. Check with your dealer/retailer before adding equipment to the outside of the vehicle.

Driving and Operating

Driving Information

Driving for Better Fuel Economy	8-2
Defensive Driving	8-2
Drunk Driving	8-3
Control of a Vehicle	8-3
Braking	8-4
Steering	8-5
Off-Road Recovery	8-6
Loss of Control	8-6
Competitive Driving	8-7
Driving on Wet Roads	8-8
Highway Hypnosis	8-9
Hill and Mountain Roads	8-9
Winter Driving	8-10
If the Vehicle is Stuck	8-11
Vehicle Load Limits	8-12

Starting and Operating

New Vehicle Break-In	8-16
Ignition Positions	8-17
Retained Accessory Power (RAP)	8-19
Starting the Engine	8-19

Engine Heater	8-20
Shifting Into Park	8-21
Shifting Out of Park	8-22
Parking	8-24
Parking Over Things That Burn	8-24
Active Fuel Management™	8-25

Engine Exhaust

Engine Exhaust	8-25
Running the Vehicle While Parked	8-26

Automatic Transmission

Automatic Transmission	8-26
Manual Mode	8-29

Manual Transmission

Manual Transmission	8-30
---------------------------	------

Brakes

Antilock Brake System (ABS)	8-31
Parking Brake	8-32
Brake Assist	8-33

Ride Control Systems

Traction Control System (TCS)	8-34
StabiliTrak System	8-36
Competitive Driving Mode	8-37
Limited-Slip Rear Axle	8-38

Cruise Control

Cruise Control	8-38
----------------------	------

Object Detection Systems

Ultrasonic Parking Assist	8-41
---------------------------------	------

Fuel

Fuel	8-43
Recommended Fuel	8-44
Gasoline Specifications	8-44
California Fuel Requirements	8-45
Fuels in Foreign Countries	8-45
Fuel Additives	8-45
Filling the Tank	8-46
Filling a Portable Fuel Container	8-48

Towing

General Towing Information	8-48
Driving Characteristics and Towing Tips	8-49
Trailer Towing	8-53
Towing Equipment	8-55

Conversions and Add-Ons

Add-On Electrical Equipment	8-55
-----------------------------------	------

Driving Information

Driving for Better Fuel Economy

Driving habits can affect fuel mileage. Here are some driving tips to get the best fuel economy possible.

- Avoid fast starts and accelerate smoothly.
- Brake gradually and avoid abrupt stops.
- Avoid idling the engine for long periods of time.
- When road and weather conditions are appropriate, use cruise control, if equipped.
- Always follow posted speed limits or drive more slowly when conditions require.

- Keep vehicle tires properly inflated.
- Combine several trips into a single trip.
- Replace the vehicle's tires with the same TPC Spec number molded into the tire's sidewall near the size.
- Follow recommended scheduled maintenance.

Defensive Driving

Defensive driving means “always expect the unexpected.” The first step in driving defensively is to wear your safety belt, see *Safety Belts* on page 2-6.

WARNING

Assume that other road users (pedestrians, bicyclists, and other drivers) are going to be careless and make mistakes. Anticipate what they might do and be ready. In addition:

- Allow enough following distance between you and the driver in front of you.
- Focus on the task of driving.

Driver distraction can cause collisions resulting in injury or possible death. These simple defensive driving techniques could save your life.

Drunk Driving

WARNING

Drinking and then driving is very dangerous. Your reflexes, perceptions, attentiveness, and judgment can be affected by even a small amount of alcohol. You can have a serious — or even fatal — collision if you drive after drinking. Do not drink and drive or ride with a driver who has been drinking. Ride home in a cab; or if you are with a group, designate a driver who will not drink.

Death and injury associated with drinking and driving is a global tragedy.

Alcohol affects four things that anyone needs to drive a vehicle: judgment, muscular coordination, vision, and attentiveness.

Police records show that almost 40 percent of all motor vehicle-related deaths involve alcohol. In most cases, these deaths are the result of someone who was drinking and driving. In recent years, more than 17,000 annual motor vehicle-related deaths have been associated with the use of alcohol, with about 250,000 people injured.

For persons under 21, it is against the law in every U.S. state to drink alcohol. There are good medical, psychological, and developmental reasons for these laws.

The obvious way to eliminate the leading highway safety problem is for people never to drink alcohol and then drive.

Medical research shows that alcohol in a person's system can make crash injuries worse, especially injuries to the brain, spinal cord, or heart.

This means that when anyone who has been drinking — driver or passenger — is in a crash, that person's chance of being killed or permanently disabled is higher than if the person had not been drinking.

Control of a Vehicle

The following three systems help to control the vehicle while driving — brakes, steering, and accelerator. At times, as when driving on snow or ice, it is easy to ask more of those control systems than the tires and road can provide. Meaning, you can lose control of the vehicle. See *StabiliTrak System on page 8-36*.

Adding non-dealer/non-retailer accessories can affect vehicle performance. See *Accessories and Modifications on page 9-3*.

8-4 Driving and Operating

Braking

See *Brake System Warning Light* on page 4-22.

Braking action involves perception time and reaction time. Deciding to push the brake pedal is perception time. Actually doing it is reaction time.

Average reaction time is about three-fourths of a second. But that is only an average. It might be less with one driver and as long as two or three seconds or more with another. Age, physical condition, alertness, coordination, and eyesight all play a part. So do alcohol, drugs, and frustration. But even in three-fourths of a second, a vehicle moving at 100 km/h (60 mph) travels 20 m (66 ft). That could be a lot of distance in an emergency, so keeping enough space between the vehicle and others is important.

And, of course, actual stopping distances vary greatly with the surface of the road, whether it is pavement or gravel; the condition of the road, whether it is wet, dry, or icy; tire tread; the condition of the brakes; the weight of the vehicle; and the amount of brake force applied.

Avoid needless heavy braking. Some people drive in spurts — heavy acceleration followed by heavy braking — rather than keeping pace with traffic. This is a mistake. The brakes might not have time to cool between hard stops. The brakes will wear out much faster with a lot of heavy braking. Keeping pace with the traffic and allowing realistic following distances eliminates a lot of unnecessary braking. That means better braking and longer brake life.

If the engine ever stops while the vehicle is being driven, brake normally but do not pump the brakes. If the brakes are pumped, the pedal could get harder to push down. If the engine stops, there will still be some power brake assist but it will be used when the brake is applied. Once the power assist is used up, it can take longer to stop and the brake pedal will be harder to push.

Adding non-dealer/non-retailer accessories can affect vehicle performance. See *Accessories and Modifications* on page 9-3.

Steering

Power Steering

If power steering assist is lost because the engine stops or the power steering system is not functioning, the vehicle can be steered but it will take more effort.

Steering Tips

It is important to take curves at a reasonable speed.

Traction in a curve depends on the condition of the tires and the road surface, the angle at which the curve is banked, and vehicle speed. While in a curve, speed is the one factor that can be controlled.

If there is a need to reduce speed, do it before entering the curve, while the front wheels are straight.

Try to adjust the speed so you can drive through the curve. Maintain a reasonable, steady speed. Wait to accelerate until out of the curve, and then accelerate gently into the straightaway.

Steering in Emergencies

There are times when steering can be more effective than braking. For example, you come over a hill and find a truck stopped in your lane, or a car suddenly pulls out from nowhere, or a child darts out from between parked cars and stops right in front of you. These problems can be avoided by braking — if you can stop in time. But sometimes you cannot stop in time because there is no room. That is the time for evasive action — steering around the problem.

The vehicle can perform very well in emergencies like these. First apply the brakes. See *Braking on page 8-4*. It is better to remove as much speed as possible from a collision. Then steer around the problem, to the left or right depending on the space available.



An emergency like this requires close attention and a quick decision. If holding the steering wheel at the recommended 9 and 3 o'clock positions, it can be turned a full 180 degrees very quickly without removing either hand. But you have to act fast, steer quickly, and just as quickly straighten the wheel once you have avoided the object.

The fact that such emergency situations are always possible is a good reason to practice defensive driving at all times and wear safety belts properly.

8-6 Driving and Operating

Off-Road Recovery

The vehicle's right wheels can drop off the edge of a road onto the shoulder while driving.



If the level of the shoulder is only slightly below the pavement, recovery should be fairly easy. Ease off the accelerator and then,

if there is nothing in the way, steer so that the vehicle straddles the edge of the pavement. Turn the steering wheel 8 to 13 cm, 3 to 5 inches, (about one-eighth turn) until the right front tire contacts the pavement edge. Then turn the steering wheel to go straight down the roadway.

Loss of Control

Let us review what driving experts say about what happens when the three control systems — brakes, steering, and acceleration — do not have enough friction where the tires meet the road to do what the driver has asked.

In any emergency, do not give up. Keep trying to steer and constantly seek an escape route or area of less danger.

Skidding

In a skid, a driver can lose control of the vehicle. Defensive drivers avoid most skids by taking reasonable care suited to existing conditions, and by not overdriving those conditions. But skids are always possible.

The three types of skids correspond to the vehicle's three control systems. In the braking skid, the wheels are not rolling. In the steering or cornering skid, too much speed or steering in a curve causes tires to slip and lose cornering force. And in the acceleration skid, too much throttle causes the driving wheels to spin.

If the vehicle starts to slide, ease your foot off the accelerator pedal and quickly steer the way you want the vehicle to go. If you start steering quickly enough, the vehicle may straighten out. Always be ready for a second skid if it occurs.

Of course, traction is reduced when water, snow, ice, gravel, or other material is on the road. For safety, slow down and adjust your driving to these conditions. It is important to slow down on slippery surfaces because stopping distance is longer and vehicle control more limited.

While driving on a surface with reduced traction, try your best to avoid sudden steering, acceleration, or braking, including reducing vehicle speed by shifting to a lower gear. Any sudden changes could cause the tires to slide. You might not realize the surface is slippery until the vehicle is skidding. Learn to recognize warning clues — such as enough water, ice, or packed snow on the road to make a mirrored surface — and slow down when you have any doubt.

Remember: Any Antilock Brake System (ABS) helps avoid only the braking skid.

Competitive Driving

Competitive driving may affect the vehicle warranty. See the warranty book before using the vehicle for racing or other competitive driving.

The new vehicle break-in must be performed before the vehicle is used for competitive driving. See *New Vehicle Break-In* on page 8-16.

Notice: If you use your vehicle for competitive driving, the engine may use more oil than it would with normal use. Low oil levels can damage the engine. Be sure to check the oil level often during competitive driving and keep the level at or near the upper mark that shows the proper operating range on the engine oil dipstick. For information on how to add oil, see *Engine Oil* on page 9-10.

For competitive driving, it is recommended that the brake fluid be replaced with a high performance brake fluid that has a dry boiling point greater than 279°C (534°F). After conversion to the high performance brake fluid, follow the brake fluid service recommendations outlined by the fluid manufacturer. Do not use silicone or DOT-5 brake fluids.

If the vehicle is used for racing, competitive driving, sustained high speed, or events that generate excessive wheel slip, the rear axle fluid temperatures will be higher than would occur in normal driving. We recommend that the rear axle fluid be drained and refilled with new fluid after every six hours of racing or competitive driving. See *Recommended Fluids and Lubricants* on page 10-7 for what fluid to use.

8-8 Driving and Operating

Regularly inspect the driveshaft/propshaft couplings and halfshaft boots for cracking or grease leakage. It is not recommended that the vehicle be used for ongoing race track/competitive driving.

Driving on Wet Roads

Rain and wet roads can reduce vehicle traction and affect your ability to stop and accelerate. Always drive slower in these types of driving conditions and avoid driving through large puddles and deep-standing or flowing water.

WARNING

Wet brakes can cause crashes. They might not work as well in a quick stop and could cause pulling to one side. You could lose control of the vehicle.

After driving through a large puddle of water or a car/vehicle wash, lightly apply the brake pedal until the brakes work normally.

Flowing or rushing water creates strong forces. Driving through flowing water could cause your vehicle to be carried away. If this happens, you and other vehicle occupants could drown. Do not ignore police warnings and be very cautious about trying to drive through flowing water.

Hydroplaning

Hydroplaning is dangerous. Water can build up under your vehicle's tires so they actually ride on the water. This can happen if the road is wet enough and you are going fast enough. When your vehicle is hydroplaning, it has little or no contact with the road.

There is no hard and fast rule about hydroplaning. The best advice is to slow down when the road is wet.

Other Rainy Weather Tips

Besides slowing down, other wet weather driving tips include:

- Allow extra following distance.
- Pass with caution.
- Keep windshield wiping equipment in good shape.
- Keep the windshield washer fluid reservoir filled.
- Have good tires with proper tread depth. See *Tires* on page 9-48.
- Turn off cruise control.

Highway Hypnosis

Always be alert and pay attention to your surroundings while driving. If you become tired or sleepy, find a safe place to park your vehicle and rest.

Other driving tips include:

- Keep the vehicle well ventilated.
- Keep interior temperature cool.
- Keep your eyes moving — scan the road ahead and to the sides.
- Check the rearview mirror and vehicle instruments often.

Hill and Mountain Roads

Driving on steep hills or through mountains is different than driving on flat or rolling terrain. Tips for driving in these conditions include:

- Keep the vehicle serviced and in good shape.
- Check all fluid levels and brakes, tires, cooling system, and transmission.
- Going down steep or long hills, shift to a lower gear.

WARNING

If you do not shift down, the brakes could get so hot that they would not work well. You would then have poor braking or even none going down a hill. You could crash. Shift down to let the engine assist the brakes on a steep downhill slope.

WARNING

Coasting downhill in N (Neutral) or with the ignition off is dangerous. The brakes will have to do all the work of slowing down and they could get so hot that they would not work well. You would then have poor braking or even none going down a hill. You could crash. Always have the engine running and the vehicle in gear when going downhill.

- Stay in your own lane. Do not swing wide or cut across the center of the road. Drive at speeds that let you stay in your own lane.
- Top of hills: Be alert — something could be in your lane (stalled car, accident).
- Pay attention to special road signs (falling rocks area, winding roads, long grades, passing or no-passing zones) and take appropriate action.

Winter Driving

Driving on Snow or Ice

Drive carefully when there is snow or ice between the tires and the road, creating less traction or grip. Wet ice can occur at about 0°C (32°F) when freezing rain begins to fall, resulting in even less traction. Avoid driving on wet ice or in freezing rain until roads can be treated with salt or sand.

Drive with caution, whatever the condition. Accelerate gently so traction is not lost. Accelerating too quickly causes the wheels to spin and makes the surface under the tires slick, so there is even less traction.

Try not to break the fragile traction. If you accelerate too fast, the drive wheels will spin and polish the surface under the tires even more.

The *Antilock Brake System (ABS)* on page 8-31 improves vehicle stability during hard stops on a slippery roads, but apply the brakes sooner than when on dry pavement.

Allow greater following distance on any slippery road and watch for slippery spots. Icy patches can occur on otherwise clear roads in shaded areas. The surface of a curve or an overpass can remain icy when the surrounding roads are clear. Avoid sudden steering maneuvers and braking while on ice.

Turn off cruise control, if equipped, on slippery surfaces.

Blizzard Conditions

Being stuck in snow can be in a serious situation. Stay with the vehicle unless there is help nearby. If possible, use the *Roadside Assistance Program* on page 12-6. To get help and keep everyone in the vehicle safe:

- Turn on the hazard warning flashers.
- Tie a red cloth to an outside mirror.

WARNING

Snow can trap engine exhaust under the vehicle. This may cause exhaust gases to get inside. Engine exhaust contains carbon monoxide (CO) which cannot be seen or smelled. It can cause unconsciousness and even death.

If the vehicle is stuck in the snow:

- Clear away snow from around the base of your vehicle, especially any that is blocking the exhaust pipe.
- Check again from time to time to be sure snow does not collect there.
- Open a window about 5 cm (two inches) on the side of the vehicle that is away from the wind to bring in fresh air.

(Continued)

WARNING (Continued)

- Fully open the air outlets on or under the instrument panel.
- Adjust the Climate Control system to a setting that circulates the air inside the vehicle and set the fan speed to the highest setting. See Climate Control System in the Index.

For more information about carbon monoxide, see *Engine Exhaust on page 8-25*.

Snow can trap exhaust gases under your vehicle. This can cause deadly CO (carbon monoxide) gas to get inside. CO could overcome you and kill you. You cannot see it or smell it, so you might not know it is in your vehicle. Clear away snow from around the base of your vehicle, especially any that is blocking the exhaust.

Run the engine for short periods only as needed to keep warm, but be careful.

To save fuel, run the engine for only short periods as needed to warm the vehicle and then shut the engine off and close the window most of the way to save heat. Repeat this until help arrives but only when you feel really uncomfortable from the cold. Moving about to keep warm also helps.

If it takes some time for help to arrive, now and then when you run the engine, push the accelerator pedal slightly so the engine runs faster than the idle speed. This keeps the battery charged to restart the vehicle and to signal for help with the headlamps. Do this as little as possible to save fuel.

If the Vehicle is Stuck

Slowly and cautiously spin the wheels to free the vehicle when stuck in sand, mud, ice, or snow.

If stuck too severely for the traction system to free the vehicle, turn the traction system off and use the rocking method.

 **WARNING**

If you let your vehicle's tires spin at high speed, they can explode, and you or others could be injured. The vehicle can overheat, causing an engine compartment fire or other damage. Spin the wheels as little as possible and avoid going above 55 km/h (35 mph) as shown on the speedometer.

For information about using tire chains on the vehicle, see *Tire Chains on page 9-68*.

8-12 Driving and Operating

Rocking the Vehicle to Get it Out

Turn the steering wheel left and right to clear the area around the front wheels. Turn off any traction system. Shift back and forth between R (Reverse) and a forward gear, or with a manual transmission, between 1 (First) or 2 (Second) and R (Reverse), spinning the wheels as little as possible. To prevent transmission wear, wait until the wheels stop spinning before shifting gears. Release the accelerator pedal while shifting, and press lightly on the accelerator pedal when the transmission is in gear. Slowly spinning the wheels in the forward and reverse directions causes a rocking motion that could free the vehicle. If that does not get the vehicle out after a few tries, it might need to be towed out. If the vehicle does need to be towed out, see *Towing the Vehicle on page 9-87*.

Vehicle Load Limits

It is very important to know how much weight the vehicle can carry. This weight is called the vehicle capacity weight and includes the weight of all occupants, cargo and all nonfactory-installed options. Two labels on the vehicle show how much weight it may properly carry, the Tire and Loading Information label and the Certification label.

WARNING

Do not load the vehicle any heavier than the Gross Vehicle Weight Rating (GVWR), or either the maximum front or rear Gross Axle Weight Rating (GAWR). If you do, parts on the vehicle can break, and it can change the way your vehicle handles. These could cause you to lose control and crash. Also, overloading can shorten the life of the vehicle.

Tire and Loading Information Label

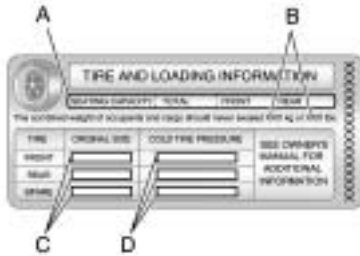

Label Example

A vehicle specific Tire and Loading Information label is attached to the vehicle's center pillar (B-pillar). With the driver's door open, you will find the label attached near the door lock post.

The Tire and Loading Information label shows the number of occupant seating positions (A), and the maximum vehicle capacity weight (B) in kilograms and pounds.

The Tire and Loading Information label also shows the tire size of the original equipment tires (C) and the recommended cold tire inflation pressures (D). For more information on tires and inflation see *Tires on page 9-48* and *Tire Pressure on page 9-54*.

There is also important loading information on the Certification label. It tells you the Gross Vehicle Weight Rating (GVWR) and the Gross Axle Weight Rating (GAWR) for the front and rear axle. See "Certification Label" later in this section.

Steps for Determining Correct Load Limit

1. Locate the statement "The combined weight of occupants and cargo should never exceed XXX kg or XXX lbs" on your vehicle placard.
2. Determine the combined weight of the driver and passengers that will be riding in your vehicle.
3. Subtract the combined weight of the driver and passengers from XXX kg or XXX lbs.
4. The resulting figure equals the available amount of cargo and luggage load capacity. For example, if the "XXX" amount equals 1400 lbs and there will be five 150 lb passengers in your vehicle, the amount of available cargo and luggage load capacity is 650 lbs (1400 – 750 (5 x 150) = 650 lbs).

8-14 Driving and Operating

- Determine the combined weight of luggage and cargo being loaded on the vehicle. That weight may not safely exceed the available cargo and luggage load capacity calculated in Step 4.
- If your vehicle will be towing a trailer, the load from your trailer will be transferred to your vehicle. Consult this manual to determine how this reduces the available cargo and luggage load capacity of your vehicle.

See *Trailer Towing on page 8-53* for important information on towing a trailer, towing safety rules and trailering tips.

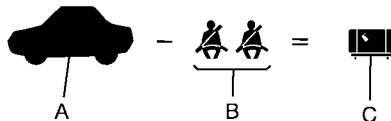

Example 1

- Vehicle Capacity Weight for Example 1 = 453 kg (1,000 lbs).
- Subtract Occupant Weight $68 \text{ kg (150 lbs)} \times 2 = 136 \text{ kg (300 lbs)}$.
- Available Occupant and Cargo Weight = 317 kg (700 lbs).

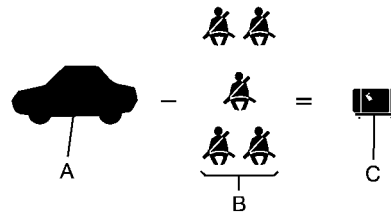

Example 2

- Vehicle Capacity Weight for Example 2 = 453 kg (1,000 lbs).
- Subtract Occupant Weight $68 \text{ kg (150 lbs)} \times 5 = 340 \text{ kg (750 lbs)}$.
- Available Cargo Weight = 113 kg (250 lbs).

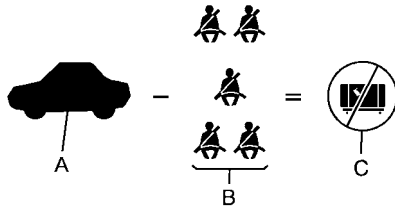

Example 3

- A. Vehicle Capacity Weight for Example 3 = 453 kg (1,000 lbs).
- B. Subtract Occupant Weight 91 kg (200 lbs) × 5 = 453 kg (1,000 lbs).
- C. Available Cargo Weight = 0 kg (0 lbs).

Refer to the vehicle’s Tire and Loading Information label for specific information about the vehicle’s capacity weight and

seating positions. The combined weight of the driver, passengers, and cargo should never exceed the vehicle’s capacity weight.

Certification Label



Label Example

A vehicle specific Certification label is attached to the driver side center pillar. The label tells you the gross weight capacity of the vehicle, called the Gross Vehicle Weight Rating (GVWR).

The GVWR includes the weight of the vehicle, all occupants, fuel, and cargo. Never exceed the GVWR for the vehicle, or the Gross Axle Weight Rating (GAWR) for either the front or rear axle.

And, if you do have a heavy load, you should spread it out. See “Steps for Determining Correct Load Limit” earlier in this section.

⚠ WARNING

Do not load the vehicle any heavier than the Gross Vehicle Weight Rating (GVWR), or either the maximum front or rear Gross Axle Weight Rating (GAWR). If you do, parts on the vehicle can break, and it can change the way your vehicle handles. These could cause you to lose control and crash. Also, overloading can shorten the life of the vehicle.

If you put things inside the vehicle — like suitcases, tools, packages, or anything else — they will go as fast as the vehicle goes. If you have to stop or turn quickly, or if there is a crash, they will keep going.

WARNING

Things you put inside the vehicle can strike and injure people in a sudden stop or turn, or in a crash.

- Put things in the trunk of your vehicle. In a trunk, put them as far forward as you can. Try to spread the weight evenly.

(Continued)

WARNING (Continued)

- Never stack heavier things, like suitcases, inside the vehicle so that some of them are above the tops of the seats.
- Do not leave an unsecured child restraint in the vehicle.
- When you carry something inside the vehicle, secure it whenever you can.
- Do not leave a seat folded down unless you need to.

Starting and Operating

New Vehicle Break-In

Notice: Follow these recommended guidelines during the first 2 414 km/1,500 miles of driving this vehicle. Parts have a break-in period and performance will be better in the long run.

- For the first 2 414 km/1,500 miles:
 - Avoid full throttle starts and abrupt stops.
 - Do not exceed 4,000 engine rpm.
 - Avoid driving at any one constant speed, fast or slow.
 - Do not drive above 160 km/h (100 mph).

- Avoid downshifting to brake or slow the vehicle when the engine speed will exceed 4000 RPM.
 - Do not let the engine labor. Never lug the engine in high gear at low speeds. With a manual transmission, shift to the next lower gear. This rule applies at all times, not just during the break-in period.
 - Do not participate in racing events, sport driving schools, or similar activities during this break-in period.
 - Check engine oil with every refueling and add if necessary. Oil and fuel consumption may be higher than normal during the first 2 414 km/1,500 miles.
- To break in new tires, drive at moderate speeds and avoid hard cornering for the first 322 km/200 miles. New tires do not have maximum traction and may tend to slip.
 - New brake linings also need a break-in period. Avoid making hard stops during the first 322 km/200 miles. This is recommended every time brake linings are replaced.
 - Should the vehicle be used for racing or competitive driving (after break-in), the rear axle lubricant must be replaced beforehand.

Ignition Positions

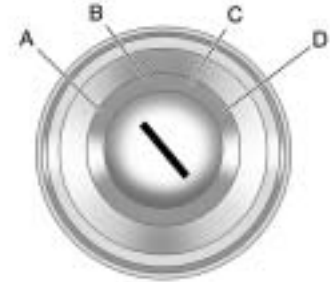

The ignition switch has four different positions.

Notice: Using a tool to force the key to turn in the ignition could cause damage to the switch or break the key. Use the correct key, make sure it is all the way in, and turn it only with your hand. If the key cannot be turned by hand, see your dealer/retailer.

To shift out of P (Park), turn the ignition to ON/RUN and apply the brake pedal.

8-18 Driving and Operating

A (LOCK/OFF): This is the only position from which the key can be removed. This locks the steering wheel, ignition and automatic transmission.

On vehicles with an automatic transmission, the shift lever must be in P (Park) to turn the ignition switch to the LOCK/OFF position.

The ignition switch can bind in the LOCK/OFF position with the wheels turned off center. If this happens, move the steering wheel from right to left while turning the key to ACC/ACCESSORY. If this does not work, then the vehicle needs service.

B (ACC/ACCESSORY): This position provides power to some of the electrical accessories. It unlocks the steering wheel and ignition. The transmission is also unlocked in this position on automatic transmission vehicles. To move the key from ACC/ACCESSORY to LOCK/OFF, push in the key and then turn it to LOCK/OFF.

C (ON/RUN): The ignition switch stays in this position when the engine is running. This position can be used to operate the electrical accessories, including the ventilation fan and 12 volt power outlet, as well as to display some warning and indicator lights.

The battery could be drained if the key is left in the ACC/ACCESSORY or ON/RUN position with the engine off. The vehicle might not start if the battery is allowed to drain for an extended period of time.

D (START): This position starts the engine. When the engine starts, release the key. The ignition switch will return to ON/RUN for normal driving.

A warning tone sounds when the driver door is opened if the ignition is still in ACC/ACCESSORY and the key is in the ignition.

Key Lock Release

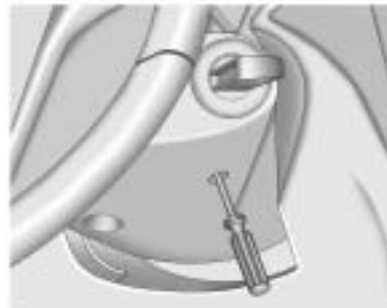

This vehicle is equipped with an electronic key lock release system. The key lock release is designed to prevent ignition key removal unless the shift lever is in P (Park).

The key lock release is always functional except in the case of an uncharged or low voltage (less than 9 volt) battery. If the vehicle has an uncharged battery or a battery with low voltage, try charging or jump starting the battery. See *Jump Starting* on page 9-84.

If charging or jump starting the battery does not work, remove the plug covering the hole below the ignition lock. Insert a screwdriver into the opening as far as it will go and remove the key from the ignition.

Retained Accessory Power (RAP)

These vehicle accessories may be used for up to 10 minutes after the engine is turned off:

- Audio System
- Power Windows

The power windows will continue to work for up to 10 minutes or until any door is opened. The radio will work when the key is in ON/RUN or ACC/ACCESSORY. Once the key is turned from ON/RUN to LOCK/OFF, the radio will continue to work for 10 minutes, or until the driver door is opened or the key is removed from the ignition.

Starting the Engine

Place the transmission in the proper gear.

Automatic Transmission

Move the shift lever to P (Park) or N (Neutral). The engine will not start in any other position. To restart the vehicle when it is already moving, use N (Neutral) only.

Notice: Do not try to shift to P (Park) if the vehicle is moving. If you do, you could damage the transmission. Shift to P (Park) only when the vehicle is stopped.

Manual Transmission

The shift lever should be in N (Neutral) and the parking brake engaged. Hold the clutch pedal down to the floor and start the engine. The vehicle will not start if the clutch pedal is not all the way down.

Starting Procedure

1. With your foot off the accelerator pedal, turn the ignition key to START. When the engine starts, let go of the key. The idle speed will go down as the engine warms. Do not race the engine immediately after starting it. Allow the oil to warm up and lubricate all moving parts.

The vehicle has a Computer-Controlled Cranking System. This feature assists in starting the engine and protects components. If the ignition key is turned to the START position, and then released when the engine begins cranking, the engine will continue cranking for a few seconds or until the vehicle starts. If the engine does not start and the key is held in START for many seconds, cranking stops after 15 seconds to prevent cranking motor damage.

To prevent gear damage, this system also prevents cranking if the engine is already running. Engine cranking can be stopped by turning the ignition switch to ACC/ACCESSORY or LOCK/OFF.

Notice: Cranking the engine for long periods of time, by returning the key to the START position immediately after cranking has ended, can overheat and damage the cranking motor, and drain the battery. Wait at least 15 seconds between each try, to let the cranking motor cool down.

2. If the engine does not start after 5-10 seconds, especially in very cold weather (below 0°F or -18°C), it could be flooded with too much gasoline. Push the accelerator pedal all the way to the floor and holding it there as you hold the key in START for a maximum of 15 seconds. Wait at

least 15 seconds between each try, to allow the cranking motor to cool. When the engine starts, let go of the key and accelerator. If the vehicle starts briefly but then stops again, repeat the procedure. This clears the extra gasoline from the engine. Do not race the engine immediately after starting it. Operate the engine and transmission gently until the oil warms up and lubricates all moving parts.

Notice: The engine is designed to work with the electronics in the vehicle. If you add electrical parts or accessories, you could change the way the engine operates. Before adding electrical equipment, check with your dealer/retailer. If you do not, the engine might not perform properly. Any resulting damage would not be covered by the vehicle warranty.

Engine Heater

The engine coolant heater, if available, can help in cold weather conditions at or below 0°F (-18°C) for easier starting and better fuel economy during engine warm-up. Plug in the coolant heater at least four hours before starting the vehicle. An internal thermostat in the plug-end of the cord will prevent engine coolant heater operation at temperatures above 0°F (-18°C).

To Use The Engine Coolant Heater

1. Turn off the engine.
2. Open the hood and unwrap the electrical cord.

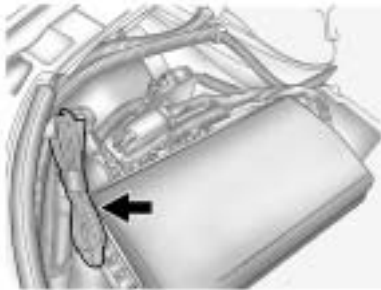

The electrical cord is located on the passenger side of the engine compartment, in front of the underhood fuse block for V6 models.

3. Plug it into a normal, grounded 110-volt AC outlet.

WARNING

Plugging the cord into an ungrounded outlet could cause an electrical shock. Also, the wrong kind of extension cord could overheat and cause a fire. You could be seriously injured. Plug the cord into a properly grounded three-prong 110-volt AC outlet. If the cord will not reach, use a heavy-duty three-prong extension cord rated for at least 15 amps.

4. Before starting the engine, be sure to unplug and store the cord as it was before to keep it away from moving engine parts. If you do not it could be damaged.

The length of time the heater should remain plugged in depends on several factors. Ask a dealer/retailer in the area where you will be parking the vehicle for the best advice on this.

Shifting Into Park

WARNING

It can be dangerous to get out of the vehicle if the shift lever is not fully in P (Park) with the parking brake firmly set. The vehicle can roll. If you have left the engine running, the vehicle can move suddenly. You or others could be injured. To be sure the vehicle will not move, even when you are on fairly level ground, use the steps that follow. If you are pulling a trailer, see *Driving Characteristics and Towing Tips on page 8-49*.

Use this procedure to shift into P (Park):

1. Hold the brake pedal down and set the parking brake.
See *Parking Brake on page 8-32* for more information.
2. Hold the button on the shift lever and push the lever toward the front of the vehicle into P (Park).

8-22 Driving and Operating

3. Turn the ignition to LOCK/OFF.
4. Remove the key.

Leaving the Vehicle With the Engine Running

WARNING

It can be dangerous to leave the vehicle with the engine running. The vehicle could move suddenly if the shift lever is not fully in P (Park) with the parking brake firmly set. And, if you leave the vehicle with the engine running, it could overheat and even catch fire. You or others could be injured. Do not leave the vehicle with the engine running.

If you have to leave the vehicle with the engine running, the vehicle must be in P (Park) and the parking brake set.

Release the button and check that the shift lever cannot be moved out of P (Park).

Torque Lock

Torque lock is when the weight of the vehicle puts too much force on the parking pawl in the transmission. This happens when parking on a hill and shifting the transmission into P (Park) is not done properly and then it is difficult to shift out of P (Park). To prevent torque lock, set the parking brake and then shift into P (Park). To find out how, see “Shifting Into P (Park)” listed previously.

If torque lock does occur, the vehicle may need to be pushed uphill by another vehicle to relieve the parking pawl pressure, so you can shift out of P (Park).

Shifting Out of Park

This vehicle is equipped with an electronic shift lock release system. The shift lock release is designed to:

- Prevent ignition key removal unless the shift lever is in P (Park) with the shift lever button fully released.
- Prevent movement of the shift lever out of P (Park), unless the ignition is in ON/RUN or ACC/ACCESSORY and the brake pedal is applied.

The shift lock release is always functional except in the case of an uncharged or low voltage (less than 9 volt) battery.

If the vehicle has an uncharged battery or a battery with low voltage, try charging or jump starting the battery. See *Jump Starting* on page 9-84

To shift out of P (Park):

1. Apply the brake pedal.
2. Press the shift lever button.
3. Move the shift lever to the desired position.

If still unable to shift out of P (Park):

1. Fully release the shift lever button.
2. Hold the brake pedal down and press the shift lever button again.
3. Move the shift lever to the desired position.

If the shift lever still cannot be moved from P (Park), see Shift Lock Manual Release.

Shift Lock Manual Release

The transmission has an electric park lock called a shift lock manual release. The key must be in the ON/RUN position, and the brake pedal pressed so the transmission gear selector can be moved from the P (Park) position. If the battery has lost power, the selector cannot be moved from P (Park) unless the shift lock manual release is disengaged manually.

To access the shift lock manual release:

1. Apply the park brake.

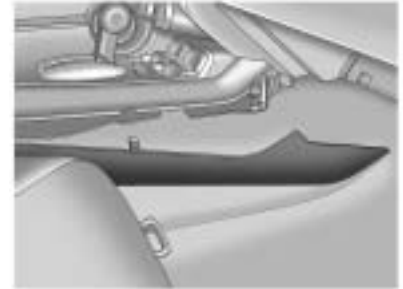

2. Pull the passenger side console trim away from the front half of the console to expose the shifter mechanism.

8-24 Driving and Operating



3. Remove the retainer and the shift lock manual release cover.
4. Push and hold the manual release lever toward the rear of the vehicle.
5. Press the select button and move the transmission gear selector to the N (Neutral) position.
6. Release the lever.
7. After the vehicle has been moved, align the shift lock manual release cover plate and install the retainer so the automatic transmission can operate properly.
8. Place the console trim panel in the original position, aligning the fasteners on the trim panel with the slots in the console. Press in the side trim until it clicks in place.

The transmission selector locks if it is moved back to the P (Park) position.

Parking

If the vehicle has a manual transmission, before getting out of the vehicle, move the shift lever into R (Reverse), and firmly apply the parking brake. Once the shift lever has been placed into R (Reverse) with the clutch pedal pressed in, turn the ignition key to LOCK/OFF, remove the key and release the clutch.

If parking on a hill, or if the vehicle is pulling a trailer, see *Driving Characteristics and Towing Tips* on page 8-49.

Parking Over Things That Burn

WARNING

Things that can burn could touch hot exhaust parts under the vehicle and ignite. Do not park over papers, leaves, dry grass, or other things that can burn.

Active Fuel Management™

Vehicles with V8 engines and an automatic transmission have Active Fuel Management™. This system allows the engine to operate on either all or half of its cylinders, depending on the driving conditions.

When less power is required, such as cruising at a constant vehicle speed, the system will operate in the half cylinder mode, allowing the vehicle to achieve better fuel economy. When greater power demands are required, such as accelerating from a stop, passing, or merging onto a freeway, the system will maintain full-cylinder operation.

Engine Exhaust

WARNING

Engine exhaust contains Carbon Monoxide (CO) which cannot be seen or smelled. Exposure to CO can cause unconsciousness and even death.

Exhaust may enter the vehicle if:

- The vehicle idles in areas with poor ventilation (parking garages, tunnels, deep snow that may block underbody airflow or tail pipes).
- The exhaust smells or sounds strange or different.
- The exhaust system leaks due to corrosion or damage.

(Continued)

WARNING (Continued)

- The vehicle's exhaust system has been modified, damaged or improperly repaired.
- There are holes or openings in the vehicle body from damage or after-market modifications that are not completely sealed.

If unusual fumes are detected or if it is suspected that exhaust is coming into the vehicle:

- Drive it only with the windows completely down.
- Have the vehicle repaired immediately.

Never park the vehicle with the engine running in an enclosed area such as a garage or a building that has no fresh air ventilation.

Running the Vehicle While Parked

It is better not to park with the engine running. But if you ever have to, here are some things to know.

WARNING

Idling a vehicle in an enclosed area with poor ventilation is dangerous. Engine exhaust may enter the vehicle. Engine exhaust contains Carbon Monoxide (CO) which cannot be seen or smelled. It can cause unconsciousness and even death. Never run the engine in an enclosed area that has no fresh air ventilation. For more information, see *Engine Exhaust* on page 8-25.

WARNING

It can be dangerous to get out of the vehicle if the automatic transmission shift lever is not fully in P (Park) with the parking brake firmly set. The vehicle can roll. Do not leave the vehicle when the engine is running unless you have to. If you have left the engine running, the vehicle can move suddenly. You or others could be injured. To be sure the vehicle will not move, even when you are on fairly level ground, always set the parking brake and move the shift lever to P (Park).

Follow the proper steps to be sure the vehicle will not move. See *Shifting Into Park* on page 8-21.

If parking on a hill and pulling a trailer, see *Driving Characteristics and Towing Tips* on page 8-49.

Automatic Transmission

The automatic transmission has a shift lever located on the console between the seats.



P (Park): This position locks the rear wheels. It is the best position to use when starting the engine because the vehicle cannot move easily.

 **WARNING**

It is dangerous to get out of the vehicle if the shift lever is not fully in P (Park) with the parking brake firmly set. The vehicle can roll.

Do not leave the vehicle when the engine is running unless you have to. If you have left the engine running, the vehicle can move suddenly. You or others could be injured. To be sure the vehicle will not move, even when you are on fairly level ground, always set the parking brake and move the shift lever to P (Park). See *Shifting Into Park* on page 8-21. If you are pulling a trailer, see *Driving Characteristics and Towing Tips* on page 8-49.

Make sure the shift lever is fully in P (Park) before starting the engine. The vehicle has an automatic transmission shift lock control system. The regular brake

must be fully applied first and then the shift lever button pressed before shifting from P (Park) when the ignition key is in ON/RUN. If you cannot shift out of P (Park), ease pressure on the shift lever, then push the shift lever all the way into P (Park) as you maintain brake application. Then press the shift lever button and move the shift lever into another gear. See *Shifting Out of Park* on page 8-22.

R (Reverse): Use this gear to back up.

Notice: **Shifting to R (Reverse) while the vehicle is moving forward could damage the transmission. The repairs would not be covered by the vehicle warranty. Shift to R (Reverse) only after the vehicle is stopped.**

To rock the vehicle back and forth to get out of snow, ice or sand without damaging the transmission, see *If the Vehicle is Stuck* on page 8-11.

N (Neutral): In this position, the engine does not connect with the wheels. To restart the engine when the vehicle is already moving, use N (Neutral) only. Also, use N (Neutral) when the vehicle is being towed.

 **WARNING**

Shifting into a drive gear while the engine is running at high speed is dangerous. Unless your foot is firmly on the brake pedal, the vehicle could move very rapidly. You could lose control and hit people or objects. Do not shift into a drive gear while the engine is running at high speed.

Notice: **Shifting out of P (Park) or N (Neutral) with the engine running at high speed may damage the transmission. The repairs would not be covered by the vehicle warranty. Be sure the engine is not running at high speed when shifting the vehicle.**

8-28 Driving and Operating

D (Drive): This position is for normal driving. It provides the best fuel economy. If more power is needed for passing, and the vehicle is:

- Going less than 35 mph (56 km/h), push the accelerator pedal about halfway down.
- Going about 35 mph (56 km/h) or more, push the accelerator all the way down.

Powertrain Braking (V8 and V6 Engines)

When driving on steep descents in D (Drive) or M (Manual Mode) where frequent braking is required, the transmission will shift down a gear to help hold vehicle speed and reduce brake wear. If the driver continues to press the brake, the transmission will downshift until 3 (Third) gear is reached.

If the brake is released for some time, the transmission will upshift a gear. If the road levels out and the

accelerator pedal is pressed, the transmission will upshift until the appropriate gear is reached.

4 (Fourth) Gear Hold (V6 Engine)

If, during highway driving, you wish to pass another vehicle, but then change your mind (quickly pushing the accelerator pedal all the way to the floor and then immediately releasing the pedal), the transmission will shift to a lower gear and then upshift to 4 (Fourth). This leaves the transmission prepared with increased responsiveness for additional driver input. The passing maneuver can then be resumed from 4 (Fourth) gear, or 4 (Fourth) gear hold can be canceled by lightly pressing on the accelerator pedal.

Notice: If the vehicle seems to accelerate slowly or not shift gears when you go faster, and you continue to drive the vehicle that way, you could damage the transmission. Have the vehicle serviced right away.

M (Manual Mode): This position engages Sport Mode and allows the driver to select the range of gears appropriate for current driving conditions.

In M (Manual Mode) the transmission will shift as an automatic until the Tap Shift controls are used. Tap Shift activates driver manual gear selection.

While driving in M (Manual Mode), if Tap Shift has not been activated, the transmission determines when the vehicle is being driven in a competitive manner and will select and hold the transmission in lower gears and have more noticeable upshifts for sportier vehicle performance.

See *Manual Mode* on page 8-29 for more information.

Manual Mode

Tap Shift



Tap Shift allows the driver to manually control the automatic transmission. To use Tap Shift, the shift lever must be in M (Manual Mode). Vehicles with this feature have flags on the top of the steering wheel to indicate to the driver the location of the switches on the back of the steering wheel. Tap the left

switch to downshift, and the right switch to upshift. A display in the Driver Information Center will show which gear the vehicle is in. See *Driver Information Center (DIC)* on page 4-27 for more information.

While using the Tap Shift feature, the vehicle will have firmer, quicker shifting for increased performance. You can use this for sport driving or when climbing or descending hills, to stay in gear longer, or to down shift for more power or engine braking. The transmission will only allow you to shift into gears appropriate for the vehicle speed and engine Revolutions Per Minute (RPM). The transmission will not automatically shift to the next higher gear if the engine RPM is too high. If shifting is prevented for any reason, the message Shift Denied will appear in the DIC, indicating that the transmission has not

shifted gears. While in the Tap Shift mode, the transmission will not automatically downshift on hard acceleration.

When coasting to a stop, the V6 transmission will automatically downshift to 1 (First) gear, and the V8 transmission will automatically downshift to 2 (Second) gear. A 1 (first) gear start can be selected using the Tap Shift controls on V8 models. When accelerating from a stop the transmissions will hold these gears until the driver manually selects higher gears using the Tap Shift controls.

When accelerating the vehicle from a stop in snowy and icy conditions, you may want to shift into second gear. A higher gear ratio allows you to gain more traction on slippery surfaces.

Manual Transmission

Shift Pattern (V8 Engines)

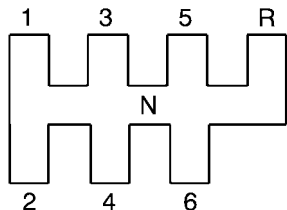

Shift Pattern (V6 Engine)

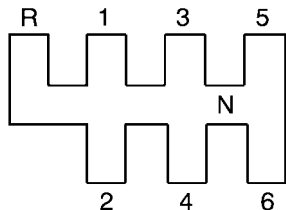

These are the shift patterns for the six-speed manual transmissions.

To operate the transmission:

1 (First): Press the clutch pedal and shift into 1 (First). Then slowly let up on the clutch pedal as you press the accelerator pedal.

You can shift into 1 (First) when you are going less than 64 km/h (40 mph). If you come to a complete stop and it is hard to shift into 1 (First), put the shift lever in Neutral and let up on the clutch. Press the clutch pedal back down. Then shift into 1 (First).

2 (Second): Press the clutch pedal as you let up on the accelerator pedal and shift into 2 (Second). Then, slowly let up on the clutch pedal as you press the accelerator pedal.

3 (Third), 4 (Fourth), 5 (Fifth) and 6 (Sixth): Shift into 3 (Third), 4 (Fourth), 5 (Fifth) and 6 (Sixth) the same way you do for 2 (Second). Slowly let up on the clutch pedal as you press the accelerator pedal.

To stop, let up on the accelerator pedal and press the brake pedal. Just before the vehicle stops, press the clutch pedal and the brake pedal, and shift to Neutral.

Neutral: Use this position when you start or idle the engine. The shift lever is in Neutral when it is centered in the shift pattern, not in any gear.

R (Reverse): To back up, press down the clutch pedal and shift into R (Reverse). On V8 models, apply pressure to get the lever past 5 (Fifth) and 6 (Sixth) into R (Reverse). Let up on the clutch pedal slowly while pressing the accelerator pedal.

One to Four Shift Light Message (V8 Only)

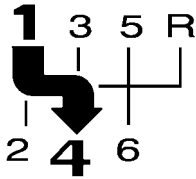

Driver Information Center

When this message comes on, you can only shift from 1 (First) to 4 (Fourth) instead of 1 (First) to 2 (Second). The message will be displayed in the Driver Information Center.

You must complete the shift into 4 (Fourth) to turn off this feature. This helps you get the best possible fuel economy.

After shifting to 4 (Fourth), you may downshift to a lower gear if you prefer.

Notice: Forcing the shift lever into any gear except 4 (Fourth) when the 1 TO 4 SHIFT message comes on may damage the transmission. Shift only from 1 (First) to 4 (Fourth) when the message comes on.

This message will come on when:

- The engine coolant temperature is higher than 76°C (169°F),
- The vehicle is going 24 to 31 km/h (15 to 19 mph) and
- The vehicle is at 21 percent throttle or less.

Brakes

Antilock Brake System (ABS)

This vehicle has the Antilock Brake System (ABS), an advanced electronic braking system that helps prevent a braking skid.

When the engine is started and the vehicle begins to drive away, ABS checks itself. A momentary motor or clicking noise might be heard while this test is going on, and it might even be noticed that the brake pedal moves a little. This is normal.



If there is a problem with ABS, this warning light stays on. See *Antilock Brake System (ABS) Warning Light* on page 4-23.

8-32 Driving and Operating

Let us say the road is wet and you are driving safely. Suddenly, an animal jumps out in front of you. You slam on the brakes and continue braking. Here is what happens with ABS:

A computer senses that the wheels are slowing down. If one of the wheels is about to stop rolling, the computer will separately work the brakes at each wheel.

ABS can change the brake pressure to each wheel, as required, faster than any driver could. This can help the driver steer around the obstacle while braking hard.

As the brakes are applied, the computer keeps receiving updates on wheel speed and controls braking pressure accordingly.

Remember: ABS does not change the time needed to get a foot up to the brake pedal or always decrease stopping distance. If you get too close to the vehicle in front of you, there will not be enough time to apply the brakes if that vehicle suddenly slows or stops. Always leave enough room up ahead to stop, even with ABS.

Using ABS

Do not pump the brakes. Just hold the brake pedal down firmly and let antilock work. The antilock pump or motor might be heard operating, and the brake pedal might be felt to pulsate, but this is normal.

Braking in Emergencies

ABS allows the driver to steer and brake at the same time. In many emergencies, steering can help more than even the very best braking.

Parking Brake

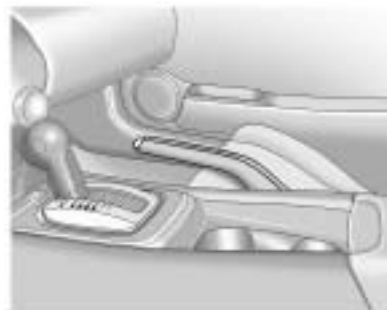

To apply the parking brake, pull up on the parking brake handle. It is not necessary to push in on the release button while applying the parking brake. If the ignition is in the ON/RUN position, the brake system warning light will come on. See *Brake System Warning Light* on page 4-22.

To release the parking brake:

1. Hold the brake pedal down.
2. Pull the parking brake handle up until you can press the release button.
3. Hold the release button in as you move the brake handle all the way down.

Notice: Driving with the parking brake on can overheat the brake system and cause premature wear or damage to brake system parts. Make sure that the parking brake is fully released and the brake warning light is off before driving.

Driving with the parking brake applied will cause a warning chime to sound and the Park Brake message to appear in the DIC. The message will remain on until:

- the parking brake is released
- the vehicle comes to a stop.

If you are towing a trailer and you are parking on a hill, see *Driving Characteristics and Towing Tips* on page 8-49.

Brake Assist

This vehicle has a Brake Assist feature designed to assist the driver in stopping or decreasing vehicle speed in emergency driving conditions. This feature uses the stability system hydraulic brake

control module to supplement the power brake system under conditions where the driver has quickly and forcefully applied the brake pedal in an attempt to quickly stop or slow down the vehicle. The stability system hydraulic brake control module increases brake pressure at each corner of the vehicle until the ABS activates. Minor brake pedal pulsations or pedal movement during this time is normal and the driver should continue to apply the brake pedal as the driving situation dictates. The Brake Assist feature will automatically disengage when the brake pedal is released or brake pedal pressure is quickly decreased.

Ride Control Systems

Traction Control System (TCS)

The vehicle has a Traction Control System (TCS) that limits wheel spin. The system utilizes engine and braking controls to control wheel spin during acceleration at all driving speeds for maximum driver control regardless of conditions. When the system senses impending wheel slip during acceleration, it signals the throttle control to reduce drive wheel torque. Under extreme situations, such as going from pavement to ice during acceleration, the system will selectively apply the brakes to maintain control. The system may be heard or felt while it is working, but this is normal.



The TCS/StabiliTrak warning light flashes when the traction control system is limiting wheel spin.

The StabiliTrak/TCS warning light comes on solid if there is a problem with the traction control system.

See *Traction Control System (TCS)/StabiliTrak® Light* on page 4-24 for more information.

If the light stays on, see your dealer/retailer for service. When the TCS/StabiliTrak warning light is on, the system will not limit wheel spin. Adjust your driving accordingly.

TCS automatically comes on whenever the vehicle is started. To limit wheel spin, especially in slippery road conditions, the system

should always be left on, but it may be necessary to turn the system off if the vehicle is stuck in sand, mud or snow and rocking the vehicle is required. Also, turn TCS off while in deep snow or on loose gravel, to assist vehicle motion at lower speeds. See *If the Vehicle is Stuck* on page 8-11 for more information. See also *Winter Driving* on page 8-10 for information on using TCS when driving in snowy or icy conditions.



To turn the system off, press and release the StabiliTrak/TCS button located on the console in front of the shift lever.



Press and release the StabiliTrak/TCS button and the traction control system turns off and the TCS warning light comes on. Press and release the button again to turn the system back on. For information on turning StabiliTrak off and on, see StabiliTrak System following.

Launch Control (V8 with Manual Transmission Models Only)

Launch Control uses a form of traction control specifically tuned to optimize tire spin while launching the vehicle during closed track events and competitive driving. The feature is activated when the vehicle is at rest while in Competitive Mode. See *Competitive Driving Mode on page 8-37* for more information. At rest, if the accelerator pedal is pressed to the floor with the clutch engaged, the RPM is limited to a predetermined level. A smooth, quick release of the clutch while keeping the accelerator pedal on the floor will provide controlled wheel spin for consistent acceleration. Complete shifts as described in *Manual Transmission on page 8-30*.



When in Competitive Mode the StabiliTrak Off light comes on the instrument panel cluster. Adjust your driving accordingly. See *Competitive Driving Mode on page 8-37* for more information.

Adding non-dealer/non-retailer accessories can affect the vehicle's performance. See *Accessories and Modifications on page 9-3* for more information.

StabiliTrak System

The vehicle has an electronic stability control system called StabiliTrak. It is an advanced computer controlled system that assists with directional control of the vehicle in difficult driving conditions.

StabiliTrak activates when the computer senses a discrepancy between the intended path and the direction the vehicle is actually traveling. StabiliTrak selectively applies braking pressure at any one of the vehicle's brakes to help steer the vehicle in the direction which you are steering.

If cruise control is being used when StabiliTrak activates, the cruise control will automatically disengage. Press the cruise control button to reengage when road conditions allow. See *Cruise Control* on page 8-38 for more information.



OFF

The StabiliTrak/TCS button is located in front of the shift lever.



When the system activates, the StabiliTrak/Traction Control System (TCS) warning light flashes on the instrument panel cluster. You may also hear a noise or feel vibration in the brake pedal. This is normal. Continue to steer the vehicle in the intended direction.



If there is a problem detected with StabiliTrak, a Service StabiliTrak message displays on the DIC and the StabiliTrak/TCS warning light on the instrument panel cluster comes on. When this message and warning light displays, the system is not operational. Driving should be adjusted accordingly. See *Ride Control System Messages* on page 4-34 and *Traction Control System (TCS)/StabiliTrak® Light* on page 4-24 for more information.



StabiliTrak comes on automatically whenever the vehicle is started. The system should be left on to help assist with directional control of the vehicle. If StabiliTrak needs to be turned off, press and hold the StabiliTrak/TCS button until the

Traction Control Off light and the StabiliTrak Off light come on the instrument panel cluster. If the system has been turned off, press and release the StabiliTrak/TCS button to turn the system back on.

Engine Drag Control (EDC)

EDC improves vehicle stability by sensing if there is difference in speed between the free rolling front wheels and the rear drive wheels that often occurs when the driver takes their foot off the accelerator pedal on slippery surfaces (snow, ice, etc.). When this is detected, EDC sends more torque to the rear wheels to make sure all four wheels are spinning at similar speeds, making the vehicle more stable.

Competitive Driving Mode



On vehicles with a V8 engine, the driver can select this optional handling mode by pressing the StabiliTrak/TCS button two times quickly while Traction Control and StabiliTrak are turned on. When the system is on, the StabiliTrak Off light comes on and StabiliTrak Competitive Mode will be displayed in the Driver Information Center (DIC). See *Ride Control System Messages* on page 4-34.

Competitive Driving Mode is designed and recommended for use only during closed track events and at competitive driving venues. The TCS system uses engine and brake systems to control wheel spin during acceleration and cornering while the StabiliTrak system helps maintain directional control of the vehicle by selective brake application.

When the StabiliTrak button is pressed again, or the vehicle is restarted, the StabiliTrak and TCS will be turned back on to normal operation.

Notice: When traction control is turned off, or Competitive Driving Mode is active, it is possible to lose traction. If you

attempt to shift with the drive wheels spinning with a loss of traction, it is possible to cause damage to the transmission. Do not attempt to shift when the drive wheels do not have traction. Damage caused by misuse of the vehicle is not covered. See the warranty book for additional information.

Limited-Slip Rear Axle

Vehicles with a limited-slip rear axle can give more traction on snow, mud, ice, sand or gravel. It works like a standard axle most of the time, but when traction is low, this feature allows the drive wheel with the most traction to move the vehicle.

Cruise Control

With cruise control, the vehicle can maintain a speed of about 40 km/h (25 mph) or more without keeping your foot on the accelerator. Cruise control does not work at speeds below 40 km/h (25 mph).

WARNING

Cruise control can be dangerous where you cannot drive safely at a steady speed. So, do not use the cruise control on winding roads or in heavy traffic.

Cruise control can be dangerous on slippery roads. On such roads, fast changes in tire traction can cause excessive wheel slip, and you could lose control. Do not use cruise control on slippery roads.

Setting Cruise Control

WARNING

If you leave your cruise control on when you are not using cruise, you might hit a button and go into cruise when you do not want to. You could be startled and even lose control. Keep the cruise control switch off until you want to use cruise control.

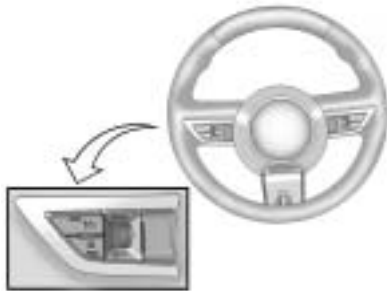

The cruise control buttons are located on the outboard side of the steering wheel.

 **(On/Off):** Press to turn the cruise control system on and off. An indicator light comes on in the instrument panel cluster.

 **(Cancel):** Press to cancel cruise control without erasing the set speed from memory.

RES/+ (Resume/Accel): Move the thumbwheel up to resume a set speed or to accelerate to a higher speed.

SET/- (Set/Coast): Move the thumbwheel down to set a speed or to decrease the speed.

To set a speed:

1. Press  to turn cruise control on. The indicator light in the instrument panel cluster comes on.
2. Get to the speed desired.

3. Press the thumbwheel toward SET/- and release it.
4. Take your foot off the accelerator pedal.

When the brakes are applied, the cruise control shuts off.

Resuming a Set Speed

If the cruise control is set at a desired speed and then the brakes are applied, the cruise control is disengaged. The indicator light on the instrument panel cluster goes out when the cruise is no longer engaged. To return to the previously set speed, press the thumbwheel up toward RES/+ briefly when the vehicle has reached a speed of about 40 km/h (25 mph) or more.

This accelerates the vehicle to the previously selected speed.

Increasing Speed While Using Cruise Control

There are two ways to go to a higher speed.

- Disengage the cruise control, but do not turn it off.
- If the cruise control system is already engaged, press the thumbwheel up toward RES/+ and hold it until the vehicle accelerates to the desired speed, and then release the switch. To increase the speed in small amounts, press the thumbwheel up toward RES/+ briefly and then release it. Each time this is done, the vehicle goes about 1.6 km/h (1 mph) faster.

Reducing Speed While Using Cruise Control

If the cruise control system is already engaged,

- Push the thumbwheel toward SET/- and hold until the desired lower speed is reached, then release it.

- To slow down in very small amounts, push the thumbwheel toward SET/- briefly. Each time this is done, the vehicle goes about 1.6 km/h (1 mph) slower.

Passing Another Vehicle While Using Cruise Control



Use the accelerator pedal to increase the vehicle's speed. When you take your foot off the pedal, the vehicle will slow down to the previously set cruise control speed.

Using Cruise Control on Hills

How well the cruise control works on hills depends upon the vehicle's speed, load, and the steepness of the hills. When going up steep hills, you might have to step on the accelerator pedal to maintain the vehicle's speed. When going downhill, you might have to brake or shift to a lower gear to maintain the vehicle's speed. When the brakes are applied the cruise control shuts off.

Ending Cruise Control

There are three ways to end the cruise control:

- Step lightly on the brake pedal or clutch; when cruise control disengages, the indicator light on the instrument panel cluster goes out.
- Press  to turn off the cruise control system.
- Press  to disengage the cruise control.

Erasing Speed Memory

The cruise control set speed memory is erased when the cruise control or the ignition is turned off.

Object Detection Systems

Ultrasonic Parking Assist

For vehicles with the Ultrasonic Rear Parking Assist (URPA) system, it assists the driver with parking and avoiding objects while in R (Reverse). URPA operates at speeds less than 8 km/h (5 mph), and the sensors on the rear bumper detect objects up to 2.4m (8 feet) behind the vehicle, and at least 20 cm (8 inches) off the ground.

WARNING

The Ultrasonic Rear Parking Assist (URPA) system does not replace driver vision. It cannot detect:

- objects that are below the bumper, underneath the vehicle, or if they are too close or far from the vehicle
- children, pedestrians, bicyclists, or pets.

If you do not use proper care before and while backing; vehicle damage, injury, or death could occur. Even with URPA, always check behind the vehicle before backing up. While backing, be sure to look for objects and check the vehicle's mirrors.

The display is located in the center of the rear seat back filler panel trim and uses three color-coded lights to provide distance and system information.

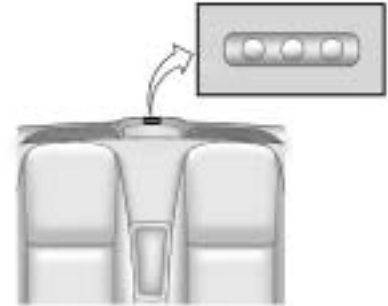

8-42 Driving and Operating

How the System Works

URPA comes on automatically and the display briefly illuminates to indicate the system is working when the shift lever is moved into R (Reverse).

If the vehicle is traveling faster than 8 km/h (5 mph) in reverse, the red light on the rear display flashes.

Objects must be at least 20 cm (8 inches) off the ground and below trunk level, and within 2.4m (8 feet) from the rear bumper to be detected. The distance may be less during warmer or humid weather.

A single beep sounds the first time an object is detected between 1.0 m (40 inches) and 2.4m (8 feet) away. Beeping occurs continuously when the vehicle is 0.6 m (23 inches) or closer to an object.

The following describes how the URPA display lights appear as the vehicle gets closer to a detected object:

Description	Metric	English
amber light	2.4 m	8 ft
amber/amber lights	1.0 m	40 in
amber/amber/red lights and continuous beeping for five seconds	0.6 m	23 in
amber/amber/red lights flashing and continuous beeping for five seconds	0.3 m	1 ft

PARK ASSIST OFF displays on the Driver Information Center (DIC) to indicate that URPA is off. The message disappears after a short period of time.

See *Object Detection System Messages on page 4-34* for other URPA messages.

When the System Does Not Seem to Work Properly

If the URPA system does not activate due to a temporary condition, the message PARK ASSIST OFF displays on the DIC and a red light comes on the rear URPA display when the shift lever is moved into R (Reverse). This can occur under the following conditions:

- The ultrasonic sensors are not clean. Keep the vehicle's rear bumper free of mud, dirt, snow, ice and slush. For cleaning instructions, see *Exterior Care on page 9-88*.
- A trailer was attached to the vehicle, or an object was hanging out of the trunk during the last drive cycle, making the red light come on in the rear display. Once the attached object is removed, URPA will return to normal operation.

- A tow bar is attached to the vehicle.
- The vehicle's bumper is damaged. Take the vehicle to your dealer/retailer to repair the system.
- Other conditions may affect system performance, such as vibrations from a jackhammer or the compression of air brakes on a very large truck that is near the vehicle.

If the system is still disabled, after driving forward at least 25 km/h (15 mph), take the vehicle to your dealer/retailer.

Fuel

Use of the recommended fuel is an important part of the proper maintenance of this vehicle. To help keep the engine clean and maintain optimum vehicle performance, we recommend the use of gasoline advertised as TOP TIER Detergent Gasoline.

Look for the TOP TIER label on the fuel pump to ensure gasoline meets enhanced detergency standards developed by auto companies. A list of marketers providing TOP TIER Detergent Gasoline can be found at www.toptiergas.com.



The 8th digit of the Vehicle Identification Number (VIN) shows the code letter or number that identifies the vehicle's engine. The VIN is at the top left of the instrument panel. See *Vehicle Identification Number (VIN)* on page 11-1.

Recommended Fuel

If the vehicle has the 3.6L V6 engine (VIN Code V), use regular unleaded gasoline with a posted octane rating of 87 or higher. If the octane rating is less than 87, you might notice an audible knocking noise when you drive, commonly referred to as spark knock. If this occurs, use a gasoline rated at 87 octane or higher as soon as possible. If you are using gasoline rated at 87 octane or higher and you hear heavy knocking, the engine needs service.

If the vehicle has the 6.2L V8 engine (VIN Code W) or the 6.2L V8 engine (VIN Code J), use premium unleaded gasoline with a posted octane rating of 91 or higher. For best performance, use premium unleaded gasoline with a posted octane rating of 93. You can also use regular unleaded gasoline rated at 87 octane or higher, but the vehicle's acceleration could be slightly reduced, and you might notice a

slight audible knocking noise, commonly referred to as a spark knock. If the octane is less than 87, you might notice a heavy knocking noise when you drive. If this occurs, use a gasoline rated at 87 octane or higher as soon as possible. Otherwise, you could damage the engine. If you are using gasoline rated at 87 octane or higher and you hear heavy knocking, the engine needs service.

Gasoline Specifications

At a minimum, gasoline should meet ASTM specification D 4814 in the United States or CAN/CGSB-3.5 or 3.511 in Canada. Some gasolines contain an octane-enhancing additive called methylcyclopentadienyl manganese tricarbonyl (MMT). We recommend against the use of gasolines containing MMT. See *Fuel Additives* on page 8-45 for additional information.

California Fuel Requirements

If the vehicle is certified to meet California Emissions Standards, it is designed to operate on fuels that meet California specifications. See the underhood emission control label. If this fuel is not available in states adopting California emissions standards, the vehicle will operate satisfactorily on fuels meeting federal specifications, but emission control system performance might be affected. The malfunction indicator lamp could turn on and the vehicle might fail a smog-check test. See *Malfunction Indicator Lamp* on page 4-19. If this occurs, return to your authorized dealer/retailer for diagnosis. If it is determined that the condition is caused by the type of fuel used, repairs might not be covered by the vehicle warranty.

Fuels in Foreign Countries

If you plan on driving in another country outside the United States or Canada, the proper fuel might be hard to find. Never use leaded gasoline or any other fuel not recommended in the previous text on fuel. Costly repairs caused by use of improper fuel would not be covered by the vehicle warranty.

To check the fuel availability, ask an auto club, or contact a major oil company that does business in the country where you will be driving.

Fuel Additives

To provide cleaner air, all gasolines in the United States are now required to contain additives that help prevent engine and fuel system deposits from forming, allowing the emission control system to work properly. In most cases, you should not have to add anything to the fuel. However, some gasolines contain only the

minimum amount of additive required to meet U.S. Environmental Protection Agency regulations. To help keep fuel injectors and intake valves clean, or if the vehicle experiences problems due to dirty injectors or valves, look for gasoline that is advertised as TOP TIER Detergent Gasoline. Look for the TOP TIER label on the fuel pump to ensure gasoline meets enhanced detergency standards developed by the auto companies. A list of marketers providing TOP TIER Detergent Gasoline can be found at www.toptiergas.com.

For customers who do not use TOP TIER Detergent Gasoline regularly, one bottle of GM Fuel System Treatment PLUS, added to the fuel tank at every engine oil change, can help clean deposits from fuel injectors and intake valves. GM Fuel System Treatment PLUS is the only gasoline additive recommended by General Motors. It is available at your dealer/retailer.

8-46 Driving and Operating

Gasolines containing oxygenates, such as ethers and ethanol, and reformulated gasolines might be available in your area. We recommend that you use these gasolines, if they comply with the specifications described earlier. However, E85 (85% ethanol) and other fuels containing more than 10% ethanol must not be used in vehicles that were not designed for those fuels.

Notice: This vehicle was not designed for fuel that contains methanol. Do not use fuel containing methanol. It can corrode metal parts in the fuel system and also damage plastic and rubber parts. That damage would not be covered under the vehicle warranty.

Some gasolines that are not reformulated for low emissions can contain an octane-enhancing additive called methylcyclopentadienyl manganese tricarbonyl (MMT); ask the attendant where you buy gasoline whether the fuel contains MMT. We recommend against the use of such gasolines. Fuels containing MMT can reduce the life of spark plugs and the performance of the emission control system could be affected. The malfunction indicator lamp might turn on. If this occurs, return to your dealer/retailer for service.

Filling the Tank



Fuel vapor burns violently and a fuel fire can cause bad injuries. To help avoid injuries to you and others, read and follow all the instructions on the fuel pump island. Turn off the engine when refueling. Do not smoke near fuel or when refueling the vehicle. Do not use cellular phones. Keep sparks, flames, and smoking materials away from fuel. Do not leave the fuel pump unattended when refueling the vehicle. This is against the law in some places. Do not re-enter the vehicle while pumping fuel. Keep children away from the fuel pump; never let children pump fuel.

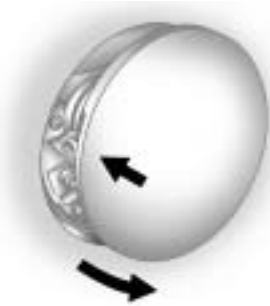

The fuel cap is located behind a hinged fuel door on the passenger side of the vehicle.

To open the fuel door, push the rearward center edge in and release and it will open.

When reinstalling the cap, turn it clockwise until it clicks, otherwise the Malfunction Indicator Lamp may turn on. See *Malfunction Indicator Lamp* on page 4-19.

⚠ WARNING

Fuel can spray out on you if you open the fuel cap too quickly. If you spill fuel and then something ignites it, you could be badly burned. This spray can happen if the tank is nearly full, and is more likely in hot weather. Open the fuel cap slowly and wait for any hiss noise to stop. Then unscrew the cap all the way.

Be careful not to spill fuel. Do not top off or overfill the tank and wait a few seconds after you have finished pumping before removing the nozzle. Clean fuel from painted surfaces as soon as possible. See *Exterior Care* on page 9-88.

When replacing the fuel cap, turn it clockwise until it clicks. Make sure the cap is fully installed. The diagnostic system can determine if the fuel cap has been left off or improperly installed.

This would allow fuel to evaporate into the atmosphere. See *Malfunction Indicator Lamp* on page 4-19.

⚠ WARNING

If a fire starts while you are refueling, do not remove the nozzle. Shut off the flow of fuel by shutting off the pump or by notifying the station attendant. Leave the area immediately.

Notice: If a new fuel cap is needed, be sure to get the right type of cap from your dealer/retailer. The wrong type fuel cap might not fit properly, might cause the malfunction indicator lamp to light, and could damage the fuel tank and emissions system. See *Malfunction Indicator Lamp* on page 4-19.

Filling a Portable Fuel Container

WARNING

Never fill a portable fuel container while it is in the vehicle. Static electricity discharge from the container can ignite the fuel vapor. You can be badly burned and the vehicle damaged if this occurs. To help avoid injury to you and others:

- Dispense fuel only into approved containers.
- Do not fill a container while it is inside a vehicle, in a vehicle's trunk, pickup bed, or on any surface other than the ground.

(Continued)

WARNING (Continued)

- Bring the fill nozzle in contact with the inside of the fill opening before operating the nozzle. Contact should be maintained until the filling is complete.
- Do not smoke while pumping fuel.
- Do not use a cellular phone while pumping fuel.

Towing

General Towing Information

Only use towing equipment that has been designed for the vehicle. Contact your dealer/retailer or towing retailer for assistance with preparing the vehicle for towing a trailer.

See the following trailer towing information in this section:

- For information on driving while towing a trailer, see Driving Characteristics and Towing Tips.
- For maximum vehicle and trailer weights, see Trailer Towing.
- For information on equipment to tow a trailer, see Towing Equipment.

For information on towing a disabled vehicle, see *Towing the Vehicle on page 9-87*. For information on towing the vehicle behind another vehicle — such as a motorhome, see *Recreational Vehicle Towing on page 9-87*.

Driving Characteristics and Towing Tips

WARNING

The driver can lose control when pulling a trailer if the correct equipment is not used or the vehicle is not driven properly. For example, if the trailer is too heavy, the brakes may not work well — or even at all. The driver and passengers could be seriously injured. The vehicle may also be damaged; the resulting repairs would not be covered by the vehicle warranty. Pull a trailer only if all the steps in this section have been followed. Ask your dealer/retailer for advice and information about towing a trailer with the vehicle.

The vehicle can tow a trailer if it is equipped with the proper trailer towing equipment. To identify the trailering capacity of the vehicle, see *Trailer Towing on page 8-53*. Trailering changes handling, acceleration, braking, durability and fuel economy. With the added weight, the engine, transmission, wheel assemblies and tires are forced to work harder and under greater loads. The trailer also adds wind resistance, increasing the pulling requirements. For safe trailering, correctly use the proper trailering equipment.

The following information has important trailering tips and rules for your safety and that of your passengers. Read this section carefully before pulling a trailer.

Pulling A Trailer

Here are some important points:

- There are many laws, including speed limit restrictions that apply to trailering. Check for legal requirements with state or provincial police.
- Do not tow a trailer at all during the first 1 600 km (1,000 miles) the new vehicle is driven. The engine, axle or other parts could be damaged.
- During the first 800 km (500 miles) that a trailer is towed, do not drive over 80 km/h (50 mph) and do not make starts at full throttle. This reduces wear on the vehicle.

- Vehicles with automatic transmissions can tow in D (Drive) but M (Manual Mode) is recommended. See “Manual Mode” in *Automatic Transmission on page 8-26* for more information. Use a lower gear if the transmission shifts too often. For vehicles with a manual transmission, it is better not to use the highest gear.
- Use the cruise control when towing.
- Obey speed limit restrictions. Do not drive faster than the maximum posted speed for trailers, or no more than 90 km/h (55 mph), to reduce wear on the vehicle.

Driving with a Trailer

Towing a trailer requires experience. Get familiar with handling and braking with the added trailer weight. The vehicle is now longer and not as responsive as the vehicle is by itself.

Check all trailer hitch parts and attachments, safety chains, electrical connectors, lamps, tires and mirror adjustments. If the trailer has electric brakes, start the vehicle and trailer moving and then apply the trailer brake controller by hand to be sure the brakes are working.

During the trip, check regularly to be sure that the load is secure, and the lamps and trailer brakes are working properly.

Towing with a Stability Control System

When towing, the sound of the stability control system might be heard. The system is reacting to the vehicle movement caused by the trailer, which mainly occurs during cornering. This is normal when towing heavier trailers.

Following Distance

Stay at least twice as far behind the vehicle ahead as you would when driving the vehicle without a trailer. This can help to avoid situations that require heavy braking and sudden turns.

Passing

More passing distance is needed when towing a trailer. Because the rig is longer, it is necessary to go much farther beyond the passed vehicle before returning to the lane.

Backing Up

Hold the bottom of the steering wheel with one hand. Then, to move the trailer to the left, move that hand to the left. To move the trailer to the right, move your hand to the right. Always back up slowly and, if possible, have someone guide you.

Making Turns

Notice: Making very sharp turns while trailering could cause the trailer to come in contact with the vehicle. The vehicle could be damaged. Avoid making very sharp turns while trailering.

When turning with a trailer, make wider turns than normal. Do this so the trailer won't strike soft shoulders, curbs, road signs, trees or other objects. Avoid jerky or sudden maneuvers. Signal well in advance.

Turn Signals When Towing a Trailer

The arrows on the instrument panel flash whenever signaling a turn or lane change. Properly hooked up, the trailer lamps also flash, telling other drivers the vehicle is turning, changing lanes or stopping.

When towing a trailer, the arrows on the instrument panel flash for turns even if the bulbs on the trailer are burned out. For this reason you may think other drivers are seeing the signal when they are not. It is important to check occasionally to be sure the trailer bulbs are still working.

Driving On Grades

Reduce speed and shift to a lower gear before starting down a long or steep downgrade. If the transmission is not shifted down, the brakes might have to be used so much that they would get hot and no longer work well.

Vehicles with an automatic transmission can tow in D (Drive). Shift the transmission to a lower gear if the transmission shifts too often under heavy loads and/or hilly conditions. For vehicles with a manual transmission, it is better not to use the highest gear.

When towing at high altitude on steep uphill grades, consider the following: Engine coolant will boil at a lower temperature than at normal altitudes. If the engine is turned off immediately after towing at high altitude on steep uphill grades, the vehicle may show signs similar to engine overheating. To avoid this, let the engine run while parked, preferably on level ground, with the automatic transmission in P (Park) for a few minutes before turning the engine off.

8-52 Driving and Operating

For vehicles with manual transmissions, let the engine run while parked, preferably on level ground, with the transmission out of gear and the parking brake applied, for a few minutes before turning the engine off. If the overheat warning comes on, see *Engine Overheating on page 9-24*.

Parking on Hills

WARNING

Parking the vehicle on a hill with the trailer attached can be dangerous. If something goes wrong, the rig could start to move. People can be injured, and both the vehicle and the trailer can be damaged. When possible, always park the rig on a flat surface.

If parking the rig on a hill:

1. Press the brake pedal, but do not shift into P (Park) yet for vehicles with an automatic transmission, or into gear for vehicles with a manual transmission. Turn the wheels into the curb if facing downhill or into traffic if facing uphill.
2. Have someone place chocks under the trailer wheels.
3. When the wheel chocks are in place, release the brake pedal until the chocks absorb the load.
4. Reapply the brake pedal. Then apply the parking brake and shift into P (Park) for vehicles with an automatic transmission or into gear for vehicles with a manual transmission.
5. Release the brake pedal.

Leaving After Parking on a Hill

1. Apply and hold the brake pedal while you:
 - start the engine,
 - shift into a gear, and
 - release the parking brake.
2. Let up on the brake pedal.
3. Drive slowly until the trailer is clear of the chocks.
4. Stop and have someone pick up and store the chocks.

Maintenance When Trailer Towing

The vehicle needs service more often when pulling a trailer. See this manual's Maintenance Schedule or Index for more information. Things that are especially important in trailer operation are automatic transmission fluid, engine oil, axle lubricant, belts, cooling system and brake system. It is a good idea to inspect these before and during the trip.

Check periodically to see that all hitch nuts and bolts are tight.

Engine Cooling When Trailer Towing

The cooling system may temporarily overheat during severe operating conditions. See *Engine Overheating* on page 9-24.

Trailer Towing

Before pulling a trailer, there are three important considerations that have to do with weight:

- The weight of the trailer.
- The weight of the trailer tongue.
- The total weight on your vehicle's tires.

Weight of the Trailer

How heavy can a trailer safely be?

It should never weigh more than 1,000 lbs (454 kg). But even that can be too heavy.

It depends on how the rig is used. For example, speed, altitude, road grades, outside temperature and how much the vehicle is used to pull a trailer are all important. It can

depend on any special equipment on the vehicle, and the amount of tongue weight the vehicle can carry. See "Weight of the Trailer Tongue" later in this section for more information.

Maximum trailer weight is calculated assuming only the driver is in the tow vehicle and it has all the required trailering equipment. The weight of additional optional equipment, passengers and cargo in the tow vehicle must be subtracted from the maximum trailer weight.

Ask your dealer/retailer for our trailering information or advice, or you can write us at our Customer Assistance Offices. See *Customer Assistance Offices* on page 12-3 for more information.

8-54 Driving and Operating

Weight of the Trailer Tongue

The tongue load (A) of any trailer is an important weight to measure because it affects the total gross weight of the vehicle. The Gross Vehicle Weight (GVW) includes the curb weight of the vehicle, any cargo carried in it, and the people who will be riding in the vehicle. If there are a lot of options, equipment, passengers or cargo in the vehicle, it will reduce the tongue weight the vehicle can carry, which will also reduce the trailer weight the vehicle can tow. If towing a trailer, the tongue load must be added to the GVW because the vehicle will be carrying that weight, too. See *Vehicle Load Limits on page 8-12* for more information about the vehicle's maximum load capacity.

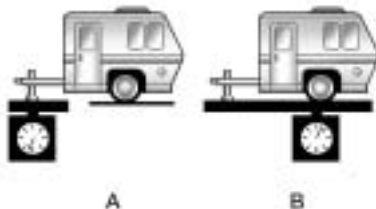

The trailer tongue (A) should weigh 10 to 15 percent of the total loaded trailer weight (B).

After loading the trailer, weigh the trailer and then the tongue, separately, to see if the weights are proper. If they aren't, adjustments might be made by moving some items around in the trailer.

Total Weight on Your Vehicle's Tires

Be sure the vehicle's tires are inflated to the upper limit for cold tires. These numbers can be found on the Tire-Loading Information label. See *Vehicle Load Limits on page 8-12*. Make sure not to go over the GVW limit for the vehicle, including the weight of the trailer tongue.

Towing Equipment

Hitches

Use the correct hitch equipment. See your dealer/retailer or a hitch dealer for assistance.

- The rear bumper on the vehicle is not intended for hitches. Do not attach rental hitches or other bumper-type hitches to it. Use only a frame-mounted hitch that does not attach to the bumper.
- Will any holes be made in the body of the vehicle when the trailer hitch is installed? If there are, seal the holes when the hitch is removed. If the holes are not sealed, dirt, water, and deadly carbon monoxide (CO) from the exhaust can get into the vehicle. See *Engine Exhaust* on page 8-25.

Safety Chains

Always attach chains between the vehicle and the trailer. Cross the safety chains under the tongue of the trailer to help prevent the tongue from contacting the road if it becomes separated from the hitch. Leave enough slack so the rig can turn. Never allow safety chains to drag on the ground.

Trailer Brakes

Does the trailer have its own brakes? Be sure to read and follow the instructions for the trailer brakes so they are installed, adjusted and maintained properly.

Because the vehicle has antilock brakes, do not tap into the vehicle's brake system. If this is done, both brake systems will not work well, or at all.

Conversions and Add-Ons

Add-On Electrical Equipment

Notice: Do not add anything electrical to the vehicle unless you check with your dealer/retailer first. Some electrical equipment can damage the vehicle and the damage would not be covered by the vehicle's warranty. Some add-on electrical equipment can keep other components from working as they should.

Add-on equipment can drain the vehicle battery, even if the vehicle is not operating.

The vehicle has an airbag system. Before attempting to add anything electrical to the vehicle, see *Servicing the Airbag-Equipped Vehicle* on page 2-32 and *Adding Equipment to the Airbag-Equipped Vehicle* on page 2-33.

Vehicle Care

General Information

General Information	9-2
California Proposition 65 Warning	9-2
California Perchlorate Materials Requirements	9-3
Accessories and Modifications	9-3

Vehicle Checks

Doing Your Own Service Work	9-4
Hood	9-5
Engine Compartment Overview	9-6
Engine Cover	9-9
Engine Oil	9-10
Engine Oil Life System	9-13
Automatic Transmission Fluid	9-14
Manual Transmission Fluid	9-15
Hydraulic Clutch	9-15
Engine Air Cleaner/Filter	9-16
Cooling System	9-17
Engine Coolant	9-19
Engine Overheating	9-24
Power Steering Fluid	9-25

Washer Fluid	9-26
Brakes	9-27
Brake Fluid	9-28
Battery	9-29
Rear Axle	9-30
Starter Switch Check	9-31
Automatic Transmission Shift Lock Control System Check	9-32
Ignition Transmission Lock Check	9-32
Park Brake and P (Park) Mechanism Check	9-32
Wiper Blade Replacement	9-33

Headlamp Aiming

Headlamp Aiming	9-34
-----------------------	------

Bulb Replacement

Bulb Replacement	9-37
Halogen Bulbs	9-37
High Intensity Discharge (HID) Lighting	9-37
Headlamps, Front Turn Signal and Parking Lamps (Base Vehicle)	9-37
Headlamps, Front Turn Signal and Parking Lamps (Up-Level Vehicle)	9-38
Daytime Running Lamps (DRL)	9-39
Fog Lamps	9-40

Taillamps, Turn Signal, and Stoplamps	9-40
License Plate Lamp	9-40
Replacement Bulbs	9-41

Electrical System

Electrical System Overload	9-41
Fuses and Circuit Breakers	9-42
Engine Compartment Fuse Block	9-42
Instrument Panel Fuse Block	9-45
Rear Compartment Fuse Block	9-46

Wheels and Tires

Tires	9-48
Winter Tires	9-48
Tire Sidewall Labeling	9-49
Tire Designations	9-51
Tire Terminology and Definitions	9-52
Tire Pressure	9-54
Tire Pressure for High-Speed Operation	9-56
Tire Pressure Monitor System	9-56
Tire Pressure Monitor Operation	9-57
Tire Inspection	9-61

9-2 Vehicle Care

Tire Rotation	9-61
When It Is Time for New Tires	9-62
Buying New Tires	9-63
Different Size Tires and Wheels	9-65
Uniform Tire Quality Grading	9-65
Wheel Alignment and Tire Balance	9-67
Wheel Replacement	9-67
Tire Chains	9-68
If a Tire Goes Flat	9-69
Tire Sealant and Compressor Kit	9-71
Storing the Tire Sealant and Compressor Kit	9-77
Tire Changing	9-77
Compact Spare Tire	9-83

Jump Starting

Jump Starting	9-84
---------------------	------

Towing

Towing the Vehicle	9-87
Recreational Vehicle Towing	9-87

Appearance Care

Exterior Care	9-88
Interior Care	9-92

General Information

For service and parts needs, visit your dealer/retailer. You will receive genuine GM parts and GM-trained and supported service people.

Genuine GM parts have one of these marks:



California Proposition 65 Warning

Most motor vehicles, including this one, contain and/or emit chemicals known to the State of California to cause cancer and birth defects or other reproductive harm. Engine exhaust, many parts and systems (including some inside the vehicle), many fluids, and some component wear by-products contain and/or emit these chemicals.

California Perchlorate Materials Requirements

Certain types of automotive applications, such as airbag initiators, seat belt pretensioners, and lithium batteries contained in remote keyless transmitters, may contain perchlorate materials. Special handling may be necessary. For additional information, see www.dtsc.ca.gov/hazardouswaste/perchlorate.

Accessories and Modifications

Adding non-dealer/non-retailer accessories to the vehicle can affect vehicle performance and safety, including such things as airbags, braking, stability, ride and handling, emissions systems, aerodynamics, durability, and electronic systems like antilock brakes, traction control, and stability control. Some of these accessories could even cause malfunction or damage not covered by the vehicle warranty.

Damage to vehicle components resulting from the installation or use of non-GM certified parts, including control module modifications, are not covered under the terms of the vehicle warranty and may affect remaining warranty coverage for affected parts.

GM Accessories are designed to complement and function with other systems on the vehicle. Your GM dealer/retailer can accessorize the vehicle using genuine GM Accessories. When you go to your GM dealer/retailer and ask for GM Accessories, you will know that GM-trained and supported service technicians will perform the work using genuine GM Accessories.

Also, see *Adding Equipment to the Airbag-Equipped Vehicle* on page 2-33.

Vehicle Checks

Doing Your Own Service Work

 **WARNING**

You can be injured and the vehicle could be damaged if you try to do service work on a vehicle without knowing enough about it.

- Be sure you have sufficient knowledge, experience, the proper replacement parts, and tools before attempting any vehicle maintenance task.

(Continued)

WARNING (Continued)

- Be sure to use the proper nuts, bolts, and other fasteners. English and metric fasteners can be easily confused. If the wrong fasteners are used, parts can later break or fall off. You could be hurt.

If doing some of your own service work, use the proper service manual. It tells you much more about how to service the vehicle than this manual can. To order the proper service manual, see *Service Publications Ordering Information* on page 12-12.

This vehicle has an airbag system. Before attempting to do your own service work, see *Airbag System Check* on page 2-34.

Keep a record with all parts receipts and list the mileage and the date of any service work performed. See *Maintenance Records* on page 10-10.

Hood

To open the hood:

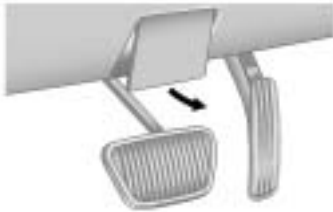

1. Pull the release handle that is located below the instrument panel to the left of the steering wheel.

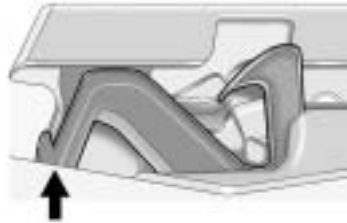

2. Pull up on the secondary hood release. The lever is located near the middle of the hood.
3. Lift the hood.

Before closing the hood, be sure all the filler caps are on properly. Then lift the hood to relieve pressure. Pull the hood down on the passenger side to close it firmly.

Engine Compartment Overview

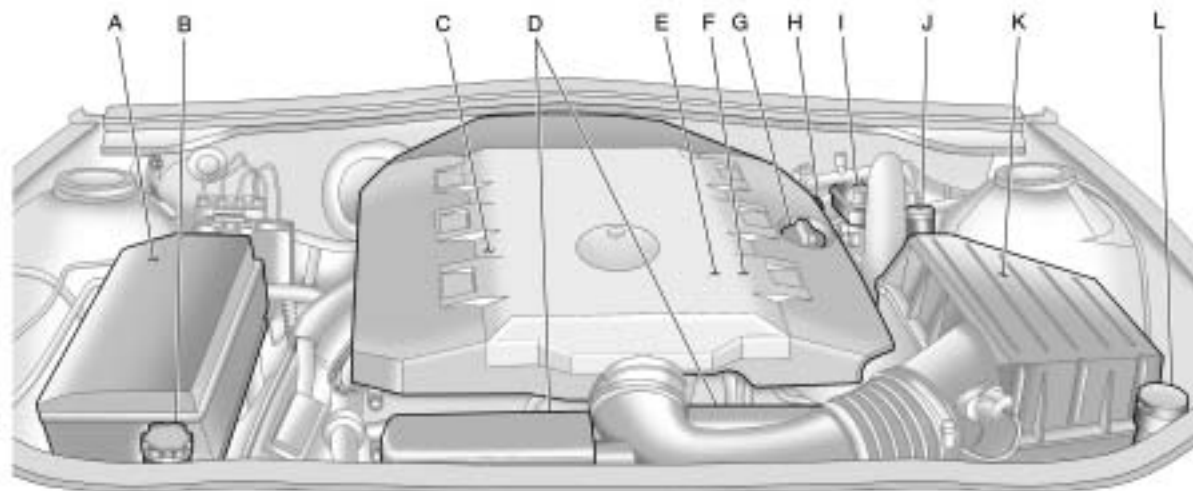

3.6 L V6 Engine

- A. Underhood Electrical Center.
See *Engine Compartment Fuse Block* on page 9-42.
- B. Engine Coolant Recovery Bottle and Cap. See *Engine Coolant* on page 9-19.
- C. *Engine Cover* on page 9-9.
- D. Engine Cooling Fans (Out of View). See *Cooling System* on page 9-17.
- E. Radiator Fill Cap (Out of View).
See *Engine Coolant* on page 9-19.
- F. Power Steering Reservoir and Cap (Out of View). See *Power Steering Fluid* on page 9-25.
- G. Engine Oil Fill Cap. See *Engine Oil* on page 9-10.
- H. Engine Oil Dipstick (Out of View). See *Engine Oil* on page 9-10.
- I. Brake Master Cylinder and Hydraulic Clutch (if equipped with manual transmission) Reservoir.
See *Brakes* on page 9-27 or *Hydraulic Clutch* on page 9-15.
- J. Remote Positive (+) Terminal.
See *Battery* on page 9-29.
- K. *Engine Air Cleaner/Filter* on page 9-16.
- L. Windshield Washer Fluid Reservoir. See *Washer Fluid* on page 9-26.

9-8 Vehicle Care

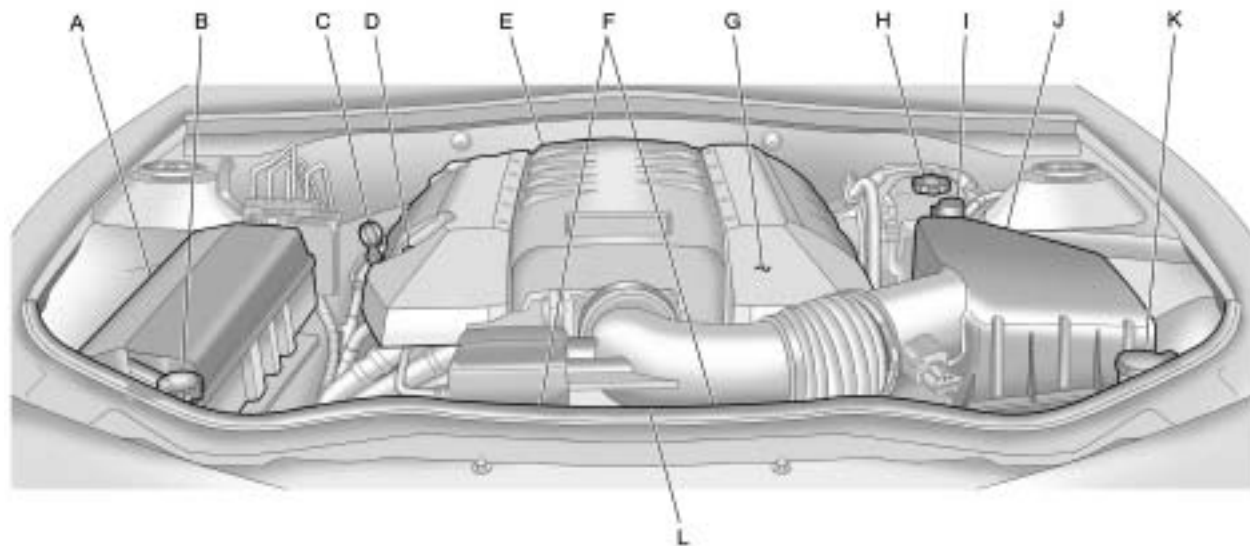

6.2 L V8 Engine (L99 Engine shown LS3 similar)

- A. Underhood Electrical Center. See *Engine Compartment Fuse Block* on page 9-42.
- B. Engine Coolant Recovery Bottle and Cap. See *Engine Coolant* on page 9-19.
- C. Engine Oil Dipstick. See *Engine Oil* on page 9-10.
- D. Engine Oil Fill Cap (Out of View). See *Engine Oil* on page 9-10.
- E. *Engine Cover* on page 9-9.
- F. Engine Cooling Fans (Out of View). See *Cooling System* on page 9-17.
- G. Power Steering Reservoir and Cap (Under Engine Cover). See *Power Steering Fluid* on page 9-25.
- H. Brake Master Cylinder and Hydraulic Clutch (if equipped with manual transmission) Reservoir. See *Brakes* on page 9-27 or *Hydraulic Clutch* on page 9-15.
- I. Remote Positive (+) Terminal. See *Battery* on page 9-29.
- J. *Engine Air Cleaner/Filter* on page 9-16.
- K. Windshield Washer Fluid Reservoir. See *Washer Fluid* on page 9-26.
- L. Radiator Fill Cap. See *Engine Coolant* on page 9-19.

Engine Cover

3.6 L V6 Engine Cover

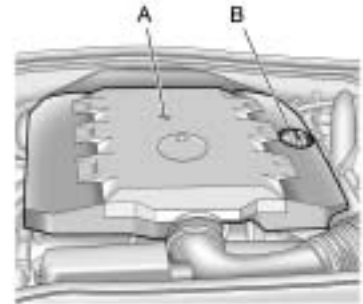

To remove:

1. Remove the engine oil fill cap (B).
2. Lift the engine cover (A) to disengage one front attachment point.
3. Pull engine cover forward to disengage from two rear tabs.
4. Reverse Steps 1 through 3 to reinstall engine cover.

6.2 L V8 Engine Cover (L99 Engine shown LS3 similar)

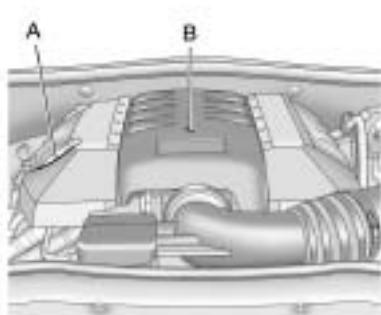

To remove:

1. Remove the engine oil fill cap (A).
2. Lift the engine cover (B) to disengage two front attachment points.
3. Pull engine cover forward to disengage from horizontal rear attachments.
4. Reverse Steps 1 through 3 to reinstall engine cover.

Engine Oil

Checking Engine Oil

It is a good idea to check the engine oil level at each fuel fill. In order to get an accurate reading, the oil must be warm and the vehicle must be on level ground.

The engine oil dipstick handle is a yellow loop. See *Engine Compartment Overview on page 9-6* for the location of the engine oil dipstick.

1. Turn off the engine and give the oil several minutes to drain back into the oil pan. If this is not done, the oil dipstick might not show the actual level.
2. Pull out the dipstick and clean it with a paper towel or cloth, then push it back in all the way. Remove it again, keeping the tip down, and check the level.

When to Add Engine Oil

If the oil is below the cross-hatched area at the tip of the dipstick, add at least one liter/quart of the recommended oil. This section explains what kind of oil to use. For engine oil crankcase capacity, see *Capacities and Specifications on page 11-2*.

Notice: Do not add too much oil. If the engine has so much oil that the oil level gets above the cross-hatched area that shows the proper operating range, the engine could be damaged.

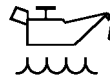

See *Engine Compartment Overview on page 9-6* for the location of the engine oil fill cap.

Add enough oil to put the level somewhere in the proper operating range. Push the dipstick all the way back in when through.

What Kind of Engine Oil to Use (V6 Engine)

Look for three things:

RECOMMENDED SAE VISCOSITY GRADE

HOT WEATHER



COLD WEATHER

DO NOT USE SAE 10W-40, SAE 20W-50
OR ANY OTHER VISCOSITY GRADE
OIL NOT RECOMMENDED

- GM6094M
Use only an oil that meets GM Standard GM6094M.
- SAE 5W-30
SAE 5W-30 is best for the vehicle. These numbers on an oil container show its viscosity, or thickness. Do not use other viscosity oils such as SAE 20W-50.
- American Petroleum Institute (API) starburst symbol



Oils meeting these requirements should have the starburst symbol on the container. This symbol indicates that the oil has been certified by the American Petroleum Institute (API).

Notice: Use only engine oil identified as meeting GM Standard GM6094M and showing the American Petroleum Institute Certified For Gasoline Engines starburst symbol. Failure to use the recommended oil can result in engine damage not covered by the vehicle warranty.

Cold Temperature Operation

If in an area of extreme cold, where the temperature falls below -29°C (-20°F), use either an SAE 5W-30 synthetic oil or an SAE 0W-30 engine oil. Both provide easier cold starting for the engine at extremely low temperatures. Always use an oil that meets the required specification, GM6094M.

9-12 Vehicle Care

What Kind of Engine Oil to Use (V8 Engines)

Look for three things:



- GM4718M

This vehicle's engine requires a special oil meeting GM Standard GM4718M. Oils meeting this standard may be identified as synthetic. However, not all synthetic oils will meet this GM standard. Use only an oil that meets GM Standard GM4718M.

Notice: Using oils that do not have the GM4718M Standard designation can cause engine damage not covered by the vehicle warranty.

- SAE 5W-30

SAE 5W-30 is best for the vehicle. These numbers on an oil container show its viscosity, or thickness. Do not use other viscosity oils such as SAE 20W-50.

- American Petroleum Institute (API) starburst symbol



Oils meeting these requirements should have the starburst symbol on the container. This symbol indicates that the oil has been certified by the American Petroleum Institute (API).

This vehicle's engine was filled at the factory with a Mobil 1[®] synthetic oil meeting all requirements for this vehicle.

Substitute Engine Oil: When adding oil to maintain engine oil level, oil meeting GM Standard GM4718M might not be available. You can add substitute oil designated SAE 5W-30 with the starburst symbol at all temperatures. Substitute oil not meeting GM Standard GM4718M should not be used for an oil change.

Engine Oil Additives / Engine Oil Flushes

Do not add anything to the oil. The recommended oils with the starburst symbol that meet GM Standard GM6094M are all that is needed for good performance and engine protection.

Engine oil system flushes are not recommended and could cause engine damage not covered by the vehicle warranty.

Engine Oil Life System

When to Change Engine Oil

This vehicle has a computer system that indicates when to change the engine oil and filter. This is based on engine revolutions and engine temperature, and not on mileage. Based on driving conditions, the mileage at which an oil change is indicated can vary considerably. For the oil life system to work properly, the system must be reset every time the oil is changed.

When the system has calculated that oil life has been diminished, it indicates that an oil change is necessary. A CHANGE ENGINE OIL SOON message comes on. See *Engine Oil Messages on page 4-32*. Change the oil as soon as possible within the next 1 000 km (600 miles). It is possible that, if driving under the best conditions, the oil life system might not indicate that an oil change is necessary for over a year. However, the engine oil and filter must be changed at least once a year and at this time the system must be reset. Your dealer/retailer has trained service people who will perform this work using genuine parts and reset the system. It is also important to check the oil regularly and keep it at the proper level.

If the system is ever reset accidentally, the oil must be changed at 5 000 km (3,000 miles) since the last oil change. Remember to reset the oil life system whenever the oil is changed.

How to Reset the Engine Oil Life System

The Engine Oil Life System calculates when to change the engine oil and filter based on vehicle use. Whenever the oil is changed, reset the system so it can calculate when the next oil change is required. If a situation occurs where the oil is changed prior to a change engine oil message being turned on, reset the system.

After changing the engine oil, reset the system:

1. Turn the ignition key to ON/RUN with the engine off.
2. Fully press and release the accelerator pedal three times within five seconds.

If the CHANGE ENGINE OIL SOON message is not on, the system is reset.

If the CHANGE ENGINE OIL SOON message comes on again and stays on for 30 seconds at the next ignition cycle, it did not reset. The system needs to be reset again.

What to Do with Used Oil

Used engine oil contains certain elements that can be unhealthy for your skin and could even cause cancer. Do not let used oil stay on your skin for very long. Clean your skin and nails with soap and water, or a good hand cleaner. Wash or properly dispose of clothing or rags containing used engine oil. See the manufacturer's warnings about the use and disposal of oil products.

Used oil can be a threat to the environment. If you change your own oil, be sure to drain all the oil from the filter before disposal. Never dispose of oil by putting it in the trash, pouring it on the ground, into sewers, or into streams or bodies of water. Recycle it by taking it to a place that collects used oil.

Automatic Transmission Fluid

How to Check Automatic Transmission Fluid

It is not necessary to check the transmission fluid level. A transmission fluid leak is the only reason for fluid loss. If a leak occurs, take the vehicle to your dealer/retailer service department and have it repaired as soon as possible.

There is a special procedure for checking and changing the transmission fluid. Because this procedure is difficult, you should have this done at your dealer/retailer service department.

Contact your dealer/retailer for additional information or the procedure can be found in the service manual. To purchase a service manual, see *Service Publications Ordering Information on page 12-12*.

Change the fluid and filter at the intervals listed in *Scheduled Maintenance on page 10-2*, and be sure to use the fluid listed in *Recommended Fluids and Lubricants on page 10-7*.

Manual Transmission Fluid

It is not necessary to check the manual transmission fluid level. A transmission fluid leak is the only reason for fluid loss. If a leak occurs, take the vehicle to your dealer/retailer service department and have it repaired as soon as possible. See *Recommended Fluids and Lubricants* on page 10-7 for the proper fluid to use.

Hydraulic Clutch

It is not necessary to regularly check brake/clutch fluid unless you suspect there is a leak in the system. Adding fluid will not correct a leak. A fluid loss in this system could indicate a problem. Have the system inspected and repaired.

When to Check and What to Use



The brake/hydraulic clutch fluid reservoir cap has this symbol on it. The common hydraulic clutch and brake master cylinder fluid reservoir is filled with DOT 3 brake fluid as indicated on the reservoir cap. See *Engine Compartment Overview* on page 9-6 for reservoir location.

How to Check and Add Fluid

Visually check the brake/clutch fluid reservoir to make sure the fluid level is at the MIN (minimum) line on the side of the reservoir. The brake/hydraulic clutch fluid system should be closed and sealed.

Do not remove the cap to check the fluid level or to top-off the fluid level. Remove the cap only when necessary to add the proper fluid until the level reaches the MIN line.

Engine Air Cleaner/Filter

See *Engine Compartment Overview on page 9-6* for the location of the engine air cleaner/filter.

When to Inspect the Engine Air Cleaner/Filter

Inspect the air cleaner/filter at the Maintenance II intervals and replace it at the first oil change after each 50,000 mile (80 000 km) interval. See "Schedule Maintenance" in Service and Maintenance for more information. If driving in dusty/dirty conditions, inspect the filter at each engine oil change.

How to Inspect the Engine Air Cleaner/Filter

To inspect the air cleaner/filter, remove the filter from the vehicle and lightly shake the filter to release loose dust and dirt. If the filter remains caked with dirt, a new filter is required.

To inspect or replace the engine air cleaner/filter:

1. Open the hood. See *Hood on page 9-5*.
2. Locate the air filter housing on the front of the driver side of the engine compartment. See *Engine Compartment Overview on page 9-6*.

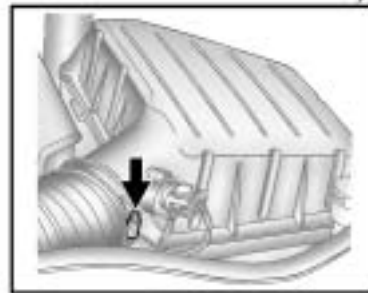

**3.6 L V6 Engine Air Cleaner/
Filter Housing shown
(6.2 L V8 Engines similar)**

3. Loosen the clamp at the duct of the air cleaner/filter housing.
4. Unlatch the retaining clips on the air cleaner/filter housing.
5. Lift cover at retaining clip location high enough to clear retaining clips and pull cover outward to remove cover from the air cleaner/filter housing hinges.
6. Pull straight up on cover, while holding the cover remove the air filter.
7. Inspect or replace the air filter. See *Maintenance Replacement Parts* on page 10-9.
8. Reverse steps 6 to 1 to install cover.

⚠ WARNING

Operating the engine with the air cleaner/filter off can cause you or others to be burned. The air cleaner not only cleans the air; it helps to stop flames if the engine backfires. If it is not there and the engine backfires, you could be burned. Do not drive with it off, and be careful working on the engine with the air cleaner/filter off.

Notice: If the air cleaner/filter is off, a backfire can cause a damaging engine fire. And, dirt can easily get into the engine, which will damage it. Always have the air cleaner/filter in place when you are driving.

Cooling System

When it is safe to lift the hood:

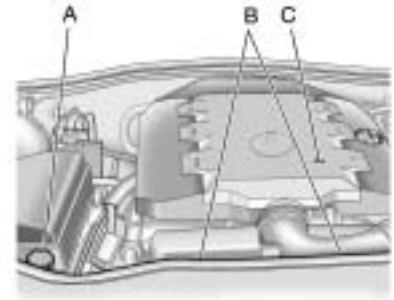

3.6 L V6 Engine

- A. Coolant Recovery Bottle
- B. Electric Cooling Fans
- C. Radiator Cap
(under engine cover)

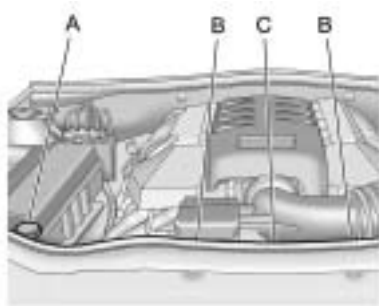

6.2 L V8 Engines (L99 shown LS3 similar)

- A. Coolant Recovery Bottle
- B. Electric Cooling Fans
- C. Radiator Cap

WARNING

An electric engine cooling fan under the hood can start up even when the engine is not running and can cause injury. Keep hands, clothing, and tools away from any underhood electric fan.

If the coolant inside the coolant recovery bottle is boiling, do not do anything else until it cools down. The vehicle should be parked on a level surface.

The coolant level should be between the MIN and MAX lines. If it is not, you may have a leak at the radiator hoses, heater hoses, radiator, water pump, or somewhere else in the cooling system.

WARNING

Heater and radiator hoses, and other engine parts, can be very hot. Do not touch them. If you do, you can be burned.

Do not run the engine if there is a leak. If you run the engine, it could lose all coolant. That could cause an engine fire, and you could be burned. Get any leak fixed before you drive the vehicle.

If there seems to be no leak, with the engine on, check to see if the electric engine cooling fans are running. If the engine is overheating, the fans should be running. If it is not, your vehicle needs service. Turn off the engine.

Notice: Using coolant other than DEX-COOL® can cause premature engine, heater core, or radiator corrosion. In addition, the engine coolant could require changing sooner, at 50 000 km (30,000 miles) or 24 months, whichever occurs first. Any repairs would not be covered by the vehicle warranty. Always use DEX-COOL® (silicate-free) coolant in the vehicle.

Engine Coolant

The cooling system in the vehicle is filled with DEX-COOL® engine coolant. This coolant is designed to remain in the vehicle for five years or 240 000 km (150,000 miles), whichever occurs first.

The following explains the cooling system and how to check and add coolant when it is low. If there is a problem with engine overheating, see *Engine Overheating on page 9-24*.

What to Use

WARNING

Adding only plain water to the cooling system can be dangerous. Plain water, or some other liquid such as alcohol, can boil before the proper coolant mixture will. The vehicle's coolant warning system is set for the proper coolant mixture. With plain water or the wrong mixture, the engine could get too hot but you would not get the overheat warning. The engine could catch fire and you or others could be burned. Use a 50/50 mixture of clean, drinkable water and DEX-COOL® coolant.

Use a 50/50 mixture of clean, drinkable water and DEX-COOL® coolant. If using this mixture, nothing else needs to be added. This mixture:

- Gives freezing protection down to -37°C (-34°F), outside temperature.
- Gives boiling protection up to 129°C (265°F), engine temperature.
- Protects against rust and corrosion.
- Will not damage aluminum parts.
- Helps keep the proper engine temperature.

Notice: If an improper coolant mixture is used, the engine could overheat and be badly damaged. The repair cost would not be covered by the vehicle warranty. Too much water in the mixture can freeze and crack the engine, radiator, heater core, and other parts.

9-20 Vehicle Care

Checking Coolant

The vehicle must be on a level surface when checking the coolant level.

Check coolant as follows:

1. Turn the ignition OFF.
2. Locate the coolant recovery bottle. See *Engine Compartment Overview* on page 9-6.



3. Turn the coolant dipstick cap counterclockwise and slowly pull out the dipstick.



4. There are maximum and minimum markings on the dipstick. When the engine is cold, the coolant level should be at or above the MIN mark on the dipstick. After the vehicle has been driven and the engine is at normal operating temperature, the level should be somewhere between half full and the maximum mark.
5. If the coolant level is correct, replace the dipstick and turn the cap clockwise to secure.

How to Add Coolant to the Coolant Recovery Bottle

WARNING

You can be burned if you spill coolant on hot engine parts. Coolant contains ethylene glycol and it will burn if the engine parts are hot enough. Do not spill coolant on a hot engine.

Notice: This vehicle has a specific coolant fill procedure. Failure to follow this procedure could cause the engine to overheat and be severely damaged.

Notice: If an improper coolant mixture is used, the engine could overheat and be badly damaged. The repair cost would not be covered by the vehicle warranty. Too much water in the mixture can freeze and crack the engine, radiator, heater core, and other parts.

Add coolant as follows:

1. Turn the coolant overflow bottle dipstick cap counterclockwise and slowly pull out the dipstick.
2. Pour the coolant into the coolant recovery bottle.
3. When the level is correct, replace the dipstick and turn the cap clockwise to secure.

How to Add Coolant to the Radiator

WARNING

You can be burned if you spill coolant on hot engine parts. Coolant contains ethylene glycol and it will burn if the engine parts are hot enough. Do not spill coolant on a hot engine.

Notice: This vehicle has a specific coolant fill procedure. Failure to follow this procedure could cause the engine to overheat and be severely damaged.

WARNING

An electric engine cooling fan under the hood can start up even when the engine is not running and can cause injury. Keep hands, clothing, and tools away from any underhood electric fan.

WARNING

Steam and scalding liquids from a hot cooling system can blow out and burn you badly. They are under pressure, and if you turn the surge tank pressure cap — even a little — they can come out at high speed. Never turn the cap when the cooling system, including the surge tank pressure cap, is hot. Wait for the cooling system and surge tank pressure cap to cool if you ever have to turn the pressure cap.

If coolant is needed, add the proper mixture directly to the radiator, but be sure the cooling system is cool before this is done.

9-22 Vehicle Care

If no coolant is visible in the coolant overflow bottle, add coolant as follows:

3.6 L V6 Engine Fill Procedure

1. Locate the radiator cap.
See *Engine Compartment Overview* on page 9-6.
2. Remove engine cover to access the radiator cap. See *Engine Cover* on page 9-9.



3. Cover the radiator cap with a thick cloth and turn it slowly counterclockwise and remove.
4. If there is no coolant visible or the level is low, slowly fill the system through the radiator cap opening with a 50/50 mixture of DEX-COOL[®] and clean drinkable water.

Wait 30 seconds for coolant to settle and continue filling if the level drops.

Do not spill coolant on the accessory drive belts.

If a spill occurs, rinse the belt with fresh water.

5. Start the engine.
6. With the engine idling, continue to add coolant through the radiator cap opening until full. Wait 30 seconds for the coolant to settle and top off, if the level drops.
7. Once the system is full, put the radiator cap back on by turning clockwise.
8. With the engine still running, raise the engine to 2500 RPM for 30–40 seconds.
9. Turn the engine OFF.
10. Repeat steps 2–7 then turn the engine off.

11. Allow engine to cool for 45 minutes. Top off coolant through the radiator cap opening and re-install the radiator cap.

12. Re-install the engine cover.
See *Engine Cover* on page 9-9.



13. Check the coolant level in the coolant recovery bottle and fill it until the level is at the top symbol on the dipstick.

6.2 L V8 Engine Fill Procedure

1. Locate the radiator cap.
See *Engine Compartment Overview* on page 9-6.



2. Cover the radiator cap with a thick cloth and turn it slowly counterclockwise and remove.
3. If there is no coolant visible or the level is low, slowly fill the system through the radiator cap opening with a 50/50 mixture of clean, drinkable water and a DEX-COOL® coolant until full.

Wait 30 seconds for coolant to settle and top off if the level drops.

Do not spill coolant on the accessory drive belts.

If a spill occurs, rinse the belt with fresh water.

4. Start the engine.
5. With the engine idling, top off the coolant through the radiator cap opening until full.
Wait 30 seconds for the coolant to settle and top off, if the level drops.
6. Once the system is full, put the radiator cap back on by turning clockwise.
7. Turn the engine OFF.



8. Check the coolant level in the coolant recovery bottle and fill it until the level is at the top mark on the dipstick.

Notice: If the pressure cap is not tightly installed, coolant loss and possible engine damage may occur. Be sure the cap is properly and tightly secured.

Engine Overheating

The vehicle has an indicator to warn of engine overheating.

There is an engine coolant temperature warning light on your vehicle's instrument panel.

See *Engine Coolant Temperature Gage* on page 4-14.

You may decide not to lift the hood when this warning appears, but instead get service help right away. See *Roadside Assistance Program* on page 12-6.

If you do decide to lift the hood, make sure the vehicle is parked on a level surface.

Then check to see if the engine cooling fans are running. If the engine is overheating, both fans should be running. If they are not, do not continue to run the engine and have the vehicle serviced.

Notice: Engine damage from running the engine without coolant is not covered by the warranty.

Notice: If the engine catches fire because of being driven with no coolant, your vehicle can be badly damaged. The costly repairs would not be covered by the vehicle warranty.

If Steam Is Coming From The Engine Compartment



Steam from an overheated engine can burn you badly, even if you just open the hood. Stay away from the engine if you see or hear steam coming from it. Just turn it off and get everyone away from the vehicle until it cools down. Wait until there is no sign of steam or coolant before you open the hood.

If you keep driving when your engine is overheated, the liquids in it can catch fire. You or others could be badly burned. Stop your engine if it overheats, and get out of the vehicle until the engine is cool.

If No Steam Is Coming From The Engine Compartment

If an engine overheat warning is displayed but no steam can be seen or heard, the problem may not be too serious. Sometimes the engine can get a little too hot when the vehicle:

- Climbs a long hill on a hot day.
- Stops after high-speed driving.
- Idles for long periods in traffic.
- Tows a trailer.

If the overheat warning is displayed with no sign of steam:

1. Turn the air off.
2. Turn the heater on to the highest temperature and to the highest fan speed. Open the windows as necessary.

3. In heavy traffic, let the engine idle in N (Neutral) while stopped. If it is safe to do so, pull off the road, shift to P (Park) or N (Neutral) and let the engine idle.

If the temperature overheat gage is no longer in the overheat zone or an overheat warning no longer displays, the vehicle can be driven. Continue to drive the vehicle slow for about 10 minutes. Keep a safe vehicle distance from the car in front of you. If the warning does not come back on, continue to drive normally.

If the warning continues, pull over, stop, and park the vehicle right away.

If there is no sign of steam, idle the engine for three minutes while parked. If the warning is still displayed, turn off the engine until it cools down. Also, see "Overheated Engine Protection Operating Mode" later in this section.

Power Steering Fluid



The power steering fluid reservoir is located under the engine cover on the driver side toward the front of the engine compartment. See *Engine Compartment Overview* on page 9-6.

When to Check Power Steering Fluid

It is not necessary to regularly check power steering fluid unless you suspect there is a leak in the system or an unusual noise is heard. A fluid loss in this system could indicate a problem. Have the system inspected and repaired.

How to Check Power Steering Fluid

Check the level after the vehicle has been driven for at least twenty minutes so the fluid is warm.

To check the power steering fluid:

1. Turn the ignition key to LOCK/OFF and let the engine compartment cool down.
2. Remove the engine cover. Refer to *Engine Cover on page 9-9*.
3. Wipe the cap and the top of the reservoir clean.
4. Turn the cap counterclockwise and pull it straight up.
5. Wipe the dipstick with a clean rag.

6. Replace the cap and completely tighten it.
7. Remove the cap again and look at the fluid level on the dipstick.



When the engine is hot, the level should be at the hot MAX level. When the engine is cold, the fluid level should be between MIN and MAX on the dipstick.

What to Use

To determine what kind of fluid to use, see *Recommended Fluids and Lubricants on page 10-7*. Always use the proper fluid.

Washer Fluid

What to Use

When windshield washer fluid is needed, be sure to read the manufacturer's instructions before use. If operating vehicle in an area where the temperature can fall below freezing, use a fluid that has sufficient protection against freezing.

Adding Washer Fluid



Open the cap with the washer symbol on it. Add washer fluid until the reservoir is full. See *Engine Compartment Overview on page 9-6* for reservoir location.

Notice:

- **When using concentrated washer fluid, follow the manufacturer's instructions for adding water.**
- **Do not mix water with ready-to-use washer fluid. Water can cause the solution to freeze and damage your washer fluid tank and other parts of the washer system. Also, water does not clean as well as washer fluid.**
- **Fill the washer fluid tank only three-quarters full when it is very cold. This allows for fluid expansion if freezing occurs, which could damage the tank if it is completely full.**
- **Do not use engine coolant (antifreeze) in your windshield washer. It can damage the vehicle's windshield washer system and paint.**

Brakes

This vehicle has disc brakes. Disc brake pads have built-in wear indicators that make a high-pitched warning sound when the brake pads are worn and new pads are needed. The sound can come and go or be heard all the time the vehicle is moving, except when applying the brake pedal firmly.

 **WARNING**

The brake wear warning sound means that soon the brakes will not work well. That could lead to an accident. When the brake wear warning sound is heard, have the vehicle serviced.

Notice: Continuing to drive with worn-out brake pads could result in costly brake repair.

Some driving conditions or climates can cause a brake squeal when the brakes are first applied or lightly applied. This does not mean something is wrong with the brakes.

Properly torqued wheel nuts are necessary to help prevent brake pulsation. When tires are rotated, inspect brake pads for wear and evenly tighten wheel nuts in the proper sequence to torque specifications in *Capacities and Specifications on page 11-2*.

Brake linings should always be replaced as complete axle sets.

Brake Pedal Travel

See your dealer/retailer if the brake pedal does not return to normal height, or if there is a rapid increase in pedal travel. This could be a sign that brake service might be required.

Brake Adjustment

Every time the brakes are applied, with or without the vehicle moving, the brakes adjust for wear.

Replacing Brake System Parts

The braking system on a vehicle is complex. Its many parts have to be of top quality and work well together if the vehicle is to have really good braking. The vehicle was designed and tested with top-quality brake parts. When parts of the braking system are replaced, be sure to get new, approved replacement parts. If this is not done, the brakes might not work properly. For example, installing disc brake pads that are wrong for the vehicle, can change the balance between the front and rear brakes—for the worse. The braking performance expected can change in many other ways if the wrong replacement brake parts are installed.

Brake Fluid



The brake/clutch master cylinder reservoir is filled with DOT 3 brake fluid as indicated on the reservoir cap. See *Engine Compartment Overview on page 9-6* for the location of the reservoir.

There are only two reasons why the fluid level in the reservoir might go down:

- The fluid level goes down because of normal brake lining wear. When new linings are installed, the fluid level goes back up.
- A fluid leak in the brake/clutch hydraulic system can also cause a low fluid level. Have the brake/clutch hydraulic system fixed, since a leak means that sooner or later the brakes and/or clutch will not work well.

Do not top off the brake/clutch fluid. Adding fluid does not correct a leak. If fluid is added when the linings are worn, there will be too much fluid when new brake linings are installed. Add or remove brake fluid, as necessary, only when work is done on the brake/clutch hydraulic system.

WARNING

If too much brake fluid is added, it can spill on the engine and burn, if the engine is hot enough. You or others could be burned, and the vehicle could be damaged. Add brake fluid only when work is done on the brake/clutch hydraulic system.

When the brake/clutch fluid falls to a low level, the brake warning light comes on. See *Brake System Warning Light on page 4-22*.

What to Add

Use only new DOT 3 brake fluid from a sealed container. See *Recommended Fluids and Lubricants* on page 10-7.

Always clean the brake/clutch fluid reservoir cap and the area around the cap before removing it. This helps keep dirt from entering the reservoir.

 **WARNING**

With the wrong kind of fluid in the brake/clutch hydraulic system, the brakes might not work well. This could cause a crash. Always use the proper brake/clutch fluid.

Notice:

- **Using the wrong fluid can badly damage brake/clutch hydraulic system parts. For example, just a few drops of mineral-based oil, such as engine oil, in the brake hydraulic system can damage brake hydraulic system parts so badly that they will have to be replaced. Do not let someone put in the wrong kind of fluid.**
- **If brake fluid is spilled on the vehicle's painted surfaces, the paint finish can be damaged. Be careful not to spill brake fluid on the vehicle. If you do, wash it off immediately.**

Battery

This vehicle has a maintenance free battery. When it is time for a new battery, see your dealer/retailer for one that has the replacement number shown on the original battery's label. See *Engine Compartment Overview* on page 9-6 for battery location.

 **WARNING**

Battery posts, terminals, and related accessories contain lead and lead compounds, chemicals known to the State of California to cause cancer and reproductive harm. Wash hands after handling.

Vehicle Storage

WARNING

Batteries have acid that can burn you and gas that can explode. You can be badly hurt if you are not careful. See *Jump Starting on page 9-84* for tips on working around a battery without getting hurt.

Infrequent Usage: If the vehicle is driven infrequently, remove the black, negative (-) cable from the battery. This helps keep the battery from running down.

Extended Storage: For extended storage of the vehicle, remove the black, negative (-) cable from the battery or use a battery trickle charger. This helps maintain the charge of the battery over an extended period of time.

Rear Axle

When to Check Lubricant

It is not necessary to regularly check rear axle fluid unless you suspect there is a leak or you hear an unusual noise. A fluid loss could indicate a problem. Have it inspected and repaired.

How to Check Lubricant

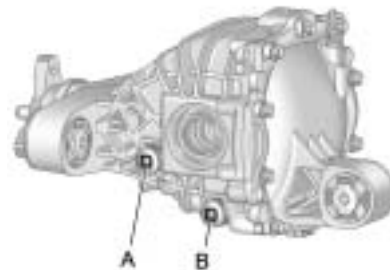

V6 Automatic Transmission shown, V6 Manual Transmission, V8 Automatic and Manual transmission similar

- A. Fill Plug Hole
- B. Drain Plug Hole

To get an accurate reading, the vehicle should be on a level surface. If the level is below the bottom of the filler plug hole, add some lubricant. Add enough lubricant to raise the level to the bottom of the filler plug hole.

What to Use

For 218 mm rear drive module (RDM) V6 manual, V8 automatic and V8 manual:

To add lubricant when the level is low, use 75W-90 LS gear oil (GM Part No. US 89021677 and 1052358, in Canada Part No. 89021678 and 992694) meeting GM Specification 9986226. To completely refill after draining, see *Recommended Fluids and Lubricants on page 10-7*. Then fill to the bottom of the filler plug hole with the Synthetic Gear Lubricant.

For 195 mm RDM V6 automatic:

To add lubricant when the level is low, use 75W-90 gear Oil (GM Part No. US 89021677, in Canada Part No. 89021678) meeting GM Specification 9986115. To completely refill after draining, see *Recommended Fluids and Lubricants on page 10-7*. Then fill to the bottom of the filler plug hole with the Synthetic Gear Lubricant.

Starter Switch Check



WARNING

When you are doing this inspection, the vehicle could move suddenly. If the vehicle moves, you or others could be injured.

1. Before starting this check, be sure there is enough room around the vehicle.
2. Firmly apply both the parking brake and the regular brake. See *Parking Brake on page 8-32*. Do not use the accelerator pedal, and be ready to turn off the engine immediately if it starts.

3. For automatic transmission vehicles, try to start the engine in each gear. The vehicle should start only in P (Park) or N (Neutral). If the vehicle starts in any other position, contact your dealer/retailer for service.

For manual transmission vehicles, put the shift lever in Neutral, push the clutch pedal down halfway, and try to start the engine. The vehicle should start only when the clutch pedal is pushed down all the way to the floor. If the vehicle starts when the clutch pedal is not pushed all the way down, contact your dealer/retailer for service.

Automatic Transmission Shift Lock Control System Check

 **WARNING**

When you are doing this inspection, the vehicle could move suddenly. If the vehicle moves, you or others could be injured.

1. Before starting this check, be sure there is enough room around the vehicle. It should be parked on a level surface.
2. Firmly apply the parking brake. See *Parking Brake* on page 8-32. Be ready to apply the regular brake immediately if the vehicle begins to move.

3. With the engine off, turn the ignition to ON/RUN, but do not start the engine. Without applying the regular brake, try to move the shift lever out of P (Park) with normal effort. If the shift lever moves out of P (Park), contact your dealer/retailer for service.

Ignition Transmission Lock Check

While parked, and with the parking brake set, try to turn the ignition to LOCK/OFF in each shift lever position.

- The ignition should turn to LOCK/OFF only when the shift lever is in P (Park).
- The ignition key should come out only in LOCK/OFF.

Contact your dealer/retailer if service is required.

Park Brake and P (Park) Mechanism Check

 **WARNING**

When you are doing this check, the vehicle could begin to move. You or others could be injured and property could be damaged. Make sure there is room in front of the vehicle in case it begins to roll. Be ready to apply the regular brake at once should the vehicle begin to move.

Park on a fairly steep hill, with the vehicle facing downhill. Keeping your foot on the regular brake, set the parking brake.

- To check the parking brake's holding ability: With the engine running and the transmission in N (Neutral), slowly remove foot pressure from the regular brake pedal. Do this until the vehicle is held by the parking brake only.
- To check the P (Park) mechanism's holding ability: With the engine running, shift to P (Park). Then release the parking brake followed by the regular brake.

Contact your dealer/retailer if service is required.

Wiper Blade Replacement

Windshield wiper blades should be inspected for wear and cracking. See *Scheduled Maintenance on page 10-2* for more information.

Replacement blades come in different types and are removed in different ways. For proper type and length, see *Maintenance Replacement Parts on page 10-9*.

To replace the windshield wiper blade:

1. Pull the windshield wiper assembly away from the windshield.

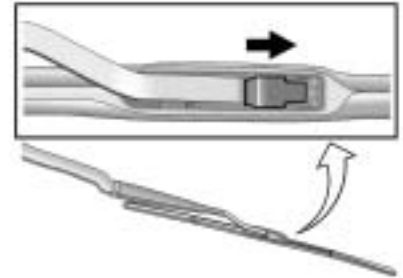

2. Lift up on the latch in the middle of the wiper blade where the wiper arm attaches.

3. With the latch open, pull the wiper blade down towards the windshield far enough to release it from the J-hooked end of the wiper arm.
4. Remove the wiper blade.
Allowing the wiper blade arm to touch the windshield when no wiper blade is installed could damage the windshield. Any damage that occurs would not be covered by the vehicle warranty. Do not allow the wiper blade arm to touch the windshield.
5. Reverse steps 1 through 3 for wiper blade replacement.

Headlamp Aiming

The headlamp aiming system has been preset at the factory.

If the vehicle is damaged in an accident, the aim of the headlamps may be affected and adjustment may be necessary.

It is recommended that a dealer/retailer adjust the headlamps. To re-aim the headlamps yourself, use the following procedure.

The vehicle should be properly prepared as follows:

- The vehicle should be placed so the headlamps are 7.6 m (25 ft) from a light colored wall.
- The vehicle must have all four tires on a level surface which is level all the way to the wall.

- The vehicle should be placed so it is perpendicular to the wall or other flat surface.
- The vehicle should not have any snow, ice, or mud on it.
- The vehicle should be fully assembled and all other work stopped while headlamp aiming is being performed.
- The vehicle should be normally loaded with a full tank of fuel and one person or 75 kg (160 lbs) sitting on the driver's seat.
- Tires should be properly inflated.

Headlamp aiming is done with the vehicle's low-beam headlamps. The high-beam headlamps will be correctly aimed if the low-beam headlamps are aimed properly.

To adjust the vertical aim:

1. Open the hood. See *Hood* on page 9-5 for more information.

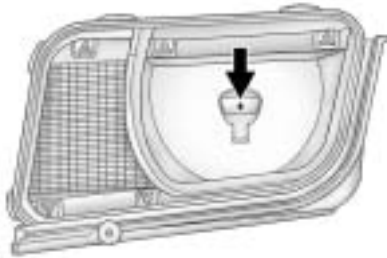

Halogen Headlamp

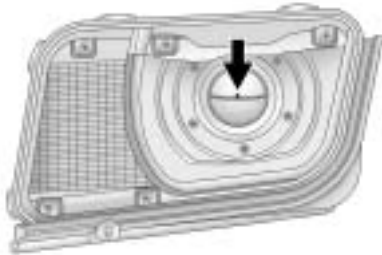

HID Headlamp

2. Locate the aim dot on the lens of the low-beam headlamp.
3. Measure the distance from the ground to the aim dot on the low-beam headlamp. Record the distance.

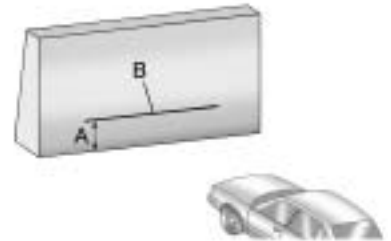

4. At the wall measure from the ground upward (A) to the recorded distance from Step 3 and mark it.
5. Draw or tape a horizontal line (B) on the wall the width of the vehicle at the height of the mark in Step 4.

9-36 Vehicle Care

Notice: Do not cover a headlamp to improve beam cut-off when aiming. Covering a headlamp may cause excessive heat build-up which may cause damage to the headlamp.

6. Turn on the low-beam headlamps and place a piece of cardboard or equivalent in front of the headlamp not being adjusted. This allows only the beam of light from the headlamp being adjusted to be seen on the flat surface.

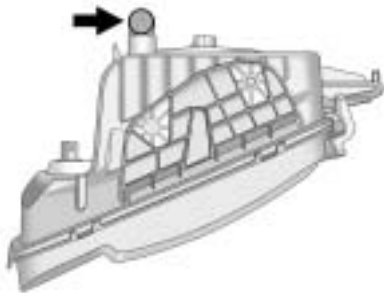

Halogen Headlamp

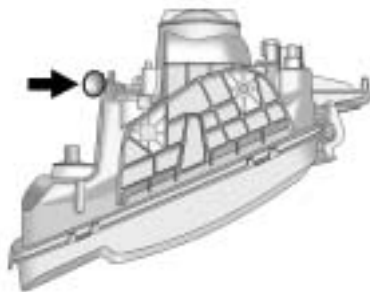

HID Headlamp

7. Locate the vertical headlamp aiming screws, which are under the hood near each headlamp assembly.
The adjustment screw can be turned with a 6 mm hex key.
8. Turn the vertical aiming screw until the headlamp beam is aimed to the horizontal tape line. Turn it clockwise or counterclockwise to raise or lower the angle of the beam.

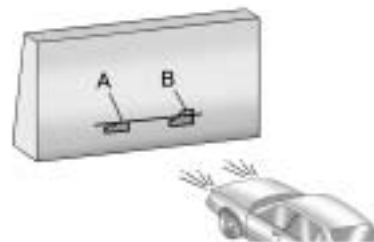

9. Make sure that the light from the headlamp is positioned at the bottom edge of the horizontal tape line. The lamp on the left (A) shows the correct headlamp aim. The lamp on the right (B) shows the incorrect headlamp aim.
10. Repeat Steps 6 through 9 for the opposite headlamp.

Bulb Replacement

For the proper type of replacement bulbs, see *Replacement Bulbs on page 9-41*.

For any bulb changing procedure not listed in this section, contact your dealer/retailer.

Halogen Bulbs

WARNING

Halogen bulbs have pressurized gas inside and can burst if you drop or scratch the bulb. You or others could be injured. Be sure to read and follow the instructions on the bulb package.

High Intensity Discharge (HID) Lighting

WARNING

The low beam high intensity discharge lighting system operates at a very high voltage. If you try to service any of the system components, you could be seriously injured. Have your dealer/retailer or a qualified technician service them.

The top-level vehicle is equipped with HID headlamps. The park lamp function is also a function of the HID headlamp. After an HID headlamp bulb has been replaced, you may notice that the beam is a slightly different shade than it was originally. This is normal.

Headlamps, Front Turn Signal and Parking Lamps (Base Vehicle)

The base model vehicle has a halogen headlamp and a turn signal/parking lamp on the headlamp assembly.

To replace one of these bulbs:

1. Open the hood. See *Hood on page 9-5*.

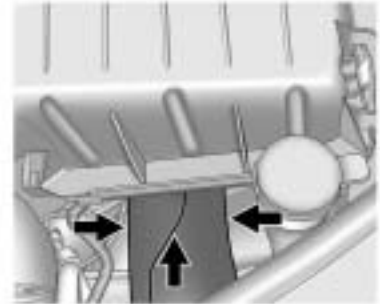

2. Press in on the tabs located on the sides of the duct and then push the duct rearward into the air cleaner/filter housing.

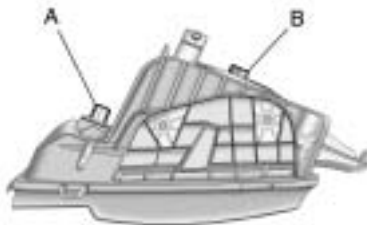

- A. Parking/Turn Signal Lamp
- B. Halogen Headlamp

3. Disconnect the wiring harness and turn the bulb socket counterclockwise to remove it from the headlamp assembly.
4. Pull the bulb straight out from the socket.

5. Push the new bulb into the socket and reinstall the socket into the headlamp assembly by turning it clockwise.
6. Reconnect the electrical connector.
7. Pull the duct back out of the air cleaner/filter housing until the tabs snap the duct back into position.

Headlamps, Front Turn Signal and Parking Lamps (Up-Level Vehicle)

The up-level model vehicle has a HID headlamp and a turn signal lamp on the headlamp assembly. The park lamp is also the function of the HID headlamp. See *High Intensity Discharge (HID) Lighting on page 9-37* for more information.

To replace the turn signal bulb:

1. Open the hood. See *Hood on page 9-5*.

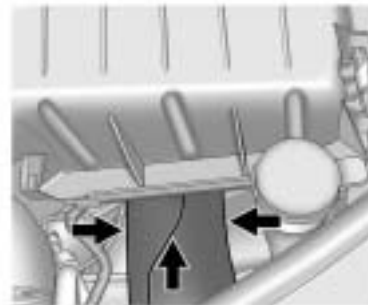

2. Press in on the tabs located on the sides of the duct and then push the duct rearward into the air cleaner/filter housing.

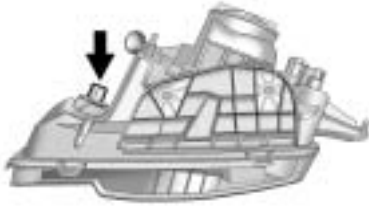

3. Disconnect the wiring harness and turn the bulb socket counterclockwise to remove it from the headlamp assembly.
4. Pull the bulb straight out from the socket.
5. Push the new bulb into the socket and reinstall the socket into the headlamp assembly by turning it clockwise.
6. Reconnect the electrical connector.
7. Pull the duct back out of the air cleaner/filter housing until the tabs snap the duct back into position.

Daytime Running Lamps (DRL)

The up-level model vehicle may have daytime running lamps which would be located on the facia.

To replace one of these bulbs:



1. Locate the bulb assembly under the front facia.
2. Disconnect the electrical connector from the bulb assembly and pull out the bulb assembly.

3. Push in the new bulb assembly to lock it into place.
4. Reconnect the electrical connector to the bulb assembly.

The base model vehicle daytime running lamps are the low beam on the halogen headlamp. If one of these lamps fail, see *Headlamps, Front Turn Signal and Parking Lamps (Base Vehicle)* on page 9-37 or *Headlamps, Front Turn Signal and Parking Lamps (Up-Level Vehicle)* on page 9-38 for replacement information.

Fog Lamps

The base model vehicle may have fog lamps which would be located on the fascia.

To replace one of these bulbs:



1. Locate the bulb assembly under the front fascia.
2. Disconnect the electrical connector from the bulb assembly and pull out the bulb assembly.
3. Push in the new bulb assembly to lock it into place.
4. Reconnect the electrical connector to the bulb assembly.

The up-level vehicle will not be equipped with fog lamps.

Taillamps, Turn Signal, and Stoplamps

To replace a taillamp, turn signal, or stoplamp bulb:

1. Open the trunk. See *Trunk* on page 1-8.

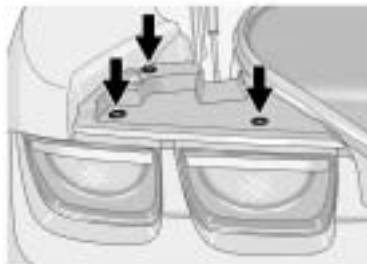

2. Remove the close out panel retainers to gain access to the bulb socket connectors.
3. Turn the bulb socket counterclockwise to remove it.

4. Pull the old bulb straight out of the bulb socket.
5. Push the new bulb straight into the bulb socket until it clicks.
6. Turn the bulb socket clockwise to reinstall.

License Plate Lamp

To replace one of these bulbs:

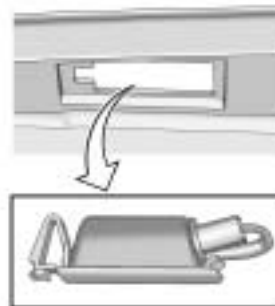

1. Unclip the license plate lamp from the fascia opening.
2. Pull the license plate lamp down through the fascia opening.

3. Turn the bulb socket counterclockwise and pull the bulb straight out of the lamp socket.
4. Install the new bulb.
5. Push the bulb straight into the socket and turn clockwise to reinstall.
6. Reinstall the license plate lamp by lifting it through the fascia opening until the clip is in place.

Replacement Bulbs

Exterior Lamp	Bulb Number
Daytime Running Lamp (Up-level vehicles)	P13W
Fog Lamp	PS24W
Front Park and Turn Signal Lamp	3457NAK
Halogen Headlamp	H13
License Plate Lamp	W5W
Rear Turn Signal and Taillamps	3157K

For replacement bulbs not listed here, contact your dealer/retailer.

Electrical System

Electrical System Overload

The vehicle has fuses and circuit breakers to protect against an electrical system overload.

When the current electrical load is too heavy, the circuit breaker opens and closes, protecting the circuit until the current load returns to normal or the problem is fixed. This greatly reduces the chance of circuit overload and fire caused by electrical problems.

Fuses and circuit breakers protect the following in the vehicle:

- Headlamp Wiring
- Windshield Wiper Motor
- Power Windows and other Power Accessories

Headlamp Wiring

An electrical overload may cause the lamps to go on and off, or in some cases to remain off. Have the headlamp wiring checked right away if the lamps go on and off or remain off.

Windshield Wipers

If the wiper motor overheats due to heavy snow or ice, the windshield wipers will stop until the motor cools and will then restart.

Although the circuit is protected from electrical overload, overload due to heavy snow or ice, may cause wiper linkage damage. Always clear ice and heavy snow from the windshield before using the windshield wipers.

If the overload is caused by an electrical problem and not snow or ice, be sure to get it fixed.

Fuses and Circuit Breakers

The wiring circuits in the vehicle are protected from short circuits by a combination of fuses and circuit breakers. This greatly reduces the chance of damage caused by electrical problems.

To check a fuse, look at the silver-colored band inside the fuse. If the band is broken or melted, replace the fuse. Be sure to replace a bad fuse with a new one of the identical size and rating.

Fuses of the same amperage can be temporarily borrowed from another fuse location, if a fuse goes out. Replace the fuse as soon as possible.

To identify and check fuses, circuit breakers, and relays, see *Engine Compartment Fuse Block* on page 9-42, *Instrument Panel Fuse Block* on page 9-45, and *Rear Compartment Fuse Block* on page 9-46.

Engine Compartment Fuse Block

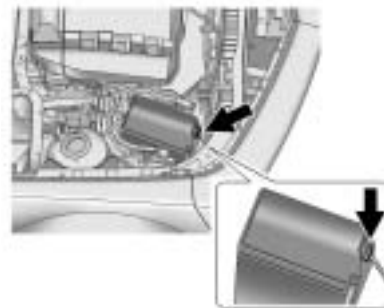

To remove the hinged fuse block cover, press the clip at the front of the cover, and swing it up.

Notice: Spilling liquid on any electrical components on the vehicle may damage it. Always keep the covers on any electrical component.

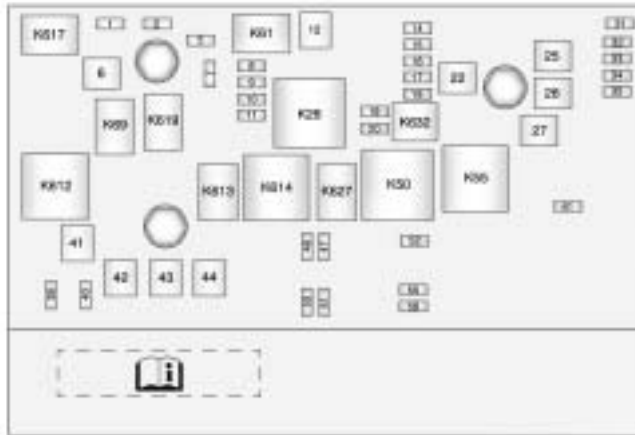

Engine Compartment Fuse Block

J-Case Fuses	Usage
41	Cooling Fan High
42	Front Heater, Ventilation and Air Conditioning
43	Antilock Brake System Pump
44	Cooling Fan Low

Mini Fuses	Usage
1	Air Conditioning Compressor Clutch
2	Transmission Control Module
5	Engine Control Module Main
7	Pre-Catalytic Converter Oxygen Sensor
8	Post-Catalytic Converter Oxygen Sensor
9	Fuel Injectors – Even
10	Fuel Injectors – Odd

J-Case Fuses	Usage
6	Wiper
12	Starter
22	Brake Vacuum Pump

J-Case Fuses	Usage
25	Power Windows Rear
26	Power Windows Front
27	Rear Defog

9-44 Vehicle Care

Mini Fuses	Usage
11	Cooling Fan Relay
14	Manifold Air Flow/Chassis Control
15	Ignition
16	Run/Crank IP
17	Sensing Diagnostic Module/Ignition
18	Run/Crank Body
19	Transmission Control Module/Ignition
20	Engine Control Module/Ignition
31	Outside Rear View Mirror
32	Canister Vent Solenoid
33	Body Control Module #6

Mini Fuses	Usage
34	Sunroof
35	Front Heated Seats
38	Washer Pump Front
40	Antilock Brake System Valves
46	HID Headlamp – Left Front
47	HID Headlamp – Right Front
50	Fog Lamps
51	Horn
52	Spare
55	High Beam Headlamp – Right Front
56	High Beam Headlamp – Left Front
61	Heated Mirror

Mini Relays	Usage
K26	Powertrain
K50	Run / Crank
K55	Rear Defog
K612	Cooling Fan High
K614	Cooling Fan Control

Micro Relays	Usage
K61	Starter
K69	Wiper Control
K613	Cooling Fan Low
K617	Air Conditioning Compressor Clutch
K619	Wiper Speed
K627	High Intensity Discharge Headlamps
K632	Brake Vacuum Pump

Instrument Panel Fuse Block



The instrument panel fuse block is located on the end of the instrument panel, on the driver side of the vehicle. To access the fuses, open the fuse panel door by pulling out.

To reinstall the door, push the door back into its original location.

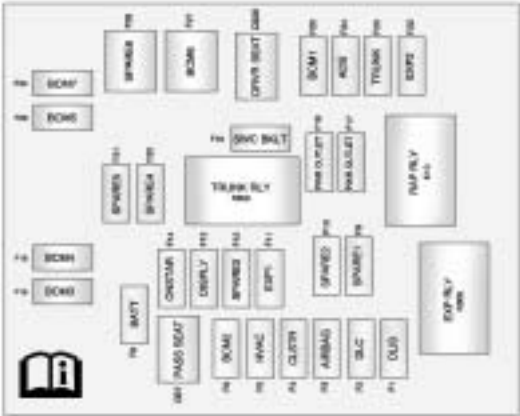

Instrument Panel Fuse Block

Fuses	Usage
F1	Discrete Logic Ignition Switch
F2	Diagnostic Link Connector
F3	Airbag
F4	Cluster

Fuses	Usage
F5	Heating Ventilation Air Conditioning Controller
F6	Body Control Module
F8	Battery
F9	Spare

Fuses	Usage
F10	Spare
F11	Spare
F12	Spare
F13	Display
F14	OnStar® Universal Hands Free Phone
F15	Body Control Module 3
F16	Body Control Module 4
F17	Power Outlet 1
F18	Power Outlet 2
F19	Steering Wheel Controls Backlight
F20	Spare
F21	Spare
F22	Spare
F23	Trunk
F24	Automatic Occupant Sensing

Fuses	Usage
F25	Body Control Module 1
F27	Body Control Module 8
F28	Spare
F29	Body Control Module 5
F30	Body Control Module 7

Circuit Breakers	Usage
CB7	Passenger Seat
CB26	Driver Seat

Relays	Usage
K10	Retained Accessory Power
K605	Not Used
K609	Trunk

Rear Compartment Fuse Block

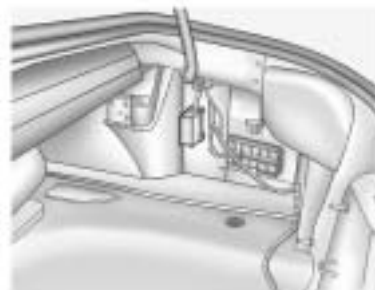

The rear compartment fuse block is located on the right side of the trunk behind a cover. Remove the six convenience net retainers, the rear sill plate, and the two passenger side trim retainers, then swing the trim out of the way.



Fuses	Usage
F9	Spare
F10	Spare
F11	Spare
F12	Spare
F13	Engine Control Module/Battery
F14	Regulated Voltage Control
F15	Fuel System Control Module
F16	Spare

Fuses	Usage
F1	Universal Garage Door Opener/ Ultrasonic Reverse Parking Aid
F2	Amplifier
F3	Radio

Fuses	Usage
F4	Spare
F5	Convertible Top 1
F6	Convertible Top 2
F7	Spare
F8	Spare

Wheels and Tires

Tires

Your new vehicle comes with high-quality tires made by a leading tire manufacturer. If you ever have questions about your tire warranty and where to obtain service, see your vehicle Warranty booklet for details. For additional information refer to the tire manufacturer.

 **WARNING**

Poorly maintained and improperly used tires are dangerous.

- Overloading your tires can cause overheating as a result of too much flexing. You could have an air-out and a serious accident. See *Vehicle Load Limits on page 8-12*.

(Continued)

WARNING (Continued)

- Underinflated tires pose the same danger as overloaded tires. The resulting accident could cause serious injury. Check all tires frequently to maintain the recommended pressure. Tire pressure should be checked when your tires are cold. See *Tire Pressure on page 9-54*.
- Overinflated tires are more likely to be cut, punctured or broken by a sudden impact — such as when you hit a pothole. Keep tires at the recommended pressure.
- Worn, old tires can cause accidents. If your tread is badly worn, or if your tires have been damaged, replace them.

Winter Tires

If you expect to drive on snow or ice covered roads often, you may want to get winter tires for your vehicle. All season tires provide good overall performance on most surfaces but they may not offer the traction you would like or the same level of performance as winter tires on snow or ice covered roads.

Winter tires, in general, are designed for increased traction on snow and ice covered roads. With winter tires, there may be decreased dry road traction, increased road noise, and shorter tread life. After switching to winter tires, be alert for changes in vehicle handling and braking.

See your dealer/retailer for details regarding winter tire availability and proper tire selection. Also, see *Buying New Tires on page 9-63*.

If you choose to use winter tires:

- Use tires of the same brand and tread type on all four wheel positions.
- Use only radial ply tires of the same size, load range, and speed rating as the original equipment tires.

Winter tires with the same speed rating as your original equipment tires may not be available for H, V, W, Y, and ZR speed rated tires. If you choose winter tires with a lower speed rating, never exceed the tire's maximum speed capability.

Tire Sidewall Labeling

Useful information about a tire is molded into its sidewall. The examples below show a typical passenger vehicle tire and a compact spare tire sidewall.

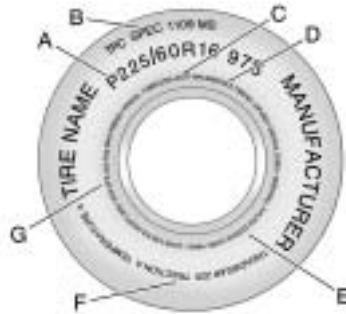

**Passenger (P-Metric)
Tire Example**

(A) Tire Size: The tire size is a combination of letters and numbers used to define a particular tire's width, height, aspect ratio, construction type, and service description. See the "Tire Size" illustration later in this section for more detail.

(B) TPC Spec (Tire Performance Criteria Specification): Original equipment tires designed to GM's specific tire performance criteria have a TPC specification code molded onto the sidewall. GM's TPC specifications meet or exceed all federal safety guidelines.

(C) DOT (Department of Transportation): The Department of Transportation (DOT) code indicates that the tire is in compliance with the U.S. Department of Transportation Motor Vehicle Safety Standards.

(D) Tire Identification Number (TIN): The letters and numbers following the DOT (Department of Transportation) code is the Tire Identification Number (TIN). The TIN shows the manufacturer and plant code, tire size, and date the tire was manufactured. The TIN is molded onto both sides of the tire, although only one side may have the date of manufacture.

(E) Tire Ply Material: The type of cord and number of plies in the sidewall and under the tread.

(F) Uniform Tire Quality Grading (UTQG): Tire manufacturers are required to grade tires based on three performance factors: treadwear, traction, and temperature resistance. For more information see *Uniform Tire Quality Grading on page 9-65*.

(G) Maximum Cold Inflation Load Limit: Maximum load that can be carried and the maximum pressure needed to support that load.

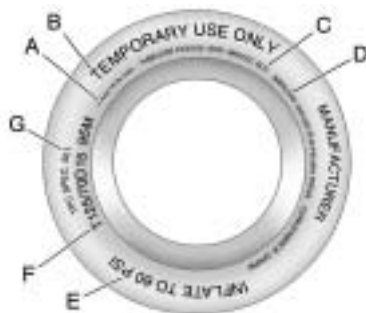

Compact Spare Tire Example

(A) Tire Ply Material: The type of cord and number of plies in the sidewall and under the tread.

(B) Temporary Use Only: The compact spare tire or temporary use tire has a tread life of approximately 3,000 miles (5 000 km) and should not be

driven at speeds over 65 mph (105 km/h). The compact spare tire is for emergency use when a regular road tire has lost air and gone flat. If your vehicle has a compact spare tire, see *Compact Spare Tire on page 9-83* and *If a Tire Goes Flat on page 9-69*.

(C) Tire Identification Number (TIN): The letters and numbers following the DOT (Department of Transportation) code is the Tire Identification Number (TIN). The TIN shows the manufacturer and plant code, tire size, and date the tire was manufactured. The TIN is molded onto both sides of the tire, although only one side may have the date of manufacture.

(D) Maximum Cold Inflation Load Limit: Maximum load that can be carried and the maximum pressure needed to support that load.

(E) Tire Inflation: The temporary use tire or compact spare tire should be inflated to 60 psi (420 kPa). For more information on tire pressure and inflation see *Tire Pressure* on page 9-54.

(F) Tire Size : A combination of letters and numbers define a tire's width, height, aspect ratio, construction type, and service description. The letter T as the first character in the tire size means the tire is for temporary use only.

(G) TPC Spec (Tire Performance Criteria Specification): Original equipment tires designed to GM's specific tire performance criteria have a TPC specification code molded onto the sidewall. GM's TPC specifications meet or exceed all federal safety guidelines.

Tire Designations

Tire Size

The following illustration shows an example of a typical passenger vehicle tire size.

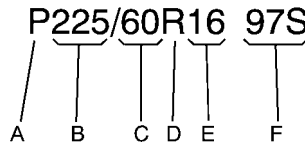

(A) Passenger (P-Metric) Tire: The United States version of a metric tire sizing system. The letter P as the first character in the tire size means a passenger vehicle tire engineered to standards set by the U.S. Tire and Rim Association.

(B) Tire Width: The three-digit number indicates the tire section width in millimeters from sidewall to sidewall.

(C) Aspect Ratio: A two-digit number that indicates the tire height-to-width measurements. For example, if the tire size aspect ratio is 60, as shown in item C of the illustration, it would mean that the tire's sidewall is 60 percent as high as it is wide.

(D) Construction Code: A letter code is used to indicate the type of ply construction in the tire. The letter R means radial ply construction; the letter D means diagonal or bias ply construction; and the letter B means belted-bias ply construction.

(E) Rim Diameter: Diameter of the wheel in inches.

(F) Service Description: These characters represent the load index and speed rating of the tire. The load index represents the load carry capacity a tire is certified to carry. The speed rating is the maximum speed a tire is certified to carry a load.

Tire Terminology and Definitions

Air Pressure: The amount of air inside the tire pressing outward on each square inch of the tire. Air pressure is expressed in pounds per square inch (psi) or kilopascal (kPa).

Accessory Weight: This means the combined weight of optional accessories. Some examples of optional accessories are, automatic transmission, power steering, power brakes, power windows, power seats, and air conditioning.

Aspect Ratio: The relationship of a tire's height to its width.

Belt: A rubber coated layer of cords that is located between the plies and the tread. Cords may be made from steel or other reinforcing materials.

Bead: The tire bead contains steel wires wrapped by steel cords that hold the tire onto the rim.

Bias Ply Tire: A pneumatic tire in which the plies are laid at alternate angles less than 90 degrees to the centerline of the tread.

Cold Tire Pressure: The amount of air pressure in a tire, measured in pounds per square inch (psi) or kilopascals (kPa) before a tire has built up heat from driving. See *Tire Pressure on page 9-54*.

Curb Weight: The weight of a motor vehicle with standard and optional equipment including the maximum capacity of fuel, oil, and coolant, but without passengers and cargo.

DOT Markings: A code molded into the sidewall of a tire signifying that the tire is in compliance with the U.S. Department of Transportation (DOT) motor vehicle safety standards. The DOT code includes the Tire Identification Number (TIN), an alphanumeric designator which can also identify the tire manufacturer, production plant, brand, and date of production.

GVWR: Gross Vehicle Weight Rating. See *Vehicle Load Limits on page 8-12*.

GAWR FRT: Gross Axle Weight Rating for the front axle. See *Vehicle Load Limits on page 8-12*.

GAWR RR: Gross Axle Weight Rating for the rear axle. See *Vehicle Load Limits on page 8-12*.

Intended Outboard Sidewall:

The side of an asymmetrical tire, that must always face outward when mounted on a vehicle.

Kilopascal (kPa): The metric unit for air pressure.

Light Truck (LT-Metric) Tire:

A tire used on light duty trucks and some multipurpose passenger vehicles.

Load Index: An assigned number ranging from 1 to 279 that corresponds to the load carrying capacity of a tire.

Maximum Inflation Pressure:

The maximum air pressure to which a cold tire can be inflated. The maximum air pressure is molded onto the sidewall.

Maximum Load Rating:

The load rating for a tire at the maximum permissible inflation pressure for that tire.

Maximum Loaded Vehicle

Weight: The sum of curb weight, accessory weight, vehicle capacity weight, and production options weight.

Normal Occupant Weight: The number of occupants a vehicle is designed to seat multiplied by 150 lbs (68 kg). See *Vehicle Load Limits on page 8-12*.

Occupant Distribution:

Designated seating positions.

Outward Facing Sidewall: The side of an asymmetrical tire that has a particular side that faces outward when mounted on a vehicle. The side of the tire that contains a whitewall, bears white lettering, or bears manufacturer, brand, and/or model name molding that is higher or deeper than the same moldings on the other sidewall of the tire.

Passenger (P-Metric) Tire:

A tire used on passenger cars and some light duty trucks and multipurpose vehicles.

Recommended Inflation

Pressure: Vehicle manufacturer's recommended tire inflation pressure as shown on the tire placard. See *Tire Pressure on page 9-54* and *Vehicle Load Limits on page 8-12*.

Radial Ply Tire: A pneumatic tire in which the ply cords that extend to the beads are laid at 90 degrees to the centerline of the tread.

Rim: A metal support for a tire and upon which the tire beads are seated.

Sidewall: The portion of a tire between the tread and the bead.

Speed Rating: An alphanumeric code assigned to a tire indicating the maximum speed at which a tire can operate.

Traction: The friction between the tire and the road surface. The amount of grip provided.

Tread: The portion of a tire that comes into contact with the road.

Treadwear Indicators: Narrow bands, sometimes called wear bars, that show across the tread of a tire when only 1/16 inch (1.6 mm) of tread remains. See *When It Is Time for New Tires* on page 9-62.

UTQGS (Uniform Tire Quality Grading Standards): A tire information system that provides consumers with ratings for a tire's traction, temperature, and treadwear. Ratings are determined by tire manufacturers using government testing

procedures. The ratings are molded into the sidewall of the tire. See *Uniform Tire Quality Grading* on page 9-65.

Vehicle Capacity Weight: The number of designated seating positions multiplied by 150 lbs (68 kg) plus the rated cargo load. See *Vehicle Load Limits* on page 8-12.

Vehicle Maximum Load on the Tire: Load on an individual tire due to curb weight, accessory weight, occupant weight, and cargo weight.

Vehicle Placard: A label permanently attached to a vehicle showing the vehicle's capacity weight and the original equipment tire size and recommended inflation pressure. See "Tire and Loading Information Label" under *Vehicle Load Limits* on page 8-12.

Tire Pressure

Tires need the correct amount of air pressure to operate effectively.

Notice: Do not let anyone tell you that under-inflation or over-inflation is all right. It is not. If your tires do not have enough air (under-inflation), you can get the following:

- Too much flexing
- Too much heat
- Tire overloading
- Premature or irregular wear
- Poor handling
- Reduced fuel economy

If your tires have too much air (over-inflation), you can get the following:

- Unusual wear
- Poor handling
- Rough ride
- Needless damage from road hazards

A vehicle specific Tire and Loading Information label is attached to your vehicle. This label shows your vehicle's original equipment tires and the correct inflation pressures for your tires when they are cold. The recommended cold tire inflation pressure, shown on the label, is the minimum amount of air pressure needed to support your vehicle's maximum load carrying capacity.

For additional information regarding how much weight your vehicle can carry, and an example of the Tire and Loading Information label, see *Vehicle Load Limits on page 8-12*. How you load your vehicle affects vehicle handling and ride comfort. Never load your vehicle with more weight than it was designed to carry.

When to Check

Check your tires once a month or more. Do not forget to check the compact spare tire, if the vehicle has one. The compact spare should be at 60 psi (420 kPa). For additional information regarding the compact spare tire, see *Compact Spare Tire on page 9-83*.

How to Check

Use a good quality pocket-type gage to check tire pressure. You cannot tell if your tires are properly inflated simply by looking at them. Radial tires may look properly inflated even when they are under-inflated. Check the tire's inflation pressure when the tires are cold. Cold means your vehicle has been sitting for at least three hours or driven no more than 1 mile (1.6 km).

Remove the valve cap from the tire valve stem. Press the tire gage firmly onto the valve to get a pressure measurement. If the cold tire inflation pressure matches the recommended pressure on the Tire and Loading Information label, no further adjustment is necessary. If the inflation pressure is low, add air until you reach the recommended amount.

If you overfill the tire, release air by pushing on the metal stem in the center of the tire valve. Re-check the tire pressure with the tire gage.

Be sure to put the valve caps back on the valve stems. They help prevent leaks by keeping out dirt and moisture.

Tire Pressure for High-Speed Operation

WARNING

Driving at high speeds, 100 mph (160 km/h) or higher, puts an additional strain on tires. Sustained high-speed driving causes excessive heat build up and can cause sudden tire failure. You could have a crash and you or others could be killed. Some high-speed rated tires require inflation pressure adjustment for high speed operation. When speed limits and road conditions are such that a vehicle can be driven at high speeds, make sure the tires are rated for high speed operation, in excellent condition, and set to the correct cold tire inflation pressure for the vehicle load.

Vehicles with 245/45ZR20 103Y, P245/50ZR19 104W and 275/40ZR20 106Y size tires, have tires capable of high speed use. Make sure the tires are inflated to the recommended cold inflation pressures before operating the vehicle at speeds over 100 mph (160 km/h). See *Vehicle Load Limits on page 8-12* and *Tire Pressure on page 9-54*.

Tire Pressure Monitor System

The Tire Pressure Monitor System (TPMS) uses radio and sensor technology to check tire pressure levels. The TPMS sensors monitor the air pressure in your vehicle's tires and transmit tire pressure readings to a receiver located in the vehicle.

Each tire, including the spare (if provided), should be checked monthly when cold and inflated to the inflation pressure recommended by the vehicle manufacturer on the

vehicle placard or tire inflation pressure label. (If your vehicle has tires of a different size than the size indicated on the vehicle placard or tire inflation pressure label, you should determine the proper tire inflation pressure for those tires.)

As an added safety feature, your vehicle has been equipped with a tire pressure monitoring system (TPMS) that illuminates a low tire pressure telltale when one or more of your tires is significantly under-inflated.

Accordingly, when the low tire pressure telltale illuminates, you should stop and check your tires as soon as possible, and inflate them to the proper pressure. Driving on a significantly under-inflated tire causes the tire to overheat and can lead to tire failure. Under-inflation also reduces fuel efficiency and tire tread life, and may affect the vehicle's handling and stopping ability.

Please note that the TPMS is not a substitute for proper tire maintenance, and it is the driver's responsibility to maintain correct tire pressure, even if under-inflation has not reached the level to trigger illumination of the TPMS low tire pressure telltale.

Your vehicle has also been equipped with a TPMS malfunction indicator to indicate when the system is not operating properly. The TPMS malfunction indicator is combined with the low tire pressure telltale. When the system detects a malfunction, the telltale will flash for approximately one minute and then remain continuously illuminated. This sequence will continue upon subsequent vehicle start-ups as long as the malfunction exists.

When the malfunction indicator is illuminated, the system may not be able to detect or signal low tire pressure as intended. TPMS malfunctions may occur for a variety

of reasons, including the installation of replacement or alternate tires or wheels on the vehicle that prevent the TPMS from functioning properly. Always check the TPMS malfunction telltale after replacing one or more tires or wheels on your vehicle to ensure that the replacement or alternate tires and wheels allow the TPMS to continue to function properly.

See *Tire Pressure Monitor Operation* on page 9-57 for additional information.

Federal Communications Commission (FCC) and Industry and Science Canada

See *Radio Frequency Statement (US, Can)* on page 12-15 for information regarding Part 15 of the Federal Communications Commission (FCC) Rules and RSS-210/211 of Industry and Science Canada.

Tire Pressure Monitor Operation

This vehicle may have a Tire Pressure Monitor System (TPMS). The TPMS is designed to warn the driver when a low tire pressure condition exists. TPMS sensors are mounted onto each tire and wheel assembly, excluding the spare tire and wheel assembly, if the vehicle has one. The TPMS sensors monitor the air pressure in the vehicle's tires and transmits the tire pressure readings to a receiver located in the vehicle.

Using the Driver Information Center (DIC), the driver can also check tire pressure levels using the DIC. For additional information and details about the DIC operation and displays see *Tire Messages* on page 4-36.



When a low tire pressure condition is detected, the TPMS illuminates the low tire pressure warning light located on the instrument panel cluster.

A DIC warning message to check the pressure in a specific tire is also shown on the DIC display screen. The low tire pressure warning light and the DIC warning message come at each ignition cycle until the tires are inflated to the correct inflation pressure.

The low tire pressure warning light may come on in cool weather when the vehicle is first started, and then turn off as you start to drive. This could be an early indicator that the air pressure in the tire(s) are getting low and need to be inflated to the proper pressure.

The Tire and Loading Information label, attached to your vehicle, shows the size of your vehicle's original equipment tires and the correct inflation pressure for the tires when they are cold. See *Vehicle Load Limits on page 8-12*, for an example of the Tire and Loading Information label and its location on your vehicle. Also see *Tire Pressure on page 9-54*.

Your vehicle's TPMS can warn you about a low tire pressure condition but it does not replace normal tire

maintenance. See *Tire Inspection on page 9-61*, *Tire Rotation on page 9-61* and *Tires on page 9-48*.

Notice: Using non-approved tire sealants could damage the Tire Pressure Monitor System (TPMS) sensors. TPMS sensor damage caused by using an incorrect tire sealant is not covered by the vehicle warranty. Always use the GM approved tire sealant available through your dealer/retailer.

Factory-installed Tire Inflator Kits use a GM approved liquid tire sealant. Using non-approved tire sealants could damage the TPMS sensors. See *Tire Sealant and Compressor Kit on page 9-71* for information regarding the inflator kit materials and instructions.

TPMS Malfunction Light and Message

The TPMS will not function properly if one or more of the TPMS sensors are missing or inoperable. When the system detects a malfunction, the low tire warning light flashes for about one minute and then stays on for the remainder of the ignition cycle. A DIC warning message is also displayed. The low tire warning light and DIC warning message come on at each ignition cycle until the problem is corrected. Some of the conditions that can cause the malfunction light and DIC message to come on are:

- One of the road tires has been replaced with the spare tire, if the vehicle has one. The spare tire does not have a TPMS sensor. The DIC message should go off once you re-install the road tire containing the TPMS sensor.
- The TPMS sensor matching process was not done or not completed successfully after rotating the vehicle's tires. The DIC message should go off after successfully completing the sensor matching process. See "TPMS Sensor Matching Process" later in this section.
- One or more TPMS sensors are missing or damaged. The DIC message and the TPMS malfunction light should go off when the TPMS sensors are installed and the sensor matching process is performed successfully. See your dealer/retailer for service.
- Replacement tires or wheels do not match your vehicle's original equipment tires or wheels. Tires and wheels other than those recommended for your vehicle could prevent the TPMS from functioning properly. See *Buying New Tires on page 9-63*.
- Operating electronic devices or being near facilities using radio wave frequencies similar to the TPMS could cause the TPMS sensors to malfunction.

If the TPMS is not functioning it cannot detect or signal a low tire condition. See your dealer/retailer for service if the TPMS malfunction light and DIC message comes on and stays on.

TPMS Sensor Matching Process

Each TPMS sensor has a unique identification code. Any time you replace one or more of the TPMS sensors or rotate your vehicle's tires, the identification codes need to be matched to the new tire/wheel position. The sensors are matched to the tire/wheel positions in the following order: driver side front tire, passenger side front tire, passenger side rear tire, and driver side rear tire using a TPMS diagnostic tool. See your dealer/retailer for service.

The TPMS sensors can also be matched to each tire/wheel position by increasing or decreasing the tire's air pressure. If increasing the tire's air pressure, do not exceed the maximum inflation pressure indicated on the tire's sidewall. To decrease the tire's air-pressure use the pointed end of the valve cap, a pencil-style air pressure gage, or a key.

You have two minutes to match the first tire/wheel position, and five minutes overall, to match all four tire/wheel positions. If it takes longer than two minutes, to match the first tire and wheel, or more than five minutes to match all four tire and wheel positions, the matching process stops and you need to start over.

The TPMS matching process is outlined below:

1. Set the parking brake.
2. Turn the ignition switch to ON/RUN with the engine off.
3. Go to the TPM vehicle information screen on the DIC. See *Driver Information Center (DIC) on page 4-27*. Press set to relearn the sensors. The horn sounds twice to signal the receiver is in relearn mode and Tire Learning Active message displays on the DIC screen.
4. Start with the driver side front tire.
 5. Remove the valve cap from the valve stem. Activate the TPMS sensor by increasing or decreasing the tire's air pressure for 10 seconds, or until a horn chirp sounds. The horn chirp, which can take up to 30 seconds to sound, confirms that the TPMS sensor identification code has been matched to this tire position.
 6. Proceed to the passenger side front tire, and repeat the procedure in Step 5.
 7. Proceed to the passenger side rear tire, and repeat the procedure in Step 5.
 8. Proceed to the driver side rear tire, and repeat the procedure in Step 5.
 9. After hearing the confirming horn chirp, for the driver side rear tire, the horn sounds two more times to signal the tire learning mode is no longer active. Turn the ignition switch to LOCK/OFF.

10. Set all four tires to the recommended air pressure level as indicated on the tire and loading information label.
11. Put the valve caps back on the valve stems.

The tires air pressure will not appear on the screen until you start driving the vehicle.

Tire Inspection

We recommend that you regularly inspect your vehicle's tires, including the spare tire, if the vehicle has one, for signs of wear or damage. See *When It Is Time for New Tires* on page 9-62 for more information.

Tire Rotation

Tire rotation is not recommended if the vehicle has different size tires on the front and rear wheels.

Different tire sizes should not be rotated front to rear. Each tire and wheel should only be used in its original front or rear position.

Tire rotation is recommended if the vehicle has the same size tires on all four wheel positions. These tires should be rotated every 5,000 to 8,000 miles (8 000 to 13 000 km). See *Scheduled Maintenance* on page 10-2.

The purpose of a regular tire rotation is to achieve a uniform wear for all tires on the vehicle. This will ensure that your vehicle continues to perform most like it did when the tires were new.

Any time you notice unusual wear, rotate the tires as soon as possible and check wheel alignment. Also check for damaged tires or wheels. See *When It Is Time for New Tires* on page 9-62 and *Wheel Replacement* on page 9-67.

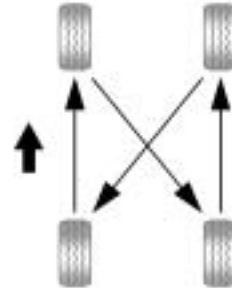

When rotating the vehicle's tires, always use the correct rotation pattern shown here.

9-62 Vehicle Care

The compact spare tire, if the vehicle has one, is not included in the tire rotation.

After the tires have been rotated, adjust the front and rear inflation pressures as shown on the Tire and Loading Information label. See *Tire Pressure on page 9-54* and *Vehicle Load Limits on page 8-12*.

Reset the Tire Pressure Monitor System. See *Tire Pressure Monitor Operation on page 9-57*.

Make certain that all wheel nuts are properly tightened. See "Wheel Nut Torque" under *Capacities and Specifications on page 11-2*.

WARNING

Rust or dirt on a wheel, or on the parts to which it is fastened, can make wheel nuts become loose after time. The wheel could come off and cause an accident. When changing a wheel, remove any rust or dirt from places where the wheel attaches to the vehicle. In an emergency, use a cloth or a paper towel to do this; but be sure to use a scraper or wire brush later, if needed, to get all the rust or dirt off. See *If a Tire Goes Flat on page 9-69*.

When It Is Time for New Tires

Various factors, such as maintenance, temperatures, driving speeds, vehicle loading, and road conditions influence when you need new tires.

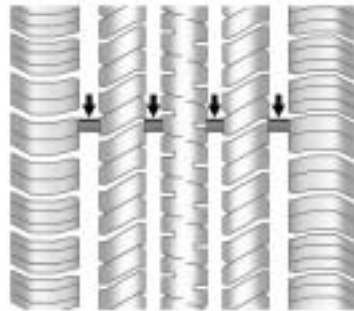

One way to tell when it is time for new tires is to check the treadwear indicators, which appear when the tires have only 1/16 inch (1.6 mm) or less of tread remaining.

The vehicle needs new tires if any of the following statements are true:

- You can see the indicators at three or more places around the tire.
- You can see cord or fabric showing through the tire's rubber.
- The tread or sidewall is cracked, cut, or snagged deep enough to show cord or fabric.
- The tire has a bump, bulge, or split.
- The tire has a puncture, cut, or other damage that cannot be repaired well because of the size or location of the damage.

The rubber in tires degrades over time, even if they are not being used. This is also true for the spare tire, if the vehicle has one. Multiple conditions affect how fast this aging takes place, including temperatures, loading conditions, and inflation

pressure maintenance. With proper care and maintenance tires typically wear out before they degrade due to age. If you are unsure about the need to replace the tires as they get older, consult the tire manufacturer for more information.

Buying New Tires

GM has developed and matched specific tires for your vehicle. The original equipment tires installed on your vehicle, when it was new, were designed to meet General Motors Tire Performance Criteria Specification (TPC Spec) system rating. If you need replacement tires, GM strongly recommends that you get tires with the same TPC Spec rating. This way, your vehicle will continue to have tires that are designed to give the same performance and vehicle safety, during normal use, as the original tires.

GM's exclusive TPC Spec system considers over a dozen critical specifications that impact the overall performance of your vehicle, including brake system performance, ride and handling, traction control, and tire pressure monitoring performance. GM's TPC Spec number is molded onto the tire's sidewall near the tire size. If the tires have an all-season tread design, the TPC Spec number will be followed by an MS for mud and snow. See *Tire Sidewall Labeling* on page 9-49 for additional information.

GM recommends replacing tires in sets of four. This is because uniform tread depth on all tires will help keep your vehicle performing most like it did when the tires were new.

Replacing less than a full set of tires can affect the braking and handling performance of your vehicle. See *Tire Inspection on page 9-61* and *Tire Rotation on page 9-61* for information on proper tire rotation.

 **WARNING**

Mixing tires could cause you to lose control while driving. If you mix tires of different sizes, brands, or types (radial and bias-belted tires), the vehicle may not handle properly, and you could have a crash. Using tires of different sizes, brands, or types may also cause damage to your vehicle. Be sure to use the correct size, brand, and type of tires on all wheels. It is all right to drive with your compact

(Continued)

WARNING (Continued)

spare temporarily, as it was developed for use on your vehicle. See *Compact Spare Tire on page 9-83*.

 **WARNING**

If you use bias-ply tires on the vehicle, the wheel rim flanges could develop cracks after many miles of driving. A tire and/or wheel could fail suddenly, causing a crash. Use only radial-ply tires with the wheels on the vehicle.

If you must replace your vehicle's tires with those that do not have a TPC Spec number, make sure they are the same size, load range, speed rating, and construction type (radial and bias-belted tires) as your vehicle's original tires.

Vehicles that have a tire pressure monitoring system could give an inaccurate low-pressure warning if non-TPC Spec rated tires are installed on your vehicle. Non-TPC Spec rated tires may give a low-pressure warning that is higher or lower than the proper warning level you would get with TPC Spec rated tires. See *Tire Pressure Monitor System on page 9-56*.

Your vehicle's original equipment tires are listed on the Tire and Loading Information Label. See *Vehicle Load Limits on page 8-12*, for more information about the Tire and Loading Information Label and its location on your vehicle.

Different Size Tires and Wheels

If you add wheels or tires that are a different size than your original equipment wheels and tires, this could affect the way your vehicle performs, including its braking, ride and handling characteristics, stability, and resistance to rollover. Additionally, if your vehicle has electronic systems such as anti-lock brakes, rollover airbags, traction control, and electronic stability control, the performance of these systems can be affected.

WARNING

If you add different sized wheels, your vehicle may not provide an acceptable level of performance and safety if tires not recommended for those wheels are selected. You may increase the chance that you will crash and suffer serious injury. Only use GM specific wheel and tire systems developed for your vehicle, and have them properly installed by a GM certified technician.

See *Buying New Tires on page 9-63* and *Accessories and Modifications on page 9-3* for additional information.

Uniform Tire Quality Grading

Quality grades can be found where applicable on the tire sidewall between tread shoulder and maximum section width. For example:

Treadwear 200 Traction AA Temperature A

The following information relates to the system developed by the United States National Highway Traffic Safety Administration (NHTSA), which grades tires by treadwear, traction, and temperature performance. This applies only to vehicles sold in the United States. The grades are molded on the sidewalls of most passenger car tires.

The Uniform Tire Quality Grading (UTQG) system does not apply to deep tread, winter-type snow tires, space-saver, or temporary use spare tires, tires with nominal rim diameters of 10 to 12 inches (25 to 30 cm), or to some limited-production tires.

While the tires available on General Motors passenger cars and light trucks may vary with respect to these grades, they must also conform to federal safety requirements and additional General Motors Tire Performance Criteria (TPC) standards.

Treadwear

The treadwear grade is a comparative rating based on the wear rate of the tire when tested under controlled conditions on a specified government test course. For example, a tire graded 150 would wear one and a half (1.5) times as well on the government course as a tire graded 100. The relative performance of tires depends upon the actual conditions of their use, however, and may depart significantly from the norm due to variations in driving habits, service practices, and differences in road characteristics and climate.

Traction – AA, A, B, C

The traction grades, from highest to lowest, are AA, A, B, and C. Those grades represent the tire's ability to stop on wet pavement as measured under controlled conditions on specified government test surfaces of asphalt and concrete. A tire marked C may have poor traction performance.

Temperature – A, B, C

The temperature grades are A (the highest), B, and C, representing the tire's resistance to the generation of heat and its ability to dissipate heat when tested under controlled conditions on a specified indoor laboratory test wheel.

Sustained high temperature can cause the material of the tire to degenerate and reduce tire life, and excessive temperature can lead to sudden tire failure. The grade C corresponds to a level of performance which all passenger car tires must meet under the Federal Motor Vehicle Safety Standard No. 109. Grades B and A represent higher levels of performance on the laboratory test wheel than the minimum required by law. It should be noted that the temperature grade for this tire is established for a tire that is properly inflated and not overloaded. Excessive speed, underinflation, or excessive loading, either separately or in combination, can cause heat buildup and possible tire failure.

Wheel Alignment and Tire Balance

The tires and wheels on the vehicle were aligned and balanced carefully at the factory to give the longest tire life and best overall performance. Adjustments to wheel alignment and tire balancing will not be necessary on a regular basis. However, if there is unusual tire wear or the vehicle pulls to one side or the other, the alignment should be checked. If the vehicle vibrates when driving on a smooth road, the tires and wheels might need to be rebalanced. See your dealer/retailer for proper diagnosis.

Wheel Replacement

Replace any wheel that is bent, cracked, or badly rusted or corroded. If wheel nuts keep coming loose, the wheel, wheel bolts, and wheel nuts should be replaced. If the wheel leaks air, replace it (except some aluminum wheels, which can sometimes be repaired). See your dealer/retailer if any of these conditions exist.

Your dealer/retailer will know the kind of wheel you need.

Each new wheel should have the same load-carrying capacity, diameter, width, offset, and be mounted the same way as the one it replaces.

If you need to replace any of the wheels, wheel bolts, wheel nuts, or Tire Pressure Monitor System (TPMS) sensors, replace them only with new GM original equipment parts. This way, you will be sure to have the right wheel, wheel bolts, wheel nuts, and TPMS sensors for the vehicle.

WARNING

Using the wrong replacement wheels, wheel bolts, or wheel nuts on your vehicle can be dangerous. It could affect the braking and handling of your vehicle, make your tires lose air and make you lose control. You could have a collision in which you or others could be injured. Always use the correct wheel, wheel bolts, and wheel nuts for replacement.

Notice: The wrong wheel can also cause problems with bearing life, brake cooling, speedometer or odometer calibration, headlamp aim, rear differential, bumper height, vehicle ground clearance, and tire or tire chain clearance to the body and chassis.

See *If a Tire Goes Flat on page 9-69* for more information.

Used Replacement Wheels

WARNING

Putting a used wheel on the vehicle is dangerous. You cannot know how it has been used or how far it has been driven. It could fail suddenly and cause a crash. If you have to replace a wheel, use a new GM original equipment wheel.

Tire Chains

WARNING

Do not use tire chains. There is not enough clearance. Tire chains used on a vehicle without the proper amount of clearance can cause damage to the brakes, suspension, or other vehicle parts. The area damaged by the tire chains could cause you to lose control of the vehicle and you or others may be injured in a crash. Use another type of traction device only if its manufacturer recommends it for use on the vehicle and tire size combination and road conditions. Follow that manufacturer's instructions.

(Continued)

WARNING (Continued)

To help avoid damage to the vehicle, drive slowly, re-adjust or remove the device if it is contacting the vehicle, and do not spin the wheels. If you do find traction devices that will fit, install them on the rear tires.

If a Tire Goes Flat

It is unusual for a tire to blowout while you are driving, especially if you maintain your vehicle's tires properly. If air goes out of a tire, it is much more likely to leak out slowly.

But if you should ever have a blowout, here are a few tips about what to expect and what to do:

If a front tire fails, the flat tire creates a drag that pulls the vehicle toward that side. Take your foot off the accelerator pedal and grip the steering wheel firmly. Steer to maintain lane position, and then gently brake to a stop well out of the traffic lane.

A rear blowout, particularly on a curve, acts much like a skid and may require the same correction you would use in a skid. In any rear blowout remove your foot from the accelerator pedal. Get the vehicle under control by steering the way you want the vehicle to go. It may be very bumpy and noisy, but you can still steer. Gently brake to a stop, well off the road if possible.

 **WARNING**

Lifting a vehicle and getting under it to do maintenance or repairs is dangerous without the appropriate safety equipment and training. If a jack is provided with the vehicle, it is designed only for changing a flat tire. If it is used for anything else, you or others could be badly injured or killed if the vehicle slips off the jack. If a jack is provided with the vehicle, only use it for changing a flat tire.

If a tire goes flat, avoid further tire and wheel damage by driving slowly to a level place.

9-70 Vehicle Care

Turn on the hazard warning flashers. See *Hazard Warning Flashers* on page 5-4.

WARNING

Changing a tire can be dangerous. The vehicle can slip off the jack and roll over or fall on you or other people. You and they could be badly injured or even killed. Find a level place to change your tire. To help prevent the vehicle from moving:

1. Set the parking brake firmly.
2. Put an automatic transmission shift lever in P (Park), or shift a manual transmission to 1 (First) or R (Reverse).

(Continued)

WARNING (Continued)

3. Turn off the engine and do not restart while the vehicle is raised.
4. Do not allow passengers to remain in the vehicle.

To be certain the vehicle will not move, put blocks at the front and rear of the tire farthest from the one being changed. That would be the tire on the other side, at the opposite end of the vehicle.

This vehicle may come with a jack and spare tire or a tire sealant and compressor kit. To use the jack and spare tire, follow the instructions below. To use the tire sealant and compressor kit, see *Tire Sealant and Compressor Kit* on page 9-71.

When the vehicle has a flat tire (B), use the following example as a guide to assist you in the placement of wheel blocks (A).

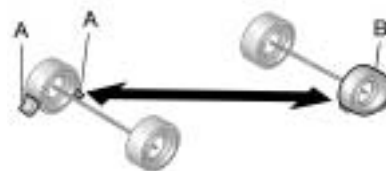

- A. Wheel Block
B. Flat Tire

The following information explains how to repair or change a tire.

Tire Sealant and Compressor Kit

WARNING

Idling a vehicle in an enclosed area with poor ventilation is dangerous. Engine exhaust may enter the vehicle. Engine exhaust contains Carbon Monoxide (CO) which cannot be seen or smelled. It can cause unconsciousness and even death. Never run the engine in an enclosed area that has no fresh air ventilation. For more information, see *Engine Exhaust on page 8-25*.

WARNING

Over-inflating a tire could cause the tire to rupture and you or others could be injured. Be sure to read and follow the tire sealant and compressor kit instructions and inflate the tire to its recommended pressure. Do not exceed the recommended pressure.

WARNING

Storing the tire sealant and compressor kit or other equipment in the passenger compartment of the vehicle could cause injury. In a sudden stop or collision, loose equipment could strike someone. Store the tire sealant and compressor kit in its original location.

If this vehicle has a tire sealant and compressor kit, there may not be a spare tire, tire changing equipment, and on some vehicles there may not be a place to store a tire.

The tire sealant and compressor can be used to temporarily seal punctures up to 6 mm (1/4 inch) in the tread area of the tire. It can also be used to inflate an under inflated tire.

If the tire has been separated from the wheel, has damaged sidewalls, or has a large puncture, the tire is too severely damaged for the tire sealant and compressor kit to be effective. See *Roadside Assistance Program on page 12-6*.

Read and follow all of the tire sealant and compressor kit instructions.

9-72 Vehicle Care

The kit includes:

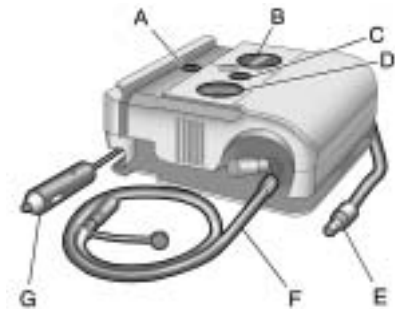

- A. On/Off Button
- B. Selector Switch
(Sealant/Air or Air Only)
- C. Pressure Relief Button
- D. Pressure Gauge
- E. Air Only Hose (Black)
- F. Sealant/Air Hose (Clear)
- G. Power Plug

Tire Sealant

Read and follow the safe handling instructions on the label adhered to the compressor.

Check the tire sealant expiration date on the sealant canister. The sealant canister should be replaced before its expiration date. Replacement sealant canisters are available at your local dealer/retailer. See "Removal and Installation of the Sealant Canister" following.

There is only enough sealant to seal one tire. After usage, the sealant canister and sealant/air hose assembly must be replaced. See "Removal and Installation of the Sealant Canister" following.

Using the Tire Sealant and Compressor Kit to Temporarily Seal and Inflate a Punctured Tire

Follow the directions closely for correct sealant usage.

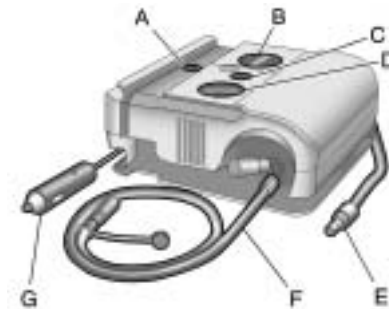

When using the tire sealant and compressor kit during cold temperatures, warm the kit in a heated environment for 5 minutes. This will help to inflate the tire faster.

Always do a safety check first. See *If a Tire Goes Flat on page 9-69*. Do not remove any objects that have penetrated the tire.

1. Remove the tire sealant and compressor kit from its storage location. See *Storing the Tire Sealant and Compressor Kit on page 9-77*.
2. Unwrap the sealant/air hose (F) and the power plug (G).
3. Place the kit on the ground.
Make sure the tire valve stem is positioned close to the ground so the hose will reach it.
4. Remove the valve stem cap from the flat tire by turning it counterclockwise.

5. Attach the sealant/air hose (F) onto the tire valve stem. Turn it clockwise until it is tight.
6. Plug the power plug (G) into the accessory power outlet in the vehicle. Unplug all items from other accessory power outlets. See *Power Outlets on page 4-9*.
If the vehicle has an accessory power outlet, do not use the cigarette lighter.
If the vehicle only has a cigarette lighter, use the cigarette lighter.
Do not pinch the power plug cord in the door or window.
7. Start the vehicle. The vehicle must be running while using the air compressor.

8. Turn the selector switch (B) clockwise to the Sealant + Air position.
9. Press the on/off (A) button to turn the tire sealant and compressor kit on.
The compressor will inject sealant and air into the tire.
The pressure gage (D) will initially show a high pressure while the compressor pushes the sealant into the tire. Once the sealant is completely dispersed into the tire, the pressure will quickly drop and start to rise again as the tire inflates with air only.

9-74 Vehicle Care

10. Inflate the tire to the recommended inflation pressure using the pressure gage (D). The recommended inflation pressure can be found on the Tire and Loading Information label. See *Tire Pressure on page 9-54*.

The pressure gage (D) may read higher than the actual tire pressure while the compressor is on. Turn the compressor off to get an accurate pressure reading. The compressor may be turned on/off until the correct pressure is reached.

Notice: If the recommended pressure cannot be reached after approximately 25 minutes, the vehicle should not be driven farther. The tire is too severely damaged and the tire sealant and compressor kit cannot inflate the tire. Remove the power plug from the accessory power outlet and unscrew the inflating hose from the tire valve. See *Roadside Assistance Program on page 12-6*.

11. Press the on/off button (A) to turn the tire sealant and compressor kit off.
- The tire is not sealed and will continue to leak air until the vehicle is driven and the sealant is distributed in the tire, therefore, Steps 12 through 18 must be done immediately after Step 11.

Be careful while handling the tire sealant and compressor kit as it could be warm after usage.

12. Unplug the power plug (G) from the accessory power outlet in the vehicle.
13. Turn the sealant/air hose (F) counterclockwise to remove it from the tire valve stem.
14. Replace the tire valve stem cap.
15. Replace the sealant/air hose (F), and the power plug (G) back in their original location.



16. If the flat tire was able to inflate to the recommended inflation pressure, remove the maximum speed label from the sealant canister and place it in a highly visible location. The label is a reminder not to exceed 90 km/h (55 mph) until the damaged tire is repaired or replaced.
17. Return the equipment to its original storage location in the vehicle.

18. Immediately drive the vehicle 8 km (5 miles) to distribute the sealant in the tire.
19. Stop at a safe location and check the tire pressure. Refer to Steps 1 through 11 under “Using the Tire Sealant and Compressor Kit without Sealant to Inflate a Tire (Not Punctured).”

If the tire pressure has fallen more than 68 kPa (10 psi) below the recommended inflation pressure, stop driving the vehicle. The tire is too severely damaged and the tire sealant cannot seal the tire. See *Roadside Assistance Program* on page 12-6.

If the tire pressure has not dropped more than 10 psi (68 kPa) from the recommended inflation pressure, inflate the tire to the recommended inflation pressure.

20. Wipe off any sealant from the wheel, tire, and vehicle.
21. Dispose of the used sealant canister and sealant/air hose (F) assembly at a local dealer/retailer or in accordance with local state codes and practices.
22. Replace it with a new canister available from your dealer/retailer.
23. After temporarily sealing a tire using the tire sealant and compressor kit, take the vehicle to an authorized dealer/retailer within a 161 km (100 miles) of driving to have the tire repaired or replaced.

Using the Tire Sealant and Compressor Kit without Sealant to Inflate a Tire (Not Punctured)

To use the air compressor to inflate a tire with air only and not sealant:

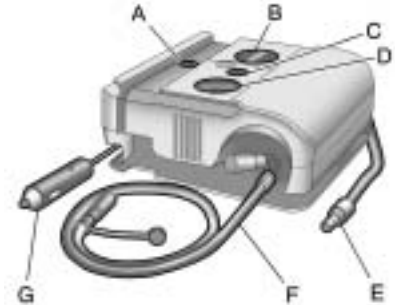

Always do a safety check first. See *If a Tire Goes Flat* on page 9-69.

1. Remove the tire sealant and compressor kit from its storage location. See *Storing the Tire Sealant and Compressor Kit* on page 9-77.
2. Unwrap the air only hose (E) and the power plug (G).

9-76 Vehicle Care

3. Place the kit on the ground.
Make sure the tire valve stem is positioned close to the ground so the hose will reach it.
4. Remove the tire valve stem cap from the flat tire by turning it counterclockwise.
5. Attach the air only hose (E) onto the tire valve stem by turning it clockwise until it is tight.
6. Plug the power plug (G) into the accessory power outlet in the vehicle. Unplug all items from other accessory power outlets. See *Power Outlets on page 4-9*.
If the vehicle has an accessory power outlet, do not use the cigarette lighter.
If the vehicle only has a cigarette lighter, use the cigarette lighter.
Do not pinch the power plug cord in the door or window.
7. Start the vehicle. The vehicle must be running while using the air compressor.
8. Turn the selector switch (B) counterclockwise to the Air Only position.
9. Press the on/off (A) button to turn the compressor on.
The compressor will inflate the tire with air only.
10. Inflate the tire to the recommended inflation pressure using the pressure gage (D). The recommended inflation pressure can be found on the Tire and Loading Information label. See *Tire Pressure on page 9-54*.
The pressure gage (D) may read higher than the actual tire pressure while the compressor is on. Turn the compressor off to get an accurate reading.
The compressor may be turned on/off until the correct pressure is reached.
11. Press the on/off button (A) to turn the tire sealant and compressor kit off.
Be careful while handling the tire sealant and compressor kit as it could be warm after usage.
12. Unplug the power plug (G) from the accessory power outlet in the vehicle.
13. Disconnect the air only hose (E) from the tire valve stem, by turning it counterclockwise, and replace the tire valve stem cap.
14. Replace the air only hose (E) and the power plug (G) and cord back in its original location.
15. Place the equipment in the original storage location in the vehicle.

Removal and Installation of the Sealant Canister

To remove the sealant canister:



1. Remove the plastic cover.
2. Unscrew the connector (B) from the canister (A).
3. Pull up on the canister (A) to remove it.
4. Replace with a new canister which is available from your dealer/retailer.

5. Push the new canister into place.
6. Screw the connector (B) to the canister (A).
7. Slide the plastic cover back on.

Storing the Tire Sealant and Compressor Kit



This vehicle may have a tire sealant and compressor kit in place of a jack or spare tire. It is located in a foam container in the trunk.

Tire Changing

Removing the Spare Tire and Tools

Spare Tire

1. Open the trunk. See *Trunk* on page 1-8.
2. Remove the carpet.

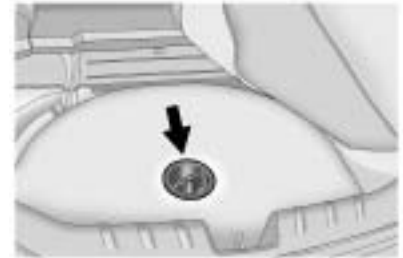

3. Turn the center retainer counterclockwise to remove the spare tire cover.
4. Remove the spare tire and place it next to the tire being changed.

Tools

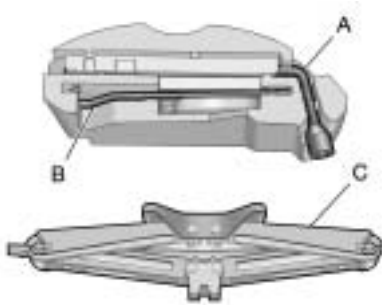

- A. Wheel Wrench
- B. Jack Handle Extension
- C. Jack



1. The jack and tools are stored below the spare tire.
Remove the jack from the retaining bracket.
2. Remove the tool container.
3. Remove the tools from the tool container.
4. Place the tools next to the tire being changed.

Removing the Flat Tire and Installing the Spare Tire

1. If the vehicle has wheel bolt caps, remove the caps. Store the caps with the wheel cover.



2. Use the fully extended wheel wrench to loosen all the wheel nuts one-half turn counterclockwise. Do not remove them.

Notice: Make sure that the jack lift head is in the correct position or you may damage your vehicle. The repairs would not be covered by your warranty.

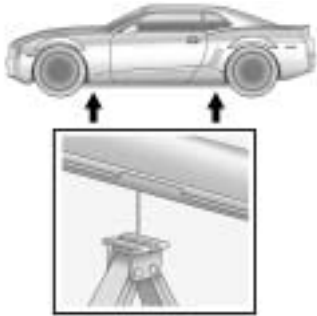

- Position the jack lift head at the jack location nearest the flat tire. The location is indicated by a mark on the bottom edge of the vehicle. The jack must not be used in any other position.
Raise the jack until it engages with the jacking point.

- Put the compact spare tire near you.

⚠ WARNING

Getting under a vehicle when it is jacked up is dangerous. If the vehicle slips off the jack, you could be badly injured or killed. Never get under a vehicle when it is supported only by a jack.

⚠ WARNING

Raising your vehicle with the jack improperly positioned can damage the vehicle and even make the vehicle fall. To help avoid personal injury and vehicle damage, be sure to fit the jack lift head into the proper location before raising the vehicle.

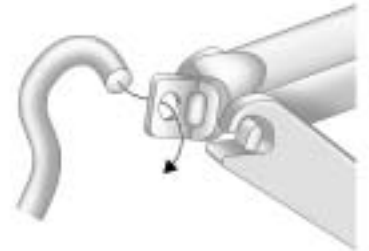

- Fit the jack handle extension onto the jack by sliding the hook through the end of the jack.



6. Insert the other end of the jack handle into the wrench.



7. Raise the vehicle by turning the jack handle extension clockwise until the vehicle is far enough off the ground to allow enough room for the compact spare tire to fit under the vehicle.

Keep the hook parallel to the ground. The wrench may need to be removed and repositioned to continue turning it.



8. Remove all of the wheel nuts and place them in a dry, clean place to avoid getting dirt in the threads.

⚠ WARNING

Rust or dirt on a wheel, or on the parts to which it is fastened, can make wheel nuts become loose after time. The wheel could come off and cause an accident. When changing a wheel, remove any rust or dirt from places where the wheel attaches to the vehicle. In an emergency, use a cloth or a paper towel to do this; but be sure to use a scraper or wire brush later, if needed, to get all the rust or dirt off. See *If a Tire Goes Flat* on page 9-69.



9. Remove any rust or dirt from the wheel bolts, mounting surfaces and spare wheel.
10. Place the compact spare tire on the wheel-mounting surface.

⚠ WARNING

Never use oil or grease on bolts or nuts because the nuts might come loose. The vehicle's wheel could fall off, causing a crash.

11. Reinstall the wheel nuts with the rounded end of the nuts toward the wheel. Tighten each nut as much as possible using the wheel wrench until the wheel is held firmly against the hub. Use your free hand to prevent the wheel from turning while you are tightening.

9-82 Vehicle Care

- Lower the vehicle by turning the jack handle counterclockwise. Lower the jack completely.



- Tighten the wheel nuts firmly in a crisscross sequence, as shown.

WARNING

Wheel nuts that are improperly or incorrectly tightened can cause the wheels to become loose or come off. The wheel nuts should be tightened with a torque wrench to the proper torque specification after replacing. Follow the torque specification supplied by the aftermarket manufacturer when using accessory locking wheel nuts. See *Capacities and Specifications* on page 11-2 for original equipment wheel nut torque specifications.

Notice: Improperly tightened wheel nuts can lead to brake pulsation and rotor damage. To avoid expensive brake repairs, evenly tighten the wheel nuts in the proper sequence and to the proper torque specification. See *Capacities and Specifications* on page 11-2 for the wheel nut torque specification.

Storing a Flat or Spare Tire and Tools

WARNING

Storing a jack, a tire, or other equipment in the passenger compartment of the vehicle could cause injury. In a sudden stop or collision, loose equipment could strike someone. Store all these in the proper place.

To store a flat or spare tire and tools:

- Replace the jack and tools.
- Replace the spare tire cover.
- Turn the retainer nut clockwise to tighten.
- Replace the rear trunk carpet.
- Place the flat tire face up on the load floor.



6. Route the strap provided, as shown, to secure the flat tire.

The compact spare tire is for temporary use only. Replace the compact spare with a full-size tire as soon as possible.

Compact Spare Tire

WARNING

Driving with more than one compact spare tire at a time could result in loss of braking and handling. This could lead to a crash and you or others could be injured. Use only one compact spare tire at a time.

If this vehicle has a compact spare tire it was fully inflated when the vehicle was new, however, it can lose air after a time. Check the inflation pressure regularly. It should be 60 psi (420 kPa).

After installing the compact spare on the vehicle, stop as soon as possible and make sure the spare tire is correctly inflated. The compact spare is made to perform well at speeds up to 65 mph (105 km/h) for distances up to 3,000 miles (5 000 km), so you can finish your trip and have the

full-size tire repaired or replaced at your convenience. Of course, it is best to replace the spare with a full-size tire as soon as possible. The spare tire will last longer and be in good shape in case it is needed again.

Notice: When the compact spare is installed, do not take the vehicle through an automatic car wash with guide rails. The compact spare can get caught on the rails which can damage the tire, wheel and other parts of the vehicle.

Do not use the compact spare on other vehicles.

Do not mix the compact spare tire or wheel with other wheels or tires. They will not fit. Keep the spare tire and its wheel together.

Notice: Tire chains will not fit the compact spare. Using them can damage the vehicle and can damage the chains too. Do not use tire chains on the compact spare.

Jump Starting

If the battery has run down, try to use another vehicle and some jumper cables to start your vehicle. Be sure to use the following steps to do it safely.

WARNING

Batteries can hurt you. They can be dangerous because:

- They contain acid that can burn you.
- They contain gas that can explode or ignite.
- They contain enough electricity to burn you.

If you do not follow these steps exactly, some or all of these things can hurt you.

Notice: Ignoring these steps could result in costly damage to the vehicle that would not be covered by the warranty.

Trying to start the vehicle by pushing or pulling it will not work, and it could damage the vehicle.

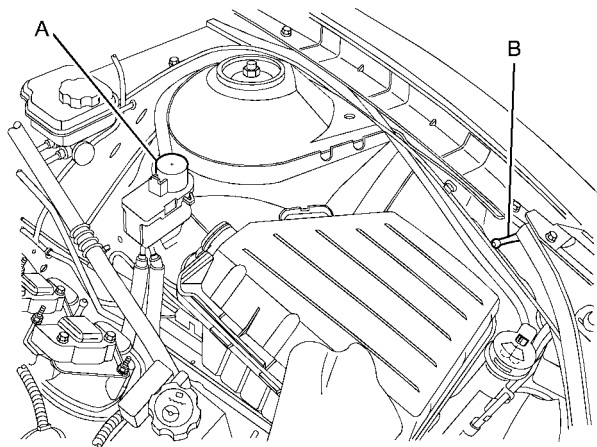

The jump start positive (A) and negative (B) posts are located in the engine compartment on the driver side of the vehicle.

These posts are used instead of a direct connection to the battery.

The positive jump start connection is covered by a red cap. Remove to expose the terminal.

1. Check the other vehicle. It must have a 12-volt battery with a negative ground system.

Notice: If the other vehicle's system is not a 12-volt system with a negative ground, both vehicles can be damaged. Only use vehicles with 12-volt systems with negative grounds to jump start your vehicle.

2. Position the two vehicles so that they are not touching.
3. Set the parking brake firmly and put the shift lever in P (Park). See *Shifting Into Park* on page 8-21.

Notice: If you leave the radio or other accessories on during the jump starting procedure, they could be damaged. The repairs would not be covered by the warranty. Always turn off the radio and other accessories when jump starting the vehicle.

4. Turn the ignition to LOCK/OFF and switch off all lights and accessories in both vehicles, except the hazard warning flashers if needed.

 **WARNING**

An electric fan can start up even when the engine is not running and can injure you. Keep hands, clothing and tools away from any underhood electric fan.

 **WARNING**

Using a match near a battery can cause battery gas to explode. People have been hurt doing this, and some have been blinded. Use a flashlight if you need more light.

Be sure the battery has enough water. You do not need to add water to the battery installed in your new vehicle. But if a battery has filler caps, be sure the right amount of fluid is there. If it is low, add water to take care of that first. If you don't, explosive gas could be present.

Battery fluid contains acid that can burn you. Do not get it on you. If you accidentally get it in your eyes or on your skin, flush the place with water and get medical help immediately.

⚠ WARNING

Fans or other moving engine parts can injure you badly. Keep your hands away from moving parts once the engine is running.

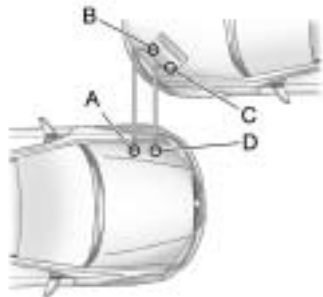

5. Connect one end of the red positive (+) cable to the jump start positive (+) post (A).
6. Connect the other end of the red positive (+) cable to the positive (+) terminal of the good battery (B).

7. Connect one end of the black negative (-) cable to the negative (-) terminal of the good battery (C).
8. Connect the other end of the black negative (-) cable to the negative (-) post (D).
9. Start the engine in the vehicle with the good battery and run the engine at idle speed for at least four minutes.
10. Try to start the vehicle that had the dead battery. If it will not start after a few tries, it probably needs service.

Notice: If the jumper cables are connected or removed in the wrong order, electrical shorting may occur and damage the vehicle. The repairs would not be covered by the vehicle warranty. Always connect and remove the jumper cables in the correct order, making sure that the cables do not touch each other or other metal.

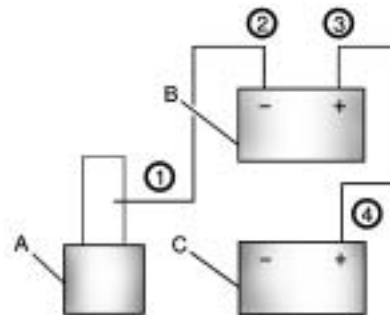

Jumper Cable Removal

- A. Heavy, Unpainted Metal Engine Part or Remote Negative (-) Terminal
- B. Good Battery or Remote Positive (+) and Remote Negative (-) Terminals
- C. Dead Battery or Remote Positive (+) Terminal

To disconnect the jumper cables from both vehicles:

1. Disconnect the black negative (-) cable from the vehicle that had the dead battery.
2. Disconnect the black negative (-) cable from the vehicle with the good battery.
3. Disconnect the red positive (+) cable from the vehicle with the good battery.
4. Disconnect the red positive (+) cable from the other vehicle.
5. Return the caps over the positive (+) and negative (-) terminals to their original positions.

Towing

Towing the Vehicle

To avoid damage, the disabled vehicle should be towed with all four wheels off the ground. Consult your dealer/retailer or a professional towing service if the disabled vehicle needs to be towed. See *Roadside Assistance Program on page 12-6*.

If the vehicle has lost battery power, the shift lever needs to be manually released to neutral for towing. See “Shift Lock Manual Release” under *Shifting Out of Park on page 8-22*.

To tow the vehicle behind another vehicle for recreational purposes — such as behind a motorhome, see Recreational Vehicle Towing following.

Recreational Vehicle Towing

Notice: Dolly towing or dinghy towing the vehicle may cause damage because of reduced ground clearance. Always put the vehicle on a flatbed truck or trailer.

The vehicle was neither designed nor intended to be towed with any of its wheels on the ground. If the vehicle must be towed, see “Towing the Vehicle” earlier in this section.

Appearance Care

Exterior Care

Cleaning Exterior Lamps/Lenses

Use only lukewarm or cold water, a soft cloth and a car washing soap to clean exterior lamps and lenses. Follow instructions under “Washing the Vehicle” later in this section.

Finish Care

Occasional waxing or mild polishing of the vehicle by hand may be necessary to remove residue from the paint finish. Approved cleaning products can be obtained from your dealer/retailer.

If the vehicle has a basecoat/clearcoat paint finish, the clearcoat gives more depth and gloss to the colored basecoat.

Always use waxes and polishes that are non-abrasive and made for a basecoat/clearcoat paint finish.

Notice: Machine compounding or aggressive polishing on a basecoat/clearcoat paint finish may damage it. Use only non-abrasive waxes and polishes that are made for a basecoat/clearcoat paint finish on the vehicle.

Foreign materials such as calcium chloride and other salts, ice melting agents, road oil and tar, tree sap, bird droppings, chemicals from industrial chimneys, etc., can damage the vehicle's finish if they remain on painted surfaces. Wash the vehicle as soon as possible. If necessary, use non-abrasive cleaners that are marked safe for painted surfaces to remove foreign matter.

Exterior painted surfaces are subject to aging, weather and chemical fallout that can take their toll over a period of years. To keep the paint finish looking new, keep the vehicle garaged or covered whenever possible.

Protecting Exterior Bright Metal Parts

Bright metal parts should be cleaned regularly to keep their luster. Wash with water or use chrome polish on chrome or stainless steel trim, if necessary.

Use special care with aluminum trim. To avoid damaging protective trim, never use auto or chrome polish, steam or caustic soap to clean aluminum. A coating of wax, rubbed to high polish, is recommended for all bright metal parts.

Washing the Vehicle

To preserve the vehicle's finish, keep it clean by washing it often.

Do not wash the vehicle in direct sunlight and use a car washing soap.

Notice: Certain cleaners contain chemicals that can damage the emblems or nameplates on the vehicle. Check the cleaning product label. If it states that it should not be used on plastic parts, do not use it on the vehicle or damage may occur and it would not be covered by the warranty.

Do not use cleaning agents that are petroleum based or that contain acid or abrasives, as they can damage the paint, metal or plastic on the vehicle. Approved cleaning products can be obtained from your dealer/retailer. Follow all manufacturer

directions regarding correct product usage, necessary safety precautions and appropriate disposal of any vehicle care product.

Rinse the vehicle well, before washing and after to remove all cleaning agents completely. If they are allowed to dry on the surface, they could stain.

Dry the finish with a soft, clean chamois or an all-cotton towel to avoid surface scratches and water spotting.

High pressure car washes could cause water to enter the vehicle. Avoid using high pressure washes closer than 30 cm (12 inches) to the surface of the vehicle. Use of power washers exceeding 8,274 kPa (1,200 psi) can result in damage or removal of paint and decals.

Notice: Conveyor systems on some automatic car washes could damage the vehicle. There may not be enough clearance for the undercarriage. Check with the car wash manager before using the automatic car wash.

Weatherstrips

Silicone grease on weatherstrips will make them last longer, seal better, and not stick or squeak. Apply silicone grease with a clean cloth. During very cold, damp weather frequent application may be required. See "Fluids and Lubricants" in the Index of the "Maintenance and Warranty and Owner assistance Information" manual.

Wheels and Trim — Aluminum or Chrome

The vehicle may have either aluminum or chrome-plated wheels.

Keep the wheels clean using a soft clean cloth with mild soap and water. Rinse with clean water. After rinsing thoroughly, dry with a soft clean towel. A wax may then be applied.

Notice: Chrome wheels and other chrome trim may be damaged if the vehicle is not washed after driving on roads that have been sprayed with magnesium, calcium or sodium chloride. These chlorides are used on roads for conditions such as ice and dust. Always wash the vehicle's chrome with soap and water after exposure.

Notice: Using strong soaps, chemicals, abrasive polishes, cleaners, brushes, or cleaners that contain acid on aluminum or chrome-plated wheels, could damage the surface of the wheel(s). The repairs would not be covered by the vehicle warranty. Use only approved cleaners on aluminum or chrome-plated wheels.

The surface of these wheels is similar to the painted surface of the vehicle. Do not use strong soaps, chemicals, abrasive polishes, abrasive cleaners, cleaners with acid, or abrasive cleaning brushes on them because the surface could be damaged. Do not use chrome polish on aluminum wheels.

Notice: Using chrome polish on aluminum wheels could damage the wheels. The repairs would not be covered by the vehicle warranty. Use chrome polish on chrome wheels only.

Use chrome polish only on chrome-plated wheels, but avoid any painted surface of the wheel, and buff off immediately after application.

Notice: Driving the vehicle through an automatic car wash that has silicone carbide tire cleaning brushes, could damage the aluminum or chrome-plated wheels. The repairs would not be covered by the vehicle warranty. Never drive a vehicle that has aluminum or chrome-plated wheels through an automatic car wash that uses silicone carbide tire cleaning brushes.

Windshield and Wiper Blades

Clean the outside of the windshield with glass cleaner.

Clean the rubber blades using a lint free cloth or paper towel soaked with windshield washer fluid or a mild detergent. Wash the windshield thoroughly when cleaning the blades. Bugs, road grime, sap, and a buildup of vehicle wash/wax treatments may cause wiper streaking. Replace the wiper blades if they are worn or damaged.

Wipers can be damaged by:

- Extreme dusty conditions
- Sand and salt
- Heat and sun
- Snow and ice, without proper removal

Tires

Use a stiff brush with tire cleaner to clean the tires.

Notice: Using petroleum-based tire dressing products on the vehicle may damage the paint finish and/or tires. When applying a tire dressing, always wipe off any overspray from all painted surfaces on the vehicle.

Sheet Metal Damage

If the vehicle is damaged and requires sheet metal repair or replacement, make sure the body repair shop applies anti-corrosion material to parts repaired or replaced to restore corrosion protection.

Original manufacturer replacement parts will provide the corrosion protection while maintaining the vehicle warranty.

Finish Damage

Any stone chips, fractures or deep scratches in the finish should be repaired right away. Bare metal will corrode quickly and may develop into major repair expense.

Minor chips and scratches can be repaired with touch-up materials available from your dealer/retailer. Larger areas of finish damage can be corrected in your dealer's/retailer's body and paint shop.

Underbody Maintenance

Chemicals used for ice and snow removal and dust control can collect on the underbody. If these are not removed, corrosion and rust can develop on the underbody parts such as fuel lines, frame, floor pan, and exhaust system even though they have corrosion protection.

At least every spring, flush these materials from the underbody with plain water. Clean any areas where mud and debris can collect. Dirt packed in close areas of the frame should be loosened before being flushed. Your dealer/retailer or an underbody car washing system can do this.

Chemical Paint Spotting

Some weather and atmospheric conditions can create a chemical fallout. Airborne pollutants can fall upon and attack painted surfaces on the vehicle. This damage can take two forms: blotchy, ring-shaped discolorations, and small, irregular dark spots etched into the paint surface.

Interior Care

The vehicle's interior will continue to look its best if it is cleaned often. Dust and dirt can accumulate on the upholstery and cause damage to the carpet, fabric, leather, and plastic surfaces. Stains should be removed quickly as extreme heat could cause them to set rapidly.

Lighter colored interiors may require more frequent cleaning. Newspapers and garments that can transfer color to home furnishings can also transfer color to the vehicle's interior.

Remove dust from small buttons and knobs with a small brush with soft bristles.

Your dealer/retailer has products for cleaning the vehicle's interior. When cleaning the vehicle's interior, only use cleaners specifically designed for the surfaces that are being cleaned. Permanent damage

can result from using cleaners on surfaces for which they were not intended. Apply the cleaner directly to the cleaning cloth to prevent over-spray. Remove any accidental over-spray from other surfaces immediately.

Notice: Using abrasive cleaners when cleaning glass surfaces on the vehicle, could scratch the glass and/or cause damage to the rear window defogger. When cleaning the glass on the vehicle, use only a soft cloth and glass cleaner.

Cleaners can contain solvents that can become concentrated in the vehicle's interior. Before using cleaners, read and adhere to all safety instructions on the label. While cleaning the vehicle's interior, maintain adequate ventilation by opening the vehicle's doors and windows.

Do not clean the interior using the following cleaners or techniques:

- Never use a knife or any other sharp object to remove a soil from any interior surface.
 - Never use a stiff brush. It can cause damage to the vehicle's interior surfaces.
 - Never apply heavy pressure or rub aggressively with a cleaning cloth. Use of heavy pressure can damage the interior and does not improve the effectiveness of soil removal.
- Use only mild, neutral-pH soaps. Avoid laundry detergents or dishwashing soaps with degreasers. Using too much soap will leave a residue that leaves streaks and attracts dirt. For liquid cleaners, about 20 drops per gallon (3.78 L) of water is a good guide.
 - Do not heavily saturate the upholstery while cleaning.
 - Damage to the vehicle's interior may result from the use of many organic solvents such as naphtha, alcohol, etc.

Fabric/Carpet

Use a vacuum cleaner with a soft brush attachment to remove dust and loose dirt. A canister vacuum with a beater bar in the nozzle may only be used on floor carpet and carpeted floor mats. For soils, always try to remove them first with plain water or club soda. Before cleaning, gently remove as much of the soil as possible using one of the following techniques:

- For liquids: gently blot the remaining soil with a paper towel. Allow the soil to absorb into the paper towel until no more can be removed.
- For solid dry soils: remove as much as possible and then vacuum.

To clean:

1. Saturate a lint-free, clean white cloth with water or club soda.
2. Remove excess moisture.
3. Start on the outside edge of the soil and gently rub toward the center. Continue cleaning, using a clean area of the cloth each time it becomes soiled.
4. Continue to gently rub the soiled area.
5. If the soil is not completely removed, use a mild soap solution and repeat the cleaning process with plain water.

If any of the soil remains, a commercial fabric cleaner or spot lifter may be necessary. Test a small hidden area for colorfastness before using a commercial upholstery cleaner or spot lifter. If the locally cleaned area gives any impression that a ring formation may result, clean the entire surface.

A paper towel can be used to blot excess moisture from the fabric or carpet after the cleaning process.

Leather

To remove dust, a soft cloth dampened with water can be used. If a more thorough cleaning is necessary, a soft cloth dampened with a mild soap solution can be used. Allow the leather to dry naturally. Do not use heat, steam, or spot lifters or spot removers, or shoe polish on leather. Many commercial leather cleaners and coatings that are sold to preserve and protect leather may permanently change the appearance and feel of the leather and are not recommended. Do not use silicone or wax-based products, or those containing organic solvents to clean the vehicle's interior because they can alter the appearance by increasing the gloss in a non-uniform manner.

Instrument Panel, Vinyl, and Other Plastic Surfaces

To remove dust, a soft cloth dampened with water can be used. If a more thorough cleaning is necessary, a clean soft cloth dampened with a mild soap solution can be used to gently remove dust and dirt. Never use spot lifters or removers on plastic surfaces. Many commercial cleaners and coatings that are sold to preserve and protect soft plastic surfaces may permanently change the appearance and feel of the interior and are not recommended. Do not use silicone or wax-based products, or those containing organic solvents to clean the vehicle's interior because they can alter the appearance by increasing the gloss in a non-uniform manner.

Some commercial products may increase gloss on the instrument panel. The increase in gloss may cause annoying reflections in the windshield and even make it difficult to see through the windshield under certain conditions.

Care of Safety Belts

Keep belts clean and dry.

WARNING

Do not bleach or dye safety belts. It may severely weaken them. In a crash, they might not be able to provide adequate protection. Clean safety belts only with mild soap and lukewarm water.

Service and Maintenance

General Information
 General Information10-1

Scheduled Maintenance
 Scheduled Maintenance10-2

Recommended Fluids, Lubricants, and Parts
 Recommended Fluids and Lubricants10-7
 Maintenance Replacement Parts10-9

Maintenance Records
 Maintenance Records10-10

General Information

Notice: Maintenance intervals, checks, inspections, recommended fluids, and lubricants are necessary to keep this vehicle in good working condition. Damage caused by failure to follow scheduled maintenance might not be covered by the vehicle warranty.

Proper vehicle maintenance helps to keep the vehicle in good working condition, improves fuel economy, and reduces vehicle emissions for better air quality.

Because of all the different ways people use vehicles, maintenance needs vary. The vehicle might need more frequent checks and services. Please read the information under Scheduled Maintenance. To keep the vehicle in good condition, see your dealer/retailer.

The maintenance schedule is for vehicles that:

- carry passengers and cargo within recommended limits on the Tire and Loading Information label. See *Vehicle Load Limits* on page 8-12.
- are driven on reasonable road surfaces within legal driving limits.
- use the recommended fuel. See *Recommended Fuel* on page 8-44.

WARNING

Performing maintenance work can be dangerous. Some jobs can cause serious injury. Perform maintenance work only if you have the required know-how and the proper tools and equipment. If in doubt, see your dealer/retailer to have a qualified technician do the work. See *Doing Your Own Service Work* on page 9-4.

10-2 Service and Maintenance

At your General Motors dealer/retailer, you can be certain that you will receive the highest level of service available. Your dealer/retailer has specially trained service technicians, uses genuine GM replacement parts, as well as, up to date tools and equipment to ensure fast and accurate diagnostics.

The proper replacement parts, fluids, and lubricants to use are listed in *Recommended Fluids and Lubricants on page 10-7* and *Maintenance Replacement Parts on page 10-9*. We recommend the use of genuine parts from your dealer/retailer.

Rotation of New Tires

Tire rotation is not recommended if the vehicle has different size tires on the front and rear wheels. If tire rotation is recommended for the vehicle, to maintain ride, handling, and performance of the vehicle, it is important that the first rotation service for new tires be performed when they have 8 000 to 13 000 km (5,000 to 8,000 miles). See *Tire Rotation on page 9-61*.

Scheduled Maintenance

When the Change Engine Oil Soon Message Displays

Change engine oil and filter. See *Engine Oil on page 9-10*.
An Emission Control Service.

When the Change Engine Oil Soon message displays, service is required for the vehicle as soon as possible, within the next 1 000 km/600 miles. If driving under the best conditions, the engine oil life system might not indicate the need for vehicle service for more than a year. The engine oil and filter must be changed at least once a year and the oil life system must be reset. Your dealer/retailer has trained service technicians who will perform this work and reset the system.

If the engine oil life system is reset accidentally, service the vehicle within 5 000 km/3,000 miles since the last service. Reset the oil life system whenever the oil is changed. See *Engine Oil Life System on page 9-13*.

When the Change Engine Oil Soon message displays, certain services, checks, and inspections are required. The services described for Maintenance I should be performed at every engine oil change. The services described for Maintenance II should be performed when:

- Maintenance I was performed the last time the engine oil was changed.
- It has been 10 months or more since the Change Engine Oil Soon message has displayed or since the last service.

Maintenance I

- Change engine oil and filter. See *Engine Oil on page 9-10. An Emission Control Service.*
- Engine coolant level check. See *Engine Coolant on page 9-19.*
- Windshield washer fluid level check. See *Washer Fluid on page 9-26.*
- Tire inflation check. See *Tire Pressure on page 9-54.*
- Tire wear inspection. See *Tire Inspection on page 9-61.*
- If tire rotation is recommended for the vehicle, rotate tires. See *Tire Rotation on page 9-61.*
- Fluids visual leak check (or every 12 months, whichever occurs first). A leak in any system must be repaired and the fluid level checked.

- Engine air cleaner filter inspection (vehicles driven in dusty conditions only). See *Engine Air Cleaner/Filter on page 9-16.*
- Brake system inspection (or every 12 months, whichever occurs first).

Maintenance II

- Perform all services described in Maintenance I.
- Steering and suspension inspection. Visual inspection for damaged, loose, or missing parts or signs of wear.
- Engine cooling system inspection. Visual inspection of hoses, pipes, fittings, and clamps and replacement, if needed.
- Windshield wiper blade inspection for wear, cracking, or contamination and windshield and wiper blade cleaning, if contaminated. See *Exterior Care on page 9-88. Worn or damaged wiper blade replacement. See Wiper Blade Replacement on page 9-33.*
- Body hinges and latches, key lock cylinders, folding seat hardware, and sunroof (if equipped) lubrication. See *Recommended Fluids and Lubricants on page 10-7.* More frequent lubrication may be required when vehicle is exposed to a corrosive environment. Applying silicone grease on weatherstrips with a clean cloth makes them last longer, seal better, and not stick or squeak.

10-4 Service and Maintenance

- Restraint system component check. See *Safety System Check* on page 2-20.
- Automatic transmission fluid level check and adding fluid, if needed. See *Automatic Transmission Fluid* on page 9-14.
- Rear axle fluid level check and adding fluid, if needed. See *Rear Axle* on page 9-30.
- Engine air cleaner filter inspection. See *Engine Air Cleaner/Filter* on page 9-16.
- Passenger compartment air filter replacement (or every 12 months, whichever occurs first). More frequent replacement may be required if vehicle is driven regularly under dusty conditions.

Additional Required Services

At Each Fuel Stop

- Engine oil level check. See *Engine Oil* on page 9-10.
- Engine coolant level check. See *Engine Coolant* on page 9-19.
- Windshield washer fluid level check. See *Washer Fluid* on page 9-26.

Once a Month

- Tire inflation check. See *Tire Pressure* on page 9-54.
- Tire wear inspection. See *Tire Inspection* on page 9-61.

Once a Year

- See *Starter Switch Check* on page 9-31.
- See *Automatic Transmission Shift Lock Control System Check* on page 9-32.
- See *Ignition Transmission Lock Check* on page 9-32.
- See *Park Brake and P (Park) Mechanism Check* on page 9-32.
- Engine cooling system and pressure cap pressure check. Radiator and air conditioning condenser outside cleaning. See *Cooling System* on page 9-17.
- If the vehicle has a Tire Sealant and Compressor Kit, check the sealant expiration date printed on the instruction label of the kit. See *Tire Sealant and Compressor Kit* on page 9-71.

First Engine Oil Change After Every 40 000 km/25,000 Miles

- Fuel system inspection for damage or leaks.
- Exhaust system inspection for loose or damaged components.

First Engine Oil Change After Every 80 000 km/50,000 Miles

- Engine air cleaner filter replacement. See *Engine Air Cleaner/Filter* on page 9-16.
- Automatic transmission fluid change (severe service) for vehicles mainly driven in heavy city traffic in hot weather, in hilly or mountainous terrain, when frequently towing a trailer, or used for taxi, police, or delivery service. See *Automatic Transmission Fluid* on page 9-14.

- Rear axle fluid change (severe service) for vehicles mainly driven in hilly or mountainous terrain, when frequently towing a trailer, used for high speed or competitive driving, or used for taxi, police, or delivery service. See *Rear Axle* on page 9-30.

First Engine Oil Change After Every 160 000 km/100,000 Miles

- Automatic transmission fluid change (normal service). See *Automatic Transmission Fluid* on page 9-14.
- Rear axle fluid change (normal service). See *Rear Axle* on page 9-30.
- Spark plug replacement. See *An Emission Control Service*.

First Engine Oil Change After Every 240 000 km/150,000 Miles

- Engine cooling system drain, flush, and refill, cooling system and cap pressure check, and cleaning of outside of radiator and air conditioning condenser (or every 5 years, whichever occurs first). See *Cooling System* on page 9-17. See *An Emission Control Service*.
- Engine accessory drive belt inspection for fraying, excessive cracks, or obvious damage and replacement, if needed. See *An Emission Control Service*.

10-6 Service and Maintenance

Service	Maintenance I	Maintenance II
Change engine oil and filter. Reset oil life system.	•	•
Engine coolant level check.	•	•
Windshield washer fluid level check.	•	•
Tire inflation pressures check.	•	•
Tire wear inspection.	•	•
If tire rotation is recommended for the vehicle, rotate tires.	•	•
Fluids visual leak check.	•	•
Engine air cleaner filter inspection (vehicles driven in dusty conditions only).	•	•
Brake system inspection.	•	•
Steering and suspension inspection.		•
Engine cooling system inspection.		•
Windshield wiper blades inspection.		•
Body components lubrication.		•
Restraint system components check.		•
Automatic transmission fluid level check.		•
Rear axle fluid level check.		•
Engine air cleaner filter inspection (vehicles not driven in dusty conditions).		•
Passenger compartment air filter replacement.		•

Recommended Fluids, Lubricants, and Parts

Recommended Fluids and Lubricants

Usage	Fluid/Lubricant
Engine Oil (V6 Engine)	Engine oil which meets GM Standard GM6094M and displays the American Petroleum Institute Certified for Gasoline Engines starburst symbol. To determine the proper viscosity for the vehicle's engine, see <i>Engine Oil on page 9-10</i> .
Engine Oil (V8 Engines)	The engine requires a special engine oil meeting GM Standard GM4718M. Oils meeting this standard can be identified with the American Petroleum Institute (API) Certified for Gasoline Engines starburst symbol. However, not all synthetic API oils with the starburst symbol will meet this GM standard. Look for and use only an oil that meets GM Standard GM4718M. For the proper viscosity, see <i>Engine Oil on page 9-10</i> .
Engine Coolant	50/50 mixture of clean, drinkable water and use only DEX-COOL [®] Coolant. See <i>Engine Coolant on page 9-19</i> .
Hydraulic Brake System	Hydraulic Brake Fluid (GM Part No. U.S. 88862806, in Canada 88862807).
Hydraulic Clutch System	Hydraulic Brake Fluid (GM Part No. U.S. 88862806, in Canada 88862807).
Windshield Washer	Optikleen [®] Washer Solvent.
Hydraulic Power Steering System	DEXRON [®] -VI Automatic Transmission Fluid.
Parking Brake Cable Guides	Chassis Lubricant (GM Part No. 12377985, in Canada 88901242) or lubricant meeting requirements of NLGI #2, Category LB or GC-LB.
Automatic Transmission	DEXRON [®] -VI Automatic Transmission Fluid.
Manual Transmission (V6 Engine)	SAE 75W-90 GL5 Gear Oil (GM Part No. U.S. 88862475, in Canada 88862476).

10-8 Service and Maintenance

Usage	Fluid/Lubricant
Manual Transmission (V8 Engine)	Manual Transmission Fluid (GM Part No. U.S. 88861800, in Canada 88861801).
Rear Axle (V6 Engine with Automatic Transmission)	Rear Differential Fluid 75W-90 to GM Specification 9986155. GM Part No. U.S. 89021677, in Canada 89021678.
Rear Axle (V6 Engine with Manual Transmission)	Rear Differential Fluid 75W-90 Limited Slip to GM Specification 9986226. GM Part No. U.S. 89021677 and Friction Modifier 1052358, in Canada 89021678 and Friction Modifier 992694.
Rear Axle (V8 Engine)	Rear Differential Fluid 75W-90 Limited Slip to GM Specification 9986226. GM Part No. U.S. 89021677 and Friction Modifier 1052358, in Canada 89021678 and Friction Modifier 992694.
Key Lock Cylinders	Multi-Purpose Lubricant, Superlube (GM Part No. U.S. 12346241, in Canada 10953474).
Hood Latch Assembly, Secondary Latch, Pivots, Spring Anchor, and Release Pawl	Lubriplate Lubricant Aerosol (GM Part No. U.S. 12346293, in Canada 992723) or lubricant meeting requirements of NLGI #2, Category LB or GC-LB.
Hood, Door, and Folding Seat Hinges	Multi-Purpose Lubricant, Superlube (GM Part No. U.S. 12346241, in Canada 10953474).
Weatherstrip Conditioning	Weatherstrip Lubricant (GM Part No. U.S. 3634770, in Canada 10953518) or Dielectric Silicone Grease (GM Part No. U.S. 12345579, in Canada 992887).

Maintenance Replacement Parts

Replacement parts identified below by name, part number, or specification can be obtained from your retailer.

Part	GM Part Number	ACDelco Part Number
Engine Air Cleaner/Filter	92196275	A3137C
Engine Oil Filter		
3.6L V6	12593333	PF459G
6.2L V8	89017524	PF48
Passenger Compartment Air Filter Element	92220249	—
Spark Plugs		
3.6L V6	12597464	41-990
6.2L V8	12621258	41-110
Wiper Blades		
Driver Side	92231676	—
Passenger Side	92231677	—

Technical Data

Vehicle Identification

Vehicle Identification	
Number (VIN)	11-1
Service Parts	
Identification Label	11-1

Vehicle Data

Capacities and	
Specifications	11-2
Engine Drive Belt Routing	11-4

Vehicle Identification

Vehicle Identification Number (VIN)



This is the legal identifier for the vehicle. It appears on a plate in the front corner of the instrument panel, on the left side of the vehicle. It can be seen through the windshield from outside the vehicle. The VIN also appears on the Vehicle Certification and Service Parts labels and the certificates of title and registration.

Engine Identification

The eighth character in the VIN is the engine code. This code helps identify the vehicle's engine, specifications, and replacement parts. See "Engine Specifications" under *Capacities and Specifications* on page 11-2 for the vehicle's engine code.

Service Parts Identification Label

This label is in the trunk. It is very helpful if parts need to be ordered. The label has the following information:

- Vehicle Identification Number (VIN)
- Model designation
- Paint information
- Production options and special equipment

Do not remove this label from the vehicle.

11-2 Technical Data

Vehicle Data

Capacities and Specifications

Application	Capacities	
	Metric	English
Air Conditioning Refrigerant R134a	For the air conditioning system refrigerant charge amount, see the refrigerant caution label located under the hood. See your dealer/retailer for more information.	
Engine Cooling System		
3.6L V6 Engine Automatic Transmission	10.2 L	10.8 qt
3.6L V6 Engine Manual Transmission	10.6 L	11.2 qt
6.2L V8 Engine (L99) Automatic Transmission	10.8 L	11.4 qt
6.2L V8 Engine (LS3) Manual Transmission	11.2 L	11.8 qt
Engine Oil with Filter		
3.6L V6 Engine	5.7 L	6.0 qt
6.2L V8 Engine (L99)	7.6 L	8.0 qt
6.2L V8 Engine (LS3)	7.6 L	8.0 qt
Fuel Tank	71.0 L	18.8 gal
Rear Axle Fluid		
V6 Engine 6-Speed Automatic	0.9 L	1.0 qt
V6 Engine 6-Speed Manual*	0.9 L	1.0 qt
V8 Engine*	0.9 L	1.0 qt

Application	Capacities	
	Metric	English
Transmission Fluid (Pan Removal and Filter Replacement)		
V6 Engine 6-Speed Automatic**	6.3 L	6.7 qt
V8 Engine 6-Speed Automatic**	6.3 L	6.7 qt
V6 Engine 6-Speed Manual	1.8 L	1.9 qt
V8 Engine 6-Speed Manual	3.9 L	4.2 qt
Wheel Nut Torque	190 N•m	140 ft lb
*Add 2.5 oz. (75 mL) of friction modifier to the specified quantity of axle lubricant.		
**See <i>Automatic Transmission Fluid</i> on page 9-14 for information on checking fluid level.		
All capacities are approximate. When adding, be sure to fill to the approximate level, as recommended in this manual. Recheck fluid level after filling.		

Engine Specifications

Engine	VIN Code	Transmission	Spark Plug Gap
3.6L V6 (LLT)	V	Automatic Manual	1.1 mm (0.043 in)
6.2L V8 (L99)	J	Automatic	1.0 mm (0.040 in)
6.2L V8 (LS3)	W	Manual	1.0 mm (0.040 in)

**Engine Drive Belt
Routing**

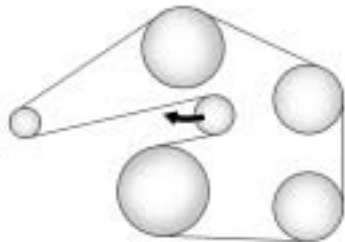

3.6L V6 Engine

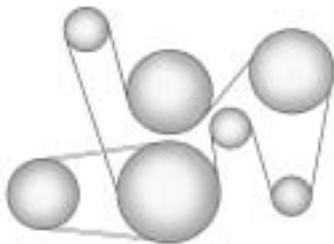

6.2L V8 Engines

Customer Information

Customer Information

- Customer Satisfaction Procedure12-1
- Customer Assistance Offices12-3
- Customer Assistance for Text Telephone (TTY) Users12-4
- Online Owner Center12-4
- GM Mobility Reimbursement Program12-5
- Roadside Assistance Program12-6
- Scheduling Service Appointments12-8
- Courtesy Transportation Program12-8
- Collision Damage Repair12-9
- Service Publications Ordering Information12-12

Reporting Safety Defects

- Reporting Safety Defects to the United States Government12-13
- Reporting Safety Defects to the Canadian Government12-13
- Reporting Safety Defects to General Motors12-13

Vehicle Data Recording and Privacy

- Vehicle Data Recording and Privacy12-14
- Event Data Recorders12-14
- OnStar®12-15
- Radio Frequency Identification (RFID)12-15
- Radio Frequency Statement (US, Can)12-15

Customer Information

Customer Satisfaction Procedure

Your satisfaction and goodwill are important to your dealer and to Chevrolet. Normally, any concerns with the sales transaction or the operation of the vehicle will be resolved by the dealer's sales or service departments. Sometimes, however, despite the best intentions of all concerned, misunderstandings can occur. If your concern has not been resolved to your satisfaction, the following steps should be taken:

STEP ONE: Discuss your concern with a member of dealership management. Normally, concerns can be quickly resolved at that level. If the matter has already been reviewed with the sales, service, or parts manager, contact the owner of the dealership or the general manager.

12-2 Customer Information

STEP TWO: If after contacting a member of dealership management, it appears your concern cannot be resolved by the dealership without further help, in the U.S., call the Chevrolet Customer Assistance Center at 1-800-222-1020. In Canada, call General Motors of Canada Customer Communication Centre at 1-800-263-3777 (English), or 1-800-263-7854 (French).

We encourage you to call the toll-free number in order to give your inquiry prompt attention. Have the following information available to give the Customer Assistance Representative:

- Vehicle Identification Number (VIN). This is available from the vehicle registration or title, or the plate at the top left of the instrument panel and visible through the windshield.
- Dealership name and location.
- Vehicle delivery date and present mileage.

When contacting Chevrolet, remember that your concern will likely be resolved at a dealer's facility. That is why we suggest following Step One first.

STEP THREE — U.S. Owners:

Both General Motors and your dealer are committed to making sure you are completely satisfied with your new vehicle. However, if you continue to remain unsatisfied after following the procedure outlined in Steps One and Two, you can file with the Better Business Bureau (BBB) Auto Line Program to enforce your rights.

The BBB Auto Line Program is an out of court program administered by the Council of Better Business Bureaus to settle automotive disputes regarding vehicle repairs or the interpretation of the New Vehicle Limited Warranty. Although you may be required to resort to this informal dispute resolution program prior to filing a court action, use of the program is free of

charge and your case will generally be heard within 40 days. If you do not agree with the decision given in your case, you may reject it and proceed with any other venue for relief available to you.

You may contact the BBB Auto Line Program using the toll-free telephone number or write them at the following address:

BBB Auto Line Program
Council of Better Business
Bureaus, Inc.
4200 Wilson Boulevard
Suite 800
Arlington, VA 22203-1838

Telephone: 1-800-955-5100
www.dr.bbb.org/goauto

This program is available in all 50 states and the District of Columbia. Eligibility is limited by vehicle age, mileage, and other factors. General Motors reserves the right to change eligibility limitations and/or discontinue its participation in this program.

STEP THREE — Canadian

Owners: In the event that you do not feel your concerns have been addressed after following the procedure outlined in Steps 1 and 2, General Motors of Canada Limited wants you to be aware of its participation in a no-charge Mediation/Arbitration Program. General Motors of Canada Limited has committed to binding arbitration of owner disputes involving factory-related vehicle service claims. The program provides for the review of the facts involved by an impartial third party arbiter, and may include an informal hearing before the arbiter. The program is designed so that the entire dispute settlement process, from the time you file your complaint to the final decision, should be completed in about 70 days. We believe our impartial program offers advantages over courts in most jurisdictions because it is informal, quick, and free of charge.

For further information concerning eligibility in the Canadian Motor Vehicle Arbitration Plan (CAMVAP), call toll-free 1-800-207-0685, or call the General Motors Customer Communication Centre, 1-800-263-3777 (English), 1-800-263-7854 (French), or write to:

The Mediation/Arbitration Program
c/o Customer Communication
Centre
General Motors of Canada Limited
Mail Code: CA1-163-005
1908 Colonel Sam Drive
Oshawa, Ontario L1H 8P7

Your inquiry should be accompanied by the Vehicle Identification Number (VIN).

Customer Assistance Offices

Chevrolet encourages customers to call the toll-free number for assistance. However, if a customer wishes to write or e-mail Chevrolet, the letter should be addressed to:

United States — Customer Assistance

Chevrolet Motor Division
Chevrolet Customer Assistance
Center
P.O. Box 33170
Detroit, MI 48232-5170

Chevrolet.com
1-800-222-1020
1-800-833-2438 (For Text
Telephone devices (TTYs))
Roadside Assistance:
1-800-CHEV-USA (243-8872)

From Puerto Rico:
1-800-496-9992 (English)
1-800-496-9993 (Spanish)

From U.S. Virgin Islands:
1-800-496-9994

12-4 Customer Information

Canada — Customer Assistance

General Motors of Canada Limited
Customer Communication Centre,
CA1-163-005

1908 Colonel Sam Drive
Oshawa, Ontario L1H 8P7

gmcanada.com

1-800-263-3777 (English)

1-800-263-7854 (French)

1-800-263-3830 (For Text
Telephone devices (TTYs))

Roadside Assistance:

1-800-268-6800

Overseas — Customer Assistance

Please contact the local General
Motors Business Unit.

Mexico, Central America and Caribbean Islands/ Countries (Except Puerto Rico and U.S. Virgin Islands) — Customer Assistance

General Motors de Mexico,
S. de R.L. de C.V.

Customer Assistance Center
Paseo de la Reforma # 2740

Col. Lomas de Bezares

C.P. 11910, Mexico, D.F.

01-800-508-0000

Long Distance: 011-52-53 29 0 800

Customer Assistance for Text Telephone (TTY) Users

To assist customers who are deaf,
hard of hearing, or speech-impaired
and who use Text Telephones
(TTYs), Chevrolet has TTY
equipment available at its Customer
Assistance Center. Any TTY user
in the U.S. can communicate
with Chevrolet by dialing:
1-800-833-CHEV (2438). (TTY users
in Canada can dial 1-800-263-3830.)

Online Owner Center

Online Owner Center (U.S.) —
[www.gmownercenter.com/](http://www.gmownercenter.com/chevrolet)
chevrolet

Information and services customized
for your specific vehicle — all in
one convenient place.

- Digital owner manual, warranty information, and more
- Online service and maintenance records

- Find Chevrolet dealers for service nationwide
- Exclusive privileges and offers
- Recall notices for your specific vehicle
- OnStar® and GM Cardmember Services Earnings summaries

Other Helpful Links:

Chevrolet – www.chevrolet.com

Chevrolet Merchandise —
www.chevymall.com

Help Center —
www.chevrolet.com/helpcenter

- FAQ
- Contact Us

My GM Canada (Canada) — www.gm.ca

My GM Canada is a password-protected section of www.gm.ca where you can save information on GM vehicles, get personalized offers, and use handy tools and forms with greater ease.

Here are a few of the valuable tools and services you will have access to:

- My Showroom: Find and save information on vehicles and current offers in your area.
- My Dealers/Retailers: Save details such as address and phone number for each of your preferred GM dealers/retailers.
- My Driveway: Access quick links to parts and service estimates, check trade-in values, or schedule a service appointment by adding the vehicles you own to your driveway profile.
- My Preferences: Manage your profile and use tools and forms with greater ease.

To sign up, visit the My GM Canada section within www.gm.ca.

GM Mobility Reimbursement Program



This program, available to qualified applicants, can reimburse you up to \$1,000 of the cost of eligible aftermarket adaptive equipment required for your vehicle, such as hand controls or a wheelchair/scooter lift.

The offer is available for a very limited period of time from the date of vehicle purchase/lease. For more details, or to determine your vehicle's eligibility, visit gmmobility.com or call the GM Mobility Assistance Center at 1-800-323-9935. Text telephone (TTY) users, call 1-800-833-9935.

12-6 Customer Information

General Motors of Canada also has a Mobility Program. Call 1-800-GM-DRIVE (463-7483) for details. TTY users call 1-800-263-3830.

Roadside Assistance Program

For U.S. purchased vehicles, call **1-800-CHEV-USA (1-800-243-8872)**; (Text telephone (TTY): **1-888-889-2438**).

For Canadian purchased vehicles, call **1-800-268-6800**.

Service is available 24 hours a day, 365 days a year.

Calling for Assistance

When calling Roadside Assistance, have the following information ready:

- Your name, home address, and home telephone number
- Telephone number of your location
- Location of the vehicle

- Model, year, color, and license plate number of the vehicle
- Odometer reading, Vehicle Identification Number (VIN), and delivery date of the vehicle
- Description of the problem

Coverage

Services are provided up to 5 years/100,000 miles (160 000 km), whichever comes first.

In the U.S., anyone driving the vehicle is covered. In Canada, a person driving the vehicle without permission from the owner is not covered.

Roadside Assistance is not a part of the New Vehicle Limited Warranty. Chevrolet and General Motors of Canada Limited reserve the right to make any changes or discontinue the Roadside Assistance program at any time without notification.

Chevrolet and General Motors of Canada Limited reserve the right to limit services or payment to an

owner or driver if they decide the claims are made too often, or the same type of claim is made many times.

Services Provided

- **Emergency Fuel Delivery:** Delivery of enough fuel for the vehicle to get to the nearest service station.
- **Lock-Out Service:** Service is provided to unlock the vehicle if you are locked out. A remote unlock may be available if you have OnStar®. For security reasons, the driver must present identification before this service is given.
- **Emergency Tow From a Public Road or Highway:** Tow to the nearest Chevrolet dealer for warranty service, or if the vehicle was in a crash and cannot be driven. Assistance is also given when the vehicle is stuck in the sand, mud, or snow.

- **Flat Tire Change:** Service is provided to change a flat tire with the spare tire. The spare tire, if equipped, must be in good condition and properly inflated. It is the owner's responsibility for the repair or replacement of the tire if it is not covered by the warranty.
- **Battery Jump Start:** Service is provided to jump start a dead battery.

Services Not Included in Roadside Assistance

- Impound towing caused by violation of any laws.
- Legal fines.
- Mounting, dismounting or changing of snow tires, chains, or other traction devices.
- Towing or services for vehicles driven on a non-public road or highway.

Services Specific to Canadian Purchased Vehicles

- **Fuel delivery:** Reimbursement is approximately \$5 Canadian. Diesel fuel delivery may be restricted. Propane and other fuels are not provided through this service.
- **Lock-Out Service:** Vehicle registration is required.
- **Trip Routing Service:** Detailed maps of North America are provided when requested either with the most direct route or the most scenic route. There is a limit of six requests per year. Additional travel information is also available. Allow three weeks for delivery.
- **Trip Interruption Benefits and Assistance:** Must be over 250 kilometres from where your trip was started to qualify. General Motors of Canada Limited requires pre-authorization, original

detailed receipts, and a copy of the repair orders. Once authorization has been received, the Roadside Assistance advisor will help you make arrangements and explain how to receive payment.

- **Alternative Service:** If assistance cannot be provided right away, the Roadside Assistance advisor may give you permission to get local emergency road service. You will receive payment, up to \$100, after sending the original receipt to Roadside Assistance. Mechanical failures may be covered, however any cost for parts and labor for repairs not covered by the warranty are the owner responsibility.

Scheduling Service Appointments

When your vehicle requires warranty service, contact your dealer/retailer and request an appointment. By scheduling a service appointment and advising your service consultant of your transportation needs, your dealer/retailer can help minimize your inconvenience.

If your vehicle cannot be scheduled into the service department immediately, keep driving it until it can be scheduled for service, unless, of course, the problem is safety-related. If it is, please call your dealership/retailer, let them know this, and ask for instructions.

If the dealer/retailer requests you to bring the vehicle for service, you are urged to do so as early in the work day as possible to allow for the same day repair.

Courtesy Transportation Program

To enhance your ownership experience, we and our participating dealers are proud to offer Courtesy Transportation, a customer support program for vehicles with the Bumper to Bumper (Base Warranty Coverage period in Canada) and extended powertrain, and hybrid specific warranty in both the U.S. and Canada.

Several courtesy transportation options are available to assist in reducing your inconvenience when warranty repairs are required.

Courtesy Transportation is not a part of the New Vehicle Limited Warranty. A separate booklet entitled "Warranty and Owner Assistance Information" furnished with each new vehicle provides detailed warranty coverage information.

Transportation Options

Warranty service can generally be completed while you wait. However, if you are unable to wait, GM helps to minimize your inconvenience by providing several transportation options. Depending on the circumstances, your dealer can offer you one of the following:

Shuttle Service

Shuttle service is the preferred means of offering Courtesy Transportation. Dealers may provide you with shuttle service to get you to your destination with minimal interruption of your daily schedule. This includes one-way or round trip shuttle service within reasonable time and distance parameters of the dealer's area.

Public Transportation or Fuel Reimbursement

If your vehicle requires overnight warranty repairs, and public transportation is used instead of the dealer's shuttle service, the expense must be supported by original receipts and can only be up to the maximum amount allowed by GM for shuttle service. In addition, for U.S. customers, should you arrange transportation through a friend or relative, limited reimbursement for reasonable fuel expenses may be available. Claim amounts should reflect actual costs and be supported by original receipts. See your dealer for information regarding the allowance amounts for reimbursement of fuel or other transportation costs.

Courtesy Rental Vehicle

Your dealer may arrange to provide you with a courtesy rental vehicle or reimburse you for a rental vehicle that you obtain if your vehicle is kept for an overnight warranty repair.

Rental reimbursement will be limited and must be supported by original receipts. This requires that you sign and complete a rental agreement and meet state/provincial, local, and rental vehicle provider requirements. Requirements vary and may include minimum age requirements, insurance coverage, credit card, etc. You are responsible for fuel usage charges and may also be responsible for taxes, levies, usage fees, excessive mileage, or rental usage beyond the completion of the repair.

It may not be possible to provide a like-vehicle as a courtesy rental.

Additional Program Information

All program options, such as shuttle service, may not be available at every dealer. Please contact your dealer for specific information about availability. All Courtesy Transportation arrangements will be administered by appropriate dealer personnel.

General Motors reserves the right to unilaterally modify, change or discontinue Courtesy Transportation at any time and to resolve all questions of claim eligibility pursuant to the terms and conditions described herein at its sole discretion.

Collision Damage Repair

If your vehicle is involved in a collision and it is damaged, have the damage repaired by a qualified technician using the proper equipment and quality replacement parts. Poorly performed collision repairs diminish your vehicle's resale value, and safety performance can be compromised in subsequent collisions.

Collision Parts

Genuine GM Collision parts are new parts made with the same materials and construction methods as the parts with which your vehicle was originally built. Genuine GM Collision parts are your best choice

12-10 Customer Information

to ensure that your vehicle's designed appearance, durability, and safety are preserved. The use of Genuine GM parts can help maintain your GM New Vehicle Warranty.

Recycled original equipment parts may also be used for repair. These parts are typically removed from vehicles that were total losses in prior crashes. In most cases, the parts being recycled are from undamaged sections of the vehicle. A recycled original equipment GM part, may be an acceptable choice to maintain your vehicle's originally designed appearance and safety performance, however, the history of these parts is not known. Such parts are not covered by your GM New Vehicle Limited Warranty, and any related failures are not covered by that warranty.

Aftermarket collision parts are also available. These are made by companies other than GM and may not have been tested for your

vehicle. As a result, these parts may fit poorly, exhibit premature durability/corrosion problems, and may not perform properly in subsequent collisions. Aftermarket parts are not covered by your GM New Vehicle Limited Warranty, and any vehicle failure related to such parts are not covered by that warranty.

Repair Facility

We recommend that you choose a collision repair facility that meets your needs before you ever need collision repairs. Your dealer/retailer may have a collision repair center with GM-trained technicians and state of the art equipment, or be able to recommend a collision repair center that has GM-trained technicians and comparable equipment.

Insuring Your Vehicle

Protect your investment in your GM vehicle with comprehensive and collision insurance coverage. There

are significant differences in the quality of coverage afforded by various insurance policy terms. Many insurance policies provide reduced protection to your GM vehicle by limiting compensation for damage repairs by using aftermarket collision parts. Some insurance companies will not specify aftermarket collision parts. When purchasing insurance, we recommend that you assure your vehicle will be repaired with GM original equipment collision parts. If such insurance coverage is not available from your current insurance carrier, consider switching to another insurance carrier.

If your vehicle is leased, the leasing company may require you to have insurance that assures repairs with Genuine GM Original Equipment Manufacturer (OEM) parts or Genuine Manufacturer replacement parts. Read your lease carefully, as you may be charged at the end of your lease for poor quality repairs.

If a Crash Occurs

If there has been an injury, call emergency services for help. Do not leave the scene of a crash until all matters have been taken care of. Move the vehicle only if its position puts you in danger, or you are instructed to move it by a police officer.

Give only the necessary information to police and other parties involved in the crash.

For emergency towing see *Roadside Assistance Program* on page 12-6.

Gather the following information:

- Driver's name, address, phone number
- Driver's license number
- Owner's name, address, phone number
- Vehicle license plate
- Vehicle make, model and model year

- Vehicle Identification Number (VIN)
- Insurance company and policy number
- General description of the damage to the other vehicle

Choose a reputable repair facility that uses quality replacement parts. See "Collision Parts" earlier in this section.

If the airbag has inflated, see *What Will You See After an Airbag Inflates?* on page 2-27.

Managing the Vehicle Damage Repair Process

In the event that your vehicle requires damage repairs, GM recommends that you take an active role in its repair. If you have a pre-determined repair facility of choice, take your vehicle there, or have it towed there. Specify to the facility that any required replacement collision parts be original equipment parts, either new

Genuine GM parts or recycled original GM parts. Remember, recycled parts will not be covered by your GM vehicle warranty.

Insurance pays the bill for the repair, but you must live with the repair. Depending on your policy limits, your insurance company may initially value the repair using aftermarket parts. Discuss this with your repair professional, and insist on Genuine GM parts. Remember if your vehicle is leased you may be obligated to have the vehicle repaired with Genuine GM parts, even if your insurance coverage does not pay the full cost.

If another party's insurance company is paying for the repairs, you are not obligated to accept a repair valuation based on that insurance company's collision policy repair limits, as you have no contractual limits with that company. In such cases, you can have control of the repair and parts choices as long as cost stays within reasonable limits.

Service Publications Ordering Information

Service Manuals

Service Manuals have the diagnosis and repair information on engines, transmission, axle suspension, brakes, electrical, steering, body, etc.

Service Bulletins

Service Bulletins give additional technical service information needed to knowledgeable service General Motors cars and trucks. Each bulletin contains instructions to assist in the diagnosis and service of your vehicle.

Owner Information

Owner publications are written specifically for owners and intended to provide basic operational information about the vehicle. The owner manual includes the Maintenance Schedule for all models.

In-Portfolio: Includes a Portfolio, Owner Manual, and Warranty Booklet.

RETAIL SELL PRICE:
\$35.00 (U.S.) plus processing fee

Without Portfolio: Owner Manual only.

RETAIL SELL PRICE:
\$25.00 (U.S.) plus processing fee

Current and Past Model Order Forms

Technical Service Bulletins and Manuals are available for current and past model GM vehicles. To request an order form, specify year and model name of the vehicle.

ORDER TOLL FREE:
1-800-551-4123 Monday-Friday
8:00 AM - 6:00 PM Eastern Time

For Credit Card Orders Only (VISA-MasterCard-Discover), visit Helm, Inc. on the World Wide Web at: helminc.com

Or you can write to:

Helm, Incorporated
P.O. Box 07130
Detroit, MI 48207

Prices are subject to change without notice and without incurring obligation. Allow ample time for delivery.

Note to Canadian Customers: All listed prices are quoted in U.S. funds. Canadian residents are to make checks payable in U.S. funds.

Reporting Safety Defects

Reporting Safety Defects to the United States Government

If you believe that your vehicle has a defect which could cause a crash or could cause injury or death, you should immediately inform the National Highway Traffic Safety Administration (NHTSA) in addition to notifying General Motors.

If NHTSA receives similar complaints, it may open an investigation, and if it finds that a safety defect exists in a group of vehicles, it may order a recall and remedy campaign. However, NHTSA cannot become involved in individual problems between you, your dealer/retailer, or General Motors.

To contact NHTSA, you may call the Vehicle Safety Hotline toll-free at 1-888-327-4236 (TTY: 1-800-424-9153); go to safercar.gov; or write to:

Administrator, NHTSA
1200 New Jersey Avenue, S.E.
Washington D.C., 20590

You can also obtain other information about motor vehicle safety from safercar.gov.

Reporting Safety Defects to the Canadian Government

If you live in Canada, and you believe that your vehicle has a safety defect, notify Transport Canada immediately, in addition to notifying General Motors of Canada Limited. Call them at 1-800-333-0510 or write to:

Transport Canada
Road Safety Branch
2780 Sheffield Road
Ottawa, Ontario K1B 3V9

Reporting Safety Defects to General Motors

In addition to notifying NHTSA (or Transport Canada) in a situation like this, please notify General Motors.

Call 1-800-222-1020, or write:

Chevrolet Motor Division
Chevrolet Customer
Assistance Center
P.O. Box 33170
Detroit, MI 48232-5170

In Canada, call 1-800-263-3777 (English) or 1-800-263-7854 (French), or write:

General Motors of Canada Limited
Customer Communication Centre,
CA1-163-005
1908 Colonel Sam Drive
Oshawa, Ontario L1H 8P7

Vehicle Data Recording and Privacy

Your GM vehicle has a number of sophisticated computers that record information about the vehicle's performance and how it is driven. For example, your vehicle uses computer modules to monitor and control engine and transmission performance, to monitor the conditions for airbag deployment and deploy airbags in a crash and, if so equipped, to provide antilock braking to help the driver control the vehicle. These modules may store data to help your dealer/retailer technician service your vehicle. Some modules may also store data about how you operate the vehicle, such as rate of fuel consumption or average speed. These modules may also retain the owner's personal preferences, such as radio pre-sets, seat positions, and temperature settings.

Event Data Recorders

This vehicle has an Event Data Recorder (EDR). The main purpose of an EDR is to record, in certain crash or near crash-like situations, such as an airbag deployment or hitting a road obstacle, data that will assist in understanding how a vehicle's systems performed. The EDR is designed to record data related to vehicle dynamics and safety systems for a short period of time, typically 30 seconds or less. The EDR in this vehicle is designed to record such data as:

- How various systems in your vehicle were operating
- Whether or not the driver and passenger safety belts were buckled/fastened
- How far, if at all, the driver was pressing the accelerator and/or brake pedal
- How fast the vehicle was traveling

This data can help provide a better understanding of the circumstances in which crashes and injuries occur.

Important: EDR data is recorded by your vehicle only if a non-trivial crash situation occurs; no data is recorded by the EDR under normal driving conditions and no personal data (e.g., name, gender, age, and crash location) is recorded. However, other parties, such as law enforcement, could combine the EDR data with the type of personally identifying data routinely acquired during a crash investigation.

To read data recorded by an EDR, special equipment is required, and access to the vehicle or the EDR is needed. In addition to the vehicle manufacturer, other parties, such as law enforcement, that have the special equipment, can read the information if they have access to the vehicle or the EDR.

GM will not access this data or share it with others except: with the consent of the vehicle owner or, if the vehicle is leased, with the consent of the lessee; in response to an official request of police or similar government office; as part of GM's defense of litigation through the discovery process; or, as required by law. Data that GM collects or receives may also be used for GM research needs or may be made available to others for research purposes, where a need is shown and the data is not tied to a specific vehicle or vehicle owner.

OnStar®

If your vehicle has OnStar and you subscribe to the OnStar services, please refer to the OnStar Terms and Conditions for information on data collection and use. See also *OnStar® System* on page 4-42 in this manual for more information.

Radio Frequency Identification (RFID)

RFID technology is used in some vehicles for functions such as tire pressure monitoring and ignition system security, as well as in connection with conveniences such as key fobs for remote door locking/unlocking and starting, and in-vehicle transmitters for garage door openers. RFID technology in GM vehicles does not use or record personal information or link with any other GM system containing personal information.

Radio Frequency Statement (US, Can)

This vehicle has systems that operate on a radio frequency that comply with Part 15 of the Federal Communications Commission (FCC) Rules and with RSS-210/211 of Industry and Science Canada.

Operation is subject to the following two conditions:

1. The device may not cause interference.
2. The device must accept any interference received, including interference that may cause undesired operation of the device.

Changes or modifications to any of these systems by other than an authorized service facility could void authorization to use this equipment.

A

Accessories and
Modifications 9-3

Accessory Power 8-19

Active Fuel Management™ 8-25

Adding Equipment to the
Airbag-Equipped Vehicle 2-33

Add-On Electrical
Equipment 8-55

Air Cleaner/Filter, Engine 9-16

Air Vents 7-3

Airbag System
Check 2-34

How Does an Airbag
Restrain? 2-27

Passenger Sensing
System 2-28

What Makes an Airbag
Inflate? 2-26

What Will You See After
an Airbag Inflates? 2-27

When Should an Airbag
Inflate? 2-25

Where Are the Airbags? 2-23

Airbag System (cont.)

Airbags
Adding Equipment to the
Vehicle 2-33

Passenger Status
Indicator 4-18

Readiness Light 4-17

Servicing Airbag-Equipped
Vehicles 2-32

System Check 2-21

Alarm System
Anti-Theft 1-10

AM-FM Radio 6-8

Antenna
Satellite Radio 6-14

Antilock Brake
System (ABS) 8-31

Warning Light 4-23

Anti-Theft
Alarm System 1-10

Alarm System Messages 4-35

Appearance Care
Exterior 9-88

Interior 9-92

Assistance Program,
Roadside 12-6

Audio Players 6-14

CD 6-14

Audio System
Backglass Antenna 6-13

Radio Reception 6-13

Theft-Deterrent Feature 6-2

Automatic
Dimming Mirrors 1-12

Headlamp System 5-3

Automatic Transmission 8-26

Fluid 9-14

Manual Mode 8-29

Shiftlock Control System
Check 9-32

Auxiliary Devices 6-16

Axle, Rear 9-30

B

Battery 9-29

Jump Starting 9-84

Load Management 5-6

Power Protection 5-7

Voltage and Charging
Messages 4-30

Blade Replacement, Wiper 9-33

Bluetooth	6-22, 6-23, 6-26
Brakes	9-27
Antilock	8-31
Assist	8-33
Fluid	9-28
Parking	8-32
System Messages	4-31
Braking	8-4
Break-In, New Vehicle	8-16
Bulb Replacement	9-41
Fog Lamps	9-40
Halogen Bulbs	9-37
Headlamp Aiming	9-34
Headlamps	9-37
Headlamps, Front Turn Signal and Parking Lamps	9-37, 9-38
High Intensity Discharge (HID) Lighting	9-37
License Plate Lamps	9-40
Taillamps, Turn Signal and Stoplamps	9-40
Buying New Tires	9-63

C

Calibration	4-8
California	
Fuel Requirements	8-45
Perchlorate Materials Requirements	9-3
Warning	9-2
Canadian Vehicle Owners	iii
Capacities and Specifications	11-2
Carbon Monoxide	
Engine Exhaust	8-25
Trunk	1-8
Winter Driving	8-10
Cautions, Danger, and Warnings	iv
CD Player	6-14
Center Console Storage	3-1
Chains, Tire	9-68
Charging System Light	4-19
Check	
Engine Lamp	4-19
Ignition Transmission Lock	9-32

Check (cont.)	
Child Restraints	
Infants and Young Children	2-37
Lower Anchors and Tethers for Children	2-43
Older Children	2-35
Securing	2-48, 2-50
Systems	2-39
Where to Put the Restraint	2-41
Circuit Breakers	9-42
Cleaning	
Exterior Care	9-88
Interior Care	9-92
Climate Control Systems	7-1
Clock	4-8
Cluster, IP	4-10
Clutch, Hydraulic	9-15
Collision Damage Repair	12-9
Compact Spare Tire	9-83
Compass	4-8
Compass Messages	4-31
Competitive Driving	8-7
Competitive Driving Mode	8-37

Compressor Kit, Tire
 Sealant 9-71
 Control of a Vehicle 8-3
 Convenience Net 3-1
 Convex Mirrors 1-12
 Coolant
 Engine 9-19
 Engine Temperature Gage ... 4-14
 Cooling System 9-17
 Engine Messages 4-32
 Courtesy Transportation
 Program 12-8
 Covers
 Engine 9-9
 Cruise Control 8-38
 Light 4-26
 Messages 4-31
 Customer Assistance 12-4
 Offices 12-3
 Text Telephone (TTY)
 Users 12-4
 Customer Information
 Service Publications
 Ordering Information 12-12
 Customer Satisfaction
 Procedure 12-1

D

Damage Repair, Collision 12-9
 Danger, Warnings, and
 Cautions iv
 Data Recorders, Event 12-14
 Daytime Running
 Lamps (DRL) 5-3, 9-39
 Defensive Driving 8-2
 Devices, Auxiliary 6-16
 Dome Lamps 5-6
 Door
 Ajar Messages 4-31
 Locks 1-6
 Power Locks 1-7
 Driver Information
 Center (DIC) 4-27
 Driving
 Better Fuel Economy 8-2
 Characteristics and
 Towing Tips 8-49
 Competitive 8-7, 8-37
 Defensive 8-2
 Drunk 8-3
 Highway Hypnosis 8-9
 Hill and Mountain Roads 8-9
 If the Vehicle is Stuck 8-11

Driving (cont.)
 Loss of Control 8-6
 Off-Road Recovery 8-6
 Vehicle Load Limits 8-12
 Winter 8-10

E

Electrical Equipment,
 Add-On 8-55
 Electrical System
 Engine Compartment
 Fuse Block 9-42
 Fuses and Circuit
 Breakers 9-42
 Instrument Panel Fuse
 Block 9-45
 Overload 9-41
 Rear Compartment
 Fuse Block 9-46
 Engine
 Air Cleaner/Filter 9-16
 Check and Service Engine
 Soon Lamp 4-19
 Compartment Overview 9-6
 Coolant 9-19

Engine (cont.)

Coolant	
Temperature Gage	4-14
Cooling System	9-17
Cooling System	
Messages	4-32
Cover	9-9
Drive Belt Routing	11-4
Exhaust	8-25
Oil Pressure Gage	4-12
Overheating	9-24
Power Messages	4-33
Pressure Light	4-25
Running While Parked	8-26
Starting	8-19
Engine Oil	
Life System	9-13
Messages	4-32
Temperature Gage	4-13
Entry Lighting	5-6
Equipment, Towing	8-55
Event Data Recorders	12-14
Extender, Safety Belt	2-20
Exterior Lamp Controls	5-1

F

Filter	
Engine Air Cleaner	9-16
Flashers, Hazard Warning	5-4
Flash-to-Pass	5-3
Flat Tire	9-69
Flat Tire, Changing	9-77
Fluid	
Automatic Transmission	9-14
Brakes	9-28
Power Steering	9-25
Washer	9-26
Fog Lamps	
Bulb Replacement	9-40
Front	5-5
Light	4-26
Front Seats	
Adjustment	2-3
Heated	2-6
Fuel	8-43
Additives	8-45
Economy Driving	8-2
Filling a Portable Fuel	
Container	8-48

Fuel (cont.)

Filling the Tank	8-46
Fuels in Foreign	
Countries	8-45
Gage	4-11
Gasoline Specifications	8-44
Management, Active	8-25
Recommended	8-44
Requirements, California	8-45
System Messages	4-33
Fuses	
Engine Compartment	
Fuse Block	9-42
Fuses and Circuit	
Breakers	9-42
Instrument Panel Fuse	
Block	9-45
Rear Compartment	
Fuse Block	9-46

G**Gages**

Engine Coolant	
Temperature	4-14
Engine Oil Pressure	4-12
Engine Oil Temperature	4-13

Gages (cont.)

- Fuel 4-11
- Odometer 4-11
- Speedometer 4-11
- Tachometer 4-11
- Transmission
 - Temperature 4-14
- Trip Odometer 4-11
- Voltmeter 4-15
- Warning Lights and Indicators 4-9
- Garage Door Opener 4-45
 - Programming 4-45
- Gasoline
 - Specifications 8-44
- General Information
 - Service and Maintenance ... 10-1
 - Towing 8-48
 - Vehicle Care 9-2
- Glove Box 3-1
- GM Mobility Reimbursement Program 12-5

H

- Halogen Bulbs 9-37
- Hazard Warning Flashers 5-4
- Head Restraints 2-2
- Headlamps
 - Aiming 9-34
 - Automatic 5-3
 - Bulb Replacement 9-37
 - Daytime Running Lamps (DRL) 5-3, 9-39
 - Flash-to-Pass 5-3
 - High Intensity Discharge (HID) Lighting 9-37
 - High/Low Beam Changer 5-2
- Heated Front Seats 2-6
- Heated Mirrors 1-12
- Highway Hypnosis 8-9
- Hill and Mountain Roads 8-9
- Hood 9-5
- Horn 4-7
- How to Wear Safety Belts
 - Properly 2-10
- Hydraulic Clutch 9-15

I

- Ignition Positions 8-17
- Ignition Transmission Lock
 - Check 9-32
- Illumination Control 5-5
- Immobilizer 1-11
- Immobilizer Light 4-26
- Infants and Young Children, Restraints 2-37
- Instrument Cluster 4-10
- Instrument Panel 5-5
- Introduction iii

J

- Jump Starting 9-84

K

- Key and Lock Messages 4-33
- Keyless Entry System 1-3
- Keys 1-2

L

Labeling, Tire Sidewall	9-49
Lamp Messages	4-33
Lamps	
Daytime	
Running (DRL)	5-3, 9-39
Dome	5-6
Exterior Controls	5-1
Front Fog	5-5
Headlamps, Front Turn	
Signal and Parking	
Lamps	9-37, 9-38
License Plate	9-40
Malfunction Indicator	4-19
Lap-Shoulder Belt	2-16
Latch, Lower Anchors and	
Tethers for Children	2-43
LATCH System	
Replacing Parts After a	
Crash	2-48
Latches, Seatback	2-5
Lighting	
Entry	5-6
Theater Dimming	5-6
Lights	
Airbag Readiness	4-17

Lights (cont.)

Antilock Brake System	
(ABS) Warning	4-23
Charging System	4-19
Cruise Control	4-26
Engine Oil Pressure	4-25
Flash-to-Pass	5-3
Fog Lamps	4-26
High/Low Beam Changer	5-2
Immobilizer	4-26
Safety Belt Reminders	4-16
Taillamp Indicator	4-26
Tire Pressure	4-24
Traction Control OFF/ StabiliTrak OFF	4-24
Traction Control System (TCS)/StabiliTrak®	4-24
Traction Off	4-23
Limited-Slip Rear Axle	8-38
Locks	
Door	1-6
Lockout Protection	1-8
Power Door	1-7
Loss of Control	8-6
Lower Anchors and Tethers for Children (LATCH SYSTEM)	2-43

M

Maintenance	
Records	10-10
Maintenance Schedule	
Recommended Fluids and Lubricants	10-7
Scheduled Maintenance	10-2
Malfunction Indicator Lamp	4-19
Manual Mode	8-29
Manual Transmission	8-30
Fluid	9-15
Messages	
Airbag System	4-35
Anti-Theft Alarm System	4-35
Battery Voltage and Charging	4-30
Brake System	4-31
Compass	4-31
Door Ajar	4-31
Engine Cooling System	4-32
Engine Oil	4-32
Engine Power	4-33
Fuel System	4-33
Key and Lock	4-33
Lamp	4-33
Object Detection System	4-34

Messages (cont.)

- Ride Control System 4-34
- Safety Belt 4-35
- Service Vehicle 4-35
- Tire 4-36
- Transmission 4-36
- Vehicle 4-37
- Vehicle Reminder 4-37
- Vehicle Speed 4-37
- Window 4-37

Mirrors

- Automatic Dimming 1-12
- Automatic Dimming
 - Rearview 1-13
- Convex 1-12
- Heated 1-12
- Manual Rearview 1-13
- Outlets 4-9
- Power 1-12

Monitor System,

- Tire Pressure 9-56

N

- Net, Convenience 3-1
- New Vehicle Break-In 8-16

O

- Object Detection System
 - Messages 4-34
- Odometer 4-11
- Trip 4-11
- Off-Road
 - Recovery 8-6
- Oil
 - Engine 9-10
 - Engine Oil Life System 9-13
 - Engine Oil
 - Pressure Gage 4-12
 - Messages 4-32
 - Pressure Light 4-25
- Older Children, Restraints 2-35
- Online Owner Center 12-4

- OnStar® System 4-42
- Operation, Infotainment
 - System 6-4
- Outlets
 - Power 4-9
- Overheating, Engine 9-24
- Overview, Infotainment
 - System 6-2

P

- Park
 - Shifting Into 8-21
 - Shifting Out of 8-22
- Parking 8-24
 - Assist, Ultrasonic 8-41
 - Brake 8-32
 - Brake and P (Park)
 - Mechanism Check 9-32
 - Over Things That Burn 8-24
- Passenger Airbag Status
 - Indicator 4-18

Passenger Sensing System ...	2-28
Perchlorate Materials	
Requirements, California	9-3
Phone	
Bluetooth	6-22, 6-23, 6-26
Power	
Door Locks	1-7
Mirrors	1-12
Protection, Battery	5-7
Retained	
Accessory (RAP)	8-19
Seat Adjustment	2-4
Steering Fluid	9-25
Windows	1-14
Pregnancy, Using	
Safety Belts	2-19
Privacy	
Radio Frequency	
Identification (RFID)	12-15
Program	
Courtesy Transportation	12-8
Proposition 65 Warning,	
California	9-2

R

Radio Frequency	
Identification (RFID)	12-15
Statement	12-15
Radios	
AM-FM Radio	6-8
Reception	6-13
Satellite	6-10
Rear Axle	9-30
Limited-Slip	8-38
Rear Seats	2-6
Rearview Mirrors	1-13
Automatic Dimming	1-13
Reclining Seatbacks	2-4
Recommended Fluids and	
Lubricants	10-7
Recommended Fuel	8-44
Records	
Maintenance	10-10
Recreational Vehicle Towing ...	9-87
Reimbursement Program,	
GM Mobility	12-5
Remote Keyless Entry (RKE)	
System	1-3

Remote Vehicle Start	1-5
Replacement Bulbs	9-41
Replacement Parts	
Airbags	2-34
Maintenance	10-9
Replacing Airbag System	2-34
Replacing LATCH System	
Parts After a Crash	2-48
Replacing Safety Belt System	
Parts After a Crash	2-21
Reporting Safety Defects	
Canadian Government	12-13
General Motors	12-13
U.S. Government	12-13
Retained Accessory Power	
(RAP)	8-19
Ride Control Systems	
Limited Slip Rear Axle	8-38
Messages	4-34
Roadside Assistance	
Program	12-6
Roof	
Sunroof	1-16
Rotation, Tires	9-61
Routing, Engine Drive Belt	11-4
Running the Vehicle While	
Parked	8-26

S

Safety Belts 2-6
 Care 2-20
 Extender 2-20
 How to Wear Safety Belts
 Properly 2-10
 Lap-Shoulder Belt 2-16
 Messages 4-35
 Reminders 4-16
 Replacing After a Crash 2-21
 Use During Pregnancy 2-19
 Safety Defects Reporting
 Canadian Government 12-13
 General Motors 12-13
 U.S. Government 12-13
 Safety System Check 2-20
 Satellite Radio 6-10
 Satellite Radio Antenna 6-14
 Scheduled Maintenance 10-2
 Scheduling Appointments 12-8
 Sealant Kit, Tire 9-71
 Seatback Latches 2-5

Seats
 Adjustment, Front 2-3
 Head Restraints 2-2
 Heated Front 2-6
 Power Adjustment, Front 2-4
 Rear 2-6
 Reclining Seatbacks 2-4
 Securing Child
 Restraints 2-48, 2-50
 Security
 Vehicle 1-10
 Service
 Accessories and
 Modifications 9-3
 Doing Your Own Work 9-4
 Engine Soon Lamp 4-19
 Maintenance, General
 Information 10-1
 Maintenance Records 10-10
 Parts Identification Label 11-1
 Publications Ordering
 Information 12-12

Service (cont.)
 Scheduling Appointments ... 12-8
 Vehicle Messages 4-35
 Servicing the Airbag-Equipped
 Vehicle 2-32
 Shifting
 Into Park 8-21
 Out of Park 8-22
 Signals, Turn and
 Lane-Change 5-4
 Spare Tire
 Compact 9-83
 Specifications and
 Capacities 11-2
 Speedometer 4-11
 StabiliTrak
 OFF Light 4-24
 StabiliTrak System 8-36
 Start Vehicle, Remote 1-5
 Starter Switch Check 9-31
 Starting the Engine 8-19

Steering	8-5
Fluid, Power	9-25
Wheel Adjustment	4-6
Wheel Controls	4-6
Storage Areas	
Center Console	3-1
Convenience Net	3-1
Glove Box	3-1
Storing the Tire Sealant and Compressor Kit	9-77
Stuck Vehicle	8-11
Sun Visors	1-16
Sunroof	1-16
Symbols	iv
System Check	
Automatic Transmission Shiftlock Control	9-32

T

Tachometer	4-11
Taillamp Indicator Light	4-26
Taillamps	
Turn Signal, and Stoplamps	9-40
Text Telephone (TTY) Users	12-4
Theater Dimming	5-6
Theft-Deterrent Systems	1-11
Immobilizer	1-11
Time	4-8
Tires	
Buying New Tires	9-63
Chains	9-68
Changing	9-77
Compact Spare	9-83
Designations	9-51

Tires (cont.)	
Different Size	9-65
If a Tire Goes Flat	9-69
Inflation Monitor System	9-57
Inspection	9-61
Messages	4-36
Pressure High-Speed Operation	9-56
Pressure Light	4-24
Pressure Monitor System ...	9-56
Rotation	9-61
Sealant and Compressor Kit	9-71
Sealant and Compressor Kit, Storing	9-77
Sidewall Labeling	9-49
Terminology and Definitions	9-52

Tires (cont.)
 Uniform Tire Quality Grading 9-65
 Wheel Alignment and Tire Balance 9-67
 Wheel Replacement 9-67
 When It Is Time for New Tires 9-62
 Winter 9-48
 Towing
 Driving Characteristics 8-49
 Equipment 8-55
 General Information 8-48
 Recreational Vehicle 9-87
 Trailer 8-53
 Vehicle 9-87
 Traction 4-24
 Control OFF/StabiliTrak
 OFF Light 4-24
 Control System (TCS) 8-34
 Control System (TCS)/
 StabiliTrak® Light 4-24
 Limited-Slip Rear Axle 8-38
 Off Light 4-23

Trailer Towing 8-53
 Transmission
 Automatic 8-26
 Fluid, Automatic 9-14
 Fluid, Manual 9-15
 Messages 4-36
 Temperature Gage 4-14
 Transportation Program,
 Courtesy 12-8
 Trip Odometer 4-11
 Trunk 1-8
 Turn and Lane-Change
 Signals 5-4

U

Ultrasonic Parking Assist 8-41
 Uniform Tire Quality
 Grading 9-65
 Universal Remote System 4-45
 Operation 4-48
 Programming 4-45
 Using this Manual iv

V

Vehicle
 Canadian Owners iii
 Control 8-3
 Load Limits 8-12
 Messages 4-37
 Personalization 4-38
 Remote Start 1-5
 Security 1-10
 Speed Messages 4-37
 Towing 9-87
 Vehicle Care
 Storing the Tire Sealant
 and Compressor Kit 9-77
 Tire Pressure 9-54
 Vehicle Identification
 Number (VIN) 11-1
 Service Parts Identification
 Label 11-1
 Vehicle Reminder
 Messages 4-37
 Ventilation, Air 7-3
 Visors 1-16
 Voltmeter Gage 4-15

W

Warning Lights, Gages, and Indicators	4-9	When It Is Time for New Tires	9-62
Warnings	iv	Where to Put the Child Restraint	2-41
Cautions and Danger	iv	Windows	1-14
Hazard Flashers	5-4	Messages	4-37
Washer Fluid	9-26	Power	1-14
Wheels		Windshield	
Alignment and Tire Balance	9-67	Wiper/Washer	4-7
Different Size	9-65	Winter Driving	8-10
Replacement	9-67	Winter Tires	9-48
		Wiper Blade Replacement	9-33