

2011 Chevrolet Volt Owner Manual

In Brief	1-1	Seats and Restraints	3-1	Instruments and Controls	5-1
Instrument Panel	1-2	Head Restraints	3-2	Instrument Panel Overview	5-4
Initial Drive Information	1-4	Front Seats	3-4	Controls	5-6
Vehicle Features	1-14	Rear Seats	3-8	Warning Lights, Gauges, and	
Battery and Efficiency	1-16	Safety Belts	3-10	Indicators	5-9
Performance and		Airbag System	3-25	Information Displays	5-28
Maintenance	1-20	Child Restraints	3-40	Vehicle Messages	5-40
Keys, Doors and Windows ...	2-1	Storage	4-1	Vehicle Personalization	5-48
Keys and Locks	2-2	Storage Compartments	4-1	Universal Remote System	5-55
Doors	2-10	Additional Storage Features ...	4-2	Lighting	6-1
Vehicle Security	2-12			Exterior Lighting	6-1
Exterior Mirrors	2-13			Interior Lighting	6-5
Interior Mirrors	2-15			Lighting Features	6-5
Windows	2-15				

2011 Chevrolet Volt Owner Manual

Infotainment System	7-1	Brakes	9-31	Service and Maintenance ...	11-1
Introduction	7-1	Ride Control Systems	9-34	General Information	11-1
Radio	7-8	Cruise Control	9-36	Scheduled Maintenance	11-3
Audio Players	7-16	Object Detection Systems	9-39	Recommended Fluids, Lubricants, and Parts	11-6
Navigation	7-36	Charging	9-44	Maintenance Records	11-8
Voice Recognition	7-71	Fuel	9-52	Technical Data	12-1
Phone	7-78	Towing	9-57	Vehicle Identification	12-1
Climate Controls	8-1	Conversions and Add-Ons ...	9-57	Vehicle Data	12-2
Climate Control Systems	8-1	Vehicle Care	10-1	Customer Information	13-1
Air Vents	8-8	General Information	10-2	Customer Information	13-1
Driving and Operating	9-1	Vehicle Checks	10-6	Reporting Safety Defects	13-23
Driving Information	9-2	Headlamp Aiming	10-27	Vehicle Data Recording and Privacy	13-24
Starting and Operating	9-18	Bulb Replacement	10-29	Index	i-1
Electric Vehicle Operating Modes	9-23	Electrical System	10-32		
Engine Exhaust	9-28	Wheels and Tires	10-42		
Electric Drive Unit	9-29	Jump Starting	10-71		
		Towing	10-77		
		Appearance Care	10-81		



The names, logos, emblems, slogans, vehicle model names, and vehicle body designs appearing in this manual including, but not limited to, GM, the GM logo, CHEVROLET, the CHEVROLET Emblem, VOLT, and the VOLT logo are trademarks and/or service marks of General Motors LLC, its subsidiaries, affiliates, or licensors.

This manual describes features that may or may not be on your specific vehicle either because they are options that you did not purchase or due to changes subsequent to the printing of this owner manual. Please refer to the purchase documentation relating to your specific vehicle to confirm each of the features found on your vehicle. For vehicles first sold in Canada, substitute the name "General Motors of Canada Limited" for Chevrolet Motor Division wherever it appears in this manual.

Keep this manual in the vehicle for quick reference.

Canadian Vehicle Owners

Propriétaires Canadiens

A French language copy of this manual can be obtained from your dealer or from:

On peut obtenir un exemplaire de ce guide en français auprès du concessionnaire ou à l'adresse suivante:

Helm, Incorporated
P.O. Box 07130
Detroit, MI 48207

1-800-551-4123
Numéro de poste 6438 de langue
française
www.helminc.com

Using this Manual

To quickly locate information about the vehicle, use the Index in the back of the manual. It is an alphabetical list of what is in the manual and the page number where it can be found.

Danger, Warnings, and Cautions

Warning messages found on vehicle labels and in this manual describe hazards and what to do to avoid or reduce them.

Danger indicates a hazard with a high level of risk which will result in serious injury or death.

Warning or **Caution** indicates a hazard that could result in injury or death.

WARNING

These mean there is something that could hurt you or other people.

Notice: This means there is something that could result in property or vehicle damage. This would not be covered by the vehicle's warranty.



A circle with a slash through it is a safety symbol which means “Do Not,” “Do not do this,” or “Do not let this happen.”

Symbols

The vehicle has components and labels that use symbols instead of text. Symbols are shown along with the text describing the operation or information relating to a specific component, control, message, gauge, or indicator.

 : This symbol is shown when you need to see your owner manual for additional instructions or information.

 : This symbol is shown when you need to see a service manual for additional instructions or information.

Vehicle Symbol Chart

Here are some additional symbols that may be found on the vehicle and what they mean. For more information on the symbol, refer to the Index.

 : Airbag Readiness Light

 : Air Conditioning

 : Antilock Brake System (ABS)

 : Audio Steering Wheel Controls or OnStar®

BRAKE : Brake System Warning Light

 : Charge Port Door

 : Charging System (12-Volt Battery)

 : Cruise Control

 : Electric Parking Brake

 : Electronic Stability Control (ESC)

 : Engine Coolant Temperature

 : Exterior Lamps

 : Fault

 : First Responder

 : Fuel Gauge

 : Fuses

 : Headlamp High/Low-Beam Changer

 : High Voltage

 : LATCH System Child Restraints

 : Leaf

 : Malfunction Indicator Lamp

 : Oil Pressure

 : Power

 : Remote Vehicle Start

 : Safety Belt Reminders

 : Tire Pressure Monitor

 : Windshield Washer Fluid

In Brief

Instrument Panel

Instrument Panel 1-2

Initial Drive Information

Initial Drive Information 1-4

Remote Keyless Entry (RKE)
System 1-4

Remote Vehicle Start 1-5

Door Locks 1-5

Windows 1-6

Seat Adjustment 1-6

Heated Seats 1-7

Head Restraint Adjustment 1-8

Safety Belts 1-9

Sensing System for Passenger

Airbag 1-9

Mirror Adjustment 1-9

Steering Wheel

Adjustment 1-10

Interior Lighting 1-10

Exterior Lighting 1-11

Windshield Wiper/Washer 1-11

Climate Controls 1-12

Vehicle Features

Radio(s) 1-14

Satellite Radio 1-14

Portable Audio Devices 1-14

Bluetooth® 1-14

Steering Wheel Controls 1-14

Cruise Control 1-15

Navigation System 1-15

Power Outlets 1-16

Battery and Efficiency

High Voltage Safety
Information 1-16

Charging 1-17

Fueling 1-19

Total Vehicle Range 1-20

Regenerative Braking 1-20

Service 1-20

Performance and Maintenance

Traction Control
System (TCS) 1-20

Electronic Stability
Control (ESC) 1-20

Tire Pressure Monitor 1-21

Tire Sealant and
Compressor Kit 1-21

Engine Oil Life System 1-21

Driving for Better Energy
Efficiency 1-22

Roadside Assistance
Program 1-23

OnStar® 1-24

Instrument Panel

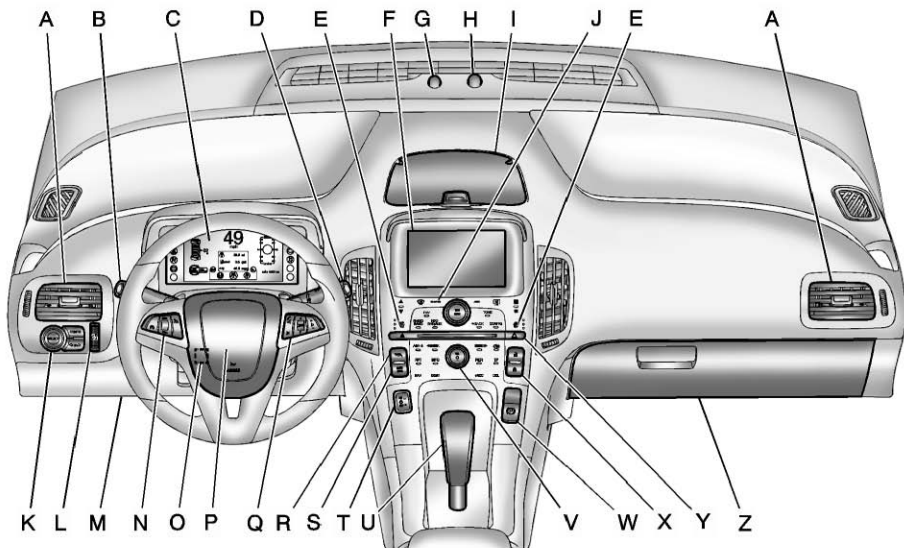

- A. *Air Vents on page 8-8.*
- B. *Turn and Lane-Change Lever. See Turn and Lane-Change Signals on page 6-4. Exterior Lamp Controls on page 6-1. Pedestrian Friendly Alert on page 6-2.*
- C. *Instrument Cluster on page 5-9. Driver Information Center (DIC) Display. See Driver Information Center (DIC) on page 5-38.*
- D. *Windshield Wiper/Washer on page 5-7.*
- E. *Heated Front Seats on page 3-6 (If Equipped).*
- F. *Center Stack Display on page 5-28.*
- G. *Charging Status Indicator. See Charging Status Feedback on page 9-47.*
- H. *Light Sensor. See Daytime Running Lamps (DRL) on page 6-3.*
- I. *Instrument Panel Storage on page 4-1.*
- J. *Automatic Climate Control System on page 8-1.*
- K. *Driver Information Center (DIC) Controls. See Driver Information Center (DIC) on page 5-38.*
- L. *Instrument Panel Illumination Control on page 6-5.*
- M. *Data Link Connector (DLC) (Out of View). See Malfunction Indicator Lamp on page 5-19.*
- N. *Cruise Control on page 9-36.*
- O. *Steering Wheel Adjustment on page 5-6.*
- P. *Horn on page 5-7.*
- Q. *Steering Wheel Controls on page 5-6 (If Equipped).*
- R. *Leaf Button. See Center Stack Display on page 5-28.*
- S. *DRIVE MODE Button. See Driver Selected Operating Modes on page 9-24.*
- T. *Power Button on page 9-18.*
- U. *Shift Lever. See Electric Drive Unit on page 9-29.*
- V. *Infotainment on page 7-1. Navigation System. See Using the Navigation System on page 7-36.*
- W. *Electric Parking Brake on page 9-32.*
- X. *Power Door Locks on page 2-9.*
- Y. *Hazard Warning Flashers on page 6-4.*
- Z. *Glove Box on page 4-1.*

Initial Drive Information

This section provides a brief overview about some of the important features that may or may not be on your specific vehicle.

For more detailed information, refer to each of the features which can be found later in this owner manual.

Remote Keyless Entry (RKE) System

The Remote Keyless Entry (RKE) transmitter will work up to 60 m (195 ft) away from the vehicle.

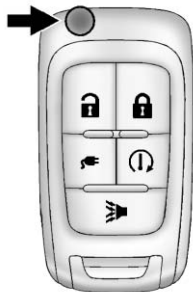





Press the key release button to extend the key. The key can be used for all locks.

 : Press once to unlock the driver door. Press a second time within five seconds to unlock all doors.

 : Press to lock all doors.

Lock and unlock feedback can be personalized. See *Vehicle Personalization* on page 5-48.

 : Press and release to locate the vehicle. Press and hold for three seconds to sound the panic alarm. Press again to cancel the panic alarm.

 : Press  and then press and hold  within five seconds to start the vehicle's heating or air conditioning systems and rear window defogger from outside the vehicle using the RKE transmitter. See *Remote Start* on page 2-7 for more information.



 : Press to open the charge port door. See *Plug-In Charging* on page 9-44 for more information.

See *Keys* on page 2-2 and *Remote Keyless Entry (RKE) System Operation* on page 2-3.

Remote Vehicle Start

This feature starts the heating or air conditioning systems and rear window defogger from outside the vehicle. Normal operation of the system will return after the vehicle has been turned on. The engine may start to support the climate control operation.



Activating the Remote Start

1. Aim the RKE transmitter at the vehicle.
2. Press  on the RKE transmitter; the doors will lock.
3. Within five seconds, press and hold  until the turn signal lamps flash or for approximately four seconds. Pressing  again during a remote start will turn the feature off.

After entering the vehicle during a remote start, press the POWER  button on the center stack with the brake pedal applied to operate as normal.

Canceling Remote Start

To cancel a remote start, do any of the following:

- Aim the RKE transmitter at the vehicle and press and hold  until the parking lamps turn off.
- Turn on the hazard warning flashers.
- Press the POWER  button on the center stack, with the brake pedal applied, then press the POWER  button again to turn the vehicle off.

See *Remote Start* on page 2-7.

Door Locks

To lock or unlock the door, use the Remote Keyless Entry (RKE) transmitter or the key from outside the vehicle. Use the door lock knob or switch from inside the vehicle.

See *Door Locks* on page 2-8.

Power Door Locks



The power door lock switches are on the center stack.

 : Press to unlock the doors.

 : Press to lock the doors.

See *Power Door Locks* on page 2-9.

Hatch

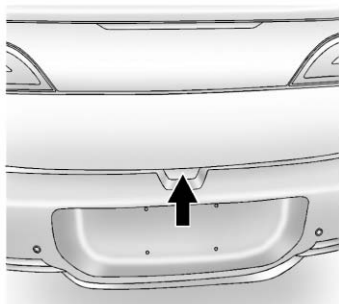

To open the hatch, with all doors unlocked, press the button on the underside of the hatch and lift up.

Always close the hatch before driving. Do not press the button while closing the hatch; it will unlock it again.

See *Hatch* on page 2-10.

Windows

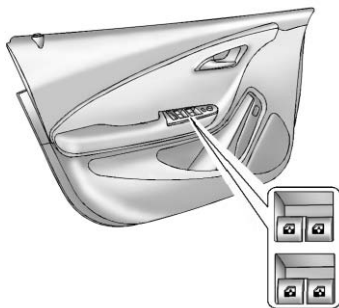

The power window switches are on the driver door armrest. Each passenger door has a switch that controls only that window.

Press the front of the switch to lower the window. Pull the switch up to raise it.

The driver and passenger windows have an express-down feature and the driver window has express-up.

See *Power Windows* on page 2-16.

Seat Adjustment

Seat Position

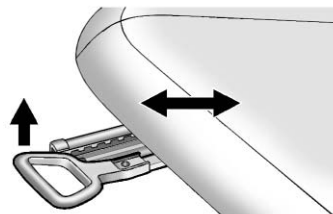

To adjust the seat position:

1. Pull the handle at the front of the seat cushion to unlock it.
2. Move the seat forward or rearward and release the handle.
3. Try to move the seat back and forth to be sure it is locked in place.

See *Seat Adjustment* on page 3-4.

Height Adjustment

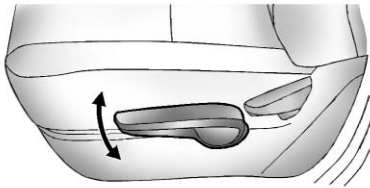

Move the lever up or down to raise or lower the seat.

See “Seat Height Adjuster” under *Seat Adjustment* on page 3-4.

Reclining Seatbacks

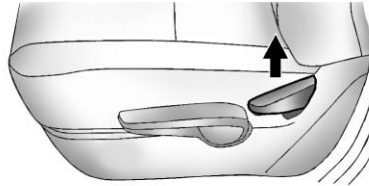

To recline the seatback:

1. Lift the lever.
2. Move the seatback to the desired position, and then release the lever to lock the seatback in place.
3. Push and pull on the seatback to make sure it is locked.

To return the seatback to the upright position:

1. Lift the lever fully without applying pressure to the seatback, and the seatback will return to the upright position.

2. Push and pull on the seatback to make sure it is locked.

See *Reclining Seatbacks* on page 3-4.

Heated Seats

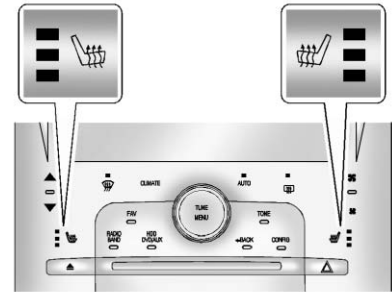

If available, the controls are on the center stack. To operate, the vehicle must be on.

Press or to heat the driver or passenger seat cushion and seatback.

1-8 In Brief

Press the button once for the highest setting. With each press of the button, the heated seat will change to the next lower setting, and then the off setting. Three lights indicate the highest setting and one light the lowest.

See *Heated Front Seats* on page 3-6 for more information.

Auto Heated Seats

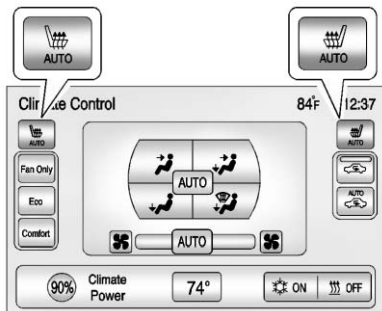

If available, the controls can be accessed while the vehicle is on by pressing the CLIMATE button on the center stack.

Press the touch screen AUTO or AUTO button. The button color will change to green when this feature is on.

When the vehicle is on, this feature will automatically activate the heated seats at the level required by the vehicle's interior temperature. The active high, medium, low, or off heated seat level will be indicated by the manual heated seat button lights on the center stack. Use the manual heated seat buttons on the center stack to turn auto heated seats off.

See *Heated Front Seats* on page 3-6 for more information.

The heated seats can also be programmed to come on during a remote start. See "Remote Start Auto Heat Seats" under *Vehicle Personalization* on page 5-48 for more information.

Head Restraint Adjustment

Do not drive until the head restraints for all occupants are installed and adjusted properly.

To achieve a comfortable seating position, change the seatback recline angle as little as necessary while keeping the seat and the head restraint height in the proper position.

For more information see *Head Restraints* on page 3-2 and *Seat Adjustment* on page 3-4.

Safety Belts



Refer to the following sections for important information on how to use safety belts properly.

- *Safety Belts on page 3-10.*
- *How to Wear Safety Belts Properly on page 3-13.*
- *Lap-Shoulder Belt on page 3-19.*
- *Lower Anchors and Tethers for Children (LATCH System) on page 3-47.*

Sensing System for Passenger Airbag



The passenger sensing system will turn off the right front passenger frontal airbag and passenger knee airbag under certain conditions. The driver airbags, seat-mounted side impact airbags, and roof-rail airbags are not affected by the passenger sensing system. See *Passenger Sensing System on page 3-33* for more information.

The passenger airbag status indicator will be visible on the overhead console when the vehicle is started. See *Passenger Airbag Status Indicator on page 5-18.*

Mirror Adjustment

Exterior

Mirrors can be folded inward toward the vehicle to prevent damage when going through an automatic car wash. Push the mirror outward to return it to the original position.

See *Folding Mirrors on page 2-14.*

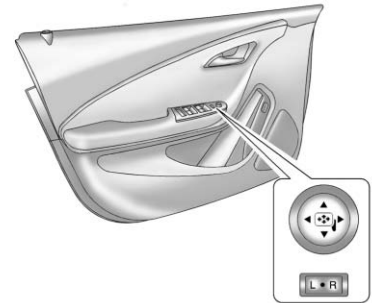

Controls for the outside power mirrors are on the driver door.

To adjust a mirror:

1. Move the selector switch to L (left) or R (right) to choose the driver or passenger mirror.
2. Press the arrows on the control pad to move each mirror in the desired direction.
3. Return the selector switch to the center position.

See *Power Mirrors on page 2-14*.

When the rear window defogger is activated, the heated mirrors, if equipped, will also come on. See *Heated Mirrors on page 2-14*.

Interior

The vehicle has an automatic dimming inside rearview mirror. Automatic dimming reduces the glare from the headlamps of the vehicle behind you. The dimming feature and the indicator light come on each time the vehicle is started. Hold the mirror in the center to adjust it. See *Automatic Dimming Rearview Mirror on page 2-15*.

Steering Wheel Adjustment

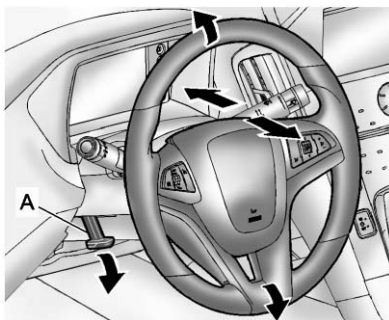

To adjust the steering wheel:

1. Pull the lever (A) down.
2. Move the steering wheel up or down.
3. Pull or push the steering wheel closer or away from you.
4. Pull the lever (A) up to lock the steering wheel in place.

Do not adjust the steering wheel while driving.

Interior Lighting

Dome Lamps

The dome lamp controls are in the overhead console.

To operate, press the following buttons:

 : Press to turn on the dome lamps.

 : Press to turn the lamps on automatically when a door is opened.

 : Press to turn the lamps off, even when a door is open.

Reading Lamps

The front reading lamps are in the overhead console.

 : Press to turn each lamp on or off.

For more information on interior lighting, see *Instrument Panel Illumination Control on page 6-5*.

Exterior Lighting



The exterior lamp control is on the turn signal/lane change lever.

: Turn to operate the exterior lamps.

: Turns the exterior lamps off.

AUTO: Turns the exterior lamps on and off automatically depending on the exterior light.

: Turns on the parking lamps, together with the sidemarker lamps, taillamps, license plate lamps, and instrument panel lights.

: Turns on the headlamps, together with the parking lamps, sidemarker lamps, taillamps, license plate lamps, and instrument panel lights.

For more information, see:

- *Exterior Lamp Controls on page 6-1.*
- *Turn and Lane-Change Signals on page 6-4.*
- *Headlamp High/Low-Beam Changer on page 6-2.*

Windshield Wiper/Washer

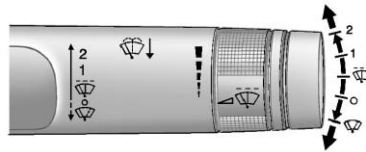

The windshield wiper lever is on the side of the steering column. With the vehicle on, move the windshield wiper lever to select the wiper speed.

2: Move the lever up to 2 for fast wipes.

1: Move the lever up to 1 for slow wipes.

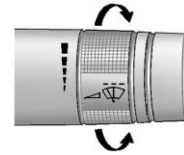

: Move the lever up to for adjustable interval wipes, then turn the band up for more frequent wipes or down for less frequent wipes.

: Use to turn the windshield wipers off.

: For a single wipe, briefly move the wiper lever down. For several wipes, hold the wiper lever down.

Windshield Washer

Pull the windshield wiper lever toward you to spray windshield washer fluid and activate the wipers.

See *Windshield Wiper/Washer on page 5-7.*

Climate Controls

Heating, cooling, and ventilation can be controlled by using the climate control buttons and the climate touch screen.

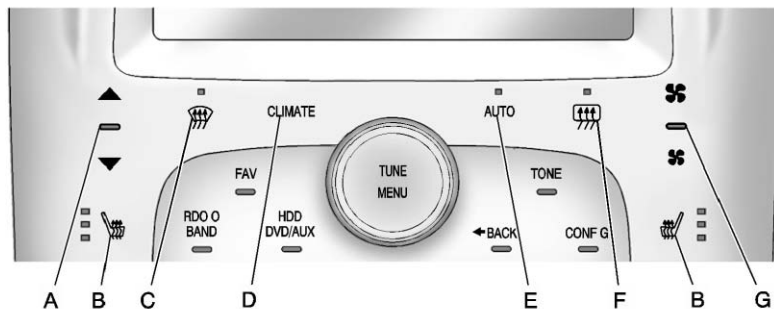

Climate Control Buttons

- | | |
|--------------------------------------|------------|
| A. Temperature Control | C. Defrost |
| B. Driver and Passenger Heated Seats | D. Climate |

- E. Auto (Automatic Operation)
- F. Rear Window Defogger
- G. Manual Fan Control

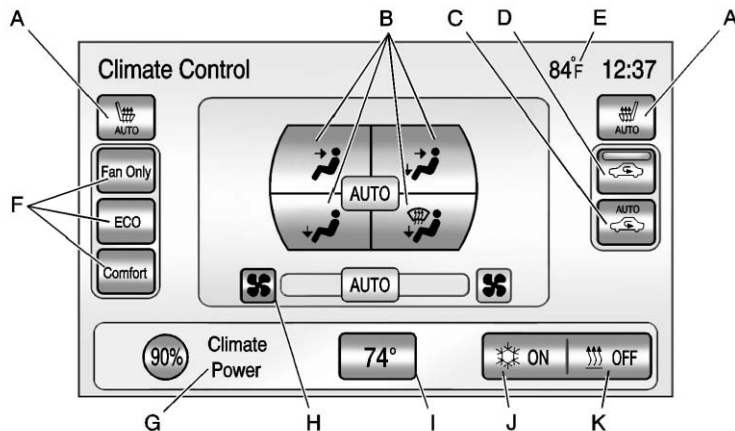

Climate Touch Screen Controls

See *Automatic Climate Control System* on page 8-1.

Auto Heated Seats are selected using the climate control touch screen. See *Heated Front Seats* on page 3-6.

- | | |
|---|--|
| A. Driver and Passenger Auto Heated Seats | F. Climate Modes: Fan Only, ECO, Comfort |
| B. Air Delivery Mode Controls | G. Climate Power Gauge |
| C. Auto Recirculation | H. Manual Fan Control |
| D. Manual Recirculation | I. Temperature Setting Display |
| E. Outside Air Temperature Display | J. Air Conditioning Indicator |
| | K. Heat Status Indicator |

Vehicle Features

Radio(s)

This vehicle's radio is part of the navigation system. See *Infotainment* on page 7-1.

Satellite Radio

Vehicles with an XM™ Satellite Radio tuner and a valid XM Satellite Radio subscription can receive XM programming.

XM Satellite Radio Service

XM is a satellite radio service based in the 48 contiguous United States and 10 Canadian provinces. XM Satellite Radio has a wide variety of programming and commercial-free music, coast to coast, and in digital-quality sound. A fee is required to receive the XM service.

For more information refer to:

- www.xmradio.com or call 1-800-929-2100 (U.S.).
- www.xmradio.ca or call 1-877-438-9677 (Canada).

For more information, see *Satellite Radio* on page 7-13.

Portable Audio Devices

This vehicle has a 3.5 mm (1/8 in) auxiliary input and a USB port located in the center stack. External devices such as iPods®, laptop computers, MP3 players, CD changers, and USB storage devices may be connected, depending on the audio system.

For more information, see *Auxiliary Devices* on page 7-36.

Bluetooth®

The Bluetooth® system allows users with a Bluetooth-enabled cell phone to make and receive hands-free calls using the vehicle audio system, microphone, and controls.

The Bluetooth-enabled cell phone must be paired with the in-vehicle Bluetooth system before it can be used in the vehicle. Not all phones will support all functions.

See *Bluetooth* on page 7-78.

Steering Wheel Controls

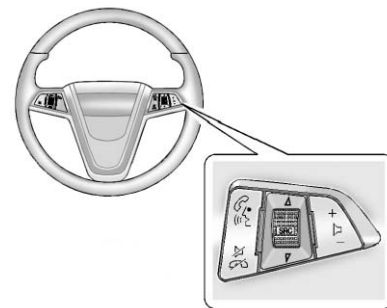

For vehicles with audio steering wheel controls, some audio controls can be adjusted at the steering wheel.

 : Press to interact with the available Bluetooth, OnStar, or navigation system.

 : Press to silence the vehicle speakers only. Press again to turn the sound on. For vehicles with OnStar or Bluetooth systems, press to reject an incoming call, or to end a current call.

△ SRC ▽ : Turn **△** or **▽** to select a radio band or audio source.

Turn **△** or **▽** to select the next or previous favorite radio station, CD, DVD track/chapter (with navigation), or MP3 track.

Press SRC to change between radio and CD or DVD.

+ ▢ - : Press **+** to increase or **-** to decrease the volume.

For more information, see *Steering Wheel Controls* on page 5-6.

Cruise Control

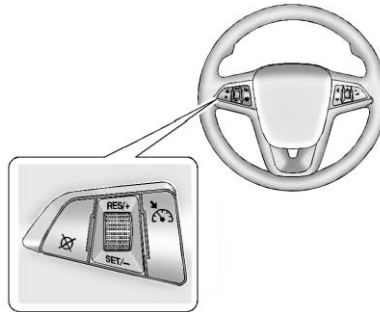

The cruise control buttons are on the steering wheel.

 : Press to turn the cruise control system on and off. An indicator light will turn on or off in the instrument cluster.

 : Press to disengage cruise control without erasing the set speed from memory.

RES/+ : Move the thumbwheel up to resume to a previously set speed or to accelerate.

SET/- : Move the thumbwheel down to set a speed and activate cruise control or to make the vehicle decelerate.

See *Cruise Control* on page 9-36.

Navigation System

The vehicle has a navigation system that includes information about the radio, audio players, and navigation system.

The navigation system provides detailed maps of most major freeways and roads. After a destination has been set, the system provides turn-by-turn instructions for reaching the destination. In addition, the system can help locate a variety of POIs (Points of Interest), such as banks, airports, restaurants, and more.

See *Infotainment* on page 7-1 for more information.

Power Outlets

The accessory power outlets can be used to plug in electrical equipment, such as a cell phone or MP3 player.

There are three accessory power outlets:

- Inside the front of the center floor console.
- On the rear of the center floor console.
- Inside the instrument panel storage area.

The power outlets supply power while the vehicle is on, or if the vehicle is in Retained Accessory Power (RAP). See *Retained Accessory Power (RAP)* on page 9-21.

Remove the cover to access and replace when not in use.

See *Power Outlets* on page 5-8.

Battery and Efficiency

High Voltage Safety Information

 **WARNING**

Exposure to high voltage can cause shock, burns, and even death. The high voltage components in the vehicle can only be serviced by technicians with special training.

High voltage components are identified by labels. Do not remove, open, take apart, or modify these components. High voltage cable or wiring has orange covering. Do not probe, tamper with, cut, or modify high voltage cable or wiring.

This vehicle has a high voltage battery and a standard 12-volt battery.

If the vehicle is in a crash, the sensing system may shut down the high voltage system. When this occurs, the high voltage battery is disconnected and the vehicle will not start. The SERVICE VEHICLE SOON message in the Driver Information Center (DIC) will be displayed. Before the vehicle can be operated again, it must be serviced at your dealer.

See *Battery* on page 10-24 for important safety information. If an airbag has inflated, see *What Will You See After an Airbag Inflates?* on page 3-31.

Only a trained service technician with the proper knowledge and tools should inspect, test, or replace the high voltage battery. See your dealer if the high voltage battery needs service.

See *Battery* on page 10-24.

Charging

The high voltage battery can be charged using a household electrical outlet. There are three ways to program how the vehicle is charged. See *Charging on page 5-30* for more information.

This section explains the process for charging the high voltage battery. Do not allow the vehicle to remain in temperature extremes for long periods without being driven or plugged in. It is recommended that the vehicle be plugged in when temperatures are below 0°C (32°F) and above 32°C (90°F) to maximize high voltage battery life.

The charging system may run fans and pumps that result in sounds from the vehicle while it is turned off. Additional unexpected clicking sounds may be experienced caused by the electrical devices used while charging.

Charging

Start Charge

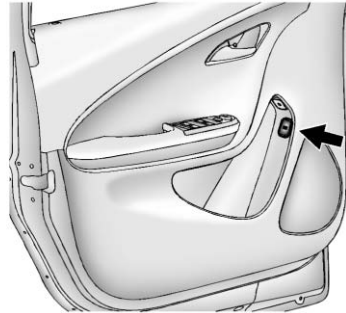

1. The charge port door release button is on the driver door inner trim panel. With the vehicle in P (Park), press the button for one second and release to open the charge port door. The charge port door can also be opened using the RKE transmitter. See *Remote Keyless Entry (RKE) System Operation on page 2-3*.

In cold weather conditions, ice may form around the charge port door. The charge port door may not open on the first attempt. Remove ice from the area and repeat attempting to open the charge port door.

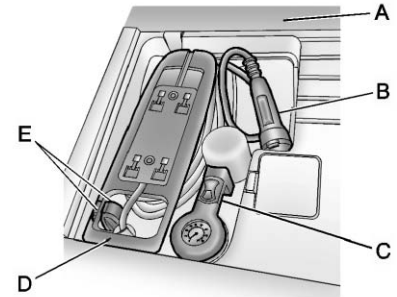

2. Open the rear hatch, lift the load support floor covering (A), and remove the charge cord. It is located near the tire sealant and compressor kit (C). Pull up on the charge cord handle (D) to release it from the handle clip (E). Lift the charge cord up

1-18 In Brief

and rearward to remove it from the vehicle. The vehicle plug (B) is stored as shown.

3. Plug the charge cord into the electrical outlet. See *Electrical Requirements for Battery Charging* on page 9-51. Verify that the charge cord status indicators are both green. See *Charge Cord* on page 9-49 for more information.

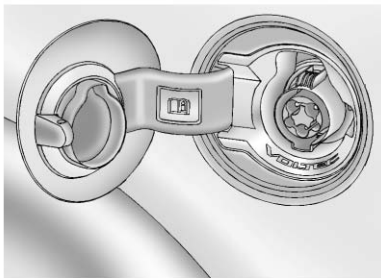

4. Then plug in the vehicle plug of the charge cord into the charge port on the vehicle. Verify that the charging status indicator

illuminates on top of the instrument panel and a horn chirp occurs. See *Charging Status Feedback* on page 9-47 for more information.

5. To arm the charge cord theft alert, lock the vehicle with the RKE transmitter. This feature can be disabled by a service technician.

End Charge

1. Unlock the vehicle with the RKE transmitter to disarm the charge cord theft alert.

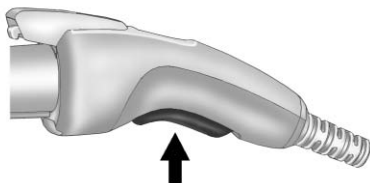

2. Unplug the vehicle plug of the charge cord from the vehicle by squeezing the vehicle plug lever and pull to remove.

3. Unplug the charge cord from the electrical outlet.
4. Before storing the charge cord, have the charge cord face up and wrap the charge cable neatly counterclockwise around the body of the charge cord.

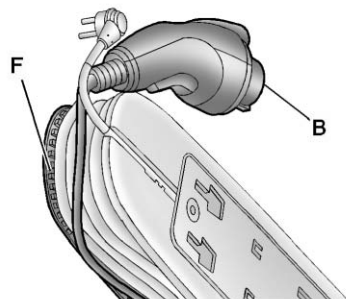

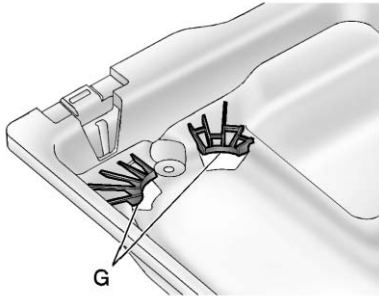

- Place the charge cord, face down, into the storage compartment with the front edge (F) of the charge cord body under the clips (G) located in the front of the storage compartment. The vehicle plug (B) should be on the right side of the charge cord.

Push the charge cord handle down until it locks into the handle clip at the rear of the storage compartment.

While the charge cord is plugged into the vehicle, the vehicle cannot be driven.

Fueling

The fuel system on this vehicle requires a refueling process to control evaporative emissions. To refuel the vehicle:

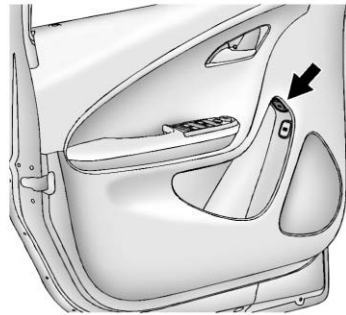

- Press the fuel door button on the driver door for one second. A WAIT TO REFUEL message displays on the Driver Information Center.



- When the READY TO REFUEL message displays, the fuel door on the passenger side will unlock. Push the rearward edge of the fuel door in and release to open the door.
- Turn the fuel cap counterclockwise to remove. While refueling, hang the fuel cap tether from the hook on the inside of the fuel door.
- After refueling, reinstall the fuel cap by turning it clockwise until it clicks. Close the fuel door.

See *Filling the Tank* on page 9-55.

Total Vehicle Range



Total vehicle range is the remaining distance the vehicle can be driven combining the electric range and fuel range.

See *Driving for Better Energy Efficiency* on page 9-2.

Regenerative Braking

Regenerative braking takes some of the energy from the moving vehicle and turns it back into electrical energy. This energy is then stored back into the high voltage battery system, contributing to increased energy efficiency.

See *Regenerative Braking* on page 9-33.

Service

WARNING

Never try to do your own service on high voltage components. You can be injured and the vehicle can be damaged if you try to do your own service work. Service and repair of these high voltage components should only be performed by a trained service technician with the proper knowledge and tools. See *Doing Your Own Service Work* on page 10-6.

Performance and Maintenance

Traction Control System (TCS)

The Traction Control System limits wheel spin. The system turns on automatically every time the vehicle is on and cannot be turned off.

For more information, see *Traction Control System (TCS)* on page 9-34.

Electronic Stability Control (ESC)

Electronic Stability Control assists with directional control of the vehicle in difficult driving conditions. The system turns on automatically every time the vehicle is on and cannot be turned off.

For more information, see *Electronic Stability Control (ESC)* on page 9-35.

Tire Pressure Monitor

This vehicle may have a Tire Pressure Monitor System (TPMS).



The TPMS warning light alerts you to a significant loss in pressure of one of the vehicle's tires. If the warning light comes on, stop as soon as possible and inflate the tires to the recommended pressure shown on the Tire and Loading Information label. See *Vehicle Load Limits* on page 9-13. The warning light will remain on until the tire pressure is corrected.

During cooler conditions, the low tire pressure warning light may appear when the vehicle is first started and then turn off. This may be an early

indicator that the tire pressures are getting low and the tires need to be inflated to the proper pressure.

The TPMS does not replace normal monthly tire maintenance. It is the driver's responsibility to maintain correct tire pressures.

See *Tire Pressure Monitor System* on page 10-49.

Tire Sealant and Compressor Kit

This vehicle may have a tire sealant and compressor kit that can be used to seal small punctures in the tread area of the tire. Significant sidewall damage will require the tire to be replaced.

See *Tire Sealant and Compressor Kit* on page 10-63 for complete operating information.

Engine Oil Life System

The engine oil life system calculates engine oil life based on vehicle use and displays the CHANGE ENGINE OIL SOON message when it is time to change the engine oil and filter. The oil life system should be reset to 100% only following an oil change.

Resetting the Oil Life System

1. Use the SELECT knob to select OIL LIFE on the DIC menu.
2. Press SELECT to start the OIL LIFE reset procedure.
3. The DIC menu will display "Are you sure that you want to reset?" Use SELECT to choose YES to reset oil life or NO to exit and return to the previous menu.

- If YES is selected, the DIC menu will display RESET OIL LIFE for a short time and then 100% OIL LIFE will be displayed when OIL LIFE is successfully reset.

See *Engine Oil Life System* on page 10-12.

Driving for Better Energy Efficiency

Use the following tips to help maximize energy efficiency and range.

Driving Style

Efficiency Gauge (Instrument Cluster)

The ball indicator should be kept green and in the center of the gauge.

Inefficient acceleration is indicated when the ball turns yellow and travels above the center of the gauge.

Aggressive braking is indicated when the ball turns yellow and travels below the center of the gauge.

Acceleration/Braking/Coasting

Avoid unnecessary rapid accelerations and decelerations.

Electric range is maximized at 80 km/h (50 mph) and below. Higher speeds use more energy and can significantly reduce electric range.

Use cruise control when appropriate.

Plan ahead for decelerations and coast whenever possible. For example, do not rush to traffic signals.

Do not shift to N (Neutral) to coast. The vehicle recovers energy while coasting and braking in D (Drive) or L (Low).

Drive Mode and PRNDL Selection

Use Normal Mode when possible.

Sport Mode provides more responsive acceleration than Normal Mode but reduces efficiency.

Use Mountain Mode prior to climbing long, steep grades in mountainous areas. Be sure to engage Mountain Mode before starting to climb. Mountain Mode reduces electric range and power but may be needed to maintain speeds above 96 km/h (60 mph) when climbing grades of 5% or greater.

Use L (Low) in heavy stop-and-go traffic or when traveling downhill. L (Low) requires less brake pedal application and provides a controlled, efficient way to slow the vehicle down.

Climate Setting

Using the heat and air conditioning systems decreases the energy available for electric driving.

Optimal energy efficiency is achieved with the heat, air conditioning, and fan turned off.

Less energy is used at low fan speeds. When using the fan:

- Fan Only is the most energy efficient climate setting.
- ECO is for moderate air conditioning and heater operation and is the next most energy efficient setting.
- Comfort provides the most comfort but is the least energy efficient.

Use the auto heated seat feature instead of climate settings. Heating the seat uses less energy than heating the vehicle interior.

Use remote start when the vehicle is plugged in to attain a comfortable vehicle interior temperature.

In hot weather, avoid parking in direct sunlight or use sunshades inside the vehicle.

Turn off the front and rear window defog/defrost when they are no longer needed.

Avoid driving with the windows open at highway speeds.

Vehicle Charging/Maintenance

Charging

Keep the vehicle plugged in, even when fully charged, to keep the battery temperature ready for the next drive. This is important when outside temperatures are extremely hot or cold.

Maintenance

Always keep the tires properly inflated and the vehicle properly aligned.

The weight of excess cargo in the vehicle affects efficiency and range. Avoid carrying more than is needed.

If fuel is not regularly used, consider keeping the fuel tank only one-third full. Excess fuel weight impacts efficiency and range.

Use premium fuel.

Avoid unnecessary use of electrical accessories. Power used for functions other than propelling the vehicle will reduce EV range.

Using a rooftop carrier will reduce efficiency due to additional weight and drag.

Roadside Assistance Program

U.S.: 1-888-811-1926

TTY Users: 1-888-889-2438

Canada: 1-800-268-6800

As the owner of a new Chevrolet, you are automatically enrolled in the Roadside Assistance program. This program provides security and convenience in the event of an on-road failure or emergency situation.

Service is provided 24 hours a day, 365 days a year for the 5 year/ 160 000 km (100,000 mi) coverage period.

See *Roadside Assistance Program* on page 13-6 for more information.

Roadside Assistance and OnStar

If you have an active OnStar subscription, press the  button and the current GPS location will be sent to an OnStar advisor who will assess your problem, contact Roadside Assistance, and relay your exact location to get the help you need.

Online Owner Center

The Online Owner Center is a complimentary service that includes online service reminders, vehicle maintenance tips, online owner manual, special privileges, and more.

Sign up today at:

www.chevyownercenter.com
(U.S.) or www.gm.ca (Canada).

OnStar[®]





For vehicles with an active OnStar subscription, OnStar uses several innovative technologies and live Advisors to provide a wide range of safety, security, navigation, diagnostics, and calling services.

Automatic Crash Response

In a crash, built-in sensors can automatically alert an OnStar Advisor who is immediately connected to the vehicle to see if you need help.

How OnStar Service Works

 : Push this blue button to connect to a specially trained OnStar Advisor to verify your account information and to answer questions.

 : Push this red emergency button to get priority help from specially trained OnStar Emergency Advisors.

 : Push this button for hands-free, voice-activated calling and to give voice commands for Hands-Free Calling and Turn-by-Turn Navigation.

Automatic Crash Response, Emergency Services, Crisis Assist, Stolen Vehicle Assistance, Vehicle Diagnostics, Remote Door Unlock, Roadside Assistance, Turn-by-Turn Navigation, and Hands-Free Calling are available on most vehicles. Not all OnStar services are available on all vehicles. For more information see the OnStar Owner's Guide or visit www.onstar.com (U.S.) or www.onstar.ca (Canada), contact

OnStar at 1-888-4-ONSTAR (1-888-466-7827) or TTY 1-877-248-2080, or push the  button to speak with an OnStar Advisor 24 hours a day, 7 days a week.

For a full description of OnStar services and system limitations, see the OnStar Owner's Guide in the glove box.

OnStar service is subject to the OnStar Terms and Conditions included in the OnStar Glove Box Kit.

OnStar service requires wireless communication networks and the Global Positioning System (GPS) satellite network. Not all OnStar services are available everywhere or on all vehicles at all times.

OnStar service can't work unless your vehicle is in a place where OnStar has an agreement with a wireless service provider for service in that area, and the wireless service provider has coverage, network capacity, reception, and technology compatible with OnStar service. Service involving location information about your vehicle can't work unless GPS signals are available, unobstructed, and compatible with the OnStar hardware. The vehicle has to have a working electrical system and adequate 12-volt battery power for the OnStar equipment to operate. OnStar service may not work if the OnStar equipment isn't properly installed or you haven't maintained it and your vehicle is in good

working order and in compliance with all government regulations. If you try to add, connect, or modify any equipment or software in your vehicle, OnStar service may not work. Other problems OnStar can't control may prevent service to you, such as hills, tall buildings, tunnels, weather, electrical system design and architecture of your vehicle, damage to important parts of your vehicle in a crash, or wireless phone network congestion or jamming.

See *Radio Frequency Statement on page 13-26* for information regarding Part 15 of the Federal Communications Commission (FCC) rules and Industry Canada Standards RSS-210/220/310.



OnStar Steering Wheel Controls

This vehicle may have talk and mute buttons that can be used to interact with OnStar Hands-Free Calling. See *Steering Wheel Controls on page 5-6* for more information.

On some vehicles, the mute button can be used to dial numbers into voice mail systems, or to dial phone extensions. See the OnStar Owner's Guide for more information.

Your Responsibility

Increase the volume of the radio if the OnStar Advisor cannot be heard.

If the light next to the OnStar buttons is red, the system may not be functioning properly. Push the  button and request a vehicle diagnostic check. If the light appears clear or no light appears, your OnStar subscription has expired and all services have been deactivated. Push the  button to confirm that the OnStar equipment is active.

OnStar[®]

If the vehicle is equipped with an active OnStar system, that system may also record data in crash or near crash-like situations. The OnStar Terms and Conditions provides information on data collection and use and is available in the OnStar Glove Box Kit, at www.onstar.com (U.S.) or www.onstar.ca (Canada), or by pushing  and speaking to an Advisor.

Keys, Doors and Windows

Keys and Locks

Keys	2-2
Remote Keyless Entry (RKE) System	2-2
Remote Keyless Entry (RKE) System Operation	2-3
Remote Start	2-7
Door Locks	2-8
Power Door Locks	2-9
Delayed Locking	2-9
Automatic Door Locks	2-10
Lockout Protection	2-10
Safety Locks	2-10

Doors

Hatch	2-10
-------------	------

Vehicle Security

Vehicle Security	2-12
Anti-Theft Alarm System	2-12
Immobilizer	2-12
Immobilizer Operation	2-13

Exterior Mirrors

Convex Mirrors	2-13
Power Mirrors	2-14
Folding Mirrors	2-14
Heated Mirrors	2-14

Interior Mirrors

Automatic Dimming Rearview Mirror	2-15
--	------

Windows

Windows	2-15
Power Windows	2-16
Sun Visors	2-17

Keys and Locks

Keys

WARNING

Leaving children in a vehicle with the Remote Keyless Entry (RKE) transmitter is dangerous for many reasons; children or others could be badly injured or even killed. They could operate the power windows or other controls or even make the vehicle move. The windows will function with the RKE transmitter in the vehicle and they could be seriously injured or killed if caught in the path of a closing window. Do not leave the RKE transmitter in a vehicle with children.

The key that is part of the RKE transmitter can be used for all locks.

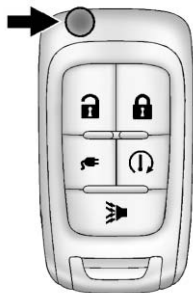

Press the key release button on the RKE transmitter to extend the key. Press the key release button and fold the key blade to retract the key.

The key has a bar-coded key tag that the dealer or qualified locksmith can use to make new keys. Store this information in a safe place, not in the vehicle.

See your dealer if a replacement key or an additional key is needed.

Notice: If the keys get locked in the vehicle, it may have to be damaged to get them out. Always carry a spare key.

If you are locked out of the vehicle, call the Roadside Assistance Center. See *Roadside Assistance Program* on page 13-6.

Remote Keyless Entry (RKE) System

See *Radio Frequency Statement* on page 13-26 for information regarding Part 15 of the Federal Communications Commission (FCC) rules and Industry Canada Standards RSS-210/220/310.

If there is a decrease in the RKE operating range:

- Check the distance. The transmitter may be too far from the vehicle.
- Check the location. Other vehicles or objects may be blocking the signal.
- Check the transmitter's battery. See "Battery Replacement" later in this section.
- If the transmitter is still not working correctly, see your dealer or a qualified technician for service.

Remote Keyless Entry (RKE) System Operation

The RKE transmitter functions will work up to 60 m (195 ft) away from the vehicle.

Keep in mind that other conditions, such as those previously stated, can impact the performance of the transmitter.

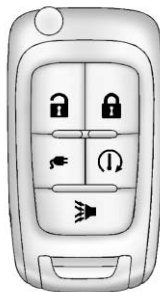

🔓 (Unlock): Press once to unlock the driver door. Press a second time within five seconds to unlock all doors.

The hazard warning lamps will flash twice each time the button is pressed and the anti-theft alarm system will be disarmed. See *Anti-Theft Alarm System on page 2-12*.

🔒 (Lock): Press to lock all doors. The hazard warning lamps will flash once and the anti-theft alarm system will be armed. See *Anti-Theft Alarm System on page 2-12*.

If the driver door is open when **🔒** is pressed, all doors lock and then the driver door will unlock if the Unlocked Door Anti Lock Out feature is enabled through the vehicle personalization. See "Unlocked Door Anti Lock Out Feature" under *Vehicle Personalization on page 5-48* for more information. This may vary based on vehicle personalization.

🚨 (Panic Alarm): Press and release one time to locate the vehicle. The exterior lamps flash and the horn chirps three times. Press and hold for three seconds to sound the panic alarm. The horn sounds and the turn signals flash for 30 seconds. Press again to cancel the panic alarm.

2-4 Keys, Doors and Windows

(1) (Remote Start): Press  and then press and hold (1) within five seconds to start the vehicle's heating or air conditioning systems and rear window defogger from outside the vehicle using the RKE transmitter. See *Remote Start on page 2-7* for more information.

The auto heated seats, if equipped, can be programmed to come on when the vehicle is remotely started. See *Vehicle Personalization on page 5-48* for more information. Also see "Auto Heated Seats" under *Heated Front Seats on page 3-6*.

(2) (Charge Port Door): Press to open the charge port door. See *Plug-In Charging on page 9-44* for more information.

Programming Transmitters to the Vehicle

Only RKE transmitters programmed to this vehicle will work. If a transmitter is lost or stolen, a replacement can be purchased and programmed through your dealer.

When the replacement transmitter is programmed to this vehicle, all remaining transmitters must also be reprogrammed. Any lost or stolen transmitters will no longer work once the new transmitter is programmed. Each vehicle can have up to five transmitters matched to it.

Programming with a Recognized Transmitter

A new transmitter can be programmed to the vehicle when there is one recognized transmitter. For vehicles sold in Canada, two recognized transmitters are required to program a new transmitter. To program, the vehicle must be off and all of the transmitters, both currently recognized and new, must be in the vehicle.

1. Place the recognized transmitter(s) in the cupholder.
2. Insert the vehicle key of the new transmitter into the key lock cylinder on the outside of the

driver door and turn the key to the unlock position five times within 10 seconds.

The Driver Information Center (DIC) displays READY FOR REMOTE #2, 3, 4 OR 5.

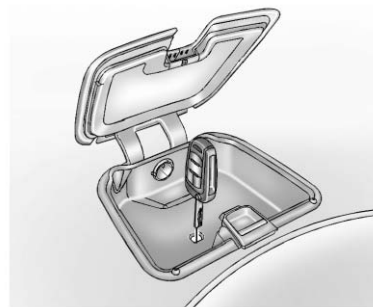

3. Remove the rubber mat in the instrument panel storage. Extend the key blade on the new transmitter and insert the key blade into the transmitter slot.
4. Press and hold the POWER  button on the center stack for two seconds. When the

transmitter is programmed, the DIC will show that it is ready to program the next transmitter.

5. Remove the transmitter from the transmitter slot and press  on the transmitter.

To program additional transmitters, repeat Steps 3 through 5.

When all additional transmitters are programmed, press and hold the POWER  button for 10 seconds to exit programming mode.

Programming without a Recognized Transmitter

Non-Canadian (U.S.) owners are permitted to program a new transmitter to their vehicle when a recognized transmitter is not available. The Canadian regulations require that Canadian owners see their dealer for programming new transmitters when two recognized transmitters are not available.

If there are no currently recognized transmitters available, follow this procedure to program up to five transmitters. This procedure will take approximately 30 minutes to complete. The vehicle must be off and all of the transmitters must be in the vehicle.

1. Insert the vehicle key of the transmitter into the key lock cylinder on the outside of the driver door and turn the key to the unlock position five times within 10 seconds.
The Driver Information Center (DIC) displays REMOTE LEARN PENDING, PLEASE WAIT.
2. Wait for 10 minutes until the DIC displays PRESS START BUTTON TO LEARN and then press the POWER  button on the center stack.

The DIC display will again show REMOTE LEARN PENDING, PLEASE WAIT.

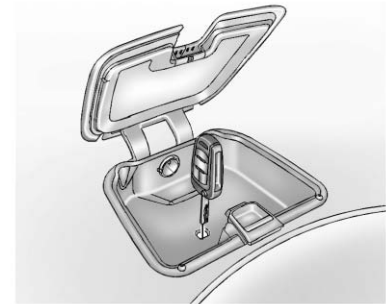

3. Repeat Step 2 two more times. After the third time, all previously known transmitters will no longer work with the vehicle. Remaining transmitters can be programmed during the next steps.

The DIC display should now show READY FOR REMOTE # 1.



4. Remove the rubber mat in the instrument panel storage. Extend the key blade on the new transmitter and insert the key blade into the transmitter slot.

2-6 Keys, Doors and Windows

5. Press and hold the POWER  button for two seconds. When the transmitter is programmed, the DIC will show that it is ready to program the next transmitter.
6. Remove the transmitter from the transmitter slot and press  on the transmitter.

To program additional transmitters, repeat Steps 4 through 6.

When all additional transmitters are programmed, press and hold the POWER  button for 10 seconds to exit programming mode.

Starting the Vehicle with a Low Transmitter Battery

If the transmitter battery is weak, the DIC may display NO REMOTE DETECTED when you try to start the vehicle. The REPLACE BATTERY IN REMOTE KEY message may also be displayed at this time.

To start the vehicle:

1. Open the instrument panel storage and remove the rubber mat.



2. Extend the key blade and place the blade into the slot.
3. With the vehicle in P (Park) or N (Neutral), press the brake pedal and the POWER  button on the center stack. See *Power Button* on page 9-18 for additional information.

Replace the transmitter battery as soon as possible.

Battery Replacement

Notice: When replacing the battery, do not touch any of the circuitry on the transmitter. Static from your body could damage the transmitter.

To replace the battery:

1. Extend the key blade and open the battery cover on the back of the unit.
2. Remove the used battery. Avoid touching the circuit board to other components.
3. Insert the new battery, positive side facing down toward the base.
4. Reassemble the battery cover.
5. Check the operation of the transmitter with the vehicle.

Remote Start

This feature starts the heating or air conditioning systems and rear window defogger from outside the vehicle. Normal operation of the system will return after the vehicle has been turned on.

(Ⓜ) (Remote Start): This button is on the RKE transmitter.

During remote start:

- The climate control system will default to an appropriate heating or cooling mode. See *Automatic Climate Control System on page 8-1* for more information.
- If the vehicle has heated seats, and this feature has been enabled through vehicle personalization, the heated seats will turn on during colder outside temperatures. See “Remote Start Heated Seats” under *Heated Front Seats on page 3-6* and *Vehicle Personalization on page 5-48* for additional information.

- The engine may start to provide energy for heating and cooling, independent of the vehicle being plugged in or completely charged.
- Vehicle range may decrease if the vehicle is not plugged into an electrical outlet. If the vehicle is plugged in, much of the energy needed to support this feature will be provided from the utility, not from the high voltage battery.

Laws in some communities may restrict the use of features that remotely start the engine. For example, some laws may require a person using the remote start feature to have the vehicle in view when doing so. Check local regulations for any requirements on remote starting of vehicles.

With the remote start feature, the RKE transmitter functions will have an increased range of operation. However, the range may be less while the vehicle is running.

Other conditions can affect the performance of the transmitter. See *Remote Keyless Entry (RKE) System on page 2-2* for additional information.

Activating the Remote Start

To heat or cool the passenger compartment using remote start:

1. Aim the RKE transmitter at the vehicle.
2. Press **(Ⓜ)** on the RKE transmitter; the doors will lock.
3. Within five seconds press and hold **(Ⓜ)** until the turn signal lamps flash or for approximately four seconds. Pressing **(Ⓜ)** again during a remote start will turn the feature off.

Remote start will automatically shut off after 10 minutes unless a time extension is done.

While the remote start is active, the parking lamps will turn on and remain on.

2-8 Keys, Doors and Windows

After entering the vehicle during a remote start, press the POWER  button on the center stack with the brake pedal applied to operate as normal.

The remote start can be initiated two separate times between driving. For each remote start, the passenger compartment will be heated or cooled for 10 minutes.



Extending the Time

To extend the time of the first remote start, repeat the steps for activating remote start. Remote start can only be extended one time between driving.

Canceling Remote Start

To cancel a remote start, do any of the following:

- Aim the RKE transmitter at the vehicle and press and hold  until the parking lamps turn off.
- Turn on the hazard warning flashers.

- Press the POWER  button on the center stack, with the brake pedal applied, then press the POWER  button again to turn the vehicle off.

Conditions in Which Remote Start May Not Work

Conditions in which a remote start may not occur include:

- An open hood.
- Vehicle propulsion system fault conditions, including an emission control system malfunction.
- High voltage battery fault conditions.

A second remote start or extension will not occur if the fuel level is low.

During a remote start, conditions in which a remote start may be canceled include:

- Vehicle propulsion system or high voltage battery fault conditions.
- Low engine oil pressure.
- Engine coolant temperature that is too high.

Door Locks

WARNING

Unlocked doors can be dangerous.

- Passengers, especially children, can easily open the doors and fall out of a moving vehicle. The chance of being thrown out of the vehicle in a crash is increased if the doors are not locked. So, all passengers should wear safety belts properly and the

(Continued)

WARNING (Continued)

doors should be locked whenever the vehicle is driven.

- Young children who get into unlocked vehicles may be unable to get out. A child can be overcome by extreme heat and can suffer permanent injuries or even death from heat stroke. Always lock the vehicle whenever leaving it.
- Outsiders can easily enter through an unlocked door when slowing or stopping the vehicle. Lock the doors to help prevent this from happening.

To lock or unlock the door, use the Remote Keyless Entry (RKE) transmitter or the key from outside the vehicle. Use the door lock knob or switch from inside the vehicle.

Power Door Locks

The power door lock switches are on the center stack.

🔒 (Lock): Press to lock the doors.

🔓 (Unlock): Press to unlock the doors.

Delayed Locking

This vehicle may have a delayed locking feature. If delayed locking is enabled, a chime will sound to indicate a door or hatch is open when the doors are locked with the power door lock switch. The doors will automatically lock and the theft-deterrent system will arm after all doors are closed and five seconds have passed. Press the lock button again to make the doors lock immediately. Press the unlock switch to cancel the delayed lock operation. To enable this feature, see “Power Door Locks” in *Vehicle Personalization on page 5-48*. To arm and disarm the theft-deterrent system, see *Anti-Theft Alarm System on page 2-12*.

Automatic Door Locks

Automatic Door Lock

The doors are programmed to automatically lock when the shift lever is moved out of P (Park).

The automatic door lock feature cannot be disabled.

Automatic Door Unlock

The doors can be programmed to automatically unlock when the shift lever is moved into P (Park). See “Power Door Locks” in *Vehicle Personalization on page 5-48*.

Lockout Protection



If the power door lock switch is pressed when the driver door is open and the vehicle is on, all the doors will lock and then the driver door will unlock.

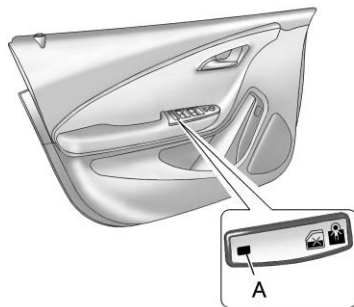

This feature can also be enabled to function when the vehicle is off. To enable this feature, see “Unlocked Door Anti Lock Out” in *Vehicle Personalization on page 5-48*.

Safety Locks



The rear door safety locks prevent passengers from opening the rear doors from inside the vehicle.

Press   to activate the rear door safety locks. The LED light (A) comes on when activated.

Press   again to deactivate the safety locks.

Doors

Hatch

WARNING

Exhaust gases can enter the vehicle if it is driven in Extended Range Mode with the hatch open, or with any objects that pass through the seal between the body and the hatch. Engine exhaust contains Carbon Monoxide (CO) which cannot be seen or smelled. It can cause unconsciousness and even death.

If the vehicle must be driven in Extended Range Mode with the hatch open:

- Do not operate in Mountain Mode if driving with the hatch open.
- Close all of the windows.

(Continued)

WARNING (Continued)

- Fully open the air outlets on the instrument panel.
- Adjust the Climate Control system to a setting that brings in only outside air and set the fan speed to the highest setting. See *Automatic Climate Control System* on page 8-1.

For more information about carbon monoxide, see *Engine Exhaust* on page 9-28.

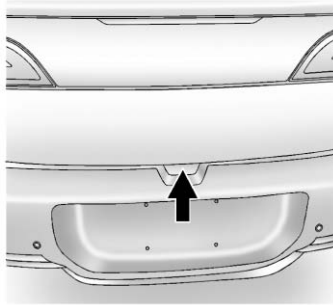

To open the hatch, with all doors unlocked, press the button on the underside of the hatch and lift up.

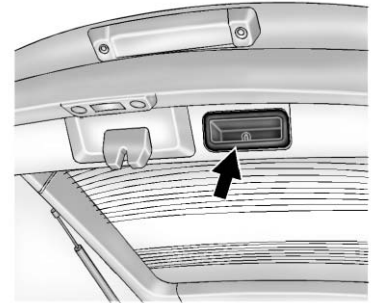

Use the inside pull handle to lower and close the hatch.

Always close the hatch before driving. Do not press the button while closing the hatch; it will unlock again.

Vehicle Security

This vehicle has theft-deterrent features; however, they do not make it impossible to steal.

Anti-Theft Alarm System

This vehicle has an anti-theft alarm system.

Arming the System

To arm the system, close all of the windows and doors and then:

- Press  on the RKE transmitter.
- Or, lock the vehicle using the power door lock switch in the center stack if Unlocked Door Anti Lock Out is turned off. See “Unlocked Door Anti Lock Out” under *Vehicle Personalization on page 5-48* for more information.

The alarm automatically arms after about 30 seconds.

Pressing  on the RKE transmitter a second time will bypass the 30-second delay and immediately arm the system.



Disarming the System

To disarm the system, press  on the RKE transmitter.

Turning off the System Alarm

If there is an attempt to open the doors, hatch, or hood without first pressing  on the RKE transmitter, the system alarm will be activated. The exterior lamps will flash and the horn will sound for about 30 seconds.

To turn off the system alarm:

- Press  on the RKE transmitter.
- Or, start the vehicle by pressing POWER  on the center stack with the brake pedal applied and the RKE transmitter in the vehicle.

Charge Cord Theft Alert

To arm or disarm the charge cord theft alert, lock or unlock the vehicle with the RKE transmitter.

If there is an attempt to remove the charge cord while the vehicle is locked, the system alarm will be activated. To turn off the system alarm, press  on the RKE transmitter.

Immobilizer

See *Radio Frequency Statement on page 13-26* for information regarding Part 15 of the Federal Communications Commission (FCC) rules and Industry Canada Standards RSS-210/220/310.

Immobilizer Operation

This vehicle has a passive theft-deterrent system. The system does not have to be manually armed or disarmed.

The vehicle is automatically immobilized when the vehicle is turned off.

The system is automatically disarmed when the vehicle is started with a valid RKE transmitter in the vehicle. The RKE transmitter uses electronic coding that matches an immobilizer control unit in the vehicle and automatically disarms the system. Only a correct transmitter can be used to turn the vehicle on.



The security light in the instrument cluster comes on if there is a problem with arming or disarming the theft-deterrent system.

When trying to start the vehicle, the security light comes on briefly when the vehicle is turned on.

If the vehicle does not start and the security light stays on, there is a problem with the system. Attempt to turn the vehicle off and try it again.

Do not leave the RKE transmitter in the vehicle.

Exterior Mirrors

Convex Mirrors

 **WARNING**

A convex mirror can make things, like other vehicles, look farther away than they really are. If you cut too sharply into the right lane, you could hit a vehicle on the right. Check the inside mirror or glance over your shoulder before changing lanes.

The passenger side mirror is convex shaped. A convex mirror's surface is curved so more can be seen from the driver seat.

Power Mirrors

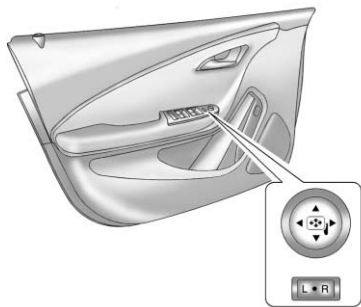

Controls for the outside power mirrors are on the driver door.

To adjust a mirror:

1. Move the selector switch to L (left) or R (right) to choose the driver or passenger mirror.
2. Press the arrows on the control pad to move each mirror in the desired direction.
3. Return the selector switch to the center position.

Folding Mirrors

Manual Foldaway Mirrors

The mirrors can be folded inward toward the vehicle to prevent damage when going through an automatic car wash. Push the mirror outward to return it to the original position.

Heated Mirrors

The vehicle may have heated mirrors.

 **(Rear Window Defogger):** Press to heat the outside rearview mirrors. See “Rear Window Defogger” under *Automatic Climate Control System on page 8-1* for more information.

Interior Mirrors

Automatic Dimming Rearview Mirror

The vehicle has an automatic dimming inside rearview mirror. Automatic dimming reduces the glare from the headlamps of the vehicle behind you. The dimming feature and the indicator light come on each time the vehicle is started. Hold the mirror in the center to adjust it.

Cleaning the Mirror

Do not spray glass cleaner directly on the mirror. Use a soft towel dampened with water.

Windows

WARNING

Leaving children, helpless adults, or pets in a vehicle with the windows closed is dangerous. They can be overcome by the extreme heat and suffer permanent injuries or even death from heat stroke. Never leave a child, a helpless adult, or a pet alone in a vehicle, especially with the windows closed in warm or hot weather.



The vehicle aerodynamics are designed to improve fuel economy performance. This may result in a pulsing sound when either rear window is down and the front windows are up. To reduce the sound, open either a front window or the sunroof (if equipped).

Power Windows

WARNING

Leaving children in a vehicle with the RKE transmitter is dangerous for many reasons; children or others could be badly injured or even killed. They could operate the power windows or other controls or even make the vehicle move. The windows will function with the RKE transmitter in the vehicle and they could be seriously injured or killed if caught in the path of a closing window. Do not leave the RKE transmitter in a vehicle with children.

When there are children in the rear seat, use the window lockout button to prevent unintentional operation of the windows.

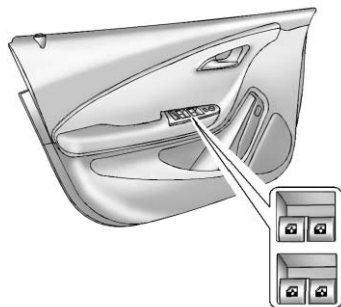

The window switches on the driver door control all windows in the vehicle. Each passenger door has a switch that controls only that window.

Press the front of the switch to open the window. Pull the switch up to close it.

The power windows work when the vehicle is on, or when Retained Accessory Power (RAP) is active. See *Retained Accessory Power (RAP)* on page 9-21.

Express-Down/Up Windows

Windows with an express-down or up feature allow the window to be lowered or raised without holding the switch. The driver window has express-down and up; the passenger and rear windows have only express-down.

Pull a window switch up or push it down all the way, release it, and the window goes up or down automatically. Stop the window by pushing or pulling the switch.

Express Window Anti-Pinch Feature

If any object is in the path of the window when the express-up is active, the window will stop at the obstruction and auto-reverse to a preset factory position. Weather conditions such as severe icing may also cause the window to auto-reverse. The window will return to normal operation once the obstruction or condition is removed.

Express Window Anti-Pinch Override

In an emergency, the anti-pinch feature can be overridden in a supervised mode. Hold the window switch all the way up to the second position. The window will rise for as long as the switch is held. Once the switch is released, the express mode is re-activated.

In this mode, the window can still close on an object in its path. Use care when using the override mode.

Programming the Power Windows

Programming the power windows may be necessary if the 12-volt battery has been disconnected or discharged.

To program the window:

1. Close all doors with the vehicle on, or when Retained Accessory Power (RAP) is active. See *Retained Accessory Power (RAP)* on page 9-21.

2. Pull the window switch to completely close the window. Continue to hold the window switch two seconds after the window is closed.
3. Repeat for each window.

Window Lockout

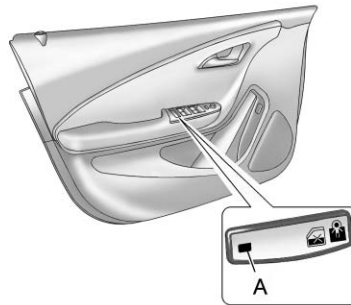

The rear window lockout switch is on the driver door. This feature prevents the rear passenger windows from operating, except from the driver position.

Press  to activate the rear window lockout switch. The LED light (A) comes on when activated.

Press  again to deactivate the lockout switch.

Sun Visors

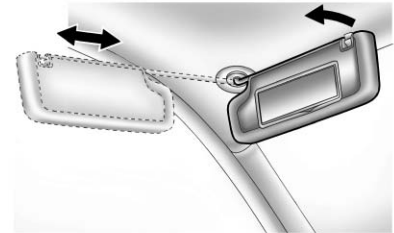

Pull the sun visor down to block glare. Detach the sun visor from the center mount to pivot to the side window, or to extend along the rod, if available.

Seats and Restraints

Head Restraints

Head Restraints 3-2

Front Seats

Seat Adjustment 3-4

Reclining Seatbacks 3-4

Heated Front Seats 3-6

Rear Seats

Rear Seats 3-8

Safety Belts

Safety Belts 3-10

How to Wear Safety Belts

Properly 3-13

Lap-Shoulder Belt 3-19

Safety Belt Use During

Pregnancy 3-23

Safety Belt Extender 3-23

Safety System Check 3-23

Safety Belt Care 3-24

Replacing Safety Belt System

Parts After a Crash 3-24

Airbag System

Airbag System 3-25

Where Are the Airbags? 3-27

When Should an Airbag

Inflate? 3-29

What Makes an Airbag

Inflate? 3-30

How Does an Airbag

Restrain? 3-31

What Will You See After an

Airbag Inflates? 3-31

Passenger Sensing

System 3-33

Servicing the Airbag-Equipped

Vehicle 3-37

Adding Equipment to the

Airbag-Equipped Vehicle ... 3-38

Airbag System Check 3-39

Replacing Airbag System

Parts After a Crash 3-39

Child Restraints

Older Children 3-40

Infants and Young

Children 3-42

Child Restraint Systems 3-44

Where to Put the Restraint ... 3-46

Lower Anchors and Tethers

for Children (LATCH

System) 3-47

Replacing LATCH System

Parts After a Crash 3-54

Securing Child Restraints

(Rear Seat) 3-54

Securing Child Restraints

(Front Passenger Seat) 3-56

Head Restraints

⚠ WARNING

With head restraints that are not installed and adjusted properly, there is a greater chance that occupants will suffer a neck/spinal injury in a crash. Do not drive until the head restraints for all occupants are installed and adjusted properly.

Front Seats

The vehicle's front seats have adjustable head restraints in the outboard seating positions.



Adjust the head restraint so that the top of the restraint is at the same height as the top of the occupant's head. This position reduces the chance of a neck injury in a crash.

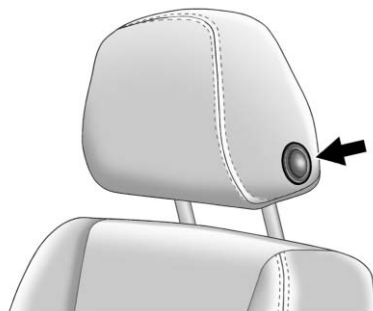

To raise or lower the head restraint, press the button located on the side of the head restraint and pull up or push the head restraint down and release the button.

Pull and push on the head restraint after the button is released to make sure that it is locked in place.

The front seat outboard head restraints are not designed to be removed.

Rear Seats

The vehicle's rear seats have adjustable head restraints in the outboard seating positions.

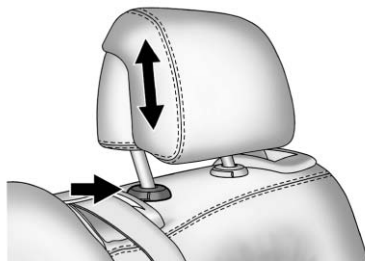

The height of the head restraint can be adjusted. Pull the head restraint up to raise it. Try to move the head restraint to make sure that it is locked in place.

To lower the head restraint, press the button, located on the top of the seatback, and push the head restraint down. Try to move the head restraint after the button is released to make sure that it is locked in place.

If you are installing a child restraint in the rear seat, see “Securing a Child Restraint Designed for the LATCH System” under *Lower Anchors and Tethers for Children (LATCH System)* on page 3-47.

Front Seats

Seat Adjustment

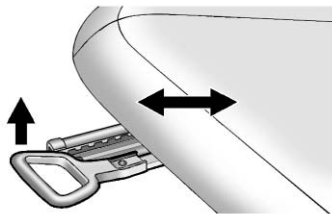

WARNING

You can lose control of the vehicle if you try to adjust a manual driver seat while the vehicle is moving. The sudden movement could startle and confuse you, or make you push a pedal when you do not want to. Adjust the driver seat only when the vehicle is not moving.

To adjust the seat position:

1. Pull the handle at the front of the seat cushion to unlock it.
2. Move the seat forward or rearward and release the handle.
3. Try to move the seat back and forth to be sure it is locked in place.

Seat Height Adjuster

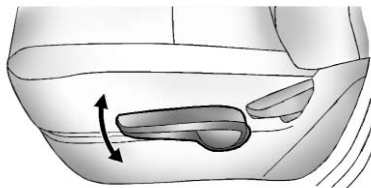

Move the lever up or down to raise or lower the seat.

Reclining Seatbacks

WARNING

You can lose control of the vehicle if you try to adjust a manual driver seat while the vehicle is moving. The sudden movement could startle and confuse you, or make you push a pedal when you do not want to. Adjust the driver seat only when the vehicle is not moving.

WARNING

If either seatback is not locked, it could move forward in a sudden stop or crash. That could cause injury to the person sitting there. Always push and pull on the seatbacks to be sure they are locked.

To recline the seatback:

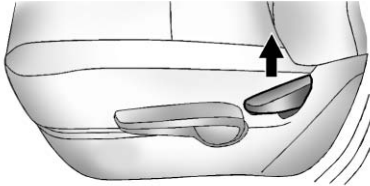

1. Lift the lever.
2. Move the seatback to the desired position, and then release the lever to lock the seatback in place.
3. Push and pull on the seatback to make sure it is locked.

To return the seatback to the upright position:

1. Lift the lever fully without applying pressure to the seatback, and the seatback returns to the upright position.
2. Push and pull on the seatback to make sure it is locked.

⚠ WARNING

Sitting in a reclined position when the vehicle is in motion can be dangerous. Even when buckled up, the safety belts cannot do their job when reclined like this.

The shoulder belt cannot do its job because it will not be against your body. Instead, it will be in front of you. In a crash, you could go into it, receiving neck or other injuries.

The lap belt cannot do its job either. In a crash, the belt could go up over your abdomen. The belt forces would be there, not at your pelvic bones. This could cause serious internal injuries.

(Continued)

WARNING (Continued)

For proper protection when the vehicle is in motion, have the seatback upright. Then sit well back in the seat and wear the safety belt properly.



Do not have a seatback reclined if the vehicle is moving.

3-6 Seats and Restraints



Heated Front Seats

WARNING

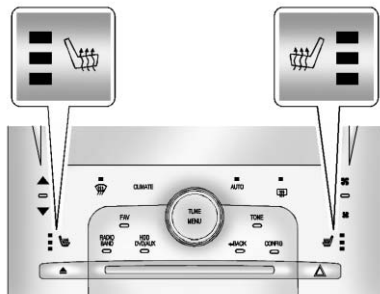
If you cannot feel temperature change or pain to the skin, the seat heater may cause burns even at low temperatures. To reduce the risk of burns, people with such a condition should use care when using the seat heater, especially for long periods of time. Do not place anything on the seat that insulates against heat, such as a blanket, cushion, cover, or similar item. This may cause the seat heater to overheat. An overheated seat heater may cause a burn or may damage the seat.



If available, the controls are on the center stack. To operate, the vehicle must be on.



Press  or  to heat the driver or passenger seat cushion and seatback.

Press the button once for the highest setting. With each press of the button, the heated seat will change to the next lower setting, and then the off setting. Three lights indicate the highest setting and one light the lowest.

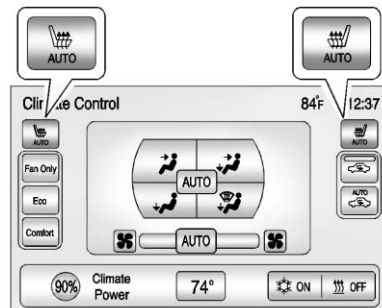
Auto Heated Seats



If available, the controls can be accessed while the vehicle is on by pressing the CLIMATE button on the center stack.

Press the touch screen  AUTO or  AUTO button. The button color will change to green when this feature is on.

When the vehicle is on, this feature will automatically activate the heated seats at the level required by the vehicle's interior temperature. The active high, medium, low, or off heated seat level will be indicated by the manual heated seat button lights on the center stack. Use the manual heated seat buttons on the center stack to turn auto heated seats off.

If the passenger seat is unoccupied, the auto heated seats feature will not activate that seat.

The auto heated seats feature can be programmed to always be enabled when the vehicle is on. See "Auto Heated Seats" under *Vehicle Personalization on page 5-48* for more information.

Remote Start Heated Seats

When it is cold outside, the heated seats can be programmed to turn on automatically during a remote vehicle start. Unless the auto heated seats feature is available and enabled, the heated seats will be canceled when the vehicle is turned on. If the vehicle has auto heated seats and the feature is enabled, the seat heating level will automatically change to the level required by the vehicle's interior temperature.

The indicator lights on the heated seat buttons do not turn on during a remote start.

The temperature performance of an unoccupied seat may be reduced. This is normal.

The heated seats will not turn on during a remote start unless the heated seats feature is enabled in the vehicle personalization menu. See "Remote Start Auto Heat Seats" under *Vehicle Personalization on page 5-48* for more information.

Rear Seats

Folding the Seatback

WARNING

If either seatback is not locked, it could move forward in a sudden stop or crash. That could cause injury to the person sitting there. Always push and pull on the seatbacks to be sure they are locked.

WARNING

A safety belt that is improperly routed, not properly attached, or twisted will not provide the protection needed in a crash. The person wearing the belt could be seriously injured. After raising the rear seatback, always check to be sure that the safety belts are properly routed and attached, and are not twisted.

To fold the seatback down:

Notice: Folding a rear seat with the safety belts still fastened may cause damage to the seat or the safety belts. Always unbuckle the safety belts and return them to their normal stowed position before folding a rear seat.

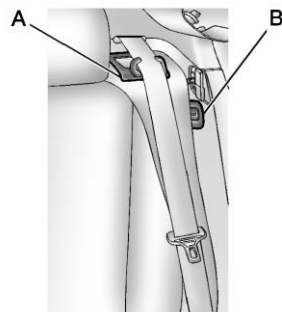

A. Safety Belt Guide

B. Safety Belt Storage Clip

1. Remove the safety belt from the safety belt guide (A) and place it in the storage clip (B).

The safety belt should remain in the storage clip while the seatback is in the folded position.

2. Pull the seatback release lever to unlock the seatback.

A tab near the lever raises when the seatback is unlocked.

3. Fold the seatback forward.

Raising the Seatback

Notice: Damage to the safety belt or rear seat locking mechanism can occur if the safety belt is caught between the rear seatback and the seat locking mechanism. The safety belt must be out of the way when the rear seat is raised to the upright, locked position. If the safety belt is damaged, see your dealer and have it replaced.

To raise the seatback:

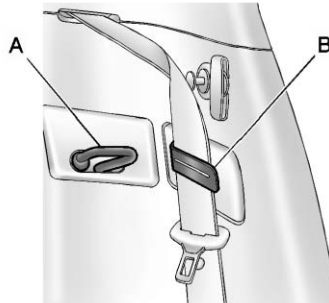

- A. Seatback Locking Mechanism
- B. Safety Belt Storage Clip

1. Make sure the safety belt is in the storage clip (B) before raising the seatback.

The safety belt should not cross the seatback locking mechanism (A) when raising the seatback.

2. Raise the seatback and push it rearward to lock it into place.
A tab near the seatback release lever retracts when the seatback is locked.
3. Push and pull the top of the seatback to be sure it is locked into position.
4. Return the safety belt to the safety belt guide after raising the seatback.

Keep the seat in the upright, locked position when not in use.

Safety Belts

This section of the manual describes how to use safety belts properly. It also describes some things not to do with safety belts.

WARNING

Do not let anyone ride where a safety belt cannot be worn properly. In a crash, if you or your passenger(s) are not wearing safety belts, the injuries can be much worse. You can hit things inside the vehicle harder or be ejected from the vehicle. You and your passenger(s) can be seriously injured or killed. In the same crash, you might not be, if you are buckled up. Always fasten your safety belt, and check that your passenger(s) are restrained properly too.

WARNING

It is extremely dangerous to ride in a cargo area, inside or outside of a vehicle. In a collision, people riding in these areas are more likely to be seriously injured or killed. Do not allow people to ride in any area of your vehicle that is not equipped with seats and safety belts. Be sure everyone in the vehicle is in a seat and using a safety belt properly.

This vehicle has indicators as a reminder to buckle the safety belts. See *Safety Belt Reminders* on page 5-17 for additional information.

In most states and in all Canadian provinces, the law requires wearing safety belts. Here is why:

You never know if you will be in a crash. If you do have a crash, you do not know if it will be a serious one.

A few crashes are mild, and some crashes can be so serious that even buckled up, a person would not survive. But most crashes are in between. In many of them, people who buckle up can survive and sometimes walk away. Without safety belts they could have been badly hurt or killed.

After more than 40 years of safety belts in vehicles, the facts are clear. In most crashes buckling up does matter ... a lot!

Why Safety Belts Work

When you ride in or on anything, you go as fast as it goes.

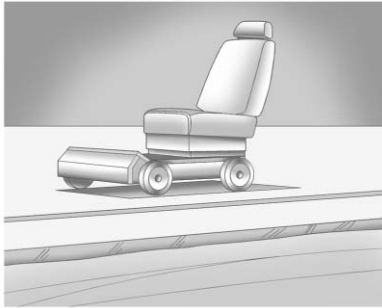

Take the simplest vehicle. Suppose it is just a seat on wheels.

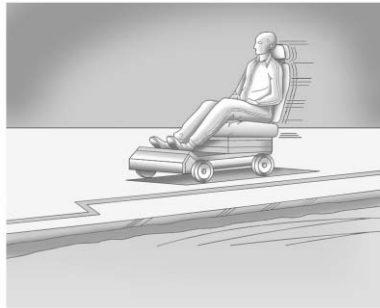

Put someone on it.

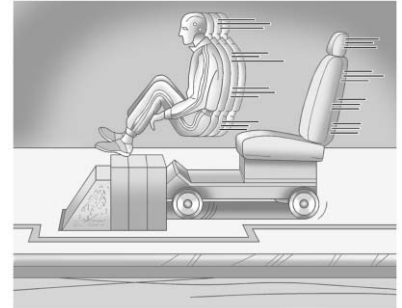

Get it up to speed. Then stop the vehicle. The rider does not stop.

3-12 Seats and Restraints

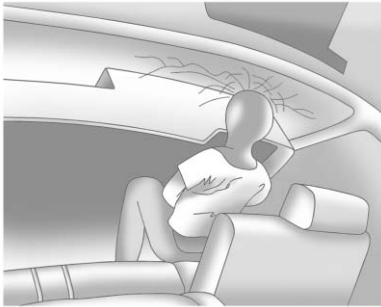

The person keeps going until stopped by something. In a real vehicle, it could be the windshield...

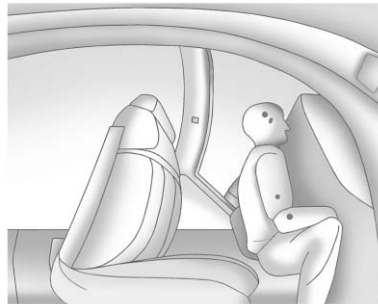

or the instrument panel...



or the safety belts!

With safety belts, you slow down as the vehicle does. You get more time to stop. You stop over more distance, and your strongest bones take the forces. That is why safety belts make such good sense.

Questions and Answers About Safety Belts

Q: Will I be trapped in the vehicle after a crash if I am wearing a safety belt?

A: You *could* be — whether you are wearing a safety belt or not. But your chance of being conscious during and after an accident, so you *can* unbuckle and get out, is *much* greater if you are belted. And you can unbuckle a safety belt, even if you are upside down.

Q: If my vehicle has airbags, why should I have to wear safety belts?

A: Airbags are supplemental systems only; so they work *with* safety belts — not instead of them. Whether or not an airbag is provided, all occupants still have to buckle up to get the most protection. That is true not only in frontal collisions, but especially in side and other collisions.

Q: If I am a good driver, and I never drive far from home, why should I wear safety belts?

A: You may be an excellent driver, but if you are in a crash — even one that is not your fault — you and your passenger(s) can be hurt. Being a good driver does not protect you from things beyond your control, such as bad drivers.

Most accidents occur within 40 km (25 mi) of home. And the greatest number of serious injuries and deaths occur at speeds of less than 65 km/h (40 mph).

Safety belts are for everyone.

How to Wear Safety Belts Properly

This section is only for people of adult size.

Be aware that there are special things to know about safety belts and children. And there are different rules for smaller children and infants. If a child will be riding in the vehicle, see *Older Children on page 3-40* or *Infants and Young Children on page 3-42*. Follow those rules for everyone's protection.

It is very important for all occupants to buckle up. Statistics show that unbelted people are hurt more often in crashes than those who are wearing safety belts.

Occupants who are not buckled up can be thrown out of the vehicle in a crash. And they can strike others in the vehicle who are wearing safety belts.

3-14 Seats and Restraints

First, before you or your passenger(s) wear a safety belt, there is important information you should know.

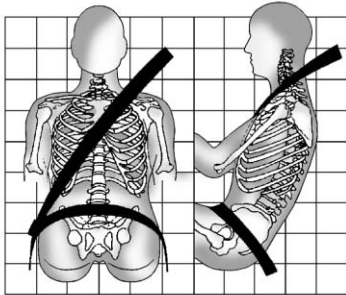

Sit up straight and always keep your feet on the floor in front of you. The lap part of the belt should be worn low and snug on the hips, just touching the thighs.

In a crash, this applies force to the strong pelvic bones and you would be less likely to slide under the lap belt. If you slid under it, the belt would apply force on your abdomen. This could cause serious or even fatal injuries. The shoulder belt should go over the shoulder and across the chest. These parts of the body are best able to take belt restraining forces.

The shoulder belt locks if there is a sudden stop or crash.

Q: What is wrong with this?

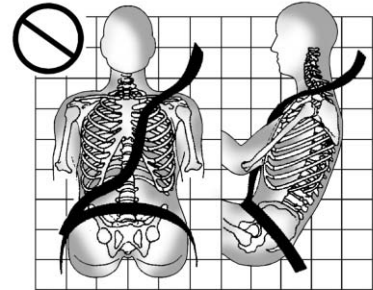

A: The shoulder belt is too loose. It will not give as much protection this way.

⚠ WARNING

You can be seriously hurt if the shoulder belt is too loose. In a crash, you would move forward too much, which could increase injury. The shoulder belt should fit snugly against your body.

Q: What is wrong with this?

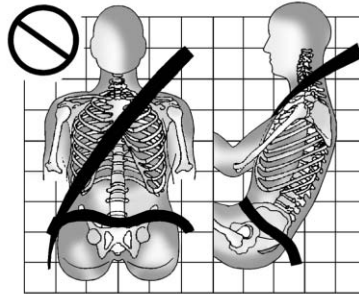

A: The lap belt is too loose. It will not give nearly as much protection this way.

⚠ WARNING

You can be seriously hurt if the lap belt is too loose. In a crash, you could slide under the lap belt and apply force on your abdomen. This could cause serious or even fatal injuries. The lap belt should be worn low and snug on the hips, just touching the thighs.

3-16 Seats and Restraints

Q: What is wrong with this?

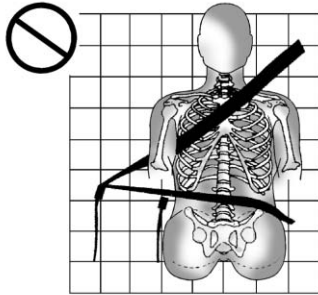

A: The belt is buckled in the wrong buckle.

WARNING

You can be seriously injured if the belt is buckled in the wrong place like this. In a crash, the belt would go up over your abdomen. The belt forces would be there, not on the pelvic bones. This could cause serious internal injuries. Always buckle the belt into the buckle nearest you.

Q: What is wrong with this?

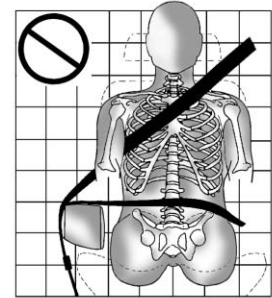

A: The belt is over an armrest.

⚠ WARNING

You can be seriously injured if the belt goes over an armrest like this. The belt would be much too high. In a crash, you can slide under the belt. The belt force would then be applied on the abdomen, not on the pelvic bones, and that could cause serious or fatal injuries. Be sure the belt goes under the armrests.

Q: What is wrong with this?

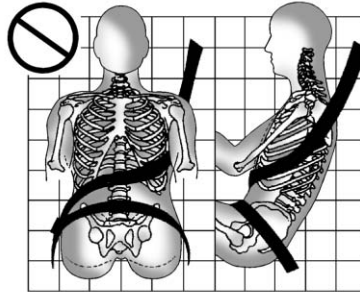

A: The shoulder belt is worn under the arm. It should be worn over the shoulder at all times.

⚠ WARNING

You can be seriously injured if you wear the shoulder belt under your arm. In a crash, your body would move too far forward, which would increase the chance of head and neck injury. Also, the belt would apply too much force to the ribs, which are not as strong as shoulder bones. You could also severely injure internal organs like your liver or spleen. The shoulder belt should go over the shoulder and across the chest.

3-18 Seats and Restraints

Q: What is wrong with this?

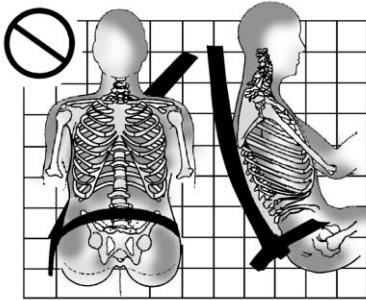

A: The belt is behind the body.

WARNING

You can be seriously injured by not wearing the lap-shoulder belt properly. In a crash, you would not be restrained by the shoulder belt. Your body could move too far forward increasing the chance of head and neck injury. You might also slide under the lap belt. The belt force would then be applied right on the abdomen. That could cause serious or fatal injuries. The shoulder belt should go over the shoulder and across the chest.

Q: What is wrong with this?

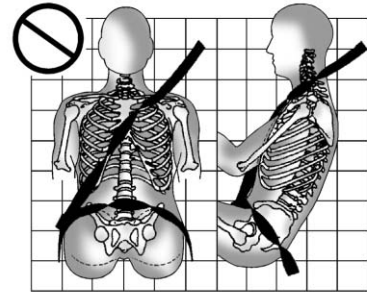

A: The belt is twisted across the body.

⚠ WARNING

You can be seriously injured by a twisted belt. In a crash, you would not have the full width of the belt to spread impact forces. If a belt is twisted, make it straight so it can work properly, or ask your dealer to fix it.

Lap-Shoulder Belt

All seating positions in the vehicle have a lap-shoulder belt.

The following instructions explain how to wear a lap-shoulder belt properly.

1. If the seat has a safety belt guide, and the safety belt is not routed through the guide, slide the edge of the belt webbing through the opening on the guide. Be sure the belt is not twisted.

2. Adjust the seat, if the seat is adjustable, so you can sit up straight. To see how, see "Seats" in the Index.
3. Pick up the latch plate and pull the belt across you. Do not let it get twisted.

The lap-shoulder belt may lock if you pull the belt across you very quickly. If this happens, let the belt go back slightly to unlock it. Then pull the belt across you more slowly.

If the shoulder portion of a passenger belt is pulled out all the way, the child restraint locking feature may be engaged. If this happens, let the belt go back all the way and start again.

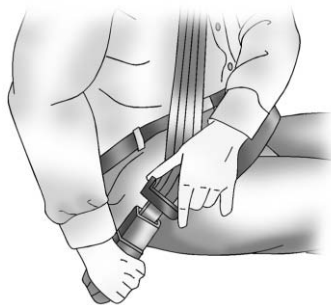

4. Push the latch plate into the buckle until it clicks.
Pull up on the latch plate to make sure it is secure. If the belt is not long enough, see *Safety Belt Extender* on page 3-23.
Position the release button on the buckle so that the safety belt could be quickly unbuckled if necessary.

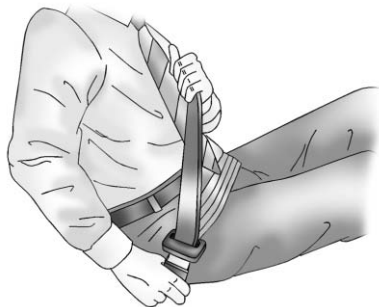

5. To make the lap part tight, pull up on the shoulder belt.

It may be necessary to pull stitching on the safety belt through the latch plate to fully tighten the lap belt on smaller occupants.

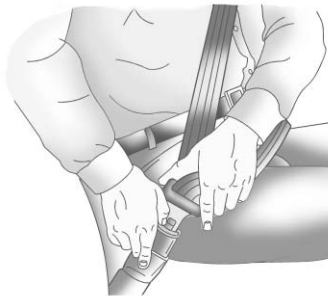

To unlatch the belt, push the button on the buckle. The belt should return to its stowed position.

Before a door is closed, be sure the safety belt is out of the way. If a door is slammed against a safety belt, damage can occur to both the safety belt and the vehicle.

Safety Belt Pretensioners

This vehicle has safety belt pretensioners for front outboard occupants. Although the safety belt pretensioners cannot be seen, they are part of the safety belt assembly. They can help tighten the safety belts during the early stages of a moderate to severe frontal, near frontal, or rear crash if the threshold conditions for pretensioner activation are met.

And, if the vehicle has side impact airbags, safety belt pretensioners can help tighten the safety belts in a side crash or a rollover event.

Pretensioners work only once. If the pretensioners activate in a crash, they need to be replaced, and other new parts for the vehicle's safety belt system may be required. See *Replacing Safety Belt System Parts After a Crash* on page 3-24.

Rear Safety Belt Comfort Guides

This vehicle may have rear safety belt comfort guides. If not, they are available through your dealer. The guides may provide added safety belt comfort for older children who have outgrown booster seats and for some adults. When installed and properly adjusted, the comfort guide positions the belt away from the neck and head.

There is one guide, if equipped, for each outside passenger position in the rear seat. When using a comfort guide, remove the safety belt from the seat-mounted guide before using the comfort guide. To install a comfort guide to the safety belt:

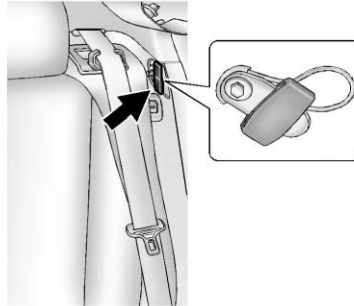

1. Remove the guide from its storage clip on the interior body trim next to the rear seat.

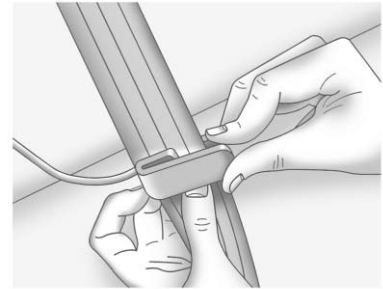

2. Place the guide over the belt, and insert the two edges of the belt into the slots of the guide.

3-22 Seats and Restraints

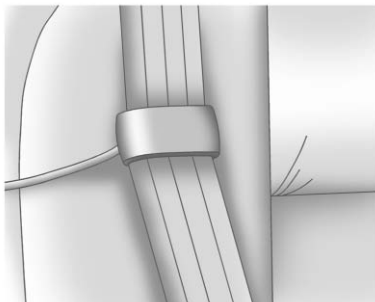

3. The belt should not be twisted and it should lie flat. The elastic cord must be under the belt and the guide on top.

WARNING

A safety belt that is not properly worn may not provide the protection needed in a crash. The person wearing the belt could be seriously injured. The shoulder belt should go over the shoulder and across the chest. These parts of the body are best able to take belt restraining forces.



4. Buckle, position, and release the safety belt as described previously in this section. Make sure that the shoulder belt crosses the shoulder.

To remove and store the comfort guide, squeeze the belt edges together so that the safety belt can be removed from the guide. Slide the guide back into its storage clip located on the interior body trim next to the side of the seatback.

Safety Belt Use During Pregnancy

Safety belts work for everyone, including pregnant women. Like all occupants, they are more likely to be seriously injured if they do not wear safety belts.



A pregnant woman should wear a lap-shoulder belt, and the lap portion should be worn as low as possible, below the rounding, throughout the pregnancy.

The best way to protect the fetus is to protect the mother. When a safety belt is worn properly, it is more likely that the fetus will not be hurt in a crash. For pregnant women, as for anyone, the key to making safety belts effective is wearing them properly.

Safety Belt Extender

If the vehicle's safety belt will fasten around you, you should use it.

But if a safety belt is not long enough, your dealer will order you an extender. When you go in to order it, take the heaviest coat you will wear, so the extender will be long enough for you. To help avoid personal injury, do not let someone else use it, and use it only for the seat it is made to fit. The extender has been designed for adults. Never use it for securing child seats. To wear it, attach it to the regular safety belt. For more information, see the instruction sheet that comes with the extender.

Safety System Check

Now and then, check that the safety belt reminder light, safety belts, buckles, latch plates, retractors, and anchorages are working properly. Look for any other loose or damaged safety belt system parts that might keep a safety belt system from doing its job. See your dealer to have it repaired. Torn or frayed safety belts may not protect you in a crash. They can rip apart under impact forces. If a belt is torn or frayed, get a new one right away.

Make sure the safety belt reminder light is working. See *Safety Belt Reminders on page 5-17* for more information.

Keep safety belts clean and dry. See *Safety Belt Care on page 3-24*.

Safety Belt Care

Keep belts clean and dry.

 **WARNING**

Do not bleach or dye safety belts. It may severely weaken them. In a crash, they might not be able to provide adequate protection. Clean safety belts only with mild soap and lukewarm water.

Replacing Safety Belt System Parts After a Crash

 **WARNING**

A crash can damage the safety belt system in the vehicle. A damaged safety belt system may not properly protect the person using it, resulting in serious injury or even death in a crash. To help make sure the safety belt systems are working properly after a crash, have them inspected and any necessary replacements made as soon as possible.

After a minor crash, replacement of safety belts may not be necessary. But the safety belt assemblies that were used during any crash may have been stressed or damaged. See your dealer to have the safety belt assemblies inspected or replaced.

New parts and repairs may be necessary even if the safety belt system was not being used at the time of the crash.

Have the safety belt pretensioners checked if the vehicle has been in a crash, or if the airbag readiness light stays on after you start the vehicle or while you are driving. See *Airbag Readiness Light* on page 5-18.

Airbag System

The vehicle has the following airbags:

- A frontal airbag for the driver.
- A frontal airbag for the right front passenger.
- A knee airbag for the driver.
- A knee airbag for the front passenger.
- A seat-mounted side impact airbag for the driver.
- A seat-mounted side impact airbag for the right front passenger.

- A roof-rail airbag for the driver and the passenger seated directly behind the driver.
- A roof-rail airbag for the right front passenger and the passenger seated directly behind the right front passenger.

All of the airbags in the vehicle will have the word AIRBAG embossed in the trim or on an attached label near the deployment opening.

For frontal airbags, the word AIRBAG will appear on the middle part of the steering wheel for the driver and on the instrument panel for the right front passenger.

With knee airbags, the word AIRBAG will appear on the lower portion of the instrument panel.

With seat-mounted side impact airbags, the word AIRBAG will appear on the side of the seatback closest to the door.

With roof-rail airbags, the word AIRBAG will appear along the headliner or trim.

Airbags are designed to supplement the protection provided by safety belts. Even though today's airbags are also designed to help reduce the risk of injury from the force of an inflating bag, all airbags must inflate very quickly to do their job.

3-26 Seats and Restraints

Here are the most important things to know about the airbag system:

WARNING

You can be severely injured or killed in a crash if you are not wearing a safety belt — even if the vehicle has airbags. Airbags are designed to work with safety belts, but do not replace them.

Also, airbags are not designed to deploy in every crash. In some crashes safety belts are the only restraint. See *When Should an Airbag Inflate?* on page 3-29.

Wearing a safety belt during a crash helps reduce your chance of hitting things inside the vehicle or being ejected from it. Airbags are “supplemental restraints” to the safety belts. Everyone in the vehicle should wear a safety belt properly — whether or not there is an airbag for that person.

WARNING

Airbags inflate with great force, faster than the blink of an eye. Anyone who is up against, or very close to, any airbag when it inflates can be seriously injured or killed. Do not sit unnecessarily close to any airbag, as you would be if you were sitting on the edge of the seat or leaning forward.

Safety belts help keep you in position before and during a crash. Always wear a safety belt, even with airbags. The driver should sit as far back as possible while still maintaining control of the vehicle.

Occupants should not lean on or sleep against the door or side windows in seating positions with seat-mounted side impact airbags and/or roof-rail airbags.

WARNING

Children who are up against, or very close to, any airbag when it inflates can be seriously injured or killed. Airbags plus lap-shoulder belts offer protection for adults and older children, but not for young children and infants. Neither the vehicle's safety belt system nor its airbag system is designed for them. Young children and infants need the protection that a child restraint system can provide. Always secure children properly in the vehicle. To read how, see *Older Children* on page 3-40 or *Infants and Young Children* on page 3-42.



There is an airbag readiness light on the instrument cluster, which shows the airbag symbol. The system checks the airbag electrical system for malfunctions. The light tells you if there is an electrical problem. See *Airbag Readiness Light* on page 5-18 for more information.

Where Are the Airbags?

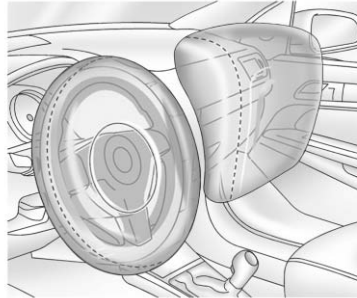

The driver frontal airbag is in the middle of the steering wheel.

The right front passenger frontal airbag is in the instrument panel on the passenger side.

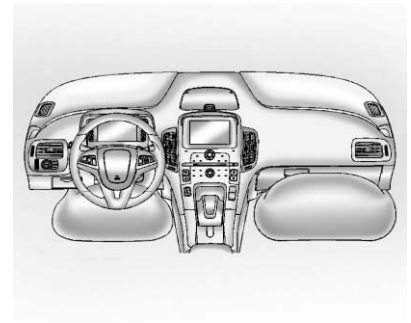

The driver knee airbag is below the steering column. The right front passenger knee airbag is below the glove box.

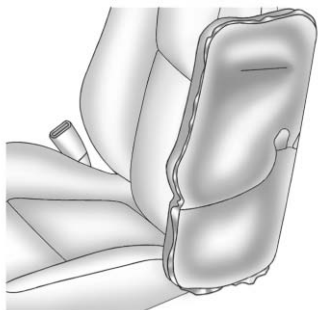

Driver Side Shown, Passenger Side Similar

The seat-mounted side impact airbags for the driver and right front passenger are in the side of the seatbacks closest to the door.



Driver Side Shown, Passenger Side Similar

The roof-rail airbags for the driver, right front passenger, and second row outboard passengers are in the ceiling above the side windows.

⚠ WARNING

If something is between an occupant and an airbag, the airbag might not inflate properly or it might force the object into that person causing severe injury
(Continued)

WARNING (Continued)

or even death. The path of an inflating airbag must be kept clear. Do not put anything between an occupant and an airbag, and do not attach or put anything on the steering wheel hub or on or near any other airbag covering.

Do not use seat accessories that block the inflation path of a seat-mounted side impact airbag.

Never secure anything to the roof of a vehicle with roof-rail airbags by routing a rope or tie down through any door or window opening. If you do, the path of an inflating roof-rail airbag will be blocked.

When Should an Airbag Inflate?

Frontal airbags are designed to inflate in moderate to severe frontal or near frontal crashes to help reduce the potential for severe injuries mainly to the driver's or right front passenger's head and chest. However, they are only designed to inflate if the impact exceeds a predetermined deployment threshold. Deployment thresholds are used to predict how severe a crash is likely to be in time for the airbags to inflate and help restrain the occupants.

Whether the frontal airbags will or should deploy is not based on how fast your vehicle is traveling. It depends largely on what you hit, the direction of the impact, and how quickly your vehicle slows down.

Frontal airbags may inflate at different crash speeds. For example:

- If the vehicle hits a stationary object, the airbags could inflate at a different crash speed than if the vehicle hits a moving object.
- If the vehicle hits an object that deforms, the airbags could inflate at a different crash speed than if the vehicle hits an object that does not deform.
- If the vehicle hits a narrow object (like a pole), the airbags could inflate at a different crash speed than if the vehicle hits a wide object (like a wall).
- If the vehicle goes into an object at an angle, the airbags could inflate at a different crash speed than if the vehicle goes straight into the object.

Thresholds can also vary with specific vehicle design.

Frontal airbags are not intended to inflate during vehicle rollovers, rear impacts, or in many side impacts.

In addition the vehicle has dual-stage frontal airbags. Dual-stage airbags adjust the restraint according to crash severity.

Frontal knee airbags are designed to inflate in moderate to severe frontal or near frontal impacts that exceed a predetermined deployment threshold.

The vehicle has electronic frontal sensors, which help the sensing system distinguish between a moderate frontal impact and a more severe frontal impact. For moderate frontal impacts, dual-stage airbags inflate at a level less than full deployment. For more severe frontal impacts, full deployment occurs.

3-30 Seats and Restraints

The vehicle has seat-mounted side impact airbags and roof-rail airbags. See *Airbag System* on page 3-25. Seat-mounted side impact and roof-rail airbags are intended to inflate in moderate to severe side crashes. In addition, these roof-rail airbags are intended to inflate during a rollover or in a severe frontal impact. Seat-mounted side impact and roof-rail airbags will inflate if the crash severity is above the system's designed threshold level. The threshold level can vary with specific vehicle design.

Roof-rail airbags are not intended to inflate in rear impacts. A seat-mounted side impact airbag is intended to deploy on the side of the vehicle that is struck. Both roof-rail airbags will deploy when either side

of the vehicle is struck or if the sensing system predicts that the vehicle is about to roll over, or in a severe frontal impact.

In any particular crash, no one can say whether an airbag should have inflated simply because of the damage to a vehicle or because of what the repair costs were. For frontal airbags, inflation is determined by what the vehicle hits, the angle of the impact, and how quickly the vehicle slows down. For seat-mounted side impact and roof-rail airbags, deployment is determined by the location and severity of the side impact.

In a rollover event, roof-rail airbag deployment is determined by the direction of the roll.

What Makes an Airbag Inflate?

In a deployment event, the sensing system sends an electrical signal triggering a release of gas from the inflator. Gas from the inflator fills the airbag causing the bag to break out of the cover and deploy. The inflator, the airbag, and related hardware are all part of the airbag module.

Frontal airbag modules are located inside the steering wheel and instrument panel. For vehicles with knee airbags, there are airbag modules below the steering column and below the glove box. For vehicles with seat-mounted side impact airbags, there are airbag modules in the side of the front seatbacks closest to the door. For vehicles with roof-rail airbags, there are airbag modules in the ceiling of the vehicle, near the side windows that have occupant seating positions.

How Does an Airbag Restrain?

In moderate to severe frontal or near frontal collisions, even belted occupants can contact the steering wheel or the instrument panel. In moderate to severe side collisions, even belted occupants can contact the inside of the vehicle.

Airbags supplement the protection provided by safety belts. Frontal airbags with knee airbags distribute the force of the impact more evenly over the occupant's body, stopping the occupant more gradually.

Seat-mounted side impact and roof-rail airbags distribute the force of the impact more evenly over the occupant's upper body.

Rollover capable roof-rail airbags are designed to help contain the head and chest of occupants in the outboard seating positions in the first and second rows. The rollover capable roof-rail airbags are designed to help reduce the risk of full or partial ejection in rollover events, although no system can prevent all such ejections.

But airbags would not help in many types of collisions, primarily because the occupant's motion is not toward those airbags. See *When Should an Airbag Inflate?* on page 3-29 for more information.

Airbags should never be regarded as anything more than a supplement to safety belts.

What Will You See After an Airbag Inflates?

After the frontal airbags and seat-mounted side impact airbags inflate, they quickly deflate, so quickly that some people may not even realize an airbag inflated. Roof-rail airbags may still be at least partially inflated for some time after they deploy. Some components of the airbag module may be hot for several minutes. For location of the airbag modules, see *What Makes an Airbag Inflate?* on page 3-30.

3-32 Seats and Restraints

The parts of the airbag that come into contact with you may be warm, but not too hot to touch. There may be some smoke and dust coming from the vents in the deflated airbags. Airbag inflation does not prevent the driver from seeing out of the windshield or being able to steer the vehicle, nor does it prevent people from leaving the vehicle.

WARNING

When an airbag inflates, there may be dust in the air. This dust could cause breathing problems for people with a history of asthma or other breathing trouble. To avoid this, everyone in the vehicle should get out as soon as it is safe to do so. If you have breathing problems but cannot get out of the vehicle after an airbag inflates, then get fresh air by opening a window or a door. If you experience breathing

(Continued)

WARNING (Continued)

problems following an airbag deployment, you should seek medical attention.

The vehicle has a feature that may automatically unlock the doors, turn on the interior lamps and hazard warning flashers, and shut off the fuel system after the airbags inflate. You can lock the doors, turn off the interior lamps and hazard warning flashers by using the controls for those features.

WARNING

A crash severe enough to inflate the airbags may have also damaged important functions in the vehicle, such as the fuel system, brake and steering systems, etc. Even if the vehicle appears to be drivable after a

(Continued)

WARNING (Continued)

moderate crash, there may be concealed damage that could make it difficult to safely operate the vehicle.

Use caution if attempting to restart the vehicle after a crash has occurred.

In many crashes severe enough to inflate the airbag, windshields are broken by vehicle deformation. Additional windshield breakage may also occur from the right front passenger airbag.

- Airbags are designed to inflate only once. After an airbag inflates, you will need some new parts for the airbag system. If you do not get them, the airbag system will not be there to help protect you in another crash. A new system will include airbag modules and possibly

other parts. The service manual for your vehicle covers the need to replace other parts.

- The vehicle has a crash sensing and diagnostic module which records information after a crash. See *Vehicle Data Recording and Privacy on page 13-24* and *Event Data Recorders on page 13-24*.
- Let only qualified technicians work on the airbag systems. Improper service can mean that an airbag system will not work properly. See your dealer for service.

Passenger Sensing System

The vehicle has a passenger sensing system for the right front passenger position. The passenger airbag status indicator will be visible on the overhead console when the vehicle is started.



The words ON and OFF are visible during the system check. When the system check is complete, either the word ON or OFF will be visible. See *Passenger Airbag Status Indicator on page 5-18*.

The passenger sensing system turns off the right front passenger frontal airbag and the knee airbag on the passenger side, under certain conditions. The driver airbag, the driver knee airbag, the seat-mounted side impact airbags, and the roof-rail airbags are not affected by the passenger sensing system.

The passenger sensing system works with sensors that are part of the right front passenger seat. The sensors are designed to detect the presence of a properly seated occupant and determine if the right front passenger frontal airbag and passenger knee airbag should be enabled (may inflate) or not.

According to accident statistics, children are safer when properly secured in a rear seat in a correct child restraint for their weight and size.

3-34 Seats and Restraints

We recommend that children be secured in a rear seat, including: an infant or a child riding in a rear-facing child restraint; a child riding in a forward-facing child seat; an older child riding in a booster seat; and children, who are large enough, using safety belts.

A label on the sun visor says, "Never put a rear-facing child seat in the front." This is because the risk to the rear-facing child is so great, if the airbag deploys.

WARNING

A child in a rear-facing child restraint can be seriously injured or killed if the right front passenger airbag inflates. This is because the back of the rear-facing child restraint would be very close to the inflating airbag. A child in a forward-facing child restraint can be seriously injured or killed if the right front

(Continued)

WARNING (Continued)

passenger airbag inflates and the passenger seat is in a forward position.

Even if the passenger sensing system has turned off the right front passenger airbag(s), no system is fail-safe. No one can guarantee that an airbag will not deploy under some unusual circumstance, even though the airbag(s) are turned off.

Secure rear-facing child restraints in a rear seat, even if the airbag(s) are off. If you secure a forward-facing child restraint in the right front seat, always move the front passenger seat as far back as it will go. It is better to secure the child restraint in a rear seat.

The passenger sensing system is designed to turn off the right front passenger airbag and passenger knee airbag if:

- The right front passenger seat is unoccupied.
- The system determines that an infant is present in a child restraint.
- A right front passenger takes his/her weight off of the seat for a period of time.
- Or, if there is a critical problem with the airbag system or the passenger sensing system.

When the passenger sensing system has turned off the right front passenger frontal airbag and passenger knee airbag, the off indicator will light and stay lit to remind you that the airbags are off. See *Passenger Airbag Status Indicator* on page 5-18.

The passenger sensing system is designed to turn on (may inflate) the right front passenger frontal airbag and passenger knee airbag anytime the system senses that a person of adult size is sitting properly in the right front passenger seat.

When the passenger sensing system has allowed the airbags to be enabled, the on indicator will light and stay lit to remind you that the airbags are active.

For some children, including children in child restraints, and for very small adults, the passenger sensing system may or may not turn off the right front passenger frontal airbag and passenger knee airbag, depending upon the person's seating posture and body build. Everyone in the vehicle who has outgrown child restraints should wear a safety belt properly — whether or not there is an airbag for that person.

 **WARNING**

If the airbag readiness light ever comes on and stays on, it means that something may be wrong with the airbag system. To help avoid injury to yourself or others, have the vehicle serviced right away. See *Airbag Readiness Light* on page 5-18 for more information, including important safety information.

If the On Indicator is Lit for a Child Restraint

If a child restraint has been installed and the on indicator is lit:

1. Turn the vehicle off.
2. Remove the child restraint from the vehicle.
3. Remove any additional items from the seat such as blankets, cushions, seat covers, seat heaters, or seat massagers.

4. Reinstall the child restraint following the directions provided by the child restraint manufacturer and refer to *Securing Child Restraints (Rear Seat)* on page 3-54 or *Securing Child Restraints (Front Passenger Seat)* on page 3-56.
5. If, after reinstalling the child restraint and restarting the vehicle, the on indicator is still lit, turn the vehicle off. Then slightly recline the vehicle seatback and adjust the seat cushion, if adjustable, to make sure that the vehicle seatback is not pushing the child restraint into the seat cushion.

Also make sure the child restraint is not trapped under the vehicle head restraint. If this happens, adjust the head restraint. See *Head Restraints* on page 3-2.
6. Restart the vehicle.

3-36 Seats and Restraints

The passenger sensing system may or may not turn off the airbags for a child in a child restraint depending upon the child's seating posture and body build. It is better to secure a child restraint in a rear seat.

If the Off Indicator is Lit for an Adult-Size Occupant



If a person of adult size is sitting in the right front passenger seat, but the off indicator is lit, it could be because that person is not sitting

properly in the seat. If this happens, use the following steps to allow the system to detect that person and enable the right front passenger frontal airbag and passenger knee airbag:

1. Turn the vehicle off.
2. Remove any additional material from the seat, such as blankets, cushions, seat covers, seat heaters, or seat massagers.
3. Place the seatback in the fully upright position.
4. Have the person sit upright in the seat, centered on the seat cushion, with legs comfortably extended.
5. Restart the vehicle and have the person remain in this position for two to three minutes after the on indicator is lit.

Additional Factors Affecting System Operation

Safety belts help keep the passenger in position on the seat during vehicle maneuvers and braking, which helps the passenger sensing system maintain the passenger airbag status. See "Safety Belts" and "Child Restraints" in the Index for additional information about the importance of proper restraint use.

A thick layer of additional material, such as a blanket or cushion, or aftermarket equipment such as seat covers, seat heaters, and seat massagers can affect how well the passenger sensing system operates. We recommend that you not use seat covers or other aftermarket equipment except when approved by GM for your specific vehicle. See *Adding Equipment to the Airbag-Equipped Vehicle* on page 3-38 for more information about modifications that can affect how the system operates.

A wet seat can affect the performance of the passenger sensing system. Here is how:

- The passenger sensing system may turn off the passenger frontal airbag and passenger knee airbag when liquid is soaked into the seat. If this happens, the off indicator will be lit, and the airbag readiness light on the instrument panel will also be lit.
- Liquid pooled on the seat that has not soaked in may make it more likely that the passenger sensing system will enable (turn on) the passenger frontal airbag and passenger knee airbag while a child restraint or child occupant is on the seat. If the passenger frontal airbag and passenger knee airbag are turned on, the on indicator will be lit.

If the passenger seat gets wet, dry the seat immediately. If the airbag readiness light is lit, do not install a

child restraint or allow anyone to occupy the seat. See *Airbag Readiness Light* on page 5-18 for important safety information.

The on indicator may be lit if an object, such as a briefcase, handbag, grocery bag, laptop or other electronic device, is put on an unoccupied seat. If this is not desired remove the object from the seat.

 **WARNING**

Stowing of articles under the passenger seat or between the passenger seat cushion and seatback may interfere with the proper operation of the passenger sensing system.

Servicing the Airbag-Equipped Vehicle

Airbags affect how the vehicle should be serviced. There are parts of the airbag system in several

places around the vehicle. Your dealer and the service manual have information about servicing the vehicle and the airbag system. To purchase a service manual, see *Service Publications Ordering Information* on page 13-12.

 **WARNING**

For up to 10 seconds after the vehicle is turned off and the 12-volt battery is disconnected, an airbag can still inflate during improper service. You can be injured if you are close to an airbag when it inflates. Avoid yellow connectors. They are probably part of the airbag system. Be sure to follow proper service procedures, and make sure the person performing work for you is qualified to do so.

Adding Equipment to the Airbag-Equipped Vehicle

Q: Is there anything I might add to or change about the vehicle that could keep the airbags from working properly?

A: Yes. If you add things that change the vehicle's frame, bumper system, height, front end or side sheet metal, they may keep the airbag system from working properly. Changing or moving any parts of the front seats, safety belts, the airbag sensing and diagnostic module, steering wheel, instrument panel, roof-rail airbag modules, ceiling headliner or pillar garnish trim, overhead console, front sensors, side impact sensors, rollover sensor module, or airbag wiring can affect the operation of the airbag system.

In addition, the vehicle has a passenger sensing system for the right front passenger position, which includes sensors that are part of the passenger seat. The passenger sensing system may not operate properly if the original seat trim is replaced with non-GM covers, upholstery or trim, or with GM covers, upholstery or trim designed for a different vehicle. Any object, such as an aftermarket seat heater or a comfort enhancing pad or device, installed under or on top of the seat fabric, could also interfere with the operation of the passenger sensing system.

This could either prevent proper deployment of the passenger airbag(s) or prevent the passenger sensing system from properly turning off the passenger airbag(s). See *Passenger Sensing System* on page 3-33.

If you have questions, call Customer Assistance. The phone numbers and addresses for Customer Assistance are in Step Two of the Customer Satisfaction Procedure in this manual. See *Customer Satisfaction Procedure* on page 13-1.

If the vehicle has rollover roof-rail airbags, see *Different Size Tires and Wheels* on page 10-58 for additional important information.

Q: Because I have a disability, I have to get my vehicle modified. How can I find out whether this will affect my airbag system?

A: If you have questions, call Customer Assistance. The phone numbers and addresses for Customer Assistance are in Step Two of the Customer Satisfaction Procedure in this manual. See *Customer Satisfaction Procedure on page 13-1*.

In addition, the dealer and the service manual have information about the location of the airbag sensors, sensing and diagnostic module, and airbag wiring.

Airbag System Check

The airbag system does not need regularly scheduled maintenance or replacement. Make sure the airbag readiness light is working. See *Airbag Readiness Light on page 5-18* for more information.

Notice: If an airbag covering is damaged, opened, or broken, the airbag may not work properly. Do not open or break the airbag coverings. If there are any opened or broken airbag covers, have the airbag covering and/or airbag module replaced. For the location of the airbag modules, see *What Makes an Airbag Inflate? on page 3-30*. See your dealer for service.

Replacing Airbag System Parts After a Crash

 **WARNING**

A crash can damage the airbag systems in the vehicle. A damaged airbag system may not work properly and may not protect you and your passenger(s) in a crash, resulting in serious injury or even death. To help make sure the airbag

(Continued)

WARNING (Continued)

systems are working properly after a crash, have them inspected and any necessary replacements made as soon as possible.

If an airbag inflates, you will need to replace airbag system parts. See your dealer for service.

If the airbag readiness light stays on after the vehicle is started or comes on when you are driving, the airbag system may not work properly. Have the vehicle serviced right away. See *Airbag Readiness Light on page 5-18* for more information.

Child Restraints

Older Children

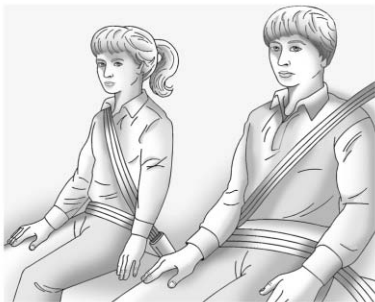

Older children who have outgrown booster seats should wear the vehicle safety belts.

The manufacturer's instructions that come with the booster seat state the weight and height limitations for that booster. Use a booster seat with a lap-shoulder belt until the child passes the fit test below:

- Sit all the way back on the seat. Do the knees bend at the seat edge? If yes, continue. If no, return to the booster seat.
- Buckle the lap-shoulder belt. Does the shoulder belt rest on the shoulder? If yes, continue. If no, try using the rear safety belt comfort guide. See "Rear Safety Belt Comfort Guides" under *Lap-Shoulder Belt on page 3-19* for more information. If the shoulder belt still does not rest on the shoulder, then return to the booster seat.

- Does the lap belt fit low and snug on the hips, touching the thighs? If yes, continue. If no, return to the booster seat.
- Can proper safety belt fit be maintained for the length of the trip? If yes, continue. If no, return to the booster seat.

Q: What is the proper way to wear safety belts?

A: An older child should wear a lap-shoulder belt and get the additional restraint a shoulder belt can provide. The shoulder belt should not cross the face or neck. The lap belt should fit snugly below the hips, just touching the top of the thighs. This applies belt force to the child's pelvic bones in a crash. It should never be worn over the abdomen, which could cause severe or even fatal internal injuries in a crash.

Also see "Rear Safety Belt Comfort Guides" under *Lap-Shoulder Belt on page 3-19*.

According to accident statistics, children and infants are safer when properly restrained in a child restraint system or infant restraint system secured in a rear seating position.

In a crash, children who are not buckled up can strike other people who are buckled up, or can be thrown out of the vehicle. Older children need to use safety belts properly.

⚠ WARNING

Never do this.

Never allow two children to wear the same safety belt. The safety belt can not properly spread the impact forces. In a crash, the two children can be crushed together and seriously injured. A safety belt must be used by only one person at a time.



⚠ WARNING

Never do this.

Never allow a child to wear the safety belt with the shoulder belt behind their back. A child can be seriously injured by not wearing the lap-shoulder belt properly. In a crash, the child would not be restrained by the shoulder belt. The child could move too far forward increasing the chance of head and neck injury. The child

(Continued)

WARNING (Continued)

might also slide under the lap belt. The belt force would then be applied right on the abdomen. That could cause serious or fatal injuries. The shoulder belt should go over the shoulder and across the chest.



Infants and Young Children

Everyone in a vehicle needs protection! This includes infants and all other children. Neither the distance traveled nor the age and size of the traveler changes the need, for everyone, to use safety restraints. In fact, the law in every state in the United States and in every Canadian province says children up to some age must be restrained while in a vehicle.

WARNING

Children can be seriously injured or strangled if a shoulder belt is wrapped around their neck and the safety belt continues to tighten. Never leave children unattended in a vehicle and never allow children to play with the safety belts.

Airbags plus lap-shoulder belts offer protection for adults and older children, but not for young children and infants. Neither the vehicle's safety belt system nor its airbag system is designed for them. Every time infants and young children ride in vehicles, they should have the protection provided by appropriate child restraints.

Children who are not restrained properly can strike other people, or can be thrown out of the vehicle.

WARNING

Never do this.

Never hold an infant or a child while riding in a vehicle. Due to crash forces, an infant or a child will become so heavy it is not possible to hold it during a crash.

(Continued)

WARNING (Continued)

For example, in a crash at only 40 km/h (25 mph), a 5.5 kg (12 lb) infant will suddenly become a 110 kg (240 lb) force on a person's arms. An infant should be secured in an appropriate restraint.



⚠ WARNING

Never do this.

Children who are up against, or very close to, any airbag when it inflates can be seriously injured or killed. Never put a rear-facing child restraint in the right front seat. Secure a rear-facing child restraint in a rear seat. It is also better to secure a forward-facing child restraint in a rear seat. If you must secure a forward-facing child restraint in the right front seat, always move the front passenger seat as far back as it will go.



Q: What are the different types of add-on child restraints?

A: Add-on child restraints, which are purchased by the vehicle owner, are available in four basic types. Selection of a particular restraint should take into consideration not only the child's weight, height, and age but also whether or not the restraint will be compatible with the motor vehicle in which it will be used.

For most basic types of child restraints, there are many different models available. When purchasing a child restraint, be sure it is designed to be used in a motor vehicle. If it is, the restraint will have a label saying that it meets federal motor vehicle safety standards.

3-44 Seats and Restraints

The restraint manufacturer's instructions that come with the restraint state the weight and height limitations for a particular child restraint. In addition, there are many kinds of restraints available for children with special needs.

WARNING

To reduce the risk of neck and head injury during a crash, infants need complete support. This is because an infant's neck is not fully developed and its head weighs so much compared with the rest of its body. In a crash, an infant in a rear-facing child restraint settles into the restraint, so the crash forces can be distributed across the strongest part of an infant's body, the back and shoulders. Infants should always be secured in rear-facing child restraints.

WARNING

A young child's hip bones are still so small that the vehicle's regular safety belt may not remain low on the hip bones, as it should. Instead, it may settle up around the child's abdomen. In a crash, the belt would apply force on a body area that is unprotected by any bony structure. This alone could cause serious or fatal injuries. To reduce the risk of serious or fatal injuries during a crash, young children should always be secured in appropriate child restraints.

Child Restraint Systems

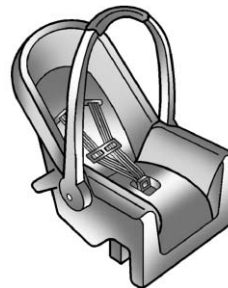

(A) Rear-Facing Infant Seat

A rear-facing infant seat (A) provides restraint with the seating surface against the back of the infant.

The harness system holds the infant in place and, in a crash, acts to keep the infant positioned in the restraint.



(B) Forward-Facing Child Seat

A forward-facing child seat (B) provides restraint for the child's body with the harness.

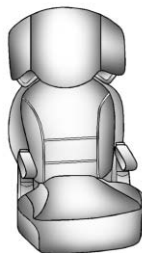
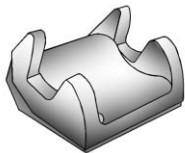

(C) Booster Seats

A booster seat (C) is a child restraint designed to improve the fit of the vehicle's safety belt system. A booster seat can also help a child to see out the window.

Securing an Add-On Child Restraint in the Vehicle

⚠ WARNING

A child can be seriously injured or killed in a crash if the child restraint is not properly secured in the vehicle. Secure the child restraint properly in the vehicle using the vehicle safety belt or LATCH system, following the instructions that came with that child restraint and the instructions in this manual.

To help reduce the chance of injury, the child restraint must be secured in the vehicle. Child restraint systems must be secured in vehicle seats by lap belts or the lap belt portion of a lap-shoulder belt, or by the LATCH system. See *Lower Anchors and Tethers for Children (LATCH System)* on page 3-47 for more information.

3-46 Seats and Restraints

Children can be endangered in a crash if the child restraint is not properly secured in the vehicle.

When securing an add-on child restraint, refer to the instructions that come with the restraint which may be on the restraint itself or in a booklet, or both, and to this manual. The child restraint instructions are important, so if they are not available, obtain a replacement copy from the manufacturer.

Keep in mind that an unsecured child restraint can move around in a collision or sudden stop and injure people in the vehicle. Be sure to properly secure any child restraint in the vehicle — even when no child is in it.

In some areas, Certified Child Passenger Safety Technicians (CPSTs) are available to inspect and demonstrate how to correctly use and install child restraints. In the U.S., refer to the National Highway Traffic Safety Administration (NHTSA) website

to locate the nearest child safety seat inspection station. For CPST availability in Canada, check with Transport Canada or the Provincial Ministry of Transportation office.

Securing the Child within the Child Restraint

WARNING

A child can be seriously injured or killed in a crash if the child is not properly secured in the child restraint. Secure the child properly following the instructions that came with that child restraint.

Where to Put the Restraint

According to accident statistics, children and infants are safer when properly restrained in a child restraint system or infant restraint system secured in a rear seating position.

We recommend that children and child restraints be secured in a rear seat, including: an infant or a child riding in a rear-facing child restraint; a child riding in a forward-facing child seat; an older child riding in a booster seat; and children, who are large enough, using safety belts.

A label on the sun visor says, “Never put a rear-facing child restraint in the front.” This is because the risk to the rear-facing child is so great, if the airbag deploys.

WARNING

A child in a rear-facing child restraint can be seriously injured or killed if the right front passenger airbag inflates. This is because the back of the rear-facing child restraint would be very close to the inflating airbag. A child in a forward-facing child restraint can be seriously

(Continued)

WARNING (Continued)

injured or killed if the right front passenger airbag inflates and the passenger seat is in a forward position.

Even if the passenger sensing system has turned off the right front passenger airbag(s), no system is fail-safe. No one can guarantee that an airbag will not deploy under some unusual circumstance, even though the airbag(s) are turned off.

Secure rear-facing child restraints in a rear seat, even if the airbag(s) are off. If you secure a forward-facing child restraint in the right front seat, always move the front passenger seat as far back as it will go. It is better to secure the child restraint in a rear seat.

(Continued)

WARNING (Continued)

See *Passenger Sensing System* on page 3-33 for additional information.

When securing a child restraint in a rear seating position, study the instructions that came with the child restraint to make sure it is compatible with this vehicle.

Child restraints and booster seats vary considerably in size, and some may fit in certain seating positions better than others. Always make sure the child restraint is properly secured.

Depending on where you place the child restraint and the size of the child restraint, you may not be able to access adjacent safety belt assemblies or LATCH anchors for additional passengers or child restraints. Adjacent seating positions should not be used if the

child restraint prevents access to or interferes with the routing of the safety belt.

Wherever a child restraint is installed, be sure to secure the child restraint properly.

Keep in mind that an unsecured child restraint can move around in a collision or sudden stop and injure people in the vehicle. Be sure to properly secure any child restraint in the vehicle — even when no child is in it.

Lower Anchors and Tethers for Children (LATCH System)

The LATCH system holds a child restraint during driving or in a crash. This system is designed to make installation of a child restraint easier. The LATCH system uses anchors in the vehicle and attachments on the child restraint that are made for use with the LATCH system.

3-48 Seats and Restraints

Make sure that a LATCH-compatible child restraint is properly installed using the anchors, or use the vehicle's safety belts to secure the restraint, following the instructions that came with that restraint, and also the instructions in this manual. When installing a child restraint with a top tether, you must also use either the lower anchors or the safety belts to properly secure the child restraint. A child restraint must never be attached using only the top tether and anchor.

In order to use the LATCH system in your vehicle, you need a child restraint that has LATCH attachments. The child restraint manufacturer will provide you with instructions on how to use the child restraint and its attachments. The following explains how to attach a child restraint with these attachments in the vehicle.

Not all vehicle seating positions or child restraints have lower anchors and attachments or top tether anchors and attachments.

Lower Anchors

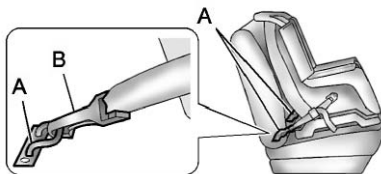

Lower anchors (A) are metal bars built into the vehicle. There are two lower anchors for each LATCH seating position that will accommodate a child restraint with lower attachments (B).

Top Tether Anchor

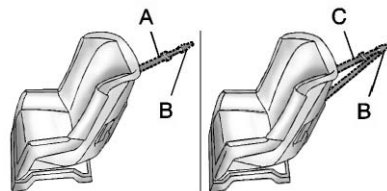

A top tether (A, C) anchors the top of the child restraint to the vehicle. A top tether anchor is built into the vehicle. The top tether attachment (B) on the child restraint connects to the top tether anchor in the vehicle in order to reduce the forward movement and rotation of the child restraint during driving or in a crash.

The child restraint may have a single tether (A) or a dual tether (C). Either will have a single attachment (B) to secure the top tether to the anchor.

Some child restraints that have a top tether are designed for use with or without the top tether being attached. Others require the top tether always to be attached. Be sure to read and follow the instructions for the child restraint.

Lower Anchor and Top Tether Anchor Locations



Rear Seat

 **(Top Tether Anchor):** Seating positions with top tether anchors.

 **(Lower Anchor):** Seating positions with two lower anchors.



To assist you in locating the lower anchors, each seating position with lower anchors has two labels, near the crease between the seatback and the seat cushion.



To assist you in locating the top tether anchors, the top tether anchor symbol is located near the top tether anchor.

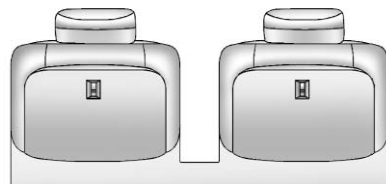

Top Tether Anchors

The top tether anchors for outboard rear seating positions are located on the back of the rear seatback. Be sure to use an anchor located on the same side of the vehicle as the seating position where the child restraint will be placed.

Do not secure a child restraint in a position without a top tether anchor if a national or local law requires that the top tether be attached, or if the instructions that come with the child restraint say that the top tether must be attached.

3-50 Seats and Restraints

According to accident statistics, children and infants are safer when properly restrained in a child restraint system or infant restraint system secured in a rear seating position. See *Where to Put the Restraint* on page 3-46 for additional information.

Securing a Child Restraint Designed for the LATCH System

WARNING

If a LATCH-type child restraint is not attached to anchors, the child restraint will not be able to protect the child correctly. In a crash, the child could be seriously injured or killed. Install a LATCH-type child restraint properly using the anchors, or use the vehicle safety belts to secure the restraint, following the instructions that came with the child restraint and the instructions in this manual.

WARNING

Do not attach more than one child restraint to a single anchor. Attaching more than one child restraint to a single anchor could cause the anchor or attachment to come loose or even break during a crash. A child or others could be injured. To reduce the risk of serious or fatal injuries during a crash, attach only one child restraint per anchor.

WARNING

Children can be seriously injured or strangled if a shoulder belt is wrapped around their neck and the safety belt continues to tighten. Buckle any unused safety belts behind the child restraint so children cannot reach them. Pull the shoulder belt all the way out

(Continued)

WARNING (Continued)

of the retractor to set the lock, if the vehicle has one, after the child restraint has been installed.

Notice: Do not let the LATCH attachments rub against the vehicle's safety belts. This may damage these parts. If necessary, move buckled safety belts to avoid rubbing the LATCH attachments.

Do not fold the empty rear seat with a safety belt buckled. This could damage the safety belt or the seat. Unbuckle and return the safety belt to its stowed position, before folding the seat.

Make sure to attach the child restraint at the proper anchor location.

This system is designed to make installation of child restraints easier. When using lower anchors, do not use the vehicle's safety belts.

Instead use the vehicle's anchors and child restraint attachments to secure the restraints. Some restraints also use another vehicle anchor to secure a top tether.

1. Attach and tighten the lower attachments to the lower anchors. If the child restraint does not have lower attachments or the desired seating position does not have lower anchors, secure the child restraint with the top tether and the safety belts. Refer to your child restraint manufacturer instructions and the instructions in this manual.

- 1.1. Find the lower anchors for the desired seating position.

- 1.2. Put the child restraint on the seat.

If the head restraint interferes with the proper installation of the child restraint, the head restraint may be removed. See "Head Restraint Removal and Reinstallation" at the end of this section.

- 1.3. Attach and tighten the lower attachments on the child restraint to the lower anchors.

2. If the child restraint manufacturer recommends that the top tether be attached, attach and tighten the top tether to the top tether anchor, if equipped. Refer to the child restraint instructions and the following steps:

- 2.1. Find the top tether anchor on the back of the rear seatback.

- 2.2. Route, attach, and tighten the top tether according to your child restraint instructions and the following instructions:

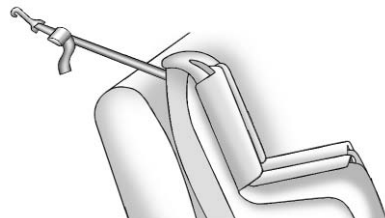

If the position you are using does not have a headrest or head restraint, or the headrest or head restraint has been removed, and you are using a single tether, route the tether over the seatback.

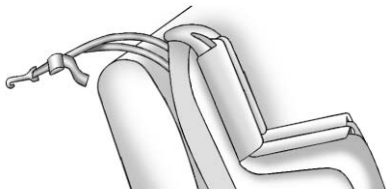

If the position you are using does not have a headrest or head restraint, or the headrest or head restraint has been removed, and you are using a dual tether, route the tether over the seatback.

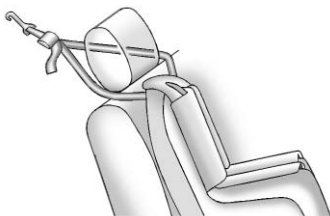

If the rear outboard seating position you are using has an adjustable head restraint and you are using a dual tether, route the tether around the head restraint.

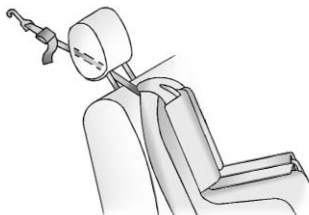

If the rear outboard seating position you are using has an adjustable head restraint

and you are using a single tether, raise the head restraint and route the tether under the head restraint and in between the head restraint posts.

3. Before placing a child in the child restraint, make sure it is securely held in place. To check, grasp the child restraint at the LATCH path and attempt to move it side to side and back and forth. There should be no more than 2.5 cm (1 in) of movement for proper installation.

Head Restraint Removal and Reinstallation

The rear outboard head restraints can be removed if they interfere with the proper installation of the child restraint.

To remove the head restraint:

1. Partially fold the seatback forward. See *Rear Seats on page 3-8* for additional information.

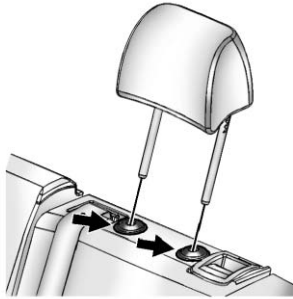

2. Press both buttons on the head restraint posts at the same time, and pull up on the head restraint.
3. Store the head restraint in the cargo area of the vehicle.
4. When the child restraint is removed, reinstall the head restraint before the seating position is used.

⚠ WARNING

With head restraints that are not installed and adjusted properly, there is a greater chance that occupants will suffer a neck/spinal injury in a crash. Do not drive until the head restraints for all occupants are installed and adjusted properly.

To reinstall the head restraint:

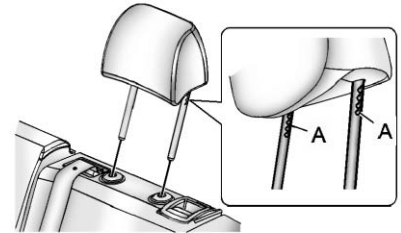

1. Insert the head restraint posts into the holes in the top of the seatback. The notches (A) on the posts must face the driver side of the vehicle.
2. Push the head restraint down.
If necessary, press the height adjustment release button to further lower the head restraint. See *Head Restraints on page 3-2*.

3-54 Seats and Restraints

3. Try to move the head restraint to make sure that it is locked in place.

Replacing LATCH System Parts After a Crash

WARNING

A crash can damage the LATCH system in the vehicle. A damaged LATCH system may not properly secure the child restraint, resulting in serious injury or even death in a crash. To help make sure the LATCH system is working properly after a crash, see your dealer to have the system inspected and any necessary replacements made as soon as possible.

If the vehicle has the LATCH system and it was being used during a crash, new LATCH system parts may be needed.

New parts and repairs may be necessary even if the LATCH system was not being used at the time of the crash.

Securing Child Restraints (Rear Seat)

When securing a child restraint in a rear seating position, study the instructions that came with the child restraint to make sure it is compatible with this vehicle.

If the child restraint has the LATCH system, see *Lower Anchors and Tethers for Children (LATCH System)* on page 3-47 for how and where to install the child restraint using LATCH. If a child restraint is secured in the vehicle using a safety belt and it uses a top tether, see *Lower Anchors and Tethers for Children (LATCH System)* on page 3-47 for top tether anchor locations.

Do not secure a child seat in a position without a top tether anchor if a national or local law requires

that the top tether be anchored, or if the instructions that come with the child restraint say that the top strap must be anchored.

If the child restraint does not have the LATCH system, you will be using the safety belt to secure the child restraint in this position. Be sure to follow the instructions that came with the child restraint. Secure the child in the child restraint when and as the instructions say.

If more than one child restraint needs to be installed in the rear seat, be sure to read *Where to Put the Restraint* on page 3-46.

1. Put the child restraint on the seat.

If the head restraint interferes with the proper installation of the child restraint, the head restraint may be removed. See “Head Restraint Removal and Reinstallation” under *Lower Anchors and Tethers for Children (LATCH System)* on page 3-47.

2. Remove the safety belt from the guide on the seatback by sliding the webbing through the opening on the guide. Do not secure the child restraint with the safety belt routed through the guide.
3. Pick up the latch plate, and run the lap and shoulder portions of the vehicle's safety belt through or around the restraint. The child restraint instructions will show you how.

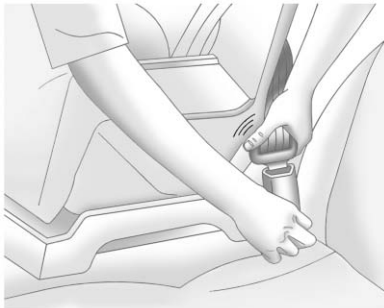

4. Push the latch plate into the buckle until it clicks.

Position the release button on the buckle so that the safety belt could be quickly unbuckled if necessary.



5. Pull the shoulder belt all the way out of the retractor to set the lock. When the retractor lock is set, the belt can be tightened but not pulled out of the retractor.

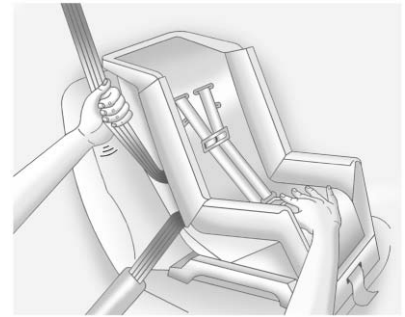

6. To tighten the belt, push down on the child restraint, pull the shoulder portion of the belt to tighten the lap portion of the belt, and feed the shoulder belt back into the retractor. When installing a forward-facing child restraint, it may be helpful to use your knee to push down on the child restraint as you tighten the belt.

Try to pull the belt out of the retractor to make sure the retractor is locked. If the retractor is not locked, repeat Steps 5 and 6.

7. If the child restraint has a top tether, follow the child restraint manufacturer's instructions regarding the use of the top tether. See *Lower Anchors and Tethers for Children (LATCH System)* on page 3-47 for more information.
8. Before placing a child in the child restraint, make sure it is securely held in place. To check, grasp the child restraint at the safety belt path and attempt to move it side to side and back and forth. When the child restraint is properly installed, there should be no more than 2.5 cm (1 in) of movement.

To remove the child restraint, unbuckle the vehicle safety belt and let it return to the stowed position. If the top tether is attached to a top tether anchor, disconnect it. If the head restraint was removed, reinstall it before the seating position is used. See "Head Restraint Removal and Reinstallation" under *Lower Anchors and Tethers for Children (LATCH System)* on page 3-47 for additional information on installing the head restraint properly.

If the seat has a safety belt guide, return the safety belt into the guide on the seatback by sliding the webbing through the opening on the guide.

Securing Child Restraints (Front Passenger Seat)

This vehicle has airbags. A rear seat is a safer place to secure a forward-facing child restraint. See *Where to Put the Restraint* on page 3-46.

In addition, the vehicle has a passenger sensing system which is designed to turn off the right front passenger frontal airbag and passenger knee airbag under certain conditions. See *Passenger Sensing System* on page 3-33 and *Passenger Airbag Status Indicator* on page 5-18 for more information, including important safety information.

A label on the sun visor says, “Never put a rear-facing child seat in the front.” This is because the risk to the rear-facing child is so great, if the airbag deploys.

 **WARNING**

A child in a rear-facing child restraint can be seriously injured or killed if the right front passenger airbag inflates. This is because the back of the rear-facing child restraint would be very close to the inflating airbag. A child in a forward-facing child restraint can be seriously injured or killed if the right front passenger airbag inflates and the passenger seat is in a forward position.

(Continued)

WARNING (Continued)

Even if the passenger sensing system has turned off the right front passenger airbag(s), no system is fail-safe. No one can guarantee that an airbag will not deploy under some unusual circumstance, even though the airbag(s) are turned off.

Secure rear-facing child restraints in a rear seat, even if the airbag(s) are off. If you secure a forward-facing child restraint in the right front seat, always move the front passenger seat as far back as it will go. It is better to secure the child restraint in a rear seat.

See *Passenger Sensing System* on page 3-33 for additional information.

If the child restraint has the LATCH system, see *Lower Anchors and Tethers for Children (LATCH System)* on page 3-47 for how and where to install the child restraint using LATCH. If a child restraint is secured using a safety belt and it uses a top tether, see *Lower Anchors and Tethers for Children (LATCH System)* on page 3-47 for top tether anchor locations.

Do not secure a child seat in a position without a top tether anchor if a national or local law requires that the top tether be anchored, or if the instructions that come with the child restraint say that the top strap must be anchored.

In Canada, the law requires that forward-facing child restraints have a top tether, and that the tether be attached.

3-58 Seats and Restraints

You will be using the lap-shoulder belt to secure the child restraint in this position. Follow the instructions that came with the child restraint.

1. Move the seat as far back as it will go before securing the forward-facing child restraint.

When the passenger sensing system has turned off the right front passenger frontal airbag and passenger knee airbag, the off indicator on the passenger airbag status indicator should light and stay lit when you start the vehicle. See *Passenger Airbag Status Indicator* on page 5-18.

2. Put the child restraint on the seat.
3. Pick up the latch plate, and run the lap and shoulder portions of the vehicle's safety belt through or around the restraint. The child restraint instructions will show you how.

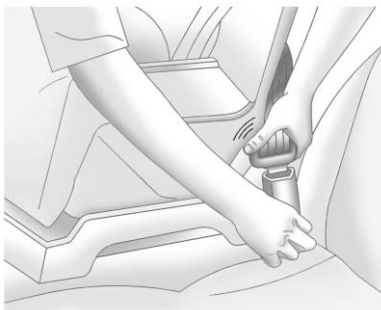

4. Push the latch plate into the buckle until it clicks.
Position the release button on the buckle so that the safety belt could be quickly unbuckled if necessary.



5. Pull the shoulder belt all the way out of the retractor to set the lock. When the retractor lock is set, the belt can be tightened but not pulled out of the retractor.

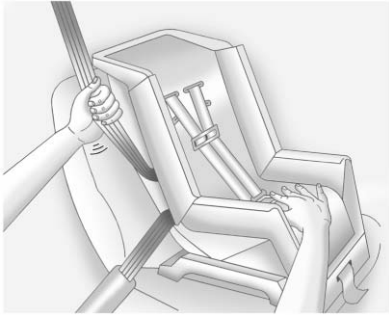

6. To tighten the belt, push down on the child restraint, pull the shoulder portion of the belt to tighten the lap portion of the belt, and feed the shoulder belt back into the retractor. When installing a forward-facing child restraint, it may be helpful to use your knee to push down on the child restraint as you tighten the belt.

Try to pull the belt out of the retractor to make sure the retractor is locked. If the retractor is not locked, repeat Steps 5 and 6.

7. Before placing a child in the child restraint, make sure it is securely held in place. To check, grasp the child restraint at the safety belt path and attempt to move it side to side and back and forth. When the child restraint is properly installed, there should be no more than 2.5 cm (1 in) of movement.

If the airbags are off, the off indicator in the passenger airbag status indicator will come on and stay on when the vehicle is started.

If a child restraint has been installed and the on indicator is lit, see "If the On Indicator is Lit for a Child Restraint" under *Passenger Sensing System* on page 3-33 for more information.

To remove the child restraint, unbuckle the vehicle safety belt and let it return to the stowed position.

Storage

Storage Compartments

Instrument Panel Storage	4-1
Glove Box	4-1
Floor Console Storage	4-1
Umbrella Storage	4-2

Additional Storage Features

Cargo Cover	4-2
-----------------------	-----

Storage Compartments

Instrument Panel Storage

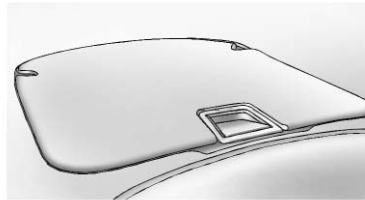

There is a storage compartment on top of the instrument panel that includes an auxiliary power outlet.

Inside is a transmitter slot for the Remote Keyless Entry (RKE) transmitter. See *Remote Keyless Entry (RKE) System Operation* on page 2-3.

Glove Box

Open the glove box by lifting up on the lever.

Floor Console Storage

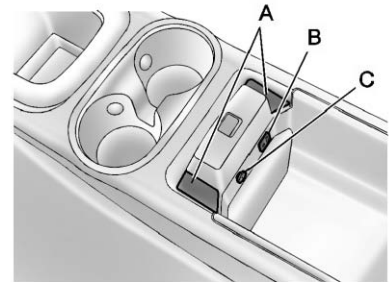

Inside the front of the floor console is an auxiliary power outlet (C) and a jack for auxiliary input devices (B). Cords can be routed in the pass-thru (A). See *Auxiliary Devices* on page 7-36.

The console has cupholders and a storage area.

4-2 Storage

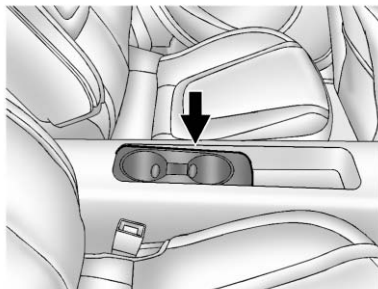

The rear console has open storage with an auxiliary power outlet and cupholders.

Umbrella Storage



Slide an umbrella into the opening on either the driver or passenger doors.

Additional Storage Features

Cargo Cover

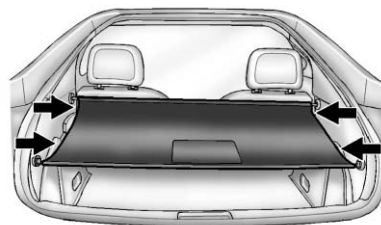

There is a cover for the rear cargo area. Use the four cargo cover loops to hook the cover to the side panels.

Instruments and Controls

Instrument Panel Overview

Instrument Panel Overview 5-4

Controls

Steering Wheel Adjustment ... 5-6
 Steering Wheel Controls 5-6
 Horn 5-7
 Windshield Wiper/Washer 5-7
 Power Outlets 5-8

Warning Lights, Gauges, and Indicators

Warning Lights, Gauges, and Indicators 5-9
 Instrument Cluster 5-9
 Speedometer 5-15
 Odometer 5-15
 Trip Odometer 5-15
 Compass 5-15

Battery Gauge (High Voltage) 5-15
 Fuel Gauge 5-16
 Driver Efficiency Gauge 5-16
 Total Vehicle Range 5-16
 Safety Belt Reminders 5-17
 Airbag Readiness Light 5-18
 Passenger Airbag Status Indicator 5-18
 Charging System Light (12-Volt Battery) 5-19
 Malfunction Indicator Lamp 5-19
 Brake System Warning Light 5-22
 Electric Parking Brake Light 5-22
 Service Electric Parking Brake Light 5-23
 Antilock Brake System (ABS) Warning Light 5-23
 Sport Mode Light 5-24
 Mountain Mode Light 5-24

Traction Control System (TCS)/StabiliTrak® Light 5-24
 Engine Coolant Temperature Warning Light 5-24
 Tire Pressure Light 5-25
 Engine Oil Pressure Light 5-25
 Low Fuel Warning Light 5-26
 Security Light 5-26
 High-Beam On Light 5-26
 Lamps On Reminder 5-26
 Cruise Control Light 5-27
 Door, Hood, or Hatch Open Light 5-27

Information Displays

Center Stack Display 5-28
 Power Flows 5-28
 Charging 5-30
 Energy Information 5-37
 Clock 5-38
 Driver Information Center (DIC) 5-38

5-2 Instruments and Controls

Vehicle Messages

Vehicle Messages	5-40
Battery and Charging Messages	5-41
Brake System Messages	5-41
Cruise Control Messages	5-42
Door Ajar Messages	5-42
Drive Mode Messages	5-42
Electric Drive Unit Messages	5-43
Engine Cooling System Messages	5-43
Engine Oil Messages	5-43
Fuel System Messages	5-43

Key and Lock Messages	5-44
Lamp Messages	5-45
Object Detection System Messages	5-45
Propulsion Power Messages	5-45
Ride Control System Messages	5-46
Airbag System Messages	5-46
Anti-Theft Alarm System Messages	5-46
Service Vehicle Messages ...	5-46
Starting the Vehicle Messages	5-47

Tire Messages	5-47
Vehicle Speed Messages	5-48
Washer Fluid Messages	5-48

Vehicle Personalization

Vehicle Personalization	5-48
-------------------------------	------

Universal Remote System

Universal Remote System ...	5-55
Universal Remote System Programming	5-55
Universal Remote System Operation	5-58

Instrument Panel Overview

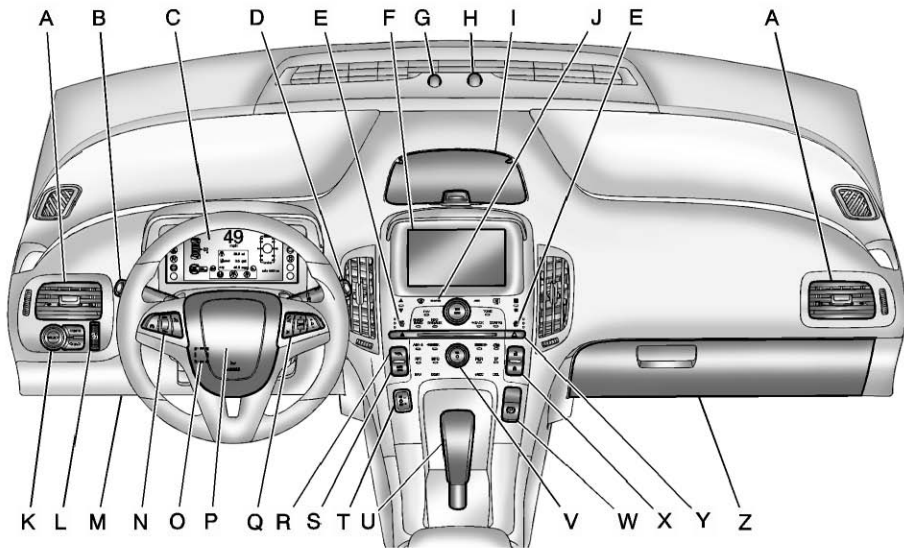

- A. *Air Vents on page 8-8.*
- B. *Turn and Lane-Change Lever. See Turn and Lane-Change Signals on page 6-4.*
Exterior Lamp Controls on page 6-1.
Pedestrian Friendly Alert on page 6-2.
- C. *Instrument Cluster on page 5-9.*
Driver Information Center (DIC) Display. See Driver Information Center (DIC) on page 5-38.
- D. *Windshield Wiper/Washer on page 5-7.*
- E. *Heated Front Seats on page 3-6 (If Equipped).*
- F. *Center Stack Display on page 5-28.*
- G. *Charging Status Indicator. See Charging Status Feedback on page 9-47.*
- H. *Light Sensor. See Daytime Running Lamps (DRL) on page 6-3.*
- I. *Instrument Panel Storage on page 4-1.*
- J. *Automatic Climate Control System on page 8-1.*
- K. *Driver Information Center (DIC) Controls. See Driver Information Center (DIC) on page 5-38.*
- L. *Instrument Panel Illumination Control on page 6-5.*
- M. *Data Link Connector (DLC) (Out of View). See Malfunction Indicator Lamp on page 5-19.*
- N. *Cruise Control on page 9-36.*
- O. *Steering Wheel Adjustment on page 5-6.*
- P. *Horn on page 5-7.*
- Q. *Steering Wheel Controls on page 5-6 (If Equipped).*
- R. *Leaf Button. See Center Stack Display on page 5-28.*
- S. *DRIVE MODE Button. See Driver Selected Operating Modes on page 9-24.*
- T. *Power Button on page 9-18.*
- U. *Shift Lever. See Electric Drive Unit on page 9-29.*
- V. *Infotainment on page 7-1.*
Navigation System. See Using the Navigation System on page 7-36.
- W. *Electric Parking Brake on page 9-32.*
- X. *Power Door Locks on page 2-9.*
- Y. *Hazard Warning Flashers on page 6-4.*
- Z. *Glove Box on page 4-1.*

Controls

Steering Wheel Adjustment

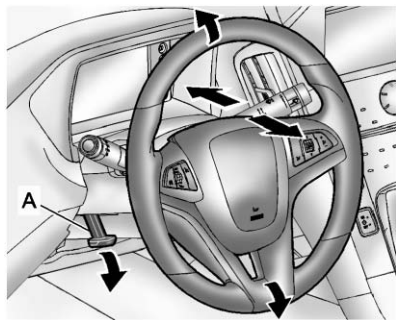

To adjust the steering wheel:

1. Pull the lever (A) down.
2. Move the steering wheel up or down.
3. Pull or push the steering wheel closer or away from you.
4. Pull the lever (A) up to lock the steering wheel in place.

Do not adjust the steering wheel while driving.

Steering Wheel Controls

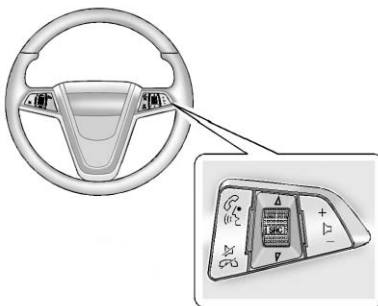

For vehicles with audio steering wheel controls, some audio controls can be adjusted at the steering wheel.

Push to Talk: For vehicles with an OnStar, Bluetooth, or navigation system, press to interact with those systems.

See *Bluetooth* on page 7-78 and the OnStar Glove Box Kit for more information.

End Call/Mute: Press to silence the vehicle speakers only. Press again to turn the sound on. For vehicles with OnStar or Bluetooth systems, press to reject an incoming call, or to end a current call.

SRC (Rotary Control): Press Δ or ∇ to select a radio band or audio source.

Press Δ or ∇ to select the next or previous favorite radio station, CD track, DVD track/chapter, or MP3 track.

Press SRC to change between radio and CD or DVD.

+ - (Volume): Press + to increase the volume; press - to decrease the volume.

Horn

Press near the horn symbols to sound the horn.

The Pedestrian Friendly Alert provides momentary soft-note horn sound. See *Pedestrian Friendly Alert on page 6-2* for more information.

Windshield Wiper/Washer

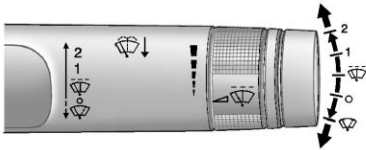

The windshield wiper lever is on the side of the steering column. With the vehicle on, move the windshield wiper lever to select the wiper speed.

2: Move the lever up to 2 for fast wiper.

1: Move the lever up to 1 for slow wiper.

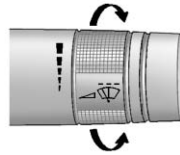

(Adjustable Interval Wiper):

Move the lever up to  for adjustable interval wiper, then turn the band up for more frequent wiper or down for less frequent wiper.

○ (Off): Use to turn the windshield wiper off.

 (Mist): For a single wipe, briefly move the wiper lever down. For several wiper, hold the wiper lever down.

Clear ice and snow from the wiper blades before using them. If frozen to the windshield, carefully loosen or thaw them. Damaged wiper blades should be replaced. See *Wiper Blade Replacement on page 10-26*.

Heavy snow or ice can overload the wiper. If the wiper motor overheats, the windshield wiper will stop until the motor cools and the wiper control is turned off. See *Electrical System Overload on page 10-33*.

Wipe Parking

If the vehicle is turned off, while the wiper are on 1, 2, or , they will stop immediately.

If the windshield wiper lever is then moved to off before the driver door is opened or within 10 minutes, the wiper will restart and move to the base of the windshield.

If the vehicle is turned off during a windshield wash, the wiper will stop when they reach the base of the windshield.

Windshield Washer

Pull the windshield wiper lever toward you to spray windshield washer fluid and activate the wipers.

The washer and wipers will continue until the lever is released or the maximum wash time is reached.

When the windshield wiper lever is released, additional wipes may occur depending on how long the windshield washer had been activated. See *Washer Fluid* on page 10-20 for information on filling the windshield washer fluid reservoir.

WARNING

In freezing weather, do not use the washer until the windshield is warmed. Otherwise the washer fluid can form ice on the windshield, blocking your vision.

Power Outlets

The accessory power outlets can be used to plug in electrical equipment, such as a cell phone or MP3 player.

There are three accessory power outlets:

- Inside the front of the center floor console.
- On the rear of the center floor console.
- Inside the instrument panel storage area.

The power outlets supply power while the vehicle is on, or if the vehicle is in Retained Accessory Power (RAP). See *Retained Accessory Power (RAP)* on page 9-21.

Remove the cover to access and replace when not in use.

Certain accessory plugs may not be compatible with the accessory power outlet and could overload vehicle or adapter fuses. If a problem is experienced, see your dealer.

When adding electrical equipment, be sure to follow the installation instructions included with the equipment. See *Add-On Electrical Equipment* on page 9-57.

Notice: Hanging heavy equipment from the power outlet can cause damage not covered by the vehicle warranty. The power outlets are designed for accessory power plugs only, such as cell phone charge cords.

Warning Lights, Gauges, and Indicators

Warning lights and gauges can signal that something is wrong before it becomes serious enough to cause an expensive repair or replacement. Paying attention to the warning lights and gauges could prevent injury.

Warning lights come on when there could be a problem with a vehicle function. Some warning lights come on briefly when the propulsion system is started to indicate they are working.

Gauges can indicate when there could be a problem with a vehicle function. Often gauges and warning lights work together to indicate a problem with the vehicle.

When one of the warning lights comes on and stays on while driving, or when one of the gauges shows there may be a problem, check the section that explains what to do. Waiting to do repairs can be costly and even dangerous.

Instrument Cluster

The instrument cluster displays a preview of information that includes electric range, charging, odometer, and battery status. This happens upon entry when the driver door is opened, and following the welcome animation, before starting the vehicle.

A CHARGING OVERRIDE/
INTERRUPTION OCCURRED
message may display on the lower left of the screen. This indicates that an override of the charge settings by the owner via OnStar has occurred.

5-10 Instruments and Controls

The following screens may appear, depending on the status.

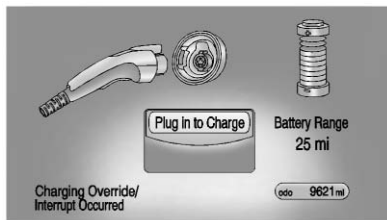

This screen indicates that the charge cord is not connected. Plug the charge cord in to charge the vehicle.

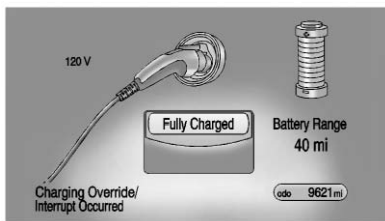

This screen indicates that the charge cord is connected and the charging is complete.

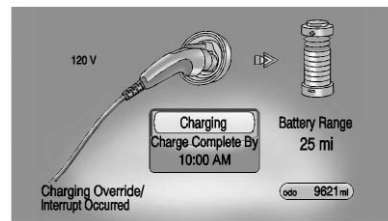

This screen indicates that charging is active and the estimated charge completion time is 10:00 a.m.

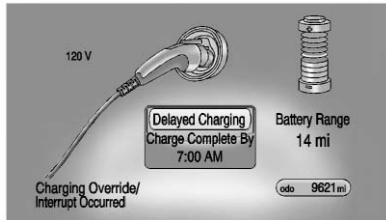

This screen indicates that charging is programmed to be delayed with an estimated completion time of 7:00 a.m.

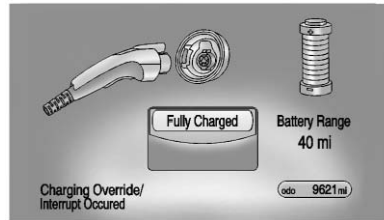

This screen indicates that the vehicle is fully charged and the charge cord is not connected.

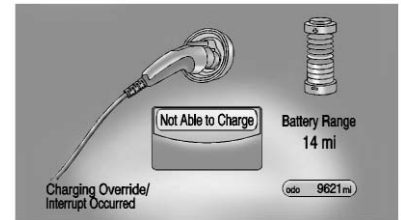

This screen indicates that the charge cord is connected, but the vehicle cannot be charged.

5-12 Instruments and Controls

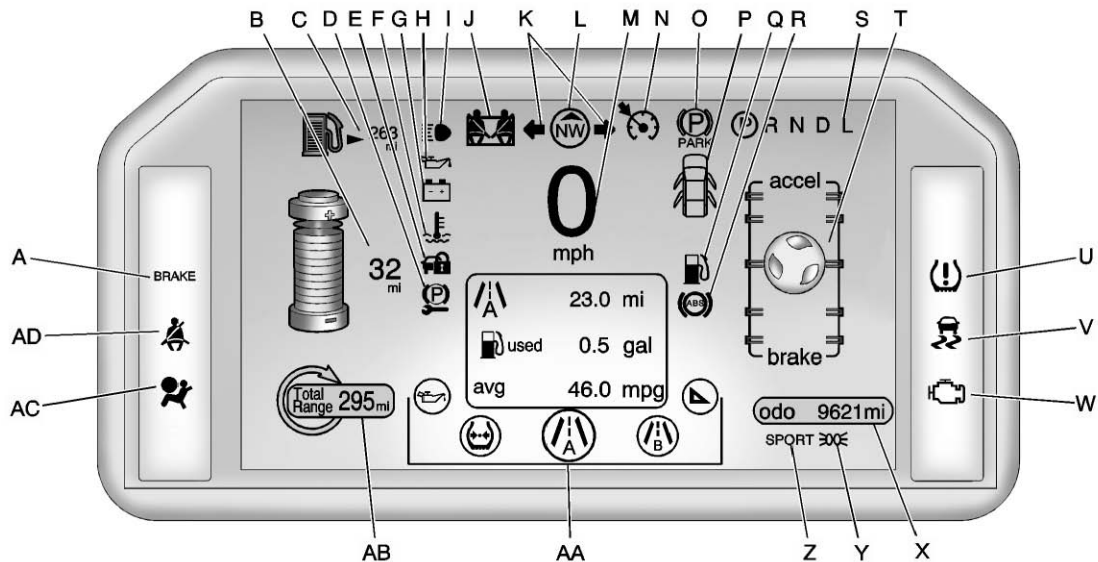

Complete Cluster with Enhanced Configuration in Electric Mode

- A. *Brake System Warning Light on page 5-22.*
- B. *Battery Gauge (High Voltage) on page 5-15.*
- C. *Fuel Gauge on page 5-16.*
- D. *Service Electric Parking Brake Light on page 5-23.*
- E. *Security Light on page 5-26.*
- F. *Engine Coolant Temperature Warning Light on page 5-24.*
- G. *Charging System Light (12-Volt Battery) on page 5-19.*
- H. *Engine Oil Pressure Light on page 5-25.*
- I. *High-Beam On Light on page 5-26.*
- J. *Second Row Passenger Safety Belt Reminder Light. See Safety Belt Reminders on page 5-17.*
- K. *Turn and Lane-Change Signals on page 6-4.*
- L. *Compass on page 5-15.*
- M. *Speedometer on page 5-15.*
- N. *Cruise Control Light on page 5-27.*
- O. *Electric Parking Brake Light on page 5-22.*
- P. *Door, Hood, or Hatch Open Light on page 5-27.*
- Q. *Low Fuel Warning Light on page 5-26.*
- R. *Antilock Brake System (ABS) Warning Light on page 5-23.*
- S. *Electric Drive Unit Positions. See Electric Drive Unit on page 9-29.*
- T. *Driver Efficiency Gauge on page 5-16.*
- U. *Tire Pressure Light on page 5-25.*
- V. *Traction Control System (TCS)/StabiliTrak[®] Light on page 5-24.*
- W. *Malfunction Indicator Lamp on page 5-19.*
- X. *Odometer on page 5-15.*
- Y. *Lamps On Reminder on page 5-26.*
- Z. *Sport Mode Light on page 5-24 and Mountain Mode Light on page 5-24.*
- AA. *Driver Information Center (DIC) on page 5-38.*
- AB. *Total Vehicle Range on page 5-16.*
- AC. *Airbag Readiness Light on page 5-18.*
- AD. *Driver Safety Belt Reminder Light. See Safety Belt Reminders on page 5-17.*

5-14 Instruments and Controls

Instrument Cluster Display Configurations

There are two instrument cluster display configurations to choose from. Press CONFIG located left of the steering wheel to change the configuration. See *Driver Information Center (DIC)* on page 5-38 for more information.

Choose either the Simple or Enhanced Configuration display.



**Simple Configuration
in Electric Mode**



**Enhanced Configuration
in Electric Mode**



**Simple Configuration in Extended
Range Mode**



**Enhanced Configuration
in Extended Range Mode**

The Enhanced Configuration displays the Driver Efficiency Gauge.

Speedometer

The speedometer shows the vehicle speed in both kilometers per hour (km/h) and miles per hour (mph). The DIC menu can be used to change the units.

See *Driver Information Center (DIC)* on page 5-38.

Odometer

The odometer shows how far the vehicle has been driven, in either kilometers or miles.

Trip Odometer

The trip odometer is within the Driver Information Center. See *Driver Information Center (DIC)* on page 5-38 for more information.

Compass

The vehicle has a compass display in the instrument cluster above the speedometer. The compass receives its heading and other information from the Global Positioning System (GPS) antenna and vehicle speed information.

The compass system has automatic calibration and zone adjustment features.

Avoid covering the GPS antenna for long periods of time with objects that may interfere with the antenna's ability to receive a satellite signal. See *Multi-Band Antenna* on page 7-15 for the location of the vehicle's antenna. The compass system is designed to operate for a certain number of miles or degrees of turn before needing a signal from the GPS satellites. The compass system will automatically determine when a GPS signal is restored and provide a heading.

Battery Gauge (High Voltage)



This indicator displays the high voltage battery charge level.

When this indicator is displayed in the foreground, the vehicle is operating in Electric Mode. The number next to the indicator displays an estimate of how far the vehicle can be driven while in this mode.

See *Electric Mode* on page 9-23.

Fuel Gauge



This indicator displays the fuel level. When this indicator is in the foreground, the vehicle is operating in Extended Range Mode.

The number next to the indicator displays an estimate of how far the vehicle can be driven while in this mode.

See *Extended Range Mode* on page 9-23.

Driver Efficiency Gauge



This gauge is a guide to driving in an efficient manner by keeping the ball green and in the center of the gauge. The leaves stop spinning when the vehicle stops or when the ball travels away from the center of the gauge.

See *Driving for Better Energy Efficiency* on page 9-2.

accel: If the ball turns yellow and travels above the center of the gauge, acceleration is too aggressive to optimize efficiency.

brake: If the ball turns yellow and travels below the center of the gauge, braking is too aggressive to optimize efficiency.

Total Vehicle Range



Total vehicle range is the remaining distance the vehicle can be driven combining the electric range and fuel range.

See *Driving for Better Energy Efficiency* on page 9-2.

Safety Belt Reminders

Driver Safety Belt Reminder Light



When the vehicle is started, this light flashes and a chime may come on to remind the driver to fasten their safety belt. The light stays on solid until the belt is buckled.

This cycle may continue several times if the driver remains or becomes unbuckled during driving while the vehicle is moving.

If the driver safety belt is already buckled, neither the light nor the chime comes on.

Passenger Safety Belt Reminder Light



When the vehicle is started, this light flashes and a chime may come on to remind the passenger to fasten their safety belt. The light stays on solid until the belt is buckled.

This cycle may continue several times if the passenger remains or becomes unbuckled while the vehicle is moving.

If the passenger safety belt is buckled, neither the chime nor the light comes on.

The front passenger safety belt reminder light and chime may turn on if an object is put on the seat such as a briefcase, handbag, grocery bag, laptop, or other

electronic device. To turn off the reminder light and/or chime, remove the object from the seat or buckle the safety belt.

Second Row Passenger Safety Belt Reminder Light



Second row seating positions monitored for safety belt use are represented by a colored icon indicating safety belt status.

When the vehicle is started, two safety belt symbols come on and stay on for several seconds in the instrument cluster to alert the driver that passengers may need to fasten their safety belts.

5-18 Instruments and Controls

After the passenger safety belt is buckled, the corresponding safety belt symbol in the instrument cluster turns green. If a safety belt is not initially buckled, the instrument cluster displays a red safety belt icon.

While the vehicle is moving, if a second row passenger that was previously buckled becomes unbuckled, the corresponding safety belt indicator will change to flashing red and a chime may sound.

Airbag Readiness Light

This light shows if there is an electrical problem. The system check includes the airbag sensor, the pretensioners, the airbag modules, the wiring, and the crash sensing and diagnostic module. For more information on the airbag system, see *Airbag System on page 3-25*.



The airbag readiness light comes on and stays on for several seconds when the vehicle is started. Then the light goes out.

A message may also display in the Driver Information Center (DIC).

See *Airbag System Messages on page 5-46* for more information.

WARNING

If the airbag readiness light stays on after the vehicle is started or comes on while driving, it means the airbag system might not be working properly. The airbags in the vehicle might not inflate in a crash, or they could even inflate without a crash. To help avoid injury, have the vehicle serviced right away.

Passenger Airbag Status Indicator

The vehicle has a passenger sensing system. See *Passenger Sensing System on page 3-33* for important safety information. The passenger airbag status indicator is in the overhead console.



When the vehicle is started, the passenger airbag status indicator will light ON and OFF for several seconds as a system check. Then, after several more seconds, the status indicator will light either ON or OFF to let you know the status of the right front passenger frontal airbag and the passenger knee airbag.

If the word ON is lit on the passenger airbag status indicator, it means that the right front passenger frontal airbag and the passenger knee airbag are enabled and may inflate.

If the word OFF is lit on the airbag status indicator, it means that the passenger sensing system has turned off the right front passenger frontal airbag and the passenger knee airbag.

If, after several seconds, both status indicator lights remain on, or if there are no lights at all, there may be a problem with the lights or the passenger sensing system. See your dealer for service.



WARNING

If the airbag readiness light ever comes on and stays on, it means that something may be wrong with the airbag system. To help avoid injury to yourself or others,

(Continued)

WARNING (Continued)

have the vehicle serviced right away. See *Airbag Readiness Light* on page 5-18 for more information, including important safety information.

Charging System Light (12-Volt Battery)

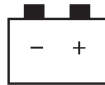

The charging system light comes on briefly when the vehicle is in ON/RUN, as a check to show the light is working.

If the light stays on, or comes on while driving, there could be a problem with the electrical charging system. Have it checked by your dealer. Driving while this light is on could drain the 12-volt battery.

If a short distance must be driven with the light on, be sure to turn off all accessories, such as the radio.

Malfunction Indicator Lamp

A computer system called OBD II (On-Board Diagnostics-Second Generation) monitors operation of the fuel, ignition, and emission control systems. It ensures that emissions are at acceptable levels for the life of the vehicle, helping to produce a cleaner environment.



If the malfunction indicator lamp comes on and stays on, while the vehicle is in ON/RUN, this indicates that there is an OBD II problem and service is required.

Malfunctions often are indicated by the system before any problem is apparent. Being aware of the light can prevent more serious damage to the vehicle. This system assists the service technician in correctly diagnosing any malfunction.

Notice: If the vehicle is continually driven with this light on, after a while, the emission controls might not work as well,

the vehicle fuel economy might not be as good, and the engine might not run as smoothly. This could lead to costly repairs that might not be covered by the vehicle warranty.

Notice: Modifications made to the engine, electric drive unit, exhaust, intake, or fuel system of the vehicle or the replacement of the original tires with other than those of the same Tire Performance Criteria (TPC) can affect the vehicle emission controls and can cause this light to come on. Modifications to these systems could lead to costly repairs not covered by the vehicle warranty. This could also result in a failure to pass a required Emission Inspection/Maintenance test. See *Accessories and Modifications on page 10-3*.

This light comes on during a malfunction in one of two ways:

Light Flashing: A misfire condition has been detected. A misfire increases vehicle emissions and could damage the emission control system on the vehicle. Diagnosis and service might be required.

The following can prevent more serious damage to the vehicle:

- Reduce vehicle speed.
- Avoid hard accelerations.
- Avoid steep uphill grades.

If the light continues to flash, when it is safe to do so, stop the vehicle. Find a safe place to park the vehicle. Turn the vehicle off, wait at least 10 seconds, and restart the vehicle. If the light is still flashing, follow the previous steps and see your dealer for service as soon as possible.

Light On Steady: An emission control system malfunction has been detected on the vehicle. Diagnosis and service might be required.

The following may correct an emission system malfunction:

- Check that the fuel cap is fully installed. The diagnostic system can determine if the fuel cap has been left off or improperly installed. A loose or missing fuel cap allows fuel to evaporate into the atmosphere. A few driving trips with the cap properly installed should turn the light off.
- Check that the electrical system is not wet. The system could be wet if the vehicle was driven through a deep puddle of water. The condition is usually corrected when the electrical system dries out. A few driving trips should turn the light off.
- Check that good quality fuel is used. Poor fuel quality causes the engine not to run as

efficiently as designed and may cause stalling after start-up or misfiring. These conditions might go away once the engine is warmed up.

If one or more of these conditions occurs, change the fuel brand used. It will require at least one full tank of the proper fuel to turn the light off.

If none of the above have made the light turn off, your dealer can check the vehicle. The dealer has the proper test equipment and diagnostic tools to fix any mechanical or electrical problems that might have developed.

Emissions Inspection and Maintenance Programs

Some state and local governments have or might begin programs to inspect the emission control equipment on the vehicle. Failure to pass this inspection could prevent getting a vehicle registration.

Here are some things to know to help the vehicle pass an inspection:

- The vehicle will not pass this inspection if the malfunction indicator lamp is on while the vehicle is in ON/RUN. See your dealer for assistance in verifying operation of the malfunction indicator lamp.
- The vehicle will not pass this inspection if the OBD II (On-Board Diagnostic) system determines that critical emission control systems have not been completely diagnosed by the system. The vehicle would be considered not ready for inspection. This can happen if the 12-volt battery has recently been replaced or if the 12-volt battery has run down. The diagnostic system is designed to evaluate critical emission control systems during normal driving.

This can take several days of routine driving. If this has been done and the vehicle still does not pass the inspection for lack of OBD II system readiness, your dealer can prepare the vehicle for inspection.

Brake System Warning Light

The vehicle brake system consists of two hydraulic circuits. If one circuit is not working, the remaining circuit can still work to stop the vehicle. For normal braking performance, both circuits need to be working.

If the warning light comes on, there is a brake problem. Have the brake system inspected right away.

BRAKE

This light comes on briefly when the vehicle is turned on. If it does not come on then, have it fixed so it will be ready to warn if there is a problem.

If the light comes on and stays on, there is a base brake problem.

WARNING

The brake system might not be working properly if the brake system warning light is on. Driving with the brake system warning light on can lead to a crash. If the light is still on after the vehicle has been pulled off the road and carefully stopped, have the vehicle towed for service.

Electric Parking Brake Light



This status light comes on when the parking brake is applied. If the light flashes and stays on after the parking brake is released, or while driving, there is a problem with the Electric Parking Brake system.

If the light does not come on, or remains flashing, see your dealer.

See *Electric Parking Brake on page 9-32* for more information.

Service Electric Parking Brake Light



The Service Electric Parking Brake light should come on briefly when the vehicle is in ON/RUN. If it does not come on, have it fixed so it will be ready to warn if there is a problem.

If this light stays on, there is a problem with a system on the vehicle that is causing the parking brake system to work at a reduced level. The vehicle can still be driven, but should be taken to a dealer as soon as possible. See *Electric Parking Brake* on page 9-32 for more information. If a message displays in the Driver Information

Center (DIC), see *Brake System Messages* on page 5-41 for more information.

Antilock Brake System (ABS) Warning Light



This light should come on briefly when the vehicle is in ON/RUN. If it does not come on, have the vehicle serviced by your dealer.

If the ABS warning light stays on longer than a few seconds after the vehicle is in ON/RUN, or comes on and stays on while driving, try resetting the system. To reset the system:

1. While driving, pull over when it is safe to do so.
2. Place the vehicle in P (Park).

3. Turn the vehicle off.
4. Restart the vehicle.

If the ABS warning light remains on after resetting the system or comes on again while driving, the vehicle needs service. If the ABS warning light is on, but the regular brake system warning light is not on, the antilock brakes are not working properly, but the regular brakes are still functioning. Have the vehicle serviced right away. If both brake lights are on, the vehicle does not have antilock brakes, and there is a problem with the regular brakes as well. Have the vehicle towed for service. See *Towing the Vehicle* on page 10-77.

Sport Mode Light

SPORT

This light comes on when Sport Mode is selected. See “Sport Mode” in *Driver Selected Operating Modes* on page 9-24 for more information.

Mountain Mode Light

MOUNTAIN

This light comes on when Mountain Mode is selected. See “Mountain Mode” in *Driver Selected Operating Modes* on page 9-24 for more information.

Traction Control System (TCS)/StabiliTrak[®] Light



This light comes on briefly while starting the vehicle.

If it does not, have the vehicle serviced by your dealer. If the system is working normally the indicator light then goes off.

If the light comes on and stays on while driving, there could be a problem with the TCS/StabiliTrak system and the vehicle might need service. When this warning light is on, the TCS/StabiliTrak system is off and does not limit wheel spin.

The light flashes if the system is active and is working to assist the driver with directional control of the vehicle in difficult driving conditions.

Engine Coolant Temperature Warning Light



The engine coolant temperature warning light comes on briefly when the vehicle is started.

If it does not, have the vehicle serviced by your dealer. If the system is working normally the indicator light then goes off.

If the light comes on and stays on while driving, the vehicle may have a problem with the cooling system. Stop and turn off the vehicle to avoid damage to the engine.

A warning chime sounds when this light is on.

See *Engine Overheating* on page 10-20 for more information.

Tire Pressure Light



For vehicles with the Tire Pressure Monitor System (TPMS), this light comes on briefly when the vehicle is in ON/RUN. It provides information about tire pressures and the TPMS.

When the Light is On Steady

This indicates that one or more of the tires are significantly underinflated.

A message in the Driver Information Center (DIC) may also display. See *Tire Messages on page 5-47* for more information. Stop as soon as possible, and inflate the tires to the pressure value shown on the Tire and Loading Information Label. See *Tires on page 10-42* for more information.

When the Light Flashes First and Then is On Steady

This indicates that there may be a problem with the Tire Pressure Monitor System. The light flashes for about one minute and stays on steady until the vehicle is in OFF. This sequence repeats each time the vehicle is in ON/RUN. See *Tire Pressure Monitor System on page 10-49* for more information.

Engine Oil Pressure Light



Do not keep driving if the oil pressure is low. The engine can become so hot that it catches fire. Someone could be burned. Check the oil as soon as possible and have the vehicle serviced.

Notice: Lack of proper engine oil maintenance can damage the engine. The repairs would not be covered by the vehicle warranty. Always follow the maintenance schedule for changing engine oil.



The oil pressure light should come on briefly as the vehicle is started. If it does not come on have the vehicle serviced by your dealer.

If the light comes on and stays on, it means that oil is not flowing through the engine properly. The vehicle could be low on oil and might have some other system problem. See your dealer.

Low Fuel Warning Light



The low fuel warning light comes on briefly when the vehicle is started.

This light also comes on when the fuel level is low. When fuel is added, the light should go off. If it does not, have the vehicle serviced.

Security Light



This light comes on briefly when the vehicle is started.

If the light remains on while driving, there is a problem with the security system. See your dealer for service.

For more information, see *Vehicle Security* on page 2-12.

High-Beam On Light



The high-beam on light comes on when the high-beam headlamps are in use.

See *Headlamp High/Low-Beam Changer* on page 6-2 for more information.

Lamps On Reminder



This light comes on when the parking lamps, headlamps, or taillamps are on.

Cruise Control Light



The cruise control light comes on when the cruise control is turned on and turns green when cruise control is engaged.

See *Cruise Control* on page 9-36 for more information.

Door, Hood, or Hatch Open Light

If a door, hood, or hatch is not completely closed, a light comes on together with a graphic in the Driver Information Center (DIC).

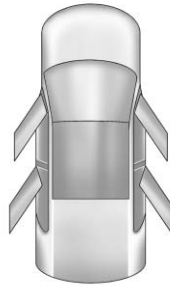

Door(s) Open

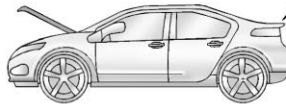
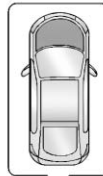

Hood Open

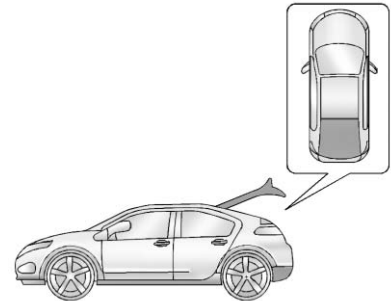

Hatch Open

The DIC indicates when a door, the hood, or the hatch is open. The light displays the open area as shaded.

The DIC and the light both display when the vehicle is moving. Only the light displays if the vehicle is stopped.

Information Displays

Center Stack Display

The center stack screen displays Charging, Power Flow, and Energy Information. See the information that follows.

The Climate Control, Infotainment, and Vehicle Personalization also display information in this screen. For more information on these systems, see:

- *Automatic Climate Control System on page 8-1.*
- *Infotainment on page 7-1.*
- *Vehicle Personalization on page 5-48.*

The center stack controls only need a light touch to operate and work best with bare hands. The controls will work with most gloves although they may take longer to respond.

Use the finger pad rather than the finger tip to minimize response time. If the controls are not responding, remove the gloves.

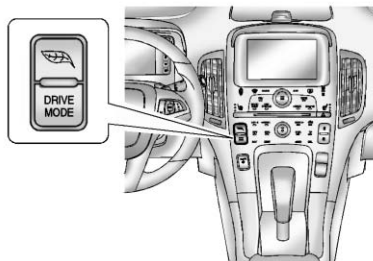

To view the Power Flow, Charging, and Energy Information, press the  button on the center stack.

Power Flows

To view the Power Flow screens, press the  button on the center stack and then press the Power Flow button at the top of the touch screen. The Power Flow screens indicate the current system operating condition. The screens show the energy flow between the engine, electric drive unit, and high voltage battery. These components will be highlighted when they are active.

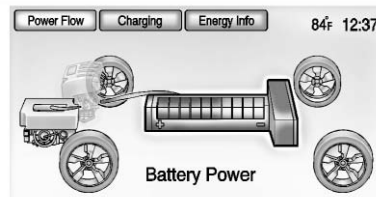

Battery Power - Battery is active with energy flowing to the wheels.

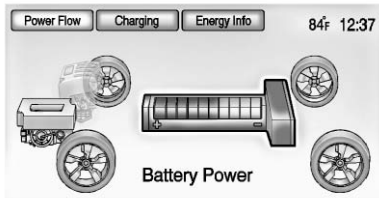

Battery Power - Vehicle is stationary in electric mode and no power is flowing to the wheels.

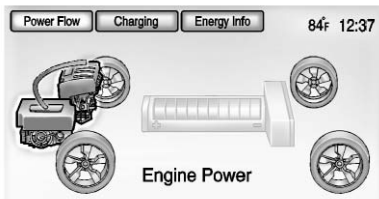

Engine Power - Engine is active with energy flowing to the wheels.

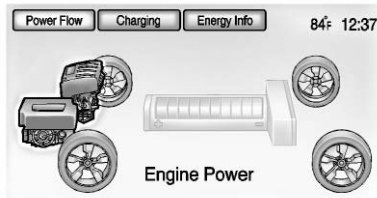

Engine Power - Vehicle is stationary in extended range mode and no power is flowing to the wheels.

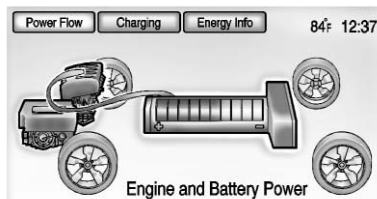

Engine and Battery Power - Both the engine and battery are active with energy flowing to the wheels.

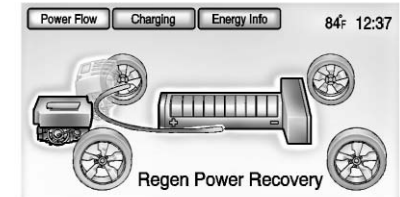
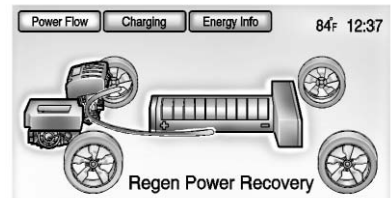

Regen Power Recovery - Power from the wheels returns to the battery during regenerative braking or coasting.

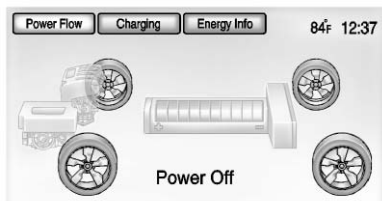

Power Off - No power is flowing to the wheels.

Charging

Programmable Charging

This vehicle has three programmable charge modes. To view the current charge mode status in the center stack display, press the  button on the center stack and then press the Charging button at the top of the touch screen.

The current charge mode status can also be viewed in a temporary pop-up in the center stack display by pressing the charge port door release button on the driver door.

The Charge Start and Charge Complete time estimations are also displayed on the screen. These estimations are most accurate when the vehicle is plugged in and in moderate temperature conditions.

Charge Mode Status

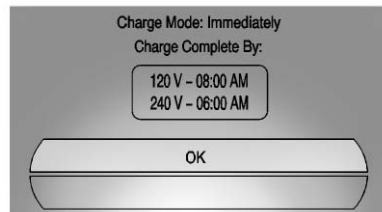
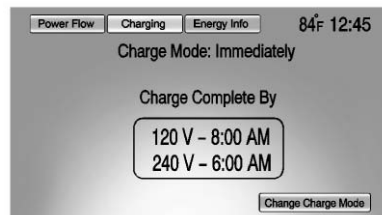

Immediately: The vehicle starts charging as soon as it is connected to an electrical outlet. See *Plug-In Charging* on page 9-44.

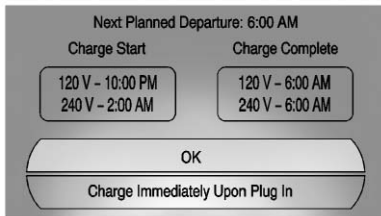
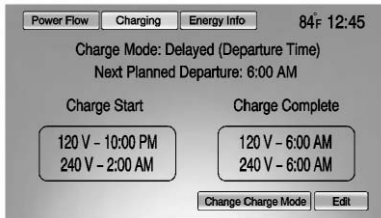

Delayed Departure Time: The vehicle estimates the charging start time considering the programmed departure time for the current day of the week. Charging begins at the start time and is complete by the departure time only if sufficient time is allowed after the charge cord is plugged in. The vehicle uses an

internal clock for programmable charging, not the clock in the center stack.

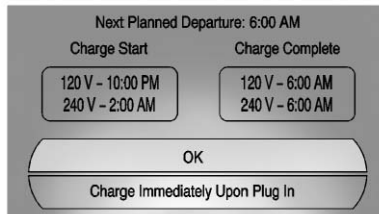
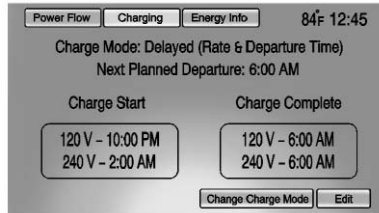

Delayed Rate and Departure Time: The vehicle estimates the charging start time based on the utility rate schedule, utility rate preference, and the programmed

departure time for the current day of the week. The vehicle will charge during the least expensive rate periods to achieve a full battery charge by the departure time. Electrical rate information from the utility company for the charging location is required for this mode.

Charge Mode Selection

From the Charge Mode Status screen, press Change Charge Mode.

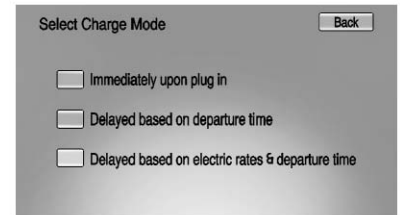

Select one option:

- Immediately upon plug in.
- Delayed based on departure time.

5-32 Instruments and Controls

- Delayed based on electric rates & departure time.

Departure Time Entry

From the Delayed Charge Mode Status screen, press Edit to change the departure time for each day of the week to match your personal schedule.

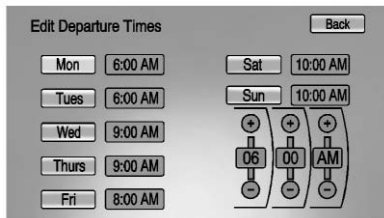

1. Press the day to change.
2. Press + or - to change the hours and minutes.
3. Press + or - to change AM or PM.
4. Press Back to store changes and return to the previous screen.

Charge Rate Selection

From the Delayed Rate and Departure Time Charge Mode Status screen, press Edit.

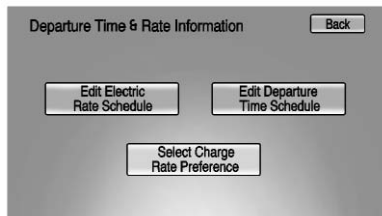

Select one of the following:

- Edit Electric Rate Schedule.
- Edit Departure Time Schedule. See "Departure Time Entry."
- Select Charge Rate Preference.

Charge Rate Preference Selection

From the Departure Time & Rate Information screen, press Select Charge Rate Preference.

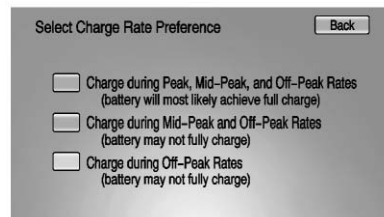

Press one of the following options to select the Charge Rate Preference.

- Charge during Peak, Mid-Peak, and Off-Peak Rates: The vehicle will charge during any rate period and will select when to charge to minimize the total cost of the charge.
- Charge during Mid-Peak and Off-Peak Rates: The vehicle will charge during Off-Peak and/or Mid-Peak rate periods only and will select when to charge to minimize the total cost of the charge.
- Charge during Off-Peak Rates: The vehicle will only charge during Off-Peak rate periods.

Charging begins at the start time and is complete by the departure time only if sufficient time is allowed after the charge cord is plugged in. For example, if the vehicle is plugged in for only one hour prior to the departure time, and the battery is completely discharged, the vehicle will not be fully charged by the departure time regardless of the rate selection.

Electric Rate Plan Selection

Electric rates, or cost per unit, may vary based on time, weekday/weekend, and season. During the day when the demand for electricity is high, the rates are usually higher and called Peak rates. At night when the demand for electricity is low, the rates are usually lower and called Off-Peak rates. In some areas, a Mid-Peak rate is offered.

Contact the utility company to obtain the rate schedule for your area. The summer and winter start dates must be established to use a summer/winter schedule.

From the Departure Time & Rate Information screen, press Edit Electric Rate Schedule.

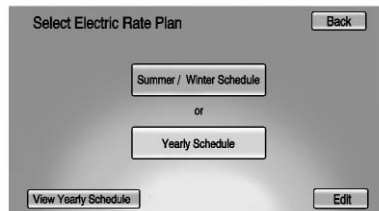
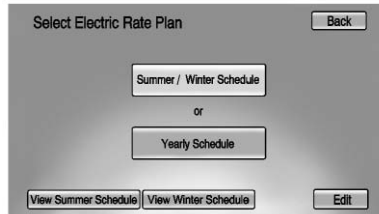

To edit the Summer/Winter Schedule:

1. Press Summer/Winter Schedule.
2. Press Edit.

To edit the Yearly Schedule:

1. Press Yearly Schedule.
2. Press Edit.

Summer/Winter Schedule Start Date Entering

From the Select Electric Rate Plan screen, press Summer/Winter Schedule then press Edit.

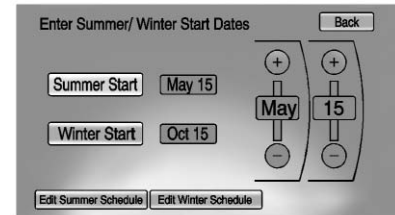

1. Press Summer Start.
2. Press + or - to set the month and day for the start of summer.
3. Press Winter Start.
4. Press + or - to set the month and day for the start of winter.

5-34 Instruments and Controls

5. Press Edit Summer Schedule or Edit Winter Schedule to edit the daily electric rate schedule.

Electric Rate Schedule Editing

From the Enter Summer/Winter Start Dates screen, press Edit Summer Schedule or Edit Winter Schedule.

From the Select Electric Rate Plan screen, press Yearly Schedule and then press Edit.

	Start	Finish	Rate	
	12:00 AM	10:00 AM	Off-Peak	Edit
Weekday	10:00 AM	7:00 PM	Peak	Edit
Weekend	7:00 PM	12:00 AM	Off-Peak	Edit
	---:--:	---:--:	---	Edit
	---:--:	---:--:	---	Edit

	Start	Finish	Rate	
	12:00 AM	10:00 AM	Off-Peak	Edit
Weekday	10:00 AM	7:00 PM	Peak	Edit
Weekend	7:00 PM	12:00 AM	Off-Peak	Edit
	---:--:	---:--:	---	Edit
	---:--:	---:--:	---	Edit

	Start	Finish	Rate	
	12:00 AM	10:00 AM	Off-Peak	Edit
Weekday	10:00 AM	7:00 PM	Peak	Edit
Weekend	7:00 PM	12:00 AM	Off-Peak	Edit
	---:--:	---:--:	---	Edit
	---:--:	---:--:	---	Edit

1. Press Weekday or Weekend.
2. Press Edit next to the row to be changed.
 - Weekdays are Monday through Friday and use the same rate schedule.
 - Weekends are Saturday and Sunday and use the same rate schedule.

Both weekday and weekend schedules must be set. The rate schedule only applies for a 24-hour period, starting at 12:00 AM and ending at 12:00 AM. There can be five rate changes for each day; not all must be used.

The finish times must be consecutive. If a finish time does not follow a start time, the error message displays "An invalid entry was found in the data entered. Please re-enter data."

Electric Rate Finish Time Editing

From the Edit (Summer, Winter, or Yearly) Electric Rate Schedule screen, press Edit next to the row to change.

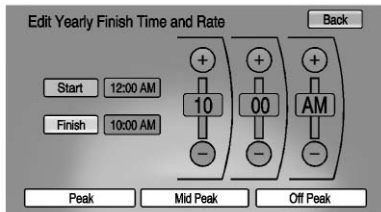
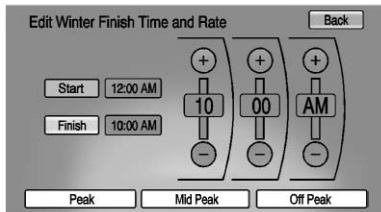
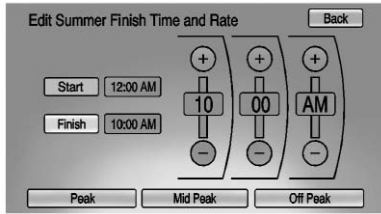

1. Press + or - to adjust the time.

2. Press Peak, Mid-Peak, or Off-Peak to select the electric rate.
3. Press the Back button to store changes.

Only the finish time can be edited. The start time is automatically populated in the rate table.

Electric Rate Schedule Viewing

From the Select Electric Rate Plan screen, press View (Summer, Winter, or Yearly) Schedule.

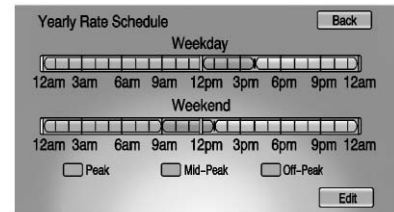
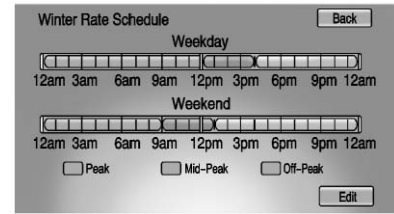
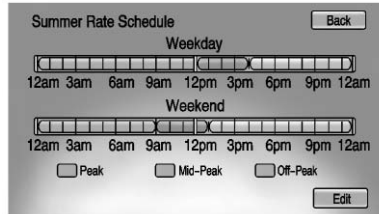

Temporary Charge Mode Override and Cancel

Programmed Delayed Charge Modes can be temporarily overridden to an Immediate Charge Mode for one charge cycle. There are also other ways to temporarily override a Delayed Charge Mode. See *Plug-In Charging on page 9-44*.

5-36 Instruments and Controls

To temporarily override a Delayed Charge Mode from inside the vehicle:

1. Press the charge port door release button on the driver door to view the Charge Mode Status pop-up in the center stack display.

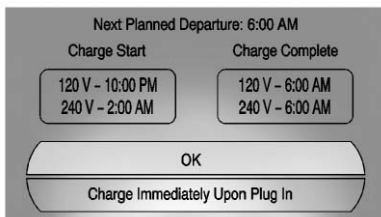

2. Press Charge Immediately Upon Plug In.

The new Temporary Charge Mode Status screen will automatically display the revised charge complete time.

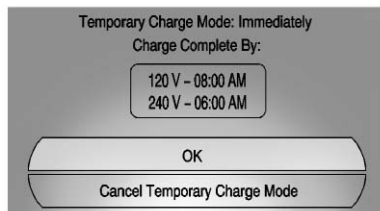
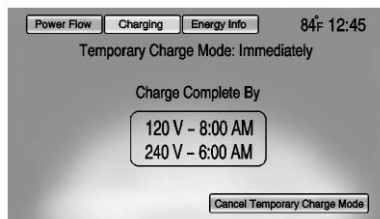

To cancel the temporary override from the Temporary Charge Mode Status screen or pop-up, press Cancel Temporary Charge Mode on the bottom of the touch screen.

The vehicle will reinstate the programmed delayed charge mode settings.

Programmable Charging Disabled

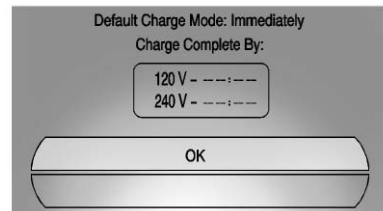
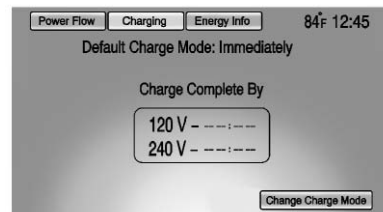

When the Programmable Charging system is disabled, the Default Charge Mode Status screen and the pop-up display. If the Programmable Charging system is disabled, see your dealer for details.

Energy Information

To view the Energy Usage, Energy Efficiency, and Efficiency Tips, press the  button on the center stack and then press the Energy Info button at the top of the touch screen.

Energy Usage

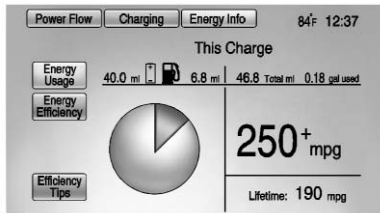

The Energy Usage screen displays information for the total of all the drive cycles since the last time the high voltage battery was fully charged. This includes distance traveled in Electric Mode, distance traveled in Extended Range Mode, total distance traveled, total fuel used, and average fuel economy.

There are maximum limits to some of the values that can be displayed. When these values are replaced with dashes, the value limits have been reached. To reset these values, the high voltage battery will need to be fully recharged. The circle graph also represents the percentage of distance traveled using Electric Mode versus Extended Range Mode. The Lifetime Fuel Economy is a total over the life of the vehicle and can only be reset by the dealer.

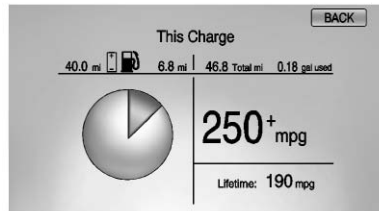

The Energy Usage information will also appear automatically on power off when Retained Accessory Power is active. This automatic pop-up can be disabled through the vehicle

personalization. See “Energy Summary Exit Pop-up” under *Vehicle Personalization on page 5-48*.

Energy Efficiency

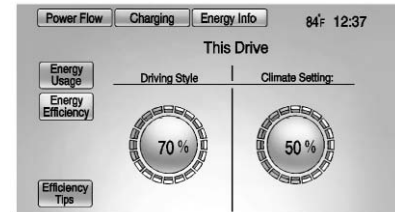

The Energy Efficiency screen is accessed by pressing Energy Efficiency on the Energy Usage screen. This screen displays the energy efficiency over the drive cycle based on driving style and climate settings. Driving in a more efficient manner will result in a higher percentage displayed for driving style. Minimizing the use of the climate control system will result in a higher percentage displayed for climate setting.

5-38 Instruments and Controls

Efficiency Tips

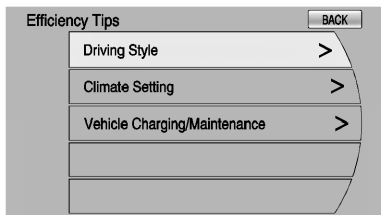

The Efficiency Tips screen is accessed by pressing Efficiency Tips from the Energy Usage or Energy Efficiency screen. This screen provides a guide on how to improve energy usage to increase fuel economy and range.

Clock

The clock is in the center stack display.

To set the time:

1. Press the CONFIG button to enter the menu options, then press it again until the time is selected or press the Time touch screen button in the upper right corner of the touch screen.
2. Press + or – to increase or decrease the Hours and Minutes displayed on the clock.

12/24 HR Format: Select the 12 HR touch screen button for standard time; select the 24 HR touch screen button for military time.

Day + or Day –: Press the day + or day – touch screen buttons to increase or decrease the day.

Driver Information Center (DIC)



The Driver Information Center (DIC) display is in the instrument cluster. The DIC displays information about the vehicle. It also displays warning messages if a system problem is detected. See *Vehicle Messages on page 5-40* for more information.

DIC Operation and Displays

View the DIC displays by pressing the DIC buttons located to the left of the steering wheel. The DIC displays trip, fuel, and warning messages if a system problem is detected.

DIC Controls

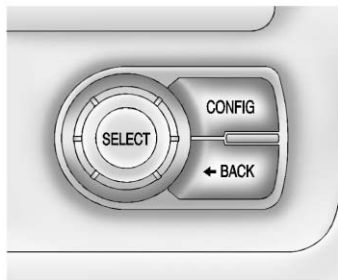

CONFIG: Press to select either the Simple or Enhanced instrument cluster configuration display.

◀ **BACK:** Press to return to the previous screen, exit a screen, or return to the main menu. Press ◀ **BACK** to minimize the DIC menu display.

SELECT: Press the center of the knob to select the highlighted item. Turn the knob to scroll through the menu items.

DIC Menu Items

At the main DIC menu:

1. Turn the SELECT knob to scroll through the possible DIC menus.
2. Press the center of the SELECT knob when a menu item is highlighted to enter that menu.
3. Continue to turn and press the SELECT knob to scroll through and select the available menu items:
 - Trip A
 - Trip B
 - Oil Life
 - Tire Pressure
 - Vehicle Messages
 - Units
 - Tutorial Mode

Trip A and Trip B

The trip displays show fuel used, average fuel economy, and distance traveled since the last trip reset.

Reset the trip data by pressing and holding the SELECT button when either Trip A or Trip B is displayed.

Oil Life

This displays the percentage of remaining oil life. The lower the percentage, the closer the vehicle is to needing an oil change.

When the oil life is depleted, the CHANGE ENGINE OIL SOON message displays. Change the oil as soon as possible. Additional maintenance is also recommended in the Maintenance Schedule. See *Scheduled Maintenance on page 11-3* and *Engine Oil on page 10-9*.

The oil life must be reset after each oil change. Avoid accidental resetting of the Engine Oil Life System. It cannot be reset accurately until the next oil change. To reset the Engine Oil Life System, see *Engine Oil Life System on page 10-12*. The system is reset when 100% displays.

Tire Pressure

The display will show a vehicle with the approximate pressures of all four tires. Tire pressure is displayed in either kilopascals (kPa) or in pounds per square inch (psi).

If a low or high tire pressure is detected, a message is displayed advising to check the tire pressure in the specified tire. See *Tire Pressure on page 10-48* and *Tire Messages on page 5-47* for more information.

If the tire pressure display shows dashes instead of a value, there may be a problem with the vehicle. See your dealer for service.

Vehicle Messages

Turn the SELECT knob to scroll through any active warning messages. Press SELECT to review the messages.

Units

Turn the SELECT knob to change the unit display to METRIC or US when the display is active. Press SELECT to confirm the setting. This will change the displays on the cluster and DIC to either metric or English (US) measurements.

Tutorial Mode

Select this menu item to view a screen that explains some of the unique features of the cluster.

Tutorial mode is only available when the vehicle is in P (Park).

Vehicle Messages

Messages displayed in the DIC indicate the status of the vehicle or some action that may be needed to correct a condition. Multiple messages may display one after the other.

Messages that do not require immediate action can be acknowledged and cleared by pressing the SELECT knob. The messages requiring immediate action cannot be cleared until that action is performed. All messages should be taken seriously. Clearing the messages does not correct the problem.

Battery and Charging Messages

BATTERY SAVER ACTIVE

This message displays when the vehicle has detected that the 12-volt battery voltage has dropped and vehicle features are being disabled. The 12-volt battery saver system starts reducing certain features trying to save the charge of the 12-volt battery. Turn off unnecessary features to allow the battery to recharge.

BATTERY TOO COLD, PLUG IN TO WARM

This message displays during extremely cold temperatures, when the vehicle will not start until the high voltage battery is warm enough.

Plug the vehicle in to allow the charging system to warm the high voltage battery, then the vehicle can be started.

CHARGE CORD CONNECTED

This message displays when the charge cord is connected to the vehicle. The vehicle cannot be shifted out of P (Park) with the charge cord connected.

CHARGE DOOR OPEN

This message displays when the charge door is open and the vehicle is shifted out of P (Park).

LOW BATTERY

This message displays when the 12-volt battery voltage is low. See *Battery on page 10-24* for more information.

SERVICE BATTERY CHARGING SYSTEM

This message displays when there is a fault in the 12-volt battery charging system. Take the vehicle to your dealer for service.

SERVICE HIGH VOLTAGE CHARGING SYSTEM

This message displays when there is a problem with the high voltage charging system. See your dealer for service.

Brake System Messages

BRAKE FLUID LOW

This message displays when the brake fluid level is low. See *Brake Fluid on page 10-22*.

RELEASE PARKING BRAKE

This message displays if the electric parking brake is on while the vehicle is in motion. Release it before attempting to drive. See *Electric Parking Brake on page 9-32* for more information.

SERVICE BRAKE ASSIST

This message displays when there is a problem with the brake boost assist system. When this message displays, the brake boost assist motor might be heard operating and a pulsation may be felt in the brake pedal. Take the vehicle to your dealer for service.

SERVICE PARKING BRAKE

This message displays when there is a problem with the parking brake. Take the vehicle to your dealer for service.

STEP ON BRAKE TO RELEASE PARK BRAKE

This message displays when attempting to release the electric parking brake without the brake pedal applied. See *Electric Parking Brake on page 9-32* for more information.

Cruise Control Messages

CRUISE SET TO XXX

This message displays when the cruise control is set and shows the speed it was set to. See *Cruise Control on page 9-36* for more information.

Door Ajar Messages

DOOR(S) OPEN, HOOD OPEN, HATCH OPEN

A symbol will appear on the display showing the area that is open. See *Door, Hood, or Hatch Open Light on page 5-27*.

Drive Mode Messages

MOUNTAIN MODE NOT AVAILABLE

This message displays when in Mountain Mode and the mode becomes unavailable. See "Mountain Mode" under *Driver Selected Operating Modes on page 9-24*.

SPORT MODE NOT AVAILABLE

This message displays when in Sport Mode and the mode becomes unavailable. See "Sport Mode" under *Driver Selected Operating Modes on page 9-24*.

Electric Drive Unit Messages

SHIFT TO PARK

This message displays when the vehicle should be shifted to P (Park). This may appear when attempting to turn off the vehicle when it is not in P (Park).

Engine Cooling System Messages

ENGINE OVERHEATED — REDUCE SPEED

This message displays when the engine coolant temperature or engine oil is too hot. Reduce speed and allow the vehicle to cool down.

ENGINE OVERHEATED — TURN VEHICLE OFF

This message displays and a continuous chime sounds if the engine cooling system reaches

unsafe temperatures for operation. Stop and turn off the vehicle as soon as it is safe to do so to avoid severe damage. This message clears when the engine has cooled to a safe operating temperature.

ENGINE RUNNING DUE TO TEMPERATURE

This message displays when the high voltage battery is charged but the engine has to come on because of the outside temperature or high voltage battery temperature.

Engine Oil Messages

CHANGE ENGINE OIL SOON

This message displays when the engine oil needs to be changed. After changing the engine oil, the Engine Oil Life System must be reset. See *Engine Oil Life System* on page 10-12 and *Driver Information Center (DIC)* on page 5-38 for information on how to reset the system. See *Engine Oil* on

page 10-9 and *Scheduled Maintenance* on page 11-3 for more information.

OIL PRESSURE LOW — TURN VEHICLE OFF

This message displays if low oil pressure levels occur. Stop the vehicle as soon as safely possible and do not operate it until the cause of the low oil pressure has been corrected. Check the oil as soon as possible and have the vehicle serviced by your dealer.

Fuel System Messages

CLOSE FUEL DOOR

This message displays when the fuel door is open and the vehicle is moving.

ENGINE NOT AVAILABLE ADD FUEL

This message displays when the engine is not available due to running out of fuel. The vehicle can continue to be driven in Electric Mode until the battery is depleted, but will have reduced acceleration. When this message is displayed, refuel the vehicle. See *Out of Fuel/Engine Unavailable* on page 9-26.

FUEL LEVEL LOW

This message displays when the vehicle is low on fuel. Refuel as soon as possible.

READY TO REFUEL

This message displays when the fuel system is depressurized and the vehicle can be refueled.

SERVICE REFUELING SYSTEM

This message displays when there is a problem with the vehicle refueling system. See your dealer for service.

TIGHTEN GAS CAP

This message displays when the fuel cap is not on tight. Tighten the fuel cap.

WAIT TO REFUEL

This message displays when the fuel system is pressurized and you must wait to refuel the vehicle.

Key and Lock Messages

When programming new Remote Keyless Entry (RKE) transmitters, DIC messages display. See *Remote Keyless Entry (RKE) System Operation* on page 2-3 for more information.

NO REMOTE DETECTED

This message displays when the RKE transmitter is not detected while attempting to start the vehicle. The transmitter battery may be weak. See “Starting the Vehicle with a Low Transmitter Battery” under

Remote Keyless Entry (RKE) System Operation on page 2-3 for more information.

NO REMOTE DETECTED, PRESS BRAKE TO RESTART

This message displays if the RKE transmitter is no longer detected in the vehicle. Press the brake pedal and the POWER ⏻ button to restart the vehicle, or press the POWER ⏻ button without pressing the brake pedal to turn the vehicle off. If the vehicle is turned off and a valid transmitter is not available, the vehicle will not restart.

REMINDER: KEY LEFT IN VEHICLE

This message displays when leaving the vehicle with the RKE transmitter still inside.

REPLACE BATTERY IN REMOTE KEY

This message displays when the battery in the RKE transmitter needs to be replaced.

SERVICE KEYLESS START SYSTEM

This message displays when the keyless start system needs service. Take the vehicle to your dealer.

Lamp Messages

AUTOMATIC LIGHT CONTROL ON OR OFF

A message will display when the automatic light control has been turned on or off.

CHECK LAMP or LAMP FAILURE

Depending on the lamp, one of these messages may display. See *Bulb Replacement on page 10-29*.

TURN SIGNAL ON

This message displays if the turn signal has been left on. Turn off the turn signal.

Object Detection System Messages

PARK ASSIST OFF

This message displays when the park assist system has been turned off. See *Ultrasonic Parking Assist on page 9-39*.

SERVICE PARKING ASSIST

This message displays if there is a problem with the park assist system. Take the vehicle to your dealer for service.

Propulsion Power Messages

PROPULSION POWER IS REDUCED

This message displays when the propulsion power is reduced and can affect the ability to accelerate. If this message is on, but there is no reduction in performance, proceed to your destination. The performance may be reduced the next time the vehicle is driven. The vehicle may be driven at a reduced speed while this message is on, but maximum acceleration and speed may be reduced. If this message stays on when the malfunction indicator lamp is on, the vehicle should be taken to your dealer for service as soon as possible.

Ride Control System Messages

LOW TRACTION

This message displays when the Antilock Brake System (ABS) is active and is working to assist the driver with control of the vehicle in difficult driving conditions.

SERVICE STABILITRAK

This message displays when there is a problem detected with the StabiliTrak system. The vehicle is safe to drive, but the StabiliTrak system is not operational.

See *Electronic Stability Control (ESC)* on page 9-35 for information on resetting the system.

SERVICE TRACTION CONTROL

This message displays when there is a problem detected with the Traction Control System (TCS). The vehicle is safe to drive, but the TCS is not operational. See *Traction*

Control System (TCS) on page 9-34 for information on resetting the system.

Airbag System Messages

SERVICE AIRBAG

This message displays if there is a problem with the airbag system. Take the vehicle to your dealer for service.

Anti-Theft Alarm System Messages

SERVICE THEFT ALARM

This message displays if there is a problem with the alarm. See your dealer for service.

SERVICE THEFT DETERRENT SYSTEM

This message displays if there is a problem with the theft-deterrent system. See your dealer for service.

Service Vehicle Messages

ENGINE MAINTENANCE XXX% COMPLETE

This message displays when the Engine Maintenance Mode is running. See "Engine Maintenance Mode" under *Maintenance Modes* on page 9-26.

ENGINE NOT AVAILABLE SERVICE SOON

This message displays when the engine is not available due to a malfunction that will not allow the engine to start. The vehicle can continue to be driven in Electric Mode until the battery is depleted, but will have reduced acceleration. When this message is displayed, the vehicle should be taken to your dealer for service as soon as possible. See *Out of Fuel/Engine Unavailable* on page 9-26.

SERVICE AC SYSTEM

This message displays if there is a problem with the air conditioning system. Take the vehicle to your dealer for service.

SERVICE HEATER SOON

This message displays if there is a problem with the heater system. Take the vehicle to your dealer for service.

SERVICE POWER STEERING

This message displays if there is a problem with the power steering system. Take the vehicle to your dealer for service.

SERVICE VEHICLE SOON

This message displays if there is a problem with the vehicle. Take the vehicle to your dealer for service. Depending on the severity of a crash, this message may come on along with the airbag readiness light.

Starting the Vehicle Messages**PRESS BRAKE TO START VEHICLE**

This message displays when attempting to start the vehicle without first pressing the brake pedal.

PRESS BUTTON AGAIN TO TURN OFF

This message displays as a reminder to press the POWER  button to turn the vehicle off when an attempt is made to turn off the vehicle while it is in motion.

Tire Messages**SERVICE TIRE MONITOR SYSTEM**

This message displays if there is a problem with the Tire Pressure Monitor System (TPMS). See *Tire Pressure Monitor Operation* on page 10-50 for more information.

TIRE LEARNING ACTIVE

This message displays when the system is learning new tires. See *Tire Pressure Monitor Operation* on page 10-50 for more information.

TIRE LOW ADD AIR TO TIRE

This message displays when the pressure in one or more of the vehicle tires is low.

This message also displays LEFT FRONT, RIGHT FRONT, LEFT REAR, or RIGHT REAR to indicate the location of the low tire.

The low tire pressure warning light will also come on. See *Tire Pressure Light* on page 5-25.

If a tire pressure message appears on the DIC, stop as soon as you can. Inflate the tires by adding air until the tire pressure is equal to the values shown on the Tire and Loading Information label. See *Tires* on page 10-42, *Vehicle Load Limits* on page 9-13, and *Tire Pressure* on page 10-48.

You can receive more than one tire pressure message at a time. The DIC also shows the tire pressure values. See *Driver Information Center (DIC) on page 5-38*.

Vehicle Speed Messages

SPEED LIMITED TO XXX

This message displays when the vehicle speed is limited.

Washer Fluid Messages

WASHER FLUID LOW ADD FLUID

This message displays when the washer fluid level is low. For information on filling the washer fluid, see *Washer Fluid on page 10-20*.

Vehicle Personalization

The Vehicle Personalization features can be accessed by using either the infotainment controls or the touch screen in the center stack display. See *Overview on page 7-2* under “Infotainment System” for more information.

Using the Infotainment Controls

Use the CONFIG, TUNE/MENU knob, and  BACK buttons on the center stack to select personalization features.

CONFIG (Configuration): Press to scroll through the available menus across the top of the touch screen display.

TUNE/MENU Knob

- Press to enter, select, or activate a highlighted menu option.
- Turn to highlight a menu option.
- Press to turn a system setting on or off.

BACK

- Press to exit a menu.
- Press to return to a previous screen.

Submenus

An arrow on the right-hand edge of the menu indicates that it has a submenu with other options.

Selecting a Menu Option

1. Turn the TUNE/MENU knob to highlight the function.
2. Press the TUNE/MENU knob to select the highlighted option. A checkmark next to the option indicates the selected option.

Turning a Function On or Off

1. Turn the TUNE/MENU knob to highlight the function.
2. Press the TUNE/MENU knob to turn the function on or off.
A checkmark next to the function indicates that the function is on.

Using the Touch Screen

Use the touch screen icons and menus on the center stack display to select personalization features.

△ : Touch to scroll up.

▽ : Touch to scroll down.

Back: Touch Back in the upper right corner of the display to return to the previous menu.

Submenus

An arrow on the right-hand edge of the menu indicates that it has a submenu with other options.

Selecting a Menu Option

Touch any one of the available menu options on the touch screen to select the option. A checkmark next to the option indicates the selected option.

Turning a Function On or Off

Touch the screen where the available function is listed to turn it on or off. A checkmark next to the function indicates that the function is on.

Entering the Personalization Menu

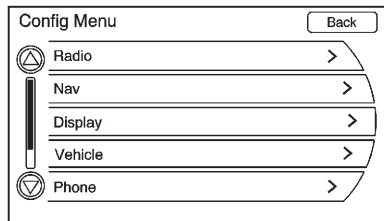

Press Vehicle menu on the touch screen.

The Vehicle menu features may include:

- Climate and Air Quality
- Comfort and Convenience
- Languages
- Lighting
- Power Door Locks
- Remote Locking, Unlocking, Starting
- Return to Factory Settings

Climate and Air Quality

Select the Climate and Air Quality menu to display:

- Auto Fan Speed
- Auto Heated Seats
- Remote Start Auto Heat Seats
- Auto Defog

Auto Fan Speed

This feature sets the automatic fan speed to maintain the desired interior temperature. This selection is available on vehicles with the Automatic Climate Control system. Choose a blower setting:

High: Increased speed.

Medium: Moderate speed.

Low: Reduced speed.

To select the auto fan speed:

1. Press the Vehicle menu.
2. Select Climate and Air Quality.
3. Select Auto Fan Speed.
4. Select the fan speed.
5. Press Back to return to the previous menu.

Auto Heated Seats

When enabled, the auto heated seat buttons on the touch screen will be highlighted. This feature will automatically activate heated seats at the level required by the interior

temperature. The auto heated seats can be turned off by using the heated seat buttons on the center stack.

To turn the auto heated seats on or off:

1. Press the Vehicle menu.
2. Select Climate and Air Quality.
3. Turn the auto heated seats feature on or off.
4. Press Back to return to the previous menu.

Remote Start Auto Heat Seats

When on, this feature will turn the heated seats on when using remote start.

To turn the remote start auto heat seats on or off:

1. Press the Vehicle menu.
2. Select Climate and Air Quality.

3. Turn the remote start auto heat seats feature on or off.
4. Press Back to return to the previous menu.

Auto Defog

When on and high humidity is detected, the Climate Control system will adjust the outside air, air conditioner, or heat to decrease fogging. The fan speed may increase. When high humidity is no longer detected, the system will return to previous operation.

To turn the auto defog on or off:

1. Press the Vehicle menu.
2. Select Climate and Air Quality.
3. Turn the auto defog feature on or off.
4. Press Back to return to the previous menu.

Comfort and Convenience

Select the Comfort and Convenience menu and the following will be displayed:

- Chime Volume
- Button Chime
- Energy Summary Exit Pop-up
- Charge Port Door Release Pop-up

Chime Volume

This allows the selection of the chime volume level to be either normal or high.

To select the chime volume level:

1. Press the Vehicle menu.
2. Select Comfort and Convenience.
3. Select Chime Volume.
4. Select the volume level.
5. Press Back to return to the previous menu.

Button Chime

This allows a tone to be heard when a selection is made using the infotainment system.

To turn the button chime on or off:

1. Press the Vehicle menu.
2. Select Comfort and Convenience.
3. Turn the button chime feature on or off.
4. Press Back to return to the previous menu.

Energy Summary Exit Pop-up

This allows the energy summary exit pop-up to be turned on or off:

1. Press the Vehicle menu.
2. Select Comfort and Convenience.
3. Turn the energy summary exit pop-up feature on or off.
4. Press Back to return to the previous menu.

Charge Port Door Release Pop-up

This allows the charge port door release pop-up to be turned on or off:

1. Press the Vehicle menu.
2. Select Comfort and Convenience.
3. Turn the charge port door release pop-up feature on or off.
4. Press Back to return to the previous menu.

Languages

This allows the selection of a language:

1. Press the Vehicle menu.
2. Select Languages.
3. Select English, French, or Spanish.
4. Press Back to return to the previous menu.

5-52 Instruments and Controls

Lighting

Select the Lighting menu and the following will be displayed:

- Exit Lighting
- Vehicle Locator Lights

Exit Lighting

This allows the selection of how long the exterior headlamps stay on when leaving the vehicle and it is dark outside.

The available options are:

- OFF
- 30 seconds
- 1 minute
- 2 minutes

To select the length of time the exterior lamps will remain on:

1. Press the Vehicle menu.
2. Select Lighting.
3. Select Exit Lighting.
4. Select the length of time the exterior lamps will remain on.

5. Press Back to return to the previous menu.

Vehicle Locator Lights

This allows the vehicle locator lights to be turned on or off. When on, the headlamps, parklamps, taillamps, license plate lamps, and back-up lamps will illuminate when  is pressed on the RKE transmitter.

To turn the vehicle locator lights on or off:

1. Press the Vehicle menu.
2. Select Lighting.
3. Turn the vehicle locator lights on or off.
4. Press Back to return to the previous menu.

Power Door Locks

Select Power Door Locks and the following will be displayed:

- Auto Door Unlock
- Unlocked Door Anti Lock Out
- Delayed Door Lock

Auto Door Unlock

This allows selection of which doors will automatically unlock when the vehicle is shifted into P (Park).

The available options are:

- All Doors
- Driver Door
- OFF

To select how the doors will automatically unlock:

1. Press the Vehicle menu.
2. Select Power Door Locks.
3. Select Auto Door Unlock.
4. Select how the doors will automatically unlock.
5. Press Back to return to the previous menu.

Unlocked Door Anti Lock Out

When on, this feature will keep the driver door from locking until the door is closed. If this feature is turned on, the Delayed Door Lock menu will be available.

To turn the unlocked door anti lock out feature on or off:

1. Press the Vehicle menu.
2. Select Unlocked Door Anti Lock Out.
3. Turn the unlocked door anti lock out feature on or off.
4. Press Back to return to the previous menu.

Delayed Door Lock

When on, this feature will delay the locking of the doors. To override the delay, press the power door lock switch on the center stack.

To turn the delayed door lock feature on or off:

1. Press the Vehicle menu.
2. Select Power Door Locks.
3. Turn the delayed door lock feature on or off.
4. Press Back to return to the previous menu.

Remote Locking, Unlocking, Starting

Select Remote Locking, Unlocking, Starting and the following will be displayed:

- Remote Lock Feedback
- Remote Unlock Light Feedback
- Door Unlock or Remote Door Unlock
- Remote Left in Vehicle Reminder

Remote Lock Feedback

This allows selection of what feedback is provided when unlocking the vehicle with the RKE transmitter.

The available options are:

- Lights and Horn
- Lights Only
- Horn Only
- OFF

To select the remote lock feedback:

1. Press the Vehicle menu.
2. Select Remote Locking, Unlocking, Starting.
3. Select Remote Lock Feedback.
4. Select the remote feedback.
5. Press Back to return to the previous menu.

Remote Unlock Light Feedback

When on, the exterior lamps will flash when unlocking the vehicle with the RKE transmitter.

To turn the remote unlock light feedback feature on or off:

1. Press the Vehicle menu.
2. Select Remote Locking, Unlocking, Starting.
3. Turn the remote unlock light feedback feature on or off.
4. Press Back to return to the previous menu.

5-54 Instruments and Controls



Door Unlock or Remote Door Unlock

This allows selection of which doors will unlock when pressing  on the RKE transmitter.

The available options are:

- All Doors
- Driver Door

If All Doors is selected, all doors will be unlocked.

If Driver Door is selected, only the driver door will be unlocked on the first press of . All doors will be unlocked on the second press of  within five seconds of the prior press.

To select how the doors will unlock with the RKE transmitter:

1. Press the Vehicle menu.
2. Select Remote Locking, Unlocking, Starting.
3. Select Door Unlock or Remote Door Unlock.
4. Select how the doors will unlock.
5. Press Back to return to the previous menu.

Remote Left in Vehicle Reminder

When on, the horn will chirp rapidly three times if an RKE transmitter is left in the vehicle.

To turn the remote left in vehicle reminder feature on or off:

1. Press the Vehicle menu.
2. Select Remote Locking, Unlocking, Starting.

3. Turn the remote left in vehicle reminder feature on or off.
4. Press Back to return to the previous menu.

Return to Factory Settings

This returns all of the vehicle personalization settings to the factory settings.

1. Press the Vehicle menu.
2. Select Return to Factory Settings.
3. Select Yes or No.
4. Press Back to return to the previous menu.

Universal Remote System

See *Radio Frequency Statement on page 13-26* for information regarding Part 15 of the Federal Communications Commission (FCC) rules and Industry Canada Standards RSS-210/220/310.

Universal Remote System Programming



If the vehicle has this feature, you will see these buttons with one LED indicator next to them in the overhead console.

This system provides a way to replace up to three remote control transmitters used to activate

devices such as garage door openers, security systems, and home automation devices.

Do not use the Universal Remote system with any garage door opener that does not have the stop and reverse feature. This includes any garage door opener model manufactured before April 1, 1982.

Read the instructions completely before attempting to program the Universal Remote system. Because of the steps involved, it may be helpful to have another person available to assist with programming the Universal Remote system.

Keep the original hand-held transmitter for use in other vehicles as well as for future Universal Remote system programming. It is also recommended that upon the sale of the vehicle, the programmed Universal Remote system buttons be erased for security purposes. See “Erasing Universal Remote System Buttons” later in this section.

When programming a garage door, park outside of the garage. Park directly in line with and facing the garage door opener motor-head or gate motor-head. Be sure that people and objects are clear of the garage door or gate being programmed.

It is recommended that a new battery be installed in the hand-held transmitter for quicker and more accurate transmission of the radio-frequency signal.

Programming the Universal Remote System

For questions or help programming the Universal Remote system, call 1-800-355-3515 or go to www.homelink.com.

Programming a garage door opener involves time-sensitive actions, so read the entire procedure before starting. Otherwise, the device will time out and the procedure will have to be repeated.

5-56 Instruments and Controls

To program up to three devices:

1. Hold the end of the hand-held transmitter about 3 to 8 cm (1 to 3 in) away from the Universal Remote system buttons while keeping the indicator light in view. The hand-held transmitter was supplied by the manufacturer of the garage door opener receiver (motor-head unit).
2. At the same time, press and hold both the hand-held transmitter button and one of the three Universal Remote system buttons to be used to operate the garage door. Do not release the Universal Remote system button or the hand-held transmitter button until the indicator light changes from a slowly to a rapidly flashing light. You now may release both buttons.

Some entry gates and garage door openers may require substitution of Step 2 with the

procedure noted in “Gate Operator and Canadian Programming” later in this section.

3. Press and hold for five seconds the newly trained Universal Remote system button (the button selected in Step 2) while observing the indicator light and garage door activation.
 - If the indicator light stays on continuously or the garage door starts to move when the Universal Remote system button is pressed and released, then the programming is complete. There is no need to continue programming Steps 4 through 6.
 - If the Universal Remote system indicator light blinks rapidly for two seconds, then turns to a constant light and the garage door

does not move, continue with programming Steps 4 through 6.

It may be helpful to have another person assist with the remaining Steps 4 through 6.

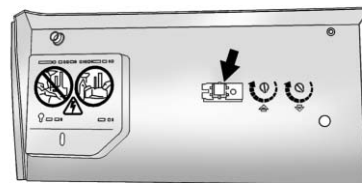

“Learn” or “Smart” Buttons

4. After Steps 1 through 3 have been completed, locate the “Learn” or “Smart” button inside the garage on the garage door opener receiver (motor-head unit). The name and color of the button may vary by manufacturer.

5. Firmly press and release the “Learn” or “Smart” button. After you press this button, you will have 30 seconds to complete Step 6.
6. Immediately return to the vehicle. Firmly press and hold for two seconds the Universal Remote system button, selected in Step 2 to control the garage door, and then release it. If the garage door does not move or the lamp on the garage door opener receiver (motor-head unit) does not flash, press and hold the same button a second time for two seconds, and then release it. Again, if the door does not move or the garage door lamp does not flash, press and hold the same button a third time for two seconds, and then release.

The Universal Remote system should now activate the garage door.

To program the remaining two Universal Remote system buttons, begin with Step 1 of “Programming the Universal Remote System.”

Gate Operator and Canadian Programming

If you have questions or need help programming the Universal Remote system, call 1-800-355-3515 or go to www.homelink.com.

Canadian radio-frequency laws require transmitter signals to time out or quit after several seconds of transmission. This may not be long enough for the Universal Remote system to pick up the signal during programming. Similarly, some U.S. gate operators are manufactured to time out in the same manner.

If you live in Canada, or you are having difficulty programming a gate operator or garage door opener by using the “Programming the Universal Remote System” procedures, regardless of where you live, replace Step 2 under “Programming the Universal Remote System” with the following:

Continue to press and hold the Universal Remote system button while you press and release every two seconds (cycle) the hand-held transmitter button until the frequency signal has been successfully accepted by the Universal Remote system. The Universal Remote system indicator light will flash slowly at first and then rapidly. Proceed with Step 3 under “Programming the Universal Remote System” to complete.

Universal Remote System Operation

Using the Universal Remote System

Press and hold the appropriate Universal Remote system button for at least half of a second. The indicator light will come on while the signal is being transmitted.

Erasing Universal Remote System Buttons

All programmed buttons should be erased when the vehicle is sold or the lease ends.

To erase all programmed buttons on the Universal Remote system device:

1. Press and hold down the two outside buttons until the indicator light begins to flash. This should take about 10 seconds.
2. Release both buttons.

Reprogramming a Single Universal Remote System Button

To reprogram any of the three Universal Remote system buttons:

1. Press and hold the desired Universal Remote system button. Do not release the button.
2. The indicator light will begin to flash after 20 seconds. Without releasing the button, proceed with Step 1 of the section "Programming the Universal Remote System."

If you have questions or need help programming the Universal Remote system, call 1-800-355-3515 or go to www.homelink.com. You may also call the customer assistance phone number under *Customer Assistance Offices* on page 13-3.

Lighting

Exterior Lighting

Exterior Lamp Controls	6-1
Headlamp High/Low-Beam Changer	6-2
Flash-to-Pass	6-2
Pedestrian Friendly Alert	6-2
Daytime Running Lamps (DRL)	6-3
Hazard Warning Flashers	6-4
Turn and Lane-Change Signals	6-4

Interior Lighting

Instrument Panel Illumination Control	6-5
Dome Lamps	6-5
Reading Lamps	6-5

Lighting Features

Entry Lighting	6-5
Exit Lighting	6-5
Battery Power Protection	6-6

Exterior Lighting

Exterior Lamp Controls



The exterior lamp control is on the turn signal/lane change lever.

 **(Exterior Lamp Control):** Operates the exterior lamps. Turn to one of the following positions:

 **(Off):** Turns the exterior lamps off.

AUTO (Automatic Headlamps):

Turns the exterior lamps on and off automatically depending on the exterior light.

 **(Parking Lamps):** Turns on the parking lamps together with the following:

- Sidemarkers Lamps
- Taillamps
- License Plate Lamps
- Instrument Panel Lights

 **(Headlamps):** Turns on the headlamps, together with the previously listed lamps and lights.

6-2 Lighting

Headlamp High/ Low-Beam Changer

 **Headlamp High/Low-Beam Changer:** Push the turn signal/lane change lever away from you and release, to turn the high beams on. To return to low beams, push the lever again or pull it toward you and release.



This indicator light turns on in the instrument cluster when the high-beam headlamps are on.

Flash-to-Pass

The flash-to-pass feature works with the low beams or Daytime Running Lamps (DRL) on or off.

To flash the high beams, pull the turn signal/lane change lever toward you momentarily and then release it. The Pedestrian Friendly Alert will also sound if the vehicle is moving less than 64 km/h (40 mph).

Pedestrian Friendly Alert

While driving at low speeds, such as in parking lots, use this feature to alert people who may not hear your vehicle approaching.

The pedestrian alert is only available when the vehicle is moving at less than 64 km/h (40 mph) or is stopped and is not in P (Park).

To use the pedestrian friendly alert:

Pull the turn signal/lane change lever all the way toward you momentarily. See *Exterior Lamp Controls on page 6-1* and *Headlamp High/Low-Beam Changer on page 6-2*. The high-beam headlamps and indicator light will turn on, and a soft-note alert will momentarily sound.

When the turn signal/lane change lever is released, the high-beam headlamps and indicator light will turn off.

Repeat for additional activations of the pedestrian friendly alert.

Daytime Running Lamps (DRL)

The Daytime Running Lamps (DRL) system comes on in daylight when the following conditions are met:

- The vehicle is on.
- The exterior lamp control is in the automatic position.
- The electric drive unit is not in P (Park).
- The light sensor determines it is daytime.

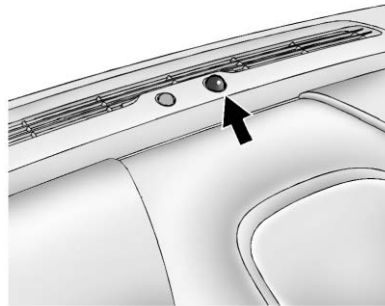

A light sensor on top of the instrument panel makes the DRL work, so be sure it is not covered.

Fully functional DRL are required on all vehicles first sold in Canada.

When the DRL are on, the taillamps, sidemarker lamps, instrument panel lights, and other lamps will not be on. The instrument cluster will be lit.

When the exterior lamp control band is turned to the headlamp position, the low-beam headlamps come on. The other lamps that come on with the headlamps will also come on.

When the vehicle is on and you are stopped, the DRL can be turned off by moving the shift lever to P (Park). The DRL will stay off until the shift lever is moved out of the P (Park) position.

The regular headlamp system should be turned on when needed.

6-4 Lighting

Hazard Warning Flashers

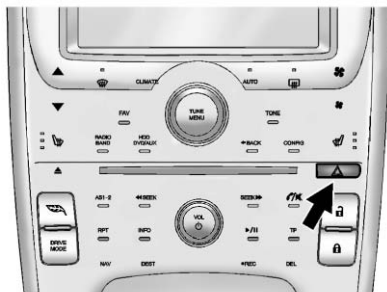

△ (Hazard Warning Flasher): Press this button, on the center stack, to make the front and rear turn signal lamps flash on and off. This warns others that you are having trouble.

Press **△** again to turn the flashers off.

Turn and Lane-Change Signals

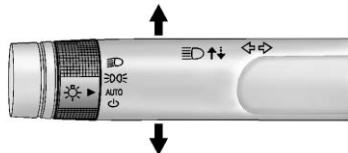

An arrow on the instrument cluster will flash in the direction of the turn or lane change.

Move the lever all the way up or down to signal a turn.

Raise or lower the lever until the arrow starts to flash to signal a lane change. Hold it there until the lane change is complete. If the lever is moved momentarily to the lane change position, the arrow will flash three times.

The lever returns to its starting position when it is released.

If a turn signal arrow flashes rapidly or does not come on, a signal bulb may need to be replaced. See *Bulb Replacement* on page 10-29.

Interior Lighting

Instrument Panel Illumination Control

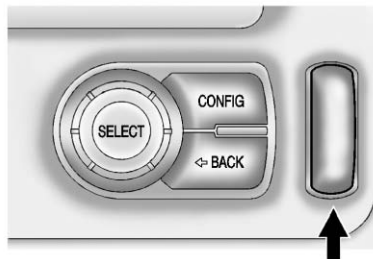

The brightness of the instrument panel cluster display, infotainment display and controls, steering wheel controls, and all other illuminated controls, as well as feature status indicators can be adjusted.

The thumbwheel is on the instrument panel to the left of the steering column.

Move the thumbwheel up or down to brighten or dim the lights.

Dome Lamps

The dome lamp controls are in the overhead console.

To operate, press the following buttons:



 **(On):** Press to turn on the dome lamps.

 **(Door):** Press to turn the lamps on automatically when a door is opened.

 **(Off):** Press to turn the lamps off, even when a door is open.



Reading Lamps

The front reading lamps are in the overhead console.

  : Press to turn each lamp on or off.

Lighting Features

Entry Lighting

The headlamps, parking lamps, taillamps, back-up lamps, and the interior lights turn on briefly, when the Remote Keyless Entry (RKE) transmitter  is pressed. The lights turn off immediately when the POWER  button is pressed or automatically after a brief period.

Exit Lighting

The headlamps, parking lamps, taillamps, back-up lamps, and license plate lamps come on when the vehicle is turned off. Some interior lights also come on when the vehicle is turned off. The exterior lamps and interior lights remain on after the door is closed for a brief period and then turn off.

The exit lighting feature can be changed. See *Vehicle Personalization* on page 5-48.

Battery Power Protection

The battery saver feature is designed to protect the vehicle's 12-volt battery.

If the exterior lamps or any interior lamp is left on and the vehicle is turned off, the battery rundown protection system automatically turns the lamps off after about 10 minutes.

Infotainment System

Introduction

Infotainment 7-1
 Theft-Deterrent Feature 7-2
 Overview 7-2

Radio

AM-FM Radio 7-8
 Satellite Radio 7-13
 Radio Reception 7-15
 Multi-Band Antenna 7-15

Audio Players

CD/DVD Player 7-16
 MP3 7-21
 Hard Drive Device (HDD) 7-24
 Auxiliary Devices 7-36

Navigation

Using the Navigation System 7-36
 Maps 7-42
 Navigation Symbols 7-44
 Destination 7-48
 OnStar® Destination Download 7-59
 Configure Menu 7-61
 Global Positioning System (GPS) 7-68
 Vehicle Positioning 7-69
 Problems with Route Guidance 7-70
 If the System Needs Service 7-70
 Ordering Map DVDs 7-70
 Database Coverage Explanations 7-71

Voice Recognition

Voice Recognition 7-71

Phone

Bluetooth 7-78

Introduction

Infotainment

The vehicle has a navigation system with an AM-FM radio. Read the following pages to become familiar with its features.

 **WARNING**

Taking your eyes off the road for extended periods could cause a crash resulting in injury or death to you or others. Do not give extended attention to entertainment tasks while driving.

This system provides access to many audio and non-audio listings.

7-2 Infotainment System

To minimize taking your eyes off the road while driving, do the following while the vehicle is parked:

- Become familiar with the operation and controls of the audio system.
- Set up the tone, speaker adjustments, and preset radio stations.

For more information, see *Defensive Driving* on page 9-4.

Notice: Contact your dealer before adding any equipment.

Adding audio or communication equipment could interfere with the operation of the engine, radio, or other systems, and could damage them. Follow federal rules covering mobile radio and telephone equipment.

The vehicle has Retained Accessory Power (RAP). With RAP, the audio system can be played even after the vehicle is turned off. See *Retained Accessory Power (RAP)* on page 9-21 for more information.

Theft-Deterrent Feature

The theft-deterrent feature works by learning a portion of the Vehicle Identification Number (VIN) to the infotainment system. The infotainment system does not operate if it is stolen or moved to a different vehicle.

Overview

When the navigation system is turned on, a screen may appear that must be read and acknowledged.

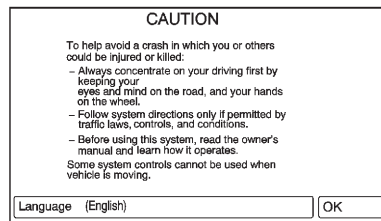

If the Caution screen appears, press OK. If either the NAV or DEST buttons are pressed, this Caution screen appears and OK must be pressed to access the NAV and DEST functions. See instructions later in this section.

To get started, set your preferences or delete information in the navigation system using various options.

Navigation System Overview

See "Navigation Buttons" under *Using the Navigation System* on page 7-36 for more information.

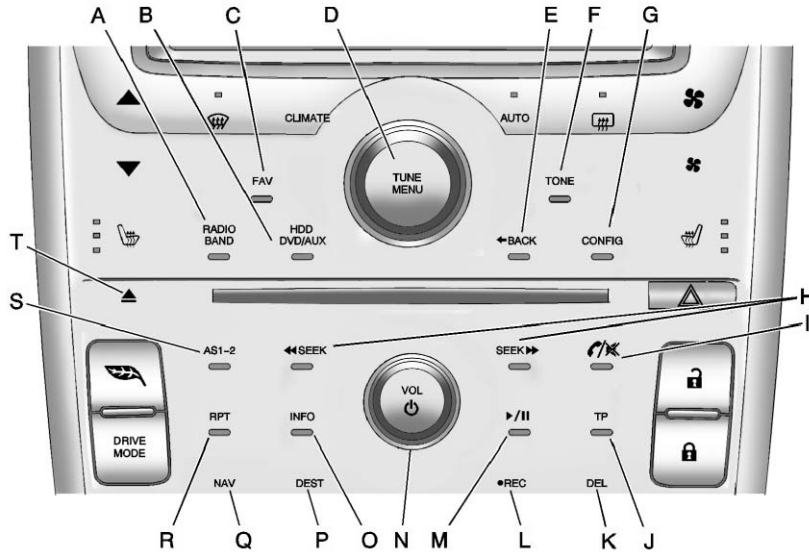

- A. RADIO BAND (AM, FM, XM)
- B. HDD/DVD/AUX (Source)
- C. FAV (Favorite)
- D. TUNE/MENU
- E. ◀ BACK
- F. TONE
- G. CONFIG (Configuration)
- H. ◀◀ SEEK/SEEK ▶▶
- I. 📞 / 🔇 (Phone/Mute)
- J. TP (Time Program)
- K. DEL (Delete)
- L. ● REC (Record)
- M. ▶/|| (Play/Pause)
- N. VOL/ ⏻ (Volume/Power)
- O. INFO (Information)
- P. DEST (Destination)
- Q. NAV (Navigation)
- R. RPT (Repeat)
- S. AS1-2 (Autostore)
- T. ▲ (Eject)

7-4 Infotainment System

NAV (Navigation) Menu

Use the Navigation Menu screen to access the navigation system settings. See *Using the Navigation System on page 7-36* for more information.

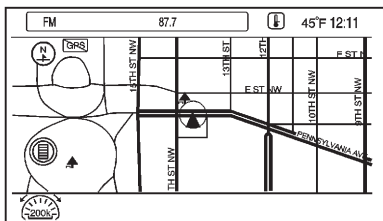

- Press the NAV button to view the navigation map screen. The map and the current vehicle location display.

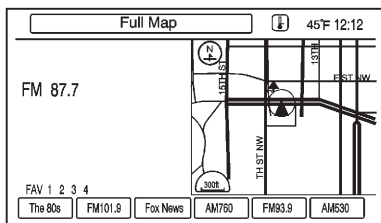

- Press the NAV button to change between a map/audio split view or a full map view.

Config Setup Menu

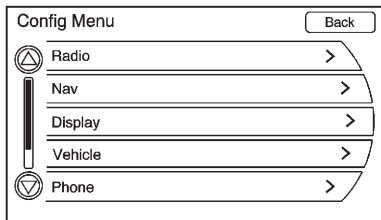

Press the CONFIG button to display the Config Menu. The Config Menu is used for changing the screens for

the audio, navigation display, phone, vehicle configuration, and time features.

Turn the TUNE/MENU knob to scroll through the available setup features. Once the desired feature displays, press the TUNE/MENU knob or press the desired feature on the screen, to display more options within that feature.

Languages

To change the display language, see *Vehicle Personalization on page 5-48* for more information.

The vehicle supports English, French Canadian, and Spanish. The default language is English.

English and Metric Unit Conversion

To change the display readings between English and metric units, see *Driver Information Center (DIC) on page 5-38* for more information.

Deleting Personal Information

The navigation system can record and store destinations and personal information such as names and addresses.

It is recommended that this information be deleted when selling or disposing of the vehicle:

- Previous Destinations
- Address Book, Fav Route, Preset Destinations, and HDD Music Files

Storing Radio Station Presets

Up to 36 preset stations can be stored. AM, FM, and XM, if equipped, can be mixed.

To store presets:

1. Press VOL/  to turn the system on.
If viewing a map screen, press the RADIO BAND button.
2. Select the band.
3. Seek or tune to the desired station to select it.

4. Press and hold one of the preset screen buttons for more than two seconds.
5. Repeat the steps for each preset.

To change the number of preset pages, see “Mixed-Band Presets” under *AM-FM Radio on page 7-8* for more information.

Entering an Address and Point of Interest, and Storing Preset Destinations

The vehicle must be in P (Park) to perform these operations.

Entering an Address

To more easily find a city or a street name:

- Enter the street name first instead of the city name, or vice versa.
- Enter more characters or reduce the number of characters to reduce or expand the available options.

To set a destination by entering a street name:

1. Press the DEST button.
2. Press the Address Entry button on the touch screen.
3. Select the street name field. Enter the street name. Do not enter directional information or street type. Use the space screen button between street and city names. Use the backspace  screen button to delete an incorrect character.
A list displays if four or fewer names are available. If there are more than four, there is a match counter with a number of available streets. Press the List screen button to view the list and select the street.
4. Press the state/province name field on the touch screen to change it. The last state/province name is automatically recalled.

7-6 Infotainment System

5. Select the city from the list or enter the city name.
6. Enter the house number. This field is automatically selected.
7. Press the OK screen button. The address information screen displays the address entered.
8. Press the Go screen button if correct. The route will calculate.
9. Select the route preference for Fastest, Shortest, or Easiest. See "Navigation Settings" under *Using the Navigation System on page 7-36* for more information.
10. Press the Start Guidance screen button and the route is calculated.

See "Address Entry" under *Destination on page 7-48* for more information.

Entering a Point of Interest (POI)

To set a destination by entering a Point of Interest (POI):

1. Press VOL/ \cup to turn the system on.
2. A caution could appear. Press OK to proceed.
3. Press the DEST button.
4. Press the Point of Interest screen button.
5. Enter the specific title of the POI in the POI name space (e.g., Washington Monument).
If four or fewer names are available, a list displays. If more than four are available, there is a match counter with a number in it, representing the number of available POI names. Press the List screen button to view the list. Select the POI.
6. Press the Go screen button. The system calculates the route.

7. Select the route preference for Fastest, Shortest, or Easiest. The system highlights the route.
8. Press the Start Guidance screen button. The route is now ready to be started.

See *Destination on page 7-48* for more information on how to enter a POI.

Storing Preset Destinations

1. Press VOL/ \cup to turn the system on.
2. If a caution appears, press the OK screen button to proceed.
3. Press the DEST button.
4. Enter a destination. See *Destination on page 7-48* for information on how to enter a destination.
5. Press Save from the map screen to add the current final destination to the address book.

6. Press the Edit screen button and then press the Change Name field on the screen. An alpha-keyboard displays. Enter the name.
7. Press and hold one of the screen buttons at the bottom of the screen until the text in the button changes.

The address book entry name appears in that preset destination screen button and is now available to select from the Select Destination screen. See “Using the Stored Preset Destinations” following to select it as a destination.

See *Destination on page 7-48* for more information on how to add preset destinations.

Using the Stored Preset Destinations

These destinations are available for selection while driving.

1. Press VOL/  to turn the system on.
2. A caution could appear. Press the OK screen button to proceed.
3. Press the DEST button.
4. Press one of the available preset destination screen buttons. The system calculates the route.
5. Select the route preference for Fastest, Shortest, or Easiest. The system highlights the route.
6. Press the Start Guidance screen button. The route is now ready to be started.

See “Preset Destinations” under *Destination on page 7-48* for more information.

Canceling Guidance

Guidance is canceled at the final destination. To cancel guidance prior to reaching the final destination:

1. Press the DEST button.
2. Press the Cancel Guidance screen button.
3. Press the Yes screen button to confirm cancellation.

Voice Guidance

To adjust the volume of voice guidance prompts:

1. Press the CONFIG button to enter the menu features. Turn the TUNE/MENU knob until Nav displays. Press the TUNE/MENU knob to select Nav or press the Nav screen button to display more options within that feature.
2. Press Voice Prompt.
3. Press Voice Volume.

7-8 Infotainment System

4. Press the + or – screen buttons to increase or to decrease the volume of the voice prompts.

See *Using the Navigation System on page 7-36* for more information.

Cleaning the Display

If the center stack or the display is stained, wipe it with a dry, soft cloth.

Notice: Using abrasive cleaners when cleaning glass surfaces, could scratch the glass. When cleaning the glass, use only a soft cloth and do not spray cleaner directly on the system.

Do not wipe the center stack with a hard cloth or use a volatile liquid such as paint thinner; it could scratch the surface or erase the characters on the buttons.

Radio

AM-FM Radio

Playing the Radio

Audio Source Menu

VOL/ (Volume/Power):

1. Press to turn the radio on or off.
2. Turn to increase or decrease the volume. The volume is adjusted for the current audio source, active navigation voice guidance, voice prompts, or audio cues.

The steering wheel controls can also be used to adjust the volume. See *Steering Wheel Controls on page 5-6* for more information.

TUNE/MENU: Turn to change the radio station. See “Finding a Station” in this section for more information.

RADIO BAND: Press to select the AM, FM, and XM (if equipped) band.

The audio sources can also be changed by using the steering wheel controls. See *Steering Wheel Controls on page 5-6* for more information.

HDD/DVD/AUX: Change to the Hard Drive, CD, DVD, USB, or AUX by pressing the HDD/DVD/AUX button until the desired source is selected.

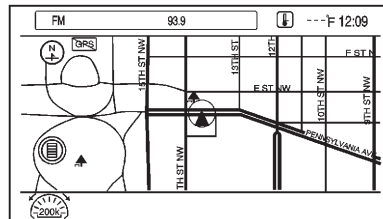

If the audio source is on while viewing a map screen, a source indicator button displays at the top of the map screen.

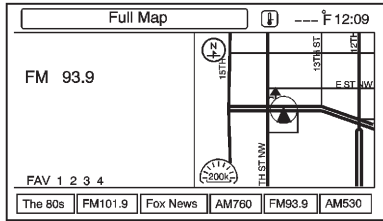

Press the source indicator button to display the current audio source screen. The display shows a split screen with the audio source screen on the left side and the map or guidance screen on the right side. Press the Full Map button to exit the split screen.

Navigation Audio System

Sound Menu

To access the Sound menu, press the TONE button.

Use the Sound menu to adjust the following features:

- Setting the Tone
- Adjusting the Speakers

Setting the Tone

To adjust the tone using the Sound menu:

- Treble: Press + or – to change the level.
- Mid (Midrange): Press + or – to change the level.
- Bass: Press + or – to change the level.

Adjusting the Speakers

To adjust the speaker balance using the Sound menu:

- Press and hold the left arrow for more sound from the left speakers or the right arrow for more sound from the right speakers. The middle position balances the sound between the left and right speakers.

To adjust the speaker fade:

- Press and hold the front arrow for more sound from the front speakers and the rear arrow for more sound from the rear speakers. The middle position balances the sound between the front and rear speakers.

EQ Settings

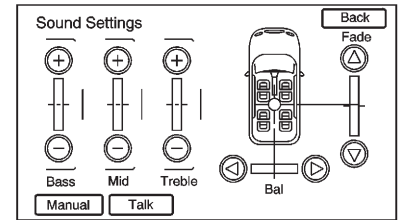

EQ (Equalization): The EQ settings are selected through the Sound menu. If the vehicle is equipped with the Bose® Energy Efficient Series sound system, EQ provides a choice of Manual or Talk settings.

7-10 Infotainment System

Radio Menu

There are two ways to access the Radio menu:

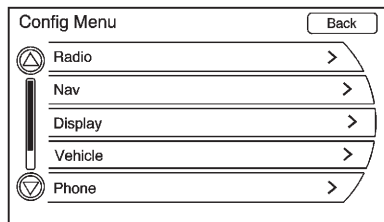

- Press the CONFIG button, then press the Radio screen button.
- Turn the TUNE/MENU knob until Radio displays. Press the TUNE/MENU knob to select Radio or press the Radio screen button to display more options within that feature.

Audio Cue Options

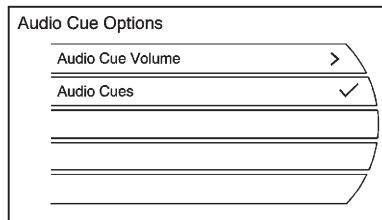

This menu allows changes to the Audio Cue features.

Audio Cue Options are used to welcome the driver to the car as well as indicate when the vehicle is ready to drive or when the vehicle is no longer driving.

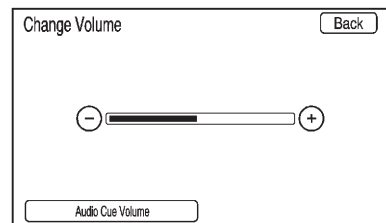

Audio Cue Volume: Press the + or – screen buttons to adjust the audio cue volume. The audio cue volume has a minimum volume. A “Limit Reached” pop-up will display when the volume has been changed to less than the minimum volume.

Press the Audio Cue Volume screen button to hear the selected sound level.

The audio cues can also be changed by adjusting the TUNE/MENU knob.

Audio Cues: Press to turn the audio cues on or off. A checkmark indicates the audio cues are on.

Auto Volume

Select OFF, Low, Medium, or High sensitivity to automatically adjust the volume to minimize the effects of unwanted background noise that can result from changing road surfaces, driving speeds, or open windows. This feature works best at lower volume settings where background noise is typically louder than the sound system volume.

Number of Favorite Pages

Change the number of mixed-band preset pages when using the FAV button. Press 1-6 to select the number of preset lists.

HDD FAV Pages (Number of Favorite Categories for HDD Mode)

Select the categories such as Playlist, Artist, Album, and Genre to be used as a favorite category during HDD mode.

Show/Hide XM Categories

Configure favorite categories to be used during XM mode.

DivX Registration Code

Display the DivX registration code used for DivX media playback.

Finding a Station

To select the band, see “Audio Source Menu” earlier in this section.

Turn the TUNE/MENU knob to find a radio station. To select a preset station, press the corresponding preset button.

See “Mixed-Band Presets” later for more information.

Seeking a Station

Press ◀ SEEK/SEEK ▶ to search for a station.

Local Station List Search

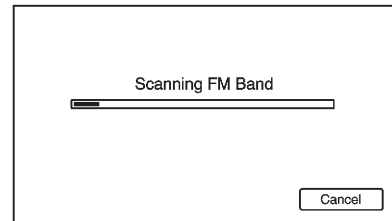

To find a list of local stations in the current band, press the TUNE/MENU knob. The radio performs a search for available stations.

Mixed-Band Presets

Up to 36 preset stations can be stored. Each page can store six preset stations. The presets within a page can be from different radio bands.

7-12 Infotainment System

To scroll through the pages, press the FAV button. The current page number displays above the preset buttons. The stored stations for each list display on the preset buttons at the bottom of the screen. The number of preset FAV lists can be changed.

To store a radio station to a mixed-band preset list:

1. Press the RADIO BAND button, then press AM, FM, or XM, if equipped, to select the desired band.
2. Tune to the station.
3. Press the FAV button to scroll to the list.
4. Press and hold one of the preset buttons for more than two seconds. The station frequency appears on the preset button at the bottom of the display.
5. Repeat the steps for each preset in each page.

To recall a preset station from a FAV page:

1. Press the FAV button to scroll to the page.
2. Press the preset button. The stored preset station is recalled.

Timeshift

The timeshift feature automatically begins recording the audio when listening to the radio.

The recording allows playback of content that was missed.

Timeshift stores up to 20 minutes of content. After 20 minutes, it removes the oldest content and continues recording new content.

While listening to the radio, press ▶/|| (Play/Pause) to stop hearing the information through the speaker. During this paused time, timeshift keeps recording. A status bar displays the length of the recording.

To resume listening to the broadcast at the point left off, press ▶/|| again.

Timeshift stops recording and erases the buffer when the vehicle is turned off or the station or source is changed.

Before turning the vehicle off, press ▶/|| so that timeshift keeps recording for 20 minutes. If the vehicle is still off after 20 minutes, the system stops recording and all information is lost. If a low 12-volt battery condition occurs, timeshift stops recording and all information is erased.

Radio Data System (RDS)

The audio system has a Radio Data System (RDS). RDS features are available for use only on FM stations that broadcast RDS information. With RDS, the radio can:

- Seek to stations broadcasting the selected type of programming.

- Receive announcements concerning local and national emergencies.
- Display messages from radio stations.

This system relies on receiving specific information from these stations and only works when the information is available. In rare cases, a radio station could broadcast incorrect information that causes the radio features to work improperly. If this happens, contact the radio station.

The RDS system is always on. When information is broadcast from the current FM station, the station name or call letters display on the audio screen. RDS can provide a program type (PTY) for current programming and the name of the program being broadcast.

Satellite Radio

XM™ Satellite Radio Service

Vehicles with an XM satellite radio tuner and an XM satellite radio subscription can receive XM programming.

XM is a satellite radio service based in the 48 contiguous United States and 10 Canadian provinces. XM satellite radio has a wide variety of programming and commercial-free music, coast to coast, and in digital-quality sound. A service fee is required to receive the XM service. For more information, see www.xmradio.com or call 1-800-929-2100 in the U.S. In Canada, see www.xmradio.ca or call 1-877-438-9677.

When XM is active, the channel name and number, category name, song title, and artist display on the screen.

XM Categories

XM stations are organized in categories.

Removing or Adding Categories

1. Press the CONFIG button. Turn the TUNE/MENU knob until Radio displays. Press the TUNE/MENU knob or press Radio to display the radio settings menu.
2. Select the Show/Hide XM Categories screen button.
3. Press the category buttons on the screen to show or hide the category.

XM Messages

XL (Explicit Language

Channels): These channels, or any others, can be blocked by request, by calling 1-800-929-2100 in the U.S., and 1-877-438-9677 in Canada.

7-14 Infotainment System

XM Updating: The encryption code in the receiver is being updated. No action is required. This process should take no longer than 30 seconds.

Loading XM: The audio system is acquiring and processing audio and text data. No action is needed. This message should disappear shortly.

Channel Off Air: This channel is not currently in service. Tune in to another channel.

Channel Unauth: This channel is blocked or cannot be received with your XM subscription package.

Channel Unavailable: This previously assigned channel is no longer assigned. Tune to another station.

No Artist Info: The system is working properly. No artist information is available at this time on this channel.

No Title Info: The system is working properly. No song title information is available at this time on this channel.

No CAT Info: The system is working properly. No category information is available at this time on this channel.

No Information: The system is working properly. No text or informational messages are available at this time on this channel.

No XM Signal: The system is working properly. The vehicle may be in a location where the XM signal is being blocked. When the vehicle is moved into an open area, the signal should return.

CAT Not Found: The system is working properly. There are no channels available for the selected category.

XM Radio ID: If tuned to channel 0, this message alternates with the XM radio eight-digit radio ID label. This label is needed to activate the service.

Unknown: If this message is received when tuned to channel 0, there could be a receiver fault. Consult with your dealer.

Check Antenna: If this message does not clear within a short period of time, the receiver could have a fault. Consult with your dealer.

XM Not Available: If this message does not clear within a short period of time, the receiver could have a fault. Consult with your dealer.

Radio Reception

Frequency interference and static can occur during normal radio reception if items such as cell phone chargers, vehicle convenience accessories, and external electronic devices are plugged into the accessory power outlet. If there is interference or static, unplug the item from the accessory power outlet.

FM

FM signals only reach about 16 to 65 km (10 to 40 mi). Although the radio has a built-in electronic circuit that automatically works to reduce interference, some static can occur, especially around tall buildings or hills, causing the sound to fade in and out.

AM

The range for most AM stations is greater than for FM, especially at night. The longer range can cause station frequencies to interfere with each other. Static can occur when things like storms and power lines interfere with radio reception. When this happens, try reducing the treble on the radio.

XM™ Satellite Radio Service

XM Satellite Radio Service gives digital radio reception from coast to coast in the 48 contiguous United States, and in Canada. Just as with FM, tall buildings or hills can interfere with satellite radio signals, causing the sound to fade in and out. In addition, traveling or standing under heavy foliage, bridges, garages, or tunnels may cause loss of the XM signal for a period of time.

Cellular Phone Usage

Cellular phone usage can cause interference with the vehicle's radio.

Multi-Band Antenna

The multi-band antenna is on the roof of the vehicle. The antenna is used for the AM-FM radio, OnStar, the XM Satellite Radio Service System, and GPS (Global Positioning System), if the vehicle has these features. Keep the antenna clear of obstructions for clear reception.

Audio Players

CD/DVD Player

The player can be used for CD, MP3, and DVD audio, and as a DVD video player.

With the vehicle on, insert a CD/DVD into the slot, label side up. The player pulls it in and begins playing. While playing, the navigation system is available.

The vehicle must be in P (Park) for video to display.

The DVD player is only compatible with DVDs of the appropriate region code printed on the jacket of most DVDs.

The system is capable of playing:

- Most audio CDs
- CD-R
- CD-RW
- MP3 or unprotected WMA formats
- DVD-Video
- DVD-Audio
- DVD-R/RW
- DVD+R/RW

When playing any compatible recordable disc, the sound quality can be reduced due to disc quality, the method of recording, the quality of the music or video that has been recorded, or the way the disc has been handled.

There can be increased skipping, difficulty in recording tracks, difficulty in finding tracks/chapters, and/or difficulty in loading and ejecting. If these problems occur, check the disc for damage or try a known good disc.

To avoid damage to the CD/DVD player:

- Do not use scratched or damaged discs.
- Do not apply labels to discs. The labels could get caught in the player.
- Insert only one disc at a time.
- Keep the loading slot free of foreign materials, liquids, and debris.
- Use a marking pen to label the top of the disc.

Loading and Ejecting Discs

To load a disc:

1. Turn the vehicle on.
2. Insert a disc into the slot, label side up. The player pulls it in the rest of the way. If the disc is damaged or improperly loaded, there is an error and the disc ejects.

The disc automatically plays once loaded.

Press  to eject a disc from the CD/DVD player. If the disc is not removed within a short period of time, it is automatically pulled back into the player.

Playing a CD/DVD

A disc must be loaded to select the source.

When a disc is loaded, the disc icon displays.

There are two ways to play a CD/DVD:

- Insert the disc and play starts automatically.
- Press the HDD/DVD/AUX button, then press the disc screen button.

Playing an Audio CD

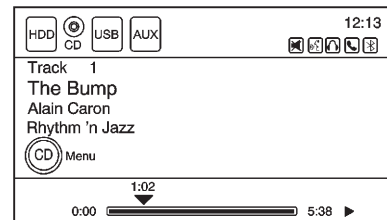

A track number displays at the beginning of each track. Song, Artist, and Album information displays when available.

Use the following controls to play the disc:

▶/|| (Play/Pause): Use to start, pause, or resume play.

7-18 Infotainment System

SEEK ►►:

- Press to seek to the next track.
- Press and hold to fast forward through a track. Release the button to return to playing speed. Elapsed time displays.

◀◀ SEEK:

- Press to seek to the beginning of the current or previous track. If the track has been playing for less than five seconds, it seeks the previous track. If longer than five seconds, the current track starts from the beginning.
- Press and hold to fast reverse through a track. Release the button to return to playing speed. Elapsed time displays.

TUNE/MENU: Turn to the right or left to display the track list. Turn it again to cycle through the list. Press this knob to select the track. The system plays the selected track and returns to the CD screen.

CD Menu

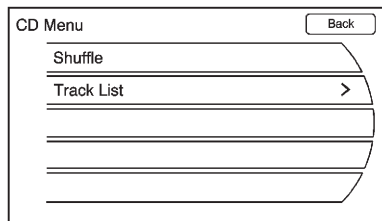

Press the CD Menu screen button to display the CD Menu.

Shuffle: Press to play the tracks randomly rather than in sequence. Press again to stop shuffle. A checkmark indicates shuffle is on.

Track List: Press to display the list of tracks on the disc. Select a track from the list. The selected track plays and the CD screen displays.

Playing an Audio and Video DVD

To view the DVD video, the vehicle must be in P (Park) or the parking brake must be engaged.

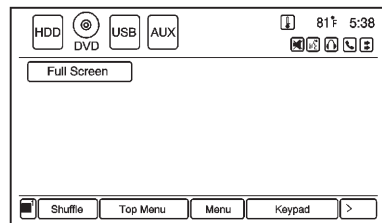

After the DVD is loaded, the menu options display on the DVD screen. The menu options time out and a full screen appears after about 10 seconds. Press anywhere on the navigation system screen or press the FAV, HDD/DVD/AUX, or ◀◀ BACK button to view the menu screen again.

Use the preset keys or press screen buttons to operate the DVD options.

There are two pages of DVD options. Press the arrow screen button, in the bottom right corner of the screen, to access the other page. Only the highlighted functions are available for use. Some menu options are only available when the disc is not playing.

DVD Options

Full Screen:

1. Press to hide the DVD options and display the full video image.
2. Press anywhere on the navigation system screen or press the FAV, HDD/DVD/AUX, or BACK button to display the source screen buttons over the video image.

Cursor: Press this button to access the Cursor menu. The arrows and other cursor options allow navigation of the DVD menu options. The Cursor menu options are only available if a DVD has a menu.

, , , (Arrow Buttons): Use these arrow screen buttons to navigate through the DVD menu.

/|| (Play/Pause): Use to start, pause, or resume play.

SEEK

1. Press to seek to the next chapter.
2. Press more than once to continue moving forward through the disc.
3. Press and hold to fast forward through a disc. When fast forward is active, press again to change the speed. Elapsed time displays.
4. Press /|| to resume playing.

SEEK:

1. Press to seek to the beginning of the current or previous chapter. If the chapter has played for less than five seconds, it goes to the previous chapter. If the chapter has played longer than five seconds, the current chapter is restarted. More than one press continues moving back through the disc.
2. Press and hold to fast reverse through a disc. When fast reverse is active, press again to change the speed. Elapsed time displays.
3. Press /|| to resume playing.

TUNE/MENU: Press SEEK/SEEK to go to the next or previous chapter. You can also change chapters by turning the TUNE/MENU knob after touching the screen.

Stop:

1. Press on the display screen to show the available buttons. Press the stop button to stop the DVD.
2. To resume playing the DVD from where it stopped, press ▶/||.
3. Press ▶/|| twice to start the DVD from the beginning.

⌘ (Shuffle):

1. Press to play the tracks randomly rather than in sequence.
2. Press again to play sequentially. This button is available for DVD audio discs.

Top Menu: Press to display the first menu of the DVD. Availability of this feature is dependent on the DVD.

Menu: Press to display the menu for the part of the DVD currently playing. Availability of this feature is dependent on the DVD and is not available for audio DVDs.

Keypad: Press to display and search through the chapter, track, or menu number screen. On the keypad, enter the title/chapter number or the group/track number.

Search: Press to perform a title search.

Angle: Press to adjust the viewing angle of the DVD, depending on the DVD, while the DVD is playing. Continue pressing to cycle through the viewing angles.

Audio: Press to change the audio stream and the audio language heard, while the DVD is playing. Continue pressing to cycle through the available audio streams or languages, depending on the DVD.

Subtitle: Press while a DVD is playing to view with subtitles on or off or to change the language of the subtitles. Continue pressing to cycle through the available subtitle languages and to turn subtitles off, depending on the DVD playing.

Pan Scan: Pan Scan is a method of adjusting widescreen film images so that they can be proportioned to fit the DVD screen display. Press this screen button to turn on Pan Scan.

Error Messages

If Disc Read Error displays and/or the disc comes out, it could be for one of the following reasons:

- The disc has an invalid or unknown format.
- The disc is not from a correct region.
- The disc is very hot. Try the disc again when the temperature returns to normal.

- The road is very rough. Try the disc again when the road is smoother.
- The disc is dirty, scratched, wet, or upside down.
- The air is very humid. Try the disc again later.
- There was a problem while burning the disc.
- The label is caught in the CD/DVD player.

If the CD or DVD is not playing correctly, for any other reason, try a known good CD or DVD.

If any error continues, contact your dealer.

MP3

Playing an MP3 CD and DVD

The following guidelines must be met when creating an MP3 disc, otherwise the CD might not play:

- Sampling rate: 8 kHz, 16 kHz, 22.05 kHz, 24 kHz, 32 kHz, 44.1 kHz, and 48 kHz.
- Bit rates supported: 8, 16, 24, 32, 40, 48, 56, 64, 80, 96, 112, 128, 144, 160, 192, 224, 256, and 320 kbps.
- Maximum number of folders: 255 with a maximum hierarchy of eight folders.
- Maximum of 1,024 files on a disc.
- Recorded on a CD-R or CD-RW with a maximum capacity of 700 MB.
- DVD-Dual Layer discs should not be used.

- The Artist/Album/Song Titles/Genre information requires a CD to be fully scanned before the music navigator works with these menus. Disc scanning does not occur when the disc is being played.

When an MP3 is loaded in the player, MP3 displays.

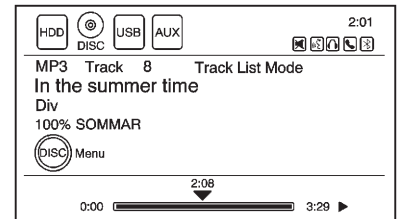

If a disc is already loaded, but you are currently on a map screen or listening to a different audio source, press the HDD/DVD/AUX button to switch to the disc source. A track number appears on the display when each track starts to play.

7-22 Infotainment System

To play a disc:

▶/|| (Play/Pause): Use to start, pause, or resume play of a loaded disc.

SEEK ▶▶:

1. Press to seek to the next track.
2. Press again to continue moving forward through the disc.
3. Press and hold to advance quickly through playback.
4. Release the button to return to playing speed. Elapsed time displays.

◀◀ SEEK:

1. Press to seek to the beginning of the current or previous track. If the track has played for less than five seconds, it goes to the previous track. If longer than five seconds, the current track restarts.

2. Press again to continue moving back through the disc.
3. Press and hold this button to reverse quickly through playback.
4. Release the button to return to playing speed. Elapsed time displays.

TUNE/MENU:

1. Turn to the right or left to display the track list.
2. Turn it again to cycle through the list.
3. Press TUNE/MENU to select the track. The system plays the selected track and returns to the CD screen.

MP3 Music Menu

Press the Disc Menu screen button or press the TUNE/MENU knob on the faceplate while on the disc audio screen to display the MP3 Music Menu.

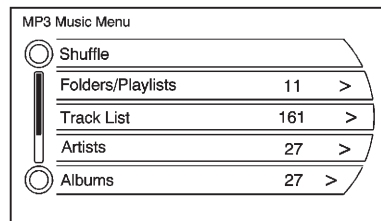

Press any of the following category buttons on the MP3 Music Menu to display the corresponding category screen:

- **Folders/Playlists**

Press to view the folders stored on the disc. Select a folder to view the list of all songs in that folder. There might be a delay before the list displays. Select the song from the list and it begins to play.

- **Track List (All Songs)**

Press to view a list of all songs on the disc. There might be a delay before the list displays. Select a song from the list and it begins to play. Songs are displayed based on the CD burning application folder and file structure used.

- **Artists**

Press to view the list of artists stored on the disc. Select an artist name to view a list of all songs by the artist. There might be a delay before the list displays. Select the desired song from the list and it begins to play.

- **Albums**

Press to view the albums on the disc. Select the album to view a list of all songs on the album. There might be a delay before the list displays. Select a song from the list and it begins to play.

- **Genres**

Press to view the genres on the disc. Select a genre to view a list of all songs of that genre. There might be a delay before the list displays. Select a song from the list and it begins to play.

- **Song Titles**

Press to display a list of all songs on the disc. There might be a delay before the list displays. Select a song from the list and it begins to play. Songs are displayed in alphabetical order based on the Song Title ID3 tag, if available.

Root Directory

The root directory is treated as a folder. All files contained directly under the root directory are accessed prior to any root directory folders.

Empty Directory or Folder

If a root directory or folder is empty or contains only folders, the player advances to the next folder in the file structure that contains a compressed audio file. The empty folder(s) are not displayed or numbered.

No Folder

When the CD only contains compressed audio files without any folders or playlists, all files are under the root folder.

File System and Naming

The displayed song title is taken from the file's ID3 tag. If a song title is not present in the ID3 tag, the radio displays the file name as the track name.

Preprogrammed Playlists

The radio recognizes preprogrammed playlists; however, there is no editing capability. These playlists are treated as special folders containing compressed audio song files.

Hard Drive Device (HDD)

With a Hard Drive Device (HDD), songs can be recorded.

The types of formats supported by the HDD are:

- MP3
- MP3-Pro
- WMA
- Audible.com
- M4A

Songs can be recorded from a CD player or a mass media storage device connected by a USB connector. The hard drive has 30 GB memory capacity for storage of media files.

For optimal recording performance, make sure the disc is clean with no damage; otherwise the system might partially record the track.



To select the hard drive audio source:

Press the HDD/DVD/AUX button; cycle through the available audio sources until the HDD source displays or press the HDD/DVD/AUX button once, and then press the HDD source button.

Recording from a CD to the Hard Drive

The speed of the recording increases if you are listening to another source while recording.

To record all tracks from the disc:

1. Load a CD or press the HDD/DVD/AUX button until the Disc screen displays.
2. Press the ● REC button.
3. A confirmation displays.

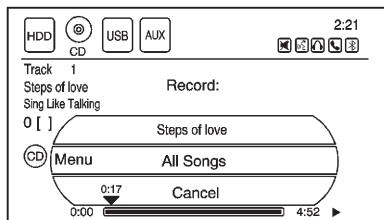

4. Select All Songs to record all tracks. A progress bar displays.

To record selected tracks from the disc:

1. Load a CD or press the HDD/DVD/AUX button until the Disc screen displays.
2. Press ◀ SEEK/SEEK ▶ or the CD/MP3 Music Menu to select a song for recording.
3. Press the ● REC button.
4. A confirmation displays.
5. Select the song name to record. A progress bar displays.

Recording from a USB Device to the Hard Drive

To copy all tracks from the USB device:

1. Connect a USB device or press the HDD/DVD/AUX button until the disc screen displays the USB screen.
2. Press the ● REC button.

3. A confirmation displays.
4. Select All Songs to copy all tracks. A progress bar displays.

To record selected tracks:

1. Connect a USB device or press the HDD/DVD/AUX button until the disc screen displays the USB screen.
2. Use the ◀ SEEK/SEEK ▶ or the Music Menu to select a song for recording.
3. Press the ● REC button.
4. A confirmation displays.
5. Select the song name to record. A progress bar displays.

Duplicate Content

When the record function starts, there is a check to verify that the content does not already exist on the hard drive. If the entire content of the CD exists on the hard drive, it will not record the content.

If it is determined that some or none of the content exists, then only that missing content will be copied to the hard drive.

If the same file is recorded from the USB and CD, it is possible to have duplicate tracks.

CD Eject

If the CD ejects before the recording process completes, only tracks that have been completely recorded are stored to the hard drive. Incomplete tracks are discarded.

Power Mode

If the system is turned off during a CD or USB recording process, it stops. When the radio is turned back on, the recording process does not resume automatically.

Playing Hard Disc Drive Content

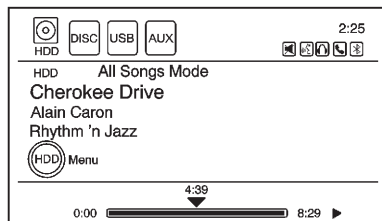

To operate hard drive functions while the HDD source is active, use the following buttons or touch-sensitive buttons:

▶/|| (Play/Pause): Press to start, pause, or resume play of the current media source.

SEEK ▶▶:

1. Press to seek to the next track.
2. Press and hold to advance quickly through playback.
3. Release the button to return to playing speed. Elapsed time displays.

◀◀ SEEK:

1. Press to seek to the beginning of the current or previous track. If the track has been playing for less than five seconds, the previous track plays. If longer than five seconds, the current track restarts.
2. Press and hold this button to reverse quickly through playback.
3. Release the button to return to playing speed. Elapsed time displays.

TUNE/MENU:

1. Turn to the right or left to display All Songs.
2. Turn it again to cycle through the list.
3. Press the TUNE/MENU knob to select the song. The system plays the selected song and returns to the CD screen.

DEL (Delete):

1. Select the song from the HDD Music Menu screen to delete.
2. Press the DEL button.

To delete an entire list of Artists, Albums, or Genres, select the category from the HDD Music Menu screen. Press the DEL button.

HDD Music Menu

From the HDD screen, press the HDD Menu screen button on the HDD screen to display the HDD Music Menu.

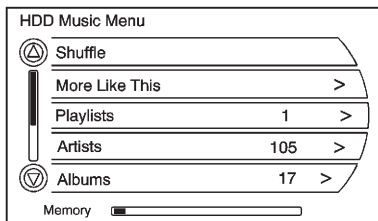

Press any of the following buttons on the HDD Music Menu:

Shuffle: Press to play the tracks randomly rather than in sequence.

More Like This: Press to use Gracenote® music recognition technology and related data to generate a list of songs similar to the current song. Select a song from the list.

This feature is only available with songs recorded to the HDD from audio CDs, not MP3s and other compressed audio.

When recording CDs to the HDD, there might be delays to build the list until all files are compressed.

Playlists:

1. Press to view the playlists on the hard drive.
2. Select a playlist to view a list of all songs in the playlist.
3. Select a song from the list. Once selected, Playlist Mode displays.

Artists:

1. Press to view the artists on the hard drive.
2. Select an artist to view a list of all songs by that artist.
3. Select a song from the list. Once selected, Artist Mode displays.

Albums:

1. Press to view the albums on the hard drive.
2. Select an album to view a list of all songs on the album.
3. Select a song from the list. Once selected, Album Mode displays.

All Songs:

1. Press to view a list of all songs on the hard drive.
2. Select a song from the list. Once selected, All Songs Mode displays.

Genres:

1. Press to view the genres on the hard drive.
2. Select a genre to view a list of all songs of that genre.
3. Select a song from the list. Once selected, Genre Mode displays.

Recently Saved: Press to view a list of the 50 most recently saved songs to the HDD. Once selected, Recently Saved Mode displays.

Saving HDD Favorites

During HDD playback, to save the current song playing to a category preset:

1. Press the FAV button until the FAV playlist category displays.
2. Press and hold a preset button on the bottom of the screen until the Saved to Favorites message displays.

To save an entire Artist, Album, or Genre to a FAV category preset:

1. Press the FAV button until the correct FAV category appears.
2. Press and hold a preset button on the bottom of the screen.

Playing HDD Favorites

Favorites can be played two different ways:

- Press the FAV button until the appropriate FAV HDD category displays. Press a preset button at the bottom of the FAV HDD screen.
- Select FAV from the HDD Music Menu. Favorite Artist, Album, and Genre are in the corresponding list.

USB-Supported Devices

The USB connector uses the following:

- USB 2.0.
- USB flash sticks or pen drives.
- Portable USB Hard Drives. Special care needs to be taken related to the power source of these devices (USB bus powered vs. external power).

- Portable media adapters that support SD Flash, Compact Flash, or SD Micro.

Depending on the USB mass storage device, some devices might not be recognized.

Music can be played directly from the USB device and controlled through the MP3 control functions and menu.

Playing from a USB

A USB mass storage device can be connected to the USB port to copy compressed audio files onto the hard drive. Content can also be played directly from the USB device.

The USB port is in the center console.

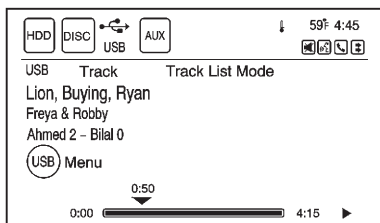

The USB icon displays when the USB device is connected.

To play a USB device:

1. Connect the USB and it begins to play.
2. Press the HDD/DVD/AUX button, then press the USB screen button.

While the USB source is active, use the following to operate USB function:

▶/|| (Play/Pause): Press to start, pause, or resume play of the current media source.

SEEK ►►:

1. Press to seek to the next track.
2. Press and hold to advance quickly through playback. Release the button to return to playing speed. Elapsed time displays.

◀◀ SEEK:

1. Press to seek to the beginning of the current or previous track. If the track has been playing for less than five seconds, the previous track plays. If playing longer than five seconds, the current track restarts.
2. Press and hold to reverse quickly through playback.
3. Release the button to return to playing speed. Elapsed time displays.

TUNE/MENU:

1. Turn to the right or left to display the track list.
2. Turn it again to cycle through the list.
3. Press the TUNE/MENU knob to select the track. The system plays the selected track and returns to the USB screen.

USB Music Menu

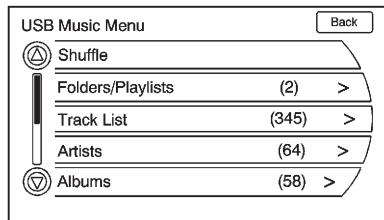

Press the USB Menu screen button or press the TUNE/MENU knob while on the USB Audio screen to display the USB Music Menu.

Select any of the following buttons on the USB Music Menu:

Shuffle: Press to play the tracks randomly rather than in sequence. Select again to stop this function.

Folders/Playlists: Select to view the playlists stored on the USB. Select a folder/playlist to view a list of all songs in the folder/playlist. Select a song from the list. Once selected, Folder/Playlist Mode displays.

Track List: Press to view a list of songs and what track the songs are stored on.

Artists: Press to view the artists stored on the USB. Select an artist to view a list of all songs by the artist. Select a song from the list. Once selected, Artist Mode displays.

Albums: Press to view the albums stored on the USB. Select an album to view a list of all songs on the album. Select a song from the list. Once selected, Album Mode displays.

All Songs: Press to view a list of all songs stored on the USB. Select a song from the list. Once selected, All Songs Mode displays.

Genres: Press to view the genres stored on the USB. Select a genre to view a list of all songs of that genre. Select a song from the list. Once selected, Genre Mode displays.

Eject USB: Press when the USB is to be removed. If the USB is disconnected without selecting Eject USB, the files could become corrupted.

Playing from an iPod®

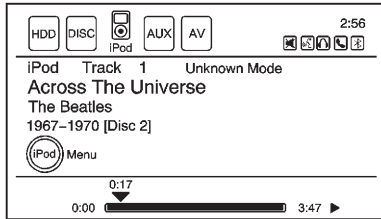

This feature supports the following iPod models:

- iPod (fifth generation or later)
- iPod nano (first, second, third, fourth, and fifth generation)
- iPod classic
- iPod touch (first and second generation)

For proper operation, make sure the iPod has the latest firmware from Apple®. iPod firmware can be updated using the latest iTunes® application. For more information, visit www.apple.com/itunes.

Recording from the iPod to the HDD is not supported. Media must be recorded using a USB mass storage device.

To connect and control an iPod, connect one end of the standard iPod USB cable to the iPod's dock connector. Connect the other end to the USB port in the center console.

iPod music information displays on the radio's display and begins playing through the vehicle's audio system.

The iPod battery recharges automatically while the vehicle is on. When the vehicle is off while an iPod is connected using the iPod USB cable, the iPod battery stops charging and the iPod automatically turns off.

If the iPod is an unsupported model, it can still be listened to in the vehicle by connecting to the auxiliary input jack using a standard 3.5 mm (1/8 in) stereo cable. See *Auxiliary Devices* on page 7-36 for more information.

iPod Music Menu

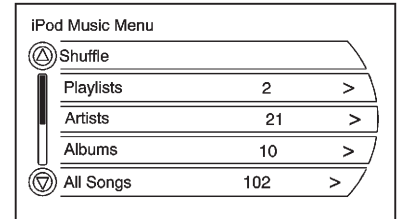

Press any of the following buttons on the iPod Music Menu to display the corresponding screen:

Shuffle:

1. Press to play the tracks randomly rather than in sequence.
2. Press the button again to stop this function.

Playlists:

1. Press to view the playlists stored on the iPod.
2. Select a playlist name to view a list of all songs in the playlist.

7-32 Infotainment System

3. Select the desired song from the list. Once a song has been selected, Playlist Mode appears on the iPod main screen.

Artists:

1. Press to view the artists stored on the iPod.
2. Select an artist name to view a list of all songs by the artist.
3. Select the desired song from the list. Once a song has been selected, Artist Mode appears on the iPod main screen.

Albums:

1. Press to view the albums stored on the iPod.
2. Select an album name to view a list of all songs on the album.
3. Select the desired song from the list. Once a song has been selected, Album Mode appears on the iPod main screen.

All Songs:

1. Press to view a list of all songs stored on the iPod.
2. Select the desired song from the list. Once a song has been selected, All Songs Mode appears on the iPod main screen.

Genres:

1. Press to view the genres stored on the iPod.
2. Select a genre name to view a list of all songs of that genre.
3. Select the desired song from the list. Once a song has been selected, Genre Mode appears on the iPod main screen.

Composers:

1. Press to view the composers stored on the iPod.
2. Select a composer name to view a list of all songs by that composer.

3. Select the desired song from the list. Once a song has been selected, Composer Mode appears on the iPod main screen.

Audio Books:

1. Press to view the audio books stored on the iPod.
2. Select the audio book from the list. Once an audio book has been selected, Audio Book Mode appears on the iPod main screen.

Podcasts appear with the general music. They do not have their own category. Like the other music files, they are searchable by title, artist, and album.

Eject iPod: Press to remove the iPod. If the iPod is disconnected without selecting this button, the files on the iPod could be corrupted.

Audio Book

The system can play back audio book content downloaded from Audible.com by either burning it to a CD or recording it to a USB storage device.

Audible.com is a provider of spoken word audio entertainment, information, and educational programming. The use of the Audible.com playback feature requires that the Audible.com account be activated with the radio. For more information on creating an account or how to activate the radio with an existing account, visit www.audible.com/caraudio. The activation process requires the Vehicle Identification Number (VIN) of the vehicle.

Once activated, files can be transferred by burning them to a CD or by using a USB storage device.

After inserting the USB or CD storage media, the following screen displays:

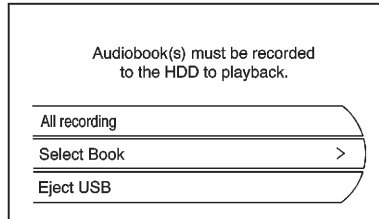

Press the All recording screen button to record all available audio books. A specific audio book to record can be selected by pressing the Select Book screen button.

After the files have been recorded, eject the CD/USB external media.

Playing Audio Book Content

After activating and transferring www.audible.com files to the system, play the files:

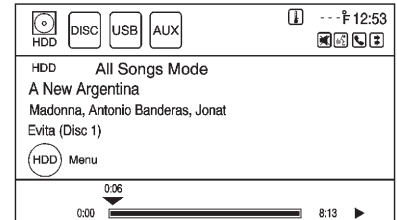

1. Press the HDD/DVD/AUX button until the HDD source is selected.

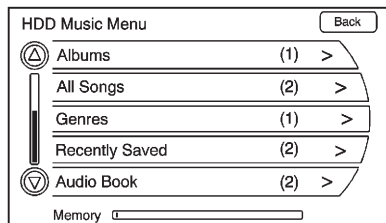

2. Press the HDD Menu. The HDD Music Menu displays. Scroll down to the Audio Book option and select.

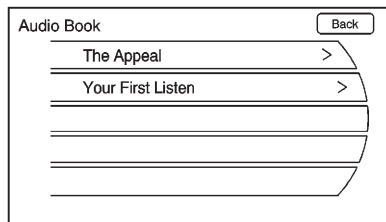

3. The Audio Book screen displays a list of the available audio books for playback. Select a book.

4. Select a chapter to start playback.

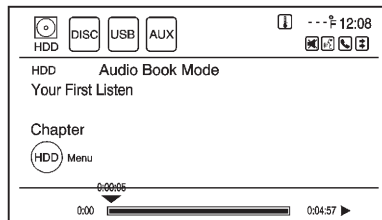

5. The audio book begins playback.

Selecting Another Audio Book

To play a different audio book from the one selected, return to the Audio Book menu options.

To change the audio book currently playing:

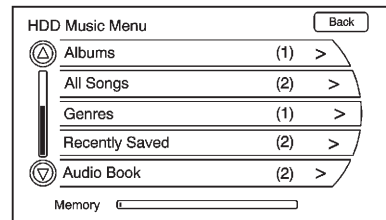

1. Press the TUNE/MENU knob or press the HDD Menu screen button. The HDD Music Menu displays. Scroll down to the Audio Book option.

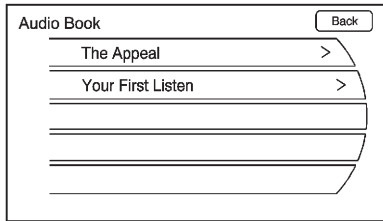

- The Audio Book screen displays a list of the available audio books for playback. Select a book.

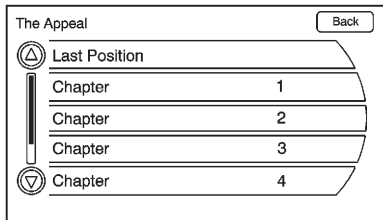

- Select a chapter to start playback.

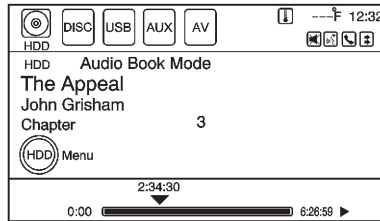

- The audio book begins playback.

Changing Chapters within an Audio Book

To change chapters within an audio book:

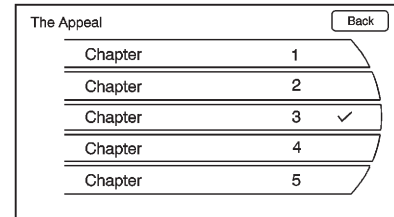

While the audio book is playing, turn the TUNE/MENU knob. The chapter list of the current book displays. Select a chapter from the list. To return to the current chapter being played, select the chapter with the checkmark at the right.

Auxiliary Devices

This vehicle may have an auxiliary input jack in the center console. Possible auxiliary audio sources include:

- Laptop computer
- MP3 player
- Tape player

This jack is not an audio output. Do not plug headphones into the auxiliary input jack. Drivers are encouraged to set up any auxiliary device while the vehicle is in P (Park).

Connect a 3.5 mm (1/8 in) cable from the auxiliary device to the auxiliary input jack. When a device is connected, the system automatically begins playing audio from the device over the vehicle speakers.

If an auxiliary device has already been connected, but a different source is currently active, do either of the following to switch back to the auxiliary source:

- Press the HDD/DVD/AUX button repeatedly to cycle through all of the available audio source screens, until the AUX source screen is selected.
- Press the HDD/DVD/AUX button once, then press the AUX source screen button.

Navigation

Using the Navigation System

Read this section thoroughly to become familiar with how the navigation system operates.

Keeping your eyes on the road and your mind on driving is important for safe driving. The navigation system has built-in features intended to help do this. Some features may be disabled while driving. A grayed-out function indicates it is not available when the vehicle is moving.

All functions are available when the vehicle is parked. Do the following before driving:

- Become familiar with the navigation system operation, buttons on the faceplate, and touch-sensitive screen buttons of the navigation system.

- Set up the audio by presetting favorite stations, setting the tone, and adjusting the speakers.
- Set up the navigation features before beginning to drive, such as entering an address or a preset destination.
- For vehicles equipped with phone capability, set up phone numbers in advance so they can be called with the press of a single button or a single voice command.

 **WARNING**

Taking your eyes off the road too long or too often while using the navigation system could cause a crash resulting in injury or death to you or others. Focus your attention on driving.

 **WARNING**

Avoid looking too long or too often at the moving map on the navigation screen. This could cause a crash and you or others can be injured or killed. Use the turn-by-turn voice guidance directions whenever possible.

Use the navigation system to:

- Plan a route by selecting a destination using the various methods and choices.
- Follow turn-by-turn instructions and map guidance with voice prompts, when permitted by traffic laws, controls, and conditions.
- Receive RDS broadcast announcements.

Always be alert and obey traffic and roadway laws and instructions, regardless of the guidance from the navigation system. Because the navigation system uses street map information that does not include all traffic restrictions or the latest road changes, it may suggest using a road that is now closed for construction or a turn that is prohibited by signs at the intersection. Because the system uses limited information, always evaluate whether following the system's directions is safe and legal for the current conditions.

Use the buttons on the navigation system and the available screen buttons on the navigation screen to operate the system. See *Overview on page 7-2*.

Various functions are disabled when the vehicle is moving.

Navigation Buttons

The buttons are on the navigation system:

RADIO BAND: Press to select AM, FM, or XM, if equipped.

HDD/DVD/AUX (Source): Change to the Hard Drive, CD, DVD, USB, or AUX by pressing the HDD/DVD/AUX button until the desired source is selected.

The audio sources can also be changed by using the steering wheel controls. See *Steering Wheel Controls on page 5-6* for more information.

FAV (Favorites): Press to display the current page number above the preset buttons. The stored stations for each list display on the preset buttons at the bottom of the touch screen. The number of preset FAV lists can be changed.

TUNE/MENU: Turn to highlight a feature. Press to activate the highlighted feature.

◀ **BACK:** Press to return to the previous screen in a menu. The ◀ **BACK** button does not work in primary screens, such as the map, audio, leaf, or climate screens.

STONE: Press to open the tone menu for sound adjustment.

CONFIG (Configure): Press to adjust features for radio, navigation, display, phone, vehicle, and time. See *Configure Menu on page 7-61* for more information.

SEEK ▶▶:

1. Press to seek to the next track or chapter.
2. Press and hold to advance quickly through playback.
3. Release the button to return to playing speed. Elapsed time displays.

◀◀ **SEEK:**

1. Press to seek to the beginning of the current or previous track or chapter. If the track or chapter has been playing for less than five seconds, the previous track or chapter plays. If playing longer than five seconds, the current track or chapter restarts.
2. Press and hold to reverse quickly through playback. Release the button to return to playing speed. Elapsed time displays.

📶 / 📞 **(Phone):** See *Bluetooth on page 7-78* for more information.

▶/|| **(Play/Pause):** Press to start, pause, or resume play of the current media source.

TP (Time Program): Press to display the Time settings. This button can be pressed to quickly go to the Time menu instead of pathing through the Config menu and the

TUNE/MENU knob. Adjust the time as needed. See *Configure Menu* on page 7-61 later in this section.

● **REC (Record):** Press to record from a CD player or a mass media storage device connected by a USB connector.

DEL (Delete): Press to delete XM categories and information from the hard drive.

VOL/  (Volume/Power): Press to turn the system on and off. Turn this knob to adjust the volume for the audio, OnStar, voice guidance, and voice recognition voice prompts.

DEST (Destination): Press to plan a route through the Select Destination menu. If route guidance is active, press to access the Route menu. See *Destination* on page 7-48 for more information.

NAV (Navigation): Press to view the vehicle's current position on the map screen. Continue pressing to cycle through the full map and split screen. Full Map displays the

screen in full view; Split Screen displays both map and audio information.

INFO (Information): Press for weather information, if equipped, and climate control displays, if equipped.

RPT (Navigation Repeat): Press to repeat the last voice guidance prompt.

AS1-2 (Autostore): The stations that can be received best in an AM or FM band can be searched for and stored automatically through the autostore function. Each band has two autostore lists (AS 1, AS 2), in each of which six stations can be stored.

 **(CD/DVD Eject):** Press to eject a CD or a DVD.

Touch Screen Buttons

Touch screen buttons are on the screen and are highlighted when a feature is available. Some screen buttons highlight when active and grey out when inactive.

Alpha-Numeric Keyboard

Letters of the alphabet, symbols, punctuation, and numbers, when available, display on the navigation screen as an alpha or numeric keyboard. The alpha keyboard displays when data needs to be entered.

All characters are touch screen buttons. Touch to select.

À-Ý (Accent Alphabet): To select letters with accent symbols.

A-Z (Alphabet): To select letters from the alphabet.

Symbols: To select symbols.

 **(Space):** To enter a space between characters or the words of a name.

 **(Backspace):** To delete an incorrect character that has been selected.

To make name selection easier, the system highlights only characters that are available after the previously entered one.

7-40 Infotainment System

If a name does not display after entry, try entering it differently. The map database may not contain all information.

Navigation Settings

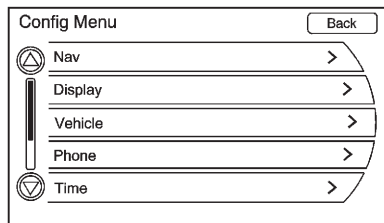

The Config Menu screen accesses the navigation system settings.

To access:

1. Press the CONFIG button to display the Setup menu.
2. Turn the TUNE/MENU knob to scroll through the available setup features. Press the TUNE/MENU knob or press the Nav screen button to display other options within that feature.

3. Select the navigation setting to change.

Voice Prompt

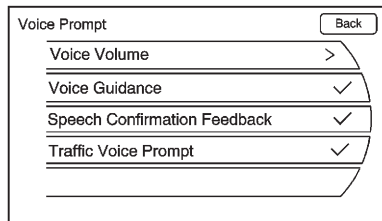

This menu allows changes to the voice features.

The touch screen buttons available are:

Voice Volume: Adjust the voice volume for guidance and voice recognition prompts by pressing the - or + screen buttons or by turning the VOL/ \cup knob on the infotainment system. Press Guidance Volume to preview the selected sound level.

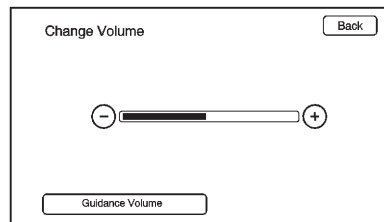

Voice Guidance: Press to enable or disable voice guidance. A checkmark indicates on.

Speech Confirmation Feedback: Press to turn the speech confirmation feedback on or off. A checkmark indicates on.

Traffic Voice Prompt: Press to enable or disable traffic voice prompts. If the voice prompts are on and an Alert for Approaching Traffic displays, the related voice prompt is provided. A checkmark indicates on.

Route Preference

Press the Route Preference screen button to change route options when a route is calculated.

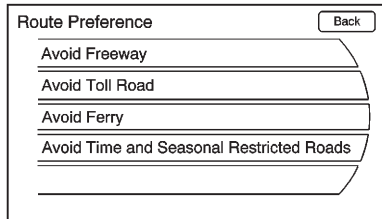

Avoid Freeway: Major roads are avoided.

Avoid Toll Road: Toll roads are avoided.

Avoid Ferry: Ferries are avoided.

Avoid Time and Seasonal Restricted Roads: Time restricted and seasonal roads are avoided.

Back Track

Press the Back Track screen button to turn on, off, or delete the recording and displaying of the traveled path.

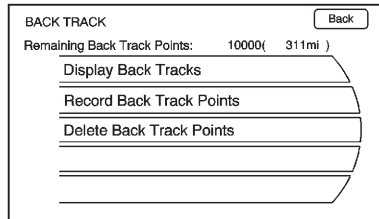

Display Back Tracks: When active, the traveled path displays.

Record Back Track Points: When active, the traveled path is recorded.

Delete Back Track Points: The recorded path is deleted.

Map Database Information

Displays map database version information.

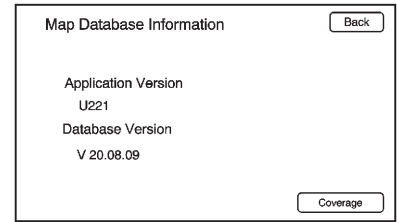

Press the Coverage button to view the major metropolitan coverage area.

Low Fuel Warning

When selected, a pop-up screen displays gas station icons on the map or lists the five nearest gas stations.

Back Track Mode

When selected, the back track feature is on. See “Back Track” earlier in this section.

Off-Road Mode

When selected, the off-road feature is on. When the off-road mode is turned on, the navigation system will show the path being traveled by the vehicle when not on a marked road.

Weather Warning (If Equipped)

When selected, a pop-up screen displays weather warnings.

Show 3-D Landmark

When selected, 3-D landmarks display on the map screen.

Maps

This section includes basic information about the map database.

Map Coverage

The navigation maps are stored on the hard drive.

For more information on map coverage, see “Navigation Settings” earlier in this section.

Installing the DVD Map Disc

Your dealer installs the map database information on the HDD.

An updated map disc can be used to update the map database information. See *Ordering Map DVDs on page 7-70*.

Before updating the map database on the HDD, read the following steps:

1. Turn the vehicle on.
2. Press VOL/  to turn the system on.
3. Insert the map update disc into the slot, label side up.
4. Press the Update screen button when the Update Confirmation screen displays.
5. Enter the Authentication Code, then press Enter.
6. If the correct code is entered, the system starts updating and the status bar displays.

7. Press  after the map database update is completed.

If the application update file is included in the disc, the application update is also done.

Handling the DVD Map Disc

- Handle the disc very carefully to avoid contamination or flaws. Signals might not read out properly.
- Use a soft cloth if the disc gets soiled and gently wipe it from the center of the disc to the outside. Do not use cleaners or solvents.
- Do not use the disc to rest on while writing or drawing with any writing utensil or attach a seal to any of the sides of the disc.
- Do not keep the disc in direct sunlight, high temperatures, or humidity.
- Place the disc back into the original case after use.

Map Adjustments

The scale of view on the map can be adjusted.

Map Scales

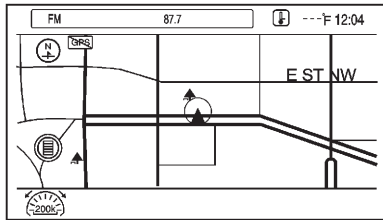

There are two methods to change the map scale:

- Turn the TUNE/MENU knob clockwise or counterclockwise to zoom out or in.
- Press the Map Scale button on the left bottom corner of the map screen to change the zoom level.

The map scale bar times out if the zoom level is not changed within a few seconds.

The scale ranges from 100 m (150 ft) to 400 km (250 mi). To change from metric to English, see *Driver Information Center (DIC)* on page 5-38 for more information.

Scroll Features



- To scroll within the map, touch anywhere on the map screen and the scroll symbol displays.
- Tap the map to center that location on the screen.
- Press the screen in any direction outside the scroll symbol to scroll the map in that direction.

- Scroll speed increases when touching closer to the edge of the screen.
- Press NAV on the faceplate to exit map scrolling and return to the current vehicle location on the map.
- While scrolling the map, this symbol can display the distance to the crosshair area.



For example, this shows that the map has been scrolled 160 m (0.1 mi) away from the current vehicle position.

Navigation Symbols

Following are the most common symbols that appear on a map screen.



The vehicle symbol indicates the current position and heading direction of the vehicle on the map.



The destination symbol marks the final destination after a route has been planned.



The waypoint symbol marks a set waypoint and is numbered depending on how many have been set.

A waypoint is a stopover destination point added to the planned route.

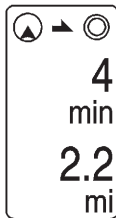

If waypoints have been added to the current route, each waypoint destination displays estimated time and distance to the destination.



This symbol indicates that the map view is North-up: North-up displays North at the top of the map screen regardless of the direction the vehicle is traveling. Select this screen symbol to change the view to Heading-up or 3-D.



This symbol indicates that the map view is Heading-up.

Heading-up view displays the direction the vehicle is traveling at the top of the map screen. The shaded triangle indicates North.

Press this screen symbol to change to 3-D mode.

The 3-D symbol is the same as the Heading-up symbol, but the map is in 3-D.



The No GPS symbol appears when there is no Global Positioning System (GPS) satellite signal.



The upper symbol indicates the information can be displayed on the right side of the map. The lower

symbol indicates the information can be hidden to show a full screen map view.



This symbol indicates that a menu is available and displays on the left side of the screen. Press this symbol or the TUNE/MENU knob to access the screen menu.

Driving on a Route

While driving on a route, the next maneuver the map screen displays is either an urgent maneuver or a non-urgent maneuver.

Urgent Maneuver

An urgent maneuver is displayed when the next maneuver is less than or equal to 0.8 km (0.5 mi) away on a residential road or less than or equal to 1.5 km (2 mi) away on a highway.

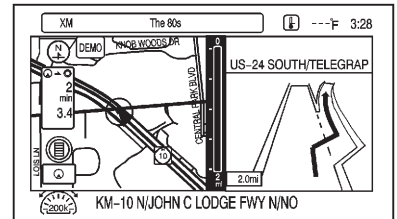

Driving on a Highway

7-46 Infotainment System

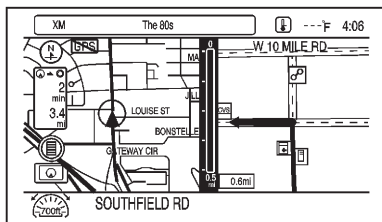

Driving on a Residential Road

Non-Urgent Maneuver

A non-urgent maneuver is when the distance to the next maneuver is greater than 0.8 km (0.5 mi) when driving on a residential road or greater than 1.5 km (2 mi) when driving on a highway. This is indicated by a small arrow in the top right corner of the screen.

Map Screen Options

While on route, several options are available while viewing the map screen. To access this menu:

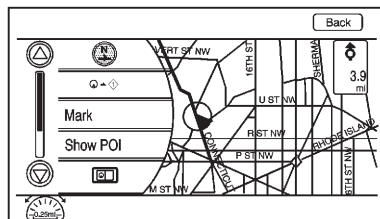

Press the TUNE/MENU knob to display the menu on the left side.

See *Navigation Symbols on page 7-44* to learn how to change the map view to North-up, Heading-up, or 3-D view.



When this symbol is selected, the distance and time remaining from the current vehicle position to the first waypoint displays.

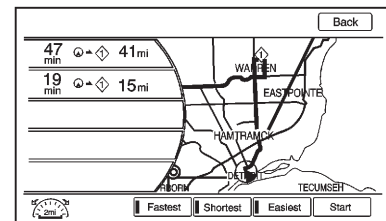

This menu displays if the symbol and waypoints are entered. Select the main map view to display the distance and time remaining from the current vehicle position to any of the set waypoints or final destination.

Save: Press to save a specific location to the address book.

Show POI: Press to view POI information nearby and on route.

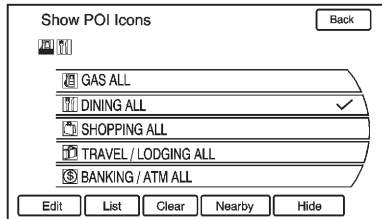

There are several Preset options on the bottom of the screen.

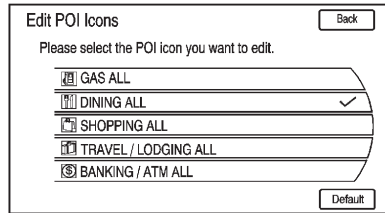

Edit: Press to display a list of POI icons.

1. Select the POI icon to edit. The POI icon is replaced by another icon that is selected from the next menu.

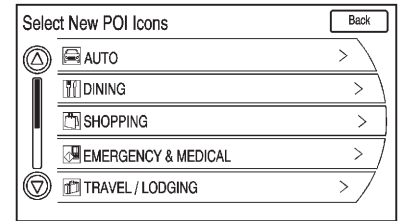

2. Select the new POI icon.
3. The new icon is on the Show POI Icons menu.

List: Displays all available POIs.

Clear: Clears all selected POIs.

Nearby: Displays up to 200 of the selected POIs within 32 km (20 mi) of the current vehicle position. The POIs can be sorted by distance, icon, or type.

Hide: Press to hide the POIs from view on the map. To display, go to the Map menu, press the Show POI Icons menu and press the Show option. See “Map Screen Options” earlier for more information on showing the POIs.



Press this button to change the full map screen to the half map screen and half exit information.

Traffic: Press to provide nearby traffic information and traffic events on the planned route.

Whole Route: Press to choose options for the entire route.

Cancel Guidance: Press to cancel guidance of the current route.

Destination

While destination is not set, press the DEST button to access the Select Destination screen. Several options can be selected to plan a route by entering destinations.

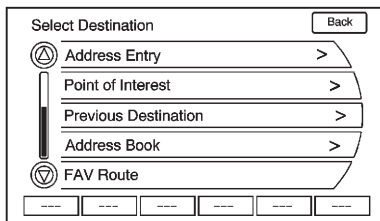

Address Entry

Set a route by entering the state/province name, city name, street name, and house number.

State/Province: Enter a state/province name.

City: Enter a city name.

Street Name: Enter a street name.

House #: Enter a valid address number.

Cross Street Name: Enter a street name that intersects with the selected street.

A checkmark displays on the right side when the field has been selected and the destination can be entered. After an entry step is completed, the checkmark moves to the next item.

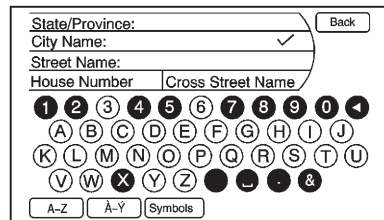

Entering the city name first:

1. Press the DEST button.
2. If necessary, enter the state/province name. The last state/province is automatically recalled.
3. Enter the city name. The city field is automatically selected.

4. Enter the street name. This field is automatically selected. Do not enter directional information or street type. Use the space screen button between street and city names. Use the backspace ◀ screen button to delete an incorrectly entered character.

A list displays if four or fewer names are available. If there are more than four, there is a match counter with a number of available streets. Press the List screen button to view the list and select the street.

5. Enter the house number. This field is automatically selected.
6. Press the OK screen button. The address information screen displays the address entered.
7. Press Go located on the confirmation screen if the information is correct. The route is calculated.

8. Select the route preference for Fastest, Shortest, or Easiest. The chosen route preference highlights. See “Entering an Address and Point of Interest, and Storing Preset Destinations” under *Overview on page 7-2* for more information.

9. Press the Start Guidance screen button and the route is calculated.

Entering the street name first:

1. Press the DEST button.
2. If necessary, enter the state/ province name. The last state/ province name is automatically recalled.
3. Select the street name field. Enter the street name. Do not enter directional information or street type. Use the space screen button between street and city names. Use the backspace ◀ screen button to delete an incorrect character.

A list displays if four or fewer names are available. If there are more than four, there is a match counter with a number of available streets. Press the List screen button to view the list and select the street.

4. Select the city from the list or enter the city name.
5. Enter the house number. This field is automatically selected.
6. Press the OK screen button.
7. Press Go located on the confirmation screen if the information is correct. The route is calculated.

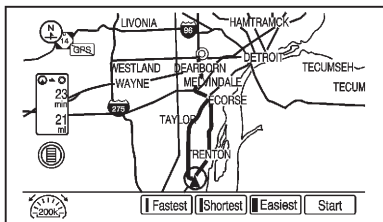

8. Select the route preference for Fastest, Shortest, or Easiest. The chosen route preference highlights. See “Entering an Address and Point of Interest, and Storing Preset Destinations” under *Overview on page 7-2* for more information.
9. Press the Start Guidance screen button and the route is calculated.

Point of Interest

The POI destination entry allows selection of a destination by providing the POI name or city name, or selecting from the POI list.

Entering by POI name/phone number:

1. Press the DEST button.
2. Select Point of Interest.

State/Province: Back

POI Name: ✓

Phone #:

1	2	3	4	5	6	7	8	9	0	◀
A	B	C	D	E	F	G	H	I	J	
K	L	M	N	O	P	Q	R	S	T	U
V	W	X	Y	Z	.	'	⋮	&		

A-Z
A-Y
Symbols
Browse

3. Enter the name or select by phone number.

A list displays if four or fewer names are available. If there are more than four, there is a match counter with a number of available POI names. Press the List screen button to view the list.

4. Select the POI name from the list.
5. Press Go located on the confirmation screen if the information is correct.
6. Select the route preference for Fastest, Shortest, or Easiest.
7. Press the Start Guidance screen button and start the route.

Entering a POI by city name:

1. Press the DEST button.
2. Select Point of Interest.
3. Press the Browse screen button.
4. Select the Change Location screen button.
5. Enter the new state and city.

6. Select a category, then a sub-category.
The available POI names will display.
7. Select the POI name.
8. If the POI is correct, press the Go screen button. The route is calculated.
9. Select the route preference for Fastest, Shortest, or Easiest.
10. Press the Start Guidance screen button and start the route.

Selecting from a POI Category:

1. Press the DEST button.
2. Select Point of Interest.
3. Press the Browse screen button.

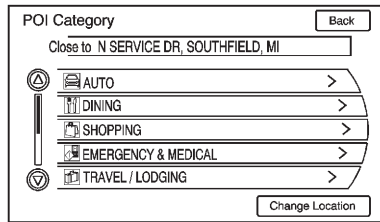

4. Select a category, then a sub-category.
The available POI names display.
5. Select the POI name.
6. If the POI is correct, press the Go screen button. The route is calculated.
7. Select the route preference for Fastest, Shortest, or Easiest.
8. Press the Start Guidance screen button and start the route.

Previous Destination

Select a destination from a list of previous destinations. Up to 15 points that have been previously entered can be recalled. If the list is full, the oldest destinations are automatically deleted once the newest destinations are added.

1. Press the DEST button.
2. Press Previous Destination.
A list displays the previous destinations.
3. Select the destination.
4. Press Go located on the confirmation screen if the information is correct. The route is calculated.
5. Select the route preference for Fastest, Shortest, or Easiest. See “Entering an Address and Point of Interest, and Storing Preset Destinations” under *Overview on page 7-2* for more information.

7-52 Infotainment System

6. Press the Start Guidance screen button and start the route.

Address Book

Choose a destination by selecting an address that has been stored in the address book.

1. Press the DEST button.

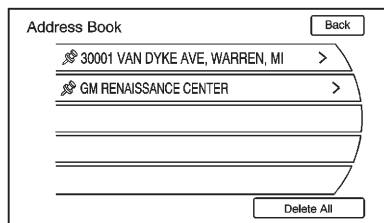

2. Press Address Book. A list displays the address book entries.
3. Select the destination from the list.
4. Press Go on the confirmation screen if the information is correct. The route calculates.

5. Select the route preference for Fastest, Shortest, or Easiest. See “Entering an Address and Point of Interest, and Storing Preset Destinations” under *Overview on page 7-2* for more information.

6. Press the Start Guidance screen button and start the route.

Pick From Map

Select a destination by scrolling on the map.

1. Press the DEST button.
2. Press the Pick From Map screen button. A map screen with a scroll symbol displays.
3. Press the Zoom in/out arrow key on the screen and press the map to locate the destination to select. Press and hold a finger on the map to activate fast scrolling.
4. Press Go on the confirmation screen if the information is correct. The route calculates.

5. Select the route preference for Fastest, Shortest, or Easiest. See “Entering an Address and Point of Interest, and Storing Preset Destinations” under *Overview on page 7-2* for more information.

6. Press the Start Guidance screen button and start the route.

Lat/Long Coordinates

Choose a destination based on latitudinal and longitudinal coordinates.

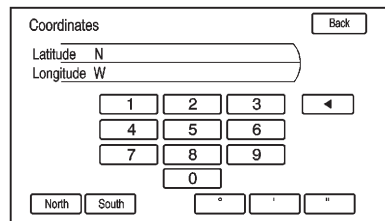

Enter the location as coordinates, latitude and longitude.

1. Press the DEST button.

2. Press the Lat/Long screen button.
3. Enter the coordinates for the destination in degrees, minutes, and seconds.
4. Press Go on the confirmation screen if the information is correct. The route calculates.
5. Select the route preference for Fastest, Shortest, or Easiest. See "Entering an Address and Point of Interest, and Storing Preset Destinations" under *Overview on page 7-2* for more information.
6. Press the Start Guidance screen button and start the route.

Preset Destinations

Set a destination by selecting from one of six previously stored destinations. If a destination is not set for one of the screen buttons, the button dims and is not available to use. See "Entering an Address and Point of Interest, and Storing

Preset Destinations" under *Overview on page 7-2* for more information.

1. Press the DEST button.
2. Select one of the available preset destination screen buttons. The screen buttons were stored with the name selected. The route is calculated.
3. Select the route preference for Fastest, Shortest, or Easiest. See "Entering an Address and Point of Interest, and Storing Preset Destinations" under *Overview on page 7-2* for more information.
4. Press the Start Guidance screen button and start the route.

Getting Started on the Route

Several functions can be performed after a destination has been entered. Press the DEST button to access the Route Menu screen.

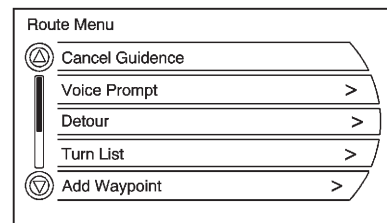

Cancel Guidance

From the Route Menu screen, press Cancel Guidance to cancel the current route. Press Yes on the confirmation screen to cancel or No to continue the guidance.

Voice Prompt

Select Voice Volume to change the volume of voice prompts and voice recognition.

Select the Voice Guidance, Speech Confirmation Feedback, or Traffic Voice Prompt screen buttons to turn voice prompts on or off for each category. See "Navigation Settings" under *Using the Navigation System on page 7-36* for more information.

7-54 Infotainment System

Detour

While on the surface streets, select a detour around the current route, select the Route screen, then select to detour 2, 5, or 10 km (1, 3, or 5 mi). While on the highway, select to detour 2, 5, or 10 km (5, 15, or 25 mi). Select Whole Route to detour the entire route. This is only available while driving on a route.

Turn List

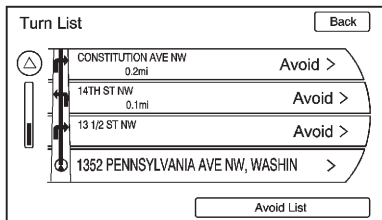

To view the list of maneuvers for the entire route, select Turn List from the Route Menu screen.

Waypoints

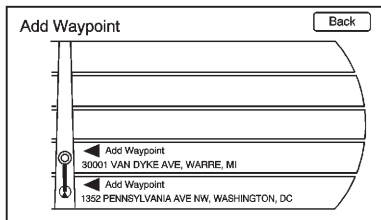

Up to three waypoints can be added to the current route, between the start point and final destination. The waypoints can be edited or deleted.

To add a waypoint:

1. Press the DEST button.
2. Press the Add Waypoint screen button. This button is only available if the route has been calculated.
3. Enter the waypoint by any of the add destination methods. See *Destination on page 7-48* for more information. The system

calculates and highlights the route and the route can be started.

4. To add more waypoints, press the DEST button. Press the Add Waypoint screen button to add the waypoint in the order desired on the route. The system calculates and highlights the route and the route can be started.

To delete a waypoint:

1. Press the DEST button.
2. Press the Delete Waypoint screen button.
3. Select the waypoint to be deleted by touching the screen.
4. A confirmation message displays. Press the Yes screen button to delete the waypoint; press No to cancel this operation. The system calculates and highlights the route and the route can be started.

Route Preview

Preview the entire route in either direction.

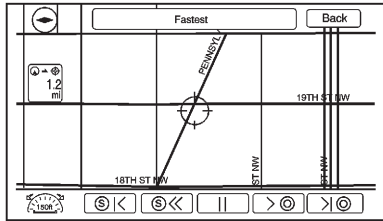

< > (Reverse or Forward Skip):

- Press the reverse skip arrow to go to the start point.
- Press the forward skip arrow to go to the final destination.

<< >> (Fast Reverse or Forward Scroll):

- Press the fast reverse scroll arrow to go to the start point.

- Press the fast forward scroll arrow to go to the final destination. These buttons display once the reverse/forward scroll button has been selected.

< > (Reverse or Forward Scroll):

- Press the reverse scroll arrow to go to the start point.
- Press the forward scroll arrow to go to the final destination.

|| (Pause): Pauses the route preview, while in reverse, fast reverse, forward, or fast forward scroll.

Suspend/Resume Guidance

Press the Suspend/Resume Guidance screen button to suspend or resume guidance on the current route.

Previous Destinations — Deleting

To delete all previous destinations from the system:

1. Press the DEST button.
2. Press the Previous Destination screen button.
3. Press the Clear All screen button.
4. Press OK to Clear All Previous Destinations, or press the Cancel screen button to cancel this operation.

Address Book

Options for saving to the address book:

- **Scrolling on map or Pick from Map in the Dest Menu:** Scroll to the location. Press the TUNE/MENU knob on the faceplate. A menu displays on the left side of the screen. Press the Save screen button and the location is saved.

- **Address Entry:** Enter a destination through the Address Entry menu. Press the Go screen button. The Save screen button displays at the bottom of the screen. Press the Save screen button to save this location to the address book.
- **POI Menu:** Select a POI. Press Save located at the bottom of the information page display.
- **Previous Destination:** From the Previous Destination Menu, select the destination to save. Press Save located at the bottom of the information page.

To change the map icon of an address book entry:

1. Press the DEST button.
2. Press the Address Book screen button. A list displays the address book entries.
3. Select the address book entry to be changed.

4. Press Edit, located on the bottom of the screen.

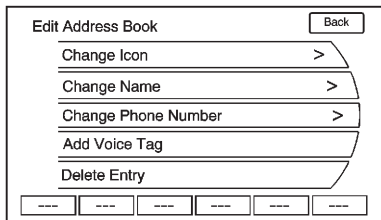

5. Press Change Icon.
6. Select an icon from the list.
7. Press the OK screen button to save the changes.

To edit the name of an address book:

1. Press the DEST button.
2. Press the Address Book screen button. A list displays the address book entries.
3. Select the address book entry to be changed.

4. Press Edit, located on the bottom of the screen.
5. Press the Change Name option.
6. Use the alpha keyboard to enter the name.
7. Press the OK screen button to save the changes.

To add or change the phone number of an address book entry:

1. Press the DEST button.
2. Press the Address Book screen button. A list of address book entries displays.
3. Select the address book entry to be changed.
4. Press Edit, located on the bottom of the screen.
5. Press the Change Phone Number option.
6. Use the numeric keyboard to enter or change the phone number.
7. Press the OK screen button to save the changes.

To add a voice tag to an address book entry:

1. Press the DEST button.
2. Press the Address Book screen button. A list displays the address book entries.
3. Select the address book entry to be changed.
4. Press Edit, located on the bottom of the screen.
5. Press the Add Voice Tag screen button.
6. Speak the name after the beep and within four seconds. The name is repeated back.

To delete an address book entry:

1. Press the DEST button.
2. Press the Address Book screen button. A list displays the address book entries.
3. Select the address book entry to be deleted.

4. Press the Delete Entry screen button. A confirmation message displays.

To add a preset destination from the address book:

1. Press the DEST button.
2. Press the Address Book screen button.
3. Select the address book entry to add as a preset. The Address Book Information screen displays.
4. Press Edit, located on the bottom of the screen.
5. Press and hold one of the six screen buttons at the bottom of the screen until the text within the button changes.
6. The name appears in that preset destination screen button and can be selected from the Select Destination screen.

Favorite Route

1. After the route has been planned, press the NAV button until the full map screen is shown.
2. Press the TUNE/MENU knob. A menu displays.
3. Scroll down and select Whole Route. The whole route map screen displays.
4. Press the Add Route screen button. The route is stored as a favorite.

To change the route name, add a voice tag, or delete a favorite route:

1. Press the DEST button.
2. Press the Fav Route screen button.
3. Select the route.
4. Press Edit, located on the bottom of the screen.
5. Select from: Change Route Name, Add Voice Tag, or Delete Favorite Route.

7-58 Infotainment System

To change the route name:

1. Select Change Route Name.
2. Using the keypad, enter the name.
3. Select the Favorite Route entry to be edited.
4. Press the OK screen button. The new name will be in the Favorite Route Menu.

To add a voice tag:

1. Press the Add Voice Tag screen button.
2. Speak the name after the beep within four seconds. The name is repeated back.

To delete a favorite route:

1. Press Delete Favorite Route. The confirmation screen displays.
2. Press the Yes screen button to delete the route or press No to cancel from deleting the route.

Menu Screen Button

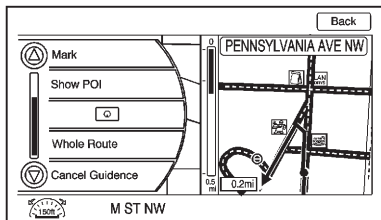

Various navigation system settings are available through the Menu screen button. Some options are only available after a route is planned.

1. Press the NAV button to view the Map screen.
2. Press the Menu screen button or the TUNE/MENU knob on the faceplate.

Map Heading



Press to change the view to North-up, Heading-up, or 3-D mode. See *Navigation Symbols on page 7-44* for more information.

Traffic: Press to view the Traffic Information screen. See *Configure Menu on page 7-61* for more information.

Save: Press to save a location to the address book.

Show POI: Press to display POI icons to be shown on the map. Select from a list of six pre-programmed POI sub-categories. Scroll through a list of categories, or select nearby and on route options.



Press this screen button to minimize the guidance window and expand the map window.

Whole Route: Press to view the entire route from starting point to destination on the map.

Cancel Guidance: Press to stop the current route.

OnStar® Destination Download

The OnStar Destination Download lets an OnStar subscriber ask an OnStar Advisor to download a destination to the navigation system. OnStar will send address information and location coordinates of the destination into the navigation system.

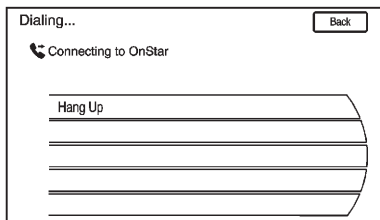

OnStar Destination Download Screen

Using Destination Download

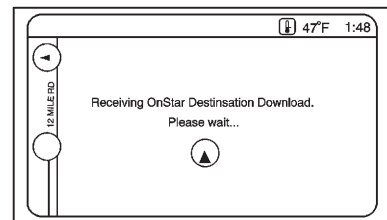

The navigation system displays a “Please wait” as the address is searched within the map database.

If the address is not found within the map database, the system may use latitude and longitude coordinates to locate the destination.

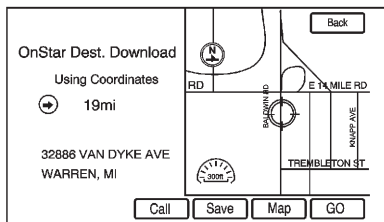

In this case, “Using Coordinates” displays on the downloaded screen.

If the system is unable to locate the address, the Destination Not Found screen displays.

Route Guidance Not Active

If an OnStar destination is downloaded while route guidance is not active, the navigation system displays a pop-up screen and the following available screen functions:

- Press the Go screen button; the navigation system starts route calculation to the destination(s) received.

- Press the Map screen button; the navigation system displays the Destination Map screen.
- Press the Call screen button; the navigation system initiates a call with Bluetooth Phone (if available) or OnStar Hands-Free Calling.
- Press the Save screen button; the navigation system copies the downloaded destination to the address book and displays the new address book entry. The destination saves this download even if it is only partial information such as a phone number.
- Press the Back screen button; the navigation system cancels OnStar Destination Download and returns to the previous screen. The downloaded address is not added to the previous destinations.

Route Guidance Active

If an OnStar destination is downloaded while route guidance is already active, the system displays a pop-up screen and the following available screen functions:

- Press the Go screen button; the navigation system adds the downloaded destination before the next waypoint of the existing route (closest to the current vehicle position).
- All other buttons on the pop-up screen operate as described under “Route Guidance Not Active.”

Previous Destinations

Previously downloaded OnStar destinations are saved under Previous Destinations in the navigation system where they can be accessed or saved to the address book.

Map Destination Screen Functions

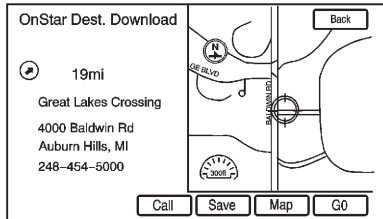

Destination Map Screen

If the map screen is used to show destination, it has map screen capabilities such as Go, Save, Zoom, Scroll, etc. The address is shown at the top of the screen.

Configure Menu

Adjust features and preferences through the Configure Menu. The last selected menu screen displays. Adjust features for Sound, Radio, Nav (navigation), Display, or Time.

Radio

Press the CONFIG button to enter the Menu options. Turn the TUNE/MENU knob to scroll through the available menu options. Press the TUNE/MENU knob or press Radio to display the radio settings. Press this feature to make changes for radio information displayed, preset pages, Auto Volume, Audio Cue Options, and XM Categories Restore. See *Satellite Radio on page 7-13* for more information.

Nav (Navigation)

Press the CONFIG button to enter the Menu options. Turn the TUNE/MENU knob to scroll through the available menu options. Press the TUNE/MENU knob or press the Nav screen button.

XM NavTraffic® (if equipped)

The navigation system might have an XM NavTraffic receiver. It is a subscription service provided through XM Satellite Radio.

A service fee is required to receive the XM NavTraffic service. Real-time traffic information is provided to fully integrate the navigation system to display current traffic conditions for the chosen route.

A screen displays to indicate if the XM NavTraffic subscription is not activated.

If activated, traffic information displays:

- Unscheduled traffic incident data, such as accidents and disabled vehicles.
- Scheduled traffic incident data, such as road construction and road closures.
- Traffic flow information (rate of speed data). Flow data might not be available in all markets.

Traffic information is delivered to the vehicle by the XM Radio satellites. XM NavTraffic provides continuously updated traffic information.

7-62 Infotainment System

XM NavTraffic currently broadcasts the traffic information for many markets nationally. The service may be available in more cities in the future. Visit www.xmnavtraffic.com for more details on local coverage.

To turn XM NavTraffic on or off:

1. Press the CONFIG button to enter the menu options. Turn the TUNE/MENU knob to scroll through the available menu options. Press the TUNE/MENU knob or press the Nav screen button to display the other navigation settings.
2. Press the Traffic Information button.
3. Press the Traffic screen button. This button highlights and a checkmark displays when active. Selecting Alert for Approaching Traffic Events displays a screen to notify of possible traffic events ahead.

Traffic Icon

When traffic conditions are found in the local area, the Traffic Icon appears in the lower left side of the map.

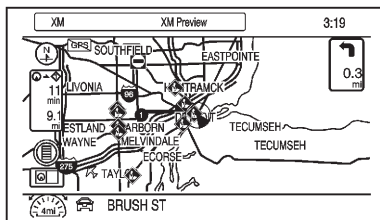

The Traffic Icon has three different condition displays. These are:

- No icon displays if there is no XM NavTraffic subscription or there are no traffic events.
- A single car icon displays if there are traffic events in the area, but none are on route.
- A multiple car icon displays if there are traffic events on the route.

It could take some time to sort the received information. The list of traffic conditions displays in the order of distance from the vehicle, for up to approximately 125 km (75 mi). With a route planned, traffic events display on the route. Not all traffic conditions may display.

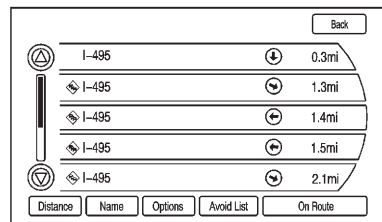

To view the traffic condition location and information on the map:

1. Press NAV to show the map, then press the TUNE/MENU knob for the map menu.
2. Scroll down and press the Traffic screen button. A list of traffic conditions with distance from the vehicle's current position displays.

An arrow may appear before the distance. The arrow indicates the distance is a straight line distance and the direction of the event from the vehicle's current position. If no arrow appears, the distance indicates how far the event is ahead on current route. No more than three pages of traffic events may be viewed while the vehicle is moving.

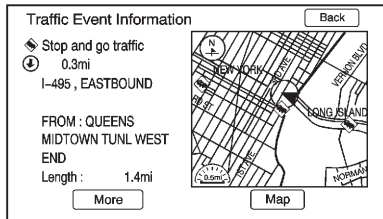

3. Select a traffic condition to get more detailed information.

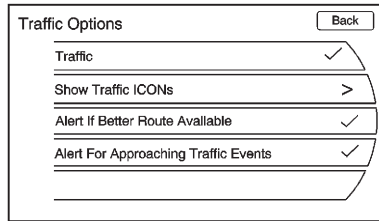

Select Options. A Traffic Options menu displays. Select the traffic-related option.

Traffic: Press to enable or disable the traffic function.

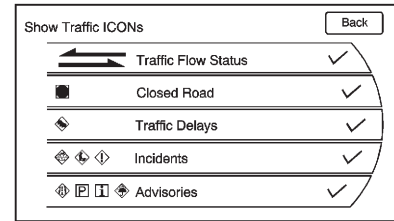

Show Traffic ICONs: Press to display traffic icons on the map screen. Also, select what traffic information displays.

Traffic Flow Status — Enables or disables the green, yellow, red, and black arrows that display beside the roads and shows the traffic flow or extent of a traffic event.

- Black indicates a closed road segment.
- Red indicates significantly impaired traffic flow with average speed of less than 40 km/h (25 mph).

7-64 Infotainment System

- Yellow indicates slightly impaired traffic flow with average speed between 40 km and 73 km/h (25 and 45 mph).
- Green indicates normal traffic flow with average speed above 73 km/h (45 mph).

Traffic flow data arrows display on the map when scaled up to eight miles. For Closed Road, Traffic Delays, Incidents, and Advisories, select the traffic event icon that appears on the map screens.

Alert For Approaching Traffic Events:

When On, if an approaching traffic event is within the alert range, one of two traffic alerts displays:

- With no route planned, while on expressways, the Approaching Traffic Event without Avoid screen displays.
- With a route planned, the Traffic Event on Route screen displays. If the Alert For Approaching Traffic Events is Off, the alert does not display.

On Route

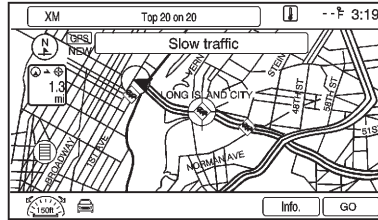

Press the On Route screen button to display all events ahead on the current active route. No traffic events reported on route displays if there are none to report.

Name

Press the Name screen button to display traffic events in alphabetical order.

Distance

Press the Distance screen button to display traffic events in order of distance with the closest event shown first.

Scrolling to Traffic Events on the Map

While scrolling the map, the traffic event icons can appear indicating a traffic event within 125 km (75 mi) from current position. To receive information about the traffic event, place the crosshairs over the traffic condition icon. Traffic events beyond 125 km (75 mi) from current position will not be displayed.

Press the Info. button to display the type of traffic, the street name, and a description of the traffic event.

Traffic Event Display Categories

The following are traffic event categories and symbols that can appear on the display:

 **(Road Closed):** Road and/or ramps closed.

 **(Stopped Traffic):** Traffic stopped, stop-and-go traffic, delayed and congested traffic.

◆ **(Alert):** Object on the roadway, disabled vehicle, or dangerous road conditions.

🚗 **(Accident):** Roadway obstructed due to accident.

◆ **(Road Work):** Delayed traffic due to construction.

🚧 / ◆ **(Road Condition):** Delayed or stopped traffic, lane blocked or closed due to a road condition.

☁️ **(Weather):** Heavy rain, snow, or fog weather condition.

P **(Parking):** Available parking area.

i **(Information):** Special event, general information, or warning.

Traffic Event Information

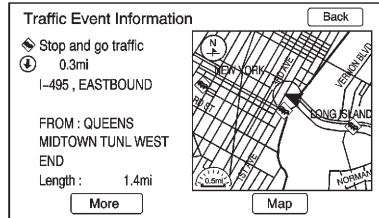

Use to display additional details of a traffic event. This screen can display when:

- Scrolling to an event on the map and then pressing Info.
- Selecting a traffic event listed on the Traffic Event List screen.
- Approaching a traffic event.

Back, Map, More, and Avoid

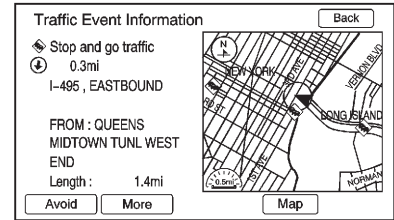

These buttons have common functions across all Detailed Traffic Event screens.

Back: Return to the previous screen.

Map: Display related traffic events on the map if available.

More: View more information for the traffic event.

Avoid: Avoid the location of an event on the route and calculate a new route. The full map screen shows the new route. The Avoid button is only available if the event is on the route ahead.

7-66 Infotainment System

Traffic Voice Prompts

The traffic voice prompt can be turned on and off by selecting Traffic Voice Prompt in Voice Prompt on the CONFIG Nav screen.

If the voice prompts are on and an Alert for Approaching Traffic displays, the related voice prompt is provided.

The RPT (Repeat) button does not repeat traffic prompts, only navigation traffic maneuvers. The current prompt playback cancels if RPT is pressed during a traffic voice prompt.

Traffic prompts are disabled during OnStar or Voice Recognition activity.

Alternate Route

When Alternate Route Available displays, a possible quicker route is available and can be selected to detour around the traffic condition. Press the Yes screen button and the new route is calculated. This option is only available when the multiple car icon appears.

XM NavTraffic information might not be provided for the alternate route, depending on what type of road the vehicle is traveling on.

Traffic Condition Symbols

The following traffic condition symbols may display:



Stopped Traffic



Traffic Jam



Accident



Road Closed



Lane Narrows



Road Construction



Alert



Road Condition



Road Visibility



Other

XM™ Weather (where available)

Press INFO, then press it again until the Weather screen button is selected or press the Weather screen button.

Current Condition

Press INFO until the Weather screen button is selected to show the current weather condition in the city of the vehicle's current position.

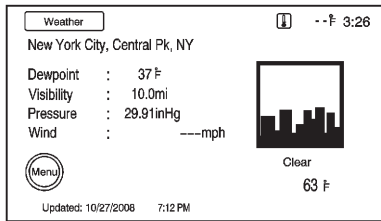

Allow up to 15 minutes for the current weather in the area to display.

Extended Forecast

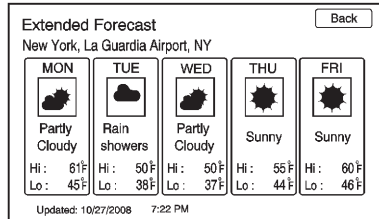

Enter the weather menu by pressing the TUNE/MENU knob or press the Menu button on the screen. From this screen, press Extended Forecast.

Weather Along the Route

If a destination is set, there is the option to view weather conditions for up to three locations along the route:

- Current vehicle position.
- Midway point from current position to final destination.
- Current weather condition of the destination city.

From the XM Weather Menu Screen, press Along the Route:

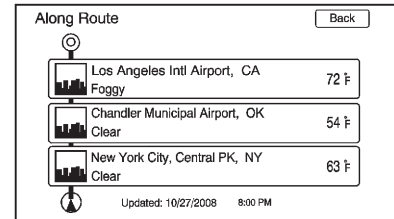

Weather Alerts

From the XM Weather Menu, press Weather Alerts to display any current weather advisory warnings in effect near the current position.

Display

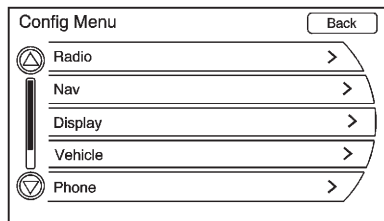

Press the CONFIG button to enter the menu options. Turn the TUNE/MENU knob to scroll through the available setup features. Press the TUNE/MENU knob or press the Display screen button to display other options within that feature.

Dimming Mode

Auto (Automatic): The screen background automatically adjusts depending on exterior lighting conditions.

Day: The map background brightens.

Night: The map background darkens.

To change the overall brightness setting for the display, use the vehicle interior lighting dimming control.

Setting the Clock

To set the time:

1. Press the CONFIG button to enter the menu options. Turn the TUNE/MENU knob to scroll through the available setup features. Press the TUNE/MENU knob or press the Time screen button to display other options within that feature.
2. Press + or - to decrease or increase the Hours and Minutes displayed on the clock.

12/24 HR Format: Press the 12 HR screen button for standard time; press the 24 HR screen button for military time.

Day + or Day -: Press the day + or day - display buttons to increase or decrease the day.

Display: Press Display to turn the display of the time on the screen on or off.

Global Positioning System (GPS)

The position of the vehicle is determined by using satellite signals, various vehicle signals, and map data.

At times, other interferences such as the satellite condition, road configuration, the condition of the vehicle, and/or other circumstances can interfere with the navigation system's ability to determine the accurate position of the vehicle.

The GPS shows the current position of the vehicle using signals sent by the GPS Satellites of the United States Department of Defense.

When the vehicle is not receiving signals from the satellites, a symbol appears on the map screen. See *Navigation Symbols on page 7-44*.

This system might not be available or interferences can occur if any of the following is true:

- Signals are obstructed by tall buildings, trees, large trucks, or a tunnel.
- Satellites are being repaired or improved.

For more information if the GPS is not functioning properly, see “If the System Needs Service” and “Problems with Route Guidance.”

Vehicle Positioning

At times, the position of the vehicle on the map could be inaccurate due to one or more of the following reasons:

- The road system has changed.
- The vehicle is driving on slippery road surfaces such as in sand, gravel, and/or snow.
- The vehicle is traveling on winding roads or long straight roads.
- Approaching a tall building or a large vehicle.
- The surface streets run parallel to a freeway.
- The vehicle has been transferred by a vehicle carrier or a ferry.
- The current position calibration is set incorrectly.
- The vehicle is traveling at high speed.

- The vehicle changes directions more than once, or the vehicle is turning on a turn table in a parking lot.
- The vehicle is entering and/or exiting a parking lot, garage, or a lot with a roof.
- The GPS signal is not received.
- A roof carrier is installed on the vehicle.
- Tire chains have been installed.
- The tires are replaced or worn.
- The tire pressure for the tires is incorrect.
- This is the first navigation use after the map data is updated.
- The 12-volt battery is disconnected for several days.
- The vehicle is driving in heavy traffic where driving is at low speeds, and the vehicle is stopped and started repeatedly.

Problems with Route Guidance

Inappropriate route guidance can occur under one or more of the following conditions:

- The turn was not made on the road indicated.
- Route guidance might not be available when using automatic rerouting for the next right or left turn.
- The route might not be changed when using automatic rerouting.
- There is no route guidance when turning at an intersection.
- Plural names of places might be announced occasionally.
- It could take a long time to operate automatic rerouting during high-speed driving.
- Automatic rerouting might display a route returning to the set waypoint if heading for a destination without passing through a set waypoint.

- The route prohibits the entry of a vehicle due to a regulation by time or season or any other regulation which may be given.
- Some routes might not be searched.
- The route to the destination might not be shown if there are new roads, if roads have recently changed, or if certain roads are not listed in the map data. See *Maps on page 7-42* for more information.

To recalibrate the vehicle's position on the map, park with the vehicle on for two to five minutes, until the vehicle position updates.

If the System Needs Service

If the navigation system needs service and the steps listed here have been followed but there are still problems, see your dealer for assistance.

Ordering Map DVDs

The map data in the vehicle is the most up-to-date information available when the vehicle was produced. The map data is updated periodically, provided that the map information has changed.

For questions about the operation of the navigation system or the update process, contact the GM Nav Disc Center toll-free phone number, 1-877-NAV-DISC (1-877-628-3472) or go to the center's website, www.gmnavdisc.com. If updates are needed, call the GM Nav Disc Center or order a new disc online. To order a disc, have the vehicle's Vehicle Identification Number (VIN) available. See "Vehicle Identification Number (VIN)."

After receiving the updated disc, see "Installing the DVD Map Disc" under *Maps on page 7-42* for more information.

Database Coverage Explanations

Coverage areas vary with respect to the level of map detail available for any given area. Some areas feature greater levels of detail than others. If this happens, it does not mean there is a problem with the system. As the map data is updated, more detail can become available for areas which previously had limited detail. See *Ordering Map DVDs on page 7-70* for more information.

Voice Recognition

The navigation system's voice recognition allows for hands-free operation of the navigation system and the audio system features. Voice recognition only works if the map database is installed in the system.

If the radio is off, the only commands would be Hands Free and Help.

Navigation voice commands are not available until the I Agree button has been selected.

Voice recognition can be used when the vehicle is on or when Retained Accessory Power (RAP) is active. See *Retained Accessory Power (RAP) on page 9-21* for more information.

Using Voice Recognition



1. Press and release the  steering wheel button. The audio system mutes, and a beep is heard. A voice prompt stating, "Please start speaking after the beep" might be heard.

If there is no beep, make sure that the voice volume setting is not turned down. See *Configure Menu on page 7-61* for more information.

While voice recognition is active, the system displays a  symbol.

2. Clearly speak one of the commands listed later in this section.

Canceling Voice Recognition

1. Press and release the   steering wheel button to cancel a command, or if the system response does not match the verbal command.

7-72 Infotainment System

- The system replies, "Voice recognition canceled."
Pressing any other radio or steering wheel control, other than the volume knob or the volume steering wheel button cancels the session.
- Press and release the  steering wheel button to restart the voice recognition session.

Helpful Hints for Speaking Commands

- When multiple commands are available, choose the command that best works for you.
- Words that are in brackets are optional. For example, for the command "Radio [band] FM," saying "Radio FM" or "Radio Band FM" are both valid commands.
- Words separated by a (/) mean there is a choice of using a word on either side of the slash. For example, for the command (CD/DVD/Disc) [help], you can say "CD [help]" or "DVD [help]" or "Disc [help]."
- When the system recognizes the command, the system will either perform the function or ask to confirm the choice by clearly saying "yes" or "no."
- When the system does not recognize the command, the system issues an error message such as "pardon" or "command not recognized." The system could also say, "voice recognition canceled."
- If experiencing difficulty with the system recognizing a command, confirm that the command is correct. Try saying the command clearly or wait for a brief moment after the beep.
- Background noise such as a climate control fan positioned on high, open windows, and very loud outside noises, even if the windows are closed, can cause voice commands to be misunderstood.
- This system is able to recognize commands in different languages, such as English, French Canadian, and Spanish. The system only recognizes commands based on the language selected.
- To increase or decrease the voice volume during a voice recognition session, turn the volume knob of the radio, or press the volume steering wheel buttons. If the volume is adjusted during a voice recognition session, a Voice Volume bar appears on the screen showing the voice volume level as it is being adjusted. This also changes the volume of the guidance prompts.

Voice Recognition Help

To enter the help playback session, clearly speak one of the help commands.

Help: The system plays back more specific help commands (such as Radio Help, Display Help, Navigation Help) for the user to choose from.

Radio [help]: The system plays back helpful advice about radio commands, and some common radio commands which are available. Use this command to learn about how to select a band (AM, FM, or XM), and how to change radio stations (by speaking frequency numbers).

(CD/DVD/Disc) [help]: The system plays back helpful advice about disc commands, and some common disc commands which are available. Use this command to learn about how to select Disc mode playback, and how to change track numbers.

Display [help]: The system plays back helpful advice about display commands, and some common display commands which are available to adjust the display setting.

Navigation [help]: The system plays back helpful advice about navigation commands, and some common navigation commands which are available.

Voice Recognition Commands

The following list shows the voice commands available for the navigation system with a brief description of each. The commands are listed with the optional words in brackets. To use the voice commands, see the instructions listed previously.

Display Commands

Display [set] day [mode], display [select] day [mode]: This command instructs the system to switch the display to day mode.

Display [set] night [mode], display [select] night [mode]: This command instructs the system to switch the display to night mode.

Display [set] auto [mode], display [select] auto [mode]: This command instructs the system to switch the display to auto mode.

Display [help]: This command instructs the system to play back helpful advice about display commands, and some common display commands which are available to adjust the display setting.

Radio Commands

Radio AM, radio [band] AM, radio FM, radio [band] FM, radio XM, radio [band] XM: These commands instruct the system to go to either the AM, FM, or XM radio bands.

7-74 Infotainment System

Radio select [frequency] AM, radio select [frequency] FM:

These commands instruct the system to go to a specific frequency on either the AM or FM band. For example, radio select ninety seven point one FM or radio select ten forty AM.

Radio select [channel] XM: This command instructs the system to go to a specific channel on the XM band (if equipped). For example, radio select one fifty one XM.

Radio [help]: This command instructs the system to play back some helpful advice about radio commands, and some common radio commands which are available to the user.

CD/DVD/Disc Commands

The following commands are only available when a CD, MP3, or DVD is loaded:

Radio CD, radio DVD, radio disc:

These commands instruct the system to go to Disc mode.

Radio CD select [track number], radio DVD select [track number], radio disc select [track number]:

These commands instruct the system to play a specific track on the disc. For example, radio disc select ten. This command supports up to 254 tracks.

CD [help], DVD [help], disc

[help]: This command instructs the system to play back helpful advice about disc commands, and some common disc commands which are available.

General Navigation Commands

Feedback on, feedback off: This command instructs the system to turn on and off the voice recognition feedback. When feedback is ON, the system responds to commands with a talk back phrase. When feedback is OFF, the system responds to commands with a chime.

Navigation voice [guidance] on, navigation voice [guidance] off:

This command instructs the system to turn on and off voice guidance prompts during route guidance.

Cancel: This instructs the system to cancel the command.

Point of Interest (POI) Commands

The following is a list of POI commands. POIs only display on the map screen if the map scale is 800 m (0.50 mi) or less. If POIs display on a map with the wrong scale, the system reminds that this cannot be done. The available POI commands are:

Navigation show gas station[s], navigation show gas, navigation hide gas station[s], navigation hide gas:

These commands instruct the system to display and hide gas station POIs on the map screen.

Navigation show restaurant[s], navigation show dining, navigation hide restaurant[s], navigation hide dining: These commands instruct the system to display and hide restaurant POIs on the map screen.

Navigation show ATM[s], navigation hide ATM[s]: These commands instruct the system to display and hide ATM POIs on the map screen.

Navigation show hotel[s], navigation hide hotel[s]: These commands instruct the system to display and hide hotel POIs on the map screen.

Navigation show airport[s], navigation hide airport[s]: These commands instruct the system to display and hide airport POIs on the map screen.

Navigation show shop[s], navigation show shopping, navigation hide shop[s], navigation hide shopping: These commands instruct the system to display and hide shopping POIs on the map screen.

Destination and Guidance Commands

Navigation [go to] preset destination [number] (one, two, three, four, five, or six): These commands instruct the system to set one of the preset destinations one through six as the new destination.

Navigation delete: This command instructs the system to delete the destination, route, or next waypoint. The system requests a confirmation of which item should be deleted (destination, route, or next waypoint).

Destination (available for English language only): This command instructs the system that the user wants to enter a destination using voice recognition. After this command is stated, the system displays a state abbreviation (such as NY for New York). If the destination to be entered is in the displayed state, then say the desired city name. Otherwise, say “Change State” and say the state name the search should take place in. Then, say the desired city name when prompted, and say the desired street name and house number when prompted.

To set a destination using voice recognition:

1. Press and release the  steering wheel control. The audio system mutes, and a beep is heard.

7-76 Infotainment System

2. Say the command “Destination.”
The system replies with “Please say city name or change state,” and the system shows a pop-up banner of an abbreviated state name, such as NY for New York. If the state is correct, then go to Step 4. Otherwise, say “Change State.”

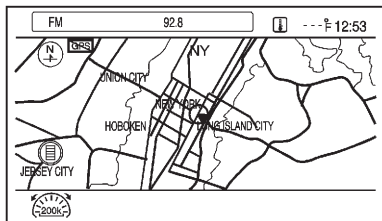

For example, if the desired destination is in Ohio, but the system shows New York (NY) in the pop-up banner, say “Change State.”

3. After saying “Change State,” the system replies with “Please say state name.” Say the correct state.

Candidate List	
1 OH	
2 ON	1
3 CO	
4 OR	

The state name displays. In some cases the radio shows a candidate list with the closest matches to the spoken state name. The system asks the user to select an item from the candidate list either by pressing the desired choice, or by saying the list number of the desired choice.

4. The system asks the user to say the city name. As shown earlier, the radio can display a candidate list with the closest matches to the spoken city name. Say the correct city name.

5. Reply with the street name including the suffix (Blvd, Ave, Rd, etc.), when prompted. The radio might display a candidate list with the closest matches to the spoken street name. Say the correct street name.
6. Reply with the house number when prompted. The radio might display a candidate list with the closest matches to the spoken house number. Say the house number as a single digit.
7. Confirm the correct address is displayed, then reply with yes or no, when prompted.
8. This address is now set as the destination. Select the Start screen button to begin destination guidance.

Voice Tag Commands

Voice tags are recorded phrases that can be stored in the navigation system. These voice tags are associated with address book entries, and once these voice tags are stored, they can be used as part of a voice recognition command that sets the particular address book entry as a destination. See “Address Book” earlier in this manual for information about instructions on how to store a voice tag in the system.

Navigation [go to] (voice tag):

This command allows selection of a destination saved under the stored voice tag. The system plays back the voice tag and asks to confirm by saying yes or no.

If a destination is set to “Home,” say “Navigation go to Home.” After the system plays back the voice tag and it is confirmed, the system sets “Home” as the destination.

OnStar (if equipped) Command

Hands Free: This command instructs the system to enter the OnStar voice recognition system. See “Hands-Free Calling” in the OnStar Owner’s Guide for more information.

Help Commands

Help
 Radio [help]
 CD [help], DVD [help],
 Disc [help]
 Display [help]
 Navigation [help]

Display Commands

Display [set/select] day [mode]
 Display [set/select] night [mode]
 Display [set/select] auto [mode]

Radio Commands

[radio/radio band] AM
 [radio/radio band] FM
 [radio/radio band] XM
 Radio select <frequency> AM
 Radio select <frequency> FM
 Radio select <frequency> XM

CD/DVD/Disc Commands

Radio [CD/DVD/Disc]
 Radio [CD/DVD/Disc] select
 <track number>

General Navigation Commands

Feedback On
 Feedback Off
 Navigation voice [guidance] on
 Navigation voice [guidance] off
 [cancel/goodbye/quit]

Point of Interest (POI) Commands

Navigation show [gas/gas station/gas stations]
 Navigation show [dining/restaurant/restaurants]
 Navigation show [ATM/ATMs]
 Navigation show [hotel/hotels]
 Navigation show [airport/airports]
 Navigation show [shop/shops/shopping]
 Navigation hide [gas/gas station/gas stations]
 Navigation hide [dining/restaurant/restaurants]

Navigation hide [ATM/ATMs]
Navigation hide [hotel/hotels]
Navigation hide [airport/airports]
Navigation hide [shop/shops/
shopping]

Destination and Guidance Commands

Navigation [go to] preset
destination [number] one
Navigation [go to] preset
destination [number] two
Navigation [go to] preset
destination [number] three
Navigation [go to] preset
destination [number] four
Navigation [go to] preset
destination [number] five
Navigation [go to] preset
destination [number] six
Navigation delete [destination/
route/next waypoint]
Route (used in conjunction with
another command)

Next waypoint (used in
conjunction with another
command)
Add to waypoint (used in
conjunction with another
command)
Replace destination (used in
conjunction with another
command)
Yes (used in conjunction with
another command)
No (used in conjunction with
another command)
Destination (used for
Destination VR entry, available
in English language only)

Voice Tag Commands

Navigation [go to] <Voice Tag>

OnStar Command

Hands Free

Phone

Bluetooth

For vehicles equipped with Bluetooth capability, the system can interact with many cell phones, allowing:

- Placement and receipt of calls in a hands-free mode.
- Sharing of the cell phone's address book or contact list with the vehicle.

To minimize driver distraction, before driving, and with the vehicle parked:

- Become familiar with the features of the cell phone. Organize the phone book and contact lists clearly and delete duplicate or rarely used entries. If possible, program speed dial or other shortcuts.
- Review the controls and operation of the infotainment and navigation system.

- Pair cell phone(s) to the vehicle. The system may not work with all cell phones. See “Pairing a Phone” in this section for more information.
- If the cell phone has voice dialing capability, learn to use that feature to access the address book or contact list. See “Voice Pass-Thru” in this section for more information.
- See “Storing and Deleting Phone Numbers” in this section for more information.

 **WARNING**

When using a cell phone, it can be distracting to look too long or too often at the screen of the phone or the infotainment (navigation) system. Taking your eyes off the road too long or too often could cause a crash resulting in injury or death. Focus your attention on driving.

Using Voice Recognition

To use voice recognition, press the  button on the steering wheel.

The system responds with a tone. After the tone say “Hands Free” to use the Bluetooth voice recognition system. The system then responds with “Ready,” followed by a tone. After the tone, say a command.

For additional information say “Help” while you are in a voice recognition menu.



Pairing a Phone

1. Press . Say “Hands Free” after the tone.
2. Say “Bluetooth.”
3. Say “Pair.” The system responds with instructions and a four-digit Personal Identification Number (PIN). The PIN is used in Step 5.

4. Start the pairing process on the cell phone that you want to pair. For help with this process, see your cell phone manufacturer's user guide.
5. Locate the device named “Your Vehicle” in the list on the cell phone. Follow the instructions on the cell phone to enter the PIN that was provided in Step 3. After the PIN is successfully entered, the system prompts you to provide a name for the paired cell phone. This name will be used to indicate which phones are paired and connected to the vehicle. See “Listing All Paired and Connected Phones” later in this section for more information.
6. Repeat Steps 1 through 5 to pair additional phones.



Listing All Paired and Connected Phones

The system can list all cell phones paired to it. If a paired cell phone is also connected to the vehicle, the system responds with “is connected” after that phone name.

1. Press  . Say “Hands Free” after the tone.
2. Say “Bluetooth.”
3. Say “List.”



Deleting a Paired Phone

If the phone name you want to delete is unknown, see “Listing All Paired and Connected Phones.”

1. Press  . Say “Hands Free” after the tone.
2. Say “Bluetooth.”
3. Say “Delete.” The system asks for which phone to delete.
4. Say the name of the phone you want to delete.

Connecting to a Different Phone

To connect to a different cell phone, the Bluetooth system looks for the next available cell phone in the order in which all available cell phones were paired. Depending on which cell phone you want to connect to, you may have to use this command several times.

1. Press  . Say “Hands Free” after the tone.
2. Say “Bluetooth.”
3. Say “Change phone.”
 - If another cell phone is found, the response will be “<Phone name> is now connected.”
 - If another cell phone is not found, the original phone remains connected.

Storing and Deleting Phone Numbers

The system can store up to 30 phone numbers as name tags in the Hands-Free Directory that is shared between the Bluetooth and OnStar systems.

The following commands are used to delete and store phone numbers.

Store: This command will store a phone number, or a group of numbers as a name tag.

Digit Store: This command allows a phone number to be stored as a name tag by entering the digits one at a time.

Delete: This command is used to delete individual name tags.

Delete All Name Tags: This command deletes all stored name tags in the Hands-Free Calling Directory and the OnStar Turn-by-Turn Destinations Directory.

Using the “Store” Command

1. Press . Say “Hands Free” after the tone.
2. Say “Store.”
3. Say the phone number or group of numbers to store all at once with no pauses, then follow the directions given by the system to save a name tag for this number.

Using the “Digit Store” Command

If an unwanted number is recognized by the system, say “Clear” at any time to clear the last number.

To hear all of the numbers recognized by the system, say “Verify” at any time.

1. Press . Say “Hands Free” after the tone.
2. Say “Digit Store.”

3. One at a time, say each number to store. After each number is entered, the system repeats back the number it heard followed by a tone. After the last number has been entered, say “Store,” and then follow the directions given by the system to save a name tag for this number.

Using the “Delete” Command

1. Press . Say “Hands Free” after the tone.
2. Say “Delete.”
3. Say the name tag you want to delete.

Using the “Delete All Name Tags” Command

This command deletes all stored name tags in the Hands-Free Calling Directory and the OnStar Turn-by-Turn Destinations Directory.

To delete all name tags:

1. Press . Say “Hands Free” after the tone.
2. Say “Delete all name tags.”

Listing Stored Numbers

The list command will list all the stored numbers and name tags.

Using the “List” Command

1. Press . Say “Hands Free” after the tone.
2. Say “Directory.”
3. Say “Hands-Free Calling.”
4. Say “List.”

Making a Call

Calls can be made using the following commands:



Dial or Call: The dial or call command can be used interchangeably to dial a phone number or a stored name tag.

7-82 Infotainment System

Digit Dial: This command allows a phone number to be dialed by entering the digits one at a time.

Re-dial: This command is used to dial the last number used on the cell phone.

Using the “Dial” or “Call” Command

1. Press  . Say “Hands Free” after the tone.
2. Say “Dial” or “Call.”
3. Say the entire number without pausing or say the name tag.



Once connected, the person called will be heard through the audio speakers.

Using the “Digit Dial” Command

The digit dial command allows a phone number to be dialed by entering the number one at a time. After each number is entered, the system repeats back the number it heard followed by a tone.



If an unwanted number is recognized by the system, say “Clear” at any time to clear the last number.

To hear all of the numbers recognized by the system, say “Verify” at any time.

1. Press  . Say “Hands Free” after the tone.
2. Say “Digit Dial.”
3. Say each digit, one at a time, that you want to dial. After each digit is entered, the system repeats back the digit it heard followed by a tone. After the last digit has been entered, say “Dial.”

Once connected, the person called will be heard through the audio speakers.





Using the “Re-dial” Command

1. Press  . Say “Hands Free” after the tone.
2. After the tone, say “Re-dial.”

Once connected, the person called will be heard through the audio speakers.



Receiving a Call





When an incoming call is received, the audio system mutes and a ring tone is heard in the vehicle.

- Press   to answer the call.
- Press   to ignore a call.

Call Waiting





Call waiting must be supported on the cell phone and enabled by the wireless service carrier.

- Press   to answer an incoming call when another call is active. The original call is placed on hold.



- Press   again to return to the original call.
- To ignore the incoming call, no action is required.
- Press   to disconnect the current call and switch to the call on hold.

Three-Way Calling

Three-way calling must be supported on the cell phone and enabled by the wireless service carrier.



1. While on a call, press  .
2. Say “Three-way call.”
3. Use the dial or call command to dial the number of the third party to be called.
4. Once the call is connected, press   to link all callers together.



Ending a Call

Press   to end a call.

Muting a Call

During a call, all sounds from inside the vehicle can be muted so that the person on the other end of the call cannot hear them.

To mute a call, press  , and then say “Mute Call.”

To cancel mute, press  , and then say “Un-mute Call.”



Transferring a Call

Audio can be transferred between the Bluetooth system and the cell phone.



The cell phone must be paired and connected with the Bluetooth system before a call can be transferred. The connection process can take up to two minutes after the vehicle is started.

To Transfer Audio from the Bluetooth System to a Cell Phone

During a call with the audio in the vehicle:

1. Press  .
2. Say “Transfer Call.”

To Transfer Audio to the Bluetooth System from a Cell Phone

During a call with the audio on the cell phone, press  . The audio transfers to the vehicle. If the audio does not transfer to the vehicle, use the audio transfer feature on the cell phone. See your cell phone manufacturer’s user guide for more information.

Voice Pass-Thru

Voice pass-thru allows access to the voice recognition commands on the cell phone. See your cell phone manufacturer’s user guide to see if the cell phone supports this feature.

7-84 Infotainment System

To access contacts stored in the cell phone:

1. Press . Say "Hands Free" after the tone.
2. Say "Bluetooth." The system responds "Bluetooth ready," followed by a tone.
3. Say "Voice." The system responds "OK, accessing <phone name>."

The cell phone's normal prompt messages will go through their cycle according to the phone's operating instructions.

Dual Tone Multi-Frequency (DTMF) Tones

The Bluetooth system can send numbers and numbers stored as name tags during a call. Use this feature when calling a menu-driven phone system. Account numbers can also be stored for use.

Sending a Number or Name Tag During a Call

1. Press . The system responds "Ready," followed by a tone.
2. Say "Dial."
3. Say the number or name tag to send.

Clearing the System

Unless information is deleted out of the in-vehicle Bluetooth system, it will be retained indefinitely. This includes all saved name tags in the phone book and phone pairing information. For information on how to delete this information, see the previous sections on "Deleting a Paired Phone" and "Storing and Deleting Phone Numbers."

Pairing a Phone Using the Infotainment System

The pairing process can be started by using the controls on the infotainment system.

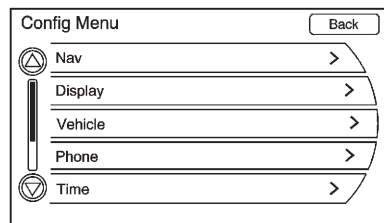

1. Press the CONFIG button. Turn the TUNE/MENU knob until the Phone menu displays. Press the TUNE/MENU knob or press the Phone screen button to display other options.

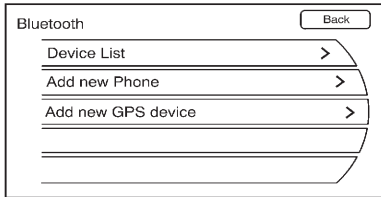

2. Turn the TUNE/MENU knob until Bluetooth displays. Press the TUNE/MENU knob or press the Bluetooth screen button to display other options.
3. Select "Add new Phone." The pairing process will begin searching for Bluetooth devices on the cell phone. See the cell phone manufacturer's user guide for information on this process.

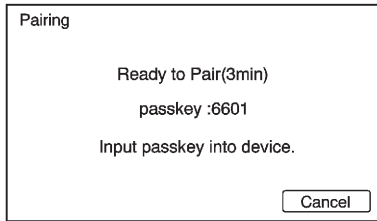

- On the cell phone, locate the device named "Your Vehicle." Follow the instructions given on the cell phone or follow the voice prompts, to enter the four-digit Personal Identification Number (PIN) that has been provided.
4. The system voice prompt requests a name for the phone being paired. Use a name that best describes the phone. The system voice prompt then repeats the name you provided for confirmation; say "Yes."
 5. The system responds with "phone name has been successfully paired" after the pairing process is complete.

Listing All Paired and Connected Phones

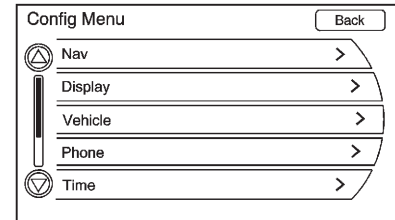

1. Press the CONFIG button. Turn the TUNE/MENU knob until the Phone menu displays. Press the TUNE/MENU knob or press the Phone screen button to display other options.

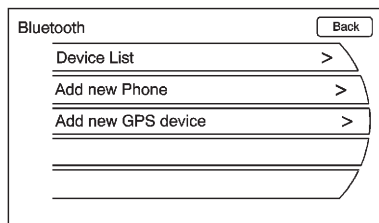

2. Turn the TUNE/MENU knob until Bluetooth displays. Press the TUNE/MENU knob or press the Bluetooth screen button to display other options.

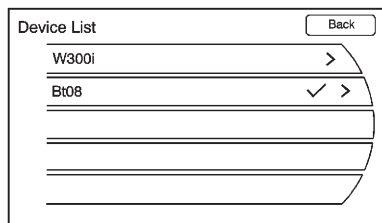

3. Turn the TUNE/MENU knob until Device List displays. Press the TUNE/MENU knob or press the Device List screen button to display other options.

A list of all previously paired phones will be displayed. If there is a currently connected phone, a checkmark will appear on the right side of the phone name.

Deleting a Paired Phone

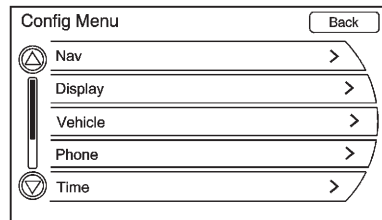

1. Press the CONFIG button. Turn the TUNE/MENU knob until the Phone menu displays. Press the MENU knob or press the Phone screen button to display other options.

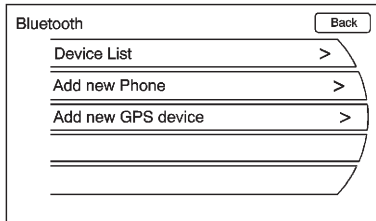

2. Turn the TUNE/MENU knob until Bluetooth displays. Press the TUNE/MENU knob or press the Bluetooth screen button to display other options.

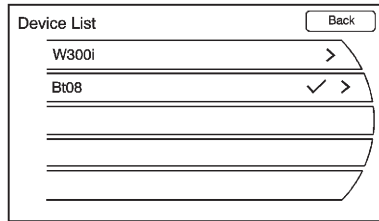

3. Turn the TUNE/MENU knob until Device List displays. Press the TUNE/MENU knob or press the Device List screen button to display other options.

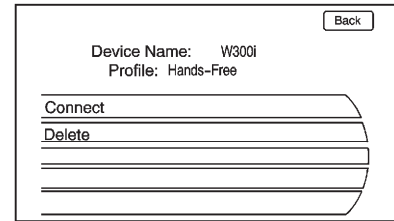

4. Turn the TUNE/MENU knob, then press it to select the phone to be deleted. Follow the on-screen prompts to delete the device from the system.
5. Once a phone has been deleted, the only way to connect back to that phone is to pair the phone again.

Linking to a Different Phone

To link to a different phone, the new phone must be in the vehicle and available to be connected to the Bluetooth system before the process is started.

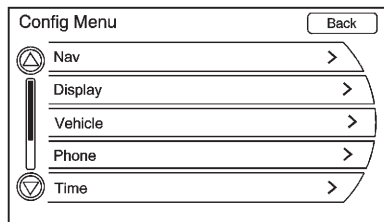

1. Press the CONFIG button. Turn the TUNE/MENU knob until the Phone menu displays. Press the TUNE/MENU knob or press the Phone screen button to display other options.

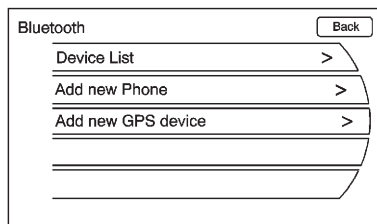

2. Turn the TUNE/MENU knob until Bluetooth displays. Press the TUNE/MENU knob or press the Bluetooth screen button to display other options.

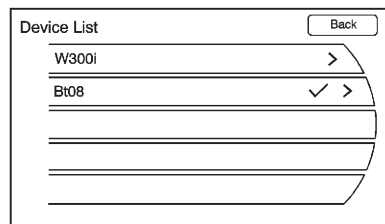

3. Turn the TUNE/MENU knob until Device List displays. Press the TUNE/MENU knob or press the Device List screen button to display other options.

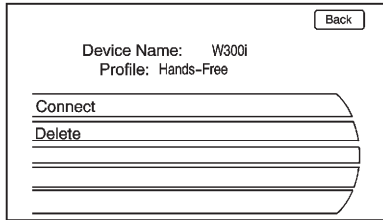

4. Select the phone to be linked and then follow the on-screen prompts.

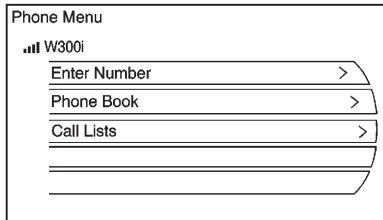

5. The Phone menu will be displayed with the name of the phone linked.

Making a Call

Press / on the infotainment system, to access the Phone Menu.

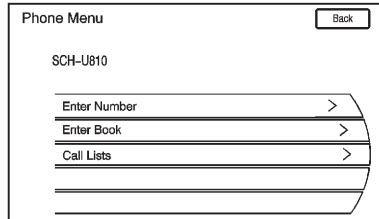

Enter Number

Use this option to enter a phone number and make a call.

1. Turn the TUNE/MENU knob, then press it to select Enter Number selection. A dial pad displays.

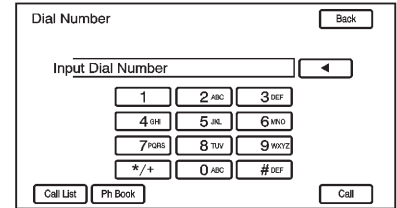

2. Enter the phone number by pressing the numbers on the keypad.
3. Press the Call button on the screen to make the call.

Phone Book

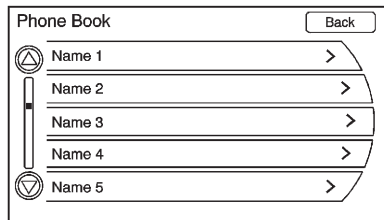

The phone book can be accessed by pressing the Phone Book selection on the Phone Menu screen.

Turn the TUNE/MENU knob to select the person or place to call. Press the TUNE/MENU knob or press the desired person or place to display the number. Press the TUNE/MENU knob or press the number to make the call.

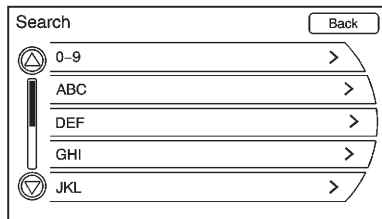

The Phone Book feature also has a search menu that can be accessed by pressing that option screen button. Once the Search menu displays, turn the TUNE/MENU knob to scroll through the list, then

press the TUNE/MENU button to select the desired list item. These lists are saved in alphabetical order. Press the TUNE/MENU knob or press the appropriate search line to obtain the numbers of the listed persons or places that have been saved.

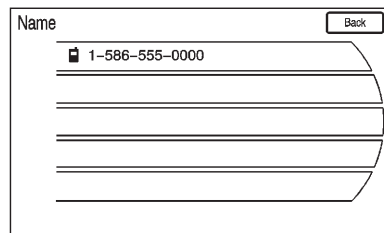

Call Lists

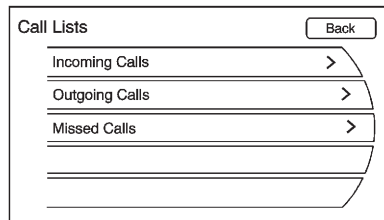

The Call Lists selection from the Phone Menu screen can be used to show a list of incoming calls, outgoing calls, and missed calls.

1. Press the CONFIG button. Turn the TUNE/MENU knob until Phone displays. Press the MENU knob or press the Phone screen button to display other options.
2. Turn the TUNE/MENU knob, then press this knob or press either Incoming Calls, Outgoing Calls, or Missed Calls.

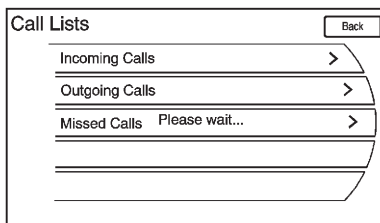

Once one of these options has been selected, a pop-up menu displays. A list of persons and places will display for the selected option.

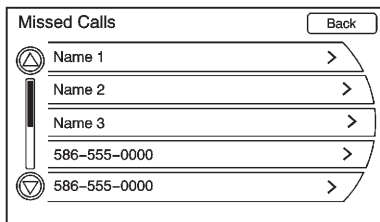

Turn the TUNE/MENU knob, then press this knob or press the appropriate screen button to select

someone on that list. A menu displays showing the phone number for that person.

Accepting or Declining an Incoming Call

When an incoming call is received, the audio is muted and a ring tone sounds.

Accepting a Call

Press the appropriate screen button for the Answer option on the screen to answer the call.

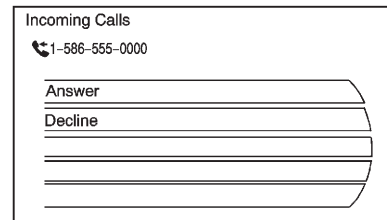

Declining a Call

Select the Decline option on the screen.

7-92 Infotainment System

Call Waiting

Call waiting must be supported on the Bluetooth phone and enabled by the wireless service carrier to work.

Switching Calls (Only Available with Call Waiting)

This feature allows switching between calls, making one call active, and placing the other on hold.

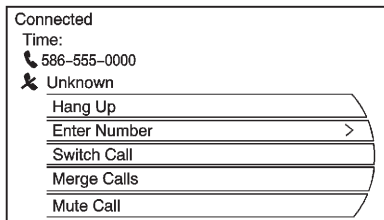

Switch Call: Turn or press the TUNE/MENU knob to Switch Call and press Enter or press the Switch Call option.

Conference Calling

Conference and three-way calling must be supported on the Bluetooth phone and enabled by the wireless service carrier to work.

To start a conference while in a current call:

1. Press  on the infotainment system until the Phone main screen is shown with the current active call.

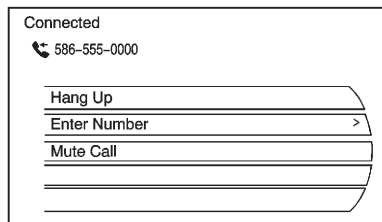

2. Select Enter Number on the screen.

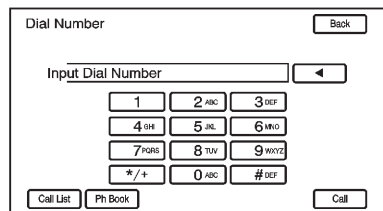

3. Make another call. The first call will be placed on hold while the second call is dialing and connected.
4. To make a conference call, select Merge Calls and both calls merge into one conference call.
5. To add more callers to the conference call, repeat Steps 2 through 4. The number of callers that can be added is limited by your wireless service carrier.

Ending a Call

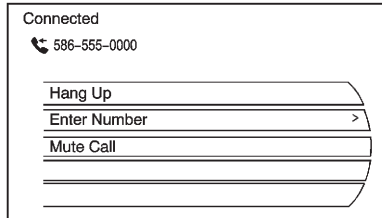

To end a call:

1. Press / .
2. Select Hang Up.

Mute or UnMute a Call

1. Press / .
2. Select Mute Call.
3. Select Mute Call again to unmute the call.

Dual Tone Multi-Frequency (DTMF) Tones

The in-vehicle Bluetooth system can send numbers during a call. This is used when calling a menu-driven phone system.

1. Press / .

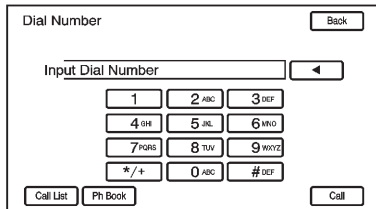

2. Turn the TUNE/MENU knob, then press this knob or press the Enter Number option and enter the number sequence.

The DTMF Tones will be generated on the network as you enter each number.

Climate Controls

Climate Control Systems

Automatic Climate Control System 8-1

Air Vents

Air Vents 8-8

Climate Control Systems

Automatic Climate Control System

The climate control buttons and the touch screen are used to adjust the heating, cooling, and ventilation.

The vehicle may require the use of an auxiliary heat source under certain cold conditions. This provides additional heating and defrost capability obtained by

running the engine, even if the high voltage battery is adequately charged. Under these conditions, the engine will start and use fuel. Make sure there is fuel in the tank.

Do not allow the vehicle to remain in extreme temperatures for long periods without being driven or being plugged in.

8-2 Climate Controls

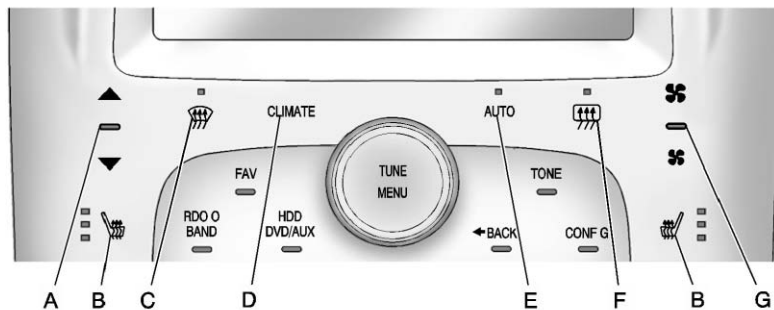

Climate Control Buttons

- | | |
|--------------------------------------|-------------------------------------|
| A. Temperature Control | D. Climate |
| B. Driver and Passenger Heated Seats | E. Auto (Automatic Climate Control) |
| C. Defrost | F. Rear Window Defogger |
| | G. Manual Fan Control |

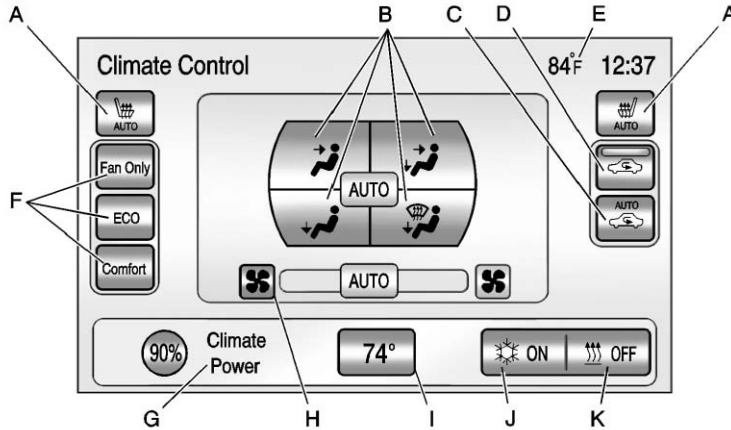

Climate Touch Screen Controls

- | | |
|--|--|
| <ul style="list-style-type: none"> A. Driver and Passenger Auto Heated Seats B. Air Delivery Mode Controls C. Auto Recirculation D. Manual Recirculation E. Outside Air Temperature Display | <ul style="list-style-type: none"> F. Climate Modes: Fan Only, ECO, Comfort G. Climate Power Gauge H. Manual Fan Control I. Temperature Setting Display J. Air Conditioning Indicator K. Heat Status Indicator |
|--|--|

Climate Control Touch Screen

The climate mode, fan, air delivery, recirculation, and auto heated seats are controlled by pressing the CLIMATE button on the center stack and viewing information in the center stack display.

Climate Mode Operation

There are three climate mode settings: Fan Only, ECO, and Comfort. These settings adjust the impact the climate control system has on the vehicle's electric range or fuel economy.

To select a climate mode:

1. Press CLIMATE on the center stack.
2. Press the climate mode button on the touch screen. The climate mode will be lit.

8-4 Climate Controls

Fan Only Mode: The air conditioning and electric heat are turned off. The climate control settings may not have a noticeable effect on the vehicle electric range and fuel economy.

When in Fan Only mode, the air conditioning system may turn on automatically if the high voltage battery is being cooled. The climate control system could blow cold air. This is normal.

To prevent cold air from blowing into the interior, turn off the fan control and select the vent mode and manual recirculation mode, and close the air vents.

When in Fan Only mode, if Auto Defog is selected, the air conditioning and electric heat may turn on when high humidity conditions exist. See "Climate and Air Quality" under *Vehicle Personalization* on page 5-48 for more information on the Auto Defog selection. The air conditioning may also run if defrost mode is selected.

ECO Mode: The vehicle air conditioning and electric heat are controlled to balance comfort with fuel economy. In this mode, the vehicle electric range or fuel economy will decrease less than in Comfort mode, but will result in moderate comfort.

Comfort Mode: The vehicle air conditioning and electric heat are controlled to reach the best comfort level based on the temperature setting selected. In this mode, vehicle electric range or fuel economy will decrease depending on the amount of energy required to reach the best comfort levels.



Climate Power Gauge

When the climate mode is changed, the Climate Power gauge displays the impact that user setting changes

have on energy consumption. The higher the reading, the more energy is being used.

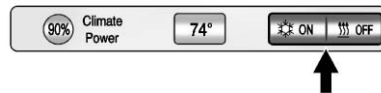

Air Conditioning/Heat Status Indicators

The air conditioning/heat status displays when the air conditioning or electric heat is being used.

The air conditioning and heater could be on at the same time when dehumidification is required in ECO or Comfort modes.

In Fan Only mode, occasionally the air conditioning and/or heating status will be on if the Auto Defog function is enabled and high humidity is detected. See "Climate and Air Quality" under *Vehicle*

Personalization on page 5-48, for details on enabling or disabling the Auto Defog function.

Automatic Operation

The system automatically controls the fan speed, air delivery mode, and recirculation to heat or cool the vehicle to the selected temperature.

When the AUTO indicator light is on, the system is in full automatic operation. If the air delivery mode, fan speed, or recirculation setting is adjusted, the AUTO indicator turns off and the selected settings display.

For automatic operation:

1. Press AUTO.
2. Set the temperature. An initial setting of 23°C (74°F) is recommended. Allow the system time to stabilize. Adjust the temperature as needed.

▲ / ▼ (Temperature Control):

Press to increase or decrease the temperature.

Auto Defog: The system will monitor high humidity inside the vehicle. When high humidity is detected, the climate control system may adjust to outside air supply and turn on the air conditioner or the heater. The fan speed may slightly increase to help prevent fogging. When high humidity is no longer detected, the system will return to its prior operation. To turn Auto Defog off or on, see “Climate and Air Quality” under *Vehicle Personalization on page 5-48*.

Manual Operation

 **(Fan Control):** Press the fan control buttons or the touch screen fan control, to increase or decrease the fan speed. The fan speed setting displays. Pressing either button cancels automatic fan control and the fan can be controlled manually. Press AUTO to return to automatic operation. Press the fan down button repeatedly to turn off the fan and the climate control system.

Air Delivery Mode Control: Press CLIMATE to select the Climate touch screen. Press the air delivery mode touch screen button to change the direction of the airflow. The selected air delivery mode button is lit. Pressing any of the air delivery buttons cancels automatic air delivery control and the direction of the airflow can be controlled manually. Press AUTO to return to automatic operation.

To change the current mode, select one of the following:

 **(Vent):** Air is directed to the instrument panel outlets.

 **(Bi-Level):** Air is divided between the instrument panel outlets and the floor outlets.

 **(Floor):** Air is directed to the floor outlets.

 **(Defog):** Air is directed to the windshield and floor outlets. Clears the windows of fog or moisture.

8-6 Climate Controls

 **(Defrost):** Air is directed to the windshield. The windshield is cleared of fog or frost more quickly. Selecting defrost will disable automatic control.

For best results, clear all snow and ice from the windshield before defrosting.

(Auto Recirculation):



Press to allow the system to automatically choose the air supply mode for best performance in terms of comfort, efficiency, and defogging. Air is recirculated or outside air is pulled into the vehicle. The touch screen button is lit.



(Manual Recirculation):



Press to alternate between recirculating air inside the vehicle or pulling in outside air. When selected, the touch screen button lights up to indicate that air is being recirculated. This helps to quickly cool the air inside the vehicle or prevent outside air and odors from entering.



Pressing this button cancels automatic recirculation. Press AUTO or AUTO  to return to automatic operation; recirculation runs automatically as needed.

Manual recirculation mode is not available when in Defrost or Defog modes.

 /  **(Manual Heated Seats):** If available, the controls are on the center stack. To operate, the vehicle must be on.

Press  or  to heat the driver or passenger seat cushion and seatback. For more information, see *Heated Front Seats on page 3-6*.

 **AUTO/**  **AUTO (Auto Heated Seats):** If available, the controls are on the touch screen on the center stack.

Press the touch screen  AUTO or  AUTO button. The button color will change to green when this feature is on. When the vehicle is on, this feature will automatically activate the heated seats at the level required by the vehicle's interior temperature. The active high, medium, low, or off heated seat level will be indicated by the manual heated seat button lights on the center stack. Use of the manual heated seat buttons on the center stack will turn auto heated seats off. For more information, see *Heated Front Seats on page 3-6*.

Rear Window Defogger

 **(Rear Window Defogger):** Press to turn the rear window defogger on or off.

The rear window defogger turns off automatically after about five minutes. If turned on again, it runs for about five minutes before turning off. The defogger can also be turned off by turning the vehicle off.

For vehicles with heated outside rearview mirrors, they turn on when the rear window defogger button is on and help to clear fog or frost from the surface of the mirror. See *Heated Mirrors on page 2-14*.

Notice: Do not try to clear frost or other material from the inside of the front windshield and rear window with a razor blade or anything else that is sharp. This may damage the rear window defogger grid and affect the radio's ability to pick up stations clearly. The repairs wouldn't be covered by the vehicle warranty.

Remote Start: For vehicles with this feature, the climate control system may be started by using the Remote Keyless Entry (RKE) transmitter. The climate control system will default to an appropriate heating or cooling mode. See *Remote Start on page 2-7*.

The rear window defogger turns on if it is cold outside.

Compressor

The vehicle has an electric powered air conditioning compressor. This allows for continuous air conditioning and/or high voltage battery cooling operation, without running the engine.

The compressor operating speed is not tied to the engine speed, so some noise may be heard from the compressor, especially when air conditioning use is high and the engine has turned off. This is normal.

Sensors

Solar Sensor

The solar sensor is located on top of the instrument panel, near the windshield, where it monitors solar intensity.

The climate control system uses the sensor information to adjust the temperature, fan speed, recirculation, and air delivery mode for best comfort.

Do not cover the sensor; otherwise the automatic climate control system may not work properly.

Humidity Sensor

The humidity sensor is near the base of the inside rearview mirror. The climate control system uses the sensor information to adjust the temperature and recirculation for best comfort.

Outside Air Temperature Sensor

The outside air temperature sensor is located behind the front grille of the vehicle. The vehicle uses the sensor information to display outside air temperature. The climate control system uses the information to adjust the climate system operation.

Air Vents

Use the louvers on the air vents to change the direction of the airflow.

Use the thumbwheels near each vent to open and close off the airflow.

Operation Tips

- Keep all outlets open whenever possible for best system performance.
- Keep the path under all seats clear of objects to help circulate the air inside the vehicle more effectively.
- Use of non-GM approved hood deflectors can adversely affect the performance of the system.

Driving and Operating

Driving Information

Driving for Better Energy	
Efficiency	9-2
Defensive Driving	9-4
Drunk Driving	9-4
Control of a Vehicle	9-5
Braking	9-6
Steering	9-7
Off-Road Recovery	9-8
Loss of Control	9-8
Driving on Wet Roads	9-9
Highway Hypnosis	9-10
Hill and Mountain Roads	9-10
Winter Driving	9-11
If the Vehicle is Stuck	9-13
Vehicle Load Limits	9-13

Starting and Operating

New Vehicle Break-In	9-18
Power Button	9-18
Starting and Stopping the Vehicle	9-19

Retained Accessory Power (RAP)	9-21
Shifting Into Park	9-21
Shifting Out of Park	9-22
Parking Over Things That Burn	9-22

Electric Vehicle Operating Modes

System Operation	9-23
Electric Mode	9-23
Extended Range Mode	9-23
Driver Selected Operating Modes	9-24
Out of Fuel/Engine Unavailable	9-26
Maintenance Modes	9-26

Engine Exhaust

Engine Exhaust	9-28
Running the Vehicle While Parked	9-28

Electric Drive Unit

Electric Drive Unit	9-29
---------------------------	------

Brakes

Antilock Brake System (ABS)	9-31
Electric Parking Brake	9-32
Regenerative Braking	9-33

Ride Control Systems

Traction Control System (TCS)	9-34
Electronic Stability Control (ESC)	9-35

Cruise Control

Cruise Control	9-36
----------------------	------

Object Detection Systems

Ultrasonic Parking Assist	9-39
Rear Vision Camera (RVC)	9-41

Charging

Plug-In Charging	9-44
Delayed Charging Override	9-47
Charging Status Feedback	9-47
Charge Cord	9-49
Electrical Requirements for Battery Charging	9-51

9-2 Driving and Operating

Fuel

Fuel	9-52
Gasoline Specifications (U.S. and Canada Only)	9-53
California Fuel Requirements	9-53
Fuels in Foreign Countries	9-53
Fuel Additives	9-54
Filling the Tank	9-55
Filling a Portable Fuel Container	9-56

Towing

General Towing Information	9-57
-------------------------------------	------

Conversions and Add-Ons

Add-On Electrical Equipment	9-57
--------------------------------------	------

Driving Information

Driving for Better Energy Efficiency

Use the following tips to help maximize energy efficiency and range.

Driving Style

Efficiency Gauge (Instrument Cluster)

The ball indicator should be kept green and in the center of the gauge.

Inefficient acceleration is indicated when the ball turns yellow and travels above the center of the gauge.

Aggressive braking is indicated when the ball turns yellow and travels below the center of the gauge.

Acceleration/Braking/Coasting

Avoid unnecessary rapid accelerations and decelerations.

Electric range is maximized at 80 km/h (50 mph) and below. Higher speeds use more energy and can significantly reduce electric range.

Use cruise control when appropriate.

Plan ahead for decelerations and coast whenever possible. For example, do not rush to traffic signals.

Do not shift to N (Neutral) to coast. The vehicle recovers energy while coasting and braking in D (Drive) or L (Low).

Drive Mode and PRNDL Selection

Use Normal Mode when possible.

Sport Mode provides more responsive acceleration than Normal Mode but reduces efficiency.

Use Mountain Mode prior to climbing long, steep grades in mountainous areas. Be sure to engage Mountain Mode before starting to climb. Mountain Mode reduces electric range and power but may be needed to maintain speeds above 96 km/h (60 mph) when climbing grades of 5% or greater.

Use L (Low) in heavy stop-and-go traffic or when traveling downhill. L (Low) requires less brake pedal application and provides a controlled, efficient way to slow the vehicle down.

Climate Setting

Using the heat and air conditioning systems decreases the energy available for electric driving.

Optimal energy efficiency is achieved with the heat, air conditioning, and fan turned off.

Less energy is used at low fan speeds. When using the fan:

- Fan Only is the most energy efficient climate setting.
- ECO is for moderate air conditioning and heater operation and is the next most energy efficient setting.
- Comfort provides the most comfort but is the least energy efficient.

Use the auto heated seat feature instead of climate settings. Heating the seat uses less energy than heating the vehicle interior.

Use remote start when the vehicle is plugged in to attain a comfortable vehicle interior temperature.

In hot weather, avoid parking in direct sunlight or use sunshades inside the vehicle.

Turn off the front and rear window defog/defrost when they are no longer needed.

Avoid driving with the windows open at high speeds.

Vehicle Charging/Maintenance**Charging**

Keep the vehicle plugged in, even when fully charged, to keep the battery temperature ready for the next drive. This is important when outside temperatures are extremely hot or cold.

9-4 Driving and Operating

Maintenance

Always keep the tires properly inflated and the vehicle properly aligned.

The weight of excess cargo in the vehicle affects efficiency and range. Avoid carrying more than is needed.

If fuel is not regularly used, consider keeping the fuel tank only one-third full. Excess fuel weight impacts efficiency and range.

Use premium fuel.

Avoid unnecessary use of electrical accessories. Power used for functions other than propelling the vehicle will reduce EV range.

Using a rooftop carrier will reduce efficiency due to additional weight and drag.

Defensive Driving

Defensive driving means “always expect the unexpected.” The first step in driving defensively is to wear the safety belt. See *Safety Belts on page 3-10*.

WARNING

Assume that other road users (pedestrians, bicyclists, and other drivers) are going to be careless and make mistakes. Anticipate what they might do and be ready. In addition:

- Allow enough following distance between you and the driver in front of you.
- Focus on the task of driving.

Driver distraction can cause collisions resulting in injury or possible death. These simple defensive driving techniques could save your life.

Drunk Driving

WARNING

Drinking and then driving is very dangerous. Your reflexes, perceptions, attentiveness, and judgment can be affected by even a small amount of alcohol. You can have a serious — or even fatal — collision if you drive after drinking.

Do not drink and drive or ride with a driver who has been drinking. Ride home in a cab; or if you are with a group, designate a driver who will not drink.

Death and injury associated with drinking and driving is a global tragedy.

Alcohol affects four things that anyone needs to drive a vehicle: judgment, muscular coordination, vision, and attentiveness.

Police records show that almost 40 percent of all motor vehicle-related deaths involve alcohol. In most cases, these deaths are the result of someone who was drinking and driving. In recent years, more than 17,000 annual motor vehicle-related deaths have been associated with the use of alcohol, with about 250,000 people injured.

For persons under 21, it is against the law in every U.S. state to drink alcohol. There are good medical, psychological, and developmental reasons for these laws.

The obvious way to eliminate the leading highway safety problem is for people never to drink alcohol and then drive.

Medical research shows that alcohol in a person's system can make crash injuries worse, especially injuries to the brain, spinal cord, or heart. This means that when anyone who has been drinking — driver or passenger — is in a crash, that person's chance of being killed or permanently disabled is higher than if the person had not been drinking.

Control of a Vehicle

The following three systems help to control the vehicle while driving — brakes, steering, and accelerator. At times, as when driving on snow or ice, it is easy to ask more of those control systems than the tires and road can provide. Meaning, you can lose control of the vehicle.

Adding non-dealer accessories can affect vehicle performance. See *Accessories and Modifications* on page 10-3.

9-6 Driving and Operating

Braking

See *Brake System Warning Light* on page 5-22.

Braking action involves perception time and reaction time. Deciding to push the brake pedal is perception time. Actually doing it is reaction time.

Average reaction time is about three-fourths of a second. But that is only an average. It might be less with one driver and as long as two or three seconds or more with another. Age, physical condition, alertness, coordination, and eyesight all play a part. So do alcohol, drugs, and frustration. But even in three-fourths of a second, a vehicle moving at 100 km/h (60 mph) travels 20 m (66 ft).

That could be a lot of distance in an emergency, so keeping enough space between the vehicle and others is important.

And, of course, actual stopping distances vary greatly with the surface of the road, whether it is pavement or gravel; the condition of the road, whether it is wet, dry, or icy; tire tread; the condition of the brakes; the weight of the vehicle; and the amount of brake force applied.

Avoid needless heavy braking. Some people drive in spurts — heavy acceleration followed by heavy braking — rather than keeping pace with traffic. This is a mistake. The brakes might not have time to cool between hard stops. The brakes will wear out

much faster with a lot of heavy braking. Keeping pace with the traffic and allowing realistic following distances eliminates a lot of unnecessary braking. That means better braking and longer brake life.

If propulsion is disabled while the vehicle is being driven, brake normally but do not pump the brakes. If the brakes are pumped, the pedal could get harder to push down. If propulsion stops, there will still be some power brake assist but it will be used when the brake is applied. Once the power assist is used up, it can take longer to stop and the brake pedal will be harder to push.

Steering

Electric Power Steering

If propulsion is disabled, the power steering assist system may continue to operate until you are able to stop the vehicle. If power steering assist is lost because the electric power steering system is not functioning, the vehicle can be steered but it will take more effort.

The electric power steering system does not require regular maintenance. If you suspect steering system problems and/or the SERVICE POWER STEERING message comes on, contact your dealer for service. See *Service Vehicle Messages on page 5-46*.

Steering Tips

It is important to take curves at a reasonable speed.

Traction in a curve depends on the condition of the tires and the road surface, the angle at which the curve is banked, and vehicle speed. While in a curve, speed is the one factor that can be controlled.

If there is a need to reduce speed, do it before entering the curve, while the front wheels are straight.

Try to adjust the speed so you can drive through the curve. Maintain a reasonable, steady speed. Wait to accelerate until out of the curve, and then accelerate gently into the straightaway.

Steering in Emergencies

There are times when steering can be more effective than braking. For example, you come over a hill and find a truck stopped in your lane, or a car suddenly pulls out from nowhere, or a child darts out from between parked cars and stops right in front of you. These problems can be avoided by braking — if you can stop in time. But sometimes you cannot stop in time because there is no room. That is the time for evasive action — steering around the problem.

The vehicle can perform very well in emergencies like these. First apply the brakes. See *Braking on page 9-6*. It is better to remove as much speed as possible from a collision. Then steer around the problem, to the left or right depending on the space available.

9-8 Driving and Operating



An emergency like this requires close attention and a quick decision. If holding the steering wheel at the recommended 9 and 3 o'clock positions, it can be turned a full 180 degrees very quickly without removing either hand. But you have to act fast, steer quickly, and just as quickly straighten the wheel once you have avoided the object.

The fact that such emergency situations are always possible is a good reason to practice defensive driving at all times and wear safety belts properly.

Off-Road Recovery

The vehicle's right wheels can drop off the edge of a road onto the shoulder while driving.

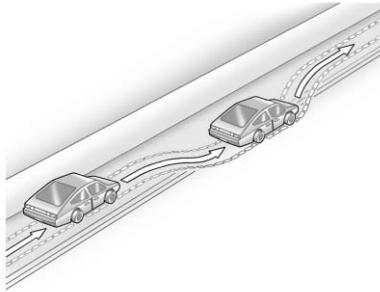

If the level of the shoulder is only slightly below the pavement, recovery should be fairly easy. Ease off the accelerator and then, if there is nothing in the way, steer so that the vehicle straddles the edge of the pavement. Turn the steering wheel 8 to 13 cm (3 to 5 in), about one-eighth turn, until the right front

tire contacts the pavement edge. Then turn the steering wheel to go straight down the roadway.

Loss of Control

Let us review what driving experts say about what happens when the three control systems — brakes, steering, and acceleration — do not have enough friction where the tires meet the road to do what the driver has asked.

In any emergency, do not give up. Keep trying to steer and constantly seek an escape route or area of less danger.

Skidding

In a skid, a driver can lose control of the vehicle. Defensive drivers avoid most skids by taking reasonable care suited to existing conditions, and by not overdriving those conditions. But skids are always possible.

The three types of skids correspond to the vehicle's three control systems. In the braking skid, the wheels are not rolling. In the steering or cornering skid, too much speed or steering in a curve causes tires to slip and lose cornering force. And in the acceleration skid, too much throttle causes the driving wheels to spin.

If the vehicle starts to slide, ease your foot off the accelerator pedal and quickly steer the way you want the vehicle to go. If you start steering quickly enough, the vehicle may straighten out. Always be ready for a second skid if it occurs.

Of course, traction is reduced when water, snow, ice, gravel, or other material is on the road. For safety, slow down and adjust your driving to these conditions. It is important to slow down on slippery surfaces because stopping distance is longer and vehicle control more limited.

While driving on a surface with reduced traction, try to avoid sudden steering, acceleration, or braking, including reducing vehicle speed by shifting to a lower gear. Any sudden changes could cause the tires to slide. You might not realize the surface is slippery until the vehicle is skidding. Learn to recognize warning clues — such as enough water, ice, or packed snow on the road to make a mirrored surface — and slow down when you have any doubt.

Remember: Antilock brakes help avoid only the braking skid.

Driving on Wet Roads

Rain and wet roads can reduce vehicle traction and affect your ability to stop and accelerate. Always drive slower in these types of driving conditions and avoid driving through large puddles and deep-standing or flowing water.

WARNING

Wet brakes can cause crashes. They might not work as well in a quick stop and could cause pulling to one side. You could lose control of the vehicle.

After driving through a large puddle of water or a car/vehicle wash, lightly apply the brake pedal until the brakes work normally.

Flowing or rushing water creates strong forces. Driving through flowing water could cause the vehicle to be carried away. If this happens, you and other vehicle occupants could drown. Do not ignore police warnings and be very cautious about trying to drive through flowing water.

Hydroplaning

Hydroplaning is dangerous. Water can build up under the vehicle's tires so they actually ride on the water. This can happen if the road is wet enough and you are going fast enough. When the vehicle is hydroplaning, it has little or no contact with the road.

There is no hard and fast rule about hydroplaning. The best advice is to slow down when the road is wet.

Other Rainy Weather Tips

Besides slowing down, other wet weather driving tips include:

- Allow extra following distance.
- Pass with caution.
- Keep windshield wiping equipment in good shape.
- Keep the windshield washer fluid reservoir filled.

- Have good tires with proper tread depth. See *Tires* on page 10-42.
- Turn off cruise control.

Highway Hypnosis

Always be alert and pay attention to your surroundings while driving. If you become tired or sleepy, find a safe place to park the vehicle and rest.

Other driving tips include:

- Keep the vehicle well ventilated.
- Keep interior temperature cool.
- Keep your eyes moving — scan the road ahead and to the sides.
- Check the rearview mirror and vehicle instruments often.

Hill and Mountain Roads

Driving on steep hills or through mountains is different than driving on flat or rolling terrain. See “Mountain Mode” under *Driver Selected Operating Modes* on page 9-24. Tips for driving in these conditions include:

- Keep the vehicle serviced and in good shape.
- Check all fluid levels and brakes, tires, cooling system, and electric drive unit.
- Keep the vehicle in gear when going down steep or long hills.

WARNING

Coasting downhill in N (Neutral) or with the vehicle turned off is dangerous. The brakes will have to do all the work of slowing down the vehicle and could become too hot. Hot brakes may not be able

(Continued)

WARNING (Continued)

to slow the vehicle enough to maintain speed and control. You could crash. Always have the vehicle running and in gear (preferably LOW range) when going downhill. This will allow the electric drive unit to assist in slowing and maintaining speed.

- Stay in your own lane. Do not swing wide or cut across the center of the road. Drive at speeds that let you stay in your own lane.
- Top of hills: Be alert — something could be in your lane (stalled car, accident).
- Pay attention to special road signs (falling rocks area, winding roads, long grades, passing or no-passing zones) and take appropriate action.

Winter Driving**Driving on Snow or Ice**

Drive carefully when there is snow or ice between the tires and the road, creating less traction or grip. Wet ice can occur at about 0°C (32°F) when freezing rain begins to fall, resulting in even less traction. Avoid driving on wet ice or in freezing rain until roads can be treated with salt or sand.

Drive with caution, whatever the condition. Accelerate gently so traction is not lost. Accelerating too quickly causes the wheels to spin and makes the surface under the tires slick, so there is even less traction.

Try not to break the fragile traction. If you accelerate too fast, the drive wheels will spin and polish the surface under the tires even more.

The Antilock Brake System (ABS) improves vehicle stability during hard stops on slippery roads, but apply the brakes sooner than when on dry pavement.

Allow greater following distance on any slippery road and watch for slippery spots. Icy patches can occur on otherwise clear roads in shaded areas. The surface of a curve or an overpass can remain icy when the surrounding roads are clear. Avoid sudden steering maneuvers and braking while on ice.

Turn off cruise control on slippery surfaces.

9-12 Driving and Operating

Blizzard Conditions

Being stuck in snow can be a serious situation. Stay with the vehicle unless there is help nearby. If possible, use the Roadside Assistance Program. To get help and keep everyone in the vehicle safe:

- Turn on the hazard warning flashers.
- Tie a red cloth to an outside mirror.

WARNING

Snow can trap engine exhaust under the vehicle. This may cause exhaust gases to get inside. Engine exhaust contains Carbon Monoxide (CO) which cannot be seen or smelled. It can cause unconsciousness and even death.

(Continued)

WARNING (Continued)

If the vehicle is stuck in the snow:

- Clear away snow from around the base of the vehicle, especially any that is blocking the exhaust pipe.
- Check again from time to time to be sure snow does not collect there.
- Open a window about 5 cm (2 in) on the side of the vehicle that is away from the wind to bring in fresh air.
- Fully open the air outlets on or under the instrument panel.
- Adjust the climate control system to a setting that circulates the air inside the vehicle and set the fan speed to the highest setting. See Climate Control Systems in the Index.

(Continued)

WARNING (Continued)

For more information about carbon monoxide, see *Engine Exhaust* on page 9-28.

To conserve energy, run the vehicle for only short periods as needed to warm the vehicle and then shut the vehicle off and close the window most of the way to save heat. Repeat this until help arrives but only when you feel really uncomfortable from the cold. Moving about to keep warm also helps.

If it takes some time for help to arrive, start the vehicle. The engine may start to charge the 12-volt battery. Turn off unnecessary accessories to conserve energy.

If the Vehicle is Stuck

Slowly and cautiously spin the wheels to free the vehicle when stuck in sand, mud, ice, or snow.

Shifting the vehicle into L will allow the driver to achieve more wheel spin. The wheel spin will still be limited by the traction control system to prevent any driveline damage. The increase in allowable wheel spin is only active at low speeds.

WARNING

If the vehicle's tires spin at high speed, they can explode, and you or others could be injured. The vehicle can overheat, causing an engine compartment fire or other damage. Spin the wheels as little as possible and avoid going above 55 km/h (35 mph).

For information about using tire chains on the vehicle, see *Tire Chains* on page 10-61.

Rocking the Vehicle to Get it Out

Turn the steering wheel left and right to clear the area around the front wheels. Shift back and forth between R (Reverse) and a forward gear, spinning the wheels as little as possible. The Traction Control System prevents the tires from spinning at high speeds. To prevent electric drive unit wear, wait until the wheels stop spinning before shifting gears. Release the accelerator pedal while shifting, and press lightly on the accelerator pedal when the electric drive unit is in

gear. Slowly spinning the wheels in the forward and reverse directions causes a rocking motion that could free the vehicle. If that does not get the vehicle out after a few tries, it might need to be towed out. If the vehicle does need to be towed out, see *Towing the Vehicle* on page 10-77.

Vehicle Load Limits

It is very important to know how much weight the vehicle can carry. This weight is called the vehicle capacity weight and includes the weight of all occupants, cargo, and all nonfactory-installed options.

9-14 Driving and Operating

Two labels on the vehicle show how much weight it was designed to carry, the Tire and Loading Information label and the Certification label.

WARNING

Do not load the vehicle any heavier than the Gross Vehicle Weight Rating (GVWR), or either the maximum front or rear Gross Axle Weight Rating (GAWR). This can cause systems to break and change the way the vehicle handles. This could cause loss of control and a crash. Overloading can also shorten the life of the vehicle.

Tire and Loading Information Label

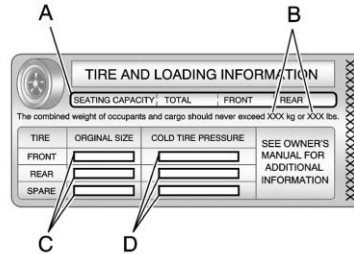

Label Example

A vehicle-specific Tire and Loading Information label is attached to the center pillar (B-pillar). With the driver door open, the label is attached below the door lock post.

The Tire and Loading Information label shows the number of occupant seating positions (A), and the maximum vehicle capacity weight (B) in kilograms and pounds.

The Tire and Loading Information label also shows the tire size of the original equipment tires (C) and the recommended cold tire inflation pressures (D). For more information on tires and inflation see *Tires on page 10-42* and *Tire Pressure on page 10-48*.

There is also important loading information on the Certification label. It tells you the Gross Vehicle Weight Rating (GVWR) and the Gross Axle Weight Rating (GAWR) for the front and rear axle; see "Certification Label" later in this section.

Steps for Determining Correct Load Limit

1. Locate the statement "The combined weight of occupants and cargo should never exceed XXX kg or XXX lbs" on your vehicle's placard.
2. Determine the combined weight of the driver and passengers that will be riding in your vehicle.
3. Subtract the combined weight of the driver and passengers from XXX kg or XXX lbs.
4. The resulting figure equals the available amount of cargo and luggage load capacity. For example, if the "XXX" amount equals 1400 lbs and there will be five 150 lb passengers in your vehicle,

the amount of available cargo and luggage load capacity is 650 lbs (1400 – 750 (5 x 150) = 650 lbs).

5. Determine the combined weight of luggage and cargo being loaded on the vehicle. That weight may not safely exceed the available cargo and luggage load capacity calculated in Step 4.
6. If your vehicle will be towing a trailer, the load from your trailer will be transferred to your vehicle. Consult this manual to determine how this reduces the available cargo and luggage load capacity of your vehicle.

The vehicle is neither designed nor intended to tow a trailer.

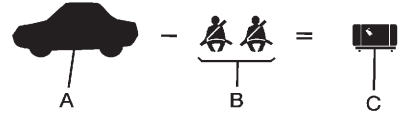

Example 1

- A. Vehicle Capacity Weight for Example 1 = 453 kg (1,000 lbs).
- B. Subtract Occupant Weight @ 68 kg (150 lbs) × 2 = 136 kg (300 lbs).
- C. Available Occupant and Cargo Weight = 317 kg (700 lbs).

9-16 Driving and Operating

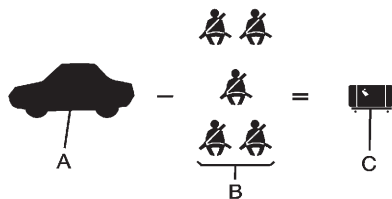

Example 2

- Vehicle Capacity Weight for Example 2 = 453 kg (1,000 lbs).
- Subtract Occupant Weight @ 68 kg (150 lbs) \times 5 = 340 kg (750 lbs).
- Available Cargo Weight = 113 kg (250 lbs).

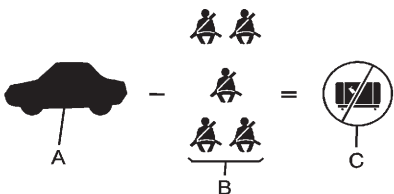

Example 3

- Vehicle Capacity Weight for Example 3 = 453 kg (1,000 lbs).
- Subtract Occupant Weight @ 91 kg (200 lbs) \times 5 = 453 kg (1,000 lbs).
- Available Cargo Weight = 0 kg (0 lbs).

Refer to the vehicle's Tire and Loading Information label for specific information about the vehicle's capacity weight and

seating positions. The combined weight of the driver, passengers, and cargo should never exceed the vehicle's capacity weight.

Certification Label

DATE	GVWR	GAWR FR	GAWR RR	
THIS VEHICLE CONFORMS TO ALL APPLICABLE U.S. FEDERAL MOTOR VEHICLE SAFETY, BUMPER, AND THEFT PREVENTION STANDARDS IN EFFECT ON THE DATE OF MANUFACTURE SHOWN ABOVE.				
	TYPE: _____			

Label Example

A vehicle-specific Certification label is found on the center pillar (B-pillar). The label shows the gross weight capacity of the vehicle. This is the Gross Vehicle Weight Rating (GVWR) and includes the weight of the vehicle, all occupants, fuel, and

cargo. Never exceed the GVWR for the vehicle, or the Gross Axle Weight Rating (GAWR) for either the front or rear axle.

Spread out heavy loads equally on both sides of the vehicle. See “Steps for Determining Correct Load Limit” earlier in this section.

 **WARNING**

Do not load the vehicle any heavier than the Gross Vehicle Weight Rating (GVWR), or either the maximum front or rear Gross Axle Weight Rating (GAWR). This can cause systems to break and change the way the vehicle handles. This could cause loss of control and a crash. Overloading can also shorten the life of the vehicle.

If you put things inside the vehicle — like suitcases, tools, packages, or anything else — they will go as fast as the vehicle goes. If you have to stop or turn quickly, or if there is a crash, they will keep going.

 **WARNING**

Things inside the vehicle can strike and injure people in a sudden stop or turn, or in a crash.

- Put things in the cargo area of the vehicle. In the cargo area, put them as far forward as possible. Try to spread the weight evenly.

(Continued)

WARNING (Continued)

- Never stack heavier things, like suitcases, inside the vehicle so that some of them are above the tops of the seats.
- Do not leave an unsecured child restraint in the vehicle.
- Secure loose items in the vehicle.
- Do not leave a seat folded down unless needed.

Starting and Operating



New Vehicle Break-In

Notice: The vehicle does not require a break-in period. Vehicle break-in is performed during manufacturing.

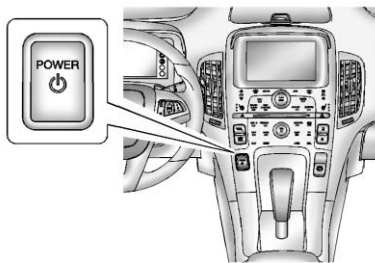
Power Button



The vehicle has an electronic push-button start. The POWER  button light flashes when the driver door is open and the vehicle is not

on. The flashing light will eventually time out. The POWER  button light is on steady when in ON/RUN power mode. When the vehicle is turned off, the POWER  button light will turn off.

The Remote Keyless Entry (RKE) transmitter must be in the vehicle for the system to operate. If the vehicle will not start, place the RKE transmitter in the transmitter slot. See *Remote Keyless Entry (RKE) System Operation* on page 2-3.

ON/RUN: This position is for driving and starting. With the vehicle off, and the brake pedal applied, pressing the POWER  button once will place the vehicle in ON/RUN. The instrument cluster displays an active fuel or battery gauge, along with an audio startup cue, when the vehicle is ready to be driven. This could take up to 15 seconds at extremely cold temperatures. The engine will only start if needed.

If the vehicle did not start, the instrument cluster will display a screen with inactive fuel and battery gauges. See *Starting and Stopping the Vehicle* on page 9-19.

STOPPING THE VEHICLE/OFF:

To turn the vehicle off, push the POWER  button with the vehicle in P (Park). Retained Accessory Power (RAP) will remain active until the driver door is opened. See *Retained Accessory Power (RAP)* on page 9-21. When turning off the vehicle, if the vehicle is not in P (Park), the vehicle will go to ACC/ACCESSORY and display the message SHIFT TO PARK in the Driver Information Center (DIC). See *Electric Drive Unit Messages* on page 5-43.

In an emergency, if the vehicle must be stopped while driving:

1. Brake using a firm and steady pressure. Do not pump the brakes repeatedly. This may deplete power assist, requiring increased brake pedal force.

2. Shift the vehicle to N (Neutral). This can be done while the vehicle is moving. After shifting to N (Neutral), firmly apply the brakes and steer the vehicle to a safe location.
3. Come to a complete stop, shift to P (Park), and turn the vehicle to OFF by pushing the POWER  button.
4. Set the parking brake. See *Electric Parking Brake* on page 9-32.

 **WARNING**

Turning off the vehicle while moving may disable the airbags. While driving, only shut the propulsion system off in an emergency.

5. If the vehicle must be stopped while driving, press and hold the POWER  button for either longer than two seconds, or press twice in five seconds.

Starting and Stopping the Vehicle

Starting Procedure

Move the shift lever to P (Park) or N (Neutral). The propulsion system will not start in any other position.

Notice: Do not try to shift to P (Park) if the vehicle is moving or the electric drive unit could be damaged. Shift to P (Park) only when the vehicle is stopped.

Notice: The vehicle is designed to work with the electronics in the vehicle. If you add electrical parts or accessories, you could change the way the vehicle operates. Before adding electrical equipment, check with your dealer. If you do not, the vehicle might not perform properly. Any resulting damage would not be covered by the vehicle warranty.

The Remote Keyless Entry (RKE) transmitter must be in the vehicle. Press the brake pedal and push and release the POWER  button.

If the RKE transmitter is not in the vehicle or something is interfering with the transmitter, a message displays in the Driver Information Center (DIC). See *Key and Lock Messages* on page 5-44.

If the vehicle will not start due to a low RKE transmitter battery, the vehicle can still be driven. See “Starting the Vehicle with a Low Transmitter Battery” in *Remote Keyless Entry (RKE) System Operation* on page 2-3.

9-20 Driving and Operating



A Welcome, Ready, and Good-bye audio message will be heard in the vehicle and animated on the instrument cluster when opening the driver door upon entry, when the vehicle is ready to be driven, and when the vehicle is turned off.

The instrument cluster displays an active fuel or battery gauge, along with an audio startup cue, when the vehicle is ready to be driven. This could take up to 15 seconds at extremely cold temperatures. The engine will only start if needed.

If the vehicle did not start, the instrument cluster will display a screen with inactive fuel and battery gauges. See *Starting and Stopping the Vehicle* on page 9-19.

Restarting Procedure

If the vehicle must be restarted while it is still moving, move the shift lever to N (Neutral) and press the POWER  button twice without pressing the brake pedal. The propulsion system will not restart in any other position.

Computers determine when the engine needs to run. The engine may start, if required, when the propulsion system is on. Some vehicle conditions that force the engine to run are:

- Cold ambient temperatures.
- The hood is open or not completely latched.

- The high voltage battery has a low charge.
- The engine is needed to maintain the high voltage battery temperature.
- The engine needs to run for maintenance.

See *Maintenance Modes* on page 9-26.

A chime will sound if the driver door is opened while the vehicle is in ON/RUN. Always press the POWER  button to turn the vehicle off before exiting.

Stopping Procedure

For information on how to turn the vehicle off, see *Power Button* on page 9-18.

Retained Accessory Power (RAP)

The following features will operate for up to 10 minutes or until the driver door is opened:

- Audio System
- Power Windows
- Accessory Power Outlets

Shifting Into Park

WARNING

It can be dangerous to get out of the vehicle if the shift lever is not fully in P (Park) with the parking brake firmly set. The vehicle can roll. If you have left the propulsion system on, the vehicle can move suddenly. You or others could be injured. To be sure the vehicle will not move, even when you are on fairly level ground, use the steps that follow.

1. Hold the brake pedal down and set the parking brake.
See Electric Parking Brake on page 9-32 for more information.
2. Move the shift lever into P (Park) by pushing the lever all the way toward the front of the vehicle.
3. Turn the vehicle off.

Leaving the Vehicle with the Propulsion System On

WARNING

It can be dangerous to leave the vehicle with the propulsion system on. The vehicle could move suddenly if the shift lever is not fully in P (Park) with the parking brake firmly set. And, if you leave the vehicle with the propulsion system on, it could overheat and even catch fire. You or others could be injured. Do not leave the vehicle with the propulsion system on.

If you have to leave the vehicle with the propulsion system on, be sure the vehicle is in P (Park) and the parking brake is firmly set before you leave it. After you have moved the shift lever into P (Park), hold down the regular brake pedal. See if you can move the shift lever away from P (Park) without first pulling it toward you. If you can, it means that the shift lever was not fully locked into P (Park).

Torque Lock

Torque lock is when the weight of the vehicle puts too much force on the parking pawl in the electric drive unit. This happens when parking on a hill and shifting the electric drive unit into P (Park) is not done properly and then it is difficult to shift out of P (Park). To prevent torque lock, set the parking brake and then shift into P (Park).

9-22 Driving and Operating

If torque lock does occur, your vehicle may need to be pushed uphill by another vehicle to relieve the parking pawl pressure, so you can shift out of P (Park).

Shifting Out of Park

To shift out of P (Park), the vehicle must be in ON/RUN, the brake pedal must be applied, and the charge cord must be unplugged.

The vehicle has an electronic shift lock release system. The shift lock release is designed to:

- Prevent the vehicle from turning off unless the shift lever is in P (Park).
- Prevent moving the shift lever out of P (Park), unless the vehicle is in ON/RUN, the brake pedal is applied, and the charge cord is unplugged.

The shift lock is always functional except in the case of an uncharged or low charged 12-volt battery (less than 9 volts).

If the vehicle has an uncharged 12-volt battery or a 12-volt battery with low voltage, try charging or jump starting the 12-volt battery. See *Jump Starting on page 10-71*.

If the console shift lever cannot be moved out of P (Park):

1. Apply and maintain the regular brakes.
2. Turn the vehicle on using the POWER  button. See *Power Button on page 9-18*.
3. Let up on the shift lever and make sure the shift lever is pushed all the way into P (Park).

4. Press the shift lever button.
5. Move the shift lever into the desired gear.

If you still cannot move the shift lever from P (Park), see your dealer or a professional towing service.

Parking Over Things That Burn



Things that can burn could touch hot exhaust parts under the vehicle and ignite. Do not park over papers, leaves, dry grass, or other things that can burn.

Electric Vehicle Operating Modes

System Operation

This vehicle is an Extended Range Electric Vehicle (EREV). It uses an electric propulsion system to drive the vehicle at all times. Electricity is the vehicle's primary source of energy, while gasoline is the secondary source.

The vehicle has two modes of operation: Electric and Extended Range. In both modes, the vehicle is propelled by its electric drive unit. It converts electrical energy into mechanical energy to drive the wheels. The vehicle's performance remains the same in either mode. See *Driving for Better Energy Efficiency* on page 9-2.

Electric Mode

In Electric Mode, the vehicle does not use fuel or produce tailpipe emissions. During this primary mode, the vehicle is powered by electrical energy stored in the high voltage battery. The vehicle can operate in this mode until the battery has reached a low charge.

There are some conditions when the battery charge is high enough to provide Electric Mode operation, but the engine still runs. They are:

- Cold ambient temperatures.
- Hot or cold high voltage battery temperatures.
- The hood being open or not completely closed and latched.
- Certain high voltage battery fault conditions.
- Engine Maintenance Mode or Fuel Maintenance Mode being run.

Extended Range Mode

When the vehicle reaches the end of its electric range, it switches to Extended Range Mode (ERM). In this secondary mode, electricity is produced by the fuel-powered engine. This secondary source of electric power extends the vehicle range. Operation will continue in ERM until the vehicle can be plugged in to recharge the high voltage battery and restore Electric Mode.

The high voltage battery will continue to provide some power and work together with the engine to provide peak performance when it is required, such as driving up a steep incline or for high acceleration maneuvers. The battery will not be charged nor will electric vehicle range be restored by the engine.

9-24 Driving and Operating

In either Electric Mode or Extended Range Mode, when the hood is open, the engine will run without turning off if the vehicle is on. The high voltage battery is neither charged nor discharged when this occurs.

In either Electric Mode or Extended Range Mode, if there is a high voltage battery fault, the engine may run without turning off to generate needed electricity. The Malfunction Indicator Lamp will turn on. See *Malfunction Indicator Lamp* on page 5-19.

Driver Selected Operating Modes

While driving in Electric or Extended Range Mode, additional operating modes can be selected.

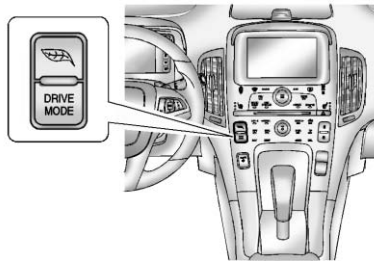

Press the DRIVE MODE button to display selectable drive modes in the Driver Information Center (DIC). Continue pressing to scroll through the modes.

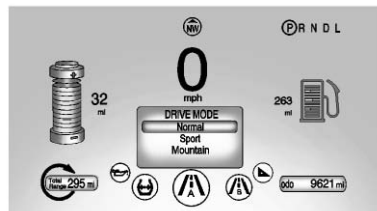

Highlight either the Mountain or Sport Mode, then release the DRIVE MODE button. After three seconds, the new drive mode will become active.

Pressing the DRIVE MODE button again will return to Normal Mode, and become active after three seconds.

At next start, the vehicle will default to the Normal Mode. Drive modes can then be selected again as desired.

During some conditions, certain drive modes may be unavailable. The unavailable mode is grayed out in the DIC menu and cannot be selected.

If in Sport or Mountain Mode, either may become unavailable and the vehicle will return to Normal Mode. The indicator light goes off and a DIC message displays. See *Propulsion Power Messages on page 5-45*.

Sport Mode

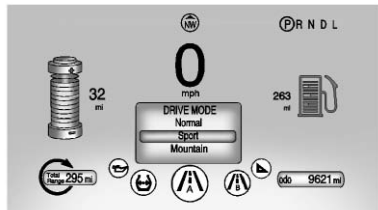

Sport Mode releases more energy from the high voltage battery under heavy acceleration. The vehicle will be more responsive to the accelerator pedal.

Press the DRIVE MODE button to select Sport Mode.

Press the DRIVE MODE button again to return to Normal Mode and it becomes active after three seconds.

The Sport light comes on when Sport Mode is selected. See *Sport Mode Light on page 5-24*.

Mountain Mode

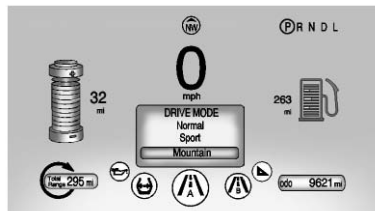

Mountain Mode should be selected at the beginning of a trip before climbing steep, uphill grades and when expecting to drive in very hilly or mountainous terrain. This mode maintains a reserve electrical charge of the high voltage battery to provide better grade climbing

performance. While driving in Mountain Mode, the vehicle will have less responsive acceleration.

Mountain Mode will not change normal vehicle braking performance for steep downhill grades. See *Hill and Mountain Roads on page 9-10* and *Electric Drive Unit on page 9-29*.

Press the DRIVE MODE button to select Mountain Mode. The engine may run when Mountain Mode is selected, depending on high voltage battery charge, to build reserve electrical charge for uphill climbs.

Operating in Mountain Mode will adjust the electric range by subtracting just the electric range being held in reserve. Electric range reserve still unused upon exiting Mountain Mode will be added back to the electric range display. See *Driving for Better Energy Efficiency on page 9-2*.

Press the Drive Mode button again to return to Normal Mode and it becomes active in three seconds.

The MOUNTAIN light comes on when Mountain Mode is selected. See *Mountain Mode Light on page 5-24*.

Out of Fuel/Engine Unavailable

If the vehicle runs out of fuel, or the engine will not start due to a malfunction, the vehicle can continue to be driven in Electric Mode. The vehicle will have less responsive acceleration. DIC messages indicate reduced propulsion power, that the engine is not available, and the need for fuel or service. Once the vehicle is refueled, or the malfunction is corrected, the engine will perform a self test and attempt to start the next time the vehicle is turned on. Once the engine starts, normal operation will continue. See *Fuel System Messages on page 5-43* and *Service Vehicle Messages on page 5-46*.

Maintenance Modes

Engine Maintenance Mode (EMM)

Engine Maintenance Mode (EMM) runs the engine to keep it in good working condition after approximately six weeks of no or very limited engine operation. EMM will force the engine to run, even if there is a charge to power the vehicle. When EMM is needed, the EMM Request screen appears on the center stack display at vehicle start.

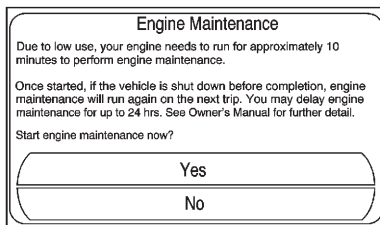

If Yes is selected, EMM will begin. The engine will run for a set amount of time without turning off. During

EMM, a DIC message displays to show the EMM percentage complete.

If No is selected, the EMM Request screen will appear when the vehicle is next started. The EMM request can be delayed for only one day.

If the EMM request was delayed for one day, EMM will automatically start the engine at the next vehicle start. An EMM Notification screen will appear in the center stack display.

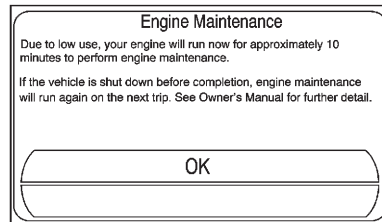

If the vehicle shuts off during EMM, it will restart the next time the vehicle is driven. A message displays to indicate that EMM is active.

If EMM is required and the fuel level is low, EMM may eventually empty the fuel tank if fuel is not added. This will result in reduced, or no power. An adequate fuel level must be maintained in the vehicle to keep it operational. See *Propulsion Power Messages on page 5-45*.

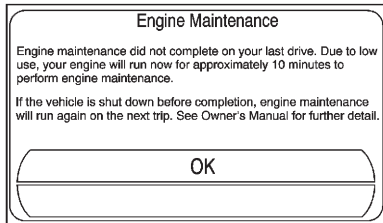

Fuel Maintenance Mode (FMM)

Fuel Maintenance Mode (FMM) tracks average fuel age. Old fuel can cause engine problems. If low engine usage causes average fuel age to exceed approximately one year, FMM will run the engine to use up the old fuel. The engine will

run until enough fresh fuel is added to bring the average fuel age into an acceptable range. Allowing more old fuel to be used up by FMM and adding a larger amount of fresh fuel will maximize the length of time before another fuel maintenance mode is needed. During FMM the engine may turn on and off.

When FMM is needed, the FMM Request screen appears on the center stack display at vehicle start.

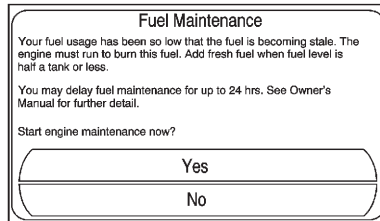

If Yes is selected, FMM will begin. FMM will automatically continue at each vehicle start until fresh fuel is added.

If No is selected, the FMM Request screen will appear when the vehicle is next started. The FMM request can be delayed for only one day.

If the FMM request was delayed for one day, FMM will start at the next vehicle start and display the FMM Notification screen on the center stack display.

If FMM is required and the fuel level is low, FMM may eventually empty the fuel tank if fuel is not added. This will result in reduced, or no power. An adequate fuel level must be maintained in the vehicle to keep it operational. See *Propulsion Power Messages on page 5-45*.

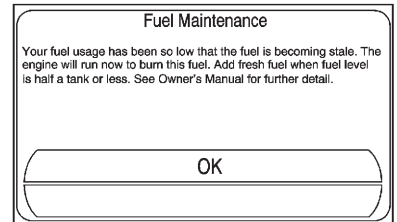

Engine Exhaust

WARNING

Engine exhaust contains Carbon Monoxide (CO) which cannot be seen or smelled. Exposure to CO can cause unconsciousness and even death.

Exhaust may enter the vehicle if:

- The engine is running in Extended Range Mode in areas with poor ventilation (parking garages, tunnels, or deep snow that may block underbody airflow or tail pipes).
- The exhaust smells or sounds strange or different.
- The exhaust system leaks due to corrosion or damage.

(Continued)

WARNING (Continued)

- The vehicle exhaust system has been modified, damaged, or improperly repaired.
- There are holes or openings in the vehicle body from damage or aftermarket modifications that are not completely sealed.

If unusual fumes are detected or if it is suspected that exhaust is coming into the vehicle:

- Drive it only with the windows completely down.
- Have the vehicle repaired immediately.

Never park with the engine running in Extended Range Mode in an enclosed area such as a garage or a building that has no fresh air ventilation.

Running the Vehicle While Parked

It is better not to park with the propulsion system on. But if you ever have to, here are some things to know.

WARNING

Leaving the engine running in Extended Range Mode in an enclosed area with poor ventilation is dangerous. Engine exhaust may enter the vehicle. Engine exhaust contains Carbon Monoxide (CO) which cannot be seen or smelled. It can cause unconsciousness and even death. Never run the engine in an enclosed area that has no fresh air ventilation. For more information, see *Engine Exhaust on page 9-28*.

⚠ WARNING

It can be dangerous to get out of the vehicle if the electric drive unit shift lever is not fully in P (Park) with the parking brake firmly set. The vehicle can roll. Do not leave the vehicle with the propulsion system on unless you have to. If you have left the propulsion system on, the vehicle can move suddenly. You or others could be injured. To be sure the vehicle will not move, even when you are on level ground, always set the parking brake and move the shift lever to P (Park).

Follow the proper steps to be sure the vehicle will not move. See *Shifting Into Park* on page 9-21.

Electric Drive Unit

The vehicle uses an electric drive unit. The shift lever is on the console between the seats.

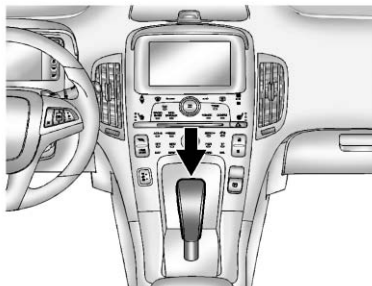

P (Park): This position locks the front wheels. It is the best position to use when starting the propulsion system because the vehicle cannot move easily.

⚠ WARNING

It is dangerous to get out of the vehicle if the shift lever is not fully in P (Park) with the parking brake firmly set. The vehicle can roll.

Do not leave the vehicle when the propulsion system is running unless you have to. If you have left the propulsion system running, the vehicle can move suddenly. You or others could be injured. To be sure the vehicle will not move, even when you are on fairly level ground, always set the parking brake and move the shift lever to P (Park). See *Shifting Into Park* on page 9-21.

Make sure the shift lever is fully in P (Park) before starting the propulsion system. The vehicle has an electric drive unit shift lock

9-30 Driving and Operating

control system. The regular brake must be fully applied first and then the shift lever button pressed before shifting from P (Park) when the vehicle is in ON/RUN. If you cannot shift out of P (Park), ease pressure on the shift lever, then push the shift lever all the way into P (Park) as you maintain brake application.

Then press the shift lever button and move the shift lever into another gear. See *Shifting Out of Park* on page 9-22.

R (Reverse): Use this gear to back up.

Notice: Shifting to R (Reverse) while the vehicle is moving forward could damage the electric drive unit. The repairs would not be covered by the vehicle warranty. Shift to R (Reverse) only after the vehicle is stopped.

To rock the vehicle back and forth to get out of snow, ice, or sand without damaging the electric drive unit, see *If the Vehicle is Stuck* on page 9-13.

N (Neutral): In this position, the propulsion system does not connect with the wheels.

D (Drive): This position is for normal driving. It provides the best fuel economy. If more power is needed for passing, and the vehicle is:

- Going less than 56 km/h (35 mph), push the accelerator pedal about halfway down.
- Going about 56 km/h (35 mph) or more, push the accelerator all the way down.

Notice: If the vehicle seems to accelerate slowly or not respond when you go faster, and you continue to drive the vehicle that way, you could damage the electric drive unit. Have the vehicle serviced right away.

L (Low): This position reduces vehicle speed without using the brakes. You can use L (Low) on hills. It can help control vehicle speed going down steep mountain roads along with using the brakes off and on. You can use L (Low) on very steep hills, in deep snow, or in mud.

Notice: Spinning the tires or holding the vehicle in one place on a hill using only the accelerator pedal may damage the electric drive unit. The repair will not be covered by the vehicle warranty. If you are stuck, do not spin the tires. When stopping on a hill, use the brakes to hold the vehicle in place.

Brakes

Antilock Brake System (ABS)

This vehicle has the Antilock Brake System (ABS), an advanced electronic braking system that helps prevent a braking skid.

When propulsion is active and the vehicle begins to drive away, ABS checks itself. A momentary motor or clicking noise might be heard while this test is going on, and it might even be noticed that the brake pedal moves a little. This is normal.



If there is a problem with ABS, this warning light stays on. See *Antilock Brake System (ABS) Warning Light* on page 5-23.

If driving safely on a wet road and it becomes necessary to slam on the brakes and continue braking to avoid a sudden obstacle, a computer senses that the wheels are slowing down. If one of the wheels is about to stop rolling, the computer will separately work the brakes at each wheel.

ABS can change the brake pressure to each wheel, as required, faster than any driver could. This can help the driver steer around the obstacle while braking hard.

As the brakes are applied, the computer keeps receiving updates on wheel speed and controls braking pressure accordingly.

Remember: ABS does not change the time needed to get a foot up to the brake pedal or always decrease stopping distance. If you get too close to the vehicle in front of you, there will not be enough time to apply the brakes if that vehicle

suddenly slows or stops. Always leave enough room up ahead to stop, even with ABS.

Using ABS

Do not pump the brakes. Just hold the brake pedal down firmly and let ABS work. You might hear the ABS pump or motor operating and feel the brake pedal pulsate, but this is normal.

Braking in Emergencies

ABS allows the driver to steer and brake at the same time. In many emergencies, steering can help more than even the very best braking.

Electric Parking Brake

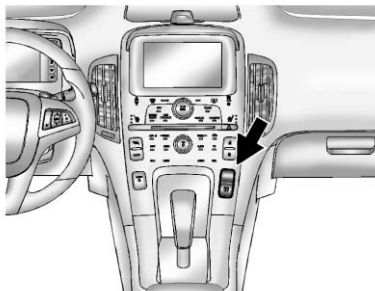

The vehicle has an Electric Parking Brake (EPB). The (P) switch is on the center stack. The EPB can always be activated, even if the vehicle is off. To prevent draining the 12-volt battery, avoid repeated cycles of the EPB system when the vehicle is off.

In case of insufficient electrical power, the EPB cannot be applied or released.

Before leaving the vehicle, check the Electric Parking Brake Light to ensure the parking brake is applied.

EPB Apply

The EPB can be applied anytime the vehicle is stopped. The EPB is applied by momentarily lifting up on the (P) switch. Once fully applied, the Electric Parking Brake Light will be on. While the brake is being applied, the Electric Parking Brake Light will flash until full apply is reached. If the light does not come on, or remains flashing, have the vehicle serviced. Do not drive the vehicle if the Electric Parking Brake Light is flashing. See your dealer.

If the EPB is applied while the vehicle is in motion, a chime will sound, and the DIC message RELEASE PARKING BRAKE will be displayed. The vehicle will decelerate as long as the switch is held in the up position.

Releasing the (P) switch during the deceleration will release the parking brake. If the (P) switch is held in the up position until the vehicle comes to a stop, the EPB will remain applied.

If the Electric Parking Brake Light flashes continuously, the EPB is only partially applied or released, or there is a problem with the EPB. The DIC message SERVICE PARKING BRAKE will be displayed. If this light flashes continuously, release the EPB, and attempt to apply it again. If this light continues to flash, do not drive the vehicle. See your dealer.

If the Service Electric Parking Brake Light is on, the EPB has detected a system problem and is operating with reduced functionality. To apply the EPB when this light is on, lift up on the (P) switch and hold it in the up position. Full application of the parking brake by the EPB system may take a longer period of time than normal when this light is on.

Continue to hold the (P) switch until the Electric Parking Brake Light remains on. If the Service Electric Parking Brake Light is on, see your dealer.

If the EPB fails to apply, the rear wheels should be blocked to prevent vehicle movement.

For maximum EPB force when parking on a hill, pull the EPB switch twice.

EPB Release

To release the EPB, place the vehicle in ON/RUN, apply and hold the brake pedal, and push down momentarily on the (P) switch. If attempting to release the EPB without the brake pedal applied, a chime will sound, and the DIC message STEP ON BRAKE TO RELEASE PARK BRAKE will be displayed. The EPB is released when the Electric Parking Brake Light is off.

If the Service Electric Parking Brake Light is on, the EPB has detected a system problem, and is operating with reduced functionality. To release the EPB when this light is on, push down on the (P) switch and hold it in the down position. EPB release may take a longer period of time than normal when this light is on. Continue to hold the (P) switch until the Electric Parking Brake Light is off. If the light is on, see your dealer.

Notice: Driving with the parking brake on can overheat the brake system and cause premature wear or damage to brake system parts. Make sure that the parking brake is fully released and the Electric Parking Brake Light is off before driving.

Automatic EPB Release

The EPB will automatically release if the vehicle is running, placed into gear, and an attempt is made to drive away. Avoid rapid acceleration when the EPB is applied, to preserve parking brake lining life.

See *Electric Parking Brake Light on page 5-22*, *Service Electric Parking Brake Light on page 5-23*, and *Brake System Messages on page 5-41*.

Regenerative Braking

Regenerative braking takes some of the energy from the moving vehicle and turns it back into electrical energy. This energy is then stored back into the high voltage battery system, contributing to increased energy efficiency.

The hydraulic disc brakes work with the regenerative braking to ensure effective braking, such as when a high braking demand is requested.

The braking system is computer controlled and blends the regenerative braking with the conventional hydraulic disc brakes to meet any requirements for deceleration. The controller interprets the braking request and uses regenerative braking, conventional hydraulic braking, or a combination of both as necessary. Because the controller applies the hydraulic brakes through its high pressure accumulator, you may occasionally hear the motor-driven pump when it recharges the system. This is normal.

See *Warning Lights, Gauges, and Indicators on page 5-9* and *Driver Information Center (DIC) on page 5-38*. In the event of a controller problem, the brake pedal may be harder to push and the stopping distance may be longer.

Ride Control Systems

Traction Control System (TCS)

The vehicle has a Traction Control System (TCS) that limits wheel spin. The system operates if it senses that one or both of the drive wheels are spinning or beginning to lose traction. When this happens, the system brakes the spinning wheel(s) and/or reduces power to limit wheel spin.

The system may be heard or felt while it is working, but this is normal.

To assist with directional control of the vehicle, TCS comes on automatically whenever the vehicle is started and cannot be turned off.

When the vehicle is started and begins to move, the system performs several diagnostic checks to ensure there are no problems.

The system may be heard or felt while it is working. This is normal and does not mean there is a problem with the vehicle. The system should initialize before the vehicle reaches 32 km/h (20 mph). In some cases, it may take approximately 3.2 km (2 mi) of driving before the system initializes.

The Traction Control System may activate on dry or rough roads or under conditions such as heavy acceleration while turning or abrupt changes in output from the electric drive unit. When this happens, a reduction in acceleration may be noticed, or a noise or vibration may be heard. This is normal.



The TCS/StabiliTrak warning light will flash to indicate that the traction control system is active.

If there is a problem detected, the SERVICE TRACTION CONTROL message displays in the DIC. See *Ride Control System Messages on page 5-46*. When this message is displayed and  comes on and stays on, the vehicle is safe to drive but the system is not operational.

If  comes on and stays on, reset the system:

1. Stop the vehicle.
2. Turn the vehicle off and wait 15 seconds.
3. Start the vehicle.

If  still comes on and stays on, the vehicle needs service.

Adding non-GM accessories can affect vehicle performance. See *Accessories and Modifications on page 10-3* for more information.

Electronic Stability Control (ESC)

The vehicle has an Electronic Stability Control system called StabiliTrak. It is an advanced computer-controlled system that assists with directional control of the vehicle in difficult driving conditions.

StabiliTrak comes on automatically whenever the vehicle is started and cannot be turned off.

The system may be heard or felt while it is working, but this is normal.

StabiliTrak activates when the computer senses a difference between the intended path and the direction the vehicle is actually traveling. StabiliTrak selectively applies braking pressure to help steer the vehicle in the intended direction.

When the vehicle is started and begins to move, the system performs several diagnostic checks to ensure there are no problems. The system may be heard or felt while it is working. This is normal and does not mean there is a problem with the vehicle. The system should initialize before the vehicle reaches 32 km/h (20 mph). In some cases, it may take approximately 3.2 km (2 mi) of driving before the system initializes.



When the stability control system activates, the Traction Control System (TCS)/StabiliTrak light flashes on the instrument cluster. This also occurs when traction control is activated. This is normal. Continue to steer the vehicle in the intended direction.

If there is a problem detected, the SERVICE STABILITRAK message displays in the DIC. When this message is displayed and the StabiliTrak light comes on and stays on, the vehicle is safe to drive but the system is not operational. See *Ride Control System Messages on page 5-46*.

If  comes on and stays on, reset the system:

1. Stop the vehicle.
2. Turn the vehicle off and wait 15 seconds.
3. Start the vehicle.

If  still comes on and stays on, the vehicle needs service.

If cruise control is being used when StabiliTrak activates, the cruise control will automatically disengage. Press the cruise control button to reengage when road conditions allow. See *Cruise Control on page 9-36* for more information.

Cruise Control

The cruise control lets the vehicle maintain a speed of about 40 km/h (25 mph) or more without keeping your foot on the accelerator. Cruise control does not work at speeds below 40 km/h (25 mph).

With the Traction Control System (TCS) or Electronic Stability Control (ESC), the system may begin to limit wheel spin while you are using cruise control. If this happens, the cruise control will automatically disengage. See *Traction Control System (TCS) on page 9-34* or *Electronic Stability Control (ESC) on page 9-35*.

WARNING

Cruise control can be dangerous where you cannot drive safely at a steady speed. So, do not use the cruise control on winding roads or in heavy traffic.

(Continued)

WARNING (Continued)

Cruise control can be dangerous on slippery roads. On such roads, fast changes in tire traction can cause excessive wheel slip, and you could lose control. Do not use cruise control on slippery roads.

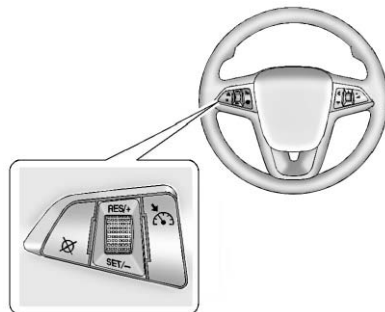

The cruise control buttons are on the steering wheel.

 **(On/Off):** Press to turn the cruise control system on and off. An indicator light will turn on or off in the instrument cluster.

 **(Cancel):** Press to disengage cruise control without erasing the set speed from memory.

RES/+ (Resume/Accel): Move the thumbwheel up to resume to a previously set speed or to accelerate.

SET/- (Set/Coast): Move the thumbwheel down to set a speed and activate cruise control or to make the vehicle decelerate.

Setting Cruise Control

If the cruise button is on when not in use, it could get bumped and go into cruise when not desired. Keep the cruise control button off when cruise is not being used.

To set a speed:

1. Press  to turn cruise control on.
2. Get up to the speed desired.
3. Move the thumbwheel down toward SET/- and release it. The desired set speed briefly appears in the instrument cluster.
4. Take your foot off the accelerator pedal.

When the brakes are applied, the cruise control shuts off.

Resuming a Set Speed

If the cruise control is set at a desired speed and then the brakes are applied, the cruise control is disengaged without erasing the set speed from memory. Once the vehicle speed is about 40 km/h (25 mph) or greater, move the thumbwheel up toward RES/+ briefly and then release it. The vehicle returns to the previously set speed and stays there.

Increasing Speed While Using Cruise Control

If the cruise control system is already activated:

- Move the thumbwheel up toward RES/+ and hold it until the vehicle accelerates to the desired speed, then release it.
- To increase the speed in small amounts, move the thumbwheel up toward RES/+ briefly and then release it. Each time this is done, the vehicle goes about 1.6 km/h (1 mph) faster.

Reducing Speed While Using Cruise Control

If the cruise control system is already activated:

- Move the thumbwheel toward SET/- and hold until the desired lower speed is reached, then release it.
- To slow down in very small amounts, move the thumbwheel toward SET/- briefly. Each time this is done, the vehicle goes about 1.6 km/h (1 mph) slower.

Passing Another Vehicle While Using Cruise Control



Use the accelerator pedal to increase vehicle speed. When you take your foot off the pedal, the vehicle will slow down to the previously set cruise control speed.

Using Cruise Control on Hills

How well the cruise control works on hills depends upon the vehicle speed, load, and the steepness of the hills. When going up steep hills, you might have to step on the accelerator pedal to maintain the vehicle speed. When going downhill, you might have to brake or shift to a lower gear to maintain the vehicle speed. When the brakes are applied the cruise control is disengaged.

Ending Cruise Control

There are three ways to end cruise control:

- Step lightly on the brake pedal; when cruise control disengages, the indicator light will not be lit.
- Press .
- Press  to turn the cruise control system off completely. The cruise control cannot be resumed.

Erasing Speed Memory

The cruise control set speed is erased from memory by pressing  or if the vehicle is turned off.

Object Detection Systems

Ultrasonic Parking Assist

For vehicles with the Ultrasonic Front and Rear Parking Assist (UFRPA) system, it assists the driver with parking and avoiding objects. UFRPA operates at speeds less than 8 km/h (5 mph). The sensors on the front and rear bumper detect objects up to 1.2 m (4 ft) in front of the vehicle, 2.5 m (8 ft) behind the vehicle, and at least 25.4 cm (10 in) off the ground.

WARNING

The Ultrasonic Front and Rear Parking Assist (UFRPA) system does not replace driver vision. It cannot detect:

- Objects that are below the bumper, underneath the vehicle, or if they are too close or far from the vehicle.
- Children, pedestrians, bicyclists, or pets.

If you do not use proper care before moving forward and while backing; vehicle damage, injury, or death could occur. Even with UFRPA, always check in front of the vehicle before moving forward and behind the vehicle before backing up. While moving forward and backing, be sure to look for objects and check the vehicle mirrors.

How the System Works

UFRPA comes on automatically when the shift lever is moved into R (Reverse). The front and rear sensors are automatically turned on. After the vehicle is shifted out of R (Reverse), the rear sensors are turned off and the front sensors stay on until the vehicle is above a speed of 8 km/h (5 mph). The front sensors may also be turned on by pressing the park assist button in the overhead console without shifting into R (Reverse) while the vehicle is traveling at a low speed. See “Turning the System On and Off” later in this section.

When the vehicle is in N (Neutral), the system may be active. If the vehicle is in a car wash, the sensors may detect objects in the car wash. See “Turning the System On and Off” later in this section to turn the system off.

High-toned beeps from the front speakers are for objects detected near the front bumper. Low-toned beeps from the rear speakers are for objects detected near the rear bumper. The interval between the beeps becomes shorter as the vehicle gets closer to the obstacle. When the distance is less than 30 cm (12 in) the beeps are continuous.

To be detected, objects must be at least 25.4 cm (10 in) off the ground and below hood or hatch level. Objects must also be within 1.2 m (4 ft) in front of the vehicle and 2.5 m (8 ft) from the rear bumper. This distance may be less during warmer or humid weather.

PARK ASSIST OFF displays on the Driver Information Center (DIC) to indicate that UFRPA is off. The message disappears after a short period of time.

Objects Detected by Both the Front and Rear Sensors

If objects are detected at the same time near both the front and rear bumpers while backing up, the beeps only sound to indicate that objects are close to the rear bumper.

If an object comes within 0.3 m (1 ft) of the front bumper while the vehicle is backing up and at the same time there is another object further than 0.3 m (1 ft) from the rear bumper, then the beeps only sound to indicate the object that is closer to the front bumper.

Turning the System On and Off

The UFRPA system can be turned on and off by pressing the park assist button in the overhead console.



The park assist button lights up when the system is on and turns off when it has been disabled.

When the System Does Not Seem to Work Properly

If UFRPA does not turn on due to a temporary condition, the message PARK ASSIST OFF displays on the DIC, and the light on the park assist button turns off. This can occur under the following conditions:

- The ultrasonic sensors are not clean. Keep the sensors free of mud, dirt, snow, ice, and slush. For cleaning instructions, see *Exterior Care on page 10-81*.

- The vehicle was washed in cold weather. This may cause frost or ice to form in the park assist sensors. Keep the sensors free of frost or ice.
- An object was hanging out of the hatch during the last drive cycle. Once the attached object is removed, UFRPA will return to normal operation.
- The bumper is damaged. Take the vehicle to your dealer to repair the system.
- Other conditions may affect system performance, such as vibrations from a jackhammer or the compression of air brakes on a very large truck.

Rear Vision Camera (RVC)

The vehicle may have a Rear Vision Camera (RVC) system. Read this entire section before using it.

The RVC system can assist the driver when backing up by displaying a view of the area behind the vehicle.

WARNING

The Rear Vision Camera (RVC) system does not replace driver vision. RVC does not:

- Detect objects that are outside the camera's field of view, below the bumper, or underneath the vehicle.
- Detect children, pedestrians, bicyclists, or pets.

Do not back the vehicle by only looking at the RVC screen, or use the screen during longer, higher speed backing maneuvers or where there could be cross-traffic. Your judged distances using the screen will differ from actual distances.

(Continued)

WARNING (Continued)

If you do not use proper care before backing up, you could hit a vehicle, child, pedestrian, bicyclist, or pet, resulting in vehicle damage, injury, or death. Even though the vehicle has the RVC system, always check carefully before backing up by checking behind and around the vehicle.

How the System Works

When the vehicle is shifted into R (Reverse), the image of the area behind the vehicle appears in the center stack display with the message CHECK SURROUNDINGS FOR SAFETY. The previous screen displays when the vehicle is shifted out of R (Reverse) after approximately 10 seconds.

9-42 Driving and Operating

To cancel the delay, do one of the following:

- Press a button on the infotainment system.
- Shift into P (Park).
- Reach a vehicle speed of 8 km/h (5 mph).

Turning the Rear Vision Camera System On or Off

To turn the RVC system on or off:

1. Shift into P (Park).
2. Press the CONFIG button on the center stack.
3. Select Display.
4. Select Camera. When a checkmark appears next to Camera, then the RVC system is on.

Symbols

The navigation system may have a feature that lets the driver view symbols on the navigation screen while using the RVC. The Ultrasonic Front and Rear Parking Assist (UFRPA) system must not be disabled to use the caution symbols. The error message REAR PARKING ASSIST SYMBOLS UNAVAILABLE may display if UFRPA has been disabled and the symbols have been turned on. See *Ultrasonic Parking Assist on page 9-39*.

The symbols appear and may cover an object when viewing the navigation screen when an object is detected by the UFRPA system.

To turn the symbols on or off:

1. Shift into P (Park).
2. Press the CONFIG button on the center stack.
3. Select Display.
4. Select Symbols. When a checkmark appears next to Symbols, symbols will appear.

Guidelines

The RVC system has a guideline overlay that can help the driver align the vehicle when backing into a parking spot.

To turn the guidelines on or off:

1. Shift into P (Park).
2. Press the CONFIG button on the center stack.
3. Select Display.
4. Select Guidelines. When a checkmark appears next to Guidelines, guidelines will appear.

Rear Vision Camera Error Messages

SERVICE REAR VISION CAMERA SYSTEM: If this message appears in the center stack display, the system is not receiving information it requires from other vehicle systems.

If any other problem occurs or if a problem persists, see your dealer.

Rear Vision Camera Location

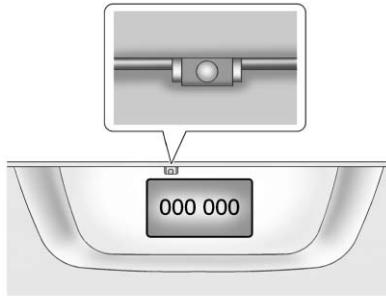

The RVC is located above the license plate.

The area displayed by the camera is limited.

It does not display objects that are close to either corner or under the bumper and can vary depending on vehicle orientation or road conditions. The distance of the image that appears on the screen is different from the actual distance.

The following illustration shows the field of view that the camera provides.

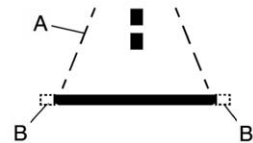
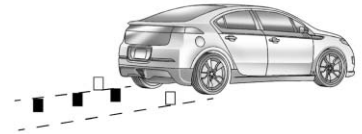

- A. View displayed by the camera.
- B. Corner of the rear bumper.

When the System Does Not Seem To Work Properly

The RVC system may not work properly or display a clear image if:

- The RVC is turned off. See “Turning the Rear Vision Camera System On or Off” earlier in this section.
- It is dark.
- The sun or the beam of headlamps is shining directly into the camera lens.
- Ice, snow, mud, or anything else has built up on the camera lens. Clean the lens, rinse it with water, and wipe it with a soft cloth.
- The back of the vehicle was in an accident. The position and mounting angle of the camera can change or the camera can be affected. Be sure to have the camera and its position and mounting angle checked at your dealer.

Charging

Plug-In Charging

This section explains the process for charging the vehicle's high voltage battery. Do not allow the vehicle to remain in temperature extremes for long periods without being driven or plugged in. It is recommended that the vehicle be plugged in when temperatures are below 0°C (32°F) and above 32°C (90°F) to maximize high voltage battery life.

The charging system may run fans and pumps that result in sounds from the vehicle while it is turned off. Additional unexpected clicking sounds may be experienced caused by the electrical devices used while charging.

Charging

Start Charge

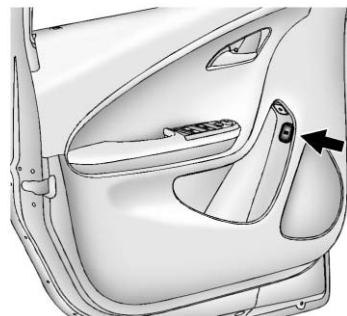

1. The charge port door release button is on the driver door inner trim panel. With the vehicle in P (Park), press the button for one second and release to open the charge port door. The charge port door can also be opened using the RKE transmitter. See *Remote Keyless Entry (RKE) System Operation* on page 2-3.

In cold weather conditions, ice may form around the charge port door. The charge port door may not open on the first attempt. Remove ice from the area and repeat attempting to open the charge port door.

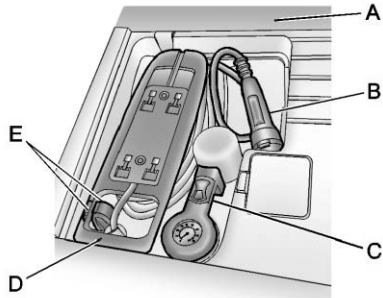

2. Open the rear hatch, lift the load support floor covering (A), and remove the charge cord. It is located near the tire sealant and compressor kit (C).

Pull up on the charge cord handle (D) to release it from the handle clip (E). Lift the charge cord up and rearward to remove it from the vehicle. The vehicle plug (B) is stored as shown.

3. Plug the charge cord into the electrical outlet. See *Electrical Requirements for Battery Charging* on page 9-51. Verify that the charge cord status indicators are both green. See *Charge Cord* on page 9-49 for more information.

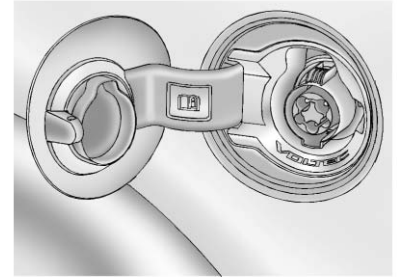

4. Then plug in the vehicle plug of the charge cord into the charge port on the vehicle. Verify that the charging status indicator illuminates on top of the instrument panel and a horn chirp occurs. See *Charging Status Feedback* on page 9-47 for more information.
5. To arm the charge cord theft alert, lock the vehicle with the RKE transmitter. This feature can be disabled by a service technician.

9-46 Driving and Operating

End Charge

1. Unlock the vehicle with the RKE transmitter to disarm the charge cord theft alert.

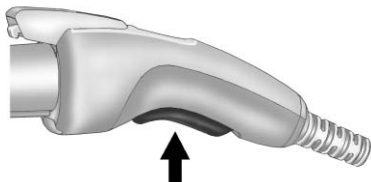

2. Unplug the vehicle plug of the charge cord from the vehicle by squeezing the vehicle plug lever and pull to remove.
3. Unplug the charge cord from the electrical outlet.
4. Before storing the charge cord, have the charge cord face up and wrap the charge cable neatly counterclockwise around the body of the charge cord.

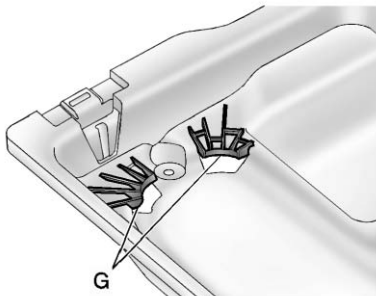
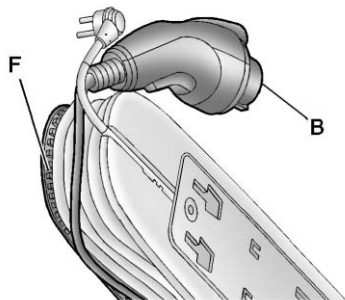

5. Place the charge cord, face down, into the storage compartment with the front edge (F) of the charge cord body under the clips (G) located in the front of the storage compartment. The vehicle plug (B) should be on the right side of the charge cord.

Push the charge cord handle down until it locks into the handle clip at the rear of the storage compartment.

While the charge cord is plugged into the vehicle, the vehicle cannot be driven.

Delayed Charging Override

To temporarily override a delayed charge event, unplug the charge cord from the charge port and then plug it back in within five seconds. A single horn chirp will sound and charging will begin immediately.

To cancel a temporary override, unplug the charge cord, wait for 10 seconds, and then plug the charge cord back in. A double horn chirp will sound and charging will be delayed.

See “Programmable Charging” in *Charging on page 5-30* for advance charge scheduling options.

Charging Status Feedback



The vehicle has a Charging Status Indicator (CSI) at the center of the instrument panel near the windshield. When the vehicle is plugged in and the vehicle power is off, the CSI indicates the following:

- Solid Green – Vehicle is plugged in. Battery is not fully charged. Battery is charging.

- Long Flashing Green – Vehicle is plugged in. Battery is not fully charged. Battery charging is delayed.
- Short Flashing Green – Vehicle is plugged in. Battery is fully charged.
- Solid Yellow – Vehicle is plugged in. Charging system has detected a fault and will not charge the battery. See “Charge Cord Status Indicators” later in this section.

The system may be thermally conditioning the battery during any of the states above, requiring electrical energy to be transferred to the vehicle.

9-48 Driving and Operating

If the vehicle is plugged in and vehicle power is on, the CSI will be on solid green. The same is true during a remote start if the vehicle is plugged in.

If the vehicle is plugged in and the CSI is off, a charging fault has been detected. See "Charge Cord Status Indicators" later in this section.

This chart indicates vehicle feedback when the charge cord is plugged in.

Charging Status Indicator	Sound	Action/Reason
Solid Green	One horn chirp	Charging has begun.
Long Flashing Green	Two horn chirps	Charging is delayed, scheduled to begin later.
Short Flashing Green	None	Charging is complete.
Solid Yellow	None	Charge cord is okay, but vehicle is not charging. See <i>Malfunction Indicator Lamp</i> on page 5-19.
Solid Green or Long Flashing Green	Four horn chirps	Insufficient time to fully charge by departure time.
None	None	Charge cord connection should be checked.

Charging Status Indicator	Sound	Action/Reason
None	Repeated horn chirps To stop this alert, do one of the following: <ul style="list-style-type: none"> • Unplug the charge cord. • Sound the horn. • Sound the panic alarm and then cancel it. This feature can be disabled by a service technician.	Electricity was interrupted before charging was complete.

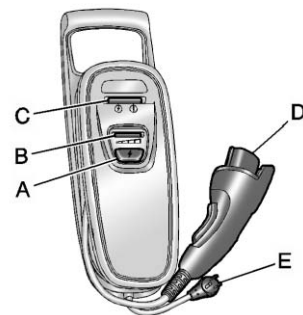

- A. Charge Level Button
- B. Charge Level Indicators
- C. Charge Cord Status Indicators
- D. Vehicle Plug
- E. Wall Plug

Charge Cord

See *Radio Frequency Statement on page 13-26* for information regarding Part 15 of the Federal

Communications Commission (FCC) rules and Industry Canada Standards RSS-210/220/310.

A portable charge cord used to charge the vehicle high voltage battery is stored under the rear luggage compartment.

9-50 Driving and Operating

The charge cord used to charge the vehicle is a high-powered electrical device. During normal operation, the AC wall plug of the charge cord may feel warm. The AC wall plug must fit tightly into an AC outlet that is in good condition.

WARNING

Using the charge cord with a worn or damaged AC outlet may cause burns or start a fire. Periodically, check the AC wall plug and charge cord while the vehicle is charging. If the AC wall plug feels hot, unplug the charge cord and have the AC outlet replaced by a qualified electrician. Replace the charge cord if the AC wall plug or cord are damaged. Do not use an AC outlet that is worn or damaged.

WARNING

An extension cord should not be used to charge the vehicle. Use of an extension cord may increase the risk of electric shock or other hazards.

If an extension cord is used because of limited access to 120V AC power, use the following safeguards:

The 120V AC outlet should be GFCI protected.

The extension cord should be:

- GFCI protected.
- 12 or 14 gage, 3 conductor.
- Rated for outdoor.

Charge Cord Status Indicators

The charge cord status indicators illuminate green or flashing red to identify the charge cord status. When both indicators are green, the vehicle can be charged. If any indicators are flashing red, the charge cord will not permit vehicle charging.

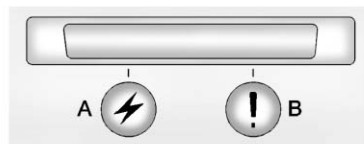

A flashing red AC PRESENT (A) indicates the AC voltage is out of range.

Flashing red AC PRESENT (A) and FAULT (B) indicate the AC outlet does not have a proper safety ground. Charging is not permitted for safety reasons. The AC outlet must be repaired or another outlet source should be used.

A flashing red FAULT (B) indicates a charge cord fault. The charge cord will attempt to reset automatically. If the flashing red FAULT (B) continues for more than 30 seconds, unplug the charge cord from the wall to reset. If the fault remains, see your dealer for service.

Charge Level Button

Two charge levels are available by pressing the charge level button. Select reduced or normal level.

The charge level cannot be changed when the vehicle plug is plugged into the charge port on the vehicle. If the charge level button is pressed while the vehicle plug is plugged into the charge port on the vehicle, the charge level indicators

will flash briefly. To change the charge level, unplug the vehicle plug from the charge port on the vehicle and select the desired charge level.

Normal Level: This level is recommended. All four charge level indicators will be lit.

Reduced Level: Use when the electrical current is limited. Two charge level indicators will be lit.

Vehicle Plug

The vehicle plug attaches to the charge port on the vehicle. There is a flashlight built into the vehicle plug that can be used by squeezing the vehicle plug lever. The flashlight will turn off when the connection is complete and the lever is released.

Electrical Requirements for Battery Charging

The AC outlet must have a grounded, dedicated, 15 amp or greater, three-prong wall plug. That means there should be no other major appliances connected to the same circuit. If it is not a dedicated circuit, the current rating of the outlet circuit breaker could be exceeded and cause it to trip or open. The vehicle can be charged in the reduced level mode. See "Charge Level Button" in this section. Reduced level mode allows a non-dedicated circuit to be used but increases the charging time.

This vehicle is capable of being charged with a variety of standard vehicle charging equipment.

9-52 Driving and Operating

The following are the minimum requirements for circuits used to charge this vehicle:

- 120V/15Amp
- 240V/20Amp

Charging equipment with a rating of at least 240V/20Amp will provide the fastest charging time to recharge the high voltage battery. 240V/40Amp circuits provide flexibility for future vehicle charging needs. Contact your dealer for more information.

Do not use non-grounded electrical plug adapters.

Notice: Do not use portable or stationary backup generating equipment to charge the vehicle. This may cause damage to the vehicle's charging system. Only charge the vehicle from utility supplied power.

Fuel

Use of the recommended fuel is an important part of the proper maintenance of this vehicle. To help keep the engine clean and maintain optimum vehicle performance, we recommend the use of gasoline advertised as TOP TIER Detergent Gasoline.

Look for the TOP TIER label on the fuel pump to ensure gasoline meets enhanced detergency standards developed by auto companies. A list of marketers providing TOP TIER Detergent Gasoline can be found at www.toptiergas.com.



Use premium unleaded gasoline with a posted octane rating of 91 or higher. If the octane is less than 91, you could damage the engine. If heavy knocking is heard when using gasoline rated at 91 octane or higher, the engine needs service.

Gasoline Specifications (U.S. and Canada Only)

At a minimum, gasoline should meet ASTM specification D 4814 in the United States or CAN/CGSB-3.5 or 3.511 in Canada. Some gasolines contain an octane-enhancing additive called methylcyclopentadienyl manganese tricarbonyl (MMT). We recommend against the use of gasolines containing MMT. See *Fuel Additives* on page 9-54 for additional information.

California Fuel Requirements

If the vehicle is certified to meet California Emissions Standards, it is designed to operate on fuels that meet California specifications. See the underhood emission control label. If this fuel is not available in states adopting California Emissions Standards, the vehicle will operate satisfactorily on fuels meeting federal specifications, but emission control system performance might be affected. The malfunction indicator lamp could turn on and the vehicle might fail a smog-check test. See *Malfunction Indicator Lamp* on page 5-19. If this occurs, return to your authorized dealer for diagnosis. If it is determined that the condition is caused by the type of fuel used, repairs might not be covered by the vehicle warranty.

Fuels in Foreign Countries

Never use leaded gasoline or any other fuel not recommended in the previous text on fuel. Costly repairs caused by use of improper fuel would not be covered by the vehicle warranty.

To check the fuel availability, ask an auto club, or contact a major oil company that does business in the country where you will be driving.

Fuel Additives

To provide cleaner air, all gasolines in the United States are now required to contain additives that help prevent engine and fuel system deposits from forming, allowing the emission control system to work properly. In most cases, nothing should have to be added to the fuel. However, some gasolines contain only the minimum amount of additive required to meet U.S. Environmental Protection Agency regulations. To help keep fuel injectors and intake valves clean and avoid problems due to dirty injectors or valves, look for gasoline that is advertised as TOP TIER Detergent Gasoline. Look for the TOP TIER label on the fuel pump to ensure gasoline meets enhanced detergency standards developed by the auto companies. A list of marketers providing TOP TIER Detergent Gasoline can be found at www.toptiergas.com.

For customers who do not use TOP TIER Detergent Gasoline regularly, one bottle of GM Fuel System Treatment PLUS, added to the fuel tank at every engine oil change, can help clean deposits from fuel injectors and intake valves. GM Fuel System Treatment PLUS is the only gasoline additive recommended by General Motors. It is available at your dealer.

Gasolines containing oxygenates, such as ethers and ethanol, and reformulated gasolines might be available in your area. We recommend that you use these gasolines, if they comply with the specifications described earlier. However, E85 (85% ethanol) and other fuels containing more than 10% ethanol must not be used in vehicles that were not designed for those fuels.

Notice: This vehicle was not designed for fuel that contains methanol. Do not use fuel containing methanol. It can corrode metal parts in the fuel system and also damage plastic and rubber parts. That damage would not be covered under the vehicle warranty.

Some gasolines that are not reformulated for low emissions can contain an octane-enhancing additive called methylcyclopentadienyl manganese tricarbonyl (MMT); ask the attendant where you buy gasoline whether the fuel contains MMT. We recommend against the use of such gasolines. Fuels containing MMT can reduce spark plug life and affect emission control system performance. The malfunction indicator lamp might turn on. If this occurs, return to your dealer for service.

Filling the Tank

WARNING

Fuel vapor burns violently and a fuel fire can cause bad injuries. To help avoid injuries to you and others, read and follow all the instructions on the fuel pump island. Turn off the vehicle when refueling. Do not smoke near fuel or when refueling the vehicle. Do not use cellular phones. Keep sparks, flames, and smoking materials away from fuel. Do not leave the fuel pump unattended when refueling the vehicle. This is against the law in some places. Do not re-enter the vehicle while pumping fuel. Keep children away from the fuel pump; never let children pump fuel.

The fuel system on this vehicle requires a refueling process to control evaporative emissions. To refuel the vehicle:

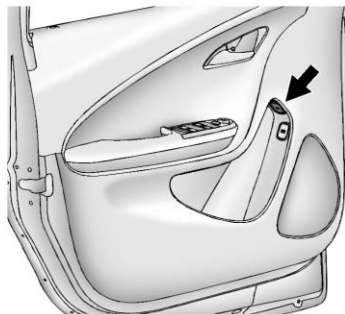

1. Press the fuel door button on the driver door for one second. A WAIT TO REFUEL message displays on the Driver Information Center.



2. When the READY TO REFUEL message displays, the fuel door on the passenger side will unlock. Push the rearward edge of the fuel door in and release to open the door.
3. Turn the fuel cap counterclockwise to remove. While refueling, hang the fuel cap tether from the hook on the inside of the fuel door.
4. After refueling, reinstall the fuel cap by turning it clockwise until it clicks. Close the fuel door.

 **WARNING**

Fuel can spray out on you if you open the fuel cap too quickly. If you spill fuel and then something ignites it, you could be badly burned. This spray can happen if the tank is nearly full, and is more likely in hot weather. Open the fuel cap slowly and wait for any hiss noise to stop. Then unscrew the cap all the way.

Do not top off or overfill the tank and wait a few seconds before removing the nozzle. Clean fuel from painted surfaces as soon as possible. See *Exterior Care* on page 10-81.

 **WARNING**

If a fire starts while you are refueling, do not remove the nozzle. Shut off the flow of fuel by shutting off the pump or by notifying the station attendant. Leave the area immediately.

Notice: If a new fuel cap is needed, be sure to get the right type of cap from your dealer. The wrong type of fuel cap might not fit properly, might cause the malfunction indicator lamp to light, and could damage the fuel tank and emissions system. See *Malfunction Indicator Lamp* on page 5-19.

Filling a Portable Fuel Container

 **WARNING**

Never fill a portable fuel container while it is in the vehicle. Static electricity discharge from the container can ignite the fuel vapor. You can be badly burned and the vehicle damaged if this occurs. To help avoid injury to you and others:

- Dispense fuel only into approved containers.
- Do not fill a container while it is inside a vehicle, in a vehicle's trunk, pickup bed, or on any surface other than the ground.

(Continued)

WARNING (Continued)

- Bring the fill nozzle in contact with the inside of the fill opening before operating the nozzle. Contact should be maintained until the filling is complete.
- Do not smoke while pumping fuel.
- Do not use a cellular phone while pumping fuel.

Towing

General Towing Information

The vehicle is neither designed nor intended to tow a trailer or another vehicle.

For information on towing a disabled vehicle, see *Towing the Vehicle on page 10-77*. For information on towing the vehicle behind another vehicle such as a motor home, see *Recreational Vehicle Towing on page 10-79*.

Conversions and Add-Ons

Add-On Electrical Equipment

Notice: Do not add anything electrical to the vehicle unless you check with your dealer first. Some electrical equipment can damage the vehicle and the damage would not be covered by the vehicle's warranty. Some add-on electrical equipment can keep other components from working as they should.

Add-on equipment can drain the vehicle's 12-volt battery, even if the vehicle is not operating.

The vehicle has an airbag system. Before attempting to add anything electrical to the vehicle, see *Servicing the Airbag-Equipped Vehicle on page 3-37* and *Adding Equipment to the Airbag-Equipped Vehicle on page 3-38*.

Vehicle Care

General Information

General Information	10-2
California Proposition 65 Warning	10-2
California Perchlorate Materials Requirements	10-2
Accessories and Modifications	10-3
Lifting the Vehicle	10-3

Vehicle Checks

Doing Your Own Service Work	10-6
Hood	10-7
Engine Compartment Overview	10-8
Engine Oil	10-9
Engine Oil Life System	10-12
Engine Air Cleaner/Filter	10-13
Cooling System (Engine) ...	10-15
Cooling System (High Voltage Battery)	10-16
Cooling System (Power Electronics and Charger Modules)	10-16

Engine Coolant	10-17
Engine Overheating	10-20
Power Steering Fluid	10-20
Washer Fluid	10-20
Brakes	10-21
Brake Fluid	10-22
Battery	10-24
Propulsion System Start Check	10-25
Electrical Drive Unit Shift Lock Control Function Check	10-25
Park Brake and P (Park) Mechanism Check	10-26
Wiper Blade Replacement	10-26

Headlamp Aiming

Headlamp Aiming	10-27
-----------------------	-------

Bulb Replacement

Bulb Replacement	10-29
Halogen Bulbs	10-29
Headlamps	10-30
Back-Up Lamps	10-31
License Plate Lamp	10-31
Replacement Bulbs	10-32

Electrical System

High Voltage Devices and Wiring	10-32
Electrical System Overload	10-33
Engine Compartment Fuse Block	10-33
Instrument Panel Fuse Block (Left Side)	10-37
Instrument Panel Fuse Block (Right Side)	10-39
Rear Compartment Fuse Block	10-41

Wheels and Tires

Tires	10-42
Winter Tires	10-43
Tire Sidewall Labeling	10-44
Tire Designations	10-45
Tire Terminology and Definitions	10-45
Tire Pressure	10-48
Tire Pressure Monitor System	10-49
Tire Pressure Monitor Operation	10-50
Tire Inspection	10-54
Tire Rotation	10-54

10-2 Vehicle Care

When It Is Time for New Tires	10-55
Buying New Tires	10-56
Different Size Tires and Wheels	10-58
Uniform Tire Quality Grading	10-58
Wheel Alignment and Tire Balance	10-60
Wheel Replacement	10-60
Tire Chains	10-61
If a Tire Goes Flat	10-62
Tire Sealant and Compressor Kit	10-63
Storing the Tire Sealant and Compressor Kit	10-70
Jump Starting	
Jump Starting	10-71
Towing	
Towing the Vehicle	10-77
Recreational Vehicle Towing	10-79
Appearance Care	
Exterior Care	10-81
Interior Care	10-85
Floor Mats	10-88

General Information

For service and parts needs, visit your dealer. You will receive genuine GM parts and GM-trained and supported service people.

Genuine GM parts have one of these marks:

ACDelco.

Genuine  **Parts**

 **Goodwrench.**

 **Accessories**

California Proposition 65 Warning

Most motor vehicles, including this one, contain and/or emit chemicals known to the State of California to cause cancer and birth defects or other reproductive harm. Engine exhaust, many parts and systems, many fluids, and some component wear by-products contain and/or emit these chemicals.

California Perchlorate Materials Requirements

Certain types of automotive applications, such as airbag initiators, seat belt pretensioners, and lithium batteries contained in Remote Keyless Entry transmitters, may contain perchlorate materials. Special handling may be necessary. For additional information, see www.dtsc.ca.gov/hazardouswaste/perchlorate.

Accessories and Modifications

Adding non-dealer accessories or making modifications to the vehicle can affect vehicle performance and safety, including such things as airbags, braking, stability, ride and handling, emissions systems, aerodynamics, durability, and electronic systems like antilock brakes, traction control, and stability control. These accessories or modifications could even cause malfunction or damage not covered by the vehicle warranty.

Damage to vehicle components resulting from modifications or the installation or use of non-GM certified parts, including control module or software modifications, is not covered under the terms of the vehicle warranty and may affect remaining warranty coverage for affected parts.

GM Accessories are designed to complement and function with other systems on the vehicle. Your GM dealer can accessorize the vehicle using genuine GM Accessories. When you go to your GM dealer and ask for GM Accessories, you will know that GM-trained and supported service technicians will perform the work using genuine GM Accessories.

Also, see *Adding Equipment to the Airbag-Equipped Vehicle* on page 3-38.

Lifting the Vehicle

This vehicle can be lifted with a hoist or a service jack. Do not use any other type of jack to lift the vehicle.

Lifting the Vehicle with a Hoist

This vehicle can be lifted with a hoist at the four locations, as illustrated.

Notice: Lifting the vehicle improperly can damage the vehicle and result in costly repairs not covered by the warranty.

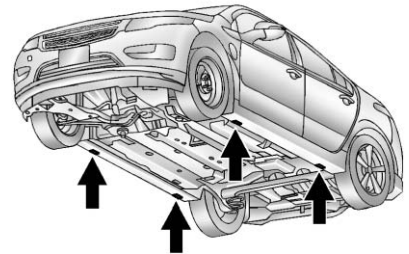

The front lifting points can be accessed from either side of the vehicle, behind the front tires.

The rear lifting points can be accessed from either side of the vehicle, in front of the rear tires.

10-4 Vehicle Care

Lifting the Vehicle with a Service Jack

WARNING

Lifting a vehicle can cause an injury. The vehicle can slip off the jack and roll over you or other people. You and they could be badly injured. Find a level place to lift your vehicle. To help prevent the vehicle from moving:

1. Set the parking brake firmly.
2. Put the shift lever in P (Park).
3. Turn off the vehicle.

To be even more certain the vehicle will not move, put blocks in front of and behind the wheels.

WARNING

Getting under a vehicle when it is jacked up is dangerous. If the vehicle slips off the jack, you could be badly injured or killed. Never get under a vehicle when it is supported only by a jack.

WARNING

Raising the vehicle with the jack improperly positioned can damage the vehicle or the vehicle may fall and cause you or others injury.

When using a jack to lift the vehicle, follow the instructions that came with the jack and be sure to use the correct lifting points to avoid damaging the vehicle.

Notice: Lifting the vehicle improperly can cause damage and result in costly repairs not covered by the warranty. To lift the vehicle properly, use this procedure.

For additional information, see your dealer and the service manual.

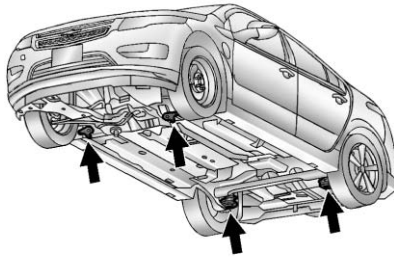

There are four points where the vehicle can be lifted with a service jack.

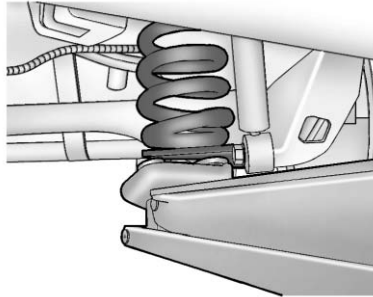

When lifting the vehicle from the rear, place the service jack directly under the spring seat.

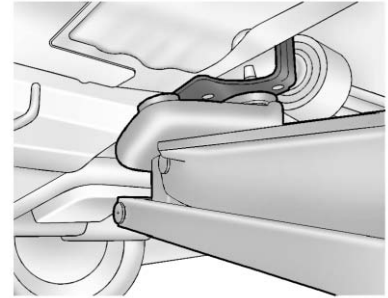

When lifting the vehicle from the front, place the service jack directly under the cradle mount. Ramps may be needed under the front tires to provide the necessary clearance for certain service jacks in this location.

For more information, see *Doing Your Own Service Work* on page 10-6.

Vehicle Checks

Doing Your Own Service Work

 **WARNING**

Never try to do your own service on high voltage battery components. You can be injured and the vehicle can be damaged if you try to do your own service work. Service and repair of these high voltage battery components should only be performed by a trained service technician with the proper knowledge and tools.

Exposure to high voltage can cause shock, burns, and even death. The high voltage components in the vehicle can only be serviced by technicians with special training.

(Continued)

WARNING (Continued)

High voltage components are identified by labels. Do not remove, open, take apart, or modify these components. High voltage cable or wiring has orange covering. Do not probe, tamper with, cut, or modify high voltage cable or wiring.

 **WARNING**

You can be injured and the vehicle could be damaged if you try to do service work on a vehicle without knowing enough about it.

- Be sure you have sufficient knowledge, experience, the proper replacement parts, and tools before attempting any vehicle maintenance task.

(Continued)

WARNING (Continued)

- Be sure to use the proper nuts, bolts, and other fasteners. Metric and English fasteners can be easily confused. If the wrong fasteners are used, parts can later break or fall off. You could be hurt.

If doing some of your own service work, use the proper service manual. It tells you much more about how to service the vehicle than this manual can. To order the proper service manual, see *Service Publications Ordering Information on page 13-12*.

This vehicle has an airbag system. Before attempting to do your own service work, see *Airbag System Check on page 3-39*.

Keep a record with all parts receipts and list the mileage and the date of any service work performed. See *Maintenance Records on page 11-8*.

Hood

To open the hood:

1. Turn the vehicle off before opening the hood. If the vehicle is on, the engine will start when the hood is opened. See *Electric Mode on page 9-23* and *Extended Range Mode on page 9-23*.



2. Pull the release handle with this symbol. It is below the instrument panel to the left of the steering wheel.

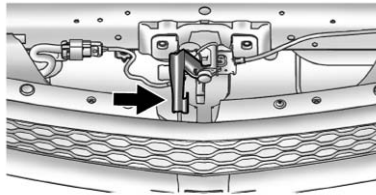

3. Go to the front of the vehicle and locate the secondary release lever under the front center of the hood. Push the secondary hood release lever to the right to disengage.
4. Lift the hood and release the hood prop rod from its retainer above the radiator support. Place the prop rod securely into the slotted retainer in the hood.

To close the hood:

1. Before closing the hood, check that all filler caps are properly installed. Then, lift the hood to relieve pressure on the hood prop.
2. Remove the hood prop from the slotted retainer in the hood and return it to its retainer above the radiator support. The prop rod must lock into place when returning it to the retainer to prevent hood damage.
3. Lower the hood 20 cm (8 in) above the vehicle and release it so it fully latches. Check to make sure the hood is firmly closed. Repeat the process if necessary.

Engine Compartment Overview

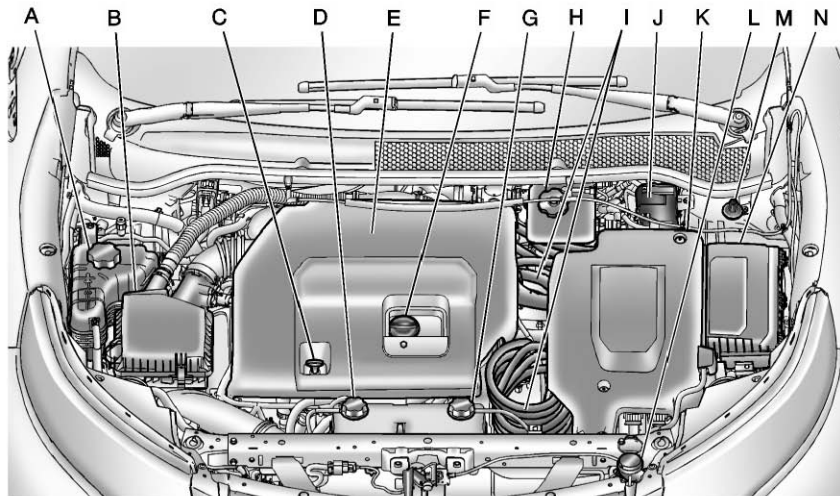

- A. Engine Coolant Surge Tank and Pressure Cap. See *Engine Coolant* on page 10-17.
- B. *Engine Air Cleaner/Filter* on page 10-13.
- C. Engine Oil Dipstick. See *Engine Oil* on page 10-9.
- D. High Voltage Battery Coolant Reservoir and Pressure Cap. See *Cooling System (Engine)* on page 10-15 or *Cooling System (High Voltage Battery)* on page 10-16 or *Cooling System (Power Electronics and Charger Modules)* on page 10-16.
- E. Engine Cover.
- F. Engine Oil Fill Cap. See *Engine Oil* on page 10-9.
- G. Power Electronics Coolant Reservoir and Pressure Cap. See *Cooling System (Engine)* on page 10-15 or *Cooling*

- System (High Voltage Battery)* on page 10-16 or *Cooling System (Power Electronics and Charger Modules)* on page 10-16.
- H. Brake Fluid Reservoir. See “Brake Fluid” under *Brakes* on page 10-21.
- I. High Voltage Cables (Orange Color).
- J. Remote Positive (+) Terminal. See *Jump Starting* on page 10-71.
- K. Power Electronics Module.
- L. Windshield Washer Fluid Reservoir. See “Adding Washer Fluid” under *Washer Fluid* on page 10-20.
- M. Remote Negative (-) Terminal. See *Jump Starting* on page 10-71.
- N. *Engine Compartment Fuse Block* on page 10-33.

Engine Oil

To ensure proper engine performance and long life, careful attention must be paid to engine oil. Following these simple, but important steps will help protect your investment:

- Always use engine oil approved to the proper specification and of the proper viscosity grade. See “Selecting the Right Engine Oil” in this section.
- Check the engine oil level regularly and maintain the proper oil level. See “Checking Engine Oil” and “When to Add Engine Oil” in this section.
- Change the engine oil at the appropriate time. See *Engine Oil Life System* on page 10-12.
- Always dispose of engine oil properly. See “What to Do with Used Oil” in this section.

Checking Engine Oil

It is a good idea to check the engine oil level at each fuel fill. In order to get an accurate reading, the vehicle must be on level ground. The engine oil dipstick handle is a yellow loop. See *Engine Compartment Overview* on page 10-8 for the location of the engine oil dipstick.

Obtaining an accurate oil level reading is essential:

1. If the engine has been running recently, turn off the propulsion system and allow several minutes for the oil to drain back into the oil pan. Checking the oil level too soon after engine shut off will not provide an accurate oil level reading.
2. Pull the dipstick and clean it with a paper towel or cloth, then push it back in all the way. Remove it again, keeping the tip down, and check the level.

When to Add Engine Oil

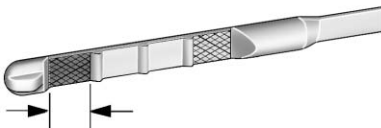

If the oil is below the cross-hatched area at the tip of the dipstick, add 1 L (1 qt) of the recommended oil and then recheck the level. See “Selecting the Right Engine Oil” in this section for an explanation of what kind of oil to use. For engine oil crankcase capacity, see *Capacities and Specifications* on page 12-2.

Notice: Do not add too much oil. Oil levels above or below the acceptable operating range shown on the dipstick are harmful to the engine. If you find that you have an oil level above the operating range, i.e., the engine has so much oil that the oil level gets above the cross-hatched

area that shows the proper operating range, the engine could be damaged. You should drain out the excess oil or limit driving of the vehicle and seek a service professional to remove the excess amount of oil.

See *Engine Compartment Overview* on page 10-8 for the location of the engine oil fill cap.

Add enough oil to put the level somewhere in the proper operating range. Push the dipstick all the way back in when through.

Selecting the Right Engine Oil

Selecting the right engine oil depends on both the proper oil specification and viscosity grade:

Specification

Use and ask for engine oils with the dexos™ certification mark. Oils meeting the requirements of the vehicle should have the dexos certification mark on the container.

This certification mark indicates that the oil has been approved to the dexos specification.



This vehicle was filled at the factory with dexos-approved engine oil.

Notice: Use only engine oil that is approved to the dexos specification or an equivalent engine oil of the appropriate viscosity grade. Engine oils approved to the dexos specification will show the dexos symbol on the container. Failure to use the recommended engine oil or equivalent can result in engine damage not covered by

the vehicle warranty. If you are unsure whether the oil is approved to the dexos specification, ask your service provider.

Use of Substitute Engine Oils if dexos is unavailable: In the event that dexos-approved engine oil is not available at an oil change or for maintaining proper oil level, you may use substitute engine oil displaying the API Starburst symbol and of SAE 5W-30 viscosity grade. Use of oils that do not meet the dexos specification, however, may result in reduced performance under certain circumstances.

Viscosity Grade

SAE 5W-30 is the best viscosity grade for the vehicle. Do not use other viscosity oils such as SAE 10W-30, 10W-40, or 20W-50.

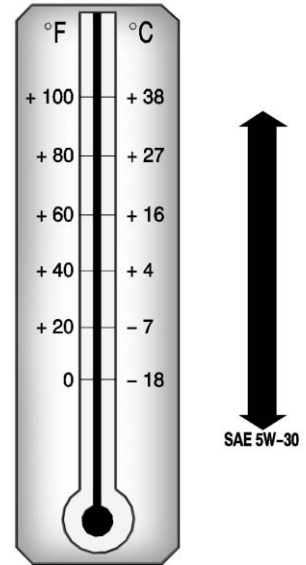

Cold Temperature Operation: In an area of extreme cold, where the temperature falls below -29°C (-20°F), an SAE 0W-30 oil should

be used. An oil of this viscosity grade will provide easier cold starting for the engine at extremely low temperatures. When selecting an oil of the appropriate viscosity grade, be sure to always select an oil that meets the required specification, dexos. See “Specification” earlier in this section for more information.

Engine Oil Additives/Engine Oil Flushes

Do not add anything to the oil. The recommended oils with the dexos specification and displaying the dexos certification mark are all that is needed for good performance and engine protection.

Engine oil system flushes are not recommended and could cause engine damage not covered by the vehicle warranty.

What to Do with Used Oil

Used engine oil contains certain elements that can be unhealthy for your skin and could even cause cancer. Do not let used oil stay on your skin for very long. Clean your skin and nails with soap and water, or a good hand cleaner. Wash or properly dispose of clothing or rags containing used engine oil. See the manufacturer's warnings about the use and disposal of oil products.

Used oil can be a threat to the environment. If you change your own oil, be sure to drain all the oil from the filter before disposal. Never dispose of oil by putting it in the trash or pouring it on the ground, into sewers, or into streams or bodies of water. Recycle it by taking it to a place that collects used oil.

Engine Oil Life System

When to Change Engine Oil

This vehicle has a computer system that indicates when to change the engine oil and filter. This is based on engine revolutions and engine temperature, and not on mileage. Based on driving conditions, the mileage at which an oil change is indicated can vary considerably. For the oil life system to work properly, the system must be reset every time the oil is changed.

When the system has calculated that oil life has been diminished, it indicates that an oil change is necessary. A CHANGE ENGINE OIL SOON message comes on. Change the oil as soon as possible within the next 1 000 km (600 mi). It is possible that, if driving under the best conditions, the oil life system might indicate that an oil change is not necessary for up to two years. The engine oil and filter must be changed at least once every two years and, at this time,

the system must be reset. Your dealer has trained service people who will perform this work and reset the system. It is also important to check the oil regularly over the course of an oil drain interval and keep it at the proper level.

If the system is ever reset accidentally, the oil must be changed at 5 000 km (3,000 mi) since the last oil change. Remember to reset the oil life system whenever the oil is changed.

How to Reset the Engine Oil Life System

Reset the system whenever the engine oil is changed so that the system can calculate the next engine oil change. To reset the system:

1. Use the SELECT knob to select OIL LIFE on the DIC menu.
2. Press SELECT to start the OIL LIFE reset procedure.

3. The DIC menu will display “Are you sure that you want to reset?” Use SELECT to choose YES to reset oil life or NO to exit and return to the previous menu.
4. If YES is selected, the DIC menu will display RESET OIL LIFE for a short time and then 100% OIL LIFE will be displayed when OIL LIFE is successfully reset.

If the CHANGE ENGINE OIL SOON message comes back on when the vehicle is started, the engine oil life system has not reset. Repeat the procedure.

Engine Air Cleaner/Filter

See *Engine Compartment Overview on page 10-8* for the location of the engine air cleaner/filter.

When to Inspect the Engine Air Filter

Inspect the air filter at the scheduled maintenance intervals and replace it at the first oil change after each 80 000 km (50,000 mi) interval.

See *Scheduled Maintenance on page 11-3* for more information. If driving in dusty/dirty conditions, inspect the air filter at each engine oil change.

How to Inspect the Engine Air Filter

To inspect the air filter, remove it from the engine air cleaner/filter assembly and lightly shake to release loose dust and dirt. If the air filter remains covered with dirt, a new air filter is required.

To inspect or replace the air filter:

1. Open the hood. See *Hood on page 10-7*.
2. Locate the engine air cleaner/filter assembly on the passenger side of the engine compartment. See *Engine Compartment Overview on page 10-8*.

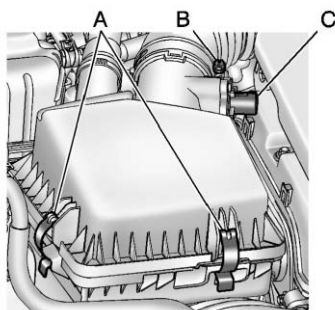

A. Retaining Clips

B. Air Duct Clamp

C. Electrical Connector

3. Disconnect the air duct by loosening the air duct clamp (B).
4. Disconnect the electrical connector (C).
5. Lift the retaining clips (A) from the engine air cleaner/filter assembly.
6. Turn and tilt the air cleaner cover slightly upward and slide it out. Remove the air filter.

How to Reinstall the Engine Air Filter

1. Install the air filter into the engine air cleaner/filter assembly. The outer air filter seal must be fitted properly in the engine air cleaner/filter assembly.
2. Replace the air cleaner cover by lowering it to meet the bottom of the engine air cleaner/filter assembly. Place the retaining clips (A) on the engine air cleaner/filter assembly and secure. The rear tabs must be secured into the lower portion of the air cleaner.
3. Reconnect the air duct and tighten the air duct clamp (B).
4. Reconnect the electrical connector (C).

WARNING

Operating the engine with the air cleaner/filter off can cause you or others to be burned. The air cleaner not only cleans the air; it helps to stop flames if the engine backfires. Use caution when working on the engine and do not drive with the air cleaner/filter off.

Notice: If the air cleaner/filter is off, dirt can easily get into the engine, which could damage it. Always have the air cleaner/filter in place when you are driving.

Cooling System (Engine)

When it is safe to lift the hood:

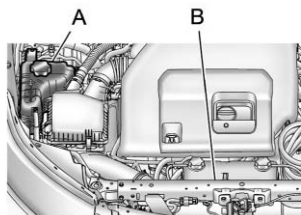

- A. Engine Coolant Surge Tank and Pressure Cap
- B. Engine Cooling Fans (Out of View)

WARNING

The electric cooling fans under the hood can start up even when the engine is not running and can cause injury. Keep hands, clothing, and tools away from any underhood electric fan.

If the coolant inside the coolant surge tank is boiling, do not do anything else until it cools down. The vehicle should be parked on a level surface.

The coolant level should be up to the cold fill line. If it is not, there might be a leak at the radiator hoses, heater hoses, radiator, water pump, or somewhere else in the cooling system.

WARNING

Heater and radiator hoses, and other engine parts, can be very hot. Do not touch them. If you do, you can be burned.

Do not run the vehicle if there is a leak. If you run the engine, it could lose all coolant. That could cause an engine fire, and you could be burned. Get any leak fixed before you drive the vehicle.

If there seems to be no leak, with the engine on, check to see if the electric engine cooling fans are running. If the engine is overheating, the fans should be running. If it is not, the vehicle needs service. Turn off the vehicle.

Notice: Using coolant other than DEX-COOL® can cause premature engine, heater core, or radiator corrosion. In addition, the engine coolant could require changing sooner, at 50 000 km (30,000 mi) or 24 months, whichever occurs first. Any repairs would not be covered by the vehicle warranty. Always use DEX-COOL (silicate-free) coolant in the vehicle.

Cooling System (High Voltage Battery)

During vehicle operation and also during charging, the high voltage battery cells in the vehicle are kept within a normal operating temperature range. If the temperature rises above this temperature, the battery cooling system turns on the air conditioning compressor and cools the coolant until the correct temperature is reached. If the temperature falls below this temperature, a high voltage heater, located in the battery, heats the coolant until the correct temperature is reached.

What to Use

The high voltage battery coolant reservoir in the vehicle is filled with a 50/50 mixture of DEX-COOL engine coolant and deionized water. If using this mixture, nothing else needs to be added.

Checking Coolant

The vehicle must be on a level surface when checking the coolant level.

The high voltage battery coolant reservoir is located on the passenger side of the engine compartment. See *Engine Compartment Overview on page 10-8* for more information on location.

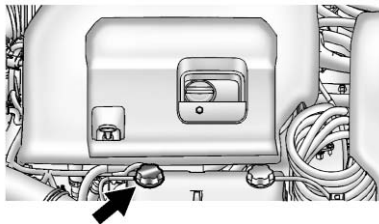

Check to see if coolant is visible in the high voltage battery coolant reservoir. If coolant is visible but the coolant level is below the cold fill line, there could be a leak in the cooling system.

The high voltage battery coolant should only be serviced by a qualified technician.

Cooling System (Power Electronics and Charger Modules)

The power electronics and charger modules are cooled using the same coolant loop.

The power electronics and charger modules in the vehicle are kept below a maximum temperature. If the temperature rises above this temperature, the electric engine cooling fans will turn on and cool the coolant until the correct temperature is reached.

What to Use

The power electronics and charger modules coolant reservoir in the vehicle is filled with a 50/50 mixture of DEX-COOL engine coolant and deionized water. If using this mixture, nothing else needs to be added.

Checking Coolant

The vehicle must be on a level surface when checking the coolant level.

The power electronics and charger modules coolant reservoir is located on the driver side of the engine compartment. See *Engine Compartment Overview* on page 10-8 for more information on location.

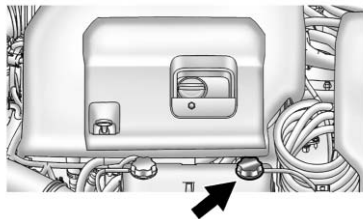

Check to see if coolant is visible in the power electronics and charger modules coolant reservoir. If coolant is visible but the coolant level is below the cold fill line, there could be a leak in the cooling system.

The power electronics and charger modules coolant should only be serviced by a qualified technician.

Engine Coolant

The engine cooling system in the vehicle is filled with DEX-COOL engine coolant. This coolant is designed to remain in the vehicle for 5 years or 240 000 km (150,000 mi), whichever occurs first.

The following explains the cooling system and how to check and add coolant when it is low. If there is a problem with engine overheating, see *Engine Overheating* on page 10-20.

What to Use

WARNING

Adding only plain water or some other liquid to the cooling system can be dangerous. Plain water and other liquids, can boil before

(Continued)

WARNING (Continued)

the proper coolant mixture will. The coolant warning system is set for the proper coolant mixture. With plain water or the wrong mixture, the engine could get too hot but you would not get the overheat warning. The engine could catch fire and you or others could be burned. Use a 50/50 mixture of clean, drinkable water and DEX-COOL coolant.

Use a 50/50 mixture of clean, drinkable water and DEX-COOL coolant. If using this mixture, nothing else needs to be added. This mixture:

- Gives freezing protection down to -37°C (-34°F), outside temperature.
- Gives boiling protection up to 129°C (265°F), engine temperature.

10-18 Vehicle Care

- Protects against rust and corrosion.
- Will not damage aluminum parts.
- Helps keep the proper engine temperature.

Notice: If an improper coolant mixture is used, the engine could overheat and be badly damaged. The repair cost would not be covered by the vehicle warranty. Too much water in the mixture can freeze and crack the engine, radiator, heater core, and other parts.

Never dispose of engine coolant by putting it in the trash, pouring it on the ground, or into sewers, streams, or bodies of water. Have the coolant changed by an authorized service center, familiar with legal requirements regarding used coolant disposal. This will help protect the environment and your health.

Checking Coolant

The vehicle must be on a level surface when checking the coolant level.

Check to see if coolant is visible in the coolant surge tank. If the coolant inside the coolant surge tank is boiling, do not do anything else until it cools down. If coolant is visible but the coolant level is not at or above the cold fill mark, add a 50/50 mixture of clean, drinkable water and DEX-COOL coolant at the coolant surge tank, but be sure the cooling system is cool before this is done. See *Engine Overheating on page 10-20* for more information.

The coolant reservoir is located on the passenger side of the engine compartment. See *Engine Compartment Overview on page 10-8* for more information on location.

The coolant level should be at or above the cold fill line on the coolant surge tank. If it is not, there could be a leak in the cooling system.

How to Add Coolant to the Coolant Surge Tank



You can be burned if you spill coolant on hot engine parts. Coolant contains ethylene glycol and it will burn if the engine parts are hot enough. Do not spill coolant on a hot engine.

Notice: This vehicle has a specific coolant fill procedure. Failure to follow this procedure could cause the engine to overheat and be severely damaged.

⚠ WARNING

The electric cooling fans under the hood can start up even when the engine is not running and can cause injury. Keep hands, clothing, and tools away from any underhood electric fan.

⚠ WARNING

Steam and scalding liquids from a hot cooling system can blow out and burn you badly. They are under pressure, and if you turn the surge tank pressure cap — even a little — they can come out at high speed. Never turn the cap when the cooling system, including the surge tank pressure cap, is hot. Wait for the cooling system and surge tank pressure cap to cool if you ever have to turn the pressure cap.

If coolant is needed, add the proper DEX-COOL coolant mixture at the coolant surge tank.



The coolant surge tank pressure cap can be removed when the cooling system, including the surge tank pressure cap and upper radiator hose, is no longer hot.

1. Turn the pressure cap slowly counterclockwise. If a hiss is heard, wait for that to stop. A hiss means there is still some pressure left.
2. Keep turning the cap and remove it.

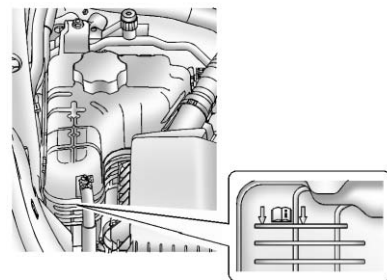

3. Fill the coolant surge tank with the proper mixture to the cold fill line.
4. Replace the pressure cap. Be sure the pressure cap is hand-tight and fully seated.

Notice: If the pressure cap is not tightly installed, coolant loss and possible engine damage may occur. Be sure the cap is properly and tightly secured.

Engine Overheating

The vehicle has an indicator to warn of engine overheating.

If the decision is made not to lift the hood when this warning appears, get service help right away. See *Roadside Assistance Program on page 13-6*.

If the decision is made to lift the hood, make sure the vehicle is parked on a level surface.

Then check to see if the engine cooling fans are running. If the engine is overheating, the fans should be running. If they are not, do not continue to run the vehicle and have the vehicle serviced.

Notice: Engine damage from running the engine without coolant is not covered by the warranty.

Power Steering Fluid

The vehicle is equipped with an electric power steering system. No fluid or general maintenance is required.

Washer Fluid

What to Use

When adding windshield washer fluid to the vehicle, be sure to read the manufacturer's instructions before use. If operating the vehicle in an area where the temperature may fall below freezing, use a fluid that has sufficient protection against freezing.

Adding Washer Fluid

The WASHER FLUID LOW ADD FLUID message will appear on the Driver Information Center (DIC) when the fluid level is low. See *Driver Information Center (DIC) on page 5-38* for more information.

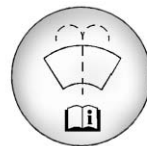

Open the cap with the washer symbol on it. Add washer fluid until the tank is full. See *Engine Compartment Overview on page 10-8* for reservoir location.

Notice

- **When using concentrated washer fluid, follow the manufacturer's instructions for adding water.**
- **Do not mix water with ready-to-use washer fluid. Water can cause the solution to freeze and damage the washer fluid tank and other parts of the washer system. Also, water does not clean as well as washer fluid.**

- **Fill the washer fluid tank only three-quarters full when it is very cold. This allows for fluid expansion if freezing occurs, which could damage the tank if it is completely full.**
- **Do not use engine coolant (antifreeze) in the windshield washer. It can damage the windshield washer system and paint.**

Brakes

This vehicle has disc brakes. Disc brake pads have built-in wear indicators that make a high-pitched warning sound when the brake pads are worn and new pads are needed. The sound can come and go or be heard all the time the vehicle is moving, except when applying the brake pedal firmly.

WARNING

The brake wear warning sound means that soon the brakes will not work well. That could lead to a crash. When the brake wear warning sound is heard, have the vehicle serviced.

Notice: Continuing to drive with worn-out brake pads could result in costly brake repair.

Some driving conditions or climates can cause a brake squeal when the brakes are first applied or lightly applied. This does not mean something is wrong with the brakes.

Properly torqued wheel nuts are necessary to help prevent brake pulsation. When tires are rotated, inspect brake pads for wear and evenly tighten wheel nuts in the proper sequence to torque specifications in *Capacities and Specifications on page 12-2*.

Brake linings should always be replaced as complete axle sets.

Brake Pedal Travel

See your dealer if the brake pedal does not return to normal height, or if there is a rapid increase in pedal travel. This could be a sign that brake service might be required.

Brake Adjustment

Every time the brakes are applied, with or without the vehicle moving, the brakes adjust for wear.

Replacing Brake System Parts

The braking system on a vehicle is complex. Its many parts have to be of top quality and work well together if the vehicle is to have really good braking. The vehicle was designed and tested with top-quality brake parts. When parts of the braking system are replaced, be sure to get new, approved replacement parts. If this is not done, the brakes might not work properly.

10-22 Vehicle Care

For example, installing disc brake pads that are wrong for the vehicle, can change the balance between the front and rear brakes — for the worse. The braking performance expected can change in many other ways if the wrong replacement brake parts are installed.

Brake Fluid



The brake master cylinder reservoir is filled with DOT 3 brake fluid as indicated on the reservoir cap. See *Engine Compartment Overview on page 10-8* for the location of the reservoir.

There are only two reasons why the brake fluid level in the reservoir might go down:

- The brake fluid level goes down because of normal brake lining wear. When new linings are installed, the fluid level goes back up.
- A fluid leak in the brake hydraulic system can also cause a low fluid level. Have the brake hydraulic system fixed, since a leak means that sooner or later the brakes will not work well.

Do not top off the brake fluid. Adding fluid does not correct a leak. If fluid is added when the linings are worn, there will be too much fluid when new brake linings are installed. Add or remove brake fluid, as necessary, only when work is done on the brake hydraulic system.

WARNING

If too much brake fluid is added, it can spill on the engine and burn, if the engine is hot enough. You or others could be burned, and the vehicle could be damaged. Add brake fluid only when work is done on the brake hydraulic system.

When the brake fluid falls to a low level, the brake warning light comes on. See *Brake System Warning Light on page 5-22*.

Checking Brake Fluid

Check brake fluid by looking at the brake fluid reservoir. See *Engine Compartment Overview on page 10-8*.

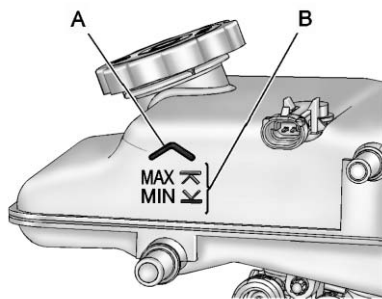

With the vehicle not running for at least one minute, the maximum fluid level (A) is at the top of the reservoir body. With the vehicle running, the fluid level should be in the proper operating range (B) between the MIN and MAX marks. If it is not, have the brake hydraulic system checked to see if there is a leak.

After work is done on the brake hydraulic system, make sure the level, with the vehicle running, is in the proper operating range (B) between the MIN and MAX marks.

What to Add

Use only new DOT 3 brake fluid from a sealed container. See *Recommended Fluids and Lubricants* on page 11-6.

Always clean the brake fluid reservoir cap and the area around the cap before removing it. This helps keep dirt from entering the reservoir.

WARNING

With the wrong kind of fluid in the brake hydraulic system, the brakes might not work well. This could cause a crash. Always use the proper brake fluid.

Notice

- Using the wrong fluid can badly damage brake hydraulic system parts. For example, just a few drops of mineral-based oil, such as engine oil, in the brake hydraulic system can damage brake hydraulic system parts so badly that they will have to be replaced. Do not let someone put in the wrong kind of fluid.
- If brake fluid is spilled on the vehicle's painted surfaces, the paint finish can be damaged. Be careful not to spill brake fluid on the vehicle. If you do, wash it off immediately.

Battery

This vehicle has a high voltage battery and a standard 12-volt battery.

If the vehicle is in a crash, the sensing system may shut down the high voltage system. When this occurs, the high voltage battery is disconnected and the vehicle will not start. The SERVICE VEHICLE SOON message in the Driver Information Center (DIC), will be displayed. Before the vehicle can be operated again, it must be serviced at your dealer.

See “If a Crash Occurs” under *Collision Damage Repair* on page 13-10 for additional information. If an airbag has inflated, see *What Will You See After an Airbag Inflates?* on page 3-31.

Only a trained service technician with the proper knowledge and tools should inspect, test, or replace the high voltage battery. See your dealer if the high voltage battery needs service. The dealer has information on how to recycle the high voltage battery. There is also information available at <http://www.recyclemybattery.com>.

Keep the vehicle plugged in, even when fully charged, to keep the high voltage battery temperature ready for the next drive. This is important when outside temperatures are extremely hot or cold.

A vehicle cover, which can reduce sun loading on the vehicle and improve high voltage battery life, is available from your dealer.

Refer to the replacement number shown on the original battery label when a new 12-volt battery is needed.

DANGER

Battery posts, terminals, and related accessories contain lead and lead compounds, chemicals known to the State of California to cause cancer and reproductive harm. Wash hands after handling.

Vehicle Storage

WARNING

12-volt batteries have acid that can burn you and gas that can explode. You can be badly hurt if you are not careful. See *Jump Starting* on page 10-71 for tips on working around a battery without getting hurt.

Extended Storage

Remove the 12-volt battery black, negative (-) cable from the battery to keep the 12-volt battery from running down or use a battery trickle charger.

In addition, to avoid potential damage to the high voltage battery, perform the following recommended steps:

- Store the high voltage battery with 1/2 charge or less.
- Always store the vehicle in an environment between -10°C (14°F) and 30°C (95°F).
- Vehicle storage at extreme temperatures can cause damage to the high voltage battery.

Remember to reconnect the 12-volt battery when ready to drive the vehicle.

Propulsion System Start Check

 **WARNING**

When you are doing this inspection, the vehicle could move suddenly. If the vehicle moves, you or others could be injured.

1. Before starting this check, be sure there is enough room around the vehicle.
2. Firmly apply both the electric parking brake and the regular brake. See *Electric Parking Brake on page 9-32*.

Do not use the accelerator pedal, and be ready to turn off the propulsion system immediately if it starts.
3. Try to start the propulsion system in each gear. The vehicle should start only in P (Park) or

N (Neutral). If the vehicle starts in any other position, contact your dealer for service.

Electrical Drive Unit Shift Lock Control Function Check

 **WARNING**

When you are doing this inspection, the vehicle could move suddenly. If the vehicle moves, you or others could be injured.

1. Before starting this check, be sure there is enough room around the vehicle. It should be parked on a level surface.
2. Firmly apply the parking brake. See *Electric Parking Brake on page 9-32*.

Be ready to apply the regular brake immediately if the vehicle begins to move.

3. With the vehicle off and the brake not applied, push the power button to ON/RUN without starting the vehicle. See *Power Button on page 9-18*. Without applying the regular brake, try to move the shift lever out of P (Park) with normal effort. If the shift lever moves out of P (Park), contact your dealer for service.

Park Brake and P (Park) Mechanism Check

WARNING

When you are doing this check, the vehicle could begin to move. You or others could be injured and property could be damaged. Make sure there is room in front of the vehicle in case it begins to roll. Be ready to apply the regular brake at once should the vehicle begin to move.

Park on a fairly steep hill, with the vehicle facing downhill. Keeping your foot on the regular brake, set the electric parking brake.

- To check the electric parking brake's holding ability: With the propulsion system active and the electric drive unit in N (Neutral), slowly remove foot pressure from the regular brake pedal. Do this until the vehicle is held by the electric parking brake only.
- To check the P (Park) mechanism's holding ability: With the propulsion system active, shift to P (Park). Then release the electric parking brake followed by the regular brake.

Contact your dealer if service is required.

Wiper Blade Replacement

Windshield wiper blades should be inspected for wear and cracking. See *Scheduled Maintenance on page 11-3* for more information.

Replacement blades come in different types and are removed in different ways. For proper type and length, see *Maintenance Replacement Parts on page 11-7*.

Notice: Allowing the wiper blade arm to touch the windshield when no wiper blade is installed could damage the windshield. Any damage that occurs would not be covered by your warranty. Do not allow the wiper blade arm to touch the windshield.

To replace the windshield wiper blade:

1. Pull the windshield wiper assembly away from the windshield.

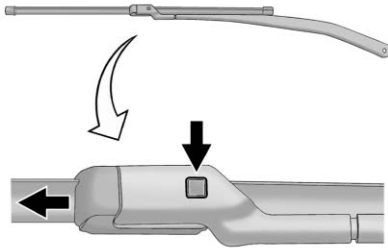

2. Press the button in the middle of the wiper arm connector, and pull the wiper blade away from the arm connector.
3. Remove the wiper blade.
4. Reverse Steps 1 through 3 for wiper blade replacement.

Headlamp Aiming

The headlamp aiming system has been preset at the factory.

If the vehicle is damaged in an accident, the aim of the headlamps may be affected and adjustment may be necessary.

It is recommended that a dealer adjust the headlamps. To re-aim the headlamps yourself, use the following procedure.

The vehicle should be properly prepared as follows:

- The vehicle should be placed so the headlamps are 7.6 m (25 ft) from a light-colored wall.
- The vehicle must have all four tires on a level surface which is level all the way to the wall.

- The vehicle should be placed so it is perpendicular to the wall or other flat surface.
- The vehicle should not have any snow, ice, or mud on it.
- The vehicle should be fully assembled and all other work stopped while headlamp aiming is being performed.
- The vehicle should be normally loaded with a full tank of fuel and one person or 75 kg (160 lbs) sitting on the driver seat.
- Tires should be properly inflated.

Headlamp aiming is done with the vehicle's low-beam headlamps. The high-beam headlamps will be correctly aimed if the low-beam headlamps are aimed properly.

10-28 Vehicle Care

To adjust the vertical aim:

1. Open the hood. See *Hood* on page 10-7 for more information.

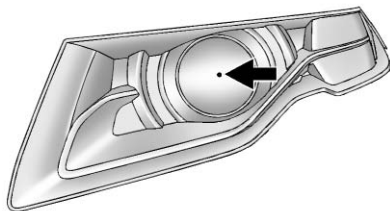

2. Locate the aim dot on the lens of the low-beam headlamp.
3. Measure the distance from the ground to the aim dot on the low-beam headlamp. Record the distance.

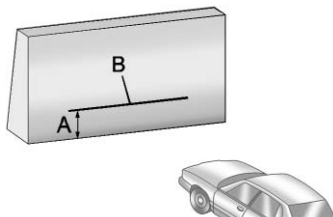

4. At the wall, measure from the ground upward (A) to the recorded distance from Step 3 and mark it.
5. Draw or tape a horizontal line (B) on the wall the width of the vehicle at the height of the mark in Step 4.

Notice: Do not cover a headlamp to improve beam cut-off when aiming. Covering a headlamp may cause excessive heat build-up which may cause damage to the headlamp.

6. Turn on the low-beam headlamps and place a piece of cardboard or something equivalent in front of the headlamp not being adjusted. This allows only the beam of light from the headlamp being adjusted to be seen on the flat surface.

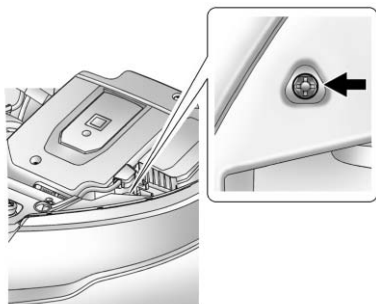

7. Locate the vertical headlamp aiming screws, which are under the hood near each headlamp assembly.
8. Turn the vertical aiming screw until the headlamp beam is aimed to the horizontal tape line. Turn it clockwise or counterclockwise to raise or lower the angle of the beam.

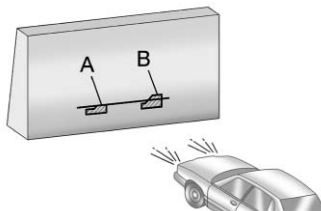

9. Make sure that the light from the headlamp is positioned at the bottom edge of the horizontal tape line. The lamp on the left (A) shows the correct headlamp aim. The lamp on the right (B) shows the incorrect headlamp aim.
10. Repeat Steps 7 through 9 for the opposite headlamp.

Bulb Replacement

For the proper type of replacement bulbs, see *Replacement Bulbs* on page 10-32.

For any bulb-changing procedure not listed in this section, contact your dealer.

Halogen Bulbs

WARNING

Halogen bulbs have pressurized gas inside and can burst if you drop or scratch the bulb. You or others could be injured. Be sure to read and follow the instructions on the bulb package.

Headlamps

Driver Side Headlamps

To replace the high/low-beam headlamp:

1. Open the hood. See *Hood* on page 10-7.

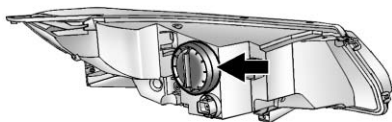

2. Remove the cover from the back of the headlamp assembly by turning it counterclockwise.
3. Remove the bulb socket from the headlamp assembly by turning it counterclockwise.
4. Remove the bulb from the socket.
5. Install the new bulb in the socket.

6. Install the bulb socket by turning it clockwise.
7. Install the cover in the back of the headlamp assembly by turning it clockwise.

Passenger Side Headlamps

To replace the high/low-beam headlamp:

1. Open the hood. See *Hood* on page 10-7.

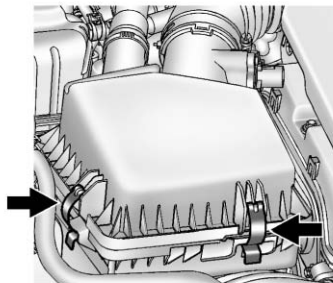

2. Remove the air cleaner cover. See *Engine Air Cleaner/Filter* on page 10-13.

3. Remove the air cleaner assembly by pulling up to release the rear two retention posts from the securing grommets. Then pull it forward to remove the remaining retention post from the securing grommet.

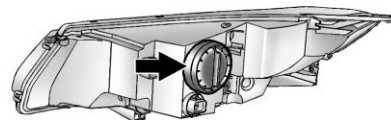

4. Remove the cover from the back of the headlamp assembly by turning it counterclockwise.
5. Remove the bulb from the headlamp assembly by turning it counterclockwise.
6. Disconnect the bulb from the wiring harness connector.
7. Install the new bulb in the headlamp assembly by turning it clockwise.

8. Reconnect the wiring harness connector.
9. Install the cover on the back of the headlamp assembly by turning it clockwise.
10. Install the air cleaner assembly by lowering the three retention posts into the grommets.
11. Install the engine air cleaner/ filter assembly cover. See *Engine Air Cleaner/Filter* on page 10-13.

Back-Up Lamps

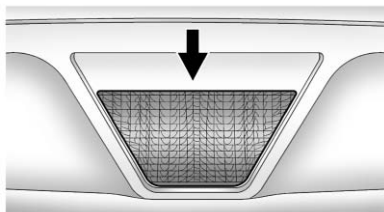

The back-up lamp is in the rear fascia.

To replace a bulb:

1. Remove the two inboard screws from the aero panel located under the rear fascia.
2. Push up on the aero panel to locate the bulb socket.
3. Turn the bulb socket counterclockwise to remove it from the bulb assembly.
4. Pull the bulb from the bulb socket.
5. Push a new bulb straight into the bulb socket.
6. Reinstall the bulb socket by lining up the tabs in the lamp assembly and turn it clockwise to lock it into place.
7. Replace the two inboard screws from the aero panel.

License Plate Lamp

To replace one of these bulbs:

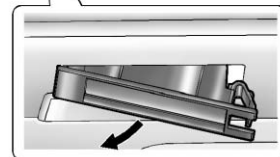
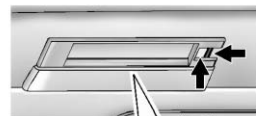

**Passenger Side Shown,
Driver Side Similar**

1. Press the spring clip on the right end of the lamp assembly to the left to unlock the lamp assembly.
2. Pull down on the lamp assembly to remove it from the fascia.

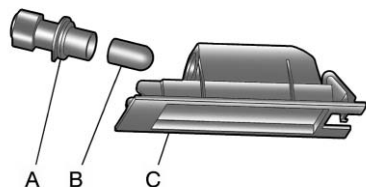

- A. Bulb Socket
- B. Bulb
- C. Lamp Assembly

3. Turn the bulb socket (A) counterclockwise to remove it from the lamp assembly (C).
4. Pull the bulb (B) straight out of the bulb socket (A).
5. Push the replacement bulb straight into the bulb socket (A) and turn the bulb socket (A) clockwise to install into the lamp assembly (C).

6. Reinstall the lamp assembly (C) into the fascia by inserting the left side first.
7. Push the spring clip side into place.

Replacement Bulbs

Exterior Lamp	Bulb Number
Back-Up Lamps	3157K
High/Low-Beam Headlamps	HIR2 (9012)
License Plate Lamps	168LL (W5W)

For replacement bulbs not listed here, contact your dealer.

Electrical System

High Voltage Devices and Wiring



Exposure to high voltage can cause shock, burns, and even death. The high voltage components in the vehicle can only be serviced by technicians with special training.

High voltage components are identified by labels. Do not remove, open, take apart, or modify these components. High voltage cable or wiring has orange covering. Do not probe, tamper with, cut, or modify high voltage cable or wiring.

Electrical System Overload

The vehicle has fuses and circuit breakers to protect against an electrical system overload.

When the current electrical load is too heavy, the circuit breaker opens and closes, protecting the circuit until the current load returns to normal or the problem is fixed.

This greatly reduces the chance of circuit overload and fire caused by electrical problems.

Fuses and circuit breakers protect the following in the vehicle:

- Headlamp Wiring
- Windshield Wiper Motor
- Power Windows and other Power Accessories

Replace a bad fuse with a new one of the identical size and rating.

If there is a problem on the road and a fuse needs to be replaced, the same amperage fuse can be

borrowed. Choose some feature of the vehicle that is not needed to use and replace it as soon as possible.

Headlamp Wiring

An electrical overload may cause the lamps to go on and off, or in some cases to remain off. Have the headlamp wiring checked right away if the lamps go on and off or remain off.

Windshield Wipers

If the wiper motor overheats due to heavy snow or ice, the windshield wipers will stop until the motor cools and the wiper control is turned off. After removal of the blockage, the wiper motor will restart when the control is then moved to the desired operating position.

Although the circuit is protected from electrical overload, overload due to heavy snow or ice, may cause wiper linkage damage. Always clear ice and heavy snow from the windshield before using the windshield wipers.

If the overload is caused by an electrical problem and not snow or ice, be sure to get it fixed.

Engine Compartment Fuse Block

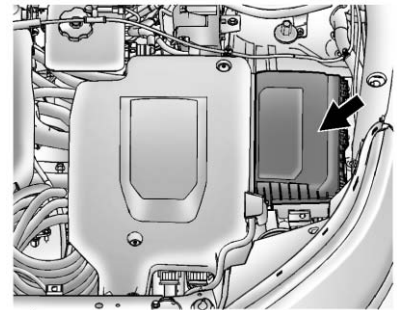

To open the fuse block cover, press the clips at the front and back and rotate the cover up to the side.

Notice: Spilling liquid on any electrical component on the vehicle may damage it. Always keep the covers on any electrical component.

10-34 Vehicle Care

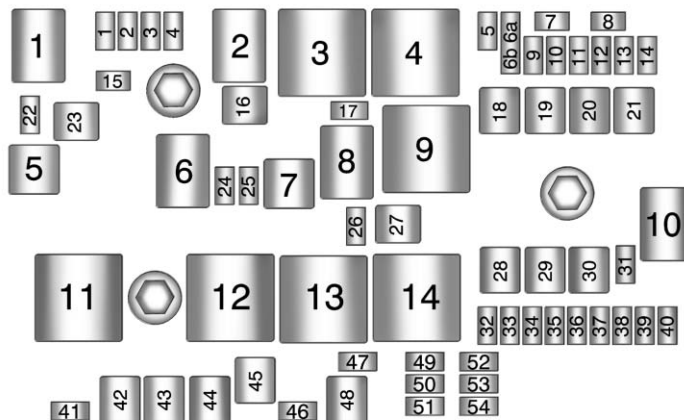

Engine Compartment Fuse Block

A fuse puller is located in the engine compartment fuse block.

The vehicle may not be equipped with all of the fuses, relays, and features shown.

Mini Fuses	Usage
1	Engine Control Module – Switched Power
2	Emissions

Mini Fuses	Usage
3	Not Used
4	Ignition Coils/ Injectors
5	Empty
6a	Empty
6b	Rear Defogger (Lower Grid)
7	Empty
8	Empty
9	Heated Mirrors
10	Air Conditioning Control Module
11	Traction Power Inverter Module – Battery
12	Cabin Heater Pump and Valve
13	Empty
14	Empty

Mini Fuses	Usage
15	Traction Power Inverter Module and Transmission Control Module – Battery
17	Engine Control Module – Battery
22	Left High-Beam Headlamp
24	Empty
25	Empty
26	Empty
31	Rechargeable Energy Storage System (High Voltage Battery) Coolant Pump
32	Sensing Diagnostic Module – Run/Crank

Mini Fuses	Usage
33	Run/Crank for Fuel System Control Module/Vehicle Integration Control Module
34	Vehicle Integration Control Module – Battery
35	Power Electronics Coolant Pump
36	Empty
37	Cabin Heater Control Module
38	Empty
39	Rechargeable Energy Storage System (High Voltage Battery) Control Module
40	Front Windshield Washer

Mini Fuses	Usage
41	Right High-Beam Headlamp
46	Empty
47	Empty
49	Empty
50	Rear Vision Camera – Run/Crank (If Equipped)
51	Run/Crank for ABS/Rechargeable Energy Storage System (High Voltage Battery)/Charger
52	Engine Control Module/Transmission Control Module – Run/Crank

10-36 Vehicle Care

Mini Fuses	Usage
53	Traction Power Inverter Module – Run/Crank
54	Run/Crank for Air Conditioning Control Module/Instrument Cluster/Passenger Airbag Display/Accessory Power Module

J-Case Fuses	Usage
16	Empty
18	Empty
19	Power Window – Front
20	Empty

J-Case Fuses	Usage
21	Antilock Brake System Electronic Control Unit
23	Charge Port Door
27	Empty
28	Empty
29	Empty
30	Antilock Brake System Motor
42	Cooling Fan – Right
43	Front Wipers
44	Charger
45	Empty
48	Cooling Fan – Left

Mini Relays	Usage
3	Powertrain
4	Rear Defog (Lower Grid)/Heated Mirrors
5	Charge Port Door
7	Empty
9	Empty
11	Empty
12	Empty
13	Empty
14	Run/Crank

Micro Relays	Usage
1	Empty
2	Empty
6	Empty
8	Empty
10	Empty

Instrument Panel Fuse Block (Left Side)

The instrument panel fuse block is on the driver side end of the instrument panel. To access the fuses, open the fuse panel door by pulling out.

To reinstall the door, insert the bottom tab first, then push the door back into its original location.

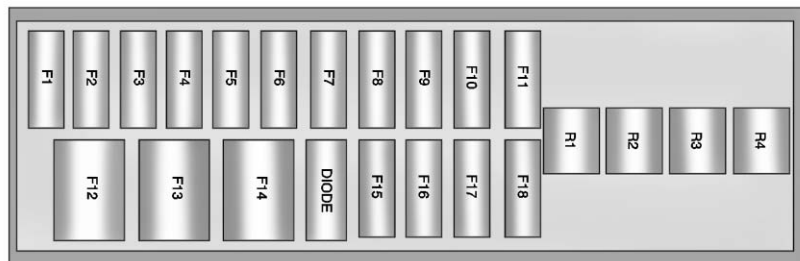

Instrument Panel Fuse Block

A fuse puller is located in the engine compartment fuse block.

The vehicle may not be equipped with all of the fuses, relays, and features shown.

Fuses	Usage
F1	Power Outlet – Top of IP Storage Bin
F2	Radio
F3	Instrument Cluster
F4	Infotainment Display
F5	Heating, Ventilation & Air Conditioning/ Integrated Center Stack Switches
F6	Airbag (Sensing Diagnostic Module/ Passenger Sensing Module)
F7	Data Link Connector 1/Data Link Connector 2
F8	Empty
F9	Empty

10-38 Vehicle Care

Fuses	Usage
F10	Body Control Module 1/Body Control Module Electronics/Keyless Entry/Power Moding/Center High Mount Stoplamp/License Lamps/Left Daytime Running Lamp/Left Front Parking Lamp/Right Rear Taillamp/Hatch Release Relay Control/Washer Pump Relay Control/Switch Indicator Lights

Fuses	Usage
F11	Body Control Module 4/Left Headlamp
F12	Empty
F13	Empty
F14	Empty
F15	Power Outlet (Inside Floor Console/Rear of Floor Console)
F16	Empty
F17	Empty
F18	Empty

Relays	Usage
R1	Retained Accessory Power Relay for Power Outlets
R2	Empty
R3	Empty
R4	Empty

Diodes	Usage
DIODE	Empty

Instrument Panel Fuse Block (Right Side)

The instrument panel fuse block is on the passenger side end of the instrument panel. To access the fuses, open the fuse panel door by pulling out.

To reinstall the door, insert the bottom tab first, then push the door back into its original location.

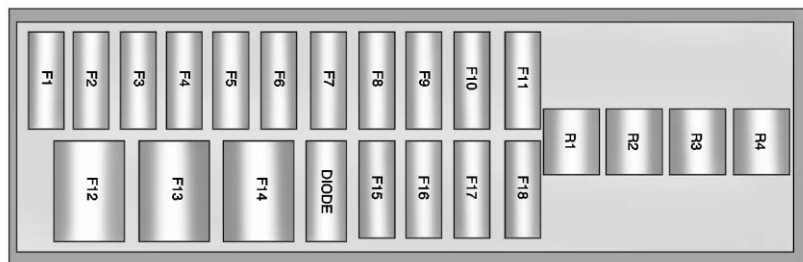

Instrument Panel Fuse Block

A fuse puller is located in the engine compartment fuse block.

The vehicle may not be equipped with all of the fuses, relays, and features shown.

Fuses	Usage
F1	Steering Wheel Switch Backlighting
F2	Empty
F3	Empty
F4	Body Control Module 3/Right Headlamp
F5	Body Control Module 2/Body Control Module Electronics/Hatch Lamp/Right Daytime Running Lamp/Shifter Lock/Switch Backlighting

10-40 Vehicle Care

Fuses	Usage
F6	Body Control Module 5/Retained Accessory Power Relay Control/Right Front Turn Signal Lamp/Left Rear Stop and Turn Signal Lamp/Right Front Parking Lamp/Left Rear Taillamp
F7	Body Control Module 6/Map Lights/Courtesy Lights/Back – up Lamp
F8	Body Control Module 7/Left Front Turn Signal/Right Rear Stop and Turn Signal Lamp/Child Security Lock Relay Control

Fuses	Usage
F9	Body Control Module 8/Locks
F10	OnStar®
F11	Universal Garage Door Opener (If Equipped)
F12	Blower Motor
F13	Empty
F14	Empty
F15	Empty
F16	Empty
F17	Empty
F18	Empty

Relays	Usage
R1	Empty
R2	Empty
R3	Empty
R4	Empty

Diodes	Usage
DIODE	Empty

Rear Compartment Fuse Block

The rear compartment fuse block is on the left side of the rear compartment behind a removable cover. Open the latch to remove the cover and access the fuse block.



A fuse puller is located in the engine compartment fuse block.

The vehicle may not have all of the fuses, relays, and features shown.

Fuses	Usage
F1	Empty
F2	Fuel System Control Module
F3	Passive Start Module
F4	Heated Seats (If Equipped)
F5	Driver Door Switches (Outside Rearview Mirror/ Charge Port Door Release/Refuel Request/Driver Window Switch)
F6	Fuel (Diurnal Valve and Evap. Leak Check Module)
F7	Accessory Power Module Cooling Fan
F8	Amplifier (If Equipped)
F9	Empty

Fuses	Usage
F10	Regulated Voltage Control/Ultrasonic Front and Rear Parking Assist (If Equipped)
F11	Horn
F12	Rear Power Windows
F13	Electric Parking Brake
F14	Rear Defog (Upper Grid)
F15	Empty
F16	Hatch Release
F17	Empty
F18	Empty

Relays	Usage
R1	Rear Defog (Upper Grid)
R2	Hatch Release
R3	Empty
R4	Empty
R5	Empty
R6	Empty
R7	Empty
R8	Horn

Diodes	Usage
DIODE	Empty

Wheels and Tires

Tires

Every new GM vehicle has high-quality tires made by a leading tire manufacturer. See the warranty manual for information regarding the tire warranty and where to get service. For additional information refer to the tire manufacturer.

WARNING

- Poorly maintained and improperly used tires are dangerous.
- Overloading the tires can cause overheating as a result of too much flexing. There could be a blowout and a serious crash. See *Vehicle Load Limits* on page 9-13.

(Continued)

WARNING (Continued)

- Underinflated tires pose the same danger as overloaded tires. The resulting crash could cause serious injury. Check all tires frequently to maintain the recommended pressure. Tire pressure should be checked when the tires are cold.
- Overinflated tires are more likely to be cut, punctured, or broken by a sudden impact — such as when hitting a pothole. Keep tires at the recommended pressure.
- Worn or old tires can cause a crash. If the tread is badly worn, replace them.
- Replace any tires that have been damaged by impacts with potholes, curbs, etc.

(Continued)

WARNING (Continued)

- Improperly repaired tires can cause a crash. Only the dealer or an authorized tire service center should repair, replace, dismount, and mount the tires.
- Do not spin the tires in excess of 55 km/h (35 mph) on slippery surfaces such as snow, mud, ice, etc. Excessive spinning may cause the tires to explode.

Winter Tires

Consider installing winter tires on the vehicle if frequent driving on snow or ice covered roads is expected. All season tires provide good overall performance on most surfaces, but they may not offer the traction or the same level of performance as winter tires on snow or ice covered roads.

Winter tires, in general, are designed for increased traction on snow and ice covered roads. With winter tires, there may be decreased dry road traction, increased road noise, and shorter tread life. After changing to winter tires, be alert for changes in vehicle handling and braking.

See your dealer for details regarding winter tire availability and proper tire selection. Also, see *Buying New Tires on page 10-56*.

If using snow tires:

- Use tires of the same brand and tread type on all four wheel positions.
- Use only radial ply tires of the same size, load range, and speed rating as the original equipment tires.

Winter tires with the same speed rating as the original equipment tires may not be available for H, V, W, Y, and ZR speed rated tires. If winter

Tire Designations

Tire Size

The following is an example of a typical passenger vehicle tire size.

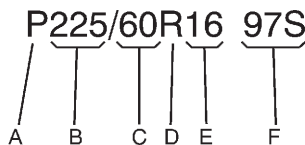

(A) Passenger (P-Metric) Tire:

The United States version of a metric tire sizing system. The letter P as the first character in the tire size means a passenger vehicle tire engineered to standards set by the U.S. Tire and Rim Association.

(B) Tire Width: The three-digit number indicates the tire section width in millimeters from sidewall to sidewall.

(C) Aspect Ratio: A two-digit number that indicates the tire height-to-width measurements. For example, if the tire size aspect ratio is 60, as shown in item C of the illustration, it would mean that the tire's sidewall is 60 percent as high as it is wide.

(D) Construction Code:

A letter code is used to indicate the type of ply construction in the tire. The letter R means radial ply construction; the letter D means diagonal or bias ply construction; and the letter B means belted-bias ply construction.

(E) Rim Diameter: Diameter of the wheel in inches.

(F) Service Description: These characters represent the load index and speed rating of the tire. The load index represents

the load carrying capacity a tire is certified to carry. The speed rating is the maximum speed a tire is certified to carry a load.

Tire Terminology and Definitions

Air Pressure: The amount of air inside the tire pressing outward on each square inch of the tire. Air pressure is expressed in kPa (kilopascal) or psi (pounds per square inch).

Accessory Weight: The combined weight of optional accessories. Some examples of optional accessories are, automatic electric drive unit, power steering, power brakes, power windows, power seats, and air conditioning.

Aspect Ratio: The relationship of a tire's height to its width.

Belt: A rubber coated layer of cords that is located between the plies and the tread. Cords may be made from steel or other reinforcing materials.

Bead: The tire bead contains steel wires wrapped by steel cords that hold the tire onto the rim.

Bias Ply Tire: A pneumatic tire in which the plies are laid at alternate angles less than 90 degrees to the centerline of the tread.

Cold Tire Pressure: The amount of air pressure in a tire, measured in kPa (kilopascal) or psi (pounds per square inch) before a tire has built up heat from driving. See *Tire Pressure on page 10-48*.

Curb Weight: The weight of a motor vehicle with standard and optional equipment including the

maximum capacity of fuel, oil, and coolant, but without passengers and cargo.

DOT Markings: A code molded into the sidewall of a tire signifying that the tire is in compliance with the U.S. Department of Transportation (DOT) Motor Vehicle Safety Standards. The DOT code includes the Tire Identification Number (TIN), an alphanumeric designator which can also identify the tire manufacturer, production plant, brand, and date of production.

GVWR: Gross Vehicle Weight Rating. See *Vehicle Load Limits on page 9-13*.

GAWR FRT: Gross Axle Weight Rating for the front axle. See *Vehicle Load Limits on page 9-13*.

GAWR RR: Gross Axle Weight Rating for the rear axle. See *Vehicle Load Limits on page 9-13*.

Intended Outboard Sidewall: The side of an asymmetrical tire, that must always face outward when mounted on a vehicle.

Kilopascal (kPa): The metric unit for air pressure.

Light Truck (LT-Metric) Tire: A tire used on light duty trucks and some multipurpose passenger vehicles.

Load Index: An assigned number ranging from 1 to 279 that corresponds to the load carrying capacity of a tire.

Maximum Inflation Pressure: The maximum air pressure to which a cold tire can be inflated. The maximum air pressure is molded onto the sidewall.

Maximum Load Rating:

The load rating for a tire at the maximum permissible inflation pressure for that tire.

Maximum Loaded Vehicle Weight:

The sum of curb weight, accessory weight, vehicle capacity weight, and production options weight.

Normal Occupant Weight: The number of occupants a vehicle is designed to seat multiplied by 68 kg (150 lbs). See *Vehicle Load Limits* on page 9-13.

Occupant Distribution:

Designated seating positions.

Outward Facing Sidewall: The side of an asymmetrical tire that has a particular side that faces outward when mounted on a vehicle. The side of the tire that contains a whitewall, bears white lettering, or bears manufacturer, brand, and/or

model name molding that is higher or deeper than the same moldings on the other sidewall of the tire.

Passenger (P-Metric) Tire:

A tire used on passenger cars and some light duty trucks and multipurpose vehicles.

Recommended Inflation

Pressure: Vehicle manufacturer's recommended tire inflation pressure as shown on the tire placard. See *Tire Pressure* on page 10-48 and *Vehicle Load Limits* on page 9-13.

Radial Ply Tire: A pneumatic tire in which the ply cords that extend to the beads are laid at 90 degrees to the centerline of the tread.

Rim: A metal support for a tire and upon which the tire beads are seated.

Sidewall: The portion of a tire between the tread and the bead.

Speed Rating:

An alphanumeric code assigned to a tire indicating the maximum speed at which a tire can operate.

Traction: The friction between the tire and the road surface. The amount of grip provided.

Tread: The portion of a tire that comes into contact with the road.

Treadwear Indicators: Narrow bands, sometimes called wear bars, that show across the tread of a tire when only 1.6 mm (1/16 in) of tread remains. See *When It Is Time for New Tires* on page 10-55.

UTQGS (Uniform Tire Quality Grading Standards): A tire information system that provides consumers with ratings for a

tire's traction, temperature, and treadwear. Ratings are determined by tire manufacturers using government testing procedures. The ratings are molded into the sidewall of the tire. See *Uniform Tire Quality Grading on page 10-58*.

Vehicle Capacity Weight:

The number of designated seating positions multiplied by 68 kg (150 lbs) plus the rated cargo load. See *Vehicle Load Limits on page 9-13*.

Vehicle Maximum Load on the Tire:

Load on an individual tire due to curb weight, accessory weight, occupant weight, and cargo weight.

Vehicle Placard: A label permanently attached to a vehicle showing the vehicle's capacity weight and the original

equipment tire size and recommended inflation pressure. See "Tire and Loading Information Label" under *Vehicle Load Limits on page 9-13*.

Tire Pressure

Tires need the correct amount of air pressure to operate effectively.

Notice: Neither tire underinflation nor overinflation is good. Underinflated tires, or tires that do not have enough air, can result in:

- **Tire overloading and over-heating which could lead to a blowout.**
- **Premature or irregular wear.**
- **Poor handling.**
- **Reduced fuel economy.**

Overinflated tires, or tires that have too much air, can result in:

- **Unusual wear.**
- **Poor handling.**
- **Rough ride.**
- **Needless damage from road hazards.**

The Tire and Loading Information label on the vehicle indicates the original equipment tires and the correct cold tire inflation pressures. The recommended pressure is the minimum air pressure needed to support the vehicle's maximum load carrying capacity.

For additional information regarding how much weight the vehicle can carry, and an example of the Tire and Loading Information label, see *Vehicle Load Limits on page 9-13*.

How the vehicle is loaded affects vehicle handling and ride comfort. Never load the vehicle with more weight than it was designed to carry.

When to Check

Check the tires once a month or more.

How to Check

Use a good quality pocket-type gauge to check tire pressure. Proper tire inflation cannot be determined by looking at the tire. Check the tire inflation pressure when the tires are cold, meaning the vehicle has not been driven for at least three hours or no more than 1.6 km (1 mi).

Remove the valve cap from the tire valve stem. Press the tire gauge firmly onto the valve to get a pressure measurement. If the cold tire inflation pressure matches the recommended

pressure on the Tire and Loading Information label, no further action is necessary.

If the inflation pressure is low, add air until the recommended pressure is reached. If the inflation pressure is high, press the metal stem in the center of the tire valve to release air. Re-check the tire pressure with the tire gauge.

Return the valve caps on the valve stems to prevent leaks and keep out dirt and moisture.

Tire Pressure Monitor System

The Tire Pressure Monitor System (TPMS) uses radio and sensor technology to check tire pressure levels. The TPMS sensors monitor the air pressure in your tires and transmit tire pressure readings to a receiver located in the vehicle.

Each tire, including the spare (if provided), should be checked monthly when cold and inflated to the inflation pressure recommended by the vehicle manufacturer on the vehicle placard or tire inflation pressure label. (If your vehicle has tires of a different size than the size indicated on the vehicle placard or tire inflation pressure label, you should determine the proper tire inflation pressure for those tires.)

As an added safety feature, your vehicle has been equipped with a tire pressure monitoring system (TPMS) that illuminates a low tire pressure telltale when one or more of your tires is significantly under-inflated.

Accordingly, when the low tire pressure telltale illuminates, you should stop and check your tires as soon as possible, and inflate them to the proper pressure. Driving on a significantly under-inflated tire causes the tire to overheat and can lead to tire failure. Under-inflation also reduces fuel efficiency and tire

tread life, and may affect the vehicle's handling and stopping ability.

Please note that the TPMS is not a substitute for proper tire maintenance, and it is the driver's responsibility to maintain correct tire pressure, even if under-inflation has not reached the level to trigger illumination of the TPMS low tire pressure telltale.

Your vehicle has also been equipped with a TPMS malfunction indicator to indicate when the system is not operating properly. The TPMS malfunction indicator is combined with the low tire pressure telltale. When the system detects a malfunction, the telltale will flash for approximately one minute and then remain continuously illuminated. This sequence will continue upon subsequent vehicle start-ups as long as the malfunction exists.

When the malfunction indicator is illuminated, the system may not be able to detect or signal low tire

pressure as intended. TPMS malfunctions may occur for a variety of reasons, including the installation of replacement or alternate tires or wheels on the vehicle that prevent the TPMS from functioning properly. Always check the TPMS malfunction telltale after replacing one or more tires or wheels on your vehicle to ensure that the replacement or alternate tires and wheels allow the TPMS to continue to function properly.

See *Tire Pressure Monitor Operation* on page 10-50 for additional information.

Federal Communications Commission (FCC) and Industry Canada

See *Radio Frequency Statement on page 13-26* for information regarding Part 15 of the Federal Communications Commission (FCC) rules and Industry Canada Standards RSS-210/220/310.

Tire Pressure Monitor Operation

This vehicle may have a Tire Pressure Monitor System (TPMS). The TPMS is designed to warn the driver when a low tire pressure condition exists. TPMS sensors are mounted onto each tire and wheel assembly. The TPMS sensors monitor the air pressure in the tires and transmit the tire pressure readings to a receiver located in the vehicle.



When a low tire pressure condition is detected, the TPMS illuminates the low tire pressure warning light located on the instrument cluster. If the warning light comes on, stop as soon as possible and inflate the tires to the recommended pressure

shown on the Tire Loading and Information label. See *Vehicle Load Limits* on page 9-13.

A message to check the pressure in a specific tire displays in the Driver Information Center (DIC). The low tire pressure warning light and the DIC warning message come on at each drive cycle until the tires are inflated to the correct inflation pressure. Using the DIC, tire pressure levels can be viewed. For additional information and details about the DIC operation and displays see *Driver Information Center (DIC)* on page 5-38.

The low tire pressure warning light may come on in cool weather when the vehicle is first started, and then turn off as the vehicle is driven. This could be an early indicator that the air pressure is getting low and needs to be inflated to the proper pressure.

A Tire and Loading Information label shows the size of the original equipment tires and the correct inflation pressure for the tires when they are cold. See *Vehicle Load Limits* on page 9-13, for an example of the Tire and Loading Information label and its location. Also see *Tire Pressure* on page 10-48.

The TPMS can warn about a low tire pressure condition but it does not replace normal tire maintenance. See *Tire Inspection* on page 10-54, *Tire Rotation* on page 10-54, and *Tires* on page 10-42.

Notice: Tire sealant materials are not all the same. A non-approved tire sealant could damage the TPMS sensors. TPMS sensor damage caused by using an incorrect tire sealant is not covered by the vehicle warranty. Always use only the GM-approved tire sealant available through your dealer or included in the vehicle.

Factory-installed Tire Inflator Kits use a GM-approved liquid tire sealant. Using non-approved tire sealants could damage the TPMS sensors. See *Tire Sealant and Compressor Kit* on page 10-63 for information regarding the inflator kit materials and instructions.

TPMS Malfunction Light and Message

The TPMS will not function properly if one or more of the TPMS sensors are missing or inoperable. When the system detects a malfunction, the low tire pressure warning light flashes for about one minute and then stays on for the remainder of the vehicle on/off cycle. A DIC warning message also displays.

The malfunction light and DIC warning message come on at each vehicle on/off cycle until the problem is corrected. Some of the conditions that can cause these to come on are:

- One of the road tires has been replaced with the spare tire, if the vehicle has one. The spare tire does not have a TPMS sensor. The malfunction light and DIC message should go off after the road tire is replaced and the sensor matching process is performed successfully. See "TPMS Sensor Matching Process" later in this section.
- The TPMS sensor matching process was started but not completed or not completed successfully after rotating the tires. The DIC message and malfunction light should go off once the TPMS sensor

matching process is performed successfully. See "TPMS Sensor Matching Process" later in this section.

- One or more TPMS sensors are missing or damaged. The DIC message and the malfunction light should go off when the TPMS sensors are installed and the sensor matching process is performed successfully. See your dealer for service.
- Replacement tires or wheels do not match the original equipment tires or wheels. Tires and wheels other than those recommended could prevent the TPMS from functioning properly. See *Buying New Tires* on page 10-56.
- Operating electronic devices or being near facilities using radio wave frequencies similar to the TPMS could cause the TPMS sensors to malfunction.

If the TPMS is not functioning properly, it cannot detect or signal a low tire condition. See your dealer for service if the TPMS malfunction light and DIC message come on and stay on.

TPMS Sensor Matching Process

Each TPMS sensor has a unique identification code. The identification code needs to be matched to a new tire/wheel position after rotating the vehicle's tires or replacing one or more of the TPMS sensors. Also, the TPMS sensor matching process should be performed after replacing a spare tire with a road tire containing the TPMS sensor. The malfunction light and the DIC message should go off at the next drive cycle. The sensors are matched to the tire/wheel positions, using a TPMS relearn tool, in the following order: driver side front tire, passenger side front tire, passenger

side rear tire, and driver side rear. See your dealer for service or to purchase a relearn tool.

There are two minutes to match the first tire/wheel position, and five minutes overall to match all four tire/wheel positions. If it takes longer, the matching process stops and must be restarted.

Follow the TPMS sensor matching process:

1. Set the parking brake.
2. Put the vehicle in ON/RUN and place the vehicle in P (Park).
3. If the DIC display is minimized, press the SELECT knob to maximize it.
4. Use the SELECT knob to scroll to the Tire Pressure display screen.
5. Press and hold the SELECT knob for five seconds to begin the sensor matching process.

A message displays confirming to begin the process.

6. Use the SELECT knob to select YES with the highlighted selection, and press the SELECT knob again to confirm the selection.

The horn sounds twice to signal the receiver is in relearn mode and the TIRE LEARNING ACTIVE message displays on the DIC screen.

7. Start with the driver side front tire.
8. Place the relearn tool against the tire sidewall, near the valve stem. Then press the button to activate the TPMS sensor. A horn chirp confirms that the sensor identification code has been matched to this tire and wheel position.
9. Proceed to the passenger side front tire, and repeat the procedure in Step 8.

10. Proceed to the passenger side rear tire, and repeat the procedure in Step 8.
11. Proceed to the driver side rear tire, and repeat the procedure in Step 8. The horn sounds two times to indicate the sensor identification code has been matched to the driver side rear tire, and the TPMS sensor matching process is no longer active. The TIRE LEARNING ACTIVE message on the DIC display screen goes off.
12. Turn the vehicle off.
13. Set all four tires to the recommended air pressure level as indicated on the Tire and Loading Information label.

Tire Inspection

GM recommends that the tires, including the spare, be inspected for signs of wear or damage at least once a month.

Replace the tire if:

- The indicators at three or more places around the tire can be seen.
- There is cord or fabric showing through the tire's rubber.
- The tread or sidewall is cracked, cut, or snagged deep enough to show cord or fabric.
- The tire has a bump, bulge, or split.
- The tire has a puncture, cut, or other damage that cannot be repaired well because of the size or location of the damage.

Tire Rotation

Tires should be rotated every 12 000 km (7,500 mi). The first rotation is the most important. See *Scheduled Maintenance on page 11-3*.

Tires are rotated to achieve a more uniform wear for all tires.

Any time unusual wear is noticed, rotate the tires as soon as possible, and check the wheel alignment. See *When It Is Time for New Tires on page 10-55* and *Wheel Replacement on page 10-60*.

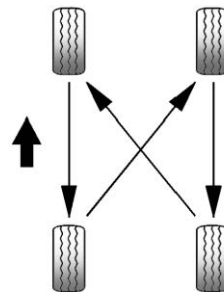

Use this rotation pattern when rotating the tires.

Adjust the front and rear tires to the recommended inflation pressure on the Tire and Loading Information label after the tires have been rotated. See *Tire Pressure on page 10-48* and *Vehicle Load Limits on page 9-13*.

Reset the Tire Pressure Monitor System. See *Tire Pressure Monitor Operation* on page 10-50.

Check that all wheel nuts are properly tightened. See “Wheel Nut Torque” under *Capacities and Specifications* on page 12-2.

⚠ WARNING

Rust or dirt on a wheel, or on the parts to which it is fastened, can make wheel nuts become loose after a time. The wheel could come off and cause a crash. When changing a wheel, remove any rust or dirt from places where

(Continued)

WARNING (Continued)

the wheel attaches to the vehicle. In an emergency, a cloth or a paper towel can be used, however, use a scraper or wire brush to remove all rust or dirt.

Lightly coat the center of the wheel hub with wheel bearing grease after a wheel change or tire rotation to prevent corrosion or rust build-up. Do not get grease on the flat wheel mounting surface or on the wheel nuts or bolts.

When It Is Time for New Tires

Factors, such as maintenance, temperatures, driving speeds, vehicle loading, and road conditions affect the wear rate of the tires.

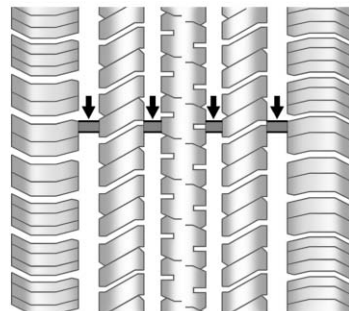

Treadwear indicators are one way to tell when it is time for new tires. Treadwear indicators appear when the tires have only 1.6 mm (1/16 in) or less of tread remaining. See *Tire Inspection* on page 10-54 and *Tire Rotation* on page 10-54 for additional information.

The rubber in tires ages over time. This also applies to the spare tire, if the vehicle has one, even if it is never used. Multiple conditions including temperatures, loading conditions, and inflation pressure maintenance affect how fast aging takes place. Tires will typically need to be replaced due to wear before they may need to be replaced due to age. Consult the tire manufacturer for more information on when tires should be replaced.

Vehicle Storage

Tires age when stored normally mounted on a parked vehicle. Park a vehicle that will be stored for at least a month in a cool, dry, clean area away from direct sunlight to slow aging. This area should be free of grease, gasoline, or other substances that can deteriorate rubber.

Parking for an extended period can cause flat spots on the tires that may result in vibrations while driving. When storing a vehicle for at least a month, remove the tires or raise the vehicle to reduce the weight from the tires.

Buying New Tires

GM has developed and matched specific tires for the vehicle. The original equipment tires installed on the vehicle, when it was new, were designed to meet General Motors Tire Performance Criteria Specification (TPC Spec) system rating. If replacement tires are needed, GM strongly recommends buying tires with the same TPC Spec rating. This way, the vehicle will continue to have tires that are designed to give the same performance and vehicle safety, during normal use, as the original tires.

GM's exclusive TPC Spec system considers over a dozen critical specifications that impact the overall performance of the vehicle, including brake system performance, ride and handling, traction control, and tire pressure monitoring performance. GM's TPC Spec number is molded onto the tire's sidewall near the tire size. If the tires have an all-season tread design, the TPC spec number will be followed by MS, for mud and snow. See *Tire Sidewall Labeling on page 10-44* for additional information.

GM recommends replacing all the tires at the same time. Uniform tread depth on all tires will help to maintain the performance of the vehicle. Braking and handling performance may be adversely affected if all the tires are not

replaced at the same time. See *Tire Inspection on page 10-54* and *Tire Rotation on page 10-54* for information on proper tire rotation.

 **WARNING**

Tires could explode during improper service. Attempting to mount or dismount a tire could cause injury or death. Only your dealer or authorized tire service center should mount or dismount the tires.

 **WARNING**

Mixing tires of different sizes, brands, or types may cause loss of control of the vehicle, resulting in a crash or other vehicle damage. Use the correct size, brand, and type of tire on all wheels.

 **WARNING**

Using bias-ply tires on the vehicle may cause the wheel rim flanges to develop cracks after many miles of driving. A tire and/or wheel could fail suddenly and cause a crash. Use only radial-ply tires with the wheels on the vehicle.

If the vehicle tires must be replaced with a tire that does not have a TPC Spec number, make sure they are the same size, load range, speed rating, and construction (either radial and bias-belted tires) as the original tires.

Vehicles that have a tire pressure monitoring system could give an inaccurate low-pressure warning if non-TPC Spec rated tires are installed. See *Tire Pressure Monitor System on page 10-49*.

The Tire and Loading Information Label indicates the original equipment tires on the vehicle. See *Vehicle Load Limits on page 9-13*, for the label location and more information about the Tire and Loading Information label.

Different Size Tires and Wheels

If wheels or tires are installed that are a different size than the original equipment wheels and tires, vehicle performance, including its braking, ride and handling characteristics, stability, and resistance to rollover may be affected. If the vehicle has electronic systems such as antilock brakes, rollover airbags, traction control, and electronic stability control, the performance of these systems can also be affected.

 **WARNING**

If different sized wheels are used, there may not be an acceptable level of performance and safety if tires not recommended for those wheels are selected. This increases the chance of a crash and serious injury. Only use GM specific wheel and tire systems

(Continued)

WARNING (Continued)

developed for the vehicle, and have them properly installed by a GM certified technician.

See *Buying New Tires on page 10-56* and *Accessories and Modifications on page 10-3* for additional information.

Uniform Tire Quality Grading

Quality grades can be found where applicable on the tire sidewall between tread shoulder and maximum section width. For example:

Treadwear 200 Traction AA Temperature A

The following information relates to the system developed by the United States National Highway Traffic Safety Administration

(NHTSA), which grades tires by treadwear, traction, and temperature performance. This applies only to vehicles sold in the United States. The grades are molded on the sidewalls of most passenger car tires. The Uniform Tire Quality Grading (UTQG) system does not apply to deep tread, winter-type snow tires, space-saver, or temporary use spare tires, tires with nominal rim diameters of 10 to 12 inches (25 to 30 cm), or to some limited-production tires.

While the tires available on General Motors passenger cars and light trucks may vary with respect to these grades, they must also conform to federal safety requirements and additional General Motors Tire Performance Criteria (TPC) standards.

All Passenger Car Tires Must Conform to Federal Safety Requirements In Addition To These Grades.

Treadwear

The treadwear grade is a comparative rating based on the wear rate of the tire when tested under controlled conditions on a specified government test course. For example, a tire graded 150 would wear one and a half (1½) times as well on the government course as a tire graded 100. The relative performance of tires depends upon the actual conditions of their use, however, and may depart significantly from the norm due to variations in driving habits, service practices and differences in road characteristics and climate.

Traction – AA, A, B, C

The traction grades, from highest to lowest, are AA, A, B, and C. Those grades represent the tire's ability to stop on wet pavement as measured under controlled conditions on specified government test surfaces of asphalt and concrete. A tire marked C may have poor traction performance. Warning: The traction grade assigned to this tire is based on straight-ahead braking traction tests, and does not include acceleration, cornering, hydroplaning, or peak traction characteristics.

Temperature – A, B, C

The temperature grades are A (the highest), B, and C, representing the tire's resistance to the generation of heat and its ability to dissipate heat when tested under controlled

conditions on a specified indoor laboratory test wheel. Sustained high temperature can cause the material of the tire to degenerate and reduce tire life, and excessive temperature can lead to sudden tire failure. The grade C corresponds to a level of performance which all passenger car tires must meet under the Federal Motor Safety Standard No. 109. Grades B and A represent higher levels of performance on the laboratory test wheel than the minimum required by law. Warning: The temperature grade for this tire is established for a tire that is properly inflated and not overloaded. Excessive speed, underinflation, or excessive loading, either separately or in combination, can cause heat buildup and possible tire failure.

Wheel Alignment and Tire Balance

The tires and wheels were aligned and balanced at the factory to provide the longest tire life and best overall performance. Adjustments to wheel alignment and tire balancing will not be necessary on a regular basis. However, check the alignment if there is unusual tire wear or the vehicle is pulling to one side or the other. If the vehicle is vibrating when driving on a smooth road, the tires and wheels may need to be rebalanced. See your dealer for proper diagnosis.

Wheel Replacement

Replace any wheel that is bent, cracked, or badly rusted or corroded. If wheel nuts keep coming loose, the wheel, wheel bolts and wheel nuts should be replaced. If the wheel leaks air, replace it. Some aluminum wheels can be repaired. See your dealer if any of these conditions exist.

Your dealer will know the kind of wheel that is needed.

Each new wheel should have the same load-carrying capacity, diameter, width, offset and be mounted the same way as the one it replaces.

Replace wheels, wheel bolts, wheel nuts, or Tire Pressure Monitor System (TPMS) sensors with new GM original equipment parts.

WARNING

Using the wrong replacement wheels, wheel bolts, or wheel nuts can be dangerous. It could affect the braking and handling of the vehicle. Tires can lose air, and cause loss of control, causing a crash. Always use the correct wheel, wheel bolts, and wheel nuts for replacement.

Notice: The wrong wheel can also cause problems with bearing life, brake cooling, speedometer or odometer calibration, headlamp aim, bumper height, vehicle ground clearance, and tire clearance to the body and chassis.

WARNING

Rust or dirt on a wheel, or on the parts to which it is fastened, can make wheel nuts become loose after a time. The wheel could come off and cause a crash. When changing a wheel, remove any rust or dirt from places where the wheel attaches to the vehicle. In an emergency, a cloth or a paper towel can be used, however, use a scraper or wire brush to remove all rust or dirt.

 **WARNING**

Never use oil or grease on studs or the threads of the wheel nuts. If you do, the wheel nuts might come loose and the wheel could fall off, causing a crash.

 **WARNING**

Incorrect wheel nuts or improperly tightened wheel nuts can cause the wheel to become loose and even come off. This could lead to a crash. Be sure to use the correct wheel nuts. If you have to replace them, be sure to get new GM original equipment wheel nuts.

Notice: Improperly tightened wheel nuts can lead to brake pulsation and rotor damage. **To avoid expensive brake repairs, evenly tighten the wheel nuts in the proper sequence and to the proper torque specification.**

Used Replacement Wheels **WARNING**

Replacing a wheel with a used one is dangerous. How it has been used or how far it has been driven may be unknown. It could fail suddenly and cause a crash. When replacing wheels, use a new GM original equipment wheel.

Tire Chains **WARNING**

Do not use tire chains. There is not enough clearance. Tire chains used on a vehicle without the proper amount of clearance can cause damage to the brakes, suspension or other vehicle parts. The area damaged by the tire chains could cause loss of control and a crash.

Use another type of traction device only if its manufacturer recommends it for the vehicle's tire size combination and road conditions. Follow that manufacturer's instructions. To avoid vehicle damage, drive slow and readjust or remove the traction device if it contacts the vehicle. Do not spin the wheels. If traction devices are used, install them on the front tires.

If a Tire Goes Flat

This vehicle has a tire sealant and compressor kit. See *Tire Sealant and Compressor Kit on page 10-63*. There is no spare tire, no tire changing equipment, and no place to store a tire.

To properly lift this vehicle, see *Lifting the Vehicle on page 10-3*.

It is unusual for a tire to blowout, especially if the tires are maintained properly. See *Tires on page 10-42*. If air goes out of a tire, it is much more likely to leak out slowly. But if there is ever a blowout, here are a few tips about what to expect and what to do:

If a front tire fails, the flat tire will create a drag that pulls the vehicle toward that side. Take your foot off the accelerator pedal and grip the steering wheel firmly. Steer to maintain lane position, and then gently brake to a stop, well off the road, if possible.

A rear blowout, particularly on a curve, acts much like a skid and may require the same correction as used in a skid. Stop pressing the accelerator pedal and steer to straighten the vehicle. It may be very bumpy and noisy. Gently brake to a stop, well off the road, if possible.

WARNING

Driving on a flat tire will cause permanent damage to the tire. Re-inflating a tire after it has been driven on while severely underinflated or flat may cause a blowout and a serious crash. Never attempt to re-inflate a tire that has been driven on while severely underinflated or flat. Have your dealer or an authorized tire service center repair or replace the flat tire as soon as possible.

If a tire goes flat, avoid further tire and wheel damage by driving slowly to a level place and stopping, well off the road, if possible.

1. Turn on the hazard warning flashers. See *Hazard Warning Flashers on page 6-4*.
2. Set the parking brake firmly.
3. Put the shift lever in P (Park). See *Shifting Into Park on page 9-21*.
4. Turn off the engine.
5. Inspect the flat tire.

If the tire has been separated from the wheel, has damaged sidewalls, or has a puncture larger than 6 mm ($\frac{1}{4}$ in), the tire is too severely damaged for the tire sealant and compressor kit to be effective. See *Roadside Assistance Program on page 13-6*.

If the tire has a puncture less than 6 mm ($\frac{1}{4}$ in) in the tread area of the tire, see *Tire Sealant and Compressor Kit on page 10-63*.

Tire Sealant and Compressor Kit

WARNING

Running the engine in Extended Range Mode in an enclosed area with poor ventilation is dangerous. Engine exhaust may enter the vehicle. Engine exhaust contains Carbon Monoxide (CO) which cannot be seen or smelled. It can cause unconsciousness and even death. Never run the engine in Extended Range Mode in an enclosed area that has no fresh air ventilation. For more information, see *Engine Exhaust* on page 9-28.

WARNING

Overinflating a tire could cause the tire to rupture and you or others could be injured. Be sure to read and follow the tire sealant and compressor kit instructions and inflate the tire to its recommended pressure. Do not exceed the recommended pressure.

WARNING

Storing the tire sealant and compressor kit or other equipment in the passenger compartment of the vehicle could cause injury. In a sudden stop or collision, loose equipment could strike someone. Store the tire sealant and compressor kit in its original location.

If this vehicle has a tire sealant and compressor kit, there may not be a spare tire, tire changing equipment, and on some vehicles there may not be a place to store a tire.

The tire sealant and compressor can be used to temporarily seal punctures up to 6 mm ($\frac{1}{4}$ in) in the tread area of the tire. It can also be used to inflate an underinflated tire.

If the tire has been separated from the wheel, has damaged sidewalls, or has a large puncture, the tire is too severely damaged for the tire sealant and compressor kit to be effective. See *Roadside Assistance Program* on page 13-6.

Read and follow all of the tire sealant and compressor kit instructions.

The kit includes:

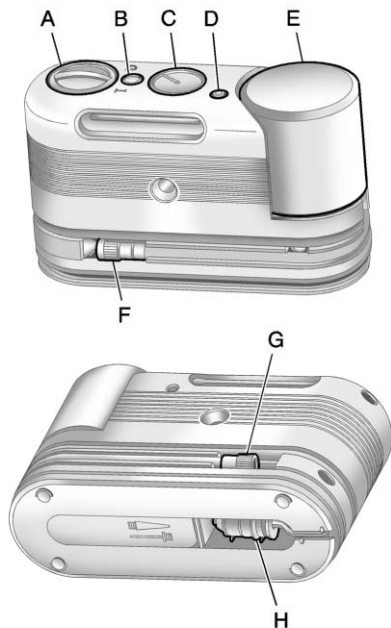

- A. Selector Switch (Sealant/Air or Air Only)
- B. On/Off Button
- C. Pressure Gauge
- D. Pressure Deflation Button (If equipped)
- E. Tire Sealant Canister
- F. Sealant/Air Hose (Clear)
- G. Air Only Hose (Black)
- H. Power Plug

Tire Sealant

Read and follow the safe handling instructions on the label adhered to the sealant canister.

Check the tire sealant expiration date on the sealant canister. The sealant canister should be replaced before its expiration date. Replacement sealant canisters are available at your local dealer. See "Removal and Installation of the Sealant Canister" following.

There is only enough sealant to seal one tire. After usage, the sealant canister and sealant/air hose assembly must be replaced. See "Removal and Installation of the Sealant Canister" following.

Using the Tire Sealant and Compressor Kit to Temporarily Seal and Inflate a Punctured Tire

Follow the directions closely for correct sealant usage.

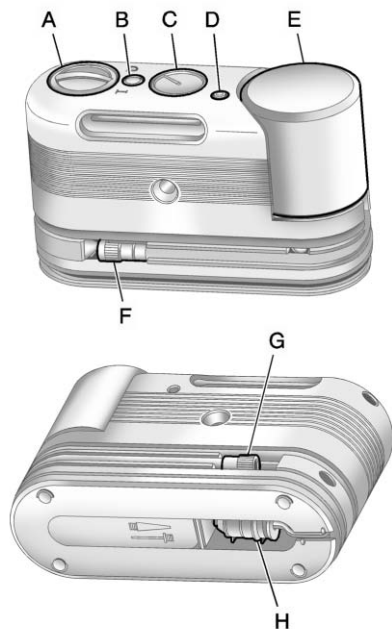

When using the tire sealant and compressor kit during cold temperatures, warm the kit in a heated environment for five minutes. This will help to inflate the tire faster.

If a tire goes flat, avoid further tire and wheel damage by driving slowly to a level place. Turn on the hazard warning flashers. See *Hazard Warning Flashers* on page 6-4.

See *If a Tire Goes Flat* on page 10-62 for other important safety warnings.

Do not remove any objects that have penetrated the tire.

1. Remove the tire sealant and compressor kit from its storage location. See *Storing the Tire Sealant and Compressor Kit* on page 10-70.
2. Unwrap the sealant/air hose (F) and the power plug (H).

3. Place the kit on the ground.
Make sure the tire valve stem is positioned close to the ground so the hose will reach it.
4. Remove the valve stem cap from the flat tire by turning it counterclockwise.
5. Attach the sealant/air hose (F) onto the tire valve stem. Turn it clockwise until it is tight.
6. Plug the power plug (H) into the accessory power outlet in the vehicle. Unplug all items from other accessory power outlets. See *Power Outlets* on page 5-8.

If the vehicle has an accessory power outlet, do not use the cigarette lighter.

If the vehicle only has a cigarette lighter, use the cigarette lighter.

Do not pinch the power plug cord in the door or window.

7. Start the vehicle. The vehicle must be running while using the air compressor.
8. Turn the selector switch (A) counterclockwise to the Sealant + Air position.
9. Press the on/off button (B) to turn the tire sealant and compressor kit on.

The compressor will inject sealant and air into the tire.

The pressure gauge (C) will initially show a high pressure while the compressor pushes the sealant into the tire. Once the sealant is completely dispersed into the tire, the pressure will quickly drop and start to rise again as the tire inflates with air only.

10. Inflate the tire to the recommended inflation pressure using the pressure gauge (C). The recommended inflation pressure can be found on the Tire and Loading Information label. See *Tire Pressure on page 10-48*.

The pressure gauge (C) may read higher than the actual tire pressure while the compressor is on. Turn the compressor off to get an accurate pressure reading. The compressor may be turned on/off until the correct pressure is reached.

Notice: If the recommended pressure cannot be reached after approximately 25 minutes, the vehicle should not be driven farther. The tire is too severely damaged and the tire sealant and compressor kit cannot inflate the

tire. Remove the power plug from the accessory power outlet and unscrew the inflating hose from the tire valve. See *Roadside Assistance Program on page 13-6*.

11. Press the on/off button (B) to turn the tire sealant and compressor kit off.

The tire is not sealed and will continue to leak air until the vehicle is driven and the sealant is distributed in the tire; therefore, Steps 12 through 18 must be done immediately after Step 11.

Be careful while handling the tire sealant and compressor kit as it could be warm after usage.

12. Unplug the power plug (H) from the accessory power outlet in the vehicle.
13. Turn the sealant/air hose (F) counterclockwise to remove it from the tire valve stem.
14. Replace the tire valve stem cap.
15. Replace the sealant/air hose (F), and the power plug (H) back in their original location.



16. If the flat tire was able to inflate to the recommended inflation pressure, remove the maximum speed label from the sealant canister (E) and place it in a highly visible location. The label is a reminder not to exceed 90 km/h (55 mph) until the damaged tire is repaired or replaced.
17. Return the equipment to its original storage location in the vehicle.
18. Immediately drive the vehicle 8 km (5 mi) to distribute the sealant in the tire.

19. Stop at a safe location and check the tire pressure. Refer to Steps 1 through 11 under “Using the Tire Sealant and Compressor Kit without Sealant to Inflate a Tire (Not Punctured).”

If the tire pressure has fallen more than 68 kPa (10 psi) below the recommended inflation pressure, stop driving the vehicle. The tire is too severely damaged and the tire sealant cannot seal the tire. See *Roadside Assistance Program* on page 13-6.

If the tire pressure has not dropped more than 68 kPa (10 psi) from the recommended inflation pressure, inflate the tire to the recommended inflation pressure.

20. Wipe off any sealant from the wheel, tire, and vehicle.

10-68 Vehicle Care

21. Dispose of the used sealant canister (E) and sealant/air hose (F) assembly at a local dealer or in accordance with local state codes and practices.
22. Replace it with a new canister available from your dealer.
23. After temporarily sealing a tire using the tire sealant and compressor kit, take the vehicle to an authorized dealer within a 161 km (100 mi) of driving to have the tire repaired or replaced.

Using the Tire Sealant and Compressor Kit without Sealant to Inflate a Tire (Not Punctured)

To use the air compressor to inflate a tire with air only and not sealant:

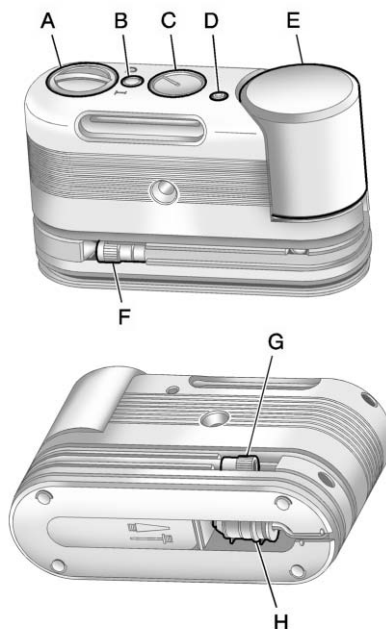

If a tire goes flat, avoid further tire and wheel damage by driving slowly to a level place. Turn on the hazard warning flashers. See *Hazard Warning Flashers* on page 6-4.

See *If a Tire Goes Flat* on page 10-62 for other important safety warnings.

1. Remove the tire sealant and compressor kit from its storage location. See *Storing the Tire Sealant and Compressor Kit* on page 10-70.
2. Unwrap the air only hose (G) and the power plug (H).
3. Place the kit on the ground.
Make sure the tire valve stem is positioned close to the ground so the hose will reach it.
4. Remove the tire valve stem cap from the flat tire by turning it counterclockwise.

- 5. Attach the air only hose (G) onto the tire valve stem by turning it clockwise until it is tight.
- 6. Plug the power plug (H) into the accessory power outlet in the vehicle. Unplug all items from other accessory power outlets. See *Power Outlets on page 5-8*.

If the vehicle has an accessory power outlet, do not use the cigarette lighter.

If the vehicle only has a cigarette lighter, use the cigarette lighter.

Do not pinch the power plug cord in the door or window.
- 7. Start the vehicle. The vehicle must be running while using the air compressor.
- 8. Turn the selector switch (A) clockwise to the Air Only position.
- 9. Press the on/off (B) button to turn the compressor on.

The compressor will inflate the tire with air only.

- 10. Inflate the tire to the recommended inflation pressure using the pressure gauge (C). The recommended inflation pressure can be found on the Tire and Loading Information label. See *Tire Pressure on page 10-48*.

The pressure gauge (C) may read higher than the actual tire pressure while the compressor is on. Turn the compressor off to get an accurate reading. The compressor may be turned on/off until the correct pressure is reached.

If you inflate the tire higher than the recommended pressure you can adjust the excess pressure by pressing the pressure deflation button (D), if equipped, until the proper pressure reading is reached. This option is only functional when using the air only hose (G).

- 11. Press the on/off button (B) to turn the tire sealant and compressor kit off.

Be careful while handling the tire sealant and compressor kit as it could be warm after usage.
- 12. Unplug the power plug (H) from the accessory power outlet in the vehicle.
- 13. Disconnect the air only hose (G) from the tire valve stem by turning it counterclockwise, and replace the tire valve stem cap.
- 14. Replace the air only hose (G) and the power plug (H) and cord back in their original locations.
- 15. Place the equipment in the original storage location in the vehicle.

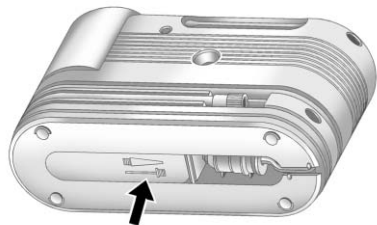

The tire sealant and compressor kit has an accessory adapter located in a compartment on the bottom of its housing that may be used to inflate air mattresses, balls, etc.

Removal and Installation of the Sealant Canister

To remove the sealant canister:

1. Unwrap the sealant hose.
2. Press the canister release button.
3. Pull up and remove the canister.
4. Replace with a new canister which is available from your dealer.
5. Push the new canister into place.

Storing the Tire Sealant and Compressor Kit

To access the tire sealant and compressor kit:

1. Open the hatch. See *Hatch on page 2-10*.
2. Lift the cover.

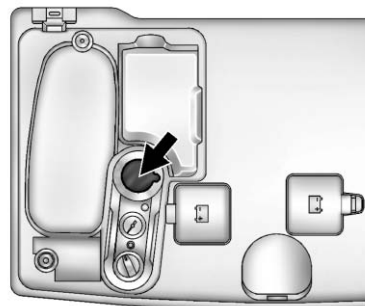

3. Remove the tire sealant and compressor kit.

To store the tire sealant and compressor kit, reverse the steps.

Jump Starting

Jump starting is connecting jumper cables between the two vehicles to enable vehicle starting. If the Volt or another vehicle has a run-down 12-volt battery, it can be jump started using good condition jumper cables. There are different procedures depending on if the Volt has a run-down battery or another vehicle has a run-down battery. Read the appropriate procedures that follow.

WARNING

The high voltage battery cannot be jump started either with another vehicle or battery charger. Personal injury, death, or damage to the vehicle could result.

WARNING

Batteries are dangerous and can cause injury. Batteries contain acid and can explode or ignite. They contain electricity that can burn. Follow the exact steps provided or injuries could occur.

Using an open flame near a battery can cause battery gas to explode; you or others could be hurt. Battery acid can cause blindness.

Be sure the battery in the other vehicle has enough water. Add water if the level is low. A low water level could cause explosive gas to be present.

Battery fluid contains acid that can burn. If battery fluid gets in eyes or on skin; flush with water and get medical help immediately.

WARNING

Electric fans can start up even when the engine is not running and can cause injury. Keep hands, clothing, and tools away from any underhood electric fans.

Notice: Ignoring these steps could result in costly damage to the vehicle that would not be covered by the warranty.

Trying to start the vehicle by pushing or pulling it will not work, and it could damage the vehicle.

Jump Starting the Volt

If the Volt won't start, the 12-volt battery may be run down. To jump start the Volt use the underhood remote positive (+) and negative (-) terminals.

1. The other vehicle used to jump start the Volt must have a 12-volt battery with a negative ground system.

Notice: Only use a vehicle that has a 12-volt system with a negative ground for jump starting. If the other vehicle does not have a 12-volt system with a negative ground, both vehicles can be damaged.

2. Park both vehicles close enough so that the jumper cables can reach both vehicles' positive (+) and negative (-) terminals. The vehicles must not touch each other. It could cause an unwanted ground connection that could damage both vehicles' electrical systems.

Put both vehicles in P (Park) for an automatic transmission or electric drive unit. For a manual transmission, place the vehicle in N (Neutral) and set the parking brake.

Notice: If the radio or other accessories are left on during the jump starting procedure, they could be damaged. The repairs would not be covered by the warranty. Always turn off the radio and other accessories when jump starting the vehicle.

3. Turn off the ignition on the other vehicle. Turn off the radio, all lamps, and accessories that are not needed in both vehicles. Unplug accessories from the cigarette lighter or the accessory power outlets. This avoids sparks and helps save both batteries and accessories.

4. Locate the positive (+) and negative (-) terminals on the other vehicle.

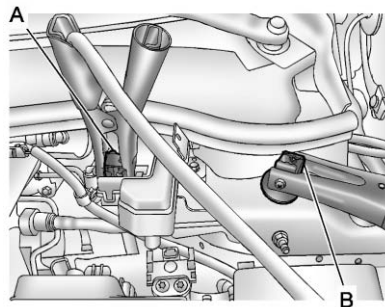

5. Open the hood to locate the positive (+) and negative (-) terminals on your Volt. Open the access cover (A) for the remote positive (+) terminal. The remote negative terminal (B) for the Volt is a stud marked GND (-) on the driver side of the engine compartment.

6. Check that the jumper cables do not have loose or missing insulation or a shock could result and the vehicles could be damaged.

Before connecting the jumper cables, here are some basic things to know. Positive (+) jumper cable goes to positive (+) battery terminal or a remote positive (+) terminal if available. Negative (-) jumper cable goes to negative (-) battery terminal or a remote negative (-) terminal if available. Do not connect positive (+) to negative (-) or there will be a short that may damage the battery and other parts of the vehicle.

Notice: If the jumper cables are connected or removed in the wrong order, electrical shorting may occur and damage the vehicle. The repairs would not be covered by the vehicle warranty.

Always connect and remove the jumper cables in the correct order, making sure that the cables do not touch each other or other metal.

Connecting the Jumper Cables

1. Connect the red positive (+) jumper cable to the remote positive (+) terminal (A) of your Volt. Do not let the other end of the cable touch metal.
2. Connect the other end of the red positive (+) jumper cable to the positive (+) terminal of the other vehicle.
3. Connect the black negative (-) jumper cable to the negative (-) battery terminal of the other vehicle battery. Do not let the other end touch anything until the next step.
4. Connect the other end of the black negative (-) jumper cable to the remote negative (-) terminal of your Volt.
5. Push the POWER  button to start. This will wake up the electronics on the Volt. After the instrument cluster initializes, the Volt will use power from the high voltage battery to charge the 12-volt battery. The jumper cables can then be disconnected. If the Volt does not start, call your dealer or Roadside Assistance. See *Roadside Assistance Program on page 13-6*.

Disconnecting the Jumper Cables

1. Disconnect the black negative (-) jumper cable from the Volt. Do not let the other end of the cable touch anything until after the next step.
2. Disconnect the black negative (-) jumper cable from the other vehicle with the good battery.
3. Disconnect the red positive (+) jumper cable from the other vehicle. Do not let the other end of the cable touch anything until after the next step.
4. Disconnect the red positive (+) jumper cable from the Volt.
5. Return the positive (+) and negative (-) terminal covers to their original positions.

Jump Starting Another Vehicle

When using the Volt to jump start another vehicle with a run-down battery, jumper cables are connected directly to the positive (+) and negative (-) terminals on the 12-volt battery in the rear cargo area. Do not use the remote terminals under the hood. This could cause a fuse to overload in the Volt.

1. Check the other vehicle. It must have a 12-volt battery with a negative ground system.

Notice: Only use a vehicle that has a 12-volt system with a negative ground for jump starting. If the other vehicle does not have a 12-volt system with a negative ground, both vehicles can be damaged.

2. Park both vehicles close enough so that the jumper cables can reach both vehicles' positive (+) and negative (-) terminals.

The vehicles must not touch each other. It could cause an unwanted ground connection that could damage both vehicles' electrical systems.

Put both vehicles in P (Park) for an automatic transmission or electric drive unit. For a manual transmission, place the vehicle in N (Neutral) and set the parking brake.

Notice: If the radio or other accessories are left on during the jump starting procedure, they could be damaged. The repairs would not be covered by the warranty. Always turn off the radio and other accessories when jump starting the vehicle.

3. Turn off both vehicles. Turn off the radio, all lamps, and accessories that are not needed in both vehicles. Unplug accessories from the cigarette lighter or the accessory power outlets. This avoids sparks and helps save both batteries and accessories.
4. Locate the positive (+) and negative (-) terminals on the vehicle with the run-down battery.

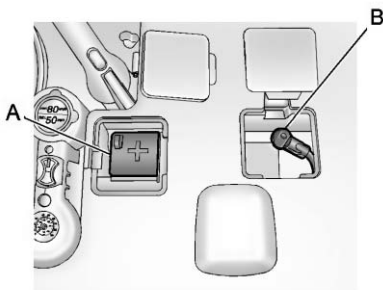

5. Locate the positive (+) and negative (-) battery terminals on the Volt. The access cover is under the load floor access cover in the rear cargo area.

- Open the access cover for the positive (+) terminal cover (A) and the negative (-) terminal cover (B).
6. Check that the jumper cables do not have loose or missing insulation or a shock could result and the vehicles could be damaged.

Before connecting the jumper cables, here are some basic things to know. Positive (+) jumper cable goes to positive (+) battery terminal or a remote positive (+) terminal if available. Negative (-) jumper cable goes to remote negative (-) terminal if available, or a heavy, unpainted metal engine part or a solid engine ground on the vehicle with the run-down battery.

Do not connect positive (+) to negative (-) or there will be a short that may damage the battery or other parts of the vehicle. Do not connect the negative (-) cable to the negative (-) terminal on the run-down battery because this can cause sparks.

Notice: If the jumper cables are connected or removed in the wrong order, electrical shorting may occur and damage the vehicle. The repairs would not be covered by the vehicle warranty. Always connect and remove the jumper cables in the correct order, making sure that the cables do not touch each other or other metal.

Connecting the Jumper Cables

1. Connect the red positive (+) jumper cable to the positive (+) terminal of the other vehicle with the run-down battery. Use a remote positive (+) terminal if available. Do not let the other end touch metal.
2. Connect the other end of the red positive (+) jumper cable to the positive (+) battery terminal of the Volt.
3. Connect the black negative (-) jumper cable to the negative (-) battery terminal of the Volt. Do not let the other end touch anything until the next step.
4. Make the final connection to a heavy, unpainted metal engine part or to the remote negative (-) terminal on the other vehicle with the run-down battery.
5. Press the POWER  button to start the Volt. This will wake up the electronics on the Volt. The engine will only start if it is needed.
6. Try to start the other vehicle that had the run-down battery. If it will not start after a few tries, it probably needs service.

Disconnecting the Jumper Cables

1. Disconnect the black negative (-) jumper cable from the other vehicle that had the run-down battery. Do not let the other end of the cable touch anything until after the next step.
2. Disconnect the black negative (-) jumper cable from the Volt.
3. Disconnect the red positive (+) jumper cable from the Volt. Do not let the other end of the cable touch anything until after the next step.
4. Disconnect the red positive (+) jumper cable from the other vehicle.
5. Return the positive (+) and negative (-) terminal covers to their original positions.

Towing

Towing the Vehicle

Notice: Incorrectly towing a disabled vehicle may cause damage to the vehicle. The disabled vehicle should be towed on a flatbed car carrier. Use care when there is low ground clearance and/or special equipment.

Attempting to pull the vehicle onto a flatbed without following the proper steps could damage the vehicle.

Consult your dealer or a professional towing service if the disabled vehicle must be towed. See *Roadside Assistance Program* on page 13-6.

To load a vehicle onto a flatbed carrier:

1. The vehicle must be on a flat surface.
2. The front tires must be properly inflated. If necessary, move a rear tire to the front to replace a flat or damaged tire.

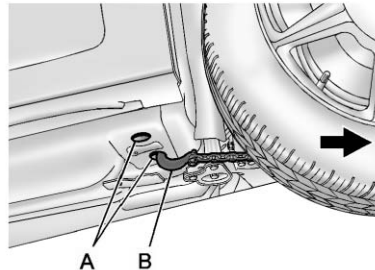

3. Place the tow chain hooks (B) into one of the torque box openings (A) behind the front wheels.

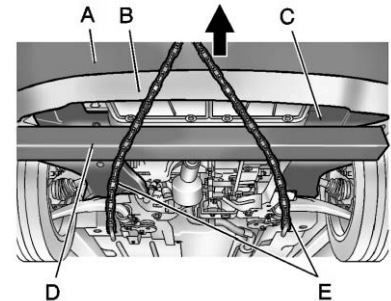

4. Place a 1.2 m (4 ft) X 102 mm (4 in) X 102 mm (4 in) wood beam (D) under the front cradle crossmember (C), and on top of both tow chains (E) to ensure the tow chains do not come into contact with the front fascia (A).

Try to minimize the contact of the chains with the flexible air dam (B).

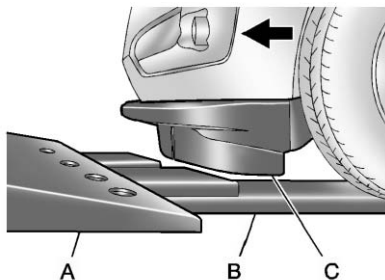

5. Ramps (B) are required for the front fascia (C) to clear the flatbed (A). The ramp height should be approximately 102 mm (4 in). Lower the flatbed onto the set of ramps.

Notice: If ramps are not used, the front fascia will come into contact with the flatbed and may cause damage. Always use ramps.

6. After the front tires are on the flatbed adjust the flatbed upward to provide additional clearance between the air dam, fascia, and flatbed.

7. When the fascia has enough clearance to clear the flatbed, lower the flatbed, and finish pulling the vehicle onto the flatbed.

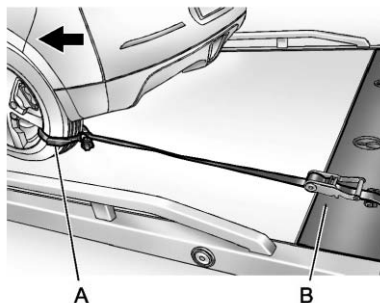

8. Secure the vehicle to the flatbed (B) using nonabrasive straps (A) through all four wheel openings and secure the straps to the flatbed (B).

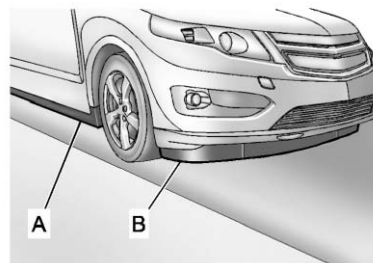

If the vehicle is parked off the shoulder of the road, at an angle that it cannot be pulled onto a flatbed, a hook/chain can be placed into either of the front torque box openings to pull the vehicle onto a flat surface. Make sure that the chains do not come in contact with the rocker panel (A) or the front fascia (B).

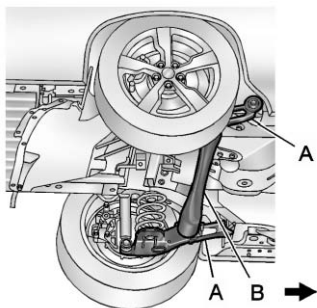

Notice: When using tow straps to move the vehicle, damage may occur if the tow straps contact the rear fascia. Do not let the tow straps contact the rear fascia.

If you cannot access the front torque box openings, wrap a tow strap through one, or both of the rear trailing arms (A) between the bushing and torque tube, and pull the vehicle onto a flat surface. Do not wrap the tow strap around the rear torque tube (B).

Recreational Vehicle Towing

Recreational vehicle towing refers to towing the vehicle behind another vehicle such as a motor home. The two most common types of recreational vehicle towing are known as dinghy towing and dolly towing. Dinghy towing is towing the vehicle with all four wheels on the ground. Dolly towing is towing the vehicle with two wheels on the ground and two wheels up on a device known as a dolly.

Here are some important things to consider before recreational vehicle towing:

- The towing capacity of the towing vehicle. Read the tow vehicle manufacturer's recommendations.
- How far the vehicle can be towed. Some vehicles have restrictions on how far and how long they can tow.
- Does the vehicle have the proper towing equipment. See your dealer or trailering professional for additional advice and equipment recommendations.
- Is the vehicle ready to be towed. Just as preparing the vehicle for a long trip, make sure the vehicle is prepared to be towed.

Dinghy Towing

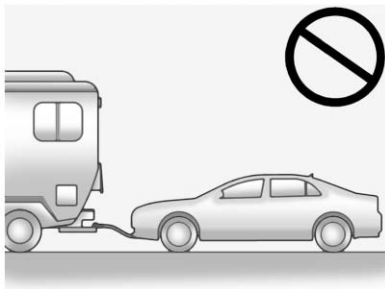

Notice: If the vehicle is towed with all four wheels on the ground, the drive unit could be damaged. Repairs would not be covered by the vehicle warranty. Do not tow the vehicle with all four wheels on the ground.

The vehicle was not designed to be towed with all four wheels on the ground. If the vehicle must be towed, a dolly should be used. See “Dolly Towing” that follows for more information.

Dolly Towing from the Front

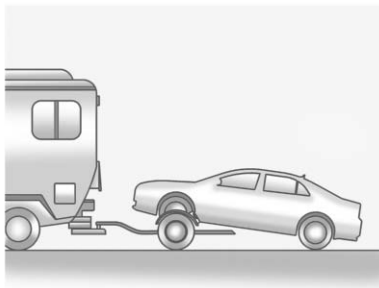

The vehicle can be towed from the front using a dolly. To tow the vehicle using a dolly, follow these steps:

1. Attach the dolly to the tow vehicle following the dolly manufacturer's instructions.
2. Drive the front wheels onto the dolly.

3. Put the shift lever in P (Park).
4. Set the parking brake and remove the key.
5. Clamp the steering wheel in a straight-ahead position with a clamping device designed for towing.
6. Secure the vehicle to the dolly.
7. Release the parking brake.
8. Check for adequate rear fascia to ground clearance.

Dolly Towing from the Rear

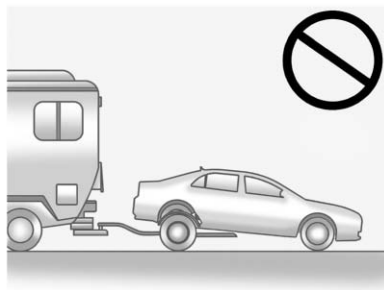

Notice: Towing the vehicle from the rear, with the front wheels on the ground, could damage the drive unit, and front fascia. Do not tow the vehicle from the rear with the front wheels on the ground.

Appearance Care

Exterior Care

Cleaning Exterior Lamps/Lenses

Use only lukewarm or cold water, a soft cloth, and a car washing soap to clean exterior lamps and lenses. Follow instructions under "Washing the Vehicle" later in this section.

Finish Care

Occasional waxing or mild polishing of the vehicle by hand may be necessary to remove residue from the paint finish. Approved cleaning products can be obtained from your dealer.

If the vehicle has a basecoat/clearcoat paint finish, the clearcoat gives more depth and gloss to the colored basecoat.

Notice: Machine compounding or aggressive polishing on a basecoat/clearcoat paint finish may damage it. Use only non-abrasive waxes and polishes that are made for a basecoat/clearcoat paint finish on the vehicle.

Foreign materials such as calcium chloride and other salts, ice melting agents, road oil and tar, tree sap, bird droppings, chemicals from industrial chimneys, etc., can damage the finish if they remain on painted surfaces. Wash the vehicle as soon as possible. If necessary, use non-abrasive cleaners that are marked safe for painted surfaces to remove foreign matter.

Exterior painted surfaces are subject to aging, weather, and chemical fallout that can take their toll over a period of years. To keep the paint finish looking new, keep the vehicle garaged or covered whenever possible.

Protecting Exterior Bright Metal Parts

Bright metal parts should be cleaned regularly to keep their luster. Wash with water or use chrome polish on chrome or stainless steel trim, if necessary.

Use special care with aluminum trim. To avoid damaging protective trim, never use auto or chrome polish, steam, or caustic soap to clean aluminum. A coating of wax, rubbed to high polish, is recommended for all bright metal parts.

Front Air Deflector

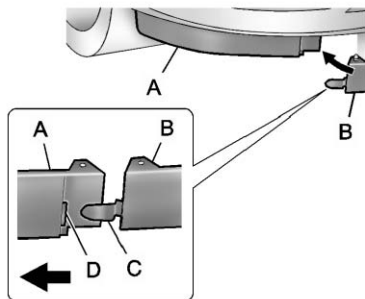

- A. Outer Air Deflector
- B. Inner Air Deflector
- C. Tab
- D. Slot

The front air deflector allows air to flow cleaner under the vehicle.

Should the front air deflector become detached, insert Tab C into Slot D. Repeat for the other side.

Washing the Vehicle

To preserve the finish, keep it clean by washing it often.

Do not wash the vehicle in direct sunlight and use a car washing soap.

Notice: Do not use cleaning agents that are petroleum based or that contain acid or abrasives, as they can damage the paint, metal, or plastic on the vehicle. Approved cleaning products can be obtained from your dealer. Follow all manufacturer directions regarding correct product usage, necessary safety precautions, and appropriate disposal of any vehicle care product. Certain cleaners contain chemicals that can damage the emblems or nameplates on the vehicle. Check the cleaning product label. If it states that it should not be used on plastic

parts, do not use it on the vehicle or damage may occur and it would not be covered by the warranty.

Follow all manufacturer directions regarding correct product usage, necessary safety precautions, and appropriate disposal of any vehicle care product.

Rinse the vehicle well, before washing and after, to remove all cleaning agents completely. If they are allowed to dry on the surface, they could stain.

Dry the finish with a soft, clean chamois or an all-cotton towel to avoid surface scratches and water spotting.

High pressure car washes could cause water to enter the vehicle. Avoid using high pressure washes closer than 30 cm (12 in) to the surface of the vehicle. Use of power washers exceeding 8,274 kPa (1,200 psi) can result in damage or removal of paint and decals.

Notice: Conveyor systems on some automatic car washes could damage the vehicle. There may not be enough clearance for the undercarriage. Check with the car wash manager before using the automatic car wash.

Weatherstrips

Silicone grease on weatherstrips will make them last longer, seal better, and not stick or squeak. Apply silicone grease with a clean cloth. During very cold, damp weather frequent application may be required. See *Recommended Fluids and Lubricants* on page 11-6.

Wheels and Trim — Aluminum or Chrome

The vehicle may have either aluminum or chrome-plated wheels. Keep the wheels clean using a soft, clean cloth with mild soap and water. Rinse with clean water. After rinsing thoroughly, dry with a soft, clean towel. A wax may then be applied.

Notice: Chrome wheels and other chrome trim may be damaged if the vehicle is not washed after driving on roads that have been sprayed with magnesium, calcium or sodium chloride. These chlorides are used on roads for conditions such as ice and dust. Always wash the chrome with soap and water after exposure.

Notice: Do not use strong soaps, chemicals, abrasive polishes, cleaners, brushes, or cleaners that contain acid on aluminum or chrome-plated wheels, because the surface could be damaged. The repairs would not be covered by the vehicle warranty. Use only approved cleaners on aluminum or chrome-plated wheels.

Notice: Never drive a vehicle that has aluminum or chrome-plated wheels through an automatic car wash that uses silicone carbide tire cleaning brushes, as this could cause damage. The repairs would not be covered by the vehicle warranty.

Windshield and Wiper Blades

Clean the outside of the windshield with glass cleaner.

Clean the rubber blades using a lint-free cloth or paper towel soaked with windshield washer fluid or a mild detergent. Wash the windshield thoroughly when cleaning the blades. Bugs, road grime, sap, and a buildup of vehicle wash/wax treatments may cause wiper streaking. Replace the wiper blades if they are worn or damaged.

Wipers can be damaged by:

- Extreme dusty conditions.
- Sand and salt.
- Heat and sun.
- Snow and ice, without proper removal.

Tires

Use a stiff brush with tire cleaner to clean the tires.

Notice: Using petroleum-based tire dressing products on the vehicle may damage the paint finish and/or tires. When applying a tire dressing, always wipe off any overspray from all painted surfaces on the vehicle.

Sheet Metal Damage

If the vehicle is damaged and requires sheet metal repair or replacement, make sure the body repair shop applies anti-corrosion material to parts repaired or replaced to restore corrosion protection.

Original manufacturer replacement parts will provide the corrosion protection while maintaining the vehicle warranty.

Finish Damage

Any stone chips, fractures, or deep scratches in the finish should be repaired right away. Bare metal will corrode quickly and may develop into a major repair expense.

Minor chips and scratches can be repaired with touch-up materials available from your dealer. Larger areas of finish damage can be corrected in your dealer's body and paint shop.

Underbody Maintenance

Chemicals used for ice and snow removal and dust control can collect on the underbody. If these are not removed, corrosion and rust can develop on the underbody parts such as fuel lines, frame, floor pan, and exhaust system even though they have corrosion protection.

At least every spring, flush these materials from the underbody with plain water. Clean any areas where mud and debris can collect. Dirt packed in close areas of the frame should be loosened before being flushed. Your dealer or an underbody car washing system can do this.

Chemical Paint Spotting

Some weather and atmospheric conditions can create a chemical fallout. Airborne pollutants can fall upon and attack painted surfaces on the vehicle. This damage can take two forms: blotchy, ring-shaped discolorations, and small, irregular dark spots etched into the paint surface.

Interior Care

The interior will continue to look its best if it is cleaned often. Dust and dirt can accumulate on the upholstery and cause damage to the carpet, fabric, leather, and plastic surfaces. Stains should be removed quickly as extreme heat could cause them to set rapidly.

Lighter colored interiors may require more frequent cleaning. Newspapers and garments that can transfer color to home furnishings can also transfer color to the interior.

Remove dust from small buttons and knobs with a small brush with soft bristles.

Your dealer has products for cleaning the interior. When cleaning the interior, only use cleaners specifically designed for the surfaces that are being cleaned.

Permanent damage can result from using cleaners on surfaces for which they were not intended. Apply the cleaner directly to the cleaning cloth to prevent over-spray. Remove any accidental over-spray from other surfaces immediately.

Notice: Using abrasive cleaners when cleaning glass surfaces on the vehicle, could scratch the glass and/or cause damage to the rear window defogger. When cleaning the glass on the vehicle, use only a soft cloth and glass cleaner.

Cleaners can contain solvents that can become concentrated in the interior. Before using cleaners, read and adhere to all safety instructions on the label. While cleaning the interior, maintain adequate ventilation by opening the doors and windows.

Do not clean the interior using the following cleaners or techniques:

- Never use a knife or any other sharp object to remove a soil from any interior surface.
- Never use a stiff brush. It can cause damage.
- Never apply heavy pressure or rub aggressively with a cleaning cloth. Use of heavy pressure can damage the interior and does not improve the effectiveness of soil removal.
- Avoid laundry detergents or dishwashing soaps with degreasers. Using too much soap will leave a residue that leaves streaks and attracts dirt. For liquid cleaners, about 20 drops per 3.78 L (1 gal) of water is a good guide. Use only mild, neutral-pH soaps.
- Do not heavily saturate the upholstery while cleaning.
- Cleaners that contain solvents can damage the interior.

Fabric/Carpet

Use a vacuum cleaner with a soft brush attachment to remove dust and loose dirt. A canister vacuum with rotating brushes in the nozzle may only be used on floor carpet and carpeted floor mats. For soils, always try to remove them first with plain water or club soda. Before cleaning, gently remove as much of the soil as possible using one of the following techniques:

- For liquids: gently blot the remaining soil with a paper towel. Allow the soil to absorb into the paper towel until no more can be removed.
- For solid dry soils: remove as much as possible and then vacuum.

To clean:

1. Saturate a lint-free, clean white cloth with water or club soda.
2. Remove excess moisture.

3. Start on the outside edge of the soil and gently rub toward the center. Continue cleaning, using a clean area of the cloth each time it becomes soiled.
4. Continue to gently rub the soiled area.
5. If the soil is not completely removed, use a mild soap solution and repeat the cleaning process with plain water.

If any of the soil remains, a commercial fabric cleaner or spot lifter may be necessary. Test a small hidden area for colorfastness before using a commercial upholstery cleaner or spot lifter. If the locally cleaned area gives any impression that a ring formation may result, clean the entire surface.

A paper towel can be used to blot excess moisture from the fabric or carpet after the cleaning process.

Leather

Leather, and lighter colored leather in particular, will need more frequent cleaning to prevent the buildup of dust, dirt, and colors transferred from other items so that these do not become permanent stains.

To remove dust, a soft cloth dampened with water can be used. If a more thorough cleaning is necessary, a soft cloth dampened with a mild soap solution can be used. Your dealer has a GM approved leather cleaner available that provides superior cleaning performance when used regularly on finished automotive leathers. Allow the leather to dry naturally. Do not use heat, steam, spot lifters or spot removers, or shoe polish on leather. Many commercial leather cleaners and coatings that are sold to preserve and protect leather may permanently change the appearance and feel of the leather and are not recommended. Do not use silicone or wax-based products,

or those containing organic solvents to clean the interior because they can alter the appearance by increasing the gloss in a non-uniform manner.

Instrument Panel, Vinyl, and Other Plastic Surfaces

To remove dust, a soft cloth dampened with water can be used. If a more thorough cleaning is necessary, a clean soft cloth dampened with a mild soap solution can be used to gently remove dust and dirt. Never use spot lifters or removers on plastic surfaces. Many commercial cleaners and coatings that are sold to preserve and protect soft plastic surfaces may permanently change the appearance and feel of the interior and are not recommended. Do not use silicone or wax-based products, or those containing organic solvents to clean the interior because they can alter the appearance by increasing the gloss in a non-uniform manner.

Some commercial products may increase gloss on the instrument panel. The increase in gloss may cause annoying reflections in the windshield and even make it difficult to see through the windshield under certain conditions.

Notice: Air fresheners contain solvents that may cause damage to plastics and painted surfaces. Follow the manufacturer's instructions when using air fresheners in the vehicle. If air freshener comes in contact with paint or a plastic surface, blot immediately with a soft cloth. Damage caused by using air fresheners would not be covered by the vehicle warranty.

Care of Safety Belts

Keep belts clean and dry.

WARNING

Do not bleach or dye safety belts. It may severely weaken them. In a crash, they might not be able to provide adequate protection. Clean safety belts only with mild soap and lukewarm water.

Floor Mats

WARNING

If a floor mat is the wrong size or is not properly installed, it can interfere with the accelerator pedal and/or brake pedal. Interference with the pedals can cause unintended acceleration and/or increased stopping distance which can cause a crash and injury. Make sure the floor mat does not interfere with the accelerator or brake pedal.

Use the following guidelines for proper floor mat usage:

- The original equipment floor mats were designed for your vehicle. If the floor mats need replacing, it is recommended that GM certified floor mats be purchased. Non-GM floor mats may not fit properly and may interfere with the accelerator or brake pedal. Always check that the floor mats do not interfere with the pedals.
- Use the floor mat with the correct side up. Do not turn it over.
- Do not place anything on top of the driver side floor mat.
- Use only a single floor mat on the driver side.
- Do not place one floor mat on top of another.

Removing and Replacing the Floor Mats

Pull up on the rear of the floor mat to unlock each retainer and remove.

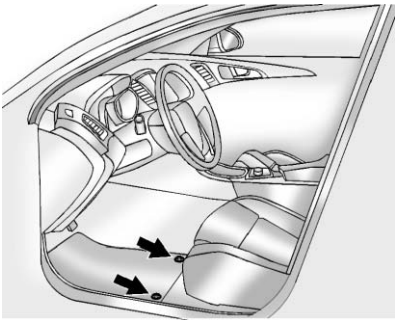

Reinstall by lining up the floor mat retainer openings over the carpet retainers and snap into position.

Make sure the floor mat is properly secured in place.

Verify the floor mat does not interfere with the accelerator or the brake pedal.

Service and Maintenance

General Information

General Information 11-1

Scheduled Maintenance

Scheduled Maintenance 11-3

Recommended Fluids, Lubricants, and Parts

Recommended Fluids and
Lubricants 11-6

Maintenance Replacement
Parts 11-7

Maintenance Records

Maintenance Records 11-8

General Information

Notice: Maintenance intervals, checks, inspections, recommended fluids, and lubricants are necessary to keep this vehicle in good working condition. Damage caused by failure to follow scheduled maintenance might not be covered by the vehicle warranty.

As the vehicle owner, you are responsible for the scheduled maintenance in this section. We recommend having your dealer perform these services. Proper vehicle maintenance helps to keep the vehicle in good working condition, improves fuel economy, and reduces vehicle emissions for better air quality.

Because of all the different ways people use vehicles, maintenance needs vary. The vehicle might need more frequent checks and services. Please read the information under Scheduled Maintenance. To keep the vehicle in good condition, see your dealer.

11-2 Service and Maintenance

The maintenance schedule is for vehicles that:

- Carry passengers and cargo within recommended limits on the Tire and Loading Information label. See *Vehicle Load Limits on page 9-13*.
- Are driven on reasonable road surfaces within legal driving limits.
- Use the required fuel. See *Fuel on page 9-52*.

WARNING

Performing maintenance work can be dangerous. Some jobs can cause serious injury. Perform maintenance work only if you have the required know-how and the proper tools and equipment. If in doubt, see your dealer to have a qualified technician do the work. See *Doing Your Own Service Work on page 10-6*.

At your dealer, you can be certain that you will receive the highest level of service available. Your dealer has specially trained service technicians, uses genuine replacement parts, as well as, up-to-date tools and equipment to ensure fast and accurate diagnostics.

The proper replacement parts, fluids, and lubricants to use are listed in *Recommended Fluids and Lubricants on page 11-6* and *Maintenance Replacement Parts on page 11-7*. We recommend the use of genuine parts from your dealer.

Rotation of New Tires

To maintain ride, handling, and performance of the vehicle, it is important that the first rotation service for new tires be performed. Tires should be rotated every 12 000 km/7,500 mi. See *Tire Rotation on page 10-54*.

Scheduled Maintenance

Required Services

Every Month

- Engine oil level check. See *Engine Oil on page 10-9*.
- Engine, power electronics, and high voltage battery pack coolant level checks. See *Cooling System (Engine) on page 10-15* or *Cooling System (High Voltage Battery) on page 10-16* or *Cooling System (Power Electronics and Charger Modules) on page 10-16* for more information.
- Fluids visual leak check. A leak in any system must be repaired and the fluid level checked.
- Windshield washer fluid level check. See *Washer Fluid on page 10-20*.

- Tire inflation check. See *Tire Pressure on page 10-48*.
- Tire wear inspection. See *Tire Inspection on page 10-54*.

Every 12 000 km/7,500 mi

- Rotate tires. See *Tire Rotation on page 10-54*.

Every 12 Months

- Check the engine oil filter for corrosion if driving in a corrosive environment, such as areas of high humidity, along an ocean coast, and/or areas that apply road salt during winter.

Have the engine oil and filter changed if the filter shows signs of corrosion. After each oil and filter change, the oil life system must be reset. See *Engine Oil Life System on page 10-12*.

- Cooling systems inspection. Visually inspect the hoses, pipes, fittings, and clamps. Replace, if needed.
- Windshield wiper blade inspection for wear, cracking, or contamination and windshield and wiper blade cleaning, if contaminated. See *Exterior Care on page 10-81*. Worn or damaged wiper blade replacement. See *Wiper Blade Replacement on page 10-26*.
- Engine air cleaner filter inspection. See *Engine Air Cleaner/Filter on page 10-13*.
- Brake system inspection. See your dealer.
- Steering and suspension inspection. Visual inspection for damaged, loose, or missing parts or signs of wear.

11-4 Service and Maintenance

- Body hinges and latches and key lock cylinders lubrication. See *Recommended Fluids and Lubricants* on page 11-6. More frequent lubrication may be required when the vehicle is exposed to a corrosive environment, such as areas of high humidity, along an ocean coast, and/or areas that apply road salt during winter. Applying silicone grease on weatherstrips with a clean cloth makes them last longer, seal better, and not stick or squeak.
 - Restraint system component check. See *Safety System Check* on page 3-23.
 - Fuel system inspection for damage or leaks.
 - Exhaust system and nearby heat shields inspection for loose or damaged components.
 - See *Propulsion System Start Check* on page 10-25.
 - See *Electrical Drive Unit Shift Lock Control Function Check* on page 10-25.
 - See *Park Brake and P (Park) Mechanism Check* on page 10-26.
 - Cooling systems check. See *Cooling System (Engine)* on page 10-15 or *Cooling System (High Voltage Battery)* on page 10-16 or *Cooling System (Power Electronics and Charger Modules)* on page 10-16.
 - Accelerator pedal check for damage, high effort, or binding. Replace if needed.
 - Check the sealant expiration date printed on the instruction label of the tire sealant and compressor kit. See *Tire Sealant and Compressor Kit* on page 10-63.
 - Hood/Decklid/Liftgate Support Gas Strut Service: Visually inspect gas strut, if equipped, for signs of wear, cracks, or other damage. Check the hold open ability of the gas strut. Contact your dealer if service is required.
- Every 24 Months or When the Change Engine Oil Soon Message Displays**
- Every 24 months or when the CHANGE ENGINE OIL SOON message displays, change the engine oil and filter as soon as possible, within the next 1 000 km/600 mi. The engine oil and filter must be changed at least once every 24 months. After each oil and filter change, the oil life system must be reset. See *Engine Oil Life System* on page 10-12. More frequent changes may be required when the vehicle is exposed to a corrosive environment, such as areas of high humidity, along an ocean coast, and/or areas that apply road salt during winter.

Your dealer has trained service technicians who will perform this work and reset the system. If the engine oil life system is reset accidentally, service the vehicle within 5 000 km/3,000 mi since the last service. Reset the oil life system whenever the oil is changed.

Every 80 000 km/50,000 mi

- Engine air cleaner filter replacement.
- Evaporative control system inspection. Check all fuel and vapor lines and hoses for proper hook-up, routing, and condition. Check that the purge valve, if the vehicle has one, works properly. Replace as needed. *An Emission Control Service. The U.S. Environmental Protection Agency or the California Air Resources Board has determined that the failure to perform this maintenance item*

will not nullify the emission warranty or limit recall liability prior to the completion of the vehicle's useful life. We, however, urge that all recommended maintenance services be performed at the indicated intervals and the maintenance be recorded.

Every 160 000 km/100,000 mi

- Spark plug replacement. *An Emission Control Service.*

Every 240 000 km/150,000 mi or every 5 years, whichever occurs first

- Engine cooling system drain, flush, and refill (or every five years, whichever occurs first). *See Cooling System (Engine) on page 10-15 or Cooling System (High Voltage Battery) on page 10-16 or Cooling System (Power Electronics and Charger Modules) on page 10-16. An Emission Control Service.*

Every 240 000 km/150,000 mi or every 10 years, whichever occurs first

- Engine drive belt inspection for fraying, excessive cracks, or obvious damage. Replace, if needed.

Every 10 Years

- Air conditioning system flush and refill and desiccant replacement.

Recommended Fluids, Lubricants, and Parts

Recommended Fluids and Lubricants

Usage	Fluid/Lubricant
Engine Oil	The engine requires engine oil approved to the dexos specification. Oils meeting this specification can be identified with the dexos certification mark. Look for and use only an engine oil that displays the dexos certification mark of the proper viscosity grade. See <i>Engine Oil on page 10-9</i> .
Engine Cooling System	50/50 mixture of clean, drinkable water and use only DEX-COOL Coolant. See <i>Engine Coolant on page 10-17</i> .
High Voltage Battery Cooling System	Always use the pre-mixed 50/50 mixture of deionized water and DEX-COOL Coolant available at your dealer.
Power Electronics Cooling System	Always use the pre-mixed 50/50 mixture of deionized water and DEX-COOL Coolant available at your dealer.
Hydraulic Brake System	DOT 3 Hydraulic Brake Fluid (GM Part No. 88863461, in Canada 88863462).
Windshield Washer	Optikleen [®] Washer Solvent.
Parking Brake Cable Guides	Chassis Lubricant (GM Part No. 12377985, in Canada 88901242) or lubricant meeting requirements of NLGI #2, Category LB or GC-LB.
Electric Drive Unit	DEXRON [®] -VI Automatic Transmission Fluid

Usage	Fluid/Lubricant
Key Lock Cylinders	Multi-Purpose Lubricant, Superlube (GM Part No. 12346241, in Canada 10953474).
Hood and Hatch Hinges	Multi-Purpose Lubricant, Superlube (GM Part No. 12346241, in Canada 10953474).
Weatherstrip Conditioning	Weatherstrip Lubricant (GM Part No. 3634770, in Canada 10953518) or Dielectric Silicone Grease (GM Part No. 12345579, in Canada 992887).

Maintenance Replacement Parts

Replacement parts identified below by name, part number, or specification can be obtained from your dealer.

Part	GM Part Number	ACDelco Part Number
Engine Air Cleaner/Filter	20871244	A3148C
Engine Oil Filter	55352643	—
Spark Plugs	55564962	—
Wiper Blades		
Driver – 65 cm (25.6 in)	22742323	—
Passenger – 65 cm (25.6 in)	22742324	—

Technical Data

Vehicle Identification

Vehicle Identification Number (VIN)	12-1
Service Parts Identification Label	12-1

Vehicle Data

Capacities and Specifications	12-2
Engine Drive Belt Routing ...	12-3

Vehicle Identification

Vehicle Identification Number (VIN)



This legal identifier is in the front corner of the instrument panel, on the left side of the vehicle. It can be seen through the windshield from outside. The VIN also appears on the Vehicle Certification and Service Parts labels and certificates of title and registration.

Engine Identification

The eighth character in the VIN is the engine code. This code identifies the vehicle's engine, specifications, and replacement parts. See "Engine Specifications" under *Capacities and Specifications* on page 12-2 for the vehicle's engine code.

Service Parts Identification Label

The label is inside the right rear cargo storage door and has the following information:

- Vehicle Identification Number (VIN).
- Model designation.
- Paint information.
- Production options and special equipment.

Do not remove this label from the vehicle.

Vehicle Data

Capacities and Specifications

The following approximate capacities are given in metric and English conversions. Refer to *Recommended Fluids and Lubricants on page 11-6* for more information.

Application	Capacities	
	Metric	English
Air Conditioning Refrigerant R134a	For the air conditioning system refrigerant charge amount, see the refrigerant label under the hood. See your dealer for more information.	
Cooling Systems		
Engine	6.3 L	6.7 qt
High Voltage Battery	6.0 L	6.3 qt
Power Electronics	3.0 L	3.2 qt
Engine Oil with Filter	3.5 L	3.7 qt
Fuel Tank	35.2 L	9.3 gal
Electric Drive Unit	8.45 L	8.93 qt
Wheel Nut Torque	140 N•m	100 lb ft
All capacities are approximate. When adding, be sure to fill to the approximate level, as recommended in this manual.		

Engine Specifications

Engine	VIN Code	Electric Drive Unit	Spark Plug Gap
1.4 L L4	4	Automatic	0.7 mm (0.027 in)

Engine Drive Belt Routing

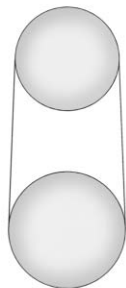

Customer Information

Customer Information

Customer Satisfaction Procedure	13-1
Customer Assistance Offices	13-3
Customer Assistance for Text Telephone (TTY) Users	13-4
Online Owner Center	13-4
GM Mobility Reimbursement Program	13-5
Roadside Assistance Program	13-6
Scheduling Service Appointments	13-8
Courtesy Transportation Program	13-8
Collision Damage Repair ...	13-10
Service Publications Ordering Information	13-12
Trademarks and License Agreements	13-13
Open Source Information ...	13-22

Reporting Safety Defects

Reporting Safety Defects to the United States Government	13-23
Reporting Safety Defects to the Canadian Government	13-23
Reporting Safety Defects to General Motors	13-24

Vehicle Data Recording and Privacy

Vehicle Data Recording and Privacy	13-24
Event Data Recorders	13-24
OnStar®	13-25
Navigation System	13-25
Radio Frequency Identification (RFID)	13-26
Radio Frequency Statement	13-26

Customer Information

Customer Satisfaction Procedure

Your satisfaction and goodwill are important to the dealer and to Chevrolet. Normally, any concerns with the sales transaction or the operation of the vehicle will be resolved by the dealer's sales or service departments. Sometimes, however, despite the best intentions of all concerned, misunderstandings can occur. If your concern has not been resolved to your satisfaction, the following steps should be taken:

STEP ONE: Discuss your concern with a member of dealership management. Normally, concerns can be quickly resolved at that level. If the matter has already been reviewed with the sales, service, or parts manager, contact the owner of the dealership or the general manager.

13-2 Customer Information

STEP TWO: If after contacting a member of dealership management, it appears your concern cannot be resolved by the dealership without further help, in the U.S., call the Chevrolet Customer Assistance Center at 1-877-486-5846 (1-877-4-Volt Info). In Canada, call General Motors of Canada Customer Communication Centre at 1-800-263-3777 (English), or 1-800-263-7854 (French).

We encourage you to call the toll-free number in order to give the inquiry prompt attention. Have the following information available to give the Customer Assistance representative:

- Vehicle Identification Number (VIN). This is available from the vehicle registration or title, or the plate at the top left of the instrument panel and visible through the windshield.
- Dealership name and location.
- Vehicle delivery date and present mileage.

When contacting Chevrolet, remember that your concern will likely be resolved at a dealer's facility. That is why we suggest following Step One first.

STEP THREE — U.S. Owners:

Both General Motors and the dealer are committed to making sure you are completely satisfied with the new vehicle. However, if you continue to remain unsatisfied after following the procedure outlined in Steps One and Two, you can file with the Better Business Bureau (BBB) Auto Line[®] Program to enforce your rights.

The BBB Auto Line Program is an out-of-court program administered by the Council of Better Business Bureaus to settle automotive disputes regarding vehicle repairs or the interpretation of the New Vehicle Limited Warranty. Although you may be required to resort to this informal dispute resolution program prior to filing a court action, use of the program is free of charge and your

case will generally be heard within 40 days. If you do not agree with the decision given in your case, you may reject it and proceed with any other venue for relief available to you.

You may contact the BBB Auto Line Program using the toll-free telephone number or write them at the following address:

BBB Auto Line Program
Council of Better Business
Bureaus, Inc.
4200 Wilson Boulevard
Suite 800
Arlington, VA 22203-1838

Telephone: 1-800-955-5100
www.dr.bbb.org/goauto

This program is available in all 50 states and the District of Columbia. Eligibility is limited by vehicle age, mileage, and other factors. General Motors reserves the right to change eligibility limitations and/or discontinue its participation in this program.

STEP THREE — Canadian

Owners: In the event that you do not feel your concerns have been addressed after following the procedure outlined in Steps One and Two, General Motors of Canada Limited wants you to be aware of its participation in a no-charge Mediation/Arbitration Program. General Motors of Canada Limited has committed to binding arbitration of owner disputes involving factory-related vehicle service claims. The program provides for the review of the facts involved by an impartial third party arbiter, and may include an informal hearing before the arbiter. The program is designed so that the entire dispute settlement process, from the time you file your complaint to the final decision, should be completed in about 70 days. We believe our impartial program offers advantages over courts in most jurisdictions because it is informal, quick, and free of charge.

For further information concerning eligibility in the Canadian Motor Vehicle Arbitration Plan (CAMVAP), call toll-free 1-800-207-0685, or call the General Motors Customer Communication Centre, 1-800-263-3777 (English), 1-800-263-7854 (French), or write to:

The Mediation/Arbitration Program
c/o Customer Communication
Centre
General Motors of Canada Limited
Mail Code: CA1-163-005
1908 Colonel Sam Drive
Oshawa, Ontario L1H 8P7

The inquiry should be accompanied by the Vehicle Identification Number (VIN).

Customer Assistance Offices

Chevrolet encourages customers to call the toll-free number for assistance. However, if a customer wishes to write or e-mail Chevrolet, the letter should be addressed to:

United States

Chevrolet Motor Division
Chevrolet Customer
Assistance Center
P.O. Box 33170
Detroit, MI 48232-5170
www.Chevrolet.com

1-877-486-5846 (1-877-4-Volt Info)
1-800-833-2438 (For Text
Telephone Devices (TTYs))
Roadside Assistance:
1-888-811-1926

From Puerto Rico:

1-800-496-9992 (English)
1-800-496-9993 (Spanish)

From U.S. Virgin Islands:

1-800-496-9994

13-4 Customer Information

Canada

General Motors of Canada Limited
Customer Communication Centre,
Mail Code: CA1-163-005
1908 Colonel Sam Drive
Oshawa, Ontario L1H 8P7
www.gm.ca

1-800-263-3777 (English)
1-800-263-7854 (French)
1-800-263-3830 (For Text
Telephone devices (TTYs))
Roadside Assistance:
1-800-268-6800

Overseas

Please contact the local General
Motors Business Unit.

Mexico, Central America, and Caribbean Islands/Countries (Except Puerto Rico and U.S. Virgin Islands)

General Motors de Mexico,
S. de R.L. de C.V.
Customer Assistance Center
Av. Ejercito Nacional #843
Col. Granada
C.P. 11520, Mexico, D.F.

01-800-466-0800
Long Distance: 011-52-53 29 0800

Customer Assistance for Text Telephone (TTY) Users

To assist customers who are deaf,
hard of hearing, or speech-impaired
and who use Text Telephones
(TTYs), Chevrolet has TTY
equipment available at its Customer
Assistance Center. Any TTY
user in the U.S. can communicate
with Chevrolet by dialing:
1-800-833-2438. TTY users in
Canada can dial 1-800-263-3830.

Online Owner Center

Chevrolet Owner Center (U.S.) www.chevyownercenter.com

Information and services
customized for your specific
vehicle — all in one convenient
place.

- Digital owner manual, warranty information, and more.
- Storage for online service and maintenance records.
- Chevrolet dealer locator for service nationwide.
- Exclusive privileges and offers.
- Recall notices for your specific vehicle.
- OnStar and GM Cardmember Services Earnings summaries.

Other Helpful Links

Chevrolet — www.chevrolet.com

Chevrolet Merchandise —
www.chevymall.com

Help Center — www.chevrolet.com/pages/mds/helpcenter/faq.do

- FAQ
- Contact Us

My GM Canada www.gm.ca

My GM Canada is a password-protected section of www.gm.ca where you can save information on GM vehicles, get personalized offers, and use handy tools and forms with greater ease.

Here are a few of the valuable tools and services you will have access to:

- **My Showroom:** Find and save information on vehicles and current offers in your area.
- **My Dealers:** Save details such as address and phone number for each of your preferred GM dealers.
- **My Driveway:** Access quick links to parts and service estimates, check trade-in values, or schedule a service appointment by adding the vehicles you own to your driveway profile.
- **My Preferences:** Manage your profile and use tools and forms with greater ease.

To sign up, visit the My GM.ca section within www.gm.ca.

GM Mobility Reimbursement Program



This program is available to qualified applicants for cost reimbursement of eligible aftermarket adaptive equipment required for the vehicle, such as hand controls or a wheelchair/scooter lift for the vehicle.

For more information on the limited offer, visit www.gmmobility.com or call the GM Mobility Assistance Center at 1-800-323-9935. Text Telephone (TTY) users, call 1-800-833-9935.

General Motors of Canada also has a Mobility Program. Call 1-800-GM-DRIVE (463-7483) for details. TTY users call 1-800-263-3830.

13-6 Customer Information

Roadside Assistance Program

From the U.S., call **1-888-811-1926**;
(Text Telephone (TTY):
1-888-889-2438).

From Canada, call **1-800-268-6800**.

Service is available 24 hours a day,
365 days a year.

Calling for Assistance

When calling Roadside Assistance,
have the following information
ready:

- Your name, home address, and home telephone number.
- Telephone number of your location.
- Location of the vehicle.
- Model, year, color, and license plate number of the vehicle.
- Odometer reading, Vehicle Identification Number (VIN), and delivery date of the vehicle.
- Description of the problem.

Coverage

Services are provided up to 5 years/
160 000 km (100,000 mi), whichever
comes first.

In the U.S., anyone driving the
vehicle is covered. In Canada, a
person driving the vehicle without
permission from the owner is not
covered.

Roadside Assistance is not a part of
the New Vehicle Limited Warranty.
Chevrolet and General Motors of
Canada Limited reserve the right to
make any changes or discontinue
the Roadside Assistance program
at any time without notification.

Chevrolet and General Motors of
Canada Limited reserve the right to
limit services or payment to an
owner or driver if they decide the
claims are made too often, or the
same type of claim is made many
times.

Services Provided

- **Emergency Fuel Delivery:**
Delivery of enough fuel for the
vehicle to get to the nearest
service station.
- **Lock-Out Service:** Service to
unlock the vehicle if you are
locked out. A remote unlock may
be available if you have OnStar.
For security reasons, the driver
must present identification
before this service is given.
- **Emergency Tow from a Public
Road or Highway:** Tow to the
nearest Chevrolet dealer for
warranty service, or if the vehicle
was in a crash and cannot be
driven. Assistance is also given
when the vehicle is stuck in the
sand, mud, or snow.

- **Flat Tire Change:** Service to change a flat tire with the tire sealant and compressor kit. If the tire has been separated from the wheel, has damaged sidewalls, or has a large puncture, the tire is too severely damaged for the tire sealant and compressor kit to be effective. It is the owner's responsibility for the repair or replacement of the tire if it is not covered by the warranty.
- **Battery Jump Start:** Service to jump start a dead battery.

Services Not Included in Roadside Assistance

- Impound towing caused by violation of any laws.
- Legal fines.
- Mounting, dismounting, or changing of snow tires, chains, or other traction devices.
- Towing or services for vehicles driven on a non-public road or highway.

Services Specific to Canadian Vehicles

- **Fuel Delivery:** Reimbursement is approximately \$5 Canadian. Diesel fuel delivery may be restricted. Propane and other fuels are not provided through this service.
- **Lock-Out Service:** Vehicle registration is required.
- **Trip Routing Service:** Detailed maps of North America are provided when requested either with the most direct route or the most scenic route. There is a limit of six requests per year. Additional travel information is also available. Allow three weeks for delivery.

- **Trip Interruption Benefits and Assistance:** Must be over 250 km (150 mi) from where the trip was started to qualify. General Motors of Canada Limited requires pre-authorization, original detailed receipts, and a copy of the repair orders. Once authorization has been received, the Roadside Assistance advisor will help to make arrangements and explain how to receive payment.
- **Alternative Service:** If assistance cannot be provided right away, the Roadside Assistance advisor may give permission to get local emergency road service. You will receive payment, up to \$100, after sending the original receipt to Roadside Assistance. Mechanical failures may be covered, however any cost for parts and labor for repairs not covered by the warranty are the owner's responsibility.

Scheduling Service Appointments

When the vehicle requires warranty service, contact the dealer and request an appointment. By scheduling a service appointment and advising the service consultant of your transportation needs, the dealer can help minimize your inconvenience.

If the vehicle cannot be scheduled into the service department immediately, keep driving it until it can be scheduled for service, unless, of course, the problem is safety related. If it is, please call the dealership, let them know this, and ask for instructions.

If the dealer requests you to bring the vehicle for service, you are urged to do so as early in the work day as possible to allow for the same-day repair.

Courtesy Transportation Program

To enhance your ownership experience, we and our participating dealers are proud to offer Courtesy Transportation, a customer support program for vehicles with the Bumper-to-Bumper (Base Warranty Coverage period in Canada) and extended powertrain warranties in both the U.S. and Canada.

Several Courtesy Transportation options are available to assist in reducing inconvenience when warranty repairs are required.

Courtesy Transportation is not a part of the New Vehicle Limited Warranty. A separate booklet entitled "Warranty and Owner Assistance Information" furnished with each new vehicle provides detailed warranty coverage information.

Transportation Options

Warranty service can generally be completed while you wait. However, if you are unable to wait, GM helps to minimize inconvenience by providing several transportation options. Depending on the circumstances, the dealer can offer one of the following:

Shuttle Service

Shuttle service is the preferred means of offering Courtesy Transportation. Dealers may provide shuttle service to get you to your destination with minimal interruption of your daily schedule. This includes one-way or round-trip shuttle service within reasonable time and distance parameters of the dealer's area.

Public Transportation or Fuel Reimbursement

If the vehicle requires overnight warranty repairs, and public transportation is used instead of the dealer's shuttle service, the expense must be supported by original receipts and can only be up to the maximum amount allowed by GM for shuttle service. In addition, for U.S. customers, should you arrange transportation through a friend or relative, limited reimbursement for reasonable fuel expenses may be available. Claim amounts should reflect actual costs and be supported by original receipts. See the dealer for information regarding the allowance amounts for reimbursement of fuel or other transportation costs.

Courtesy Rental Vehicle

The dealer may arrange to provide you with a courtesy rental vehicle or reimburse you for a rental vehicle that you obtain if the vehicle is kept for an overnight warranty repair. Rental reimbursement will be limited and must be supported by original receipts. This requires that you sign and complete a rental agreement and meet state/provincial, local, and rental vehicle provider requirements. Requirements vary and may include minimum age requirements, insurance coverage, credit card, etc. You are responsible for fuel usage charges and may also be responsible for taxes, levies, usage fees, excessive mileage, or rental usage beyond the completion of the repair.

It may not be possible to provide a like vehicle as a courtesy rental.

Additional Program Information

All program options, such as shuttle service, may not be available at every dealer. Please contact the dealer for specific information about availability. All Courtesy Transportation arrangements will be administered by appropriate dealer personnel.

General Motors reserves the right to unilaterally modify, change, or discontinue Courtesy Transportation at any time and to resolve all questions of claim eligibility pursuant to the terms and conditions described herein at its sole discretion.

Collision Damage Repair

If the vehicle is involved in a collision and it is damaged, have the damage repaired by a qualified technician using the proper equipment and quality replacement parts. Poorly performed collision repairs diminish the vehicle resale value, and safety performance can be compromised in subsequent collisions.

Collision Parts

Genuine GM Collision parts are new parts made with the same materials and construction methods as the parts with which the vehicle was originally built. Genuine GM Collision parts are the best choice to ensure that the vehicle's designed appearance, durability, and safety are preserved. The use of Genuine GM parts can help maintain the GM New Vehicle Limited Warranty.

Recycled original equipment parts may also be used for repair. These parts are typically removed from

vehicles that were total losses in prior crashes. In most cases, the parts being recycled are from undamaged sections of the vehicle. A recycled original equipment GM part may be an acceptable choice to maintain the vehicle's originally designed appearance and safety performance; however, the history of these parts is not known. Such parts are not covered by the GM New Vehicle Limited Warranty, and any related failures are not covered by that warranty.

Aftermarket collision parts are also available. These are made by companies other than GM and may not have been tested for the vehicle. As a result, these parts may fit poorly, exhibit premature durability/corrosion problems, and may not perform properly in subsequent collisions. Aftermarket parts are not covered by the GM New Vehicle Limited Warranty, and any vehicle failure related to such parts is not covered by that warranty.

Repair Facility

GM also recommends that you choose a collision repair facility that meets your needs before you ever need collision repairs. The dealer may have a collision repair center with GM-trained technicians and state-of-the-art equipment, or be able to recommend a collision repair center that has GM-trained technicians and comparable equipment.

Insuring the Vehicle

Protect your investment in the GM vehicle with comprehensive and collision insurance coverage. There are significant differences in the quality of coverage afforded by various insurance policy terms. Many insurance policies provide reduced protection to the GM vehicle by limiting compensation for damage repairs by using aftermarket collision parts. Some insurance companies will not specify aftermarket collision parts.

When purchasing insurance, we recommend that you ensure that the vehicle will be repaired with GM original equipment collision parts. If such insurance coverage is not available from your current insurance carrier, consider switching to another insurance carrier.

If the vehicle is leased, the leasing company may require you to have insurance that ensures repairs with Genuine GM Original Equipment Manufacturer (OEM) parts or Genuine Manufacturer replacement parts. Read the lease carefully, as you may be charged at the end of the lease for poor quality repairs.

If a Crash Occurs

If there has been an injury, call emergency services for help. Do not leave the scene of a crash until all matters have been taken care of. Move the vehicle only if its position puts you in danger, or you are instructed to move it by a police officer.

Give only the necessary information to police and other parties involved in the crash.

For emergency towing see *Roadside Assistance Program on page 13-6*.

Gather the following information:

- Driver name, address, and telephone number.
- Driver license number.
- Owner name, address, and telephone number.
- Vehicle license plate number.
- Vehicle make, model, and model year.
- Vehicle Identification Number (VIN).
- Insurance company and policy number.
- General description of the damage to the other vehicle.

Choose a reputable repair facility that uses quality replacement parts. See "Collision Parts" earlier in this section.

In a crash, the sensing system may shut down the high voltage system. See *Battery on page 10-24* for important safety information. If an airbag has inflated, see *What Will You See After an Airbag Inflates? on page 3-31*.

Managing the Vehicle Damage Repair Process

In the event that the vehicle requires damage repairs, GM recommends that you take an active role in its repair. If you have a pre-determined repair facility of choice, take the vehicle there, or have it towed there. Specify to the facility that any required replacement collision parts be original equipment parts, either new Genuine GM parts or recycled original GM parts. Remember, recycled parts will not be covered by the GM vehicle warranty.

13-12 Customer Information

Insurance pays the bill for the repair, but you must live with the repair. Depending on your policy limits, your insurance company may initially value the repair using aftermarket parts. Discuss this with the repair professional, and insist on Genuine GM parts. Remember, if the vehicle is leased, you may be obligated to have the vehicle repaired with Genuine GM parts, even if your insurance coverage does not pay the full cost.

If another party's insurance company is paying for the repairs, you are not obligated to accept a repair valuation based on that insurance company's collision policy repair limits, as you have no contractual limits with that company. In such cases, you can have control of the repair and parts choices as long as the cost stays within reasonable limits.

Service Publications Ordering Information

Service Manuals

Service Manuals have the diagnosis and repair information on the engines, electric drive unit, axle, suspension, brakes, electrical, steering, body, etc.

Service Bulletins

Service Bulletins give additional technical service information needed to knowledgeable service General Motors cars and trucks. Each bulletin contains instructions to assist in the diagnosis and service of the vehicle.

Owner Information

Owner publications are written specifically for owners and intended to provide basic operational information about the vehicle. The Owner Manual includes the Maintenance Schedule for all models.

In-Portfolio: Includes a Portfolio, Owner Manual, and Warranty Booklet.

RETAIL SELL PRICE:
\$35.00 (U.S.) plus handling and shipping fees.

Without Portfolio: Owner Manual only.

RETAIL SELL PRICE:
\$25.00 (U.S.) plus handling and shipping fees.

Current and Past Models

Technical Service Bulletins and Manuals are available for current and past model GM vehicles.

ORDER TOLL FREE:
1-800-551-4123 Monday - Friday
8:00 AM - 6:00 PM Eastern Time

For Credit Card Orders Only
(VISA-MasterCard-Discover), visit
Helm, Inc. at: www.helminc.com

Or write to:

Helm, Incorporated
P.O. Box 07130
Detroit, MI 48207

Prices are subject to change without notice and without incurring obligation. Allow ample time for delivery.

All listed prices are quoted in U.S. funds. Make checks payable in U.S. funds.

Trademarks and License Agreements



Manufactured under license under U.S. Patent #'s: 5,451,942; 5,956,674; 5,974,380; 5,978,762; 6,487,535 & other U.S. and worldwide patents issued &

pending. DTS and the Symbol are registered trademarks and DTS Digital Surround and the DTS logos are trademarks of DTS, Inc. Product includes software. © DTS, Inc. All Rights Reserved.



Manufactured under license from Dolby Laboratories. Dolby and the double-D symbol are trademarks of Dolby Laboratories.



MP3PRO audio decoding technology licensed from Coding Technologies, Fraunhofer IIS and Thompson.



DivX®, DivX Certified® and associated logos are registered trademarks of DivX, Inc. and are used under license.

About DivX video: DivX® is a digital video format created by DivX, Inc. This is an official DivX Certified device that plays DivX video. Visit www.divx.com for more information and software tools to convert your files into DivX video.

About DivX Video-On-Demand: This DivX Certified® device must be registered in order to play DivX Video-On-Demand (VOD) content. To generate the registration code, locate the DivX VOD section in the device setup menu. Go to www.vod.divx.com with this code to complete the registration process and learn more about DivX VOD.



“Made for iPod” means that an electronic accessory has been designed to connect specifically to iPod and has been certified by the developer to meet Apple performance standards. Apple is not responsible for the operation of this device or its compliance with safety and regulatory standards.

iPod, iPod classic, iPod nano, and iPod touch are trademarks of Apple Inc., registered in the U.S. and other countries.



Fees and Taxes: Subscription fee, taxes, one time activation fee, and other fees may apply. Subscription fee is consumer only. All fees and programming subject to change. Subscriptions subject to Customer Agreement available at www.xmradio.com. XM™ service only available in the 48 contiguous United States and Canada.

In Canada: Some deterioration of service may occur in extreme northern latitudes. This is beyond the control of XM™ Satellite Radio.

Explicit Language Notice: Channels with frequent explicit language are indicated with an “XL” preceding the

channel name. Channel blocking is available for XM Satellite Radio receivers by notifying XM at:

- USA Customers — Visit www.xmradio.com or call 1-800-xmradio (1-800-967-2346).
- Canadian Customers — Visit www.xmradio.ca or call 1-877-438-9677.

It is prohibited to copy, decompile, disassemble, reverse engineer, hack, manipulate, or otherwise make available any technology or software incorporated in receivers compatible with the XM™ Satellite Radio System or that support the XM website, the Online Service or any of its content. Furthermore, the AMBER voice compression software included in this product is protected by intellectual property rights including patent rights, copyrights, and trade secrets of Digital Voice Systems, Inc.

General Requirements:

1. A License Agreement from XM™ is required for any product that incorporates XM Technology and/or for use of any of the XM marks to be manufactured, distributed or marketed in the XM Service Area.
2. For products to be distributed, marketed and/or sold in Canada, a separate agreement is required with Canadian Satellite Radio Inc. (operating as XM Canada).



This product incorporates copyright protection technology that is protected by U.S. patents and other intellectual property rights of Rovi Corporation. Reverse engineering or disassembly is prohibited.



This product uses the source code of T-Kernel under T-License granted by the T-Engine Forum (www.t-engine.org).



Music and video recognition technology and related data are provided by Gracenote®. Gracenote is the industry standard in music recognition technology and related content delivery. For more information, visit www.gracenote.com.

CD, DVD, Blu-ray Disc, and music and video-related data from Gracenote, Inc., copyright © 2000 to present Gracenote. One or more patents owned by Gracenote apply to this product and service. See the Gracenote website for a non-exhaustive list of applicable Gracenote patents. Gracenote and CDDB, MusicID, Media VOCS, the Gracenote logo and logotype, and the "Powered by Gracenote" logo are either registered trademarks or trademarks of Gracenote in the United States and/or other countries.

If you require more information regarding the use of the Gracenote Service, visit: www.gracenote.com/corporate.

For the data provided by Gracenote® Music Recognition Service, the content is not necessarily guaranteed 100%.

13-16 Customer Information

Regarding the use of Gracenote Music Recognition Service, when this product is used, it is necessary to agree to the following articles.

Gracenote® End User License

This application or device contains software from Gracenote, Inc. of Emeryville, California (“Gracenote”). The software from Gracenote (the “Gracenote Software”) enables this application to perform disc and/or file identification and obtain music-related information, including name, artist, track, and title information (“Gracenote Data”) from online servers or embedded databases (collectively, “Gracenote Servers”) and to perform other functions. You may use Gracenote Data only by means of the intended End-User functions of this application or device. You agree that you will use Gracenote Data, the Gracenote Software, and Gracenote Servers for your own personal non-commercial use only. You agree not to assign, copy, transfer or

transmit the Gracenote Software or any Gracenote Data to any third party.

YOU AGREE NOT TO USE OR EXPLOIT GRACENOTE DATA, THE GRACENOTE SOFTWARE, OR GRACENOTE SERVERS, EXCEPT AS EXPRESSLY PERMITTED HEREIN. You agree that your non-exclusive license to use the Gracenote Data, the Gracenote Software, and Gracenote Servers will terminate if you violate these restrictions. If your license terminates, you agree to cease any and all use of the Gracenote Data, the Gracenote Software, and Gracenote Servers.

Gracenote reserves all rights in Gracenote Data, the Gracenote Software, and the Gracenote Servers, including all ownership rights.

Under no circumstances will Gracenote become liable for any payment to you for any information that you provide. You agree that

Gracenote, Inc. may enforce its rights under this Agreement against you directly in its own name.

The Gracenote service uses a unique identifier to track queries for statistical purposes.

The purpose of a randomly assigned numeric identifier is to allow the Gracenote service to count queries without knowing anything about who you are. For more information, see the web page for the Gracenote Privacy Policy for the Gracenote service.

The Gracenote Software and each item of Gracenote Data are licensed to you “AS IS.” Gracenote makes no representations or warranties, express or implied, regarding the accuracy of any Gracenote Data from in the Gracenote Servers.

Gracenote reserves the right to delete data from the Gracenote Servers or to change data categories for any cause that Gracenote deems sufficient.

No warranty is made that the Gracenote Software or Gracenote Servers are error-free or that functioning of Gracenote Software or Gracenote Servers will be uninterrupted.

Gracenote is not obligated to provide you with new enhanced or additional data types or categories that Gracenote may provide in the future and is free to discontinue its services at any time.

Gracenote disclaims all warranties express or implied, including, but not limited to, implied warranties of merchantability, fitness for a particular purpose, title, and non-infringement. Gracenote does not warrant the results that will be obtained by your use of the gracenote software or any gracenote server. In no case will gracenote be liable for any consequential or incidental damages or for any lost profits or lost revenues.

© Gracenote, Inc. 2010

Map End User License Agreement

© 2010 Tele Atlas North America, Inc. All rights reserved.

This material is proprietary and the subject of copyright protection and other intellectual property rights owned by or licensed to Tele Atlas North America, Inc.

The use of this material is subject to the terms of a license agreement. You will be held liable for any unauthorized copying or disclosure of this material.

Data by infoUSA Copyright © 2010, All Rights Reserved.

© 2010 VISA Corporation

© CoStar Realty Information, Inc.

The Bullseye Design is a registered trademark of Target Brands, Inc.

END USER LICENSE AGREEMENT

PLEASE READ THIS AGREEMENT CAREFULLY BEFORE USING THE NAVIGATION SYSTEM. THIS IS A

LICENSE AGREEMENT FOR YOUR COPY OF THE SPATIAL MAP DATABASE, INCLUDING LOCATION CODES AND RELATED PRODUCTS (COLLECTIVELY, THE "DATABASE"), USED IN THE NAVIGATION SYSTEM. BY USING THE NAVIGATION SYSTEM AND THE DATABASE, YOU ACCEPT AND AGREE TO BE BOUND BY ALL TERMS AND CONDITIONS SET FORTH BELOW.

LICENSE GRANT

DENSO CORPORATION ("DENSO"), as a licensed distributor of the DATABASE, grants to you a non-exclusive, non-perpetual license to use your copy of the DATABASE for your personal use or for your use in your business' internal operations and not for any other purpose. This license does not include the right to grant sub-licenses.

13-18 Customer Information

OWNERSHIP

The DATABASE and the copyrights and intellectual property and neighboring rights therein are owned by Tele Atlas North America, Inc. ("TANA") and its licensors. This Agreement does not transfer any title or interest in the DATABASE, except for the license to use the DATABASE according and subject to the terms and conditions of this Agreement. You shall not alter, obscure or remove any copyright notices, trademark notices or other restrictive legends relating to the DATABASE.

The DATABASE comprises confidential and proprietary information and materials of TANA. Accordingly, you shall hold the DATABASE in confidence and trust. You shall take reasonable steps to protect the DATABASE from misappropriation or misuse. You shall not extract stand-alone data from or publish any part of the DATABASE without the prior written consent of TANA and its licensors.

LIMITATIONS ON USE

The DATABASE is restricted for use in the specific system for which it was created. Except to the extent explicitly permitted by mandatory laws, you may not extract or reuse any portion of the contents of the DATABASE, nor reproduce, copy, duplicate, modify, adapt, translate, disassemble, decompile, or reverse engineer any portion of the DATABASE.

TRANSFER

You may not transfer the DATABASE to third parties, except together with the system for which it was created, provided that you do not retain any copy of the DATABASE, and provided that the transferee agrees to all terms and conditions of this AGREEMENT.

DISCLAIMER OF WARRANTY

THE DATABASE IS PROVIDED ON AN "AS IS" AND "WITH ALL FAULTS BASIS" AND DENSO AND TANA (AND THEIR LICENSORS AND SUPPLIERS) EXPRESSLY DISCLAIM ALL OTHER WARRANTIES, EXPRESS OR IMPLIED, INCLUDING BUT NOT LIMITED TO, THE IMPLIED WARRANTIES OF NON-INFRINGEMENT, MERCHANTABILITY, SATISFACTORY QUALITY, ACCURACY, TITLE AND FITNESS FOR A PARTICULAR PURPOSE. NO ORAL OR WRITTEN ADVICE OR INFORMATION PROVIDED BY DENSO OR TANA (OR ANY OF THEIR LICENSORS, AGENTS, EMPLOYEES OR THIRD PARTY PROVIDERS) SHALL CREATE A WARRANTY, AND YOU ARE NOT ENTITLED TO RELY ON ANY SUCH ADVICE OR INFORMATION.

THIS DISCLAIMER OF WARRANTIES IS AN ESSENTIAL CONDITION OF THIS AGREEMENT.

LIMITATION OF LIABILITY

IN NO EVENT SHALL DENSO OR TANA (OR THEIR LICENSORS OR SUPPLIERS) BE LIABLE FOR ANY INCIDENTAL, CONSEQUENTIAL, SPECIAL, INDIRECT OR EXEMPLARY DAMAGES ARISING OUT OF THIS AGREEMENT OR YOUR USE OF THE DATABASE, INCLUDING, WITHOUT LIMITATION, LOST PROFITS OR COSTS OF COVER, LOSS OF USE OR BUSINESS INTERRUPTION OR THE LIKE, REGARDLESS OF WHETHER THE PARTY WAS ADVISED OF THE POSSIBILITY OF SUCH DAMAGES.

IN NO EVENT WILL THE TOTAL LIABILITY OF DENSO OR TANA (OR THEIR LICENSORS OR SUPPLIERS) EXCEED THE AMOUNTS PAID BY YOU FOR THE DATABASE.

WARNINGS

The DATABASE comprises facts and information from government and other sources reflecting circumstances in existence before you received the DATABASE, which may contain errors and omissions. Accordingly, the DATABASE may contain inaccurate or incomplete information due to the passage of time, changing circumstances, and due to the nature of the sources used. The DATABASE does not include or reflect information relating to, among other things, neighborhood safety; law enforcement; emergency assistance; construction work; road or lane closures; vehicle or speed restrictions; road slope or grade; bridge height, weight or other limits; road or traffic conditions; special events; traffic congestion; or travel time.

U.S. GOVERNMENT RIGHTS

If you are an agency, department, or other entity of the United States Government, or funded in whole or in part by the United States Government, then use, duplication, reproduction, release, modification, disclosure or transfer of this commercial product and accompanying documentation, is restricted in accordance with the LIMITED or RESTRICTED rights as described in DFARS 252.227-7014(a)(1) (JUN 1995) (DOD commercial computer software definition), DFARS 227.7202-1 (DOD policy on commercial computer software), FAR 52.227-19 (JUN 1987) (commercial computer software clause for civilian agencies), DFARS 252.227-7015 (NOV 1995) (DOD technical data – commercial items clause); FAR 52.227-14 Alternates I, II, and III (JUN 1987) (civilian agency technical data and noncommercial computer software clause); and/or FAR 12.211 and

13-20 Customer Information

FAR 12.212 (commercial item acquisitions), as applicable. In case of conflict between any of the FAR and DFARS provisions listed herein and this Agreement, the construction that provides greater limitations on the Government's rights shall control. Contractor/ manufacturer is Tele Atlas North America, Inc., 11 Lafayette Street, Lebanon, NH 03766-1445. Phone: (603) 643-0330. The DATABASE is ©1984-2010 by Tele Atlas North America, Inc. ALL RIGHTS RESERVED. For purpose of any public disclosure provision under any federal, state or local law, it is agreed that the DATABASE is a trade secret and a proprietary commercial product and not subject to disclosure.

If you are an agency, department, or other entity of any State government, the United States Government or any other public entity or funded in whole or in part by the United States Government, then you hereby agree to protect the

DATABASE from public disclosure and to consider the DATABASE exempt from any statute, law, regulation, or code, including any Sunshine Act, Public Records Act, Freedom of Information Act, or equivalent, which permits public access and/or reproduction or use of the Licensed Products. In the event that such exemption is challenged under any such laws, this Agreement shall be considered breached and any and all right to retain any copies or to use of the DATABASE shall be terminated and considered immediately null and void. Any copies of the DATABASE held by you shall immediately be destroyed. If any court of competent jurisdiction considers this clause void and unenforceable, in whole or in part, for any reason, this Agreement shall be considered terminated and null and void, in its entirety, and any and all copies of the DATABASE shall immediately be destroyed.

BTV.461060.2

END USER NOTICE

PLEASE READ THIS NOTICE CAREFULLY BEFORE USING THIS NAVIGATION SYSTEM.

The Point Of Interest Data ("POI" Data) in the navigation system is in part provided by infoUSA Inc. ("infoUSA"). By using the POI Data, you accept and agree to all terms and conditions set forth below.

1. Ownership

All rights, title and interest to the infoUSA POI Data shall be retained by infoUSA.

2. Limitations on Use

Except to the extent explicitly permitted by mandatory laws, you may not extract or re-utilize any portion of the contents of the POI Data, nor reproduce, copy, modify, adapt, translate, disassemble, decompile, or reverse engineer any portion of the POI Data.

3. Transfer

You may not transfer the POI Data to third parties, except together with the system for which it was created, provided that you do not retain any copy of the POI Data.

4. Disclaimer of Warranty

EXCEPT AS STATED HEREIN, INFOUSA MAKES NO EXPRESS OR IMPLIED WARRANTIES, INCLUDING, WITHOUT LIMITATION, ANY EXPRESS OR IMPLIED WARRANTY OF FITNESS FOR A PARTICULAR PURPOSE OR WARRANTY OF MERCHANTABILITY.

5. Limitation of Liability

EITHER INFOUSA OR SUPPLIER OF POI DATA SHALL NOT BE LIABLE FOR ANY INDIRECT, CONSEQUENTIAL OR INCIDENTAL DAMAGES

MADE OR ALLEGED IN CONNECTION WITH YOUR USE OF THE POI DATA.

END USER LICENSE AGREEMENT

Personal Use Only — You agree to use this information for solely personal, non commercial purposes, and not for service bureau, time sharing or other similar purposes. You may not modify the information or remove any copyright notices that appear on the information in any way. You may not decompile, disassemble or reverse engineer any portion of this information, and may not transfer or distribute it in any form, for any purpose. Without limiting the foregoing, you may not use this information with any products, systems, or applications installed or otherwise connected to or in communication with vehicles, capable of vehicle navigation, positioning, dispatch, real time route guidance, fleet management or similar applications.

No Warranty — This information is provided to you “as is,” and you agree to use it at your own risk. DENSO and its licensors (and their licensors and suppliers, collectively “DENSO”) make no guarantees, representations or warranties of any kind, express or implied, arising by law or otherwise, including but not limited to, and DENSO expressly disclaims any warranties regarding content, quality, accuracy, completeness, effectiveness, reliability, fitness for a particular purpose, non infringement, usefulness, use or results to be obtained from this information, or that the information or server will be uninterrupted or error free. Some states, territories and countries do not allow certain warranty exclusions, so to that extent, the above exclusion may not apply to you.

13-22 Customer Information

Disclaimer of Liability: DENSO SHALL NOT BE LIABLE TO YOU FOR ANY CLAIM, DEMAND OR ACTION, IRRESPECTIVE OF ITS NATURE, ALLEGING ANY LOSS, INJURY OR DAMAGES, WHETHER DIRECT, INDIRECT, INCIDENTAL, SPECIAL OR CONSEQUENTIAL DAMAGES, INCLUDING ANY LOSS OF PROFIT, REVENUE OR CONTRACTS ARISING OUT OF YOUR POSSESSION, USE OF OR INABILITY TO USE THIS INFORMATION, ANY DEFECT IN THE INFORMATION, OR THE BREACH OF THESE TERMS OR CONDITIONS, WHETHER IN AN ACTION IN CONTRACT OR TORT OR BASED ON A WARRANTY, EVEN IF DENSO OR ITS LICENSORS HAVE BEEN ADVISED OF THE POSSIBILITY OF SUCH DAMAGES. Some states,

territories and countries do not allow certain liability exclusions or damages limitations, so to that extent the above may not apply to you.

Indemnity — You agree to indemnify, defend and hold DENSO and its licensors (including their respective licensors, suppliers, assignees, subsidiaries, affiliated companies, and the respective officers, directors, employees, shareholders, agents and representatives of each of them) free and harmless from and against any liability, loss, injury (including injuries resulting in death), demand, action, cost, expense, or claim of any kind or character, including but not limited to attorney's fees, arising out of or in connection with any use or possession by you of this information.

END USER NOTICE

The marks of companies displayed by this product to indicate business locations are the marks of their respective owners. The use of such marks in this product does not imply any sponsorship, approval, or endorsement by such companies of this product.

Open Source Information

This vehicle contains open source software, including without limitation, software distributed and/or modified under the GNU General Public License, Version 2, June 1991, and the GNU Lesser General Public License, Version 2.1, February 1999.

See www.oss.gm.com for additional information and to download related materials, including without limitation, the previous referred to licenses and software.

Reporting Safety Defects

Reporting Safety Defects to the United States Government

If you believe that your vehicle has a defect which could cause a crash or could cause injury or death, you should immediately inform the National Highway Traffic Safety Administration (NHTSA) in addition to notifying General Motors.

If NHTSA receives similar complaints, it may open an investigation, and if it finds that a safety defect exists in a group of vehicles, it may order a recall and remedy campaign.

However, NHTSA cannot become involved in individual problems between you, your dealer, or General Motors.

To contact NHTSA, you may call the Vehicle Safety Hotline toll-free at 1-888-327-4236 (TTY: 1-800-424-9153); go to <http://www.safercar.gov>; or write to:

Administrator, NHTSA
1200 New Jersey Avenue, S.E.
Washington, D.C. 20590

You can also obtain other information about motor vehicle safety from <http://www.safercar.gov>.

Reporting Safety Defects to the Canadian Government

If you live in Canada, and you believe that the vehicle has a safety defect, notify Transport Canada immediately, and notify General Motors of Canada Limited. Call them at 1-800-333-0510 or write to:

Transport Canada
Road Safety Branch
2780 Sheffield Road
Ottawa, Ontario K1B 3V9

Reporting Safety Defects to General Motors

In addition to notifying NHTSA (or Transport Canada) in a situation like this, notify General Motors.

Call 1-800-222-1020, or write:

Chevrolet Motor Division
Chevrolet Customer
Assistance Center
P.O. Box 33170
Detroit, MI 48232-5170

In Canada, call 1-800-263-3777
(English) or 1-800-263-7854
(French), or write:

General Motors of Canada Limited
Customer Communication Centre,
Mail Code: CA1-163-005
1908 Colonel Sam Drive
Oshawa, Ontario L1H 8P7

Vehicle Data Recording and Privacy

This GM vehicle has a number of sophisticated computers that record information about the vehicle's performance and how it is driven. For example, the vehicle uses computer modules to monitor and control engine and electric drive unit performance, to monitor the conditions for airbag deployment and to deploy airbags in a crash, and to provide antilock braking to help the driver control the vehicle. These modules may store data to help the dealer technician service the vehicle. Some modules may also store data about how you operate the vehicle, such as rate of fuel consumption or average speed. These modules may also retain the owner's personal preferences, such as radio pre-sets, seat positions, and temperature settings.

Event Data Recorders

This vehicle has an Event Data Recorder (EDR). The main purpose of an EDR is to record, in certain crash or near crash-like situations, such as an airbag deployment or hitting a road obstacle, data that will assist in understanding how a vehicle's systems performed. The EDR is designed to record data related to vehicle dynamics and safety systems for a short period of time, typically 30 seconds or less. The EDR in this vehicle is designed to record such data as:

- How various systems in the vehicle were operating.
- Whether or not the driver and passenger safety belts were buckled/fastened.
- How far, if at all, the driver was pressing the accelerator and/or brake pedal.
- How fast the vehicle was traveling.

This data can help provide a better understanding of the circumstances in which crashes and injuries occur.

Important: EDR data is recorded by the vehicle only if a non-trivial crash situation occurs; no data is recorded by the EDR under normal driving conditions and no personal data (e.g., name, gender, age, and crash location) is recorded. However, other parties, such as law enforcement, could combine the EDR data with the type of personally identifying data routinely acquired during a crash investigation.

To read data recorded by an EDR, special equipment is required, and access to the vehicle or the EDR is needed. In addition to the vehicle manufacturer, other parties, such as law enforcement, that have the special equipment, can read the information if they have access to the vehicle or the EDR.

GM will not access this data or share it with others except: with the consent of the vehicle owner or, if the vehicle is leased, with the consent of the lessee; in response to an official request by police or similar government office; as part of GM's defense of litigation through the discovery process; or, as required by law. Data that GM collects or receives may also be used for GM research needs or may be made available to others for research purposes, where a need is shown and the data is not tied to a specific vehicle or vehicle owner.

OnStar®

If the vehicle is equipped with an active OnStar system, that system may also record data in crash or near crash-like situations. The OnStar Terms and Conditions provides information on data collection and use and is available in the OnStar glove box kit, at www.onstar.com (U.S.) or www.onstar.ca (Canada), or by pressing the  button and speaking to an advisor.

Navigation System

If the vehicle has a navigation system, use of the system may result in the storage of destinations, addresses, telephone numbers, and other trip information. See *Using the Navigation System on page 7-36* for information on stored data and for deletion instructions.

Radio Frequency Identification (RFID)

RFID technology is used in some vehicles for functions such as tire pressure monitoring and ignition system security, as well as in connection with conveniences such as key fobs for remote door locking/unlocking and starting, and in-vehicle transmitters for garage door openers. RFID technology in GM vehicles does not use or record personal information or link with any other GM system containing personal information.

Radio Frequency Statement

This vehicle has systems that operate on a radio frequency that comply with Part 15 of the Federal Communications Commission (FCC) rules and with Industry Canada Standards RSS-210/220/310.

Operation is subject to the following two conditions:

1. The device may not cause interference.
2. The device must accept any interference received, including interference that may cause undesired operation of the device.

Changes or modifications to any of these systems by other than an authorized service facility could void authorization to use this equipment.

A

Accessories and Modifications 10-3

Accessory Power 9-21

Add-On Electrical Equipment 9-57

Air Cleaner/Filter, Engine 10-13

Air Conditioning 8-1

Air Vents 8-8

Airbag System

 Check 3-39

 How Does an Airbag Restrain? 3-31

 Passenger Sensing System 3-33

 What Makes an Airbag Inflate? 3-30

 What Will You See After an Airbag Inflates? 3-31

 When Should an Airbag Inflate? 3-29

 Where Are the Airbags? 3-27

Airbags

 Adding Equipment to the Vehicle 3-38

 Passenger Status Indicator 5-18

 Readiness Light 5-18

 Servicing Airbag-Equipped Vehicles 3-37

 System Check 3-25

Alarm System

 Anti-Theft 2-12

Alert

 Pedestrian Friendly 6-2

AM-FM Radio 7-8

Antenna

 Multi-Band 7-15

Anti-Theft

 Alarm System 2-12

 Alarm System Messages 5-46

Antilock Brake System (ABS) 9-31

 Warning Light 5-23

Appearance Care

 Exterior 10-81

 Interior 10-85

Assistance Program, Roadside 13-6

Audio Players

 CD/DVD 7-16

 MP3 7-21

Audio System

 Hard Drive Device (HDD) 7-24

 Radio Reception 7-15

 Theft-Deterrent Feature 7-2

Automatic

 Climate Control System 8-1

 Door Locks 2-10

Auxiliary Devices 7-36

B

Battery 10-24

 Gauge 5-15

 High Voltage 5-15

 Jump Starting 10-71

 Power Protection 6-6

Battery and Charging Messages 5-41

Blade Replacement, Wiper 10-26

Bluetooth 7-78

Brake

 Parking, Electric 9-32

Brake System Warning Light 5-22

Brakes	10-21
Antilock	9-31
Fluid	10-22
Regenerative Braking	9-33
System Messages	5-41
Braking	9-6
Break-In, New Vehicle	9-18
Bulb Replacement	10-32
Back-Up Lamps	10-31
Halogen Bulbs	10-29
Headlamp Aiming	10-27
Headlamps	10-29, 10-30
License Plate Lamps	10-31
Buying New Tires	10-56

C

Calibration	5-15, 5-38
California	
Fuel Requirements	9-53
Perchlorate Materials	
Requirements	10-2
Warning	10-2

Camera, Rear Vision	9-41
Canadian Vehicle Owners	iii
Capacities and	
Specifications	12-2
Carbon Monoxide	
Engine Exhaust	9-28
Hatch	2-10
Winter Driving	9-11
Cargo	
Cover	4-2
Cautions, Danger, and	
Warnings	iv
CD/DVD Player	7-16
Chains, Tire	10-61
Charge Cord	9-49
Charging	5-30
Delay Override	9-47
Electrical Requirements	9-51
Plug-In	9-44
System Light	5-19
Charging Status Screens	9-47
Check	
Engine Light	5-19

Child Restraints	
Infants and Young	
Children	3-42
Lower Anchors and	
Tethers for Children	3-47
Older Children	3-40
Securing	3-54, 3-56
Systems	3-44
Cleaning	
Exterior Care	10-81
Interior Care	10-85
Climate Control Systems	
Automatic	8-1
Cluster, Instrument	5-9
Collision Damage Repair	13-10
Compass	5-15, 5-38
Compressor Kit, Tire	
Sealant	10-63
Configure Menu	7-61
Control of a Vehicle	9-5
Convex Mirrors	2-13
Coolant	
Engine	10-17
Engine Temperature	
Warning Light	5-24

Cooling System10-15, 10-16
 Engine Messages5-43
 Courtesy Transportation
 Program 13-8
 Cover
 Cargo 4-2
 Cruise Control 9-36
 Light5-27
 Messages5-42
 Customer Assistance 13-4
 Offices13-3
 Text Telephone (TTY)
 Users13-4
 Customer Information
 Service Publications
 Ordering Information 13-12
 Customer Satisfaction
 Procedure 13-1

D

Damage Repair, Collision 13-10
 Danger, Warnings, and
 Cautions iv
 Data Recorders, Event 13-24
 Database Coverage
 Explanations 7-71

Daytime Running
 Lamps (DRL) 6-3
 Defensive Driving 9-4
 Delayed Charging Override 9-47
 Delayed Locking 2-9
 Destination, Navigation 7-48
 Devices, Auxiliary 7-36
 Dome Lamps 6-5
 Door
 Ajar Messages5-42
 Delayed Locking 2-9
 Locks 2-8
 Power Locks 2-9
 Drive Mode Messages 5-42
 Drive Unit
 Electric9-29
 Driver Efficiency Gauge 5-16
 Driver Information
 Center (DIC) 5-38
 Driver Selected Operating
 Modes 9-24
 Driving
 Defensive 9-4
 Drunk 9-4
 Highway Hypnosis9-10
 Hill and Mountain Roads9-10

Driving (cont.)
 If the Vehicle is Stuck9-13
 Loss of Control 9-8
 Off-Road Recovery 9-8
 Vehicle Load Limits9-13
 Wet Roads 9-9
 Winter 9-11
 Driving for Better
 Energy Efficiency 1-22, 9-2
 DVD/CD Player 7-16

E

Electric Drive Unit 9-29
 Electric Drive Unit
 Messages 5-43
 Electric Drive Unit Shift
 Lock Control Function
 Check 10-25
 Electric Mode 9-23
 Electric Parking Brake 9-32
 Electric Parking Brake Light ... 5-22
 Electrical Equipment,
 Add-On 9-57
 Electrical Requirements for
 Battery Charging 9-51

Electrical System
 Engine Compartment
 Fuse Block 10-33
 Instrument Panel
 Fuse Block 10-37, 10-39
 Overload 10-33
 Rear Compartment Fuse
 Block 10-41
Electronic Stability Control 9-35
Energy Efficiency
 Driving 1-22, 9-2
Energy Information 5-37
Engine
 Air Cleaner/Filter 10-13
 Check and Service Engine
 Soon Light 5-19
 Compartment Overview 10-8
 Coolant 10-17
 Coolant Temperature
 Warning Light 5-24
 Cooling System 10-15, 10-16
 Cooling System Messages ... 5-43
 Drive Belt Routing 12-3
 Exhaust 9-28

Engine (cont.)
 Overheating 10-20
 Pressure Light 5-25
 Running While Parked 9-28
Engine Oil
 Life System 10-12
 Messages 5-43
Engine Unavailable
 Out of Fuel 9-26
Entry Lighting 6-5
Event Data Recorders 13-24
Exit Lighting 6-5
Extended Range Mode 9-23
Extender, Safety Belt 3-23
Exterior Lamp Controls 6-1

F

Filter,
 Engine Air Cleaner 10-13
Flash-to-Pass 6-2
Flashers, Hazard Warning 6-4
Flat Tire 10-62
Floor Console Storage 4-1
Floor Mats 10-88

Fluid
 Brakes 10-22
 Power Steering 10-20
 Washer 10-20
Folding Mirrors 2-14
Front Seats
 Adjustment 3-4
 Heated 3-6
Fuel 9-52
 Additives 9-54
 Filling a Portable Fuel
 Container 9-56
 Filling the Tank 9-55
 Fuels in Foreign Countries ... 9-53
 Gasoline Specifications 9-53
 Gauge 5-16
 Low Fuel Warning Light 5-26
 Requirements, California 9-53
 System Messages 5-43
Function Check
 Electric Drive Unit Shift
 Lock Control 10-25

Fuses
 Engine Compartment
 Fuse Block 10-33
 Instrument Panel
 Fuse Block 10-37, 10-39
 Rear Compartment Fuse
 Block 10-41

G

Garage Door Opener 5-55
 Programming 5-55
 Gasoline
 Specifications 9-53
 Gauges
 Battery 5-15
 Driver Efficiency 5-16
 Fuel 5-16
 Odometer 5-15
 Speedometer 5-15
 Trip Odometer 5-15
 Warning Lights and
 Indicators 5-9
 General Information
 Service and Maintenance 11-1
 Towing 9-57
 Vehicle Care 10-2

Global Positioning
 System (GPS) 7-68
 Glove Box 4-1
 GM Mobility Reimbursement
 Program 13-5

H

Halogen Bulbs 10-29
 Hard Drive Device (HDD) 7-24
 Hatch 2-10
 Hazard Warning Flashers 6-4
 Head Restraints 3-2
 Headlamps 10-30
 Aiming 10-27
 Bulb Replacement 10-29
 Daytime Running
 Lamps (DRL) 6-3
 Flash-to-Pass 6-2
 High-Beam On Light 5-26
 High/Low Beam Changer 6-2
 Lamps On Reminder 5-26
 Heated Front Seats 3-6
 Heated Mirrors 2-14
 Heating and Air Conditioning ... 8-1
 High Voltage Battery Gauge ... 5-15

High Voltage Devices and
 Wiring 10-32
 High-Beam On Light 5-26
 Highway Hypnosis 9-10
 Hill and Mountain Roads 9-10
 Hood 10-7
 Hood, Door, Hatch Open
 Light 5-27
 Horn 5-7
 How to Wear Safety Belts
 Properly 3-13

I

Immobilizer 2-12
 Infants and Young Children,
 Restraints 3-42
 Information
 Energy 5-37
 Open Source 13-22
 Infotainment 7-1
 Instrument Cluster 5-9
 Instrument Panel
 Storage Area 4-1
 Introduction iii

J

Jump Starting 10-71

K

Key and Lock Messages 5-44

Keyless Entry

Remote (RKE) System 2-3

Keys 2-2

L

Labeling, Tire Sidewall 10-44

Lamp Messages 5-45

Lamps

Daytime Running (DRL) 6-3

Dome 6-5

Exterior Controls 6-1

License Plate 10-31

Malfunction Indicator 5-19

On Reminder 5-26

Reading 6-5

Lap-Shoulder Belt 3-19

LATCH System

Replacing Parts After a

Crash 3-54

LATCH, Lower Anchors and

Tethers for Children 3-47

Lifting the Vehicle, Tires 10-3

Lighting

Entry 6-5

Exit 6-5

Illumination Control 6-5

Lights

Airbag Readiness 5-18

Antilock Brake System

(ABS) Warning 5-23

Brake System Warning 5-22

Charging System 5-19

Cruise Control 5-27

Electric Parking Brake 5-22

Engine Coolant

Temperature Warning 5-24

Engine Oil Pressure 5-25

Flash-to-Pass 6-2

High-Beam On 5-26

High/Low Beam Changer 6-2

Lights (cont.)

Hood, Door, Hatch Open 5-27

Low Fuel Warning 5-26

Mountain Mode 5-24

Safety Belt Reminders 5-17

Security 5-26

Service Electric Parking

Brake 5-23

Sport Mode 5-24

Tire Pressure 5-25

Traction Control System

(TCS)/StabiliTrak[®] 5-24

Locks

Automatic Door 2-10

Delayed Locking 2-9

Door 2-8

Lockout Protection 2-10

Power Door 2-9

Safety 2-10

Loss of Control 9-8

Low Fuel Warning Light 5-26

Lower Anchors and Tethers

for Children (LATCH System) 3-47

M

Maintenance
 Records 11-8
 Maintenance Modes 9-26
 Maintenance Schedule
 Recommended Fluids and
 Lubricants 11-6
 Scheduled Maintenance 11-3
 Malfunction Indicator Lamp 5-19
 Maps 7-42
 Menu
 Configure 7-61
 Messages
 Airbag System 5-46
 Anti-Theft Alarm System 5-46
 Brake System 5-41
 Door Ajar 5-42
 Drive Mode 5-42
 Electric Drive Unit 5-43
 Engine Cooling System 5-43
 Engine Oil 5-43
 Fuel System 5-43
 Key and Lock 5-44
 Lamp 5-45
 Object Detection System 5-45
 Propulsion Power 5-45

Messages (cont.)
 Ride Control System 5-46
 Service Vehicle 5-46
 Starting the Vehicle 5-47
 Tire 5-47
 Vehicle 5-40
 Vehicle Speed 5-48
 Washer Fluid 5-48
 Mirrors
 Automatic Dimming
 Rearview 2-15
 Convex 2-13
 Folding 2-14
 Heated 2-14
 Power 2-14
 Mode
 Electric 9-23
 Extended Range 9-23
 Modes
 Driver Selected 9-24
 Maintenance 9-26
 Monitor System, Tire
 Pressure 10-49
 Mountain Mode Light 5-24
 MP3 7-21
 Multi-Band Antenna 7-15

N

Navigation
 Destination 7-48
 Symbols 7-44
 Using the System 7-36
 Vehicle Data Recording
 and Privacy 13-25
 New Vehicle Break-In 9-18

O

Object Detection System
 Messages 5-45
 Odometer 5-15
 Trip 5-15
 Off-Road
 Recovery 9-8
 Oil
 Engine 10-9
 Engine Oil Life System 10-12
 Messages 5-43
 Pressure Light 5-25
 Older Children, Restraints 3-40
 Online Owner Center 13-4
 OnStar® System 1-24
 Open Source Information 13-22

Ordering	
Map DVDs	7-70
Service Publications	13-12
Out of Fuel/Engine	
Unavailable	9-26
Outlets	
Power	5-8
Overheating, Engine	10-20
Overview, Infotainment	
System	7-2

P

Park	
Shifting Into	9-21
Shifting Out of	9-22
Parking	
Assist, Ultrasonic	9-39
Brake and P (Park)	
Mechanism Check	10-26
Over Things That Burn	9-22
Passenger Airbag Status	
Indicator	5-18
Passenger Sensing System ...	3-33
Pedestrian Friendly Alert	6-2

Perchlorate Materials	
Requirements, California	10-2
Personalization	
Vehicle	5-48
Phone	
Bluetooth	7-78
Plug-In Charging	9-44
Power	
Button	9-18
Door Locks	2-9
Flows	5-28
Mirrors	2-14
Outlets	5-8
Protection, Battery	6-6
Retained Accessory (RAP) ...	9-21
Steering Fluid	10-20
Windows	2-16
Pregnancy, Using Safety	
Belts	3-23
Privacy	
Radio Frequency	
Identification (RFID)	13-26
Problems with Route	
Guidance	7-70
Program Courtesy	
Transportation	13-8

Proposition 65 Warning,	
California	10-2
Propulsion Power	
Messages	5-45
Propulsion System Start	
Check	10-25

R

Radio Frequency	
Identification (RFID)	13-26
Statement	13-26
Radios	
AM-FM Radio	7-8
CD/DVD Player	7-16
Reception	7-15
Satellite	7-13
Reading Lamps	6-5
Rear Seats	3-8
Rear Vision Camera (RVC)	9-41
Rearview Mirror	
Automatic Dimming	2-15
Reclining Seatbacks	3-4
Recommended Fluids and	
Lubricants	11-6
Records	
Maintenance	11-8

Recreational Vehicle
 Towing 10-79
 Regenerative Braking 9-33
 Reimbursement Program,
 GM Mobility 13-5
 Remote Keyless Entry
 (RKE) System 2-2, 2-3
 Remote Start 2-7
 Replacement Bulbs 10-32
 Replacement Parts
 Airbags 3-39
 Maintenance 11-7
 Replacing Airbag System 3-39
 Replacing LATCH System
 Parts After a Crash 3-54
 Replacing Safety Belt
 System Parts After a
 Crash 3-24
 Reporting Safety Defects
 Canadian Government 13-23
 General Motors 13-24
 U.S. Government 13-23
 Requirements
 Electrical Battery Charging ... 9-51
 Restraints
 Where to Put 3-46

Retained Accessory
 Power (RAP) 9-21
 Ride Control Systems 9-35
 Electronic Stability (ESC) 9-35
 Messages 5-46
 Roads
 Driving, Wet 9-9
 Roadside Assistance
 Program 13-6
 Rotation, Tires 10-54
 Routing, Engine Drive Belt 12-3
 Running the Vehicle While
 Parked 9-28

S

Safety Belts 3-10
 Care 3-24
 Extender 3-23
 How to Wear Safety Belts
 Properly 3-13
 Lap-Shoulder Belt 3-19
 Reminders 5-17
 Replacing After a Crash 3-24
 Use During Pregnancy 3-23

Safety Defects Reporting
 Canadian Government 13-23
 General Motors 13-24
 U.S. Government 13-23
 Safety Locks 2-10
 Safety System Check 3-23
 Satellite Radio 7-13
 Scheduled Maintenance 11-3
 Scheduling Appointments 13-8
 Sealant Kit, Tire 10-63
 Seats
 Adjustment, Front 3-4
 Head Restraints 3-2
 Heated Front 3-6
 Rear 3-8
 Reclining Seatbacks 3-4
 Securing Child
 Restraints 3-54, 3-56
 Security
 Light 5-26
 Vehicle 2-12
 Service
 Accessories and
 Modifications 10-3
 Doing Your Own Work 10-6
 Engine Soon Light 5-19

Service (cont.)			
Maintenance Records	11-8		
Maintenance, General Information	11-1		
Parts Identification Label	12-1		
Publications Ordering Information	13-12		
Scheduling Appointments	13-8		
Vehicle Messages	5-46		
Service Electric Parking			
Brake Light	5-23		
Servicing the Airbag	3-37		
Shifting			
Into Park	9-21		
Out of Park	9-22		
Signals, Turn and			
Lane-Change	6-4		
Specifications and			
Capacities	12-2		
Speedometer	5-15		
Sport Mode Light	5-24		
Start			
Check Propulsion System	10-25		
Remote	2-7		
Starting and Stopping the Vehicle	9-19		
Starting the Vehicle			
Messages	5-47		
Status Screens			
Charging	9-47		
Steering	9-7		
Fluid, Power	10-20		
Wheel Adjustment	5-6		
Wheel Controls	5-6		
Storage Areas			
Cargo Cover	4-2		
Floor Console	4-1		
Glove Box	4-1		
Instrument Panel	4-1		
Umbrella	4-2		
Storing the Tire Sealant and Compressor Kit	10-70		
Stuck Vehicle	9-13		
Sun Visors	2-17		
Symbols	iv		
Symbols, Navigation	7-44		
System			
Infotainment	7-1		
System Needs Service, If	7-70		
System Operation	9-23		
		T	
		Text Telephone (TTY) Users ...	13-4
		Theft-Deterrent Systems	2-13
		Immobilizer	2-12
		Tires	
		Buying New Tires	10-56
		Chains	10-61
		Designations	10-45
		Different Size	10-58
		If a Tire Goes Flat	10-62
		Inflation Monitor System	10-50
		Inspection	10-54
		Lifting the Vehicle	10-3
		Messages	5-47
		Pressure Light	5-25
		Pressure Monitor System ...	10-49
		Rotation	10-54
		Sealant and Compressor Kit	10-63
		Sealant and Compressor Kit, Storing	10-70
		Sidewall Labeling	10-44
		Terminology and Definitions	10-45
		Uniform Tire Quality Grading	10-58

Tires (cont.)
 Wheel Alignment and Tire
 Balance 10-60
 Wheel Replacement 10-60
 When It Is Time for New
 Tires 10-55
 Winter 10-43
 Total Vehicle Range 5-16
 Towing
 General Information 9-57
 Recreational Vehicle 10-79
 Vehicle 10-77
 Traction
 Control System (TCS) 9-34
 Control System (TCS)/
 StabiliTrak® Light 5-24
 Transportation Program,
 Courtesy 13-8
 Trip Odometer 5-15
 Turn and Lane-Change
 Signals 6-4

U

Ultrasonic Parking Assist 9-39
 Umbrella Storage 4-2
 Uniform Tire Quality
 Grading 10-58
 Universal Remote System 5-55
 Operation 5-58
 Programming 5-55
 Using this Manual iv

V

Vehicle
 Canadian Owners iii
 Control 9-5
 Identification
 Number (VIN) 12-1
 Load Limits 9-13
 Messages 5-40
 Personalization 5-48
 Positioning 7-69
 Security 2-12
 Speed Messages 5-48
 Starting and Stopping 9-19
 Total Range 5-16
 Towing 10-77

Vehicle Care
 Storing the Tire Sealant
 and Compressor Kit 10-70
 Tire Pressure 10-48
 Vehicle Identification
 Service Parts Identification
 Label 12-1
 Ventilation, Air 8-8
 Visors 2-17
 Voice Recognition 7-71
 Voltage Devices and
 Wiring 10-32

W

Warning
 Brake System Light 5-22
 Warning Lights, Gauges, and
 Indicators 5-9
 Warnings iv
 Cautions and Danger iv
 Hazard Flashers 6-4
 Washer Fluid 10-20
 Washer Fluid Messages 5-48

Wheels	
Alignment and Tire	
Balance	10-60
Different Size	10-58
Replacement	10-60
When It Is Time for New	
Tires	10-55
Where to Put the Restraint	3-46
Windows	2-15
Power	2-16
Windshield	
Wiper/Washer	5-7
Winter Driving	9-11
Winter Tires	10-43
Wiper Blade Replacement	10-26
Wiring, High Voltage	
Devices	10-32