

HANDBOOK



CITROËN C4 PICASSO - GRAND C4 PICASSO



CITROËN

On-line handbook

Select one of the following means of access to view your handbook on-line...

Referring to the handbook on-line also gives you access to the latest information available, easily identified by the bookmark, associated with this symbol:



MyCITROËN

Find your handbook on the CITROËN website, under "MyCITROËN".

This personal and customisable space allows you to establish direct and special contact with the manufacturer.

If the "MyCITROËN" function is not available on the CITROËN public website for your country, you can find your handbook at the following address:

<http://service.citroen.com/ddb/>

Select:

- > the language,
 - > the vehicle, its body style,
 - > the print edition of your handbook appropriate for the date of registration of your vehicle.
-

Scan this code for direct access to your handbook.





This handbook has been designed to help to make the most of your C4 Picasso in all circumstances and in complete safety. Take the time to read through it so as to familiarise yourself with your vehicle.

This handbook covers all of the variations in equipment available across the whole C4 Picasso range.

Your vehicle will be fitted with only some of the equipment described in this document, depending on its trim level, version and the specification for the country in which it was sold.

Key

-  safety warning
-  additional information
-  contributes to the protection of the environment

Key

This key will enable you to identify the special features of your vehicle:



C4 Picasso



Grand C4 Picasso



Grand C4 Picasso with 5 seats



Grand C4 Picasso with 7 seats

The descriptions and illustrations are given as indications only. Automobiles CITROËN reserves the right to modify the technical characteristics, equipment and accessories without having to update this edition of the guide.

This document forms an integral part of your vehicle. Remember to pass it on to the new owner in the event of the sale of the vehicle.

CITROËN has a presence on every continent,
a complete product range,
bringing together technology and a permanent spirit of innovation,
for a modern and creative approach to mobility.
We thank you and congratulate you on your choice.

At the wheel of your new vehicle,
getting to know each system,
each control, each setting,
makes your trips, your journeys
more comfortable and more enjoyable.

Happy motoring!

<p>Overview ■</p>	<p>Electronic key - remote control 51</p> <p>"Keyless Entry and Starting" 54</p> <p>Central locking 61</p> <p>Doors 62</p> <p>Boot 64</p> <p>Motorised tailgate 65</p> <p>Alarm 68</p> <p>Electric windows 71</p>	<p>Access 2</p>
<p>Eco-driving ■</p>	<p>Front seats 73</p> <p>Rear seats 80</p> <p>Seat modularity 87</p> <p>Mirrors 89</p> <p>Steering wheel adjustment 91</p> <p>Ventilation 92</p> <p>Heating 94</p> <p>Dual-zone manual air conditioning 95</p> <p>Dual-zone automatic air conditioning 97</p> <p>Front demist - defrost 102</p> <p>Rear screen demist - defrost 103</p> <p>Scented air freshener 104</p> <p>Interior fittings 106</p> <p>Rear multimedia 115</p>	<p>Comfort 3</p>
<p>Monitoring 1</p> <p>7-inch touch screen tablet 11</p> <p>Instrument panels 20</p> <p>Indicator and warning lamps 25</p> <p>Adjustment buttons 44</p> <p>Setting the date and time 47</p> <p>Trip computer 48</p>	<p>Driving recommendations 123</p> <p>Starting-switching off the engine with the electronic key 124</p> <p>Starting-switching off the engine with the "Keyless Entry and Starting" system 126</p> <p>Electric parking brake 130</p> <p>Hill start assist 137</p> <p>5-speed manual gearbox 138</p> <p>6-speed manual gearbox 138</p> <p>Electronic gearbox (ETG6) 139</p> <p>Automatic gearbox 143</p> <p>Gear shift indicator 148</p> <p>Stop & Start 149</p> <p>Display of inter-vehicle time 152</p> <p>Memorising speeds 156</p> <p>Speed limiter 157</p> <p>Cruise control 160</p> <p>Active cruise control 163</p> <p>Collision risk alert 171</p> <p>Lane departure warning system 174</p> <p>Blind spot sensors 175</p> <p>Parking sensors 178</p> <p>Reversing camera 180</p> <p>360 Vision 181</p> <p>Park Assist 183</p>	<p>Driving 4</p>

 Visibility
5

Lighting controls	191
Automatic illumination of headlamps	196
Automatic headlamp dipping	197
Daytime running lamps	199
Headlamp adjustment	200
Directional lighting	202
Wiper controls	203
Screenwash	205
Automatic rain sensitive wipers	206
Courtesy lamps	208
Panoramic sunroof	209
Interior mood lighting	210

 Safety
6

Direction indicators	211
Hazard warning lamps	211
Horn	211
Emergency or assistance call	212
Warning triangle	212
Under-inflation detection	213
ESC system	216
Seat belts	220
Airbags	225
Child seats	231
Deactivating the passenger's front airbag	233
ISOFIX mountings	242
Child lock	250

 Practical information
7

Temporary puncture repair kit	251
Changing a wheel	259
Snow chains	269
Changing a bulb	270
Changing a fuse	279
12 V battery	286
Energy economy mode	289
Changing a wiper blade	290
Towing the vehicle	291
Towbar with quickly detachable towball	293
Towing a trailer	295
Roof bars	297
Very cold climate screen	299
Accessories	300

 Checks
8

Bonnet	303
Petrol engines	304
Diesel engines	305
Fuel	306
Misfuel prevention (Diesel)	307
Running out of fuel (Diesel)	309
Checking levels	310
Checks	314
AdBlue® additive and SCR system (BlueHDI Diesel)	316

 Technical data
9

Petrol engines	323
Petrol weights	325
Diesel engines	327
Diesel weights	330
Dimensions	333
Identification markings	335

 Audio and telematics

Emergency or assistance	336
7-inch touch screen tablet	339

 Alphabetical index
 ■

Exterior

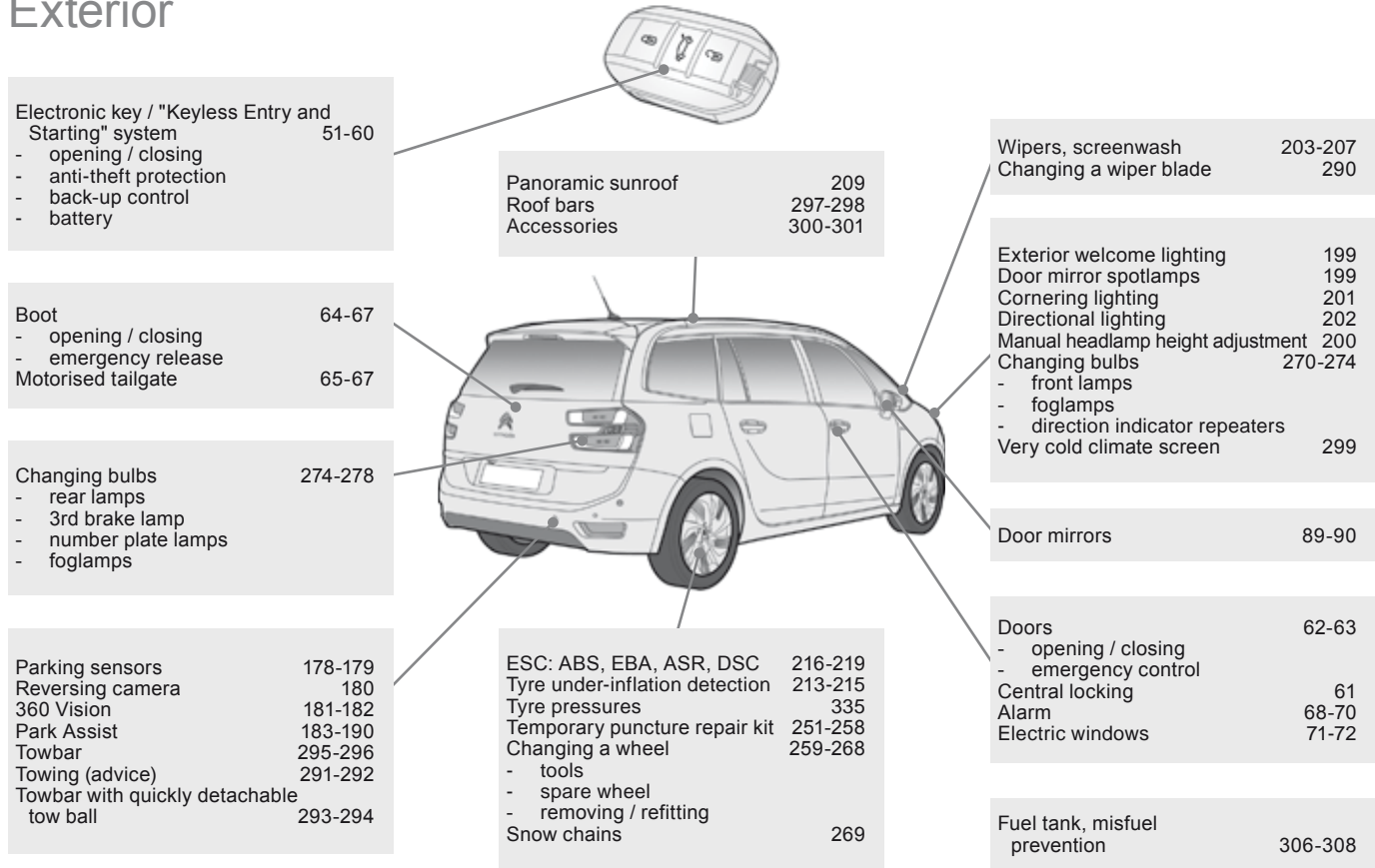

Interior

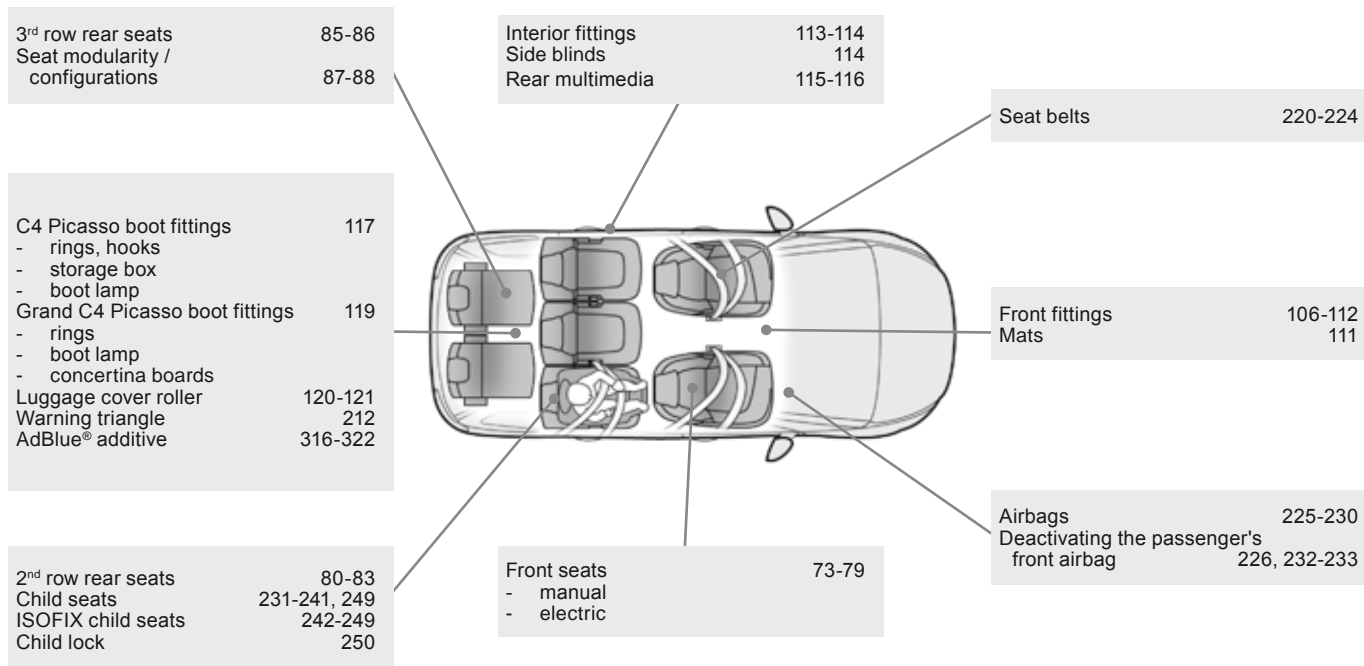

Instruments and controls

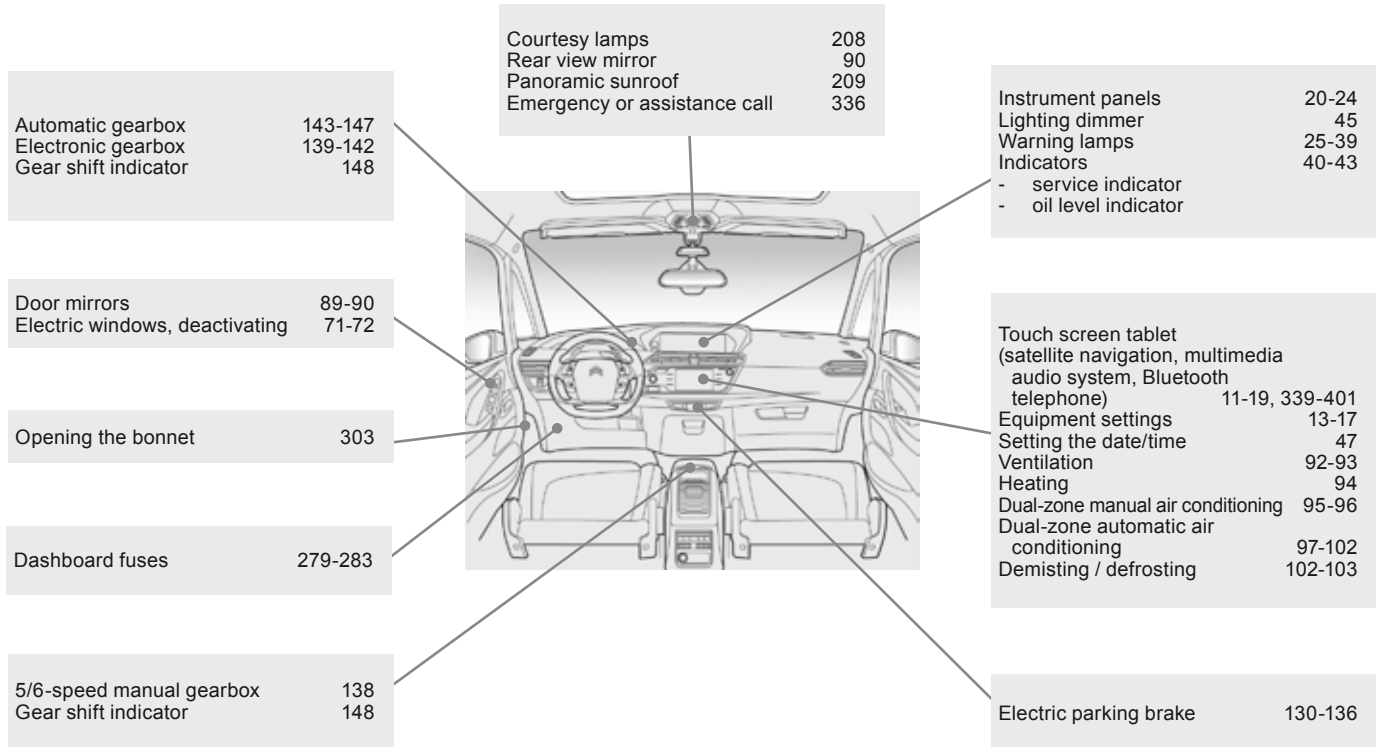

Instruments and controls (cont.)

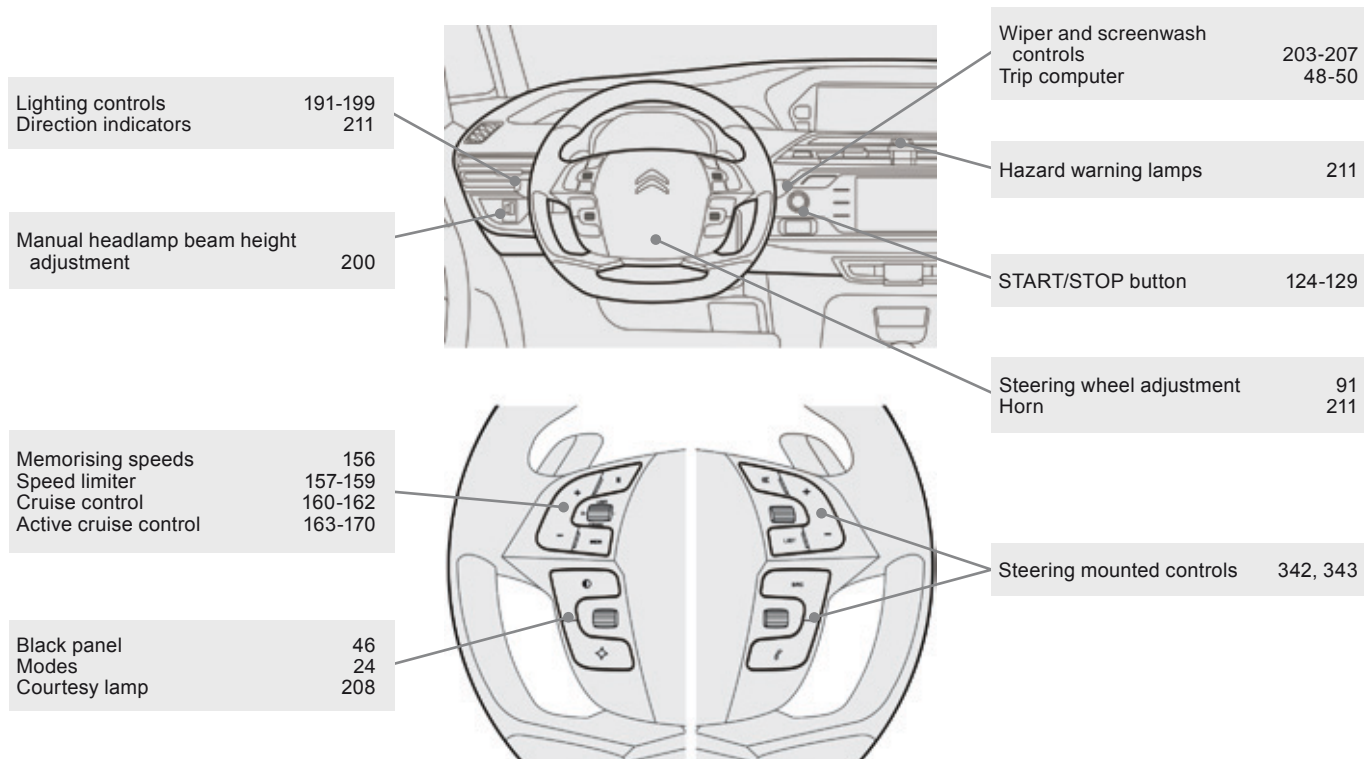

Maintenance - Technical data

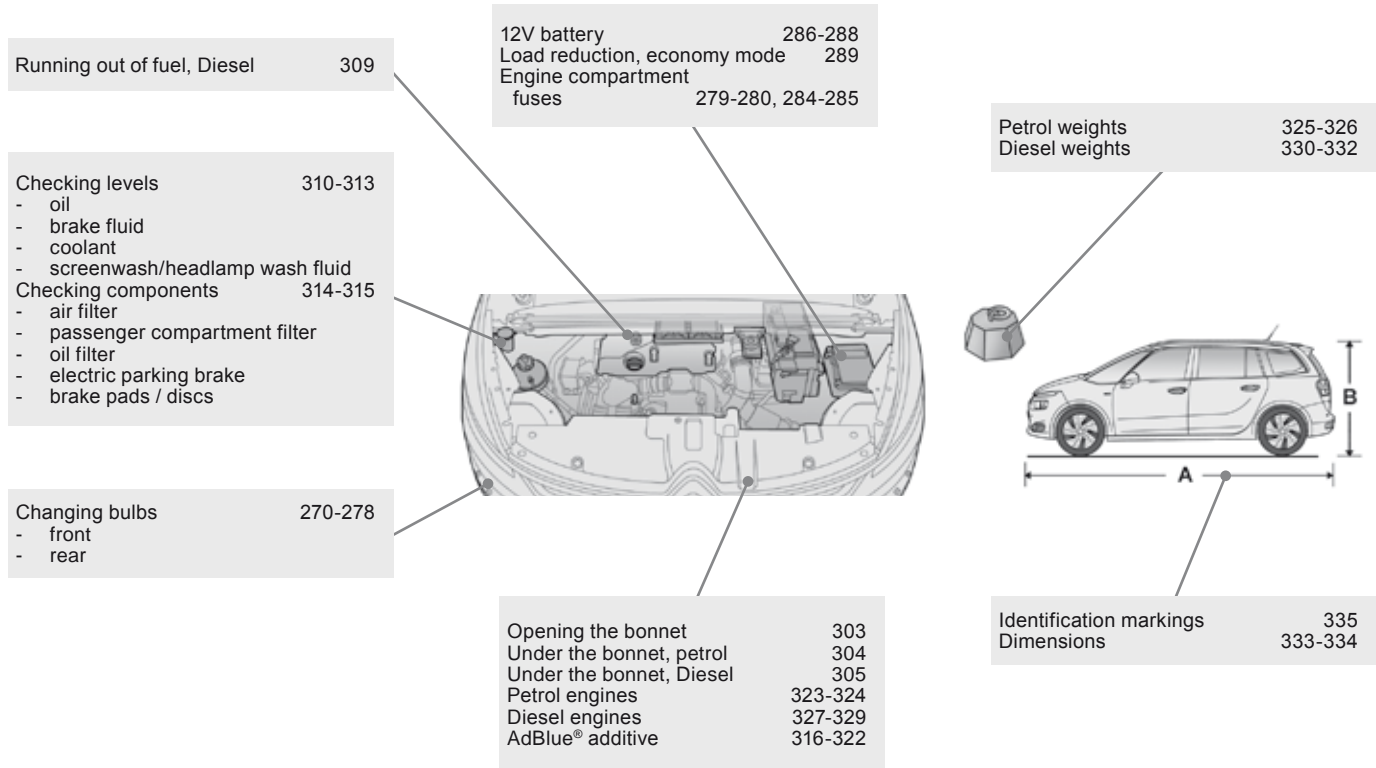

Eco-driving

Eco-driving is a range of everyday practices that allow the motorist to optimise their fuel consumption and CO₂ emissions.

Optimise the use of your gearbox

With a manual gearbox, move off gently and change up without waiting. During acceleration change up early.

With an automatic or electronic gearbox, give preference to automatic mode and avoid pressing the accelerator pedal heavily or suddenly.

The gear shift indicator invites you engage the most suitable gear: as soon as the indication is displayed in the instrument panel, follow it straight away.

For vehicles fitted with an electronic or automatic gearbox, this indicator appears only in manual mode.

Drive smoothly

Maintain a safe distance between vehicles, use engine braking rather than the brake pedal, and press the accelerator progressively. These practices contribute towards a reduction in fuel consumption and CO₂ emissions and also helps reduce the background traffic noise.

If your vehicle has cruise control, make use of the system at speeds above 25 mph (40 km/h) when the traffic is flowing well.

Control the use of your electrical equipment

Before moving off, if the passenger compartment is too warm, ventilate it by opening the windows and air vents before using the air conditioning. Above 30 mph (50 km/h), close the windows and leave the air vents open.

Remember to make use of equipment that can help keep the temperature in the passenger compartment down (sunroof and window blinds...).

Switch off the air conditioning, unless it has automatic regulation, as soon as the desired temperature is attained.

Switch off the demisting and defrosting controls, if not automatic. Switch off the heated seat as soon as possible.

Switch off the headlamps and front foglamps when the level of light does not require their use.

Avoid running the engine before moving off, particularly in winter; your vehicle will warm up much faster while driving.

As a passenger, if you avoid connecting your multimedia devices (film, music, video game...), you will contribute towards limiting the consumption of electrical energy, and so of fuel.

Disconnect your portable devices before leaving the vehicle.

Limit the causes of excess consumption

Spread loads throughout the vehicle; place the heaviest items in the bottom of the boot, as close as possible to the rear seats.

Limit the loads carried in the vehicle and reduce wind resistance (roof bars, roof rack, bicycle carrier, trailer...). Use a roof box in preference.

Remove roof bars and roof racks after use.

At the end of winter, remove snow tyres and refit your summer tyres.

Observe the recommendations on maintenance

Check the tyre pressures regularly, when cold, referring to the label in the door aperture, driver's side.

Carry out this check in particular:

- before a long journey,
- at each change of season,
- after a long period out of use.

Don't forget the spare wheel and the tyres on any trailer or caravan.

Have your vehicle serviced regularly (engine oil, oil filter, air filter, passenger compartment filter...) and observe the schedule of operations recommended in the manufacturer's service schedule.

With a BlueHDi Diesel engine, if the SCR system is faulty your vehicle becomes polluting; go to a CITROËN dealer or a qualified workshop without delay to have the emissions of nitrous oxides brought back to the legal level.

When refuelling, do not continue after the third cut-off of the nozzle to avoid any overflow.

At the wheel of your new vehicle, it is only after the first 1 800 miles (3 000 kilometres) that you will see the fuel consumption settle down to a consistent average.

7-inch touch screen tablet

The 7-inch touch screen tablet gives access to:

- the heating/air conditioning controls,
 - menus for adjusting settings for vehicle functions and systems,
 - audio and display configuration menus,
 - audio system and telephone controls and the display of associated information,
- and, depending on equipment, allows:
- the display of alert messages and the visual parking sensors information,
 - the permanent display of the time and the ambient temperature (a blue warning lamp appears when there is a risk of ice),
 - access to the controls for the navigation system and Internet services, and the display of associated information.

! For reasons of safety, the driver should only carry out operations that require close attention, with the vehicle stationary.

Some functions are not accessible when driving.

General operation

Recommendations

It is necessary to press firmly, particularly for "flick" gestures (scrolling through lists, moving the map...).

A light wipe is not enough.

The tablet does not recognise pressing with more than one finger.

This technology allows use at all temperatures and when wearing gloves.

Do not use pointed objects on the touch screen tablet.

Do not touch the tablet screen with wet hands. Uses a soft clean cloth to clean the tablet touch screen.

Principles

Use the buttons on either side of the screen for access to the menus, then press the virtual buttons in the touch screen.

Each menu is displayed over one or two pages (primary page and secondary page).



Use this button to go to the secondary page.



Use this button to return to the primary page.



After a few moments with no action on the secondary page, the primary page is displayed automatically.



Use this button for access to additional information and to the settings for certain systems.



Use this button to confirm.



Use this button to quit.

Touch screen tablet menus



1. Access to the **"Air conditioning"** menu.
Allows adjustment of the various settings for temperature, air flow... See the sections on "Heating", "Manual air conditioning" and "Automatic air conditioning".
2. Access to the **"Driving assistance"** menu.
Allows certain functions to be switched on and off and their settings adjusted.
3. Access to the **"Media"** menu.
See the Audio and telematics section.
4. Access to the **"Navigation"*** menu.
See the Audio and telematics section.
5. Access to the **"Configuration"** menu.
Allows configuration of the display and the system.
6. Access to the **"Connected services"*** menu.
See the Audio and telematics section.
7. Access to the **"Telephone"** menu.
See the Audio and telematics section.
8. Volume / mute.
See the "Audio and telematics" section.

* Depending on equipment.

"Driving assistance" menu

State of adjustable systems

Some systems have a dedicated button, to which is associated an indicator lamp.

Illumination of this lamp indicates whether the system is activated or deactivated compared to the default (factory) setting.

Green indicator: you have switched on the corresponding system.

Orange indicator: you have switched off the corresponding system.

Operating fault

In the event of a fault with one of these systems, the indicator lamp in the activation/deactivation button flashes for a few moments. An alert symbol is displayed to the right of the button symbol, then, in the case of systems that are activated by default, the orange indicator comes on permanently.

Every time the button is pressed, the indicator flashes for a few moments.

Example:

- Function not activated.

AUTO
⊞ ⊞ ⊞



- Operating fault alert.



AUTO !
⊞ ⊞ ⊞









then

AUTO !
⊞ ⊞ ⊞











The functions accessible in this menu are detailed in the tables below.

Button	Corresponding function	Comments
	Speed settings	Memorisation of speeds for use with the speed limiter or cruise control.
	Under-inflation initialisation	Reinitialisation of the under-inflation system.
CHECK	Diagnostic	List of current alerts.

Button	Corresponding function	Comments
	Vehicle settings	<p>Access to other functions with settings that can be adjusted. The functions are grouped together under three tabs:</p> <ul style="list-style-type: none"> - "Driving assistance" <ul style="list-style-type: none"> ● "Automatic rear wiper in reverse": activation of rear wiper linked to reverse gear. See the "Visibility" section. ● "Auto mirror dipping in reverse": automatic dipping of door mirrors in reverse. See the "Comfort" section. - "Lighting" <ul style="list-style-type: none"> ● "Guide-me-home lighting": automatic guide-me-home lighting. See the "Visibility" section. ● "Welcome lighting": exterior welcome lighting. See the "Visibility" section. ● "Adaptive lighting": cornering lighting / directional lighting. See the "Visibility" section. ● "Mood lighting": mood lighting. See the "Visibility" section. - "Vehicle access" <ul style="list-style-type: none"> ● "Tailgate motorisation": automatic operation of the tailgate. See the "Access" section. ● "Driver flip action": selective unlocking of the driver's door. See the "Access" section.







Button	Corresponding function	Comments
	Lane departure warning	Activation/Deactivation of the function.
	Parking sensors	Activation/Deactivation of the function.
	Automatic headlamps	Activation/Deactivation of the function.
	Park Assist	Activation/Deactivation of the function.
	Stop & Start	Activation/Deactivation of the function.
	Blind spot monitoring	Activation/Deactivation of the function.
	360 vision	Activation/Deactivation of the function then choice of options.
	Active cruise control	Choice of the standard cruise control or the active cruise control.







The state of a function, a few examples:

Button	Function	Activated	Deactivated
	Park Assist		
	Blind spot monitoring		
ECO OFF	Stop & Start	ECO OFF	
	Parking sensors		

"Configuration" menu

The functions available through this menu are detailed in the table below.

Button	Corresponding function	Comments
	Audio settings	Adjustment of volume, balance...
	Colour schemes	Choice of a colour scheme.
	Interactive help	Simplified instructions.
	Turn off screen	Turns the screen off.
 	Brightness	Adjustment of brightness.

Button	Corresponding function	Comments
	System settings	Choice of units: <ul style="list-style-type: none"> - temperature (°Celsius or °Fahrenheit) - distance and fuel consumption (l/100 km, mpg or km/l).
	Time/Date	Setting the date and time.
	Languages	Choice of language used for the touch screen tablet and the type 2 instrument panel: French, English, Italian, Spanish, German, Dutch, Portuguese, Polish, Turkish, Russian. Choice of language used for the touch screen tablet only: Serb, Croat, Hungarian.
	Screen settings	Adjustment of the display settings (scrolling of text, animations...)
	Calculator	Displays the calculator.
	Calendar	Displays the calendar.

Type 1 instrument panel

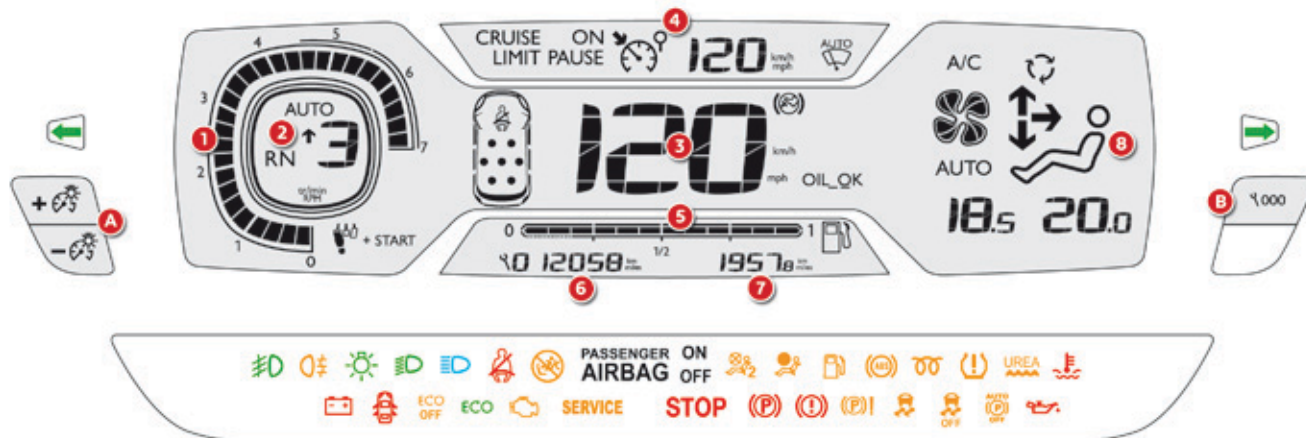

Dials and screens

1. Rev counter (x 1 000 rpm or tr/min), graduation according to engine (petrol or Diesel).
2. Gear shift indicator, selector position and gear for an electronic or automatic gearbox.
3. Digital speedometer (mph or km/h).
4. Cruise control or speed limiter settings.

5. Fuel gauge.
6. Service indicator, then total mileage recorder (miles or km).
These functions are displayed in turn when the ignition is switched on.
7. Trip mileage recorder (miles or km).
8. Repeat of air conditioning settings.

Control buttons

- A. Main lighting dimmer buttons.
- B. Recall servicing information.
Reset the function selected to zero (service indicator or trip recorder).

Type 2 instrument panel

This instrument panel is presented in the form of a 12-inch panoramic HD screen.

It can be personalised. Depending on the display mode selected, some information can be hidden.

See the "Personalisation of the instrument panel" section.

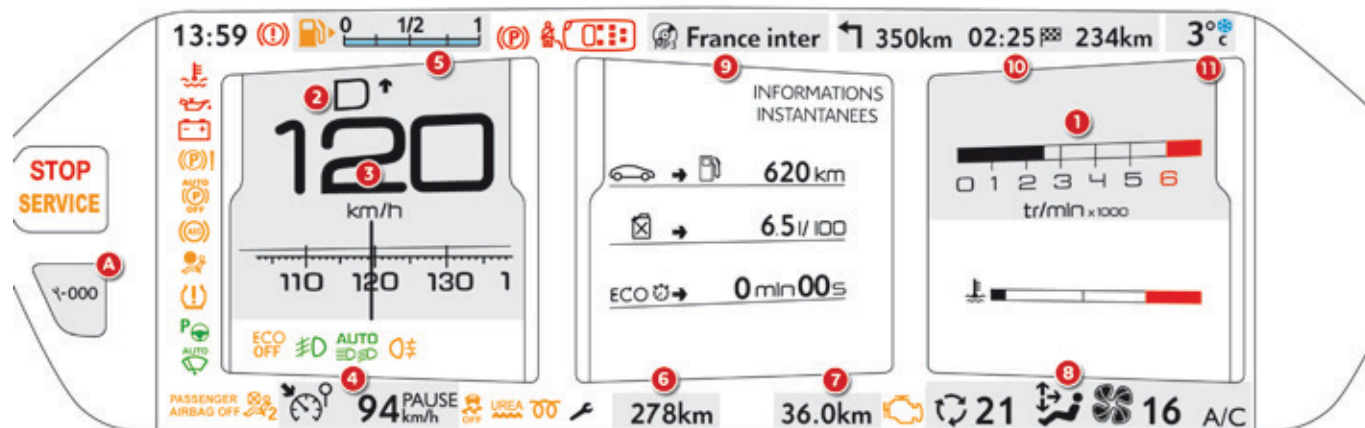

Dials and screens

- Rev counter (x 1000 tr/min or rpm) ("DIALS" mode).
- Gear shift indicator, position of the selector lever and the gear with an electronic or automatic gearbox.
- Digital speedometer (mph or km/h).
- Cruise control or speed limiter setting.
- Fuel gauge.
- Total distance recorder (miles or km).
- Trip distance recorder (miles or km).
- Repeat of the air conditioning settings.
- Repeat of the current media or telephone information.
- Repeat of the navigation information.
- Ambient temperature (a blue warning lamp comes on if there is a risk of ice).

Control button

- Recall servicing information. Recall the remaining driving range with the SCR system and the AdBlue® additive. Reset the function selected to zero (service indicator or trip recorder).

Display zones

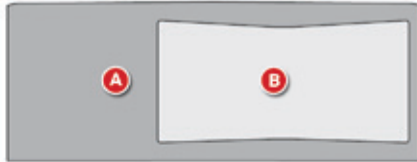

Whatever the display mode or colour scheme chosen, the instrument panel contains

- a fixed display zone **A** with:
 - the speedometer,
 - the warning lamps,
 - the fuel gauge,
 - the various repeated information and alert messages.
- a configurable display zone **B**.

Most of the warning lamps do not have a fixed position.

The warning and indicator lamps in the left hand column are displayed from top to bottom in order of importance.

For certain functions that have indicator lamps for both on and off, there is just one dedicated location.

Personalisation of the type 2 instrument panel

You can modify the appearance of the instrument panel, by choosing:

- a colour scheme,
- a display mode.

Choosing the language

This depends on the setting in the touch screen tablet.

Certain languages are not available for the type 2 instrument panel; English is selected by default.

Choosing a colour scheme

It depends on the colour scheme chosen for the touch screen tablet. To modify it with the vehicle stationary:

- ☞ select the "**Configuration**" menu of the touch screen tablet,
- ☞ press the "**Color schemes**" button,
- ☞ choose a colour scheme,
- ☞ confirm.

The system restarts to take account of the modifications to the touch screen tablet and the instrument panel.

Choice of display mode

Each mode corresponds to the type of information displayed in the configurable area.



- "DIALS": permanent display of the trip computer, rev counter and coolant temperature indicator.



- "MEDIA": display of information related to the media being played or the radio.



- "NAVIGATION": display of information related to the navigation in progress (map and instructions).



- "PHOTOS": display of the photo selected in the "Media" menu of the touch screen tablet.



- "DRIVING": used for the display of the inter-vehicle time and information related to the active cruise control. The recommended speed is displayed in the central part. The driver remains responsible for observing the driving regulations.

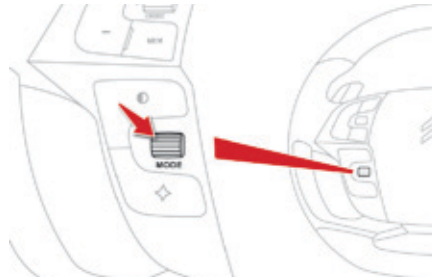

- To modify the display mode of the instrument panel:
- ☞ turn the wheel on the left of the steering wheel to display and run through the different modes in the right hand part of the instrument panel,



- ☞ once the selected display mode appears in the central window, it is applied after a few moments.

Indicator and warning lamps

Visual indicators informing the driver of the status of a system (operation or deactivation indicator lamp) or the existence of a fault (warning lamp).

When the ignition is switched on

Certain warning lamps come on for a few seconds in the instrument panel when the vehicle's ignition is switched on.

When the engine is started, these same warning lamps should go off.

If they remain on, before moving off, refer to the information on the warning lamp concerned.

Associated warnings

The switching on of certain warning lamps may be accompanied by an audible signal and a message.

The warning lamps may come on continuously (fixed) or flash.

! Certain warning lamps may come on in one of two modes: fixed (continuous) or flashing.





Only by relating the type of illumination to the operation of the vehicle can it be determined whether the situation is normal or a fault has occurred. In the event of a fault, the illumination of the warning lamp may be accompanied by a message.



Refer to the tables on the following pages for more information.

i The position of the warning lamps in the type 2 instrument panel depends on the colour scheme selected.





Operation indicator lamps



If one of the following indicator lamps comes on in the instrument panel, this confirms that the corresponding system has come into operation.

Warning / indicator lamp		State	Cause	Action / Observations
	Left-hand direction indicator	flashing with buzzer.	The lighting stalk is pushed down.	
	Right-hand direction indicator	flashing with buzzer.	The lighting stalk is pushed up.	
	Sidelamps	fixed.	The lighting stalk is in the "Sidelamps" position.	
	Dipped beam headlamps	fixed.	The lighting stalk is in the "Dipped beam headlamps" position.	
	Main beam headlamps	fixed.	The lighting stalk is pulled towards you.	Pull the stalk to return to dipped beam headlamps.

Warning / indicator lamp		State	Cause	Action / Observations
 Automatic headlamp dipping	fixed.	The lighting control stalk is in the "AUTO" position, pulled towards you, and the function is activated (" Driving assistance " menu). The system is in dipped beam mode as there is sufficient ambient light and/or the traffic conditions do not allow illumination of main beam.	<p>The camera, located in the door mirror, manages the operation of main beam, depending on the ambient lighting and driving conditions. Pulling the lighting stalk again to deactivate. For more information on this function, refer to the Visibility section.</p>	
	fixed.	The lighting control stalk is in the "AUTO" position, pulled towards you, and the function is activated (" Driving assistance " menu). The system is in main beam mode as the ambient lighting and traffic conditions allow it.		
 Front foglamps	fixed.	The front foglamps are switched on using the ring on the lighting control stalk.	Turn the ring on the lighting control stalk rearward twice to switch off the front foglamps.	
 Rear foglamps	fixed.	The rear foglamps are on.	Turn the ring on the stalk rearward to switch off the rear foglamps.	



i For more information on the lighting controls, refer to the corresponding section.

Warning / indicator lamp		State	Cause	Action / Observations
	Diesel engine pre-heating	fixed.	The " START/STOP " switch has been pressed (ignition on).	Wait until the indicator lamp goes off before starting. Once it goes off, starting is immediate, on condition that you maintain pressure on the brake pedal for an electronic or automatic gearbox, or the clutch pedal is pressed fully down for a manual gearbox. The period of illumination of the indicator lamp is determined by the ambient conditions (up to about thirty seconds in extreme conditions). If the engine does not start, switch the ignition off and then on, wait until the indicator lamp goes off again, then start the engine.
	Electric parking brake	fixed.	The electric parking brake is applied.	Release the electric parking brake to switch off the warning lamp: with your foot on the brake pedal, briefly push the electric parking brake control lever. Observe the safety recommendations. For more information on the electric parking brake, refer to the corresponding section.
	Blind spot sensors	fixed.	The blind spot monitoring function has been activated.	For more information, refer to the corresponding section.
	Park Assist	fixed.	The Park Assist function has been activated.	For more information, refer to the corresponding section.

Warning / indicator lamp		State	Cause	Action / Observations
	Automatic wiper	fixed.	The wiper control is pushed downwards.	Automatic front wiper is activated. To deactivate automatic wiper, operate the control stalk downwards or put the stalk into another position.
	Passenger airbag system	fixed.	The control switch, located at the passenger's end of the dashboard, is in the "ON" position. The passenger's front airbag is activated. In this case, do not install a rearward facing child seat on the front passenger seat.	Turn the control switch to the "OFF" position to deactivate the front passenger's airbag. In this case you can install a rearward facing child seat.
	Stop & Start	fixed.	When the vehicle stops (red lights, traffic jams, ...) the Stop & Start system has put the engine into STOP mode.	The warning lamp goes off and the engine restarts automatically in START mode, as soon as you want to move off.
		flashes for a few seconds, then goes off.	STOP mode is temporarily unavailable. or START mode is invoked automatically.	For more information on special cases with STOP mode and START mode, refer to the "Stop & Start" section.

Deactivation indicator lamps

If one of the following indicator lamps comes on, this confirms that the corresponding system has been switched off intentionally. This is may be accompanied by an audible signal and the display of a message.

Warning / indicator lamp	State	Cause	Action / Observations
 Passenger's airbag system	fixed.	<p>The control switch, located at the right hand end of the dashboard is set to the OFF position.</p> <p>The passenger's front airbag is deactivated.</p>	<p>Set the control to the "ON" position to activate the passenger's front airbag.</p> <p>In this case, do not fit a child seat in the rearward-facing position.</p>
 Dynamic stability control (DSC/ASR)	fixed.	<p>The button, located on the centre console, is pressed. Its indicator lamp is on.</p> <p>The DSC/ASR is deactivated.</p> <p>DSC: dynamic stability control.</p> <p>ASR: anti-slip regulation.</p>	<p>Press the button to activate the DSC/ASR. Its indicator lamp goes off.</p> <p>The DSC/ASR system is activated automatically when the vehicle is started.</p> <p>If deactivated, the system is reactivated automatically from around 30 mph (50 km/h).</p>
 Stop & Start	fixed.	<p>The Stop & Start has been deactivated.</p>	<p>Reactivate the function via the "Driving assistance" menu.</p>

Warning lamps



When the engine is running or the vehicle is being driven, illumination of one of the following warning lamps indicates a fault which requires action on the part of the driver.





Any fault resulting in the illumination of a warning lamp must be investigated further using the associated message.





If you encounter any problems, contact a CITROËN dealer or a qualified workshop.





Warning / indicator lamp		State	Cause	Action / Observations
STOP	STOP	fixed, associated with another warning lamp, accompanied by an audible signal and a message.	Illumination of this warning lamp is related to a serious fault detected with the braking or power steering systems, the electrical system, or with engine lubrication or cooling or a puncture.	Stop as soon as it is safe to do so as the engine may cut out. Park, switch off the ignition and call a CITROËN dealer or a qualified workshop.

Warning / indicator lamp		State	Cause	Action / Observations
SERVICE	Service	temporarily, accompanied by a message.	One or more minor faults for which there is no specific warning lamp have been detected.	Identify the cause of the fault using the message displayed in the screen. You can deal with some problems yourself, such as a door open or the start of saturation of the particle filter (as soon as the traffic conditions allow, regenerate the filter by driving at a speed of at least 40 mph (60 km/h), until the warning lamp goes off). For any other problems, such as a fault with the tyre under inflation detection system, contact a CITROËN dealer or a qualified workshop.
		fixed, accompanied by a message.	One or more major faults for which there is no specific warning lamp have been detected.	Identify the cause of the fault using the message displayed in the screen; you must then contact a CITROËN dealer or a qualified workshop.
		fixed, associated with the flashing and then fixed display of the service indicator spanner.	The servicing interval has been exceeded.	Only on BlueHDi Diesel versions. Your vehicle must be serviced as soon as possible.



Warning / indicator lamp		State	Cause	Action / Observations
	Electric parking brake	flashing.	When driving: the electric parking brake is not fully released.	Fully release the parking brake by a quick press on the control lever. If the warning persists, stop as soon as it is safe to do so. Contact a CITROËN dealer or a qualified workshop.
			When stationary: parking brake applied, the system does not guarantee immobilisation of the vehicle (when parking on a very steep slope, for example).	Secure the immobilisation of the vehicle by engaging a gear with a manual or electronic gearbox, by placing the gear selector in position P with an automatic gearbox, or by fitting a chock to one of the wheels.
	Electric parking brake fault	fixed.	The electric parking brake has a fault.	Contact a CITROËN dealer or a qualified workshop without delay. The parking brake can be released manually. For more information on the electric parking brake, refer to the corresponding section.
	Deactivation of the automatic functions of the electric parking brake	fixed.	The "automatic application" (on switching off the engine) and "automatic release" functions are deactivated or faulty. In the event of a fault, illumination of this warning lamp is accompanied by a message.	To reactivate the automatic functions, refer to the "Electric parking brake" section. Contact a CITROËN dealer or a qualified workshop if automatic application / release is not possible. The parking brake can be released manually. For more information on the electric parking brake, refer to the corresponding section.

Warning / indicator lamp		State	Cause	Action / Observations
	Braking	fixed.	The brake fluid level has dropped significantly.	You must stop as soon as it is safe to do so. Top up with brake fluid listed by CITROËN. If the problem persists, have the system checked by a CITROËN dealer or a qualified workshop.
+ 		fixed, associated with the ABS warning lamp.	The electronic brake force distribution (EBFD) system has a fault.	You must stop as soon as it is safe to do so. Have it checked by a CITROËN dealer or a qualified workshop.
	Anti-lock Braking System (ABS)	fixed.	The anti-lock braking system has a fault.	The vehicle retains conventional braking. Drive carefully at reduced speed and contact a CITROËN dealer or a qualified workshop without delay.
	Electronic stability programme (DSC/ASR)	flashing.	The DSC/ASR regulation is operating.	The system optimises traction and improves the directional stability of the vehicle.
		fixed.	Unless it has been deactivated (button pressed and its indicator lamp on) the DSC/ASR system has a fault.	Have it checked by a CITROËN or a qualified workshop.
	Engine autodiagnosis system	flashing.	The engine management system has a fault.	Risk of destruction of the catalytic converter. Have it checked by a CITROËN dealer or a qualified workshop.
		fixed.	The emission control system has a fault.	The warning lamp should go off when the engine is started. If it does not go off, contact a CITROËN dealer or qualified workshop without delay.



Warning / indicator lamp	State	Cause	Action / Observations
	Low fuel level	fixed, accompanied by an audible signal and a message. When it first comes on there remains approximately 6 litres of fuel in the tank. You are then using the fuel reserve.	You must refuel as soon as possible to avoid running out of fuel. Until sufficient fuel is added, this warning lamp will come on every time the ignition is switched on, accompanied by an audible signal and a message. This audible signal and message are repeated with increasing frequency as the drops towards "0". Fuel tank capacity: approximately 57 litres (petrol) or 55 litres (Diesel). Never continue to drive until you run out of fuel as this could damage the emission control and injection systems.
	Seat belt(s) not fastened / unfastened	fixed or flashing accompanied by an audible signal.	A seat belt has not been fastened or has been unfastened. Pull the strap then insert the tongue in the buckle.
	Airbags	on temporarily. fixed.	This lamp comes on for a few seconds when you turn on the ignition, then goes off. This lamp should go off when the engine is started. If it does not go off, contact a CITROËN dealer or a qualified workshop. One of the airbag or seat belt pretensioner systems has a fault. Have it checked by a CITROËN dealer or a qualified workshop.
	Passenger airbag system	flashing.	The passenger airbag system has a fault. Do not have a passenger seated in the front passenger seat. Have it checked by a CITROËN dealer or a qualified workshop.



Warning / indicator lamp		State	Cause	Action / Observations
	Directional headlamps	flashing.	The directional headlamps system has a fault.	Have it checked by a CITROËN dealer or a qualified workshop.
	Door(s) open*	fixed, associated with a message identifying the door, if the speed is below 6 mph (10 km/h).	A door or the boot is still open.	Close the door or boot.
		fixed, associated with a message identifying the door, and accompanied by an audible signal if the speed is above 6 mph (10 km/h).		
	Battery charge	fixed.	The battery charging circuit has a fault (dirty or loose terminals, slack or cut alternator belt, ...).	The warning lamp should go off when the engine is started. If it does not go off, contact a CITROËN dealer or a qualified workshop.
	Maximum coolant temperature	fixed.	The temperature of the cooling system is too high.	Stop as soon as it is safe to do so. Wait until the engine has cooled down before topping up the level, if necessary. If the problem persists, contact a CITROËN dealer or qualified workshop.
	Engine oil pressure	fixed.	There is a fault with the engine lubrication system.	You must stop as soon it is safe to do so. Park, switch off the ignition and contact a CITROËN dealer or a qualified workshop.

* Only with the type 1 instrument panel.

Warning / indicator lamp		State	Cause	Action / Observations
	Under-inflation	fixed, accompanied by an audible signal and a message.	The pressure in one or more tyres is too low.	Check the tyre pressures as soon as possible. This check should preferably be carried out when the tyres are cold. You must reinitialise the system after the adjustment of one or more tyre pressures and after changing one or more wheels. For more information, refer to the "Under-inflation detection" section.
		+ SERVICE	flashing then fixed, accompanied by the Service warning lamp.	The system has fault: the tyre pressures are no longer monitored.
	Foot on the brake pedal*	fixed.	The brake pedal is not pressed.	With an electronic gearbox, press the brake pedal to start the engine (lever in position N). If you wish to release the parking brake without pressing the brake pedal, this warning lamp will remain on. With an automatic gearbox, press the brake pedal to move the gear selector out of position P .
		flashing.	With an electronic gearbox, if you hold the vehicle on an incline using the accelerator for too long, the clutch overheats.	Use the brake pedal and/or the parking brake.
	Foot on the clutch*	fixed.	In the STOP mode of Stop & Start, changing to START mode is refused because the clutch pedal is not fully down.	You must declutch fully to allow the change to engine START mode.

* Only with the type 1 instrument panel.

Warning / indicator lamp		State	Cause	Action / Observations
 + 	AdBlue® additive (BlueHDi Diesel)	fixed, on switching on the ignition, accompanied by an audible signal and a message indicating the remaining driving range.	The remaining driving range is between 350 miles (600 km) and 1500 miles (2400 km).	Have the AdBlue® additive tank topped up as soon as possible: go to a CITROËN dealer or a qualified workshop, or carry out this operation yourself by referring to the corresponding section.
		flashing associated with the SERVICE warning lamp, accompanied by an audible signal and a message indicating the remaining driving range.	The remaining driving range is between 0 and 350 miles (600 km).	You must top-up the AdBlue® additive tank to avoid a breakdown : go to a CITROËN dealer or a qualified workshop, or carry out this operation yourself by referring to the corresponding section.
		flashing, associated with the SERVICE warning lamp, accompanied by an audible signal and a message indicating that starting is prevented.	The AdBlue® tank is empty: the starting inhibition system required by legislation prevents starting of the engine.	To be able to start the engine, you must top-up the AdBlue® additive tank: go to a CITROËN dealer or a qualified workshop, or carry out this operation yourself by referring to the corresponding section. It is essential to add at least 3.8 litres of AdBlue® to the additive tank.

Warning / indicator lamp	State	Cause	Action / Observations
 +  + 	SCR emissions control system (BlueHDi Diesel) fixed, on switching on the ignition, associated with the SERVICE and engine diagnostic warning lamps, accompanied by an audible signal and a message.	A fault with the SCR emissions control system has been detected.	This alert disappears once the exhaust emissions return to normal levels.
	flashing, on switching on the ignition, associated with the SERVICE and engine diagnostic warning lamps, accompanied by an audible signal and a message indicating the remaining driving range.	After confirmation of the fault with the emissions control system, you can drive for up to 650 miles (1 100 km) before the engine starting inhibition system is triggered.	Contact a CITROËN dealer or a qualified workshop without delay, to avoid a breakdown.
	flashing, on switching on the ignition, associated with the SERVICE and engine diagnostic warning lamps, accompanied by an audible signal and a message.	You have exceeded the authorised driving limit following confirmation of a fault with the emissions control system: the engine starting inhibition system prevents starting of the engine.	To be able to start the engine, you must call on a CITROËN dealer or a qualified workshop.

Service indicator

System which informs the driver when the next service is due, in accordance with the manufacturer's service schedule.

The point at which the service is due is calculated from the last indicator zero reset, according to the mileage covered and the time elapsed since the last service.

For BlueHDi Diesel versions, depending on the country of sale, the degree of deterioration of the engine oil may also be taken into account.

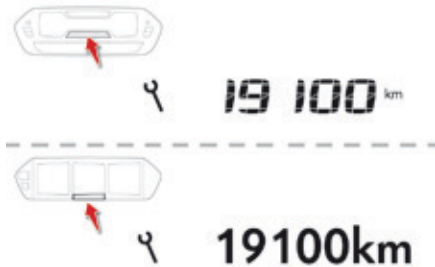

More than 1 800 miles (3 000 km) remain before the next service is due

When the ignition is switched on, no service information appears in the screen.



Between 600 miles (1 000 km) and 1 800 miles (3 000 km) remain before the next service is due

For 5 seconds after the ignition is switched on, the spanner symbolising the service operations comes on. The distance recorder display line indicates the distance remaining before the next service is due.

Example: 1 700 miles (2 800 km) remain before the next service is due.

For 5 seconds after the ignition is switched on, the screen indicates:



5 seconds after the ignition is switched on, **the spanner goes off**; the distance recorder resumes its normal operation. The screen then indicates the total and trip distances.

Less than 600 miles (1 000 km) remain before the next service is due

Example: 560 miles (900 km) remain before the next service is due.

For 5 seconds after the ignition is switched on, the screen indicates:



5 seconds after the ignition is switched on, the distance recorder resumes its normal operation. **The spanner remains on** to indicate that a service must be carried out soon.



Service overdue

For 5 seconds after the ignition is switched on, **the spanner flashes** to indicate that the service must be carried out as soon as possible.

Example: the service is overdue by 186 miles (300 km).

For 5 seconds after the ignition is switched on, the screen indicates:



5 seconds after the ignition is switched on, the distance recorder resumes its normal operation. **The spanner remains on.**

With BlueHDi Diesel versions, the **Service** warning lamp also comes on when the ignition is switched on.

i Therefore, the spanner may come on if you have exceeded the period since the last service, as indicated in the manufacturer's service schedule. For BlueHDi Diesel versions, the spanner may also come on early, according to the level of deterioration of the engine oil, which depends on the driving conditions in which the vehicle is used.

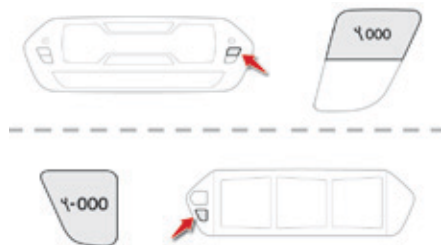

Service indicator zero reset

After each service, the service indicator must be reset to zero.

If you have carried out the service on your vehicle yourself:

- ☞ switch off the ignition,
- ☞ press and hold the trip distance recorder zero reset button,
- ☞ switch on the ignition; the distance recorder display begins a countdown,
- ☞ when the display indicates "**=0**", release the button; the spanner disappears.

i Following this operation, if you wish to disconnect the battery, lock the vehicle and wait at least five minutes for the zero reset to be registered.

Retrieving the service information

You can access the service information at any time.

- ☞ Press the trip distance recorder zero reset button.
The service information is displayed for a few seconds, then disappears.

Engine oil level indicator*

On versions fitted with an electric oil level indicator, the state of the engine oil level is displayed in the instrument panel for a few seconds, after the servicing information.

i The level read will only be correct if the vehicle is on level ground and the engine has been off for more than 30 minutes.

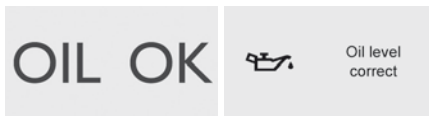

Oil level correct

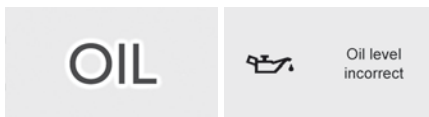

Oil level incorrect

This is indicated by the display of the message "Oil level incorrect" in the instrument panel screen, accompanied by the service warning lamp and an audible signal. If the low oil level is confirmed by a check using the dipstick, the level must be topped up to avoid damage to the engine. Refer to the "Checking levels" section.



Oil level indicator fault

This is signalled by the display of the message "Oil level measurement invalid" in the instrument panel.

Contact a CITROËN dealer or a qualified workshop.

In the event of a fault with the electric indicator, the oil level is no longer monitored.

If the system is faulty, you must check the engine oil level using the manual dipstick located under the bonnet.

Refer to the "Checking levels" section.

* Depending on version.

Distance recorders

The total and trip distances are displayed for thirty seconds when the ignition is switched off, when the driver's door is opened and when the vehicle is locked or unlocked.

i When travelling abroad, you may have to change the units of distance: the display of road speed must be in the official units (miles or km) for the country. The change of units is done via the screen configuration menu, with the vehicle stationary.



Total distance recorder

It measures the total distance travelled by the vehicle since its first registration.

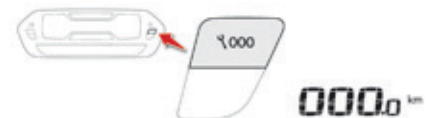

Trip distance recorder

It measures the distance travelled since it was reset to zero by the driver.

☞ With the ignition on, press the button until zeros appear.

Lighting dimmer control

Allows the manual adjustment of the brightness of the instrument panel and touch screen tablet to suit the ambient light level.

Operates only when the vehicle lighting is on, with the exception of the daytime running lamps.

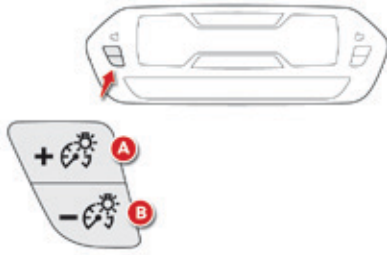

Two buttons

With the headlamps on, press button **A** to increase the brightness of the instruments and controls and the interior mood lighting or button **B** to reduce it.

As soon as the lighting reaches the required level of brightness, release the button.



Touch screen tablet

- ☞ Press on the "**Configuration**" menu.
- ☞ Adjust the brightness by pressing on the "+" or "-" buttons.

Black panel (comfortable night driving display)

When driving at night, this function allows certain displays in the instrument panel to be switched off to avoid visual fatigue for the driver.

The essential information, such as the speed of the vehicle or the cruise control or speed limiter indications remains displayed in the instrument panel.



Using the steering mounted control

- ☞ With the vehicle lighting on, press this button again to activate the black panel.
- ☞ Press this button again to deactivate it.

Black screen (touch screen tablet)



- ☞ Press on the "**Configuration**" menu.
- ☞ Press the "**Turn off screen**" button. The screen in the touch screen tablet goes off.
- ☞ Press the screen again (anywhere on its surface) to switch it on again.

Setting the date and time

This function is accessible in the touch screen tablet.

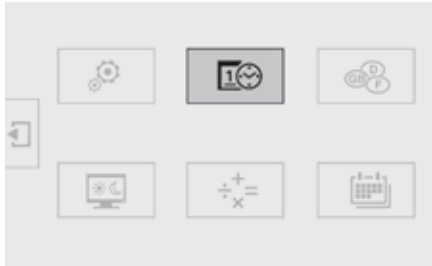

☞ Select the **"Configuration"** menu.



☞ In the secondary page, press on **"Time/Date"**.

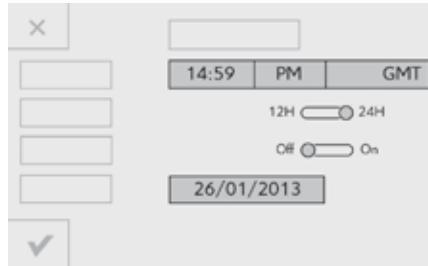

☞ Select **"Adjust time"** or **"Adjust date"** and modify the settings using the number keypad, then confirm.



☞ Press **"Confirm"** to quit.

Trip computer

Type 1 instrument panel

System that gives you information on the journey in progress (range, fuel consumption...).

The information is accessible in the "**Driving assistance**" menu.

Information display in the touch screen tablet



Permanent display:

- ☞ Select the "**Driving assistance**" menu. The trip computer information is displayed in the primary page of the menu.
- ☞ Press one of the buttons to display the desired tab.

Temporary display in a new window:

- ☞ Press the end of the wiper control stalk for access to the information and display the different tabs.



The current instantaneous fuel consumption tab with:

- the range,
- the current fuel consumption,
- the Stop & Start time counter.



The trip "1" tab with:

- the distance travelled.
 - the average fuel consumption,
 - the average speed,
- for the first trip.



The trip "2" tab with:

- the distance travelled.
 - the average fuel consumption,
 - the average speed,
- for the second trip.

Trip reset



- ☞ When the desired trip is displayed, press the reset button or on the end of the wiper control stalk.

Trips "1" and "2" are independent but their use is identical.

For example, trip "1" can be used for daily figures, and trip "2" for monthly figures.

Trip computer

Type 2 instrument panel

Information display in the instrument panel

The display of trip computer information is permanent when you select the "DIALS" display mode.

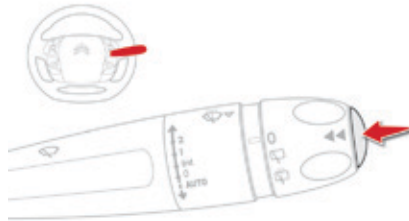

For all other display modes, pressing the end of the wiper stalk displays this information in a new window.

- ☞ Press the button on the end of the **wiper control stalk** to display the various tabs in succession.

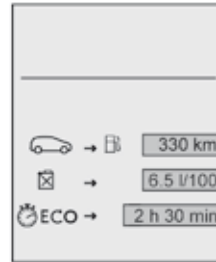

- The current information tab with:
 - the range,
 - the current fuel consumption,
 - the Stop & Start time counter.
- Trip "1" with:
 - the average speed,
 - the average fuel consumption,
 - the distance travelled, for the first trip.
- Trip "2" with:
 - the average speed,
 - the average fuel consumption,
 - the distance travelled, for the second trip.

Trip reset

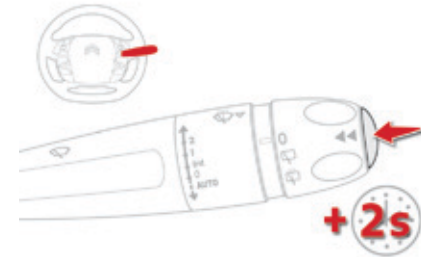

- ☞ When the trip required is displayed, press the control for more than two seconds or use the left hand thumb wheel of the steering mounted controls.
- Trips "1" and "2" are independent but their use is identical.
For example, trip "1" can be used for daily figures, and trip "2" for monthly figures.

Trip computer, a few definitions



Range

(miles or km)

The distance which can still be travelled with the fuel remaining in the tank (related to the average fuel consumption over the last few miles (kilometres) travelled).



This value may vary following a change in the style of driving or the relief, resulting in a significant change in the current fuel consumption.

When the range falls below 20 miles (30 km), dashes are displayed. After filling with at least 5 litres of fuel, the range is recalculated and is displayed when it exceeds 60 miles (100 km).



If dashes are displayed continuously while driving in place of the digits, contact a CITROËN dealer or a qualified workshop.



Current fuel consumption

(mpg or l/100 km or km/l)

Calculated over the last few seconds.



This function is only displayed from 20 mph (30 km/h).



Average fuel consumption

(mpg or l/100 km or km/l)

Calculated since the last trip computer reset.



Average speed

(mph or km/h)

Calculated since the last trip computer reset.



Distance travelled

(miles or km)

Calculated since the last trip computer reset.



Stop & Start time counter

(minutes / seconds or hours / minutes)

If your vehicle is fitted with Stop & Start, a time counter calculates the time spent in STOP mode during a journey.

It resets to zero every time the ignition is switched on.

Electronic key - remote control

System which permits remote locking or unlocking of the vehicle as well as opening the boot and, depending on version, operation of the alarm. It also allows the location and starting of the vehicle as well as providing protection against theft.

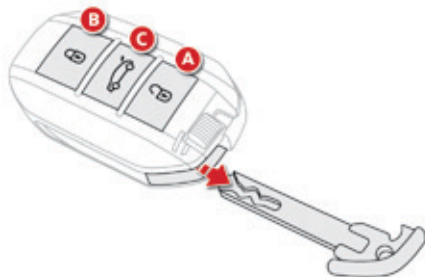

- A. Unlocking the vehicle.
- B. Central locking the vehicle.
- C. Unlocking the vehicle and, depending on version, release of the tailgate or opening the motorised tailgate.

The electronic key includes an integral back-up emergency key.

Unlocking the vehicle

Complete unlocking



- ☞ Press this button.

Selective unlocking



- ☞ To unlock only the driver's door, press this button once.

- ☞ To unlock the other doors and the boot, press this button again.

The setting of the selective unlocking is done in the "**Driving assistance**" menu, then "**Vehicle settings**".

Complete unlocking is activated by default.

Unlocking the vehicle and opening the boot



- ☞ Make a long press on this button to unlock the vehicle and, depending on version, release the tailgate or open the motorised tailgate.

Settings for the motorised tailgate can be adjusted in the "**Driving assistance**" menu, then "**Vehicle settings**".

Motorised operation is activated by default.

i The direction indicators flash for a few seconds. The door mirror spot lamps come on. Depending on version, the door mirrors unfold, the welcome lighting comes on, the alarm is deactivated.

Locking the vehicle

Normal locking



 Press this button.
Holding the button allows the windows to be raised to the desired position.

 Ensure that nothing could prevent the correct closing of the windows.
Be aware of children when operating the windows.

 The direction indicators come on for a few seconds.
Depending on your version, the door mirrors fold, the alarm is activated.

 If a door or the boot is not properly closed, locking does not take place. Nevertheless, the alarm (if fitted) will be fully activated after around 45 seconds. If the vehicle is unlocked by mistake and no action is taken on the doors or boot, the vehicle will lock itself again automatically after about thirty seconds. If the alarm had already been activated, it will not be reactivated automatically.

 The automatic folding and unfolding of the door mirrors can be deactivated by a CITROËN dealer or a qualified workshop.

Deadlocking

! Deadlocking renders the interior door controls inoperative. It also deactivates the manual central locking button. Therefore, never leave anyone inside the vehicle when it is deadlocked.



☞ With the vehicle unlocked, press this button.

☞ Within five seconds, press this button again to deadlock the vehicle.

Locating your vehicle

This function allows you to identify your vehicle from a distance, particularly in poor light. Your vehicle must be locked.



☞ Press this button.

This will switch on the courtesy lamps and the direction indicators will flash for about 10 seconds.

Keyless Entry and Starting

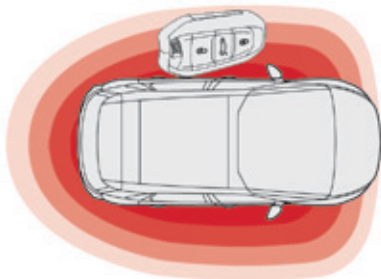

System that allows the unlocking, locking and starting of the vehicle while keeping the electronic key on your person.

i The electronic key can also be used as a remote control. For more information, refer to the "Electronic key - remote control" section.

i For reasons of safety and theft protection, do not leave your electronic key in the vehicle, even when you are close to it. It is recommended that you keep it on your person.

Unlocking the vehicle

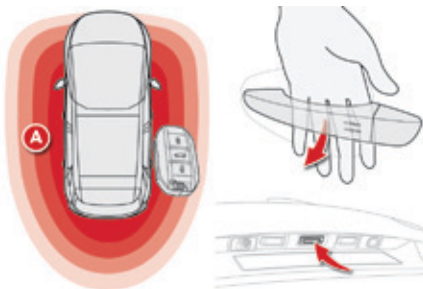

Complete unlocking

- ☞ With the electronic key on your person and in the recognition zone **A**, pass your hand behind the door handle of one of the front doors to unlock the vehicle or press the tailgate opening control (located centrally).

Selective unlocking

- ☞ To unlock only the drivers door, with the electronic key on your person, pass your hand behind the driver's door handle.
- ☞ To unlock the complete vehicle, pass your hand behind one of the door handle of the front passenger door with the electronic key close to the passenger door, or press the tailgate opening control with the electronic key close to the rear of the vehicle.

Activation or deactivation of the selective unlocking is done in the "**Driving assistance**" menu, then "**Vehicle settings**". By default, complete unlocking is activated.

i The direction indicators flash for a few seconds. Depending on version, the door mirrors unfold, the alarm is deactivated and the welcome lighting comes on.

Locking the vehicle

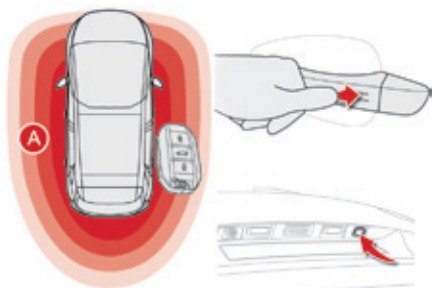

Normal locking

☞ With the electronic key in the recognition zone **A**, press with a finger or thumb on one of the front door handles (at the markings) to lock the vehicle or press the locking button on the right of the tailgate.

Maintaining pressure allows the windows to be raised to the desired position.

It is not possible to lock the vehicle if one of the keys is left inside the vehicle.

! Ensure that nothing could prevent the correct operation of the windows. Be aware of children when operating the windows.

i The direction indicators come on for a few seconds. Depending on your version, the door mirrors fold and the alarm is activated.

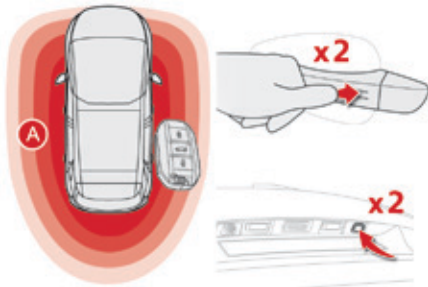

Deadlocking

! Deadlocking renders the interior door controls inoperative. It also deactivates the manual central control button. Therefore, never leave anyone inside the vehicle when it is deadlocked.

By the doors:

- ☞ With the electronic key in the recognition zone **A**, press a finger or thumb on one of the front door handles (at the markings) to lock the vehicle or the locking control located on the right of the tailgate, to lock the vehicle.
- ☞ Within five seconds, press the door handle or the locking control located on the right of the tailgate again to deadlock the vehicle.

i If one of the doors or the boot is still open or if the electronic key for the Keyless Entry and Starting system has been left inside the vehicle, the central locking does not take place. However, the alarm (if present) will be fully activated after about 45 seconds.

If the vehicle is unlocked by mistake and with no action on the doors or boot, the vehicle will lock again automatically after about thirty seconds.

If the alarm had been activated previously, it will not be reactivated automatically.

The automatic folding and unfolding of the door mirrors can be deactivated by a CITROËN dealer or a qualified workshop.

! As a safety measure (children on board), never leave the vehicle without taking the key for the Keyless Entry and Starting system, even for a short period. Be aware of the risk of theft when the key for the Keyless Entry and Starting system is in one of the defined zones with the vehicle unlocked.

i In order to preserve the battery in the electronic key and the vehicle's battery, the "Hands-free" functions are put into long-term standby after 21 days without use. To restore these functions, press one of the remote control buttons or start the engine with the electronic key in the reader (see the "Starting with the Keyless Entry and Starting system" section).

! Accumulations (water, dust, grime, salt...) on the inner surface of the door handle may affect detection. If cleaning the inner surface of the door handle using a cloth does not restore detection, contact a CITROËN dealer or a qualified workshop. A sudden splash of water (stream of water, high pressure jet washer, ...) may be identified by the system as the desire to open the vehicle.

Emergency procedure

Emergency unlocking/locking using the integral key

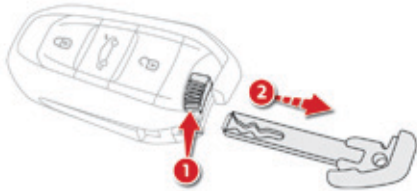

The integral key is used to lock and unlock the vehicle when the electronic key cannot operate and in the event of a fault with the Keyless Entry and Starting system:

- cell battery flat, vehicle battery discharged or disconnected, ...
 - vehicle located in an area with strong electromagnetic signals.
- ☞ To extract the emergency mechanical key from the electronic key, press button **1** and guide the key **2** out.

The integral key is also used to deactivate/reactivate the passenger's airbag. It provides a backup means of locking the passenger doors. It also allows locking of the vehicle without activation of the alarm.

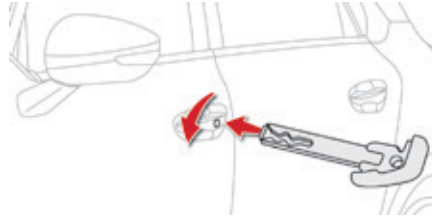

Unlocking

- ☞ Turn the key towards the front of the vehicle to unlock the vehicle.

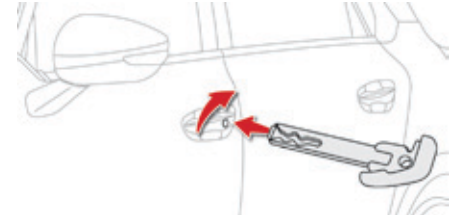

Normal locking

- ☞ Turn the key towards the rear of the vehicle to lock the vehicle completely.

Deadlocking

- ☞ Turn the key towards the rear in the driver's door lock to lock the vehicle completely.
- ☞ Turn the key towards the rear again within five seconds to deadlock the vehicle.

i Depending on your version, the direction indicators flash for a few seconds, the door mirrors unfold and the welcome lighting comes on. If the alarm was activated, the siren will sound on opening the door with the key (in the remote control). It stops when the ignition is switched on.

i Depending on your version, the direction indicators flash for a few seconds, the door mirrors fold.

! If your vehicle has an alarm, this function is not activated by locking with the integral key.

Remote control problem - reinitialisation

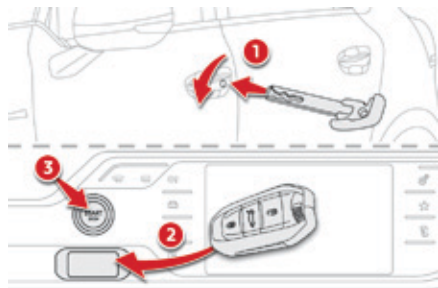

Following disconnection of the vehicle battery, replacement of the remote control battery or in the event of a remote control malfunction, you can no longer unlock, lock or locate your vehicle.

- ☞ Place the mechanical key (integral with the remote control) in the lock to unlock your vehicle.
- ☞ Place the electronic key in the reader.
- ☞ Switch on the ignition by pressing START/STOP.

The electronic key is fully operational again. If the problem persists, contact a CITROËN dealer or a qualified workshop as soon as possible.

Changing the battery

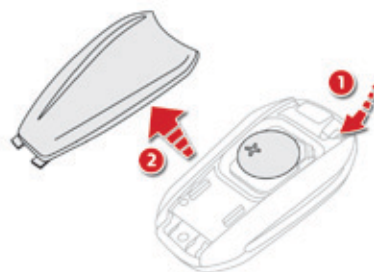

Battery ref.: CR2032 / 3 volts.
Battery replacement is signalled by the display of a message.

- ☞ Unclip the cover using a small screwdriver at the cutout.
- ☞ Lift off the cover.
- ☞ Remove the flat battery from its location.
- ☞ Fit the new battery into its location observing the original direction of fitment.
- ☞ Clip the cover onto the casing.



Do not throw the remote control batteries away, they contain metals which are harmful to the environment. Take them to an approved collection point.

! Lost electronic key

Visit a CITROËN dealer with the vehicle's registration certificate, your personal identification documents and if possible the key code label. The CITROËN dealer will be able to retrieve the key code and the transponder code required to order a new key.

Electronic key

The electronic key is a sensitive system; do not operate it while it is in your pocket as there is a possibility that it may unlock the vehicle, without you being aware of it.

Do not repeatedly press the buttons of your electronic key out of range and out of sight of your vehicle. You run the risk of stopping it from working and the remote control would have to be reinitialised.

The electronic key cannot operate as a remote control when it is in the reader or even when the ignition is switched on.

Locking the vehicle

Driving with the doors locked may make access to the passenger compartment by the emergency services more difficult in an emergency. As a safety precaution (with children on board), take the electronic key with you when you leave the vehicle, even for a short time.

Electrical interference

The electronic key may not operate if close to certain electronic devices: telephone, laptop computer, strong magnetic fields, ...

Anti-theft protection

Do not make any modifications to the electronic engine immobiliser system; this could cause malfunctions.

When purchasing a second-hand vehicle

Have all of the keys in your possession paired by a CITROËN dealer, to ensure that only your keys allow your vehicle to be unlocked and started.

Central locking

Manual central locking

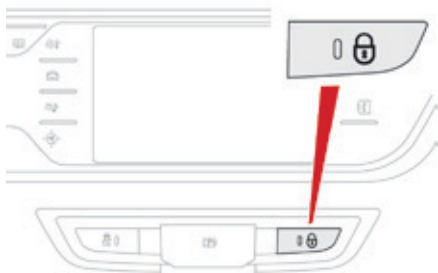

- ☞ Press this button to operate the central locking of the vehicle (doors and boot) from inside the vehicle.
- ☞ Pressing the button again unlocks the vehicle completely.

! When locking / deadlocking from the outside

If the vehicle is locked or deadlocked from the outside, the button is not active.

- ☞ After normal locking, pull one of the interior door handles to unlock the vehicle.
- ☞ After deadlocking, you have to use the remote control, the Keyless Entry and Starting system or the integral key to unlock the vehicle.

Automatic central locking of doors (anti-intrusion security)

2

The doors and boot lock automatically when driving, as soon as the speed exceeds 6 mph (10 km/h).

To activate or deactivate this function (activated by default):

- ☞ with the ignition on, press this button until a message appears in the instrument panel.

! If one of the doors or the boot is open, automatic central locking does not complete: the sound of the locks rebounding can be heard.

i Transporting long or voluminous objects

If you want to drive with the boot open but the vehicle's side doors locked, press the central locking control button to lock the doors.

! Driving with the doors locked may make access to the passenger compartment by the emergency services more difficult in an emergency.

Doors Opening

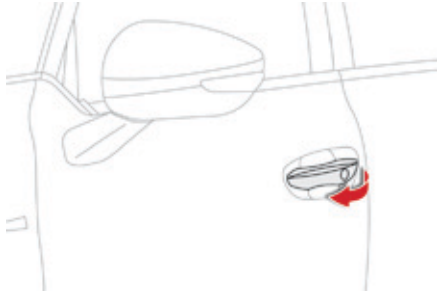

From outside

- ☞ After unlocking the vehicle using the remote control or the Keyless Entry and Starting system, pull the door handle.

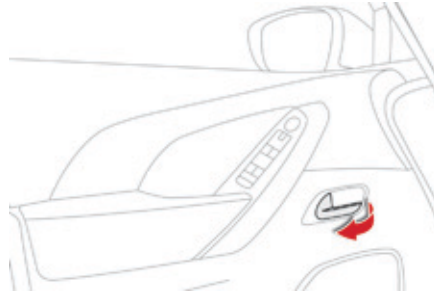

From inside

- ☞ Pull the front or rear door lever to open the door.

Closing



If a door is not properly closed:

- **with the engine running**, this warning lamp and a message appear in the instrument panel (type 1) for a few seconds,
- **when driving** (speed above 6 mph (10 km/h)), this warning lamp and a message, accompanied by an audible signal, appear in the instrument panel (type 1 and type 2) for a few seconds.

Back-up control

System allowing the doors to be locked and unlocked manually in the event of a malfunction of the central locking system or battery failure.

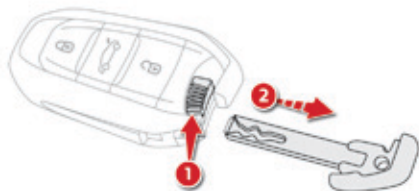

Locking the driver's door

- ☞ Insert the integral key in the door lock, then turn it to the rear.

You can also apply the procedure described for the passenger doors.

Unlocking the driver's door

- ☞ Insert the integral key in the door lock, then turn it to the front.

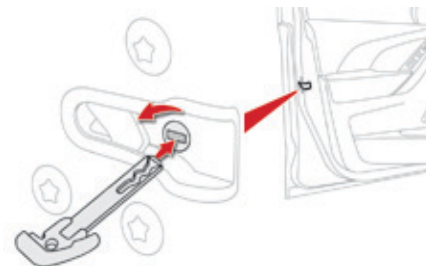

Locking the front and rear passenger doors

- ☞ Open the doors.
- ☞ For the rear doors, check that the child lock is not on (see the "Manual child lock" section).
- ☞ Insert the integral key in the latch located on the edge of the door and turn it an eighth of a turn to the right for the right hand door, and to the the left for the left hand door.
Locking is effective when the slot is horizontal.
- ☞ Close the doors and check that the vehicle has locked correctly from the outside.

Unlocking the front and rear passenger doors

- ☞ Pull the interior door opening control.

! To ensure complete locking of the vehicle, only disconnecting the battery inhibits opening of the tailgate from the outside.

Boot

Opening the tailgate

With the electronic key / remote control



- ☞ Make a long press on this button to release the tailgate. If the vehicle was locked, this action first unlocks the vehicle.
- ☞ Raise the tailgate.

i When selective unlocking is activated, the electronic key must be close to the rear of the vehicle.

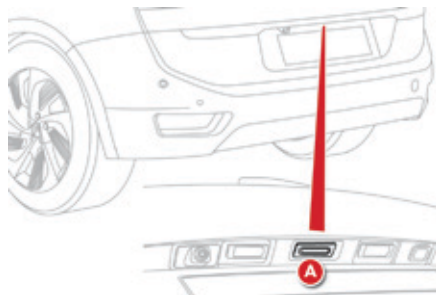

With the tailgate opening control

- ☞ With the vehicle unlocked or with the electronic key of the Keyless Entry and Starting system in the zone covered, press the tailgate control **A**.
- ☞ Raise the tailgate.

! The tailgate is not designed to take a bicycle carrier.

Closing the tailgate

- ☞ Lower the tailgate using the interior grips.
- ☞ Release the grips and press down on the outside of the tailgate to close it.



If the tailgate is not properly closed:

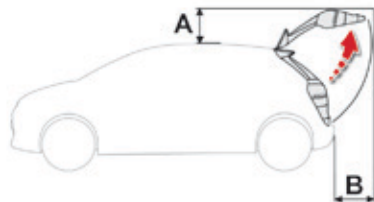

- **engine running**, this warning lamp and a message appear in the instrument panel (type 1) for a few seconds,
- **vehicle running** (speed above 6 mph (10 km/h)), this warning lamp and a message appear in the instrument panel (type 1 and type 2) for a few seconds, accompanied by an audible signal.

Motorised tailgate



	A = 517 mm B = 431 mm
	A = 448 mm B = 573 mm

Check that there is enough space to allow for the movement of the tailgate.

Activation and deactivation of the motorised tailgate function is done in the "**Driving assistance**" menu, then "**Vehicle settings**". This function is deactivated by default.

! The tailgate is not designed to support a bicycle carrier. When installing a bicycle carrier on a towbar, it is essential to deactivate the automatic operation.

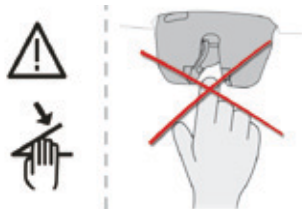

! Never place a finger in the tailgate locking system: risk of a serious accident!

! The motorised tailgate has an obstacle detection system that automatically interrupts and reverses its movement by a few degrees to allow the obstacle to be cleared.

Please note that this protection system is not active at the end of the closing travel (around 1 cm from completely closed).

To avoid the risk of injury through pinching, ensure that there is no person close to the rear of the vehicle and check your passengers, particularly any children, before and during operation of the motorised tailgate.

Tailgate controls

2



A: Exterior control

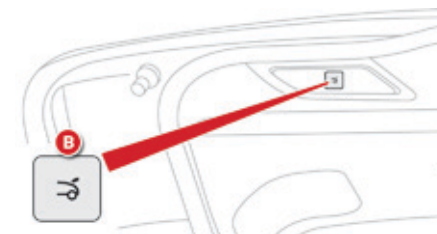

B: Interior control

Motorised opening

Unlocking and opening the tailgate with the electronic key / remote control



- ☞ Make a long press on the remote control button.

Unlocking and opening the tailgate with the Keyless Entry and Starting system

- ☞ Press button **A** on the tailgate, with the electronic key in the zone covered.

i When selective locking is activated, the electronic key must be near the rear of the vehicle.

Opening the tailgate

- ☞ After complete unlocking of the vehicle, press control **A** on the tailgate. The instruction is confirmed by an audible signal.

i By default, the tailgate opens completely or alternatively to the memorised position.

Motorised closing

There are two possibilities:

- ☞ Press and release the exterior control **A**.
- or



- ☞ Press and then release button **B**.

i The motorised tailgate has an anti-pinch system that interrupts closing if it encounters an obstacle.

i Operation of the tailgate can be interrupted at any time:



- by pressing one of these two buttons,

or

- by pressing the exterior control **A**.

After interruption of an operation, another press on one of the controls resumes the movement, with the exception of a press on the remote control button, which only allows opening.

Memorising an opening position

Where height is restricted (garage with a low ceiling, ...) it is possible to limit and memorise the opening angle of the tailgate.

This memorisation is done as follows:

- open the tailgate to the desired position,
- press button **B** or the exterior control **A** for more than 3 seconds.

Memorisation of the maximum opening position of the tailgate is confirmed by an audible signal.

To cancel the memorised position:

- stop the tailgate in an intermediate position,
- press button **B** or the exterior control **A** for more than 3 seconds.

Manual operation

The motorised tailgate can be opened and closed manually, even if motorisation is activated.

When opening and closing a motorised tailgate manually, there is no assistance from gas-filled struts. Resistance to opening and closing is therefore entirely normal.

Reinitialising the tailgate

This operation is necessary where there is no movement - after detection of an obstacle, after connecting or recharging the battery, ...

- ☞ Open the tailgate by hand, if necessary.
- ☞ Manually close the tailgate fully.

If the problem persists, contact a CITROËN dealer or a qualified workshop.

i Precautions in use

In the event of an accumulation of snow on the tailgate, clear the snow before commanding an automatic opening of the tailgate.

The formation of ice can block the tailgate and prevent its opening: wait until the ice melts with the heating of the passenger compartment.

When washing the vehicle in an automatic car wash, don't forget to lock your vehicle to avoid the risk of unexpected opening.

Repeated opening and closing of the tailgate can cause overheating of its electric motor, after which opening and closing will not be possible.

Allow 10 minutes for the motor to cool down before operating the tailgate again.

Tailgate release

System allowing the mechanical unlocking of the boot in the event of a battery or central locking system malfunction.

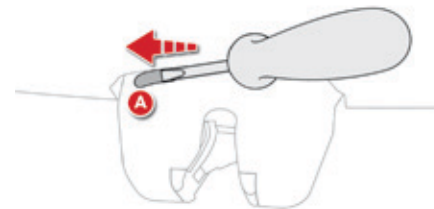

Unlocking

- ☞ Fold back the rear seats to gain access to the lock from inside the boot.
- ☞ Insert a small screwdriver into hole A of the lock to unlock the tailgate.
- ☞ Move the latch to the left.

Locking after closing

If the fault persists after closing again, the boot will remain locked.

Alarm

System which protects and provides a deterrent against theft and break-ins. It provides the following types of monitoring:

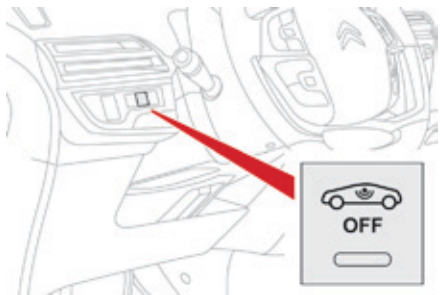

- Exterior perimeter

The system checks for opening of the vehicle. The alarm is triggered if anyone tries to open a door, the boot or the bonnet...

- Interior volumetric

The system checks for any variation in the volume in the passenger compartment. The alarm is triggered if anyone breaks a window, enters the passenger compartment or moves inside the vehicle.

! Self-protection function

The system checks for the disconnection of any of its components. The alarm is triggered if the battery, the button or the wires of the siren are disconnected or damaged.

For all work on the alarm system, contact a CITROËN dealer or a qualified workshop.

Locking the vehicle with full alarm system

Activation

☞ Switch off the ignition and get out of the vehicle.



☞ Lock the vehicle using the remote control.

or

☞ Lock the vehicle using the "Keyless Entry and Starting" system.

The monitoring system is active: the indicator lamp in the button flashes once per second and the the direction indicators come on for about 2 seconds.

After an instruction to lock the vehicle locked using the remote control or the Keyless Entry and Starting system, the exterior perimeter monitoring is activated after a delay of 5 seconds, the interior volumetric monitoring after 45 seconds.

If an opening (door, boot, bonnet...) is not closed fully, the vehicle is not locked but the exterior perimeter monitoring will be activated after a delay of 45 seconds, at the same time as the interior volumetric monitoring.

Deactivation

- ☞ Press one of the unlocking buttons on the remote control:



short press



long press

or

- ☞ Unlock the vehicle using the "Keyless Entry and Starting" system.

The monitoring system is deactivated: the indicator lamp in the button is off and the direction indicators flash for about 2 seconds.

i In the case of automatic locking of the vehicle (which occurs after a period of 30 seconds if a door or the boot is not opened), the monitoring system is not reactivated automatically. To reactivate it, it is necessary to unlock the vehicle and lock it again, using the remote control or the "Keyless Entry and Starting" system.

Locking the vehicle with exterior perimeter monitoring only

Deactivate the interior volumetric monitoring to avoid unwanted triggering of the alarm in certain cases such as:

- leaving a window partially open,
- washing your vehicle,
- changing a wheel.

Deactivation of the volumetric monitoring



- ☞ Switch of the ignition and within ten seconds press this button until its indicator lamp is on fixed.

- ☞ Get out of the vehicle.
- ☞ Immediately lock the vehicle using the remote control or the "Keyless Entry and Starting" system.

Only the exterior perimeter protection system is active: the indicator lamp in the button flashes once per second.

To be effective, this deactivation must be done every time the ignition is switched off.

Reactivation of the interior volumetric monitoring

- ☞ Deactivate the exterior perimeter monitoring by unlocking the vehicle using the remote control or the Keyless Entry and Starting system.

The indicator lamp in the button goes off.

- ☞ Reactivate the full alarm system by locking the vehicle using the remote control or the "Keyless Entry and Starting" system.

The indicator lamp in the button flashes once per second again.

Triggering of the alarm

This is indicated by sounding of the siren and flashing of the direction indicators for thirty seconds.

The monitoring functions remain active until the alarm has been triggered eleven times in succession.

When the vehicle is unlocked using the remote control or the Keyless Entry and Starting system, rapid flashing of the indicator lamp in the button informs you that the alarm was triggered during your absence. When the ignition is switched on, this flashing stops immediately.

Failure of the remote control

To deactivate the monitoring functions:

- ☞ Unlock the vehicle using the key (integral with the remote control) in the driver's door lock.
- ☞ Open the door; the alarm is triggered.
- ☞ Switch on the ignition; the alarm stops. The indicator lamp in the button goes off.

Locking the vehicle without activating the alarm

- ☞ Lock or deadlock the vehicle using the key (integral with the remote control) in the driver's door lock.

Operating fault

When the ignition is switched on, fixed illumination of the indicator lamp in the button indicates a fault in the system.

Have it checked by a CITROËN dealer or a qualified workshop.

Automatic activation*

2 minutes after the last door or the boot is closed, the system is activated automatically.

- ☞ To avoid triggering the alarm on entering the vehicle, first press the unlocking button on the remote control or unlock the vehicle using the Keyless Entry and Starting system.

* Depending on the country of sale.

Electric windows

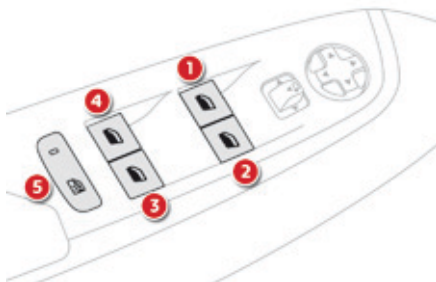

1. Left hand front electric window.
2. Right hand front electric window.
3. Right hand rear electric window.
4. Left hand rear electric window.
5. Deactivating the electric window switches located at the rear seats.

Manual operation

To open or close the window, press or pull the switch gently. The window stops as soon as the switch is released.

Automatic operation

To open or close the window, press or pull switch fully: the window opens or closes completely when the switch is released.

Pressing the switch again stops the movement of the window.

The electric window switches remain operational for approximately 45 seconds after switching off the ignition.

Once this time has elapsed, the electric windows will not operate. To reactivate them, switch the ignition on again.

Safety anti-pinch

When the window rises and meets an obstacle, it stops and immediately partially lowers again. In the event of unwanted opening of the window on closing, press the switch until the window opens completely, then pull the switch immediately until the window closes. Continue to hold the switch for approximately one second after the window has closed.

The safety anti-pinch function is not active during this operation.

Deactivating the rear controls for the rear windows



For the safety of your children, press switch **5** to prevent operation of the rear windows irrespective of their positions.

The indicator lamp in the button comes on, accompanied by a message confirming activation. It remains on, as long as the child lock is deactivated.

Use of the rear electric windows from the driver's controls remains possible.

Reinitialisation of the electric windows

Following reconnection of the battery, the safety anti-pinch function must be reinitialised. The safety anti-pinch function is not active during these operations.

For each window:

- lower the window completely, then raise it, it will rise in steps of a few centimetres with each action. Repeat the operation until the window closes completely,
- continue to pull the switch for at least one second after reaching this position, window closed.



In the event of contact during operation of the windows, you must reverse the movement of the window. To do this, press the switch concerned.

When operating the passenger electric window switches, the driver must ensure that nothing is preventing correct closing of the windows.

The driver must ensure that the passengers use the electric windows correctly.

Be particularly aware of children when operating the windows.

Be aware of passengers or other persons present when closing the windows using the the electronic key or the "Keyless Entry and Starting" system.

Front seats

Seat consisting of a seat cushion, a seat backrest and a head restraint which can all be adjusted to adapt your position for ease of driving and comfort.

! As a safety measure, seat adjustments should only be done when stationary.

Manual adjustments



Forwards-backwards

- ☞ Raise the control bar and slide the seat forwards or backwards.

When the seat is in the correct position, push it forwards and backwards without raising the control bar to check that it has latched.

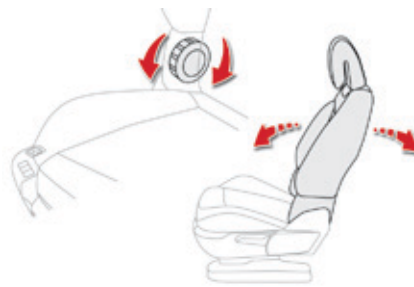

Driver's seat backrest angle

- ☞ Turn the knob to adjust the seat backrest.

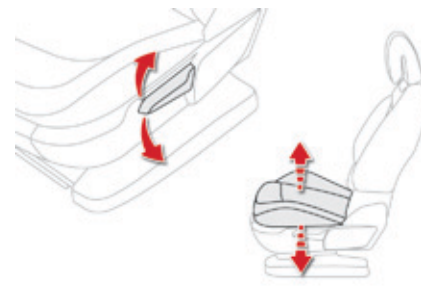

Driver's seat height

- ☞ Pull the control upwards to raise or push it downwards to lower, as many times as necessary, to obtain the position required.

! Before moving the seat backwards, ensure that there is nothing that might prevent the full travel of the seat, so as to avoid the risk of jamming the seat caused by the presence of objects on the floor behind the seat or rear passengers. If the seat jams, stop the movement immediately.

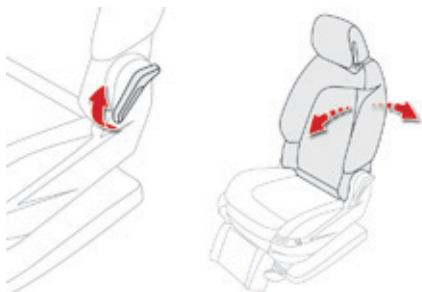

Passenger's seat backrest angle

- ☞ Pull the control upwards to adjust the backrest.

When the backrest angle is correct, release the control.

! When the backrest is at the correct angle, release the control lever. To ensure that the backrest does not suddenly fold forwards and hurt you, restrain it with your back or your hand while operating the control.



Table position for the passenger's seat backrest

! Check that there is no object that could interfere with the movement of the seat, both above and below.

- ☞ Place the head restraint in the low position, raise the armrest and fold the fixed table onto the back of the seat.
- ☞ Pull the control fully up and tip the backrest forwards.

To return to the normal position, guide the backrest backwards until it locks.

This position, associated with the position of the rear seats, allows you to carry long objects inside the vehicle.

Front seats

Electric adjustments

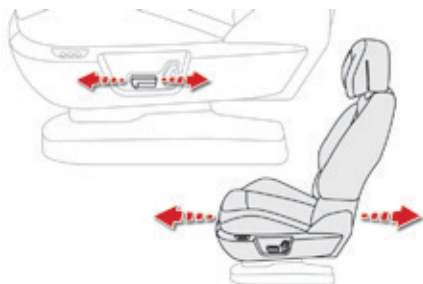

Forwards-backwards (driver's seat)

- ☞ Push the control forwards or rearwards to slide the seat.

i To avoid discharging the battery, carry out these adjustments with the engine running.



Seat backrest angle

- ☞ Tilt the control forwards or rearwards to adjust the angle of the seat backrest.

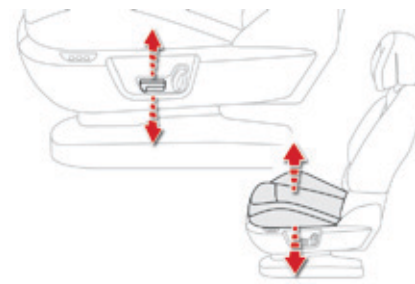

Seat cushion height and angle

- ☞ Operate the rear part of the control upwards or downwards to obtain the desired height.
- ☞ Operate the front part of the control upwards or downwards to obtain the desired angle.

! Before moving the seat backwards, ensure that there is nothing that might prevent the full travel of the seat, so as to avoid the risk of jamming the seat caused by the presence of objects on the floor behind the seat or rear passengers. If the seat jams, stop the movement immediately.

Storing driving positions

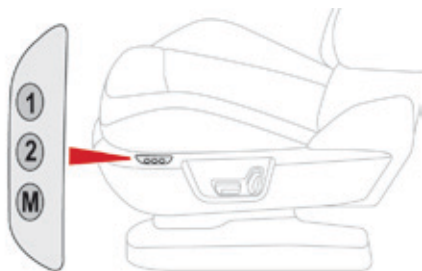

System which registers the electrical settings of the driver's seat. It enables you to store and recall two positions using the buttons on the side of the driver's seat.

Storing a position

Using buttons M / 1 / 2

- ☞ Switch on the ignition.
- ☞ Adjust your seat and the door mirrors.
- ☞ Press button **M**, then press button **1** or **2** within four seconds.

An audible signal indicates that the position has been stored.

Storing a new position cancels the previous position.

Recalling a stored position

Ignition on or engine running

- ☞ Press button **1** or **2** to recall the corresponding position.
An audible signal confirms that adjustment is complete.

You can interrupt the current movement by pressing button **M**, **1** or **2** or by using one of the seat controls.

A stored position cannot be recalled while driving.

Recalling stored positions is deactivated 45 seconds after switching off the ignition.

Additional adjustments

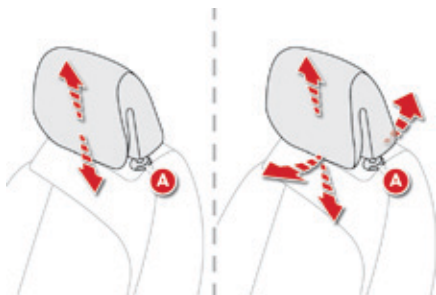

Head restraint height and angle (depending on version)

- ☞ To raise a head restraint, pull it upwards.
- ☞ To lower the head restraint, press the lug **A** and the head restraint at the same time.
- ☞ To adjust the angle of the head restraint, tilt its lower part forwards or rearwards.

The head restraint is fitted with a frame with notches which prevents it from lowering; this is a safety device in case of impact.

The adjustment is correct when the upper edge of the head restraint is level with the top of the head.

Removing a head restraint

- ☞ To remove the head restraint, press the lug **A** and pull the head restraint upwards.
- ☞ To put the head restraint back in place, engage the head restraint stems in the openings keeping them in line with the seat back and press the lug **A** at the same time.



Comfort head restraints

Depending on version, you can fold the sides to obtain a more comfortable position.

! Never drive with the head restraints removed; they must be in place and adjusted correctly.

Electric lumbar adjustment

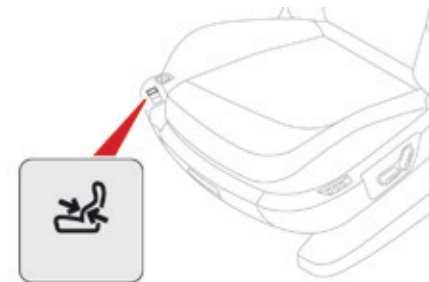

- ☞ Press the control to obtain the desired lumbar support.

Massage function

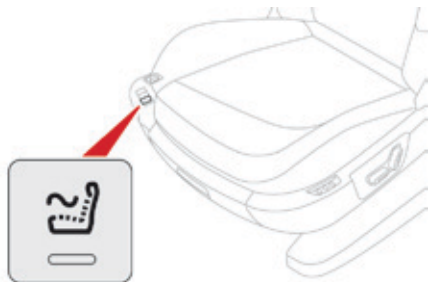

Activation



☞ Press this switch.

Its indicator lamp comes on and the massage function is activated for a period of 1 hour. During this time, massage is performed in 6 cycles of 10 minutes (6 minutes of massage followed by 4 minutes break). After one hour, the function is deactivated, the indicator lamp goes off.

Deactivation



You can deactivate the massage function at any time by pressing this switch, its indicator lamp goes off.

This function provides the front occupants with a lumbar massage. It only operates when the engine is running or in STOP mode of the Stop & Start system.

Adjustment of intensity



Press this button to select one of the two levels of massage intensity offered.

Electric leg rest

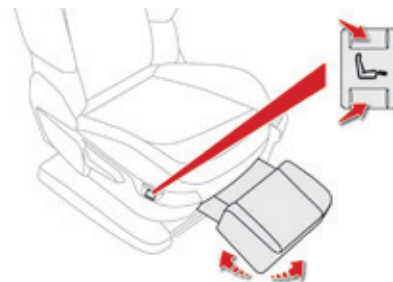

Manual passenger seat

☞ Press the front or rear part of the control to unfold or fold away the leg rest. The movement stops when you release the control.

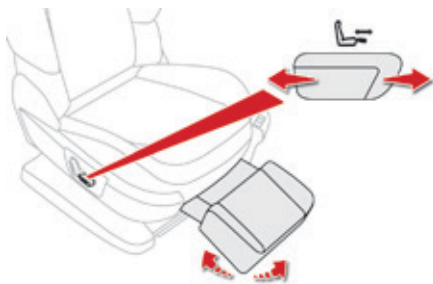

Electric passenger seat

- ☞ Push the control forwards or backwards to unfold or fold away the leg rest. The movement stops when you release the control.

i Before operating the leg rest, ensure that nothing could interfere with its movement.

Heated seats control

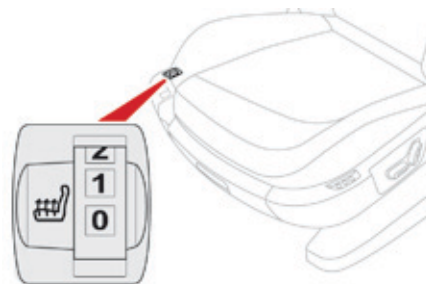

- ☞ Use the adjustment wheel to switch on and select the level of heating required:
 - 0: Off.
 - 1: Low.
 - 2: Medium.
 - 3: High.

With the engine running, the front seats can be heated separately.

Front armrest

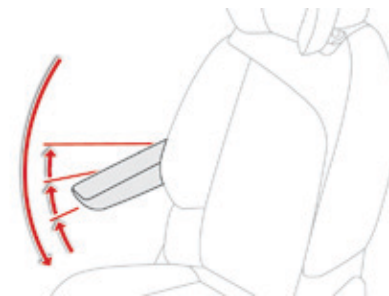

Comfort system for the driver and front passenger.

Height adjustment

- ☞ Fully lower the armrest.
- ☞ Raise it to the required position (low, intermediate or high).
- ☞ Once in the high position, lift to release it and return it to the low position.

Second-row seats

The 3 seats in the 2nd row are independent of each other and are all the same width. Their backrests can be folded to vary the load space in the boot.

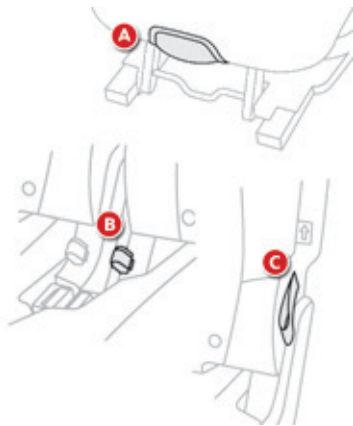

Forward-backward adjustment



- ☞ Raise the lever A, located at the front of the seat cushion, and adjust the seat to the desired position.

- A. Forward and backward adjustment: raise the lever.
- B. Backrest angle adjustment: pull the strap and guide the seat to the rear.
- C. Folding the seat: pull the strap up to release the seat.
- D. Folding the seat from the rear: pull the strap then push the seat forward.

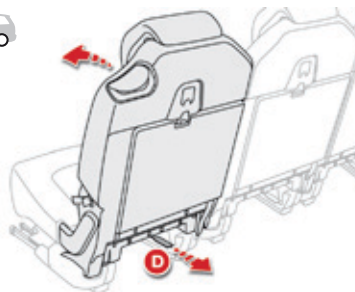

"Comfort" position



☞ Pull the strap **B** and guide the seat to the rear.

The backrest reclines and the seat base pivots slightly.

Returning the seat to the initial position

☞ Pull the strap **B** and guide the seat forward.

! Supervise any movements of seats when made by children.

Rear head restraints

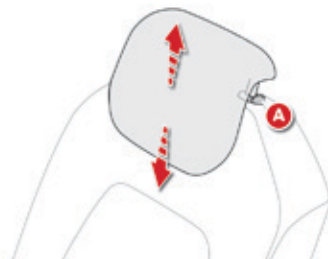

The rear head restraints can be removed and have two positions:

- high, position for use,
- low, storage position.

To raise a head restraint, pull it upwards.

To lower it, press lug **A** then the head restraint.

To remove it:

- move the head restraint to the high position,
- press lug **A** pulling the head restraint upwards at the same time.

To refit it:

- engage the rods of the head restraint in the openings keeping them in line with the seat back.

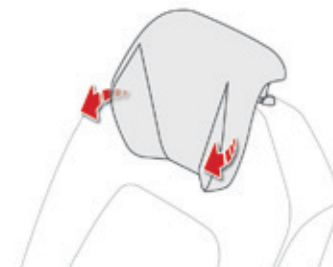

Comfort head restraints

Depending on version, the sides can be folded to obtain a more comfortable position.

! Never drive with the head restraints removed; they must be in place and correctly adjusted.

Flat floor

Each seat can be folded onto the floor to vary the the space available in the boot.

Folding a seat

- ☞ Place the seats in the fully back position.

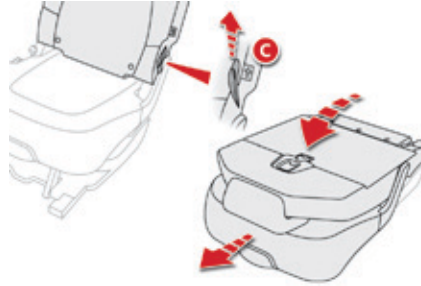

From the outside

- ☞ Pull firmly upwards on strap **C**, as indicated by the arrow, to unlock the seat; keep pulling until the seat is fully folded. Push the seat backrest gently forwards so that the backrest folds onto the seat cushion. The assembly lowers onto the floor.

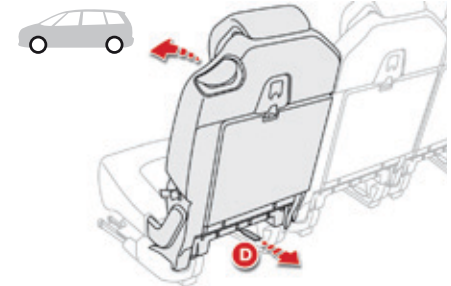

From the boot, when loading for example

- You can fold the second-row seats from the boot, after first folding the third-row seats.
- ☞ Pull on the strap **D** to release the seat in question then push forwards lightly on the backrest.
To avoid any damage to the mechanism, the strap **D** unclips if too much force is applied. Simply clip it in place again for the system to be operational again.



Repositioning a seat

- ☞ If necessary, straighten the continuity panels for the seats in the 2nd row and lock them in place.
- ☞ Raise the backrest and push it rearwards until it locks in position.

! Before operating the rear seats, check that the outer rear seat belts are not loose, to avoid damaging them. The centre belt must be stowed. Fix the tongues of the three belts to their anchorage points.

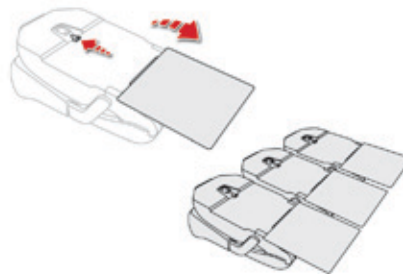

Continuity panels

Each seat has a continuity panel at the bottom of the backrest, that once unfolded:

- provides a continuous load surface in the boot, whatever the position of the seats,
- avoids objects sliding under the seats in the 2nd row.

! These continuity panels are not designed to support a weight greater than 30 kg.

Releasing / locking the continuity panels

- ☞ Before unfolding the continuity panels, check that the seats in the 2nd row are fully back.
- ☞ Slide the continuity panel latch upwards to release.
- ☞ Straighten the continuity panel, then slide the latch downwards to lock it.

3



Access to the third row seats

Access to the third-row seats is via the outer second-row seats.



- ☞ Pull the lever **E**. The seat unlocks and the seat cushion comes up against the backrest.
- ☞ Hold the lever **E** in the raised position, pushing forwards. The whole seat slides towards the front seat.

Space becomes free behind the seat, the third-row passengers can get to their seats.

i Before operating the seats, ensure that the tables on the back of the first-row seats are folded away.

Leaving the vehicle from the third-row seats

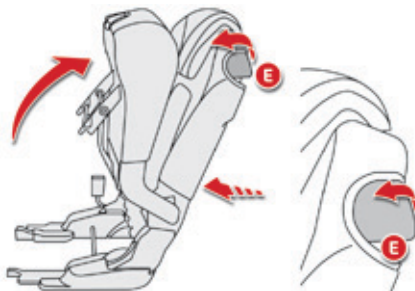

- ☞ Lift the lever **E**. The seat unlocks and the seat cushion comes up against the backrest.
- ☞ Push the seat backrest, still holding the lever **E** in the raised position.

Repositioning a seat, from the outside, with the door open

If there are passengers seated in the third row:

- ☞ manually return the assembly as far as possible rearwards; the seat does not return to the fully back position, so as to retain legroom for the third-row passengers,
- ☞ fold the seat cushion until it locks.

Ensure that there is no object on or under the seat that you want to move.

! In the event of a failure of this system (lever **E**), the passengers in the third row can also leave the vehicle after first folding the backrests of the second-row seats using the strap **D**. Do not allow children to operate the seats without supervision.

Third row seats

Concertina boards

Two rigid concertina boards, which cannot be separated from the vehicle, cover the 2 third-row seats, when these are in the folded position.

i Each of the two floor panels can support a load of 100 kg.

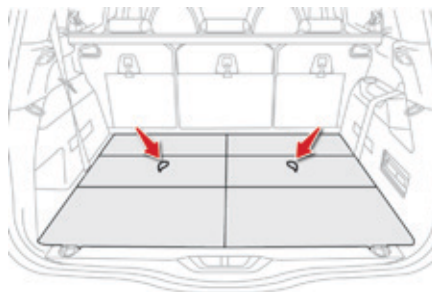

Folding the concertina boards

Pull on the control, the 3 sections of the board will fold like a concertina.

When the third-row seats are upright, these concertina boards can be left either:

- flat behind the seats,
- in the vertical position, thereby leaving a storage area available.



Repositioning the seats

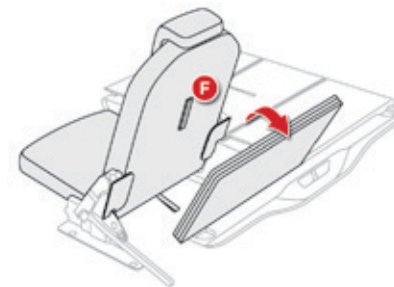

- ☞ Remove the luggage net (see the "Boot fittings" section).
- ☞ Return the second-row continuity panels to their initial position and lock them.
- ☞ Fold the concertina boards and position them vertically.
- ☞ Pull on the strap **F** located behind the seat backrest. The backrest pivots rearwards, pulling the seat base with it. The seat locks in the open position.

3



Folding the seats

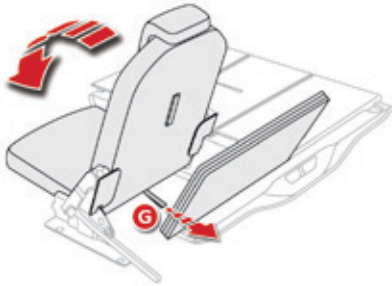

- ☞ Return the second-row continuity panels to their initial position and lock them.
- ☞ Lower the head restraints.
- ☞ Correctly position the concertina board vertically behind the seat.
- ☞ Check that the seat belts for the 3rd row seats are correctly fixed to the loops and are not folded.
- ☞ Pull the strap **G**, located at the bottom of the seat backrest. The seat unlocks.

- ☞ Next push the backrest gently forwards. The backrest pivots, folding onto the seat base. The seat base then folds into the stowage area provided for that purpose.
- ☞ Reposition the concertina boards over the folded seats.

- ! Before moving the third-row seats, return the rigid floor plates of the second-row seats to the upright position and lock them.
Do not try to fold a third-row seat that has not first had the backrest fully locked in place.
Do not leave objects either on or underneath the seat bases of the third-row seats when you are folding them.
Do not leave your hand on the control **G** as you fold the seats, as you risk trapping your fingers.
Do not allow children to operate the seats without supervision.



Seat modularity and configurations

Examples of configurations



5 seats



3 seats



4 seats

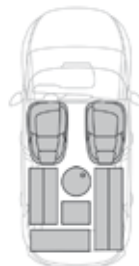

Maximum loadspace



Examples of seat configurations



7 seats

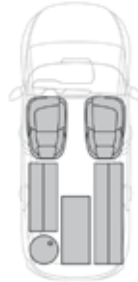

Maximum loadspace



4 seats



6 seats



5 seats

i For easy modification of your interior vehicle space, all the rear seats can be individually folded: onto the second-row floor, and under the third-row floor. You can then have a load floor that is continuous up to the front seat backrests. The seats must only be folded and unfolded with the vehicle stationary.

Mirrors

Door mirrors

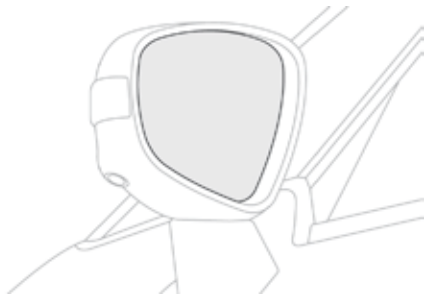

Each fitted with an adjustable mirror glass providing the lateral rearward vision necessary for overtaking or parking. They can also be folded for parking in confined spaces.

Demisting - Defrosting



Demisting-defrosting of the door mirrors operates with the engine running, by switching on the heated rear screen. Refer to the "Rear screen demist-defrost" section.

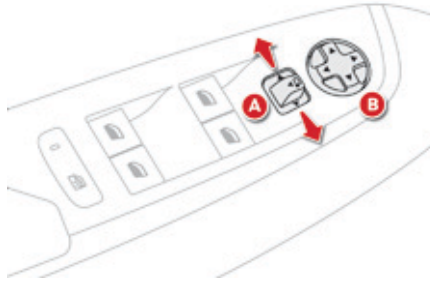

Adjustment

- ☞ Move control **A** to the right or to the left to select the corresponding mirror.
- ☞ Move control **B** in all four directions to adjust.
- ☞ Return control **A** to the central position.



As a safety measure, the mirrors should be adjusted to reduce the "blind spots".

The objects observed are, in reality, closer than they appear. Take this into account in order to correctly judge the distance of vehicles approaching from behind.

Folding

- ☞ From outside: lock the vehicle using the electronic key or the Keyless Entry and Starting system.
- ☞ From inside: with the ignition on, pull the control **A** in the central position rearwards.



If the mirrors are folded using control **A**, they will not unfold when the vehicle is unlocked. Pull again on control **A**.

Unfolding

- ☞ From outside: unlock the vehicle using the electronic key or the Keyless Entry and Starting system.
- ☞ From inside: with the ignition on, pull the control **A** in the central position rearwards.



The folding and unfolding of the door mirrors using the remote control can be deactivated by a CITROËN dealer or a qualified workshop.



If necessary, it is possible to fold the mirrors manually.

Automatic tilting in reverse gear

System which provides a view of the ground during parking manoeuvres in reverse gear.

With the engine running, on engaging reverse gear, the mirror glasses tilt downwards.

They return to their initial position:

- a few seconds after coming out of reverse gear,
- once the speed of the vehicle exceeds 6 mph (10 km/h),
- on switching off the engine.

This function can be deactivated in the "**Driving assistance**" menu, then "**Vehicle settings**".

Rear view mirror

Adjustable mirror providing a central rearward view.

Equipped with an anti-dazzle system, which darkens the mirror glass and reduces the nuisance to the driver caused by the sun, headlamps from other vehicles...

Manual day/night model

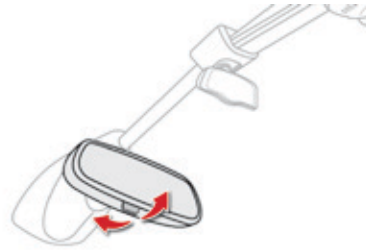

Adjustment

- ☞ Adjust the mirror so that the glass is directed correctly in the "day" position.

Day / night position

- ☞ Pull the lever to change to the "night" anti-dazzle position.
- ☞ Push the lever to change to the normal "day" position.

Automatic day/night model

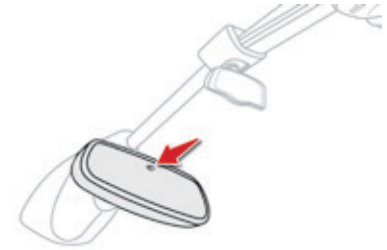

By means of a sensor, which measures the light from the rear of the vehicle, this system automatically and progressively changes between the day and night uses.

i In order to ensure optimum visibility during your manoeuvres, the mirror lightens automatically when reverse gear is engaged.

Child surveillance mirror

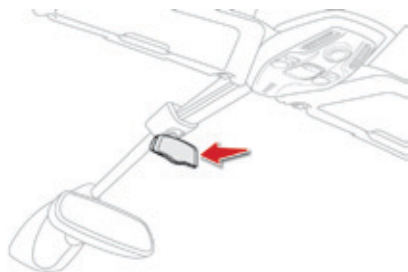

A child surveillance mirror is fitted above the rear view mirror. This allows you to monitor the vehicle's rear passengers, or it can facilitate conversation between the front and rear passengers without the need to move the rear view mirror.

It can be folded away to eliminate dazzle.

Steering wheel adjustment

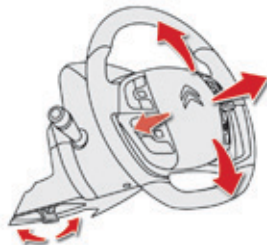

- ☞ **When stationary**, pull the control lever to release the adjustment mechanism.
- ☞ Adjust the height and reach to suit your driving position.
- ☞ Push the control lever to lock the adjustment mechanism.

! As a safety precaution, these operations should only be carried out with the vehicle stationary.

Ventilation

Air intake

The air circulating in the passenger compartment is filtered and originates either from the outside via the grille located at the base of the windscreen or from the inside in air recirculation mode.

Air treatment

The incoming air follows various routes depending on the controls selected by the driver:

- direct arrival in the passenger compartment (air intake),
- passage through a heating circuit (heating),
- passage through a cooling circuit (air conditioning).

Control panel

The controls of this system are accessible in the "**Air conditioning**" menu of the touch screen tablet **A**.

The demisting/defrosting controls for the windscreen and rear screen are located on the left of the touch screen tablet.

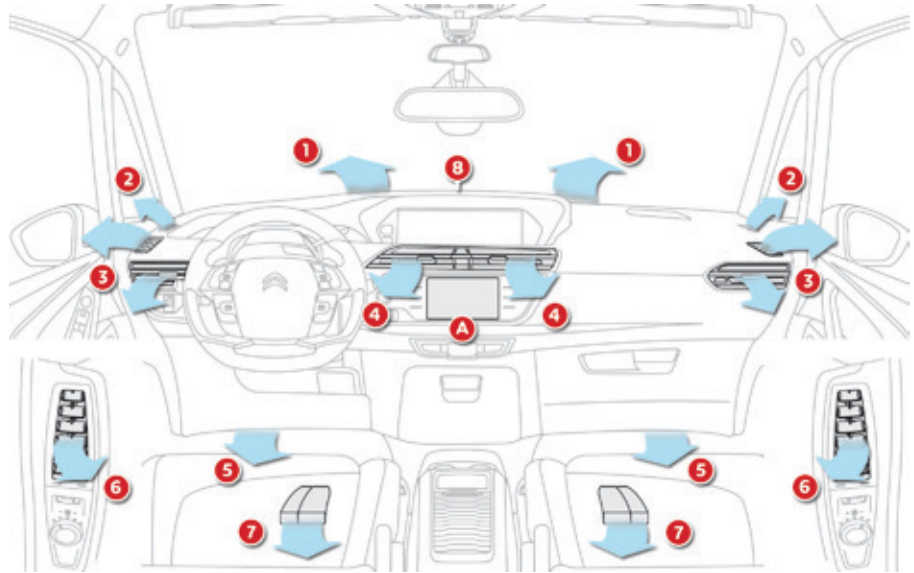

Air distribution

1. Windscreen demisting-defrosting vents.
2. Front quarter light demisting-defrosting vents.
3. Front side window demisting/defrosting vents.
4. Central adjustable air vents.
5. Air outlets for the front footwells.
6. Side vents for the 2nd row.
7. Air outlets for 2nd row footwells.
8. Sunshine sensor.

Recommendations for ventilation and air conditioning

- i** In order for these systems to be fully effective, follow the operation and maintenance guidelines below:
- ☞ To obtain an even air distribution, take care not to obstruct the exterior air intake grilles located at the base of the windscreen, the nozzles, the vents and the air outlets, as well as the air extractor located in the boot.
 - ☞ Do not cover the sunshine sensor, located on the dashboard; this is used for regulation of the air conditioning system.
 - ☞ Operate the air conditioning system for at least 5 to 10 minutes, once or twice a month to keep it in perfect working order.
 - ☞ Ensure that the passenger compartment filter is in good condition and have the filter elements replaced regularly.
- We recommend the use of a combined passenger compartment filter. Thanks to its special active additive, it contributes to the purification of the air breathed by the occupants and the cleanliness of the passenger compartment (reduction of allergic symptoms, bad odours and greasy deposits).
- ☞ To ensure correct operation of the air conditioning system, you are also advised to have it checked regularly as recommended in the maintenance and warranty guide.
 - ☞ If the system does not produce cold air, switch it off and contact a CITROËN dealer or a qualified workshop.

When towing the maximum load on a steep gradient in high temperatures, switching off the air conditioning increases the available engine power and so improves the towing ability.

- ☘** If after an extended stop in sunshine, the interior temperature is very high, first ventilate the passenger compartment for a few moments.
- Put the air flow control at a setting high enough to quickly change the air in the passenger compartment.
- The air conditioning system does not contain chlorine and does not present any danger to the ozone layer.

- i** The condensation created by the air conditioning results in a discharge of water under the vehicle which is perfectly normal.

i Stop & Start

The heating and air conditioning systems only work when the engine is running. To maintain a comfortable temperature in the passenger compartment, you can temporarily deactivate the Stop & Start system (see the corresponding section).

Heating

The heating system works only when the engine is running.

Press the button for the **"Air conditioning"** menu to display the page for the system controls.

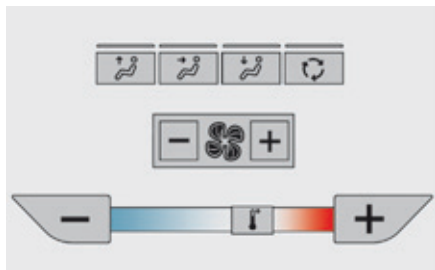

Temperature adjustment

- +** ☞ Press one of these buttons, or move the cursor from blue (cold) to red (hot) to adjust the temperature to your wishes.
-



Air flow adjustment

- +** ☞ Press one of these buttons to increase or decrease the speed of the booster fan.
-

The symbol for airflow (a fan) fills progressively according to the air flow setting made. By reducing the air flow to the minimum, you are stopping ventilation of the passenger compartment.

i Avoid driving for too long without ventilation (risk of misting and deterioration of air quality).

Air distribution adjustment

-  Windscreen.
-  Footwells.
-  Centre and side vents.

The air distribution can be varied by using more than one button.



Each press of a button activates or deactivates the function.

The indicator lamp is on when the button is activated. For an even distribution of air in the passenger compartment, the three buttons can be activated simultaneously.

Air intake / Air recirculation

The intake of exterior air prevents and eliminates misting of the windscreen and side windows.

The recirculation of interior air prevents exterior odours and smoke entering the passenger compartment.

-  ☞ Press this button to recirculate the interior air. The indicator lamp in the button comes on.
-  ☞ Press the button again to allow the intake of exterior air. This is confirmed by the indicator lamp going off.

Dual-zone manual air conditioning with temperature regulation

The air conditioning system operates with the engine running.

The temperature at the nozzles and vents is regulated by the system according to the temperature in the passenger compartment and the temperature setting.

Press the button for the "Air conditioning" menu to display the system controls page.



Temperature adjustment

The driver and front passenger can each adjust the temperature.



Press one of these buttons to reduce (blue) or increase (red) the value.

The value indicated corresponds to a level of comfort and not to a temperature in degrees Celsius or Fahrenheit (depending on the unit selected). A setting of around 21 provides optimum comfort. Depending on your requirements, a setting between 18 and 24 is normal.

In addition, it is recommended that a difference between left and right of more than 3 should be avoided.

Air flow adjustment



Press one of these buttons to increase or decrease the speed of the air booster fan.

The air flow symbol (a fan) fills progressively according to the quantity of air wanted. By reducing the air flow to minimum, you are stopping ventilation.

i Avoid driving too long without ventilation (risk of misting and deterioration of air quality).

3

Air distribution adjustment

These buttons are used to arrange the distribution of air in the passenger compartment by combining several air outlets.



Windscreen.



Footwells.



Central and side vents.

The air distribution can be adapted by using several buttons: illumination of the indicator lamp confirms the presence of fan boosted air in the direction indicated, the indicator lamp off indicates the absence of fan boosted air in the direction indicated.

For a uniform distribution of air in the passenger compartment, the three buttons can be activated simultaneously.

Air intake / Air recirculation

The intake of exterior air prevents the formation of mist on the windscreen and side windows. The recirculation of interior air isolates the passenger compartment from exterior odours and smoke.

i This function allows hot or cold air to be delivered selectively and more quickly.



- ☞ Press the button to recirculate the interior air. The indicator lamp comes on.
- ☞ Press the button again to permit the intake of exterior air. The indicator lamp goes off to confirm this.

i Avoid driving too long without recirculation of interior air (risk of misting and deterioration of air quality).

Air conditioning On / Off

A/C The air conditioning is designed to operate effectively in all seasons, with the windows closed.

It enables you to:

- lower the temperature, in summer,
- increase the effectiveness of the demisting in winter, above 3°C.

Switching on

A/C ☞ Press this button, the associated indicator lamp comes on.

i The air conditioning does not operate when the air flow adjustment is set to off.

Switching off

A/C ☞ Press the button again, the associated indicator lamp switches off.

Dual-zone automatic air conditioning

This air conditioning system operates with the engine running, but the ventilation and its controls are available with the ignition on.

Operation of the air conditioning and regulation of temperature, air flow and air distribution in the passenger compartment are automatic.

Press the button for the **"Air conditioning"** menu to display the controls for the air conditioning system.

Depending on the colour scheme chosen, the system controls page is displayed differently:

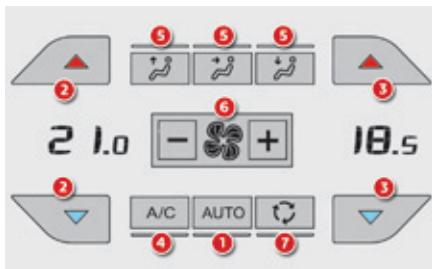

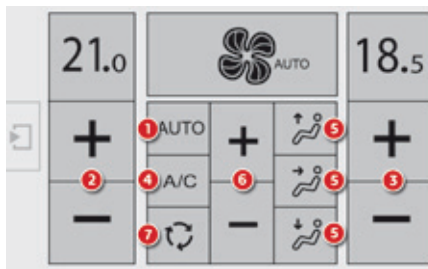

1. Automatic mode.
2. Driver's side temperature adjustment.
3. Passenger's side temperature adjustment.





4. Air conditioning On / Off.
5. Air distribution adjustment.
6. Air flow adjustment.
7. Air intake / air recirculation.

Temperature adjustment

The driver and front passenger can each set the temperature.

   Press one of these buttons to increase the value.

   Press one of these buttons to decrease the value.

It is recommended that you avoid a left/right setting difference of more than 3.

The value indicated corresponds to a level of comfort and not to a precise temperature.

3

Automatic comfort programme

- ☞ Press the **"AUTO"** button to activate or deactivate the automatic mode of the air conditioning system.

AUTO

When the indicator lamp in the button is on, the air conditioning system operates automatically: the system manages the temperature, air flow and air distribution in the passenger compartment in an optimum way according to the comfort level you have selected.

It is possible to modulate the intensity of the automatic comfort programme by choosing one of three mode settings offered in a secondary page of the **"Air conditioning"** menu.



To change the current setting, shown by the green indicator lamp, press the button for the desired mode:



"Soft": provides soft and quiet operation by limiting air flow.



"Normal": offers the best compromise between a comfortable temperature and quiet operation (default setting).



"Fast": provides strong and effective air flow.

This setting is associated with AUTO mode only. However, on deactivation of AUTO mode, the indicator for the last setting remains on. Changing the setting does not reactivate AUTO mode if deactivated.

i In cold weather with the engine cold, the air flow is increased gradually until the system has warmed up, in order to limit the delivery of cold air into the passenger compartment. On entering the vehicle, if the interior temperature is much colder or warmer than the comfort value setting, there is no need to alter the value displayed in order to reach more quickly the required level of comfort. The system compensates automatically and corrects the temperature difference as quickly as possible.

Manual control



You can manually adjust one or more settings, while retaining automatic control of the other functions:

- air flow,
- air distribution.

As soon as you modify a setting, the indicator lamp in the "AUTO" button goes off.

AUTO  Press the "AUTO" button again to activate the automatic comfort programme again.

Air flow adjustment

  Press one of these buttons to increase or decrease the speed of the booster fan.

The air flow symbol (a fan) is filled in progressively in relation to the quantity of air wanted.

By reducing the air flow to minimum, you are stopping ventilation.

"OFF" is displayed alongside the fan.

 Avoid driving for too long with the ventilation off (risk of misting and deterioration of air quality).

Air distribution adjustment

You can modulate the distribution of air in the passenger compartment using these three buttons.



Windscreen.



Footwells.



Centre and side vents.

Each press on a button activates or deactivates the function. The indicator lamp is on when the button is activated. For a uniform distribution in the passenger compartment, all three buttons can be pressed simultaneously.

In AUTO mode, the indicator lamps in all three buttons are off.

Air conditioning On/Off

A/C The air conditioning is designed to operate efficiently in all seasons, with the windows closed.

It allows you:

- in summer, to lower the temperature,
- in winter, above 3 °C, to improve demisting.

Switching on

☞ Press the "**A/C**" button to activate the air conditioning.

When the indicator lamp below the button is on, the air conditioning function is on.

The air conditioning cannot operate when the air flow is set to off.

Switching off

☞ Press the "**A/C**" button again to deactivate the air conditioning.

When the indicator lamp below the button is off, the air conditioning function is off.

Air intake/Air recirculation

The intake of exterior air avoids misting of the windscreen and side windows.

Air recirculation prevents exterior odours and smoke from entering the passenger compartment.

This function also allows faster heating or cooling of the air in the passenger compartment.



☞ Press this button to choose the mode for air entry to the passenger compartment.

When the indicator lamp under the button is off, the intake of exterior air is active.

When the indicator lamp under the button is on, air recirculation is activated, the intake of exterior air is off.



Avoid prolonged operation of the air recirculation function (risk of misting and of deterioration of the air quality).

"Mono" function

The comfort setting for the passenger's side can be indexed to the driver's comfort setting (mono-zone).

From the secondary page of the "**Air conditioning**" menu:



☞ Press this button to activate / deactivate the "Mono" function. The indicator lamp in the button is on when the function is activated.

The function is deactivated automatically when the passenger uses their temperature setting buttons.

"Rear" function

This function gives rear passengers access to the adjustment controls and allows.

- the distribution of air conditioned air to the vents for the 2nd row of seats,
- the distribution of ambient air to the vents for the 3rd row of seats.

From the secondary page of the "Air conditioning" menu:



- ☞ Press this button to activate / deactivate the "Rear" function. The indicator lamp in the button is on when the function is activated.

Settings for passengers in the 2nd row of seats



- ☞ Turn the upper wheel to open or close the rear vent.
- ☞ Turn the lower knob to reduce (to the left) or increase (to the right) the air flow.



Settings for passengers in the 3rd row of seats



- ☞ Press the vent cover.
- ☞ Adjust the flow of air to the two vents using the four-position wheel (off, low, medium, high).
- ☞ Direct the vent by turning the cover.

3

Ventilation with ignition on function

With the ignition on, you can use the ventilation system and have access to the "**Air conditioning**" menu to adjust the air flow and air distribution in the passenger compartment. This function is available for a few minutes, depending on the state of charge of the battery of your vehicle.

This function does not activate the air conditioning.

You can make use of the residual heat in the engine to warm the passenger compartment using the temperature setting buttons.

Front demist - defrost



- ☞ Press this button to demist or defrost the windscreen and side windows as quickly as possible. The indicator lamp in the button comes on.

The system automatically manages the air conditioning (depending on version), air flow and air intake, and provides optimum distribution towards the windscreen and side windows.

- ☞ To switch it off press this button, the indicator lamp goes off.

i With Stop & Start, when demisting has been activated, the STOP mode is not available.

Rear screen demist - defrost



Switch off the heating of the rear screen and door mirrors as soon as you judge it possible, as reducing the consumption of electrical current reduces fuel consumption.



The rear screen demist - defrost can only operate when the engine is running.

Switching on



- ☞ Press this button to demist/defrost the rear screen and (depending on version) the door mirrors. The indicator lamp associated with the button comes on.

Switching off

The demisting/defrosting switches off automatically to prevent an excessive consumption of current.



- ☞ It is possible to stop the demisting/defrosting operation before it is switched off automatically by pressing the button again. The indicator lamp associated with the button switches off.

Scented air freshener

The scented air freshener releases a fragrance into the passenger compartment via the central air vents.

i The air freshener contains an empty cartridge when your vehicle is delivered. You therefore need to insert a cartridge in order to use the air freshener.

Adjustment of flow

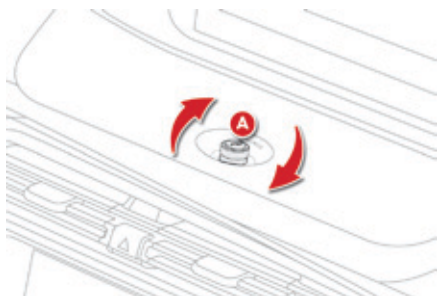

☞ Rotate the button **A** to adjust (to the left to reduce, to the right to increase) or stop (maximum to the left) the flow of scented air.

The central air vents have to be open.

i A cartridge lasts on average 3 months, based on one hour's usage per day.

To remove the air freshener

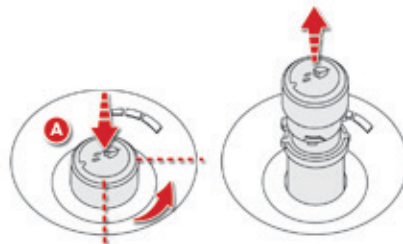

- ☞ Press the button **A**, rotating it a quarter turn to the left as far as it will go.
- ☞ Remove the air freshener from the dashboard.
- ☞ Replace the cartridge (see "Replacing a cartridge").

To insert the air freshener

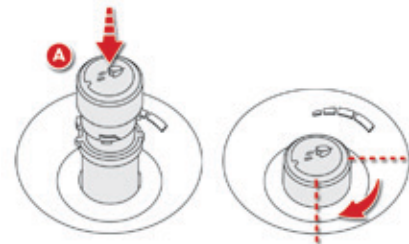

- After fitting or changing a cartridge:
- ☞ place the air freshener back in its housing.
 - ☞ rotate it a quarter turn to the right.

Replacing a cartridge

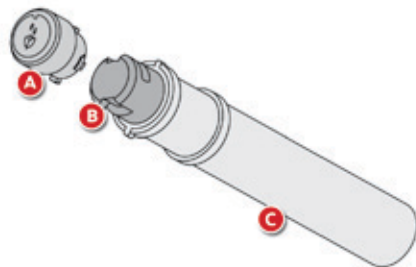

The recharge for the air freshener consists of a cartridge **B** and its sealed container **C**.

- ☞ Remove the protective film **D**.
- ☞ Place the head of the cartridge **B** on the button **A** of the air freshener.
- ☞ Rotate it a quarter turn to lock it on the button and remove the container.
- ☞ Insert the air freshener into its housing.

You can change cartridges at any time, keeping the used cartridges in their original containers.

Air freshener button

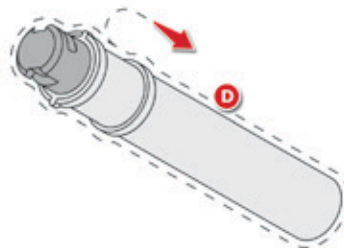

The air freshener button **A** is independent of the cartridge. Cartridges are supplied without the air freshener button **A**.

The button of the air freshener **A** can only be fitted to the centre of the dashboard with a cartridge attached.

Therefore always keep the air freshener button **A** and one cartridge.

Replacement cartridges are available, depending on country, either on the Internet site or from a CITROËN dealer or a qualified workshop.

Locations are provided in the glove box for storing cartridges and containers.

- !
- For safety, use only cartridges that are provided for this purpose.
 - Retain the containers for storing used cartridges.
 - Do not recharge or dismantle the cartridges.
 - Keep them out of reach of children and animals.
 - Avoid all contact with the skin and with the eyes.
 - In the event of ingestion, consult a doctor and show them the product packaging or label.
 - Do not install or remove a cartridge while you are driving.

Front fittings

1. Sun visor.
2. Card holder.
3. Glove box.
4. Central storage.
It contains the power and audio sockets.
5. Raised console with closed storage, low console or removable console.
6. Cup holder.
7. Door pockets.
8. Storage below the steering wheel.
(Handbook pack).

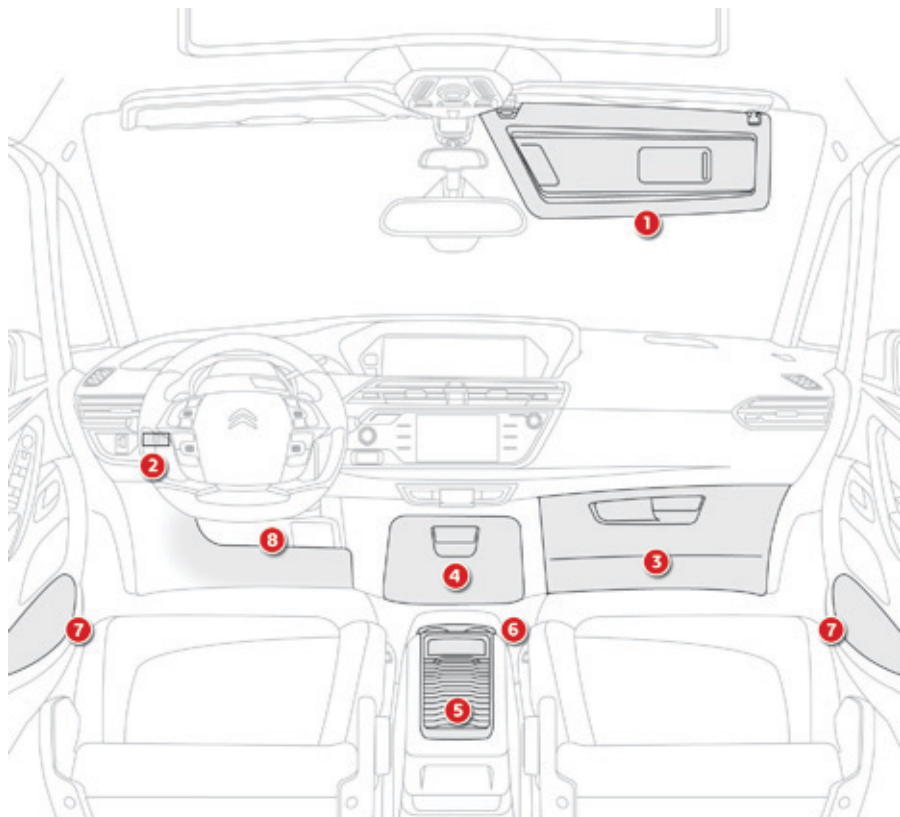

Sliding sun visor

Sliding blinds

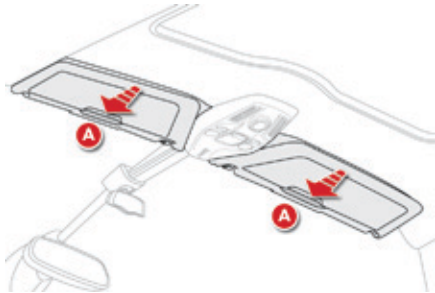

Sliding blinds are provided for your protection against bright sunlight. They can be adjusted manually.

- ☞ Slide the blind to the desired position by pushing at **A**.

Sun visor rails

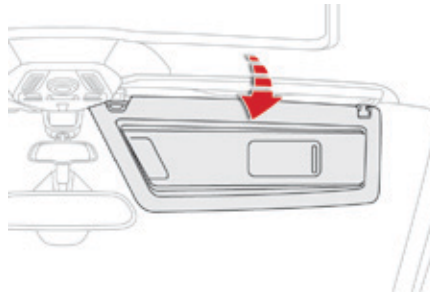

The blinds are extended on the sun visor rails. Fold the visor downwards, to protect against dazzle to the face.

If dazzle is coming from the side windows, detach the visor from its housing above the centre of the windscreen and pivot it to the side.

The visors are fitted with a locking system on their central housing when the blind is reeled in. To detach the visor or to reposition it, it must be in a vertical position.



Do not attach or suspend heavy objects on the slide rail of the sun blind.

Glove box

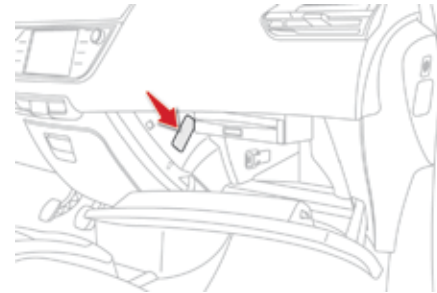

Depending on equipment, it may contain a CD player.

☞ To open the glove box, raise the handle. It is illuminated when the lid is opened. It is cooled by a manual directional ventilation nozzle.

It is connected directly to your vehicle's air conditioning system and is supplied with cool air whatever the temperature setting for the passenger compartment.

The refrigeration of your glove box operates only with the engine running and the air conditioning on.

Removable console

The removable console is a portable storage space secured to the lower centre console. It has a sliding lid, an open storage space and two cup holders.

Releasing the removable console

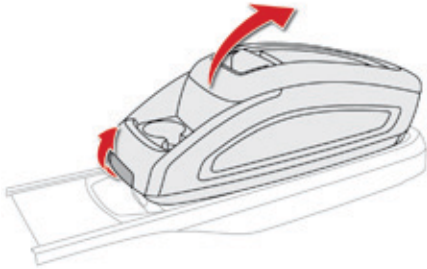

- ☞ Raise the locking control located at the front of the console.
- ☞ With one hand, lift the front part of the console.
- ☞ With the other hand, grasp the rear part to release the removable console.

Refitting the removable console

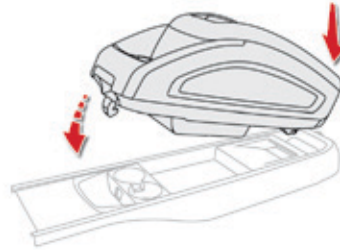

- ☞ Carry out these operations in reverse order. Ensure that the console has locked into place.

i When not fixed to its carrier, the removable console should be stowed in the boot. It could become a projectile in the event of a sudden stop or violent impact.

Central storage compartment

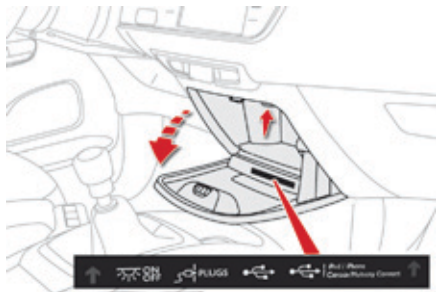

- ☞ To open the central storage compartment, pull the grip and lower the cover. It is illuminated on opening. A button on the upper part allows the lighting to be deactivated.

Depending on equipment, it may contain:

- one 230 V socket,
- one 12 V socket,
- one or two USB ports,
- one auxiliary socket.

230 V / 50 Hz power socket

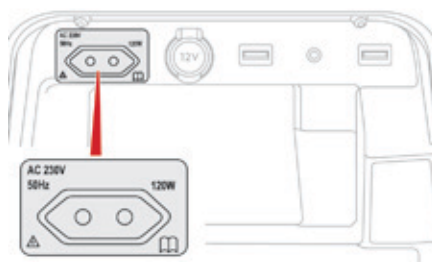

A 230 V / 50 Hz socket (maximum power: 120 W) is fitted in the central storage box.

To use the socket:

- ☞ open the central storage box,
- ☞ check that the warning lamp is on green,
- ☞ connect your multimedia or other electrical device (telephone charger, laptop computer, CD-DVD player, baby food warmer...).

This socket works with the engine running, as well as in STOP mode with Stop & Start.

In the event of a fault with the socket, the green warning lamp flashes.

Have it checked by a CITROËN dealer or a qualified workshop.

- !
- Connect only one device at a time to the socket (no extension or multi-way connector).
 - Connect only devices with class II insulation (shown on the device).
 - As a safety measure, when electrical consumption is high and when required by the vehicle's electrical system (particular weather conditions, electrical overload...), the current supply to the socket will be cut off; the green warning lamp goes off.

12 V accessory socket

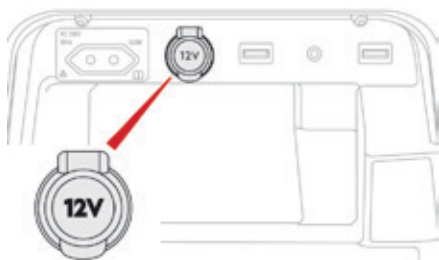

☞ To connect a 12 V accessory (maximum power: 120 Watts), lift the cover and connect a suitable adaptor.

! Do not exceed the maximum power rating of the socket (risk of damage to your device).

Auxiliary socket

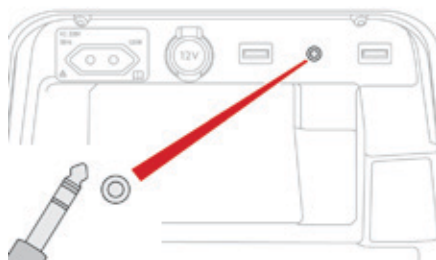

The auxiliary socket is located in the central storage box. It permits the connection of a portable device, such as a digital audio player of the iPod® type, to listen to your music files using the vehicle's speakers. The management of the files is done using your portable device.

USB ports

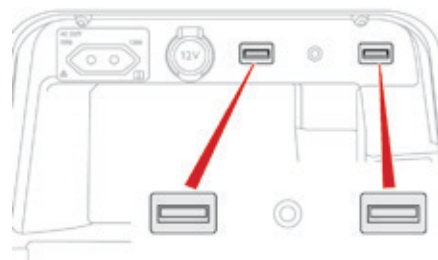

Depending on equipment, one or two USB ports are located in the central storage box. They allow the connection of a portable device or a USB memory stick. They read the audio files which are transmitted to your audio equipment and played via the vehicle's speakers. You can manage these files using the steering mounted or touch screen tablet controls.

For more information on the use of this equipment, refer to the "Audio and telematics" section.

i When a USB port is used, the portable device charges automatically. A message is displayed if the power consumption of the portable device exceeds the current supplied by the vehicle.

! Only the right hand USB port can be used to connect an Apple® player or the "CITROËN MULTICITY CONNECT" connection key.

Mats Fitting

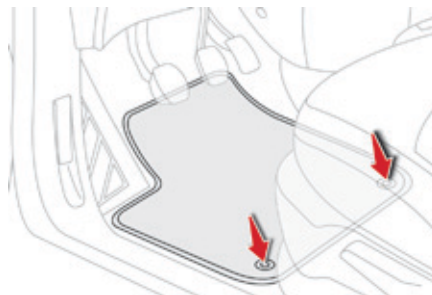

When fitting the mat for the first time, on the driver's side use only the fixings provided in the wallet attached.

The other mats are simply placed on the carpet.

Removal

To remove the mat on the driver's side:

- ☞ move the seat as far back as possible,
- ☞ unclip the fixings,
- ☞ remove the mat.

Refitting

To refit the mat on the driver's side:

- ☞ position the mat correctly,
- ☞ refit the fixings by pressing,
- ☞ check that the mat is secured correctly.

! To avoid any risk of jamming of the pedals:

- only use mats which are suited to the fixings already present in the vehicle; these fixings must be used,
- never fit one mat on top of another.

The use of mats not approved by CITROËN may interfere with access to the pedals and hinder the operation of the cruise control / speed limiter. The mats approved by CITROËN have two fixings located below the seat.

Storage boxes

Depending on equipment, storage boxes are located under the front seats.

Opening

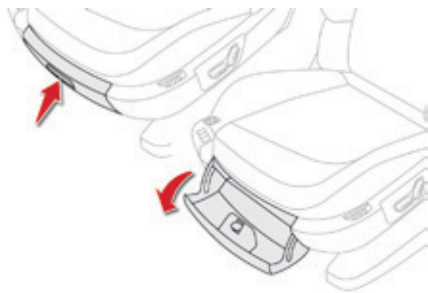

- ☞ Raise the grip and lower the storage box cover.

! Do not place heavy objects in the boxes.

Storage below the steering wheel



This storage compartment below the steering wheel is intended for stowing your vehicle's handbook pack.

Rear fittings

Aircraft-style rear tables



Rear table stowed

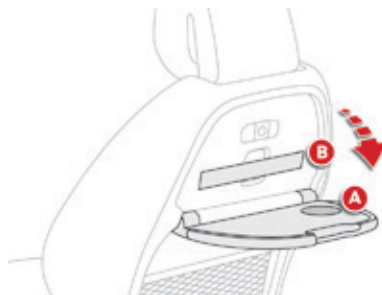

Rear table opened

These tables, fitted to the backs of the front seats, incorporate a cup-holder recess **A** and a retaining strap **B**.

- ☞ Pull the table downwards to open.
- ☞ To stow the table, raise it until the latch locks.

For safety reasons, these tables collapse downwards if excessive pressure is exerted on them.

Individual reading lamps



Reading lamps **C** may be fitted in the front seat backrests, behind the tables. They illuminate the surface of the tables without disturbing the other passengers.

They can be used only while the table is down.

- ☞ Press the "on/off" button to turn the lamp on or off.

Side blinds

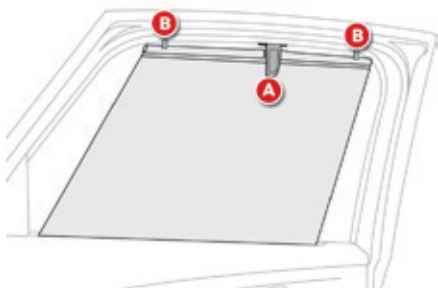

Fitted to the windows for the 2nd row seats, they protect the passenger compartment from the sun's rays.

- ☞ Pull the tab **A** and anchor the blind on the hook **B**.

Storage wells

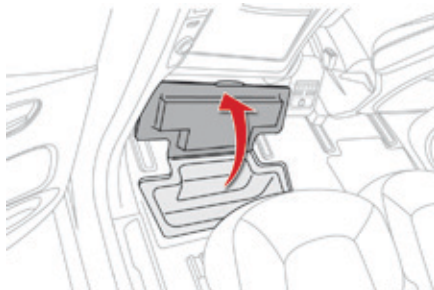

There are two storage wells under the rear passengers' feet.
To open them, lift the cover at the cutout.

12 V accessory socket

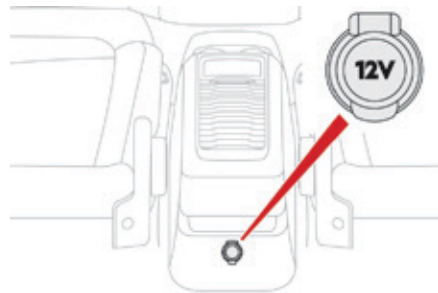

- ☞ To connect a 12 V accessory (maximum power: 120 Watts), lift the cover and connect a suitable adaptor.

! Do not exceed the maximum power rating of the socket (risk of damage to your device).



Rear multimedia



This multimedia system allows rear passengers to connect one or two external portable systems (audio or video player, games consoles, DVD player...). The sound is played through two Bluetooth® wireless headphone sets, while the video content is displayed in two 7-inch screens built into the backs of the front seat head restraints.

i This system operates only with the engine running.

Description

The pack includes:

- the connection and control panel fitted on the rear face of the centre console,
- two 7-inch screens built into the front head restraints (with protective covers),
- two wireless Bluetooth technology headphone sets with rechargeable batteries,
- a 12 V charger with two outlets allowing the simultaneous charging of two headphones.

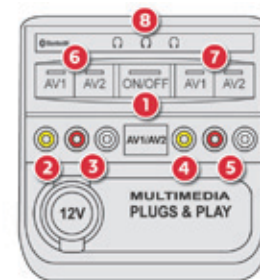

1. Power switch
2. AV1 video input (yellow RCA socket)
3. Stereo audio input A (red and white RCA sockets)
4. AV2 video input (yellow RCA socket)
5. Stereo audio input B (red and white RCA sockets)
6. Selection of display in the left hand screen (AV1 or AV2)
7. Selection of display in the right hand screen (AV1 or AV2)
8. Connection indicator lamps for the Bluetooth audio headphones (blue)



1. Screen power switch
2. Display adjustment buttons



Each headphone set has a switch, a connection indicator lamp (blue) and a channel selector (A or B).

Operation

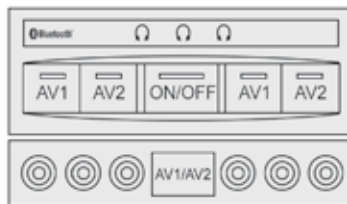

- ☞ With the engine running, connect your portable system to the RCA connectors (e.g. with AV1 on the left).
- ☞ Press the switch on the control panel, the indicator lamp comes on and the AV1 indicator lamps come on.
- ☞ Make a long press on the switch, its indicator lamp flashes in blue.
- ☞ Make a long press on the control panel switch, the pairing with the headphone set is complete when the blue indicator lamps on the headphones and on the system are on continuously.
- ☞ Repeat the operation for the other headphone set.
- ☞ Press the screen switch if you have a video source.
- ☞ Start playing your portable system.

- ☞ It is possible at any time to modify the source for the video display (using button 6 or 7 on the control panel: the indicator lamp for the source selected comes on) as well as the audio channel (using the selector on the headphones).

i The Multimedia system allows the connection of a third Bluetooth headphone set, not supplied.



i If your seat is in the table position, position a cover to avoid damaging the screen. These covers also conceal each screen.



Boot fittings

1. Rear parcel shelf
(see details on a following page)
2. Hooks
(see details on a following page)
3. Torch
(see details on a following page)
4. Storage boxes
(see details on a following page)
5. Storage net
6. Lashing eyes
7. 12 V socket (maximum power: 120 Watts)

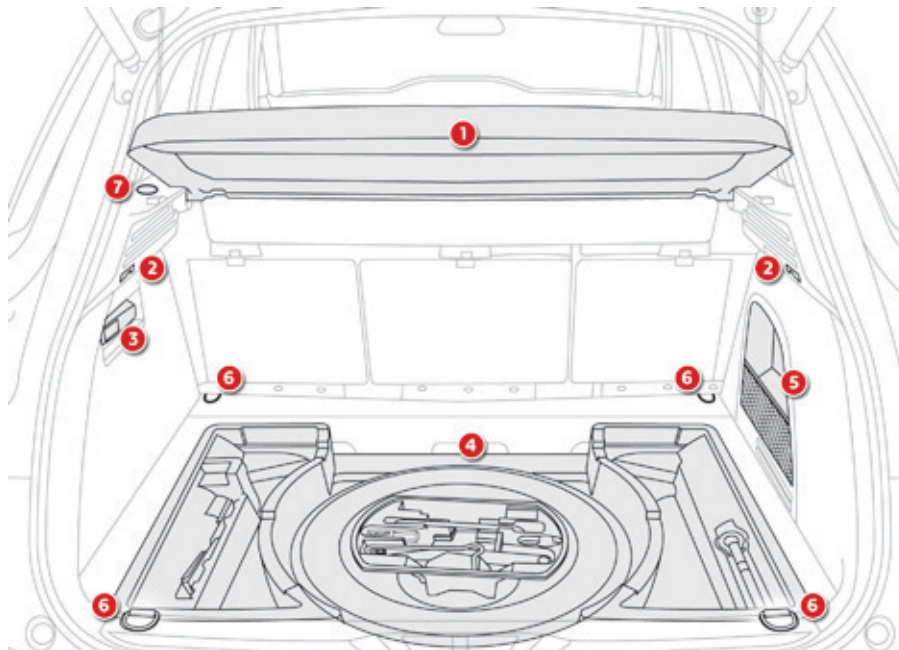

3



Versions with storage boxes: these boxes must be put in place before loading the boot.

Rear parcel shelf

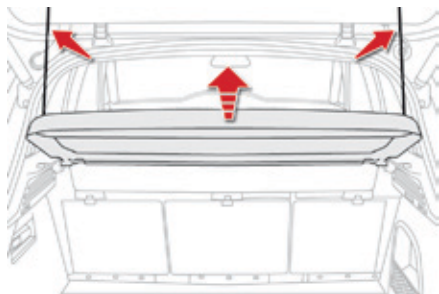

To remove the shelf:

- ☞ unhook the two cords,
- ☞ raise the shelf slightly, then remove it.

There are several options for storing the shelf:

- either upright behind the front seats,
- or flat at the base of the boot.

Hooks

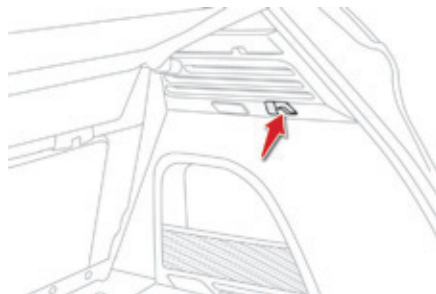

The hooks can be used to secure shopping bags.

Storage boxes

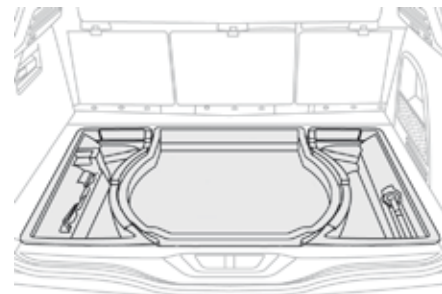

- ☞ Remove the boot carpet for access to the storage boxes.

Depending on the configuration, they are laid out for storing:

- wheel chocks,
- a puncture repair kit,
- two warning triangles,
- ...



Boot fittings

1. Luggage cover blind
(see details on a following page)
2. Torch
3. Concertina boards
4. 12 V socket (maximum power: 120 Watts)
5. Arm rest with cup holder and storage space
6. Retaining straps
7. Location for stowing the luggage cover blind
8. Open storage
9. Lower lashing eyes
10. Upper eyes (fixings for the boot net)

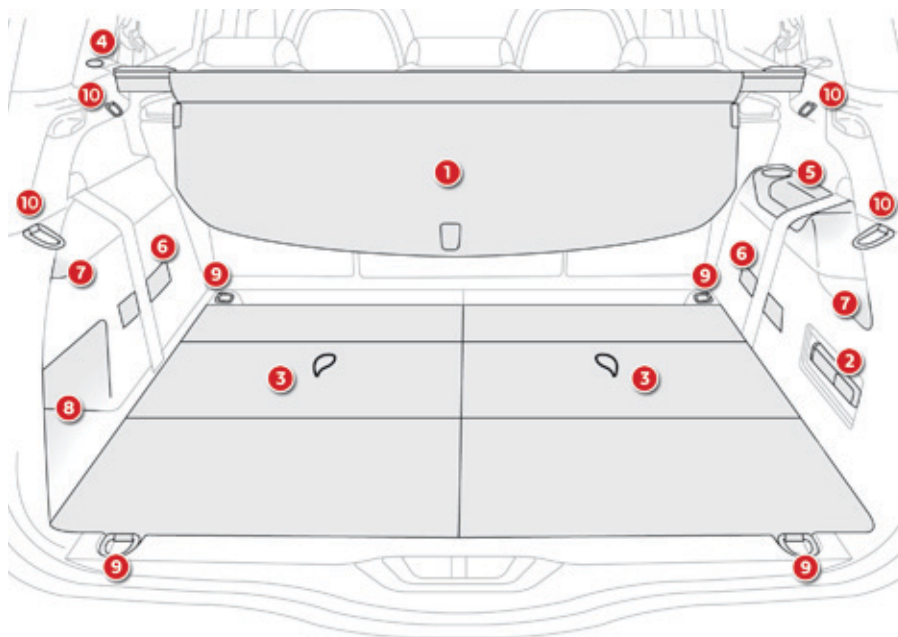

3

! The boot net fixing eyes **10**, located at the level of the parcel shelf, are not intended for lashing loads or securing luggage.



Luggage cover roller

In the 5-seat configuration, it is installed behind the second-row seats, with the third-row seats folded away.

In the 7-seat configuration, it is stowed behind the third row seats.

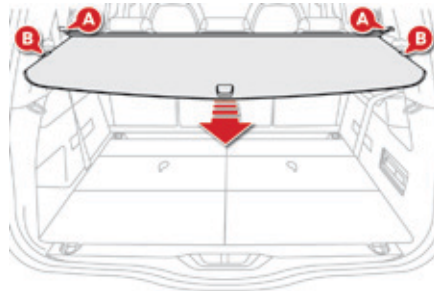

Installation

- ☞ Position the left and right hand ends of the roller in cut-out **A**, with the mobile flap at the front.
- ☞ Pull out the blind until it reaches the boot pillars.
- ☞ Insert the guides of the blind into the rails on the pillars **B**.

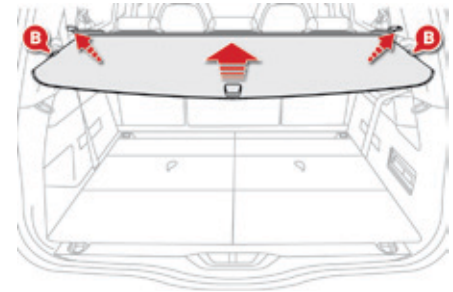

Removal

- ☞ Disengage the roller guides from the rails in the pillars **B**.
- ☞ Guide the blind as it is reeled in.
- ☞ Unlock the roller by pressing one of the grips located at the ends of the reel support.

i The mobile flap allows passengers in the second row to place their seats in the "comfort" position.

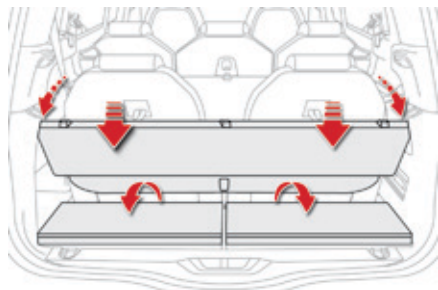

Stowing behind the 3rd row seats

- ☞ Ensure that the 3rd row seats are folded.
- ☞ Fold the first two concertina boards.
- ☞ Install the roller in the space above the arm rest, one side after the other, inclining it slightly.
- ☞ Slide the roller as far as it will go, up to the cut-outs provided at the back of the boot, with the two flaps directed downwards.
- ☞ Unfold the third row seats.

The folded concertina boards can be positioned horizontally or vertically.

To fold the 3rd row seats with the roller stowed at the rear, it is necessary to raise the concertina boards in order to allow access to the seat locking controls (red straps).

Torch

This is a removable lamp, fitted in the side of the boot, which can be used to illuminate the boot or as a torch.

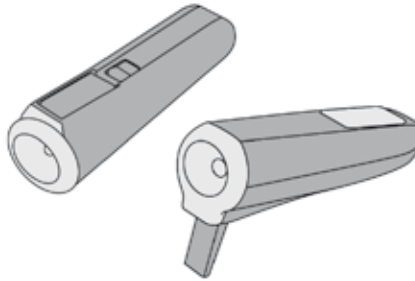
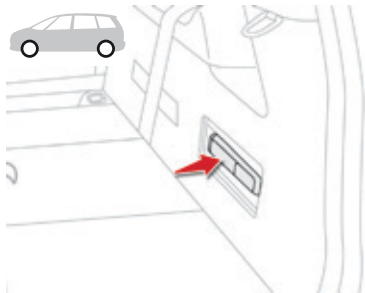
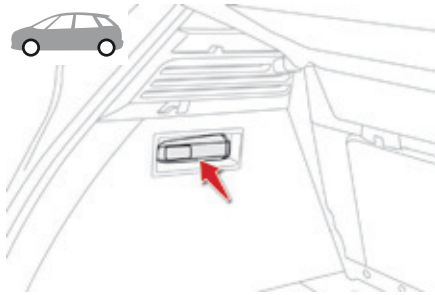

Operation

This torch operates with NiMH type rechargeable batteries.

It has a battery life of approximately 45 minutes and charges while you are driving.

! Observe the polarities when fitting the batteries.
Never replace the rechargeable batteries with single-use batteries.

Use

- ☞ Extract the torch from its location by pulling it from the front.
- ☞ Press the switch, located on the back, to switch the torch on or off.
- ☞ Unfold the support, located on the back, to set down and raise the torch; for example, when changing a wheel.

Storing

- ☞ Put the torch back in place in its location starting with the rear.
If you have forgotten to switch off the torch, this switches it off automatically.

i If the torch is not engaged correctly, it may not charge and may not come on when the boot is opened.

A few driving recommendations

Observe the driving regulations at all times and remain vigilant whatever the traffic conditions. Pay close attention to the traffic and keep your hands on the wheel so that you are ready to react at any time to any eventuality.

On a long journey, a break every two hours is strongly recommended.

In difficult weather, drive smoothly, anticipate the need to brake and increase the distance from other vehicles.

Driving on flooded roads

We strongly advise against driving on flooded roads, as this could cause serious damage to the engine or gearbox, as well as to the electrical systems of your vehicle.

If you are obliged to drive through water:



- check that the depth of water does not exceed 15 cm, taking account of waves that might be generated by other users,
- deactivate the Stop & Start system,
- drive as slowly as possible without stalling. In all cases, do not exceed 6 mph (10 km/h),
- do not stop and do not switch off the engine.

On leaving the flooded road, as soon as circumstances allow, make several light brake applications to dry the brake discs and pads.

If in doubt on the state of your vehicle, contact a CITROËN dealer or a qualified workshop.

Important!

! Never drive with the parking brake applied - Risk of overheating and damage to the braking system!
Do not park or run the engine when stationary in areas where inflammable substances and materials (dry grass, dead leaves...) might come into contact with the hot exhaust system - Risk of fire!

! Never leave a vehicle unsupervised with the engine running. If you have to leave your vehicle with the engine running, apply the parking brake and put the gearbox into neutral or position **N** or **P**, depending on the type of gearbox.

Starting-switching off the engine with the electronic key

Starting the engine

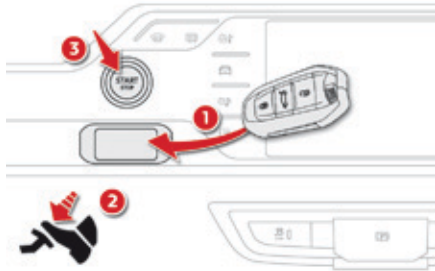

- ☞ Place the gear selector lever at **N** for vehicles with an electronic gearbox, **P** or **N** for vehicles with an automatic gearbox or neutral with a manual gearbox.
- ☞ Insert the electronic key in the reader.
- ☞ Press the brake pedal for vehicles with an electronic or automatic gearbox, or fully declutch for vehicles with a manual gearbox.



- ☞ Briefly press the "**START/STOP**" button. The steering column unlocks and the engine starts more or less immediately (see the advice for Diesel versions).



If one of the starting conditions is not met, a reminder message appears in the instrument panel screen. In some circumstances, it is necessary to turn the steering wheel slightly while pressing the "START/STOP" button to assist unlocking of the steering; a message warns you when this is needed.



For **Diesel vehicles**, in temperatures below zero the engine will not start until the preheater warning lamp has gone off. If this warning lamp comes on after pressing "START/STOP", you should hold the brake or clutch pedal down until the warning lamp goes off and do not press the START/STOP button again.

Switching off the engine

- ☞ Immobilise the vehicle.
- ☞ Place the gear selector lever at **N** for vehicles with an electronic gearbox, **P** or **N** for an automatic gearbox, or neutral with a manual gearbox.



- ☞ Briefly press the "**START/STOP**" button
The engine stops and the steering column locks .

- ☞ Remove the electronic key from the reader.

i If the vehicle is not immobilised, the engine will not stop.

! Switching off the engine leads to a loss of braking assistance.

Emergency stop



In the event of an emergency only, the engine can be switched off without any conditions. To do this, press the "START/STOP" button for about three seconds.

In this case the steering column locks as soon as the vehicle stops.



Electronic key left in the reader

If the electronic key is left in the reader, on opening the driver's door a message appears to warn you.

Starting-switching off the engine with the "Keyless Entry and Starting" system

Starting the engine



- ☞ Place the gear selector lever at **N** for vehicles with an electronic gearbox, **P** or **N** with an automatic gearbox, or neutral with a manual gearbox.
- ☞ With the electronic key inside the vehicle (it is not necessary to put it in the reader), press the brake pedal for vehicles with an electronic or automatic gearbox, or fully declutch for vehicles with a manual gearbox.



- ☞ Briefly press the "**START/STOP**" button.
The steering column unlocks and the engine starts more or less instantly (see the advice for Diesel versions).

- i** If one of the starting conditions is not met, a reminder message appears in the instrument panel screen. In some circumstances, it is necessary to turn the steering wheel slightly while pressing the "START/STOP" button to assist unlocking of the steering; a message warns you when this is needed.

The presence of the "Keyless Entry and Starting" system electronic key in the recognition zone is essential.
For safety reasons, do not leave this zone with the vehicle running.



If the electronic key is not detected in the zone, a message is displayed. Move the electronic key into the zone so that the engine can be started.



For **Diesel vehicles**, in temperatures below zero the engine will not start until the preheater warning lamp has gone off.
If this warning lamp comes on after pressing "START/STOP", you should hold the brake or clutch pedal down until the warning lamp goes off and do not press the START/STOP button again.

Switching off the engine

- ☞ Immobilise the vehicle.
- ☞ Place the gear selector lever at **N** for vehicles with an electronic gearbox, **P** or **N** with an automatic gearbox, or neutral with a manual gearbox.



- ☞ With the electronic key inside the vehicle, press the "**START/STOP**" button. The engine stops and the steering column locks.

i If the vehicle is not immobilised, the engine will not stop.

! Do not leave your vehicle with the electronic key still inside.

! Switching off the engine leads to a loss of braking assistance.

Emergency starting



When the electronic key is in the recognition zone and, after pressing the "START/STOP" button, the engine does not start:

- ☞ Place the gear selector at **N** for vehicles with an electronic gearbox, **P** or **N** for vehicles with an automatic gearbox or neutral for vehicles with a manual gearbox.
- ☞ Insert the electronic key in the reader.
- ☞ Press the brake pedal on vehicles with an electronic or automatic gearbox, or fully declutch with a manual gearbox.
- ☞ Press the "START/STOP" button. The engine starts.

Emergency switch-off



In the event of an emergency only, the engine can be switched off without conditions. To do this, press and hold the "START/STOP" button for about 3 seconds.

In this case the steering column locks as soon as the vehicle stops.

Electronic key not recognised



If the electronic key is no longer in the recognition zone when driving or when you (later) request switching off the engine, a message appears in the instrument panel.



Press and hold the "START/STOP" button for about 3 seconds if you want to force switching off the engine (**note that restarting will not be possible without the key**).

Switching the ignition on (without starting)

With the electronic key in the reader or the Keyless Entry and Starting key inside the vehicle, pressing the "START/STOP" button, **with no action on the pedals**, allows the ignition to be switched on.



☞ Press the "START/STOP" button, the instrument panel comes on but the engine does not start.

☞ Press the button again to switch off the ignition and so allow the vehicle to be locked.



With the ignition on, the system goes into energy economy mode when necessary to maintain the state of charge of the battery.

Anti-theft protection

Electronic engine immobiliser

The keys contain an electronic chip which has a secret code. When the ignition is switched on, this code must be recognised in order for starting to be possible.

This electronic engine immobiliser locks the engine management system a few minutes after the ignition is switched off and prevents starting of the engine by anyone who does not have the key.

In the event of a malfunction, you are informed by a message in the instrument panel screen. In this case, your vehicle does not start; contact a CITROËN dealer as soon as possible.

Electric parking brake



The system provides, in automatic operation, the application of the parking brake on switching off the engine and release as the vehicle moves off.

The driver can take over at any time to apply or release the parking brake, by operating the control lever:

- by briefly **pulling** the control lever to apply the brake,
- by briefly **pushing** the control lever, while pressing the foot brake, to release.

Automatic mode is activated by default.



The technology adopted for the electric parking brake does not allow the fitment of wheels smaller than 16 inches.

Indicator lamp



This indicator lamp comes on in the instrument panel and in the control lever to confirm the application of the parking brake.

It goes off to confirm the release of the parking brake.

The indicator lamp in the control lever flashes during manual application or release.

After the parking brake has been applied, the simultaneous flashing of the two indicator lamps in the instrument panel and the control lever alerts you to the need to fully secure your vehicle by engaging a gear (with a manual or electronic gearbox) or by placing the gear selector in position **P** with an automatic gearbox, or by fitting a chock to one of the wheels. (E.g.: parking on a very steep slope or on a slope with a low battery).



In the event of a battery failure, the electric parking brake no longer works. As a safety measure, if the parking brake is not applied, immobilise the vehicle by engaging a gear (with a manual gearbox) or placing a chock at one of the wheels. Contact a CITROËN dealer or a qualified workshop.



Label on door panel

! Before leaving the vehicle, check that parking brake is applied: the indicator lamps in the instrument panel and the control lever must be on fixed, not flashing.

If the parking brake is not applied, there is an audible signal and a message is displayed on opening the driver's door.

! Never leave a child alone inside the vehicle with the ignition on, as they could release the parking brake.

! When towing, parking on a steep slope, or if your vehicle is heavily laden, turn the wheels towards the kerb and engage a gear (with a manual or electronic gearbox) or place the gear selector in position **P** with an automatic gearbox.

For towing, your vehicle is approved for parking on slopes of up to 12%.

Manual operation

Manual release

With the ignition on or the engine running, to release the parking brake:

- ☞ press the brake pedal,
- ☞ while maintaining pressure on the brake pedal, briefly push the control lever.

The complete release of the parking brake is confirmed by the brake indicator lamp and the **P** indicator lamp in the control lever going off, accompanied by the display of the message "Parking brake released".

i If you push the control lever without pressing the brake pedal, the parking brake will not be released and a message is displayed.

Manual application

With the vehicle stationary: briefly pull the control lever.

Confirmation of the instruction is signaled by flashing of the indicator lamp in the control lever.



Application of the parking brake is confirmed by illumination of the brake indicator lamp and the **P** indicator lamp in the control lever, accompanied by the display of the message "Parking brake applied".

Automatic operation

Automatic release

Ensure first that the engine is running and the driver's door is properly closed.

The electric parking brake **releases automatically and progressively** when you press the accelerator:

- ☞ Manual gearbox: fully depress the clutch pedal, engage 1st or reverse gear; press the accelerator pedal and let up the clutch pedal.
- ☞ Electronic gearbox: select position **A**, **M** or **R** then press the accelerator pedal.
- ☞ Automatic gearbox: select position **D**, **M** or **R** then press the accelerator.

i With an electronic or automatic gearbox, if the brake does not release automatically, check that the front doors are correctly closed.



The complete release of the parking brake is confirmed by the brake indicator lamp and the **P** indicator lamp in the control lever going off, accompanied by the display of the message "Parking brake released".



When stationary with the engine running, do not depress the accelerator pedal unnecessarily, you risk releasing the parking brake.

Automatic application

With the vehicle stationary, the parking brake **is automatically applied when the engine is switched off** by pressing the START/STOP button.



Application of the parking brake is confirmed by illumination of the brake indicator lamp and the **P** indicator lamp in the control lever, accompanied by the display of the message "Parking brake applied".



With the engine stalled or in STOP mode of Stop & Start, automatic application does not take place.



In automatic mode, you can manually apply or release the parking brake using the control lever.

Special cases

In some situations, you may need to operate the parking brake manually.

Immobilisation of the vehicle with the engine running

To immobilise the vehicle with the engine running, briefly pull the control lever.



Application of the parking brake is confirmed by illumination of the brake indicator lamp and the **P** indicator lamp in the control lever, accompanied by the display of the message "Parking brake applied".

Parking the vehicle with the brake released



In very cold conditions, it is recommended that the parking brake not be applied (risk of freezing). To immobilise your vehicle, engage a gear or fit a chock to one of the wheels.

Immobilisation of the vehicle with the parking brake released

- ☞ Switch off the engine.
Illumination of the warning lamps in the instrument panel and control lever confirm application of the parking brake,
- ☞ Switch on the ignition again, without starting the engine.
- ☞ Release the parking brake manually by pushing the control lever while keeping your foot on the brake.



The complete release of the parking brake is confirmed by the brake indicator lamp and the **P** indicator lamp in the control lever going off, accompanied by the display of the message "Parking brake released".

- ☞ Switch off the ignition.

Deactivating automatic operation

In some situations, such as very cold weather or towing (caravan, recovery), it may be necessary to deactivate automatic operation of the system.

- ☞ Start the engine.
- ☞ Apply the parking brake with the control lever, if it is released.
- ☞ Take your foot off the brake pedal.
- ☞ Push and hold the control lever in the release direction for at least 10 seconds and no more than 15 seconds.
- ☞ Release the control lever.
- ☞ Press and hold the brake pedal.
- ☞ Pull the control lever in the apply direction for 2 seconds.



Deactivation of the automatic functions is confirmed by illumination of this indicator lamp in the instrument panel.

- ☞ Release the control lever and the brake pedal.

From this point the parking brake can only be applied and released manually using the control lever.

Repeat this procedure to reactivate automatic operation.

Reactivation of automatic operation is confirmed by the indicator lamp in the instrument panel going off.

Emergency braking



The emergency braking should only be used in an exceptional situation.

In the event of a failure of the main service brake or in an exceptional situation (e.g. driver taken ill, under instruction, etc) a continuous pull on the control lever will brake the vehicle. Braking takes place while the control lever is being pulled. It is interrupted if the control lever is released.

The ABS and DSC systems provide stability of the vehicle during emergency braking.

If the emergency braking malfunctions, the message "Parking brake control faulty" will be displayed.





If a failure of the ABS and DSC systems occurs, signalled by the illumination of one or both warning lamps in the instrument panel, then stability of the vehicle is no longer guaranteed.







In this event, stability must be assured by the driver by repeating alternate "pull-release" actions on the control lever until the vehicle is immobilised.

Operating faults

The various alert situations are described in the table below.

In the event of a fault with the electric parking brake it is recommended that you contact a CITROËN dealer or a qualified workshop without delay.

Situations	Consequences
Display of the message " Parking brake fault " and the following warning lamps: SERVICE	<ul style="list-style-type: none"> - Automatic release is not available. - If you attempt an automatic release, a help message is displayed on acceleration when the parking brake is applied, prompting you to use manual release.
Display of the message " Parking brake fault " and of the following warning lamps: SERVICE 	<ul style="list-style-type: none"> - Secondary braking does not have full power. - If automatic release is not available, a help message is displayed on acceleration when the parking brake is applied, prompting you to use manual release.
Display of the message " Parking brake fault " and of the following warning lamps: SERVICE 	<ul style="list-style-type: none"> - Automatic application is not available: use the control lever. - The electric parking brake can only be used manually. - If automatic release is also not available, a help message is displayed on acceleration when the parking brake is applied, prompting you to use manual release.
Display of the message " Parking brake fault " and of the following warning lamps: SERVICE 	<ul style="list-style-type: none"> - If manual application and release do not work, the control lever is faulty. - The automatic functions must be used in all circumstances: they are automatically reactivated in the event of failure of the control lever. - You can no longer immobilise the vehicle with the engine running.

Situations	Consequences
<p>Display of the message "Parking brake fault" and of the following warning lamps:</p> <p>SERVICE  </p>	<p>The Parking Brake is faulty, the manual and automatic functions may not operate.</p> <p>When stationary, to immobilise your vehicle:</p> <ul style="list-style-type: none"> - Pull and hold the control lever for about 7 to 15 seconds, until the warning lamp comes on in the instrument panel. <p>If this procedure does not work, you should make your vehicle safe:</p> <ul style="list-style-type: none"> - Park on a level surface. - Engage a gear with a manual or electronic gearbox, or place the gear selector in position P with an automatic gearbox. - If possible, fit a wheel chock. <p>Call on a CITROËN dealer or a qualified workshop.</p>
<p>Display of the message "Parking brake fault" and of the following warning lamps:</p> <p>SERVICE   </p>	<ul style="list-style-type: none"> - The parking brake does not have its full performance to securely hold the vehicle in all situations. <p>You should make your vehicle safe:</p> <ul style="list-style-type: none"> - Park on a level surface. - Engage a gear with a manual or electronic gearbox, or place the gear selector in position P with an automatic gearbox. - If possible, fit a wheel chock. <p>Call on a CITROËN dealer or a qualified workshop.</p> <p>The flashing of the P warning lamps on starting the vehicle indicates that the parking brake is not correctly applied.</p> <p>As soon as possible, stop the vehicle and try to completely release the parking brake, using the control lever, with your foot on the brake pedal.</p>
<p>Display of the message "Battery fault" and the following warning lamp:</p> <p></p>	<ul style="list-style-type: none"> - The state of charge of the battery is very low and requires immobilisation of the vehicle in a safe place: engage a gear with a manual gearbox or fit a chock to one of the wheels. - Once the battery is completely discharged, the controls do not operate: to release the parking brake, call on a CITROËN dealer or a qualified workshop.

Hill start assist

System which keeps your vehicle immobilised temporarily (approximately 2 seconds) when starting on a gradient, the time it takes to move your foot from the brake pedal to the accelerator pedal.

This system only operates when:

- the vehicle is completely stationary, with your foot on the brake pedal,
- certain conditions of slope are met,
- with the driver's door closed.

The hill start assist system cannot be deactivated.

Operation

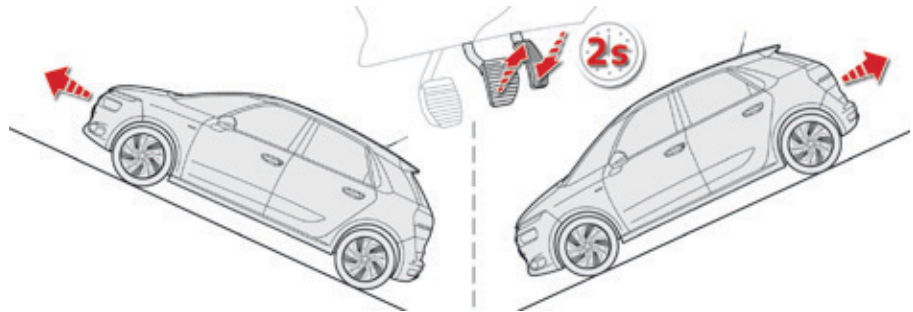

4

! Do not exit the vehicle while it is being held in the hill start assist phase. If you need to exit the vehicle with the engine running, apply the parking brake manually then ensure that the parking brake warning lamp (and the warning lamp **P** in the lever of the electric parking brake) are on fixed (not flashing).

On an ascending slope, with the vehicle stationary, the vehicle is held for a momentarily when you release the brake pedal:

- provided you are in first gear or neutral on a manual gearbox,
- provided you are in position **A** or **M** on an electronic gearbox, **D** or **M** on an automatic gearbox.

On a descending slope, with the vehicle stationary and reverse gear engaged, the vehicle is held momentarily when you release the brake pedal.

Operating fault



SERVICE

If a fault in the system occurs, these warning lamps come on, accompanied by an alert message. Contact a CITROËN dealer or a qualified workshop to have the system checked.

5-speed manual gearbox

Engaging reverse gear

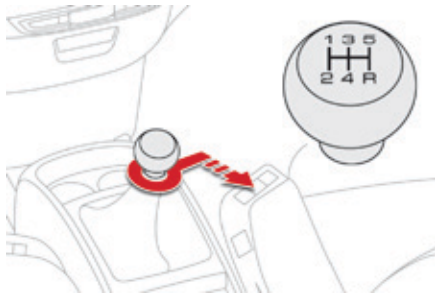

- ☞ With clutch pedal fully down, place the gear lever in neutral.
- ☞ Push the gear lever to the right then backwards.

! Only engage reverse gear when the vehicle is stationary with the engine at idle.

i As a safety precaution and to facilitate starting of the engine:

- always select neutral,
- press the clutch pedal.

6-speed manual gearbox

Engaging 5th or 6th gear

- ☞ Move the lever fully to the right to engage 5th or 6th gear.

! Failure to follow this advice may cause permanent damage to the gearbox (engagement of 3rd or 4th gear by mistake).

Engaging reverse gear

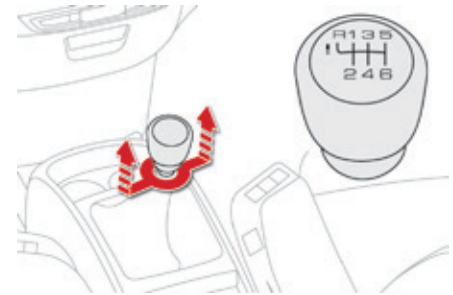

- ☞ Raise the ring under the knob and move the gear lever to the left then forwards.

! Only engage reverse gear when the vehicle is stationary with the engine at idle.

i As a safety precaution and to facilitate starting of the engine:

- always select neutral,
- press the clutch pedal.

Electronic gearbox (ETG6)

Electronically controlled gearbox which offers a choice between the comfort of fully automatic operation and manual gear changing.

There are two driving modes:

- **automated** mode for automatic control of the gears by the gearbox, without any action on the part of the driver
- **manual** mode for sequential gear changing by the driver using the steering mounted paddles.

In automated mode, you can temporarily take over control of gear changing.

Gear selector lever



- R.** Reverse
 - ☞ With your foot on the brake, move the selector lever.
- N.** Neutral.
 - ☞ With your foot on the brake, select this position to start the engine.
- A.** Automated mode.
 - ☞ Move the selector lever to position **A** to select this mode.
- M.** Manual mode with sequential manual gear changing.
 - ☞ Move the selector lever to position **M** to select this mode, then use the steering mounted control paddles to change gear.

Steering mounted control paddles

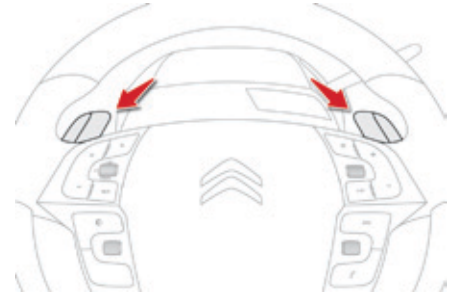

- +** Change up paddle to the right of the steering wheel.
 - ☞ Pull the "+" steering mounted paddle towards you to change up a gear.
- Change down paddle to the left of the steering wheel.
 - ☞ Pull the "-" steering mounted paddle towards you to change down a gear.

i The steering mounted paddles cannot be used to select neutral or to engage or disengage reverse gear.

Displays in the instrument panel

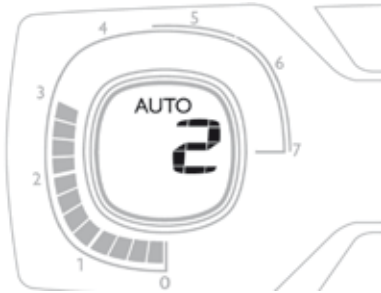

N. Neutral

R. Reverse

M. (and gear engaged) Manual mode.

AUTO or A. Automated mode.

Moving off

- ☞ Select position **N**.
- ☞ Press the brake pedal down fully.
- ☞ Start the engine.

N appears in the instrument panel screen.

i **If the engine does not start:**
If **N** flashes in the instrument panel, accompanied by an audible signal and a message, move the selector lever to position **A** then to position **N**.



If the **Foot on brake** warning lamp comes on the instrument panel, accompanied by an audible signal and a message "Foot on brake", press the brake pedal firmly.

- ☞ Select automated mode (position **A**) or manual mode (position **M**) or reverse (position **R**).
- ☞ Release the parking brake by pulling the control lever, if automatic operation has been deactivated.
- ☞ Progressively take your foot off the brake pedal.
- ☞ If the parking brake is released, the vehicle moves off.
If the parking brake is applied and the automatic mode is activated, accelerate progressively.

! If the brake does not release automatically, check that the front doors are correctly closed.



A or AUTO and **1, 1 or R** is displayed in the instrument panel.

Automated mode

☞ Select position **A**.



AUTO or **A** and the gear engaged is displayed in the instrument panel.

The gearbox operates in auto-active mode, without any action on the part of the driver. It continuously selects the most suitable gear for:

- optimisation of fuel consumption,
- the style of driving,
- the profile of the road.
- the vehicle load.

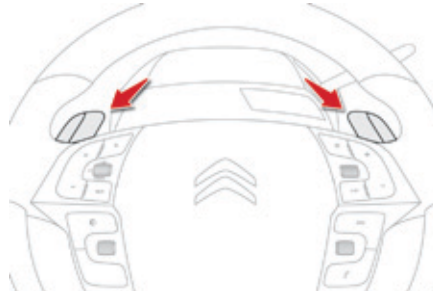

Temporary control of gear changing

You can temporarily take over control of gear changing using the "+" and "-" steering mounted paddles. If the engine speed allows, the instruction to change gear is acted on. This function allows you to anticipate certain situations such as overtaking a vehicle or the approach to a corner. After a few moments without any action on the control paddles, the gearbox resumes automatic control of the gears.

Manual mode

☞ Select position **M**.

The gears engaged are displayed in succession in the instrument panel.

The gear change requests are only acted on if the engine speed permits.

It is not necessary to release the accelerator during gear changes.

When braking or slowing down, the gearbox changes down automatically to allow the vehicle to accelerate in the correct gear.

On sharp acceleration, the gearbox will not change up unless the driver acts on the steering mounted paddles.

You can change mode at any time by moving the selector lever from **A** to **M** or the other way round.

Never select neutral **N** when driving.

i For optimum acceleration, for example when overtaking another vehicle, press the accelerator pedal firmly past the point of resistance.

Never select neutral **N** when driving.

Reverse

To engage reverse gear **R**, the vehicle must be immobilised with your foot on the brake pedal.

☞ Select position **R**.

Engagement of reverse gear is accompanied by an audible signal.

At low speed, if reverse gear is requested, the **N** indicator flashes and the gearbox goes into neutral automatically. To engage reverse, put the selector lever in position **N**, then position **R**.

Stopping the vehicle

Before switching off the engine, you can:

- move to position **N** to engage neutral, or
- leave the gear engaged; in this case, it will not be possible to move the vehicle.

In both cases, if automatic operation of the electric parking brake has been deactivated, you must **apply the parking brake** by pulling the control lever.

! When immobilising the vehicle, with the engine running, you must place the selector lever in neutral **N**.
Before carrying out any work in the engine compartment, ensure that the selector lever is in neutral **N** and that the parking brake is applied.
Whatever the circumstances, you must manually apply the parking brake when parking, if automatic operation has been deactivated.

i In the event of a battery failure, use the chock to immobilise the vehicle.

Operating fault

With the ignition on, the flashing of **A** or **AUTO**, accompanied by an audible signal and a message, indicates a malfunction of the gearbox.

Have it checked by a CITROËN dealer or a qualified workshop.

Automatic gearbox

This gearbox offers two driving modes.

- **automated** mode for automatic management of the gears by the gearbox, without any action on the part of the driver,
- **manual** mode for sequential gear changing by the driver using the steering mounted paddles.

i It is possible to change from one mode to the other at any time. With the automated mode, you can temporarily take control of the gear changes at any time.

Gear selector lever



- P.** Park.
- Immobilisation of the vehicle, parking brake applied or released.
 - Starting the engine.
- R.** Reverse.
- Reversing, vehicle stationary and engine at idle.
- N.** Neutral.
- Immobilisation of the vehicle, parking brake applied.
 - Starting the engine.
- D.** Automatic operation.
- M.** Manual operation with sequential changing of the six gears.

i To come out of position **P**, move the gear selector to the right to the desired position, while keeping your foot on the brake pedal.

i To select position **P**, move the gear selector to the highest position (towards **R**), then push it forwards and then to the left. Only engage it when the vehicle is at a complete stop. In this position, the front wheels are locked. Ensure that the gear selector is correctly positioned.

i To move the gear selector, switch on the ignition or start the engine. If the battery is not sufficiently charged, it is not possible to move the gear selector.

Steering mounted control paddles

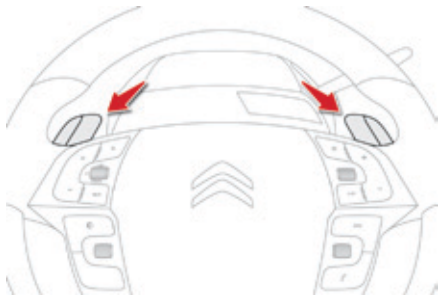

- + Control paddle for changing up, to the right of the steering wheel.
- ☞ Pull the "+" paddle towards you to change up.
- Control paddle for changing down, to the left of the steering wheel.
- ☞ Pull the "-" paddle towards you to change down.

i The steering mounted control paddles cannot be used to select neutral or to select or come out of reverse.

Displays in the instrument panel



When you move the gear selector, the symbol corresponding to its position is displayed in the instrument panel.

- P.** Park.
- R.** Reverse.
- N.** Neutral.
- D.** Drive (automatic operation).
- 1 to 6.** Gears engaged in manual operation.
- Invalid value in manual operation.

Moving off

- ☞ With your foot on the brake pedal, select position **P** or **N**.
- ☞ Start the engine.

i If these conditions are not met, there is an audible signal accompanied by a message.

i If **P** is displayed in the instrument panel, although the gear selector is in another position, place the gear selector in position **P** to be able to start the engine.

- ☞ With the engine running, press the brake pedal.
- ☞ Select automated mode (position **D**), manual mode (position **M**) or reverse (position **R**).

i  If you do not press the brake pedal to come out of position **P**, this warning lamp or symbol appears in the instrument panel, accompanied by the message "Place automatic gearbox in position **P**", flashing of **P** in the instrument panel and an audible signal.

- ☞ Check that the symbol displayed in the instrument panel agrees with the position of the selector.
- ☞ Progressively release the brake pedal.
- ☞ If the parking brake is release, the vehicle moves off.
If the parking brake is applied and automatic operation is activated, accelerate away.

! If the brake does not release automatically, check that the front doors are correctly closed.

! Never press the accelerator and brake pedals at the same time. Braking and acceleration should be done only with the right foot. Pressing both pedals together risks damaging the gearbox.

i When the engine is running at idle, brakes releases, if position **R**, **D** or **M** is selected, the vehicle will move even if the accelerator is not pressed.

! Never leave children unsupervised in the vehicle when the engine is running. When carrying out a maintenance operation with the engine running, apply the parking brake and select position **P**.

i Never select position **N** when driving. If position **N** is engaged in error when moving, allow the engine to idle, then engage position **D** to accelerate.

i Never select position **P** or **R** unless the vehicle is a a complete stop with the brake applied. When you want to engage reverse, to avoid jolts, do not accelerate immediately after engaging **R**. Changing into position **R** is accompanied by an audible signal.

Automated mode



Select position **D**.

D and the gear engaged are displayed in the instrument panel.

The gearbox operates in auto-active mode, without any action from the driver. It continuously selects the most appropriate gear according to the following conditions:

- optimisation of fuel consumption,
- driving style,
- relief of the road,
- vehicle load.

For maximum acceleration, without touching the gear selector, press the accelerator fully down (kick down). The gearbox changes down automatically and maintains the gear selected until the maximum engine speed is reached.

When braking, the gearbox changes down automatically for more effective engine braking.

When you take your foot of the accelerator pedal suddenly, the gearbox does not change up, so as to improve safety.

Temporary manual control of the gears

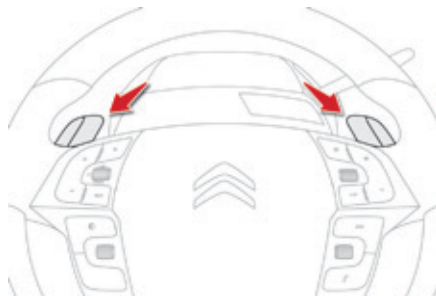

You can temporarily take control of gear changes using the "+" and "-" steering mounted control paddles. If the engine speed allows, the instruction to change gear is acted on.

This function allows you to anticipate certain situations such as overtaking another vehicle or approaching a bend.

After a few moments with no action on the control paddles, the gearbox manages the gears automatically again.

Manual mode

- ☞ Select position **M**.
- ☞ Use the "+" and "-" steering mounted control paddles to change gear.

The gears engaged are displayed successively in the instrument panel.

When stationary or at very low speed, the gearbox automatically engages **1st** gear. In manual mode, it is not necessary to release the accelerator pedal when changing gear.

The change from one gear to another is only effected if the conditions of vehicle speed and engine speed allow; otherwise the automatic laws of operation are imposed temporarily.

If the engine speed is too high or too low, the display of the gear selected flashes for a few seconds, then the new gear engaged is displayed.

Invalid value in manual operation



This symbol is displayed if a gear is not engaged correctly (gear selector between two positions).



It is possible to change mode at any time, by moving the gear selector from **D** to **M** or the other way round.

Parking the vehicle

Before switching off the engine, you can change to position **P** or **N** to be in neutral. In either case, apply the parking brake to immobilise the vehicle, unless it is programmed in automatic mode.

If the lever is not in position **P**, on opening the driver's door or approximately 45 seconds after switching off the ignition there is an audible signal and a message appears:

- ☞ move the gear selector to position **P**; the audible signal stops and the message disappears.

Whenever parking, you must apply the parking brake to immobilise the vehicle, if automatic operation has been deactivated.

i In all circumstances, ensure that the gear selector is in position **P** before leaving your vehicle.

i In the event of a battery failure, use the chock to immobilise the vehicle.

Operating fault

SERVICE In the event of a fault with the gearbox, the service warning lamp comes on in the instrument panel, accompanied by a message and an audible signal.

In this case the gearbox goes into back-up mode and stays in 3rd gear. You may then feel a noticeable jolt when going from **P** to **R** and from **N** to **R**. This jolt does not present any risk to the gearbox.

Do not exceed 60 mph (100 km/h) while also observing legal speed limits.

Have it checked by a CITROËN dealer or a qualified workshop.

Gear shift indicator

System which reduces fuel consumption by recommending the most suitable gear.

With an electronic or automatic gearbox, the system is only active in manual mode.

Operation

Depending on the driving situation and your vehicle's equipment, the system may advise you to skip one or more gears.

You can follow this instruction without going through the intermediate gears.

On BlueHDi Diesel 135 and 150 versions with manual gearbox, in certain driving conditions the system may suggest changing into neutral so that the engine can go into standby (STOP mode with Stop & Start). In this case, **N** is displayed in the instrument panel.

The gear engagement recommendations must not be considered compulsory.

This is because the configuration of the road, traffic density and safety remain important factors in the choice of the best gear.

The gear shift indicator system does not replace the need for vigilance on the part of the driver.

Example:

- You are in third gear.
- You press the accelerator pedal.
- The system may suggest that you engage a higher gear.

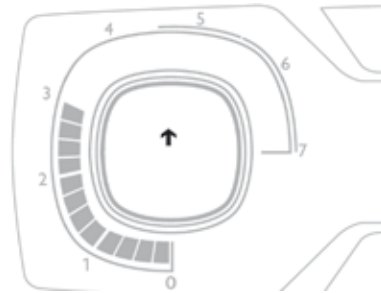

The information appears in the instrument panel in the form of an arrow.

On vehicles with manual gearbox, the arrow can be accompanied by the recommended gear.

i The system adapts its gear change recommendation according to the driving conditions (slope, load, ...) and the demands of the driver (power, acceleration, braking, ...).
The system never suggests:

- engaging first gear,
- engaging reverse gear,

i This function cannot be deactivated.

Stop & Start

Perfect for urban use, the Stop & Start system reduces fuel consumption and exhaust emissions as well as the noise level when stationary.

The Stop & Start system puts the engine temporarily into standby - STOP mode - during stops in the traffic (red lights, traffic jams, or other...). The engine restarts automatically - START mode - as soon as you want to move off. The restart takes place instantly, quickly and silently.

Operation

ECO Going into engine STOP mode

The "ECO" warning lamp comes on in the instrument panel and the engine goes into standby automatically:

- **with a manual gearbox**, at speeds below 12 mph (20 km/h), or vehicle stationary (with PureTech 130, THP 165 and BlueHDi 100, 115 and 120 versions), when you place the gear lever in neutral, and you release the clutch pedal,
- **with an ETG6 electronic gearbox**, at speeds below 5 mph (8 km/h), when you press the brake pedal or place the gear selector lever in position **N**,
- **with an automatic gearbox**, with the vehicle stationary, when you press the brake pedal or place the gear selector lever in position **N**.

If your vehicle is fitted with the system, a time counter calculates the sum of the periods in STOP mode during a journey. It resets itself to zero every time the ignition is switched on with the START/STOP button.

i For your comfort, during parking manoeuvres, STOP mode is not available for a few seconds after coming out of reverse gear. STOP mode does not affect the functionality of the vehicle, such as for example, braking, power steering...

! Never refuel with the engine in STOP mode; you must switch off the ignition with the START/STOP button.

Special cases: STOP mode not available

STOP mode is not invoked when:

- the driver's door is open,
- the driver's seat belt is not fastened,
- the vehicle has not exceeded 6 mph (10 km/h) since the last engine start using the START/STOP button,
- the electric parking brake is applied or being applied,
- the engine is needed to maintain a comfortable temperature in the passenger compartment,
- demisting is active,
- some special conditions (battery charge, engine temperature, braking assistance, ambient temperature...) where the engine is needed to assure control of a system.

ECO In this case, the "ECO" warning lamp flashes for a few seconds then goes off.

This operation is perfectly normal.

Going into engine START mode

ECO The "ECO" warning lamp goes off and the engine starts automatically:

- **with a manual gearbox**, when you **fully** depress the clutch pedal,
- **with an ETG6 electronic gearbox**:
 - gear selector lever in position **A** or **M**, when you release the brake pedal,
 - or gear selector lever in position **N** and the brake pedal released, when you place the gear selector lever in position **A** or **M**,
 - or when you engage reverse gear.
- **with an automatic gearbox**:
 - gear selector in position **D** or **M**, when you release the brake pedal,
 - or gear selector in position **N** and brake pedal released, when you place the gear selector in position **D** or **M**,
 - or when you engage reverse.

Special cases: START invoked automatically

START mode is invoked automatically when:

- you open the the driver's door,
- you unfasten the driver's seat belt,
- the speed of the vehicle exceeds 15 mph (25 km/h) with a manual gearbox (2 mph (3 km/h) with PureTech 130, THP 165 and BlueHDi 100, 115 and 120 versions), 7 mph (11 km/h) with an ETG6 gearbox and 2 mph (3 km/h) with an automatic gearbox,
- the electric parking brake is being applied,
- some special conditions (battery charge, engine temperature, braking assistance, ambient temperature...) where the engine is needed for control of a system.

ECO In this case the "ECO" warning lamp flashes for a few seconds, then goes off.

This operation is perfectly normal.

Deactivation

Deactivation of Stop & Start is done in the "Driving assistance" menu.

ECO OFF Press this button to deactivate the system.

ECO OFF This is confirmed by the indicator lamp in the button and this symbol.

i If the system has been deactivated in STOP mode, the engine restarts immediately.

! When driving on a flooded road, it is recommended that the Stop & Start function be deactivated and that you drive very slowly.

Reactivation

ECO
OFF

Press this button again.

ECO

The system is active again; this is confirmed by the indicator lamp in the button going off and illumination of this symbol.

i

The system is reactivated automatically every time the engine is started by the driver.

Operating fault

—
ECO
OFF!

In the event of a fault with the system, the symbol for the button changes to alert mode and the warning lamp flashes for a few moments then comes on continuously.

Have it checked by a CITROËN dealer or a qualified workshop.

In the event of a fault in STOP mode, the vehicle may stall.

All of the instrument panel warning lamps come on. Depending on version, an alert message may also be displayed, asking you to place the gear selector lever on position **N** and put your foot on the brake pedal.

It is then necessary to switch off the ignition and start the engine again using the "START/STOP" button.

!

Before doing anything under the bonnet, deactivate the Stop & Start system to avoid any risk of injury resulting from automatic operation of START mode.

Maintenance

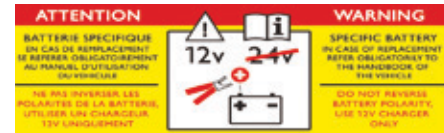

This system requires a 12 V battery with a special specification and technology (reference numbers available from CITROËN dealers). Fitting a battery not listed by CITROËN introduces the risk of malfunction of the system.

For charging, use a 12 V charger and do not reverse the polarity.

!

The Stop & Start system makes use of advanced technology. For any work on the system go to a qualified workshop with the skills and equipment required, which a CITROËN dealer is able to provide.

4

Display of inter-vehicle time

Using a radar located at the front of the vehicle, this system helps the driver maintain a safe distance between their vehicle and the one in front, by displaying the current inter-vehicle time in the instrument panel.

It is the time interval, expressed in seconds, that separates two vehicles in line. The recommended safe value is about 2 seconds: refer to the legislation or highway code in force in your country.

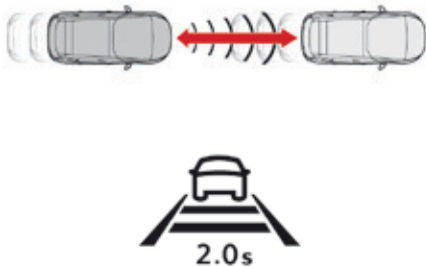

i The system is active in a speed range between 42 and 93 mph (70 and 150 km/h). Stationary vehicles and certain other road users (such as bicycles for example) are not detected. The system displays inter-vehicle time values of between 3 seconds and 0.5 of a second. Below 0.5 of a second, the value displayed is maintained at this level, even if the true inter-vehicle time is less.

! The measurement is displayed for information only: the system takes no action on the vehicle. This system does not in any circumstances replace the need for vigilance on the part of the driver who must remain in control of the vehicle at all times. The system is not designed for urban use nor for more dynamic driving (bends, acceleration, harsh braking...) but rather when driving at a steady speed.



Conditions for display



i The system is only available with the "DRIVING" display mode of the type 2 instrument panel.

i The active cruise control must not be selected (the active cruise control information is displayed instead of that for the inter-vehicle time).

Displays

Once the speed conditions are met, a symbol is displayed in the instrument panel.

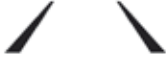
Symbol	Associated message	Comments
		No vehicle detected by the radar.
		A vehicle is detected but the inter-vehicle time is more than 3 seconds. No value is displayed.
		A vehicle is detected. The inter-vehicle time is 3 seconds or less. The minimum value displayed is 0.5 seconds, even if the true inter-vehicle time is lower.

Symbol	Associated message	Comments
 <i>System inaktiv! Geschwindigkeit</i>	"SYSTEM INACTIVE: Speed unsuitable"	If the speed of your vehicle is outside the operating range. Where the speed is not suitable, a message is displayed while the speed is outside limits (below 42 mph (70 km/h) or above 93 mph (150 km/h), approximately). However, when decelerating, the system is deactivated below 27 mph (45 km/h).
	"SYSTEM INACTIVE: Visibility reduced"	The system switches to standby automatically if the sensor does not detect the vehicle in front correctly (very difficult weather conditions, sensor out of adjustment, ...).

Operating limits

The vehicle being followed may not be detected in certain conditions such as, for example:

- when turning,
- when changing lane,
- when the vehicle in front is out of the range of the sensor (maximum range: around 100 m).

Operating fault

SERVICE

In the event of a fault with the system, this warning lamp is displayed accompanied by a message.

Have the system checked by a CITROËN dealer or a qualified workshop.



At the first use of the system after repair, a message may be displayed indicating that the system is initialising. The system is not available while this is in progress. As soon as the message disappears the system is operational again. If the message does not disappear, contact a CITROËN dealer or a qualified workshop.



The operation of the radar, located in the front bumper, may be disturbed by accumulations of grime (dust, mud...) or in certain weather conditions (snow, ice...).

The message "SYSTEM INACTIVE: Visibility reduced" is displayed to signal that the system has been put into standby.

Clean the front bumper regularly.

Memorising speeds

This function allows speeds to be saved, which can then be offered to set the two systems: the speed limiter (to limit the speed of the vehicle) or the cruise control (for a vehicle cruising speed).

You can memorise up to six speed settings for each of the two systems. By default, some speed settings are already memorised.

Memorising

This function is accessible in the touch screen tablet.



- Select the "Driving assistance" menu.

- In the secondary page, press "Speed settings".



- Select the system for which you want to memorise new speed settings:



- speed limiter

or



- cruise control.

- Press the button corresponding to the speed setting you want to modify.



- Enter the new value using the numerical keypad and confirm.
- Confirm to save the modification and quit the menu.

! For safety reasons, the driver must carry out these operations when stationary.



This button allows you to restore the factory settings.

Speed limiter "LIMIT"

System which prevents the vehicle from exceeding the speed programmed by the driver.

Once the programmed speed limit is reached, additional pressure on the accelerator pedal has no effect.

Switching on the speed limiter requires a programmed speed of at least 20 mph (30 km/h).

The speed limiter is **paused** by operation of the control.

The programmed speed can be exceeded temporarily by pressing the accelerator firmly beyond the point of resistance.

To return to the programmed speed, simply release the accelerator pedal until the vehicle returns to the programmed speed limit.

i The programmed speed remains in the memory when the ignition is switched off.

! The speed limiter cannot, in any circumstances, replace the need to observe speed limits, nor can it replace the need for vigilance on the part of the driver.

Steering mounted controls

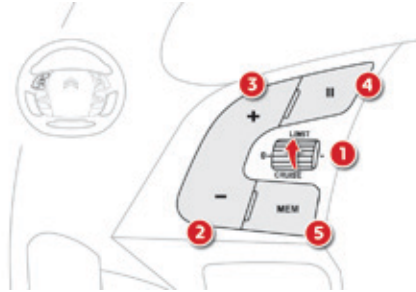

1. Select speed limiter mode.
2. Decrease programmed speed.
3. Increase programmed speed.
4. Speed limiter on / pause.
5. Display the list of memorised speeds.

For more information on the list of memorised speeds, refer to the "Memorising speeds" section.

Displays in the instrument panel

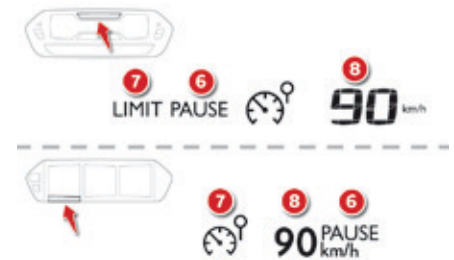

6. Speed limiter on / pause indication.
7. Speed limiter mode selection indication.
8. Speed value setting.

4

Switching on / Pause

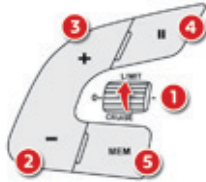

- ☞ Turn thumb wheel 1 to the "**LIMIT**" position: the speed limiter mode is selected but is not switched on (Pause).
- ☞ Switch the speed limiter back on by pressing button 4, if the speed displayed is suitable (by default, the last speed programmed).
- ☞ You can temporarily stop the the speed limiter by pressing button 4 again: the display confirms that it has been stopped (Pause).

Adjusting the speed limiter setting



- You do not have to switch the speed limiter on in order to set the speed. Once the function is selected, you can modify the speed setting by:
- pressing button 5:
 - ☞ the six speeds by memorised are displayed in the touch screen tablet,
 - ☞ press the button corresponding to the speed limit chosen
- The value is displayed in the instrument panel. The selection screen closes after a few moments.

- using buttons 2 and 3, increasing or decreasing the speed displayed:
 - ☞ by successive short presses, to modify by + or - ½ mph (1 km/h),
 - ☞ by a maintained press, to modify in steps of + or - 3 mph (5 km/h).

Temporarily exceeding the programmed speed

- ☞ Press **firmly** on the accelerator pedal, going beyond the **point of resistance**, to exceed the programmed speed limit.

The speed limiter is deactivated temporarily and the displayed programmed speed flashes. An audible signal accompanies the flashing of the programmed speed when exceeding the speed is not due to an action by the driver (steep hill...).

As soon as the vehicle's speed returns to the programmed value, the limiter operates again: the display of the programmed speed becomes steady again.

Switching off

- ☞ Turn wheel **1** to the "**0**" position. The display of information related to the speed limiter disappears.

Operating fault

Flashing of the dashes indicates a fault with the speed limiter.

Have it checked by a CITROËN dealer or a qualified workshop.



! On sharp acceleration, as when descending a steep hill, the speed limiter will not be able to prevent the vehicle from exceeding the programmed speed. The limiter is temporarily deactivated and the displayed programmed speed flashes.

An audible signal accompanies the flashing of the programmed speed when exceeding the speed is not due to an action by the driver.

The use of mats not approved by CITROËN may interfere with the operation of the speed limiter.

To avoid any risk of jamming of the pedals:

- ensure that the mat is secured correctly,
- do not fit one mat on top of another.

Cruise control "CRUISE"

System which automatically maintains the speed of the vehicle at the value programmed by the driver, without any action on the accelerator pedal.

Switching on the cruise control requires a minimum vehicle speed of 25 mph (40 km/h).

As well as engagement of:

- fourth gear or higher on a manual gearbox,
- second gear or higher in manual mode on an electronic or automatic gearbox,
- position **A** on an electronic gearbox or **D** on an automatic gearbox.

The cruise control is **paused** manually or by pressing the brake or clutch pedal or on triggering of the ESP system for safety reasons.

It is possible to exceed the programmed speed temporarily by pressing the accelerator pedal. To return to the programmed speed, simply release the accelerator pedal until the programmed cruise speed is reached again.

Steering mounted controls

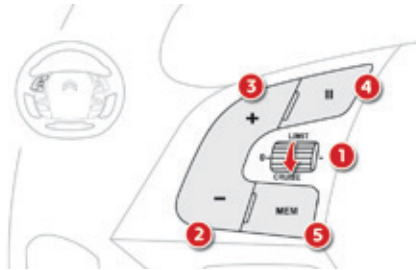

1. Select cruise control mode.
2. Activate the cruise control at the current speed of the vehicle, then **decrease** the programmed speed.
3. Activate the cruise control at the current speed of the vehicle, then **increase** the programmed speed.
4. Pause / resume cruise control.
5. Display the list of memorised speeds.

Displays in the instrument panel

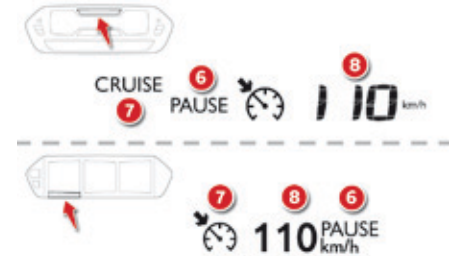

6. Cruise control pause / resume indication.
7. Cruise control mode selection indication.
8. Speed value setting.

i Switching off the ignition cancels any programmed speed value.

For more information on the list of memorised speeds, refer to "Memorising speeds" section.

! The cruise control system cannot, in any circumstances, replace the need to observe speed limits, nor can it replace the need for vigilance on the part of the driver. You are advised to keep your feet near the pedals at all times.

Switching on

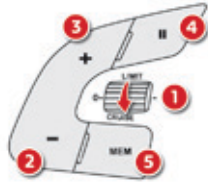

- ☞ Turn thumb wheel **1** to the "CRUISE" position: the cruise control mode is selected but is not switched on (Pause).
- ☞ Press button **2** or **3**: your vehicle's current speed becomes the cruise speed. The cruise control is activated (ON).



Modification of the cruise speed (speed setting)

Once the cruise control is switched on, you can modify the cruising speed in one of the following ways:

- by pressing button **5**:
 - ☞ the six memorised speeds are displayed in the touch screen tablet,
 - ☞ press the button for the speed setting of your choice. The value is then displayed in the instrument panel. The selection screen closes after a few moments. The modification is then accepted.

- using buttons **2** or **3**:
 - ☞ by successive short presses, to modify the speed by + or - 1 mph (km/h),
 - ☞ by a long press, to modify the speed in steps of + or - 5 mph (km/h),

Pause

You can pause the cruise control at any time by pressing button **4**: the screen confirms the pause.

Exceeding the programmed speed

If the cruise speed setting is exceeded, the displayed speed flashes.
The display becomes steady again once the vehicle returns to the cruise speed setting.

Switching off

- ☞ Turn thumb wheel **1** to the "**0**" position.
The display of information related to the cruise control disappears.

Operating fault

Flashing of the dashes indicates a fault with the cruise control.
Have it checked by a CITROËN dealer or a qualified workshop.



- ! When the cruise control is switched on, be careful if you maintain the pressure on one of the programmed speed changing buttons: this may result in a very rapid change in the speed of your vehicle.
Do not use the cruise control on slippery roads or in heavy traffic.
On a steep descent, the cruise control will not be able to prevent the vehicle from exceeding the programmed speed.
On steep climbs or when towing, the programmed speed may not be reached or maintained.
The use of mats not approved by CITROËN may interfere with the operation of the cruise control.
To avoid any risk of jamming of the pedals:
 - ensure that the mat is secured correctly,
 - never fit one mat on top of another.

Active cruise control

This systems allows, in addition to maintaining your vehicle's speed at a value that you have defined, the inter-vehicle time you have selected between your vehicle and the one ahead to be maintained.

Choice of the type of cruise control

If you want to use the standard cruise control, it is possible to **deactivate** the **active** cruise control in the the touch screen tablet.



- ☞ Place the cruise control thumb wheel at "CRUISE".



- ☞ In the "**Driving assistance**" menu, press this button; its indicator lamp goes off.

The standard cruise control is available.



This is confirmed by the display of this symbol in the control.



Refer to the previous section for the details of the operation of the standard cruise control.



You can return to the **active** cruise control at any time by pressing this button again.

Principles of operation

Using a radar with a range of about 100 metres, located at the front of the vehicle, this system detects a vehicle running in front of your vehicle.

It automatically adapts the speed of the vehicle to that of the vehicle in front.

If the vehicle in front is running more slowly, the system progressively reduces the speed of your vehicle using just engine braking (as if the driver had pressed the "-" button).

If your vehicle is too close to or approaching too quickly the vehicle in front, the cruise control is automatically deactivated. The driver is then alerted by an audible signal, accompanied by a message.

If the vehicle in front accelerates or changes lane, the active cruise control progressively accelerates your vehicle to return to the programmed speed.

If the driver operates a direction indicator to the left (left hand drive) or the right (right hand drive), to overtake a slower vehicle, the active cruise control allows your vehicle to temporarily approach the vehicle in front to assist the overtaking manoeuvre, though never exceeding the programmed speed.

i The active cruise control operates by day and at night, in fog or in moderate rainfall.

i The selection of this system deactivates the inter-vehicle time function.

! The system does not act on the braking system, but works only with engine braking. The regulation range is limited: there will no longer be any adjustment of speed if the difference between the programmed speed setting and the speed of the vehicle in front becomes too high (18 mph (30 km/h)).

! If the difference between the programmed speed setting and the speed of the vehicle in front is too great, the speed cannot be adjusted: the cruise control is automatically deactivated.

General points

The active cruise control is **switched on** manually: it requires that the speed of the vehicle be between 25 mph (40 km/h) and 90 mph (150 km/h), as well as the engagement of:

- fourth gear or higher with a manual gearbox,
- second gear or higher with an electronic or automatic gearbox in manual mode,
- position **A** with an electronic gearbox or **D** with an automatic gearbox.

! If the speed setting selected is above 93 mph (150 km/h), the system switches to standard cruise control operation (a message appears in the instrument panel).

! The active cruise control cannot in any circumstances replace the observation of speed limits, nor the need for vigilance on the part of the driver. It is recommended that you always keep your feet close to the pedals.

The active cruise control can above be **paused** using the control, or automatically:

- by pressing the brake or clutch pedal,
- in the event of operation of the ESC, for safety reasons,
- in the event of operation of the electric parking brake control lever,
- when an inter-vehicle time threshold is reached (calculated according to the relative speeds of your vehicle and the vehicle in front and the inter-vehicle time setting chosen),
- when the distance between your vehicle and the one in front becomes too small,
- when the speed of the vehicle in front is too low,
- when the speed of your vehicle becomes too low.

i The inter-vehicle time setting is memorised on switching off the ignition.

Steering mounted controls

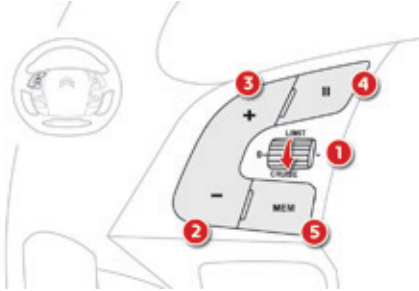

1. Cruise control mode selection wheel.
2. Button for reducing the cruise speed setting or for using the current speed of the vehicle as the cruise speed setting.
3. Button for increasing the cruise speed setting or for using the current speed of the vehicle as the cruise speed setting.
4. Button for pausing / resuming the cruise control.
5. Button for displaying the list of memorised speeds and for adjusting the inter-vehicle time.

For more information on the list of memorised speeds, refer to "Memorising speeds".

Operation

Switching on

The **active** cruise control must be selected in the "**Driving assistance**" menu.

- ☞ Turn the thumb wheel **1** to the "**CRUISE**" position: cruise control mode is selected, but not started (Pause).
- ☞ Press one of the buttons **2** or **3**: the current speed of your vehicle becomes the cruise speed setting.

The cruise control is activated (ON).

By default, the inter-vehicle time is set at 2 seconds.

Otherwise, the last speed value set will be used for operation of the system.

Modification of the cruise control speed only

Buttons 2 and 3

- ☞ By successive short presses, to modify by steps of + or - 1 mph (km/h),
- ☞ by a maintained press, to modify in steps of + or - 5 mph (km/h).

i As a precaution, it is recommended that you select a speed setting close to the current speed of your vehicle.



Modification of the cruise control speed and/or the inter-vehicle time

Button 5 (MEM)

Press button **5**, the six memorised speeds and the inter-vehicle time setting are displayed in the touch screen tablet.

- ☞ Choose a speed setting; it is displayed in the instrument panel,
- ☞ press or the "+" or "-" button to choose a new inter-vehicle time setting between 2.5 seconds and 1 second.

This speed value remains memorised, whatever the state of the system.

The selection screen closes after a few moments. The modifications are then accepted.

i If the active cruise control has not been switched on, pressing button **5** (MEM) has no effect.

i In the event of the presence of a vehicle detected by the radar, if the speed selected is much higher than the speed of that vehicle, the system is not activated and the alert message "Activation not possible, conditions unsuitable" is displayed until driving conditions are safe to allow activation of the system.

Exceeding the speed setting



It is possible to exceed the speed setting temporarily by depressing the accelerator pedal.

Then simply release the accelerator pedal to return to the programmed speed.

If the speed setting is unintentionally exceeded, descending a steep hill for example, the speed setting in the instrument panel flashes as a warning.

Displays in the instrument panel









The information is grouped together in the instrument panel.





6. Indication of cruise control pause/resume.
7. Indication of selection of cruise control mode, or vehicle speed adjustment phase.
8. Cruise speed setting, or adjusted speed lower than the cruise setting.

Driving situations and associated alerts

The table below describes the alerts and the messages displayed for the different driving situations.

The display of these alerts is not sequential.

Symbol	Display in the instrument panel	Associated message	Comments
			No vehicle detected: the system operates as a standard cruise control.
			Detection of a vehicle, at the limit of the range of the radar: the system operates as a standard cruise control.
	<i>vitesse ajustée</i>  97 km/h	"SPEED ADJUSTED"	Detection of a vehicle that is too close or running at a speed lower than your vehicle's cruise speed setting. The system uses engine braking to slow your vehicle and then hold it at the speed of the vehicle in front so as to maintain the programmed inter-vehicle time. The regulation range is limited to a maximum difference of 20 mph (30 km/h) between the speed setting and the speed of the vehicle ahead.

Symbol	Display in the instrument panel	Associated message	Comments
	<p>velocity adjusted</p> 	"SPEED ADJUSTED"	When the adjusted speed reaches the control limit (speed setting - 20 mph (30 km/h)), the adjusted speed flashes together with the speed setting, to signal that automatic deactivation of the system is imminent.
		"Cruise control paused".	If the system exceeds the limit of speed adjustment possible by the system and in the absence of any reaction by the driver (operation of the direction indicator, change of lane, reduction of the speed of the vehicle), the system is automatically paused. The display of the deactivation message is accompanied by an audible signal.

! When the active cruise control is automatically paused, it can only be reactivated when safe conditions are restored. The message "Activation not possible, conditions unsuitable" is displayed while reactivation is not possible. When the conditions allow, it is recommended that the function be reactivated by pressing button **2** or **3**, which will make the current speed of your vehicle the new cruise speed setting, rather than by pressing button **4** (on/pause) which reactivates the cruise control using the old cruise speed setting, which may be very different from the current speed of your vehicle.

Limits of operation

The active cruise control uses only engine braking to slow the vehicle. Consequently the vehicle loses speed slowly, as when releasing the accelerator pedal.

The system is paused automatically:

- if the vehicle in front slows down to much or too suddenly, and the driver does not brake,
- if a vehicle comes between your vehicle and the vehicle in front,
- if the system does not slow the vehicle enough to continue to maintain a safe distance, for example when descending a steep hill.

The regulation range is limited to a maximum difference of 20 mph (30 km/h) between the speed setting and the speed of the vehicle ahead. Above this, the system goes into pause if a safe distance is not maintained.

i Severe weather conditions (very heavy rain, accumulations of snow in front of the radar) can interfere with the operation of the system, resulting in the display of the message "SYSTEM INACTIVE: Visibility reduced". The function remains unavailable until the message disappears.

As the radar's field of view is quite narrow, it is possible that the system may not detect:



- vehicles of reduced width, such as motorcycles, for example,



- vehicles not running in the middle of the lane,

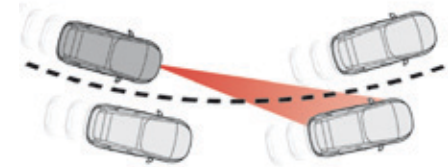

- vehicles entering a corner,
- vehicles changing lane at the last moment.

The cruise control does not take account of:

- stationary vehicles,
- vehicles driving in the opposite direction.

Operating fault

In the event of a fault with the active cruise control, you are alerted by an audible signal and display of the message message "Driving aid functions fault".

Have the system checked by a CITROËN dealer or a qualified workshop.

! When the cruise control is working, take care if making a maintained press on one of the cruise control programmed speed modification buttons: this can lead to a very quick change in the speed of your vehicle.

Do not use the active cruise control on slippery surfaces or in heavy traffic.

When descending a steep hill, the cruise control may not be able to prevent the vehicle from exceeding the programmed speed.

When ascending a steep hill or when towing, it might not be possible to attain or maintain the programmed speed.

The use of mats not approved by CITROËN may interfere with the operation of the cruise control.

To avoid any risk of jamming the pedals:

- ensure that mats are secured correctly,
- never fit one mat on top of another.

! The operation of the radar, located in the front bumper, may be disturbed by accumulations of grime (dust, mud...) or in certain weather conditions (snow, ice...).

The message "SYSTEM INACTIVE: Visibility reduced" is displayed to signal that the system has been put into standby.

Clean the front bumper regularly.

Collision risk alert

System providing a warning to the driver that their vehicle is at risk of collision with the vehicle in front.



i This system operates from 20 mph (30 km/h), only when other vehicles are running in the same direction as your vehicle; the system does not detect stationary objects. A radar is fitted at the front of the vehicle.

! This system has been designed to improve driving safety. It is the responsibility of the driver to keep a constant check on the state of the traffic, to assess the relative speed and distance of other vehicles. The collision risk alert system can never replace the need for vigilance on the part of the driver.

The collision risk alert system can be activated or deactivated by the driver.

From the secondary page of the "**Driving assistance**" menu:

- ☞ select the "**Vehicle settings**" menu,
- ☞ check the "**Collision risk alert**" line and confirm.

i This function can be deactivated permanently by a CITROËN dealer or a qualified workshop.

Setting the thresholds for the alert

The alert thresholds determine how you want to be alerted to the presence of a vehicle running in front of you.

You can choose from three thresholds:

- 1: "Distant", to be given an early alert (cautious driving).
- 2: "Normal".
- 3: "Close", to be given a later alert (sporty driving).

From the secondary page of the "**Driving assistance**" menu:

- ☞ select the "**Vehicle settings**" menu,
- ☞ check the "**Collision risk alert**" line,
- ☞ press on the magnifying glass,
- ☞ modify the alert threshold and press on "**Finish**" to memorise the threshold and leave the menu.

4

Alerts

According to the collision risk detected by the system and the alert threshold chosen, three levels of alert can be triggered.



Level 1: visual alert only (orange) indicating that the vehicle in front is very close. The message "**Vehicle close**" is displayed.

This level of alert is based on the inter-vehicle time between your vehicle and the one in front.



Level 2: visual (red) and audible alerts indicating that a collision is imminent. The message "**Brake!**" is displayed.

This level of alert is based on a time before collision. It takes account of the vehicle dynamics, the speed of your vehicle and the speed of the vehicle in front, the driving conditions, the situation with your vehicle (cornering, pedals pressed, etc.) to trigger the alert at the right moment.



Level 3: an increase in the tension of the driver's seat belt, to hold the driver against the backrest of their seat.



The 3rd level of alert is not triggered or is interrupted in the event of an impact between the two vehicles.

The increase in the tension of the driver's seat belt is intended only as an alert: it does not in any circumstances assure the function of driver safety.

The triggering of this alert does not act on the safety functions provided by the seat belts.



The change from one level of alert to the next takes place if the driving conditions do not change (speed unchanged, no change of lane...)



If the speed of your vehicle is too high when approaching another vehicle, the first level of alert may not be displayed: the level 2 alert may be displayed directly.

On the other hand, the level 1 alert is never displayed with the triggering threshold 3 (close).



Severe weather conditions (very heavy rain, accumulation of snow in front of the radar) may interfere with the operation of the system, resulting in the display of the message "**System inactive: Reduced visibility**". The system remains unavailable until the message disappears.

Operating fault

SERVICE In the event of a fault, you are alerted by the display of the Service warning lamp, accompanied by a message.
Consult a CITROËN dealer or a qualified workshop.

! The operation of the radar, located in the front bumper, may be disturbed by accumulations of grime (dust, mud...) or in certain weather conditions (snow, ice...).

The message "SYSTEM INACTIVE: Visibility reduced" is displayed to signal that the system has been put into standby.
Clean the front bumper regularly.

Lane departure warning system



System which, using a camera which recognises solid or broken lines, detects the involuntary crossing of longitudinal traffic lane markings on the ground.

To provide safe driving, the camera analyses the image then, if the driver's attention drops, triggers a warning if the vehicle drifts over a lane marking (speed higher than 50 mph (80 km/h)).

This system is particularly useful on motorways and main roads.

! The lane departure warning system cannot, in any circumstances, replace the need for vigilance and responsibility on the part of the driver.

It is necessary to observe the driving regulations and to take a break every two hours.

Activation / deactivation

Activation and deactivation of the function is done in the touch screen tablet.



- ☞ In the **Driving assistance** menu, press this button; its indicator lamp comes on.

The function is activated.



- ☞ Press this button again; its indicator lamp goes off.

The function is deactivated.

The status of the system remains in the memory when the ignition is switched off.

Detection - alert

The driver is alerted by vibration of the seat belt (at the level of the reel).

No warning is transmitted while the direction indicator is active and for approximately 20 seconds after the direction indicator is switched off.

Operating fault



In the event of a fault, the symbol for the button changes to alert mode and the warning lamp flashes for a few moments then goes off.

Contact a CITROËN dealer or a qualified workshop.

- i** The detection may be impeded:
- if the markings on the ground are worn,
 - if there is little contrast between the markings on the ground and the road surface,
 - if the windscreen is dirty,
 - in certain severe weather conditions: fog, heavy rain, snow, bright sunlight or direct exposure to the sun (low sun, leaving a tunnel, ...) and shade.

Blind spot sensors

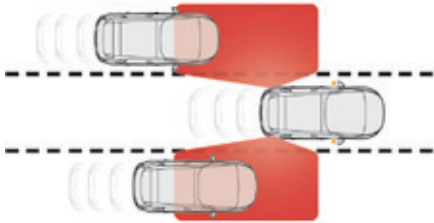

This driving assistance system warns the driver of the presence of another vehicle in the blind spot angle of their vehicle (areas masked from the driver's field of vision), as soon as this presents a potential danger.

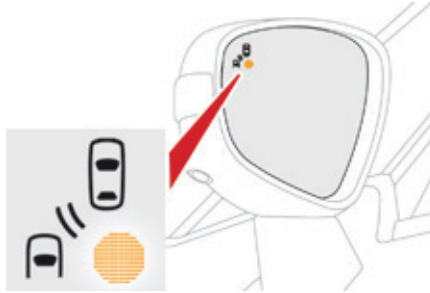

A warning lamp appears in the door mirror on the side in question:

- immediately, when being overtaken,
- after a delay of about one second, when overtaking a vehicle slowly.

Operation

Activation of the function is done in the touch screen tablet.



In the **Driving assistance** menu, press this button; its indicator lamp comes on.

The function is activated.



This indicator lamp comes on in the instrument panel.

Sensors fitted in the front and rear bumpers monitor the blind spots.

4



This system is designed to improve safety when driving and is in no circumstances a substitute for the use of the interior rear view mirror and door mirrors. It is the driver's responsibility to constantly check the traffic, to assess the distances and relative speeds of other vehicles and to predict their movements before deciding whether to change lane. The blind spot sensor system can never replace the vigilance and responsibility of the driver.

The alert is given by a warning lamp which comes on in the door mirror on the side in question as soon as a vehicle - car, lorry, bicycle - is detected and the following conditions are fulfilled:

- all the vehicles must be moving in the same direction and in adjacent lanes,
- the speed of your vehicle is between 7 and 87 mph (12 and 140 km/h),
- you overtake a vehicle with a speed difference of less than 6 mph (10 km/h),
- a vehicle overtakes you with a speed difference of less than 15 mph (25 km/h),
- the traffic must be flowing normally,
- in the case of an overtaking manoeuvre, if this is prolonged and the vehicle being overtaken remains in the blind spot,
- you are driving on a straight or slightly curved road,
- your vehicle is not pulling a trailer, a caravan...

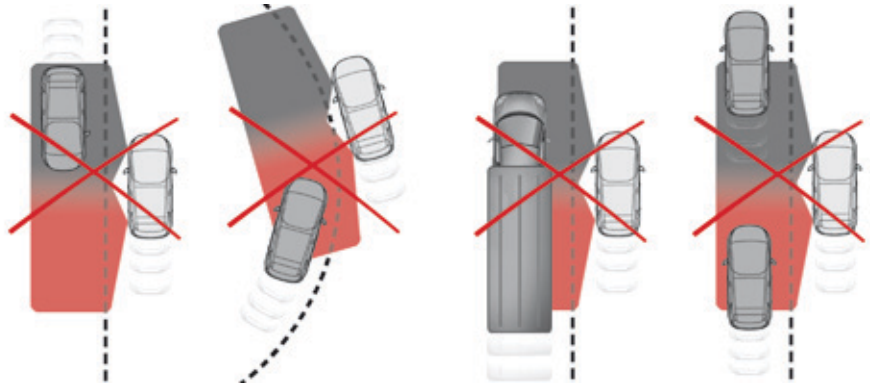

No alert will be given in the following situations:

- in the presence of non-moving objects (parked vehicles, barriers, street lamps, road signs...),
- with vehicles moving in the opposite direction,
- driving on a sinuous road or a sharp corner,
- when overtaking (or being overtaken by) a very long vehicle (lorry, coach...) which is at the same time detected at the rear in the blind spot angle and present in the driver's forward field of vision,
- in very heavy traffic: vehicles detected in front and behind are confused with a lorry or a stationary object,
- when overtaking quickly.



To deactivate the system, press this button again; its indicator lamp goes off as well as the associated indicator in the instrument panel.

The state of the system remains in memory on switching off the ignition.

i The system is automatically deactivated when towing with a towbar approved by CITROËN.

Operating fault



In the event of a fault, the symbol for the button changes to alert mode and the warning lamp flashes for a few moments then goes off.

Have it checked by a CITROËN dealer or a qualified workshop.

i The system may suffer temporary interference in certain weather conditions (rain, hail...).
In particular, driving on a wet surface or moving from a dry area to a wet area can cause false alerts (for example, the presence of a fog of water droplets in the blind spot angle is interpreted as a vehicle).

In bad or wintry weather, ensure that the sensors are not covered by mud, ice or snow.

Take care not to cover the warning zone in the door mirrors or the detection zones on the front and rear bumpers with adhesive labels or other objects; they may hamper the correct operation of the system.

! **High pressure jet wash**
When washing your vehicle, direct the lance at least 30 cm away from the sensors.

Parking sensors

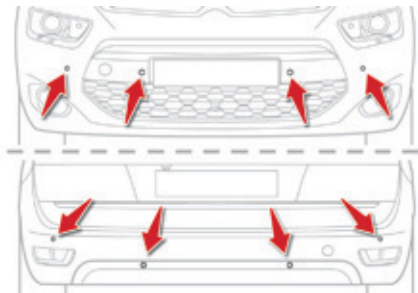

This system indicates the proximity of an obstacle (person, vehicle, tree, gate, etc.) which comes within the field of detection of sensors located in the bumper. Certain types of obstacle (stake, roadworks cone, etc.) detected initially will no longer be detected at the end of the manoeuvre, if they are located in blind spots in the sensors' field of detection.

! This function cannot, in any circumstances, take the place of the vigilance of the driver.

Rear parking sensors

The system is switched on by engaging reverse gear.

This is confirmed by an audible signal.

The system is switched off when you come out of reverse gear.



Audible assistance

The proximity information is given by an intermittent audible signal, the frequency of which increases as the vehicle approaches the obstacle. The sound emitted by the speaker (right or left) indicates the side on which the obstacle is located. When the distance between the vehicle and the obstacle becomes less than approximately thirty centimetres, the audible signal becomes continuous.



Visual assistance

This supplements the audible signal by displaying bars in the screen or the instrument panel which move progressively nearer to the vehicle. When the obstacle is near, the "Danger" symbol is displayed.

Front parking sensors

In addition to the rear parking sensors, the front parking sensors are triggered when an obstacle is detected in front and the speed of the vehicle is still below 6 mph (10 km/h). The front parking sensors are interrupted if the vehicle stops for more than three seconds in forward gear, if no further obstacles are detected or when the speed of the vehicle exceeds 6 mph (10 km/h).

i The sound emitted by the speaker (front or rear) indicates whether the obstacle is in front or behind.

Deactivation / Activation of the front and rear parking sensors

The parking sensors can be deactivated in the touch screen tablet.

☞ Select the "**Driving assistance**" menu.



☞ Press on "**Parking sensors**". The indicator lamp in the button comes on.

Pressing this button again reactivates the system. The indicator lamp goes off.

i The system will be deactivated automatically if a trailer is being towed or a bicycle carrier is fitted on a towbar (vehicle fitted with a towbar installed in line with the manufacturer's recommendations).

i The parking sensors are deactivated while the Park Assist system is measuring a space. See the "Park Assist" section.

Operating fault



In the event of a malfunction of the system, when reverse gear is engaged the symbol for the button changes to alert mode and the warning lamp flashes for a few moments then stays on continuously.

A message appears, accompanied by an audible signal (short beep).

Contact a CITROËN dealer or a qualified workshop.

i In bad weather or in winter, ensure that the sensors are not covered with mud, ice or snow. When reverse gear is engaged, an audible signal (long beep) indicates that the sensors may be dirty. Certain sound sources (motorcycle, lorry, pneumatic drill, etc.) may trigger the audible signals of the parking sensor system.

! **High pressure jet wash**
When washing your vehicle, do not direct the lance within 30 cm of the sensors.

Reversing camera

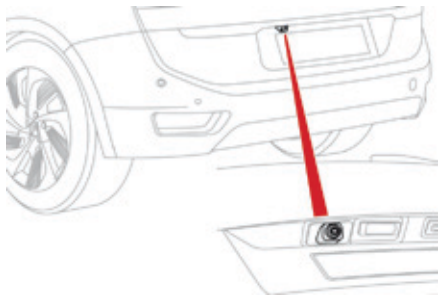

The reversing camera is activated automatically when reverse gear is engaged. Depending on version, the image is displayed in the touch screen tablet or the instrument panel.

i The reversing camera function may be completed with parking sensors.

! The reversing camera cannot in any circumstances be a substitute for vigilance on the part of the driver.

! **High pressure jet washing**
When washing your vehicle, do not direct the lance within 30 cm of the camera lens.



The superimposed representation of guide lines helps with the manoeuvre.

i They are represented by lines marked "on the ground" and do not allow the position of the vehicle to be determined relative to tall obstacles (for example: other vehicles, ...). Some deformation of the image is normal.

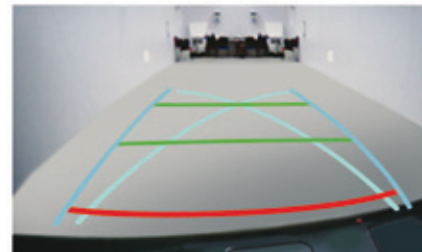

The blue lines represent the general direction of the vehicle (the difference corresponds to the width of your vehicle without the mirrors). The red lines represent a distance of about 30 cm beyond the edge of your vehicle's rear bumper. The green lines represent distances of about 1 and 2 metres beyond the edge of your vehicle's rear bumper. The turquoise blue curves represent the maximum turning circle.

! Opening the tailgate causes the display to disappear.

i Clean the reversing camera regularly using a soft, dry cloth.

360 Vision

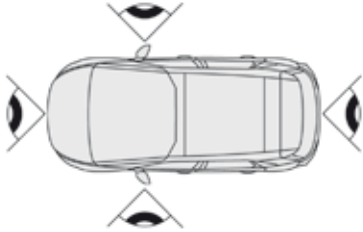

This system provides a view in the instrument panel of the near surroundings of your vehicle, using cameras mounted at the front and rear of your vehicle and under the door mirrors. Depending on the angle of view chosen (front view, rear view or 360° panoramic view), 360 Vision provides special visual assistance in particular driving conditions such as when entering a blind crossing or manoeuvring in areas of reduced visibility. Once activated, this function operates up to 9 mph (15 km/h). Above 18 mph (30 km/h), the function is deactivated automatically.

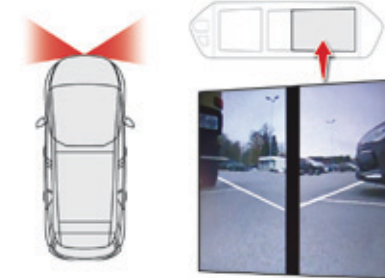

Forward vision

The camera located in the front bumper is activated and views of the areas located at front left and front right appear simultaneously in the instrument panel.

! This system is a visual aid which in no circumstances can replace the need for vigilance on the part of the driver. The images provided by the cameras may be deformed by the relief. The presence of areas in shade, in sunny conditions, or of low ambient light may darken the image and reduce contrast.

Rear vision

The camera located in the tailgate is activated and the view of the area behind your vehicle is displayed in the instrument panel and behaves like a reversing camera, whatever the position of the gear selector lever.

The blue lines represent the width of your vehicle (excluding mirrors); they move according to the position of the steering wheel. The red line represents a distance of 30 cm from the rear bumper, and the two green lines, 1 m and 2 m from the rear bumper, respectively.

i Rear vision is displayed automatically when engaging reverse, regardless of the state of the system.

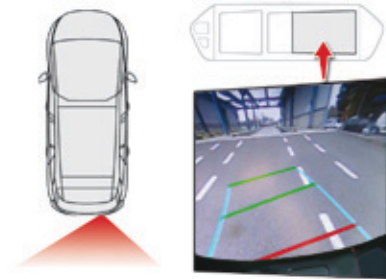

360 vision

The cameras located in the front and rear bumpers and under the door mirrors are activated and a reconstruction of the view from above your vehicle in its immediate surroundings is displayed in the instrument panel.

- i** Opening a door or the tailgate disturbs the 360 and rear views. Fitting the very cold conditions screen affects the image transmitted by the front camera.

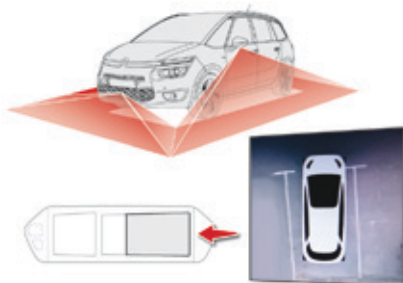

- i** The image transmitted by the camera can be slightly affected by the presence of the very cold conditions screen.

Operation





Activating the function

With the engine running:

- ☞ Select the **"Driving assistance"** menu of the touch screen tablet.
- ☞ Press this button for access to the **"360 vision"** sub-menu.



With this menu displayed, select one of the three views:

-  "Front camera".
-  "360° camera".
- 

-  "Rear camera".

The view selected is displayed in the instrument panel.

- i** The display in the instrument panel disappears above 9 mph (15 km/h).

Deactivating the function

- ☞ Accelerate so as to exceed 18 mph (30 km/h).
- or
- ☞ Select the **"Driving assistance"** menu of the touch screen tablet.
- ☞ Press this button for access to the **"360 vision"** sub-menu.
- ☞ Select "Camera Off".



- !** Check the cleanliness of the camera lenses regularly.
High pressure jet wash
When washing your vehicle, direct the lance at least 30 cm away from the camera.

Park Assist

This system provides active assistance with parking, detecting a parking space then controlling the steering to park in the space. It controls the steering while the driver manages the accelerator, brakes, gears and clutch (manual gearbox). During phases of entry into and exit from a parking space, the system provides visual and audible information to the driver in order to make the manoeuvres safe. It may be necessary to move forwards and backwards more than once.

The driver can take control at any time by gripping the steering wheel.

! The Park Assist system cannot in any circumstances replace the need for vigilance on the part of the driver. The driver must remain in control of their vehicle ensuring that the space remains clear throughout the manoeuvre. In some circumstances, the sensors may not detect small obstacles located in their blind spots.

i The Park Assist system cannot work with the engine off.

The Park Assist system provides assistance for the following manoeuvres:

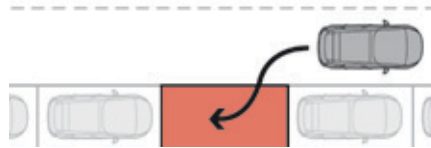

A. entry into a parallel parking space



B. exit from a parallel parking space

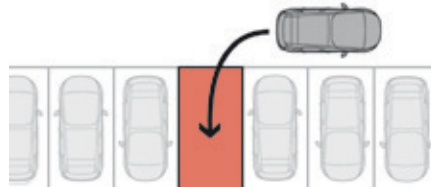

C. bay parking

! During a manoeuvre the steering wheel turns quickly: do not hold the steering wheel, do not place your hand between the spokes of the steering wheel and take care with loose and bulky clothing, scarves, handbags... There is a risk of injury.

i When Park Assist is activated, it prevents a change to STOP mode of Stop & Start. In STOP mode, activation of Park Assist restarts the engine.

i The Park Assist system takes control of the power steering for a maximum of 4 manoeuvre cycles. The function is deactivated after these 4 cycles. If you think that your vehicle is not positioned correctly, you should then take control of the steering to carry out the manoeuvre.

! The sequence of manoeuvres and the driving instructions are displayed in the instrument panel.



The assistance is activated: the display of this symbol and a speed limit indicate that the steering manoeuvres are controlled by the system: do not touch the steering wheel.



The assistance is deactivated: the display of this symbol indicates that the steering manoeuvres are no longer controlled by the system: you must take control of the steering.

! You should always check the surroundings of your vehicle before starting a manoeuvre.

i The park sensors function is not available during parking space measurement. It intervenes later when manoeuvring to warn you that your vehicle is approaching an obstacle: the audible signal becomes continuous when the obstacle is less than thirty centimetres away. If you have deactivated the parking sensors, they are automatically reactivated during assisted parking manoeuvres.

! Activation of Park Assist inhibits the blind spot monitoring function.

Operation

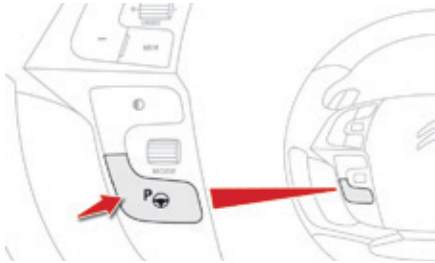

Assistance with parallel parking manoeuvres

- ☞ When you have identified a parking space.



- ☞ Press this control.

or



- ☞ Select "**Park Assist**" in the "**Driving assistance**" menu of the touch screen tablet to activate the function.



This indicator lamp comes on in the instrument panel to confirm activation of the function.

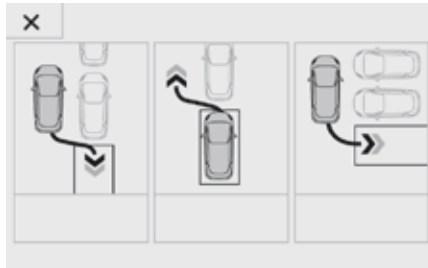

- ☞ Limit the speed of the vehicle to a maximum of 12 mph (20 km/h) and select "**Enter parking slot**" in the touch screen tablet.



To enter a parking space, the system does not identify spaces that are clearly smaller or larger than the vehicle.



- ☞ Operate the direction indicator on the parking side chosen to activate the measurement function. You should drive at a distance of between 0.5 m and 1.5 m from the row of parked vehicles.



- ☞ Drive slowly following the instructions until the system finds a free space.

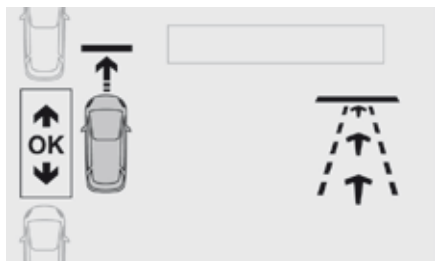

- ☞ Move forwards slowly until a message is displayed, accompanied by an audible signal, asking you to engage reverse gear.



- ☞ Select reverse, release the steering wheel and start moving without exceeding 5 mph (8 km/h).



- ☞ The assisted parking manoeuvre is in progress. Without exceeding 5 mph (8 km/h), move forwards and backwards, aided by the warnings from the "Parking sensors" system, until the indication of the end of the manoeuvre.



- ☞ At the end of the manoeuvre, the operating indicator lamp goes out in the instrument panel, accompanied by a message and an audible signal. The assistance is deactivated: you can take over control.

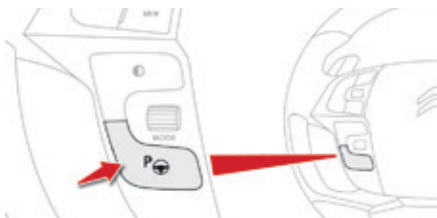

Assistance in exiting from a parallel parking space

When you want to leave a parallel parking space, start the engine.



With the vehicle stationary, press this control.

or



Select **"Park Assist"** in the **"Driving assistance"** menu of the touch screen tablet to activate the function.



This indicator lamp comes on in the instrument panel to confirm activation of the function.



Press on **"Exit parking slot"** in the touch screen tablet.



- Operate the direction indicator for the exit side chosen.
- Engage reverse or forward gear and release the steering wheel.



- The assisted parking manoeuvre is in progress. Without exceeding 3 mph (5 km/h), move forwards and backwards, aided by the warnings from the "Parking sensors" system, until the indication of the end of the manoeuvre.



The manoeuvre is complete when the vehicle's front wheels are clear of the parking space. At the end of the manoeuvre, the indicator lamp in the instrument panel goes off, accompanied by a message and an audible signal. The assistance is deactivated: you can take over control.

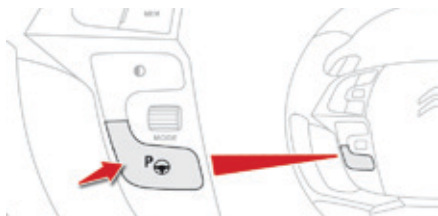

Assistance with bay parking manoeuvres



- Once you have identified a parking zone, press this control at the steering wheel,

or



- Select "**Park Assist**" in the "**Driving assistance**" menu of the touch screen tablet to activate the function.



This indicator lamp comes on in the instrument panel to confirm activation of the function.



- Limit the speed of the vehicle to a maximum of 12 mph (20 km/h) and select "**Start parking in a bay**" on the touch screen tablet.



- Operate the direction indicator on the parking side chosen to activate the measurement function. You should drive at a distance of between 0.5 m and 1.5 m from the row of parked vehicles..



- Drive slowly following the instructions until the system finds a free space.

i When several successive bays are found, the vehicle will be directed towards the last one.

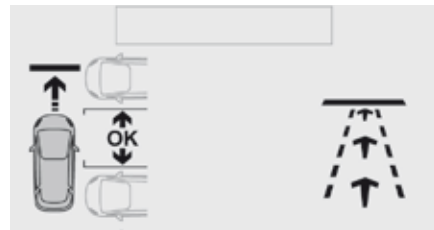

- Move forwards slowly until a message is displayed, accompanied by an audible signal, asking you to engage reverse gear.



- Select reverse, release the steering wheel and start moving without exceeding 5 mph (8 km/h).

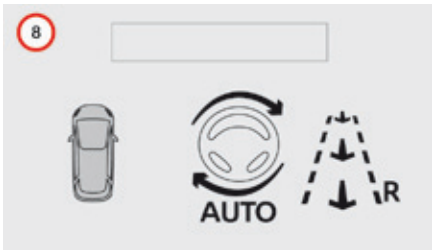

- The assisted parking manoeuvre is in progress. Without exceeding 5 mph (8 km/h), follow the instructions displayed in the instrument panel, aided by the warnings from the "Parking sensors" system, until the indication of the end of the manoeuvre.

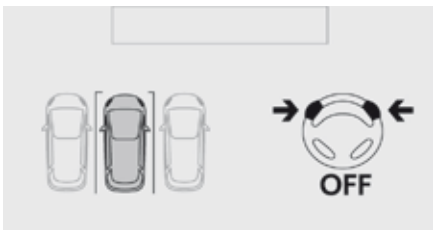

- At the end of the manoeuvre, the operating indicator lamp goes off in the instrument panel, accompanied by a message and an audible signal. The assistance is deactivated: you can take over control.

- During a bay parking manoeuvre, the Park Assist system is automatically deactivated once the rear of the vehicle is within 50 cm of an obstacle.

- During parking and exit from parking manoeuvres, the reversing camera function may come into operation. It facilitates monitoring of the surroundings of the vehicle, by displaying additional information in the instrument panel (see the corresponding section).

Deactivation

The system is deactivated by pressing the control.

The system is deactivated automatically:

- on switching off the ignition,
- if the engine stalls,
- if no manoeuvre is started within 5 minutes of selection of the type of manoeuvre,
- after a prolonged stop of the vehicle during a manoeuvre,
- if the road wheel anti-slip regulation (ASR) is triggered,
- if the speed of the vehicle exceeds the stated limit,
- when the driver interrupts movement of the steering wheel,
- after 4 manoeuvre cycles,
- on opening the driver's door,
- if one of the front wheels encounters an obstacle.

The operation indicator lamp goes off in the instrument panel and a message is displayed accompanied by an audible signal.

The driver should then take back control of the vehicle's steering.

i If the system is deactivated during a manoeuvre, the driver should reactivate it to repeat the measurement.

Switching off

The system is switched off automatically:

- when towing a trailer,
- if the driver's door is opened,
- if the speed of the vehicle is above 42 mph (70 km/h).

To switch the system off for a prolonged period, contact a CITROËN dealer or a qualified workshop.

Operating faults



In the event of a fault, the symbol for the button changes to alert mode and the warning lamp flashes for a few moments then goes off.



The indicator lamp for the function flashes for a few seconds. If the fault occurs during the use of the system, the indicator lamp goes off.

STOP

In the event of a fault with the power steering, this warning lamp flashes in the instrument panel, accompanied by a message.

Contact a CITROËN dealer or a qualified workshop.



If the lateral distance between your vehicle and the space is too great, the system may not be able to measure the space. Anything projecting beyond the envelope of the vehicle (long or wide load) is not taken into account by the Park Assist system during a manoeuvre.



In bad weather or in winter, ensure that the sensors are not covered by road dirt, ice or snow. In the event of a fault, have the system checked by a CITROËN dealer or a qualified workshop.

Exterior lighting controls

System for selection and control of the various front and rear lamps providing the vehicle's lighting.

Main lighting

The various front and rear lamps of the vehicle are designed to adapt the driver's visibility progressively according to the climatic conditions:

- sidelamps, to be seen,
- dipped beam headlamps to see without dazzling other drivers,
- main beam headlamps to see clearly when the road is clear.

i In some weather conditions (e.g. low temperature or humidity), the presence of misting on the internal surface of the glass of the headlamps and rear lamps is normal; it disappears after the lamps have been on for a few minutes.

Additional lighting

Other lamps are provided to meet the requirements of particular driving conditions:

- rear foglamps,
- front foglamps with cornering lighting,
- directional headlamps for improved visibility when cornering,
- daytime running lamps to be more visible during the day,
- guide-me-home and welcome lighting to facilitate access to the vehicle,
- parking lamps as vehicle position markers.

i In the event of the failure of one or more bulbs, a message advises you to check the lamp(s) in question.

Programming

The setting of some functions can be adjusted:

- automatic illumination of headlamps,
- Automatic headlamps,
- guide-me-home lighting,
- welcome lighting,
- cornering lighting,
- directional lighting.

i Travelling abroad

Halogen headlamps

For motoring in countries that drive on the other side of the road, it is necessary to adapt the adjustment of the dipped beams so as to not dazzle the drivers of approaching vehicles. Contact a CITROËN dealer or qualified workshop.

Xenon headlamps

The design of the dipped beam headlamps allows you to drive in a country that drives on the other side of the road, without the need for any modification.

Main lighting

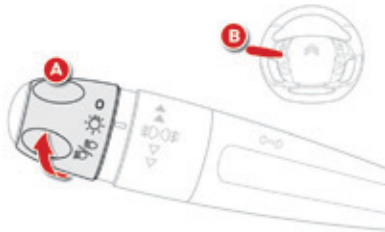

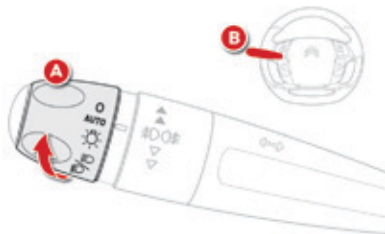

Model without AUTO lighting



Model with AUTO lighting

Selection of main lighting mode

Turn the ring **A** to place the desired symbol against the mark.

- O** Lighting off / daytime running lamps.
- AUTO** Automatic illumination of headlamps. Daytime running lamps / Dipped beam / Main beam.
-  Sidelamps.
-  Dipped or main beam headlamps.

Headlamp dipping

Pull the stalk **B** towards you to switch the lighting between dipped and main beam headlamps or to activate automatic headlamp dipping.

In the lamps off and sidelamps modes, the driver can switch on the main beam headlamps temporarily ("headlamp flash") by maintaining a pull on the stalk.

Displays

Illumination of the corresponding indicator lamp in the instrument panel confirms that the lighting selected is on.

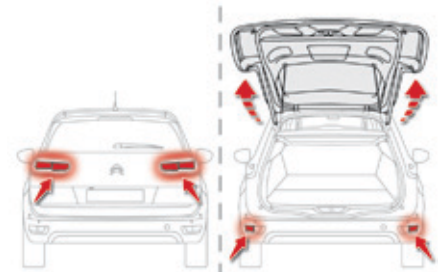

i The rear sidelamps and direction indicators are located on the tailgate. When they are on, opening the tailgate automatically transfers illumination to the lamps located in the rear bumper, to maintain the safety of the vehicle.

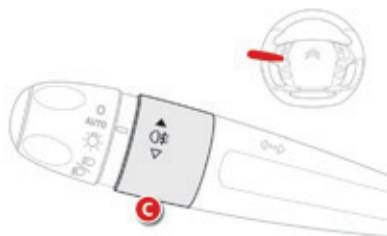

Model with rear foglamps only

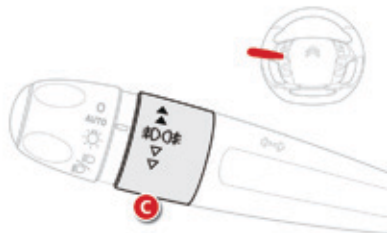

Model with front and rear foglamps

Foglamps

The foglamps operate with the dipped and main beam headlamps.

Rear foglamps

- ☞ To switch on the foglamps, turn the ring **C** forwards.
- ☞ To switch off the foglamps, turn the ring **C** rearwards.

i When switching off dipped beam manually, the rear foglamps also go off.

Front and rear foglamps

Rotate and release the ring **C**:

- ☞ forwards a first time to switch on the front foglamps,
- ☞ forwards a second time to switch on the rear foglamps,
- ☞ rearwards a first time to switch off the rear foglamps,
- ☞ rearwards a second time to switch of the front fog lamps.

When the headlamps switch off with automatic illumination of headlamps or when the dipped beam headlamps are switched off manually, the foglamps and sidelamps remain on.

- ☞ Turn the ring rearwards to switch off the foglamps, the sidelamps will then switch off.

! Operation of the rear foglamps is inhibited with the tailgate open. Opening the boot when these lamps are on causes them and their indicator lamp in the instrument panel to go off. They do not come back on automatically when the boot is closed: they must be switched on again using the control stalk.

! In good or rainy weather, by both day and night, the front foglamps and the rear foglamps are prohibited. In these situations, the power of their beams may dazzle other drivers. They should only be used in fog or falling snow. In these weather conditions, you should switch on the foglamps and dipped beam headlamps manually, as the sunshine sensor may detect sufficient light. Do not forget to switch off the front and rear foglamps when they are no longer necessary.

i **Switching off the lighting when switching off the ignition**

When the ignition is switched off, all of the lamps switch off immediately, except for the dipped beam headlamps if automatic guide-me-home lighting is activated.

i **Switching on the lighting when switching on the ignition**

To reactivate the lighting control stalk, turn the ring **A** to position "**0**" - lighting off, then to the position of your choice. If the lighting is switched on manually after switching off the ignition, there is an audible signal when a front door is opened to warn the driver that they have forgotten to switch off the vehicle's lighting, with the ignition off. They switch off automatically after a period which depends on the state of charge of the battery (entry to energy economy mode).

Parking lamps

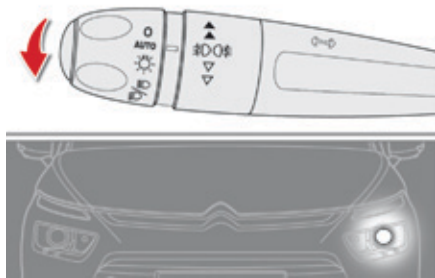

Side markers for the vehicle by illumination of the sidelamps on the traffic side only.

- ☞ Depending on version, within one minute of switching off the ignition, operate the lighting control stalk up or down depending on the traffic side (for example: when parking on the left; lighting control stalk upwards; the right hand sidelamps are on).

This is confirmed by an audible signal and illumination of the corresponding direction indicator warning lamp in the instrument panel.

To switch off the parking lamps, return the lighting control stalk to the central position.

Manual guide-me-home lighting

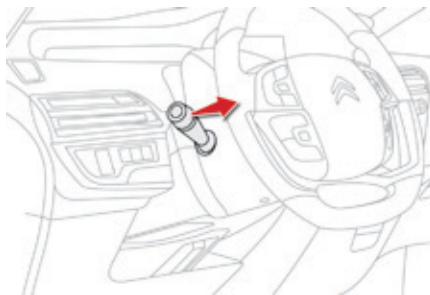

The temporary illumination of the dipped beam headlamps after the vehicle's ignition has been switched off makes the driver's exit easier when the light is poor.

Switching on

- ☞ With the ignition off, "flash" the headlamps using the lighting stalk.
- ☞ A further "headlamp flash" switches the function off.

Switching off

The manual guide-me-home lighting switches off automatically after a set time.

Guide-me-home lighting

Automatic

When the automatic illumination of headlamps is activated, if the ambient light level is low, dipped beam comes on automatically when switching off the ignition.

Activation or deactivation of the system, as well as the period for the guide-me-home lighting are set in the touch screen tablet.



- ☞ Select the "**Driving assistance**" menu.



- ☞ In the secondary page, press "**Vehicle settings**".

Automatic illumination of headlamps

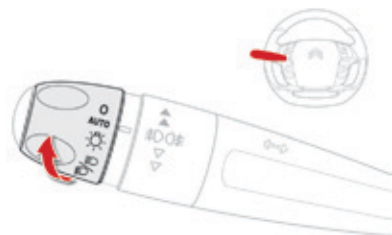

When a low level of ambient light is detected by a sunshine sensor, the number plate lamps, sidelamps and dipped beam headlamps are switched on automatically, without any action on the part of the driver. They can also come on if rain is detected, at the same time as automatic operation of the windscreen wipers. As soon as the brightness returns to a sufficient level or after the windscreen wipers are switched off, the lamps are switched off automatically.

Activation

- ☞ Turn the ring to the "AUTO" position. The activation of the function is accompanied by the display of a message.

Deactivation

- ☞ Turn the ring to another position. Deactivation of the function is accompanied by the display of a message.

Operating fault

SERVICE In the event of a malfunction of the sunshine sensor, the lighting comes on, this warning lamp is displayed in the instrument panel accompanied by an audible signal and/or a message.

Contact a CITROËN dealer or a qualified workshop.

! In fog or snow, the sunshine sensor may detect sufficient light. In this case, the lighting will not come on automatically.
Do not cover the sunshine sensor, coupled with the rain sensor and located in the centre of the windscreen behind the rear view mirror; the associated functions would no longer be controlled.

Automatic headlamp dipping

System which automatically changes between dipped and main beam according to the ambient light level and the driving conditions, using a camera located at the top of the windscreen.

! This automatic headlamp dipping system is a driving aid. The driver remains responsible for the vehicle's lighting, its correct use for the prevailing conditions of light, visibility and traffic and observation of driving and vehicle regulations.

i The system will be operational as soon as you have exceeded 15 mph (25 km/h). If the speed drops below 9 mph (15 km/h), the system no longer operates.

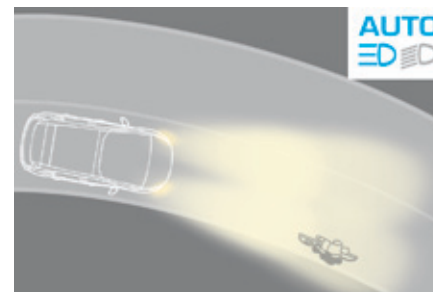
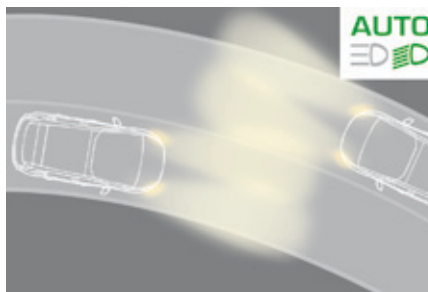
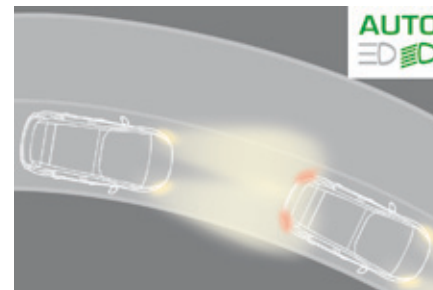
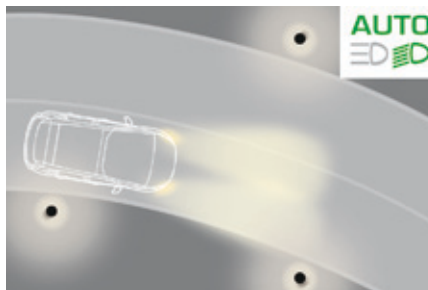

Switching on



Put the lighting control stalk ring in the "AUTO" position.

AUTO
ED ED

In the "Driving assistance" menu, press the button, its indicator lamp comes on.



Flash the headlamps (going beyond the point of resistance) to activate the function.

Operation

Once the function is activated, the system operates as follows:

If the ambient light level is sufficient and/or if the traffic conditions do not allow illumination of the main beam headlamps:

AUTO - dipped beam is maintained, this indicator lamp comes on in the instrument panel.

If the ambient light level is very low and the traffic conditions permit:

AUTO - main beam comes on automatically: this indicator lamp comes on in the instrument panel.

Pause

If the situation requires a change of headlamp beam, the driver can take over at any time.



Flashing the headlamps again pauses the function and the system changes to "automatic illumination of headlamps" mode:

- if the AUTO indicator lamp was on in green, the system changes to main beam,
- if the AUTO indicator lamp was on in blue, the system changes to dipped beam.

To reactivate the system, flash the headlamps again.



Depending on the situation, one of these two indicator lamps comes on.

Switching off



In the "Driving assistance" menu, press the button, its indicator lamp goes off and the the system changes to "automatic illumination of headlamps" mode.

- i** The system may suffer interference or not work correctly:
- under conditions of poor visibility (for example, snowfall, heavy rain or thick fog, ...),
 - if the windscreen is dirty, misted or obscured (by a sticker, ...) in front of the camera,
 - if the vehicle is facing highly reflective signs.

The system is not able to detect:

- road users that do not have their own lighting, such as pedestrians,
- road users whose lighting is obscured, such as vehicles running behind a safety barrier (on a motorway, for example),
- road users at the top or bottom of a steep slope, on twisty roads, on crossroads.

Daytime running lamps (LEDs)

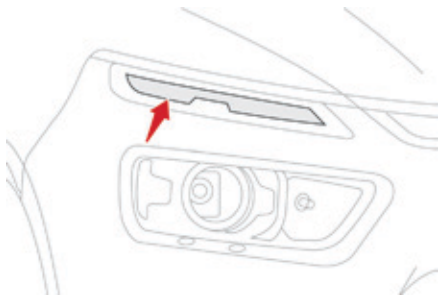

They come on automatically when the engine is started, when the lighting control stalk is in position "0" or "AUTO".

i In some weather conditions (e.g. low temperature or humidity), the presence of misting on the internal surface of the glass of the headlamps and rear lamps is normal; it disappears after the lamps have been on for a few minutes.

Door mirror spotlamps



To make your approach to the vehicle easier, these illuminate:

- the zones facing the driver's and passenger's doors,
- the zones forward of the door mirrors and rearward of the front doors.

Switching on

The spotlamps come on automatically:

- when you unlock the vehicle,
- when you remove the electronic key from the reader,
- when you open a door,
- when you use the remote control to locate the vehicle.

Switching off

They go off automatically after 30 seconds.

Exterior welcome lighting

The remote switching on of the lighting makes your approach to the vehicle easier in poor light. It is activated when the lighting control is in the "AUTO" position and the level of light detected by the sunshine sensor is low.

Switching on



Press the open padlock on the remote control or one of the front door handles with Keyless Entry and Starting.

The dipped beam headlamps and the sidelamps come on; your vehicle is also unlocked.

Switching off

The exterior welcome lighting switches off automatically after a set time, when the ignition is switched on or on locking the vehicle.

Programming

The activation, deactivation and choice of welcome lighting duration are done in the "Driving assistance" menu then "Vehicle settings".

Manual adjustment of headlamps

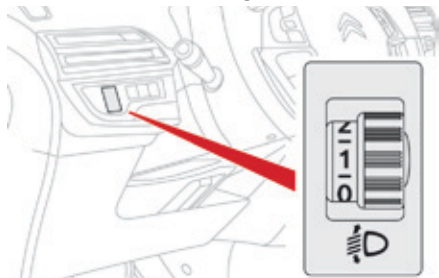

To avoid causing a nuisance to other road users, the headlamps should be adjusted according to the load in the vehicle.

- 0.** 1 or 2 people in the front seats.
 - Intermediate setting.
- 1.** 5 people + maximum authorised load.
 - Intermediate setting.
- 2.** Driver + maximum authorised load.
 - Intermediate setting.
- 3.** 5 people + maximum load in the boot.

i The initial setting is position "0".

Cornering lighting

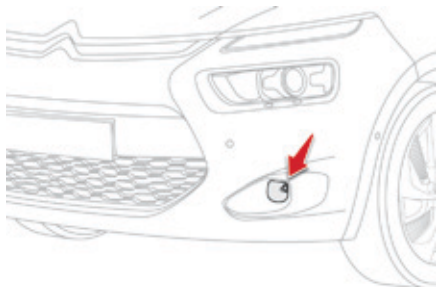

This system, if fitted to your vehicle, makes use of the beam from a front foglamp to illuminate the inside of a bend, when the main or dipped beam headlamps are on and the vehicle speed is below 25 mph (approximately 40 km/h) (urban driving, winding road, junctions, parking manoeuvres...).

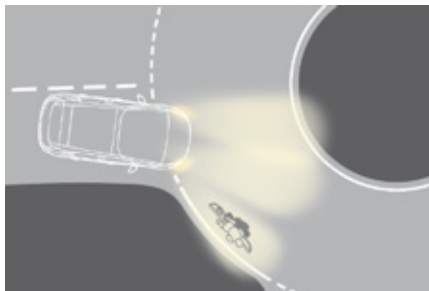

with cornering lighting

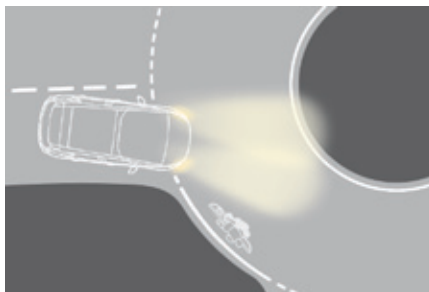

without cornering lighting

Switching on

This system starts:

- when the corresponding direction indicator is switched on,

or

- from a certain angle of rotation of the steering wheel.

Switching off

The system does not operate:

- below a certain angle of rotation of the steering wheel,
- above 25 mph (40 km/h),
- when reverse gear is engaged.

The cornering lighting can be activated or deactivated in the "**Driving assistance**" menu, then "**Vehicle settings**".

Directional lighting

When the dipped or main beam headlamps are on, this system allows the light beams to better follow the road.

Associated with xenon headlamps, this system improves the quality of lighting when cornering.



This system is inactive:

- when stationary or at low speeds,
- when reverse is engaged.

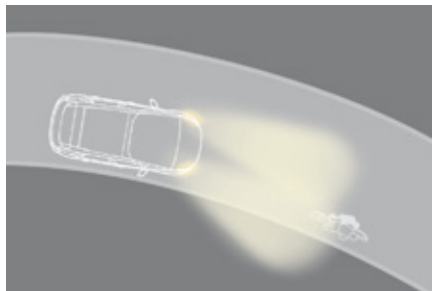

with directional lighting

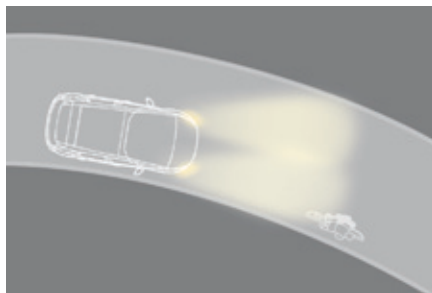

without directional lighting

Operating fault



If a fault occurs, this warning lamp flashes in the instrument panel, accompanied by a message in the screen.

Contact a CITROËN dealer or a qualified workshop.

The directional lighting can be activated or deactivated via the "**Driving aids**" menu, then "**Vehicle settings**".

Wiper controls

Programming

Your vehicle may also include some functions that can be configured:

- automatic rain sensitive windscreen wipers,
- rear wiping on engaging reverse gear.

i In wintry conditions, remove snow, ice or frost present on the windscreen, around the wiper arms and blades and the windscreen seal, before operating the wipers.

! Do not operate the wipers on a dry windscreen. Under extremely hot or cold conditions, ensure that the wiper blades are not stuck to the windscreen before operating the wipers.

Manual controls

The wipers are controlled directly by the driver.

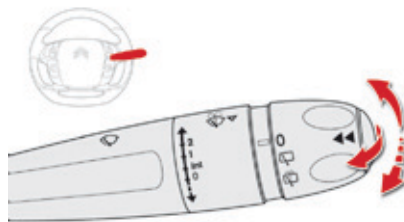

Model without AUTO wiping

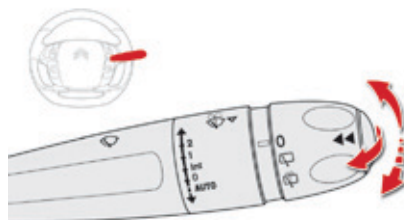

Model with AUTO wiping

Windscreen wipers

i The front wiper system includes a safety device which can temporarily inhibit operation if it detects obstacles such as ice or snow.

Wiping speed control stalk: raise or lower the stalk to the desired position.

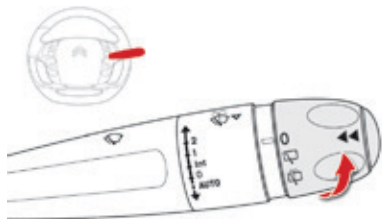

- 2** Fast wipe (heavy rain).
 - 1** Normal wipe (moderate rain).
 - Int** Intermittent wipe (proportional to the speed of the vehicle).
 - 0** Park.
 - ↓** Single wipe (press downwards or pull the stalk briefly towards you, then release).
- or
- AUTO ↓** Automatic wiping (press down, then release).
 - Single wipe (pull the stalk briefly towards you).

Rear wiper



! If a significant accumulation of snow or ice is present, deactivate the automatic rear wiper via the "**Driving assistance**" menu, then "**Vehicle settings**".

Rear wiper selection ring:

-  park,
-  intermittent wipe,
-  wash-wipe (set duration).

Reverse gear

When reverse gear is engaged, the rear wiper will come into operation if the windscreen wipers are operating.

This function can be deactivated in the "**Driving assistance**" menu, then "**Vehicle settings**".

Windscreen wash and headlamp wash

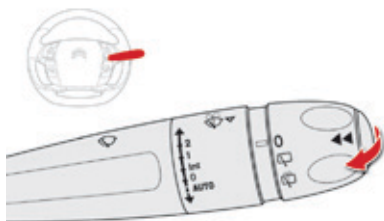

Screenwash and washer jets

☞ Pull the windscreen wiper stalk towards you. The windscreen wash then the windscreen wipers operate for a fixed period.

A few moments after releasing the wiper stalk, there is a last wipe to clear any runs from the screen.

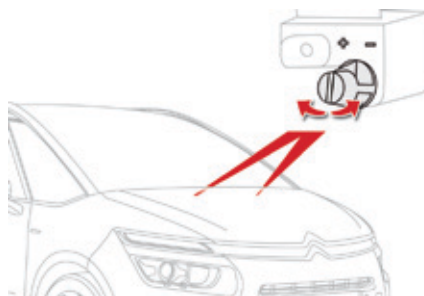

Adjusting the jets

The front washers include an adjustment for the height of delivery from the jets.

If you want to modify the factory setting, turn the screw on each jet anti-clockwise, towards the "+" to raise the jet or clockwise, towards the "-" to lower it.

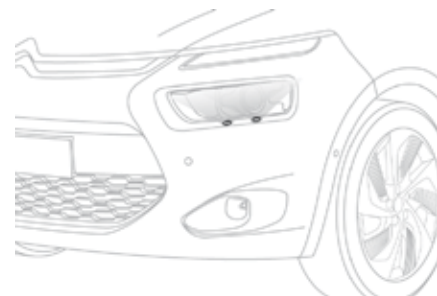

Headlamp wash

The headlamps operate when the vehicle is moving and when the dipped beam headlamps are on. However, to reduce the consumption of screenwash fluid, the headlamp wash only operates with every 7th use of the screenwash or once every 25 miles (40 km), during a given journey.

Automatic rain sensitive windscreen wipers

The windscreen wipers operate automatically, without any action on the part of the driver, if rain is detected (sensor behind the rear view mirror), adapting their speed to the intensity of the rainfall.

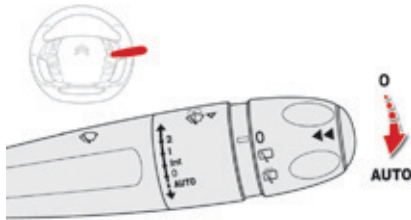

Switching on



Briefly push the control stalk downwards.

A wiping cycle confirms that the instruction has been accepted. This warning lamp comes on in the instrument panel and a message is displayed.

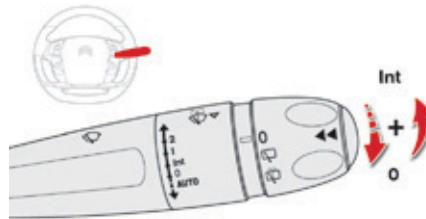

Switching off



Briefly push the control stalk downwards again, or place the control stalk in another position (Int, 1 or 2).

This warning lamp goes off in the instrument panel and a message is displayed.



The automatic rain sensitive windscreen wipers must be reactivated by pushing the control stalk downwards, if the ignition has been off for more than one minute.

Operating fault

If a fault occurs with the automatic rain sensitive wipers, the wipers will operate in intermittent mode.

Have it checked by CITROËN dealer or a qualified workshop.



Do not cover the rain sensor, linked with the sunshine sensor and located in the centre of the windscreen behind the rear view mirror.

Switch off the automatic rain sensitive wipers when using an automatic car wash. In winter, it is advisable to wait until the windscreen is completely clear of ice before activating the automatic rain sensitive wipers.

Special position of the windscreen wipers



This position permits release of the windscreen wiper blades.

It is used for cleaning or replacement of the blades. It can also be useful, in winter, to detach the blades from the windscreen.

On switching off the ignition:

- ☞ any action on the wiper stalk in the minute after switching off the ignition places the blades vertically on the screen.

When the system is no longer powered - at least one minute after switching off the ignition - it is possible to move the arms manually.

- ☞ To park the blades again, switch on the ignition and operate the wiper stalk.

i To maintain the effectiveness of the "flat-blade" type of wiper blades, it is advisable to:

- handle them with care,
- clean them regularly using soapy water,
- avoid using them to retain cardboard on the windscreen,
- replace them at the first signs of wear.

! Replacement of the arms must only be done by a CITROËN dealer or a qualified workshop.

Courtesy lamps

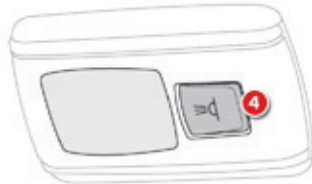
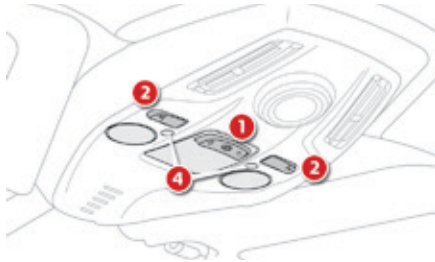

1. Front courtesy lamp
2. Front map reading lamps
3. Rear courtesy lamp
4. Rear map reading lamps

Front - rear courtesy lamps



In this position, the courtesy lamp comes on gradually:

- when the vehicle is unlocked,
- when the electronic key is removed from the reader,
- when opening a door,
- when the remote control locking button is used, in order to locate your vehicle.

It switches off gradually:

- when the vehicle is locked,
- when the ignition is switched on,
- 30 seconds after the last door is closed.



Permanently off.



Permanent lighting.

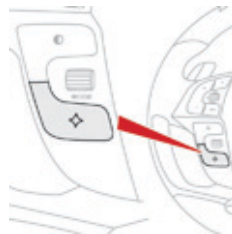

Depending on version, you can also switch the courtesy lamp on or off by pressing this button.

Front - rear map reading lamps

☞ With the ignition on, press the corresponding switch.



Take care to avoid leaving anything in contact with the courtesy lamps.



With the "permanent lighting" mode, the lighting time varies according to the circumstances:

- with the ignition off, approximately ten minutes,
- in energy economy mode, approximately thirty seconds,
- with the engine running, unlimited.

Panoramic sunroof

It is fitted with an electrically controlled blind.

Opening the roof blind

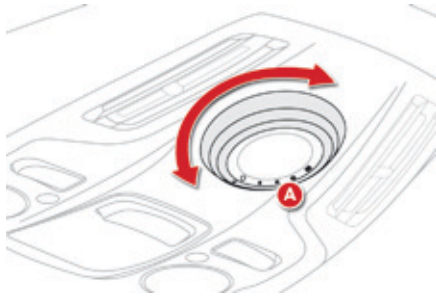

- ☞ Rotate the control **A** to slide the roof blind to the desired position (positions **1** to **4**).

Closing the roof blind

- ☞ Rotate the control **A** to position **0** to close the roof blind.

Anti-pinch

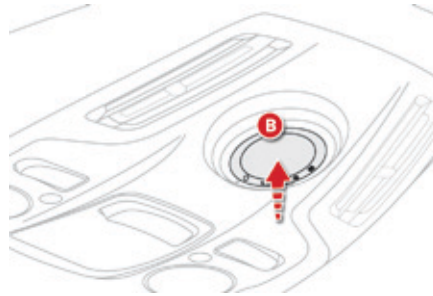

- The blind has an anti-pinch function. At the end of its travel, when the blind encounters an obstacle on closing, it stops and moves back slightly.
- Following a fault or after a battery disconnection during the movement of the blind or after it has stopped, you must re-initialise the anti-pinch function:
- ☞ place the blind in the closed position,
 - ☞ press control knob **B** for approximately two seconds.

Interior mood lighting

The dimmed passenger compartment lighting improves visibility in the vehicle when the light is poor.

Switching on

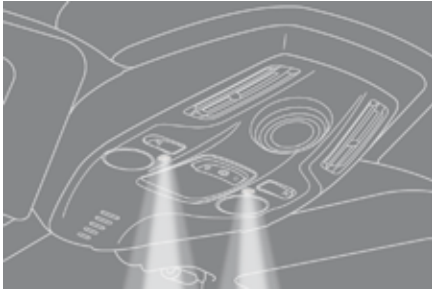

At night, the lighting of the dashboard, centre console, courtesy lamp.. come on automatically when the sidelamps are switched on. The interior mood lighting switches off automatically when the sidelamps are switched off.

The interior mood lighting can be activated or deactivated via the "**Driving assistance**" menu, then "**Vehicle settings**".

Footwell lighting



The soft lighting provided by the footwell lamps improves visibility in the vehicle when the light is poor.

Activation

Its operation is identical to that of the courtesy lamps. The lamps come on when one of the doors is opened.

Direction indicators

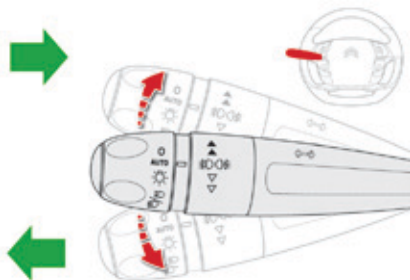

- ☞ Left: lower the lighting stalk passing the point of resistance.
- ☞ Right: raise the lighting stalk passing the point of resistance.

Three flashes of the direction indicators

- ☞ Press briefly upwards or downwards, without going beyond the point of resistance; the direction indicators will flash 3 times.

Hazard warning lamps

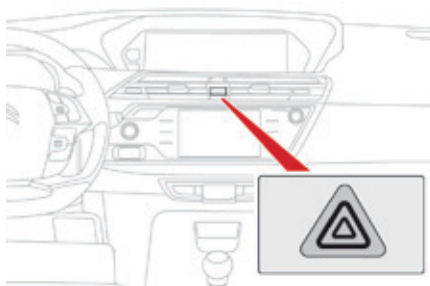

- Visual warning by means of the direction indicators to alert other road users to a vehicle breakdown, towing or accident.
- ☞ Press this button, the direction indicators flash. They can operate with the ignition off.

Automatic operation of hazard warning lamps

When braking in an emergency, depending on the deceleration, the hazard warning lamps come on automatically.

They switch off automatically the first time you accelerate.

- ☞ You can also switch them off by pressing the button.

Horn

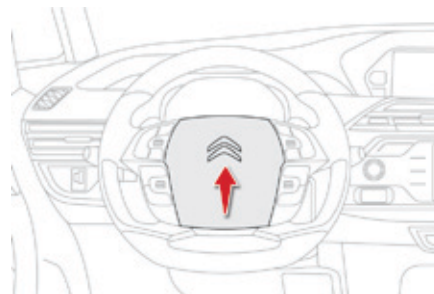

- ☞ Press the central part of the steering wheel.

Emergency or assistance call



This system allows you to make an emergency or assistance call to the emergency services or to the dedicated CITROËN service.

For more information on the use of this function, refer to the "Audio and telematics" section.

Warning triangle

This safety device should be used in addition to the hazard warning lamps. Its presence in the vehicle is mandatory.

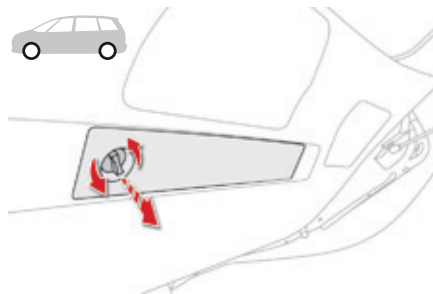

A location for stowing the warning triangle is provided in the tailgate interior trim.

! Before leaving your vehicle to set up and install the triangle, switch on the hazard warning lamps and put on your high visibility vest.

i Refer to the manufacturer's instructions on unfolding and installing supplied with the triangle.

Placing the triangle in the road

⚠ Place the triangle behind the vehicle, as required by the legislation in force in your country.

Under-inflation detection

System which automatically checks the pressures of the tyres while driving.

The system monitors the pressures in the four tyres, once the vehicle is moving.

It compares the information given by the four wheel speed sensors with **reference values, which must be reinitialised every time the tyre pressures are adjusted or a wheel changed.**

The system triggers an alert as soon as it detects a drop in the inflation pressure of one or more tyres.



The under-inflation detection system does not replace the need for vigilance on the part of the driver.

This system does not avoid the need to check the tyre pressures (including the spare wheel) every month as well as before a long journey.

Driving with under-inflated tyres impairs road holding, extends braking distances and causes premature tyre wear, particularly under arduous condition (high loading, high speed, long journey).



Driving with under-inflated tyres increases fuel consumption.



The inflation pressures defined for your vehicle can be found on the tyre pressure label.

See the "Identification markings" section.

Tyre pressures should be checked when the tyres are "cold" (vehicle stopped for 1 hour or after a journey of less than 6 miles (10 km) at moderate speeds).

Otherwise (when hot), add 0.3 bar to the pressures shown on the label.

Under-inflation alert



This is given by fixed illumination of this warning lamp, accompanied by an audible signal and, depending on equipment, the display of a message.

- ☞ Reduce speed immediately, avoid excessive steering movements and sudden braking.
- ☞ Stop the vehicle as soon as it is safe to do so.



The loss of pressure detected does not always cause visible bulging of the tyre. Do not satisfy yourself with just a visual check.

- ☞ In the event of a puncture, use the temporary puncture repair kit or the spare wheel (depending on equipment),
- or
- ☞ if you have a compressor, such as the one in the temporary puncture repair kit, check the pressures of the four tyres when cold,
- or
- ☞ if it is not possible to make this check immediately, drive carefully at reduced speed.



The alert is maintained until the system is reinitialised.

Reinitialisation

It is necessary to reinitialise the system every time one or more tyre pressure is adjusted, and after changing one or more wheels. A label attached to the middle pillar, driver's side, gives a reminder of this.

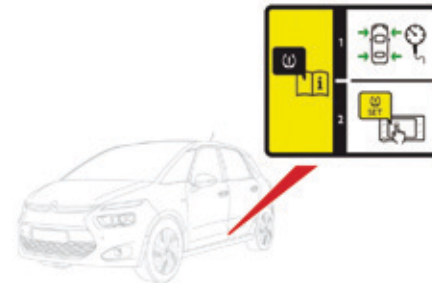

- !** Before reinitialising the system, ensure that the pressures of the four tyres are correct for the use of the vehicle and in line with the recommendations on the tyre pressure label.
- The under-inflation detection system does not give a warning if a pressure is incorrect at the time of reinitialisation.

i Snow chains

The system does not have to be reinitialised after fitting or removing snow chains.

Reinitialisation of the system is done in the the touch screen tablet, with the ignition on and the vehicle stationary.

- ☞ Select the "**Driving assistance**" menu.



- ☞ In the secondary page, press "**Under-inflation initialisation**".

- ☞ Confirm the instruction by pressing "**Yes**", an audible signal and a message confirm the reinitialisation.

The new pressure settings registered are considered to be reference values by the system.

- !** The under-inflation alert can only be relied on if reinitialisation of the system is done with the the four tyre pressures correctly set.

Operating fault



SERVICE

The flashing and then fixed illumination of the under-inflation warning lamp accompanied by illumination of the "service" warning lamp indicates a fault with the system.

In this case, under-inflation monitoring of the tyres is no longer assured.

Have the system checked by a CITROËN dealer or a qualified workshop.

- i** Before doing anything to the system, the pressures of the four tyres must be checked and the system reinitialised.

Electronic stability control (ESC)

Electronic Stability Control (ESC) incorporating the following systems:

- anti-lock braking system (ABS) and the electronic brake force distribution (EBFD),
- emergency braking assistance (EBA),
- wheel anti-slip regulation (ASR) or traction control,
- dynamic stability control (DSC).

Definitions

Anti-lock braking system (ABS) and electronic brake force distribution (EBFD)

This system improves the stability and manoeuvrability of your vehicle when braking and contributes towards improved control in corners, in particular on poor or slippery road surfaces.

The ABS prevents wheel lock in the event of emergency braking.

The electronic brake force distribution system manages the braking pressure wheel by wheel.

Emergency braking assistance (EBA)

In an emergency, this system enables you to reach the optimum braking pressure more quickly and therefore reduce the stopping distance.

It is triggered according to the speed at which the brake pedal is pressed. This is felt by a reduction in the resistance of the pedal and an increase in the effectiveness of the braking.

Anti-slip regulation (ASR)

The ASR system (also known as Traction Control) optimises traction in order to limit wheel slip by acting on the brakes of the driving wheels and on the engine. It also improves the directional stability of the vehicle on acceleration.

Dynamic stability control (DSC)

If there is a difference between the path followed by the vehicle and that required by the driver, the DSC monitors each wheel and automatically acts on the brake of one or more wheels and on the engine to return the vehicle to the required path, within the limits of the laws of physics.

Operation

Anti-lock braking system (ABS) and electronic brake force distribution (EBFD)



When this warning lamp comes on, accompanied by an audible signal and a message, it indicates that there is a fault with the ABS, which could cause loss of control of the vehicle when braking.



When this warning lamp comes on, coupled with the **STOP** warning lamp, accompanied by an audible signal and a message, it indicates that there is a fault with the electronic brake force distribution (EBFD), which could cause loss of control of the vehicle when braking.

You must stop as soon as it is safe to do so.

In both cases, contact a CITROËN dealer or a qualified workshop.



When changing wheels (tyres and rims), make sure that these are approved for your vehicle.

Normal operation of the ABS may make itself felt by slight vibrations of the brake pedal.



In emergency braking, press very firmly without releasing the pressure.

Intelligent traction control system ("Snow motion")

Depending on version, your vehicle has a system to help driving on snow: **intelligent traction control**.

This system detects situations of difficult surface adhesion that could make it difficult to move off or make progress on deep fresh snow or compacted snow.

In these situations, the **intelligent traction control** limits the amount of wheel slip to provide the best traction and trajectory control for your vehicle.

The use of snow tyres is strongly recommended on surfaces offering low levels of adhesion.

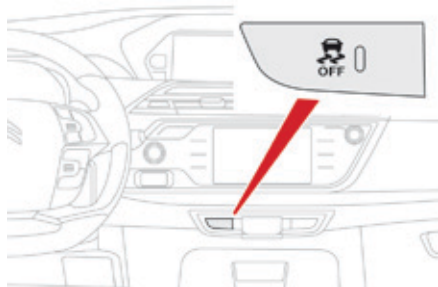

Dynamic stability control (DSC) and anti-slip regulation (ASR)

DSC/ASR

The DSC and ASR systems offer increased safety in normal driving, but they should not encourage the driver to take extra risks or drive at high speed.

It is in conditions of reduced grip (rain, snow, ice) that the risk of loss of grip increases. It is therefore important for your safety to keep the DSC and ASR systems activated in all conditions, and particularly in difficult conditions.

The correct operation of these systems depends on observation of the manufacturer's recommendations regarding as much the wheels (tyres and rims), braking and electronic components as the assembly and repair procedures used by CITROËN dealers. To benefit in full from the effectiveness of the DSC and ASR systems in wintry conditions, the vehicle must be fitted with four snow tyres, allowing the the vehicle to retain neutral behaviour on the road.

Activation

These systems are activated automatically each time the vehicle is started. As soon as they detect a problem of grip or trajectory, these systems act on the operation if the engine and brakes.



This is indicated by flashing of this warning lamp in the instrument panel.

Deactivation

In exceptional conditions (starting a vehicle which is bogged down, stuck in snow, on soft ground...), it may be advisable to deactivate the DSC and ASR, so that the wheels can turn freely and regain grip.

Reactivate the systems as soon as the level of grip permits.



Press this button.



This indicator lamp and the indicator lamp in the button come on.

The DSC and ASR systems no longer act on the operation of the engine and on the brakes in the event of a involuntary change of trajectory.

Reactivation

The systems are reactivated automatically each time the ignition is switched back on or from 30 mph (50 km/h).

Below 30 mph (50 km/h), you can reactivate them manually:



☞ Press this button again.

Operating fault



Illumination of this warning lamp, accompanied by an audible signal and a message, indicate a fault with the system.

Contact a CITROËN dealer or a qualified workshop to have the system checked.



After an impact, have these systems checked by a CITROËN dealer or a qualified workshop.

Seat belts

Front seat belts



The front seat belts are fitted with a pretensioning and force limiting system. This system improves safety in the front seats in the event of a front or side impact. Depending on the severity of the impact, the pretensioning system instantly tightens the seat belts against the body of the occupants. The pretensioning seat belts are active when the ignition is on. The force limiter reduces the pressure of the seat belt on the chest of the occupant, so improving their protection.

Seat belt reels with reversible pretension

This system provides automatic adjustment of the tension of the driver's and passenger's seat belts after fastening, once the vehicle's speed is above 6 mph (10 km/h).

In addition, as soon as the system detects a potentially dangerous driving situation, this system reacts by drawing in slack in the belt, (for example, under heavy or sharp braking or sudden avoiding manoeuvres). By automatically increasing the tension of the seat belts, the system holds the driver and passenger against their seat backrests. Once the driving situation returns to normal, the belt reel is released: the belt tension returns to the initial level of comfort.

i Deactivation of the passenger's airbag causes deactivation of the reversible seat belt reel on the passenger's side.



Front seat belt anchorage height adjustment

☞ To adjust the height of the anchorage point, squeeze the control and slide it up or down to the desired notch.

2nd row seat belts

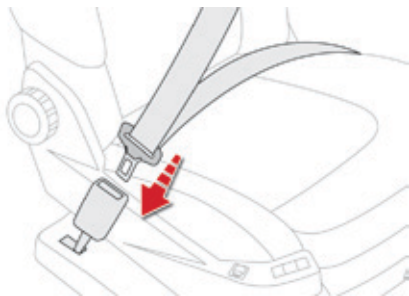

Fastening

- ☞ Pull the strap, then insert the tongue in the buckle.
- ☞ Check that the seat belt is fastened correctly by pulling the strap.

Unfastening

- ☞ Press the red button on the buckle.
- ☞ Guide the seat belt as it reels in.

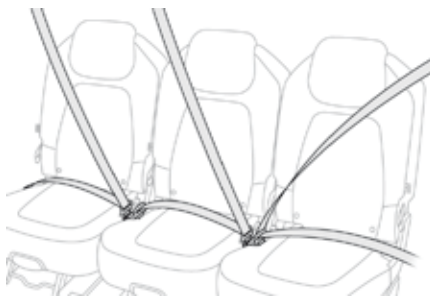

The rear seats are each fitted with a seat belt, three-point anchorages with inertia reel and force limiter (except for the centre rear seat).

2nd row outer seat belts (stowing)



Guide the belt as it reels in and place the tongue on the magnet at the side anchorage point.

2nd row centre seat belt

The seat belt for the centre rear seat is built into the roof.

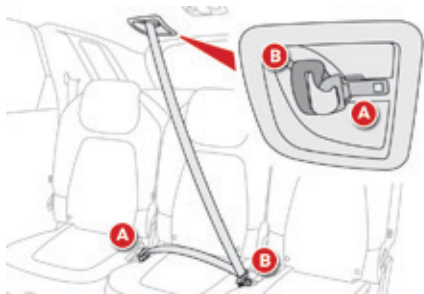

Fastening

- ☞ Pull the strap and insert the tongue **A** into the right hand buckle.
- ☞ Insert tongue **B** into the left hand buckle.
- ☞ Check that each buckle is correctly fastened by pulling on the belt webbing.

Unfastening

- ☞ Press the red button in buckle **B**, then buckle **A**.
- ☞ Guide the seat belt as it reels in and place the tongue **B** and then **A** on the magnet in the roof anchorage point.

! Before any operation of the rear seats, to avoid damage to the seat belts check that there is no slack in the outer belts and secure their tongues on the anchorage points. The centre seat belt must be fully reeled in.

3rd row seat belts

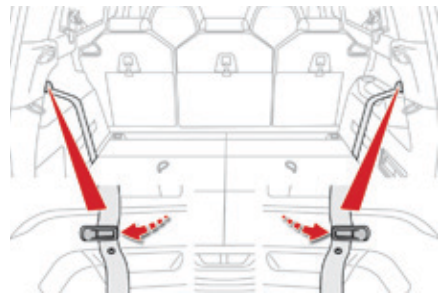

Fastening

- ☞ Detach the seat belt strap from its retaining loop located on the side trim of the boot.
- ☞ Pull on the strap and insert the tongue into the buckle.
- ☞ Check that the buckle is correctly fastened by pulling on the belt strap.

Unfastening and stowing

- ☞ Press the red button in buckle.
- ☞ Guide the seat belt strap as it reels in.
- ☞ Secure the strap, flat in the retaining loop.

! Ensure that the the seat belts are secured when not in use.

Seat belt not fastened and unfastened alerts



The instrument panel includes a seat belt not-fastened warning lamp **A** as well as an indicator of the location of the non-fastened belts **B**.

When the system detects a non-fastened or unfastened seat belt, the warning lamp **A** come on as well as the corresponding points in the indicator **B**.

Front seat belts not fastened alert



On switching on the ignition, the warning lamp **A** comes on, as well as the corresponding points in the indicator **B**, if the driver and/or front passenger have not fastened their seat belt.

At speeds above 12 mph (20 km/h), these alerts flash, accompanied by an audible signal for two minutes. After this period, these alerts remain on fixed, while the front seat belts are not fastened.

Rear seat belts not fastened alert



On switching on the ignition, engine running or the vehicle at a speed of up to 12 mph (20 km/h), the warning lamp **A** as well as the corresponding points in the indicator **B** come on for about thirty seconds, if one or more rear passengers have not fastened their seat belt.

Seat belts unfastened alert



On switching on the ignition, the warning lamp **A** remains on, as well as the corresponding points in the indicator **B**, if the driver and/or one or more passengers have not fastened their seat belt.

At speeds above 12 mph (20 km/h), these alerts flash, accompanied by a message and an audible signal for two minutes. After this period, these alerts remain on fixed, while the seat belts are not fastened.

i The driver must ensure that passengers use the seat belts correctly and that they are all restrained securely before setting off. Wherever you are seated in the vehicle, always fasten your seat belt, even for short journeys.

Do not interchange the seat belt buckles as they will not fulfil their role fully.

The seat belts are fitted with an inertia reel permitting automatic adjustment of the length of the strap to your size. The seat belt is stowed automatically when not in use. Before and after use, ensure that the seat belt is reeled in correctly.

The lower part of the strap must be positioned as low as possible on the pelvis. The upper part must be positioned in the hollow of the shoulder.

The inertia reels are fitted with an automatic locking device which comes into operation in the event of a collision, emergency braking or if the vehicle rolls over. You can release the device by pulling the strap firmly and then releasing it so that it reels in slightly.

In order to be effective, a seat belt must:

- be tightened as close to the body as possible,
- be pulled in front of you with a smooth movement, checking that it does not twist,
- be used to restrain only one person,
- not bear any trace of cuts or fraying,
- not be converted or modified to avoid affecting its performance.

In accordance with current safety regulations, for all repairs on your vehicle's seat belts, go to a qualified workshop with the skills and equipment needed, which a CITROËN dealer is able to provide. Have your seat belts checked regularly by a CITROËN dealer or a qualified workshop, particularly if the straps show signs of damage.

Clean the seat belt straps with soapy water or a textile cleaning product, sold by CITROËN dealers.

After folding or moving a seat or rear bench seat, ensure that the seat belt is positioned and reeled in correctly.

Recommendations for children

Use a suitable child seat if the passenger is less than 12 years old or shorter than one and a half metres.

Never use the same seat belt to secure more than one person.

Never allow a child to travel on your lap.

For more information, refer to the "Child seats" section.

In the event of an impact

Depending on the nature and seriousness of the impact, the pretensioning device may be deployed before and independently of the airbags. Deployment of the pretensioners is accompanied by a slight discharge of harmless smoke and a noise, due to the activation of the pyrotechnic cartridge incorporated in the system.

In all cases, the airbag warning lamp comes on. Following an impact, have the seat belts system checked, and if necessary replaced, by a CITROËN dealer or a qualified workshop.

Airbags

System designed to contribute towards improving the safety of the occupants (with the exception of the rear centre passenger) in the event of violent collisions. The airbags supplement the action of the force-limiting seat belts (with the exception of the centre rear passenger).

If a collision occurs, the electronic detectors record and analyse the front and side impacts sustained in the impact detection zones:

- in the case of a serious impact, the airbags are deployed instantly and contribute towards better protection of the occupants of the vehicle (with the exception of the rear centre passenger); immediately after the impact, the airbags deflate rapidly so that they do not hinder visibility or the exit of the occupants,
- in the case of a minor or rear impact or in certain roll-over conditions, the airbags may not be deployed; the seat belt alone contributes towards ensuring your protection in these situations.

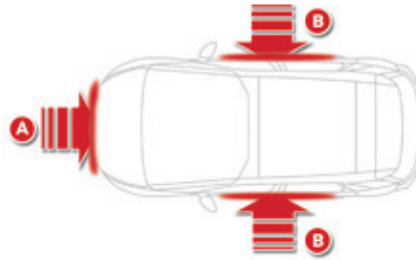

Impact detection zones

- A. Front impact zone.
- B. Side impact zone.

i Deployment of one or more of the airbags is accompanied by a slight emission of smoke and a noise, due to the activation of the pyrotechnic cartridge incorporated in the system. This smoke is not harmful, but sensitive individuals may experience slight irritation.

The noise of detonation related to the deployment of one or more airbags may result in a slight loss of hearing for a short time.

! **The airbags do not operate when the ignition is switched off.**

This equipment will only deploy once. If a second impact occurs (during the same or a subsequent accident), the airbag will not be deployed again.

Front airbags

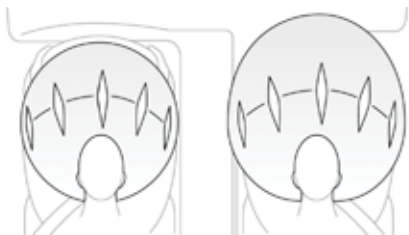

System which protects the driver and front passenger in the event of a serious front impact in order to limit the risk of injury to the head and thorax.

The driver's airbag is fitted in the centre of the steering wheel; the front passenger's airbag is fitted in the dashboard above the glove box.

Deployment

The airbags are deployed, except the passenger's front airbag if it is deactivated, in the event of a serious front impact to all or part of the front impact zone **A**, in the longitudinal centreline of the vehicle on a horizontal plane and directed from the front to the rear of the vehicle.

The front airbag inflates between the thorax and head of the front occupant of the vehicle and the steering wheel, driver's side, and the dashboard, passenger's side to cushion their forward movement.

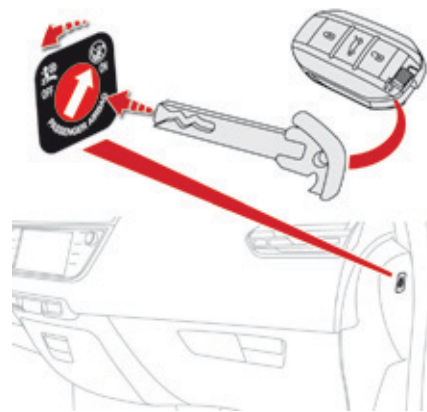

Deactivation

Only the passenger's front airbag can be deactivated.

- ☞ **With the ignition off**, insert the key in the passenger airbag deactivation switch.
- ☞ Turn it to the **"OFF"** position.
- ☞ Remove the key keeping the switch in the new position.



When the ignition is on, this warning lamp comes in the instrument panel. It stays on while the airbag is deactivated.

! To assure the safety of your child, the passenger's front airbag must be deactivated when you install a rearward facing child seat on the front passenger seat.

Otherwise, the child would risk being seriously injured or killed if the airbag were deployed.

Reactivation

When you remove the rearward facing child seat, **with the ignition off**, turn the switch to the "**ON**" position to reactivate the airbag and so assure the safety of your front passenger in the event of an impact.



When the ignition is switched on, this warning lamp comes on in the instrument panel for approximately one minute to signal that the front airbag is activated.

Operating fault



If this warning lamp comes on in the instrument panel, accompanied by an audible warning and a message, contact a CITROËN dealer or a qualified workshop to have the system checked.

The airbags may no longer be deployed in the event of a serious impact.

Lateral airbags



System which protects the driver and front passenger in the event of a serious side impact in order to limit the risk of injury to the chest, between the hip and the shoulder. Each lateral airbag is fitted in the seat backrest frame, door side.

Deployment

A lateral airbag is deployed unilaterally in the event of a serious side impact applied to all or part of the side impact zone **B**, perpendicular to the longitudinal centreline of the vehicle on a horizontal plane and directed from the outside towards the inside of the vehicle.

The lateral airbag inflates between the hip and shoulder of the front occupant of the vehicle and the corresponding door trim panel.

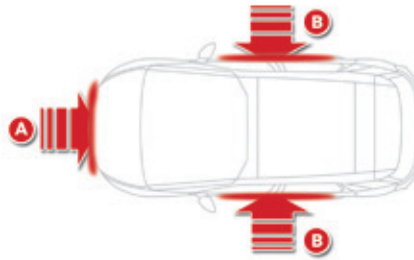

Impact detection zones

- A. Front impact zone.
- B. Side impact zone.

Curtain airbags

System contributing towards greater protection for the driver and passengers (with the exception of the rear centre passenger) in the event of a serious side impact in order to limit the risk of injury to the side of the head.

Each curtain airbag is built into the pillars and the upper passenger compartment area.

Deployment

The curtain airbag is deployed at the same time as the corresponding lateral airbag in the event of a serious side impact applied to all or part of the side impact zone **B**, perpendicular to the longitudinal centreline of the vehicle on a horizontal plane and directed from the outside towards the inside of the vehicle.

The curtain airbag inflates between the front or rear occupant of the vehicle and the windows.

Operating fault



If this warning lamp comes on in the instrument panel, accompanied by an audible signal and a message, contact a CITROËN dealer or a qualified workshop to have the system checked. The airbags may no longer be deployed in the event of a serious impact.



In the event of a minor impact or bump on the side of the vehicle or if the vehicle rolls over, the airbags may not be deployed.

In the event of a rear or front collision, none of the lateral airbags is deployed.

! Guidelines to follow:

Sit in a normal upright position.

Wear a correctly adjusted seat belt.

Do not allow anything to come between the occupants and the airbags (a child, pet, object...), do not attach or fix anything near to the airbags or their trajectories when inflating as this could cause injuries when the airbags are deployed.

Never modify the original definition of your vehicle, particularly in the area directly around the airbags.

After an accident or if the vehicle has been stolen or broken into, have the airbag systems checked.

All work on the airbag system must be carried out by a CITROËN dealer or a qualified workshop.

Even if all of the precautions mentioned are observed, a risk of injury or of minor burns to the head, chest or arms when an airbag is deployed cannot be ruled out. The bag inflates almost instantly (within a few milliseconds) then deflates within the same time discharging the hot gas via openings provided for this purpose.

Front airbags

Do not drive holding the steering wheel by its spokes or resting your hands on the centre part of the wheel.

Passengers must not place their feet on the dashboard.

Do not smoke as deployment of the airbags can cause burns or the risk of injury from a cigarette or pipe.

Never remove or pierce the steering wheel or hit it violently.

Do not fit or attach anything to the steering wheel or dashboard, this could cause injuries with deployment of the airbags.

Lateral airbags

Use only approved covers on the seats, compatible with the deployment the lateral airbags. For information on the range of seat covers suitable for your vehicle, you can contact a CITROËN dealer.

Refer to the "Accessories" section.

Do not fix or attach anything to the seat backs (clothing...). This could cause injury to the chest or arms if the lateral airbag is deployed.

Do not sit with the upper part of the body any nearer to the door than necessary.

Curtain airbags

Do not fix or attach anything to the roof. This could cause injury to the head if the curtain airbag is deployed.

If fitted on your vehicle, do not remove the grab handles installed on the roof, they play a part in securing the curtain airbags.

General points relating to child seats

Although one of CITROËN main criteria when designing your vehicle, the safety of your children also depends on you.

For maximum safety, please observe the following recommendations:

- in accordance with European regulations, **all children under the age of 12 or less than one and a half metres tall must travel in approved child seats suited to their weight**, on seats fitted with a seat belt or ISOFIX mountings*,
- **statistically, the safest seats in your vehicle for carrying children are the rear seats,**
- **a child weighing less than 9 kg must travel in the rearward facing position both in the front and in the rear.**

- i** **CITROËN recommends** that children should travel on the **rear seats** of your vehicle:
- **rearward facing** up to the age of 3,
 - **forward facing** over the age of 3.

* The regulations on carrying children are specific to each country. Refer to the legislation in force in your country.

Child seat at the front*



Rearward facing

When a rearward facing child seat is installed on the **front passenger seat**, adjust the vehicle seat to the midway longitudinal position, the lowest height position, backrest straightened. Then pull the height control lever 11 times.

The passenger's front airbag must be deactivated. Otherwise, **the child risks being seriously injured or killed if the airbag is deployed.**



Forward facing

When a forward facing child seat is installed on the **front passenger seat**, adjust the vehicle seat to the midway longitudinal position, the lowest height position, backrest straightened. Then pull the height control lever 11 times. Leave the passenger's airbag active.

i Ensure that the seat belt is properly tightened.
For child seats with a support leg, ensure that this is in firm and steady contact with the floor. If necessary, adjust the passenger's seat.



Passenger seat in the midway longitudinal position, the lowest height position, then the height control lever pulled 11 times.

* Refer to the legislation in force in your country before installing a child seat on this seating position.

Deactivating the passenger's front airbag

! Never install a rearward facing child restraint system on a seat protected by an active front airbag. This could cause the death of the child or serious injury.

The warning label present on both sides of the passenger's sun visor repeats this advice. In line with current legislation, the following tables contain this warning in all of the languages required.

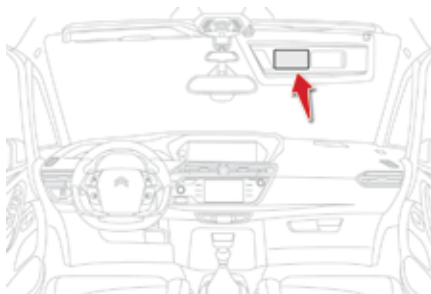

Passenger airbag OFF

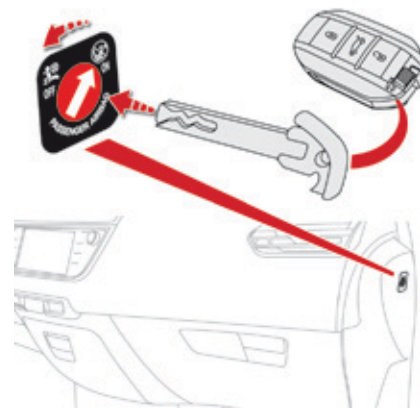

i For information on deactivating the passenger's front airbag, refer to the "Airbags" section.

AR	لا يجب أبدا تركيب نظام لإجلاس الطفل الوجه باتجاه الورااء على مقعد سيارة مجيّر بوسادة أمان هوائية أمامية مغلقة. فقد يؤدي هذا إلى التسبب بموت الطفل أو بإصابات خطيرة لديه.
BG	НИКОГА НЕ инсталирайте детско столче на седалка с АКТИВИРАНА предна ВЪЗДУШНА ВЪЗГЛАВНИЦА. Това може да причини СМЪРТ или СЕРИОЗНО НАРАНЯВАНЕ на детето.
CS	NIKDY neumistujte dětské zádržné zařízení orientované směrem dozadu na sedadlo chráněné AKTIVOVANÝM čelním AIRBAGEM. Hrozí nebezpečí SMRTI DÍTĚTE nebo VÁŽNĚHO ZRANĚNÍ.
DA	Brug ALDRIG en bagudvendt barnestol på et sæde, der er beskyttet af en AKTIV AIRBAG. BARNET risikerer at blive ALVORLIGT KVÆSTET eller DRÆBT.
DE	Montieren Sie auf einem Sitz mit AKTIVIERTEM Front-Airbag NIEMALS einen Kindersitz oder eine Babyschale entgegen der Fahrtrichtung, das Kind könnte schwere oder sogar tödliche Verletzungen erleiden.
EL	Μη χρησιμοποιείτε ΠΟΤΕ παιδικό κάθισμα με την πλάτη του προς το εμπρός μέρος του αυτοκινήτου, σε μια θέση που προστατεύεται από ΜΕΤΩΠΙΚΟ αερόσακο που είναι ΕΝΕΡΓΟΣ. Αυτό μπορεί να έχει σαν συνέπεια το ΘΑΝΑΤΟ ή το ΣΟΒΑΡΟ ΤΡΑΥΜΑΤΙΣΜΟ του ΠΑΙΔΙΟΥ.
EN	NEVER use a rearward facing child restraint on a seat protected by an ACTIVE AIRBAG in front of it, DEATH or SERIOUS INJURY to the CHILD can occur.
ES	NO INSTALAR NUNCA un sistema de retención para niños de espaldas al sentido de la marcha en un asiento protegido mediante un AIRBAG frontal ACTIVADO, ya que podría causar lesiones GRAVES o incluso la MUERTE del niño.
ET	Ärge MITTE KUNAGI paigaldage "seljaga sõidusuunas" lapseistet juhi kõrvalistmele, mille ESITURVAPADI on AKTIVEERITUD. Turvapadja avanemine võib last TÕSISELT või ELUOHTLIKULT vigastada.
FI	ÄLÄ KOSKAAN aseta lapsen turvaistuinta selkã ajosuuntaan istuimelle, jonka edessä suojana on käyttöön aktivoitu TURVATYYNYY. Sen laukeaminen voi aiheuttaa LAPSEN KUOLEMAN tai VAKAVAN LOUKKAANTUMISEN.
FR	NE JAMAIS installer de système de retenue pour enfants faisant face vers l'arrière sur un siège protégé par un COUSSIN GONFLABLE frontal ACTIVE. Cela peut provoquer la MORT de l'ENFANT ou le BLESSER GRAVEMENT.
HR	NIKADA ne postavljati dječju sjedalicu leđima u smjeru vožnje na sjedalo zaštićeno UKLJUČENIM prednjim ZRAČNIM JASTUKOM. To bi moglo uzrokovati SMRT ili TEŠKU OZLJEDU djeteta.
HU	SOHA ne használnjok menetirányinak háttal beszerelt gyermekülést AKTIVÁLT (BEKAPCSOLT) FRONTLÉGSZÁKKAL védett ülésen. Ez a gyermek HALÁLÁT vagy SÜLYÖS SÉRÜLÉSÉT okozhatja.
IT	NON installare MAI seggiolini per bambini posizionati in senso contrario a quello di marcia su un sedile protetto da un AIRBAG frontale ATTIVATO. Ciò potrebbe provocare la MORTE o FERITE GRAVI al bambino.
LT	NIEKADA neįrengkite vaiko prilaikymo priemonės su atgal atgretžtu vaiku ant sėdynės, kuri saugoma VEIKIANČIOS priekinės ORO PAGALVĖS. Išsiskleidus oro pagalvei vaikas gali būti MIRTINAI arba SUNKIAI TRAUMUOTAS.
LV	NEKAD NEuzstādiēt uz aizmuguri vērstu bērnu sēdekli priekšējā pasažiera sēdvietā, kurā ir AKTIVIZĒTS priekšējais DROŠĪBAS GAISA SPILVENS. Tas var izraisīt BĒRNA NĀVI vai radīt NOPIETNUS IEVAINOJUMUS.

MT	Qatt m'ghandek thalli tifel/tifla marbut f'siggu dahru lejn l-Airbag attiva, ghaliex tista' tikkawza korriment serju jew anke mewt lit-tifel/tifla.
NL	Plaats NOOIT een kinderzitje met de rug in de rijrichting op een zitplaats waarvan de AIRBAG is INGESCHAKELD. Bij het afgaan van de airbag kan het KIND LEVENSGEVAARLIJK GEWOND RAKEN.
NO	Installer ALDRI et barnesete med ryggen mot kjøreretningen i et sete som er beskyttet med en frontal AKTIVERT KOLLISJONSPUTE, BARNET risikerer å bli DREPT eller HARDT SKADET.
PL	NIGDY nie instalować fotelika dziecięcego w pozycji "tyłem do kierunku jazdy" na siedzeniu wyposażonym w CZŁOWA PODUSZKĘ POWIETRZNA w stanie AKTYWNYM. Może to doprowadzić do ŚMIERCI DZIECKA lub spowodować u niego POWAŻNE OBRAŻENIA CIAŁA.
PT	NUNCA instale um sistema de retenção para crianças de costas para a estrada num banco protegido por um AIRBAG frontal ACTIVADO. Esta instalação poderá provocar FERIMENTOS GRAVES ou a MORTE da CRIANÇA.
RO	Nu instalati NICIODATA un sistem de retinere pentru copii, dispus cu spatele in directia de mers, pe un loc din vehicul protejat cu AIRBAG frontal ACTIVAT. Aceasta ar putea provoca MOARTEA COPILULUI sau RANIREA lui GRAVA.
RU	ВО ВСЕХ СЛУЧАЯХ ЗАПРЕЩАЕТСЯ использовать обращенное назад детское удерживающее устройство на сиденье, защищенном ФУНКЦИОНИРУЮЩЕЙ ПОДУШКОЙ БЕЗОПАСНОСТИ, установленной перед этим сиденьем. Это может привести к ГИБЕЛИ РЕБЕНКА или НАНЕСЕНИЮ ЕМУ СЕРЬЕЗНЫХ ТЕЛЕСНЫХ ПОВРЕЖДЕНИЙ.
SK	NIKDY neinštalujte detské zádržné zariadenie orientované smerom dozadu na sedadlo chránené AKTIVOVANÝM čelným AIRBAGOM. Mohlo by dôjsť k SMRTEĽNÉMU alebo VÁŽNEMU PORANENIU DIEŤAŤA.
SL	NIKOLI ne nameščajte otroškega sedeža s hrbtom v smeri vožnje, če je VARNOSTNA BLAZINA pred sprednjim sopolnikovim sedežem AKTIVIRANA. Takšna namestitvev lahko povzroči SMRT OTROKA ali HUDE POŠKODBE.
SR	NIKADA ne koristite dečje sedište koje se okreće unazad na sedištu zaštićenim AKTIVNIM VAZDUŠNIM JASTUKOM ispred njega, jer mogu nastupiti SMRT ili OZBILJNA POVREDA DETETA.
SV	Passagerarkrockkudden fram MÅSTE vara avaktiverad om en bakåtvänd bilbarnstol installeras på denna plats. Annars riskerar barnet att DÖDAS eller SKADAS ALLVARLIGT.
TR	KESİNLİKLE HAVA YASTIĞI AKTİF olan ön koltuğa yüzü arkaya dönük bir çocuk koltuğu yerleştirmeyiniz. Bu ÇOCUĞUN ÖLMESİNE veya ÇOK AĞIR YARALANMASINA sebep olabilir.

Child seat at the rear

Rearward facing



When a rearward facing child seat is installed **on a rear passenger seat**, move the vehicle's front seat forward and straighten the backrest so that the rearward facing child seat does not touch the vehicle's front seat.

Forward facing



When a forward facing child seat is installed **on a rear passenger seat**, move the vehicle's front seat forward and straighten the backrest so that the legs of the child in the forward facing child seat do not touch the vehicle's front seat.



Seats in the 3rd row

When a child seat is installed **on a 3rd row passenger seat**, move the 2nd row seat forwards and straighten the backrest so that the child seat and the legs of the child do not touch the 2nd row seat.

A child seat with a support leg must never be installed on a **3rd row passenger seat**.

! Ensure that the seat belt is correctly tensioned.
For child seats with a support leg, ensure that this is in firm contact with the floor. If necessary, adjust the front seat of the vehicle.

Child seats recommended by CITROËN

CITROËN offers a range of recommended child seats which are secured using a **three point seat belt**.

Group 0+: from birth to 13 kg



L1

"RÖMER Baby-Safe Plus"

Installed in the rearward facing position.

Groups 2 and 3: from 15 to 36 kg



L4

"KLIPPAN Optima"

From 22 kg (approximately 6 years), the booster is used on its own.



L5

"RÖMER KIDFIX"





Can be fitted to the vehicle's ISOFIX mountings.

The child is restrained by the seat belt.



Installation of child seats secured using the seat belt

In accordance with European regulations, this table indicates the options for installing child seats secured using the seat belt and universally approved (a) in relation to the weight of the child and the seat in the vehicle.

Seat		Weight of the child / indicative age			
		Groups 0 (b) and 0+ Birth to 13 kg	Group 1 From 9 to 18 kg	Group 2 From 15 to 25 kg	Group 3 From 22 to 36 kg
1 st row	Front passenger seat (c)				
	<ul style="list-style-type: none"> - fixed  - height adjustable  	U U(R)	U U(R)	U U(R)	U U(R)
2 nd row	Fixed outer rear seats (d) 	U	U	U	U
	Outer rear seats with longitudinal adjustment (d) (e) 	U	U	U	U
	Centre rear seat (d) 	U	U	U	U





- (a) Universal child seat: child seat which can be installed in all vehicles using the seat belt.
 - (b) Group 0: from birth to 10 kg. Infant car seats and "car cots" cannot be installed on the front passenger seat. When installed in the 2nd row, they may prevent use of the other seats.
 - (c) Consult the legislation in force in your country before installing your child on this seat.
 - (d) To install a child seat on a rear seat, rearward facing or forward facing, move the front seat forward, then straighten the backrest to allow enough space for the child seat and the child's legs.
 - (e) To install a child seat on a rear seat, rearward facing or forward facing, adjust the rear seat to the fully back position, with the backrest upright.
- U:** seat suitable for the installation of a child seat secured using the seat belt and universally approved rearward facing and/or forward facing, with the passenger seat adjusted to the midway longitudinal position.
- U(R):** same as **U**, with the passenger's seat adjusted to the low position with 11 actions on the height control lever and in the midway longitudinal position.

i Remove and stow the head restraint before installing a child seat on a passenger seat. Refit the head restraint once the child seat has been removed.



Installation of child seats secured using the seat belt

In accordance with European regulations, this table indicates the options for installing child seats secured using the seat belt and universally approved (a) in relation to the weight of the child and the seat in the vehicle.

Seat		Weight of the child / indicative age			
		Groups 0 (b) and 0+ Birth to 13 kg	Group 1 From 9 to 18 kg	Group 2 From 15 to 25 kg	Group 3 From 22 to 36 kg
1 st row	Front passenger seat (c)				
	- fixed  - height adjustable	U U(R)	U U(R)	U U(R)	U U(R)
2 nd row	Fixed outer rear seats (d) 	U	U	U	U
	Outer rear seats with longitudinal adjustment (d) (e) 	U	U	U	U
	Centre rear seat (d) 	U	U	U	U
3 rd row	Rear seats 	U	U	U	U

- (a) Universal child seat: child seat which can be installed in all vehicles using the seat belt.
 - (b) Group 0: from birth to 10 kg. Infant car seats and "car cots" cannot be installed on the front passenger seat or in the 3rd row. When installed in the 2nd row, they may prevent use of the other seats.
 - (c) Consult the legislation in force in your country before installing your child on this seat.
 - (d) To install a child seat on a rear seat, rearward facing or forward facing, move the front seat forward, then straighten the backrest to allow enough space for the child seat and the child's legs.
 - (e) To install a child seat on a rear seat, rearward facing or forward facing, adjust the rear seat to the fully back position, with the backrest upright.
- U:** seat suitable for the installation of a child seat secured using the seat belt and universally approved rearward facing and/or forward facing, with the passenger seat adjusted to the midway longitudinal position.
- U(R):** same as **U**, with the passenger's seat adjusted to the low position with 11 actions on the height control lever and in the midway longitudinal position.

i Remove and stow the head restraint before installing a child seat on a passenger seat. Refit the head restraint once the child seat has been removed.

"ISOFIX" mountings

Your vehicle has been approved in accordance with the **latest ISOFIX regulations**.

The seats, represented below, are fitted with regulation ISOFIX mountings:

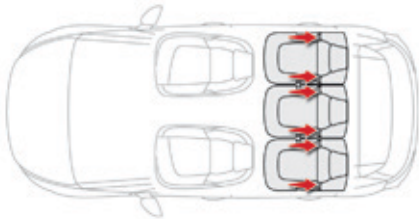

The ISOFIX mountings are three rings for each seat:

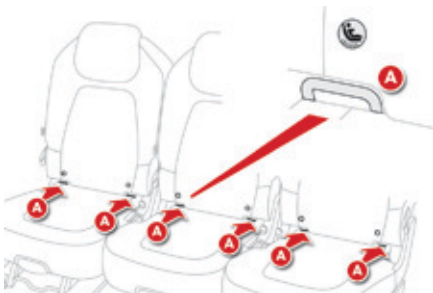

- two rings **A**, located between the vehicle seat back and cushion, indicated by a marking,

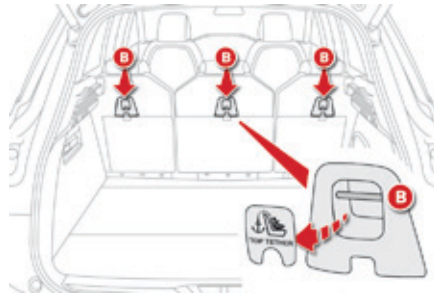

- a ring **B**, located under a cover on the back of the top of the seat backrest, referred to as the **TOP TETHER** for fixing the upper strap. Its position is indicated by a marking.

Located on the back of the seat backrest, the top tether is used to secure the upper strap of child seats that have one. This device limits forward tipping of the child seat, in the event of a front impact.

This ISOFIX mounting system ensures fast, reliable and safe fitting of the child seat in your vehicle.

The **ISOFIX child seats** are fitted with two latches which are secured easily on the two rings **A**. Some also have an **upper strap** (or top tether) which is attached to ring **B**.

To secure the child seat to the **TOP TETHER**:

- remove and stow the head restraint before installing the child seat on this seat (refit it after the child seat has been removed),
- remove the **TOP TETHER** cover by pulling at its cut-out,
- pass the child seat strap behind the seat backrest, centred between the holes for the head restraint rods,
- secure the upper strap fixing to the ring **B**,
- tighten the upper strap.

! The incorrect installation of a child seat in a vehicle compromises the child's protection in the event of an accident. Observe strictly the fitting instructions provided with the child seat.

i For information on the possibilities for fitting ISOFIX child seats to your vehicle, refer to the table of seating positions.

ISOFIX child seats recommended by CITROËN

"RÖMER Baby-Safe Plus and its Baby-Safe Plus ISOFIX base" (size category: E)

Group 0+: from birth to 13 kg

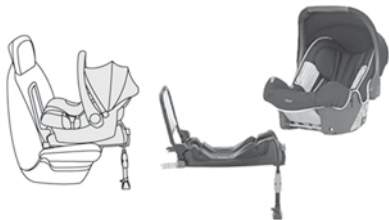

Installed rearward facing using an ISOFIX base which is attached to the rings **A**. The base has a support leg, adjustable for height, which sits on the vehicle's floor. This seat can be secured with a seat belt. In this case, only the shell is used and attached to the vehicle's seat by the three-point seat belt.

Baby P2C Mini and its ISOFIX base (size categories: C, D, E)

Group 0+: from birth to 13 kg

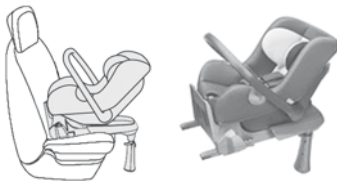

Installed rearward facing using an ISOFIX base which is attached to the anchorage rings **A**. The base has a support leg, adjustable for height, which sits on the vehicle's floor. This seat can also be secured with a seat belt. In this case only the seat shell is used.

Baby P2C Midi and its ISOFIX base (size categories: D, C, A, B, B1)

Group 1: from 9 to 18 kg



Installed rearward facing using an ISOFIX base which is attached to the rings **A**
The base has a support leg, adjustable for height, which sits on the vehicle's floor.

This child seat can also be used forward facing.

This seat can **not** be secured with a seat belt.

We recommend that you use the seat in the rearward facing position up to the age of 3 years.

i Follow the instructions for fitting child seats contained in the seat manufacturer's installation guide.



Locations for installing ISOFIX child seats

In accordance with European Regulations, this table indicates the options for installing ISOFIX child seats on seats in the vehicle fitted with ISOFIX mountings.

In the case of universal and semi-universal ISOFIX child seats, the ISOFIX size category, determined by a letter from **A** to **G**, is indicated on the child seat next to the ISOFIX logo.

	Weight of the child / indicative age									
	Less than 10 kg (group 0) Up to approx. 6 months		Less than 10 kg (group 0) Less than 13 kg (group 0+) Up to approx. 1 year			From 9 to 18 kg (group 1) From approx. 1 to 3 years				
Type of ISOFIX child seat	Sleeper cot*		rearward facing			rearward facing		forward facing		
ISOFIX size category	F	G	C	D	E	C	D	A	B	B1
Front passenger seat	Not ISOFIX									
Outer rear seats, fixed	IL-SU**		IL-SU			IL-SU		X	IUF / IL-SU	
Outer rear seats, adjustable longitudinally	IL-SU**		IL-SU			IL-SU		IUF / IL-SU (1)	IUF / IL-SU	
Centre rear seat	X		IL-SU			IL-SU		IUF / IL-SU	IUF / IL-SU	

* Sleeper cots cannot be fitted to the front passenger's seat.

** The ISOFIX sleeper cot, secured to the lower rings of an ISOFIX seat, occupies the full width of the rear seats.

IUF: seat suitable for the installation of an ISOFIX **U**niversal seat, "**F**orward facing" secured using the upper strap to the top tether on ISOFIX seats.

IL-SU: seat suitable for the installation of an Isofix **S**emi-**U**niversal seat either:

- rearward facing fitted with an upper strap or a support leg,
- forward facing fitted with a support leg,
- a sleeper cot fitted with an upper strap or a support leg.

For advice on securing the upper strap, refer to the "Isofix Mountings" section.

X: seat not suitable for the installation of a child seat or sleeper cot for the weight group indicated.

(1): The outer seat in row 2 must be adjusted to 3 notches back from the fully forward position.

! Remove and stow the head restraint before installing a child seat on a passenger seat. Refit the head restraint once the child seat has been removed.



Locations for installing ISOFIX child seats

In accordance with European Regulations, this table indicates the options for installing ISOFIX child seats on seats in the vehicle fitted with ISOFIX mountings.

In the case of universal and semi-universal ISOFIX child seats, the ISOFIX size category, determined by a letter from **A** to **G**, is indicated on the child seat next to the ISOFIX logo.

	Weight of the child / indicative age									
	Less than 10 kg (group 0) Up to approx. 6 months		Less than 10 kg (group 0) Less than 13 kg (group 0+) Up to approx. 1 year			From 9 to 18 kg (group 1) From approx. 1 to 3 years				
Type of ISOFIX child seat	Sleeper cot*		rearward facing			rearward facing		forward facing		
ISOFIX size category	F	G	C	D	E	C	D	A	B	B1
Front passenger seat	Not ISOFIX									
Outer rear seats, fixed	IL-SU**		IL-SU			IL-SU		IUF / IL-SU		IUF / IL-SU
Outer rear seats, adjustable longitudinally	IL-SU**		IL-SU			IL-SU		IUF / IL-SU		IUF / IL-SU
Centre rear seat	X		IL-SU			IL-SU		IUF / IL-SU		IUF / IL-SU
Rear seat in the 3 rd row	Not ISOFIX									

* Sleeper cots cannot be fitted to the front passenger's seat.

** An ISOFIX sleeper cot, secured to the lower rings of an ISOFIX seat, occupies the full width of the rear seats.

IUF: seat suitable for the installation of an ISOFIX **U**niversal seat, "**F**orward facing" secured using the upper strap to the top tether on ISOFIX seats.

IL-SU: seat suitable for the installation of an Isofix **S**emi-**U**niversal seat either:

- rearward facing fitted with an upper strap or a support leg,
- forward facing fitted with a support leg,
- a sleeper cot fitted with an upper strap or a support leg.

For advice on securing the upper strap, refer to the "Isofix Mountings" section.

X: seat not suitable for the installation of a child seat or sleeper cot for the weight group indicated.

! Remove and stow the head restraint before installing a child seat on a passenger seat. Refit the head restraint once the child seat has been removed.

Recommendations

! Child seats

The incorrect installation of a child seat in a vehicle compromises the child's protection in the event of an accident.

Check that there is no seat belt or seat belt buckle under the child seat as this could destabilise it.

Remember to fasten the seat belts or the child seat harnesses **keeping the slack** in relation to the child's body **to a minimum**, even for short journeys.

For the installation of a child seat using a seat belt, ensure that this is well tensioned on the child seat and that it is holding the child seat firmly against the seat of your vehicle. If your front passenger seat is adjustable, move it forward if necessary. At the rear seats, always leave sufficient space between the front seat and:

- a rearward facing child seat,
- the feet of a child seated in a forward facing child seat.

For this, move the front seat forward and if necessary straighten its backrest.

For optimum installation of the forward facing child seat, ensure that the back of the child seat is as close as possible to the backrest of the vehicle's seat, or in contact if possible. The head restraint must be removed before installing a child seat with a backrest on the passenger seat.

Ensure that the head restraint is stowed or attached securely so that it is not thrown around the vehicle in the event of sharp braking.

Refit the head restraint as soon as the child seat is removed.

Children at the front

The legislation on carrying a child on the front passenger seat is specific to each country. Refer to the legislation in force in the country in which you are driving.

Deactivate the passenger's front airbag when a rearward facing child seat is installed on the front passenger seat. Otherwise, the child would risk being seriously injured or killed if the airbag were deployed.

Installing a booster cushion

The chest part of the seat belt must be positioned on the child's shoulder without touching the neck.

Ensure that the lap part of the seat belt passes correctly over the child's thighs. CITROËN recommends the use of a booster seat which has a back, fitted with a seat belt guide at shoulder level.

As a safety precaution, do not leave:

- one or more children alone and unsupervised in a vehicle,
- a child or an animal in a vehicle which is exposed to the sun, with the windows closed,
- the keys within reach of children inside the vehicle.

To prevent accidental opening of the doors, use the child lock.

Take care not to open the rear windows by more than one third.

To protect young children from the rays of the sun, fit side blinds on the rear windows.

Child lock

This mechanical system prevents opening of the rear door using its interior control.

The control is located on the edge of each rear door and locking is independent for each door.



Locking

- ☞ Using the integral ignition key, turn the control as far as it will go:
 - to the left on the left-hand rear door,
 - to the right on the right-hand rear door.

Unlocking

- ☞ Using the integral ignition key, turn the control as far as it will go:
 - to the right on the left-hand rear door,
 - to the left on the right-hand rear door.

Temporary puncture repair kit

This kit consists of a compressor and a sealant cartridge.

It allows the **temporary repair** of a tyre.

You are then able to go to the nearest garage. It is designed to repair most punctures which could affect the tyre, located on the tyre tread or shoulder.

Its compressor can be used to check and adjust the pressure of the tyre.

Access to the kit



This kit is installed in the storage box, under the boot floor.

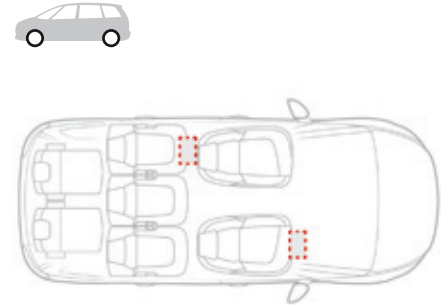

Depending on version, the kit is stowed under the front passenger's seat or in the storage box under the second row footwell.

List of tools

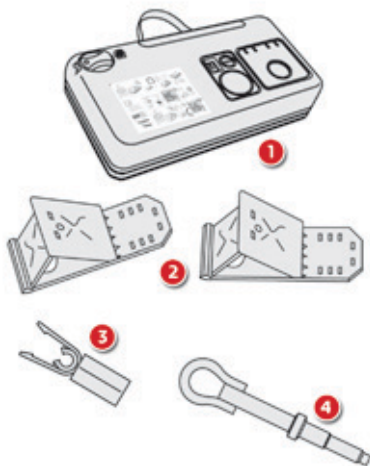

All of these tools are specific to your vehicle and can vary according to equipment. Do not use them for other purposes.

1. 12 V compressor.
Contains a sealant cartridge for the temporary repair of a tyre and can also be used for adjusting tyre pressures.
2. Chocks* to immobilise the wheels of the vehicle.
3. Bolt cover removal tool*.
For removing the wheel bolt finishers (covers) on alloy wheels.
4. Removable towing eye.
See the "Towing the vehicle" section.

* Depending on equipment.

Description of the kit



The tyre inflation pressures are given on this label.



- A. "Sealant" or "Air" position selector.
- B. On "I" / off "O" switch.
- C. Deflation button.
- D. Pressure gauge (in bar and psi).
- E. Compartment housing:
 - a cable with adaptor for 12 V socket,
 - various inflation adaptors for accessories, such as balls, bicycle tyres...



- F. Sealant cartridge.
- G. White pipe with cap for repair.
- H. Black pipe for inflation.
- I. Speed limit sticker.

i The vehicle's electric system allows the connection of a compressor for long enough to inflate a tyre after a puncture repair or for inflating a small inflatable accessory.

i The speed limit sticker I must be affixed to the vehicle's steering wheel to remind you that a wheel is in temporary use. Do not exceed a speed of 50 mph (80 km/h) when driving with a tyre repaired using this type of kit.

Repair procedure

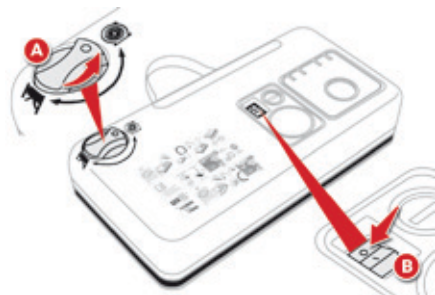

1. Sealing

- ☞ Switch off the ignition.
- ☞ Turn the selector **A** to the "sealant" position.
- ☞ Check that the switch **B** is in position "O".



- ☞ Uncoil the white pipe **G** fully.
- ☞ Unscrew the cap from the white pipe.
- ☞ Connect the white pipe to the valve of the tyre to be repaired.

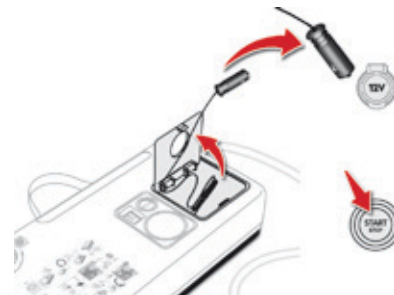

- ☞ Connect the compressor's electric plug to the vehicle's 12 V socket.
- ☞ Start the vehicle and leave the engine running.

i Avoid removing any foreign bodies which have penetrated into the tyre.

! Take care, this product is harmful (e.g. ethylene-glycol, colophony...) if swallowed and causes irritation to the eyes. Keep this product out of the reach of children.

i Do not start the compressor before connecting the white pipe to the tyre valve: the sealant product would be expelled through the pipe.

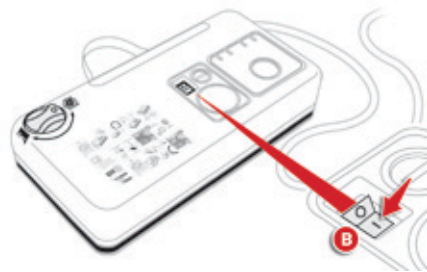

- ☞ Switch on the compressor by moving the switch **B** to position "I" until the tyre pressure reaches 2.0 bars. The sealant is injected into the tyre under pressure; do not disconnect the pipe from the valve during this operation (risk of splashing).

i If after around 5 to 7 minutes the pressure is not attained, this indicates that the tyre is not repairable; contact a CITROËN dealer or a qualified workshop for assistance.

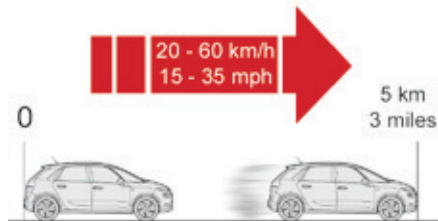

- ☞ Remove the kit and screw the cap back on the white pipe. Take care to avoid staining your vehicle with traces of fluid. Keep the kit to hand.
- ☞ Drive immediately for approximately three miles (five kilometres), at reduced speed (between 15 and 35 mph (20 and 60 km/h)), to plug the puncture.
- ☞ Stop to check the repair and the tyre pressure using the kit.

i Tyre under-inflation detection

After repair of the tyre, the warning lamp will remain on until the system is reinitialised. For more information, refer to the "Under-inflation detection" section.

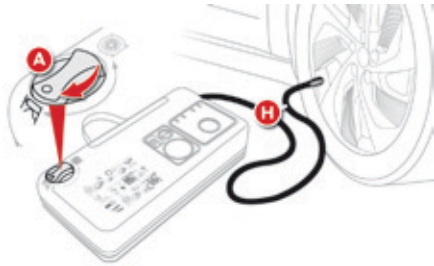

2. Inflation

- ☞ Turn the selector **A** to the "air" position.
- ☞ Uncoil the black pipe **H** fully.
- ☞ Connect the black pipe to the valve of the wheel.

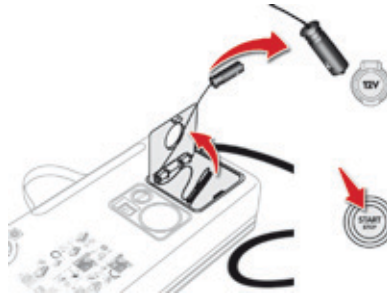

- ☞ Connect the compressor's electric plug to the vehicle's 12 V socket.
- ☞ Start the vehicle again and leave the engine running.

! As soon as possible, go to a CITROËN dealer or a qualified workshop. You must inform the technician that you have used this kit. After inspection, the technician will advise you on whether the tyre can be repaired or if it must be replaced.

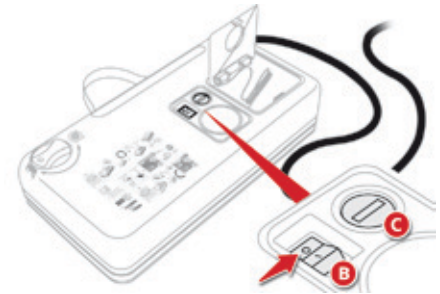

- ☞ Adjust the pressure using the compressor (to inflate: switch **B** in position "I"; to deflate: switch **B** in position "O" and press button **C**), in accordance with the vehicle's tyre pressure label (located on the left hand door aperture).
A loss of pressure indicates that the puncture has not been fully plugged; contact a CITROËN dealer or qualified workshop for assistance.
- ☞ Remove and stow the kit.
- ☞ Drive at reduced speed (50 mph [80 km/h] max) limiting the distance travelled to approximately 120 miles (200 km).

Removing the cartridge

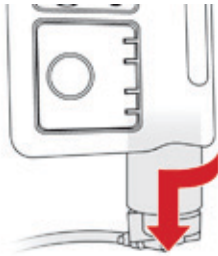

- ☞ Stow the black pipe.
- ☞ Detach the angled base from the white pipe.
- ☞ Support the compressor vertically.
- ☞ Unscrew the cartridge from the bottom.

- ! Beware of discharges of fluid.
The expiry date of the fluid is indicated on the cartridge.
The sealant cartridge is designed for single use; even if only partly used, it must be replaced.
After use, do not discard the cartridge into the environment, take it to an authorised waste disposal site or a CITROËN dealer.
Do not forget to obtain a new sealant cartridge, available from CITROËN dealers or from a qualified workshop.

Checking tyre pressures / inflating accessories

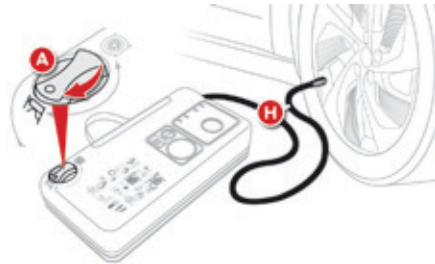

You can also use the compressor, without injecting any product, to:

- check or adjust the pressure of your tyres,
- inflate other accessories (balls, bicycle tyres...).

- ☞ Turn the selector **A** to the "Air" position.
- ☞ Uncoil the black pipe **H** fully.
- ☞ Connect the black pipe to the valve of the wheel or accessory.
If necessary, fit one of the adaptors supplied with the kit first.

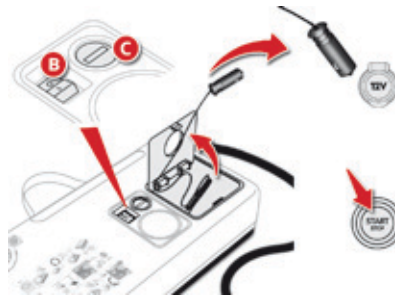

- ☞ Connect the compressor's electrical connector to the vehicle's 12 V socket.
- ☞ Start the vehicle and let the engine run.
- ☞ Adjust the pressure using the compressor (to inflate: switch **B** in position "I"; to deflate: switch **B** in position "O" and press button **C**), according to the vehicle's tyre pressure label or the accessory's pressure label.
- ☞ Remove the kit then stow it.

! Should the pressure of one or more tyres be adjusted, it is necessary to reinitialise the under-inflation detection system. Refer to the "Under-inflation detection" section.



Changing a wheel

Procedure for changing a faulty wheel for the spare wheel using the tools provided with the vehicle.

Access to the tools

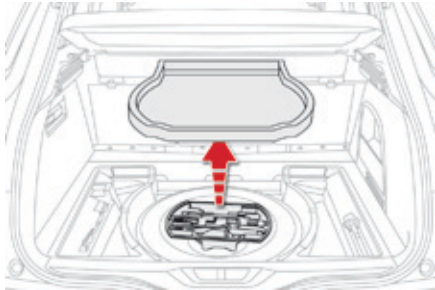

The tools are installed in the boot under the floor.

Remove the boot carpet for access to them.

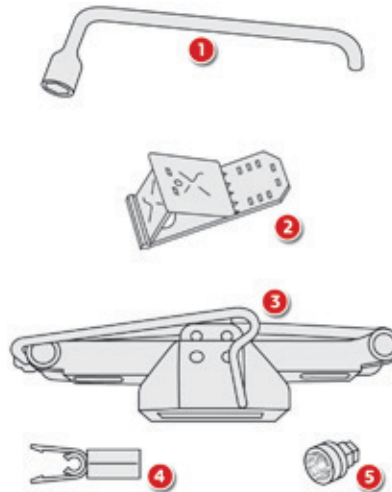

List of tools*

All of these tools are specific to your vehicle and can vary according to the level of equipment. Do not use them for other purposes.

1. Wheelbrace.
For removing the wheel trim and removing the wheel bolts.
2. Chock for immobilising the vehicle (except versions with manual gearbox).
3. Jack with integral handle.
For raising the vehicle.
4. Wheel bolt cover removal tool.
For removing the finishers on the heads of the wheel bolts on alloy wheels.
5. Socket for the security bolts (located in the glove box).
For adapting the wheelbrace to the special "security" bolts.

* According to equipment.

Access to the spare wheel

The spare wheel is located in the boot under the floor.

for access to the spare wheel, refer to the "Access to the tools" section.



Taking out the wheel

- ☞ Unscrew the central green screw.
- ☞ Lift the spare wheel towards you from the rear.
- ☞ Remove the wheel from the boot.

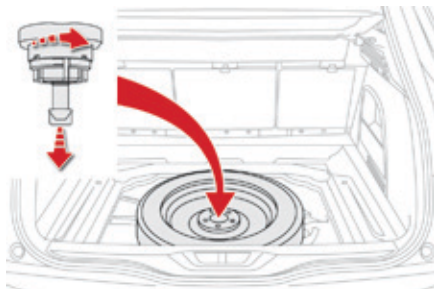

Putting the spare wheel back in place

- ☞ Return the wheel to its housing.
- ☞ Unscrew the central screw a few turns, then put it in place in the middle of the wheel.
- ☞ Fully tighten the central screw to secure the wheel correctly.

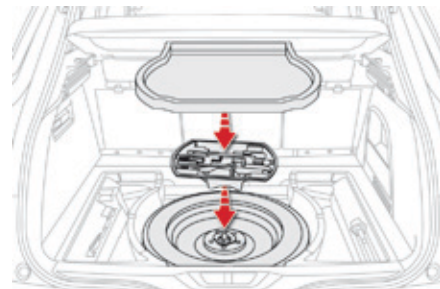

- ☞ Return the box to its position in the middle of the wheel.

i As the spare wheel is narrower than the wheels on the vehicle, in the event of a puncture, the punctured wheel must be carried in the boot.



Changing a wheel

Procedure for changing a wheel with a punctured tyre by the spare wheel using the tools provided with the vehicle.

Access to the vehicle's tools*

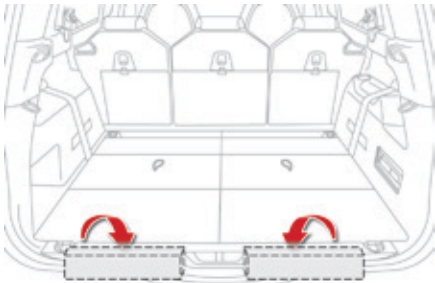

Some of the tools are accessible from inside the boot.

The wheel chock **2** as well as the wheelbrace extension **6** are stowed under the right hand boot sill trim.

The wheelbrace **1** and the towing eye **7** are stowed under the left hand boot sill.

The other tools, the jack **3** and the tool for removing the wheel bolt head finishers for alloy wheels **4**, are stowed in a box attached to the spare wheel.

The assembly is secured under the vehicle in a carrier.
(See the "Access to the spare wheel" section).

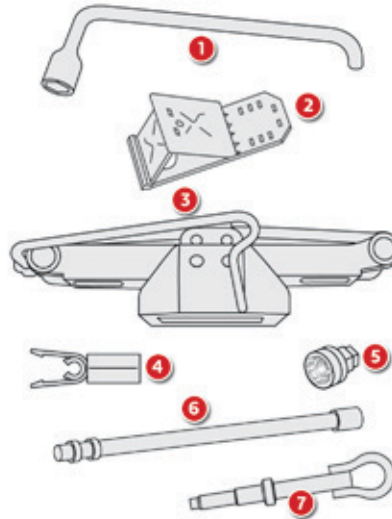

List of tools*

All of these tools are specific to your vehicle and can vary according to equipment. Do not use them for other purposes.

1. Wheelbrace.
For removing the wheel trim and the wheel fixing bolts.

2. Wheel chock for immobilising the vehicle (except versions with manual gearbox).
3. Jack with integral handle.
For raising the vehicle.
4. Wheel bolt head cover removal tool.
For removing the wheel bolt head finishers on alloy wheels.
5. Socket for the security bolts (stowed in the glove box).
For adapting the wheelbrace to the special security bolts.
6. Wheelbrace extension.
For unscrewing/tightening the spare wheel carrier drive.
7. Towing eye.

Wheel with trim

When removing the wheel, detach the trim first using the wheelbrace **1** pulling at the valve passage hole.

When refitting the wheel, refit the trim starting by placing its notch facing the valve and press around its edge with the palm of your hand.

* Depending on version. A complete set of tools is provided with the spare wheel.

Access to the spare wheel*



The spare wheel is supported by a carrier underneath the vehicle.

i Only a "space-saver" type of spare wheel can be fitted under the vehicle.

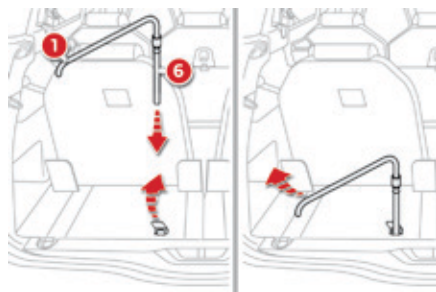

Taking out the spare wheel

- ☞ Fold the concertina board and put the left hand third row seat into position (if your vehicle has them).
- ☞ Raise the pre-cut section of carpet to expose the nut for operating the spare wheel carrier.
- ☞ Using the extension **6** fitted to the end of the wheelbrace **1**, turn the nut clockwise to unwind the carrier cable until the spare wheel reaches the ground. Unwind the length needed for access to the wheel.



- ☞ Take out the wheel / tool box assembly from the rear of the vehicle.
- ☞ Straighten the spare wheel for access to the tools (**A**).

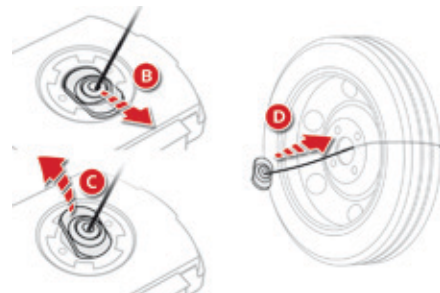

- ☞ Detach the link piece from the tool box lid (**B - C**).
- ☞ Pass the link piece through the middle of the wheel to free it (**D**).

* Depending on version.

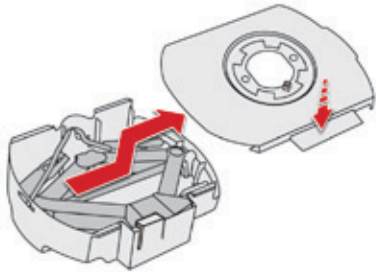

- ☞ Press the tongue, slide the tool box cover to the centre and remove it for access to the other tools (jack and wheel bolt head finisher removal tool for alloy wheels).

Stowing the tools

- ☞ Return the tools to the box and stow the box in the vehicle's boot.
- ☞ Wind in the carrier by turning the wheelbrace clockwise: once the cable is fully wound in you should no longer feel any resistance.
- ☞ Stow the other tools in the locations provided in the boot.

! A puncture wheel from the vehicle cannot be fitted under the vehicle. It must be carried in the boot. Use a cover to protect the boot.



Putting the carrier and spare wheel back in place

- ☞ Stow the corresponding tools in the box and close the cover.
- ☞ Position the tool box on the ground.

! When the spare wheel is fitted in place of a punctured wheel, it is essential to return the carrier and tools to their normal position under the vehicle before moving off.

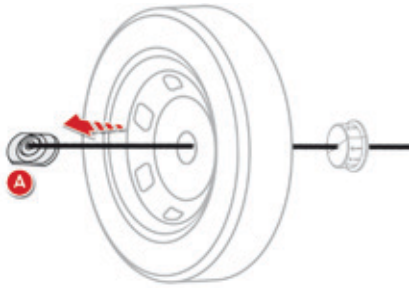

- ☞ Straighten the wheel.
- ☞ Pass the link piece through the middle of the wheel (A).

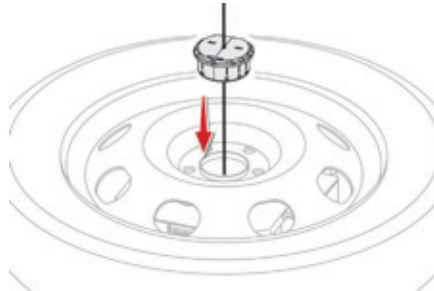

- ☞ Insert the centre guide into the middle of the wheel.
- ☞ Place the wheel / tool box assembly under the rear of the vehicle.

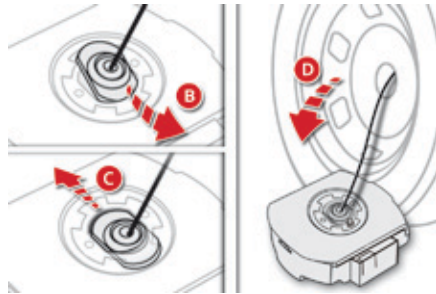

- ☞ Insert the link piece in the aperture in the tool box (B - C).
- ☞ Centre and position the spare wheel on the tool box (D).

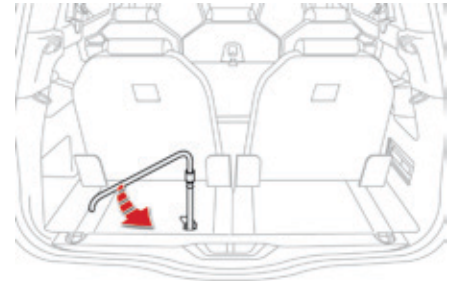

- ☞ Raise the wheel / tool box assembly underneath the vehicle by turning the carrier drive nut anticlockwise using the wheelbrace and the extension.
- ☞ Tighten fully. When the cable is fully wound in, rotation of the nut no longer presents any resistance.
- ☞ Check that the wheel is horizontally flat against the floor.

Removing a wheel

i Parking the vehicle

Immobilise the vehicle where it does not block traffic: the ground must be level, stable and not slippery.

Apply the parking brake unless it has been programmed to automatic mode, switch off the ignition and engage first gear* to block the wheels.

Check that the braking warning lamp and the **P** warning lamp in the parking brake control lever come on.

For greater safety, place the chock **2** against the wheel opposite to the one being changed.

The occupants must get out of the vehicle and wait where they are safe. Never go underneath a vehicle raised using a jack; use an axle stand.

List of operations

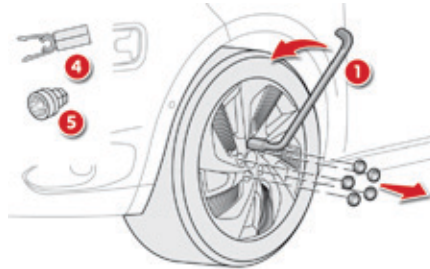

- ☞ Remove the finisher from from each of bolts using the tool **4** (depending on equipment).
- ☞ Fit the security socket **5** on the wheelbrace **1** to slacken the security bolt (if fitted).
- ☞ Slacken the other bolts (no more than a 1/4 turn) using the wheelbrace **1** only.

- !** Do not use:
- the jack for any purpose other than lifting the vehicle,
 - any other jack than the one supplied by the manufacturer.

* Position **R** for an electronic gearbox or **P** for an automatic gearbox.



- ☞ Place the foot of the jack **3** on the ground and check that it is directly below the front **A** or rear **B** jacking point provided on the underbody, whichever is closest to the wheel to be changed.



Ensure that the jack is stable. If the ground is slippery or loose, the jack may slip or drop - Risk of injury!
Ensure that the jack is positioned only at one of the jacking points **A** or **B** under the vehicle, making sure that the vehicle's contact surface is centred on the head of the jack. Otherwise there is a risk of damage to the vehicle and/or of the jack dropping - Risk of injury!

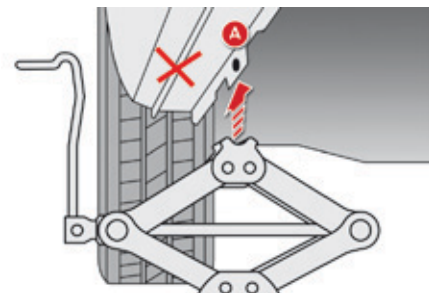
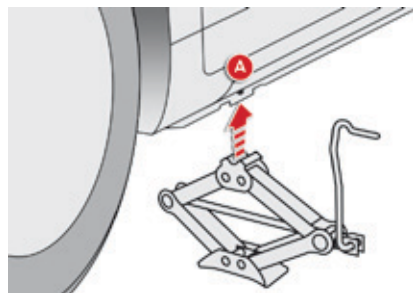

- ☞ Extend the jack **3** until its head comes into contact with the jacking point **A** or **B** used; the vehicle's contact surface **A** or **B** must engage with the central part of the head of the jack.
- ☞ Raise the vehicle until there is sufficient space between the wheel and the ground to admit the spare (not punctured) wheel easily.

Fitting a wheel

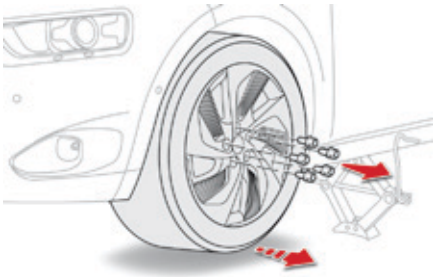

- ☞ Remove the bolts and store them in a clean place.
- ☞ Remove the wheel.



i Fitting the "space-saver" spare wheel

If your vehicle is fitted with alloy wheels, when tightening the bolts on fitting, it is normal to notice that the washers do not come into contact with the "space-saver" spare wheel. The wheel is secured by the conical surface of each bolt.

i After changing a wheel

To correctly store the punctured wheel in the boot (**not in the location of the space-saver wheel**), first remove the central cover.

When using the "space-saver" type spare wheel, do not exceed 50 mph (80 km/h).

Have the tightening of the bolts and the pressure of the spare wheel checked by a CITROËN dealer or a qualified workshop without delay.

Have the punctured wheel repaired and refitted to the vehicle as soon as possible.

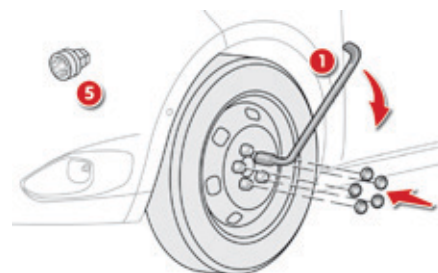
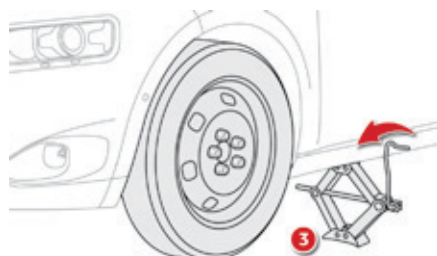
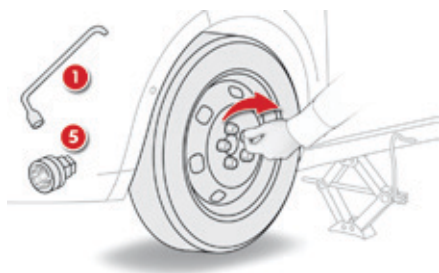

List of operations

- ☞ Put the wheel in place on the hub.
- ☞ Screw in the bolts fully by hand.
- ☞ Pre-tighten the security bolt using the wheelbrace **1** fitted with the security socket **5** (depending on equipment).
- ☞ Pre-tighten the other bolts using the wheelbrace **1** only.

- ☞ Lower the vehicle fully.
- ☞ Fold the jack **3** and detach it.

- ☞ Tighten the security bolt using the wheelbrace **1** fitted with the security socket **5** (depending on equipment).
- ☞ Tighten the other bolts using the wheelbrace **1** only.
- ☞ Refit the bolt covers on each of the bolts or the hub cap (depending on equipment).
- ☞ Store the tools in the box.

Snow chains

In wintry conditions, snow chains improve traction as well as the behaviour of the vehicle when braking.

i The snow chains must be fitted only to the front wheels. They must never be fitted to "space-saver" type spare wheels.

i It is strongly recommended that before you leave, you practise fitting the snow chains on a level and dry surface.

Use only chains designed to be fitted the type of wheel on your vehicle:

Original tyre size	Specification of chains.
205/60 R16	Maximum link size: 9 mm
205/55 R17	
225/45 R18	THULE model K-Summit K34 only

For more information on snow chains, contact a CITROËN dealer or a qualified workshop.

i Take account of the legislation in force in your country on the use of snow chains and the maximum running speed authorised.

Advice on installation

- ☞ If you have to fit the chains during a journey, stop the vehicle on a flat surface on the side of the road.
- ☞ Apply the parking brake and position any wheel chocks to prevent movement of your vehicle.
- ☞ Fit the chains following the instructions provided by the manufacturer.
- ☞ Move off gently and drive for a few moments, without exceeding 30 mph (50 km/h).
- ☞ Stop your vehicle and check that the snow chains are correctly tightened.

i Avoid driving with snow chains on roads that have been cleared of snow, to avoid damaging your vehicle's tyres and the road surface. If your vehicle is fitted with alloy wheels, check that no part of the chain or its fixings is in contact with the wheel rim.

Changing a bulb

Front lamps

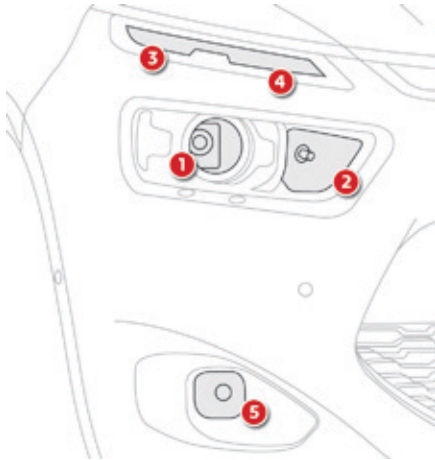

Model with xenon headlamps

1. Directional dipped beam headlamps (D5S-25W).
2. Main beam headlamps (H7-55W).
3. Daytime running lamps / sidelamps (6 light emitting diodes - LEDs).
4. Direction indicators (6 light emitting diodes - LEDs).
5. Front foglamps (H11-55W).

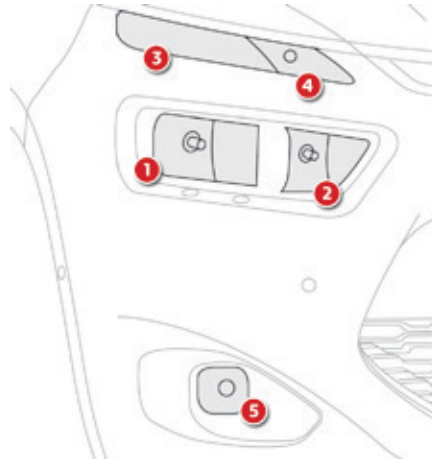

Model with halogen headlamps

1. Dipped beam headlamps (H7-55W).
2. Main beam headlamps (H7-55W).
3. Daytime running lamps/sidelamps (4 light emitting diodes - LEDs).
4. Direction indicators (PWY24W).
5. Foglamps (H11-55W).

! Risk of electrocution

Xenon bulbs (D5S-25W) must be replaced by a CITROËN dealer or a qualified workshop.

i For H7 type bulbs with lugs... take care to observe their correct installation so as to ensure the best lighting performance.

In some weather conditions (e.g. low temperature or humidity), the presence of misting on the internal surface of the glass of the headlamps and rear lamps is normal; it disappears after the lamps have been on for a few minutes.

Light emitting diodes-LEDs

For replacement, contact a CITROËN dealer or qualified workshop.

- !** The headlamps are fitted with polycarbonate glass with a protective coating:
- ☞ **do not clean them using a dry or abrasive cloth, nor with a detergent or solvent product,**
 - ☞ use a sponge and soapy water or a pH neutral product,
 - ☞ when using a high pressure washer on persistent marks, do not keep the lance directed towards the lamps or their edges for too long, so as not to damage their protective coating and seals.

Changing a bulb should only be done after the headlamp has been switched off for several minutes (risk of serious burns).

- ☞ Do not touch the bulb directly with your fingers, use a lint-free cloth.

It is imperative to use only anti-ultraviolet (UV) type bulbs to avoid damaging the headlamp.

Always replace a failed bulb with a new bulb with the same type and specification.

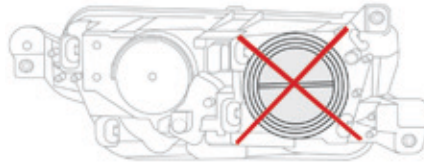

Directional dipped beam headlamps (xenon model)

- !** D5S xenon bulbs must be changed by a CITROËN dealer or a qualified workshop, as there is a risk of electrocution.
- In the event of failure of one of the D5S bulbs, it is recommended that the bulb on the other side be changed at the same time.

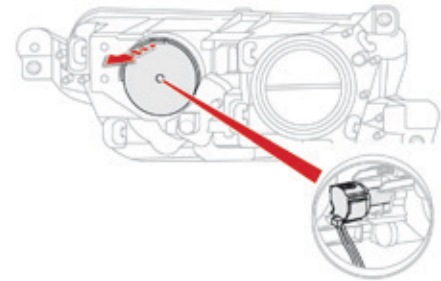

Main beam headlamps (xenon model)

- ☞ Remove the protective plastic cover by pulling the tab.
- ☞ Push the connector.
- ☞ Remove the bulb and change it.

For reassembly, carry out these operations in reverse order.

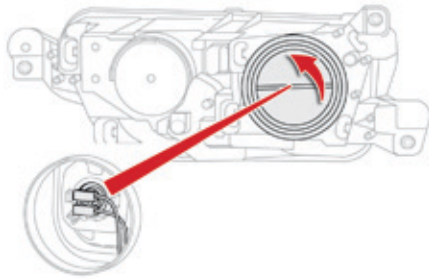

Dipped beam headlamps (halogen model)

- ☞ Turn the protective plastic cover to remove it.
- ☞ Disconnect the connector.
- ☞ Release the clips.
- ☞ Remove the bulb and change it.

For reassembly, carry out these operations in reverse order.

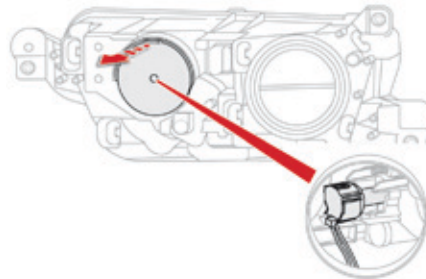

Main beam headlamps (halogen model)

- ☞ Remove the protective plastic cover by pulling the tab.
- ☞ Push the connector.
- ☞ Remove the bulb and change it.

For reassembly, carry out these operations in reverse order.

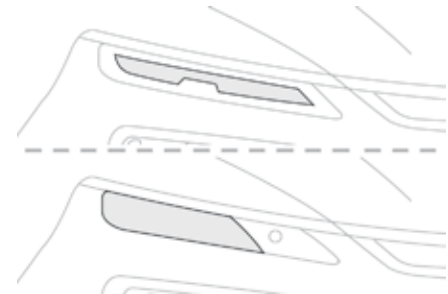

Daytime running lamps / sidelamps

For the replacement of this type of LED lamp and lighting guides, contact a CITROËN dealer or a qualified workshop.

A replacement kit for the LEDs is available from CITROËN dealers.

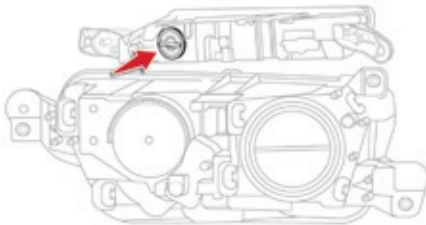

Direction indicators

- i** Faster flashing of a direction indicator warning lamp (left or right) indicates a failed bulb on that side.

The direction indicator bulb is located below the front lamp.

- ☞ Turn the bulb holder a quarter turn anti-clockwise.
- ☞ Remove the bulb holder.
- ☞ Change the failed bulb.

For reassembly, carry out these operations in reverse order.

Direction indicators (light emitting diodes - LED)

For the replacement of this type of lamp, contact a CITROËN dealer or a qualified workshop.

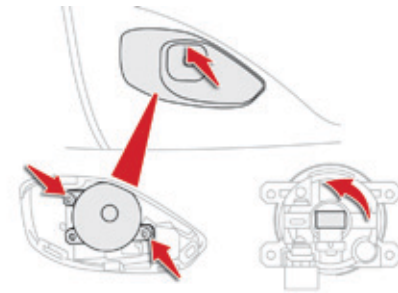

Front foglamps

- ☞ Unclip the finisher by pulling at the top.
- ☞ Remove the two screws to remove the unit.
- ☞ Turn the bulb holder a quarter turn.
- ☞ Remove the bulb holder.
- ☞ Change the failed bulb.

For reassembly, carry out these operations in reverse order, pressing on the finisher to refit it.

Door mirror spotlamps

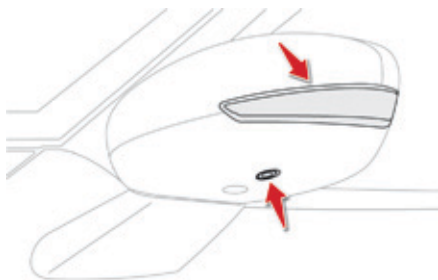

You should contact a CITROËN dealer or a qualified workshop for the replacement of the light emitting diode - LED.

Integrated direction indicator side repeaters

You should contact a CITROËN dealer or a qualified workshop for the replacement of these bulbs.

Rear lamps

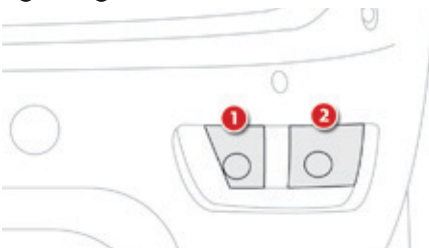

1. Direction indicator (PY21W amber).
2. Sidelamp / foglamp (P21/5W).

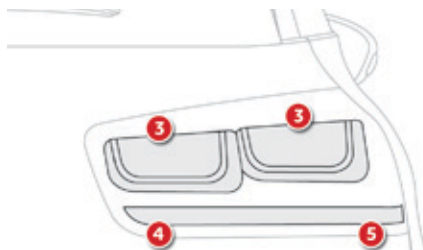

Model with LED lamps

3. Brake lamp / sidelamp (light emitting diodes-LED).
4. Reversing lamp (W16W).
5. Direction indicator (PY21W).

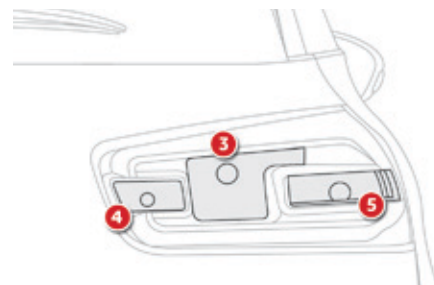

Model with conventional bulb lamps

3. Brake lamp / sidelamp (P21/5W).
4. Reversing lamp (W16W).
5. Direction indicator (PY21W).

i Light emitting diodes-LEDs

For replacement, contact a CITROËN dealer or qualified workshop.

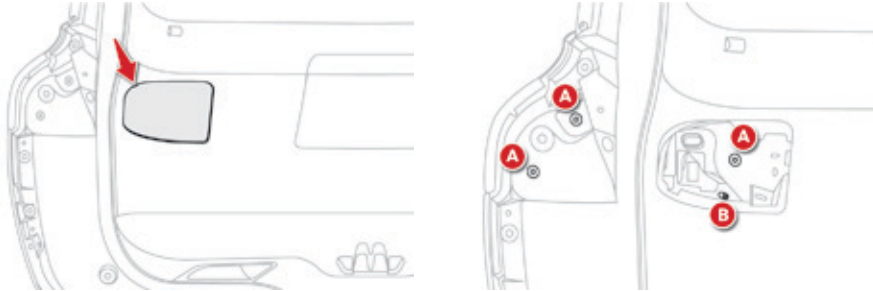

Lamps on the tailgate

Identify the failed bulb.

- ☞ Open the boot.
- ☞ Remove the access cover.

- ☞ Remove the three lamp fixing screws **A**.
- ☞ Disconnect the lamp connector.
- ☞ Carefully remove the lamp from the outside by pressing the retaining clip **B**.

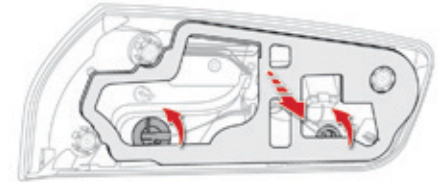

Model with LED lamps

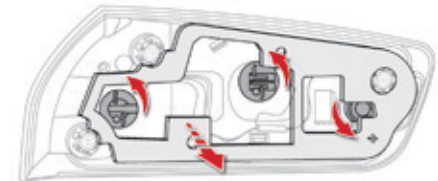

Model with conventional bulb lamps

- ☞ Turn the bulb holder a quarter of a turn anti-clockwise and pull the bulb out.
- ☞ Change the bulb.

For reassembly, carry out these operations in reverse order.



Rear lamps



1. Direction indicator (PY21W amber).
2. Sidelamp / foglamp (P21/5W).

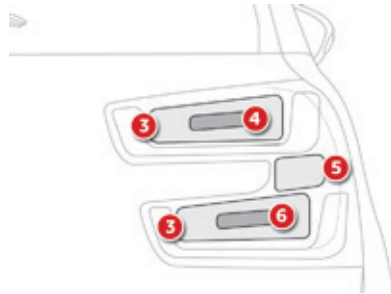

Model with LED lamps

3. Sidelamp (light emitting diodes-LED).
4. Brake lamp (light emitting diodes-LED).
5. Direction indicator (PY21W).
6. Reversing lamp (light emitting diodes-LED).

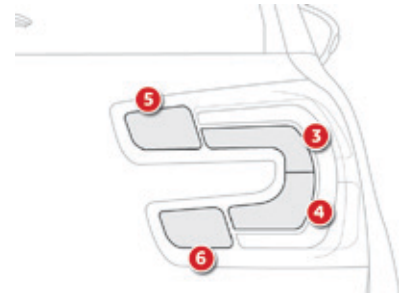

Model with conventional bulb lamps

3. Sidelamp (P21/5W).
4. Brake lamp / sidelamp (P21/5W).
5. Direction indicator (PY21W).
6. Reversing lamp (P21W).

i Light emitting diodes-LEDs

For replacement, contact a CITROËN dealer or qualified workshop.

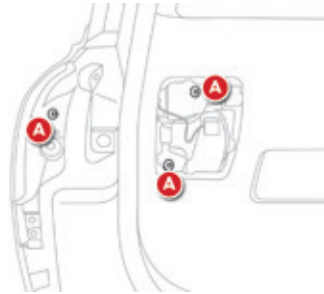
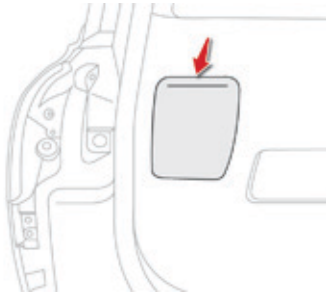

Lamps on the tailgate

Identify the failed bulb.

- ☞ Open the boot.
- ☞ Remove the access cover.

- ☞ Remove the three lamp fixing screws **A**.
- ☞ Disconnect the lamp connector.
- ☞ Carefully remove the lamp from its housing.
- ☞ Turn the bulb holder a quarter of a turn anti-clockwise and pull the bulb out.
- ☞ Change the bulb.

For reassembly, carry out these operations in reverse order.

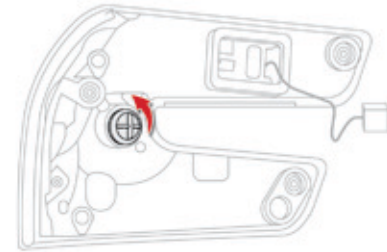

Model with LED lamps

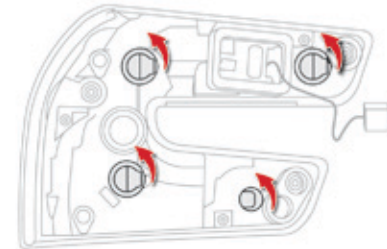

Model with conventional bulb lamps

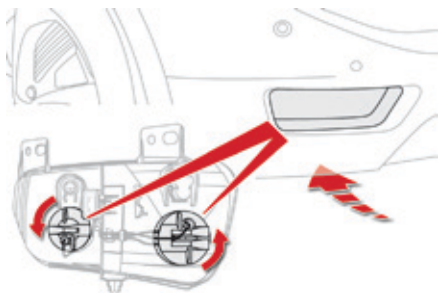

Direction indicator, sidelamp and foglamp

Access is by passing a hand under the bumper.

- ☞ Turn the bulb holder a quarter of a turn and pull it out.
- ☞ Change the bulb.

For reassembly carry out these operations in reverse order.

You can also contact a CITROËN dealer or a qualified workshop for the replacement of these bulbs.



Third brake lamp (light emitting diodes-LED)

For the replacement of this type of lamp, contact a CITROËN dealer or a qualified workshop.

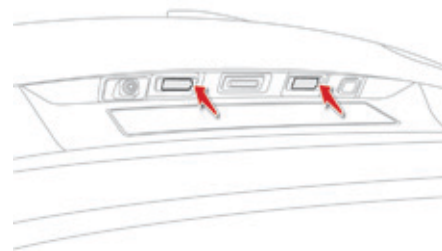

Number plate lamps (W5W)

- ☞ Insert a thin screwdriver into one of the cutouts in the lens.
- ☞ Push it outwards to unclip it.
- ☞ Remove the lens.
- ☞ Change the faulty bulb.

To refit, press on the lens to clip it in place.

Changing a fuse

Access to the tools

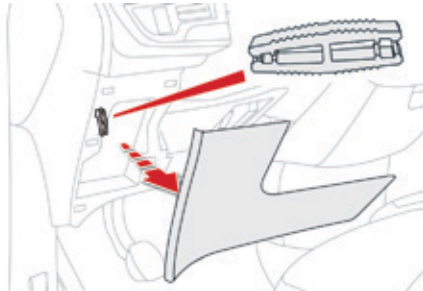

The extraction tweezer is located in the dashboard fusebox compartment.

For access to it:

- ☞ unclip the cover by pulling at the top right, then left,
- ☞ disengage the cover completely, by carefully pulling in the direction indicated by the arrow,
- ☞ remove the tweezer.

Changing a fuse

Before changing a fuse:

- ☞ the cause of the failure must be identified and rectified,
- ☞ all electrical consumers must be switched off,
- ☞ the vehicle must be immobilised with the ignition off,
- ☞ identify the failed fuse using the tables and layout drawings in the following pages.

To replace a fuse, you must:

- ☞ use the special tweezer to extract the fuse from its housing and check the condition of its filament.
- ☞ always replace the failed fuse with a fuse of the same rating (same colour); using a fuse of a different rating could cause faults (risk of fire).

If the fuse fails again soon after replacement, have the vehicle's electrical system checked by a CITROËN dealer or a qualified workshop.

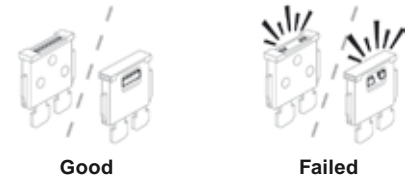

Good

Failed



Tweezer

! The replacement of a fuse not shown in the tables below may cause a serious malfunction of your vehicle. Contact a CITROËN dealer or a qualified workshop.

i Installing electrical accessories

Your vehicle's electrical system is designed to operate with standard or optional equipment.

Before installing other electrical equipment or accessories on your vehicle, contact a CITROËN dealer or a qualified workshop.

! CITROËN will not accept responsibility for the cost incurred in repairing your vehicle or for rectifying malfunctions resulting from the installation of accessories not supplied and not recommended by CITROËN and not installed in accordance with its instructions, in particular when the combined consumption of all of the additional equipment connected exceeds 10 milliamperes.

Configurations

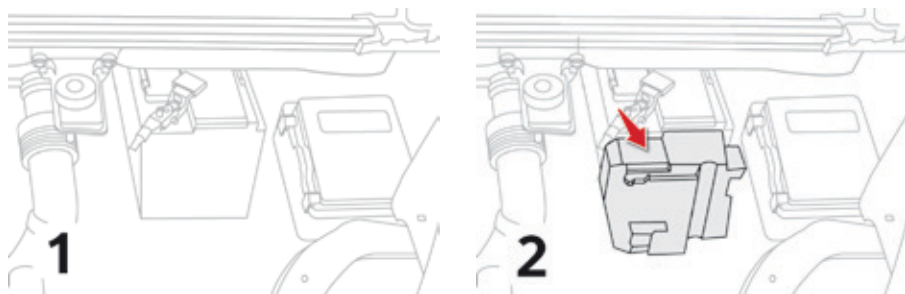

The type of electrical system of the vehicle depends on its level of equipment.

To identify the type of electrical system on your vehicle, open the bonnet: the presence of an additional fusebox in front of the battery indicates that it is type 2.

The type 1 electrical system does not have any fuses in front of the battery.

Dashboard fuses

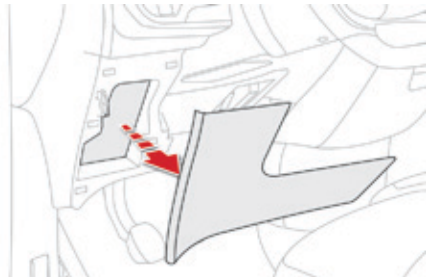

The fusebox is located in the lower dashboard (left-hand side).

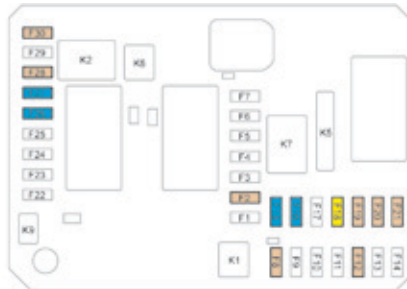

Access to the fuses

☞ Refer to the paragraph "Access to the tools".

Type 1 fuse tables

Fusebox 1

Fuse N°	Rating	Functions
F8	5 A	Steering mounted controls.
F18	20 A	Touch screen tablet, audio and navigation system, CD player, USB ports and auxiliary sockets.
F16	15 A	Front 12V socket.
F15	15 A	Boot 12V socket.
F28	5 A	START/STOP button.
F30	15 A	Rear wiper.
F27	15 A	Front screenwash pump, rear screenwash pump.
F26	15 A	Horn.
F20	5 A	Airbags.
F21	5 A	Instrument panel.
F19	5 A	Rain and sunshine sensor.
F12	5 A	Keyless starting unit.
F2	5 A	Manual headlamp adjustment control.



Fusebox 2

Fuse N°	Rating	Functions
F9	15 A	Rear 12V socket.

Type 2 fuse tables



Fuse N°	Rating	Functions
F3	3 A	START/STOP button.
F6A	15 A	Touch screen tablet, audio and navigation system, CD player, USB ports and auxiliary sockets.
F8	5 A	Alarm.
F9	3 A	Steering mounted controls.
F19	5 A	Instrument panel.
F24	3 A	Rain and sunshine sensor.
F25	5 A	Airbags.
F33	3 A	Memorisation of driving position.
F34	5 A	Electric power steering.
F13	10 A	Front 12V socket.
F14	10 A	Boot 12V socket.
F16	3 A	Map reading lamps in row 1 courtesy lamps.
F27	5 A	Electronic gearbox gear selector.
F30	20 A	Rear wiper.
F38	3 A	Manual headlamp adjustment control.

Engine compartment fuses

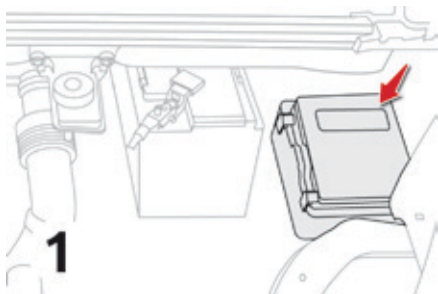

The fusebox is placed in the engine compartment near the battery (left-hand side).

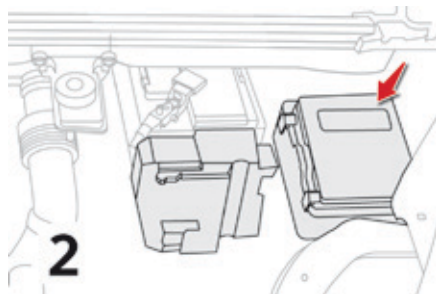

An additional fusebox is fitted in front of the battery, for type 2.

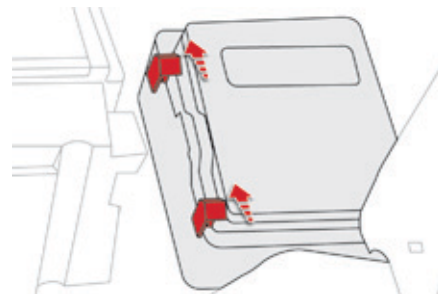

Access to the fuses

- ☞ Unclip the cover, by pushing the two red latches towards the rear of the vehicle.
- ☞ Change the fuse (see corresponding paragraph).
- ☞ When you have finished, close the cover carefully to ensure correct sealing of the fusebox.

Type 1 fuse table

Fuse N°	Rating	Functions
F18	10 A	Right hand main beam.
F19	10 A	Left hand main beam.

Type 2 fuse table

Fusebox 1

Fuse N°	Rating	Functions
F9	30 A	Motorised tailgate.
F18	25 A	Hi-Fi amplifier.
F21	3 A	Hands-free starting reader unit.

Fusebox 2

Fuse N°	Rating	Functions
F19	30 A	Front wiper slow / fast speed.
F20	15 A	Front and rear screenwash pump.
F21	20 A	Headlamp wash pump.

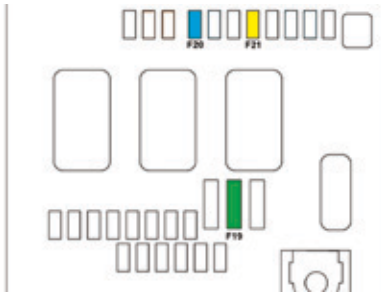

12 V battery

Procedure for starting the engine using another battery or charging a discharged battery.

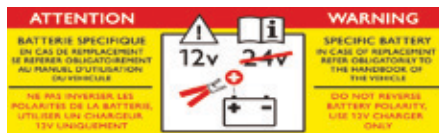

! The presence of this label, in particular with the Stop & Start system, indicates the use of a 12 V lead-acid battery with special technology and specification; the involvement of a CITROËN dealer or a qualified workshop is essential when replacing or disconnecting the battery.

i After refitting the battery, the Stop & Start system will only be active after a continuous period of immobilisation of the vehicle, a period which depends on the climatic conditions and the state of charge of the battery (up to about 8 hours).

Access to the battery

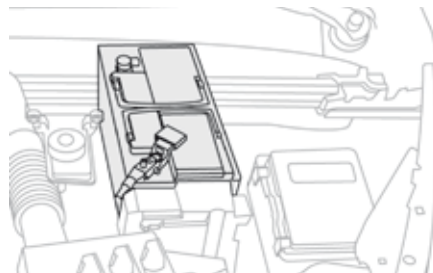

The battery is located under the bonnet.

For access to the (+) terminal:

- ☞ release the bonnet using the interior lever, then the exterior safety catch,
- ☞ raise the bonnet and secure it with its stay,
- ☞ lift the plastic cover for access to the (+) terminal.

Starting using another battery

When your vehicle's battery is discharged, the engine can be started using a slave battery (external or on another vehicle) and jump lead cables.

! First check that the slave battery has a nominal voltage of 12 V and a capacity at least equal to that of the discharged battery.
Do not try to start the engine by connecting a battery charger.
Do not disconnect the (+) terminal when the engine is running.

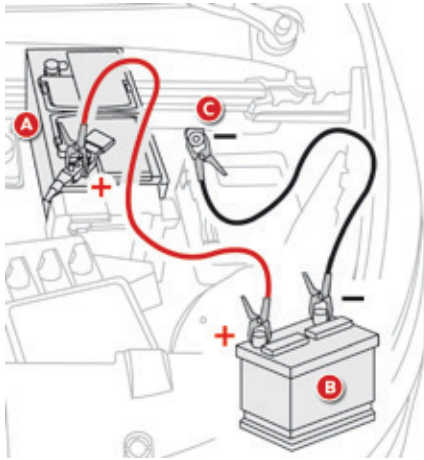

i Some functions are not available if the battery is not sufficiently charged.

- ☞ Remove the plastic cover from the (+) terminal, if your vehicle has one.
- ☞ Connect the red cable to the positive terminal (+) of the flat battery **A**, then to the positive terminal (+) of the slave battery **B**.
- ☞ Connect one end of the green or black cable to the negative terminal (-) of the slave battery **B** (or earth point on the other vehicle).
- ☞ Connect the other end of the green or black cable to the earth point **C** on the broken down vehicle (or on the engine mounting).
- ☞ Start the engine of the vehicle with the good battery and leave it running for a few minutes.
- ☞ Operate the starter on the broken down vehicle and let the engine run. If the engine does not start straight away, switch off the ignition and wait a few moments before trying again.
- ☞ Wait until the engine returns to idle then disconnect the jump lead cables in the reverse order.
- ☞ Refit the plastic cover to the (+) terminal, if your vehicle has one.

Before disconnecting the battery

Wait 2 minutes after switching off the ignition before disconnecting the battery. Close the windows and the doors before disconnecting the battery.

Following reconnection of the battery

Following reconnection of the battery, switch on the ignition and wait 1 minute before starting to permit initialisation of the electronic systems. However, if problems remain following this operation, contact a CITROËN dealer or a qualified workshop. Referring to the corresponding section, you must yourself reinitialise (depending on version):

- the remote control key,
- the electric blind(s),
- ...

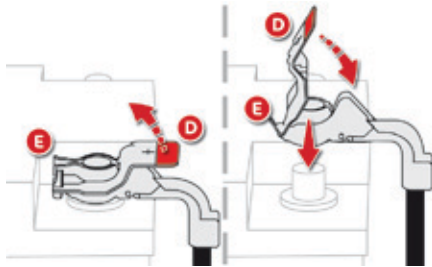

Disconnecting the (+) cable

- ☞ Raise the locking tab **D** fully to release the cable terminal clamp **E**.

Reconnecting the (+) cable

- ☞ Position the open clamp **E** of the cable on the positive post (+) of the battery.
- ☞ Press vertically on the clamp **E** to position it correctly on the battery.
- ☞ Lock the clamp by spreading the positioning lug and then lowering the tab **D**.

! Do not apply excessive force on the tab as locking will not be possible if the clamp is not positioned correctly; start the procedure again.

Charging the battery using a battery charger

i With Stop & Start, the battery does not have to be disconnected for charging.

- ☞ Disconnect the battery from the vehicle.
- ☞ Follow the instructions for use provided by the manufacturer of the charger.
- ☞ Connect the battery starting with the negative terminal (-).
- ☞ Check that the terminals and connectors are clean. If they are covered with sulphate (whitish or greenish deposit), remove them and clean them.

☘ The batteries contain harmful substances such as sulphuric acid and lead. They must be disposed of in accordance with regulations and must not, in any circumstances, be discarded with household waste. Take used remote control batteries and vehicle batteries to a special collection point.

i It is advisable to disconnect the battery if the vehicle is to be left unused for more than one month.

! Protect your eyes and face before handling the battery. All operations on the battery must be carried out in a well ventilated area and away from naked flames and sources of sparks, so as to avoid the risk of explosion or fire.

Do not try to charge a frozen battery; the battery must first be thawed out to avoid the risk of explosion. If the battery has been frozen, before charging have it checked by a CITROËN dealer or a qualified workshop who will check that the internal components have not been damaged and the casing is not cracked, which could cause a leak of toxic and corrosive acid.

Do not reverse the polarity and use only a 12 V charger.

Do not disconnect the terminals while the engine is running.

Do not charge the batteries without disconnecting the terminals first. Wash your hands afterwards.

Do not push the vehicle to start the engine if you have an electronic or automatic gearbox.

Load reduction mode

System which manages the use of certain functions according to the level of charge remaining in the battery.

When the vehicle is being driven, the load reduction function temporarily deactivates certain functions, such as the air conditioning, the heated rear screen...

The deactivated functions are reactivated automatically as soon as conditions permit.

Energy economy mode

System which manages the duration of use of certain functions to conserve a sufficient level of charge in the battery.

After the engine has stopped, you can still use functions such as the audio and telematics system, windscreen wipers, dipped beam headlamps, courtesy lamps, etc. for a maximum combined duration of about forty minutes.

Switching to economy mode

A message then appears in the instrument panel screen indicating that the vehicle has switched to economy mode and the active functions are put on standby.

If a telephone call is being made at this time, it will be maintained for around 10 minutes with the Bluetooth hands-free system of your audio system.

Exiting economy mode

These functions are reactivated automatically next time the vehicle is driven.

- ☞ In order to restore the use of these functions immediately, start the engine and let it run:
 - for less than ten minutes, to use the equipment for approximately five minutes,
 - for more than ten minutes, to use the equipment for up to approximately thirty minutes.

Let the engine run for the duration specified to ensure that the battery charge is sufficient. Do not repeatedly and continuously restart the engine in order to charge the battery.

A flat battery prevents the engine from starting (refer to the "Battery" section).

Changing a wiper blade



Before removing a front wiper blade

- ☞ Within one minute after switching off the ignition, operate the wiper stalk to position the wiper blades vertically on the windscreen,
or
- ☞ From one minute after switching off the ignition, reposition the arms manually.

Removing

- ☞ Raise the corresponding wiper arm.
- ☞ Unclip the wiper blade and remove it.

Fitting

- ☞ Put the corresponding new wiper blade in place and clip it.
- ☞ Fold down the wiper arm carefully.

After fitting a front wiper blade

- ☞ Switch on the ignition.
- ☞ Operate the wiper stalk again to park the wiper blades.

! Replacement of the arms must be done by a CITROËN dealer or a qualified workshop.

Towing the vehicle

Procedure for having your vehicle towed or for towing another vehicle using the towing eye.

Access to the tools



The towing eye is installed in the boot under the floor.

To gain access to it:

- ☞ open the boot,
- ☞ lift the floor and remove it,
- ☞ remove the towing eye from its housing.

! General recommendations

Observe the legislation in force in your country.

Ensure that the weight of the towing vehicle is higher than that of the towed vehicle.

The driver must remain at the wheel of the towed vehicle and must have a valid driving licence.

When towing a vehicle with all four wheels on the ground, always use an approved towing arm; rope and straps are prohibited.

The towing vehicle must move off gently.

When towing a vehicle with the engine off, there is no longer any power assistance for braking or steering.

In the following cases, you must always call on a professional recovery service:

- vehicle broken down on a motorway or fast road,
- four-wheel drive vehicle,
- when it is not possible to put the gearbox into neutral, unlock the steering, or release the parking brake,
- towing with only two wheels on the ground,
- where there is no approved towing arm available...

Towing your vehicle

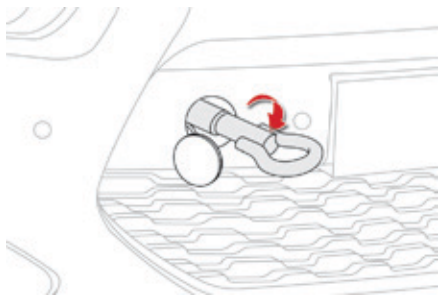

- ☞ On the front bumper, unclip the cover by pressing on the left.
- ☞ Screw the towing eye in fully.
- ☞ Install the towing bar.
- ☞ Place the gear lever in neutral (position **N** on an electronic or automatic gearbox).

i Failure to observe this instruction could result in damage to certain components (braking, transmission...) and the absence of braking assistance the next time the engine is started.

- ☞ Unlock the steering by turning the key in the ignition one notch and release the parking brake.
- ☞ Switch on the hazard warning lamps on both vehicles.
- ☞ Move off gently, drive slowly and for a short distance.

Towing another vehicle

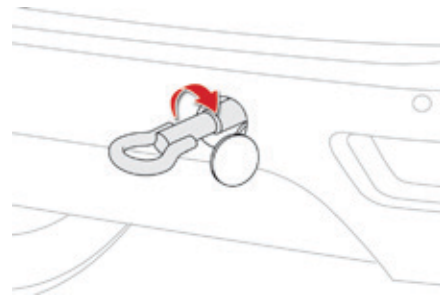

- ☞ On the rear bumper, unclip the cover by pressing at the bottom.
- ☞ Screw the towing eye in fully.
- ☞ Install the towing bar.
- ☞ Switch on the hazard warning lamps on both vehicles.
- ☞ Move off gently, drive slowly and for a short distance.

Towbar with quickly detachable towball

No tools are required to install or remove the towball on this genuine towbar system.

Fitting



- ☞ Below the rear bumper, unclip and remove the protective cover on the carrier.

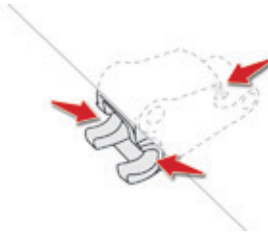

- ☞ Before fitting the towball, check that the points of contact, indicated by the arrows, are clean. Use a soft clean cloth.

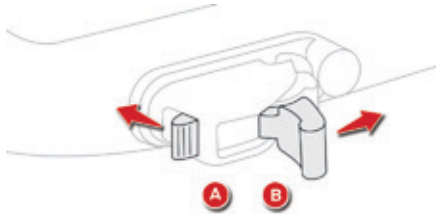

- ☞ On the towball, press and hold control **A**.
- ☞ Release the locking mechanism by pressing the trigger **B**.

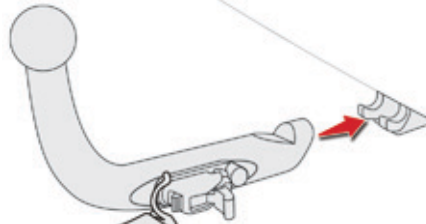

- ☞ Put the end of the towball into the carrier, located below the bumper, as far as it will go.

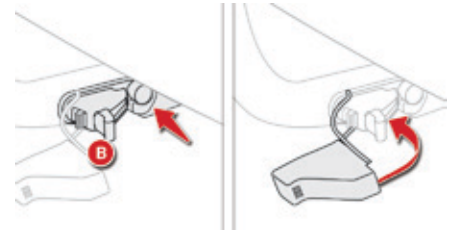

- ☞ Ensure that the towball is fully engaged. The two pins must be in contact with the cut-outs in the carrier and the trigger **B** must have returned to the "locked" position.
- ☞ Install and clip in place the protective cover, by rotating it to the left.

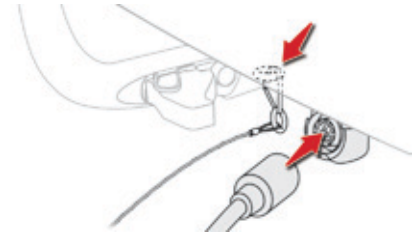

- ☞ Connect the trailer plug to the 13-way socket provided, located next to the carrier.
- ☞ Make the trailer safe by attaching its safety cable to the eye provided for this purpose, located on the carrier.

Removing



- ☞ Unclip and remove the protective cover, by turning it to the right.

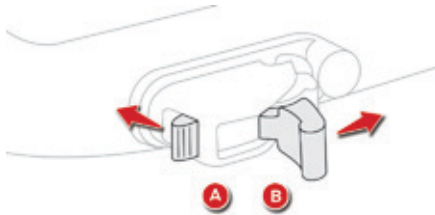

- ☞ On the towball, press and hold control **A**.
- ☞ Release the locking mechanism by pressing the trigger **B**.

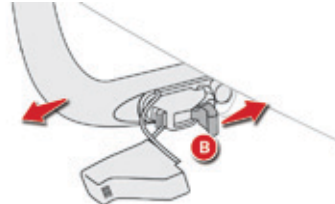

- ☞ Press the trigger **B** and remove the towball by pulling it towards you.

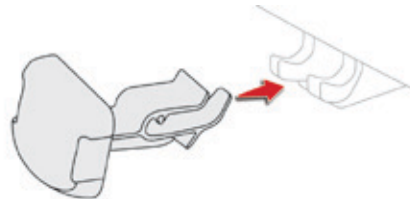

- ☞ Clip the protective cover in place on the carrier located below the bumper.

- i** When the towball is installed, it may interfere with the complete opening of the lower tailgate. Take care to avoid the tailgate coming into contact with the towball.

! If the towball is not locked in place, the trailer could separate. There is a risk of an accident. Always lock the towball in the way described.

Observe the legislation in force in the country in which you are driving. Remove the towball when it is not being used.

Before setting off, check that the trailer lighting and signalling works correctly. Maximum authorised nose weight: 70 kg.

Refer to the "Technical data" section for the maximum weights and towed loads for your vehicle.

Carrying system (box or bicycle carrier). You must not exceed the maximum nose weight on the towbar: if this weight is exceeded, the device could detach from the vehicle and cause a serious accident.

Towing a trailer



i Driving with a trailer places greater demands on the towing vehicle and the driver must take particular care.

Your vehicle is primarily designed for transporting people and luggage, but it may also be used for towing a trailer.

i We recommend the use of genuine CITROËN towbars and their harnesses that have been tested and approved from the design stage of your vehicle, and that the fitting of the towbar is entrusted to a CITROËN dealer or a qualified workshop.
If the towbar is not fitted by a CITROËN dealer, it must still be fitted in accordance with the vehicle manufacturer's instructions.

Driving advice

Distribution of loads

- ☞ Distribute the load in the trailer so that the heaviest items are as close as possible to the axle and the nose weight approaches the maximum permitted without exceeding it.

Air density decreases with altitude, thus reducing engine performance. Above 1 000 metres, the maximum towed load must be reduced by 10 % for every 1 000 metres of altitude.

Refer to the "Technical data" section for details of the weights and towed loads which apply to your vehicle.

Side wind

- ☞ Take into account the increased sensitivity to side wind.

Cooling

Towing a trailer on a slope increases the temperature of the coolant.

As the fan is electrically controlled, its cooling capacity is not dependent on the engine speed.

- ☞ To lower the engine speed, reduce your speed.

The maximum towed load on a long incline depends on the gradient and the ambient temperature.

In all cases, keep a check on the coolant temperature.



- ☞ If the warning lamp and the **STOP** warning lamp come on, stop the vehicle and switch off the engine as soon as possible.



When not towing a trailer, remove the quickly-detachable tow ball before driving.

Braking

Towing a trailer increases the braking distance. To avoid overheating of the brakes on a long mountain type of descent, the use of engine braking is recommended.

Tyres

- ☞ Check the tyre pressures of the towing vehicle and of the trailer, observing the recommended pressures.

Lighting

- ☞ Check the electrical lighting and signalling on the trailer.



The rear parking sensors will be deactivated automatically if a genuine CITROËN towbar is used.

Roof bars

For safety reasons and to avoid damaging the roof, it is essential to use transverse roof bars that are approved for your vehicle.

Observe the fitting instructions and the conditions of use given in the information provided with the roof bars.

Version without longitudinal bars

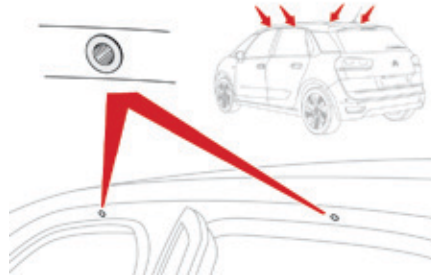

To install the roof bars, you must secure them only to the four anchorage points in the roof frame. These points are masked by the vehicle's doors when closed.

The roof bar fixings include a stud that should be introduced into the aperture at each anchorage point.

Version with longitudinal bars

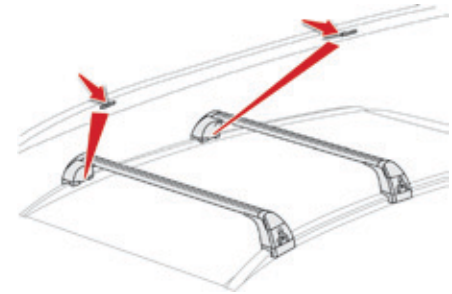

You must fit the transverse bars to the longitudinal bars at the fixing points indicated by engraved markings on the longitudinal bars.

Recommendations

- ☞ Distribute the load evenly, avoiding overloading on one side.
- ☞ Arrange the heaviest part of the load as close as possible to the roof.
- ☞ Anchor the load securely and fit a warning flag if part of it overhangs the vehicle.
- ☞ Drive gently, as the vehicle will be more liable to the effects of side winds (vehicle stability may be affected).
- ☞ Remove the roof bars as soon as they are no longer needed.



Maximum load, distributed over the roof bars, for a loading height not exceeding 40 cm: **80 kg**.

This value is subject to change, please check the maximum load stated in the instructions provided with the roof bars. If the height exceeds 40 cm, adapt the speed of the vehicle to the profile of the road to avoid damaging the roof bars and the fixings on the vehicle.

Please refer to national legislation so as to meet the requirements on carrying objects that are longer than the vehicle.



When carrying long objects, it is recommended that you deactivate the motorised operation of the tailgate.

Very cold climate screen*

Removable protective screen which prevents the accumulation of snow at the radiator cooling fan.

Fitting

- ☞ Offer up the very cold climate screen to the front of the lower section of the front bumper.
- ☞ Press around its edge to engage its fixing clips one by one.

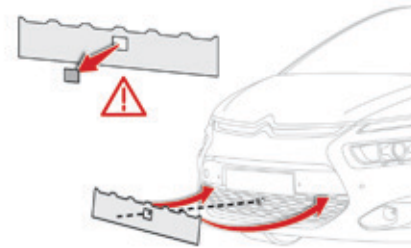

Removal

- ☞ Use a screwdriver as a lever to release each fixing clip in turn.

Do not forget to remove the very cold climate screen when:

- the ambient temperature exceeds 10 °C,
- towing,
- driving at speeds above 75 mph (120 km/h).

i 360 Vision system

The pre-cut zone must be removed before fitting the screen to the front bumper, to allow operation of the camera.

When the very cold climate screen is fitted, the image provided by the camera is slightly different.

* Depending on the country of sale.

Accessories

A wide range of accessories and genuine parts is available from the CITROËN dealer network. These accessories and parts are all suitable for your vehicle and benefit from CITROËN's recommendation and warranty.

"Comfort"

Door deflectors, side window blinds, rear screen blind, insulated module, coat hanger fixed to head restraint, mobile reading lamp, mirror for caravan, parking sensors, programmable additional heating, smoker's kit, solar film for rear door windows, portable scented air freshener...

"Transport systems"

Boot carpet, boot liner, boot net, boot spacers, transverse roof bars, ski carrier, roof boxes, towbars, towbar wiring harnesses, bicycle carriers for towbar and roof bars, towbars with fixed and detachable towball, separation net, sliding carrier, boot organiser (Grand C4 Picasso)...

If a towbar and wiring harness are fitted outside the CITROËN dealer network, the installation must be done strictly in line with the manufacturer's recommendations.

If your vehicle has a detachable towball, it is recommended that the ball be removed when not towing.

"Styling"

Gear lever knobs, aluminium foot rest, alloy wheels...

"Security and safety"

Anti-intrusion alarm, stolen vehicle tracking system, child seats and booster cushions, breathalyser, first aid kit, fire extinguisher, warning triangle, high visibility vest, wheel security bolts, snow chains, non-slip covers, winter tyres, foglamp kit, security film for front door windows, dog guard, pet seat belt...

"Protection"

Mats*, seat covers compatible with lateral airbags, mud flaps, door protective mouldings, bumper protection strips, vehicle cover, boot sill protector, door sill protectors, seat and boot protective covers for pets...

The rear bodywork has been designed to avoid spray.

- * To avoid any risk of jamming the pedals:
- ensure that mats are correctly positioned and secured,
 - never fit one mat on top of another.

"Multimedia"

Speakers, Hi-Fi module, head-up display screen, portable satellite navigation system, driving assistance systems, reversing camera, portable video screen, portable video carrier, telephone carrier, two-screen video pack, portable video player, CD player, 230 V/50 Hz socket, 230 V/12 V adaptor, iPhone/iPad charger...

By visiting a CITROËN dealer you can also obtain cleaning and maintenance products (interior and exterior) - including ecological products in the "TECHNATURE" range, products for topping up (screenwash...), paint touch-up pens and aerosols for the exact colour of your vehicle, refills (sealant cartridge for the temporary puncture repair kit...), ...

i Installation of radio communication transmitters

Before installing any after-market radio communication transmitter, you can contact a CITROËN dealer for the specification of transmitters which can be fitted (frequency, maximum power, aerial position, specific installation requirements), in line with the Vehicle Electromagnetic Compatibility Directive (2004/104/EC).

i Depending on the legislation in force in the country, certain safety equipment may be compulsory: high visibility safety vests, warning triangles, breathalyzers, spare bulbs, spare fuses, fire extinguisher, first aid kit, mud flaps at the rear of the vehicle.

! The fitting of electrical equipment or accessories which are not recommended by CITROËN may result in a failure of your vehicle's electronic system and excessive electrical consumption.
Contact a CITROËN dealer for information on the range of recommended equipment and accessories.

TOTAL & CITROËN

Partners in performance and protecting the environment

Innovation in the search for performance

For over 40 years, the TOTAL Research and Development departments have developed lubricants for CITROËN, to match the latest technical innovations on CITROËN vehicles, both for competition and for everyday motoring.

For you, this is an assurance that you will obtain the best performance from your engine.

Optimum protection for your engine

By having your CITROËN vehicle serviced with TOTAL lubricants, you are contributing towards improving the life and performance of your engine, while also protecting the environment.



CITROËN prefers **TOTAL**



Bonnet

Opening



- ☞ Open the left hand front door.
- ☞ Pull the release lever, located at the bottom of the door aperture, towards you.

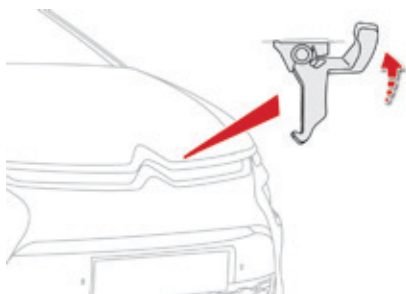

- ☞ Lift the safety catch and raise the bonnet.

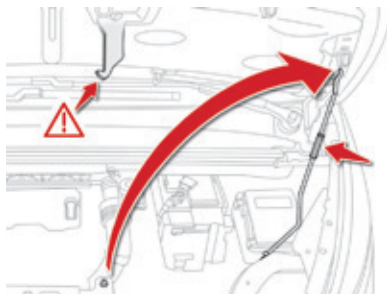

- ☞ Unclip the stay from its housing and place it in the support slot to hold the bonnet open.

Closing

- ☞ Take the stay out of its support slot.
- ☞ Clip the stay back into its housing.
- ☞ Lower the bonnet and release it at the end of its travel.
- ☞ Pull on the bonnet to check that it has latched correctly.

- ! The location of the interior bonnet release lever prevents opening of the bonnet when the left hand front door is shut.
When the engine is hot, handle the exterior safety catch and the stay with care (risk of burns), using the protected area.
When the bonnet is open, take care not to damage the safety catch.
Do not open the bonnet under very windy conditions.

- i Before doing anything under the bonnet, switch off the Stop & Start system to avoid any risk of injury resulting from an automatic change to START mode.

- ! **The cooling fan may start after switching off the engine: take care with articles and clothing that might be caught by the fan blades.**

Because of the presence of electrical equipment under the bonnet, it is recommended that exposure to water (rain, washing, ...) be limited.

Petrol engines

The various caps and covers allow access for checking the levels of the various fluids and for replacing certain components.

1. Screenwash and headlamp wash reservoir.
2. Coolant reservoir.
3. Brake fluid reservoir.
4. Battery / Fuses.
5. Fusebox.
6. Air filter.
7. Engine oil dipstick.
8. Engine oil filler cap.

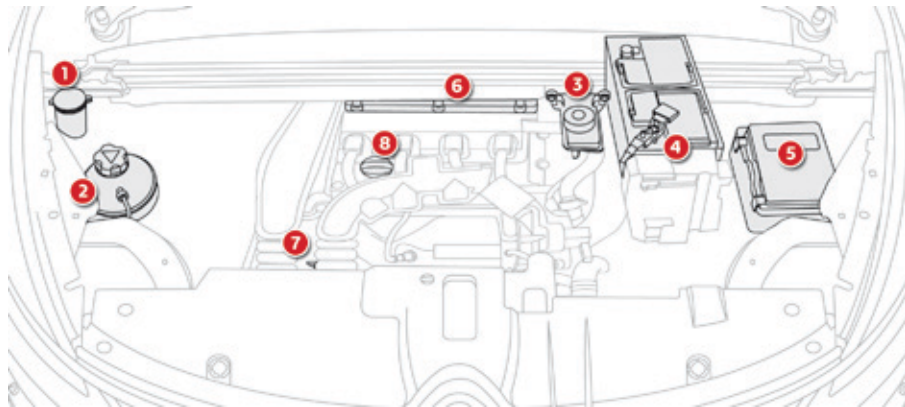
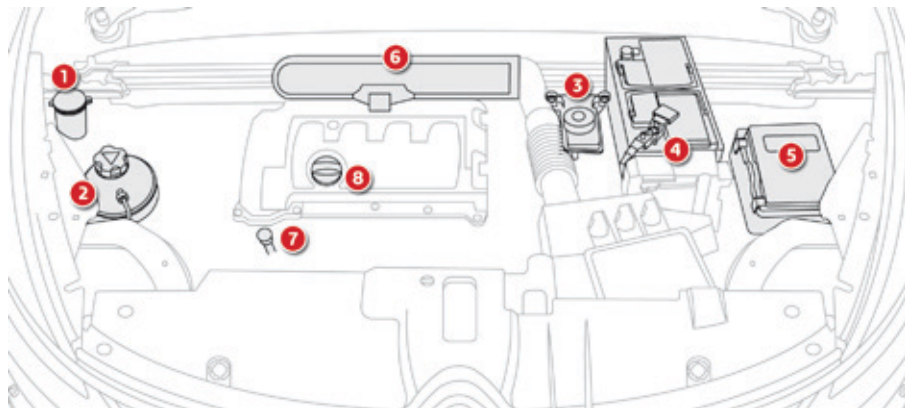

Diesel engines

The various caps and covers allow access for checking the levels of the various fluids, for replacing certain components and for priming the fuel system.

1. Screenwash and headlamp wash reservoir.
2. Coolant reservoir.
3. Brake fluid reservoir.
4. Battery / Fuses.
5. Fusebox.
6. Air filter.
7. Engine oil dipstick.
8. Engine oil filler cap.
9. Priming pump*.

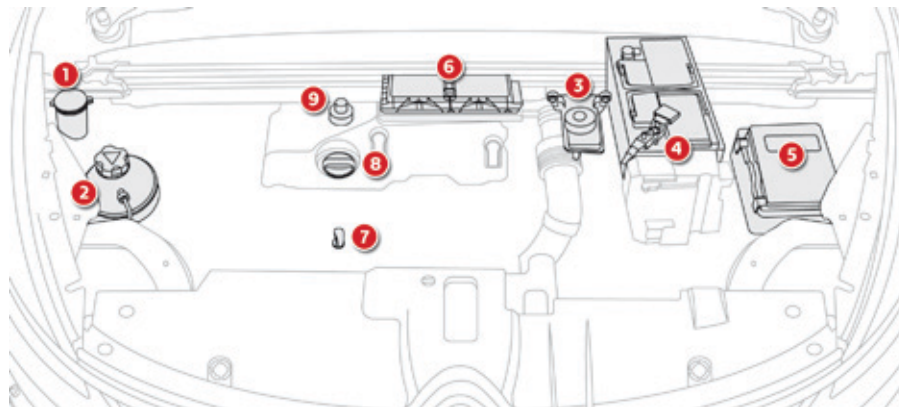

* According to engine.

Fuel

Capacity of the tank: approximately 57 litres (petrol) or 55 litres (Diesel).

Low fuel level



When the low fuel level is reached, this warning lamp comes on in the instrument panel, accompanied by an audible warning and a message and the last bar of the fuel gauge comes on in orange.

When it first comes on, **about 6 litres** of fuel remain in the tank.

Until sufficient fuel has been added, this warning lamp appears every time the ignition is switched on, accompanied by an audible warning and a message. This audible warning and message are repeated with increasing frequency as the fuel level drops towards "0". Refuel as soon as possible to avoid running out.



With Stop & Start, never refuel with the system in STOP mode; you must switch off the ignition with the START/STOP button.

Refuelling

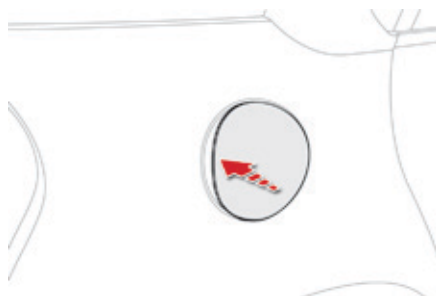

A label on the inside of the fuel filler flap reminds you of the type of fuel to use, depending on your engine type. Additions of fuel must be of at least 5 litres to be registered by the fuel gauge.

Opening the filler flap may result in an inrush of air. This is entirely normal and results from the sealing of the fuel system.

- ☞ With the vehicle unlocked, press the rear edge of the flap to open it (the filler cap is a part of it).

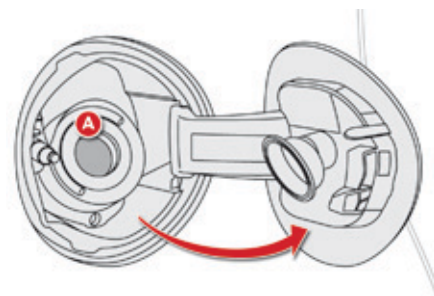

- ☞ Take care to select the pump that delivers the correct type of fuel for your vehicle.
- ☞ Introduce the nozzle so as to push in the metal non-return flap **A**.
- ☞ Make sure that the nozzle is pushed in as far as possible before starting to refuel (risk of blowback).
- ☞ Maintain this position throughout the refuelling operation.
- ☞ Push the fuel flap to close it.

If you are filling your tank to the top, do not persist after the 3rd cut-off; this could cause malfunctions.

Misfuel prevention (Diesel)*

Mechanical device which prevents filling the tank of a Diesel vehicle with petrol. It avoids the risk of engine damage that can result from filling with the wrong fuel.

The petrol or Diesel engine of your vehicle is fitted with a catalytic converter, a device which helps to reduce the level of harmful emissions in the exhaust gases.

For petrol engines, you must use unleaded fuel.

The filler neck is narrower, allowing only unleaded petrol nozzles to be introduced.

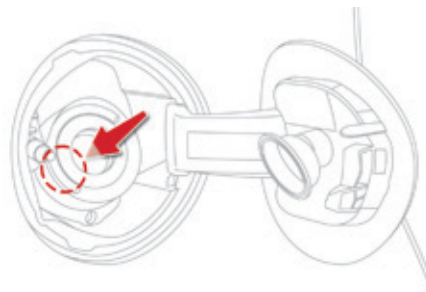

i It remains possible to use a fuel can to fill the tank.
In order to ensure a good flow of fuel, do not place the nozzle of the fuel can in direct contact with the flap of the misfuel prevention device and pour slowly.

! If you have put in the wrong fuel for your vehicle, you must have the fuel tank drained and filled with the correct fuel before starting the engine.

Fuel cut-off

Your vehicle is equipped with a safety device which cuts off the fuel supply in the event of a collision.

Operation

When a petrol filler nozzle is introduced into the fuel filler neck of your Diesel vehicle, it comes into contact with the flap. The system remains closed and prevents filling.

Do not persist but introduce a Diesel type filler nozzle.

i Travelling abroad

As Diesel fuel pump nozzles may be different in other countries, the presence of the misfuel prevention device may make refuelling impossible. Before travelling abroad, we recommend that you check with the CITROËN dealer network, whether your vehicle is suitable for the fuel pumps in the country in which you want to travel.

* Depending on the country of sale.

Fuel used for petrol engines

The petrol engines are compatible with E10 bio-petrol (containing 10 % ethanol), conforming to European standards EN 228 and EN 15376.

E85 type fuels (containing up to 85 % ethanol) are reserved exclusively for vehicles marketed for the use of this type of fuel (BioFlex vehicles). The quality of the ethanol must comply with European standard EN 15293.

Fuel used for Diesel engines

The Diesel engines are compatible with biofuels which conform to current and future European standards (Diesel fuel which complies with standard EN 590 mixed with a biofuel which complies with standard EN 14214) available at the pumps (containing up to 7 % Fatty Acid Methyl Ester).

B30 biofuel can be used in certain Diesel engines. However, this use, even occasional, requires strict application of the special servicing conditions. Contact a CITROËN dealer or a qualified workshop.

The use of any other type of (bio)fuel (vegetable or animal oils, pure or diluted, domestic fuel...) is strictly prohibited (risk of damage to the engine and fuel system).



SP95

SP95
E10

SP98



DIESEL

Running out of fuel (Diesel)

On vehicles fitted with Diesel engines, the fuel system must be primed if you run out of fuel. For all versions other than BlueHDi, refer to the corresponding engine compartment view.

i If the tank on your vehicle is fitted with a misfuel prevention device, refer to the "Misfuel prevention (Diesel)" section.

! If the engine does not start first time, don't keep trying but start the procedure again from the beginning.

BlueHDi engines

- ☞ Fill the fuel tank with at least five litres of Diesel.
- ☞ Switch on the ignition (without starting the engine).
- ☞ Wait around 6 seconds and switch off the ignition.
- ☞ Repeat the operation 10 times.
- ☞ Operate the starter to run the engine.

Other HDi engines (except BlueHDi version)



- ☞ Add at least five litres of Diesel fuel to the tank.
- ☞ Open the bonnet.
- ☞ If necessary, unclip the styling cover for access to the priming pump.
- ☞ Squeeze and release the priming pump repeatedly until resistance is felt (there may be resistance at the first press).
- ☞ Operate the starter to start the engine (if the engine does not start at the first attempt, wait around 15 seconds before trying again).
- ☞ If the engine does not start after a few attempts, operate the priming pump again then start the engine.
- ☞ Refit the styling cover and clip it in place.
- ☞ Close the bonnet.

Checking levels

Check all of these levels regularly, in line with the manufacturer's service schedule. Top them up if necessary, unless otherwise indicated.

If a level drops significantly, have the corresponding system checked by a CITROËN dealer or a qualified workshop.

! Take care when working under the bonnet, as certain areas of the engine may be extremely hot (risk of burns) and the cooling fan could start at any time (even with the ignition off).

Engine oil level



The check is carried out either when the ignition is switched on using the oil level indicator in the instrument panel for vehicles so equipped, or using the dipstick.

i To ensure that the reading is correct, your vehicle must be parked on a level surface with the engine having been off for more than 30 minutes.

It is normal to top up the oil level between two services (or oil changes). CITROËN recommends that you check the level, and top up if necessary, every 3 000 miles (5 000 kms).

Checking using the dipstick

- ☞ Locate the dipstick in the engine compartment of your vehicle. Refer to the "Petrol engine" or "Diesel engine" section.
- ☞ Take the dipstick by its coloured grip and remove it completely.
- ☞ Wipe the end of the dipstick using a clean non-fluffy cloth.
- ☞ Refit the dipstick and push fully down, then pull it out again to make the visual check: the correct level is between the marks **A** and **B**.

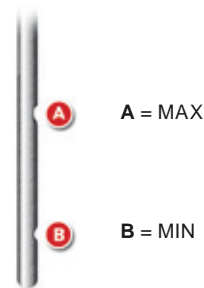

If you find that the level is above the **A** mark or below the **B** mark, **do not start the engine**.

- If the level is above the **MAX** mark (risk of damage to the engine), contact a CITROËN dealer or a qualified workshop.
- If the level is below the **MIN** mark, you must top up the engine oil.

Oil grade

Before topping-up the oil or changing the oil, check that the oil is the correct grade for your engine and conforms to the manufacturer's recommendations.

i After topping up the oil, the check when switching on the ignition with the oil level indicator in the instrument panel is not valid during the 30 minutes after topping up.

Topping up the engine oil level

- ☞ Locate the oil filler cap in the engine compartment of your vehicle.
Refer to the "Petrol engine" or "Diesel engine" section.
- ☞ Unscrew the oil filler cap to reveal the filler aperture.
- ☞ Add oil in small quantities, avoiding any spills on engine components (risk of fire).
- ☞ Wait a few minutes before checking the level again using the dipstick.
- ☞ Add more oil if necessary.
- ☞ After checking the level, carefully refit the oil filler cap and the dipstick in its tube.

Engine oil change

Refer to the manufacturer's service schedule for details of the interval for this operation. In order to maintain the reliability of the engine and emission control system, never use additives in the engine oil.

Brake fluid level



The brake fluid level should be close to the "MAX" mark. If it is not, check the brake pad wear.

Changing the fluid

Refer to the manufacturer's service schedule for details of the interval for this operation.

Fluid specification

The brake fluid must conform to the manufacturer's recommendations.

Coolant level



The coolant level should be close to the "MAX" mark but should never exceed it.

When the engine is warm, the temperature of the coolant is regulated by the fan.

The cooling fan may start after switching off the engine: take care with articles and clothing that might be caught by the fan blades.

In addition, as the cooling system is pressurised, wait at least one hour after switching off the engine before carrying out any work.

To avoid any risk of scalding, unscrew the cap by two turns to allow the pressure to drop. When the pressure has dropped, remove the cap and top up the level.

Fluid specification

The coolant must conform to the manufacturer's recommendations.

Screenwash/headlamp wash level low

SERVICE

In the case of vehicles fitted with headlamp washers, when the fluid reservoir low level is reached this warning lamp comes on in the instrument panel, accompanied by an audible signal and a message.

The warning lamp comes on when the ignition is switched on, or every time the stalk is operated, until the reservoir is refilled. Next time you stop, refill the screenwash / headlamp wash reservoir.

Diesel fuel additive level (Diesel with particle filter)

SERVICE

The additive reservoir low level is indicated by fixed illumination of this warning lamp, accompanied by an audible signal and a message that the particle filter additive level is too low.

Topping up

The reservoir must be topped up without delay by a CITROËN dealer or a qualified workshop.

Used products



Avoid prolonged contact of used oil or fluids with the skin. Most of these fluids are harmful to health or indeed very corrosive.



Do not discard used oil or fluids into sewers or onto the ground. Take used oil to a CITROËN dealer or a qualified workshop (France) or to an authorised waste disposal site.

Checks

Unless otherwise indicated, check these components in accordance with the manufacturer's service schedule and according to your engine. Otherwise, have them checked by a CITROËN dealer or a qualified workshop.

12 V battery



The battery does not require any maintenance. However, check that the terminals are clean and correctly tightened, particularly in summer and winter.

When carrying out work on the battery, refer to the "12 V battery" section for details of the precautions to be taken before disconnecting the battery and following its reconnection.

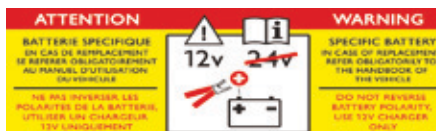

The presence of this label, in particular with the Stop & Start system, indicates the use of a specific 12 V lead-acid battery with special technology and specification. The involvement of a CITROËN dealer or a qualified workshop is essential when replacing or disconnecting the battery.

Air filter and passenger compartment filter



Refer to the manufacturer's service schedule for details of the replacement intervals for these components.

Depending on the environment (e.g. dusty atmosphere) and the use of the vehicle (e.g. city driving), **replace them twice as often if necessary**. A clogged passenger compartment filter may have an adverse effect on the performance of the air conditioning system and generate undesirable odours.

Oil filter



Replace the oil filter each time the engine oil is changed. Refer to the manufacturer's service schedule for details of the replacement interval for this component.

Particle filter (Diesel)

SERVICE

The start of saturation of the particle filter is indicated by the fixed illumination of this warning lamp accompanied by a warning message.

i As soon as the traffic conditions permit, regenerate the filter by driving at a speed of at least 40 mph (60 km/h) until the warning lamp goes off. If the warning lamp stays on, this indicates a low additive level. Refer to the "Diesel additive level" section.

On a new vehicle, the first particle filter regeneration operations may be accompanied by a "burning" smell, which is perfectly normal. Following prolonged operation of the vehicle at very low speed or at idle, you may, in exceptional circumstances, notice the emission of water vapour at the exhaust on acceleration. This does not affect the behaviour of the vehicle or the environment.

Manual gearbox



The gearbox does not require any maintenance (no oil change). Refer to the manufacturer's service schedule for the checking interval for this component.

Electronic gearbox



The gearbox does not require any maintenance (no oil change). Refer to the manufacturer's service schedule for details of the checking interval for this component.

Automatic gearbox



The gearbox does not require any maintenance (no oil change). Refer to the manufacturer's service schedule for details of the level checking interval for this component.

Brake pads



Brake wear depends on the style of driving, particularly in the case of vehicles used in town, over short distances. It may be necessary to have the condition of the brakes checked, even between vehicle services. Unless there is a leak in the circuit, a drop in the brake fluid level indicates that the brake pads are worn.

Brake disc wear



For information on checking brake disc wear, contact a CITROËN dealer or a qualified workshop.



To avoid damaging the electrical units, **never use** a high pressure jet wash in the engine compartment.

Electric parking brake



This system does not require any routine servicing. However, in the event of a problem, have the system checked by a CITROËN dealer or a qualified workshop.

For more information, refer to the "Electric parking brake - Operating faults" section.



Only use products recommended by CITROËN or products of equivalent quality and specification. In order to optimise the operation of units as important as those in the braking system, CITROËN selects and offers very specific products. After washing the vehicle, dampness, or in wintry conditions, ice can form on the brake discs and pads: braking efficiency may be reduced. Make light brake applications to dry and defrost the brakes.

AdBlue® additive and SCR system for BlueHDi Diesel engines

To assure respect for the environment and conformity with the new Euro 6 emissions standard, without adversely affecting the performance or fuel consumption of Diesel engines, CITROËN has taken the decision to equip its vehicles with an effective system that associates SCR (Selective Catalytic Reduction) with a particle filter (FAP) for the treatment of exhaust gases.

Presentation of the SCR system

Using an additive called AdBlue® containing urea, a catalytic converter turns up to 85% of nitrous oxides (NOx) into nitrogen and water, which are harmless to health and the environment.

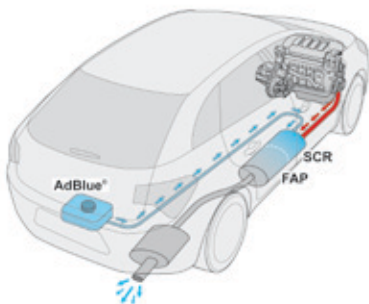

The AdBlue® additive is held in a special tank located under the boot at the rear of the vehicle. It has a capacity of 17 litres: this provides a driving range of about 12 500 miles (20 000 km), after which an alert is triggered warning you when the reserve remaining is enough for just 1 500 miles (2 400 km).

During each scheduled service of your vehicle by a CITROËN dealer or a qualified workshop, the AdBlue® additive tank is refilled in order to allow normal operation of the SCR system.

If the estimated mileage between two services is greater than 12 500 miles (20 000 km), we recommend that you go to a CITROËN dealer or a qualified workshop to have the necessary top-up carried out.

! Once the AdBlue® tank is empty, a system required by regulations prevents starting of the engine. If the SCR is faulty, the level of emissions from your vehicle will no longer meet the Euro 6 standard: your vehicle becomes polluting. In the event of a confirmed fault with the SCR system, you must go to a CITROËN dealer or a qualified workshop as soon as possible: after a running distance of 650 miles (1 100 km), a system will be triggered automatically to prevent engine starting.

Range indicators

Once the AdBlue® tank is on reserve or after detection of a fault with the SCR emissions control system, when the ignition is switched on, an indicator displays an estimate of the distance that can be covered, the range, before engine starting is prevented.

In the event of simultaneous system fault and low AdBlue® level, the shortest range figure is the one displayed.

In the event of the risk of non-starting related to a lack of AdBlue®

! The engine start prevention system required by regulations is activated automatically once the AdBlue® tank is empty.

Range greater than 1 500 miles (2 400 km)

When the ignition is switched on, no information on range is displayed automatically in the instrument panel.

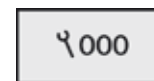

With the type 2 instrument panel, pressing this button temporarily displays the driving range. Above 3 000 miles (5 000 km), the value is not specified.

Remaining range between 350 and 1500 miles (600 and 2 400 km)



When switching on the ignition, the UREA warning lamp comes on, accompanied by an audible signal and the display of a message (e.g.: "Top up emissions additive: Starting prevented in 900 miles") indicating the remaining range expressed in miles or kilometres.

When driving, the message is displayed every 200 miles (300 km) until the additive tank has been topped-up.

Go to a CITROËN dealer or a qualified workshop to have the AdBlue® tank topped-up. You can also top-up the tank yourself. Refer to the "Topping-up" section.

Remaining range between 0 and 350 miles (0 and 600 km)



When switching on the ignition, the SERVICE warning lamp comes on and the UREA warning lamp flashes, accompanied by an audible signal and the display of a message (e.g. "Top up emissions additive: Starting prevented in 350 miles") indicating the remaining range expressed in miles or kilometres.

When driving, the message is displayed every 30 seconds until the additive tank has been topped-up.

Go to a CITROËN dealer or a qualified workshop to have the AdBlue® tank topped-up. You can also top-up the tank yourself. Refer to the "Topping-up" section. Otherwise you will not be able to restart your engine.

Breakdown related to a lack of AdBlue® additive



When switching on the ignition, the SERVICE warning lamp comes on and the UREA warning lamp flashes, accompanied by an audible signal and the display of the message "Top up emissions additive: Starting prevented". The AdBlue® tank is empty: the system required by regulations prevents engine starting.

! To be able to start the engine, we recommend that you call on a CITROËN dealer or a qualified workshop for the top-up required. If you carry out the top-up yourself, it is essential to add at least 3.8 litres of AdBlue® to the tank. Refer to the "Topping-up" section.

In the event of a fault with the the SCR emissions control system

! A system that prevents engine starting is activated automatically from 650 miles (1 100 km) after confirmation of a fault with the SCR emissions control system. Have the system checked by a CITROËN dealer or a qualified workshop as soon as possible.

In the event of the detection of a fault



The UREA, SERVICE and diagnostic warning lamps comes on, accompanied by an audible signal and the display of the message "Emissions fault".

The alert is triggered when driving when the fault is detected for the first time, then when switching on the ignition for subsequent journeys, while the fault persists.

i If it is a temporary fault, the alert disappears during the next journey, after self-diagnosis of the SCR system.

During an authorised driving phase (between 650 miles and 0 miles) (1 100 km and 0 km)



If a fault with the SCR system is confirmed (after 30 miles (50 km) covered with the permanent display of the message signalling a fault), the SERVICE and engine diagnostic warning lamps come on and the UREA warning lamp flashes, accompanied by an audible signal and the display of a message (e.g.: "Emissions fault: Starting prevented in 150 miles") indicating the remaining range express in miles or kilometres. While driving, the message is displayed every 30 seconds while the fault with the SCR system persists.

The alert is repeated when switching on the ignition.

You should go to a CITROËN dealer or a qualified workshop as soon as possible.

Otherwise, you will not be able to restart your engine.

Starting prevented



Every time the ignition is switched on, the SERVICE and engine diagnostic warning lamps come on and the UREA warning lamp flashes, accompanied by an audible signal and the display of the message "Emissions fault: Starting prevented".

! You have exceeded the authorised driving limit: the starting prevention system inhibits engine starting. To be able to start the engine, you must call on a CITROËN dealer or a qualified workshop.

Topping-up the AdBlue® additive

Filling the AdBlue® tank is an operation included in every routine service on your vehicle by a CITROËN dealer or a qualified workshop.

Nevertheless, given the capacity of the tank, it may be necessary to top-up the additive between services, more particularly if an alert (warning lamps and a message) signals the requirement.

You can go to a CITROËN dealer or a qualified workshop.

If you envisage topping-up yourself, please read the following warnings carefully.

i Freezing of the AdBlue® additive

The AdBlue® additive freezes at temperatures below around -11°C. The SCR system includes a heater for the AdBlue® tank, allowing you to continue driving in very cold conditions.

Precautions in use

The AdBlue® additive is an urea-based solution. This liquid is non-flammable, colourless and odourless (kept in a cool area). In the event of contact with the skin, wash the affected area with soap and water. In the event of contact with the eyes, wash (irrigate) the eyes with large amounts of water or with an eye wash solution for at least 15 minutes. If a burning sensation or irritation persists, get medical attention.

If swallowed, immediately wash out the mouth with clean water and then drink plenty of water. In certain conditions (high ambient temperature, for example), the risk of release of ammonia cannot be excluded: do not inhale the product. Ammonia vapour has an irritant effect on mucous membranes (eyes, nose and throat).

! Keep AdBlue® out of the reach of children, in its original bottle. Never transfer AdBlue® to another container: it would lose its purity.

Use only AdBlue® additive that meets the ISO 22241 standard.

! Never dilute the additive with water. Never pour the additive into the Diesel fuel tank.



AdBlue®

The supply in a non-drip bottle simplifies topping-up. You can obtain 1.89 litre (half a US gallon) bottles from a CITROËN dealer or a qualified workshop.

! Never top-up from an AdBlue® dispenser reserved for heavy goods vehicles.

Recommendations on storage

AdBlue® freezes at about -11°C and deteriorates above 25°C. It is recommended that bottles be stored in a cool area and protected from direct sunlight.

Under these conditions, the additive can be kept for at least a year.

If the additive has frozen, it can be used once it has completely thawed out.

! Never store bottles of AdBlue® in your vehicle.

Procedure

Before topping-up, ensure that the vehicle is parked on a flat and level surface.

In wintry conditions, ensure that the temperature of the vehicle is above -11°C.

Otherwise, by freezing, the AdBlue® cannot be poured into its tank. Park your vehicle in a warmer area for a few hours to allow the top-up to be carried out.

☞ Press the START/STOP button to switch off the engine.

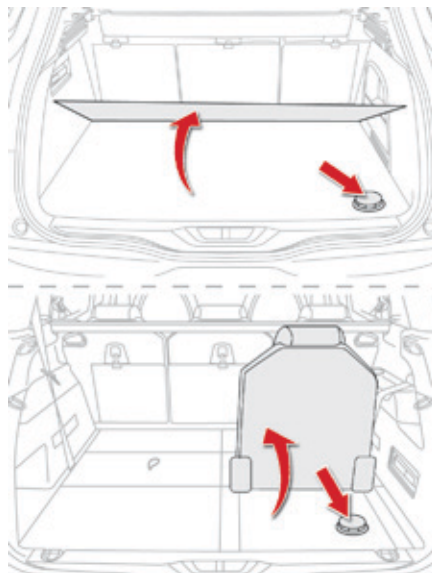

☞ For access to the AdBlue® tank, raise the boot floor, or on 7-seat versions, unfold the right hand seat in the third row.



- ☞ Without pressing, turn the black cap a quarter turn anti-clockwise and lift it off.
- ☞ Turn the blue cap a 6th of a turn anti-clockwise.
- ☞ Lift off the cap.
- ☞ Obtain a bottle of AdBlue®. After first checking the use-by date, read carefully the instructions on use on the label before pouring the contents of the bottle into your vehicle's AdBlue® tank.

! **Important:** if your vehicle's AdBlue® tank is completely empty - which is confirmed by the alert messages and the impossibility of starting the engine, you must add at least 3.8 litres (so two 1.89 litre bottles).

☞ After emptying the bottle, wipe away any spillage around the tank filler using a damp cloth.

! If any additive is split or splashed, wash immediately with cold water or wipe with a damp cloth.
If the additive has crystallised, clean it off using a sponge and hot water.

☞ Refit the blue cap to the tank and turn it a 6th of a turn clockwise, to its stop.

☞ Refit the black cap and turn it a quarter of a turn clockwise without pressing. Ensure that the indicator on the cap lines up with the indicator on the support.

- ☞ Depending on equipment, return the spare wheel and/or the storage box to the bottom of the boot.
- ☞ Refit the boot carpet and close the tailgate.

! **Important: when topping up after running out of additive**, signalled by the message "Top up emissions additive: Starting prevented", you must wait for approximately 5 minutes before switching on the ignition, **without opening the driver's door, unlocking the vehicle, placing the key of the "Keyless Entry and Starting" system inside the vehicle or inserting the electronic key in the reader.**
Switch on the ignition, wait for 10 seconds, then start the engine.



Never dispose of AdBlue® additive bottles in the household waste. Place them in a special container provided this purpose or take them to your dealer.

Petrol engines and gearboxes

Petrol engine	VTi 120	PureTech 130 S&S	THP 155
Gearbox	Manual (5-speed)	Manual (5-speed)	Manual (6-speed)
Model code	3D... 3E... 3A...	3D... 3E... 3A...	3D... 3E... 3A...
	5FS0/1	HNY... M/1S - M/2SM	5FV... 8 - 8/1
Cubic capacity (cc)	1 598	1 199	1 598
Bore x stroke (mm)	77 x 85.8	75 x 90.5	77 x 85.8
Max power*: EU standard (kW)	88	96	115
Max power engine speed (rpm)	6 000	5 500	6 000
Max torque: EU standard (Nm)	160	230	240
Max torque engine speed (rpm)	4 250	1 750	1 400
Fuel	Unleaded	Unleaded	Unleaded
Catalytic converter	yes	yes	yes
Oil capacity (in litres) (with filter replacement)	4.25	4.25	4.25

3D...: CITROËN C4 Picasso (5-seat).

3E...: CITROËN Grand C4 Picasso (5-seat).

3A...: CITROËN Grand C4 Picasso (7-seat).

9

* The maximum power corresponds to the value type-approved on a test bed, under conditions defined in European legislation (Directive 1999/99/EC).

Petrol engine	THP 150 / 160	THP 165 S&S
Gearbox	EAT6 automatic (6-speed)	EAT6 automatic (6-speed)
Model code:	3D... 3E... 3A...	3D... 3E... 3A...
	5GX - 5GY... A-A/1-A/2-A/D- A/1D- A/2D-Y-Y/1-Y/2	5GZT/S
Cubic capacity (cc)	1 598	1 598
Bore x stroke (mm)	77 x 85.8	77 x 85.8
Max power*: EU standard (kW)	110 / 121	121
Max power engine speed (rpm)	6 000	6 000
Max torque: EU standard (Nm)	240	240
Max torque engine speed (rpm)	1 400	1 400
Fuel	Unleaded	Unleaded
Catalytic converter	yes	yes
Oil capacity (in litres) (with filter replacement)	4.25	4.25

3D...: CITROËN C4 Picasso (5-seat).

3E...: CITROËN Grand C4 Picasso (5-seat).

3A...: CITROËN Grand C4 Picasso (7-seat).

* The maximum power corresponds to the value type-approved on a test bed, under conditions defined in European legislation (Directive 1999/99/EC).

Petrol weights and towed loads (in kg)

Petrol engine	VTi 120	PureTech 130*	THP 155
Gearbox	Manual (5-speed)	Manual (5-speed)	Manual (6-speed)
Model code	3D... 3E... 3A...	3D... 3E... 3A...	3D... 3E... 3A...
	5FS0/1	HNY... M/1S - M/2SM	5FV... 8 - 8/1
- Unladen weight	1 252 - 1 276 - 1 278	1 280 - 1 295 - 1 297	1 296 - 1 311 - 1 313
- Kerb weight**	1 327 - 1 351 - 1 353	1 355 - 1 370 - 1 372	1 371 - 1 386 - 1 388
- Gross vehicle weight (GVW)	1 900 - 2 060 - 2 110	1 905 - 2 075 - 2 125	1 940 - 2 100 - 2 150
- Gross train weight (GTW) on a 12 % gradient	2 900 - 2 860 - 2 860	3 175 - 3 125 - 3 175	3 360 - 3 350 - 3 350
- Braked trailer (within GTW limit) on a 10 % or 12 % gradient	1 000 - 800 - 750	1 270 - 1 050 - 1 050	1 420 - 1 250 - 1 200
- Braked trailer*** (with load transfer within the GTW limit)	1 200 - 1 100 - 1 050	1 470 - 1 350 - 1 350	1 620 - 1 550 - 1 500
- Unbraked trailer	660 - 675 - 675	640 - 647 - 648	685 - 690 - 690
- Recommended nose weight	70	70	70

* The weight values are calculated with a towbar.

** The kerb weight is equal to the unladen weight + driver (75 kg).

*** The weight of the braked trailer can be increased, within the GTW limit, if the GVW of the towing vehicle is reduced by an equal amount; warning, towing using a lightly loaded towing vehicle may have an adverse effect on its road holding.

The GTW and towed load values indicated are valid up to a maximum altitude of 1 000 metres; the towed load mentioned must be reduced by 10 % for each additional 1 000 metres of altitude.

When towing, the speed must never exceed 60 mph (100 km/h) (comply with the legislation in force in your country).

High ambient temperatures may result in a reduction in the performance of the vehicle to protect the engine; if the ambient temperature is above 37 °C, limit the towed load.

Petrol engine	THP 150 / 160	THP 165
Gearbox	EAT6 automatic (6-speed)	EAT6 automatic (6-speed)
Model code	3D... 3E... 3A...	3D... 3E... 3A...
	5GX - 5GY... A-A/1-A/2-A/D- A/1D- A/2D-Y-Y/1-Y/2	5GZT/S
- Unladen weight	1 405 - 1 428 - 1 430	1 310 - 1 318 - 1 320
- Kerb weight*	1 480 - 1 503 - 1 505	1 385- 1 393 - 1 395
- Gross vehicle weight (GVW)	1 940 - 2 140 - 2 160	1 930 - 2 100 - 2 150
- Gross train weight (GTW) on a 12% gradient	2 740 - 2 940 - 2 960	3 330 - 3 350 - 3 350
- Braked trailer (within GTW limit) on a 10% or 12% gradient	800	1 400 - 1 250 - 1 200
- Braked trailer** (with load transfer within the GTW limit)	800	1 600 - 1 550 - 1 500
- Unbraked trailer	600	685 - 690 - 690
- Recommended nose weight	70	70

* The kerb weight is equal to the unladen weight + driver (75 kg).

** The weight of the braked trailer can be increased, within the GTW limit, if the GVW of the towing vehicle is reduced by an equal amount; warning, towing using a lightly loaded towing vehicle may have an adverse effect on its road holding.

The weight of the braked trailer can be increased, within the GTW limit, if the GVW of the towing vehicle is reduced by an equal amount; warning, towing using a lightly loaded towing vehicle may have an adverse effect on its road holding.

When towing, the speed must never exceed 60 mph (100 km/h) (comply with the legislation in force in your country).

High ambient temperatures may result in a reduction in the performance of the vehicle to protect the engine; if the ambient temperature is above 37 °C, limit the towed load.

Diesel engines and gearboxes

Diesel engine	HDi 90	e-HDi 90	BlueHDi 100 S&S
Gearbox	Manual (5-speed)	ETG6 electronic (6-speed)	Manual (6-speed)
Model code:	3D...	3D... 3E... 3A...	3D... 3E... 3A...
	9HP0/1	9HP8/2PS	BHY... 6/1S - 6/2SM
Cubic capacity (cc)	1 560		1 560
Bore x stroke (mm)	75 x 88.3		75 x 88.3
Max power*: EU standard (kW)	68		73
Max power engine speed (rpm)	4 000		3 750
Max torque: EU standard (Nm)	230		254
Max torque engine speed (rpm)	1 750		1 750
Fuel	Diesel		Diesel
Catalytic converter	yes		yes
Particle filter	yes		yes
Oil capacities (in litres) (with filter replacement)	3.75		3.75

.../S: e-HDi model fitted with Stop & Start.

3D...: CITROËN C4 Picasso (5-seat).

3E...: CITROËN Grand C4 Picasso (5-seat).

3A...: CITROËN Grand C4 Picasso (7-seat).

* The maximum power corresponds to the value type-approved on a test bed, under conditions defined in European legislation (Directive 1999/99/EC).

Diesel engines and gearboxes

Diesel engine	HDi 115	e-HDi 115	
Gearbox	Manual (6-speed)	Manual (6-speed)	ETG6 electronic (6-speed)
Model code	3D... 3E... 3A...	3D... 3E... 3A...	3D... 3E... 3A...
	9HC... 8 - 8/1	9HC8/1S	9HC... 8/1PS - 8/2PS
Cubic capacity (cc)	1 560	1 560	
Bore x stroke (mm)	75 x 88.3	75 x 88.3	
Max power*: EU standard (kW)	85	85	
Max power engine speed (rpm)	3 600	3 600	
Max torque: EU standard (Nm)	270	270 - 285	
Max torque engine speed (rpm)	1 750	1 750	
Fuel	Diesel	Diesel	
Catalytic converter	yes	yes	
Particle filter	no	yes	
Oil capacities (in litres) (with filter replacement)	3.75	3.75	

.../S: e-HDi model fitted with Stop & Start.

3D...: CITROËN C4 Picasso (5-seat).

3E...: CITROËN Grand C4 Picasso (5-seat).

3A...: CITROËN Grand C4 Picasso (7-seat).

* The maximum power corresponds to the value type-approved on a test bed, under conditions defined in European legislation (Directive 1999/99/EC).

Diesel engines and gearboxes

Diesel engine	BlueHDi 115/120 S&S		BlueHDi 135/150 S&S	
	Gearbox	Manual (6-speed)	EAT6 automatic (6-speed)	Manual (6-speed)
Model code	3D... 3E... 3A...	3D... 3E... 3A...	3D... 3E... 3A...	3D... 3E... 3A...
	BHZ - BHX... M/S - M/1S	BHZ - BHX... T/1S - T/2S	AHX-AHR-AHV-AHS... M/S - M/1S	AHX... T/S - T/1S
Cubic capacity (cc)	1 560		1 997	
Bore x stroke (mm)	75 x 88.3		85 x 88	
Max power*: EU standard (kW)	85 / 88		110	
Max power engine speed (rpm)	3 500		3 750	
Max torque: EU standard (Nm)	300		370	
Max torque engine speed (rpm)	1 750		1 750	
Fuel	Diesel		Diesel	
Catalytic converter	yes		yes	
Particle filter	yes		yes	
Oil capacities (in litres) (with filter replacement)	3.75		6.1	

.../S: e-HDi model fitted with Stop & Start.

3D...: CITROËN C4 Picasso (5-seat).

3E...: CITROËN Grand C4 Picasso (5-seat).

3A...: CITROËN Grand C4 Picasso (7-seat).

* The maximum power corresponds to the value type-approved on a test bed, under conditions defined in European legislation (Directive 1999/99/EC).

Diesel weights and towed loads (in kg)

Diesel engine	HDi 90	e-HDi 90	BlueHDi 100 S&S*
Gearbox	Manual (5-speed)	ETG6 electronic (6-speed)	Manual (6-speed)
Model code	3D...	3D... 3E... 3A...	3D... 3E... 3A...
	9HP0/1	9HP8/2PS	BHY... 6/1S - 6/2SM
- Unladen weight	1 279	1 289 - 1 314 - 1 316	1 296 - 1 318 - 1 320
- Kerb weight**	1 354	1 364 - 1 389 - 1 391	1 371 - 1 393 - 1 395
- Gross vehicle weight (GVW)	1 920	1 940 - 2 110 - 2 160	1 950 - 2 120 - 2 175
- Gross train weight (GTW) on a 12% gradient	3 170	3 140 - 3 160 - 3 160	3 150 - 3 120 - 3 175
- Braked trailer (within GTW limit) on a 10% or 12% gradient	1 250	1 200 - 1 050 - 1 000	1 200 - 1 000 - 1 000
- Braked trailer*** (with load transfer with the GTW limit)	1 450	1 400 - 1 350 - 1 300	1 400 - 1 300 - 1 300
- Unbraked trailer	675	680 - 690 - 695	645 - 659 - 660
- Recommended nose weight	70	70	70

The GTW and towed load values indicated are valid up to a maximum altitude of 1 000 metres; the towed load mentioned must be reduced by 10 % for each additional 1 000 metres of altitude.

When towing, the speed must never exceed 60 mph (100 km/h) (comply with the legislation in force in your country).

High ambient temperatures may result in a reduction in the performance of the vehicle to protect the engine; if the ambient temperature is above 37 °C, limit the towed load.

* The weight values are calculated with a towbar.

** The kerb weight is equal to the unladen weight + driver (75 kg).

*** The weight of the braked trailer can be increased, within the GTW limit, if the GVW of the towing vehicle is reduced by an equal amount; warning, towing using a lightly loaded towing vehicle may have an adverse effect on its road holding.

Diesel weights and towed loads (in kg)

Diesel engine	HDi 115		e-HDi 115	
Gearbox	Manual (6-speed)		Manual (6-speed)	ETG6 electronic (6-speed)
Model code	3D... 3E... 3A...	3D... 3E... 3A...	3D... 3E... 3A...	3D... 3E... 3A...
	9HC8	9HC8/1	9HC8/1S	9HC... 8/1PS - 8/2PS
- Unladen weight	1290 - 1 310 - 1 312	1 298 - 1 318 - 1 320	1 298 - 1 318 - 1 320	1 295 - 1 318 - 1320
- Kerb weight*	1 365 - 1 385 - 1 387	1 373 - 1 393 - 1 395	1 373 - 1 393 - 1 395	1 370 - 1 393 - 1395
- Gross vehicle weight (GVW)	1 940 - 2 110 - 2 150	1 940 - 2 110 - 2 150	1 940 - 2 110 - 2 150	1 940 - 2 110 - 2 150
- Gross train weight (GTW) on a 12% gradient	3 340 - 3 350 - 3 350	2 740 - 2 910 - 2 950	3 340 - 3 350 - 3 350	3 340 - 3 350 - 3 350
- Braked trailer (within GTW limit) on a 10% or 12% gradient	1 400 - 1240 - 1 200	800	1 400 - 1 240 - 1 200	1 400 - 1 240 - 1 200
- Braked trailer** (with load transfer with the GTW limit)	1 600 - 1 540 - 1 500	800	1 600 - 1 540 - 1 500	1 600 - 1 540 - 1 500
- Unbraked trailer	680 - 690 - 690	685 - 695 - 695	685 - 695 - 695	685 - 695 - 695
- Recommended nose weight	70	70	70	70

The GTW and towed load values indicated are valid up to a maximum altitude of 1 000 metres; the towed load mentioned must be reduced by 10 % for each additional 1 000 metres of altitude.

When towing, the speed must never exceed 60 mph (100 km/h) (comply with the legislation in force in your country).

High ambient temperatures may result in a reduction in the performance of the vehicle to protect the engine; if the ambient temperature is above 37 °C, limit the towed load.

* The kerb weight is equal to the unladen weight + driver (75 kg).

** The weight of the braked trailer can be increased, within the GTW limit, if the GVW of the towing vehicle is reduced by an equal amount; warning, towing using a lightly loaded towing vehicle may have an adverse effect on its road holding.

Diesel weights and towed loads (in kg)

Diesel engine	BlueHDi 115/120 S&S		BlueHDi 135/150 S&S	
Gearbox	Manual (6-speed)	EAT6 automatic (6-speed)	Manual (6-speed)	EAT6 automatic (6-speed)
Model code	3D... 3E... 3A...	3D... 3E... 3A...	3D... 3E... 3A...	3D... 3E... 3A...
	BHZ - BHX... M/S - M/1S	BHZ - BHX... T/1S - T/2S	AHX-AHR-AHV- AHS... M/S - M/1S	AHX... T/S - T/1S
- Unladen weight	1 320 - 1 345 - 1347	1 320 - 1 357 - 1 359	1 415 - 1 428 - 1 430	1 435 - 1 474 - 1 476
- Kerb weight*	1 395 - 1 420 - 1 422	1 395 - 1 432 - 1 434	1 490 - 1 503 - 1 505	1 510 - 1 549 - 1 551
- Gross vehicle weight (GVW)	1 950 - 2 100 - 2 175	1 975 - 2 025 - 2 205	2 030 - 2 200 - 2 250	2 030 - 2 200 - 2 280
- Gross train weight (GTW) on a 12% gradient	3 350 - 3 350 - 3 375	3 375 - 3 225 - 3 405	3 530 - 3 560 - 3 650	3 530 - 3 580 - 3 580
- Braked trailer (within GTW limit) on a 10% or 12% gradient	1 400 - 1 250 - 1 200	1 400 - 1 200 - 1 200	1 500 - 1 450 - 1 400	1 500 - 1 380 - 1 300
- Braked trailer** (with load transfer with the GTW limit)	1 600 - 1 550 - 1 500	1 600 - 1 500 - 1 500	1 700 - 1 750 - 1 700	1 700 - 1 680 - 1 600
- Unbraked trailer	660 - 672 - 674	660 - 675 - 675	745 - 750 - 750	750
- Recommended nose weight	70	70	70	70

The GTW and towed load values indicated are valid up to a maximum altitude of 1 000 metres; the towed load mentioned must be reduced by 10 % for each additional 1 000 metres of altitude.

When towing, the speed must never exceed 60 mph (100 km/h) (comply with the legislation in force in your country).

High ambient temperatures may result in a reduction in the performance of the vehicle to protect the engine; if the ambient temperature is above 37 °C, limit the towed load.

* The kerb weight is equal to the unladen weight + driver (75 kg).

** The weight of the braked trailer can be increased, within the GTW limit, if the GVW of the towing vehicle is reduced by an equal amount; warning, towing using a lightly loaded towing vehicle may have an adverse effect on its road holding.

Dimensions (in mm)

These dimensions have been measured on an unladen vehicle.

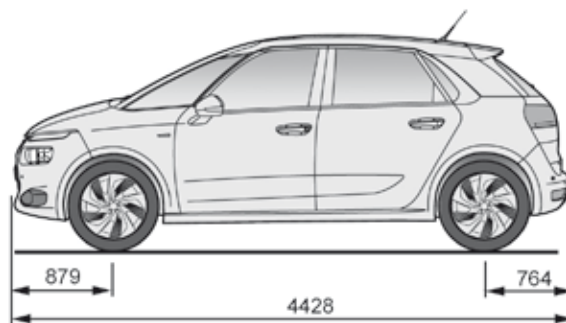
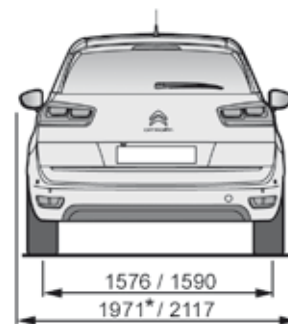
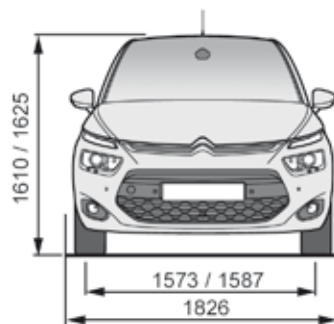

* Mirrors folded.

Dimensions (in mm)

These dimensions have been measured on an unladen vehicle.

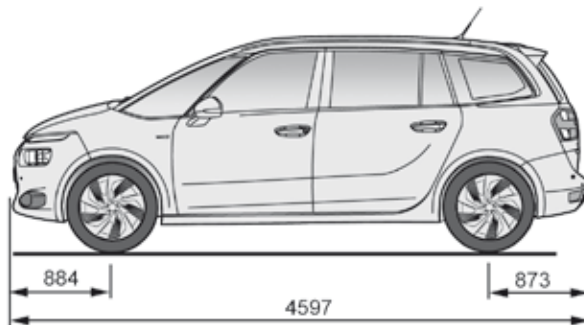
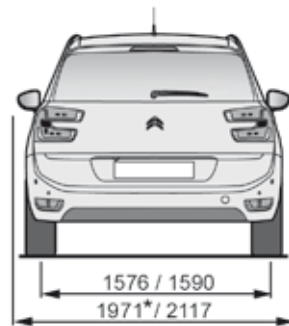
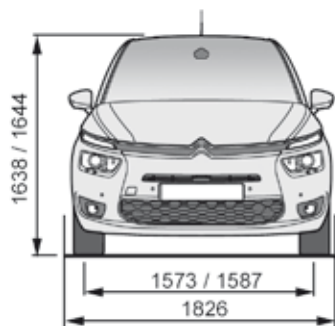

* Mirrors folded.

Identification markings

Various visible markings for the identification of your vehicle.

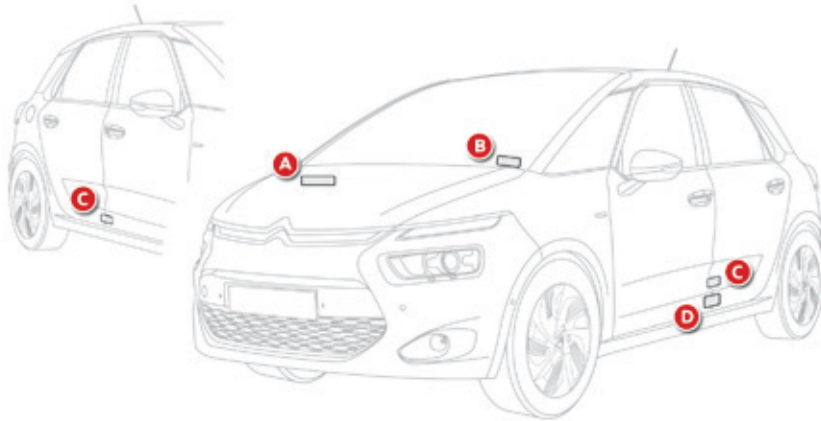

A. Vehicle Identification Number (VIN) under the bonnet.

This number is engraved on the chassis near the right hand front wheel arch.

B. Vehicle Identification Number (VIN) on the windscreen lower cross member.

This number is indicated on a self-adhesive label which is visible through the windscreen.

C. Manufacturer's label.

This self-destroying label on the middle door pillar, right or left hand side, contains the following information:

- the manufacturer's name,
- the European whole vehicle type approval number,
- the vehicle identification number (VIN),
- the maximum authorised weight (gross vehicle weight),
- the maximum authorised weight with trailer (gross train weight),
- the maximum front axle weight,
- the maximum rear axle weight.

D. Tyre/paint label.

This label on the middle door pillar, driver's side, contains the following information:

- the tyre inflation pressures, laden and unladen,
- the tyre sizes (including the tyre load index and speed rating),
- the inflation pressure for the spare wheel,
- the paint colour code.

i The tyre pressures must be checked when the tyres are cold, at least once a month.

🍀 If the tyre pressures are too low, this increases fuel consumption.

Emergency or assistance call



Localised Emergency Call



In an emergency, press this button for more than 2 seconds. Flashing of the green LED and a voice message confirm that the call has been made to the "Localised Emergency Call"* service.

Pressing this button again immediately cancels the request.

The green LED goes off.

The green LED remains on (without flashing) when communication is established. It goes off at the end of communication.

This call is dealt with by the "Localised Emergency Call" centre which receives locating information from the vehicle and can send a detailed alert to the appropriate emergency services.

In countries in which the team is not operational, or when the locating service has been expressly declined, the call is dealt with directly by the emergency services (112) without the vehicle location.

! If an impact is detected by the airbag control unit, and independently of the deployment of any airbags, an emergency call is made automatically.

i If you benefit from the CITROËN Connect Box offer with the SOS and assistance pack included, there are additional services available to you in your MyCITROËN personal space, via the CITROËN Internet website in your country, accessible on www.citroen.com.

* These services are subject to conditions and availability.
Consult a CITROËN dealer.



Operation of the system



When the ignition is switched on, the green LED comes on for 3 seconds indicating that the system is operating correctly.



The orange LED flashes then goes off: there is a system fault.

The orange LED is on continuously: the backup battery must be replaced.

In either case, the emergency and assistance calls service may not function.

Contact a qualified repairer as soon as possible.

i A fault with the system does not prevent the vehicle being driven.

Localised Assistance Call



Press this button for more than 2 seconds to request assistance if the vehicle breaks down. A voice message confirms that the call has been made*.

Pressing this button again immediately cancels the request.

The cancellation is confirmed by a voice message.

* These services are subject to conditions and availability.
Consult a CITROËN dealer.

i If you purchased your vehicle outside the CITROËN dealer network, we invite you to have a dealer check the configuration of these services and, if desired, modified to suit your wishes. In a multi-lingual country, configuration is possible in the official national language of your choice.

i For technical reasons, particularly to improve the quality of Telematic services to customers, the manufacturer reserves the right to carry out updates to the vehicle's on-board telematic system.

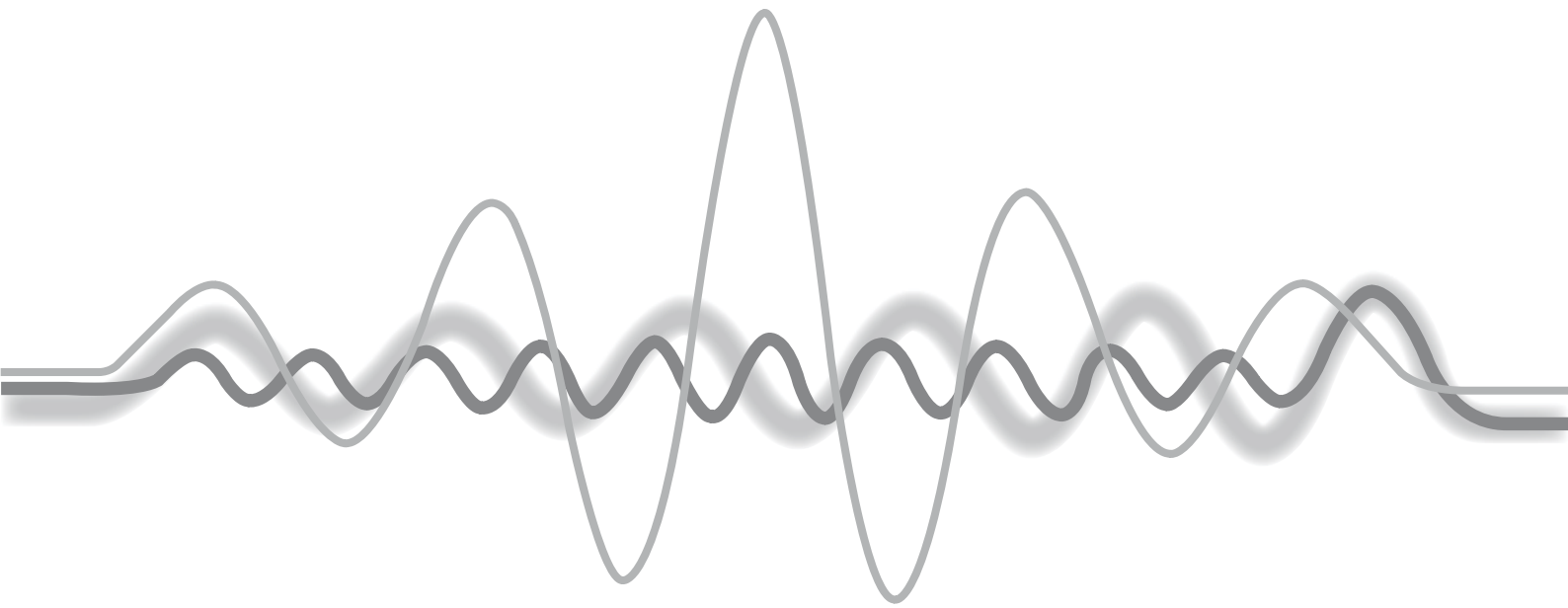

7-inch touch screen tablet

GPS satellite navigation - Multimedia audio - Bluetooth® telephone



	Contents
First steps	340
Steering mounted controls	342
Menus	344
Media	346
Radio	352
DAB (Digital Audio Broadcasting) radio	354
Music	356
Navigation	360
Navigation - Guidance	368
Traffic	372
Configuration	374
Connected services	384
CITROËN Multicity Connect	385
Telephone	386
Frequently asked questions	394

i The system is protected in such a way that it will only operate in your vehicle.

! As a safety measure, the driver should only carry out operations which require prolonged attention while the vehicle is stationary. The display of the energy economy mode message signals that the system is about to go into standby. Refer to the Energy economy (mode) section.

First steps

Use the buttons on either side of the touch screen tablet for access to the menus, then press the virtual buttons in the touch screen tablet.

Each menu is displayed in one or two pages (primary page and secondary page).



i In very hot conditions, the system may go into stand-by (screen and sound completely off) for a minimum period of 5 minutes.

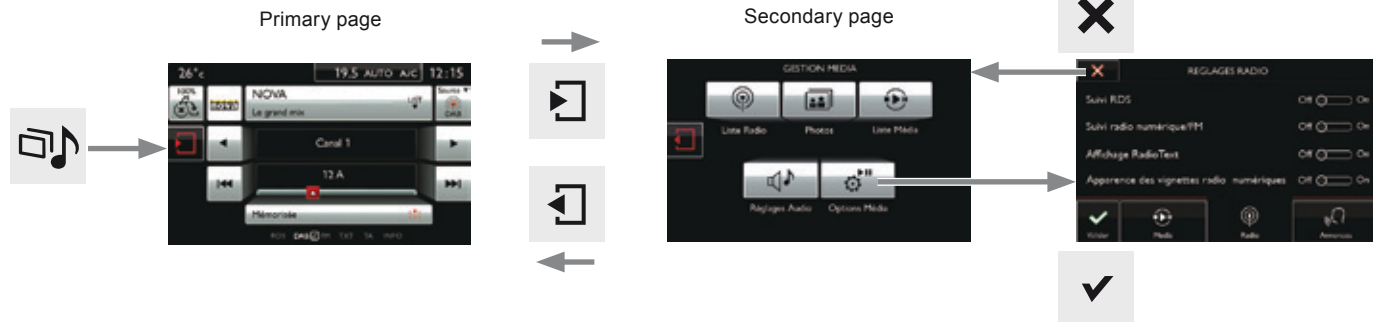

Shortcuts: using virtual buttons in the top band of the touch screen tablet, it is possible to go directly to the choice of audio source, the list of stations (or titles depending on the source) or to temperature adjustment.

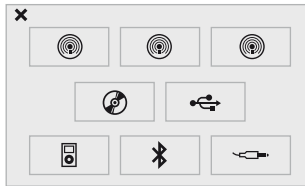

Selecting the audio source (depending on version):

- "FM" / "AM" / "DAB"* radio wavebands.
- "USB" memory stick.
- CD player (located in the glove box)*.
- Jukebox*, after first copying audio files to the internal memory of the system.
- Telephone connected by Bluetooth* Bluetooth* audio streaming.
- Media player connected to the auxiliary socket (jack, cable not supplied).

* Depending on equipment.



With the engine running, press to mute the sound.
With the ignition off, press to switch the system on.



Volume adjustment (each source is independent, including Traffic announcements (TA) and navigation instructions).



In very hot conditions, the volume may be limited to protect the system. The return to normal takes place when the temperature in the passenger compartment drops.



The screen is of the "resistive" type, it is necessary to press firmly, particularly for "flick" gestures (scrolling through a list, moving the map...). A simple wipe will not be enough. Pressing with more than one finger is not recognised. The screen can be used when wearing gloves. This technology allows use at all temperatures.



To clean the screen, use a soft non-abrasive cloth (spectacles cloth) without any additional product. Do not use pointed objects on the screen. Do not touch the screen with wet hands.

Steering mounted controls

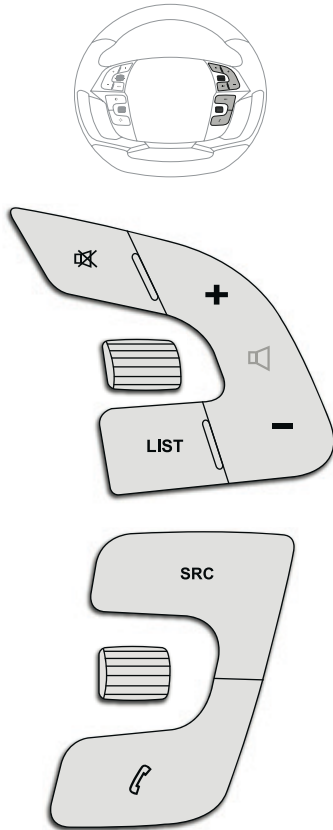

Mute.



Radio, rotate: automatic selection of the next / previous radio frequency. Media, rotate: previous / next track. Press then rotate: access to preset stations.



Radio: display the list of stations. Media: display the list of tracks. Radio, press and hold: update the list of stations received.



Increase volume.



Decrease volume.



Change the audio source.



Rotate: move in a menu; zoom in / out on the map. Press: confirm, accept the choice of audio source.



Telephone: start call. Call in progress: access to the telephone menu (End call, Secret mode, Hands-free mode). Telephone, press and hold: reject an incoming call, end a call in progress; other than call in progress, access to the telephone menu.

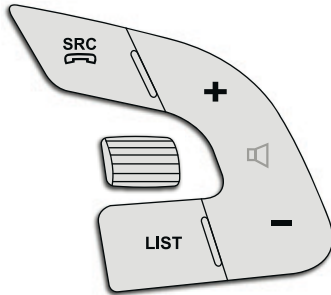
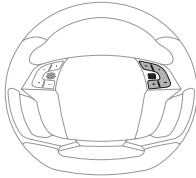

SRC
 Media: change multimedia source.
 Telephone: start call.
 Call in progress: access to the telephone menu (End call, Secret mode, Hands-free mode).
 Telephone, press and hold: reject an incoming call, end a call in progress; other than call in progress, access to the telephone menu.



Radio, rotate: automatic search for previous / next station.
 Media, rotate: previous / next track.
 Press: confirm a selection.

LIST

Radio: display the list of stations.
 Media: display the list of tracks.
 Radio, press and hold: update the list of stations received.



Increase volume.



Decrease volume.

Menus



Air conditioning



Control of the settings for temperature and air flow.



Driving assistance



Access to the trip computer.
Activate, deactivate, adjust settings for certain vehicle functions.



Media



Select an audio source, a radio station, display photographs.



Navigation

(Depending on equipment)



Enter navigation settings and choose a destination.



Configuration



Adjust settings for audio (balance, ambience, ...), colour scheme, brightness of the instruments and controls, display (language, units, date, time, ...) and access to interactive help for the vehicle's main systems and warning lamps.



Connected services

(Depending on equipment)



CITROËN MULTICITY CONNECT
Connect to an applications portal to facilitate, make safe and personalise journeys by means of a connection key available on subscription from a CITROËN dealer.











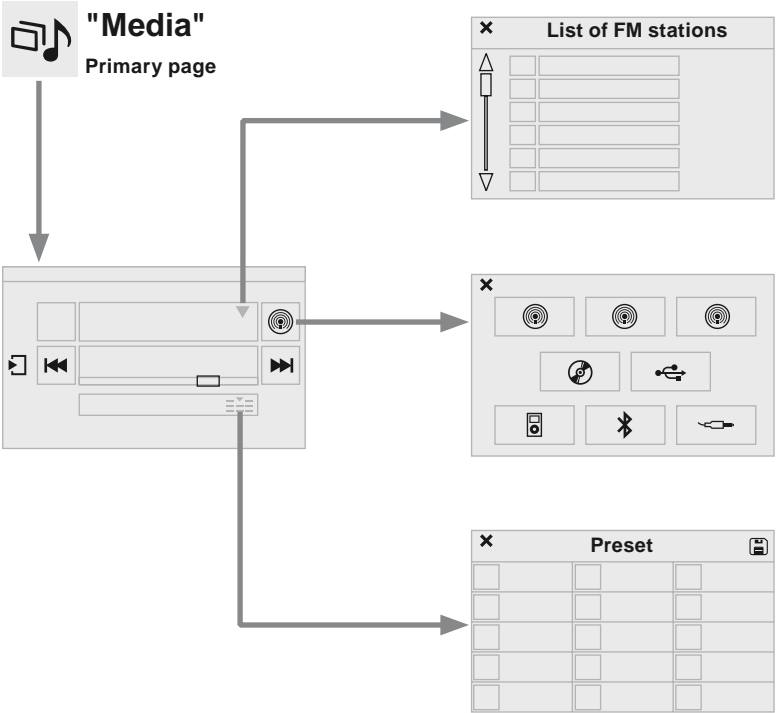









Telephone











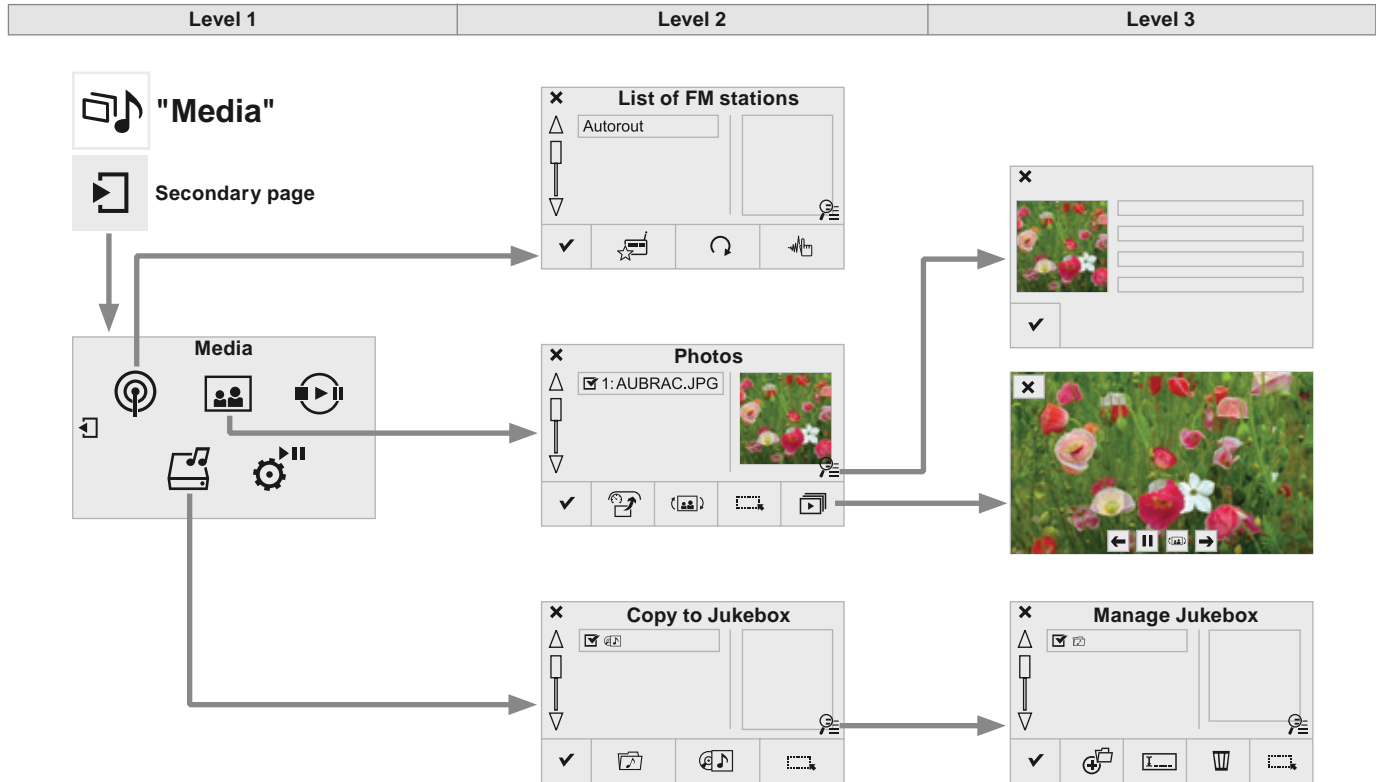





















Connect a telephone by Bluetooth®.

Media









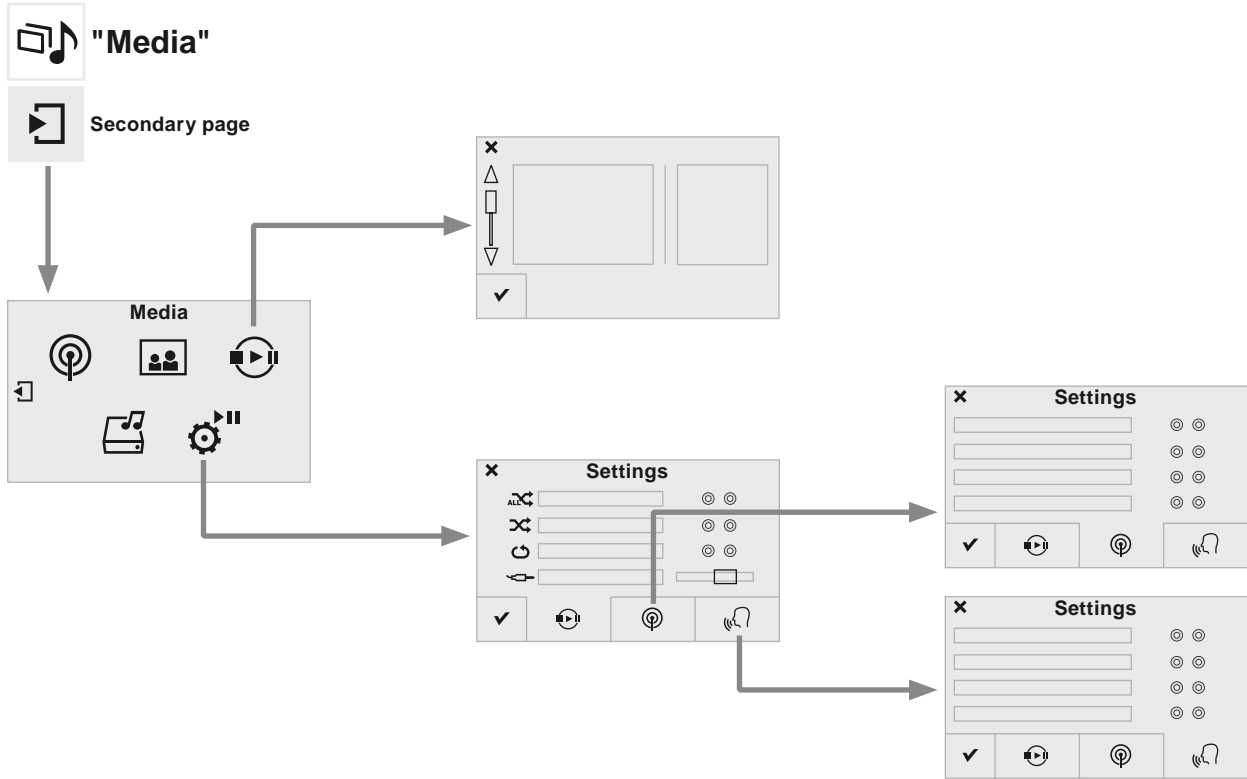









Level 1		Level 2		Comments
 	Media ↓ List		List of FM stations	Press on a radio station to select it.
 	Media ↓ Source	 Radio FM  Radio DAB  Radio AM  Jukebox  CD  USB  iPod  Bluetooth  AUX		Select change of source.
 	Media ↓ Preset			Press an empty location to Preset it.



Level 1		Level 2		Level 3		Comments				
  	<p>Media ↓ Secondary page ↓ Radio list</p>	 Preset				Press a radio station to select it.				
		 Update list				Update the list of stations received.				
		 Frequency				Enter the desired radio frequency.				
		 Confirm				Save the settings.				
  	<p>Media ↓ Secondary page ↓ Photos</p>	 Page selection				Display the selected photo full screen.				
		 Rotate				Rotate the photo 90°.				
		 Select all				Select all the photos in the list. Press again to deselect.				
		 Slideshow	 Previous photo.	 Pause / Play.  Next photo.			Display the photos in sequence, full screen.			
			 Confirm							Save the settings.
			 Sort by folder							Choose the selection mode.
 Sort by album										
 Select all				 Magnifying glass	Choose the handling mode.					
 Magnifying glass	 Create folder									
	 Rename									
	 Delete									
	 Select all									
	 Confirm			Save the options.						
 Copy					Copy files to the Jukebox.					



Level 1		Level 2		Level 3		Comments	
	Media					Presentation of the last media used.	
	Secondary page						
	Media list						
  	Media ↓ Secondary page ↓ Settings		Media ↓ Settings	 Random (all tracks):	Choose the play settings.		
				 Random (current album):			
				 Loop:			
				 Aux. amplification			
			Radio ↓ Settings		Radio ↓ Settings	<input type="checkbox"/> RDS options	Activate or deactivate the options.
						<input type="checkbox"/> DAB/FM options	
						<input type="checkbox"/> Display Radio Text	
						<input type="checkbox"/> DAB radio thumbnails	
			Announcements ↓ Settings		Announcements ↓ Settings	<input type="checkbox"/> Traffic announcements (TA)	Activate or deactivate the options.
						<input type="checkbox"/> Weather	
						<input type="checkbox"/> Varied - Sport	
						<input type="checkbox"/> Alert settings	
			Confirm				

Radio

Selecting a station



Press on **Media** to display the primary page.

or



Press on **Media** to display the primary page then go to the secondary page.



Select "**List**" in the primary page.

or



Select "**Radio list**" in the secondary page.

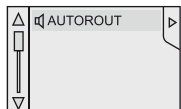

Select a radio station from the list offered.



Select "**Update list**" to refresh the list.

OR



Press **Media** to display the primary page then select "**Preset**".



Select a preset radio station in the list.



If necessary, select change of source.



Select "**FM Radio**" or "**AM Radio**".



The exterior environment (hills, buildings, tunnel, car park, below ground...) may prevent reception, even in RDS station tracking mode. This phenomenon is normal in the propagation of radio waves and is in no way indicative of a fault with the audio system.

Changing a radio frequency



Press on **Media** to display the primary page.

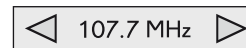

By automatic frequency search

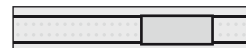

Press ◀ or ▶ to move the cursor for an automatic search down or up for a radio frequency.

OR



Press on **Media** to display the primary page then press on the secondary page.



Press on "**Enter frequency**" to display the primary page then press on the secondary page.

THEN

Select change source.



Select "**FM Radio**" or "**AM Radio**".

**OR**

Enter the frequency in full (e.g.: 92.10 MHz) using the keypad then "**Confirm**".

FRANCE BLEU

By alphabetical list

Press the current radio band then choose the radio station from the list offered.

Preset a station

Select a radio station or frequency (refer to the corresponding section).



Press on "**Preset**".

Mémoire 1

Select a number in the list to preset the previously chosen radio station.

A long press on a number presets (memorises) the station.

Or



A press on this button presets all of the stations one after the other.

Recall pre-set stations

Press on **Media** to display the primary page then select "**Save**".

**Activate/ Deactivate RDS**

Press on **Media** to display the primary page then go to the secondary page.



Select "**Settings**".



Select "**Radio**".



Off On

Activate/deactivate "**RDS options**".



RDS, if activated, allows you to continue listening to the same station by automatic retuning to alternative frequencies. However, in certain conditions, coverage of an RDS station may not be assured throughout the entire country as radio stations do not cover 100 % of the territory. This explains the loss of reception of the station during a journey.

DAB (Digital Audio Broadcasting) radio

The screenshot shows a car's infotainment screen with the following elements and annotations:

- Top status bar:** 26°C, 19.5 AUTO A/C, 12:15.
- Station information:** NOVA, Le grand mix, LIST, Source, DAB.
- Current station:** Canal 1, 12 A.
- Controls:** 100% volume, Jukebox icon, Previous/Next Multiplex buttons, Previous/Next Radio Station buttons, Preset stations (1-15), RDS, DAB, FM, TXT, TA, INFO.
- Annotations:**
 - Any thumbnail broadcast by the station. (Points to the NOVA logo)
 - Manage the Jukebox. Display current action. (Points to the Jukebox icon)
 - Secondary page. (Points to the red square icon)
 - Previous "Multiplex". Previous radio station. (Points to the left navigation buttons)
 - Display the name and number of the multiplex service being used. (Points to the Canal 1 and 12 A display)
 - Short-cut: access to the choice of audio source, the list of stations (or titles depending on the source) or temperature adjustment. (Points to the LIST button)
 - Select the radio station. (Points to the Source button)
 - Select the audio source. Display the "DAB" band. (Points to the DAB icon)
 - Display of "Radiotext" for the current station. (Points to the Le grand mix text)
 - Next "Multiplex". Next radio station. (Points to the right navigation buttons)
 - Preset stations, buttons 1 to 15. Short press: select the preset radio station. Long press: preset a radio station. (Points to the preset buttons)
 - Display of options: if active but not available, the display will be greyed out, if active and available, the display will be blank. (Points to the RDS, DAB, FM, TXT, TA, INFO buttons)

Display of options:
if active but not available, the display will be greyed out,
if active and available, the display will be blank.

i If the "DAB" radio station being listened to is not available on "FM", the "DAB FM" option is greyed out.



! Journaline® is a text-based information service designed for digital radio systems. It provides text-based information structured around topics and sub-topics. This service is available from the "LIST OF DAB STATIONS" page.

DAB (Digital Audio Broadcasting) Digital radio

! Digital radio provides higher quality reception and also the graphical display of current information on the radio station being listened to. Select "List" in the primary page.
The range of multiplexes available is displayed in alphabetical order.



Press on **Media** to display the primary page.



Select change of source.



Select "**DAB Radio**".



Select "**List**" in the primary page.

or



Select "**Radio list**" in the secondary page.

Select the radio station from the list offered.

Digital radio - DAB / FM auto tracking

i "DAB" does not cover 100% of the territory.
When the digital radio signal is weak, "DAB / FM auto tracking" allows you to continue listening to the same station, by automatically switching to the corresponding "FM" analogue station (if there is one).



Press **Media** to display the primary page then press on the secondary page.



Select "**Settings**".



Select "**RADIO**".



Select "**Digital/FM auto tracking**" then "**Confirm**".

i If "DAB / FM auto tracking" is activated, there is a difference of a few seconds when the system switches to "FM" analogue radio with sometimes a variation in volume.
When the digital signal is restored, the system automatically changes back to "DAB".

! If the "DAB" station being listened to is not available on "FM" ("**DAB/FM**" option greyed out), or "DAB / FM auto tracking" is not activated, the sound will cut out while the digital signal is too weak.

Music

USB player

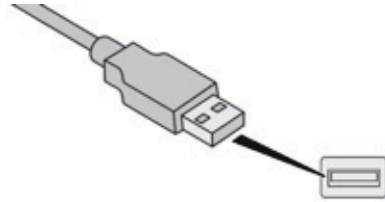

Insert the USB memory stick into the USB port or connect the USB device to the USB port using a suitable cable (not supplied).

The system builds playlists (in temporary memory), an operation which can take from a few seconds to several minutes at the first connection.

Reduce the number of non-music files and the number of folders to reduce the waiting time.

The playlists are updated every time the ignition is switched off or connection of a USB memory stick. The lists are memorised: if they are not modified, the subsequent loading time will be shorter.

Auxiliary socket (AUX)



Connect the portable device (MP3 player...) to the auxiliary Jack socket using an audio cable (not supplied).

First adjust the volume of your portable device (to a high level). Then adjust the volume of your audio system.

Display and management of the controls are via the portable device.

CD player

Insert the CD in the player.

Selection of source



Press on **Media** to display the primary page.



Select change of source.

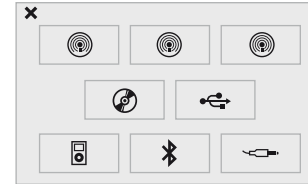

Choose the source.



The steering mounted **SRC** (source) button can be used to go to the next media source, available if the source is active.



Press **OK** to confirm the selection.

Information and advice

The audio equipment will only play audio files with ".wma, .aac, .flac, .ogg and. mp3" file extensions and with a bit rate of between 32 Kbps and 320 Kbps.

It also supports VBR (Variable Bit Rate) mode. No other type of file (.mp4, ...) can be played. "wma" files must be of the standard wma 9 type. The sampling rates supported are 11, 22, 44 and 48 KHz.

It is advisable to restrict file names to 20 characters, without using of special characters (e.g.: " " ? ; ù) to avoid any playing and displaying problems.

In order to be able to play a recorded CDR or CDRW, when recording it is preferable to select the ISO 9660 level 1, 2 or Joliet standard.

If the disc is recorded in another format it may not be played correctly.

It is recommended that the same recording standard is always used for an individual disc, with as low a speed as possible (4x maximum) for optimum sound quality.

In the particular case of a multi-session CD, the Joliet standard is recommended.

Use only USB memory sticks formatted FAT32 (file allocation table).

! The system does not support the simultaneous connection of two identical devices (two memory sticks, two Apple® players) but it is possible to connect one memory stick and one Apple® player at the same time.

i It is recommended that the USB cable for the portable device is used.

! The system supports USB mass storage devices, BlackBerry® devices or Apple® players via USB ports. The adaptor cable not supplied. Control of the peripheral device is with the audio system controls. Other peripherals, not recognised on connection, must be connected to the auxiliary socket using a Jack cable (not supplied).

Bluetooth® audio streaming

Streaming allows audio files on your telephone to be played through the vehicle's speakers.

Connect the telephone: see the "**Telephone**" section, then "**Bluetooth**".
Choose the "**Audio**" or "**All**" profile.

If play does not start automatically, it may be necessary to start the audio playback from the telephone.

Control is from the peripheral device or by using the audio system buttons.

! Once connected in streaming mode, the telephone is considered to be a media source.
It is recommended that you activate "**Repeat**" on the Bluetooth peripheral.

Connecting Apple® players

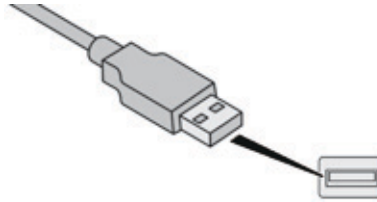

Connect the Apple® player to the USB port using a suitable cable (not supplied).
Play starts automatically.

Control is via the audio system.

i The classifications available are those of the portable device connected (artists / albums / genres / playlists / audiobooks / podcasts).
The default classification used is by artist. To modify the classification used, return to the first level of the menu then select the desired classification (playlists for example) and confirm to go down through the menu to the desired track.

The version of software in the audio system may not be compatible with the generation of your Apple® player.

Managing the Jukebox

Connect the device (MP3 player...) to the USB port or auxiliary Jack socket using a suitable audio cable.

i When no audio file is copied to the system, which has a capacity of 8 GB, all of the Jukebox function symbols are greyed and are not available.



Select "**Media list**".



Select copy "**Copy Jukebox**".



Select "**Sort by folder**".

Or



"**Sort by album**".



Select the magnifying glass to enter the folder or album and select audio file by audio file.



Select "**Confirm**" then "**Copy**".



Select "**New folder**" to create a folder structure in the Jukebox.

Or











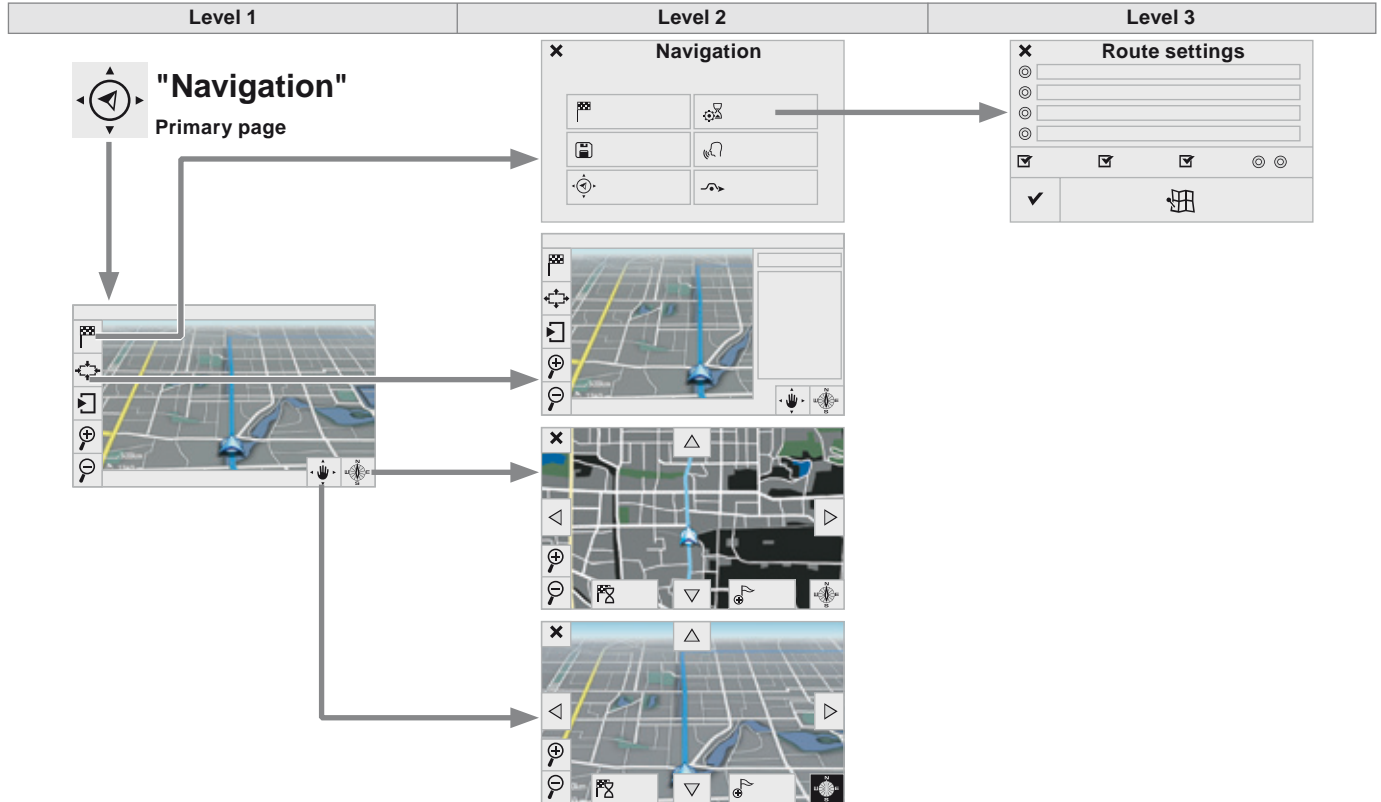















Select "**Keep structure**" to retain the structure from the device.











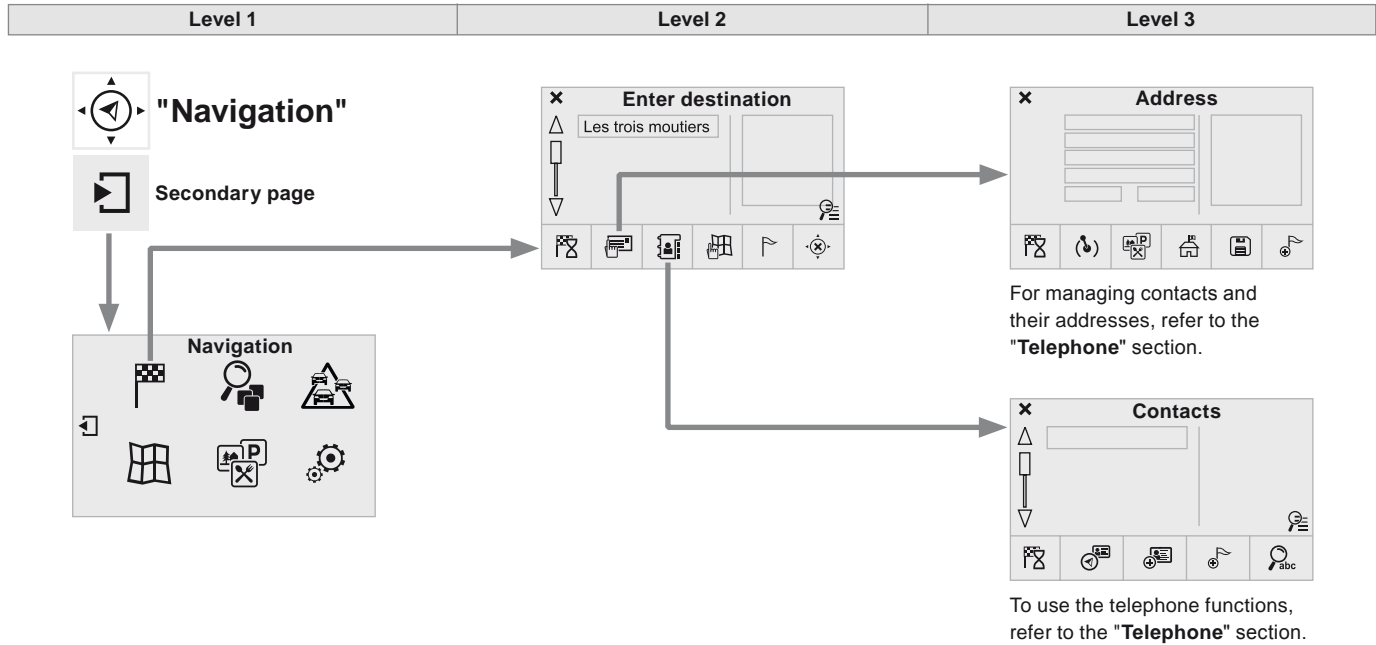











While copying the system returns to the primary page; you can go back to the copy view at any time by selecting this button.







Navigation



Level 1	Level 2		Level 3		Comments
  Navigation ↓ Settings Navigation		Enter destination			Display recent destinations
		Calculatory criteria		Fastest	Choose the navigation criteria. The map displays the route chosen according to these criteria.
				Shortest	
				Time/distance	
				Ecological	
				Tolls	
				Ferries	
				Strict - Close	
				Show route on map	
		Confirm	Save the options.		
	Save			Save the current address.	
	Stop navigation			Delete the navigation information.	
	Voice			Choose the volume for voice and announcement of street names.	
	Diversion			Detour from your initial route by a certain distance.	
 Navigation				Display in text mode	
				Zoom in.	
				Zoom out.	
					Display in full screen mode. Use the arrows to move the map.
				Switch to 2D map.	







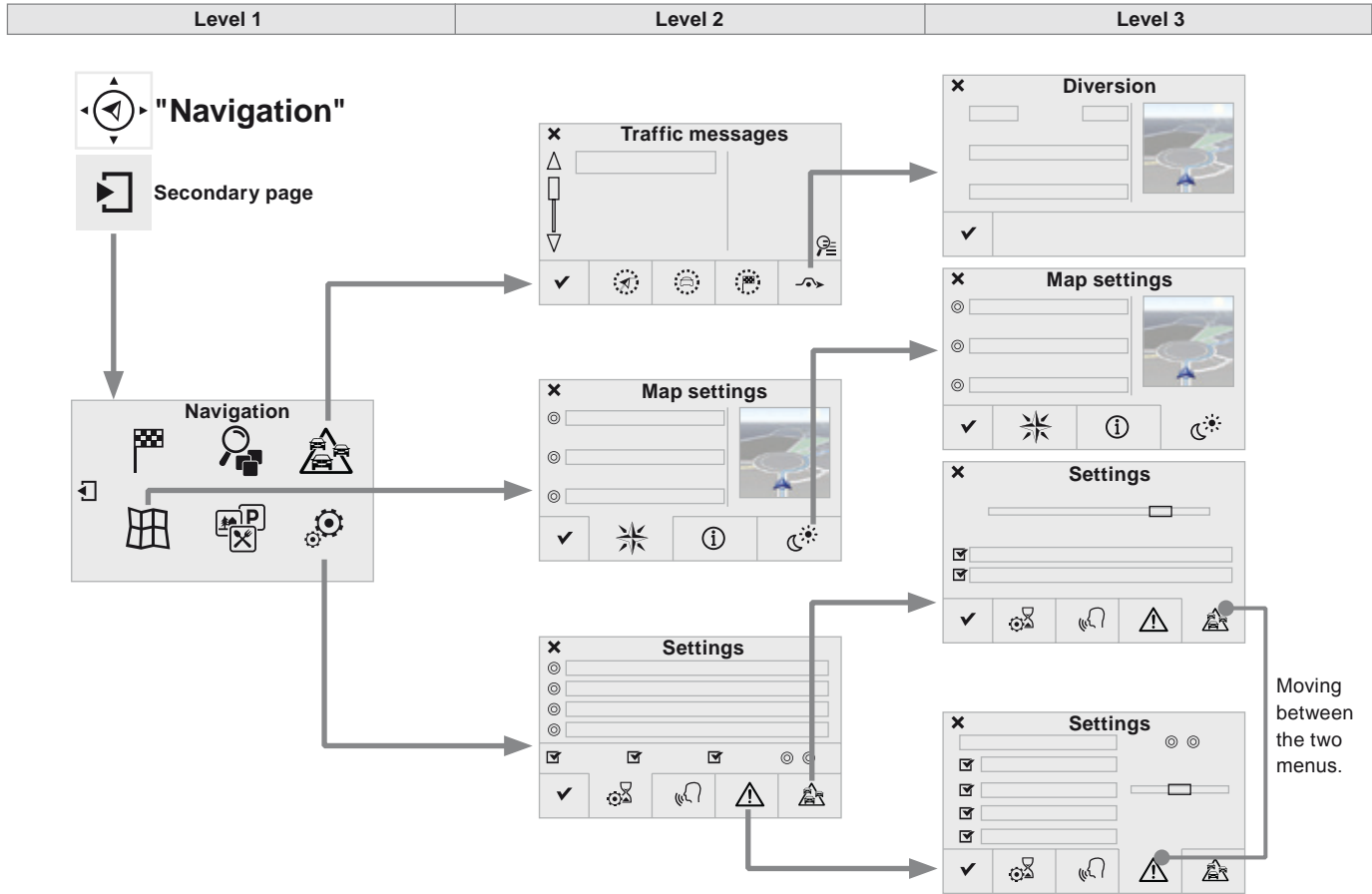















Level 1		Level 2		Level 3		Comments
  	<p style="text-align: center;"> Navigation ↓ Secondary page ↓ Enter destination </p>		Address		Curr. location	Address settings
					Points of Interest	
					Town centre	
					Save	Save the current address.
					Add waypoint	Add a waypoint to the route.
					Navigate to	Press to calculate the route.
			Contacts		Addresses	Select a contact then calculate the route.
					Add contact	
					Add waypoint	
					Search for contact	
	Navigate to					
	From map		Display the map and zoom to view the roads.			
	Itinerary		Create, add or delete a waypoint or view the itinerary.			
	Stop		Delete navigation information.			
	Navigate to		Press to calculate the route.			

Level 1		Level 2		Level 3	Comments
  	<p>Navigation ↓ Secondary page ↓ Search for POI</p>	 All POIs		List of categories available. After choosing the category, select the points of interest.	
		 Garage			
		 Dining/hotels			
		 Personal			
		 By name			
		 Search		Save the settings.	
  	<p>Navigation ↓ Secondary page ↓ Show POIs</p>	 Select all		Choose the display settings for POIs.	
		 Delete			
		 Import POIs			
		 Confirm		Save the options.	



Moving between the two menus.

Level 1		Level 2		Level 3		Comments	
  	<p>Navigation</p> <p>↓</p> <p>Secondary page</p> <p>↓</p> <p>Traffic messages</p>	 On the route				Settings for the choice of messages and the filter radius.	
		 Around vehicle					
		 Near destination					
		 Detour	<input type="radio"/>	Detour over a distance			
			<input type="radio"/>	Recalculate route			
	<input checked="" type="checkbox"/> Finish					Save the options.	
  	<p>Navigation</p> <p>↓</p> <p>Secondary page</p> <p>↓</p> <p>Map settings</p>	 Orientation		<input type="radio"/>	Flat view north heading	Choose the display and orientation of the map.	
				<input type="radio"/>	Flat view vehicle heading		
				<input type="radio"/>	Perspective view		
		 Maps					
		 Aspect	<input type="radio"/>	"Day" map colour			
			<input type="radio"/>	"Night" map colour			
	<input type="radio"/>	Automatic day/night					
	<input checked="" type="checkbox"/> Confirm					Save the settings.	
  	<p>Navigation</p> <p>↓</p> <p>Secondary page</p> <p>↓</p> <p>Settings</p>	 Route settings				Enter settings and choose the volume for the voice and announcement of street names.	
		 Voice					
		 Alert!					
		 Traffic options					
		<input checked="" type="checkbox"/> Confirm					

Navigation - Guidance

Choosing a new destination

Towards a new destination



Press on **Navigation** to display the primary page.



Press on the secondary page.



Select "**Enter destination**".



Select "**Address**".



Select the "**Country:**" from the list offered, then in the same way the "**City:**" or its post code, the "**Road:**", the "**N°:**".

Confirm each time.



Select "**Save**" to save the address entered as a contact entry. The system allows up to 200 entries.



Select "**Navigate to**".



Choose the navigation criteria: "**Fastest**" or "**Shortest**" or "**Time/distance**" or "**Ecological**".



Choose the restriction criteria: "**Include tollroads**", "**Include ferries**", "**Traffic**", "**Strict**", "**Close**".



Select "**Confirm**".

Or



Press "**Show route on map**" to start navigation.



To delete navigation information, press "**Settings**".



Press "**Stop navigation**".



To resume navigation press "**Settings**".



Press "**Resume navigation**".

Towards a recent destination



Press on **Navigation** to display the primary page.



Press on the secondary page.



Select "**Enter destination**".

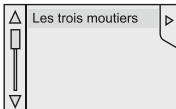

Select an address from the list offered.



Select "**Navigate to**".



Select the criteria then "**Confirm**" or press "**Show route on map**" to start navigation.

Towards a contact



To be able to use navigation "towards a contact in the directory", it is first necessary to enter the address for your contact.



Press on **Navigation** to display the primary page.



Press on the secondary page.



Select "**Enter destination**".



Select "**Contacts**".

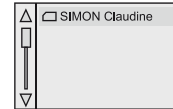

Select a destination from the contacts in the list offered.



Select "**Navigate to**".



Select the criteria then "**Confirm**" to start navigation.

Towards GPS coordinates



Press on **Navigation** to display the primary page.



Press on the secondary page.



Select "**Enter destination**".



Select "**Address**".

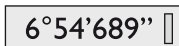

Enter the "**Longitude**:" then the "**Latitude**:".



Select "**Navigate to**".



Select the criteria then "**Confirm**" or press "**Show route on map**" to start navigation.

Towards a point on the map



Press on **Navigation** to display the primary page.



Press on the secondary page.



Select "**Enter destination**".



Select "**From map**".

Zooming in on the map shows points with information.

A long press on a point opens its content.

Towards points of interest (POI)

Points of Interest (POI) are listed in different categories.



Press on **Navigation** to display the primary page.



Press on the secondary page.



Select "**Search for POI**".



Select "**All POIs**".

Or



"**Garage**",

Or



"**Dining/hotels**",

Or



"Personal",



Select a category from the list offered.



Select "**Search**".



Select a point of interest from the list offered.



Select "**Navigate to**".

i An annual mapping update allows new points of interest to be presented to you.
You can also update the Risk areas / Danger areas every month.
The detailed procedure is available on: <http://citroen.navigation.com>.

Hazard zone / Danger zone alert settings



Press on **Navigation** to display the primary page.



Press on the secondary page.



Select "**Settings**".



Select "**Alarm!**".

It is then possible to activate Risk Areas alerts then:

- "Audible warning"
- "Alert only when navigating"
- "Alert only for overspeed"
- "Display speed limits"
- Timing: the choice of timing allows the time before giving a Risk Area alert to be defined.



Select "**Confirm**".



This series of alerts and displays is only available if Risk Areas have first been downloaded and installed on the system.

Traffic

Traffic information

Display of messages



Press on **Navigation** to display the primary page.



Press on the secondary page.



Select "**Traffic messages**".

Set the:



"**On the route**",



"**Around**",



"**Near destination**", filters to fine-tune the list of messages.

Press again to remove the filter.



Select the message from the list offered.



Select the magnifying glasses to have vocal information.

i TMC (Traffic Message Channel) messages on GPS-Navigation contain traffic information transmitted in real time.

Setting filters



Press on **Navigation** to display the primary page.



Press on the secondary page.



Select "**Settings**".



Select "**Info options**".



Select:
- "**Warn of new messages**",
- "**Speak messages**".

Then enter the filter radius.



Select "**Confirm**".

i We recommend a filter radius of:

- 12 miles (20 km) in urban areas,
- 30 miles (50 km) on motorways.

Receiving TA messages



Press on **Navigation** to display the primary page.



Press on the secondary page.



Select "**Settings**".



Select "**Voice**".









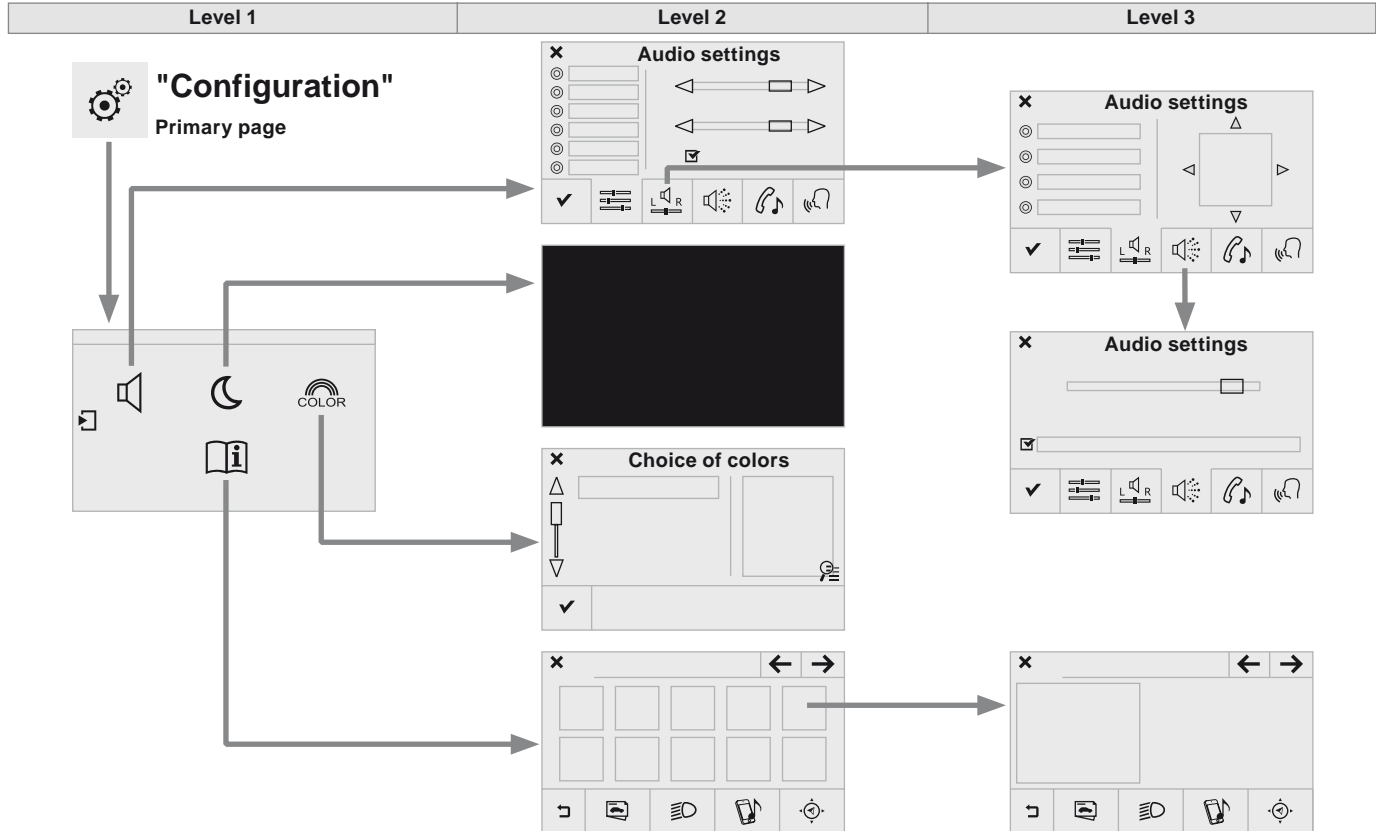













Off On

Activate / Deactivate "**Traffic (TA)**".









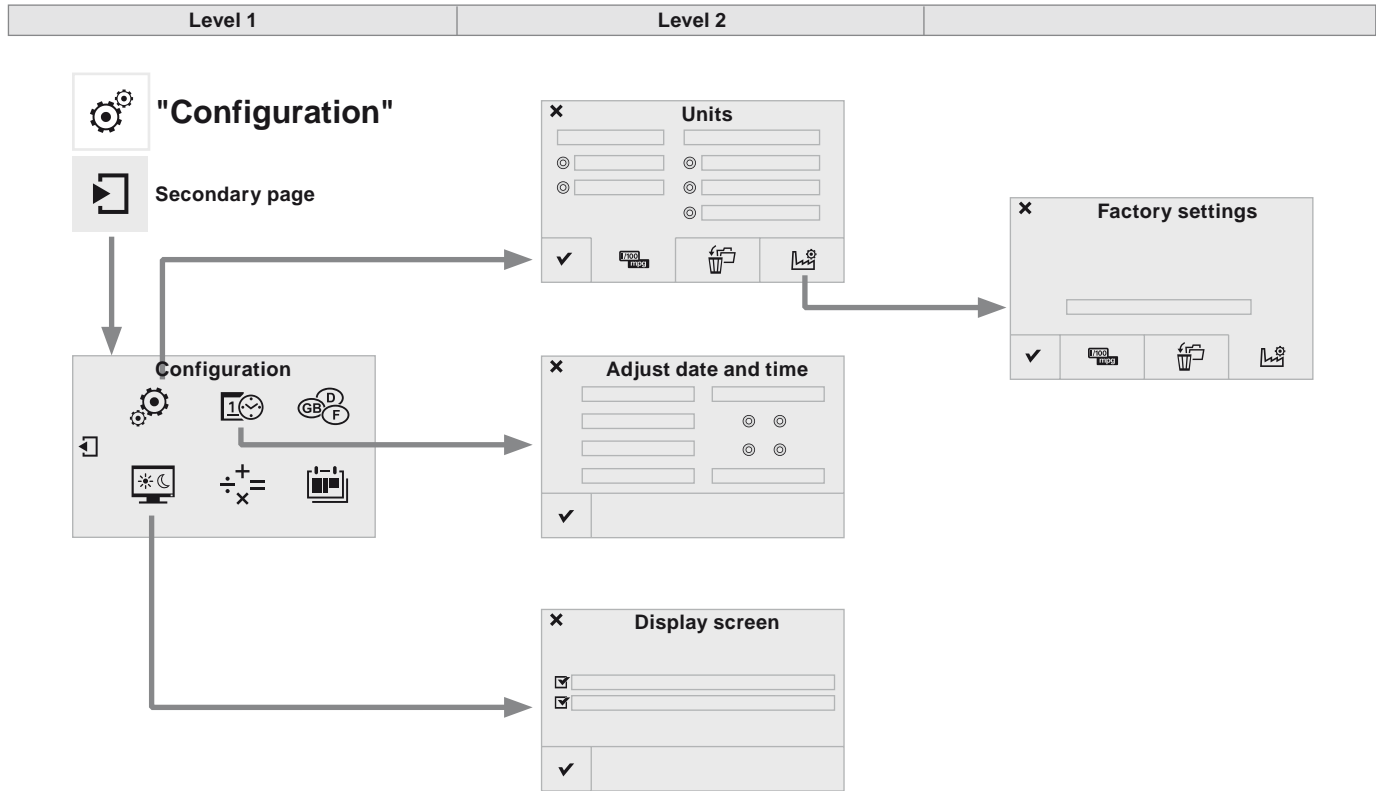



i The TA (Traffic Announcement) function gives priority to TA alert messages. To operate, this function needs good reception of a radio station transmitting this type of message. When a traffic report is transmitted, the current audio source is interrupted automatically to play the TA message. Normal playback of the audio source resumes at the end of the transmission of the message.

Configuration









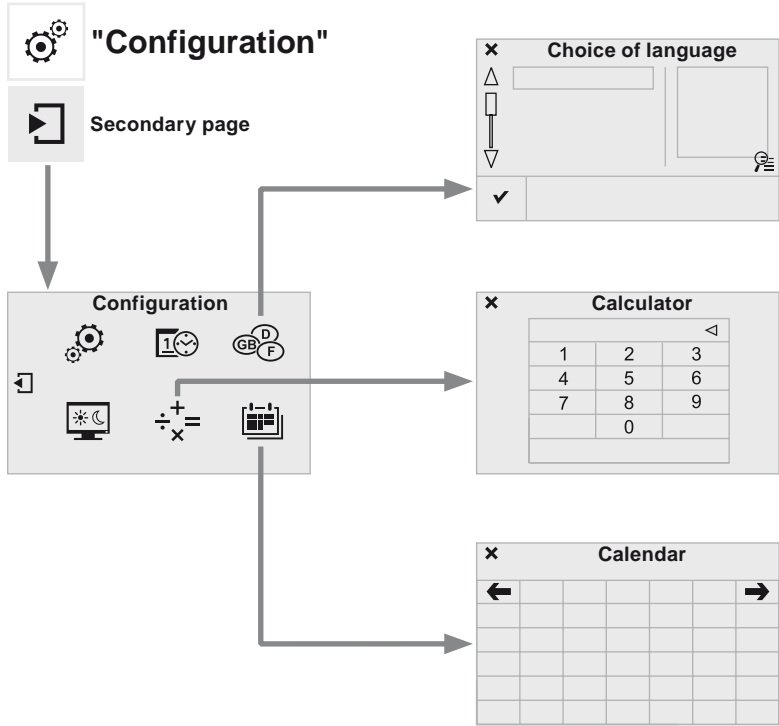

Level 1		Level 2		Level 3	Comments
 	Configuration ↓ Audio settings	 Ambience			Choose the sound ambience.
		 Balance			Set the position of the sound in the vehicle using the Arkamys® system.
		 Sound effects			Choose the volume or activate the link to vehicle speed.
		 Ringtones			Choose the telephone ringtone and volume.
		 Voice			Choose the volume for the voice and announcement of street names.
		 Confirm			Save the settings.
 	Configuration ↓ Turn off screen				Turns off the display (black screen). Pressing the black screen restores the display.
 	Configuration ↓ Color schemes		Confirm		After choosing the color scheme, save the setting.
 	Configuration ↓ Interactive help	 Go back  Driving assistance - Equipment  Warning lamps  Audio Communication  Navigation GPS  Previous page  Next page			Consult the Interactive help.



Level 1		Level 2		Comments
  	Configuration ↓ Secondary page ↓ System Settings	 Units	Set the units used to display distance, fuel consumption and temperature.	
		 Delete data	Select the desired data in the list then press Delete.	
		 Factory settings	Return to factory settings.	
		<input checked="" type="checkbox"/> Confirm	Save the settings.	
  	Configuration ↓ Secondary page ↓ Time/Date	<input checked="" type="checkbox"/> Confirm	Set the date and time then confirm.	
  	Configuration ↓ Secondary page ↓ Screen settings	<input checked="" type="checkbox"/> Automatic text scrolling	Make the setting then confirm.	
	<input checked="" type="checkbox"/> Deactivate animations			
	<input checked="" type="checkbox"/> Confirm			



Level 1		Level 2		Comments
  	Configuration ↓ Secondary page ↓ Languages	✓	Confirm	Select the language then confirm.
  	Configuration ↓ Secondary page ↓ Calculator			Select the calculator.
  	Configuration ↓ Secondary page ↓ Calendar			Select the calendar.

Audio settings



Press on **Configuration** to display the primary page.



Select "**Audio settings**".



Select "**Ambience**" or "**Balance**" or "**Sound effects**" or "**Ringtones**" or "**Voice**".



! The distribution (or spatialisation using the Arkamys® system) of sound is an audio process that allows the audio quality to be adapted to the number of listeners in the vehicle. Available only with the 6-speaker configuration.

! The audio settings (**Ambience**, **Bass**, **Treble** and **Loudness**) are different and independent for each sound source. The settings for **distribution** and **balance** are common to all sources.

!

- "**Ambience**" (choice of 6 musical ambiances)
- "**Bass**"
- "**Treble**"
- "**Loudness**" (Activate/Deactivate)
- "**Balance**" ("**Driver**", "**All passengers**", "**Front only**")
- "**Audio setting on touch screen**"
- "**Volume linked to vehicle speed:**" (Activate/Deactivate)

i On-board audio: Arkamys® Sound Staging optimises sound distribution in the the passenger compartment.

Color schemes



Press on **Configuration** to display the primary page.



Select "**Color schemes**".



Select the colour scheme in the list then "**Confirm**".



At each change of colour scheme the touch screen tablet's system restarts, showing a black screen for a few moments.



For safety reasons, the procedure for changing the colour scheme is only possible with the vehicle stationary.

Interactive help



Press on **Configuration** to display the primary page.



Select "**Interactive help**".



The interactive version of your handbook available in this touch screen is not intended as a substitute for the more complete content of the printed document.



For safety reasons, consultation of your handbook is only possible with the vehicle stationary.

System

Modify system settings



Press on **Configuration** to display the primary page then go to the secondary page.



Select "**System Settings**".



Select "**Units**" to change the units of distance, fuel consumption and temperature.



Select "**Delete data**" to delete the list of recent destinations, personal points of interest, contacts in the list. Choose the item then select "**Delete**".



Select "**Factory settings**" to return to the original settings.



Press on **Configuration** to display the primary page then go to the secondary page.



Select "**Screen settings**".



Activate or deactivate "**Activate automatic text scrolling**" and "**Activate animations**".



Press on **Configuration** to display the primary page then go to the secondary page.



Select:

- "**Time/Date**" to change the time zone, synchronisation with GPS, time and its format and then the date.
- "**Languages**" to change the language.
- "**Calculator**" to display a calculator
- "**Calendar**" to display a calendar.



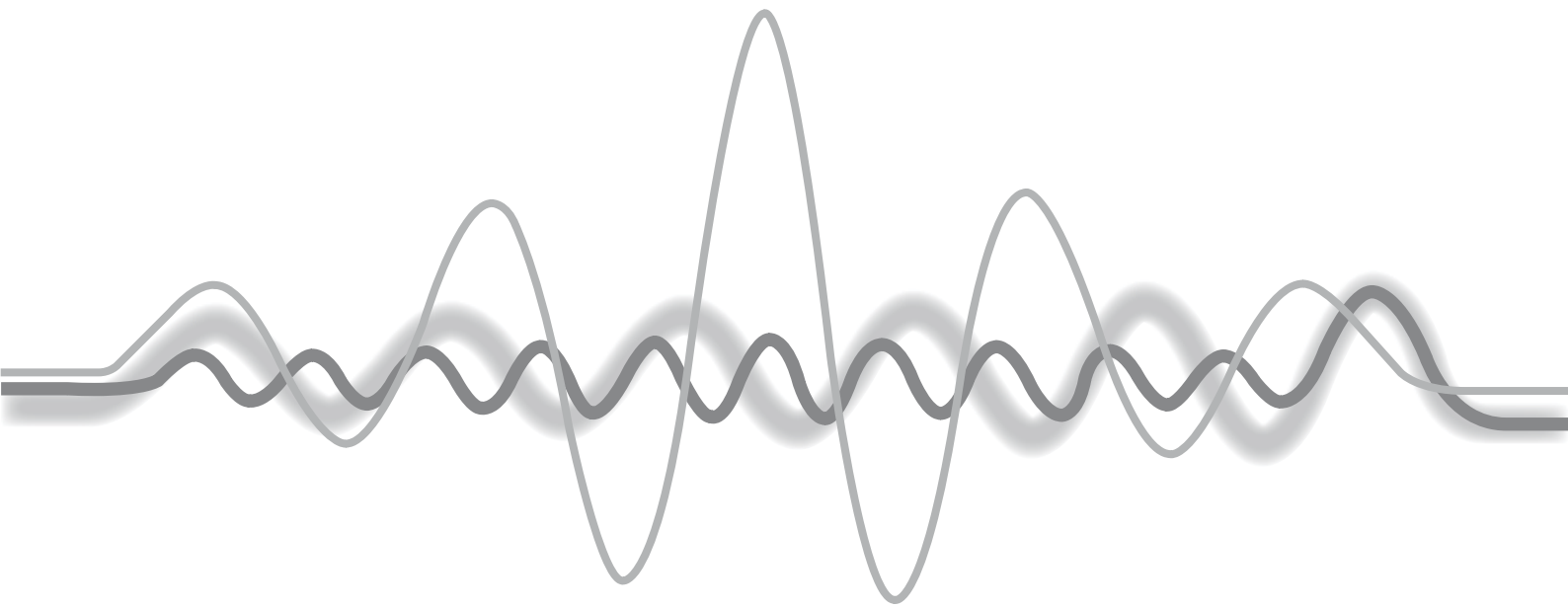

Connected services

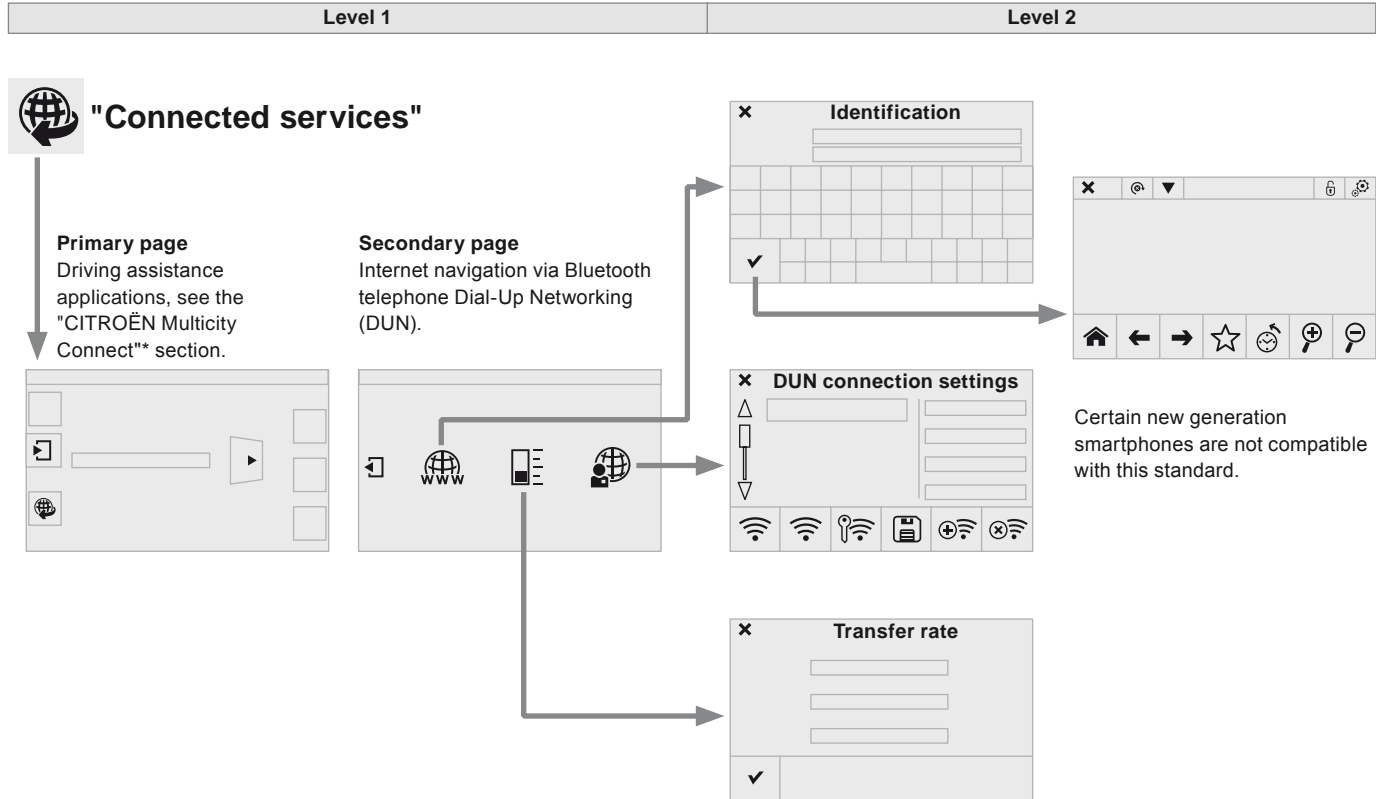

* Depending on country.

CITROËN Multicity Connect

! "CITROËN Multicity Connect"* is a service providing driving aid applications in real time; it gives access to useful information such as the state of the traffic, danger zones, fuel prices, the availability of parking places, tourist sites, weather conditions, correct addresses...

It includes access to the mobile network associated with the use of these applications. "CITROËN Multicity Connect"* is a service available under subscription contract from CITROËN dealers, depending on country and the type of touch screen, both before and after delivery of a new vehicle.



Plug the "CITROËN MULTICITY CONNECT" connection key into one of the USB ports.

* Depending on country.



Press the "Connected services" menu to display the applications.

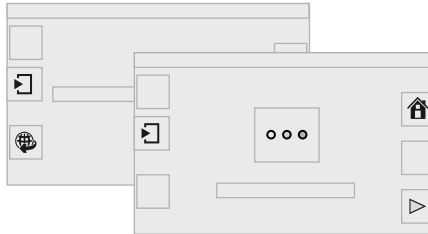

These applications use vehicle data such as the current speed, mileage, remaining fuel range or even GPS position to provide pertinent information.











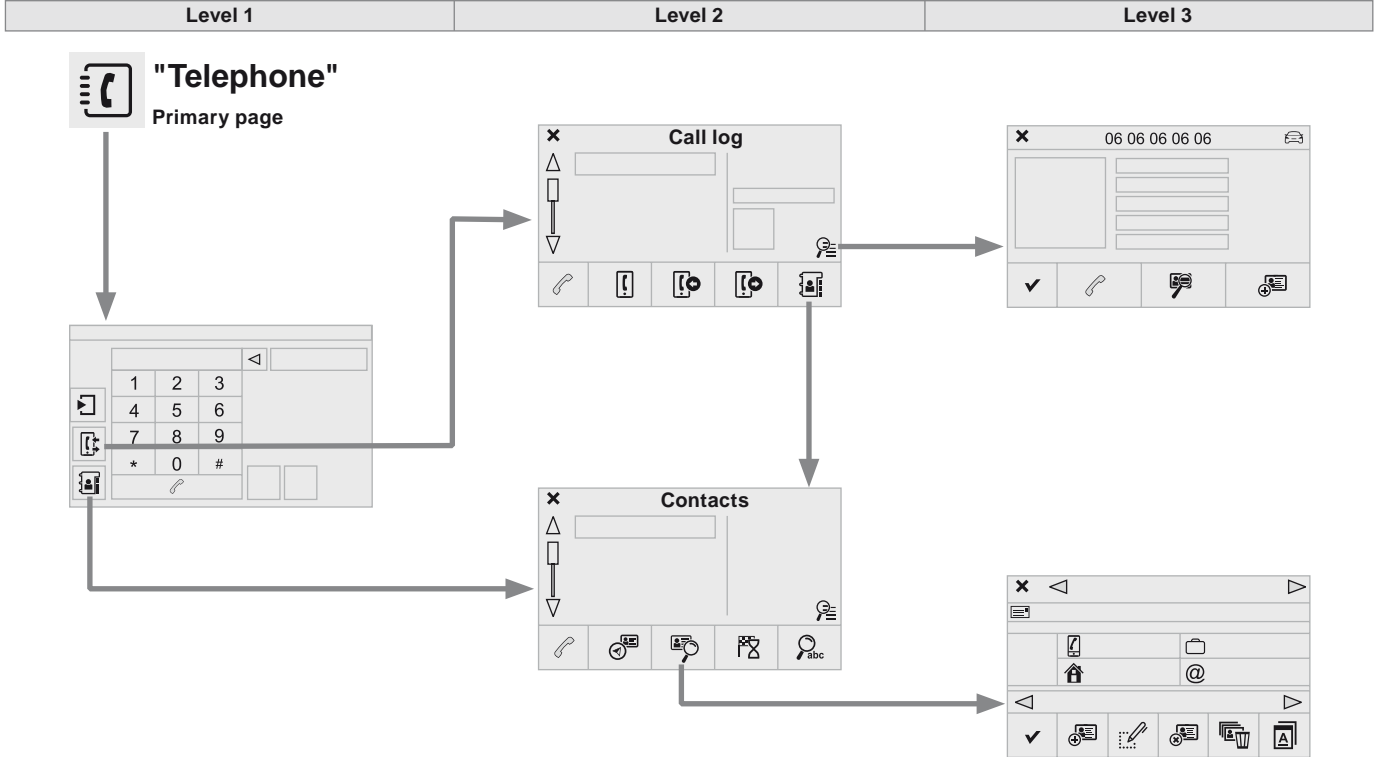















As a safety measure, some functions can only be used when stationary.



















The "MyCITROËN" application is a link between the user, the manufacturer and its dealer network. It allows the customer to know everything about their vehicle: servicing plan, accessory range, service contracts taken out, ... It also makes possible the sending of the vehicle's mileage to the "MyCITROËN" site, or to identify a dealer.



Telephone



Level 1		Level 2		Level 3		Comments
 	Telephone ↓ Call log	 All calls				After making choices, start the call.
		 Incoming calls				
		 Outgoing calls				
		 Contacts				
		 Magnifying glass	 View			
		 Call	 Create			
 	Telephone ↓ Contacts	 Addresses				After making choices, start the call.
		 View	 New			
			 Import			
			 Delete			
			 Delete all			
			 Search for contact			
			 Confirm			
		 Navigate to				
		 Search for contact				
 Call						

Level 1		Level 2		Level 3		Comments
  	Telephone connection ↓ Secondary page ↓ Bluetooth Connection	 Search				Start the search for another peripheral device to connect.
		 Disconnect				Stop the Bluetooth connection to the selected peripheral device.
		 Update				Import the contacts from the selected telephone to store them in the audio system.
		 Delete				Delete the selected telephone.
		 Confirm				Save the settings.
  	Telephone connection ↓ Secondary page ↓ Search for devices			<input checked="" type="checkbox"/>	Telephone	Start the search for peripheral devices.
		Devices detected		<input checked="" type="checkbox"/>	Audio streaming	
				<input checked="" type="checkbox"/>	Internet	
  	Telephone connection ↓ Secondary page ↓ Telephone Options	 Put on hold				Cut the microphone temporarily so that the contact cannot hear your conversation with a passenger.
		 Update				Import the contacts from the selected telephone to save then in the audio system.
		 Ringtones				Choose the telephone ringtone and volume.
		 Memory info.				Contact records used and free, percentage of storage space used by internal contacts and Bluetooth contacts.
		 Confirm				Save the settings.

Pairing a Bluetooth® telephone

! For reasons of safety and because they require prolonged attention on the part of the driver, the operations for pairing the Bluetooth mobile telephone to the hands-free system of the audio system must be carried out with the **vehicle stationary**.

Procedure (short) from the telephone

In the Bluetooth menu of your device, select the system name in the list of devices detected.

Enter a code of at least 4 figures in the device and confirm.



Enter this same code in the system, select **"OK"** and confirm.

Procedure from the system

Activate the telephone's Bluetooth function and ensure that it is "visible to all" (telephone configuration).



Press on **Telephone** to display the primary page.



Press on the secondary page.



Select **"Bluetooth connection"**.



Select **Search**.
The list of telephones detected is displayed.



If the telephone is not detected, it is recommended that you switch the Bluetooth function on your telephone off and then on again.

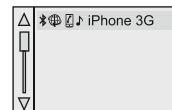

Select the name of the desired peripheral from the list and **"Confirm"**.



Enter a code of at least 4 figures for the connection then **"Confirm"**.

Enter this same code in the telephone then accept the connection.

The system offers to connect the telephone:

- in **"Telephone"** (hands-free kit, telephone only),
- in **"Audio streaming"** (streaming: wireless playing of audio files from the telephone),
- in **"Internet"** (internet browsing, only if your telephone is compatible with the "DUN" Dial-Up Networking Bluetooth standard).

Select one or more profiles and confirm.

! The services available depend on the network, the SIM card and the compatibility of the Bluetooth telephone used. Check the telephone manual and with your network provider for details of the services available to you.

! The ability of the system to connect with only one profile depends on the telephone. The three profiles may all connect by default.

Visit www.citroen.co.uk for more information (compatibility, additional help, ...).

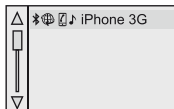

The recognised telephone appears in the list.

Depending on your telephone, you may be asked to accept automatic connection every time the ignition is switched on.

! Depending on the type of telephone, the system will ask you to accept or not the transfer of your contacts.



If not, select "**Update**".

On return to the vehicle, if the last telephone connected is present again, it is reconnected automatically and within around 30 seconds after switching on the ignition the pairing is done without any action on your part, with (Bluetooth activated).

To modify the automatic connection mode, select the telephone in the list then select the desired profile.

Connecting a Bluetooth® peripheral device

Automatic reconnection

On switching on the ignition, the telephone connected when the ignition was last switched off is automatically reconnected, if this connection mode had been activated during the pairing procedure.

The connection is confirmed by the display of a message and the name of the telephone.

Manual connection



Press on **Telephone** to display the primary page.



Press on the secondary page.



Select "**Bluetooth**" to display the list of paired peripherals.

Select the peripheral to connect.



Press on "**Search**".

The connection is confirmed by the display of a message and the name of the telephone.

Managing paired telephones

i This function allows the connection or disconnection of a peripheral device as well as the deletion of a pairing.



Press on **Telephone** to display the primary page.



Press on the secondary page.



Select "**Bluetooth**" to display the list of paired peripheral devices.

Select the peripheral in the list.



Select "**Search for devices**"

Or



"**Connect / Disconnect**" to start or end the Bluetooth connection with the selected device.

Or



"**Delete**" to delete the pairing.

Receiving a call

An incoming call is announced by a ring and a superimposed display in the screen.



Make a short press on the steering mounted **TEL** button to accept an incoming call.



Make a long press



on the steering mounted **TEL** button to reject the call.

Or



Select "**End call**".

Making a call

! Using the telephone is not recommended while driving. Park the vehicle. Make the call using the steering mounted controls.

Calling a new number



Press on **Telephone** to display the primary page.



Enter the phone number using the digital keypad. Press "**Call**" to start the call.

Calling a contact



Press on **Telephone** to display the primary page.



Or make a long press



on the steering mounted **TEL** button.



Select "**Contacts**".

Select the desired contact from the list offered.



Select "**Call**".

Calling a recently used number



Press on **Telephone** to display the primary page.



Select "**Call log**".

Select the desired contact from the list offered.



It is always possible to make a call directly from the telephone; park the vehicle first as a safety measure.

Managing contacts / entries



Press on **Telephone** to display the primary page.



Select "**Contacts**".



Select "**Add contact**".



Select "**Create**" to add a new contact.

Or



"**Modify**" to edit the selected contact.

Or



"**Delete**" to delete the selected contact.

Or



"**Delete all**" to delete all information for the selected contact.



Select "**Directory information**" for the number of entries used, available, ...

Frequently asked questions

The following table groups together the answers to the most frequently asked questions concerning your audio system.

Navigation

QUESTION	ANSWER	SOLUTION
The route calculation is not successful.	The route settings may conflict with the current location (exclusion of toll roads on a toll motorway).	Check the route settings in the "Navigation" menu.
The POIs do not appear.	The POIs have not been selected.	Select the POIs in the list of POIs.
The Hazard zone audible warning does not work.	The audible warning is not active.	Activate audible warnings in the "Navigation" menu.
The system does not suggest a detour around an incident on the route.	The guidance criteria do not take account of TMC messages.	Select the "Traffic info" function in the list of route settings.
I receive an Accident-prone area alert which is not on my route.	Other than guidance, the system announces all Hazard zones positioned in a cone located in front of the vehicle. It may provide an alert for a Hazard zone located on nearby or parallel roads.	Zoom in on the map to view the exact position of the Accident-prone area. Select "On the route" to no longer receive alerts other than navigation instructions or to reduce the time for the announcement.

QUESTION	ANSWER	SOLUTION
Certain traffic jams along the route are not indicated in real time.	On starting, it is several minutes before the system begins to receive the traffic information.	Wait until the traffic information is being received correctly (display of the traffic information icons on the map).
	The filters are too restrictive.	Modify the "Geographic filter" settings.
	In certain countries, only major routes (motorways...) are listed for the traffic information.	This phenomenon is normal. The system is dependent on the traffic information available.
The altitude is not displayed.	On starting, the initialisation of the GPS may take up to 3 minutes to receive more than 4 satellites correctly.	Wait until the system has started up completely so that there is GPS coverage by at least 4 satellites.
	Depending on the geographical environment (tunnel...) or the weather, the conditions of reception of the GPS signal may vary.	This phenomenon is normal. The system is dependent on the GPS signal reception conditions.

Radio

QUESTION	ANSWER	SOLUTION
The quality of reception of the radio station listened to gradually deteriorates or the stored stations do not function (no sound, 87.5 Mhz is displayed...).	The vehicle is too far from the transmitter used by the station listened to or there is no transmitter in the geographical area through which the vehicle is travelling.	Activate the "RDS" function by means of the short-cut menu to enable the system to check whether there is a more powerful transmitter in the geographical area.
	The environment (hills, buildings, tunnels, basement car parks...) block reception, including in RDS mode.	This phenomenon is normal and does not indicate a fault with the audio system.
	The aerial is absent or has been damaged (for example when going through a car wash or into an underground car park).	Have the aerial checked by a CITROËN dealer.
I cannot find some radio stations in the list of stations received.	The station is not received or its name has changed in the list.	Press and hold the "List" button at the steering mounted controls to update the list of stations received or press on the system update function: "Update list".
The name of the radio station changes.	Some radio stations send other information in place of their name (the title of the song for example).	
	The system interprets this information as the name of the station.	

Media

QUESTION	ANSWER	SOLUTION
Playback of my USB memory stick starts only after a very long wait (around 2 to 3 minutes).	Some files supplied with the memory stick may greatly slow down access to reading the memory stick (multiplication by 10 of the catalogue time).	Delete the files supplied with the memory stick and limit the number of sub-folders in the file structure on the memory stick.
When I connect my iPhone as a telephone and to the USB port at the same time, I am unable to play the music files.	When the iPhone connects automatically as a telephone, it forces the streaming function. The streaming function takes the place of the USB function which is then not useable, there is a period without sound of the track being played with Apple® players.	Disconnect and reconnect to the USB port (the USB function takes priority over streaming).
The CD is ejected automatically or is not played by the player.	<p>The CD is inserted upside down, is unplayable, does not contain any audio data or contains an audio format which the player cannot play.</p> <p>The CD has been recorded in a format that is not compatible with the player (udf, ...).</p> <p>The CD is protected by an anti-pirating protection system which is not recognised by the audio system.</p>	<ul style="list-style-type: none"> - Check that the CD is inserted in the player the right way up. - Check the condition of the CD: the CD cannot be played if it is too damaged. - Check the content in the case of a recorded CD: refer to the advice in the "AUDIO" section. - The audio system's CD player does not play DVDs. - Some recorded CDs will not be played by the audio system because they are not of the correct quality.
There is a long waiting period following the insertion of a CD or connection of a USB memory stick.	When a new medium is inserted, the system reads a certain amount of data (directory, title, artist, etc.). This may take from a few seconds to a few minutes.	This phenomenon is normal.

QUESTION	ANSWER	SOLUTION
The CD player sound is poor.	The CD used is scratched or of poor quality.	Insert good quality CDs and store them in suitable conditions.
	The audio equipment settings (bass, treble, ambiences) are unsuitable.	Set the treble or bass level to 0, without selecting an ambience.
Some characters in the media information are not displayed correctly while playing.	The audio system does not display some types of characters.	Use standard characters to name tracks and folders.
Playing of streaming files does not start.	The peripheral device connected does not support automatic play.	Start the playback from the device.
The names of tracks and the track length are not displayed on the screen when streaming audio.	The Bluetooth profile does not allow the transfer of this information.	

Settings

QUESTION	ANSWER	SOLUTION
In changing the setting of treble and bass the equalizer setting is deselected.	The selection of an equalizer setting imposes the balance settings. Modifying one without the other is not possible.	Modify the balance or equalizer settings to obtain the desired musical ambience.
In changing the equalizer setting, treble and bass return to zero.		
When changing the balance settings, the distribution setting is deselected.	The selection of a distribution setting imposes the balance settings. Modifying one without the other is not possible.	Modify the balance or distribution settings to obtain the desired musical ambience.
When changing an distribution setting, the balance setting is deselected.		

QUESTION	ANSWER	SOLUTION
There is a difference in sound quality between the different audio sources.	For optimum sound quality, the audio settings for Volume, Bass, Treble, Equalizer and Loudness can be adapted to the different sound sources, which may result in audible differences when changing source.	Check that the audio settings for (Volume, Bass, Treble, Equalizer, Loudness) are adapted to the sources listened to. It is advisable to set the Audio functions (Bass, Treble, Fr-Re balance, Le-Ri balance) to the middle position, select the "Linear", musical ambience and set the loudness correction to the "Active" position in CD mode or to the "Inactive" position in radio mode.
With the engine off, the system switches off after a few minutes of use.	When the engine is switched off, the system's operating time depends on the state of charge of the battery. The switch-off is normal: the system switches to economy mode and switches off to prevent discharging of the vehicle's battery.	Start the vehicle's engine to increase the battery charge.

Telephone

QUESTION	ANSWER	SOLUTION
I cannot connect my Bluetooth telephone.	The telephone's Bluetooth function may be switched off or the telephone may not be visible.	<ul style="list-style-type: none"> - Check that your telephone's Bluetooth function is switched on. - Check in the telephone settings that it is "visible to all".
	The Bluetooth telephone is not compatible with the system.	You can check the compatibility of your telephone at www.citroen.co.uk (services).
The volume of the telephone connected in Bluetooth mode is inaudible.	The volume depends both on the system and on the telephone.	Increase the volume of the audio system, to maximum if required, and increase the volume of the telephone if necessary.
	The ambient noise level has an influence on the quality of telephone communication.	Reduce the ambient noise level (close the windows, reduce the booster fan speed, slow down, ...).
Some contacts are duplicated in the list.	The options for synchronizing contacts are synchronizing the contacts on the SIM card, the contacts on the telephone, or both. When both synchronizations are selected, some contacts may be duplicated.	Select "Display SIM card contacts" or "Display telephone contacts".
Contacts are not shown in alphabetical order.	Some telephones offer display options. Depending on the settings chosen, contacts can be transferred in a specific order.	Modify the display setting in the telephone directory.
The system does not receive SMS text messages.	The Bluetooth mode does not permit sending SMS text messages to the system.	

A

Accessories	300
Accessory position	129
Access to the 3rd row	84
Additive, AdBlue.....	21, 22, 38, 316, 320
Adjusting headlamps	200
Adjusting head restraints	77
Adjusting seats.....	73-82
Adjusting the air distribution	94, 97
Adjusting the air flow.....	95, 99
Adjusting the date	47
Adjusting the height and reach of the steering wheel.....	91
Adjusting the seat belt height	220
Adjusting the temperature	94, 95, 97
Adjusting the time	47
Advice on care and maintenance	315
Advice on driving	123
Airbags.....	35, 225
Airbags, curtain.....	229, 230
Airbags, front.....	226, 230
Airbags, lateral.....	228, 230
Air conditioning	9, 95, 97
Air conditioning, automatic	93, 97
Air conditioning, manual	93, 95
Air distribution adjustment.....	94, 97
Air flow adjustment	95, 99
Air intake	96, 100
Air recirculation.....	96, 100
Air vents	92
Alarm	68
Anti-pinch.....	71, 209
Anti-theft	129
Armrest, front.....	79, 106
Assistance call.....	212, 336
Audible warning	211
Audio streaming (Bluetooth).....	358
Automatic headlamp dipping	27, 197
Auxiliary	110, 356

B

Battery.....	286-288, 314
Battery, charging.....	288
Battery, remote control	59, 60
Black panel.....	46
Blanking screen (snow shield).....	299
Blind, panoramic sunroof.....	209
Blind spot sensors	175
Blinds, side.....	107, 114
BlueHDI.....	148, 309, 316
Bluetooth (hands-free).....	390, 391
Bluetooth (telephone).....	390, 391
Bonnet.....	303
Boot	64-66
Boot (fittings).....	119
Boot, motorised	65, 66
Boot (opening).....	51
Bottle holder.....	106
Brake discs.....	315
Brake lamps	274-277
Brakes	34, 37, 315
Braking, dynamic emergency	130, 135
Bulbs (changing)	270-278

C

Cable, audio.....	110, 356
Capacity, fuel tank	306
Cap, fuel filler.....	306
Cartridge, fragrance	104

CD	356
Central locking.....	51, 55, 61
Changing a bulb	270-278
Changing a fuse.....	279 -285
Changing a wheel	259-268
Changing a wiper blade	207, 290
Changing the remote control battery.....	59
Checking the engine oil level.....	43, 310
Checking the levels.....	310-313
Checking tyre pressures (using the kit)	258
Checks	304, 305, 314, 315
Child lock.....	250
Children	224, 227, 231-250
Child seats	231-249
Child seats, conventional.....	237
Child seats, ISOFIX	243
CITROËN Connect Box	336
CITROËN Localised Emergency Call.....	336
CITROËN Multicity Connect	385
Closing the boot.....	64, 65
Closing the doors	52, 55, 58
Configurations, seats	87
Configuration, vehicle.....	11, 13
Connection, Bluetooth	390, 391
Connectors, audio.....	110, 356
Control, emergency boot release	67
Control, emergency door.....	63
Control, heated seats.....	79
Controls, steering mounted	342
Control stalk, lighting	191-196
Control stalk, wipers	203-206
Courtesy lamps.....	208
Cruise control.....	156, 160
Cruise control, active	163
Cup holder.....	106

D

DAB (Digital Audio Broadcasting) -
 Digital radio..... 354, 355
 Date (setting).....47
 Daytime running lamps.....199, 270, 272
 Deactivating
 the passenger airbag.....226
 Deadlocking 53, 56, 58
 Defrosting/demisting, front102
 Defrosting/demisting, rear103
 Diesel pre-heater 28, 124
 Dimensions 333, 334
 Dipstick.....43, 310
 Directional lighting201, 202
 Direction indicators.....195, 211, 270, 273-277
 Display of inter-vehicle time.....152
 Display screen,
 instrument panel.....22, 148
 Distance alert.....152, 171, 172
 Doors.....62
 Driving economically.....9
 Driving positions (storing).....76
 Dynamic stability control (DSC).....30, 34, 218

E

Eco-driving9
 Economy mode289
 Electronic stability control (ESC).....216

Emergency call212, 336
 Emergency warning lamps211
 Emissions control system, SCR39, 316
 Energy economy mode.....289
 Engine compartment304, 305
 Engine, Diesel.....305, 308, 309, 327-329
 Engine, petrol.....304, 308, 323
 Environment9, 59, 93, 103, 257, 313, 322
 ESC/ASR.....216

F

Filling the fuel tank.....306-308
 Filter, air314
 Filter, oil.....314
 Filter, particle313, 314
 Filter, passenger compartment.....314
 Fitting a wheel.....267
 Fitting roof bars.....297
 Fittings, boot119
 Fittings, interior106, 107
 Fittings, rear113
 Flap, fuel filler.....306, 307
 Flashing indicators.....211
 Floor, concertina85
 Foglamps, front193, 201, 270, 273
 Foglamps, rear193, 274, 276

Folding the rear seats80, 82, 84, 85
 Frequency (radio).....352, 353
 Fuel.....9, 308
 Fuel consumption.....9
 Fuel tank.....307
 Fusebox, dashboard281
 Fusebox, engine compartment.....284
 Fuses.....279

G

Gauge, fuel.....20, 21, 306
 Gearbox, automatic143, 149, 288, 315
 Gearbox, electronic139, 149, 288, 315
 Gearbox, manual138, 149, 315
 Gear shift indicator148
 Gear lever, automatic gearbox143
 Gear lever, electronic gearbox130
 Gear lever, manual gearbox138
 Glove box106, 107

H

Hazard warning lamps	211, 212
Hazard warning lamps, automatic operation	211
Headlamp adjustment	200
Headlamps, automatic illumination	192, 196
Headlamps, dipped beam	27, 191, 270, 271
Headlamps, directional	202, 270
Headlamps, halogen	270
Headlamps, main beam	27, 191, 270-272, 274
Headlamps, Xenon	270
Headlamp wash	205
Head restraints, front	77
Head restraints, rear	81
Heating	94, 95, 97
Hill start assist	137
Hooks	118

I

Identification, vehicle	335
Ignition	129
Immobiliser, electronic	60, 129
Indicator, engine oil level	43
Indicator lamps, operation	25-39
Indicator lamps, status	28, 33
Indicators, direction	211
Inflating tyres	9, 335
Inflating tyres and accessories (using the kit)	258

Instrument panels	20-22
Intelligent Traction Control	217
Interactive help	11, 13
Inter-vehicle time	152
Isofix mountings	242

J

Jack	259-262
Jukebox	359
Jump starting	286

K

Key	51-60, 129
Key, electronic	51-53, 60, 129
Keyless Entry and Starting	54-57, 60
Kit, hands-free	390, 391
Kit, temporary puncture repair	251

L

Labels, identification	335
Lamp, boot	122
Lamps, parking	195
Lane Departure Warning System (LDWS)	174
LEDs - light-emitting diodes	270, 274, 276
Leg rest, electric	78
Level, AdBlue® additive	316
Level, brake fluid	312
Level, Diesel additive	313
Level, engine coolant	312
Level, engine oil	43, 310
Level, headlamp wash	313
Levels and checks	304-322
Light-emitting diodes - LEDs	270, 274, 276
Lighting, guide-me home	195
Lighting, interior	208
Lighting, mood	210
Lighting, welcome	199
Loading	9, 296, 297
Load reduction mode	289
Localised Assistance Call	212, 336
Locating your vehicle	53
Locking from the inside	61
Locking the doors, automatic	61
Low fuel level	35, 306
Lumbar	78

M

Maintenance, routine	9
Map reading lamps	208
Markings, identification	335
Massage function	78
Mat	111
Memorising a speed	156
Menu	346, 348, 350, 360, 362, 366, 374, 386, 388
Menus (Touch screen tablet).....	339, 344, 345
Mirror, child surveillance.....	91
Mirror, rear view	90
Mirrors, door.....	89, 90, 175
Misfuel prevention.....	307
Modularity, seats.....	87
Mountings, Isofix.....	242
Multimedia, rear	115

N

Net.....	120
Number plate lamps.....	278

O

Oil change	310
Oil consumption	310
Oil, engine.....	310
Opening the bonnet	303
Opening the boot	51, 54, 64
Opening the doors	51, 54
Opening the panoramic sunroof blind	209

P

Pads, brake	315
Paint colour code.....	335
Panoramic glass sunroof.....	209
Parcel shelf, rear.....	113, 118
Park Assist	183-190
Parking brake, electric.....	130-136, 315
Parking sensors, front.....	179
Parking sensors, rear.....	178
Plates, identification.....	335
Player, Apple®	358
Player, CD	356
Player, USB.....	110, 356
Port, USB	110, 356
Pressures, tyres	253, 258, 335
Priming the fuel system	309
Protecting children.....	224, 227, 231-250
Puncture.....	251

R

Radio	352-355
Radio, digital (Digital Audio Broadcasting - DAB).....	354, 355
Range, AdBlue	317
RDS	353
Reading lamps, rear.....	113
Rear screen, demisting.....	103
Recharging the battery	288
Recirculation, air	94, 96, 100
Reduction of electrical load	289
Regeneration of the particle filter	314
Reinitialising the remote control	59
Remote control.....	51-60
Removing a wheel	265
Removing the mat.....	111
Replacing bulbs	270-278
Replacing fuses	279-285
Replacing the air filter.....	314
Replacing the oil filter	314
Replacing the passenger compartment filter	314
Resetting the service indicator	42
Resetting the trip recorder	44
Reversing camera.....	180
Reversing lamp	274-277
Risk areas (update).....	371
Roof bars.....	297
Running out of fuel (Diesel)	309

S

Safety, children	224, 227, 231-250
Scented air freshener	104
Screen, cold climate	299
Screen, colour	344, 345
Screen menu	346, 348, 350, 360, 362, 366, 374, 386, 388
Screenwash fluid level	313
Screenwash, front	205
Screenwash, rear	204
SCR (Selective Catalytic Reduction)	316
Seat belts	220-224, 237
Seats, electric	75
Seats, front	73-79
Seats, heated	79
Seats, rear	80-88
Selector, gear	139, 143
Serial number, vehicle	335
Service indicator	40
Servicing	9
Settings, equipment	11, 13
Settings (Menus)	374
Settings, system	382
Sidelamps	191, 195, 270, 272, 274, 276
Side repeater	274
Snow chains	269
Socket, 12 V accessory	106, 110, 114
Sockets, audio	110, 356
Speed limiter	156, 157
Spotlamps, side	199, 274
Starting the vehicle	124, 126, 127
Starting using another battery	286
Station, radio	352-355
Stay, bonnet	303
Steering wheel, adjustment	91
Stopping the vehicle	125, 127
Stop & Start	50, 102, 149, 150, 286, 303, 306, 314

Storage	107
Storage boxes	112, 114
Storing driving positions	76
Sun visor	107
Sun visor flap	107
Synchronising the remote control	59

Towbar	295
Towed loads	325, 330-332
Towing another vehicle	291
Traction control (ASR)	30, 34
Traffic information (TA)	373
Traffic information (TMC)	372
Trailer	295
Triangle, warning	212
Trip computer	48-50
Trip distance recorder	44
Tyres	9, 335
Tyre under-inflation detection	37, 213-215, 258

T

Table of weights	325, 330-332
Tables of engines	323, 327-329
Tables of fuses	279
Tank, AdBlue® additive	316, 320
Tank, fuel	306, 307
Technical data	323-335
Telephone	386-393, 401
Temperature adjustment	94, 95, 97
Three flashes (direction indicators)	211
Time (setting)	47
TMC (Traffic info)	372
Tools	259-262
Torch	122
Total distance recorder	44
Touch screen tablet	11, 13
Touch screen tablet (Menus)	339, 344, 345

U

Under floor storage	118
Under-inflation (detection)	37, 213-215, 258
Unlocking	51, 54
Unlocking from the inside	61
Unlocking the boot	51, 54, 58, 61
Unlocking the doors	51, 54, 58, 61
Updating risk areas	371
Updating the date	47
Updating the time	47
UREA	316
USB	110, 356

V

Ventilation	92, 93, 94, 95
Visibility	102
Vision 360°	181

W

Warning and indicator lamps	25-39
Warning lamp, braking system	34
Warning lamp, Diesel engine pre-heater	28
Warning lamp, SCR emissions control system	39
Warning lamp, Service	32
Washing (advice).....	315
Weights	325, 330-332
Wheel, spare	259-262
Window controls	71
Wiper blades (changing).....	207, 290
Wiper, rear.....	204
Wipers	29, 203-207
Wipers, automatic rain sensitive.....	29, 203, 206





Labels are fitted in various areas of your vehicle. They carry safety warnings as well as vehicle identification information. Do not remove them: they form an integral part of your vehicle.

Automobiles CITROËN declares, by application of the provisions of the European regulation (Directive 2000/53) relating to End of Life Vehicles, that it achieves the objectives set by this regulation and that recycled materials are used in the manufacture of the products that it sells.

Reproduction or translation of all or part of this document is prohibited without written authorisation from Automobiles CITROËN.

For any work on your vehicle, use a qualified workshop that has the technical information, competence and equipment required, which a CITROËN dealer is able to provide.

We draw your attention to the following points:

- The fitting of electrical equipment or accessories not listed by CITROËN may cause faults and failures with the electrical system of your vehicle. Contact a CITROËN dealer for information on the range of recommended accessories.
- As a safety measure, access to the diagnostic socket, used for the vehicle's electronic systems, is reserved strictly for CITROËN dealers or qualified workshops, equipped with the special diagnostic tool required (risk of malfunctions of the vehicle's electronic systems that could cause breakdowns or serious accidents). The manufacturer cannot be held responsible if this advice is not followed.
- Any modification or adaptation not intended or authorised by Automobiles CITROËN or carried out without meeting the technical requirements defined by the manufacturer would lead to the suspension of the legal and contractual warranty.

Printed in the EU
Anglais
03-15

Automobiles CITROËN

Siège social : 6, rue Fructidor 75017 Paris - France

Tél. : +33 (0) 1 58 79 79 79 - www.citroen.com

Société anonyme au capital de 159 000 000 € - R.C.S. : 642 050 199 R.C.S. Paris - SIRET : 642 050 199 00990 - APE : 7010Z



15B78.0040

Anglais

2015 – DOCUMENTATION DE BORD

4Deconcept

Diadeis

Interak

