

TABLE OF CONTENTS

SECTION		PAGE
1	INTRODUCTION	3
2	THINGS TO KNOW BEFORE STARTING YOUR VEHICLE	9
3	UNDERSTANDING THE FEATURES OF YOUR VEHICLE	73
4	UNDERSTANDING YOUR INSTRUMENT PANEL	143
5	STARTING AND OPERATING	223
6	WHAT TO DO IN EMERGENCIES	279
7	MAINTAINING YOUR VEHICLE	295
8	MAINTENANCE SCHEDULES	347
9	IF YOU NEED CONSUMER ASSISTANCE	371
10	INDEX	381

INTRODUCTION

CONTENTS

■ Introduction	4	■ Vehicle Identification Number	6
■ How To Use This Manual	4	■ Vehicle Modifications / Alterations	7
■ Warnings And Cautions	6		

INTRODUCTION

This manual has been prepared with the assistance of service and engineering specialists to acquaint you with the operation and maintenance of your new vehicle. It is supplemented by a Warranty Information Booklet and various customer oriented documents. You are urged to read these publications carefully. Following the instructions and recommendations in this manual will help assure safe and enjoyable operation of your vehicle.

NOTE: After you read the manual, it should be stored in the vehicle for convenient reference and remain with the vehicle when sold, so that the new owner will be aware of all safety warnings.

When it comes to service, remember that your dealer knows your vehicle best, has the factory-trained technicians and genuine Mopar® parts, and is interested in your satisfaction.

WARNING!

Engine exhaust, some of its constituents, and certain vehicle components contain or emit chemicals known to the State of California to cause cancer and birth defects or other reproductive harm. In addition, certain fluids contained in vehicles and certain products of component wear contain or emit chemicals known to the State of California to cause cancer and birth defects or other reproductive harm.

HOW TO USE THIS MANUAL

Consult the table of contents to determine which section contains the information you desire.

The detailed index, at the rear of this manual, contains a complete listing of all subjects.

Consult the following table for a description of the symbols that may be used on your vehicle or throughout this owner's manual:



8114c4bd

WARNINGS AND CAUTIONS

This manual contains **WARNINGS** against operating procedures which could result in an accident or bodily injury. It also contains **CAUTIONS** against procedures which could result in damage to your vehicle. If you do not read this entire manual you may miss important information. Observe all Warnings and Cautions.

VEHICLE IDENTIFICATION NUMBER

The vehicle identification number (VIN) is found on the left front corner of the instrument panel, visible from outside of the vehicle through the windshield. This number also appears on the Automobile Information Disclosure Label affixed to a window on your vehicle. Save this label for a convenient record of your vehicle identification number and optional equipment.

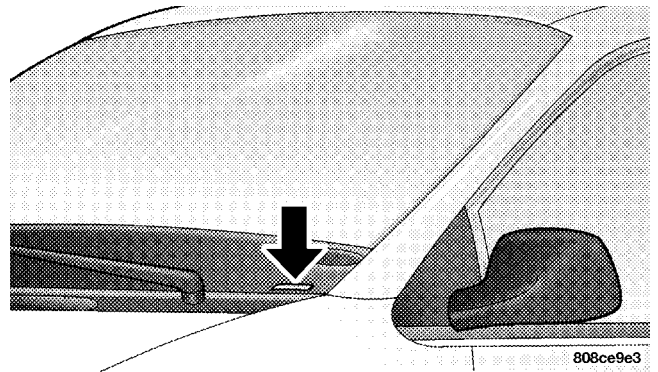

NOTE: It is illegal to remove the VIN plate.

VEHICLE MODIFICATIONS / ALTERATIONS**WARNING!**

Any modifications or alterations to this vehicle could seriously affect its roadworthiness and safety and may lead to an accident resulting in serious injury or death.

THINGS TO KNOW BEFORE STARTING YOUR VEHICLE

CONTENTS

■ A Word About Your Keys12	□ Manual Door Locks17
□ Ignition Key Removal12	□ Power Door Locks — If Equipped18
□ Key-In-Ignition Reminder13	■ Remote Keyless Entry — If Equipped20
■ Sentry Key13	□ To Unlock The Doors And Liftgate22
□ Replacement Keys15	□ To Lock The Doors And Liftgate22
□ Sentry Key Programming15	□ Using The Panic Alarm22
□ General Information16	□ To Program Transmitters23
■ Illuminated Entry System — If Equipped16	□ General Information25
■ Door Locks17	□ Transmitter Battery Service25

10 THINGS TO KNOW BEFORE STARTING YOUR VEHICLE

■ Vehicle Theft Alarm — If Equipped	26	□ Lap/Shoulder Belt Untwisting Procedure	45
■ Sliding Side Door	28	□ Center Lap Belts	47
□ Power Sliding Door — If Equipped	29	□ Seat Belt Pretensioners	47
□ Child Protection Door Lock	32	□ Seat Belts And Pregnant Women	48
■ Liftgate	33	□ Seat Belt Extender	48
□ Power Liftgate — If Equipped	34	□ Driver And Front Passenger Supplemental Restraint System - Airbag	48
■ Windows	36	□ Side Airbags Supplemental Restraint System (SRS) — If Equipped	54
□ Manual Rear Vent Windows	36	□ DaimlerChrysler Corporation Integrated Child Seat — If Equipped	58
□ Power Vent Windows — If Equipped	36	□ Child Restraint	58
□ Power Windows — If Equipped	37		
■ Occupant Restraints	38		
□ Lap/Shoulder Belts	39		

<hr/>		THINGS TO KNOW BEFORE STARTING YOUR VEHICLE	11
■ Rear Seat Delete Feature (Commercial Vehicles Only) — If Equipped66
<input type="checkbox"/> Restraining Infants And Small Children With Seat Delete Feature (Commercial Vehicles Only)67
■ Engine Break-In Recommendations70
■ Safety Tips71
<input type="checkbox"/> Exhaust Gas71
<input type="checkbox"/> Safety Checks You Should Make Inside The Vehicle71
<input type="checkbox"/> Periodic Safety Checks You Should Make Outside The Vehicle72

A WORD ABOUT YOUR KEYS

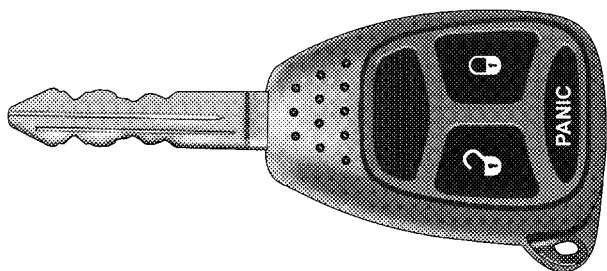

81182d3d

You can insert the double sided keys into the locks with either side up.

The dealer that sold you your new vehicle has the key code numbers for your vehicle locks. These numbers can

be used to order duplicate keys from your dealer. Ask your dealer for these numbers and keep them in a safe place.

Ignition Key Removal

The shift lever must be in PARK. Turn the key to the OFF position, then the LOCK position. Remove the key.

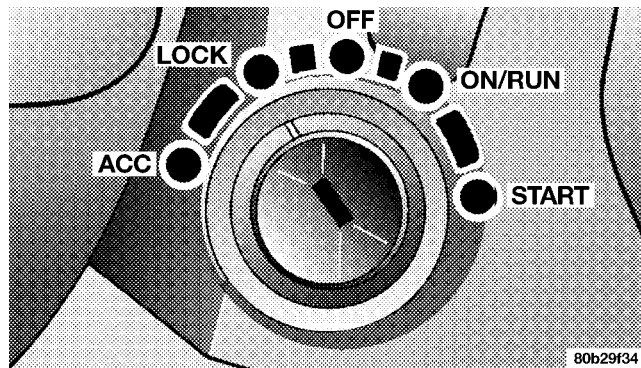

80b29f34

NOTE: The power window switches, radio, power outlets, and removable console (if equipped), will remain active for up to 45 seconds after the ignition switch has been turned off. Opening a vehicle front door will cancel this feature.

WARNING!
<p>Leaving children in a vehicle unattended is dangerous for a number of reasons. A child or others could be injured. Children should be warned not to touch the parking brake, brake pedal or the gear selector lever. Don't leave the keys in the ignition. A child could operate power windows, other controls, or move the vehicle.</p>

CAUTION!
<p>An unlocked car is an invitation to thieves. Always remove key from the ignition and lock all doors when leaving the vehicle unattended.</p>

2

Key-In-Ignition Reminder

If you open the driver's door and the key is in the ignition switch, a chime will sound to remind you to remove the key.

SENTRY KEY

The Sentry Key Immobilizer System prevents unauthorized operation of the vehicle by disabling the engine. The system will shut the engine off after 2 seconds of running if an invalid key is used to start the vehicle. This system utilizes ignition keys which have an electronic

chip (transponder) embedded into them. Only keys that have been programmed to the vehicle can be used to start and operate the vehicle.

The Sentry Key Immobilizer System does not need to be armed or activated. Operation of the system is automatic regardless of whether or not the vehicle is locked or unlocked. During normal operation, the Theft Alarm/Immobilizer Light will come on for three (3) seconds immediately after the ignition switch is turned on for a bulb check. Afterwards, if the bulb remains on, this indicates a problem with the electronics.

If the bulb begins to flash after the bulb check, this indicates that an invalid key has been used to start the vehicle. Both of these conditions will result in the engine being shut off after two (2) seconds of running.

Keep in mind that a key which has not been programmed is also considered an invalid key even if it is cut to fit the ignition lock cylinder for that vehicle.

If the Theft Alarm/Immobilizer Light comes on during normal vehicle operation (vehicle has been running for longer than 10 seconds), a fault has been detected in the electronics and the vehicle should be serviced as soon as possible.

NOTE:

- The Sentry Key Immobilizer System is not compatible with remote starting systems. Use of these systems may result in vehicle starting problems and loss of security protection.
- Exxon/Mobil Speed Pass,TM additional Sentry Keys, or any other transponder equipped components on the same keychain will **not** cause a key-related (transponder) fault unless the additional part is **physically held against the ignition key** being used when starting the vehicle. Cell phones, pagers, or other RF electronics will not cause interference with this system.

All of the keys provided with your new vehicle have been programmed to the vehicle electronics.

Replacement Keys

NOTE: Only keys that have been programmed to the vehicle electronics can be used to start the vehicle. Once a Sentry Key has been programmed to a vehicle, it can not be programmed to any other vehicle.

At the time of purchase, the original owner is provided with a four digit PIN number. This number is required for dealer replacement of keys. Duplication of keys may be performed at an authorized dealer or by using the Customer Key Programming procedure. This procedure consists of programming a blank key to the vehicle electronics. A blank key is one which has never been programmed.

NOTE: When having the Sentry Key Immobilizer System serviced, bring all vehicle keys with you to the dealer.

Sentry Key Programming

You can program new keys to the system if you have two valid sentry keys by performing the following procedure:

1. Cut the additional Sentry Key Transponder blank(s) to match the ignition switch lock cylinder key code.
2. Insert the first valid key into the ignition switch and turn the ignition switch ON for at least 3 seconds but no longer than 15 seconds. Turn the ignition switch OFF and remove the first key.
3. Insert the second valid key and turn the ignition switch ON within 15 seconds. After ten seconds a chime will sound and the Theft Alarm Light will begin to flash. Turn the ignition switch OFF and remove the second key.

4. Insert a blank Sentry Key into the ignition switch and turn the ignition switch ON within 60 seconds. After 10 seconds a single chime will sound. The Theft Alarm Light will stop flashing, turn on for 3 seconds; then turn off.

The new Sentry Key has been programmed. **The Keyless Entry Transmitter will also be programmed during this procedure.**

Repeat this procedure to program up to a total of 8 keys. If you do not have a programmed sentry key, contact your dealer for details.

NOTE: If a programmed key has been lost, see your dealer to have all remaining keys erased from the systems memory. The remaining keys must then reprogrammed. This will prevent the lost key from starting your vehicle. All vehicle keys must be taken to the dealer at the time of service to be reprogrammed.

General Information

The Sentry Key system complies with FCC rules part 15 and with RSS-210 of Industry Canada. Operation is subject to the following conditions:

- This device may not cause harmful interference.
- This device must accept any interference that may be received, including interference that may cause undesired operation.

ILLUMINATED ENTRY SYSTEM — IF EQUIPPED

The courtesy lights will turn on when you use the keyless entry transmitter or open the doors. This feature is only available if you have Remote Keyless Entry.

The lights will fade to off after about 30 seconds or they will immediately fade to off once the ignition switch is turned on.

NOTE:

- The front courtesy overhead console, door courtesy and liftgate lights do not turn on if the dimmer control is in the interior lights ON position (extreme top position).
- The illuminated entry system will not operate if the dimmer control is in the “defeat” position (extreme downward position).

DOOR LOCKS**Manual Door Locks**

Lock the doors by pushing down on the lock plungers on each door trim panel.

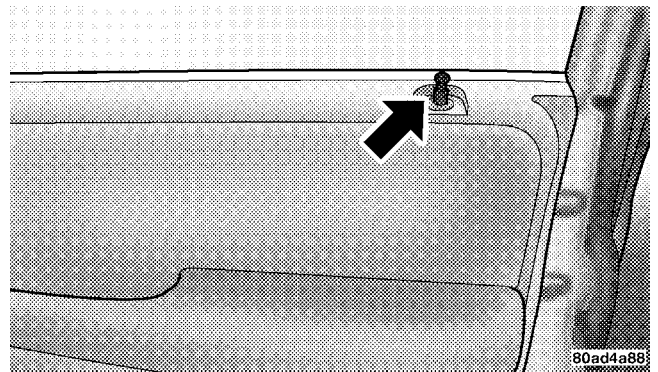

2

If the lock plunger is down when you shut the door, the door will lock. Therefore, make sure the keys are not inside the vehicle before closing the door.

WARNING!

- For personal security and safety in the event of an accident, lock the vehicle doors as you drive as well as when you park and leave the vehicle.
- When leaving the vehicle always remove the key from the ignition lock, and lock your vehicle. Do not leave children unattended in the vehicle, or with access to an unlocked vehicle. Unsupervised use of vehicle equipment may cause severe personal injuries and death.

Power Door Locks — If Equipped

A power door lock switch is on each front door trim panel. Use this switch to lock or unlock the doors.

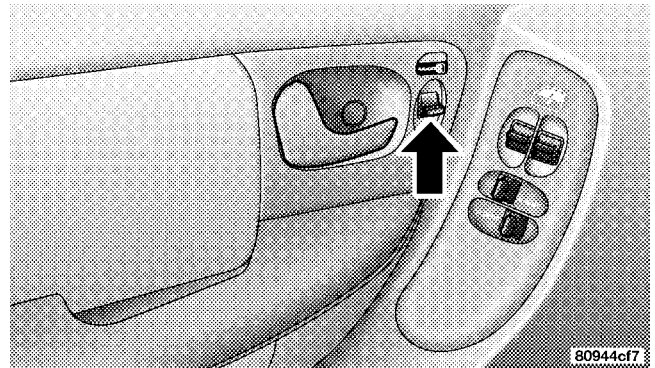

If you press the power door lock switch while the key is in the ignition, and any front door is open, the power locks will not operate. This prevents you from accidentally locking your keys in the vehicle. Removing the key or closing the door will allow the locks to operate. A chime will sound if the key is in the ignition switch and a door is open, as a reminder to remove the key.

If you press the power door lock switch while the sliding door is open, the sliding door will lock.

Automatic Door Locks — If Equipped

The doors will lock automatically on vehicles with power door locks if:

1. The transmission is in gear,
2. all doors are closed,
3. the vehicle speed is above 18 mph (29 km/h) and
4. the doors were not previously locked using the power door lock switch or remote keyless entry transmitter.

The Automatic Door Locks can be enabled or disabled by performing the following procedure:

1. Close all doors and place the key in the ignition switch.

2. Cycle the ignition switch ON/OFF four times ending in the OFF position. (do not start the engine)
3. Within 10 seconds of the final cycle, press the interior driver's door lock switch to the LOCK position.
4. A single chime will sound to signify that you have successfully completed the programming.

You can turn the feature back on by repeating the above mentioned procedure.

Auto Unlock — If Equipped

The doors will unlock automatically on vehicles with power door locks if:

1. The Auto Door Locks feature is enabled and the Auto Unlock feature is enabled,
2. the transmission was in gear and the vehicle speed returned to 0 mph (0 km/h),
3. the transmission is in NEUTRAL or PARK,

4. any door is opened (excluding liftgate) and
5. the vehicle speed is 0 mph (0 km/h).

The Auto Unlock feature can be enabled or disabled by performing the procedure in the Overhead Console, Customer Programmable Features section.

NOTE: Use the Auto Door Locks and Auto Unlock features in accordance with local laws.

REMOTE KEYLESS ENTRY — IF EQUIPPED

This system allows you to lock or unlock the doors and liftgate, and activate the panic alarm, optional power liftgate, left power sliding door, and right power sliding door from distances up to about 23 feet (7 meters) using a hand held radio transmitter. The transmitter need not be pointed at the vehicle to activate the system.

NOTE: If the key is in the ignition switch, then all buttons on that transmitter will be disabled. The buttons on the remaining transmitters will work. If the vehicle is shifted out of PARK, all the transmitter buttons are disabled for all keys.

Two (2) transmitters may be supplied with the vehicle. Vehicles built without the powered options will be equipped from the factory with three button transmitters and those built with power options will be equipped with six button transmitters.

Three button transmitters will provide basic UNLOCK, LOCK and PANIC functions.

Sound Horn On Lock, Remote Unlock Driver's Door 1st, and Flash Lights On Lock/Unlock features.

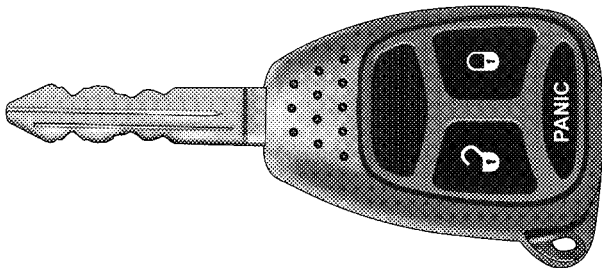

81182d3d

Three Button Transmitter

Six button transmitters will provide functions that allow the same basic operation as the three button, but may also be used to Open/Close the optional power liftgate, left power sliding door, or right power sliding door. Other options of the system allow you to turn ON/OFF the

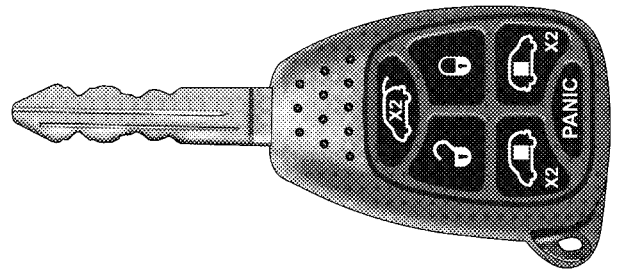

81182c6b

Six Button Transmitter

To unlock the doors and liftgate:

Press and release the UNLOCK button on the transmitter once to unlock the driver's door side of the vehicle, or twice to unlock all doors and liftgate. The illuminated entry system also turns on.

NOTE: If desired, the "Remote Unlock Driver's Door 1st" feature can be turned on and off by referring to the Customer Programmable Features of the "Overhead Console" section or by following these steps.

1. Press the UNLOCK button for 5 to 10 seconds.
2. While the UNLOCK button is pressed, (after 5 seconds) press the LOCK button. Release both buttons.

The "Remote Unlock Driver's Door 1st" feature can be reactivated by repeating this procedure.

To lock the doors and liftgate:

Press and release the LOCK button on the transmitter to lock all doors and liftgate. The horn will chirp once to acknowledge the signal. If desired, the "Sound Horn On Lock" feature can be turned on and off by referring to the Customer Programmable Features of the "Overhead Console" section or by following these steps.

1. Press the LOCK button for 5 to 10 seconds.
2. While the LOCK button is pressed (after 5 seconds), press the PANIC button. Release both buttons.

The "Sound Horn On Lock" feature can be reactivated by repeating this procedure.

Using The Panic Alarm:

To turn the panic alarm feature ON or OFF, press and hold the PANIC button on the transmitter for at least one second and release. When the panic alarm is on, the

headlights and park lights will flash, the horn will pulse on and off and the interior lights will turn on.

The panic alarm will stay on for 3 minutes unless you turn it off by pressing the PANIC button a second time or by turning the ignition switch to the ON position.

NOTE: When you turn off the panic alarm by pressing the PANIC button a second time, you may have to be closer to the vehicle due to the radio frequency noises of the system.

To Program Transmitters:

Refer to SENTRY KEY “Customer Key Programming.”

If you do not have a programmed transmitter, contact your dealer for details.

To Open/Close Power Liftgate — If Equipped

Press the LIFTGATE button twice within five seconds to open/close the power liftgate. The liftgate will beep for 2

seconds and then open/close. If the button is pushed while the liftgate is being power closed, the liftgate will reverse to the full open position.

If the liftgate is locked and is not equipped with a powered liftgate, pressing the button will result in the liftgate becoming unlocked for 30 seconds allowing you to manually access the liftgate area.

To Open/Close Left Power Sliding Door — If Equipped

Press the LEFT button twice within five seconds to open/close the left power sliding door. If the button is pushed while the door is being power closed, the door will reverse to the full open position.

If the vehicle is not equipped with a left power sliding door and the door is closed and locked, pressing the button will result in the left side doors becoming unlocked.

To Open/Close Right Power Sliding Door — If Equipped

Press the RIGHT button twice within five seconds to open/close the right power sliding door. If the button is pushed while the door is being power closed, the door will reverse to the full open position.

If the vehicle is not equipped with a right power sliding door and the door is closed and locked, pressing the button will result in the right side doors becoming unlocked.

To Turn Off “Flash Lights On Lock/Unlock” — If Equipped

NOTE: If desired, the “Flash Lights On Lock/Unlock” feature can be turned on and off by referring to the Customer Programmable Features of the “Overhead Console” section or by following these steps.

1. Press the LOCK button for 5 to 10 seconds.

2. While the LOCK button is pressed, (after 5 seconds) press the UNLOCK button. Release both buttons.

The “Flash Lights On Lock/Unlock” feature can be reactivated by repeating this procedure. The table below explains the Lamp Flash options.

Function	Which Turn Signal Lamps	Number of Flashes
Lock	All	1
Unlock 1st Press	Left Side	2
Unlock All Doors	All	2
Left Side	Left Side	2
Right Side	Right Side	2
Liftgate	All	2

General Information

This device complies with part 15 of the FCC rules and RSS 210 of Industry Canada. Operation is subject to the following conditions:

- This device may not cause harmful interference.
- This device must accept any interference received, including interference that may cause undesired operation.

If your Remote Keyless Entry transmitter fails to operate from a normal distance, check for these two conditions.

1. A weak battery in the transmitter. The expected life of the battery is a minimum of three years.
2. Closeness to a radio transmitter such as a radio station tower, airport transmitter, and some mobile or CB radios.

Transmitter Battery Service

The recommended replacement battery is one CR2032 battery.

NOTE: Do not touch the battery terminals that are on the back housing or the printed circuit board.

1. With the transmitter buttons facing down, use a thin coin to pry the two halves of the transmitter apart. Make sure not to damage the rubber gasket during removal.

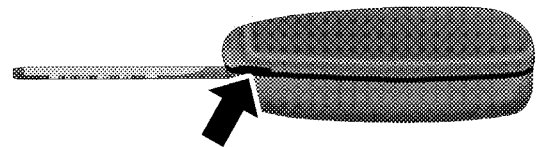

2. Remove and replace the batteries. Avoid touching the new batteries with your fingers. Skin oils may cause battery deterioration. If you touch a battery, clean it with rubbing alcohol.

3. To reassemble the transmitter case snap two halves together. Make sure there is an even “gap” between the two halves. Test transmitter operation.

VEHICLE THEFT ALARM — IF EQUIPPED

This system monitors the vehicle doors and ignition switch for unauthorized entry or operation. When the alarm is activated, the system provides both audible and visual signals. The horn will pulse, headlights/park lights will flash, the Vehicle Theft Alarm/Immobilizer light, located in the instrument cluster, will flash, and the vehicle will not start. If the alarm is triggered and no action is taken to disarm it, the system will turn off the horn after three minutes and after 15 minutes of light only operation the system will then rearm itself.

To arm the system: Remove the key from the ignition switch and either:

1. Press a power door lock button while the driver’s or passenger’s door is open.
2. Press the LOCK button on the keyless entry transmitter.

After the last door is closed, or if all doors are closed, the system will arm itself in about 16 seconds. During that time, the Vehicle Theft Alarm/Immobilizer light will flash. If it does not illuminate, the system is not arming. If you open a door during this arming period, the system will cancel the arming process. You must repeat one of the previously described arming sequences to rearm the system.

To disarm the system: Press the UNLOCK button on the keyless entry transmitter. Also, using a valid sentry key

and moving the ignition switch to the ON/START position will disarm the system. If you disarm the system and access the liftgate area, the system must be rearmed, as described previously, when closing the liftgate. If something has triggered the system in your absence, the horn will sound three times when you disarm the system. Check the vehicle for tampering.

NOTE:

- The driver's door and liftgate key cylinders cannot arm or disarm the system.
- Once the alarm is set, and the liftgate button on the keyless entry transmitter is pressed, on a non-power liftgate vehicle, you have a 30 second one time access into the liftgate area. If the liftgate is not opened within 30 seconds the liftgate will remain locked.

- The system remains armed during liftgate entry, pressing the liftgate button will not disarm the system, if someone enters the vehicle through the liftgate and opens any door the alarm will sound.
- When the system is armed, the doors can not be unlocked from the interior power door lock switches.

The Vehicle Theft Alarm system is designed to protect your vehicle, however, you can create conditions where the system will give you a false alarm. If one of the previously described arming sequences has occurred, the system will arm regardless of whether you are in the vehicle or not. If you remain in the vehicle and open a door, the alarm will sound. If this occurs, disarm the system.

The alarm system will be activated when the battery is connected if the system was previously armed. The

exterior lights will flash, the horn will sound, and the ignition will not start the vehicle. If this occurs, disarm the system.

SLIDING SIDE DOOR

The sliding door may be opened from the inside or the outside. Pull out on the outside handle to open the sliding door from the outside. To open the sliding door from the inside, press the button on the grab handle and open the door.

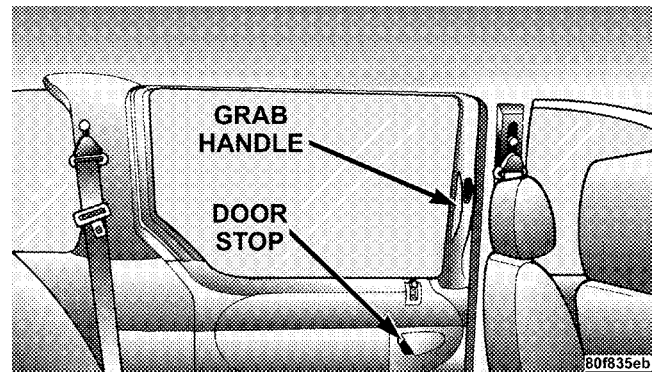

To keep your door operating properly, observe the following guidelines:

- Always open the door smoothly.

- Avoid high impacts against the door stop when opening the door. This is very important when your vehicle is parked on an incline as the door will slide faster in the downhill direction.
- There is a hold-open latch that is activated when the sliding door is fully opened. This latch will keep your sliding door open on any incline. To close the sliding door after the hold-open latch is activated, you must push the button on the inside grab handle or pull out on the outside sliding door handle.
- Use the grab handle on the inside of the sliding door to assist you in closing and securing the door.

Always make sure that the sliding door is fully latched any time the vehicle is in motion.

NOTE: The driver's side sliding door cannot be opened while the fuel door is open. This feature operates only when the sliding door is fully closed prior to opening the fuel door.

Power Sliding Door — If Equipped

NOTE: The power sliding door must be unlocked before the switches located on the trim panel, just in front of the power sliding door will operate.

The power sliding door may be opened manually or by using the buttons on the remote keyless entry transmitter.

Press the buttons on the remote keyless entry transmitter twice within five seconds, to open a power sliding door. Once the door is fully open, pressing the button twice within five seconds a second time will close the door.

The power sliding door may also be opened by pressing the switches on the overhead console or the switch located on the trim panel just in front of the sliding door. To keep your door operating properly, observe the following guidelines.

- Always open the door smoothly.
- Avoid high impacts against the door stop when opening the door manually. This is very important when your vehicle is parked on an incline as the door will slide faster in the downhill direction.
- There is a hold-open latch that is activated when the sliding door is fully opened. This latch will keep your sliding door open on any incline. To close the power sliding door after the hold-open latch is activated, you must press any one of the power sliding door switches, push the button on the inside grab handle or pull out on the outside sliding door handle.

There are power sliding door switches located on the trim panel just in front of the power sliding door for the rear seat passengers. Pressing the switch once will open the power sliding door, once the door is fully open pressing the switch a second time will close the door.

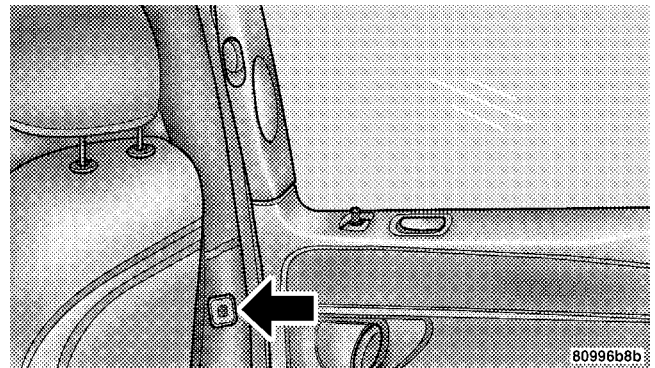

If the inside or outside door handles are used while the power sliding door is activated, the power sliding door feature will be canceled and the door must be opened or closed manually.

To avoid unintentional operation of the power sliding door from the rear seats, press the button located in the overhead console to disable the switches for the rear seat passengers.

NOTE:

- If anything obstructs the power sliding door while it is closing or opening, the door will automatically reverse to the closed or open position, provided it meets sufficient resistance.
- The driver's side sliding door cannot be opened while the fuel door is open. This feature operates only when the sliding door is fully closed prior to opening the fuel door.

- The power sliding door must be in the full open or close position for any of the switches to operate. If the door is not in the full open or close positions it must be opened or closed manually.
- The power sliding door switches will not operate if the vehicle is in gear or the vehicle speed is above 0 mph (0 km/h).
- If the power sliding door encounters multiple obstructions within the same cycle, the system will automatically stop and must be opened or closed manually.

WARNING!

You or others could be injured if caught in the path of the sliding door. Make sure the door path is clear before closing the door.

Child Protection Door Lock

To provide a safer environment for small children riding in the rear seats, the sliding doors are equipped with a child protection door lock system.

WARNING!

To avoid trapping anyone in the vehicle in a collision. Remember that the sliding doors can only be opened from the outside door handle or the switches located on the trim panel just in front of the power sliding door when the child protection locks are engaged.

To activate the system, open the sliding door and move the child lock control, located near the door's rear latch, to the ON position.

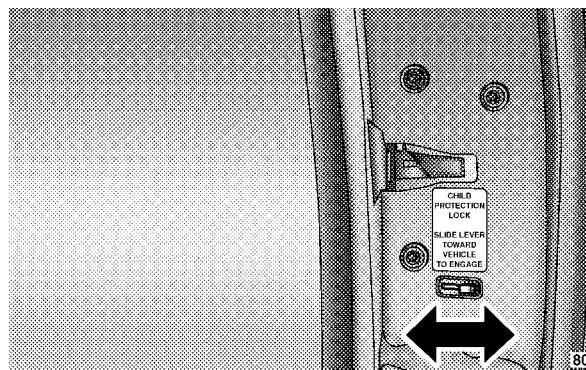

When the child lock system is engaged the door can be opened only by using the outside door handle or the switches located on the trim panel just in front of the power sliding door, even though the inside door lock is in the unlocked position.

The power sliding door will operate from the switches located on the trim panel just in front of the power sliding

door, regardless of the child lock lever position. To avoid unintentional operation of the power sliding door from the rear seats, press the button located in the overhead console to disable the switches for the rear seat passengers.

NOTE:

- The power sliding door switches will not operate if the vehicle is in gear or the vehicle speed is above 0 mph (0 km/h).
- The power sliding door will operate from the remote keyless entry transmitter, if the vehicle is in Park, regardless of the child lock lever position.

LIFTGATE

NOTE: The key that is used to start the vehicle is also used to lock or unlock the doors and open the liftgate.

To open the liftgate, insert the key into the lock and turn to the right. On vehicles equipped with power locks the

liftgate can also be unlocked using the remote keyless entry or by activating the power door lock switches located on the front doors.

Once unlocked, on vehicles equipped with power locks, the liftgate can be opened or closed without using the key. To open the liftgate, depress the liftgate release switch located on the underside of the license plate bar and pull the liftgate open with one fluid motion.

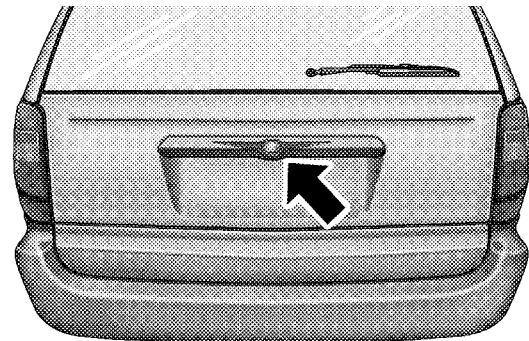

80f3ed2a

If the liftgate is locked and is not equipped with a powered liftgate, pressing the button on the remote keyless entry transmitter will result in the liftgate becoming unlocked for 30 seconds allowing you to manually access the liftgate area.

NOTE: On vehicles without power locks, the liftgate can only be opened using the vehicle keys. The key must be held in the unlocked position for the liftgate to open.

Power Liftgate — If Equipped

The power liftgate may be opened manually or by using the button on the remote keyless entry transmitter. Press the button on the remote keyless entry transmitter twice within five seconds, to open the power liftgate. Once the liftgate is fully open, pressing the button twice within five seconds a second time will close the liftgate.

The power liftgate may also be opened by pressing the button located on the overhead console.

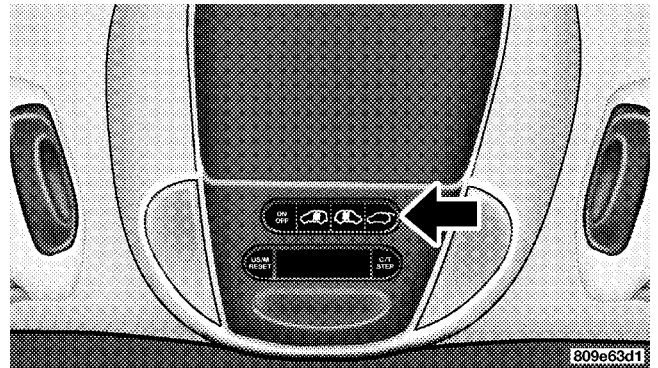

When the remote keyless entry transmitter button is pressed and the “Lamp Flash” feature is enabled, the tail lights will flash to signal that the liftgate is opening or closing.

WARNING!

During power operation, personal injury or cargo damage may occur. Ensure the liftgate travel path is clear. Make sure the liftgate is closed and latched before driving away.

NOTE:

- If anything obstructs the power liftgate while it is closing or opening, the liftgate will automatically reverse to the closed or open position, provided it meets sufficient resistance.
 - There are also pinch sensors attached to the side of the liftgate opening. Light pressure anywhere along these strips will cause the liftgate to return to the open position.
- The power liftgate must be in the full open or close positions for any of the buttons to operate. If the liftgate is not in the full open or close positions it must be opened or closed manually.
 - If the liftgate release button is activated while the power liftgate is closing, the liftgate will reverse to the full open position.
 - The power liftgate buttons will not operate if the vehicle is in gear or the vehicle speed is above 0 mph (0 km/h).
 - The power liftgate will not operate in temperatures below -12°F (-24°C) or temperatures above 143°F (62°C). Be sure to remove any build-up of snow or ice from the liftgate before pressing any of the power liftgate buttons.

- If the power liftgate encounters multiple obstructions within the same cycle, the system will automatically stop and must be opened or closed manually.

WARNING!

- **Driving with the liftgate open can allow poisonous exhaust gases into your vehicle. You and your passengers could be injured by these fumes. Keep the liftgate closed when you are operating the vehicle.**
- **If you are required to drive with the liftgate open, make sure that all windows are closed, and the climate control blower switch is set at high speed. DO NOT use the recirculation mode.**

Gas props support the liftgate in the open position. However, because the gas pressure drops with temperature, it may be necessary to assist the props when opening the liftgate in cold weather.

WINDOWS

Manual Rear Vent Windows

A lever at the rear of each window releases the window so that it can be pushed out for ventilation.

Power Vent Windows — If Equipped

Switches on the driver's door trim panel let the driver operate the two vent windows from the front seat.

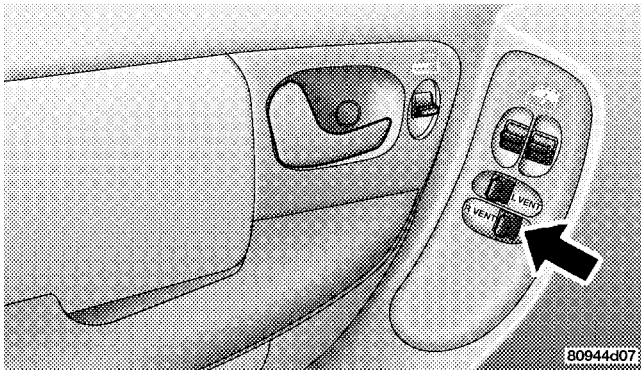

Power Windows — If Equipped

You can control either front window using switches on the driver's door trim panel. There is a single switch on the passenger's door trim panel which operates the passenger door window. The switches will operate only when the ignition switch is in the ON or ACCESSORY position.

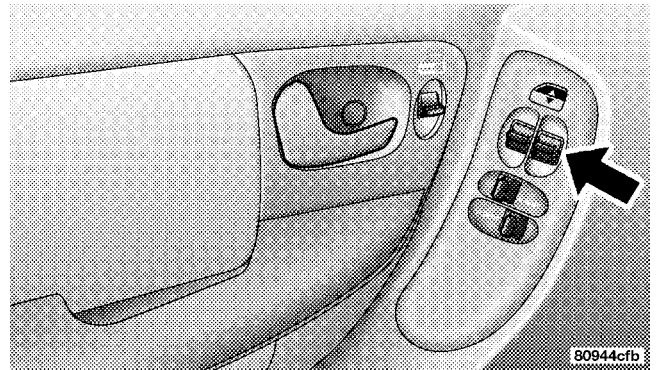

Auto Down Feature — If Equipped

The driver's window switch has an auto down feature. Press the window switch past the detent, release, and the window will go down automatically.

To open the window part way, press the window switch part way and release it when you want the window to stop.

The power window switches remain active for up to 45 seconds after the ignition switch has been turned off. Opening a vehicle front door will cancel this feature.

Wind Buffeting

Wind buffeting can be described as the perception of pressure on the ears or a helicopter type sound in the ears. Your vehicle may exhibit wind buffeting with the windows down, or the sunroof (if equipped) in certain open or partially open positions. This is a normal occurrence and can be minimized. If the buffeting occurs with the rear windows open, open the front and rear windows together to minimize the buffeting. If the buffeting occurs with the sunroof open, adjust the sunroof opening to minimize the buffeting.

OCCUPANT RESTRAINTS

Some of the most important safety features in your vehicle are the restraint systems. These include the front and rear seat belts for the driver and all passengers, front airbags for both the driver and front passenger and if equipped, side airbags for both the driver and front passenger. If you will be carrying children too small for adult-size seat belts, your seat belts or the LATCH feature (Lower Anchors and Tether for CHildren) also, can be used to hold infant and child restraint systems.

Please pay close attention to the information in this section. It tells you how to use your restraint system properly to keep you and your passengers as safe as possible.

WARNING!

In a collision, you and your passengers can suffer much greater injuries if you are not properly buckled up. You can strike the interior of your vehicle or other passengers, or you can be thrown out of the vehicle. Always be sure you and others in your vehicle are buckled up properly.

Buckle up even though you are an excellent driver, even on short trips. Someone on the road may be a poor driver and cause a collision that includes you. This can happen far away from home or on your own street.

Research has shown that seat belts save lives, and they can reduce the seriousness of injuries in a collision. Some of the worst injuries happen when people are thrown from the vehicle. Seat belts reduce the possibility of

ejection and the risk of injury caused by striking the inside of the vehicle. **Everyone** in a motor vehicle should be belted at all times.

Lap/Shoulder Belts

All the outboard seats in your vehicle are equipped with Lap/Shoulder Belts.

The belt webbing retractor is designed to lock during very sudden stops or collisions. This feature allows the shoulder part of the belt to move freely with you under normal conditions. But in a collision, the belt will lock and reduce the risk of your striking the inside of the vehicle or being thrown out.

WARNING!

- It is extremely dangerous to ride in a cargo area, inside or outside of a vehicle. In a collision, people riding in these areas are more likely to be seriously injured or killed.
- Do not allow people to ride in any area of your vehicle that is not equipped with seats and seat belts.
- Be sure everyone in your vehicle is in a seat and using a seat belt properly.

WARNING!

- Wearing a seat belt incorrectly is dangerous. Seat belts are designed to go around the large bones of your body. These are the strongest parts of your body and can take the forces of a collision the best.
- Wearing your belt in the wrong place could make your injuries in a collision much worse. You might suffer internal injuries, or you could even slide out of part of the belt. Follow these instructions to wear your seat belt safely and to keep your passengers safe, too.
- Two people should never be belted into a single seat belt. People belted together can crash into one another in a collision, hurting one another badly. Never use a lap/shoulder belt or lap belt for more than one person, no matter what their size.

Lap/Shoulder Belt Operating Instructions

1. Enter the vehicle and close the door. Sit back and adjust the seat.
2. The seat belt latch plate is near the seatback of the front seats and next to your arm in the rear seats. Grasp the latch plate and pull out the belt. Slide the latch plate up the webbing as far as necessary to allow the belt to go around your lap.

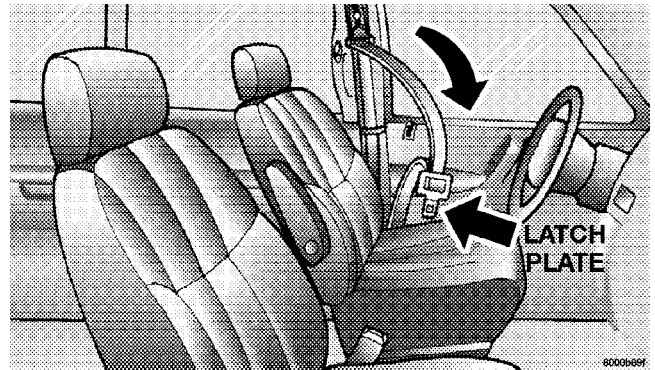

3. When the belt is long enough to fit, insert the latch plate into the buckle until you hear a “click”.

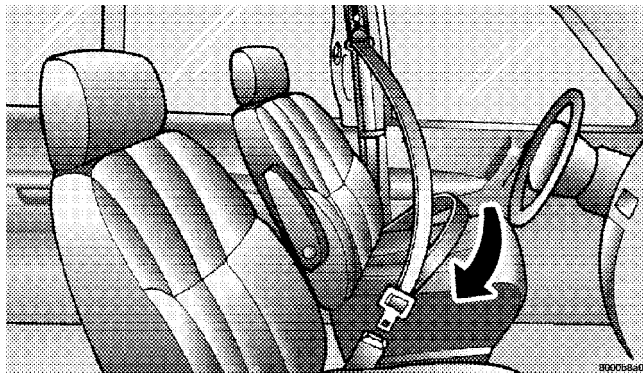

WARNING!

- A belt that is buckled into the wrong buckle will not protect you properly. The lap portion could ride too high on your body, possibly causing internal injuries. Always buckle your belt into the buckle nearest you.
- A belt that is too loose will not protect you as well. In a sudden stop you could move too far forward, increasing the possibility of injury. Wear your seat belt snugly.
- A belt that is worn under your arm is very dangerous. Your body could strike the inside surfaces of the vehicle in a collision, increasing head and neck injury. A belt worn under the arm can cause internal injuries. Ribs aren't as strong as shoulder bones. Wear the belt over your shoulder so that your strongest bones will take the force in a collision.
- A shoulder belt placed behind you will not protect you from injury during a collision. You are more likely to hit your head in a collision if you do not wear your shoulder belt. The lap and shoulder belt are meant to be used together.

4. Position the lap belt across your thighs, below your abdomen. To remove slack in the lap belt portion, pull up on the shoulder belt. To loosen the lap belt if it is too tight, tilt the latch plate and pull on the lap belt. A snug belt reduces the risk of sliding under the belt in a collision.

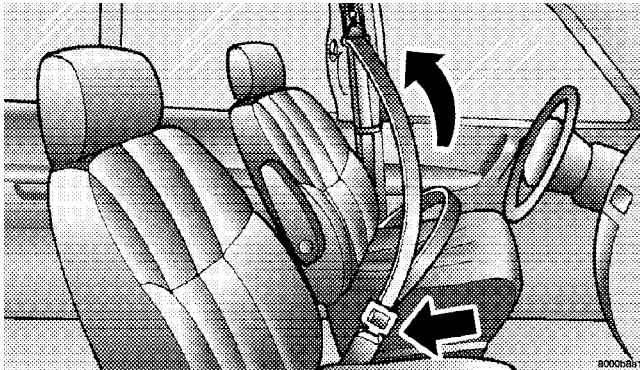

WARNING!

- A lap belt worn too high can increase the risk of internal injury in a collision. The belt forces won't be at the strong hip and pelvic bones, but across your abdomen. Always wear the lap belt as low as possible and keep it snug.
- A twisted belt can't do its job as well. In a collision it could even cut into you. Be sure the belt is straight. If you can't straighten a belt in your vehicle, take it to your dealer and have it fixed.

5. Position the shoulder belt on your chest so that it is comfortable and not resting on your neck. The retractor will withdraw any slack in the belt.

6. To release the belt, push the red button on the buckle. The belt will automatically retract to its stowed position. If necessary, slide the latch plate down the webbing to allow the belt to retract fully.

WARNING!

A frayed or torn belt could rip apart in a collision and leave you with no protection. Inspect the belt system periodically, checking for cuts, frays, or loose parts. Damaged parts must be replaced immediately. Do not disassemble or modify the system. Seat belt assemblies must be replaced after a collision if they have been damaged (bent retractor, torn webbing, etc.).

Adjustable Upper Shoulder Belt Anchorage

In the front seats and the second row outboard seats, the shoulder belt anchorage can be adjusted upward or

downward to help position the belt away from your neck. The upper anchorage can be adjusted upward by pushing anywhere on the anchorage. To move the anchorage downward, press the actuation button while simultaneously pushing down on the anchorage assembly.

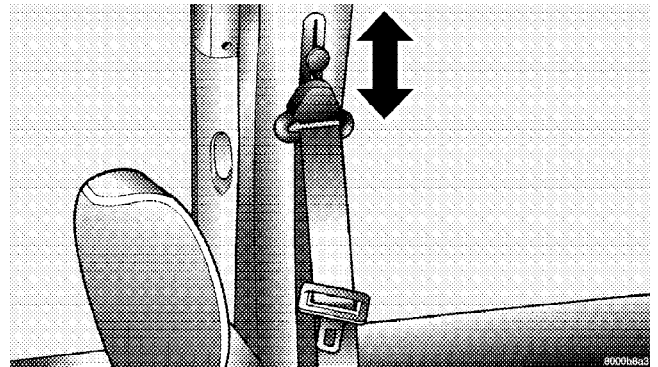

As a guide, if you are shorter than average, you will prefer a lower position, and if you are taller than average, you'll prefer a higher position. When you release the anchorage, try to move it up or down to make sure that it is locked in position.

Lap/Shoulder Belt Untwisting Procedure

Use the following procedure to untwist a twisted lap/shoulder belt.

1. Position the latch plate as close as possible to the anchor point.

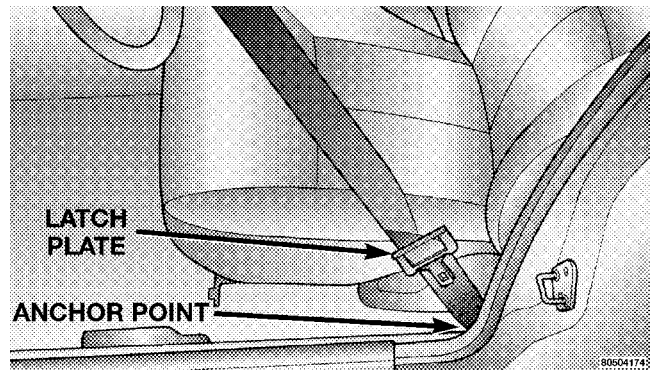

2. At about 6 to 12 inches (15 to 30 cm) above the latch plate, grasp and twist the belt webbing 180° to create a fold that begins immediately above the latch plate.

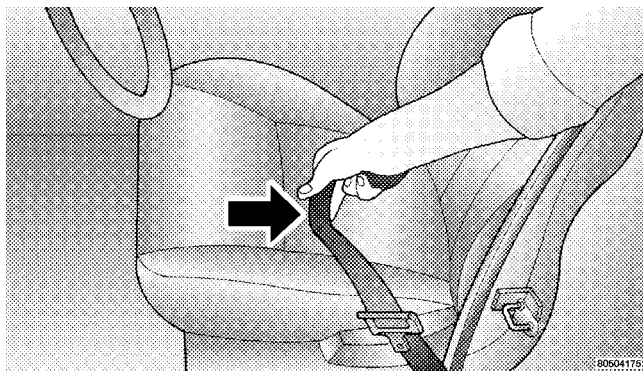

3. Slide the latch plate upward over the folded webbing. The folded webbing must enter the slot at the top of the latch plate.

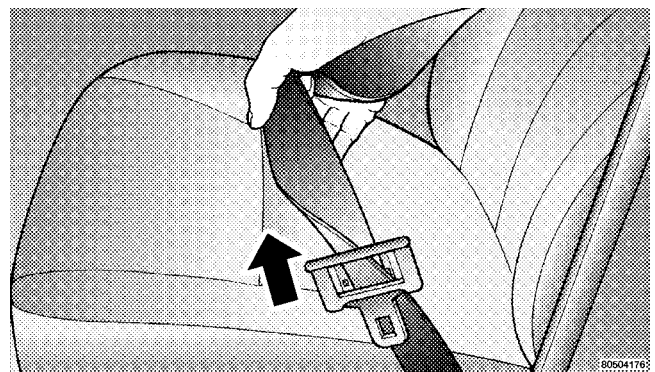

4. Continue to slide the latch plate up until it clears the folded webbing.

Center Lap Belts

The center seating positions have a lap belt only. To fasten the lap belt, slide the latch plate into the buckle until you hear a “click”. To lengthen the lap belt, tilt the latch plate and pull. To remove slack, pull the loose end of the webbing.

Wear the lap belt snug against the hips. Sit back and erect in the seat, then adjust the belt as tightly as is comfortable.

WARNING!

- A lap belt worn too loose or too high is dangerous.
- A belt worn too loose can allow you to slip down and under the belt in a collision.
- A belt that is too high will apply crash forces to the abdomen, not to the stronger hip bones. In either case, the risk of internal injuries is greater. Wear a lap belt low and snug.

Seat Belt Pretensioners

The seat belts for both front seating positions are equipped with pretensioning devices that are designed to remove slack from the seat belt in the event of a collision. These devices improve the performance of the seat belt by assuring that the belt is tight about the occupant early in a collision. Pretensioners are designed to work for all size occupants.

NOTE: These devices are not a substitute for proper seat belt placement by the occupant. The seat belt still must be worn snugly and positioned properly.

The pretensioners are triggered by the front airbag control module (see Front Airbag Section). Like the front airbags, the pretensioners are single use items. After a collision that is severe enough to deploy the front airbags and pretensioners, both must be replaced.

Seat Belts and Pregnant Women

We recommend that pregnant women use the seat belts throughout their pregnancies. Keeping the mother safe is the best way to keep the baby safe.

Pregnant women should wear the lap part of the belt across the thighs and as snug across the hips as possible. Keep the belt low so that it does not come across the abdomen. That way the strong bones of the hips will take the force if there is a collision.

Seat Belt Extender

If a seat belt is too short, even when fully extended and when the adjustable upper shoulder belt anchorage (if equipped) is in its lowest position, your dealer can provide you with a seat belt extender. This extender should be used only if the existing belt is not long enough. When it is not required, remove the extender and stow it.

WARNING!

Using a seat belt extender when not needed can increase the risk of injury in a collision. Only use when the lap belt is not long enough when it is worn low and snug, and in the recommended seating positions. Remove and store the extender when not needed.

Driver and Front Passenger Supplemental Restraint System - Airbag

This vehicle has airbags for both the driver and front passenger as a supplement to the seat belt restraint systems. The driver's front airbag is mounted in the center of the steering wheel. The passenger's front airbag is mounted in the instrument panel, above the glove compartment. The words SRS AIRBAG are embossed on the airbag covers.

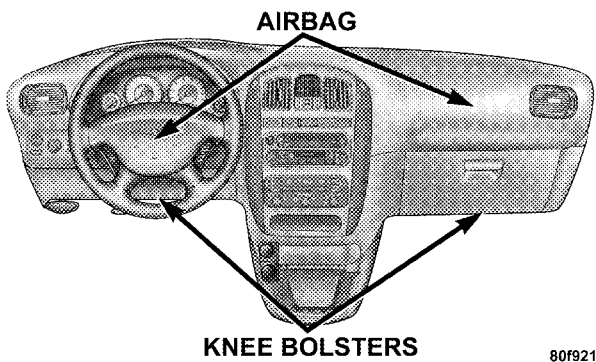

NOTE: The front airbags are certified to the Federal regulations that allow less forceful deployment in low speed collisions.

The front airbags have a multi stage inflator design. This allows the airbag to have different rates of inflation that are based on collision severity.

If the vehicle is equipped with side airbags, they are located inside the driver and front passenger seatbacks, and their seatcovers are labeled SRS AIRBAG.

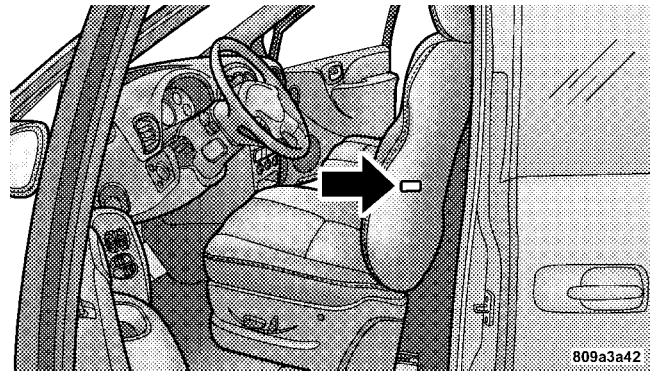

WARNING!

- **Do not put anything on or around the airbag covers or attempt to manually open them. You may damage the airbags and you could be injured because the airbags are not there to protect you. These protective covers for the airbag cushions are designed to open only when the airbags are inflating.**
- **If your vehicle is equipped with side airbags, do not use accessory seat covers or place objects between you and the side airbags; the performance could be adversely affected and/or objects could be pushed into you, causing serious injury.**
- **If your vehicle is equipped with side airbags, do not attach cup holders or any other objects on or around the door. The inflating side airbag could drive the object into occupants, causing serious injury.**

Airbags inflate in moderate to high speed impacts. Along with seat belts and pretensioners, front airbags work with the instrument panel knee bolsters to provide improved protection for the driver and front passenger. Side airbags also work with seat belts to improve occupant protection.

The seat belts are designed to protect you in many types of collisions. The front airbags deploy in moderate to severe frontal collisions. If your vehicle is equipped, the side airbag on the crash side of the vehicle is triggered in moderate to severe side collisions. In certain types of collisions, both the front and side airbags may be triggered. But even in collisions where the airbags deploy, you need the seat belts to keep you in the right position for the airbags to protect you properly.

Here are some simple steps you can take to minimize the risk of harm from a deploying airbag.

1. Children 12 years old and under should always ride buckled up in a rear seat.

Infants in rear facing child restraints should **NEVER** ride in the front seat of a vehicle with a passenger front airbag. An airbag deployment can cause severe injury or death to infants in that position.

Children that are not big enough to properly wear the vehicle seat belt (refer to section on Child Restraint) should be secured in the rear seat, in a child restraint or belt-positioning booster seat. Older children who do not use child restraints or belt-positioning booster seats should ride properly buckled up in the rear seat, and in the outboard seat if possible. Never allow children to slide the shoulder belt behind them or under their arm.

If a child from 1 to 12 years old must ride in the front passenger seat because the vehicle is crowded, move the seat as far back as possible, and use the proper child restraint. See the section on Child Restraint.

You should read the instructions provided with your child restraint to make sure that you are using it properly.

2. All occupants should wear their lap and shoulder belts properly.

3. The driver and front passenger seats should be moved back as far as practical to allow the front airbags room to inflate.

4. If your vehicle has side airbags, do not lean against the door, airbags will inflate forcefully into the space between you and the door.

WARNING!

- **Relying on the airbags alone could lead to more severe injuries in a collision. The airbags work with your seat belt to restrain you properly. In some collisions the airbags won't deploy at all. Always wear your seat belts even though you have airbags.**
- **Being too close to the steering wheel or instrument panel during front airbag deployment could cause serious injury. Airbags need room to inflate. Sit back, comfortably extending your arms to reach the steering wheel or instrument panel.**
- **If the vehicle has side airbags, they also need room to inflate. Do not lean against the door. Sit upright in the center of the seat.**

The Front Airbag System consists of the following:

- Front Airbag Control Module (with integrated side impact sensor - if equipped)
- AIRBAG Readiness Light
- Driver Airbag
- Front Passenger Airbag
- Steering Wheel and Column
- Instrument Panel
- Seat Belt Readiness Light
- Front Seat Belt Pretensioners
- Interconnecting Wiring
- Knee Impact Bolster

How The Front Airbag System Works

- The **front** airbag control module determines if a frontal impact is severe enough to require the front airbags to inflate. Based on the level of collision severity, the front airbag control module determines the proper rate of inflation. The front airbag inflators are designed to provide different rates of airbag inflation. The front airbag control module will not detect roll over, or rear collisions.

The front airbag control module also monitors the readiness of the electronic parts of the system whenever the ignition switch is in the START or ON positions. These include all of the items listed above except the knee bolster, instrument panel and the steering wheel and column. If the key is in the OFF position, in the ACC position, or not in the ignition switch, the front airbags are not on and will not inflate.



The front airbag control module sends a message to the instrument cluster to turn on the AIRBAG light in the instrument panel for 6 to 8 seconds when the ignition switch is first turned ON, then turns the light off. If the front control module detects a malfunction in any part of the system, the airbag light will turn on either momentarily or continuously.

2

WARNING!

Ignoring the AIRBAG light in your instrument panel could mean you won't have the airbags to protect you in a collision. If the light does not come on, stays on after you start the vehicle, or if it comes on as you drive, have the airbag system checked right away.

- When the front airbag control module detects a collision requiring the front airbags, it signals the inflator units. A large quantity of nontoxic gas is generated to inflate the front airbags. Different front airbag inflation rates are possible, these rates are determined by the front airbag control module based on collision severity. The front airbag covers separate and fold out of the way as the airbags inflate to their full size. The front airbags fully inflate in about 50 milliseconds. This is only about half of the time it takes you to blink your eyes. The front airbags then quickly deflate while helping to restrain the driver and front passenger. The driver's and passenger's front airbag gas is vented through the airbag material towards the instrument panel. In this way the front airbags do not interfere with your control of the vehicle.
- **The Knee Impact Bolsters** help protect the knees and position you for the best interaction with the front airbags.

Side Airbags Supplemental Restraint System (SRS) — If Equipped

The Side Airbag System, if equipped, consists of the following:

- AIRBAG Readiness Light (shared with the front airbag system)
- Side Airbag in the driver's seat
- Side Airbag in the passenger's seat
- Front Airbag Control Module (with integrated side impact sensor - if equipped)
- Interconnecting Wiring

How The Side Airbag System Works

The **front** airbag control modules determine if a side collision is severe enough to require the side airbags to inflate. The front airbag control modules will not detect roll over, or rear collisions.

The front airbag control module also monitors the readiness of the electronic parts of the system whenever the ignition switch is in the START or ON positions. These include all of the items listed above except the knee bolster, instrument panel and the steering wheel and column. If the key is in the OFF position, in the ACC position, or not in the ignition switch, the side airbags are not on and will not inflate.

In moderate to severe side collisions, the side airbag inflator on the crash side of the vehicle is triggered, releasing a quantity of nontoxic gas. The inflating side airbag exits through the seat seam into the space between the occupant and the door. The side airbag moves at a very high speed and with such a high force that it could injure you if you are not seated properly, or if items are positioned in the area where the side airbag inflates. This especially applies to children.

If An Airbag Deployment Occurs

The airbag systems are designed to deploy when the airbag control modules detect a moderate-to-severe collision, to help restrain the driver and front passenger, and then immediately deflate.

NOTE: A collision that is not severe enough to need airbag protection will not activate the system. This does not mean something is wrong with the airbag system.

If you do have a collision which deploys the airbag, any or all of the following may occur:

- The airbag material may sometimes cause abrasions and/or skin reddening to the driver and front passenger as the airbags deploy and unfold. The abrasions are similar to friction rope burns or those you might get sliding along a carpet or gymnasium floor. They are not caused by contact with chemicals. They are not permanent and normally heal quickly. However, if you

haven't healed significantly within a few days, or if you have any blistering, see your doctor immediately.

- As the airbags deflate you may see some smoke-like particles. The particles are a normal by-product of the process that generates the nontoxic gas used for airbag inflation. These airborne particles may irritate the skin, eyes, nose, or throat. If you have skin or eye irritation, rinse the area with cool water. For nose or throat irritation, move to fresh air. If the irritation continues, see your doctor. If these particles settle on your clothing, follow the garment manufacturer's instructions for cleaning.
- It is not advisable to drive your vehicle after the airbags have deployed. If you are involved in another collision, the airbags and seat belt pretensioners will not be in place to protect you.

WARNING!

Deployed airbags and seat belt pretensioners cannot protect you in another collision. Have the airbags and seat belt pretensioners replaced by an authorized dealer as soon as possible.

Enhanced Accident Response

If the airbags and seat belt pretensioners deploy after an impact and the electrical system remains functional, vehicles equipped with power door locks will unlock automatically. In addition, approximately 10 seconds after the vehicle has stopped moving, the interior lights will illuminate until the ignition switch is turned off.

Maintaining Your Airbag System

WARNING!

- **Modifications to any part of the airbag system could cause it to fail when you need it. You could be injured because the airbags are not there to protect you. Do not modify the components or wiring, including adding any kind of badges or stickers to the steering wheel hub trim cover or the upper right side of the instrument panel. Do not modify the front bumper, vehicle body structure, or frame.**
- **You need proper knee impact protection in a collision. Do not mount or locate any aftermarket equipment on or behind the knee bolsters.**
- **It is dangerous to try to repair any part of the airbag system yourself. Be sure to tell anyone who works on your vehicle that it has airbags.**

Airbag Light

You will want to have the airbags ready to inflate for your protection in a collision. While the airbag system is designed to be maintenance free, if any of the following occurs, have an authorized dealer service the system immediately.

- The AIRBAG light does not come on or flickers during the 6 to 8 seconds when the ignition switch is first turned on.
- The light remains on or flickers after the 6 to 8 second interval.
- The light flickers or comes on and remains on while driving.

DaimlerChrysler Corporation Integrated Child Seat — If Equipped

Operating instructions for this seat are included with the seat. If the instructions are not with the seat or in the Owner's Manual Package, replacement instructions can be obtained.

To obtain Integrated Child Seat replacement instructions:

Use the order form at the back of this manual and specify publication number 81-016-1950.

Child Restraint

Everyone in your vehicle needs to be buckled up at all times — babies and children, too. Every state in the United States and all Canadian provinces require that small children ride in proper restraint systems. This is the law, and you can be prosecuted for ignoring it.

Children 12 years and under should ride properly buckled up in a rear seat. According to crash statistics, children are safer when properly restrained in the rear seats, rather than in the front.

WARNING!

In a collision, an unrestrained child, even a tiny baby, can become a missile inside the vehicle. The force required to hold even an infant on your lap could become so great that you could not hold the child, no matter how strong you are. The child and others could be badly injured. Any child riding in your vehicle should be in a proper restraint for the child's size.

Infants and Small Children

There are different sizes and types of restraints for children from newborn size to the child almost large enough for an adult safety belt. Always check the child seat owner's manual to ensure you have the right seat for your child. Use the restraint that is correct for your child:

- Safety experts recommend that children ride rearward-facing in the vehicle until they are at least one year old and weigh at least 20 lbs (9 kg). Two types of child restraints can be used rearward-facing: infant carriers and "convertible" child seats. Both types of child restraints are held in the vehicle by the lap/shoulder belt or the LATCH child restraint anchorage system. Refer to "Lower Anchors and Tether for Children (LATCH)" later in this section.
- The infant carrier is only used rearward-facing in the vehicle. It is recommended for children who weigh up to about 20 lbs (9 kg). "Convertible" child seats can be used either rearward-facing or forward-facing in the vehicle. Convertible child seats often have a higher weight limit in the rearward-facing direction than infant carriers do, so they can be used rearward-facing by children who weigh more than 20 lbs (9 kg) but are less than one year old.
- Rearward-facing child seats must **NEVER** be used in the front seat of a vehicle with a front passenger airbag. An airbag deployment could cause severe injury or death to infants in this position.
- Children who weigh more than 20 lbs (9 kg) and who are older than one year can ride forward-facing in the vehicle. Forward-facing child seats and convertible child seats used in the forward-facing direction are for children who weigh 20 to 40 lbs (9 to 18 kg) and who are older than one year. These child seats are also held in the vehicle by the lap/shoulder belt or the LATCH

child restraint anchorage system. Refer to “Lower Anchors and Tether for Children (LATCH)” later in this section.

- The belt-positioning booster seat is for children weighing more than 40 lbs (18 kg), but who are still too small to fit the vehicle’s seat belts properly. If the child can not sit with knees bent over the vehicle’s seat cushion while the child’s back is against the seat back, they should use a belt-positioning booster seat. The child and booster seat are held in the vehicle by the lap/shoulder belt. (Some booster seats are equipped with a front shield and are held in the vehicle by the lap portion.)

NOTE: For additional information refer to www.seatcheck.org.

WARNING!

- **Improper installation can lead to failure of an infant or child restraint. It could come loose in a collision. The child could be badly injured or killed. Follow the manufacturer’s directions exactly when installing an infant or child restraint.**
- **A rearward facing child restraint should only be used in a rear seat. A rearward facing child restraint in the front seat may be struck by a deploying passenger airbag which may cause severe or fatal injury to the infant.**

Here are some tips on getting the most out of your child restraint:

- Before buying any restraint system, make sure that it has a label certifying that it meets all applicable Safety Standards. We also recommend that you make sure that you can install the child restraint in the vehicle where you will use it, before you buy it.
- The restraint must be appropriate for your child's weight and height. Check the label on the restraint for weight and height limits.
- Carefully follow the instructions that come with the restraint. If you install the restraint improperly, it may not work when you need it.

The passenger seat belts are equipped with cinching latch plates, which are designed to keep the lap portion tight around the child restraint so that it is not necessary to use a locking clip. Pulling up on the

shoulder portion of the lap/shoulder belt will tighten the belt. The cinching latch plate will keep the belt tight, however, any seat belt system will loosen with time, so check the belt occasionally and pull it tight if necessary.

- In the rear seat, you may have trouble tightening the lap/shoulder belt on the child restraint because the buckle or latch plate is too close to the belt path opening on the restraint. Disconnect the latch plate from the buckle and twist the short buckle end of the belt several times to shorten it. Insert the latch plate into the buckle with the release button facing out.
- If the belt still can't be tightened, or if pulling and pushing on the restraint loosens the belt, disconnect the latch plate from the buckle, turn the buckle around, and insert the latch plate into the buckle again. If you still can't make the child restraint secure, try a different seating position.

- Buckle the child into the seat according to the child restraint manufacturer's directions.
- When your child restraint is not in use, secure it in the vehicle with the seat belt or remove it from the vehicle. Don't leave it loose in the vehicle. In a sudden stop or collision, it could strike the occupants or seatbacks and cause serious personal injury.

Lower Anchors and Tether for Children (LATCH)

Each vehicle, except commercial cargo vehicles, is equipped with the child restraint anchorage system called LATCH, which stands for Lower Anchors and Tether for Children. Two LATCH child restraint anchorage systems are installed on all second-row seats. Second-row seats also feature tether strap anchorages, located in the rear surface of the seatback. In addition, all 3-passenger bench seats are equipped with a child restraint tether anchor at the center seating position.

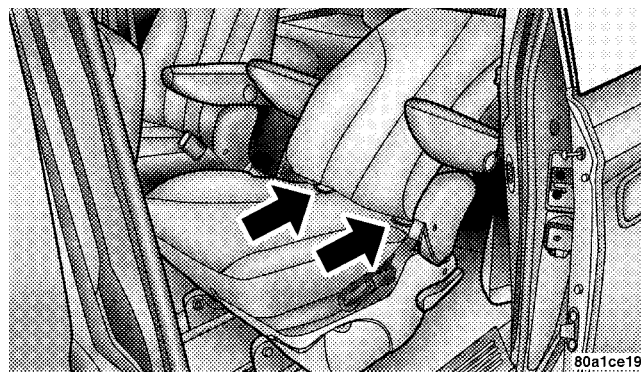

When using the tether anchorages in the outboard seating positions, ensure that the strap is routed over the top of the seatback and under the head restraint between the head restraint posts. When the tether anchorage is used in the center seating position, the strap should be positioned straight over the top of the seatback.

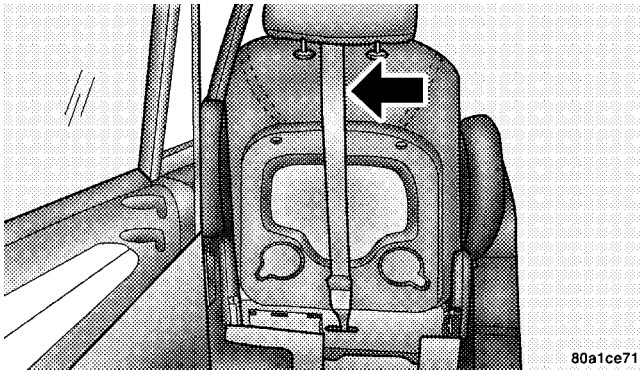
**WARNING!**

An incorrectly anchored tether strap could lead to increased head motion and possible injury to the child. Use only the anchor positions directly behind the child seat to secure a child restraint top tether strap.

Child restraint systems having attachments designed to connect to the lower anchorages are now available. Child restraints having tether straps and hooks for connection to the seatback tether anchorage have been available for some time. In fact, many child restraint manufacturers will provide add-on tether strap kits for some of their older products.

NOTE: If your child restraint seat is not LATCH compatible, install the restraint using the vehicle seat belts.

Fleet vehicles equipped with the LATCH system on the 3-passenger bench seat must have the seat adjusted to the full rear position on the tracks when the LATCH system is used. Also, when using the LATCH system, be sure the seatback is two clicks rear of its full upright position.

Because the lower anchorages are to be introduced to passenger carrying vehicles over a period of years, child restraint systems having attachments for those anchorages will continue to have features for installation in

vehicles using the lap or lap/shoulder belt. They will also have tether straps, and you are urged to take advantage of all of the available attachments provided with your child restraint in any vehicle.

Installing the Child Restraint System

If your fleet vehicle is equipped with LATCH anchorages on the 3-passenger bench seat, do not install three child restraints at the same time in this seat. The anchorages in this seat are not designed to restrain three child restraints at one time. Instead, you may install one child restraint at the center position, or one child restraint at each of the right and left positions.

WARNING!

Fleet Vehicles Only:

Do not install child restraint systems equipped with LATCH attachments at all three seating positions in the seat at one time. The LATCH anchorages in this seat are designed to restrain no more than two child restraints at a time in the event of a collision. Failure to follow this may result in serious or fatal injury.

We urge that you carefully follow the directions of the manufacturer when installing your child restraint. Many, but not all, restraint systems will be equipped with separate straps on each side, with each having a hook or connector and a means for adjusting the tension in the strap. Forward-facing toddler restraints and some rearward-facing infant restraints will also be equipped with a tether strap, a hook and means for adjusting the tension in the strap.

In general, you will first loosen the adjusters on the lower straps and tether straps so that you can more easily attach the hook or connector to the lower anchorages and tether anchorages. Then tighten all three straps as you push the child restraint rearward and downward into the seat.

Not all child restraint systems will be installed as we have described here. Again, carefully follow the instructions that come with the child restraint system.

WARNING!

Improper installation of a child restraint to the LATCH anchorages can lead to failure of an infant or child restraint. The child could be badly injured or killed. Follow the manufacturer's directions exactly when installing an infant or child restraint.

Children Too Large For Booster Seats

Children who are large enough to wear the shoulder belt comfortably, and whose legs are long enough to bend over the front of the seat when their back is against the seatback, should use the lap/shoulder belt in a rear seat.

- Make sure that the child is upright in the seat.
- The lap portion should be low on the hips and as snug as possible.
- Check belt fit periodically. A child's squirming or slouching can move the belt out of position.
- If the shoulder belt contacts the face or neck, move the child closer to the center of the vehicle. If this doesn't help, move the child to the center rear seating position and use the lap belt. Never allow a child to put the shoulder belt under an arm or behind their back.

Transporting Pets

Airbags deploying in the front seat could harm your pet. An unrestrained pet could be thrown about and possibly injured, or injure a passenger during panic braking or in a collision.

Pets should be restrained in the rear seat in pet harnesses or pet carriers that are secured by seat belts.

REAR SEAT DELETE FEATURE (COMMERCIAL VEHICLES ONLY) — IF EQUIPPED

Commercial cargo vehicles are not designed for use as a family vehicle and are not intended for carrying children in the front passenger seat. However, if you must carry a child in a vehicle without a rear seat, the passenger seat should be moved to the full rearward position and the child must be in a proper restraint system based on it's age, size and weight. NEVER carry a child in a rear facing

infant carrier in a vehicle without rear seats. In an accident, serious injury or death may occur from the deploying passenger air bag.

This vehicle is equipped with a child restraint tether anchor located on the floor, behind the front passenger seat. **Use this tether anchor to secure only forward facing child restraints equipped with an upper tether strap.**

WARNING!

Rear Facing Infant restraints must never be secured in the passenger seat of a vehicle with a passenger airbag. In an accident a passenger airbag may deploy causing severe injury or death to infants riding in rear facing infant restraints.

Restraining Infants and Small Children with Seat Delete Feature (Commercial Vehicles Only)

There are different sizes and types of restraints for children from newborn size to the child almost large enough for an adult safety belt. Use the restraint that is correct for your child:

- The rearward-facing infant carrier is for babies weighing up to about 20 lbs (9 kg), and less than one year old. **THIS TYPE OF SEAT CANNOT BE USED IN A VEHICLE EQUIPPED WITH THE REAR SEAT DELETE FEATURE (Commercial Vehicles Only).**
- The forward-facing child seat is for children from about 20 to 40 lbs (9 to 18 kg), and more than one year old.
- A “convertible” child seat, one that is designed to be used for children who are too heavy for a rear facing infant seat, may be used **IN THE FORWARD FACING POSITION ONLY, IT MUST NEVER BE INSTALLED**

FACING TO THE REAR IN A VEHICLE EQUIPPED WITH THE REAR SEAT DELETE FEATURE (Commercial Vehicles Only). When a convertible seat is properly installed forward facing, the vehicle seat should be adjusted to the **rear most position.**

- Children more than 40 lbs (18 kg) should be secured in the passenger seat in a child restraint or belt-positioning booster seat with the seat adjusted to the **rear most position.** Older children who do not use child restraints or belt-positioning booster seats should ride properly buckled in the passenger seat with the seat adjusted to the rear most position. Never allow children to slide the shoulder belt behind them or under their arm.

Tether Installation For Commercial Vehicles With Rear Seat Delete

To secure the child restraint upper tether strap to the vehicle, follow the instructions shown:

68 THINGS TO KNOW BEFORE STARTING YOUR VEHICLE

1. Locate the child restraint tether anchor on the floor just behind the front passenger seat.

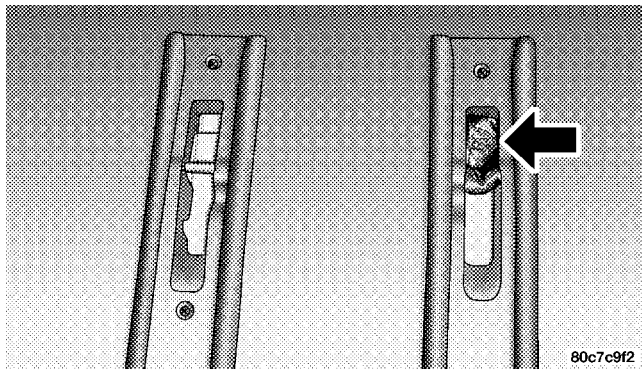

2. Extend the child restraint tether anchor forward towards the front passenger seat.

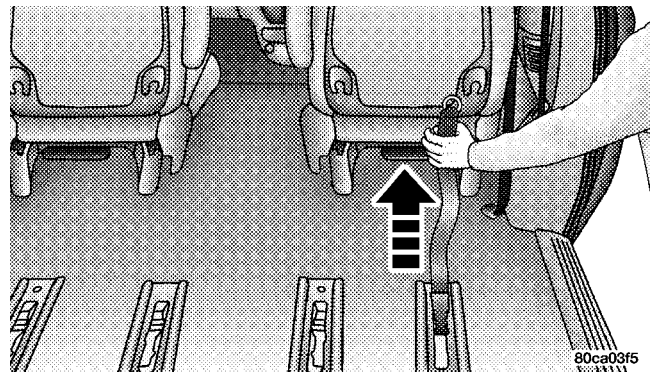

3. Follow the child restraint manufacturer's directions for proper use of connecting the child restraint to the extended tether strap.

4. If necessary, raise the passenger seat head restraint to allow the tether strap to be routed under the head restraint.

5. Route the tether strap beneath the head restraint between the two head restraint posts. Ensure that the child restraint tether strap is centered between the two head restraint posts.

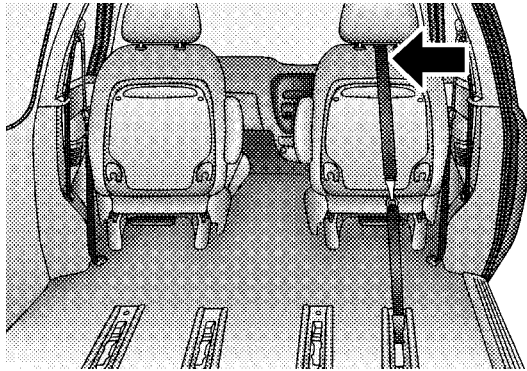

80c7c9de

6. Using the hook attached to the child restraint tether strap, attach the child restraint tether strap to the metal ring on the vehicle tether anchor.

7. Following the child seat manufacturer's instructions, tighten the child restraint tether strap.

8. If necessary, reposition the seat head restraint.

9. Inspect the tether anchor strap for nicks, abrasions, discoloration, and loose threads. If these, or any other condition that might effect the performance of the strap is observed, DO NOT USE. Contact your local DaimlerChrysler dealership for a replacement part.

NOTE: Stow the child restraint tether strap in its original position when not in use.

WARNING!

The vehicle tether anchor is designed to be used with a child restraint only. It should not be used for any other purpose. Before use inspect the tether anchor strap for nicks, abrasions, discoloration, and loose threads. If these or any other condition that might effect the performance of the strap is observed, DO NOT USE, personal injury may result. Contact your local DaimlerChrysler dealership for a replacement part.

ENGINE BREAK-IN RECOMMENDATIONS

A long break-in period is not required for the engine in your new vehicle.

Drive moderately during the first 300 miles (500 km). After the initial 60 miles (100 km), speeds up to 50 or 55 mph (80 or 90 km/h) are desirable.

While cruising, brief full-throttle acceleration, within the limits of local traffic laws, contributes to a good break-in. Wide open throttle acceleration in low gear can be detrimental and should be avoided.

The engine oil installed in the engine at the factory is a high quality energy conserving type lubricant. Oil changes should be consistent with anticipated climate conditions under which vehicle operations will occur. The recommended viscosity and quality grades are shown in Section 7 of this manual. NON-DETERGENT OR STRAIGHT MINERAL OILS MUST NEVER BE USED.

A new engine may consume some oil during its first few thousand miles (kilometers) of operation. This should be considered as a normal part of the break-in and not interpreted as an indication of difficulty.

SAFETY TIPS

Exhaust Gas

WARNING!
Exhaust gases can injure or kill. They contain carbon monoxide (CO) which is colorless and odorless. Breathing it can make you unconscious and can eventually poison you. To avoid breathing (CO) follow the safety tips below.

Do not run the engine in a closed garage or in confined areas any longer than needed to move your vehicle in or out of the area.

If it is necessary to sit in a parked vehicle with the engine running, adjust your heating or cooling controls to force outside air into the vehicle. Set the blower at high speed.

WARNING!
If you are required to drive with the liftgate open, make sure that all windows are closed, and the climate control blower switch is set at high speed. DO NOT use the recirculation mode.

If you are required to drive with the liftgate open, make sure that all windows are closed, and the climate control blower switch is set at high speed. DO NOT use the recirculation mode.
--

Safety Checks You Should Make Inside The Vehicle

Seat Belts

Inspect the belt system periodically, checking for cuts, frays and loose parts. Damaged parts must be replaced immediately. Do not disassemble or modify the system.

Front seat belt assemblies must be replaced after a collision. Rear seat belt assemblies must be replaced after a collision if they have been damaged (bent retractor, torn webbing, etc. If there is any question regarding belt or retractor condition, replace the belt.

Airbag Light

The light should come on and remain on for 6 to 8 seconds as a bulb check when the ignition switch is first turned ON. If the LED is not lit during starting, have it checked. If the light stays on or comes on while driving, have the system checked by an authorized dealer.

Defroster

Check operation by selecting the defrost mode and place the blower control on high speed. You should be able to feel the air directed against the windshield.

Periodic Safety Checks You Should Make Outside The Vehicle

Tires

Examine tires for excessive tread wear or uneven wear patterns. Check for stones, nails, glass, or other objects lodged in the tread. Inspect tread and sidewall for cuts or cracks. Check wheel nuts for tightness, and tires (including spare) for proper pressure.

Lights

Have someone observe the operation of exterior lights while you work the controls. Check turn signal and high beam indicator lights on the instrument panel.

Fluid Leaks

Check area under vehicle after overnight parking for fuel, engine coolant, oil or other fluid leaks. Also, if gasoline fumes are detected or fuel, power steering fluid or brake fluid leaks are suspected, the cause should be located and corrected immediately.

UNDERSTANDING THE FEATURES OF YOUR VEHICLE

CONTENTS

■ Mirrors77	□ Heated Remote Control Mirrors — If Equipped80
□ Inside Day/Night Mirror77	□ Illuminated Vanity Mirrors — If Equipped80
□ Automatic Dimming Mirror — If Equipped77	■ Seats80
□ Driver's Side Outside Mirror Auto Dimmer — If Equipped78	□ Manual Front Seat Adjuster80
□ Exterior Mirrors Folding Feature78	□ 8-Way Driver's Power Seat — If Equipped81
□ Outside Mirror — Driver's Side78	□ 4-Way Passenger's Power Seat — If Equipped81
□ Outside Mirror — Passenger's Side78	□ Adjustable Head Restraints — If Equipped82
□ Power Remote-Control Mirrors — If Equipped79	□ Heated Seats — If Equipped82

74 UNDERSTANDING THE FEATURES OF YOUR VEHICLE

<input type="checkbox"/> Manual Reclining Seats — If Equipped83	<input checked="" type="checkbox"/> To Open And Close The Hood96
<input type="checkbox"/> Manual Lumbar — If Equipped84	<input checked="" type="checkbox"/> Lights98
<input type="checkbox"/> Middle Rear Bench Seat Recline — If Equipped84	<input type="checkbox"/> Interior Lights98
<input type="checkbox"/> Middle Quad Fold & Tumble Seating85	<input type="checkbox"/> Park Lights99
<input type="checkbox"/> Middle Quad Fold & Tumble Seat Removal86	<input type="checkbox"/> Headlights99
<input type="checkbox"/> 50/50 Fold & Tumble Rear Seat Removal88	<input type="checkbox"/> Automatic Headlights — If Equipped	100
<input type="checkbox"/> 2 - Passenger And 3 - Passenger Bench Seats90	<input type="checkbox"/> Daytime Running Lights (Canada/Fleet Vehicles Only)	101
<input type="checkbox"/> Plastic Grocery Bag Retainer91	<input type="checkbox"/> Lights-On Reminder	101
<input type="checkbox"/> Rear-Most Bench Seat92	<input type="checkbox"/> Battery Protection	101
<input type="checkbox"/> Rear Seat Descriptions92	<input type="checkbox"/> Headlight Time Delay — If Equipped	101
<input type="checkbox"/> Rear Bench Seating Flexibility92	<input type="checkbox"/> Front Fog Lights — If Equipped	102
<input type="checkbox"/> Rear Quad And 50/50 Seating Flexibility94	<input checked="" type="checkbox"/> Multifunction Lever	102

- Turn Signals102
- Headlight Low/High Beam Selector Switch . . .103
- Passing Light103
- Windshield Wipers And Washers103
- Tilt Steering Column — If Equipped104
- Traction Control Switch — If Equipped105
- Adjustable Pedals — If Equipped106
- Electronic Speed Control — If Equipped107
 - To Activate108
 - To Set At A Desired Speed108
 - To Deactivate108
 - To Resume Speed108
 - To Vary The Speed Setting109

UNDERSTANDING THE FEATURES OF YOUR VEHICLE 75

- To Accelerate For Passing109
- Overhead Console — If Equipped110
 - Courtesy/Reading Lights110
 - Sunglass Storage111
 - Compass/Temperature Display111
 - Mini-Trip Computer114
 - Electronic Vehicle Information Center (EVIC) — If Equipped115
 - Customer Programmable Features — If Equipped116
- Garage Door Opener — If Equipped119
 - Programming Homelink120
 - Canadian Programming/Gate Programming . .123
 - Using Homelink123

76 UNDERSTANDING THE FEATURES OF YOUR VEHICLE

<input type="checkbox"/> Erasing Homelink Buttons	124	<input type="checkbox"/> Convenience Tray And Optional Smoker's Package Kit	130
<input type="checkbox"/> Reprogramming a Single Homelink Button . . .	124	<input type="checkbox"/> Rear Cupholders	130
<input type="checkbox"/> Security	124	■ Storage	132
■ Power Sunroof — If Equipped	125	<input type="checkbox"/> Front Seat Storage Bin — If Equipped	132
<input type="checkbox"/> Express Open Feature	126	<input type="checkbox"/> Removable Floor Console — If Equipped	132
<input type="checkbox"/> Wind Buffeting	127	<input type="checkbox"/> Rear Compartment Storage Bins	135
<input type="checkbox"/> Sunroof Maintenance	127	<input type="checkbox"/> Cargo Area Storage	135
■ Electrical Power Outlets — If Equipped	127	<input type="checkbox"/> Cargo Organizer — If Equipped	136
<input type="checkbox"/> Electrical Outlet Use With Engine Off	129	■ Roof Luggage Rack — If Equipped	139
■ Convenience Tray Drawer And Cup Holders . . .	129	■ Load Leveling System	141
<input type="checkbox"/> Instrument Panel Cup Holders	129		

MIRRORS

Inside Day/Night Mirror

Adjust the mirror to center on the view through the rear window. A two point pivot system allows for horizontal and vertical adjustment of the mirror.

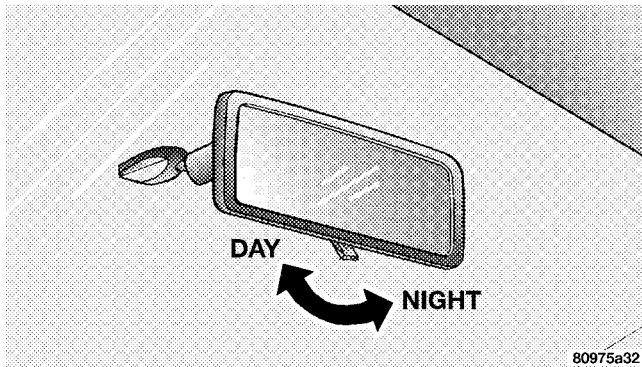

Annoying headlight glare can be reduced by moving the small control under the mirror to the night position

(toward rear of vehicle). The mirror should be adjusted while set in the day position (toward windshield).

Automatic Dimming Mirror — If Equipped

If the switch is in the “Auto” position the mirror will automatically adjust for annoying headlight glare from vehicles behind you. You can turn the feature on or off by pressing the button at the base of the mirror. A light in the button will illuminate to indicate when this feature is on.

3

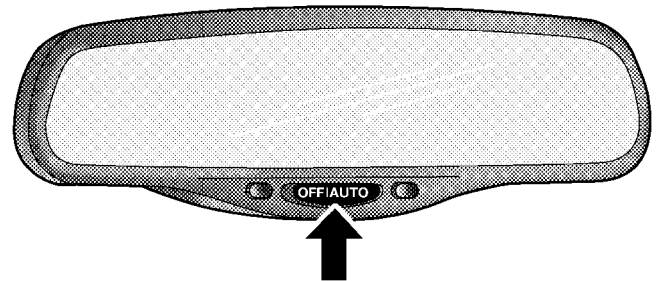

81074fc3

CAUTION!

To avoid damage to the mirror during cleaning, never spray any cleaning solution directly onto the mirror. Apply the solution onto a clean cloth and wipe the mirror clean.

Driver's Side Outside Mirror Auto Dimmer — If Equipped

This mirror automatically adjusts for annoying headlight glare from vehicles behind you. You can turn this feature on or off by pressing the button at the base of the Rearview Mirror.

Exterior Mirrors Folding Feature

All exterior mirrors are hinged and may be moved either forward or rearward to resist damage. The hinges have three detent positions; full forward, full rearward, and normal.

Outside Mirror — Driver's Side

Adjust the outside mirror to center on the adjacent lane of traffic, with a slight overlap of the view obtained on the inside mirror.

Outside Mirror — Passenger's Side

Adjust the convex outside mirror so you can just see the side of your vehicle in the portion of the mirror closest to the vehicle. This type of mirror will give a much wider view to the rear, and especially of the lane next to your vehicle.

WARNING!

Vehicles and other objects seen in the right side convex mirror will look smaller and farther away than they really are. Relying too much on your right side mirror could cause you to collide with another vehicle or other object.

Use your inside mirror when judging the size or distance of a vehicle seen in this convex mirror.

Power Remote-Control Mirrors — If Equipped

Use the mirror select switch, located on the instrument panel to the left of the steering column, to adjust the view obtained in the outside mirrors. Press the rocker switch to the L or R for Left or Right mirror selection. Use the center off position to guard against accidentally moving a mirror position.

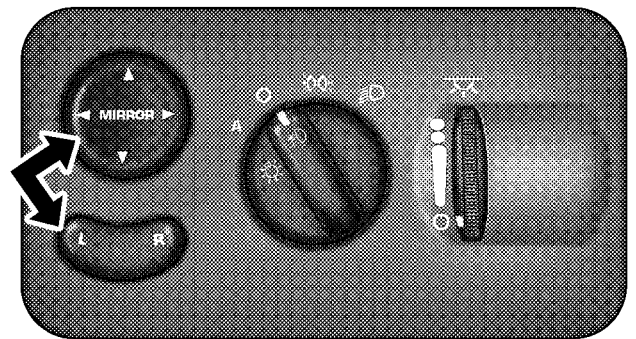

80944bc4

Select a mirror and press one of the four arrows for the direction you want the mirror to move.

Heated Remote Control Mirrors — If Equipped

These mirrors are heated to melt frost or ice. This feature is activated whenever you turn on the Rear Window Defrost.

Illuminated Vanity Mirrors — If Equipped

An illuminated vanity mirror is on the sun visor. To use the mirror, rotate the sun visor down and swing the mirror cover upward. The lights turn on automatically. Closing the mirror cover turns off the lights.

Sun Visor Extension — If Equipped

This feature has a pull out extension on the sun visor for increased coverage.

SEATS

Manual Front Seat Adjuster

The adjusting bar is located under the front of the seat. Pull the bar up and move the seat to the desired position. Release the bar to lock the seat into position.

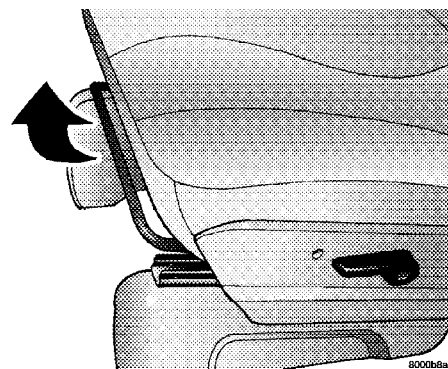

Using body pressure, move forward and rearward on the seat to be sure the seat adjusters have latched.

WARNING!

Adjust the seat only while the vehicle is parked. Adjusting a seat while the vehicle is moving is dangerous. The sudden movement of the seat could cause you to lose control. The seat belt might not be properly adjusted and you could be injured.

Your vehicle may be equipped with side airbags. Refer to section 2 "Occupant Restraints -- Side Airbags" for more information.

8-Way Driver's Power Seat — If Equipped

The driver's power seat switches are located on the outboard side of the seat. The front switch controls up/down, forward/rearward, and tilt adjustment. The rear switch controls the seatback recline adjustment.

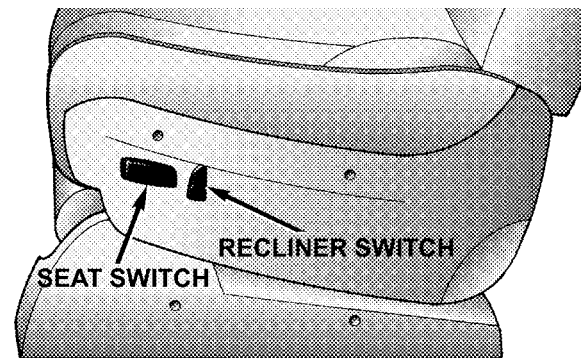

80f62542

4-Way Passenger's Power Seat — If Equipped

The passenger's power seat switches are located on the outboard side of the seat. The front switch controls forward and rearward adjustment. The rear switch controls the seatback recline adjustment.

CAUTION!

Do not place any article under a power seat or impede its ability to move as it may cause damage to the seat controls. Seat travel may become limited if movement is stopped by an obstruction in the seat's path.

Adjustable Head Restraints — If Equipped

Head restraints can reduce the risk of whiplash injury in the event of impact from the rear. Pull up or push down on the head restraint so that the upper edge is as high as practical. To raise the head restraint, pull up on the head restraint. To lower the head restraint, depress the release tab located at the base of the head restraint and push down on the head restraint.

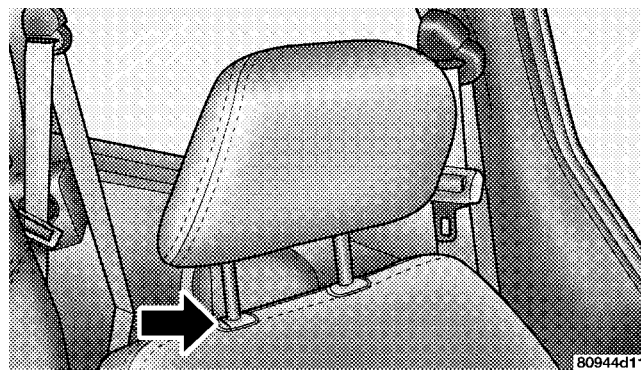
**Heated Seats — If Equipped**

This feature heats the front driver and passenger seats. The controls for the heated seats are located on the instrument panel above the radio. You may choose LOW, HIGH or No Heat. The switch position as well as an indicator light will show when the LOW or HIGH heat is ON.

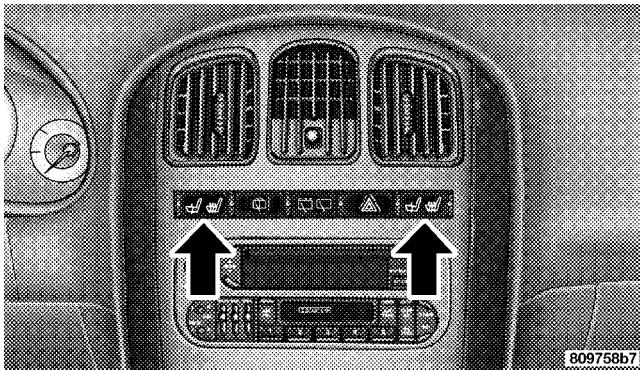

Manual Reclining Seats — If Equipped

The recliner mechanism control is on the outboard side of the seat. To recline, lean forward slightly, lift the lever, then push back to the desired position and release the lever. Lean forward and lift the lever to return the

seatback to its normal position. Using body pressure, lean forward and rearward on the seat to be sure the seatback has latched.

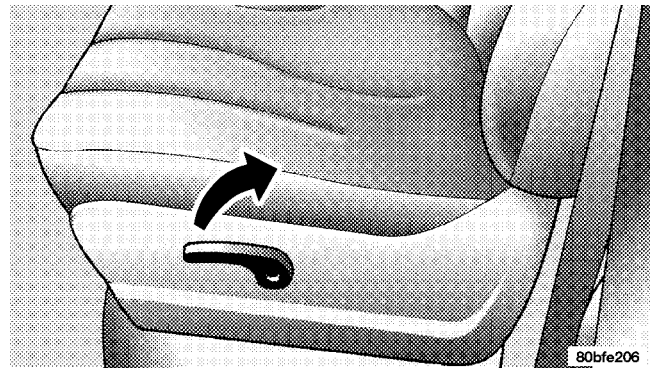

WARNING!

Do not ride with the seatback reclined so that the shoulder belt is no longer resting against your chest. In a collision you could slide under the seat belt and be seriously or fatally injured. Use the recliner only when the vehicle is parked.

Manual Lumbar — If Equipped

The lumbar adjustment handle is located inboard under the armrest. To increase the support, rotate the handle down.

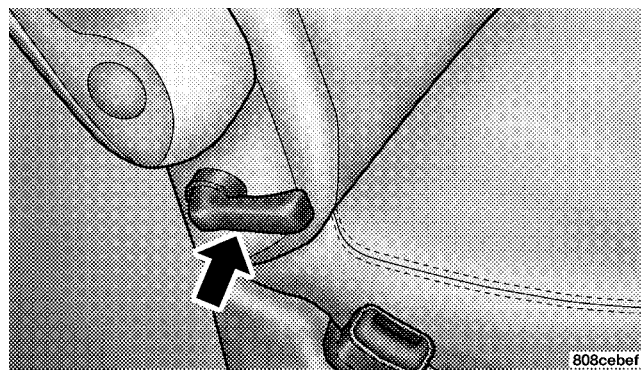

Middle Rear Bench Seat Recline — If Equipped

Pull up on the handle located on the side of the seat to release the seatback. This allows the seatback to be either reclined or folded forward.

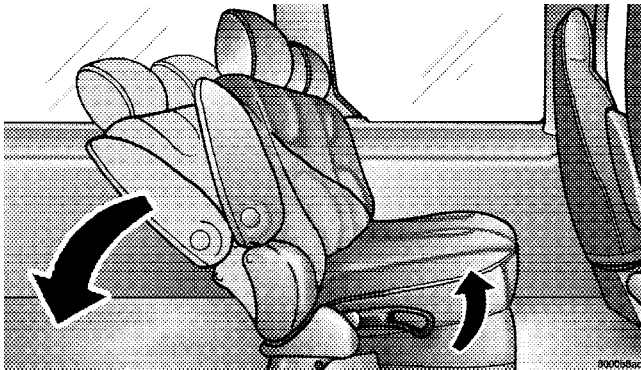
**Middle Quad Fold & Tumble Seating**

The passenger's and driver's side middle quad seats can be tilted forward for easy access to the third seat or rear cargo area.

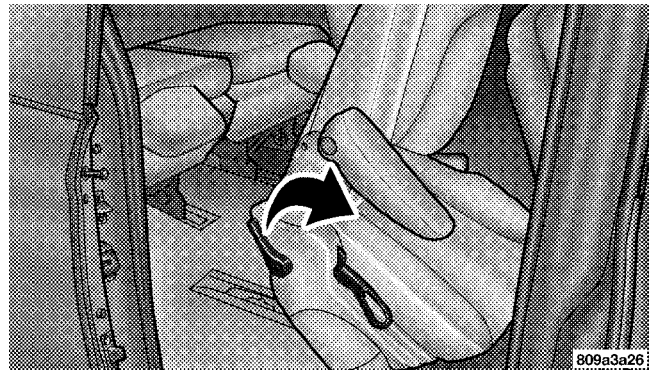

To tilt the seat, pull up on the release handle and tilt the seat fully forward. To return the seat, lower the seat and ensure that it is latched.

WARNING!

In the event of a collision you could be injured if the seat is not fully latched.

Middle Quad Fold & Tumble Seat Removal

1. Remove any obstructions from the floor in front of the seat.
2. Lower the head restraint to its full downward position and ensure that the cupholder is closed.
3. Pull up on the seatback release lever located on the outboard side of the seat and fold the seatback down. If the head restraint contacts the rear of the front seat, move the front seat forward on its tracks.

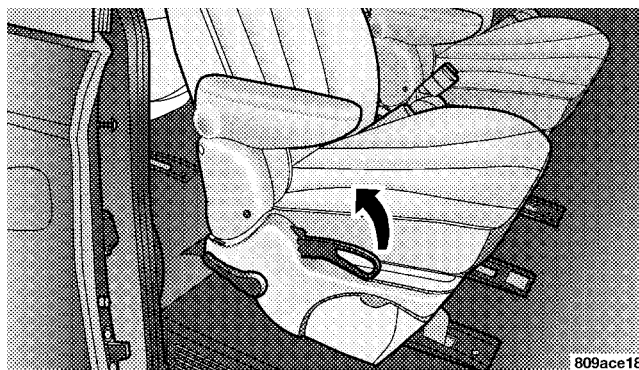

4. Pull up on the release handle and tumble the seat fully forward.

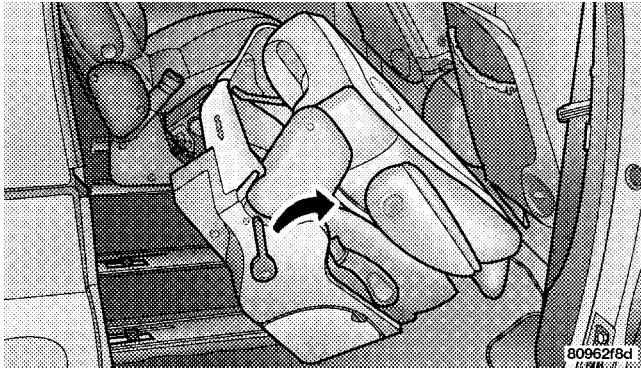

5. Pull the release bar located at the bottom front edge of the seat to disengage the front attachments.

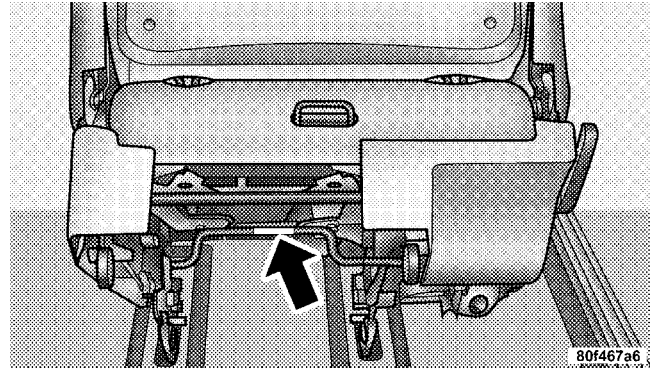

6. The seat assembly can now be removed from the vehicle and moved on its Easy Out® Rollers.

To reinstall the seat, remove any obstructions from the floor in front of the seat and ensure the head restraint is in its full downward position. Align the seat in the floor tracks and tilt the seat forward to engage the front floor attachments, then tilt the seat rearward and push down

to engage the rear attachments. Pull the seatback release lever to return the seatback to its full upright position. Ensure that the seatback is fully latched in the upright position.

WARNING!

In a collision, you or others in your vehicle could be injured if seats are not properly latched to their floor attachments. Always be sure the seats are fully latched.

50/50 Fold & Tumble Rear Seat Removal

1. Lower the head restraint and pull up on release lever "1" to fold the seatback down.

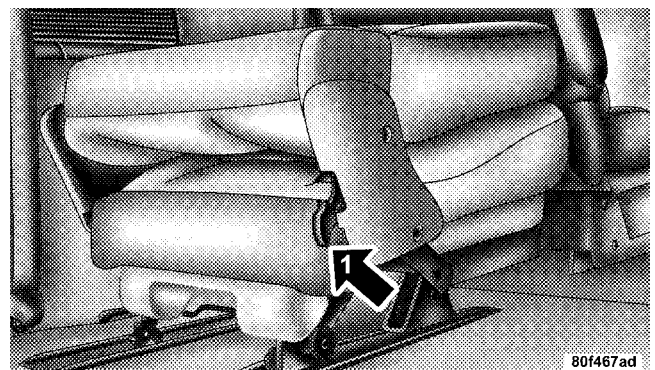

2. Pull up on release lever "2" and tumble the seat fully forward.

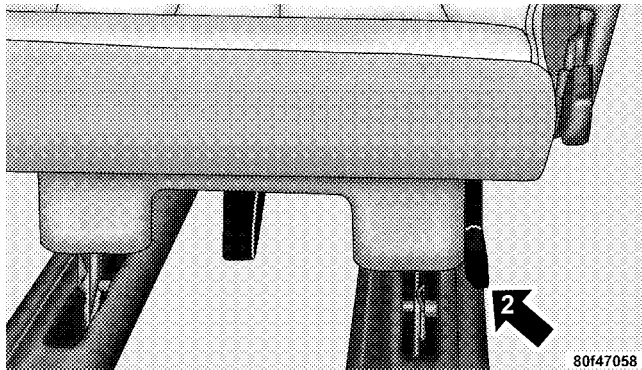

3. Pull the release strap “3” located at the bottom of the seat to disengage the front attachments.

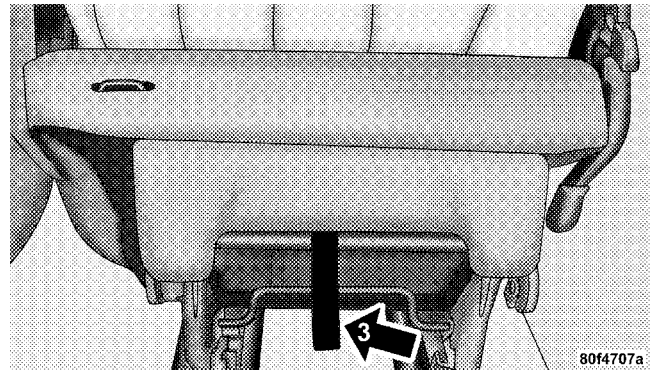

4. The seat assembly can now be removed from the vehicle and moved on its Easy Out® Rollers.

To reinstall the 50/50 rear seat, lower the head restraint to the full down position, tilt the seat forward and engage the front floor attachments, then tilt the seat rearward to engage the rear attachments. Pull the seatback release

lever to return the seatback to its full upright position. Ensure that the seatback is fully latched in the upright position.

WARNING!

In a collision, you or others in your vehicle could be injured if seats are not properly latched to their floor attachments. Always be sure the seats are fully latched.

2 – Passenger and 3 – Passenger Bench Seats

Release levers are located on the rear leg assemblies, near the floor. To remove the seat, squeeze each release handle and rotate downwards to deploy the wheels. A lock indicator button pops up when the seat is unlocked. The seat assembly can now be removed from the vehicle and moved on its Easy Out® Rollers.

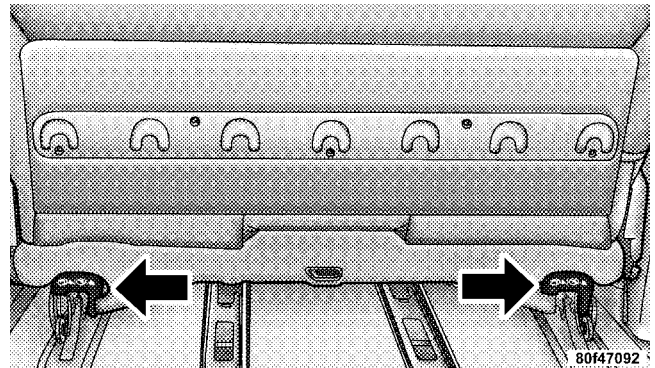

To reinstall the seat, align the seat into the detent positions on the floor. Squeeze the release handle and rotate upward until the lock indicator button returns into the handle.

WARNING!

If not properly latched, the bench seats could become loose. Personal injuries could result. After reinstalling these seats, be sure the red indicator button on the release handles return into the handles.

Plastic Grocery Bag Retainer

Retainer hooks which will hold plastic grocery bag handles are built into the seatbacks of all rear seats and some front seats. The floor supports the partial weight of the bagged goods.

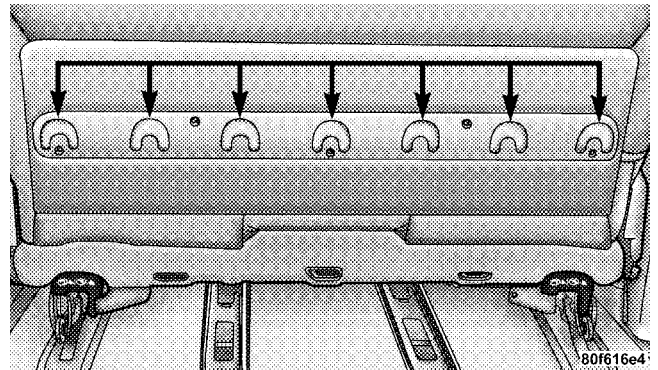

Rear-Most Bench Seat

The seat position can be adjusted fore and aft to any of three positions - normal (rearward), intermediate, and full forward. In this way varying needs for legroom and cargo space behind the seat can be accommodated.

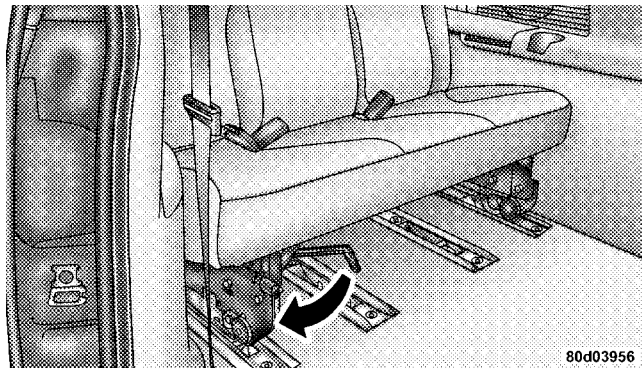

The release lever is below the seat and is accessible from the front and back of the seat.

Rear Seat Descriptions

7 Passenger Model — 2- passenger bench or bucket seats in the second position and 3- passenger bench seat or 50/50 bench seat in the third position. All rear seats are removable.

Rear Bench Seating Flexibility

The 3- passenger bench seat may be adjusted to any of 3 positions on its tracks while installed in the vehicle. The bench seat may also be moved to the second seating position or removed from the vehicle.

1. Normal Seating—

The 2nd and 3rd row seats are installed. The 3rd row bench seat is in the full rear position on the tracks.

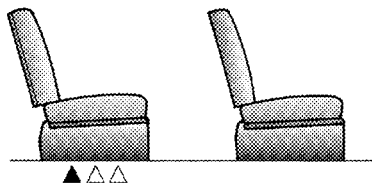

80de80fe

2. Increased Storage—

Increased storage area is provided by adjusting 3rd row bench seat to the intermediate track position. Rear seating for 3 passengers (children) is still provided.

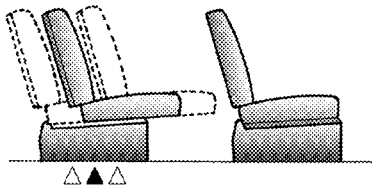

80de80c7

3. Additional Storage—

The 2nd and 3rd row seats installed. The 3rd row bench seat is in the full forward position on the tracks and one or both of the rear seatbacks are folded down.

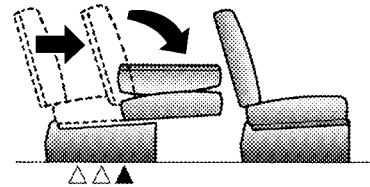

80de8049

4. Auxiliary Seating—

The middle quad seats are removed from the vehicle. The 3- passenger bench seat can be installed in either the second or third row.

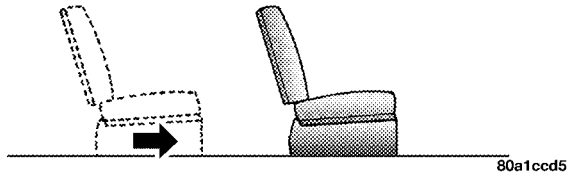

Rear Quad and 50/50 Seating Flexibility

The seats may be used with either or both seatbacks folded forward for additional storage space, or with either or both seats removed from the vehicle. Both 50/50 seats may also be moved to the 2nd row seating position when the middle quad seats are removed.

1. Normal Seating—

The 2nd and 3rd row seats are installed. Both seatbacks are in the upright position.

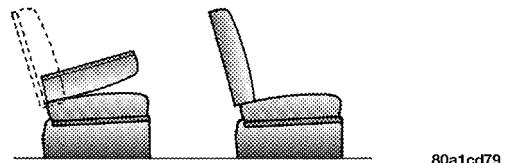

2. Increased Storage—

Increased storage area is provided by folding either or both seatbacks. With one seatback folded forward, rear seating for another occupant is still provided. Either or both seats may Fold and Tumble forward for more storage space. For maximum storage, remove the head restraint and place on the seat cushion, then fold the seatback over the head restraint by lifting lever "1" and tumble the seat forward by lifting lever "2".

NOTE:

Driving with the 2nd-row seats in the tumbled position is not recommended when passengers occupy the 3rd row seats. This position is intended only to increase available cargo area without requiring removal of the seats.

Do not leave the head restraint stored between the cushions for extended periods of time or inadvertent damage to the seat cover or head restraint may occur.

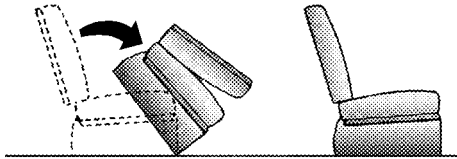

80a1cd44

3. Additional Storage—

The 2nd row seats are installed in the middle seating position. Either or both of the rear seats are removed from the vehicle.

4. Auxiliary Seating—

The 2nd row seats are removed from the vehicle. Then the third row seats can be installed in either the rear or middle seat position.

If the seat is not occupied, the seatback can be folded forward to obtain additional cargo space. To fold the seatback forward, pull the handle labeled “1” located behind the seat on the passenger side.

The seatback will latch in the folded position. To assure the seatback is latched in the folded position, additional downward pressure on the seatback may be required when folding.

The same lever is used to return the seatback to the upright position.

NOTE: The head restraints are removable, if needed. To remove them, press the release tab on the right side of the base of the head restraint.

WARNING!

- Not all head restraints in this vehicle are the same. Head restraints from one seating position should not be removed and installed in any other seating position. In a collision, serious injury or death may result if the proper head restraint is not installed on each seat.
- The cargo area in the rear of the vehicle should not be used as a play area by children. They could be seriously injured in a collision. Children should be seated and using the proper restraint system.
- It is extremely dangerous to ride in a cargo area, inside or outside of a vehicle. In a collision, people riding in these areas are more likely to be seriously injured or killed.
- Do not allow people to ride in any area of your vehicle that is not equipped with seats and seat belts.
- Be sure everyone in your vehicle is in a seat and using a seat belt properly.

TO OPEN AND CLOSE THE HOOD

To open the hood, two latches must be released. First pull the hood release lever located under the left side of the instrument panel.

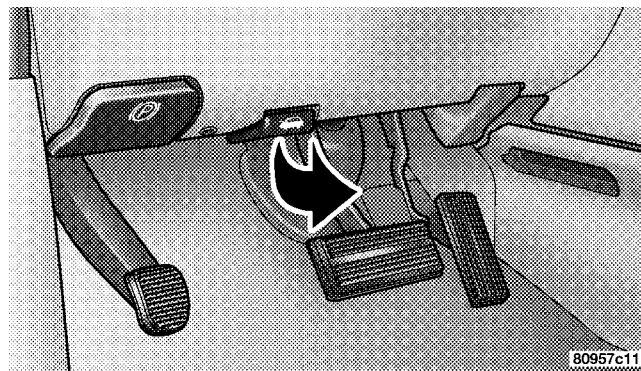

80957c11

Next, push to the left the safety catch located under the front edge of the hood, near the center.

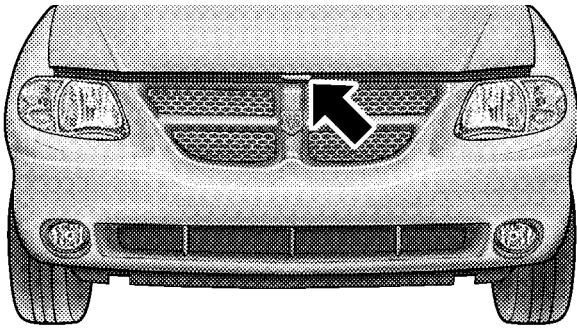

809ace14

Use the hood prop rod to secure the hood in the open position.

To prevent possible damage, do not slam the hood to close it. Lower the hood until it is open approximately 30 cm (12 inches) and then drop it. This should secure both latches. Never drive your vehicle unless the hood is fully closed, with both latches engaged.

WARNING!

If the hood is not fully latched, it could fly up when the vehicle is moving and block your forward vision. You could have a collision. Be sure all hood latches are fully latched before driving.

LIGHTS

All of the lights, except the hazard warning lights, are controlled by switches to the left of the steering column on the instrument panel.

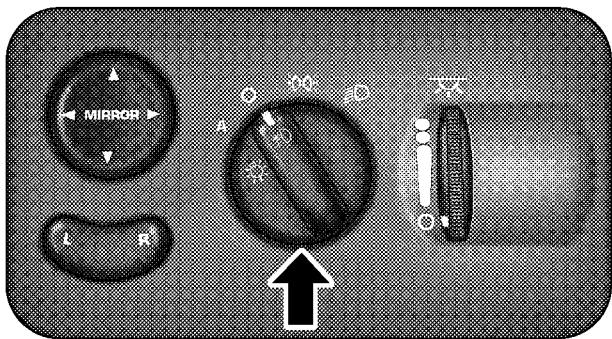

80944bd1

Interior Lights

Interior lights are turned on when a door or liftgate is opened, the keyless entry transmitter is activated, or when the dimmer control is moved to the extreme top.

NOTE: On long wheel base vehicles the dome lights for the second row seat passenger's can be turned on or off by pressing the lens. The lights will remain on until the lens is pressed a second time, so be sure they have been turned off before leaving the vehicle.

The interior lights will automatically turn off in about 15 minutes if any of the following occur.

- A door, sliding door or the liftgate is left open.
- Any overhead reading light is left on.
- If the dimmer control is in the extreme top position.

NOTE: The key must be out of the ignition switch or the ignition switch must be in the OFF position for this feature to operate.

Park Lights

 Turn this switch to the first detent to turn the park lights on. This also turns on all instrument panel lighting.

Headlights

 Turn the headlight switch to the 2nd detent to turn the headlights and park lights on. This also turns on all instrument panel lighting.

To change the brightness of the instrument panel lights, rotate the dimmer control up or down.

Dimmer Control

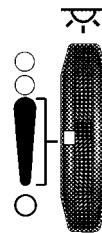

80944d81

With the park lights or headlights on, rotating the dimmer control for the interior lights on the instrument panel upward will increase the brightness of the instrument panel lights.

Dome Light Position

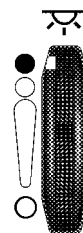

80944d6c

Rotate the dimmer control completely upward to the second detent (extreme top position) to turn on the interior lights, except the front reading/courtesy lights. The interior lights will remain on when the dimmer control is in this position.

Interior Light Defeat (OFF)

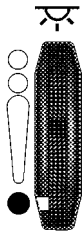

80944d62

Rotate the dimmer control to the OFF position (extreme bottom). The interior lights will remain off when the doors or liftgate are open.

Parade Mode (Daytime Brightness Feature)

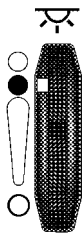

80944d8e

Rotate the dimmer control to the first detent. This feature brightens the odometer, radio and overhead displays when the park lights or headlights are on.

Automatic Headlights — If Equipped

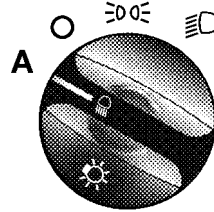

809ad55a

This system automatically turns your headlights ON or OFF based on ambient light levels. To turn the system ON, turn the headlight switch to the extreme counter-clockwise position. When the system is ON, the Headlight Time Delay feature is also ON. This means your headlights will stay

ON for up to 90 seconds after you turn the ignition switch OFF. To turn the Automatic System OFF, turn the headlight switch clockwise to the OFF position.

NOTE: The engine must be running before the headlights will come ON in the Automatic mode.

Daytime Running Lights (Canada/Fleet Vehicles Only)

The Daytime Running Lights will come on whenever the vehicle is running, the headlights are off, and the parking brake is off. The headlight switch must be used for normal night time driving.

Lights-on Reminder

If the headlights or the park lights are left on, or if the dimmer control is in the extreme top position after the ignition switch is turned off, a chime will sound when the driver's door is opened.

Battery Protection

This feature provides battery protection to avoid wearing down the battery if the headlights, park lights, or front fog lights are left on for extended periods of time when the ignition switch is in the LOCK position. After 3 minutes of the ignition switch being in the LOCK position and the headlight switch in any position other than

OFF or AUTO, the lights will turn off automatically until the next cycle of the ignition switch or headlight switch.

The battery protection feature will be disabled if the ignition switch is turned to any other position other than LOCK during the 3 minute delay.

Headlight Time Delay — If Equipped

This feature provides the safety of headlight illumination for up to 90 seconds, when leaving your vehicle in an unlighted area.

To activate the delay feature, turn off the ignition switch while the headlights are still on. Then turn off the headlights within 45 seconds. The 90 second delay interval begins when headlight switch is turned off. If the headlights or park lights are turned back on or the ignition switch is turned on, the delay will be cancelled.

If the headlights are turned off before the ignition, they will turn off in the normal manner.

NOTE: The lights must be turned off within 45 seconds of turning the ignition off to activate this feature

Front Fog Lights — If Equipped

#0 To activate the front fog lights, turn on the park lights or the low beam headlights and pull out on the headlight switch control knob. An indicator in the headlight switch shows that the front fog lights are on. Pressing the headlight switch control knob in will turn the front fog lights off.

MULTIFUNCTION LEVER

Turn Signals

Move the Multifunction Lever up or down and the arrows on each side of the base instrument cluster or Information Center flash to indicate proper operation of the front and rear turn signal lights. You can signal a lane change by moving the lever partially up or down.

If either indicator flashes at a rapid rate, check for a defective outside turn signal light bulb. If one of the indicators fails to light when the lever is moved, it would suggest that the indicator light is defective.

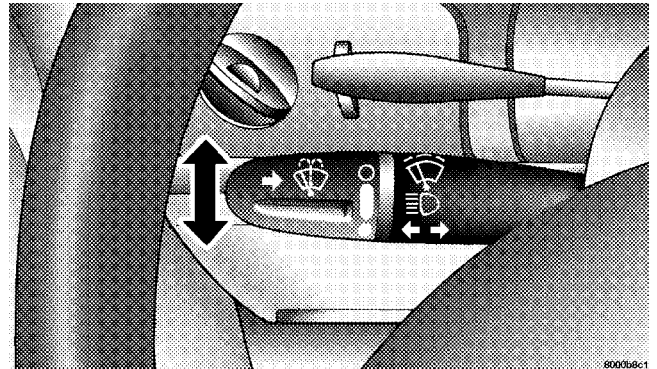

Turn Signal Warning

If the vehicle electronics sense that the vehicle has traveled at over 18 mph (29 km/h) for about one mile with the turn signals on, a chime will sound to alert the driver.

Headlight Low/High Beam Selector Switch

Pull the multifunction lever toward the steering wheel to switch the headlights between HIGH and LOW beam.

Passing Light

You can signal another vehicle with your headlights by lightly pulling the multifunction lever toward the steering wheel. This will cause the headlights to turn on at high beam and remain on until the lever is released.

Windshield Wipers and Washers

The wipers and washers are operated by a switch in the multifunction lever. Rotate the end of the lever to select the desired wiper speed.

NOTE: Always remove any build-up of snow that prevents the windshield wiper blades from returning to the OFF position. If the windshield wiper switch is turned OFF and the blades cannot return to the OFF position, damage to the wiper motor may occur.

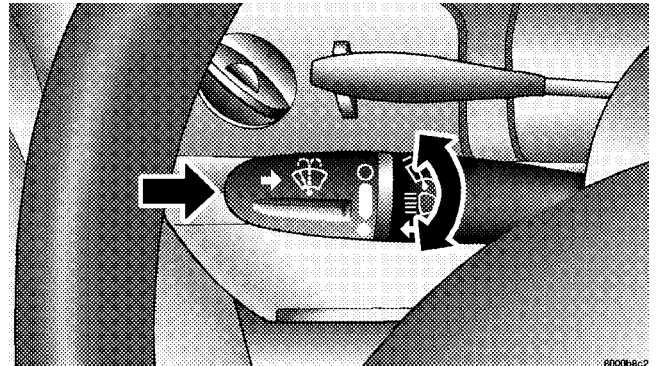

To use the washer, press the end of the multifunction lever in when spray is desired, the washers will spray for

a maximum of 20 seconds or until the lever is released. If another washer cycle is desired the end of the lever must be pressed again to get another 20 second washer cycle. If the lever is depressed while in the delay range, the wipers will operate for several seconds after the lever is released, and then resume the intermittent interval previously selected.

If the end of the lever is depressed while in the OFF position, the wipers will operate for approximately two wipe cycles, then turn OFF.

WARNING!

Sudden loss of visibility through the windshield could lead to an accident. You might not see other vehicles or other obstacles. To avoid sudden icing of the windshield during freezing weather, warm the windshield with defroster before and during windshield washer use.

Intermittent Wiper System

Use the intermittent wipers when weather conditions make a single wiping cycle, with a variable pause between cycles, desirable.

Rotate the end of the lever to the first detent position, then turn the end of the lever to select the desired delay interval. The delay can be regulated from a maximum of about 20 seconds between cycles, to a cycle every 2 seconds. The time delay will be doubled if the vehicle speed is less than 10 mph (16 km/h).

TILT STEERING COLUMN — IF EQUIPPED

To tilt the column, pull the small lever, located behind the turn signal control, toward you and move the wheel up or down, as desired. Release the lever to lock the wheel firmly in place.

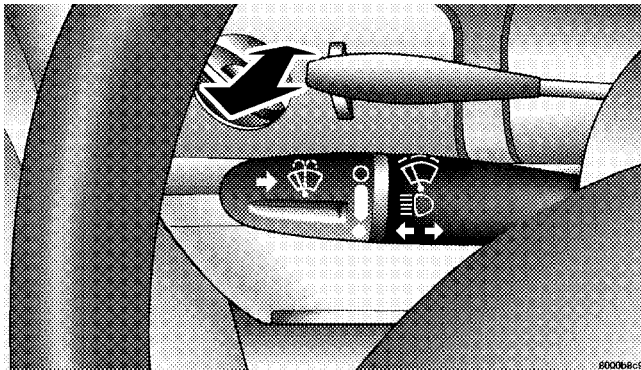

WARNING!

Tilting the steering column while the vehicle is moving is dangerous. Without a stable steering column, you could lose control of the vehicle and have an accident. Adjust the column only while the vehicle is stopped. Be sure it is locked before driving.

TRACTION CONTROL SWITCH — IF EQUIPPED

The TRAC indicator, located below the instrument cluster odometer, will light up when the Traction Control is in use.

To turn the system OFF, press the TRAC OFF switch located on the steering column, until the TRAC OFF indicator below the instrument cluster odometer lights up.

3

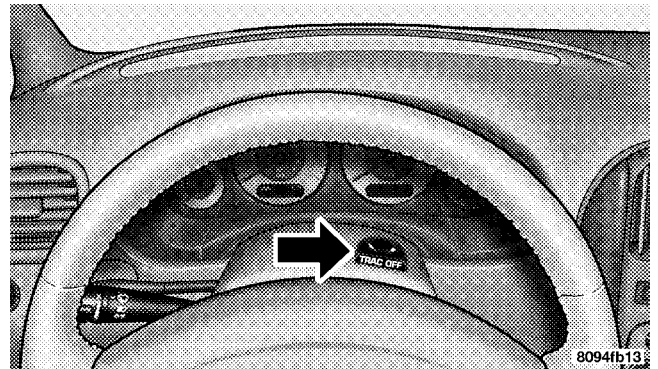

8094fb13

To turn the system back ON, press the switch a second time until the TRAC OFF indicator turns OFF.

NOTE:

- The Traction Control System indicator comes on each time the ignition switch is turned ON. This will occur even if you used the switch to turn the system OFF.
- The Traction Control will make buzzing or clicking sounds when in operation.

ADJUSTABLE PEDALS — IF EQUIPPED

This feature allows both the brake and accelerator pedals to move toward or away from the driver to provide improved position with the steering wheel. The adjustable pedal system is designed to allow a greater range of driver comfort for steering wheel tilt and seat position. The switch is located on the right side of the steering column.

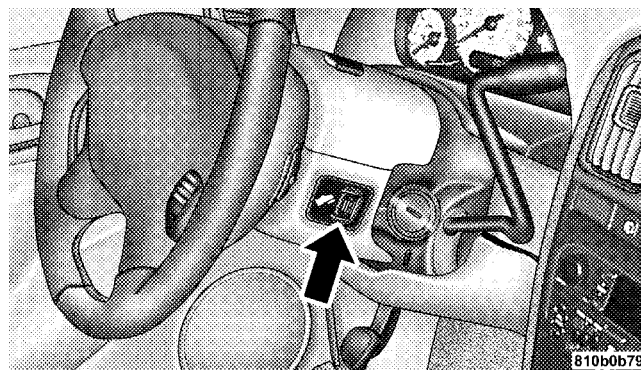

Press the button forward to move the pedals forward (toward the front of the vehicle).

Press the button rearward to move the pedals rearward (toward the driver).

- The pedals can be adjusted with the ignition OFF.
- The pedals can be adjusted while driving.

- The pedals **cannot** be adjusted when the vehicle is in R (Reverse) or when the Speed Control System is ON. The following messages will be displayed on vehicles equipped with the Electronic Vehicle Information System (EVIC) if the pedals are attempted to be adjusted when the system is locked out (“Adjustable Pedal Disabled — Cruise Control Engaged” or “Adjustable Pedal Disabled — Vehicle In Reverse”).

CAUTION!

Do not place any article under the adjustable pedals or impede its ability to move as it may cause damage to the pedal controls. Pedal travel may become limited if movement is stopped by an obstruction in the adjustable pedal’s path.

ELECTRONIC SPEED CONTROL — IF EQUIPPED

When engaged, this device takes over the accelerator operation at speeds greater than 30 mph (50 km/h). The speed control switches are located on the steering wheel.

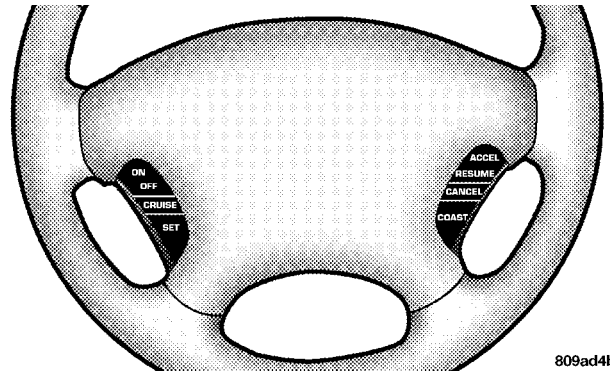

809ad4b1

To Activate:

Push the “ON/OFF” button once and the CRUISE indicator located below the instrument cluster odometer will illuminate showing the electronic speed control system is on. To turn the system OFF, push the “ON/OFF” button again and the system and indicator will turn off.

WARNING!

Leaving the Electronic Speed Control system on when not in use is dangerous. You could accidentally set the system or cause it to go faster than you want. You could lose control and have an accident. Always leave the system OFF when you aren't using it.

To Set At A Desired Speed:

When the vehicle has reached the desired speed, press and release the “SET” button. Release the accelerator and the vehicle will operate at the selected speed.

To Deactivate:

A soft tap on the brake pedal, pushing the “CANCEL” button or normal braking while slowing the vehicle will deactivate the speed control without erasing the set speed memory. Pushing the “ON/OFF” button to the OFF position or turning off the ignition erases the set speed memory.

To Resume Speed:

To resume a previously set speed, push and release the “RESUME/ACCEL” button. Resume can be used at any speed above 40 km/h (25 mph).

To Vary the Speed Setting:

When the speed control is set, speed can be increased by pressing and holding the “RESUME/ACCEL” button. When the button is released, a new set speed will be established.

Tapping the “RESUME/ACCEL” button once will result in a 2 mph (3 km/h) speed increase. Each time the button is tapped, speed increases so that tapping the button three times will increase speed by 6 mph (10 km/h), etc.

To decrease speed while speed control is set, press and hold the “COAST” button. Release the button when the desired speed is reached, and the new speed will be set.

Tapping the “COAST” button once will result in a 1 mph (2 km/h) speed decrease. Each time the button is tapped, speed decreases.

To Accelerate For Passing:

Depress the accelerator as you would normally. When the pedal is released, the vehicle will return to the set speed.

NOTE: The speed control system maintains speed up and down hills. A slight speed change on moderate hills is normal.

Your vehicle will experience a downshift to 3rd gear while climbing uphill or descending downhill. This downshift to 3rd gear is necessary to maintain vehicle set speed.

On steep hills a greater speed loss or gain may occur so it may be preferable to drive without speed control.

WARNING!

Speed Control can be dangerous where the system can't maintain a constant speed. Your vehicle could go too fast for the conditions, and you could lose control. An accident could be the result. Don't use Speed Control in heavy traffic or on roads that are winding, icy, snow-covered, or slippery.

OVERHEAD CONSOLE — IF EQUIPPED

The overhead console can contain courtesy/reading lights, an optional universal garage door opener (HomeLink®), storage for sunglasses, compass/temperature display, a mini-trip computer, optional electronic vehicle information center (EVIC), power sliding door switches and an optional power liftgate switch.

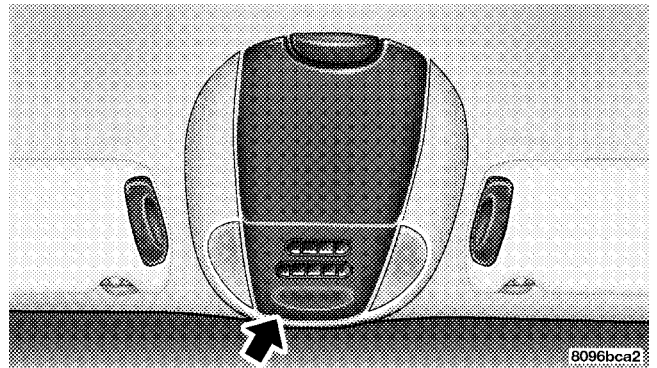
**Courtesy/Reading Lights**

At the forward end of the console are two courtesy/reading lights.

Press the lens to turn these lights on. Press a second time to turn the lights off.

The lights also turn on when a front door, a sliding door or the liftgate is opened. If your vehicle is equipped with Remote Keyless Entry, the lights will also turn on when the unlock button on the transmitter is pressed.

The area around the instrument panel cupholders is also illuminated from a light in the overhead console. This light is turned on when the headlight switch is on and will adjust in brightness when the dimmer control is rotated up or down.

Sunglass Storage

At the rear of the console a compartment is provided for the storage of two pair of sunglasses.

Press the door latch to open the compartment. The door will slowly rotate to an open position.

Compass/Temperature Display

This display provides the outside temperature and one of eight compass readings to indicate the direction the vehicle is facing.

WARNING!

Even if the display still reads a few degrees above 32°F (0°C), the road surface may be icy, particularly in woods or on bridges. Drive carefully under such conditions to prevent an accident and possible personal injury or property damage.

3

Automatic Compass Calibration

This compass is self calibrating which eliminates the need to manually set the compass. When the vehicle is new, the compass may appear erratic and the "CAL" symbol will be displayed. After completing three 360°

turns in an area free from large metal or metallic objects, the “CAL” symbol will turn off and the compass will function normally.

Manual Compass Calibration

If the compass appears erratic and the “CAL” symbol does not appear, you must put the compass into the Calibration Mode manually.

To put into a Calibration Mode: Turn on the ignition switch and set the display to Comp/Temp. Press the RESET button on vehicles equipped with a Compass/Mini Trip Computer for at least 10 seconds until the “CAL” symbol appears. On vehicles equipped with Compass/Temp press and hold the C/T and US/M buttons for 10 seconds. Release the RESET button and complete three 360° turns in an area free from large metal objects. The “CAL” symbol will turn off and the compass will function normally.

CAUTION!

Do not place any external magnets, such as magnetic roof mount antennas, in the vicinity of the compass. Do not use magnetic tools when servicing the overhead console.

Compass Variance

Compass Variance is the difference between magnetic North and Geographic North. In some areas of the country, the difference between magnetic and geographic North is great enough to cause the compass to give false readings. If this occurs, the compass variance must be set.

NOTE: Magnetic materials should be kept away from the overhead console.

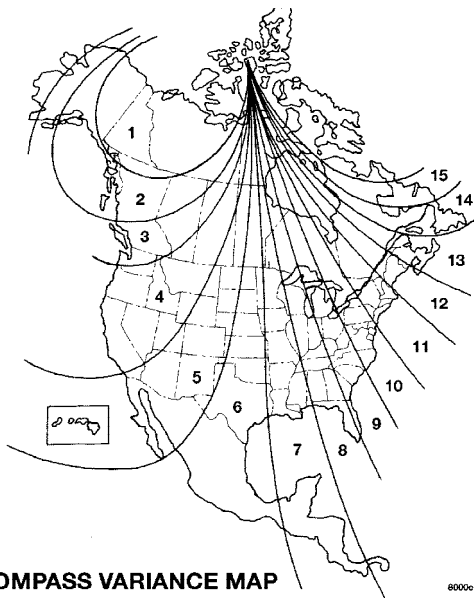

To set the variance: Turn the ignition switch ON and set the display to Comp/Temp. On vehicles equipped with a Compass/Mini Trip Computer press the RESET button for approximately 5 seconds. On vehicles equipped with Compass/Temp press and hold the C/T and US/M buttons for 5 seconds. The “VAR” symbol will light and the last variance zone number will be displayed. Press the STEP button on vehicles equipped with a Compass/Mini Trip Computer or the US/M button on vehicles equipped with Compass/Temp to select the proper variance zone as shown in the map. Press the RESET button on vehicles equipped with a Compass/Mini Trip Computer or the C/T button on vehicles equipped with Compass/Temp to set the new variance zone and resume normal operation.

Mini-Trip Computer

This displays information on the following:

- **Average Fuel Economy (ECO AVG)**
Shows the average fuel economy since the last reset.
- **Distance To Empty (DTE)**
Shows the estimated distance that can be travelled with the fuel remaining in the tank. This estimated distance is determined using the MPG for the last few minutes.
- **Trip Odometer (ODO)**
Shows the distance travelled since the last reset.
- **Elapsed Time (ET)**
Shows the accumulated ignition ON time since the last reset.
- **Off Mode**
Shows a blank display.

- **Step Button**

Push this button to cycle through all the Compass/Mini-trip Computer displays.

- **US/M Button**

Press this button to convert the display from U.S. to metric.

To Reset The Display

Pressing the Reset button once will clear the resettable function currently being displayed. Resettable functions are average fuel economy, trip odometer and elapsed time. Pressing the reset button twice within four seconds will clear all resettable functions. Reset will only occur if a resettable function is currently being displayed.

Electronic Vehicle Information Center (EVIC) — If Equipped

The Electronic Vehicle Information Center, when the appropriate conditions exist, displays the following WARNING messages and symbols. Each message is accompanied by a single chime:

- TURN SIGNALS ON (with graphic)
- PERFORM SERVICE
- DOOR AJAR (one or more, with graphic)
- LIFTGATE AJAR (with graphic)
- WASHER FLUID LOW (with graphic)
- 1,2,3 OR 4 LOW TIRE(S) PRESSURE (Refer to “Starting And Operating, Tire Section”)
- 1,2,3 OR 4 HIGH TIRE(S) PRESSURE (Refer to “Starting And Operating, Tire Section”)
- SERVICE TIRE PRESS. SYSTEM/SEE OWNER’S MANUAL (Refer to “Starting And Operating, Tire Section”)
- TIRE PRESSURE UNAVAILABLE (Refer to “Starting And Operating, Tire Section”)
- TIRE PRESSURE NOW AVAILABLE (Refer to “Starting And Operating, Tire Section”)
- SPARE TIRE IN USE? YES/NO (Refer to “Starting And Operating, Tire Section”)
- ALL 5 TIRES WITH CAR? YES/NO (Refer to “Starting And Operating, Tire Section”)
- MEMORY SEAT DISABLED (Not in Park) — If Equipped
- ADJUSTABLE PEDAL DISABLED/CRUISE ENGAGED
- ADJUSTABLE PEDAL DISABLED/VEHICLE IN REVERSE

NOTE: Tire pressure menu items are available only on vehicles equipped with the Tire Pressure Monitor System.

Customer Programmable Features — If Equipped

Press the “MENU” button until one of the display choices following appears:

Language

When in this display you may select one of five languages for all display nomenclature, including the trip computer functions. Press the “STEP” button while in this display selects English, Francaise, Deutsch, Italiano, or Espanol. As you continue the displayed information will be shown in the selected language.

US or Metric

Pressing the “STEP” button when in this display selects US or Metric. The overhead console and climate control displays will be in the selected units.

Service Interval

When this feature is selected a service interval between 2,000 miles (3 200 km) and 6,000 miles (9 600 km) in 500 mile (800 km) increments may be selected. Pressing the “STEP” button when in this display will select distances between 2,000 miles (3 200 km) and 6,000 miles (9 600 km) in 500 mile (800 km) increments.

Reset Service Distance (Displays Only if Service Interval was Changed)

When this feature is selected the current accumulated service distance can be reset to the newly selected service interval. Pressing the “STEP” button when in this display will select “Yes” or “No.”

Retrain Tire Sensors (Available with Tire Pressure Monitor System Only)

The Tire Pressure Monitor system must be retrained following a tire rotation or wheel rim mounted sensor replacement. If you unintentionally choose “Yes” to train

the Tire Pressure Monitor system and the training routine is not performed, training will be cancelled after one minute or the next time you cycle the ignition key. See your authorized dealer for service and retraining of the system.

Use Factory Settings

If “Yes” is selected, all of the customer programmable features will be set to the factory default and not displayed. If “No” is selected you can program the Vehicle Information Center to your own personal preferences.

Auto Door Locks

When this feature is selected, all doors and the liftgate lock automatically when the speed of the vehicle reaches 18 mph (29 km/h). Pressing the “STEP” button when in this display will select “Yes” or “No.”

Auto Unlock On Exit (Available Only When the AUTO DOOR LOCKS Feature is Turned On)

When this feature is selected all the vehicle’s doors will unlock whenever any door is opened if the vehicle is stopped and the transmission is in “P” (Park) or “N” (Neutral) position. Pressing the “STEP” button when in this display will select “Yes” or “No.”

Remote Unlock Driver’s Door 1st

When this feature is selected only the driver’s door will unlock on the first press of the remote keyless entry unlock button and require a second press to unlock the remaining locked doors and liftgate. When “**REMOTE UNLOCK ALL DOORS**” is selected all of the doors and the liftgate will unlock at the first press of the remote keyless entry unlock button. Pressing the “STEP” button when in this display will select “DRIVER’S DOOR 1ST” or “ALL DOORS”.

Remote Linked To Memory (Available with Memory Seat and Pedals Only)

When this feature is selected, pressing the Unlock button on any Remote Keyless Entry transmitter already linked to memory will return the driver's seat, driver's outside mirror, adjustable brake and accelerator pedals, and radio station presets to their memory set positions.

If this feature is not selected, the driver's seat, driver's mirror, adjustable pedals, and radio settings can only return to their memory set positions using the memory recall buttons (1or 2) on the driver's door panel.

Any transmitter linked to memory will remain linked, but will not recall the memory positions. The transmitter memory recall function will operate again when this feature is selected. Refer to Driver Memory System for more information. Pressing the "STEP" button when in this mode will select between "Yes" or "No".

Sound Horn On Lock

When this feature is selected a short horn sound will occur when the remote keyless entry "Lock" button is pressed. This feature may be selected with or without the flash lights on LOCK/UNLOCK feature. Pressing the "STEP" button when in this display will select "Yes" or "No."

Flash Lights On Lock/Unlock?

When this feature is selected, the front and rear turn signals will flash when the doors are locked or unlocked using the remote keyless entry transmitter. This feature may be selected with or without the sound horn on lock feature selected. Pressing the "STEP" button when in this display will select "Yes" or "No."

Headlamp Delay

When this feature is selected the driver can choose, when exiting the vehicle, to have the headlamps remain on for

30, 60, or 90 seconds, or not remain on. Pressing the “STEP” button when in this display will select 30, 60, 90, or “OFF.”

Headlamp On With Wipers (Available with Auto Headlights Only)

When this feature is selected and the headlight switch has been moved to the “AUTO” position, the engine is running and, the front wipers are turned on for 10 seconds, the headlights will turn ON. The display will remain on Parade Mode (Daytime Brightness) for ease of viewing. Pressing the “STEP” button when in this display will select “Yes” or “No.”

Power Accessory Delay

When this feature is selected, accessory power will be supplied for up to 45 seconds for the power windows,

radio, power vent windows, power outlets, and removable center console, when the ignition switch is turned off or until the key is removed and either front door is opened.

GARAGE DOOR OPENER — IF EQUIPPED

The HomeLink® Universal Transceiver replaces up to three remote controls (hand held transmitters) that operate devices such as garage door openers, motorized gates, or home lighting. It triggers these devices at the push of a button. The Universal Transceiver operates off your vehicle’s battery and charging system; no batteries are needed.

For additional information on HomeLink®, call 1-800-355-3515, or on the internet at www.homelink.com.

WARNING!

A moving garage door can cause injury to people and pets in the path of the door. People or pets could be seriously or fatally injured. Only use this transceiver with a garage door opener that has a “stop and reverse” feature as required by federal safety standards. This includes most garage door opener models manufactured after 1982. Do not use a garage door opener without these safety features it could cause injury or death. Call toll-free 1-800-355-3515 or, on the Internet at www.homelink.com for safety information or assistance.

Programming HomeLink

NOTE: When programming a garage door opener, it is advised to park outside the garage. Some vehicles may require the ignition switch to be turned to the second (or “accessories”) position for programming and/or operation of HomeLink. It is also recommended that a new battery be placed in the hand-held transmitter of the device being programmed to HomeLink for quicker training and accurate transmission of the radio-frequency signal.

1. Press and hold the two outer HomeLink buttons, and release only when the indicator light begins to flash (after 20 seconds). **Do not** hold the buttons for longer than 30 seconds and **do not** repeat step one to program a second and/or third hand-held transmitter to the remaining two HomeLink buttons.

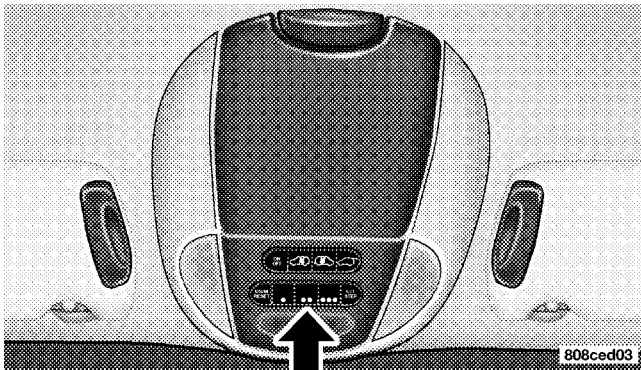
**WARNING!**

Vehicle exhaust contains carbon monoxide, a dangerous gas. Do not run the vehicle's exhaust while training the transceiver. Exhaust gas can cause serious injury or death.

WARNING!

Your motorized door or gate will open and close while you are training the Universal Transceiver. Do not train the transceiver if people or pets are in the path of the door or gate. A moving door or gate can cause serious injury or death to people and pets or damage to objects.

3

2. Position the end of your hand-held transmitter 1-3 inches (3-8 cm) away from the HomeLink buttons while keeping the indicator light in view.
3. Simultaneously press and hold both the HomeLink button that you want to train and the hand-held transmitter buttons. **Do not release the buttons until step 4 has been completed.**

NOTE: Some gate operators and garage door openers may require you to replace this Programming Step 3 with procedures noted in the "Gate Operator/Canadian Programming" section.

4. The HomeLink indicator light will flash slowly and then rapidly after HomeLink successfully receives the frequency signal from the hand-held transmitter. Release both buttons after the indicator light changes from the slow to the rapid flash.

5. Press and hold the just trained HomeLink button and observe the indicator light. If the indicator light **stays on constantly, programming is complete** and your device should activate when the HomeLink button is pressed and released.

NOTE: To program the remaining two HomeLink buttons, begin with "Programming" **step two. Do not repeat step one.**

If the indicator light blinks **rapidly for two seconds and then turns to a constant light continue with "Programming" steps 6-8** to complete the programming of a rolling code equipped device (most commonly a garage door opener).

6. At the garage door opener receiver (motor-head unit) in the garage, locate the "learn" or "smart" button. This can usually be found where the hanging antenna wire is attached to the motor-head unit.

7. Firmly press and release the "learn" or "smart" button. (The name and color of the button may vary by manufacturer.)

NOTE: There are 30 seconds in which to initiate step eight.

8. Return to the vehicle and firmly **press, hold for two seconds and release** the programmed HomeLink button. Repeat the "**press/hold/release**" sequence a second time,

and, depending on the brand of the garage door opener (or other rolling code equipped device), repeat this sequence a third time to complete the programming.

HomeLink should now activate your rolling code equipped device.

NOTE: To program the remaining two HomeLink buttons, begin with "Programming" **step two**. **Do not repeat step one**. For questions or comments, please contact HomeLink at www.homelink.com or **1-800-355-3515**.

Canadian Programming/Gate Programming

Canadian radio-frequency laws require transmitter signals to "time-out" (or quit) after several seconds of transmission which may not be long enough for HomeLink to pick up the signal during programming. Similar to this Canadian law, some U.S. gate operators are designed to "time-out" in the same manner.

If you live in Canada or you are having difficulties programming a gate operator by using the "Programming" procedures (regardless of where you live), **replace "Programming HomeLink" step 3** with the following:

NOTE: If programming a garage door opener or gate operator, it is advised to unplug the device during the "cycling" process to prevent possible overheating.

3. Continue to press and hold the HomeLink button while you **press and release every two seconds** ("cycle") your hand-held transmitter until the frequency signal has successfully been accepted by HomeLink. (The indicator light will flash slowly and then rapidly.) Proceed with "Programming" step four to complete.

Using HomeLink

To operate, simply press and release the programmed HomeLink button. Activation will now occur for the trained device (i.e. garage door opener, gate operator, security system, entry door lock, home/office lighting,

etc.). For convenience, the hand-held transmitter of the device may also be used at any time. In the event that there are still programming difficulties or questions, contact HomeLink at: www.homelink.com or 1-800-355-3515.

Erasing HomeLink Buttons

To erase programming from the three buttons (individual buttons cannot be erased but can be "reprogrammed" - note below), follow the step noted:

- Press and hold the two outer HomeLink buttons until the indicator light begins to flash-after 20 seconds. Release both buttons. Do not hold for longer than 30 seconds. HomeLink is now in the train (or learning) mode and can be programmed at any time beginning with "Programming" - step 2.

Reprogramming a Single HomeLink Button

To program a device to HomeLink using a HomeLink button previously trained, follow these steps:

1. Press and hold the desired HomeLink button. **Do NOT** release the button.
2. The indicator light will begin to flash after 20 seconds. Without releasing the HomeLink button, proceed with "Programming" step 2

For questions or comments, contact HomeLink at: www.homelink.com or 1-800-355-3515.

Security

If you sell your vehicle, be sure to erase the frequencies.

To erase all of the previously trained frequencies, hold down both outside buttons until the green light begins to flash.

This device complies with part 15 of FCC rules and with RSS-210 of Industry Canada. Operation is subject to the following conditions:

- This device may not cause harmful interference.
- This device must accept any interference that may be received including interference that may cause undesired operation.

NOTE: Changes or modifications not expressly approved by the party responsible for compliance could void the user's authority to operate the equipment.

HomeLink® is a trademark owned by Johnson Controls, Inc.

POWER SUNROOF — IF EQUIPPED

The power sunroof control is located between the sun visors on the overhead console.

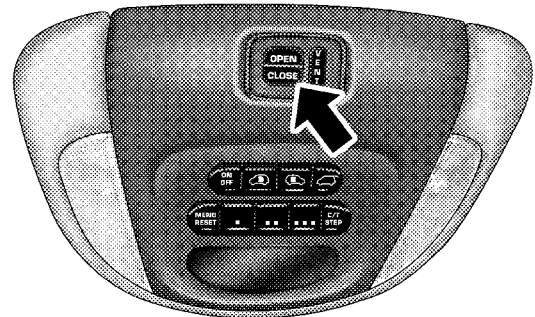

3

80ec7b49

Press and hold the switch rearward to fully open the sunroof. The sunroof can be stopped at any position between closed and full open. Momentarily pressing the

switch rearward will activate the Express Open Feature, causing the sunroof to open automatically.

Press and hold the button located to the right of the sunroof switch, to open the vent. The sunroof can be stopped at any position between closed and full vent. To close the sunroof from the vent position, press and hold the switch forward. Releasing the switch will stop the movement of the sunroof and the sunroof will remain in the partial vent position until the switch is pushed forward again.

Express Open Feature

During the Express Open operation, any movement of the switch will stop the sunroof and it will remain in a partial open position. Again, momentarily pressing the switch rearward will activate the Express Open Feature.

To close the sunroof, hold the switch in the forward position. Again, any release of the switch will stop the

movement and the sunroof will remain in a partial open condition until the switch is pushed forward again.

The sunshade can be opened manually. It will also open as the sunroof opens. The sunshade cannot be closed if the sunroof is open.

WARNING!

Never leave children in a vehicle, with the keys in the ignition switch. Occupants, particularly unattended children, can become entrapped by the power sunroof while operating the power sunroof switch. Such entrapment may result in serious injury or death.

WARNING!

In an accident, there is a greater risk of being thrown from a vehicle with an open sunroof. You could also be seriously injured or killed. Always fasten your seat belt properly and make sure all passengers are properly secured too.

Do not allow small children to operate the sunroof. Never allow fingers or other body parts, or any object to project through the sunroof opening. Injury may result.

Wind Buffeting

Wind buffeting can be described as the perception of pressure on the ears or a helicopter type sound in the ears. Your vehicle may exhibit wind buffeting with the windows down, or the sunroof (if equipped) in certain

open or partially open positions. This is a normal occurrence and can be minimized. If the buffeting occurs with the rear windows open, open the front and rear windows together to minimize the buffeting. If the buffeting occurs with the sunroof open, adjust the sunroof opening to minimize the buffeting or open any window.

Sunroof Maintenance

Use only a non-abrasive cleaner and a soft cloth to clean the glass panel.

ELECTRICAL POWER OUTLETS — IF EQUIPPED

To the left of the instrument panel cup holder are two 12 volt power outlets. The upper outlet is controlled by the ignition switch and the lower outlet is connected directly to the battery. The upper outlet will also operate a conventional cigar lighter unit (if equipped with an optional Smoker's Package).

A third outlet is located on the driver's side, just to the rear of the sliding door and is also controlled by the ignition switch. The lower and rear outlets will not accommodate a conventional cigar lighter unit.

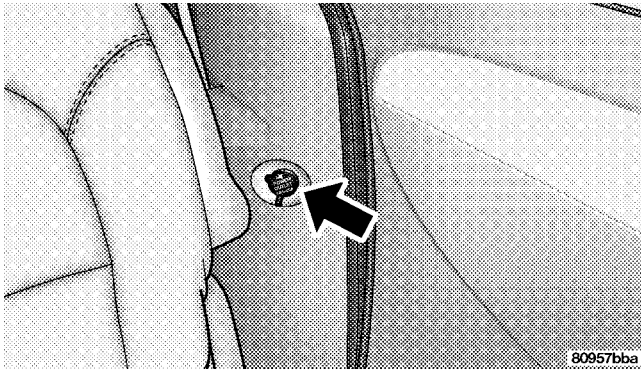

The outlets include tethered caps labeled with a key or battery symbol indicating the power source. The lower

instrument panel outlet is powered directly from the battery, items plugged into this outlet may discharge the battery and/or prevent engine starting.

The lower outlet is protected by an automatic reset circuit breaker. The automatic circuit breaker restores power when the overload is removed. The circuit breaker also supplies power to the outlet in the removable floor console, when in the front position. Refer to section 3 "Removable Floor Console" in this manual.

NOTE: If desired, all of the power outlets can be converted by your authorized dealer to provide power with the ignition switch in the OFF position.

Electrical Outlet Use With Engine Off**CAUTION!**

- Many accessories that can be plugged in draw power from the vehicle's battery, even when not in use (i.e. cellular phones, etc.). Eventually, if plugged in long enough, the vehicle's battery will discharge sufficiently to degrade battery life and/or prevent engine starting.
- Accessories that draw higher power (i.e. coolers, vacuum cleaners, lights, etc.), will degrade the battery even more quickly. Only use these intermittently and with greater caution.
- After the use of high power draw accessories, or long periods of the vehicle not being started (with accessories still plugged in), the vehicle must be driven a sufficient length of time to allow the alternator to recharge the vehicle's battery.
- Power outlets are designed for accessory plugs only. Do not hang any type of accessory or accessory bracket from the plug. Improper use of the power outlet can cause damage not covered by your warranty.

CONVENIENCE TRAY DRAWER AND CUP HOLDERS**Instrument Panel Cup Holders**

The instrument panel cupholders are located in a pull out drawer just below the climate controls.

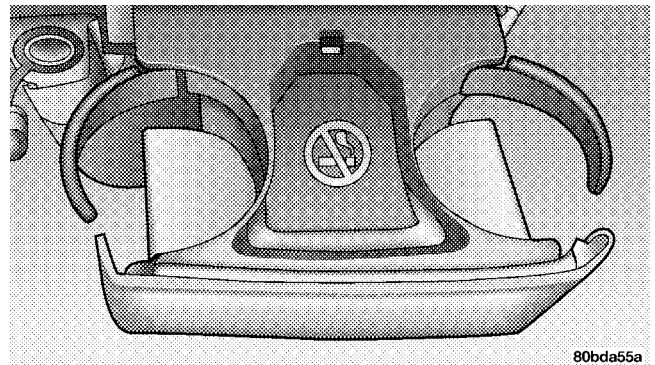

When the drawer is pulled out firmly, the arms of the cupholders will spring out. Place the container to be held

into one of the cupholders and then push the arm toward the container until the container is held stable. There are adjustable positions for the arm so the cupholder can accommodate a wide variety of container types and sizes, including those with handles. The arms of the cupholder can be adjusted in or out without damaging the detent mechanism.

NOTE: Be sure the drawer is pulled out completely, otherwise the adjustable arm detents will not engage and the container will not be held stable.

Convenience Tray And Optional Smoker's Package Kit

Located between the instrument panel cupholders is a convenience tray that has been designed to hold miscellaneous small items.

NOTE: The convenience tray should never be used for ashes without the optional ash receiver in place. Permanent burn marks may result.

With the optional dealer installed Smoker's package, a removable ash receiver is inserted into the convenience tray location. To install the ash receiver, slide the forward edge into the convenience tray opening and push down to lock it into position. For cleaning of the ash receiver, its removal is accomplished by inserting the end of a key in the pry slot that is molded into the rear edge of the ash receiver and then twisting the key slightly.

Rear Cupholders

There are dual stationary cupholders located in the passenger side rear trim panel and a single stationary cup holder on the driver side rear trim panel.

There are also dual underseat cupholders for the 2nd seat passengers. With a bench seat in the 2nd seat position these cupholders slide out from under the center of the seat.

If your vehicle is equipped with quad seats in the 2nd seat position, these cupholders are located on the out-board side of the seat pedestal.

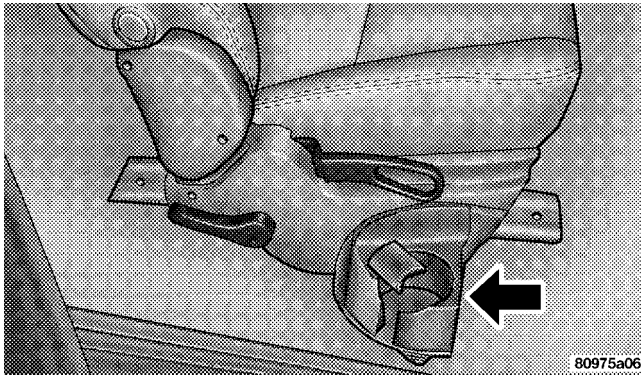

NOTE:

- The quad seat cupholders will remain upright if the seat is tilted forward.
- The quad seat cupholders are designed to break away if stepped on. To return the cupholder to its normal position, simply push the cupholder up to snap it into place.
- The floor mat must be in position for optimum cupholder operation.

There are also two cupholders and a flat tray on the seat back of the quad seats. These can be used when the seat back is folded forward.

STORAGE

Front Seat Storage Bin — If Equipped

The storage bin is located under the front passenger's seat. If equipped with a lock, it can be locked with the ignition key.

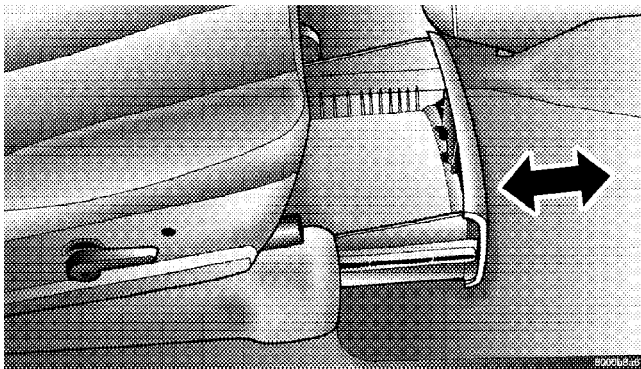

Removable Floor Console — If Equipped

The removable floor console has a power outlet, storage tray, light, cell phone holder, tissue holder, and a map holder. It can be placed between either the front seats or middle seats.

NOTE: When the console is located between the front seats the outlet is protected by an automatic circuit breaker and is powered directly from the battery, items plugged into this outlet may discharge the battery and/or prevent engine starting.

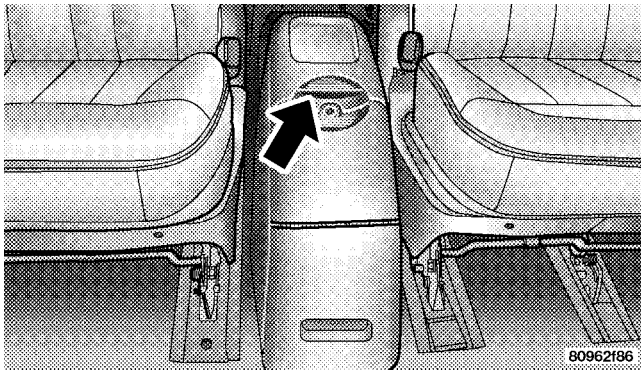

To remove the console use the following procedure:

1. Open the rear lid and remove the storage tray.
2. Pull the release handle located inside the floor console, reinstall the storage tray and close the rear lid.

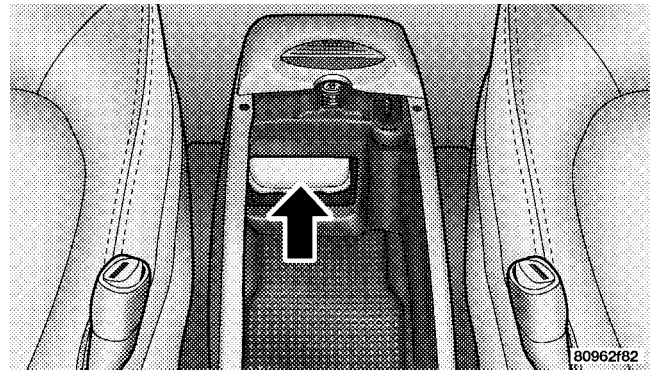

3. Using the front and rear grab handles, slide the console rearward to disengage the front of the console and lift up to remove the console from the floor.

4. Place the rubber mat on the floor tray.

To reinstall the console, remove the rubber mat and relocate to the alternate floor tray, slide the console

forward to engage the front of the console into the floor tray. Rapidly push down on the rear of the console with enough force to engage the latch, you should hear the latch “snap” into place. Pull up on the console to be sure it’s firmly attached.

NOTE: When the removable floor console is located between the middle seats, the power outlet only has power supplied to it when the ignition switch is ON.

Cell Phone Holder

1. Open the front lid and remove the cell phone holder by pulling rearward and up on the lower edge of the holder.

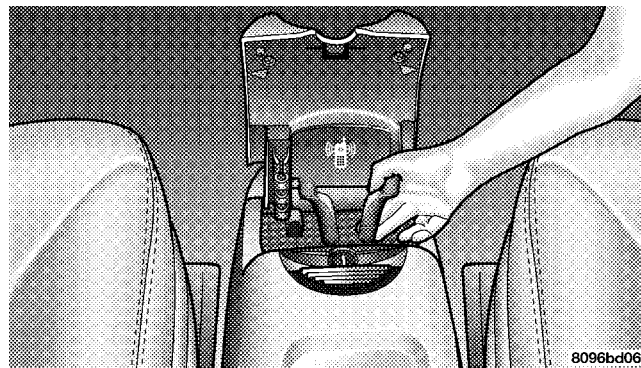

2. Plug in the power cord for the cellular phone into the outlet located in the bottom of the forward console bin and reinstall the cell phone holder

3. Place the cell phone into the holder.

CAUTION!

- Many accessories that can be plugged in draw power from the vehicle's battery, even when not in use (i.e. cellular phones, etc.). Eventually, if plugged in long enough, the vehicle's battery will discharge sufficiently to degrade battery life and/or prevent engine starting.
- Accessories that draw higher power (i.e. coolers, vacuum cleaners, lights, etc.), will degrade the battery even more quickly. Only use these intermittently and with greater caution.
- After the use of high power draw accessories, or long periods of the vehicle not being started (with accessories still plugged in), the vehicle must be driven a sufficient length of time to allow the generator to recharge the vehicle's battery.

Rear Compartment Storage Bins

Your vehicle may be equipped with open storage bins located in each rear trim panel or your vehicle may be equipped with storage bins located under the armrest in each rear trim panel.

Cargo Area Storage

The seats in your vehicle are in-line which enables you to stow long objects, such as lumber or skis, on the floor without moving the seats.

NOTE: With all rear seat backs folded, a 4x8 foot sheet of building material may be stored in the long-wheelbase body style on top of the folded seats with the liftgate closed. The front seats must be moved slightly forward of the rearmost position. If the rear seats are removed no front seat adjustment is needed and more than one 4x8 sheet of building material may be stored.

The liftgate sill plate has a raised line with the statement "Load To This Line". This line indicates how far rearward cargo can be placed without interfering with liftgate closing.

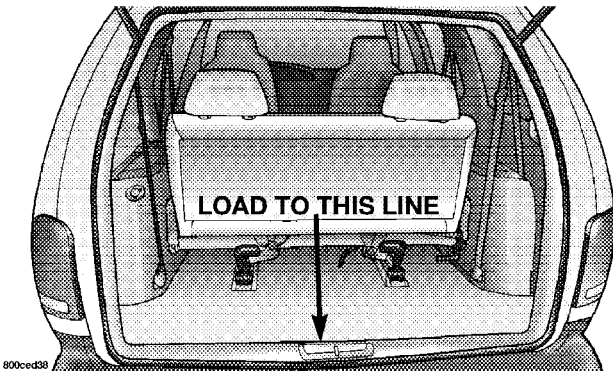

Cargo Organizer — If Equipped

Long wheel base vehicle with rear air conditioning may be equipped with a cargo organizer that mounts on the floor behind the rear seat. Items may be placed on the flat surface or stored in the three storage compartments.

WARNING!

- To avoid tipping, lock the shelf securely in all positions.
- Do not drive this vehicle with the liftgate open, or use the shelf as a seat.
- Failure to follow these warnings could result in serious or fatal injury.

1. To raise the cargo organizer pull up on the handle and pull towards the rear of the vehicle.

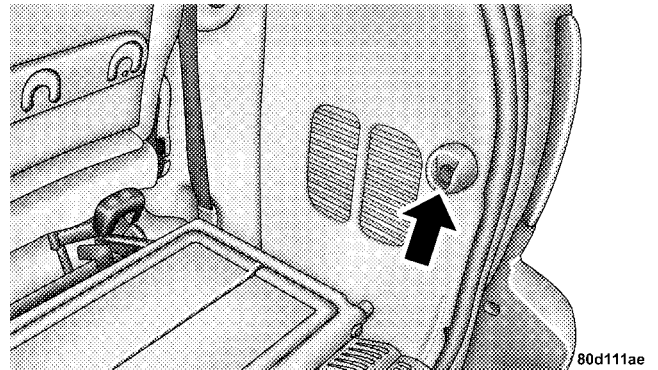
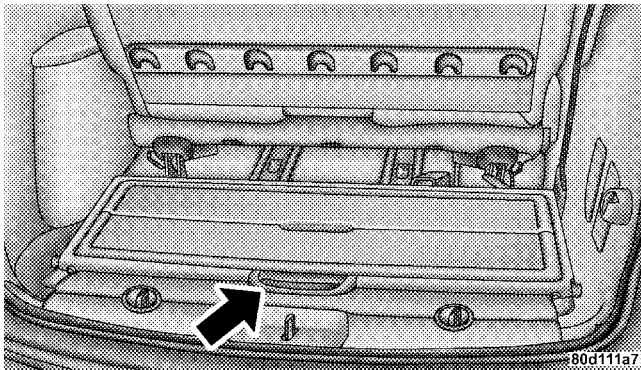

3

2. Place the rear corners of the cargo organizer into the supports located on the rear trim panel. Press down on the back of the cargo organizer to lock it into place.

WARNING!

Do not load objects over 20 lbs (9 kg) in the upper position. Failure to follow this warning could cause the cargo organizer to collapse resulting in personal injury.

CAUTION!

Do not load objects over 100 lbs (45 kg) in the lower position. Failure to follow this could cause damage to the cargo organizer.

To Open Storage Compartments

1. Pull up on the center opening of the cargo organizer.

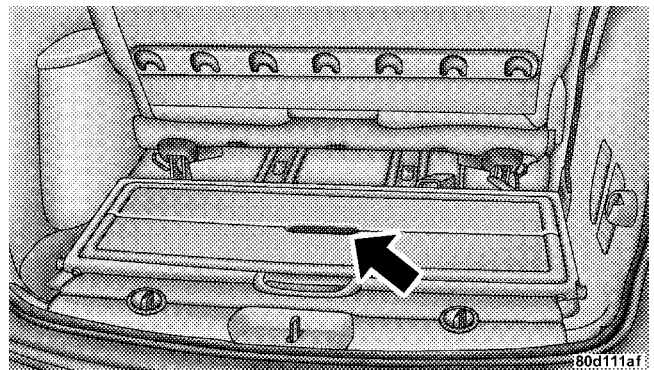

2. Lift up on the storage compartment dividers and lock into place.

Cargo Organizer removal

Unscrew the two plastic fasteners located on the floor of the rear of the cargo area and remove the cargo organizer from the vehicle.

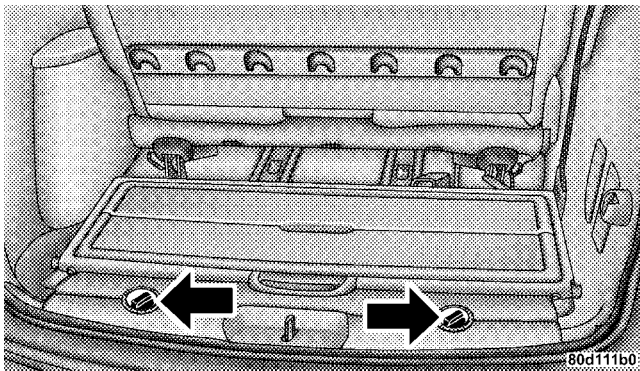

NOTE: The cargo organizer must be removed to take out the third row seat.

ROOF LUGGAGE RACK — IF EQUIPPED

The crossbars and siderails are designed to carry the weight on vehicles equipped with a luggage rack. The load must not exceed 150 lbs (68 kg), and should be uniformly distributed over the luggage rack crossbars.

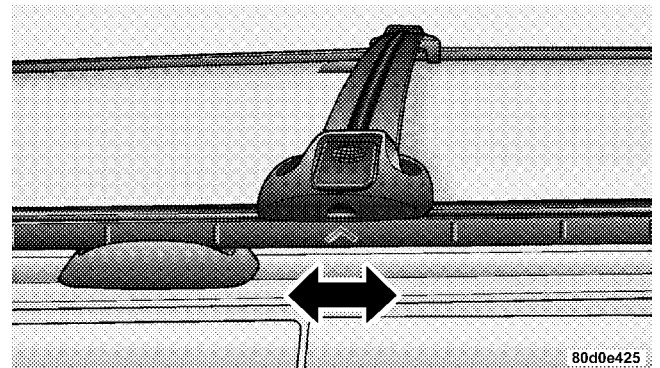

Distribute cargo weight evenly on the roof rack crossbars. The roof rack does not increase the total load carrying

capacity of the vehicle. Be sure the total load of cargo inside the vehicle plus that on the external rack does not exceed the maximum vehicle load capacity.

To move the cross bars, press the upper edge of each cross bar button past the detent, then move the cross bar to the desired position. Once the cross bar is in place, press the lower edge of the cross bar button to lock it into position.

Attempt to move the crossbar again to ensure that it has properly locked into position.

NOTE: To help control wind noise when installing the cross bars make sure that the arrows marked on the front side of the cross bars are facing the front of the vehicle. Also, when the cross bars are not in use the notch on the cross bars should be aligned with the arrows on the side rails. This will help reduce the amount of wind noise when the crossbars are not in use.

The tie down holes on the cross bar ends should always be used to tie down the load. Check the straps frequently to be sure that the load remains securely attached.

CAUTION!

- To avoid damage to the roof rack and vehicle, do not exceed the maximum roof rack load capacity of 150 lbs (68 kg). Always distribute heavy loads as evenly as possible and secure the load appropriately.
- Long loads which extend over the windshield, such as wood panels or surfboards, or loads with large frontal area should be secured to both the front and rear of the vehicle.
- Travel at reduced speeds and turn corners carefully when carrying large or heavy loads on the roof rack. Wind forces, due to natural causes or nearby truck traffic, can add sudden upward loads. This is especially true on large flat loads and may result in damage to the cargo or your vehicle.

WARNING!

Cargo must be securely tied before driving your vehicle. Improperly secured loads can fly off the vehicle, particularly at high speeds, resulting in personal injury or property damage. Follow the Roof Rack Cautions when carrying cargo on your roof rack.

3**LOAD LEVELING SYSTEM**

The automatic load leveling system will provide a level riding vehicle under most passenger and cargo loading conditions.

A hydraulic pump contained within the shock absorbers raises the rear of the vehicle to the correct height. It takes approximately 1 mile (1.6 km) of driving for the leveling to complete depending on road surface conditions.

If the leveled vehicle is not moved for approximately 15 hours, the leveling system will bleed itself down. The vehicle must be driven to reset the system.

WARNING!

Do not install the load leveling system on vehicles that are not equipped with Anti-Lock Brakes. Vehicles without Anti-Lock Brakes (ABS) have a height-sensing proportioning valve. Installing a leveling system will render this system ineffective, inappropriately reducing rear brake pressure, resulting in increased stopping distances. You could have an accident.

UNDERSTANDING YOUR INSTRUMENT PANEL

CONTENTS

■ Instruments And Controls	148	■ Radio General Information	160
■ Base Instrument Cluster	149	□ Radio Broadcast Signals	160
■ Instrument Cluster With Tach	150	□ Two Types Of Signals	160
■ Instrument Cluster Descriptions	151	□ Electrical Disturbances	160
■ Information Center — If Equipped	159	□ AM Reception	161
□ Turn Signal Indicators	159	□ FM Reception	161
□ High Beam Light	159	■ Sales Code RAZ—AM/ FM Stereo Radio With Cassette Tape Player, CD Player And CD Changer Controls — If Equipped	161
■ Electronic Digital Clock	159	□ Operating Instructions — Radio	161
□ Clock Setting Procedure	160		

144 UNDERSTANDING YOUR INSTRUMENT PANEL

□ Power Switch, Volume Control	162	□ Fast Forward (FF)	166
□ Seek Button (Radio Mode)	162	□ Rewind (RW)	166
□ Tuning	162	□ Tape Eject	166
□ PTY (Program Type) Button	162	□ Scan Button	166
□ Balance	164	□ Changing Tape Direction	166
□ Fade	164	□ Metal Tape Selection	166
□ Tone Control	164	□ Pinch Roller Release	167
□ AM/FM Selection	164	□ Noise Reduction	167
□ Scan Button	164	□ Operating Instructions — CD Player	167
□ To Set The Radio Push-Button Memory	165	□ Inserting The Compact Disc	167
□ To Change From Clock To Radio Mode	165	□ Seek Button	168
□ Operating Instructions — Tape Player	165	□ EJT CD (Eject) Button	168
□ Seek Button	165	□ FF/Tune/RW	169

□ Program Button 4 (Random Play)	169	□ CD Player Operation	180
□ Mode	169	□ CD Changer Control Capability — If Equipped	182
□ Tape CD Button	169	□ Radio Display Messages	184
□ Time Button	170	■ 6 Disc CD Changer — If Equipped	184
□ Scan Button	170	□ Loading The CD Changer	185
□ CD Changer Control Capability — If Equipped	170	□ Playing Discs	185
■ Sales Code RBQ—AM/FM Stereo Radio With 6 - Disc CD Changer	171	□ Seek Button	185
□ Radio Operation	171	□ FF/Tune/RW	185
□ CD Player Operation	174	□ Mode Button	186
■ Sales Code RBK—AM/ FM Stereo Radio With CD Player And CD Changer Controls	178	□ Program Button 1	186
□ Radio Operation	178	□ Program Button 4 (Random Play)	186
		□ Program Button 5	186

- Time Button186
- Changing Modes186
- Removing Discs From The CD Changer187
- CD Changer Operation With The Changer Off187
- 6 Disc CD/Digital Video Disc (DVD) Changer — If Equipped187
 - Operating Instructions — CD/DVD Changer . . .188
 - Eject (EJT) Button189
 - Operating Instructions — Remote Control189
 - Operating Instructions — Video Screen191
 - Operating Instructions — Headphones192
 - Operating Instructions — MP3 Player194
 - Operating Instructions — Video Games/Camcorders195
- Remote Sound System Controls — If Equipped . . .195
 - Radio Operation196
 - Tape Player196
 - CD Player197
- Cassette Tape And Player Maintenance197
- CD/DVD Disc Maintenance198
- Radio Operation And Cellular Phones198
- Climate Controls199
 - Manual Air Conditioning And Heating System199
 - Front Mode Control200

<ul style="list-style-type: none"> □ Manual Air Conditioning Operation203 □ Manual Rear Zone Climate Control — If Equipped206 □ Infrared Three-Zone Automatic Temperature Control — If Equipped208 ■ Rear Window Features219 <ul style="list-style-type: none"> □ Intermittent Rear Wiper Operation — Manual Temperature Control Only219 □ Rear Washer Operation — Manual Temperature Control Only219 	<ul style="list-style-type: none"> □ Rear Wiper Operation — Automatic Temperature Control Only220 □ Intermittent Rear Wiper Operation — Automatic Temperature Control Only220 □ Rear Washer Operation — Automatic Temperature Control Only221 □ Electric Rear Window Defroster — If Equipped222
--	---

INSTRUMENTS AND CONTROLS

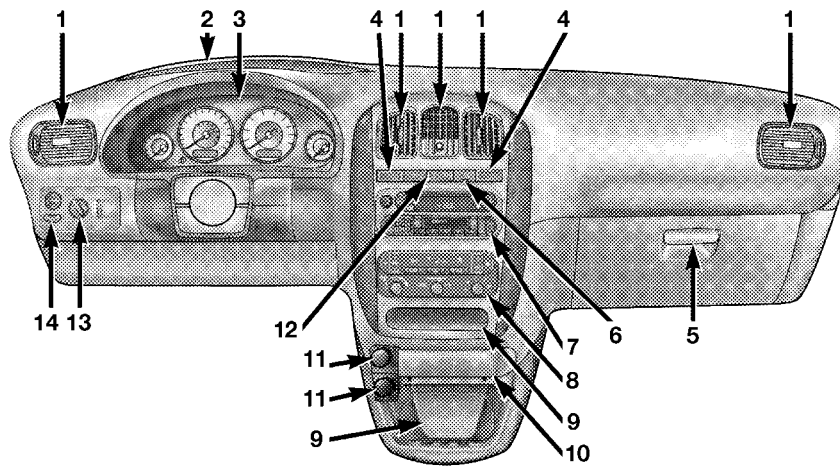

- 1. Air Outlets
- 2. Information Center*
- 3. Instrument Cluster
- 4. Heated Seat Switches*
- 5. Glove Box

- 6. Hazard Switch
- 7. Radio
- 8. Climate Controls
- 9. Storage Bins*
- 10. Convenience Tray/Cupholder

- 11. Power Outlets
- 12. Rear Window Features
- 13. Light Controls
- 14. Power Mirror Control
*If Equipped

BASE INSTRUMENT CLUSTER

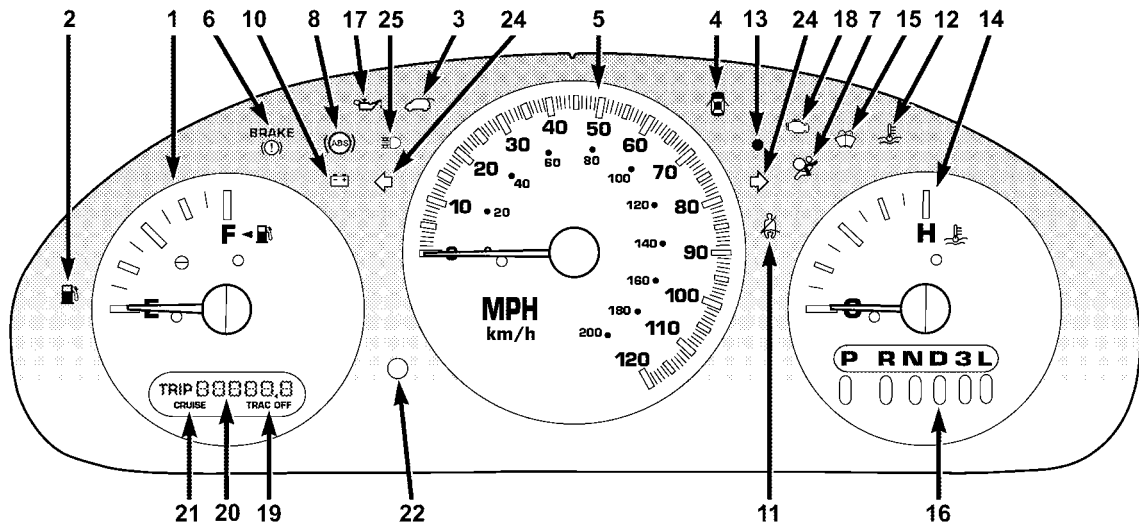

INSTRUMENT CLUSTER WITH TACH

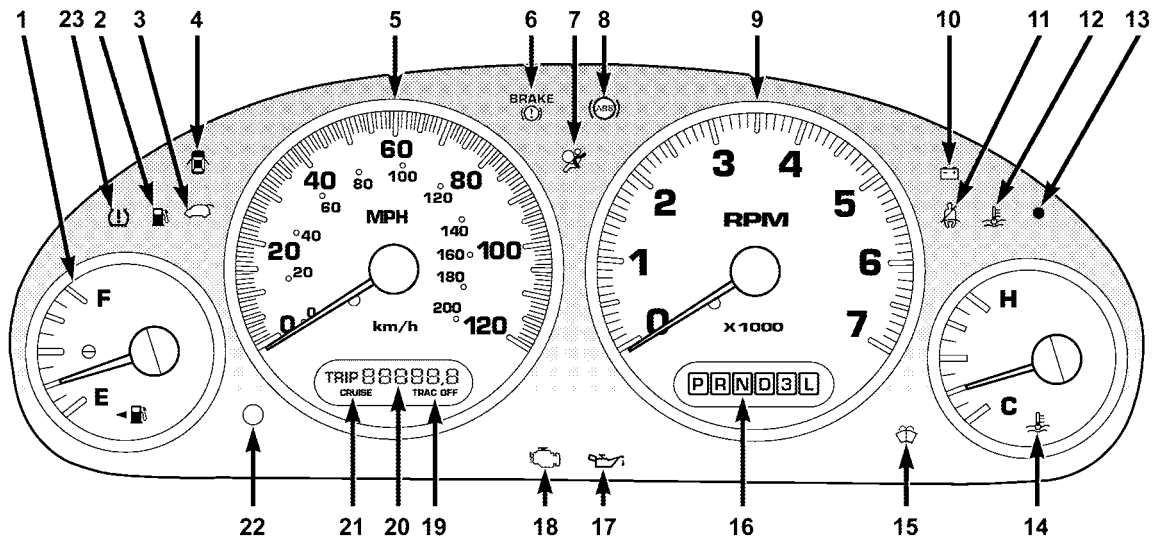

INSTRUMENT CLUSTER DESCRIPTIONS

1. Fuel Gauge

The pointer shows the level of fuel in the fuel tank when the ignition switch is in the ON position.

2. Low Fuel Light



When the fuel level reaches approximately 3.0 gallons (11.0 liters) this light will turn on and remain on until fuel is added.

3. Liftgate Ajar



This light turns on if the liftgate is not completely closed.

4. Door Ajar Light



This light turns on if a door is not completely closed.

5. Speedometer

Indicates vehicle speed.

6. Brake System Warning Light

BRAKE



This light monitors various brake functions, including brake fluid level and parking brake application. If the brake light turns on, it may indicate that the parking brake is applied, there is a low brake fluid level or there is a problem with the anti-lock brake system.

The dual brake system provides a reserve braking capacity in the event of a failure to a portion of the hydraulic system. Failure of either half of the dual brake system is indicated by the Brake Warning Light which will turn on when the brake fluid level in the master cylinder has dropped below a specified level.

The light will remain on until the cause is corrected.

NOTE: The light may flash momentarily during sharp cornering maneuvers which change fluid level conditions. The vehicle should have service performed.

If brake failure is indicated, immediate repair is necessary.

WARNING!

Driving a vehicle with the brake light on is dangerous. Part of the brake system may have failed. It will take longer to stop the vehicle. You could have an accident. Have the vehicle checked immediately.

Vehicles equipped with Anti-Lock brakes (ABS), are also equipped with Electronic Brake Force Distribution (EBD). In the event of an EBD failure, the Brake Warning Light will turn on along with the ABS Light. Immediate repair to the ABS system is required.

The operation of the Brake Warning Light can be checked by turning the ignition switch from the OFF position to the ON position. The light should illuminate for approximately four seconds. The light should then turn off unless the parking brake is applied or a brake fault is detected. If the light does not illuminate, have the light inspected by an authorized dealer.

The light also will turn on when the parking brake is applied with the ignition switch in the ON position.

NOTE: This light shows only that the parking brake is applied. It does not show the degree of brake application.

7. Airbag Light



This light turns on and remains on for 6 to 8 seconds as a bulb check when the ignition switch is first turned ON. If the light is not on during starting, stays on, or turns on while driving, have the system inspected by an authorized dealer as soon as possible.

8. Anti-Lock Light

This light monitors the Anti-Lock Brake System. The light will turn on when the ignition switch is turned to the ON position and may stay on for as long as four seconds.

If the ABS light remains on or turns on while driving, it indicates that the Anti-Lock portion of the brake system is not functioning and that service is required. However, the conventional brake system will continue to operate normally if the BRAKE warning light is not on.

If the ABS light is on, the brake system should be serviced as soon as possible to restore the benefits of Anti-Lock brakes. If the ABS light does not turn on when the Ignition switch is turned to the ON position, have the light inspected by an authorized dealer.

9. Tachometer — If Equipped

The red segments indicate the maximum permissible engine revolutions-per-minute (r.p.m. x 1000) for each gear range. Before reaching the red area, ease up on the accelerator.

10. Voltage Light

This light monitors the electrical system voltage. The light should turn on momentarily as the engine is started. If the light stays on or turns on while driving, it indicates a problem with the charging system. Immediate service should be obtained.

4

11. Seat Belt Reminder Light

The light will turn on when the ignition switch is turned to the ON position as a reminder to “buckle up”. The light will remain on until the driver’s seat belt is buckled.

12. Engine Temperature Warning Light

This light warns of an overheated engine condition. If the engine is critically hot, a continuous chime will sound for 4 minutes. After the chime turns off, the engine will still be critically hot until the light turns off.

13. Vehicle Theft Alarm Light — If Equipped

This light will flash for approximately 15 seconds when the vehicle theft alarm is arming.

14. Temperature Gauge

The temperature gauge shows engine coolant temperature. Any reading within the normal range indicates that the engine cooling system is operating satisfactorily.

The gauge pointer will likely indicate a higher temperature when driving in hot weather, up mountain grades, or when towing a trailer. It should not be allowed to exceed the upper limits of the normal operating range.

CAUTION!

Driving with a hot engine cooling system could damage your vehicle. If temperature gauge reads (H), pull over and stop the vehicle. Idle the vehicle with the air conditioner turned off until the pointer drops back into the normal range. If the pointer remains on the "H", and you hear continuous chimes, turn the engine off immediately, and call for service.

WARNING!

A hot engine cooling system is dangerous. You or others could be badly burned by steam or boiling coolant. You may want to call a service center if your vehicle overheats. If you decide to look under the hood yourself, see Section 7 of this manual. Follow the warnings under the Cooling System Pressure Cap paragraph.

15. Washer Fluid Light

This light turns on when the washer fluid level falls below approximately 1/4 filled. The light will remain on until fluid is added.

16. Transmission Range Indicator

This vacuum fluorescent display indicator shows the automatic transaxle gear selection.

17. Oil Pressure Warning Light

This light shows low engine oil pressure. The light should turn on momentarily when the engine is started. If the light turns on while driving, stop the vehicle and shut off the engine as soon as possible. A chime will sound for 4 minutes when this light turns on.

Do not operate the vehicle until the cause is corrected. This light does not show how much oil is in the engine. The engine oil level must be checked under the hood.

18. Malfunction Indicator Light

This light is part of an onboard diagnostic system called OBD that monitors engine and automatic transmission control systems. The light will illuminate when the key is in the ON position before engine start. If the bulb does not come when turning the key from OFF to ON, have the condition checked promptly.

Certain conditions such as a loose or missing gas cap, poor fuel quality, etc. may illuminate the light after

engine start. The vehicle should be serviced if the light stays on through several of your typical driving cycles. In most situations the vehicle will drive normally and will not require towing.

The Malfunction Indicator Light flashes to alert to serious conditions that could lead to immediate loss of power or severe catalytic converter damage. The vehicle should be serviced as soon as possible if this occurs.

19. Trac Off Indicator — If Equipped

This vacuum fluorescent display indicator should illuminate for approximately four seconds as a bulb check when the ignition switch is first turned ON.

The “TRAC OFF” Indicator will flash if the traction control is in use.

The “TRAC OFF” Indicator will illuminate if:

- The Traction Control switch has been used to turn the system OFF.

- There is a Traction Control System malfunction
- The system has been deactivated to prevent damage to the brake system due to overheated brake temperatures.

NOTE: Extended heavy use of Traction Control may cause the system to deactivate and turn on the TRAC and the OFF indicators located in the instrument cluster.

This is to prevent overheating of the brake system and is a normal condition. The system will remain disabled for about 4 minutes until the brakes have cooled. The system will automatically reactivate and turn off the TRAC and the OFF indicators.

If your vehicle becomes stuck in mud, ice, or snow, turn the Traction Control System OFF before attempting to “rock” the vehicle free.

20. Odometer/Trip Odometer

The odometer shows the total distance the vehicle has been driven.

U.S. federal regulations require that upon transfer of vehicle ownership, the seller certify to the purchaser the correct mileage that the vehicle has been driven. Therefore, if the odometer reading is changed during repair or replacement, be sure to keep a record of the reading before and after the service so that the correct mileage can be determined.

The trip odometer shows individual trip mileage. To switch from odometer to trip odometer, press the Trip Odometer button.

21. Cruise Indicator

This vacuum fluorescent display indicator shows that the Speed Control System is ON.

22. Trip Odometer Button

Press this button to change the display from odometer to trip odometer. The word TRIP will appear when in the trip odometer mode.

Push in and hold the button for two seconds to reset the trip odometer to 0 miles or kilometers. The odometer must be in trip mode to reset.

23. Tire Pressure Monitor Warning Light — If Equipped

This light will turn on when there is a Low tire pressure condition. The light will also turn on if a problem exist with any tire sensor. The light will remain on until the tire pressure is properly set or the problem with the sensor is corrected.

This light will turn on momentarily as a bulb check when the engine is started.

When the tire pressure monitoring system warning light is lit, one or more of your tires is significantly underinflated. You should stop and check your tires as soon as possible, and inflate them to the proper pressure as indicated on the tire and loading information placard. Driving on a significantly underinflated tire causes the tire to overheat and can lead to tire failure. Underinflation also reduces fuel efficiency and tire tread life, and may affect the vehicle's handling and stopping ability. Each tire, including the spare, should be checked monthly when cold and set to the recommended inflation pressure as specified in the tire and loading information placard and owner's manual.

24. Turn Signal Indicators — Base Cluster Only

 The arrow will flash with the exterior turn signal when the turn signal lever is operated.

If the vehicle electronics sense that the vehicle has traveled about one mile with the turn signals on, a chime will sound to alert you to turn the signals off. If either indicator flashes at a rapid rate, check for a defective outside light bulb.

25. High Beam Light — Base Cluster Only

 This light shows that the headlights are on high beam. Pull the turn signal lever towards the steering wheel to switch the headlights from high or low beam.

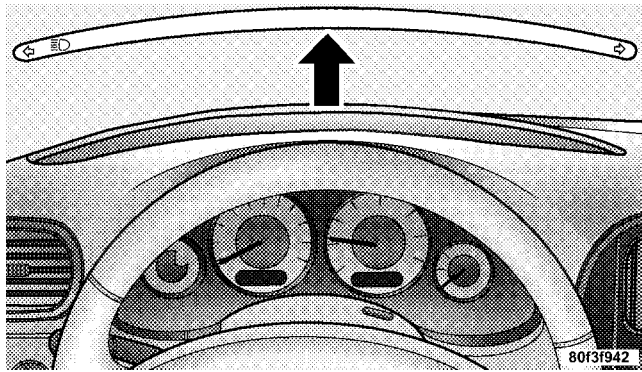
INFORMATION CENTER — IF EQUIPPED**Turn Signal Indicators**

← The arrow will flash with the exterior turn signal when the turn signal lever is operated.

If the vehicle electronics sense that the vehicle has traveled about one mile with the turn signals on, a chime

will sound to alert you to turn the signals off. If either indicator flashes at a rapid rate, check for a defective outside light bulb.

High Beam Light

☰ This light shows that the headlights are on high beam. Pull the turn signal lever towards the steering wheel to switch the headlights from high or low beam.

ELECTRONIC DIGITAL CLOCK

The clock and radio each use the display panel built into the radio. A digital readout shows the time in hours and minutes whenever the ignition switch is in the ON or ACC position and the time button is pressed.

When the ignition switch is in the OFF position, or when the radio frequency is being displayed, time keeping is accurately maintained.

Clock Setting Procedure

1. Turn the ignition switch to the ON or ACC position and press the time button. Using the tip of a ballpoint pen or similar object, press either the hour (H) or minute (M) buttons on the radio.
2. Press the H button to set hours or the M button to set minutes. The time setting will increase each time you press a button.

RADIO GENERAL INFORMATION**Radio Broadcast Signals**

Your new radio will provide excellent reception under most operating conditions. Like any system, however, car radios have performance limitations, due to mobile operation and natural phenomena, which might lead you to believe your sound system is malfunctioning. To help

you understand and save you concern about these “apparent” malfunctions, you must understand a point or two about the transmission and reception of radio signals.

Two Types of Signals

There are two basic types of radio signals... AM or Amplitude Modulation, in which the transmitted sound causes the amplitude, or height, of the radio waves to vary... and FM or Frequency Modulation, in which the frequency of the wave is varied to carry the sound.

Electrical Disturbances

Radio waves may pick up electrical disturbances during transmission. They mainly affect the wave amplitude, and thus remain a part of the AM reception. They interfere very little with the frequency variations that carry the FM signal.

AM Reception

AM sound is based on wave amplitude, so AM reception can be disrupted by such things as lightning, power lines and neon signs.

FM Reception

Because FM transmission is based on frequency variations, interference that consists of amplitude variations can be filtered out, leaving the reception relatively clear, which is the major feature of FM radio.

NOTE: On vehicles so equipped the radio, steering wheel radio controls and 6 disc CD/DVD changer if equipped, will remain active for up to 45 seconds after the ignition switch has been turned off. Opening a vehicle front door will cancel this feature.

SALES CODE RAZ—AM/ FM STEREO RADIO WITH CASSETTE TAPE PLAYER, CD PLAYER AND CD CHANGER CONTROLS — IF EQUIPPED

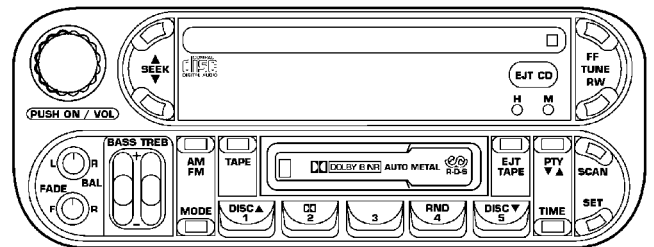

4

Operating Instructions — Radio

NOTE: Power to operate the radio is controlled by the ignition switch. It must be in the ON or ACC position to operate the radio.

Power Switch, Volume Control

Press the ON/VOL control to turn the radio on. Turn the volume control clockwise to increase the volume. The volume will be displayed and continuously updated while the button is pressed.

Seek Button (Radio Mode)

Press and release the Seek button to search for the next station in either the AM or FM mode. Press the top of the button to seek up and the bottom to seek down. Holding the button will by pass stations until you release the button.

Tuning

Press the TUNE control up or down to increase or decrease the frequency. If you press and hold the button, the radio will continue to tune until you release the button. The frequency will be displayed and continuously updated while the button is pressed.

PTY (Program Type) Button

Pressing this button once will turn on the PTY mode for 5 seconds. If no action is taken during the 5 second time out the PTY icon will turn off. Pressing the PTY button within 5 seconds will allow the program format type to be selected. Many radio stations do not currently broadcast PTY information.

Toggle the PTY button to select the following format types:

Program Type	Radio Display
Adult Hits	Adlt Hit
Classical	Classicl
Classic Rock	Cls Rock
College	College
Country	Country
Information	Inform
Jazz	Jazz
Foreign Language	Language

Program Type	Radio Display
News	News
Nostalgia	Nostalgia
Oldies	Oldies
Personality	Persnlty
Public	Public
Rhythm and Blues	R & B
Religious Music	Rel Musc
Religious Talk	Rel Talk
Rock	Rock
Soft	Soft
Soft Rock	Soft Rck
Soft Rhythm and Blues	Soft R&B
Sports	Sports
Talk	Talk
Top 40	Top 40
Weather	Weather

By pressing the SEEK button when the PTY icon is displayed, the radio will be tuned to the next frequency station with the same selected PTY name. The PTY function only operates when in the FM mode.

The radio display will flash “SEEK” and the selected PTY program type when searching for the next PTY station. If no station is found with the selected PTY program type, the radio will return to the last preset station.

If a preset button is activated while in the PTY (Program Type) mode, the PTY mode will be exited and the radio will tune to the preset station.

Pressing PTY, then SCAN will scan the FM Band and stop at all RDS stations. Each RDS station will be played for a 5 second scan once around the FM Band and stop at the last station. The PTY icon will then turn off.

Balance

The Balance control adjusts the left-to-right speaker balance. Push in the button and it will pop out. Adjust the balance and push the button back in. The balance will be displayed and continuously updated while the button is pressed.

Fade

The Fade control provides for balance between the front and rear speakers. Push in the button and it will pop out. Adjust the balance and push the button back in. The fade will be displayed and continuously updated while the button is pressed.

Tone Control

Slide the Bass and/or Treble controls up or down to adjust the sound for the desired tone. The treble, and bass will be displayed and continuously updated while the slide is moved.

AM/FM Selection

Press the AM/FM button to change from AM to FM. The operating mode will be displayed next to the station frequency. The display will show ST when a stereo station is received.

Scan Button

Pressing the SCAN button causes the tuner to search for the next station, in either AM or FM, pausing for 5 seconds at each listenable station before continuing to the next.

Pressing the AM/FM button continues the search in the alternate frequency band.

To stop the search, press SCAN a second time.

To Set The Radio Push-button Memory

When you are receiving a station that you wish to commit to push-button memory, press the SET button. SET 1 will show in the display window. Select the push-button you wish to lock onto this station and press and release that button. If a station is not selected within 5 seconds after pressing the SET button, the station will continue to play but will not be locked into push-button memory.

You may add a second station to each push-button by repeating the above procedure with this exception: Press the SET button twice and SET 2 will show in the display window. Each button can be set for SET 1 and SET 2 in both AM and FM. This allows a total of 10 AM and 10 FM stations to be locked into memory. You can recall the stations stored in SET 2 memory by pressing the push-button twice.

To Change From Clock To Radio Mode

Press the Time button to change the display between radio frequency and time.

Operating Instructions — Tape Player

Insert the cassette with the exposed tape side toward the right and the mechanical action of the player will gently pull the cassette into the play position.

NOTE: When subjected to extremely cold temperatures, the tape mechanism may require a few minutes to warm up for proper operation. Sometimes poor playback may be experienced due to a defective cassette tape. Clean and demagnetize the tape heads at least twice a year.

Seek Button

Press the SEEK button up for the next selection on the tape and down to return to the beginning of the current selection.

Press the SEEK button up or down to move the track number to skip forward or backward 1 to 6 selections. Press the SEEK button once to move 1 selection, twice to move 2 selections, etc.

Fast Forward (FF)

Press the FF button up momentarily to advance the tape in the direction that it is playing. The tape will advance until the button is pressed again or the end of the tape is reached. At the end of the tape, the tape will play in the opposite direction.

Rewind (RW)

Press the RW button momentarily to reverse the tape direction. The tape will reverse until the button is pressed again or until the end of the tape is reached. At the end of the tape, the tape will play in the opposite direction.

Tape Eject

Press the EJT Tape button and the cassette will disengage and eject from the radio.

Scan Button

Press this button to play 10 seconds of each selection. Press the scan button a second time to cancel the feature.

Changing Tape Direction

If you wish to change the direction of tape travel (side being played), press the PTY button. The lighted arrow in the display window will show the new direction.

Metal Tape Selection

If a standard metal tape is inserted into the player, the player will automatically select the correct equalization and the 70 symbol will appear in the display window.

Pinch Roller Release

If ignition power or the radio ON/OFF switch are turned off, the pinch roller will automatically retract to protect the tape from any damage. When power is restored to the tape player, the pinch roller will automatically reengage and the tape will resume play.

Noise Reduction

The Dolby Noise Reduction System* is on whenever the tape player is on, but may be switched off.

To turn off the Dolby Noise reduction System: Press the Dolby button (button 2) after you insert the tape. The NR light in the display will go off when the Dolby System is off. The Dolby System is automatically reactivated each time a tape is inserted.

* "Dolby" noise reduction manufactured under license from Dolby Laboratories Licensing Corporation. Dolby and the double-D symbol are trademarks of Dolby Laboratories Licensing Corporation.

Operating Instructions — CD Player

NOTE: The ignition switch must be in the ON or ACC position and the volume control ON before the CD player will operate.

CAUTION!

This CD player will accept 4 ¾ inch (12 cm) discs only. The use of other sized discs may damage the CD player mechanism.

Inserting The Compact Disc

The CD player contained within the radio is not a multi-disc changer, and will only accept one CD. Gently insert one CD into the CD player with the CD label facing up. The CD will automatically be pulled into the CD Player.

If the volume control is ON, the unit will switch from radio to CD mode and begin to play. The display will show the track number and index time in minutes and seconds. Play will begin at the start of track one.

NOTE:

- You may eject a disc with the radio OFF. The ignition switch must be in the ON or ACC position to insert a disc with the radio OFF.
- If you insert a disc with the ignition ON and the radio OFF, the CD will automatically be pulled into the CD Player and the display will show the time of day. If you insert a disc with the ignition OFF, the display will show the time of day for about 5 seconds, then go out.

Seek Button

Press the top of the SEEK button for the next selection on the CD. Press the bottom of the button to return to the beginning of the current selection, or return to the beginning of the previous selection if the CD is within the first 10 seconds of the current selection.

EJT CD (Eject) Button

Press this button and the disc will unload and move to the entrance for easy removal. The unit will switch to the radio mode.

If you do not remove the disc within 15 seconds, it will be reloaded. The radio mode will continue to appear.

The disc can be ejected with the radio OFF.

FF/TUNE/RW

Press FF (Fast Forward) and the CD player will begin to fast forward until FF is released. The RW (Reverse) button works in a similar manner.

Program Button 4 (Random Play)

Press this button while the CD is playing to activate Random Play. This feature plays the tracks on the selected disc in random order to provide an interesting change of pace.

Press the SEEK button to move to the next randomly selected track.

Press TUNE FF to fast forward through the tracks. Press the FF button a second time to stop the fast forward feature. If TUNE RW is pressed, the current track will reverse to the beginning of the track and begin playing.

Press button 4 a second time to stop Random Play.

MODE

Press the MODE button to select between the tape player, CD player, or satellite radio (if equipped).

To select Satellite Radio (if equipped), press the MODE button until the word SIRIUS appears. The following will be displayed in this order: After three seconds, the current channel name and number will be displayed for five seconds. The current program type and channel number will then be displayed for five seconds. The current channel name and number will then be displayed until an action occurs. A CD or tape may remain in the player while in the Satellite Radio mode.

Tape CD Button

Press this button to select between CD player and Tape player.

Time Button

Press this button to change the display from elapsed CD playing time to time of day.

Scan Button

Press this button to play the first 10 seconds of each track. To stop the scan function, press the button a second time.

CD Changer Control Capability — If Equipped

This radio is compatible with a remote mounted CD changer available through Mopar Accessories. The following instructions are for the radio controls that operate this CD changer.

Mode Button

To activate the CD changer, press the MODE button until CD information appears on the display.

Push-Button

While the CD changer is playing, press the NUMBER 1 push-button or the NUMBER 5 push-button to select a disc numbered higher or lower than the one currently being played.

Seek Button

Press the SEEK up or down to select another track on the same disc. A SEEK symbol will appear on the display.

Fast Forward And Rewind Buttons

Press and hold the FF button for fast forward. Press and hold the RW button for fast reverse.

The audio output can be heard when fast forward and fast reverse are activated.

Random Play (RND)

Press the Random button to play the tracks on the selected disc in random order for an interesting change of pace.

Random can be cancelled by pressing the button a second time or by ejecting the CD from the changer.

CD Diagnostic Indicators

When driving over a very rough road, the CD player may skip momentarily. Skipping will not damage the disc or the player, and play will resume automatically.

As a safeguard and to protect your CD player, one of the following warning symbols may appear on your display.

A CD HOT symbol indicates the player is too hot.

CD HOT will pause the operation. Play can be resumed when the operating temperature is corrected or another MODE is selected.

An ERR symbol will appear on the display if the laser is unable to read the Disc data for the following reasons:

- Excessive vibration
- Disc inserted upside down
- Damaged disc
- Water condensation on optics

SALES CODE RBQ—AM/FM STEREO RADIO WITH 6 - DISC CD CHANGER

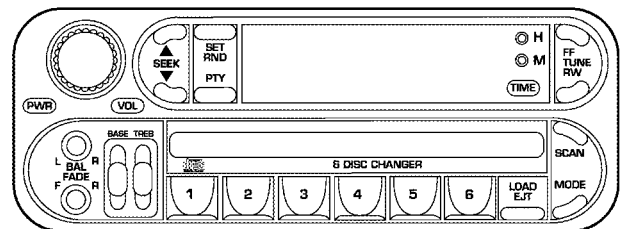

80f1ee0e

Radio Operation

Power/Volume Control

Press the PWR/VOL control to turn the radio on. Turn the volume control clockwise to increase the volume.

NOTE: Power to operate the radio is controlled by the ignition switch. It must be in the ON or ACC position to operate the radio.

Mode

Press the MODE button repeatedly to select between AM, FM, the CD changer and Sirius Satellite Radio™ (if equipped). The display will show ST when a stereo station is received.

To select Sirius Satellite Radio™ (if equipped), press the MODE button until the word SIRIUS appears. The following will be displayed in this order: After three seconds, the current channel name and number will be displayed for five seconds. The current program type and channel number will then be displayed for five seconds. The current channel name and number will then be displayed until an action occurs. CD's may remain in the player while in the Satellite Radio mode.

Seek

Press and release the SEEK button to search for the next station in either the AM or FM mode. Press the top of the button to seek up and the bottom to seek down. The radio will remain tuned to the new station until you make another selection. Holding the button in will bypass stations without stopping until you release it.

Tune

Press the TUNE control up or down to increase or decrease the frequency. If the button is pressed and held, the radio will continue to tune until the button is released. The frequency will be displayed and continuously updated while the button is pressed.

Balance — BAL

The Balance control adjusts the left-to-right speaker balance. Press the BAL button in and it will pop out. Adjust the balance and push the button back in.

Fade

The Fade control provides for balance between the front and rear speakers. Press the FADE button in and it will pop out. Adjust the balance and push the button back in.

Tone Control

The tone controls affect the Bass and Treble frequency bands. Each is controlled by a slider control with a detent at the mid position. Moving a control up or down increases or decreases amplification of the band. The mid position provides a balanced output.

To Set The Radio Push-Button Memory

When you are receiving a station that you wish to commit to push-button memory, press the SET RND button. SET 1 will show in the display window. Select the “1-6” button you wish to lock onto this station and press and release that button. If a button is not selected within

5 seconds after pressing the SET RND button, the station will continue to play but will not be locked into push-button memory.

You may add a second station to each push-button by repeating the above procedure with this exception: Press the SET button twice and SET 2 will show in the display window. Each button can be set for SET 1 and SET 2 in both AM and FM. This allows a total of 12 AM and 12 FM stations to be locked into push-button memory. The stations stored in SET 2 memory can be selected by pressing the corresponding push-button twice. Every time a preset button is used, a corresponding button number will be displayed.

Time Button

Press the TIME button to change the display between radio frequency and time.

General Information

This radio complies with Part 15 of FCC rules and with RSS-210 of Industry Canada. Operation is subject to the following conditions:

1. This device may not cause harmful interference,
2. This device must accept any interference received, including interference that may cause undesired operation.

NOTE: Changes or modifications not expressly approved by the party responsible for compliance could void the user's authority to operate the equipment.

CD Player Operation

NOTE: The ignition switch must be in the ON or ACC position and the Power / Volume control pushed ON before the CD player will operate.

Inserting The Compact Disc**CAUTION!**

This CD player will accept 4 ¾ inch (12 cm) discs only. The use of other sized discs may damage the CD player mechanism.

You may either insert or eject a disc with the radio OFF.

If you insert a disc with the ignition ON and the radio OFF, the display will show the time of day. If you insert a disc with the ignition OFF, the display will show the time of day for about 5 seconds, then go out.

If you insert a disc with the ignition ON and the radio ON, the unit will switch from radio to CD mode and begin to play when you insert the disc. The display will

show the disc number, the track number, and index time in minutes and seconds. Play will begin at the start of track 1.

LOAD/ EJT — Load

Press the LOAD/ EJT button and the button with the corresponding number where the CD is being loaded. After the radio displays “load” insert the CD into the player.

Radio display will show “loading” when it is being loaded.

LOAD / EJT — Eject

Press the LOAD/ EJT button and the button with the corresponding number where the CD was loaded and the disc will unload and move to the entrance for easy removal.

Radio display will show “ejecting” when it is being ejected.

If you have ejected a disc and have not removed it within 15 seconds, it will be reloaded. If the CD is not removed, the radio will continue to play the non-removed CD. If the CD is removed and there are other CD's in the radio, the radio will play the next CD. If the CD is removed and there are no other CD's in the radio, the radio will return to the last selected AM or FM mode.

The disc can be ejected with the radio and ignition OFF.

Seek

Press the top of the SEEK button for the next selection on the CD. Press the bottom of the button to return to the beginning of the current selection, or return to the beginning of the previous selection if the CD is within the first second of the current selection.

Scan

Press the Scan button to scan through each track on the CD currently playing.

FF/TUNE/RW

Press FF (Fast Forward) and the CD player will begin to fast forward until FF is released. The RW (Reverse) button works in a similar manner.

Random Play — SET / RND

Press the RND button while the CD is playing to activate Random Play. This feature plays the tracks on the disc in random order to provide an interesting change of pace.

Press the SEEK button to move to the next randomly selected track.

Press TUNE FF to fast forward through the tracks. Press the FF button a second time to stop the fast forward feature. If TUNE RW is pressed, the current track will reverse to the beginning of the track and begin playing.

Press the SET / RND button a second time to stop Random Play.

PTY (Program Type) Button

Pressing this button once will turn on the PTY mode for 5 seconds. If no action is taken during the 5 second time out the PTY icon will turn off. Pressing the PTY button within 5 seconds will allow the program format type to be selected. Many radio stations do not currently broadcast PTY information.

Toggle the PTY button to select the following format types:

Program Type	Radio Display
Adult Hits	Adlt Hit
Classical	Classicl
Classic Rock	Cls Rock
College	College
Country	Country
Emergency	ALERT!
Emergency Test	Test
Information	Inform
Jazz	Jazz

Program Type	Radio Display
Foreign Language	Language
News	News
Nostalgia	Nostalga
Oldies	Oldies
Personality	Persnlty
Public	Public
Rhythm and Blues	R & B
Religious Music	Rel Musc
Religious Talk	Rel Talk
Rock	Rock
Soft	Soft
Soft Rock	Soft Rck
Soft Rhythm and Blues	Soft R&B
Sports	Sports
Talk	Talk
Top 40	Top 40
Weather	Weather

By pressing the SEEK button when the PTY icon is displayed, the radio will be tuned to the next frequency station with the same selected PTY name. The PTY function only operates when in the FM mode.

The radio display will flash “SEEK” and the selected PTY program type when searching for the next PTY station. If no station is found with the selected PTY program type, the radio will return to the last station.

If a preset button is activated while in the PTY (Program Type) mode, the PTY mode will be exited and the radio will tune to the preset station.

By pressing the SCAN button when the PTY icon is displayed, the radio will stop at every PTY station on the band and list each corresponding program type in the radio display.

Time

Press the TIME button to change the display from elapsed CD playing time to time of day.

**SALES CODE RBK—AM/ FM STEREO RADIO
WITH CD PLAYER AND CD CHANGER
CONTROLS**

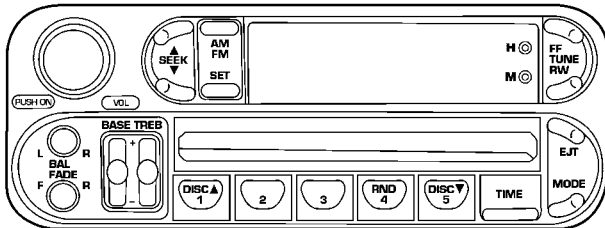

80e571f6

Radio Operation**Power/Volume Control**

Press the ON/VOL control to turn the radio on. Turn the volume control clockwise to increase the volume.

NOTE: Power to operate the radio is supplied through the ignition switch. It must be in the ON or ACC position to operate the radio.

Seek

Press and release the SEEK button to search for the next station in either the AM or FM mode. Press the top of the button to seek up and the bottom to seek down. The radio will remain tuned to the new station until you make another selection. Holding the button in will bypass stations without stopping until you release it.

Tune

Press the TUNE control up or down to increase or decrease the frequency. If you press and hold the button,

the radio will continue to tune until you release the button. The frequency will be displayed and continuously updated while the button is pressed.

Balance

The Balance control adjusts the left-to-right speaker balance. Press the BAL button in and it will pop out. Adjust the balance and push the button back in.

Fade

The Fade control provides for balance between the front and rear speakers. Press the FADE button in and it will pop out. Adjust the balance and push the button back in.

Bass and Treble Tone Control

The tone controls consist of 2 separate bands. The bass band is on the left, and the treble band is on the right. Each band is adjusted by a slider control with a detent at the mid-position. Moving the control up or down increases or decreases amplification of that band. The mid position provides a balanced output.

AM/FM Selection

Press the AM/FM button to change from AM to FM. The operating mode will be displayed next to the station frequency. The display will show ST when a stereo station is received.

To Set The Radio Push-Button Memory

When you are receiving a station that you wish to commit to push-button memory, press the SET button. SET 1 will show in the display window. Select the "1-5" button you wish to lock onto this station and press and release that button. If a button is not selected within 5 seconds after pressing the SET button, the station will continue to play but will not be locked into push-button memory.

You may add a second station to each push-button by repeating the above procedure with this exception: Press the SET button twice and SET 2 will show in the display window. Each button can be set for SET 1 and SET 2 in

both AM and FM. This allows a total of 10 AM and 10 FM stations to be locked into push-button memory. The stations stored in SET 2 memory can be selected by pressing the push-button twice. Every time a preset button is used a corresponding button number will be displayed.

Time

Press the TIME button to change the display between radio frequency and time.

General Information

This radio complies with Part 15 of FCC rules and with RSS-210 of Industry Canada. Operation is subject to the following conditions:

1. This device may not cause harmful interference,
2. This device must accept any interference received, including interference that may cause undesired operation.

NOTE: Changes or modifications not expressly approved by the party responsible for compliance could void the user's authority to operate the equipment.

CD Player Operation

NOTE: The ignition switch must be in the ON or ACC position and the volume control ON before the CD player will operate.

Inserting The Compact Disc**CAUTION!**

This CD player will accept 4 ¾ inch (12 cm) discs only. The use of other sized discs may damage the CD player mechanism.

You may either insert or eject a disc with the radio OFF.

If you insert a disc with the ignition ON and the radio OFF, the display will show the time of day.

If the power is ON, the unit will switch from radio to CD mode and begin to play when you insert the disc. The display will show the track number and index time in minutes and seconds. Play will begin at the start of track one.

Seek

Press the top of the SEEK button for the next selection on the CD. Press the bottom of the button to return to the beginning of the current selection, or return to the beginning of the previous selection if the CD is within the first second of the current selection.

EJT — Eject

Press the EJT button and the disc will unload and move to the entrance for easy removal. The unit will switch to the radio mode.

If you do not remove the disc within 15 seconds, it will be reloaded. The unit will continue in radio mode.

The disc can be ejected with the radio and ignition OFF.

FF/TUNE/RW

Press FF (Fast Forward) and the CD player will begin to fast forward until FF is released. The RW (Reverse) button works in a similar manner.

Random Play — RND/Program Button 4

Press the RND (button 4) button while the CD is playing to activate Random Play. This feature plays the tracks on the selected disc in random order to provide an interesting change of pace.

Press the SEEK button to move to the next randomly selected track.

Press the RND (button 4) button a second time to stop Random Play.

Mode

Press the MODE button repeatedly to select between the CD player, the optional remote CD changer and the Satellite Radio (if equipped). When Satellite Radio (if equipped) is selected “SA” will appear in your radio display.

A CD or tape may remain in the player while in the Satellite mode.

Time

Press the TIME button to change the display from elapsed CD playing time to time of day.

CD Changer Control Capability — If Equipped

This radio is compatible with a remote mounted CD changer available through Mopar Accessories. The following instructions are for the radio controls that operate this CD changer.

Mode Button

To activate the CD changer, press the MODE button until CD information appears on the display.

Push-Button

While the CD changer is playing, press the NUMBER 1 push-button or the NUMBER 5 push-button to select a disc numbered higher or lower than the one currently being played.

Seek Button

Press the SEEK up or down to select another track on the same disc. A SEEK symbol will appear on the display.

Fast Forward And Rewind Buttons

Press and hold the FF button for fast forward. Press and hold the RW button for fast reverse.

The audio output can be heard when fast forward and fast reverse are activated.

Random Play (RND)

Press the Random button to play the tracks on the selected disc in random order for an interesting change of pace.

Random can be cancelled by pressing the button a second time or by ejecting the CD from the changer.

CD Diagnostic Indicators

When driving over a very rough road, the CD player may skip momentarily. Skipping will not damage the disc or the player, and play will resume automatically.

As a safeguard and to protect your CD player, one of the following warning symbols may appear on your display.

A CD HOT symbol indicates the player is too hot.

CD HOT will pause the operation. Play can be resumed when the operating temperature is corrected or another MODE is selected.

An ERR symbol will appear on the display if the laser is unable to read the Disc data for the following reasons:

- Excessive vibration
- Disc inserted upside down
- Damaged disc
- Water condensation on optics

Radio Display Messages

Your radio has been designed to display certain messages when a problem is detected with the CD player.

DISPLAY	EXPLANATION	WHAT TO DO
E-01	Deadlock problem	See your dealer for service
E-02	Disc eject problem	See your dealer for service
E-06	Elevator problem	See your dealer for service
E-07	Magazine eject problem	Check that magazine is OK- if not see your dealer for service
	No discs in magazine. Load discs in magazine.	
	Player overheating. Allow to cool down.	

6 DISC CD CHANGER — IF EQUIPPED

The CD changer is located below the radio in the instrument panel. The changer plays only 4 ¾ inch (12 cm) discs. The changer holds up to 6 discs. Each disc is loaded and ejected through a single slot in front of the changer. Each disc has a numbered button with an amber light above it which, when illuminated, indicates that a disc is loaded in that particular chamber.

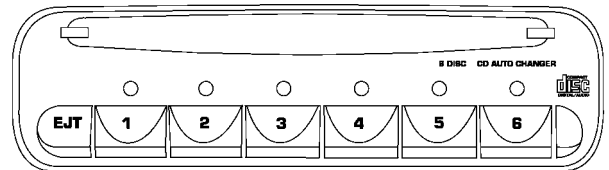

80ef1625

Loading the CD Changer

When inserting the first CD into the changer if the radio is on, wait until the single slot is illuminated on both sides and simply insert the first disc.

To insert additional CDs into the changer, the instructions follow:

1. Select and press any numbered button without an illuminated light above it.
2. Insert the CD while the light above the chosen button is flashing and the two lights on either side of the slot are illuminated.
3. Upon insertion, the CD will begin to play, and both the button light and the lights in the corner of the loading slot will illuminate.
4. Repeat the process for loading any additional CDs. The CD player will stop while additional CDs are loaded.

Playing Discs

The radio will show the CD number, the CD track number, and the Track Time Elapsed while the radio is in the CD mode. If more than one CD is loaded in the changer, the changer will automatically play the next disc after playing the last track of the current disc.

Seek Button

Press the top of this button on the radio once to play the next track. Press the bottom of the button once to return to the beginning of the current track. Press the bottom of the button twice to play the previous track.

FF/TUNE/RW

Press the FF (fast forward) button and the CD player will fast forward through the tracks until the button is released. Press the RW (rewind) button and the CD player will reverse through the tracks until the button is released.

Mode Button

Press this button to toggle between radio and cd modes.

Program Button 1

Press this button to play the next available disc.

Program Button 4 (Random Play)

Press this button while the CD is playing to activate Random Play. This feature plays the selections on the current compact disc in random order to provide an interesting change of pace. The CD changer stays in the random play mode when changing to the next disc.

NOTE: The changer will not random play between discs.

Press the top of the Seek button once to move to the next randomly selected track. Press the bottom of the Seek button to go back to the beginning of the track.

Press button 4 a second time to stop random play.

Program Button 5

Press this button to play the previous disc.

Time Button

Press this button to switch between time of day and CD track time.

Changing Modes

While in the radio mode, if a cassette is loaded, press the Mode button to switch to the tape mode. If a CD is loaded, press the Mode button to select the CD mode. If neither a tape nor CD is loaded, the radio will ignore the command.

- Inserting either a tape or CD automatically starts that mode of play.
- Pressing the AM/FM button while in the tape or CD mode will select the radio mode.
- If in the CD mode and the last CD is ejected, the radio will tune to the last station selected.

Removing Discs from the CD Changer

If there is a single CD in the changer, press the EJT button and the CD will eject. If the CD is not removed within 15 seconds, it will automatically reload into the CD changer. To eject additional CDs from the changer, first select the numbered button where the CD is located and then press the EJT button.

CD Changer Operation with the Changer Off

The CD changer is able to load and eject discs with the ignition power off. However, while the ignition is off, one of the six numbered buttons must be pressed first.

**6 DISC CD/DIGITAL VIDEO DISC (DVD) CHANGER
— IF EQUIPPED**

The Rear Seat Audio/Video System allows passengers to listen to a CD or DVD from the 6 disc CD/DVD changer through the headphones, while the front seat passengers listen to either AM/FM, Cassette or CDs from the radio. A remote control is provided for functions such as changing tracks or DVD functions, as well as selecting discs loaded in the 6 disc CD/DVD changer while listening to the Rear Audio/Video System.

4

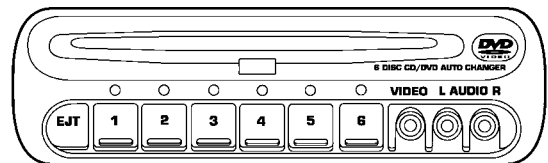

Operating Instructions — CD/DVD Changer

Loading The CD/DVD Changer



The CD/DVD changer is a multi-disc changer, and will accept up to six discs. Gently insert one disc into the CD/DVD changer with the label facing up. The disc will automatically be pulled into the CD/DVD changer.

To insert additional discs into the changer, follow the instructions shown:

1. Select and press any numbered button without an illuminated light above it.
2. Insert the disc while the light above the chosen button is flashing and the light below the loading slot is illuminated.
3. Upon insertion, the disc will begin to play, and both the button light and the light below the loading slot will illuminate.

4. Repeat the process for loading any additional CD/DVDs. The CD/DVD changer will stop while additional CD/DVDs are loaded.

If the volume control is ON, the unit will switch from radio to CD/DVD mode and begin to play. The radio display will show the chapter number and index time in hours and minutes of the DVD, and the track number, minutes and second of the CD. Play will begin automatically in approximately 20 seconds. If the DVD does not play automatically, press the “ENTER” button on the remote control or on the side of the video screen to select play from the menu options.

NOTE:

- You may eject a disc with the radio OFF. The ignition switch must be in the ON or ACC position to insert a disc with the radio OFF.

- If you insert a disc with the ignition ON and the radio OFF, the DVD will automatically be pulled into the DVD changer and the display will show the time of day.

EJECT (EJT) Button

If there is a single disc in the changer, press the EJT button and the disc will eject. The unit will switch to the radio mode. If you do not remove the disc within 10 seconds, it will be reloaded and the display will show PAUSE. The radio mode will continue to operate.

To eject additional discs from the changer, first select the numbered button where the disc is located and then press the EJT button.

The disc can be ejected with the radio OFF.

Operating Instructions — Remote Control**Power Button (PWR)**

Pressing the “POWER” button will turn the rear audio/video system ON/OFF. The headphone symbol will flash for approximately 5 seconds in the radio display and sound can be heard from the headphones.

NOTE:

- The power button on the headphones must be turned ON before sound can be heard from the headphones.
- When the rear audio/video system is ON, sound can only be heard from the front speakers. The rear speakers will turn back on when the rear audio/video system is turned OFF.

MENU Button

This button only functions in the DVD video mode. Press this button once to go to the on-screen menu, press the button a second time to go to the main menu. When the DVD is in stop mode, pressing the menu button for 3 seconds will display the set-up screen.

PAUSE/STOP/ PLAY Button

This button only functions in the DVD video mode. Press this button once to pause the video, press a second time to play the video. Press and hold this button for more than 6 seconds to stop playing the video.

ENTER/ARROW Buttons

These buttons only function in the DVD video mode. Use the "ENTER" button to play the DVD video or to enter selections from the menu screens. Use the arrow buttons to toggle through the menu screen options.

MODE Button

No Function

SEEK Button

- **CD/DVD changer**

Press the right side of the "SEEK" button for the next chapter or track on the disc. Press the left side to return to the beginning of the current chapter or track. Press the left side of the "SEEK" button twice within 2 seconds to return to the previous chapter or track. Each press of the "SEEK" button up or down will toggle through the chapters or tracks.

FF/RW Button

- **CD/DVD changer**

Press and hold "FF" (Fast Forward) once and the CD/DVD changer will begin to fast forward until the FF button is released. The RW (Reverse) button works in a similar manner.

Program Button (PROG)

No Function

Channel Button

Press this button to select between channel “A” or channel “B”, or if interference is heard through the headphones.

Remote Control Battery Service

- To replace the batteries for the remote control slide the cover rearward.

The replacement batteries for the remote control are two AAA batteries.

Operating Instructions — Video Screen

Push up on the release button to lower the video screen.

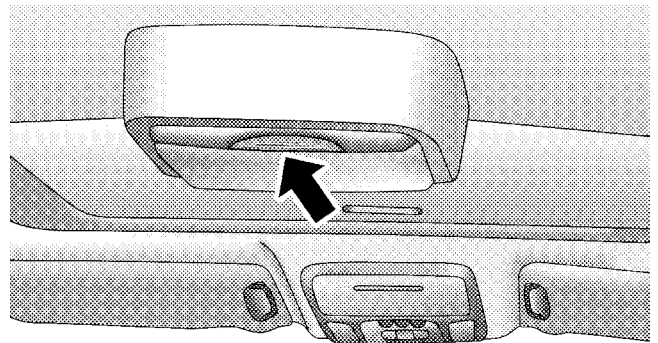

810386a2

1. Screen Width Button

Changes the width of the screen picture.

2. Enter Button

This button will enter the selection from the on-screen menu.

3. Brightness Button

Changes the brightness of the screen picture.

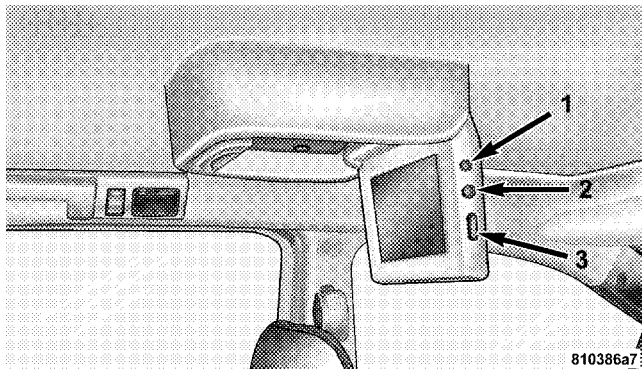

Operating Instructions — Headphones

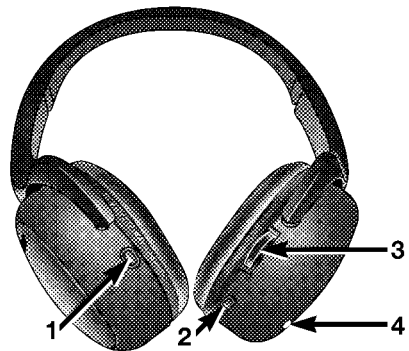

80c7f3e2

1. ON/OFF Button
2. Scan Button
3. Volume Control
4. LED

Power Button

Pressing the power button will turn the headphones ON/OFF.

NOTE:

- The headphones will turn off automatically and the red LED will illuminate for approximately 2 minutes when the radio or rear audio/video system is turned off.
- The rear audio/video system must be turned ON before sound can be heard from the headphones.

Volume Control

Rotate the volume control upward to increase the volume.

Scan Button

Pressing the scan button will automatically find the audio signal that is transmitted from the CD/DVD changer when the rear audio/video system and the headphones are on. This button is used only if the headphones are locked on to a source other than the vehicle's radio.

NOTE: When the "GREEN LED" is showing the headphones are receiving the audio signal. When the "RED LED" is showing the headphones are searching for the audio signal

Headphone Battery Service

- Using a key or similar flat object insert into the slot.

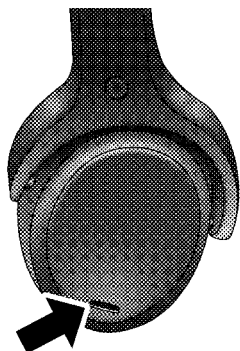

- Pry on the release tab to open the cover.
- Replace the batteries and reinstall the cover.

The replacement batteries for the headphones are three AAA batteries.

General Information

This device complies with part 15 of the FCC rules and RSS 210 of Industry Canada. Operation is subject to the following two conditions: (1) This device may not cause harmful interference and (2) This device must accept any interference received, including interference that may cause undesired operation.

If you experience static or the headphones will not hold a channel, check for these two conditions:

1. A weak battery in the headphones.
2. Closeness to a radio transmitter such as a radio station tower, airport transmitter, and some mobile or CB radios.

Operating Instructions — MP3 Player

An MP3 player can be connected to the audio system. Connect the cables to the RCA jacks located on the front of the CD/DVD changer.

80c7f3ae

NOTE: Follow the manufactures instructions for the correct colors when connecting the RCA cables.

Operating Instructions — Video Games/Camcorders

A video game unit or camcorder can be connected to the rear audio/video system. Connect the cables to the RCA jacks located on the front of the CD/DVD changer.

NOTE: To operate a video game unit a DC to AC adapter may be required, plug the adapter into any power outlet.

Follow the manufactures instructions for the correct colors when connecting the RCA cables.

NOTE: MP3 player's, video game systems, camcorders connected to the RCA jacks and CD's or DVD's inserted into the CD/DVD changer can be heard through the headphones.

REMOTE SOUND SYSTEM CONTROLS — IF EQUIPPED

The remote sound system controls are located on the rear surface of the steering wheel at the 3 and 9 O'clock positions.

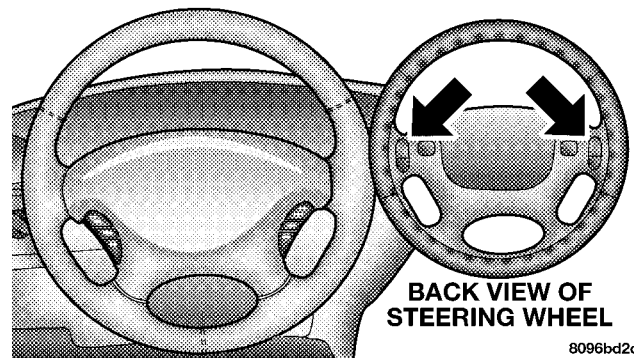

The right hand rocker switch has a push button in the center and controls the volume and mode of the sound

system. Pressing the top of the rocker switch will increase the volume and pressing the bottom of the rocker switch will decrease the volume. Pressing the center button changes the operation of the radio from AM to FM to Tape or CD mode depending on which radio is in the vehicle.

The left hand rocker switch has a push button in the center. The function of the left hand switch is different depending on which mode you are in.

The following describes the left hand rocker switch operation in each mode:

Radio Operation

Pressing the top of the switch will SEEK up for the next listenable station and pressing the bottom of the switch will SEEK down for the next listenable station.

The button located in the center of the left hand switch will tune to the next pre-set station that you have programmed in the radio pre-set push-button.

Tape Player

Pressing the top of the switch once will go to the next selection on the cassette. Pressing the bottom of the switch once will go to the beginning of the current selection or to the beginning of the previous selection if it is within the first 5 seconds of the current selection.

If you press the switch up or down twice it plays the second selection, three times, it will play the third, etc.

The button in the center of the left hand switch has no function in this mode.

CD Player

Pressing the top of the switch once will go to the next track on the CD. Pressing the bottom of the switch once will go to the beginning of the current track or to the beginning of the previous track if it is within one second after the current track begins to play.

If you press the switch up or down twice it plays the second track, three times, it will play the third, etc.

The button in the center of the left hand switch has no function in this mode.

CASSETTE TAPE AND PLAYER MAINTENANCE

To keep the cassette tapes and player in good condition, take the following precautions:

1. Do not use cassette tapes longer than C-90; otherwise, sound quality and tape durability will be greatly diminished.

2. Keep the cassette tape in its case to protect from slackness and dust when it is not in use.

3. Keep the cassette tape away from direct sunlight, heat and magnetic fields such as the radio speakers.

4. Before inserting a tape, make sure that the label is adhering flatly to the cassette.

5. A loose tape should be corrected before use. To rewind a loose tape, insert the eraser end of a pencil into the tape drive gear and twist the pencil in the required directions.

Maintain your cassette tape player. The head and capstan shaft in the cassette player can pick up dirt or tape deposits each time a cassette is played. The result of deposits on the capstan shaft may cause the tape to wrap around and become lodged in the tape transport. The other adverse condition is low or “muddy” sound from one or both channels, as if the treble tone control were

turned all the way down. To prevent this, you should periodically clean the head with a commercially available WET cleaning cassette.

As preventive maintenance, clean the head about every 30 hours of use. If you wait until the head becomes very dirty (noticeably poor sound), it may not be possible to remove all deposits with a simple WET cleaning cassette.

CD/DVD DISC MAINTENANCE

To keep the CD/DVD discs in good condition, take the following precautions:

1. Handle the disc by its edge; avoid touching the surface.
2. If the disc is stained, clean the surface with a soft cloth, wiping from center to edge.
3. Do not apply paper, paper CD labels, or tape to the disc; avoid scratching the disc.

4. Do not use solvents such as benzine, thinner, cleaners, or antistatic sprays.

5. Store the disc in its case after playing.

6. Do not expose the disc to direct sunlight.

7. Do not store the disc where temperatures may become too high.

RADIO OPERATION AND CELLULAR PHONES

Under certain conditions, the cellular phone being On in your vehicle can cause erratic or noisy performance from your radio. This condition may be lessened or eliminated by relocating the cellular phone antenna. This condition is not harmful to the radio. If your radio performance does not satisfactorily “clear” by the repositioning of the antenna, it is recommended that the radio volume be turned down or off during cellular phone operation.

CLIMATE CONTROLS

The Air Conditioning and Heating System is designed to make you comfortable in all types of weather.

Manual Air Conditioning and Heating System

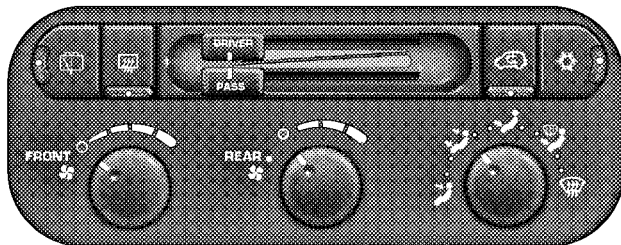

811a44f0

Front Blower Control

 The Front Blower Control selects whether the Climate Control System is ON or OFF. When the blower

control is set to the O (OFF) position the front blower will turn off and the system will be placed in the Recirculation mode. When the blower control is set to any position other than off, it selects the amount of air delivered to the passenger compartment. There are four blower speeds.

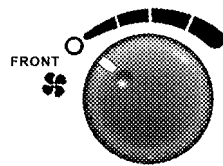

811a44f8

The fan speed increases as you move the control clockwise.

Dual Zone Temperature Control — If Equipped

With the Dual Zone Temperature Control System, each front seat occupant can independently control the temperature of air coming from the outlets on their side of the vehicle.

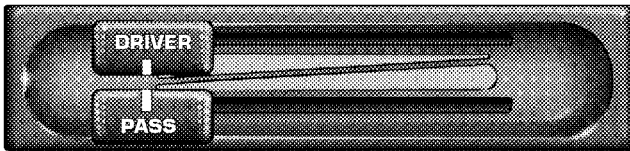

8096321c

This is accomplished by having a separate temperature control lever for both the driver and front seat passenger. The blue area of the scale indicates cooler temperatures while the red area indicates warmer temperatures.

Front Mode Control

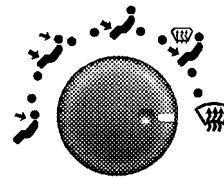

809630dd

The mode control allows you to choose from several patterns of air distribution.

NOTE: To improve your selection choices, the system allows you to operate at intermediate positions between the major modes. These intermediate positions are identified by the small dots.

Panel Mode

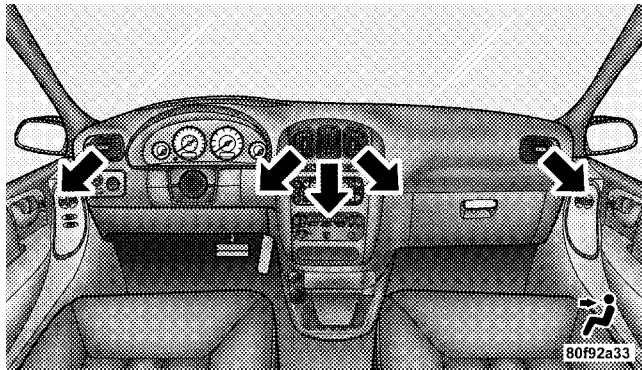

Air comes from the outlets in the instrument panel. Each of these outlets can be individually adjusted to direct the flow of air. Moving the air vane knob on the center outlets down, will close off the air flow from the center

outlets. The thumbwheel next to the outboard outlets can be rotated to regulate or shut off the air flow from these outlets.

Bi-Level Mode

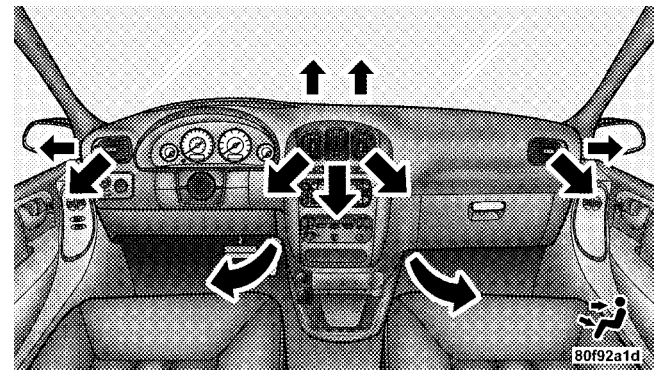

Air comes from both the instrument panel outlets, floor outlets and defrost. A slight amount of air is also directed through the side window demister outlets.

NOTE: In many temperature lever positions, the bi-level mode is designed to provide cooler air out of the panel outlets and warmer air from the floor outlets.

Floor Mode

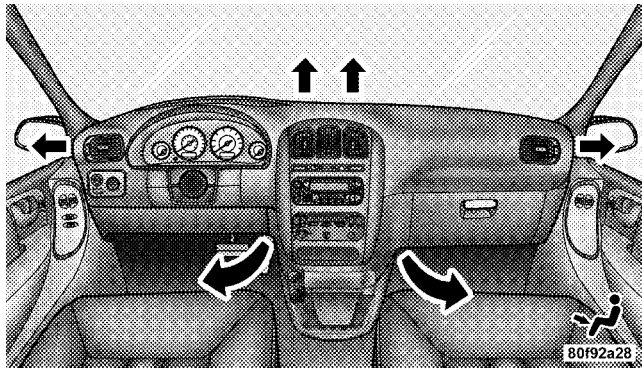

Air comes from the floor outlets. A slight amount of air is directed through the defrost and side window demister outlets.

Mix Mode

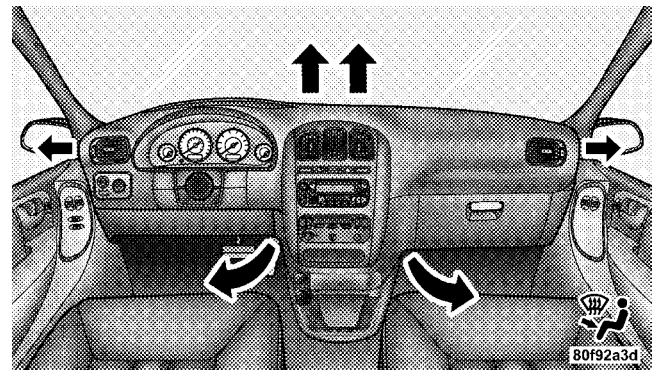

Air comes from the floor, defrost and side window demister outlets. This mode works best in cold or snowy conditions. It allows you to stay comfortable while keeping the windshield clear.

Defrost Mode

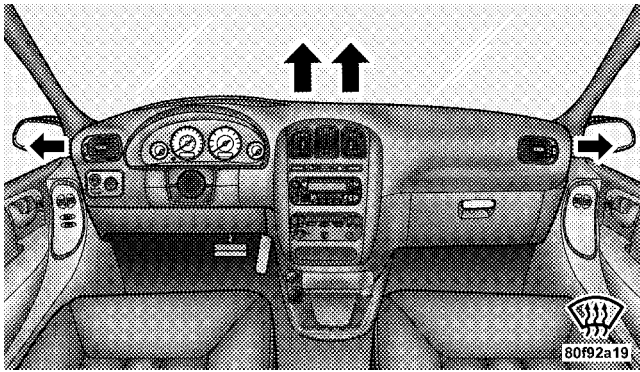

Air comes from the windshield and side window demist outlets. Use this setting when necessary to defrost your windshield and side windows.

NOTE: For improved safety, the compressor is activated and the recirculation mode is deactivated when Mix or

Defrost modes are selected. This is done to assist in drying the air and it will help in keeping the windows from fogging.

Manual Air Conditioning Operation

 To turn on the air conditioning, set the front blower control to any position except O (OFF) and press the A/C button which is located next to the recirculation button. An indicator light on the A/C button shows that the air conditioning is on.

Cool dehumidified air comes through the outlets selected by the Mode Control. To turn off the air conditioning, press the A/C button a second time. The indicator light will turn off.

NOTE:

- The compressor will not engage until the engine has been running for a few seconds.

- If your air conditioning performance seems lower than expected, check the A/C air filter and the front of the A/C condenser for an accumulation of dirt or insects. The A/C condenser is located in front of the radiator. The A/C air filter is located under the instrument panel on the passenger side.
- Fabric type fascia protectors tend to block the amount of air to the condenser and may reduce air conditioning performance.

Economy Mode

If economy mode is desired, press the A/C button to turn off the indicator light, and the A/C compressor. Move the temperature control lever to the desired temperature.

Recirculation Control



Press the recirculation button to recirculate the air inside the vehicle. This is located next to the A/C button. An indicator light on the button shows that air is being recirculated. Use the

recirculation mode to rapidly cool the inside of the vehicle. The recirculation mode can also be used to temporarily block out outside odors, smoke, and dust.

NOTE:

- When the ignition switch is turned OFF, the recirculation feature will be cancelled.
- In cold weather, use of the Recirculation mode may lead to excessive window fogging. The Recirculation mode is not allowed in the Mix and Defrost modes to improve window clearing operation. Recirculation will be disabled automatically if these modes are selected.
- If the recirculation button is pressed while in the Mix or Defrost mode, the indicator light in the recirculation button will flash 3 times indicating that recirculation is not allowed.

A/C Recirculation Programming

The recirculation control is programmed to cancel the recirculation mode when the ignition key is turned OFF and will reset to outside air mode when the ignition key is turned ON. The frequent use of outside air will help keep odors from building up within the air conditioner-heater housing. It is recommended that the recirculation mode be used as little as possible, especially in humid climates.

For hot and dry climates, or people who are allergic to pollen and find frequent use of the recirculation mode necessary, the recirculation mode can be programmed to not automatically reset to the outside mode by using the following procedures:

- Turn the ignition switch to the OFF position.
- Set the mode control to "PANEL".
- Depress and hold in the "Rear Wipe/Wash" button.

- Start the engine, and continue to hold in the "Rear Wipe/Wash" button until the indicator light starts flashing repeatedly.
- Press the recirculation button until the indicator light remains lit.
- The selection will be stored when the ignition switch is turned OFF or if the "Rear Wipe/Wash" button is pressed.

If the recirculation indicator light is lit, the recirculation mode will not reset when the engine is started. If the recirculation indicator light is not lit, the recirculation mode will reset to the outside air mode when the engine is started. The programmed status can be changed back and forth by following the above mentioned procedure.

Manual Rear Zone Climate Control — If Equipped

The Manual Rear Zone Climate Control system has floor air outlets to the rear of the right side sliding door and overhead outlets at each outboard rear seating position. The unit provides warm or cool air through the floor and upper outlets.

The rear blower and temperature controls for the rear seat passengers are located in the headliner near the center of the vehicle.



8094fa17

Rear Blower Control

The primary control for the rear blower is on the front climate control unit located on the instrument panel.

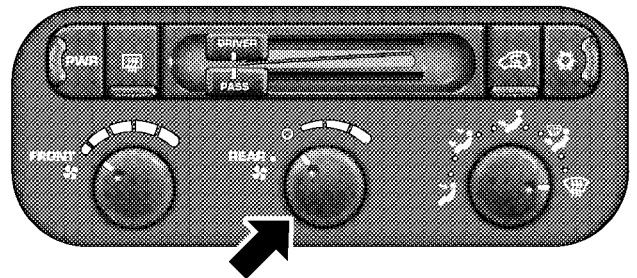

809630cd

The center knob on the front climate control unit has five positions, “REAR”, “OFF”, and a range of blower speeds. Only when the primary control for the rear blower is in the “REAR” position do the second seat occupants have control of the rear blower speed.

The rear blower control, located in the headliner near the center of the vehicle has an OFF position and 3 blower

speed positions. This allows the second seat occupants to control the volume of air circulated in the rear of the vehicle.

CAUTION!

Interior air enters the Manual Rear Zone Climate Control system through an intake grille located in the passenger side trim panel behind the third seat. The heater outlets are located in the passenger side trim panel just behind the sliding door. Do not block or place objects directly in front of the inlet grille or heater outlets. The electrical system could overload causing damage to the blower motor.

Rear Temperature And Mode Control

When the center knob on the front climate control unit is set to the “REAR” position, the second seat occupants also have control of the rear temperature and modes as follows:

- The rear temperature knob controls both the rear temperature and mode. When the temperature knob is in the cold position, cold air will be delivered from the headliner outlets. As the rear temperature knob is turned towards hot, the air will get warmer, and the air will be delivered from both the headliner and floor outlets. When the rear temperature knob reaches the full hot position, all of the air will be delivered from the floor outlets.
- When the center knob on the front climate control unit is set to any position other than “REAR”, the rear

temperature selection follows the setting of the driver's temperature control on the front climate control unit. The rear mode selection follows the setting of the front mode control.

Rear Economy Mode

If rear economy mode is desired, set the center knob on the front control unit to the "REAR" position. Turn the A/C button OFF and select any mode except "MIX" or "DEFROST".

The rear temperature knob and the rear blower speed can be adjusted as desired by the second seat occupants.

Infrared Three-Zone Automatic Temperature Control — If Equipped

The Infrared Three-Zone Automatic Temperature Control System automatically maintains the interior comfort level desired by the driver and all passengers. This is accomplished by using three infrared sensors, two located in the center of the instrument panel and one in the rear

control unit. The three infrared sensors independently measure the surface temperature of the driver and passengers. Based on the sensor input, the system automatically adjusts the air temperature, the air flow volume, and amount of outside air recirculation. This maintains a comfortable temperature even under changing conditions.

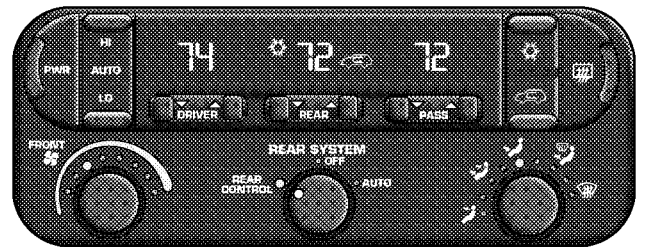

80944b30

Operation of the system is quite simple. Begin by pressing the auto rocker switch to the "HI" or "LO" position, the word "AUTO" will illuminate in the front ATC

display along with “HI” or “LO”. The system will then automatically regulate the amount of air flow. Next, dial in the temperature you would like the system to maintain by pressing the driver’s or passenger’s temperature control button. The rear temperature can only be adjusted from the front when the “REAR SYSTEM” knob on the front ATC unit is in the “AUTO” position. Once the desired temperature is displayed, the system will achieve and maintain that comfort level automatically. When the system is set up for your comfort level, it is not necessary to change the settings. You will experience the greatest efficiency by simply allowing the system to function automatically.

NOTE:

- It is not necessary to move the temperature settings for cold or hot vehicles. The system automatically adjusts the temperature, mode and fan speed to provide comfort as quickly as possible.

- The temperature can be displayed in U.S. or Metric by selecting the US/M customer programmable feature. Refer to the “Overhead Console-Customer Programmable Features” in Section 3 of this manual.

To provide you with maximum comfort in the automatic mode, during cold start-ups the blower fan will remain off and “DELAY” will appear in the front ATC display until the engine warms up. Also, an estimate of the time remaining until the “DELAY” is over will appear periodically in the display. However, the fan will engage immediately if the defrost mode is selected or by rotating the blower control to any fixed blower speed.

This feature may be disabled using the following procedure:

- Press and hold the Heated Rear Window and Auto LO buttons for 5 seconds.

- The “DELAY” symbol will flash to indicate that the feature as been disabled.

This feature may be enabled using the following procedure:

- Press and hold the Heated Rear Window and Auto HI buttons for 5 seconds.
- The “DELAY” symbol will flash to indicate that the feature as been enabled.

Power Button

This button turns the entire system ON/OFF. When the system is turned on it will return to the previous settings.

Manual Operation

This system offers a full complement of manual override features. The “AUTO” symbol in the front ATC display will be turned off when the system is being used in the manual mode.

The left blower control knob can be set to any fixed blower speed by rotating the knob from low to high. This allows the front occupants to control the volume of air circulated in the vehicle and cancel the “AUTO” mode.

The operator can also select the direction of the air by rotating the right mode control knob to one of the following positions.

Panel Mode

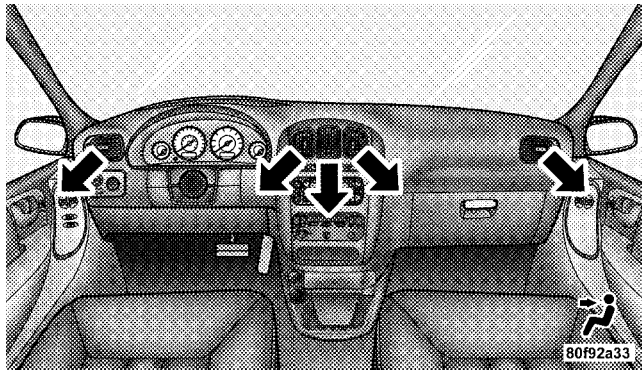

Air comes from the outlets in the instrument panel. Each of these outlets can be individually adjusted to direct the flow of air. Moving the air vane knob on the center outlets down, will close off the air flow from the center

outlets. The thumbwheel next to the outboard outlets can be rotated to regulate or shut off the air flow from these outlets.

Bi-Level Mode

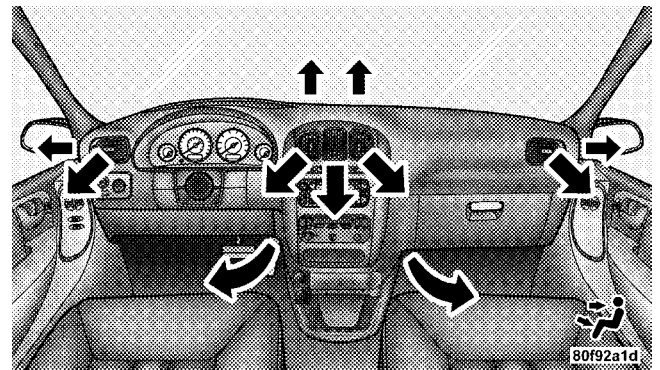

Air comes from both the instrument panel outlets, floor outlets and defrost. A slight amount of air is also directed through the side window demister outlets.

NOTE: In many temperature positions, the bi-level mode is designed to provide cooler air out of the panel outlets and warmer air from the floor outlets.

Floor Mode

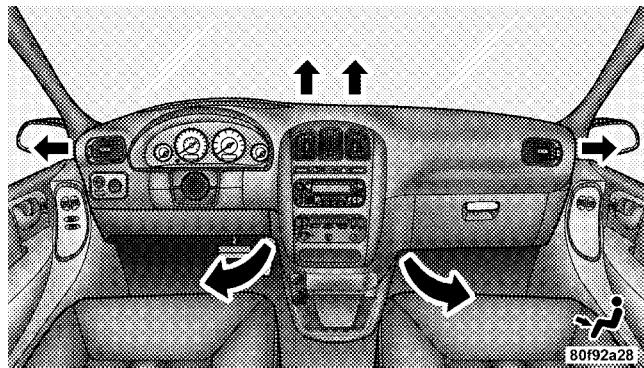

Air comes from the floor outlets. A slight amount of air is directed through the defrost and side window demister outlets.

Mix Mode

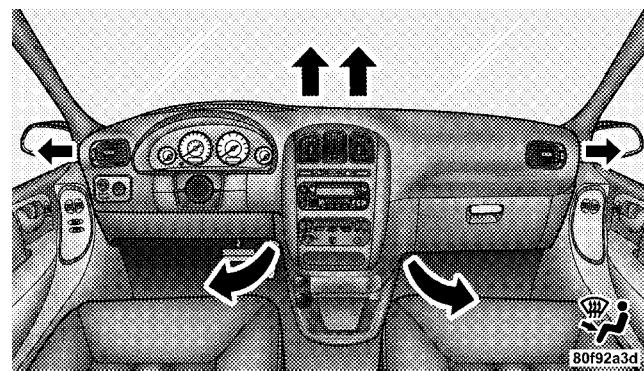

Air comes from the floor, defrost and side window demister outlets. This mode works best in cold or snowy conditions. It allows you to stay comfortable while keeping the windshield clear.

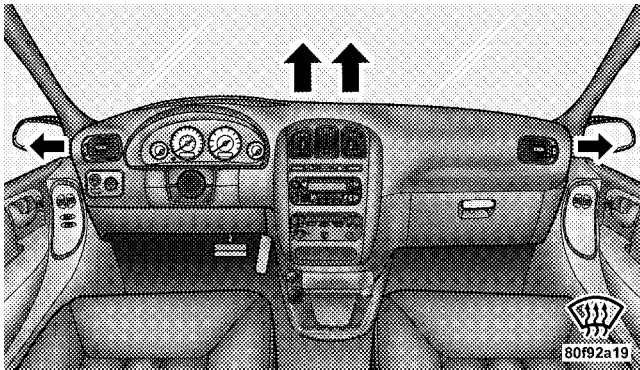
Defrost Mode

Air comes from the windshield and side window demist outlets. Use this setting when necessary to defrost your windshield and side windows.



Depress the “A/C” button to turn on and off the air conditioning during manual operation only. Cool dehumidified air comes through the outlets

selected by the Mode Control. To turn off the air conditioning, press the A/C button a second time. The A/C symbol in the display will turn off.

Recirculation Control

When the outside air contains smoke, odors, high humidity, or if rapid cooling is desired you may wish to recirculate interior air by pressing the recirculation icon button. The recirculation mode should only be used temporarily. The recirculate symbol will illuminate in the display when this button is selected. You may select the recirculation mode separately or with the A/C feature, if rapid cooling is desired. Push in on the buttons a second time to turn the systems off.

NOTE: In cold weather, use of the Recirculation mode may lead to excessive window fogging. The Recirculation mode is not allowed in the Mix and Defrost modes to

improve window clearing operation. Recirculation will be disabled automatically if these modes are selected.

Auxiliary Rear Automatic Temperature Control — If Equipped

The Rear Automatic Temperature Control System has floor air outlets to the rear of the right side sliding door and overhead outlets at each outboard rear seating position. The unit provides heated air through the floor outlets or cool, dehumidified air through the headliner outlets.

The “REAR SYSTEM” knob for the Rear Automatic Temperature Control System is on the front ATC control unit located on the instrument panel.

Selecting the “AUTO” position for the Rear Automatic Temperature Control System from the front ATC control unit, illuminates a “LOCK” symbol in the rear display. The rear temperature and air source are controlled from the front ATC control unit.

The “REAR SYSTEM” knob on the front ATC control unit has three positions, “REAR CONTROL”, “OFF”, and “AUTO”. Only when the “REAR SYSTEM” knob is in the “REAR CONTROL” position do the second seat occupants have control of the Rear Automatic Temperature Control System.

The Rear Automatic Temperature Control System is located in the headliner near the center of the vehicle.

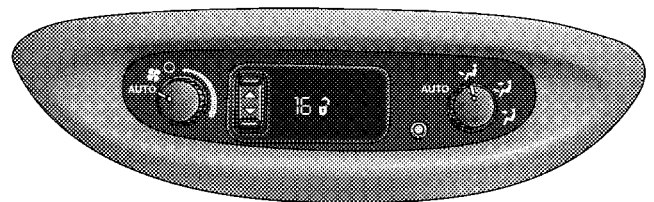

Operation of the rear system is quite simple. Begin by rotating the rear system center control knob on the front ATC control unit to the “REAR CONTROL” position, this illuminates an “UNLOCK” symbol in the rear display. Next, rotate the Rear Blower Control and the Rear Mode Control to the “AUTO” positions. Select the temperature you would like the system to maintain by pressing the Rear Temperature Control button. Once the desired temperature is displayed, the system will achieve and maintain that comfort level automatically. When the system is set up for your comfort level, it is not necessary to change the settings. You will experience the greatest efficiency by simply allowing the system to function automatically.

NOTE:

- It is not necessary to move the temperature settings for cold or hot vehicles. The system automatically adjusts the temperature, mode and fan speed to provide comfort as quickly as possible.

- The temperature can be displayed in U.S. or Metric by selecting the US/M customer programmable feature. Refer to the “Overhead Console-Customer Programmable Features” in Section 3 of this manual.

Rear Blower Control

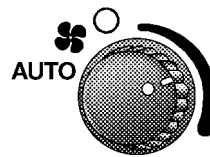

The rear blower control, located in the headliner near the center of the vehicle has an “OFF”, “AUTO” and a range of blower speeds.

The rear blower control knob can be manually set to “OFF” or any fixed blower speed by rotating the knob from low to high. This allows the rear seat occupants to control the volume of air circulated in the rear of the vehicle.

CAUTION!

Interior air enters the Rear Automatic Temperature Control System through an intake grille located in the passenger side trim panel behind the third seat. The heater outlets are located in the passenger side trim panel just behind the sliding door. Do not block or place objects directly in front of the inlet grille or heater outlets. The electrical system could overload causing damage to the blower motor.

Rear Temperature Control

To change the temperature in the rear of the vehicle, press the temperature control button down for cold and up for heated air.

Rear Mode Control

The Rear Mode Control, located in the headliner near the center of the vehicle can be used to select between Auto, Headliner, Bi-Level and Floor modes.

Auto Mode

The rear system automatically maintains the correct mode and comfort level desired by the rear seat occupants.

Floor Mode

 Air comes from the floor outlets.

Bi-Level Mode

 Air comes from both the headliner outlets and the floor outlets.

NOTE: In many temperature positions, the bi-level mode is designed to provide cooler air out of the headliner outlets and warmer air from the floor outlets.

Headliner Mode

 Air comes from the outlets in the headliner. Each of these outlets can be individually adjusted to direct the flow of air. Moving the air vane knob on the outlets to one side will shut off the air flow.

Summer Operation

The engine cooling system in air conditioned vehicles must be protected with a high-quality antifreeze coolant to provide proper corrosion protection and to protect against engine overheating. A 50% solution of ethylene

glycol antifreeze coolant in water is recommended. Refer to section 7, Maintenance Procedures, of this manual for proper coolant selection.

Winter Operation

The air from the heater system will heat faster in cold weather if you use only low blower speeds for the first 10 minutes of vehicle operation. Use of the air Recirculation mode during winter months is not recommended because it may cause window fogging.

Vacation Storage

Anytime you store your vehicle, or keep it out of service (i.e. vacation) for two weeks or more, run the air conditioning system at idle for about five minutes in the fresh air and high blower setting. This will insure adequate system lubrication to minimize the possibility of compressor damage when the system is started again.

Window Fogging











Vehicle windows tend to fog on the inside in mild rainy or humid weather. To clear the windows, use the A/C, PANEL and blower controls. Direct the panel outlets toward the side windows. Do not use the Recirculation mode without A/C for long periods as fogging may occur.

Interior fogging on the windshield can be quickly removed by using the defrost mode.

Outside Air Intake

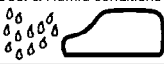
Make sure the air intake, located directly in front of the windshield, is free of obstructions such as leaves. Leaves collected in the air intake may reduce airflow and if they enter the plenum they could plug the water drains. In winter months make sure the air intake is clear of ice, slush and snow.

Operating Tips

WEATHER	CONTROL SETTINGS
Hot weather and vehicle interior is very hot 	Set the mode control to   on, and blower on high. Roll down the windows for a minute to flush out the hot air. Once comfort is achieved adjust controls for comfort.
Warm weather 	Turn  on and set the mode control to the  position.
Cool Sunny	Operate in  position.
Cool & Humid conditions 	Set the mode control to  and turn on  to keep windows clear.
Cold Weather	Set the mode control to the  position. If windshield fogging starts to occur, move the control towards the  position.

A/C Air Filter — If Equipped

The climate control system filters out dust, pollen and some odors from the air. Strong odors can not be totally filtered out. Refer to section 7 “Air Conditioning” for filter replacement instructions.

REAR WINDOW FEATURES**Intermittent Rear Wiper Operation — Manual Temperature Control Only**

 The controls are located on the Manual Temperature Control head above the front blower control. When the button is pressed and released and the Ignition Switch in ON, the rear wiper will operate at a fixed interval of about 8 seconds. As vehicle speed increases, the time delay will shorten. The LED indicator will light when the wiper is ON. Pressing and releasing the button again will turn the wiper off.

Rear Washer Operation — Manual Temperature Control Only

 The controls are located on the Manual Temperature Control head above the front blower control. Press and hold the button for as long as spray is desired. If the button is depressed and held while the Intermittent wiper is on, the wiper will operate for a few seconds after the button is released, then resume intermittent operation. If the button was pressed and held when the intermittent wiper is off, the wiper will operate for two cycles, then turn off. The LED will not illuminate when Washer is selected and Intermittent is OFF.

NOTE: The washer will stop spraying if the switch is pressed longer than 10 seconds.

Vehicles equipped with Automatic Temperature Control, the controls for these features are located in the middle of the instrument panel above the radio.

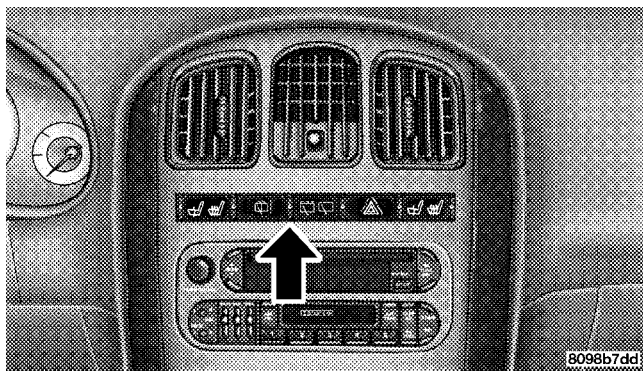

Rear Wiper Operation — Automatic Temperature Control Only

 Press this button to have the rear wiper have a continuous wipe. When the ignition switch is in the ON/RUN position, the rear wiper switch position as well as an indicator light will show that the wiper is ON.

Intermittent Rear Wiper Operation — Automatic Temperature Control Only

 When this button is pressed and the ignition switch is in the ON position, the rear wiper will operate at a fixed interval of about 8 seconds. As vehicle speed increases, the time delay will shorten. The switch position as well as an indicator light will show when the wiper is ON.

Rear Washer Operation — Automatic Temperature Control Only

 Press and hold the button as long as spray is desired. If the switch is depressed while the wipers are on, the wipers will operate for a few seconds after the switch is released then resume the previously set mode of intermittent wiper or continuous wipe. If the switch is depressed when the wipers are off, the wipers will operate for two cycles, then turn off.

NOTE: The washers will stop spraying if the switch is pressed longer than 10 seconds.

Adding Washer Fluid

The fluid reservoir for the windshield washers and the rear window washer is shared. It is located in the front of the engine compartment on the passenger side and should be checked for fluid level at regular intervals. Fill

the reservoir with windshield washer solvent (not radiator antifreeze) and operate the system for a few seconds to flush out the residual water.

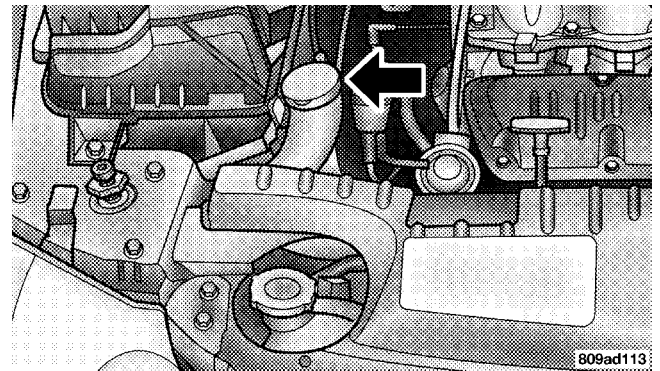

The washer fluid reservoir will hold a full gallon of fluid when the Low Washer Fluid Light illuminates.

Electric Rear Window Defroster — If Equipped

Press this button to turn on the rear window defroster and the optional heated mirrors. A light will show that the defroster is on. The defroster automatically turns off after about 10 minutes of operation.

If your vehicle is equipped with Infrared Three-Zone Automatic Temperature Control the rear defroster symbol will show in the display screen when the rear window defroster is on.

CAUTION!

To avoid damaging the electrical conductors of the rear window defroster, do not use scrapers, sharp instruments, or abrasive window cleaners on the interior surface of the window.

Labels can be peeled off after soaking with warm water.

STARTING AND OPERATING

CONTENTS

■ Starting Procedures	226	■ All Wheel Drive — If Equipped	235
□ 2.4L Engine	226	■ Parking Brake	235
□ 3.3L And 3.8L Engine	228	■ Brake System	237
■ Engine Block Heater — If Equipped	230	□ Anti-Lock Brake System — If Equipped	237
■ Automatic Transmission	231	■ Power Steering	240
□ Brake/Transmission Interlock System	232	■ Traction Control — If Equipped	241
□ Automatic Transmission Ignition Interlock System	232	■ Tire Safety Information	242
□ Four Speed Automatic Transmission	232	□ Tire Markings	242
		□ Tire Identification Number (TIN)	246

224 STARTING AND OPERATING

<input type="checkbox"/> Tire Loading And Tire Pressure	247	<input type="checkbox"/> 1,2,3, Or 4 Tire(s) High Pressure	260
■ Tires—General Information	251	<input type="checkbox"/> Service Tire Pressure System/See Owner’s Manual	260
<input type="checkbox"/> Tire Pressure	251	<input type="checkbox"/> Tire Pressure Unavailable	260
<input type="checkbox"/> Tire Inflation Pressures	252	<input type="checkbox"/> Tire Pressure Now Available	261
<input type="checkbox"/> Radial-Ply Tires	255	<input type="checkbox"/> Spare Tire In Use? Yes/No	261
<input type="checkbox"/> Compact Spare Tire — If Equipped	255	<input type="checkbox"/> All 5 Tires With Car? Yes/No	261
<input type="checkbox"/> Tire Spinning	256	<input type="checkbox"/> General Information	263
<input type="checkbox"/> Tread Wear Indicators	256	■ Tire Chains	263
<input type="checkbox"/> Replacement Tires	257	■ Snow Tires	264
<input type="checkbox"/> Alignment And Balance	258	■ Tire Rotation Recommendations	265
■ All Wheel Drive (AWD) — If Equipped	259	■ Fuel Requirements	266
■ Tire Pressure Monitor System — If Equipped	259	<input type="checkbox"/> Reformulated Gasoline	266
<input type="checkbox"/> 1,2,3, Or 4 Tire(s) Low Pressure	260		

□ Gasoline/Oxygenate Blends	267	■ Vehicle Loading	272
□ MMT In Gasoline	267	□ Vehicle Certification Label	272
□ Sulfur In Gasoline	268	□ Gross Vehicle Weight Rating (GVWR)	273
□ Materials Added To Fuel	268	□ Gross Axle Weight Rating (GAWR)	273
□ Fuel System Cautions	269	□ Overloading	273
□ Carbon Monoxide Warnings	269	□ Loading	274
■ Adding Fuel	270	■ Trailer Towing	275
□ Fuel Filler Cap (Gas Cap)	270	□ Warranty Requirements	275

STARTING PROCEDURES**CAUTION!**

Long periods of engine idling, especially at high engine speeds, can cause excessive exhaust temperatures which can damage your vehicle. Do not leave your vehicle unattended with the engine running.

WARNING!

Do not leave animals or children inside parked vehicles in hot weather; interior heat build up may cause serious injury or death.

The gear selector must be in the NEUTRAL or PARK position before you can start the engine. Apply the brakes before shifting into any driving gear.

2.4L Engine

Normal Starting of either a cold or a warm engine is obtained without pumping or depressing the accelerator pedal. Turn the key to the "START" position and release when the engine starts. If the engine has not started within 3 seconds, slightly depress the accelerator pedal while continuing to crank. If the engine fails to start within 15 seconds, turn the key to the "OFF" position, wait 10 to 15 seconds, then repeat the normal starting procedure.

Cold Weather (Below 0° C or 32° F) or **High Altitude** (Above 4,000 feet at all temperatures). If engine has not been started within past 3 to 4 hours, slightly depress and hold the accelerator pedal before attempting to start a cold engine. Turn the key to the "START" position. When the engine starts, release first the key, then the accelerator pedal. If the engine fails to start within 15 seconds, discontinue cranking and return the key to the "OFF" position. Repeat the starting procedure.

Extremely Cold Weather (below -29°C or -20°F). To insure reliable starting at these temperatures, use of an externally powered electric engine block heater (available from your dealer) is recommended.

WARNING!

Do not attempt to push or tow your vehicle to get it started. Vehicles equipped with an automatic transmission cannot be started this way. Unburned fuel could enter the catalytic converter and once the engine has started, ignite and damage the converter and vehicle. If the vehicle has a discharged battery, booster cables may be used to obtain a start from a booster battery or the battery in another vehicle. This type of start can be dangerous if done improperly. See section 6 of this manual for the proper jump starting procedures and follow them carefully.

WARNING!

Never pour fuel or other flammable liquid into the throttle body air inlet opening in an attempt to start the vehicle. This could result in flash fire causing serious personal injury.

If Engine Fails to Start

If the engine fails to start after you have followed the “NORMAL STARTING”, “COLD WEATHER” or “HIGH ALTITUDE” procedures, it may be flooded. Push the accelerator pedal all the way to the floor and hold it there while cranking the engine. This should clear any excess fuel in case the engine is flooded.

CAUTION!

To prevent damage to the starter, do not crank the engine for more than 15 seconds at a time. Wait 10 to 15 seconds before trying again.

If the engine has been flooded, it may start to run, but not have enough power to continue running when the key is released. If this occurs, continue cranking with the accelerator pedal pushed all the way to the floor. Release the accelerator pedal and the key once the engine is running smoothly. Do not overspeed engine.

If the engine shows no sign of starting after two 15 second periods of cranking with the accelerator pedal held to the floor, the "NORMAL STARTING", "COLD WEATHER" or "HIGH ALTITUDE" procedure should be repeated.

After Starting

The idle speed will automatically decrease as the engine warms up.

3.3L and 3.8L Engine

Normal Starting of either a cold or a warm engine is obtained without pumping or depressing the accelerator pedal. Turn the key to the "START" position and release when the engine starts. If the engine has not started within 3 seconds, slightly depress the accelerator pedal while continuing to crank. If the engine fails to start within 15 seconds, turn the key to the "OFF" position, wait 10 to 15 seconds, then repeat the normal starting procedure.

Extremely Cold Weather (below -29°C or -20°F) To insure reliable starting at these temperatures, use of an externally powered electric engine block heater (available from your dealer) is recommended.

WARNING!

Do not attempt to push or tow your vehicle to get it started. Vehicles equipped with an automatic transmission cannot be started this way. Unburned fuel could enter the catalytic converter and once the engine has started, ignite and damage the converter and vehicle. If the vehicle has a discharged battery, booster cables may be used to obtain a start from a booster battery or the battery in another vehicle. This type of start can be dangerous if done improperly. See section 6 of this manual for the proper jump starting procedures and follow them carefully.

WARNING!

Never pour fuel or other flammable liquid into the throttle body air inlet opening in an attempt to start the vehicle. This could result in flash fire causing serious personal injury.

If Engine Fails to Start

If the engine fails to start after you have followed the "NORMAL STARTING" procedure, it may be flooded. Push the accelerator pedal all the way to the floor and hold it there while cranking the engine. This should clear any excess fuel in case the engine is flooded.

CAUTION!

To prevent damage to the starter, do not crank the engine for more than 15 seconds at a time. Wait 10 to 15 seconds before trying again.

If the engine has been flooded, it may start to run, but not have enough power to continue running when the key is released. If this occurs, continue cranking up to 15 seconds with the accelerator pedal pushed all the way to the floor. Release the accelerator pedal and the key once the engine is running smoothly. Do not overspeed engine.

If the engine shows no sign of starting after two 15 second periods of cranking with the accelerator pedal held to the floor, the "NORMAL STARTING" procedure should be repeated.

After Starting

The idle speed will automatically decrease as the engine warms up.

ENGINE BLOCK HEATER — IF EQUIPPED

The engine block heater warms engine coolant and permits quicker starts in cold weather. Connect the cord to a standard 110-115 volt AC electrical outlet with a grounded, three-wire extension cord.

The engine block heater cord is routed under the hood on the driver side of the vehicle. It has a removable cap that is located on the driver side of the Integrated Power Module.

WARNING!

Remember to disconnect the cord before driving. Damage to the 110-115 volt electrical cord could cause electrocution.

AUTOMATIC TRANSMISSION**CAUTION!**

Damage to the transmission may occur if the following precautions are not observed:

- Shift into PARK only after the vehicle has come to a complete stop.
- Shift into or out of REVERSE only after the vehicle has come to a complete stop and the engine is at idle speed.
- Do not shift from REVERSE, PARK, or NEUTRAL into any forward gear when the engine is above idle speed.
- Before shifting into any gear, make sure your foot is firmly on the brake pedal.

WARNING!

It is dangerous to shift the selector lever out of “P” or “N” if the engine speed is higher than idle speed. If your foot is not firmly on the brake pedal, the vehicle could accelerate quickly forward or in reverse. You could lose control of the vehicle and hit someone or something. Only shift into gear when the engine is idling normally and when your right foot is firmly on the brake pedal.

Brake/Transmission Interlock System

This system prevents you from moving the gear shift out of Park and into any gear unless the brake pedal is pressed. This system is active only while the ignition switch is in the ON position. Always depress the **brake pedal first**, before moving the gear selector out of PARK.

Automatic Transmission Ignition Interlock System

This system prevents the key from being removed unless the shift lever is in PARK. It also prevents shifting out of PARK unless the key is in the OFF or ON positions.

NOTE: If a malfunction occurs, the system will trap the key in the ignition cylinder to warn you that this safety feature is inoperable. The engine can be started and stopped but the key cannot be removed until you obtain service.

Four Speed Automatic Transmission

The electronically controlled transmission provides a precise shift schedule. The transmission electronics are self-calibrating; therefore, the first few shifts on a new vehicle, may be somewhat abrupt. This is a normal condition, and precision shifts will develop within a few hundred miles.

Reset Mode - Electronic Transmission

The transmission is monitored electronically for abnormal conditions. If a condition is detected that could cause damage, the transmission automatically shifts into second gear. The transmission remains in second gear despite the forward gear selected. Park (P), Reverse (R), and Neutral (N) will continue to operate. This Reset feature allows the vehicle to be driven to a dealer for service without damaging the transmission.

In the event that the problem has been momentary, the transmission can be reset to regain all forward gears.

- Stop the vehicle and shift into Park (P).
- Turn the key to OFF then restart the engine.
- Shift into the desired range and resume driving.

NOTE: Even if the transmission can be reset, it is recommended that you visit a dealer at your earliest

possible convenience. Your dealer has diagnostic equipment to determine if the problem could recur.

If the transmission cannot be reset, dealer service is required.

Gear Ranges

DO NOT race the engine when shifting from PARK or NEUTRAL positions into another gear range.



P R N D 3 L

8000cbb1

- **“P” Park**

Supplements the parking brake by locking the transmission. The engine can be started in this range. Never attempt to use PARK while vehicle is in motion.

Apply parking brake when leaving vehicle in this range.

- **“R” Reverse**

Shift into this range only after the vehicle has come to a complete stop.

- **“N” Neutral**

Engine may be started in this range.

- **“D” Overdrive**

For most city and highway driving, it provides smoothest upshifts and downshifts and best fuel economy. When frequent transmission shifting occurs while using the “D” Overdrive position, such as when operating the vehicle under heavy loading conditions, (i.e. in hilly terrain, traveling into strong head winds or while towing heavy trailers), using the “3” position will improve performance and extend transmission life by reducing excessive shifting and heat build-up.

- **“3” Drive**

This range eliminates shifts into Overdrive. The transmission will operate normally in First, Second and Third while in this range. The “3” position should also be used when descending steep grades to prevent brake system distress.

NOTE: Using the “3” range while operating the vehicle under heavy operating conditions will improve performance and extend transmission life by reducing excessive shifting and heat build up.

- **“L” Low**

This range should be used for engine braking when descending very steep grades. In this range, upshifts will occur only to prevent engine overspeed while downshifts occur earlier than other gear range selections.

NOTE: The vehicle computer will over ride Overdrive and “3” Drive ranges by changing shift points if the

transmission operating temperature exceeds acceptable limits. This is done to prevent transmission damage due to overheating.

ALL WHEEL DRIVE — IF EQUIPPED

This feature provides full time, on-demand, All Wheel Drive (AWD). The system is automatic with no driver inputs or additional driving skills required. Under normal driving conditions, the front wheels provide most of the traction. If the front wheels begin to lose traction, power is shifted automatically to the rear wheels. The greater the front wheel traction loss, the greater the power transfer to the rear wheels.

CAUTION!

All wheels must have the same size and type tires. Unequal tire sizes must not be used. Unequal tire size may cause failure of the power transfer unit and/or the viscous coupling.

PARKING BRAKE

When the parking brake is applied with the ignition switch on, the brake light in the instrument cluster will turn on.

NOTE: This light only shows that the parking brake is applied. It does not show the degree of brake application.

Before leaving the vehicle, make sure that the parking brake is fully applied and place the gear selector in the

Park position. To release the parking brake, pull out on the parking brake release located on the left side of the instrument panel.

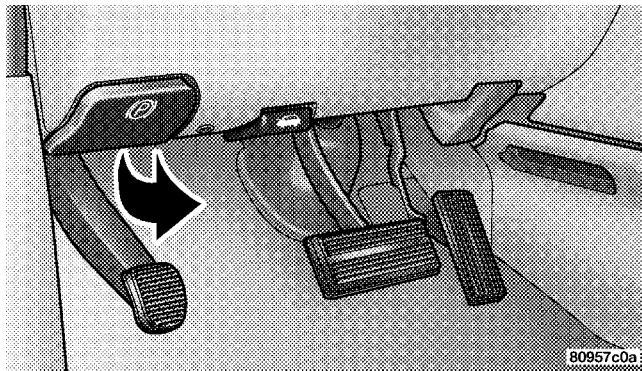

When parking on a hill, it is important to set the parking brake before placing the gear selector in Park, otherwise the load on the transmission locking mechanism may make it difficult to move the selector out of park. As an

added precaution, turn the front wheels toward the curb on a downhill grade and away from the curb on an uphill grade.

The parking brake should always be applied when the driver is not in the vehicle.

WARNING!

Leaving children in a vehicle unattended is dangerous for a number of reasons. A child or others could be injured. Children should be warned not to touch the parking brake, brake pedal or the gear selector lever. Don't leave the keys in the ignition. A child could operate power windows, other controls, or move the vehicle.

WARNING!

Be sure the parking brake is fully disengaged before driving: failure to do so can lead to brake failure, and an accident.

BRAKE SYSTEM

In the event power assist is lost for any reason (for example, repeated brake applications with the engine off), the brakes will still function. The effort required to brake the vehicle will be much greater than that required with the power system operating.

BRAKE  Your vehicle is equipped with dual hydraulic brake systems. If either of the two hydraulic systems lose normal capability, the remaining system will still function. There will be some loss of overall braking effectiveness. This may be evident

by increased pedal travel during application, greater pedal force required to slow or stop, and potential activation of the Brake Warning Lamp.

Anti-Lock Brake System — If Equipped

The Anti-Lock Brake System provides increased vehicle stability and brake performance under most braking conditions. The system automatically “pumps” the brakes during severe braking conditions to prevent wheel lock-up.

WARNING!

Pumping of the Anti-Lock Brakes will diminish their effectiveness and may lead to an accident. Pumping makes the stopping distance longer. Just press firmly on your brake pedal when you need to slow down or stop.

 The ABS light monitors the Anti-Lock Brake System. The light will come on when the ignition switch is turned to the ON position and may stay on for as long as four seconds.

If the ABS light remains on or comes on while driving, it indicates that the Anti-Lock portion of the brake system is not functioning and that service is required. However, the conventional brake system will continue to operate normally if the BRAKE warning light is not on.

If the ABS light is on, the brake system should be serviced as soon as possible to restore the benefits of Anti-Lock brakes. If the ABS light does not come on when the Ignition switch is turned to the ON position, have the bulb repaired as soon as possible.

If both the Brake Warning Light and the ABS Light remain on, the Anti-Lock brakes (ABS) and Electronic Brake Force Distribution (EBD) systems are not functioning. Immediate repair to the ABS system is required.

When the vehicle is driven over approximately 15 mph (25 km/h), you may also hear a slight clicking sound as well as some related motor noises. These noises are the system performing its self check cycle to ensure that the ABS system is working properly. This self check occurs each time the vehicle is started and accelerated past approximately 15 mph (25 km/h).

ABS is activated during braking under certain road or stopping conditions. ABS-inducing conditions can include ice, snow, gravel, bumps, railroad tracks, loose debris, or panic stops.

You also may experience the following when the brake system goes into Anti-lock:

- The ABS motor running (it may continue to run for a short time after the stop),
- the clicking sound of solenoid valves,
- brake pedal pulsations,

- and a slight drop or fall away of the brake pedal at the end of the stop.

These are all normal characteristics of ABS.

WARNING!

The Anti-Lock Brake System contains sophisticated electronic equipment that may be susceptible to interference caused by improperly installed or high output radio transmitting equipment. This interference can cause possible loss of anti-lock braking capability. Installation of such equipment should be performed by qualified professionals.

WARNING!

- Anti-lock system (ABS) cannot prevent the natural laws of physics from acting on the vehicle, nor can it increase braking or steering efficiency beyond that afforded by the condition of the vehicle brakes and tires or the traction afforded.
- The ABS cannot prevent accidents, including those resulting from excessive speed in turns, following another vehicle too closely, or hydroplaning. Only a safe, attentive, and skillful driver can prevent accidents.
- The capabilities of an ABS equipped vehicle must never be exploited in a reckless or dangerous manner which could jeopardize the user's safety or the safety of others.

All vehicle wheels and tires must be the same size and type and tires must be properly inflated to produce accurate signals for the computer.

POWER STEERING

The standard power steering system will give you good vehicle response and increased ease of maneuverability in tight spaces. The system will provide mechanical steering capability if power assist is lost.

If for some reason, the power assist is interrupted, it will still be possible to steer your vehicle. Under these conditions you will observe a substantial increase in steering effort, especially at very low vehicle speeds and during parking maneuvers.

NOTE: Increased noise levels at the end of the steering wheel travel are considered normal and does not indicate that there is a problem with the power steering system.

WARNING!

Continued operation with reduced power steering assist could pose a safety risk to yourself and others. Service should be obtained as soon as possible.

CAUTION!

Prolong operation of the steering system at the end of the steering wheel travel will increase the steering fluid temperature and should be avoided when possible. Damage to the power steering pump may occur.

TRACTION CONTROL — IF EQUIPPED

The Traction Control System reduces wheel slip and maintains traction at the driving (front) wheels. The system reduces wheel slip by engaging the brake on the wheel that is losing traction (spinning). The system operates at speeds below 35 mph (56 km/h).

The system is always in the “stand by” mode unless,

- The Traction Control Switch has been used to turn the system OFF

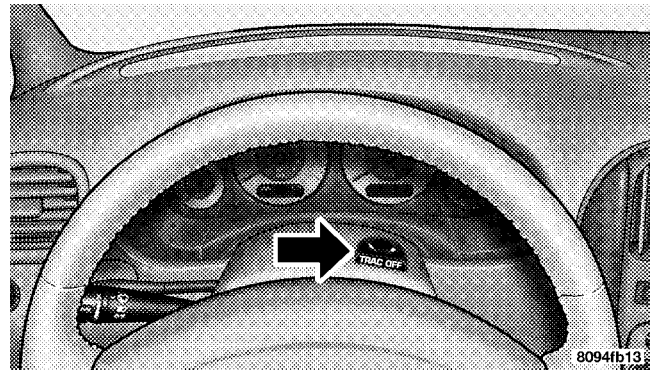

5

- There is a Traction Control System malfunction
- The system has been deactivated to prevent damage to the brake system due to overheated brake temperatures

NOTE: The Traction Control will make buzzing or clicking sounds when in operation.

NOTE: Extended heavy use of Traction Control may cause the system to deactivate and turn on the TRAC and the OFF indicators located in the instrument cluster.

This is to prevent overheating of the brake system and is a normal condition. The system will remain disabled for about 4 minutes until the brakes have cooled. The system will automatically reactivate and turn off the TRAC and the OFF indicators.

If your vehicle becomes stuck in mud, ice, or snow, turn the Traction Control System OFF before attempting to “rock” the vehicle free.

TIRE SAFETY INFORMATION

Tire Markings

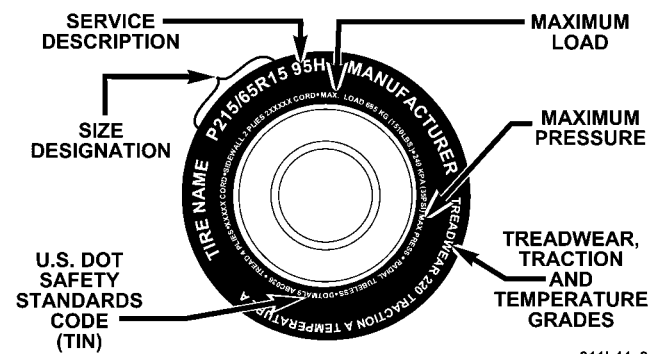

811b44e8

NOTE:

- P(Passenger)-Metric tire sizing is based on U.S. design standards. P-Metric tires have the letter “P” molded into the sidewall preceding the size designation. Example: P215/65R15 95H.

- European Metric tire sizing is based on European design standards. Tires designed to this standard have the tire size molded into the sidewall beginning with the section width. The letter "P" is absent from this tire size designation. Example: 215/65R15 96H
- LT(Light Truck)-Metric tire sizing is based on U.S. design standards. The size designation for LT-Metric tires is the same as for P-Metric tires except for the letters "LT" that are molded into the sidewall preceding the size designation. Example: LT235/85R16.
- Temporary Spare tires are high pressure compact spares designed for temporary emergency use only. Tires designed to this standard have the letter "T" molded into the sidewall preceding the size designation. Example: T145/80D18 103M.
- High Flotation tire sizing is based on U.S. design standards and begins with the tire diameter molded into the sidewall. Example: 31x10.5 R15 LT.

Tire Sizing Chart

EXAMPLE:	
Size Designation:	
P = Passenger car tire size based on U.S. design standards	
"...blank..." = Passenger car tire based on European design standards	
LT = Light Truck tire based on U.S. design standards	
T = Temporary Spare tire	
31 = Overall Diameter in Inches (in)	
215 = Section Width in Millimeters (mm)	
65 = Aspect Ratio in Percent (%)	
	—Ratio of section height to section width of tire.
10.5 = Section Width in Inches (in)	
R = Construction Code	
	—"R" means Radial Construction.
	—"D" means Diagonal or Bias Construction.
15 = Rim Diameter in Inches (in)	

EXAMPLE:**Service Description:****95 = Load Index**

—A numerical code associated with the maximum load a tire can carry.

H = Speed Symbol

—A symbol indicating the range of speeds at which a tire can carry a load corresponding to its load index under certain operating conditions.

—The maximum speed corresponding to the Speed Symbol should only be achieved under specified operating conditions. (ie. tire pressure, vehicle loading, road conditions and posted speed limits).

Load Identification:

"...blank..." = Absence of any text on sidewall of the tire indicates a Standard Load (SL) Tire

Extra Load (XL) = Extra Load (or Reinforced) Tire

Light Load = Light Load Tire

C,D,E = Load range associated with the maximum load a tire can carry at a specified pressure

Maximum Load — Maximum Load indicates the maximum load this tire is designed to carry.

Maximum Pressure — Maximum Pressure indicates the maximum permissible cold tire inflation pressure for this tire.

Tire Identification Number (TIN)

The TIN may be found on one or both sides of the tire however the date code may only be on one side. Tires with white sidewalls will have the full TIN including date code located on the white sidewall side of the tire.

Look for the TIN on the outboard side of black sidewall tires as mounted on the vehicle. If the TIN is not found on the outboard side then you will find it on the inboard side of the tire.

EXAMPLE:
DOT MA L9 ABCD 0301
DOT = Department of Transportation —This symbol certifies that the tire is in compliance with the U.S. Department of Transportation tire safety standards, and is approved for highway use.
MA = Code representing the tire manufacturing location.(2 digits)
L9 = Code representing the tire size.(2 digits)
ABCD = Code used by tire manufacturer.(1 to 4 digits)
03 = Number representing the week in which the tire was manufactured.(2 digits) —03 means the 3rd week.
01 = Number representing the year in which the tire was manufactured.(2 digits) —01 means the year 2001. —Prior to July 2000, tire manufacturers were only required to have 1 number to represent the year in which the tire was manufactured. Example: 031 could represent the 3rd week of 1981 or 1991.

Tire Loading and Tire Pressure

Tire Placard Location

NOTE: Some vehicles have a “Tire and Loading Information” placard located on the driver’s side “B” pillar.

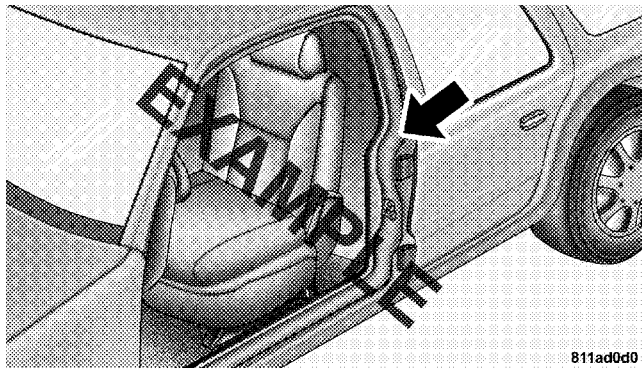

Tire and Loading Information Placard

TIRE AND LOADING INFORMATION			
SEATING CAPACITY - TOTAL 5 FRONT 2 REAR 3			
THE COMBINED WEIGHT OF OCCUPANTS AND CARGO SHOULD NEVER EXCEED XXX KG OR XXX LBS.			
TIRE	FRONT	REAR	SPARE
ORIGINAL TIRE SIZE	P195/70R14	P195/70R14	T125/70D15
COLD TIRE INFLATION PRESSURE	200kPa, 29PSI	200kPa, 29PSI	420kPa, 60PSI
SEE OWNER'S MANUAL FOR ADDITIONAL INFORMATION			4N109268

811b5a9a

This placard tells you important information about the,

- 1) number of people that can be carried in the vehicle
- 2) the total weight your vehicle can carry
- 3) the tire size designed for your vehicle
- 4) the cold tire inflation pressures for the front, rear and spare tires.

Loading

The vehicle maximum load on the tire must not exceed the load carrying capacity of the tire on your vehicle. You will not exceed the tire's load carrying capacity if you adhere to the loading conditions, tire size and cold tire inflation pressures specified on the Tire and Loading Information placard and the Vehicle Loading section of this manual.

NOTE: Under a maximum loaded vehicle condition, gross axle weight ratings (GAWR's) for the front and rear axles must not be exceeded. For further information on GAWR's, vehicle loading and trailer towing, see the Vehicle Loading section of this manual.

To determine the maximum loading conditions of your vehicle, locate the statement "The combined weight of occupants and cargo should never exceed XXX kg or XXX lbs." on the Tire and Loading Information placard. The combined weight of occupants, cargo/luggage and trailer tongue weight (if applicable) should never exceed the weight referenced here.

Steps for Determining Correct Load Limit

1. Locate the statement “The combined weight of occupants and cargo should never exceed XXX pounds” on your vehicle’s placard.
2. Determine the combined weight of the driver and passengers that will be riding in your vehicle.
3. Subtract the combined weight of the driver and passengers from XXX kilograms or XXX pounds.
4. The resulting figure equals the available amount of cargo and luggage load capacity. For example, if “XXX” amount equals 1400 lbs. and there will be five 150 lb. passengers in your vehicle, the amount of available cargo and luggage load capacity is 650 lb. (1400–750 (5 x 150) = 650 lb.)

5. Determine the combined weight of luggage and cargo being loaded on the vehicle. That weight may not safely exceed the available cargo and luggage load capacity calculated in step 4.

6. If your vehicle will be towing a trailer, load from your trailer will be transferred to your vehicle. Consult this manual to determine how this reduces the available cargo and luggage load capacity of your vehicle.

NOTE: The following table shows examples on how to calculate total load, cargo/luggage and towing capacities of your vehicle with varying seating configurations and number and size of occupants. This table is for illustration purposes only and may not be accurate for the seating and load carry capacity of your vehicle.

NOTE: For the following example the combined weight of occupants and cargo should never exceed 865 lbs. (392 Kg).

250 STARTING AND OPERATING

Occupants			Combined weight of occupants and cargo from Tire Placard	MINUS	Combined Occupant's weight	=	AVAILABLE Cargo/Luggage and Trailer Tongue Weight
TOTAL	FRONT	REAR					
<u>EXAMPLE 1</u>			865 lbs	minus	Occupant 1: 200 lbs Occupant 2: 130 lbs Occupant 3: 160 lbs Occupant 4: 100 lbs Occupant 5: 80 lbs TOTAL WEIGHT: 670 lbs	=	195 lbs
5	2	3					
<u>EXAMPLE 2</u>			865 lbs	minus	Occupant 1: 210 lbs Occupant 2: 180 lbs Occupant 3: 150 lbs TOTAL WEIGHT: 540 lbs	=	325 lbs
3	2	1					
<u>EXAMPLE 3</u>			865 lbs	minus	Occupant 1: 200 lbs Occupant 2: 200 lbs TOTAL WEIGHT: 400 lbs	=	465 lbs
2	2	0					

WARNING!

Overloading of your tire is dangerous. Overloading can cause tire failure, affect vehicle handling, and increase your stopping distance. Use tires of the recommended load capacity for your vehicle—never overload them.

TIRES—GENERAL INFORMATION**Tire Pressure**

Proper tire inflation pressure is essential to the safe and satisfactory operation of your vehicle. Three primary areas are affected by improper tire pressure:

1. Safety—**WARNING!**

Improperly inflated tires are dangerous and can cause accidents.

- Under inflation increases tire flexing and can result in tire failure.
- Over inflation reduces a tire's ability to cushion shock. Objects on the road and chuck holes can cause damage that results in tire failure.
- Unequal tire pressures can cause steering problems. You could lose control of your vehicle.
- Over inflated or under inflated tires can affect vehicle handling and can fail suddenly, resulting in loss of vehicle control.
- Unequal tire pressures from one side of the vehicle to the other can cause the vehicle to drift to the right or left.

Always drive with each tire inflated to the recommended cold tire inflation pressure.

2. Economy—

Improper inflation pressures can cause uneven wear patterns to develop across the tire tread. These abnormal wear patterns will reduce tread life resulting in a need for earlier tire replacement. Underinflation also increases tire rolling resistance and results in higher fuel consumption.

3. Ride Comfort and Vehicle Stability—

Proper tire inflation contributes to a comfortable ride. Overinflation produces a jarring and uncomfortable ride.

Tire Inflation Pressures

The proper cold tire inflation pressure for passenger cars is listed on either the face of the driver's door or the driver's side "B" pillar. For vehicles other than passenger cars, the cold tire inflation pressures are listed on either the "B" pillar, the Certification Label or in the Tire Inflation Pressures brochure in the glove compartment.

Some vehicles may have Supplemental Tire Pressure Information for vehicle loads that are less than the maximum loaded vehicle condition. These pressure conditions will be found in the "Supplemental Tire Pressure Information" section of this manual.

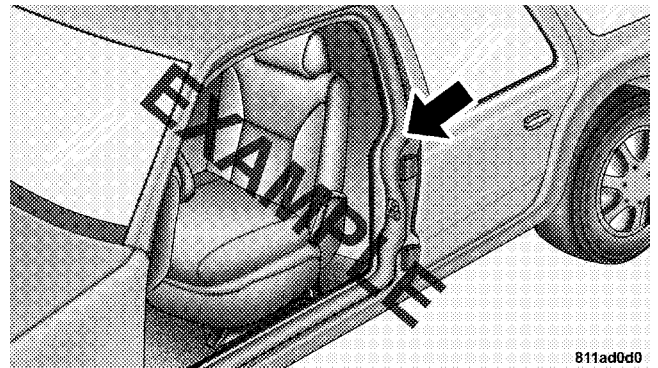

"B" PILLAR

811ad0d0

The pressure should be checked and adjusted as well as inspecting for signs of tire wear or visible damage at least once a month. Use a good quality pocket-type gauge to check tire pressure. Do not make a visual judgement when determining proper inflation. Radial tires may look properly inflated even when they are underinflated.

CAUTION!

After inspecting or adjusting the tire pressure always reinstall the valve stem cap—if equipped. This will prevent moisture and dirt from entering the valve stem, which could damage the valve stem.

Inflation pressures specified on the placard are always “cold tire inflation pressure”. Cold tire inflation pressure is defined as the tire pressure after the vehicle has not been driven for at least 3 hours, or driven less than 1 mile

(1 km) after a 3 hour period. The cold tire inflation pressure must not exceed the maximum inflation pressure molded into the tire side wall.

Check tire pressures more often if subject to a wide range of outdoor temperatures, as tire pressures vary with temperature changes.

Tire pressures change by approximately 1 psi (7 kPa) per 12° F (7° C) of air temperature change. Keep this in mind when checking tire pressure inside a garage especially in the winter.

Example: If garage temperature = 68° F (20° C) and the outside temperature = 32° F (0° C) then the cold tire inflation pressure should be increased by 3 psi (21 kPa), which equals 1 psi (7 kPa) for every 12° F (7° C) for this outside temperature condition.

Tire pressure may increase from 2 to 6 psi (13 to 40 kPa) during operation. DO NOT reduce this normal pressure build up or your tire pressure will be too low.

Tire Pressures for High Speed Operation

The manufacturer advocates driving at safe speeds within posted speed limits. Where speed limits or conditions are such that the vehicle can be driven at high speeds, maintaining correct tire inflation pressure is very important. Increased tire pressure and reduced vehicle loading may be required for high speed vehicle operation. Refer to original equipment or an authorized tire dealer for recommended safe operating speeds, loading and cold tire inflation pressures.

WARNING!

High speed driving with your vehicle under maximum load is dangerous. The added strain on your tires could cause them to fail. You could have a serious accident. Don't drive a vehicle loaded to the maximum capacity at continuous speeds above 75 mph (120 km/h).

Radial-Ply Tires

WARNING!

Combining radial ply tires with other types of tires on your vehicle will cause your vehicle to handle poorly. The instability could cause an accident. Always use radial ply tires in sets of four (or 6, in case of trucks with dual rear wheels). Never combine them with other types of tires.

Cuts and punctures in radial tires are repairable only in the tread area because of sidewall flexing. Consult your authorized tire dealer for radial tire repairs.

Compact Spare Tire — If Equipped

The compact spare is for temporary emergency use with radial tires. It is engineered to be used on your style vehicle only. Since this tire has limited tread life, the original tire should be repaired (or replaced) and reinstalled at the first opportunity.

WARNING!

Temporary use spare tires are for emergency use only. With these tires, do not drive more than 50 mph (80 km/h). Temporary-use spare tires have a total tread life of 3,000 miles (4 800 km). Be sure to follow the warnings which apply to your spare. Failure to do so could result in spare tire failure and loss of vehicle control.

Do not install a wheel cover or attempt to mount a conventional tire on the compact spare wheel, since the wheel is designed specifically for the compact spare.

CAUTION!

Because of the reduced ground clearance, do not take your vehicle through an automatic car wash with the compact spare installed. Damage to the vehicle may result.

Tire Spinning

When stuck in mud, sand, snow, or ice conditions, do not spin your vehicle's wheels above 35 mph (55 km/h).

See the paragraph on Freeing A Stuck Vehicle in Section 6 of this manual.

WARNING!

Fast spinning tires can be dangerous. Forces generated by excessive wheel speeds may cause tire damage or failure. A tire could explode and injure someone. Do not spin your vehicle's wheels faster than 35 mph (55km/h) when you are stuck. And don't let anyone near a spinning wheel, no matter what the speed.

Tread Wear Indicators

Tread wear indicators are in the original equipment tires to help you in determining when your tires should be replaced.

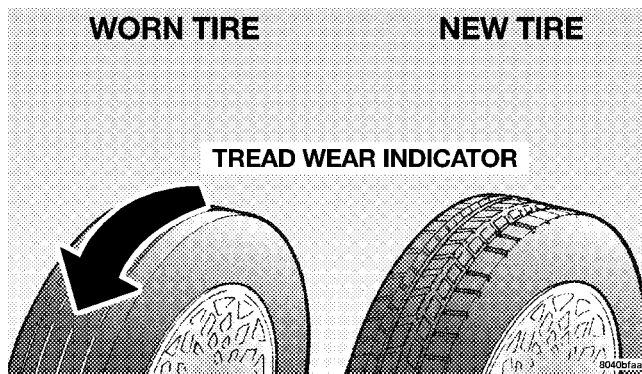

These indicators are molded into the bottom of the tread grooves and will appear as bands when the tread depth becomes 1/16 inch (2 mm). When the indicators appear in 2 or more adjacent grooves, the tire should be replaced.

Many states have laws requiring tire replacement at this point.

Replacement Tires

The tires on your new vehicle provide a balance of many characteristics. They should be inspected regularly for wear and correct cold tire inflation pressure. The manufacturer strongly recommends that you use tires equivalent to the originals in size, quality and performance when replacement is needed (see the paragraph on tread wear indicators). Refer to the Tire and Loading Information placard for the size designation of your tire. The service description and load identification will be found on the original equipment tire. Failure to use equivalent replacement tires may adversely affect the safety, handling, and ride of your vehicle. We recommend that you contact your original equipment or an authorized tire dealer with any questions you may have on tire specifications or capability.

WARNING!

- Do not use a tire, wheel size or rating other than that specified for your vehicle. Some combinations of unapproved tires and wheels may change suspension dimensions and performance characteristics, resulting in changes to steering, handling, and braking of your vehicle. This can cause unpredictable handling and stress to steering and suspension components. You could lose control and have an accident resulting in serious injury or death. Use only the tire and wheel sizes with load ratings approved for your vehicle.
- Never use a tire with a smaller load index or capacity, other than what was originally equipped on your vehicle. Using a tire with a smaller load index could result in tire overloading and failure. You could lose control and have an accident.
- Failure to equip your vehicle with tires having adequate speed capability can result in sudden tire failure and loss of vehicle control.

CAUTION!

Replacing original tires with tires of a different size may result in false speedometer and odometer readings.

Alignment And Balance

Poor suspension alignment may result in:

- fast tire wear;
- uneven tire wear, such as feathering and one-sided wear;
- vehicle pull to right or left.

Tires may also cause the vehicle to pull to the left or right. Alignment will not correct this condition. See your dealer for proper diagnosis.

Improper alignment will not cause vehicle vibration. Vibration may be a result of tire and wheel out-of-balance. Proper balancing will reduce vibration and avoid tire cupping and spotty wear.

ALL WHEEL DRIVE (AWD) — IF EQUIPPED

CAUTION!

All Wheel Drive (AWD) vehicles must have the same size and type tires on all wheel positions. Unequal tire sizes must not be used. Unequal tire size may cause failure of the power transfer unit and/or the viscous coupling.

TIRE PRESSURE MONITOR SYSTEM — IF EQUIPPED

The Tire Pressure Monitor System (TPM) system uses wireless technology with wheel rim mounted electronic sensors to monitor tire pressure levels (EXCLUDING THE SPARE TIRE). Sensors, mounted to each wheel as part of the valve stem, transmit tire pressure readings to a receiver located in the overhead console.

NOTE: The tire pressure monitoring system on your vehicle will warn you when one of your tires is significantly underinflated and when some combinations of your tires are significantly underinflated. However, there are other combinations of significantly underinflated tires for which your tire pressure monitoring system may not warn you. These other combinations are relatively common, accounting for approximately half the instances in which vehicles have significantly underinflated tires. For example, your system may not warn you when both tires on the same side or on the same axle of your vehicle

are significantly underinflated. It is particularly important, therefore, for you to check the tire pressure in all of your tires regularly and maintain proper pressure.

1,2,3, OR 4 TIRE(S) LOW PRESSURE

Low tire pressure levels of 28 psi [1.9 bars] (193 kPa) or less detected in one or more tires.

Inspect all tires for proper inflation pressure, once proper tire pressure has been set the TPM system warning will reset automatically once ignition switch has been turned ON.

1,2,3, OR 4 TIRE(S) HIGH PRESSURE

High tire pressure levels of 48 psi [3.3 bars] (330 kPa) or more detected in one or more tires.

Inspect all tires for proper inflation pressure, once proper tire pressure has been set the TPM system warning will reset automatically once ignition switch has been turned ON.

SERVICE TIRE PRESSURE SYSTEM/SEE OWNER'S MANUAL

The Tire Pressure Monitor System (TPM) system requires service.

See your authorized dealer for service.

TIRE PRESSURE UNAVAILABLE

The TPM system function is temporarily unavailable due to external electromagnetic interference, such as portable electronic devices, or near by radio or TV towers.

Move the vehicle to an area free from radio, TV antennas and transmitting towers or disconnect any portable electronic devices, once the external interference is removed the TPM system will resume normal operation and "TIRE PRESSURE NOW AVAILABLE" will appear in the overhead console display.

TIRE PRESSURE NOW AVAILABLE

The TPM system is functioning normally and the external interference is no longer affecting the system.

SPARE TIRE IN USE? YES/NO

The TPM system requires more information to determine the correct mode of operation, one or more of the vehicle active tires has been replaced by the spare, a wheel rim not equipped with a TPM sensor or the TPM system requires service.

If the spare tire or non TPM sensor equipped wheel rim is in active use (mounted on the vehicle), answer YES and the TPM system will resume normal operation.

If the spare tire or non TPM sensor equipped wheel rim is **NOT** in active use (mounted on the vehicle), answer NO and the TPM system will resume normal operation.

ALL 5 TIRES WITH CAR? YES/NO

The TPM system requires more information to determine the correct mode of operation, one or more of the vehicle active tires has been replaced by the spare, a wheel rim not equipped with a TPM sensor or the TPM system requires service.

If the spare tire or non TPM sensor equipped wheel rim is in active use (mounted on the vehicle), answer YES and the TPM system will resume normal operation.

If the spare tire or non TPM sensor equipped wheel rim is **NOT** in active use (mounted on the vehicle), answer NO and the TPM system will resume normal operation.

CAUTION!

The TPM system has been optimized for the original equipment tires and wheels. TPM system pressures have been established for the tire size equipped on your vehicle. Undesirable operation or sensor damage may result when using replacement equipment that is not of the same size, type, and/or style. After-market wheels can cause sensor damage. Do not use tire sealant or balance beads if your vehicle is equipped with TPM system as damage to the sensors may result.

NOTE:

- The TPM system can inform the driver of a low tire pressure condition of 28 psi [1.9 bars] (193 kPa) or less, or high a tire pressure condition of 48 psi [3.3 bars] (330 kPa) or more.

- The TPM system is not intended to replace normal tire care and maintenance, nor to provide warning of a tire failure or condition.
- The TPM system should not be used as a tire pressure gauge while adjusting your tire pressure.
- The TPM system must be retrained after a tire rotation or wheel rim mounted sensor replacement. See your authorized dealer for service.

CAUTION!

After inspecting or adjusting the tire pressure always reinstall the valve stem cap. This will prevent moisture and dirt entry into the valve stem, which could damage the wheel rim sensor.

General Information

This device complies with part 15 of the FCC rules and RSS 210 of Industry Canada. Operation is subject to the following conditions:

- This device may not cause harmful interference.
- This device must accept any interference received, including interference that may cause undesired operation.

The tire pressure sensors are covered under one of the following licenses:

United States KR5S120123
 Canada 2671-S120123

TIRE CHAINS

Use only compact chains, or other traction aids that meet SAE type “Class S” specifications. Chains must be the proper size for the vehicle, as recommended by the chain manufacturer.

NOTE: Do not use tire chains on a compact spare tire.

CAUTION!

To avoid damage to your vehicle or tires, observe the following precautions:

- Because of restricted chain clearance between tires and other suspension components, it is important that only chains in good condition are used. Broken chains can cause serious damage. Stop the vehicle immediately if noise occurs that could indicate chain breakage. Remove the damaged parts of the chain before further use.
- Install chains on the front wheels as tightly as possible and then retighten after driving about ½ mile (0.8 km).
- Do not exceed 45 mph (70 km/h).
- Drive cautiously and avoid severe turns and large bumps, especially with a loaded vehicle.
- Do not use on rear wheels of All Wheel Drive (AWD) vehicles.
- Do not drive for prolonged period on dry pavement.
- Observe the tire chain manufacturer's instructions on the method of installation, operating speed, and conditions for use. Always use the lower suggested operating speed of the chain manufacturer if different than the speed recommended by the manufacture.

NOTE: In order to avoid damage to tires, chains, and your vehicle do not drive for a prolonged period of time on dry pavement. Observe the tire chain manufacturer's instructions on method of installation, operating speed, and conditions for usage.

Always use the lower suggested operating speed if both the chain manufacturer and vehicle manufacture suggest a maximum speed. This notice applies to all chain traction devices, including link and cable (radial) chains.

SNOW TIRES

Some areas of the country require the use of snow tires during winter. Standard tires are of the all season type and satisfy this requirement as indicated by the M+S designation on the tire side wall.

If you need snow tires, select tires equivalent in size and type to the original equipment tires. Use snow tires only in sets of 4, failure to do so may adversely affect the safety and handling of your vehicle.

Snow tires generally have lower speed ratings than what was originally equipped with your vehicle and should not be operated at sustained speeds over 75 mph (120 km/h).

TIRE ROTATION RECOMMENDATIONS

Tires on the front and rear axles of vehicles operate at different loads and perform different steering, driving, and braking functions. For these reasons, they wear at unequal rates, and tend to develop irregular wear patterns.

These effects can be reduced by timely rotation of tires. The benefits of rotation are especially worthwhile with aggressive tread designs such as those on all season type tires. Rotation will increase tread life, help to maintain mud, snow, and wet traction levels, and contribute to a smooth, quiet ride.

Follow the recommended tire rotation frequency for your type of driving found in the “Maintenance Schedules”

Section of this manual. More frequent rotation is permissible if desired. The reasons for any rapid or unusual wear should be corrected prior to rotation being performed.

NOTE: The Tire Pressure Monitor system must be retrained following a tire rotation. See your authorized dealer for service.

The suggested rotation method is the “forward-cross” shown in the following diagram.

TIRE ROTATION PATTERN

← FRONT OF VEHICLE

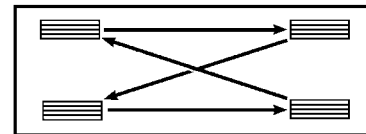

4 TIRE ROTATION

FUEL REQUIREMENTS



Your vehicle is designed to meet all emission regulations and provide excellent fuel economy when using high quality regular unleaded gasoline with an octane rating of 87. The use of premium gasoline is not recommended. The use of premium gasoline will provide no benefit over high quality regular gasolines, and in some circumstances, may result in poorer performance.

Light spark knock at low engine speeds is not harmful to your engine. However, continued heavy spark knock at high speeds can cause damage and immediate service is required. Engine damage resulting from operating with a heavy spark knock may not be covered by the new vehicle warranty.

Poor quality gasoline can cause problems such as hard starting, stalling and hesitations. If you experience these symptoms, try another brand of “regular” gasoline before considering service for the vehicle.

Over 40 automobile manufacturers around the world have issued and endorsed consistent gasoline specifications (the World Wide Fuel Charter, WWFC) to define fuel properties necessary to deliver enhanced emissions, engine performance, and durability for your vehicle. The manufacturer recommends the use of gasolines that meet the WWFC specifications if they are available.

Reformulated Gasoline

Many areas of the country require the use of cleaner burning gasoline referred to as “Reformulated Gasoline”.

Reformulated gasolines contain oxygenates, and are specifically blended to reduce vehicle emissions and improve air quality.

The manufacturer supports the use of reformulated gasolines. Properly blended reformulated gasolines will provide excellent performance and durability of engine and fuel system components.

Gasoline/Oxygenate Blends

Some fuel suppliers blend unleaded gasoline with oxygenates such as 10% ethanol, MTBE, and ETBE. Oxygenates are required in some areas of the country during the winter months to reduce carbon monoxide emissions. Fuels blended with these oxygenates may be used in your vehicle.

CAUTION!

DO NOT use gasolines containing Methanol. Use of these blends may result in starting and driveability problems and may damage critical fuel system components.

Problems that result from using methanol/gasoline blends are not the responsibility of the manufacturer and may not be covered by the vehicle warranty. While MTBE is an oxygenate made from Methanol, it does not have the negative effects of Methanol.

MMT In Gasoline

MMT is a manganese containing metallic additive that is blended into some gasoline to increase the octane number. Gasolines blended with MMT offer no performance advantage beyond gasolines of the same octane number without MMT. Gasolines blended with MMT have shown to reduce spark plug life and reduce emission system performance in some vehicles. The manufacturer recommends using gasolines without MMT. Since the MMT content of gasoline may not be indicated on the pump, you should ask your gasoline retailer whether or not his/her gasoline contains MMT.

It is even more important to look for gasolines without MMT in Canada, because MMT can be used at levels higher than those allowed in the United States.

MMT is prohibited in Federal and California reformulated gasolines.

Sulfur In Gasoline

Your vehicle may have been designed to meet California low emission standards when using cleaner burning California reformulated gasoline with low sulfur. This vehicle may be sold nationwide. Your vehicle will operate satisfactorily on fuels meeting Federal specification, but emission control system performance may be adversely affected.

Gasoline sold outside of California is permitted to have higher sulfur levels which may affect the performance of the vehicle's catalytic converter. This may cause the Malfunction Indicator Light to illuminate. The manufacturer recommends that you try a different brand of

unleaded gasoline having lower sulfur to determine if the problem is fuel related prior to returning your vehicle to an authorized dealer for service.

CAUTION!



If the Malfunction Indicator light is flashing, immediate service is required. Refer to the paragraph on the Onboard Diagnostics System in section 7 of this manual.

Materials Added to Fuel

All gasoline sold in the United States is required to contain effective detergent additives. Use of additional detergents or other additives are not needed under normal conditions and would result in additional cost. Therefore you should not have to add anything to the fuel.

Fuel System Cautions**CAUTION!**

Follow these guidelines to maintain your vehicle's performance:

- The use of leaded gas is prohibited by Federal law. Using leaded gasoline can impair engine performance, damage the emission control system, and could result in loss of warranty coverage.
- An out-of-tune engine, or certain fuel or ignition malfunctions, can cause the catalytic converter to overheat. If you notice a pungent burning odor or some light smoke, your engine may be out-of-tune or malfunctioning and may require immediate service. Contact your dealer for service assistance.

- The use of fuel additives which are now being sold as octane enhancers are not recommended. Most of these products contain high concentrations of methanol. Fuel system damage or vehicle performance problems resulting from the use of such fuels or additives are not the responsibility of the manufacturer and may not be covered under the New Vehicle Warranty.

NOTE: Intentional tampering with emissions control systems can result in civil penalties being assessed against you.

Carbon Monoxide Warnings**WARNING!**

Carbon monoxide (CO) in exhaust gases is deadly. Follow the precautions below to prevent carbon monoxide poisoning:

- Do not inhale exhaust gases. They contain carbon monoxide, a colorless and odorless gas which can kill. Never run the engine in a closed area, such as a garage, and never sit in a parked vehicle with the engine running for an extended period. If the vehicle is stopped in an open area with the engine running for more than a short period, adjust the ventilation system to force fresh, outside air into the vehicle.
- Guard against carbon monoxide with proper maintenance. Have the exhaust system inspected every time the vehicle is raised. Have any abnormal conditions repaired promptly. Until repaired, drive with all side windows fully open.
- Keep the liftgate closed when driving your vehicle to prevent carbon monoxide and other poisonous exhaust gases from entering the vehicle.

ADDING FUEL

Fuel Filler Cap (Gas Cap)

The gas cap is behind the fuel filler door on the left side of the vehicle. If the gas cap is lost or damaged, be sure the replacement cap is for use with this vehicle.

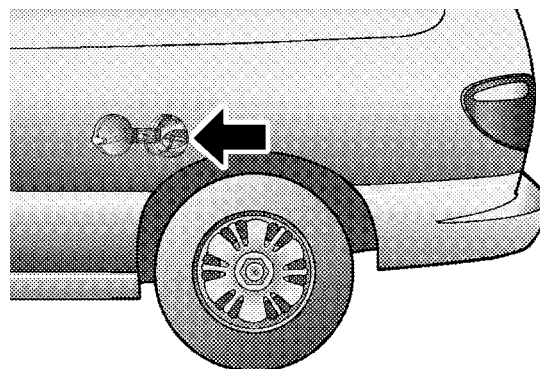

CAUTION!

Damage to the fuel system or emission control system could result from using an improper fuel tank filler tube cap (gas cap). A poorly fitting cap could let impurities into the fuel system.

NOTE: The driver's side sliding door cannot be opened while the fuel door is open. This feature operates only when the sliding door is fully closed prior to opening the fuel door.

The fuel tank filler tube, on vehicles equipped with a catalytic converter, has a restricting door about 50 mm (2 inches) inside the opening. If using a portable fuel container, it should have a flexible nozzle long enough to force open the restricting door.

CAUTION!

To avoid fuel spillage and overfilling, do not "top off" the fuel tank after filling.

NOTE:

- Tighten the gas cap until you hear a "clicking" sound. This is an indication that the gas cap is properly tightened. If the gas cap is not secured properly the Malfunction Indicator Light will turn on. Make sure that the gas cap is tightened each time the vehicle is refueled.
- When the fuel nozzle "clicks" or shuts off, the fuel tank is full.

WARNING!

- Remove the fuel tank filler tube cap (gas cap) slowly to prevent fuel spray from the filler neck which may cause injury.
- The volatility of some gasolines may cause a buildup of pressure in the fuel tank that may increase while you drive. This pressure can result in a spray of gasoline and/or vapors when the cap is removed from a hot vehicle. Removing the cap slowly allows the pressure to vent and prevents fuel spray.
- Never have any smoking materials lit in or near the vehicle when the gas cap is removed or the tank filled.
- Never add fuel to the vehicle when the engine is running.
- A fire may result if gasoline is pumped into a portable container that is inside of a vehicle. You could be burned. Always place gas containers on the ground while filling.

VEHICLE LOADING

The load carrying capacity of your vehicle is shown in the charts that follow. This information should be used for passenger and luggage loading as indicated.

If seats are removed for carrying cargo, do not exceed the specified GVWR and GAWR.

Vehicle Certification Label

Your vehicle has a certification label attached to the driver's door pillar.

The label contains the following information:

- Name of manufacturer
- Month and year of manufacture
- Gross Vehicle Weight Rating (GVWR)
- Gross Axle Weight Rating (GAWR) front
- Gross Axle Weight Rating (GAWR) rear

- Vehicle Identification Number (VIN)
- Type of Vehicle
- Month Day and Hour of Manufacture (MDH)

The bar code allows a computer scanner to read the Vehicle Identification Number (VIN).

Gross Vehicle Weight Rating (GVWR)

The GVWR is the total allowable weight of your vehicle. This includes driver, passengers, and cargo. The total load must be limited so that you do not exceed the GVWR.

Gross Axle Weight Rating (GAWR)

The GAWR is the maximum capacity of the front and rear axles. Distribute the load over the front and rear axles evenly. Make sure that you do not exceed either front or rear GAWR.

WARNING!

Because the front wheels drive and steer the vehicle, it is important that you do not exceed the maximum front or rear GAWR. A dangerous driving condition can result if either rating is exceeded. You could lose control of the vehicle and have an accident.

Overloading

The load carrying components (axle, springs, tires, wheels, etc.) of your vehicle will provide satisfactory service as long as you do not exceed the GVWR and front and rear GAWR.

The best way to figure out the total weight of your vehicle is to weigh it when it is fully loaded and ready for operation. Weigh it on a commercial scale to insure that it is not over the GVWR.

Figure out the weight on the front and rear of the vehicle separately. It is important that you distribute the load evenly over the front and rear axles.

Overloading can cause potential safety hazards and shorten useful service life. Heavier axles or suspension components do not necessarily increase the vehicle's GVWR.

Loading

To load your vehicle properly, first figure out its empty weight, axle by axle and side by side. Store heavier items down low and be sure you distribute their weight as evenly as possible. Stow all loose items securely before driving. If weighing the loaded vehicle shows that you have exceeded either GAWR, but the total load is within the specified GVWR, you must redistribute the weight. Improper weight distribution can have an adverse effect on the way your vehicle steers and handles and the way the brakes operate.

A loaded vehicle is shown in the illustration. Note that neither the GVWR or the GAWR capacities have been exceeded.

**GROSS VEHICLE WEIGHT RATING (GVWR) 5050 LBS.
(Example Only)**

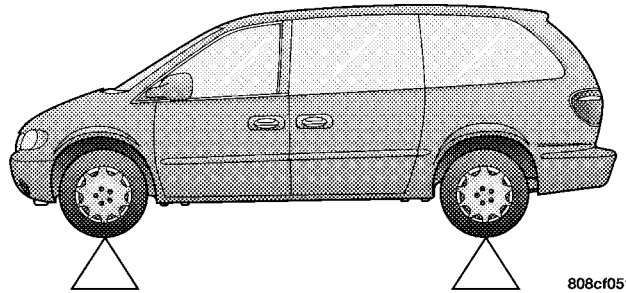

808c051

	Front Axle	Rear Axle
Empty Weight	2140 lbs	1470 lbs
Load (Including driver, passengers and cargo)	360 lbs	980 lbs
Total	2500 lbs	2450 lbs
GAWR	2544 lbs	2544 lbs

TRAILER TOWING

In this section you will find safety tips and information on limits to the type of towing you can reasonably do with your vehicle. Before towing a trailer carefully review this information to tow your load as efficiently and safely as possible.

To maintain warranty coverage, follow the requirements and recommendations in this manual concerning vehicles used for trailer towing.

Perform maintenance services as prescribed in the maintenance schedules manual. When your vehicle is used for trailer towing, never exceed the gross axle weight rating (GAWR) by the addition of:

- The tongue weight of the trailer.
- The weight of any other type of cargo or equipment put in or on your vehicle.
- Remember that everything put in or on the trailer adds to the load on your vehicle.

Warranty Requirements

The Manufacturer's Passenger Vehicle Warranty will apply to vehicles used to tow trailers for non-commercial use. However the following conditions must be met:

- The maximum frontal area of the trailer cannot exceed 20 square feet (1.86 square meters).

- The trailer tongue load must be considered as part of the combined weight of occupants and cargo, and should never exceed the weight referenced on the Tire and Loading Information placard. Refer to the Tire-Safety Information Section in this manual.
- The “D” range can be selected when towing. However, if frequent shifting occurs while in this range, the “3” range must be selected.

NOTE: Using the “3” range while operating the vehicle under heavy operating conditions will improve performance and extend transaxle life by reducing excessive shifting and heat build up.

WARNING!

Connecting trailer brakes to your vehicle’s hydraulic brake lines can overload your brake system and cause it to fail. You might not have brakes when you need them and could have an accident.

- Do not attempt to tow a trailer while using a compact spare tire.
- Whenever you pull a trailer, regardless of the trailer size, stop lights and turn signals on the trailer are recommended for motoring safety.
- The automatic transaxle fluid and filter should be changed if you REGULARLY tow a trailer for more than 45 minutes of continuous operation. See Schedule “B” in section 8 of this manual for transaxle fluid change intervals.

NOTE: Check the automatic transaxle fluid level before towing. Fluid discoloration, or a burnt odor, shows the need for a transmission fluid and filter change.

TRAVEL CONDITION	MAXIMUM TRAILER WEIGHT (TRAILER FRONTAL AREA NOT TO EXCEED 32 SQ. FT.)				
	2.4L ENGINES	3.3L, & 3.8L ENGINES	3.3L & 3.8L ENGINES WITH HEAVY DUTY TRAILER TOW PACKAGE	3.8L ENGINES	3.8L ENGINES WITH HEAVY DUTY TRAILER TOW PACKAGE
	MAX. COMBINED WEIGHT OF VEHICLE AND TRAILER NOT TO EXCEED 5,200 lbs (2358 kg)	MAX. COMBINED WEIGHT OF VEHICLE AND TRAILER NOT TO EXCEED 6,600 lbs (2993 kg)	MAX. COMBINED WEIGHT OF VEHICLE AND TRAILER NOT TO EXCEED 8,600 lbs (3900 kg)	MAX. COMBINED WEIGHT OF VEHICLE AND TRAILER NOT TO EXCEED 6,600 lbs (2993 kg)	MAX. COMBINED WEIGHT OF VEHICLE AND TRAILER NOT TO EXCEED 8,600 lbs (3900 kg)
	ALL MODELS	FWD	FWD	AWD	AWD
UP TO 2 PERSONS & LUGGAGE	850 lbs (385 kg)	1,800 lbs (816 kg)	3,800 lbs (1723 kg)	1,550 lbs (703 kg)	3,550 lbs (1610 kg)
3 TO 5 PERSONS & LUGGAGE	400 lbs (181 kg)	1,350 lbs (612 kg)	3,350 lbs (1519 kg)	1,100 lbs (498 kg)	3,100 lbs (1406 kg)
6 TO 7 PERSONS & LUGGAGE	Not Recommended	1,000 lbs (454 kg)	3,000 lbs (1360 kg)	750 lbs (340 kg)	2,750 lbs (1247 kg)

A load equalizing hitch is recommended for loaded trailer weights above 1,000 lbs (454 kg) and required for weights above 2,000 lbs (907 kg).

CAUTION!

If the trailer weighs more than 1,000 lbs (454 kg) loaded, it should have its own brakes and they should be of adequate capacity. Failure to do this could lead to accelerated brake lining wear, higher brake pedal effort, and longer stopping distances.

WARNING!

Connecting trailer brakes to your vehicle's hydraulic brake lines can overload your brake system and cause it to fail. You might not have brakes when you need them and could have an accident.

WHAT TO DO IN EMERGENCIES

CONTENTS

■ Hazard Warning Flasher	280	□ Traction	290
■ If Your Engine Overheats	281	■ Freeing A Stuck Vehicle	291
■ Jacking And Tire Changing	282	■ Towing A Disabled Vehicle	291
□ Jack Location	283	□ With Ignition Key	291
□ Spare Tire Stowage	283	□ Without The Ignition Key	293
□ Preparations For Jacking	284	□ Towing This Vehicle Behind Another Vehicle (Flat Towing With All Four Wheels On The Ground)	293
□ Jacking Instructions	285	□ Towing This Vehicle Behind Another Vehicle With A Tow Dolley	293
■ Jump-Starting Procedures If Battery Is Low	288		
■ Driving On Slippery Surfaces	290		
□ Acceleration	290		

HAZARD WARNING FLASHER

The hazard flasher switch is located in the center of the instrument panel above the radio.

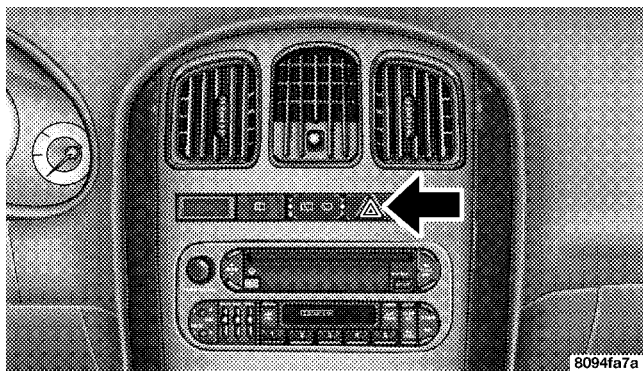

To engage the Hazard Warning Flashers, depress the switch on the instrument panel. When the Hazard Warning Switch is activated, all directional turn signals will

flash on and off to warn oncoming traffic of an emergency. Push the switch a second time to turn off the flashers.

This is an emergency warning system and should not be used when the vehicle is in motion. Use it when your vehicle is disabled and is creating a safety hazard for other motorists.

When you must leave the vehicle to seek assistance, the Hazard Warning Flashers will continue to operate even though the ignition switch is OFF.

NOTE: With extended use, the Hazard Warning Flashers may wear down your battery.

IF YOUR ENGINE OVERHEATS

In any of the following situations, you can reduce the potential for overheating by taking the appropriate action.

- On the highways — Slow down.
- In city traffic — While stopped, put transaxle in neutral, but do not increase engine idle speed.

NOTE: There are steps that you can take to slow down an impending overheat condition. If your air conditioner is on, turn it off. The air conditioning system adds heat to the engine cooling system and turning off the A/C removes this heat. You can also turn the Temperature control to maximum heat, the Mode control to floor, and the fan control to High. This allows the heater core to act as a supplement to the radiator and aids in removing heat from the engine cooling system.

CAUTION!

Driving with a hot cooling system could damage your vehicle. If temperature gauge reads “H”, pull over and stop the vehicle. Idle the vehicle with the air conditioner turned off until the pointer drops back into the normal range. If the pointer remains on the “H”, turn the engine off immediately, and call for service.

WARNING!

A hot engine cooling system is dangerous. You or others could be badly burned by steam or boiling coolant. You may want to call a service center if your vehicle overheats. If you decide to look under the hood yourself, see Section 7, Maintenance, of this manual. Follow the warnings under the Cooling System Pressure Cap paragraph.

JACKING AND TIRE CHANGING**WARNING!**

- Getting under a jacked-up vehicle is dangerous. The vehicle could slip off the jack and fall on you. You could be crushed. Never get any part of your body under a vehicle that is on a jack. If you need to get under a raised vehicle, take it to a service center where it can be raised on a lift.
- The jack is designed to use as a tool for changing tires only. The jack should not be used to lift the vehicle for service purposes. The vehicle should be jacked on a firm level surface only. Avoid ice or slippery areas.

Jack Location

The jack and jack-handle are stowed behind the rear left side trim panel in the cargo area. Pull up on the lever to release the cover.

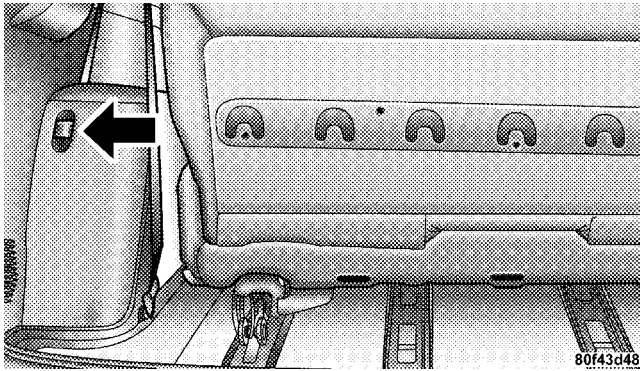

Spare Tire Stowage

The spare tire is stowed under the rear of the vehicle by means of a cable winch mechanism. To remove or stow the spare, use the jack handle to rotate the “spare tire drive” nut. The nut is located under the plastic cover at the center-rear of the cargo floor area, just inside the liftgate opening.

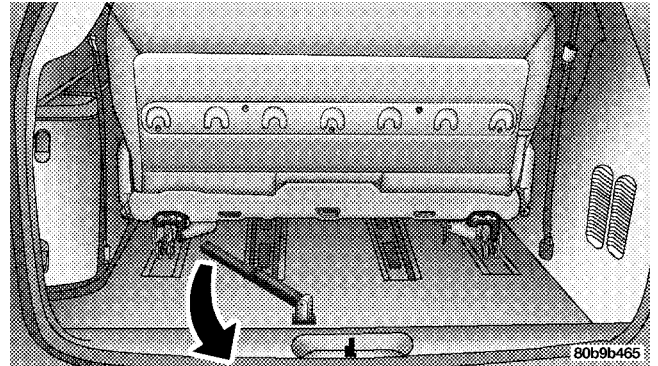

Spare Tire Removal

Fit the jack-handle over the drive nut. Rotate the nut to the left until the spare is on the ground with enough slack cable to allow you to pull the tire out from under the vehicle.

CAUTION!

The winch mechanism is designed for use with the jack handle only. Use of an air wrench or other power tools is not recommended and can damage the winch.

When the spare is clear, tilt the retainer at the end of the cable and pull it through the center of the wheel.

Preparations For Jacking

Park the vehicle on a firm level surface, avoid ice or slippery areas, **set the parking brake** and place the gear selector in PARK. Turn OFF the ignition.

WARNING!

Do not attempt to change a tire on the side of the vehicle close to moving traffic. Pull far enough off the road to avoid the danger of being hit when operating the jack or changing the wheel.

- Turn on the Hazard Warning Flasher.

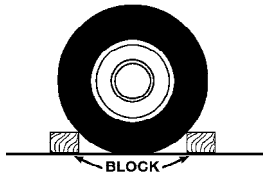

- Block both the front and rear of the wheel diagonally opposite the jacking position. For example, if changing the right front tire, block the left rear wheel.

- Passengers should not remain in the vehicle when the vehicle is being jacked.

Jacking Instructions

1. Remove the spare wheel, scissors jack and jack-handle from stowage.
2. Loosen (but do not remove) the wheel lug nuts by turning them to the left one turn while the wheel is still on the ground.
3. There are two jack engagement locations on each side of the body — see illustration.

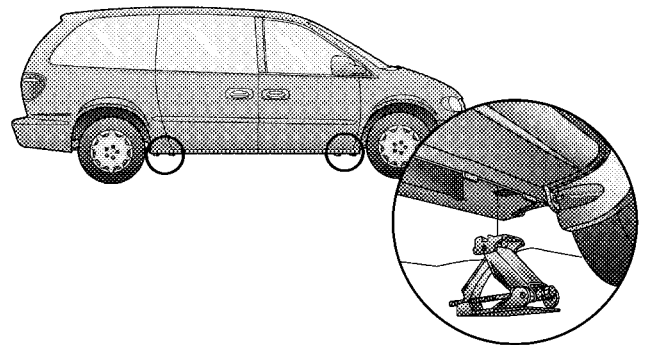

808cf09a

4. These locations are on the sill flange of the body and consist of a pair of downstanding tabs. The jack is to be located, engaging the flange, between the pair of tabs closest to the wheel to be changed. Place the wrench on the jack screw and turn to the right until the jack head is

properly engaged in the described location. **Do not raise the vehicle until you are sure the jack is securely engaged.**

5. Raise the vehicle by turning the jack screw to the right, using the swivel wrench. Raise the vehicle only until the tire just clears the surface and enough clearance is obtained to install the spare tire. Minimum tire lift provides maximum stability.

WARNING!

Raising the vehicle higher than necessary can make the vehicle less stable. It could slip off the jack and hurt someone near it. Raise the vehicle only enough to remove the tire.

6. Remove the wheel lug nuts, for vehicles with wheel covers, remove the cover from the wheel by hand. Do not pry the wheel cover off. Then pull the wheel off the hub.

7. Install the spare wheel, for vehicles with wheel covers, align the notch in the wheel cover with the valve stem on the wheel. Install the cover on the wheel by hand only and install the wheel lug nuts with the cone shaped end of the nut toward the wheel. Lightly tighten the nuts. To avoid the risk of forcing the vehicle off the jack, do not tighten the lug nuts fully until the vehicle has been lowered.

NOTE: Do not install the wheel cover on the compact spare.

Do not use a hammer or force to install the wheel covers.

8. Lower the vehicle by turning the jack screw to the left.

9. Finish tightening the lug nuts. Push down on the wrench while tightening for increased leverage. Alternate nuts until each nut has been tightened twice. Correct wheel nut tightness is 130 N·m (95 ft. lbs). If in doubt

about the correct tightness, have them checked with a torque wrench by your dealer or at a service station.

10. Lower the jack to its fully closed position.

WARNING!

A loose tire or jack, thrown forward in a collision or hard stop could endanger the occupants of the vehicle. Always stow the jack parts and the spare tire in the places provided.

11. Secure the flat or spare tire as follows:

- If your vehicle is equipped with cast aluminum wheels, the center cap of the wheel must be removed prior to flat tire stowage. Store the center cap inside the glove box or other storage compartment.

- Turn the wheel so that the valve-stem is down. Slide the wheel retainer through the center of the wheel and position it properly across the wheel opening.
- For convenience in checking the spare tire inflation, stow with the valve-stem toward the rear of the vehicle.
- Using the jack-handle, rotate the drive nut to the right until the wheel is drawn into place against the underside of the vehicle.
- Continue to rotate the nut until you hear the mechanism click three times. It cannot be overtightened. Push against the tire several times to be sure it is securely in place.

12. Stow jack and handle.

13. Check the tire pressure as soon as possible. Correct pressure as required.

JUMP-STARTING PROCEDURES IF BATTERY IS LOW**WARNING!**

Take care to avoid the radiator cooling fan whenever the hood is raised. It can start anytime the ignition switch is on. You can be hurt by the fan.

WARNING!

- Do not attempt to push or tow your vehicle to get it started. Vehicles equipped with an automatic transmission cannot be started this way. Unburned fuel could enter the catalytic converter and once the engine has started, ignite and damage the converter and vehicle. If the vehicle has a discharged battery, booster cables may be used to obtain a start from another vehicle. This type of start can be dangerous if done improperly, so follow this procedure carefully.
- Battery fluid is a corrosive acid solution; do not allow battery fluid to contact eyes, skin or clothing. Don't lean over battery when attaching clamps or allow the clamps to touch each other. If acid splashes in eyes or on skin, flush contaminated area immediately with large quantities of water.
- A battery generates hydrogen gas which is flammable and explosive. Keep flame or spark away from the vent holes. Do not use a booster battery or any other booster source with an output that exceeds 12 volts.

1. Wear eye protection and remove any metal jewelry such as watch bands or bracelets that might make an inadvertent electrical contact.
2. When boost is provided by a battery in another vehicle, park that vehicle within booster cable reach and without letting the vehicles touch. Set the parking brake, place the automatic transmission in PARK and turn the ignition switch to the OFF position for both vehicles.
3. Turn off the heater, radio and all unnecessary electrical loads.
4. Connect one end of a jumper cable to the positive terminal of the discharged battery. Connect the other end of the same cable to the positive terminal of the booster battery.
5. Connect the other cable, first to the negative terminal of the booster battery and **then to the engine of the vehicle with the discharged battery**. Make sure you have a good contact on the engine.
6. Start the engine in the vehicle which has the booster battery, let the engine idle a few minutes, then start the engine in the vehicle with the discharged battery.
7. When removing the jumper cables, reverse the above sequence exactly. Be careful of the moving belts and fan.

DRIVING ON SLIPPERY SURFACES

Acceleration

Rapid acceleration on snow covered, wet, or other slippery surfaces may cause the front wheels to pull erratically to the right or left. This phenomenon occurs when there is a difference in the surface traction under the front (driving) wheels.

WARNING!

Rapid acceleration on slippery surfaces is dangerous. Unequal traction can cause sudden pulling of the front wheels. You could lose control of the vehicle and possibly have an accident. Accelerate slowly and carefully whenever there is likely to be poor traction (ice, snow, wet mud, loose sand, etc.).

Traction

When driving on wet or slushy roads, it is possible for a wedge of water to build up between the tire and road surface. This is known as hydroplaning and may cause partial or complete loss of vehicle control and stopping ability. To reduce this possibility, the following precautions should be observed:

1. Slow down during rainstorms or when roads are slushy.
2. Slow down if road has standing water or puddles.
3. Replace tires when tread wear indicators first become visible.
4. Keep tires properly inflated.
5. Maintain sufficient distance between your vehicle and the vehicle in front to avoid a collision in a sudden stop.

FREEING A STUCK VEHICLE

If your vehicle becomes stuck in mud, sand or snow, it can often be moved by a rocking motion. Turn your steering wheel right and left to clear the area around the front wheels. Then shift back and forth between Reverse and Drive. Usually the least accelerator pedal pressure to maintain the rocking motion without spinning the wheels is most effective.

WARNING!

Fast spinning tires can be dangerous. Forces generated by excessive wheel speeds may cause tire damage or failure. A tire could explode and injure someone. Do not spin your vehicle's wheels faster than 35 mph (55 km/h) when you are stuck. And don't let anyone near a spinning wheel, no matter what the speed.

CAUTION!

Racing the engine or spinning the wheels too fast may lead to transmission overheating and failure. It can also damage the tires. Do not spin the wheels above 35 mph (55 km/h).

TOWING A DISABLED VEHICLE**With Ignition Key****Front Wheel Drive**

Your vehicle may be towed under the following conditions: The gear selector must be in NEUTRAL, the distance to be traveled must not exceed 100 miles (160 km), and the towing speed must not exceed 44 mph (72

km/h). Exceeding these towing limits may cause a transmission geartrain failure. If the transmission is not operative, or if the vehicle is to be towed more than 100 miles (160 km), the vehicle must be towed with the front wheels off the ground.

All Wheel Drive

Your vehicle may be towed under the following conditions: The gear selector must be in NEUTRAL, the distance to be traveled must not exceed 100 miles (160 km), the towing speed must not exceed 44 mph (72 km/h), and both front and rear wheels must be on the ground. If your vehicle must be towed farther or at a higher rate of speed, it must be transported on a flat bed truck.

All Transmissions

CAUTION!

- **Do not attempt to tow this vehicle from the front with sling type towing equipment. Damage to the front fascia will result.**
- **Always use wheel lift equipment when towing from the front. The only other approved method of towing is with a flat bed truck.**
- **Do not tow the vehicle from the rear. Damage to the rear sheet metal, liftgate and fascia will occur.**
- **Do not push or tow this vehicle with another vehicle as damage to the bumper fascia and transmission may result.**
- **If the vehicle being towed requires steering, the ignition switch must be in the OFF position, not in the LOCK or ACCESSORY positions.**

If it is necessary to use the accessories while being towed (wipers, defrosters, etc.), the key must be in the ON position, not the ACCESSORY position. Make certain the transmission remains in NEUTRAL.

Without The Ignition Key

Special care must be taken when the vehicle is towed with the ignition in the LOCK position. The only approved method of towing with out the ignition key is with a flat bed truck. Proper towing equipment is necessary to prevent damage to the vehicle.

TOWING THIS VEHICLE BEHIND ANOTHER VEHICLE (Flat towing with all four wheels on the ground)

Flat towing of vehicles equipped with an automatic transmission, is only permitted within the limitations described in this section.

TOWING THIS VEHICLE BEHIND ANOTHER VEHICLE WITH A TOW DOLLEY

The manufacture **does not recommend** that you tow an All-Wheel Drive (AWD) or front wheel drive vehicle on a tow dolley. Vehicle damage may occur.

MAINTAINING YOUR VEHICLE

CONTENTS

■ 2.4L Engine	298	□ Engine Oil Filter	307
■ 3.3L/3.8L Engines	299	□ Drive Belts — Check Condition And Tension . .	307
■ Onboard Diagnostic System — OBD II	300	□ Spark Plugs	308
■ Emissions Inspection And Maintenance Programs	301	□ Engine Air Cleaner Filter	308
■ Replacement Parts	302	□ Engine Fuel Filter	309
■ Dealer Service	302	□ Catalytic Converter	309
■ Maintenance Procedures	303	□ Maintenance-Free Battery	311
□ Engine Oil	303	□ Air Conditioner	312
		□ Power Steering — Fluid Check	314

□ Front Suspension Ball Joints	314	□ Fuel System Hoses	326
□ Steering Shaft Seal	314	□ Automatic Transmission	326
□ Steering Linkage	315	□ All Wheel Drive (AWD)	329
□ Drive Shaft Universal Joints	315	□ Front And Rear Wheel Bearings	330
□ Body Lubrication	315	□ Appearance Care And Protection From Corrosion	330
□ Windshield Wiper Blades	316	□ Cleaning The Instrument Panel And Underseat Cup Holders	334
□ Windshield And Rear Window Washers	316	■ Integrated Power Module (IPM)	336
□ Exhaust System	317	■ Vehicle Storage	337
□ Cooling System	318	■ Replacement Light Bulbs	338
□ Hoses And Vacuum/Vapor Harnesses	322	■ Bulb Replacement	339
□ Brakes	323	□ Headlights	339
□ Master Cylinder — ABS Brakes Brake Fluid Level Check	324		

□ Front Park/Turn Signal And Sidemarker Lights	340	■ Fluid Capacities	343
□ Front Fog Light	341	■ Recommended Fluids, Lubricants And Genuine Parts	344
□ Rear Tail, Stop, Turn Signal, Side Marker And Back-Up Lights	342	□ Engine	344
□ Center High Mounted Stop Light (CHMSL)	343	□ Chassis	345
□ License Light	343		

2.4L ENGINE

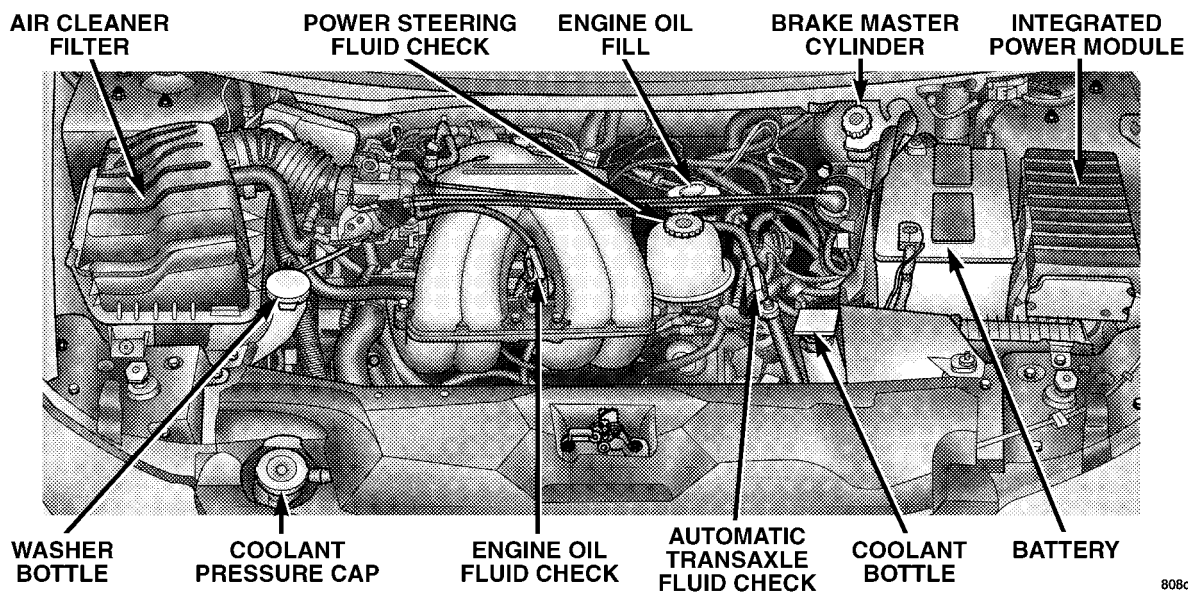

3.3L/3.8L ENGINES

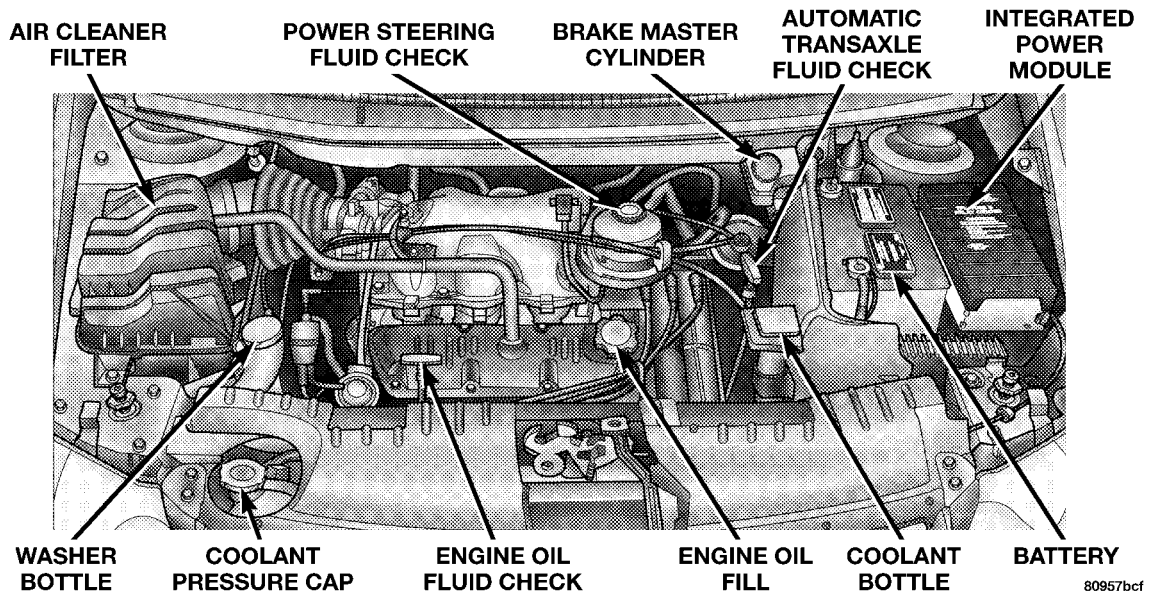

ONBOARD DIAGNOSTIC SYSTEM — OBD II

Your vehicle is equipped with a sophisticated onboard diagnostic system called OBD II. This system monitors the performance of the emissions, engine, and automatic transmission control systems. When these systems are operating properly, your vehicle will provide excellent performance and fuel economy, as well as engine emissions well within current government regulations.

If any of these systems require service, the OBD II system will turn on the “Malfunction Indicator Light.” It will also store diagnostic codes and other information to assist your service technician in making repairs. Although your vehicle will usually be drivable and not need towing, see your dealer for service as soon as possible.

CAUTION!

Prolonged driving with the “Malfunction Indicator Light” on could cause further damage to the emission control system. It could also affect fuel economy and driveability. The vehicle must be serviced before any emissions tests can be performed.

If the “Malfunction Indicator Light” is flashing while the engine is running, severe catalytic converter damage and power loss will soon occur. Immediate service is required.

EMISSIONS INSPECTION AND MAINTENANCE PROGRAMS

In some localities, it may be a legal requirement to pass an inspection of your vehicle's emissions control system. Failure to pass could prevent vehicle registration.



For states which have an I/M (Inspection and Maintenance) requirement, this check verifies the following: the MIL (Malfunction Indicator Lamp) is functioning and is not on when the engine is running, and that the OBD (On Board Diagnostic) system is ready for testing.

Normally, the OBD system will be ready. The OBD system may **not** be ready if your vehicle was recently serviced, if you recently had a dead battery, or a battery replacement. If the OBD system should be determined not ready for the I/M test, your vehicle may fail the test.

Your vehicle has a simple ignition key actuated test which you can use prior to going to the test station. To check if your vehicle's OBD system is ready, you must do the following:

1. Insert your ignition key into the ignition switch.
2. Turn the ignition to the ON position, but do not crank or start the engine.
3. If you crank or start the engine, you will have to start this test over.
4. As soon as you turn your key to the ON position, you will see your MIL symbol come on as part of a normal bulb check.
5. Approximately 15 seconds later, one of two things will happen:
 - a. The MIL will flash for about 10 seconds and then return to being fully illuminated until you turn off the

ignition key or start the engine. This means that your vehicle's OBD system is **not ready** and you should **not** proceed to the I/M station.

b. The MIL will not flash at all and will remain fully illuminated until you turn off the ignition key or start the engine. This means that your vehicle's OBD system is **ready** and you can proceed to the I/M station.

If your OBD system is **not ready**, you should see your authorized dealer or repair facility. If your vehicle was recently serviced or had a battery failure or replacement, you may need to do nothing more than drive your vehicle as you normally would in order for your OBD system to update. A recheck with the above test routine may then indicate that the system is now ready.

Regardless of whether your vehicle's OBD system is ready or not ready, if the MIL symbol is illuminated during normal vehicle operation, you should have your

vehicle serviced before going to the I/M station. The I/M station can fail your vehicle because the MIL symbol is on with the engine running.

REPLACEMENT PARTS

Use of genuine Mopar® parts for normal/scheduled maintenance and repairs is highly recommended to insure the designed performance. Damage or failures caused by the use of non-Mopar® parts for maintenance and repairs will not be covered by the manufacturer's warranty.

DEALER SERVICE

Your dealer has the qualified service personnel, special tools and equipment to perform all service operations in an expert manner. Service Manuals are available which include detailed service information for your vehicle. Refer to these manuals before attempting any procedure yourself.

NOTE: Intentional tampering with emissions control systems can result in civil penalties being assessed against you.

WARNING!

You can be badly injured working on or around a motor vehicle. Do only that service work for which you have the knowledge and the proper equipment. If you have any doubt about your ability to perform a service job, take your vehicle to a competent mechanic.

MAINTENANCE PROCEDURES

The pages that follow contain the **required** maintenance services determined by the engineers who designed your vehicle.

Besides the maintenance items for which there are fixed maintenance intervals, there are other items that should operate satisfactorily without periodic maintenance. However, if a malfunction of these items does occur, it could adversely affect the engine or vehicle performance. These items should be inspected if a malfunction is observed or suspected.

Engine Oil

Checking Oil Level

To assure proper engine lubrication, the engine oil must be maintained at the correct level. Check the oil level at regular intervals, such as every fuel stop.

The best time to check the engine oil level is about 5 minutes after a fully warmed engine is shut off or before starting the engine after it has sat overnight.

Checking the oil while the vehicle is on level ground will improve the accuracy of the oil level readings. Maintain the oil level between the MIN and MAX markings on the dipstick. Adding one quart of oil when the reading is at the MIN mark will result in a MAX reading on these engines.

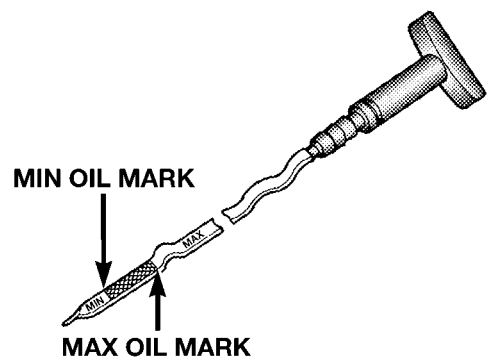

80975a64

CAUTION!

Overfilling or underfilling will cause oil aeration or loss of oil pressure. This could damage your engine.

Change Engine Oil

Road conditions and your kind of driving affects the interval at which your oil should be changed. Check the following list to see if any apply to you.

- Day or night temperatures are below 32°F (0°C).
- Stop and Go driving.
- Extensive engine idling.
- Driving in dusty conditions.
- Short trips of less than 10 miles (16 km).
- More than 50% of your driving is at sustained high speeds during hot weather, above 90°F (32°C).
- Trailer towing.
- Taxi, Police or delivery service (commercial service).
- Off-Road or desert operation.

If **ANY** of these apply to you, then change your engine oil at every interval shown in schedule “B” of the “Maintenance Schedules” section of this manual.

If none of these apply to you, then change your engine oil at every interval shown on schedule “A” of the “Maintenance Schedules” section of this manual

NOTE: Under no circumstances should oil change intervals exceed 6000 miles (10 000 km) or 6 months whichever comes first.

Engine Oil Selection

For best performance and maximum protection under all types of operating conditions, the manufacture only recommends engine oils that are API certified and meet the requirements of DaimlerChrysler Material Standard MS-6395. Use Mopar or an equivalent oil meeting the specification MS-6395.

American Petroleum Institute (API) Engine Oil Identification Symbol



This symbol means that the oil has been certified by the American Petroleum Institute (API). The manufacturer only recommends API Certified engine oils that meet the requirements of DaimlerChrysler Material Standard MS-6395. Use Mopar or an equivalent oil meeting the specifi-

cation MS-6395.

Engine Oil Viscosity Chart

The proper SAE viscosity grade of engine oil should be selected based on the following recommendation and be within the operating temperature shown in the engine oil viscosity chart.

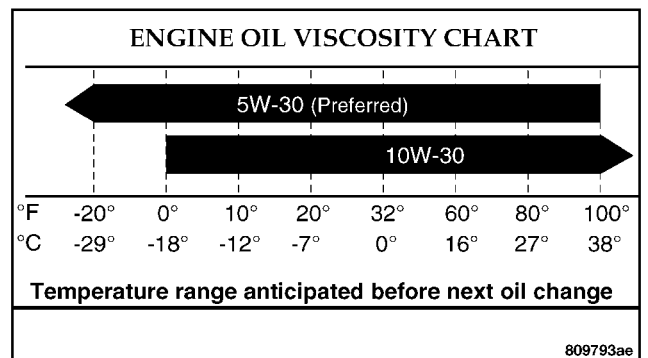

- **SAE 5W-30** engine oil is preferred. SAE 5W-30 engine oils improve low temperature starting and helps vehicle fuel economy.

Lubricants which do not have both, the engine oil certification mark and the correct SAE viscosity grade number should not be used.

Synthetic Engine Oils

There are a number of engine oils being promoted as either synthetic or semi-synthetic. If you chose to use such a product, use **only** those oils that meet the American Petroleum Institute (API) and SAE viscosity standard. Follow the service schedule that describes your driving type.

Materials Added to Engine Oil

The manufacture strongly recommends against the addition of any additives (other than leak detection dyes) to the engine oil. Engine oil is an engineered product and it's performance may be impaired by supplemental additives.

Disposing of Used Engine Oil And Oil Filters

Care should be taken in disposing of used engine oil and oil filters from your vehicle. Used oil and oil filters, indiscriminately discarded, can present a problem to the environment. Contact your dealer, service station, or

governmental agency for advice on how and where used oil and oil filters can be safely discarded in your area.

Engine Oil Filter

The engine oil filter should be replaced at every engine oil change.

Engine Oil Filter Selection

All the manufacturers engines have a full-flow type oil filter. Use a filter of this type for replacement. The quality of replacement filters varies considerably. Only high quality filters should be used to assure most efficient service. Mopar Engine Oil Filters are a high quality oil filter and are recommended.

Drive Belts — Check Condition and Tension

At the mileage indicated in the maintenance schedule, all belts should be checked for condition and proper tension. Improper belt tension can cause belt slippage and failure.

Belts should be inspected for evidence of cuts, cracks, or glazing, and replaced if there is indication of damage which could result in belt failure. If adjustment is required, the belts must be adjusted according to the specifications and procedures described in the Service Manual. Low generator belt tension can cause battery failure. A special tool is required to properly measure tension and to restore belt tension to factory specifications.

Also check belt routing to make sure there is no interference between the belts and other engine components.

Spark Plugs

Spark plugs must fire properly to assure engine performance and emission control. New plugs should be installed at the specified mileage. The entire set should be replaced if there is any malfunction due to a faulty spark

plug, malfunctioning spark plugs can damage the catalytic converter. For proper type of replacement spark plugs, refer to the "Vehicle Emission Control Information" label in the engine compartment.

Engine Air Cleaner Filter

Under normal driving conditions, replace the air filter at the intervals shown on Schedule "A". If, however, you drive the vehicle frequently under dusty or severe conditions, the filter element should be inspected periodically and replaced if necessary at the intervals shown on Schedule "B".

WARNING!

The air cleaner can provide a measure of protection in the case of engine backfire. Do not remove the air cleaner unless such removal is necessary for repair or maintenance. Make sure that no one is near the engine compartment before starting the vehicle with the air cleaner removed. Failure to do so can result in serious personal injury.

Engine Fuel Filter

A plugged fuel filter can cause stalling, limit the speed at which a vehicle can be driven or cause hard starting. Should an excessive amount of dirt accumulate in the fuel tank, filter replacement may be necessary.

Catalytic Converter

The catalytic converter requires the use of unleaded fuel only. Leaded gasoline will destroy the effectiveness of the catalyst as an emission control device.

Under normal operating conditions, the catalytic converter will not require maintenance. However, it is important to keep the engine properly tuned to assure proper catalyst operation and prevent possible catalyst damage.

CAUTION!

Damage to the catalytic converter can result if your vehicle is not kept in proper operating condition. In the event of engine malfunction, particularly involving engine misfire or other apparent loss of performance, have your vehicle serviced promptly. Continued operation of your vehicle with a severe malfunction could cause the converter to overheat, resulting in possible damage to the converter and the vehicle.

NOTE: Intentional tampering with emissions control systems can result in civil penalties being assessed against you.

WARNING!

A hot exhaust system can start a fire if you park over materials that can burn. Such materials might be grass or leaves coming into contact with your exhaust system. Do not park or operate your vehicle in areas where your exhaust system can contact anything that can burn.

In unusual situations involving grossly malfunctioning engine operation, a scorching odor may indicate severe and abnormal catalyst overheating. If this occurs, the vehicle should be stopped, the engine shut off and the vehicle allowed to cool. Thereafter, service, including a tune-up to manufacturer's specifications, should be obtained immediately.

To minimize the possibility of catalyst damage:

- Do not shut off the engine or interrupt the ignition when the transmission is in gear and the vehicle is in motion.
- Do not try to start engine by pushing or towing the vehicle.
- Do not idle the engine with any spark plug wires disconnected or removed, such as when diagnostic testing, or for prolonged periods during very rough idling or malfunctioning operating conditions.

Maintenance-Free Battery

The top of the MAINTENANCE-FREE battery is permanently sealed. You will never have to add water, nor is periodic maintenance required.

WARNING!

- **Battery fluid is a corrosive acid solution and can burn or even blind you. Don't allow battery fluid to contact your eyes, skin or clothing. Don't lean over a battery when attaching clamps. If acid splashes in eyes or on skin, flush the area immediately with large amounts of water.**
- **Battery gas is flammable and explosive. Keep flame or sparks away from the battery. Don't use a booster battery or any other booster source with an output greater than 12 volts. Don't allow cable clamps to touch each other.**
- **Battery posts, terminals and related accessories contain lead and lead compounds. Wash hands after handling.**

CAUTION!

- It is essential when replacing the cables on the battery that the positive cable is attached to the positive post and the negative cable is attached to the negative post. Battery posts are marked positive (+) and negative (-) and identified on the battery case. Cable clamps should be tight on the terminal posts and free of corrosion.
- If a “fast charger” is used while battery is in vehicle, disconnect both vehicle battery cables before connecting the charger to battery. Do not use a “fast charger” to provide starting voltage.

Air Conditioner

For best possible performance, your air conditioner should be checked and serviced by an Authorized Dealer at the start of each warm season. This service should include cleaning of the condenser fins and a system performance check. Drive belt tension should also be checked at this time.

WARNING!

- **Use only refrigerants approved by this manufacturer for your air conditioning system. Some unapproved refrigerants are flammable and can explode, injuring you. Other unapproved refrigerants can cause the system to fail, requiring costly repairs.**
- **Never add air conditioning refrigerant to correct a non-cooling problem unless pressure gauges are connected to the system by a certified technician. Lack of cooling could be due to a restriction and adding refrigerant may cause a dangerous pressure rise and you could be injured.**

Refrigerant Recovery And Recycling

The air conditioning system of your vehicle contains R-134a, a refrigerant that does not deplete the ozone layer in the upper atmosphere. The manufacturer recommends

that air conditioning service be done by facilities using refrigerant recycling and recovery equipment that meets SAE standard J1991.

A/C Air Filter

The filter access door is located under the instrument panel on the passenger side. To replace the filter slide the lock toward the rear of the vehicle (unlock position). Remove the access door and pull the filter downward. When installing a new filter, ensure its proper orientation. Align the black arrow on the bottom of the filter frame with the direction of airflow (away from the blower motor and towards the center of the car).

Refer to the “Maintenance Schedules” section of this manual for the recommended air conditioning filter replacement intervals.

Power Steering — Fluid Check

Checking the power steering fluid level at a defined service interval is not required. The fluid should only be checked if a leak is suspected, abnormal noises are apparent, and/or the system is not functioning as anticipated. Coordinate inspection efforts through a certified DaimlerChrysler Dealership."

WARNING!

Fluid level should be checked on a level surface and with the engine off to prevent injury from moving parts and to insure accurate fluid level reading. Do not overfill. Use only manufacturers recommended power steering fluid.

If necessary, add fluid to restore to the proper indicated level. With a clean cloth, wipe any spilled fluid from all surfaces. Refer to Recommended Fluids, Lubricants, and Genuine Parts for correct fluid type.

Front Suspension Ball Joints

The front suspension ball joints are permanently sealed. No regular maintenance is required for these components.

Steering Shaft Seal

The steering shaft seal, at the point where the shaft passes through the bulkhead, is lubricated when it is installed. If the seal becomes noisy when the steering shaft is turned, it should be lubricated. Use only manufacturers recommended lubricant, refer to Recommended Fluids, Lubricants and Genuine Parts for correct lubricant type.

Steering Linkage

The tie rod end ball joints are permanently lubricated and do not require periodic maintenance.

Drive Shaft Universal Joints

Your vehicle has constant velocity universal joints. Periodic lubrication of these joints is not required. However, the joint boots should be inspected for external leakage or damage when other maintenance is performed. If leakage or damage is evident, the universal joint boot and grease should be replaced immediately.

Continued operation could result in failure of the universal joint due to water and dirt contamination of the grease. This would require complete replacement of the joint assembly.

Body Lubrication

Locks and all body pivot points, including such items as seat tracks, doors, liftgate, sliding doors and hood hinges, should be lubricated periodically to assure quiet, easy operation and to protect against rust and wear. Prior to the application of any lubricant, the parts concerned should be wiped clean to remove dust and grit; after lubricating excess oil and grease should be removed. Particular attention should also be given to hood latching components to insure proper function. When performing other underhood services, the hood latch, release mechanism and safety catch should be cleaned and lubricated.

The external lock cylinders should be lubricated twice a year, preferably in the fall and spring. Apply a small amount of a high quality lubricant such as Mopar® Lock Cylinder Lubricant directly into the lock cylinder.

Windshield Wiper Blades

The rubber edges of the wiper blades and the windshield should be cleaned periodically with a sponge or soft cloth and a mild nonabrasive cleaner. This will remove accumulations of salt or road film.

Operation of the wipers on dry glass for long periods may cause deterioration of the wiper blades. Always use washer fluid when using the wipers to remove salt or dirt from a dry windshield.

Avoid using the wiper blades to remove frost or ice from the windshield. Keep the blade rubber out of contact with petroleum products such as engine oil, gasoline, etc.

Windshield and Rear Window Washers

The fluid reservoir for the windshield washers and the rear window washer is shared. It is located in the engine compartment and should be checked for fluid level at regular intervals. Fill the reservoir with windshield

washer solvent (not radiator antifreeze) and operate the system for a few seconds to flush out the residual water.

The washer fluid reservoir will hold a full gallon of fluid when the Low Washer Fluid Light illuminates.

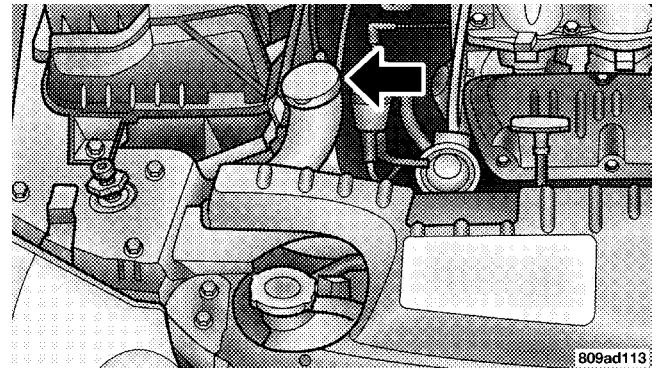

Exhaust System

The best protection against carbon monoxide entry into the vehicle body is a properly maintained engine exhaust system.

Whenever a change is noticed in the sound of the exhaust system, when exhaust fumes can be detected inside the vehicle, or when the underside or rear of the vehicle is damaged, have a competent mechanic inspect the complete exhaust system and adjacent body areas for broken, damaged, deteriorated, or mispositioned parts. Open seams or loose connections could permit exhaust fumes to seep into the passenger compartment. In addition, inspect the exhaust system each time the vehicle is raised for lubrication or oil change. Replace as required.

WARNING!

Exhaust gases can injure or kill. They contain carbon monoxide (CO) which is colorless and odorless. Breathing it can make you unconscious and can eventually poison you. To avoid breathing CO, follow the preceding safety tips.

Cooling System

Inspection

WARNING!

- **When working near the radiator cooling fan, turn the ignition key to the OFF position. The fan is temperature controlled and can start at any time when the ignition key is in the ON position.**
- **You or others can be badly burned by hot coolant or steam from your radiator. If you see or hear steam coming from under the hood, don't open the hood until the radiator has had time to cool. Never try to open a cooling system pressure cap when the radiator is hot.**

Coolant Checks

Coolant protection checks should be made every 12 months (prior to the onset of freezing weather, where applicable). If coolant is dirty or rusty in appearance, the system should be drained, flushed and refilled with fresh coolant. Check the front of the A/C condenser for any accumulation of bugs, leaves, etc. If dirty, clean by removing the upper grill support and gently spraying water from a garden hose vertically down the face of the condenser.

Check the coolant recovery bottle tubing for brittle rubber, cracking, tears, cuts and tightness of the connection at the bottle and radiator. Inspect the entire system for leaks.

With the engine at normal operating temperature (but not running), check the coolant pressure cap for proper vacuum sealing by draining a small amount of coolant

from the radiator drain cock. If the cap is sealing properly, the coolant will begin to drain from the coolant recovery bottle. **DO NOT REMOVE THE COOLANT PRESSURE CAP WHEN THE COOLING SYSTEM IS HOT.**

Cooling System — Drain, Flush and Refill

At the intervals shown in the maintenance schedules, the system should be drained, flushed and refilled.

If the solution is dirty or contains a considerable amount of sediment, clean and flush with a reliable cooling system cleaner. Follow with a thorough rinsing to remove all deposits and chemicals. Properly dispose of old antifreeze solution.

Selection Of Coolant

Use only the manufacturers recommended coolant, refer to Recommended Fluids, Lubricants and Genuine Parts for correct coolant type.

CAUTION!

- **Mixing of coolants other than specified (non-HOAT), may result in engine damage that may not be covered under the new vehicle warranty, and decreased corrosion protection. If a non-HOAT coolant is introduced into the cooling system in an emergency, it should be replaced with the specified coolant as soon as possible.**
- **Do not use plain water alone or alcohol base antifreeze products. Do not use additional rust inhibitors or antirust products, as they may not be compatible with the radiator coolant and may plug the radiator.**
- **This vehicle has not been designed for use with Propylene Glycol based coolants. Use of Propylene Glycol based coolants is not recommended.**

Adding Coolant

When adding coolant, or refilling the system, a minimum of 50% solution of ethylene glycol antifreeze coolant in water should be used. Higher concentrations (not to exceed 70%) are required if temperatures below -37°F (-38°C) are anticipated.

Use only high purity water such as distilled or deionized water when mixing the water/antifreeze solution. The use of lower quality water will reduce the amount of corrosion protection in the engine cooling system.

Please note that it is the owner's responsibility to maintain the proper level of protection against freezing according to the temperatures occurring in the area where the vehicle is operated.

NOTE: Mixing coolant types will decrease the life of the engine coolant and will require more frequent coolant changes.

Coolant Pressure Cap

The coolant pressure cap must be fully tightened to prevent loss of coolant, and to insure that coolant will return to the radiator from the coolant recovery bottle. The coolant pressure cap should be inspected and cleaned if there is any accumulation of foreign material on the sealing surfaces.

WARNING!

The warning words "DO NOT OPEN HOT" on the coolant pressure cap are a safety precaution. Never add coolant to the radiator when the engine is overheated. Do not loosen or remove the coolant pressure cap to cool an overheated engine. Heat causes pressure to build up in the cooling system. To prevent scalding or injury, do not remove the coolant pressure cap while the system is hot or under pressure.

Disposal of Used Engine Coolant

Used ethylene glycol based engine coolant is a regulated substance requiring proper disposal. Check with your local authorities to determine the disposal rules for your community. To prevent ingestion by animals or children do not store ethylene glycol based engine coolant in open containers or allow it to remain in puddles on the ground. If ingested by a child, contact a physician immediately. Clean up any ground spills immediately.

Coolant Level

The coolant recovery bottle provides a quick visual method for determining that the coolant level is adequate. With the engine cold, the level of the coolant in the coolant recovery bottle should be between the “MAX” and “MIN” marks. The radiator normally remains completely full, so there is no need to remove the radiator cap except for checking coolant freeze point or replacement with new antifreeze coolant. Your service attendant should be advised of this. So long as the engine

operating temperature is satisfactory, the coolant recovery bottle need only be checked once a month.

When additional coolant is needed to maintain the proper level, it should be added to the coolant recovery bottle. Do not overfill.

Points to Remember

NOTE: When the vehicle is stopped after a few miles of operation, you may observe vapor coming from the front of the engine compartment. This is normally a result of moisture from rain, snow, or high humidity accumulating on the radiator and being vaporized when the thermostat opens, allowing hot water to enter the radiator.

If an examination of your engine compartment shows no evidence of radiator or hose leaks, the vehicle may be safely driven. The vapor will soon dissipate.

- Do not overfill the coolant recovery bottle.

- Check coolant freeze point in the radiator and in the coolant recovery bottle. If antifreeze needs to be added, contents of coolant recovery bottle must also be protected against freezing.
- If frequent coolant additions are required, or if the level in the coolant recovery bottle does not drop when the engine cools, the cooling system should be pressure tested for leaks.
- Maintain coolant concentration at 50% ethylene glycol antifreeze (minimum) in water for proper corrosion protection of your engine which contains aluminum components.
- Make sure that the radiator and coolant recovery bottle overflow hoses are not kinked or obstructed.
- Keep the front of the radiator clean. If your vehicle is equipped with air conditioning, keep the front of the condenser clean, also.
- Do not change the thermostat for summer or winter operation. If replacement is ever necessary, install **ONLY** the correct type thermostat. Other designs may result in unsatisfactory cooling performance.
- Increasing engine speed at idle does not reduce coolant temperature! Put transmission in NEUTRAL and let engine idle at normal engine idle speed.

Hoses And Vacuum/Vapor Harnesses

Inspect surfaces of hoses and nylon tubing for evidence of heat and mechanical damage. Hard or soft spots, brittle rubber, cracking, tears, cuts, abrasions, and excessive swelling indicate deterioration of the rubber.

Pay particular attention to those hoses nearest to high heat sources such as the exhaust manifold. Inspect hose routing to be sure hoses do not come in contact with any heat source or moving component which may cause heat damage or mechanical wear.

Insure nylon tubing in these areas has not melted or collapsed.

Inspect all hose connections such as clamps and couplings to make sure they are secure and no leaks are present.

Components should be replaced immediately if there is any evidence of wear or damage that could cause failure.

Brakes

In order to assure brake system performance, all brake system components should be inspected periodically. Suggested service intervals can be found in the Maintenance Schedules.

WARNING!

Riding the brakes can lead to brake failure and possibly an accident. Driving with your foot resting or riding on the brake pedal can result in abnormally high brake temperatures, excessive lining wear, and possible brake damage. You wouldn't have your full braking capacity in an emergency.

Brake And Power Steering Hoses

When the vehicle is serviced for scheduled maintenance, inspect surface of hoses and nylon tubing for evidence of heat and mechanical damage. Hard and brittle rubber, cracking, tears, cuts, abrasion, and excessive swelling indicate deterioration of the rubber. Particular attention should be made to examining those hose surfaces nearest to high heat sources, such as the exhaust manifold.

Inspect nylon tubing in these areas has not melted or collapsed.

Inspect all hose connections such as clamps and couplings to make sure they are secure and no leaks are present.

NOTE: Often, fluid such as oil, power steering fluid, and brake fluid are used during assembly plant operations to facilitate the assembly of hoses to couplings. Therefore, oil wetness at the hose-coupling area is not necessarily an indication of leakage. Actual dripping of hot fluid when systems are under pressure (during vehicle operation), should be noted before hose is replaced based on leakage.

NOTE: Inspection of brake hoses should be performed whenever the brake system is serviced and every engine oil change. Inspect hydraulic brake hoses for surface cracking, scuffing, or worn spots. If there is any evidence of cracking, scuffing, or worn spots, the hose should be

replaced immediately! Eventual deterioration of the hose can take place resulting in a possibility of a burst failure.

WARNING!

Worn brake hoses can burst and cause brake failure. You could have an accident. If you see any signs of cracking, scuffing, or worn spots, have the brake hoses replaced immediately.

Master Cylinder — ABS Brakes Brake Fluid Level Check

The fluid level in the master cylinder should be checked when performing underhood services, or immediately if the brake system warning light indicates system failure.

Clean the top of the master cylinder area before removing the cap. Add fluid to bring the level up to the top of the "FULL" mark on the side of the master cylinder reservoir.

Overfilling of fluid is not recommended because it may cause leaking in the system.

Add enough fluid to bring the level up to the requirements described on the brake fluid reservoir. With disc brakes, fluid level can be expected to fall as the brake pads wear. However, low fluid level may be caused by a leak and a checkup may be needed.

Use only manufacturers recommended brake fluid, refer to Recommended Fluids, Lubricants and Genuine Parts for correct fluid type.

WARNING!

Use of brake fluid that may have a lower initial boiling point or unidentified as to specification, may result in sudden brake failure during hard prolonged braking. You could have an accident.

WARNING!

Overfilling the brake fluid reservoir can result in spilling brake fluid on hot engine parts and the brake fluid catching fire.

Use only brake fluid that has been in a tightly closed container to avoid contamination from foreign matter or moisture.

CAUTION!

Do not allow petroleum base fluid to contaminate the brake fluid, all brake seal components could be damaged causing partial or complete brake failure.

Fuel System Hoses

Electronic Fuel Injection high pressure fuel systems are designed with hoses and clamps which have unique material characteristics to provide adequate sealing and resist attack by deteriorated gasoline.

You are urged to use only the manufacturers specified hoses and clamps, or their equivalent in material and specification, in any fuel system servicing. It is mandatory to replace all clamps that have been loosened or removed during service. Care should be taken in installing new clamps to insure they are properly torqued.

Automatic Transmission

The automatic transmission and differential assembly are contained within a single housing.

All automatic transmissions are equipped with a conventional filler tube and dipstick. If fluid is added, it should be added through the dipstick hole in the case.

The dipstick is located just behind the radiator, lower right side.

Selection of Lubricant

It is important that the proper lubricant is used in the transmission to assure optimum transmission performance. Use only manufacturers recommended transmission fluid, refer to Recommended Fluids, Lubricants and Genuine Parts for correct fluid type. It is important that the transmission fluid be maintained at the prescribed level using the recommended fluid.

CAUTION!

Using a transmission fluid other than the manufacturers recommended fluid may cause deterioration in transmission shift quality and/or torque converter shudder. Using a transmission fluid other than the manufacturers recommended fluid will result in more frequent fluid and filter changes. Refer to Recommended Fluids, Lubricants and Genuine Parts for correct fluid type.

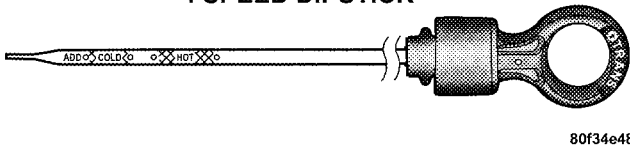
4 SPEED DIPSTICK

80f34e48

Procedure For Checking Fluid Level

The fluid level in the automatic transmission should be checked whenever the vehicle is serviced. Operation with an improper fluid level will greatly reduce the life of the transmission and of the fluid.

To properly check the automatic transmission fluid level, the following procedure must be used:

1. The vehicle must be on level ground.
2. The engine should be running at curb idle speed for a minimum of 60 seconds.
3. Fully apply parking brake.
4. Place the gear selector momentarily in each gear position ending with the lever in P (PARK). Wipe the area around the dipstick clean to eliminate the possibility of dirt entering the transmission.

5. Remove the dipstick and determine if the fluid is hot or warm. Hot fluid is approximately 180°F (82°C), which is the normal operating temperature after the vehicle has been driven at least 15 miles (24 km). The fluid cannot be comfortably held between the finger tips. Cold is when the fluid is below 80°F (27°C).

6. Wipe the dipstick clean and reinsert until seated. Remove dipstick and note reading.

a. If the fluid is hot, the reading should be in the crosshatched area marked "HOT" (between the upper two holes in the dipstick).

b. If the fluid is cold, the fluid level should be between the lower two holes in the area marked "COLD".

If the fluid level indicates low, add sufficient fluid to bring to the proper level.

CAUTION!

Do not overfill. Dirt and water in the transmission can cause serious damage. To prevent dirt and water from entering the transmission after checking or replenishing fluid, make certain that the dipstick cap is reseated properly.

Fluid and Filter Changes

Automatic transmission fluid should be changed on all transmissions as follows:

Normal Usage — No change necessary

Severe Usage (fluid and filter) — 60,000 miles (96 000 km)

Severe Usage is defined as:

- Police, taxi, limousine, commercial type operation, or trailer towing where the vehicle is driven regularly for more than 45 minutes of continuous operation.

NOTE: Refer to Section 8 of this manual for Maintenance Schedules.

If the transmission is disassembled for any reason, the fluid and filter should be changed.

Special Additives

Do not add any fluid additives to the transmission. The only exception to this policy is the use of special dyes to aid in detecting fluid leaks. The use of transmission sealers should be avoided as they may adversely affect seals.

All Wheel Drive (AWD)

Under normal operating conditions, periodic fluid level checks and lubricant changes for the Power Transfer Unit, Overrunning Clutch and Rear Carrier, are not required. However when the vehicle is serviced for other reasons, the exterior surface of these components should be inspected for evidence of fluid leaks. Confirmed leaks should be repaired as soon as possible.

Power Transfer Unit

The fluid should be maintained at the bottom of the filler hole opening. If it becomes necessary to add or replace the fluid, use only the manufacturers recommended fluid, refer to Recommended Fluids, Lubricants and Genuine Parts for correct fluid type.

Overrunning Clutch

The fluid should be maintained at the bottom of the filler hole opening. If it becomes necessary to add or replace the fluid, use only the manufacturers recommended

transmission fluid, refer to Recommended Fluids, Lubricants and Genuine Parts for correct fluid type. To assure performance, it is important that the proper lubricant be used.

Rear Carrier

The fluid should be maintained at the bottom of the filler hole opening. If it becomes necessary to add or replace the fluid, use only the manufacturer's recommended fluid, refer to Recommended Fluids, Lubricants and Genuine Parts for correct fluid type.

Fluid Changes

The fluid should be changed as follows:

Normal Usage	No Service Required
Severe Usage	
Power Transfer Unit	15,000 miles (24 000 km)
Overrunning Clutch	22,500 miles (36 000 km)
Rear Carrier	22,500 miles (36 000 km)

Severe Usage is defined as:

1. More than 50% of vehicle operation in stop and go traffic where the vehicle is driven regularly for more than 45 minutes of continuous operation, such as in heavy city or in construction zone traffic,
2. Police, taxi, limousine, commercial type operation, or trailer towing where the vehicle is driven regularly for more than 45 minutes of continuous operation.

Front And Rear Wheel Bearings

Front and rear wheel bearings are permanently sealed. No regular maintenance is required for these components.

Appearance Care and Protection from Corrosion

Protection of Body and Paint from Corrosion

Vehicle body care requirements vary according to geographic locations and usage. Chemicals that make roads passable in snow and ice, and those that are sprayed on

trees and road surfaces during other seasons, are highly corrosive to the metal in your vehicle. Outside parking, which exposes your vehicle to airborne contaminants, road surfaces on which the vehicle is operated, extreme hot or cold weather and other extreme conditions will have an adverse effect on paint, metal trim, and underbody protection.

The following maintenance recommendations will enable you to obtain maximum benefit from the corrosion resistance built into your vehicle.

What Causes Corrosion?

Corrosion is the result of deterioration or removal of paint and protective coatings from your vehicle.

The most common causes are:

- Road salt, dirt and moisture accumulation.
- Stone and gravel impact.

- Insects, tree sap and tar.
- Salt in the air near seacoast localities.
- Atmospheric fallout/industrial pollutants.

Washing

- Wash your vehicle regularly. Always wash your vehicle in the shade using a mild car wash soap, and rinse the panels completely with clear water.
- If insects, tar or other similar deposits have accumulated on your vehicle, wash it as soon as possible.
- Use Mopar auto polish to remove road film and stains and to polish your vehicle. Take care never to scratch the paint.
- Avoid using abrasive compounds and power buffing that may diminish the gloss or thin out the paint finish.

CAUTION!

Do not use abrasive or strong cleaning materials such as steel wool or scouring powder, which will scratch metal and painted surfaces.

Special Care

- If you drive on salted or dusty roads or if you drive near the ocean, hose off the undercarriage at least once a month.
- It is important that the drain holes in the lower edges of the doors, rocker panels and liftgate be kept clear and open.
- If you detect any stone chips or scratches in the paint, touch them up immediately. The cost of such repairs is considered the responsibility of the owner.
- If your vehicle is damaged due to an accident or similar cause which destroys the paint and protective coating have your vehicle repaired as soon as possible. The cost of such repairs is considered the responsibility of the owner.
- All wheels and wheel trim, especially aluminum and chrome plated wheels should be cleaned regularly with mild soap and water to prevent corrosion. To remove heavy soil, select a nonabrasive, non-acidic cleaner. Do not use scouring pads, steel wool, a bristle brush or metal polishes. Only Mopar cleaners are recommended. Do not use oven cleaner. Avoid automatic car washes that use acidic solutions or harsh brushes that may damage the wheels' protective finish.
- If you carry special cargo such as chemicals, fertilizers, de-icer salt, etc., be sure that such materials are well packaged and sealed.

- If a lot of driving is done on gravel roads, consider mud or stone shields behind each wheel.
- Use Mopar touch up paint on scratches as soon as possible. Your dealer has touch up paint to match the color of your vehicle.

Interior Care

Use Mopar Fabric Cleaner to clean fabric upholstery and carpeting.

Use Mopar Vinyl Cleaner to clean vinyl upholstery and trim.

Mopar Total Clean is specifically recommended for leather upholstery.

Your leather upholstery can be best preserved by regular cleaning with a damp soft cloth. Small particles of dirt can act as an abrasive and damage the leather upholstery and should be removed promptly with a damp cloth. Stubborn soils can be removed easily with a soft cloth

and Mopar Total Clean. Care should be taken to avoid soaking your leather upholstery with any liquid. Please do not use polishes, oils, cleaning fluids, solvents, detergents, or ammonia based cleaners to clean your leather upholstery. Application of a leather conditioner is not required to maintain the original condition.

WARNING!

Do not use volatile solvents for cleaning purposes. Many are potentially flammable, and if used in closed areas they may cause respiratory harm.

Glass Surfaces

All glass surfaces should be cleaned on a regular basis with any commercial household-type glass cleaner. Never use an abrasive type cleaner. Use caution when cleaning inside rear windows equipped with electric

defrosters or windshields equipped with a windshield wiper de-icer. Do not use scrapers or other sharp instruments which may scratch the elements.

When cleaning the rear view mirror, spray cleaner on the towel or rag that you are using. Do not spray cleaner directly on the mirror.

Cleaning Plastic Instrument Cluster Lenses

The lenses in front of the instruments in this vehicle are molded in clear plastic. When cleaning the lenses, care must be taken to avoid scratching the plastic.

1. Clean with a wet soft rag. A mild soap solution may be used, but do not use high alcohol content or abrasive cleaners. If soap is used, wipe clean with a clean damp rag.
2. Dry with a soft tissue.

Seat Belt Maintenance

Do not bleach, dye or clean the belts with chemical solvents or abrasive cleaners. This will weaken the fabric. Sun damage will also weaken the fabric.

If the belts need cleaning, use a mild soap solution or lukewarm water. Do not remove the belts from the car to wash them.

Replace the belts if they appear frayed or worn or if the buckles do not work properly.

Cleaning The Instrument Panel and Underseat Cup Holders

Removal

Remove the ash receiver from the convenience tray if there is a smoker's package in your vehicle. With your index finger, locate the stop tab located at the rear of the convenience tray.

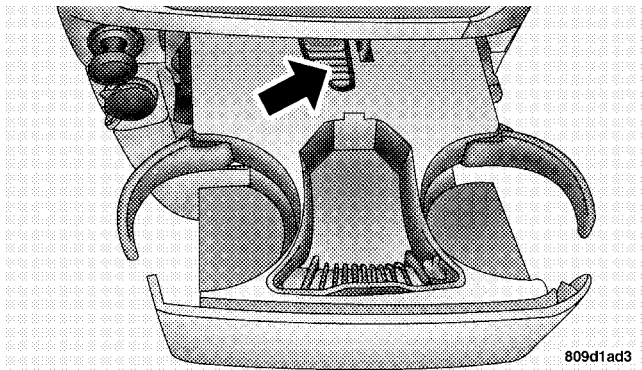

Press the stop tab, slide the entire drawer out and remove it from the instrument panel.

Cleaning

Soak the drawer, with the drawer front facing up, in a mixture of medium hot tap water and one teaspoon of mild liquid dish soap. Let soak for approximately one hour. After one hour pull the drawer from the water and dip it back into the water about six times. This will loosen any remaining debris. Rinse the drawer thoroughly under warm running water. Shake the excess water from the drawer and dry the outer surfaces with a clean soft cloth. Let the drawer sit in a dish drainer overnight to allow the inside mechanism to dry.

Installation

Align the drawer so the plastic tracks on the drawer fit into the steel retainer in the instrument panel. Push the drawer forward. You may want to cycle the drawer open and closed a few times to ensure proper operation.

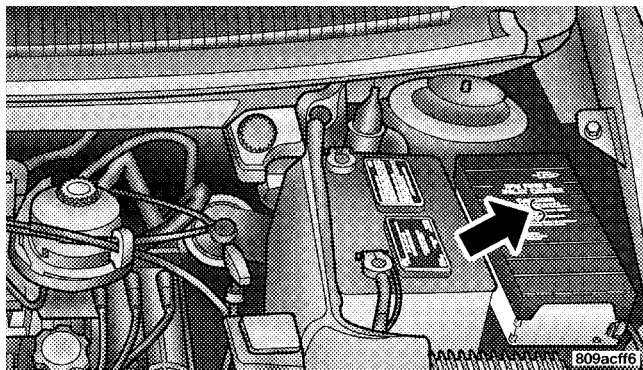
INTEGRATED POWER MODULE (IPM)

An Integrated Power Module is located in the engine compartment near the battery. This center contains fuses and relays. A label that identifies each component is printed on the inside of the cover.

CAUTION!

- When installing the Integrated Power Module cover, it is important to ensure the cover is properly positioned and fully latched. Failure to do so may allow water to get into the Integrated Power Module, and possibly result in a electrical system failure.
- When replacing a blown fuse, it is important to use only a fuse having the correct amperage rating. The use of a fuse with a rating other than indicated may result in a dangerous electrical system overload. If a properly rated fuse continues to blow, it indicates a problem in the circuit that must be corrected.

The Heated Mirrors, Lower Instrument Panel Power Outlet and Removable Floor Console, when in the front position are fused with self resetting fuses that are only serviceable by an authorized dealer. The power seats are fused by a 30 Amp circuit breaker located under the driver's seat. The Power Windows are fused by a 25 Amp circuit breaker located under the instrument panel near the steering column. If you experience temporary or permanent loss of these systems see your authorized dealer for service.

VEHICLE STORAGE

If you are leaving your vehicle dormant for more than 21 days you may want to take steps to protect your battery. You may:

- Remove the 20 Amp mini fuse in the Integrated Power Module labeled Ignition-Off Draw (IOD).
- Or, disconnect the negative cable from the battery.
- Anytime you store your vehicle, or keep it out of service (i.e. vacation) for two weeks or more, run the air conditioning system at idle for about five minutes in the fresh air and high blower setting. This will insure adequate system lubrication to minimize the possibility of compressor damage when the system is started again.

REPLACEMENT LIGHT BULBS

LIGHT BULBS — Interior	Bulb Number
Center & Rear Dome Light	578
Center & Rear Reading Lights	578
Front Door Courtesy Light	578
Front Header Reading Lights (If Equipped)	578
Instrument Cluster Lights	PC74
Liftgate Light(s)	578
Overhead Console Reading Lights	PC579
Removable Console Light (If Equipped)	194
Visor Vanity Lights	6501966

NOTE: For lighted switches, see your dealer for replacement instructions.

All of the interior bulbs are glass wedge base or glass cartridge types. Aluminum base bulbs are not approved and should not be used for replacement.

LIGHT BULBS — Exterior	Bulb Number
Back-up, Tail, Stop, Turn Signal, & Sidemarker . . .	3057
Center High-Mounted Stop Light	921
Fog Light	9040
Front Side marker, Park/Turn Signal	3157A
Headlight	9007
License	168

BULB REPLACEMENT

Headlights

1. Remove the three screws securing the headlight module.

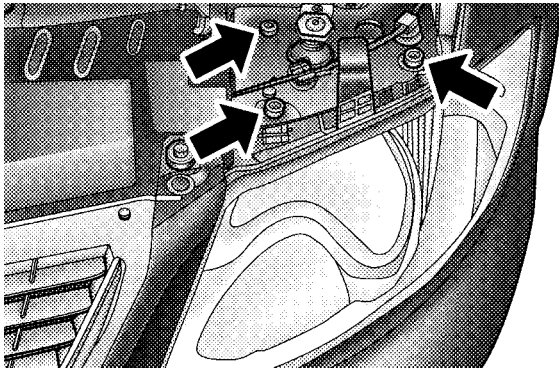

809c0b2e

2. Turn the bulb socket retaining ring counterclockwise.

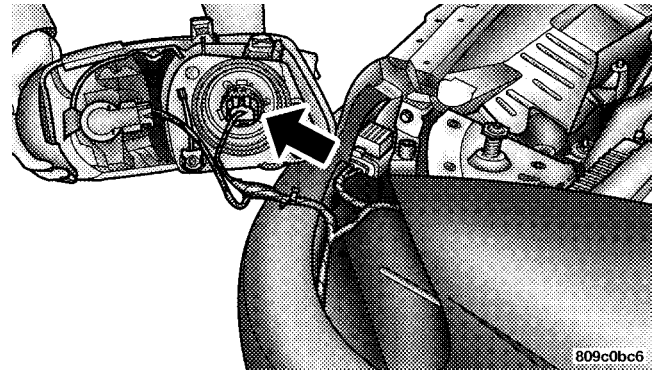

809c0bc6

3. Disconnect the electrical connector and replace the bulb.

CAUTION!

Do not touch the new bulb with your fingers. Oil contamination will severely shorten bulb life. If the bulb comes in contact with an oily surface, clean the bulb with rubbing alcohol.

Front Park/Turn Signal and Sidemarker Lights

1. Remove the three screws securing the headlight module.

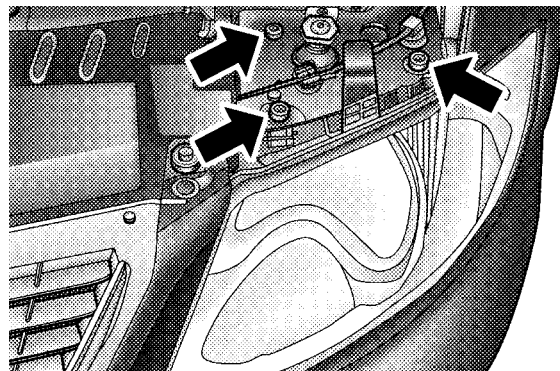

809c0b2e

2. Twist the turn signal socket to remove from the headlight module and pull bulb from socket.

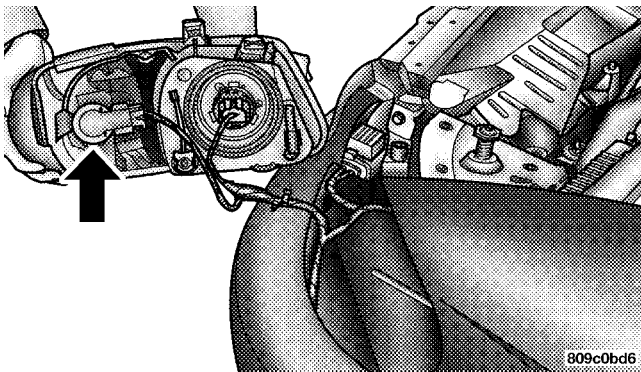

3. Replace bulb, reinstall socket and then reinstall the headlight module.

Front Fog Light

1. Reach behind the front fascia from under the vehicle.
2. Twist the front fog light bulb to remove from the fog light module.
3. Disconnect the electrical connector and replace the bulb.

CAUTION!

Do not touch the new bulb with your fingers. Oil contamination will severely shorten bulb life. If the bulb comes in contact with an oily surface, clean the bulb with rubbing alcohol.

Rear Tail, Stop, Turn Signal, Side Marker and Back-up Lights

1. Raise the liftgate.
2. Remove the two light assembly push-in type fasteners.

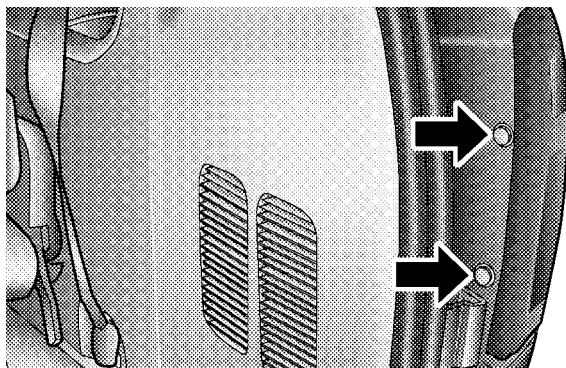

809c0bf2

3. Squeeze the socket assembly tabs to remove it from the housing.

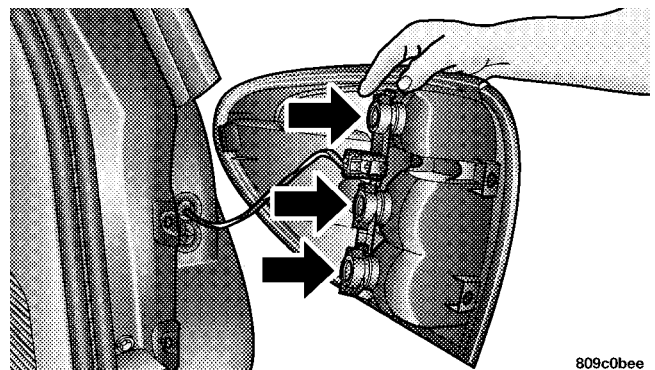

809c0bee

4. Pull the bulb to remove it from the socket.
5. Replace the bulb, reinstall the socket, and reattach the light assembly.

Center High Mounted Stop Light (CHMSL)

1. Remove the two screws securing the CHMSL.

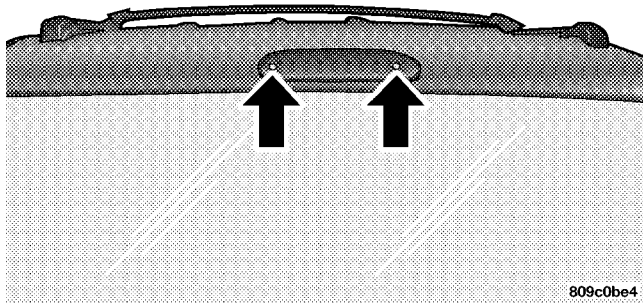

2. Twist the bulb socket to remove from the CHMSL housing.
3. Pull the bulb out of the socket.
4. Replace the bulb, reinstall the socket and reattach the CHMSL.

License Light

1. Remove the two lens assembly mounting screws.
2. Pull the bulb out of the socket. Replace the bulb and reattach the lens assembly.

FLUID CAPACITIES

	U.S.	Metric
Fuel (Approximate)	20 Gallons	76 Liters
Engine Oil-with filter		
2.4 Liter Engine	5.0 qts	4.7 Liters
3.3 & 3.8 Liter Engines	5.0 qts	4.7 Liters
Cooling System *		
2.4 Liter Engines	11.4 qts	10.7 Liters
† 3.3 & 3.8 Liter Engines	13.4 qts	12.6 Liters

* Includes heater and coolant recovery bottle filled to MAX level.
 † * Add 2.9 quarts (2.8 liters) if equipped with a rear heater.

RECOMMENDED FLUIDS, LUBRICANTS AND GENUINE PARTS**Engine**

Component	Fluids, Lubricants and Genuine Parts
Engine Coolant	Mopar® Antifreeze/Coolant 5 Year/100,000 Mile Formula HOAT (Hybrid Organic Additive Technology)
Engine Oil	Use API Certified, meeting material standard MS-6395, (GF-3). Refer to oil viscosity chart for correct SAE grade.
Oil Filter 2.4 liter engines	Mopar 4105409 or equiv.
Oil Filter 3.3/3.8 liter engines	Mopar 5281090 or equiv.
Spark Plugs	Refer to the Vehicle Emission Control Information label in the engine compartment.
Fuel Selection	87 Octane

Chassis

Component	Fluids, Lubricants and Genuine Parts.
Automatic Transmission	Mopar® ATF+4 Automatic Transmission Fluid.
AWD Power Transfer Unit	Mopar® Gear Lubricant 75W-90.
AWD Overrunning Clutch	Mopar® ATF+4 Automatic Transmission Fluid.
AWD Rear Carrier	Mopar® Gear Lubricant 75W-90.
Brake Master Cylinder	Mopar® DOT 3 and SAE J1703 should be used. If DOT 3 brake fluid is not available, then DOT 4 or DOT 4+ is acceptable. Use only recommended brake fluids.
Power Steering Reservoir	Mopar® ATF+4 Automatic Transmission Fluid.

MAINTENANCE SCHEDULES

CONTENTS

■ Emission Control System Maintenance	348	□ Schedule “B”	351
■ Maintenance Schedules	348	□ Schedule “A”	363

EMISSION CONTROL SYSTEM MAINTENANCE

The “Scheduled” maintenance services, listed in **bold type** must be done at the times or mileages specified to assure the continued proper functioning of the emission control system. These, and all other maintenance services included in this manual, should be done to provide best vehicle performance and reliability. More frequent maintenance may be needed for vehicles in severe operating conditions such as dusty areas and very short trip driving.

Inspection and service also should be done any time a malfunction is suspected.

NOTE: Maintenance, replacement, or repair of the emission control devices and systems on your vehicle may be performed by any automotive repair establishment or individual using any automotive part which has been certified pursuant to U.S. EPA or, in the State of California, California Air Resources Board regulations.

MAINTENANCE SCHEDULES

There are two maintenance schedules that show the **required** service for your vehicle.

First is Schedule “**B**”. It is for vehicles that are operated under the conditions that are listed below and at the beginning of the schedule.

- Day or night temperatures are below 32° F (0° C).
- Stop and go driving.
- Extensive engine idling.
- Driving in dusty conditions.
- Short trips of less than 10 miles (16 km).
- More than 50% of your driving is at sustained high speeds during hot weather, above 90° F (32° C).
- Trailer towing. ◇

- Taxi, police, or delivery service (commercial service). ◇
- Off-road or desert operation.

NOTE: Most vehicles are operated under the conditions listed for Schedule "B".

Second is Schedule "A". It is for vehicles that are not operated under any of the conditions listed under Schedule "B".

Use the schedule that best describes your driving conditions. Where time and mileage are listed, follow the interval that occurs first.

CAUTION!

Failure to perform the required maintenance items may result in damage to the vehicle.

At Each Stop for Fuel

- Check the engine oil level about 5 minutes after a fully warmed engine is shut off. Checking the oil level while the vehicle is on level ground will improve the accuracy of the oil level reading. Add oil only when the level is at or below the ADD or MIN mark.
- Check the windshield washer solvent and add if required.

Once a Month

- Check tire pressure and look for unusual wear or damage.
- Inspect the battery and clean and tighten the terminals as required.
- Check the fluid levels of coolant reservoir, brake master cylinder and transmission; add as needed.
- Check all lights and all other electrical items for correct operation.

350 MAINTENANCE SCHEDULES

At Each Oil Change

- Change the engine oil filter.
- Inspect the exhaust system.
- Inspect the brake hoses.
- Inspect the CV joints and front suspension components.

- Check the automatic transmission fluid level.
- Check the coolant level, hoses, and clamps.

Tire Rotation

- Rotate the tires at 6,000 miles (10 000 km).

SCHEDULE "B"

Follow schedule "B" if you usually operate your vehicle under one or more of the following conditions. Change the automatic transmission fluid and filter every 60,000 miles (96 000 km) if the vehicle is usually operated under one or more of the conditions marked with an \diamond .

- Day or night temperatures are below 32° F (0° C).
- Stop and go driving.
- Extensive engine idling.
- Driving in dusty conditions.
- Short trips of less than 10 miles (16 km).
- More than 50% of your driving is at sustained high speeds during hot weather, above 90° F (32° C).
- Trailer towing. \diamond
- Taxi, police, or delivery service (commercial service). \diamond
- Off-road or desert operation.

352 SCHEDULE "B"

Miles (Kilometers)	3, 000 (5 000)	6, 000 (10 000)	9, 000 (14 000)	12, 000 (19 000)	15, 000 (24 000)	18, 000 (29 000)
Change engine oil and engine oil filter.	X	X	X	X	X	X
Inspect the brake linings.			X			X
Inspect the engine air cleaner filter, replace if necessary. *	X	X	X	X		X
Replace the engine air cleaner filter. *					X	
Inspect and adjust the power steering pump belt tension on 2.4 liter engines.					X	
Inspect the generator belt on 2.4 liter engines, replace if necessary.					X	
Change the All Wheel Drive (AWD) power transfer unit fluid. (See note at the end of this chart)					X	
Replace the air conditioning filter.				X		

Miles (Kilometers)	21, 000 (34 000)	24, 000 (38 000)	27, 000 (43 000)	30, 000 (48 000)	33, 000 (53 000)	36, 000 (58 000)
Change engine oil and engine oil filter.	X	X	X	X	X	X
Inspect the brake linings.			X			X
Inspect the engine air cleaner filter, replace if necessary. *	X	X	X		X	X
Replace the engine air cleaner filter .				X		
Replace the spark plugs 2.4 liter engines.				X		
Inspect the tie rod ends and boot seals.				X		
Inspect and adjust the power steering pump belt tension on 2.4 liter engines.				X		
Inspect the generator belt on 2.4 liter engines, replace if necessary.				X		
Inspect the PCV valve and replace as necessary.*				X		
Change the All Wheel Drive (AWD) power transfer unit fluid. (See note at the end of this chart)				X		

354 SCHEDULE "B"

Miles (Kilometers)	21, 000 (34 000)	24, 000 (38 000)	27, 000 (43 000)	30, 000 (48 000)	33, 000 (53 000)	36, 000 (58 000)
Change the All Wheel Drive (AWD) overrunning clutch and rear carrier fluid. (See the note at the end of this chart)	X					
Replace the air conditioning filter.		X				X

Miles (Kilometers)	39, 000 (62 000)	42, 000 (67 000)	45, 000 (72 000)	48, 000 (77 000)	51, 000 (82 000)	54, 000 (86 000)
Change engine oil and engine oil filter.	X	X	X	X	X	X
Inspect the brake linings.			X			X
Inspect the engine air cleaner filter, replace if necessary. *	X	X		X	X	X
Replace the engine air cleaner filter. *			X			
Inspect and adjust the power steering pump belt tension on 2.4 liter engines.			X			
Inspect the generator belt on 2.4 liter engines, replace if necessary.			X			
Change the All Wheel Drive power transfer unit fluid. (See the note at the end of this chart.)			X			
Change the All Wheel Drive (AWD) overrunning clutch and rear carrier fluid. (See note at the end of this chart)		X				
Replace the air conditioning filter.				X		

356 SCHEDULE "B"

Miles (Kilometers)	57, 000 (91 000)	60, 000 (96 000)	63, 000 (101 000)	66, 000 (106 000)	69, 000 (110 000)	72, 000 (115 000)
Change engine oil and engine oil filter.	X	X	X	X	X	X
Inspect the brake linings.			X			X
Inspect the engine air cleaner filter, replace if necessary. *	X		X	X	X	X
Replace the engine air cleaner filter .		X				
Replace the spark plugs on 2.4 liter engines.		X				
Replace the ignition cables on 2.4 liter engines.		X				
Inspect the tie rod ends and boot seals.		X				
Inspect and adjust the power steering pump belt tension on 2.4 liter engines.		X				
Inspect the generator belt on 2.4 liter engines, replace if necessary.		X				
Inspect the PCV valve and replace if necessary.*		X				

Miles (Kilometers)	57, 000 (91 000)	60, 000 (96 000)	63, 000 (101 000)	66, 000 (106 000)	69, 000 (110 000)	72, 000 (115 000)
Inspect the serpentine drive belt on 3.3 liter and 3.8 liter engines, replace if necessary.		X				
Change the automatic transaxle fluid and filter.		X				
Change the All Wheel Drive (AWD) power transfer unit fluid. (See note at the end of this chart)		X				
Change the All Wheel Drive (AWD) overrunning clutch and rear carrier fluid. (See note at the end of this chart)			X			
Replace the air conditioning filter.		X				X

358 SCHEDULE "B"

Miles (Kilometers)	75, 000 (120 000)	78, 000 (125 000)	81, 000 (130 000)	84, 000 (134 000)	87, 000 (139 000)	90, 000 (144 000)
Change engine oil and engine oil filter.	X	X	X	X	X	X
Inspect the brake linings.			X			X
Inspect the engine air cleaner filter, replace if necessary. *		X	X	X	X	
Replace the engine air cleaner filter	X					X
Replace the spark plugs on 3.3 liter and 3.8 liter engines.	X					
Replace the ignition cables on 3.3 liter and 3.8 liter engines.	X					
Replace the spark plugs on 2.4 liter engines.						X
Inspect and adjust the power steering pump belt tension on 2.4 liter engines.	X					X
Inspect the generator belt on 2.4 liter engines, replace if necessary.	X					X
Inspect the tie rod ends and boot seals.						X

Miles (Kilometers)	75,000 (120,000)	78,000 (125,000)	81,000 (130,000)	84,000 (134,000)	87,000 (139,000)	90,000 (144,000)
Inspect engine accessory drive belts on 3.3 liter and 3.8 liter engines, replace if necessary. ‡	X					X
Check the PCV valve and replace if necessary. Not required if previously changed.*						X
Change the All Wheel Drive power transfer unit fluid. (See the note at the end of this chart.)	X					X
Change the All Wheel Drive (AWD) overrunning clutch and rear carrier fluid. (See note at the end of this chart)				X		
Replace the engine timing belt on 2.4 liter engines. *						X
Replace the air conditioning filter.				X		

360 SCHEDULE "B"

Miles (Kilometers)	93, 000 (149 000)	96, 000 (154 000)	99, 000 (158 000)	100, 000 (160 000)	102, 000 (163 000)	105, 000 (168 000)
Change engine oil and engine oil filter.	X	X	X		X	X
Inspect the brake linings.			X			
Inspect the engine air cleaner filter, replace if necessary. *	X	X	X	X	X	
Replace the engine air cleaner filter *						X
Inspect and adjust the power steering pump belt tension on 2.4 liter engines.						X
Inspect the generator belt on 2.4 liter engines, replace if necessary.						X
Inspect engine accessory drive belts on 3.3 liter and 3.8 liter engines, replace if necessary. †						X
Change the All Wheel Drive (AWD) power transfer unit, overrunning clutch and rear carrier fluid. (See note at the end of this chart)						X
Flush and replace the engine coolant at 60 months or 100,000 miles.				X		
Replace the air conditioning filter.		X				

Miles (Kilometers)	108, 000 (173 000)	111, 000 (178 000)	114, 000 (182 000)	117, 000 (187 000)	120, 000 (192 000)
Change engine oil and engine oil filter.	X	X	X	X	X
Inspect the brake linings.	X			X	
Inspect the engine air cleaner filter, replace if necessary. *	X	X	X	X	
Replace the engine air cleaner filter .					X
Replace the spark plugs on 2.4 liter engines.					X
Replace the ignition cables on 2.4 liter engines.					X
Inspect and adjust the power steering pump belt tension on 2.4 liter engines.					X
Inspect the generator belt on 2.4 liter engines, replace if necessary.					X
Inspect engine accessory drive belts on 3.3 liter and 3.8 liter engines, replace if necessary. ‡					X
Inspect the tie rod ends and boot seals.					X
Inspect the PCV valve and replace as necessary.*					X
Change the automatic transaxle fluid and filter.					X

362 SCHEDULE "B"

Miles (Kilometers)	108, 000 (173 000)	111, 000 (178 000)	114, 000 (182 000)	117, 000 (187 000)	120, 000 (192 000)
Change the All Wheel Drive (AWD) power transfer unit fluid. (See note at the end of this chart)					X
Replace the air conditioning filter.	X				X

* This maintenance is recommended by the manufacture to the owner but is not required to maintain the emissions warranty.

‡ This maintenance is not required if previously replaced.

Inspection and service should also be performed anytime a malfunction is observed or suspected. Retain all receipts.

NOTE: The AWD power transfer unit fluid and the AWD overrunning clutch/ rear carrier fluid must be changed at the intervals shown in schedule B if the vehicle is operated under any of the conditions noted by a diamond at the beginning of the schedule.

SCHEDULE "A"

Miles (Kilometers) [Months]	6, 000 (10 000) [6]	12, 000 (19 000) [12]	18, 000 (29 000) [18]	24, 000 (38 000) [24]	30, 000 (48 000) [30]	36, 000 (58 000) [36]
Change engine oil and engine oil filter.	X	X	X	X	X	X
Inspect the brake linings.			X			X
Inspect the engine air cleaner filter, replace if necessary. *	X	X	X	X		X
Replace the engine air cleaner filter .					X	
Replace the spark plugs on 2.4 liter engines.					X	
Inspect the tie rod ends and boot seals.					X	
Inspect and adjust the power steering pump belt tension on 2.4 liter engines.					X	
Replace the air conditioning filter.		X		X		X

364 SCHEDULE "A"

Miles (Kilometers) [Months]	42, 000 (67 000) [42]	48, 000 (77 000) [48]	54, 000 (86 000) [54]	60, 000 (96 000) [60]	66, 000 (106 000) [66]	72, 000 (115 000) [72]
Change engine oil and engine oil filter.	X	X	X	X	X	X
Inspect the brake linings.			X			X
Inspect the engine air cleaner filter, replace if necessary. *	X	X	X		X	X
Replace the engine air cleaner filter .				X		
Replace the spark plugs on 2.4 liter engines.				X		
Replace the ignition cables 2.4 liter engines.				X		
Inspect and adjust the power steering pump belt tension on 2.4 liter engines.				X		
Inspect the tie rod ends and boot seals.				X		
Inspect the generator belt on 2.4 liter engines, replace if necessary.	X					X
Check the PCV valve and replace, if necessary.*				X		

Miles (Kilometers) [Months]	42, 000 (67 000) [42]	48, 000 (77 000) [48]	54, 000 (86 000) [54]	60, 000 (96 000) [60]	66, 000 (106 000) [66]	72, 000 (115 000) [72]
Inspect the serpentine drive belt on 3.3 liter and 3.8 liter engines, replace if necessary. ‡				X		X
Flush and replace the engine coolant at 60 months, regardless of mileage.				X		
Replace the air conditioning filter.		X		X		X

366 SCHEDULE "A"

Miles (Kilometers) [Months]	78, 000 (125 000) [78]	84, 000 (134 000) [84]	90, 000 (144 000) [90]	96, 000 (154 000) [96]	100, 000 (160 000)
Change engine oil and engine oil filter.	X	X	X	X	
Inspect the brake linings.			X		
Inspect the engine air cleaner filter, replace if necessary. *	X	X		X	X
Replace the engine air cleaner filter .			X		
Replace the spark plugs on 2.4 liter engines.			X		
Inspect the tie rod ends and boot seals.			X		
Inspect and adjust the power steering pump belt tension on 2.4 liter engines.			X		
Inspect the generator belt on 2.4 liter engines, replace if necessary.					X
Check and replace the PCV valve , if necessary.*			X		
Inspect the serpentine drive belt on 3.3 liter and 3.8 liter engines, replace if necessary. ‡			X		

Miles (Kilometers) [Months]	78, 000 (125 000) [78]	84, 000 (134 000) [84]	90, 000 (144 000) [90]	96, 000 (154 000) [96]	100, 000 (160 000)
Replace the spark plugs 3.3 liter and 3.8 liter engines.					X
Replace the ignition cables 3.3 liter and 3.8 liter engines.					X
Flush and replace the engine coolant at 100,000 miles, if not done at 60 months.					X
Replace the air conditioning filter.		X		X	

368 SCHEDULE "A"

Miles (Kilometers) [Months]	102, 000 (163 000) [102]	108, 000 (173 000) [108]	114, 000 (182 000) [114]	120, 000 (192 000) [120]
Change engine oil and engine oil filter.	X	X	X	X
Inspect the brake linings.		X		
Inspect the engine air cleaner filter, replace if necessary. *	X	X	X	
Replace the engine air cleaner filter .				X
Replace the spark plugs on 2.4 liter engines.				X
Replace the ignition cables 2.4 liter engines.				X
Inspect and adjust the power steering pump belt tension on 2.4 liter engines.				X
Inspect the tie rod ends and boot seals.				X
Check the PCV valve and replace, if necessary.*				X
Inspect the serpentine drive belt on 3.3 liter and 3.8 liter engines, replace if necessary. †	X			X
Replace the engine timing belt on 2.4 liter engines only.				X

Miles (Kilometers) [Months]	102, 000 (163 000) [102]	108, 000 (173 000) [108]	114, 000 (182 000) [114]	120, 000 (192 000) [120]
Flush and replace the engine coolant at 120 months, if not done at 100,000 miles (160 000 km).				X
Replace the air conditioning filter.		X		X

* This maintenance is recommended by the manufacture to the owner but is not required to maintain the emissions warranty.

‡ This maintenance is not required if previously replaced.

Inspection and service should also be performed anytime a malfunction is observed or suspected. Retain all receipts.

WARNING!
You can be badly injured working on or around a motor vehicle. Do only that service work for which you have the knowledge and the right equipment. If you have any doubt about your ability to perform a service job, take your vehicle to a competent mechanic.

IF YOU NEED CONSUMER ASSISTANCE

CONTENTS

■ Suggestions For Obtaining Service For Your Vehicle	372	■ Reporting Safety Defects	376
□ Prepare For The Appointment	372	□ In Canada	376
□ Prepare A List	372	■ Publication Order Forms	376
□ Be Reasonable With Requests	372	■ Department Of Transportation Uniform Tire Quality Grades	378
■ If You Need Assistance	372	□ Treadwear	378
■ Warranty Information	375	□ Traction Grades	378
■ Mopar® Parts	375	□ Temperature Grades	379

SUGGESTIONS FOR OBTAINING SERVICE FOR YOUR VEHICLE**Prepare For The Appointment**

If you're having warranty work done, be sure to have the right papers with you. Take your warranty folder. All work to be performed may not be covered by the warranty, discuss additional charges with the service manager. Keep a maintenance log of your vehicle's service history. This can often provide a clue to the current problem.

Prepare A List

Make a written list of your vehicle's problems or the specific work you want done. If you've had an accident, or work done that is not on your maintenance log, let the service advisor know.

Be Reasonable With Requests

If you list a number of items, and you must have your vehicle by the end of the day, discuss the situation with the service advisor and list the items in order of priority. At many dealers you may obtain a rental vehicle at a minimal daily charge. If you need a rental, it is advisable to make these arrangements when you call for an appointment.

IF YOU NEED ASSISTANCE

The manufacturer and its dealers are vitally interested in your satisfaction. We want you to be happy with our products and services.

Your selling dealer is best equipped and most anxious to provide prompt resolution for any warranty issue or related matter that you may experience. The manufacturer's dealers have the facilities, factory-trained technicians, special tools, and the latest information to assure your vehicle is fixed correctly and in a timely manner.

The manufacturer has empowered its dealers to make warranty and repair decisions that ensure you are not inconvenienced. There is no need for you to wait for a decision from the manufacturer. If a special circumstance occurs that requires information from the manufacturer, we have asked the dealer's service management to make the contact on your behalf.

This is why you should always talk to your dealer's service manager first. Most matters can be resolved with this process.

- If for some reason you are still not satisfied, talk to the general manager or owner of the dealership. They want to know if you need assistance.
- If your dealership is unable to resolve the concern, you may contact the Manufacturer's Customer Center.

Any communication to the Manufacturer's Customer Center should include the following information:

- Owner's name and address
- Owner's telephone number (home and office)
- Dealership name
- Vehicle identification number
- Vehicle delivery date and mileage

DaimlerChrysler Motors Corporation Customer Center

P.O. Box 21-8004

Auburn Hills, MI 48321-8004

Phone: (800) 992-1997

DaimlerChrysler Canada Inc. Customer Center

P.O. Box 1621

Windsor, Ontario N9A 4H6

Phone —(800) 465-2001

In Mexico contact:

Av. Prolongacion Paseo de la Reforma, 1240
Sante Fe C.P. 05109
Mexico, D. F.
In Mexico (915) 729-1248 or 729-1240
Outside Mexico (525) 729-1248 or 729-1240

Customer Assistance For The Hearing Or Speech Impaired (TDD/TTY)

To assist customers who have hearing difficulties, the manufacturer has installed special TDD (Telecommunication Devices for the Deaf) equipment at its Customer Center. Any hearing or speech impaired customer who has access to a TDD or a conventional teletypewriter (TTY) in the United States can communicate with the manufacturer by dialing 1-800-380-CHRY.

Service Contract

You may have purchased a service contract for your vehicle to help protect you from the high cost of unexpected repairs after your manufacturer's new vehicle limited warranty expires. The manufacturer stands behind only the manufacturer's Service Contracts. If you purchased a manufacturer's Service Contract, you will receive Plan Provisions and an Owner Identification Card in the mail within three weeks of your vehicle delivery date. If you have any questions about your service contract, call the manufacturer's Service Contract National Customer Hotline at 1-800-521-9922.

The manufacturer will not stand behind any service contract that is not the manufacturer's Service Contract. It is not responsible for any service contract other than the manufacturer's Service Contract. If you purchased a service contract that is not a manufacturer's Service

Contract, and you require service after your manufacturer's new vehicle limited warranty expires, please refer to your contract documents, and contact the person listed in those documents.

We appreciate that you have made a major investment when you purchased your new vehicle. Your dealer has also made a major investment in facilities, tools, and training to assure that you are absolutely delighted with your ownership experience. You'll be pleased with their sincere efforts to resolve any warranty issues or related concerns.

WARRANTY INFORMATION

See your manufacturer's Warranty Information Booklet for information on warranty coverage and transfer of warranty.

TIME/MILEAGE															
1 YEAR/ 12,000	2 YEAR/ 24,000	3 YEAR/ 36,000	3 YEAR/ 50,000	3 YEAR/ UNLMTD	5 YEAR/ 100,000	7 YEAR/ 70,000	8 YEAR/ 80,000								
BASIC LIMITED WARRANTY COVERAGE															
SPECIAL EXTENDED WARRANTY COVERAGE															
<table border="1"> <tr> <td><input type="checkbox"/></td> <td><input type="checkbox"/></td> <td><input type="checkbox"/></td> <td><input type="checkbox"/></td> <td><input type="checkbox"/></td> <td><input type="checkbox"/></td> <td><input type="checkbox"/></td> <td><input type="checkbox"/></td> </tr> </table> POWERTRAIN LIMITED WARRANTY (\$100 DEDUCTIBLE)								<input type="checkbox"/>	<input type="checkbox"/>	<input type="checkbox"/>	<input type="checkbox"/>	<input type="checkbox"/>	<input type="checkbox"/>	<input type="checkbox"/>	<input type="checkbox"/>
<input type="checkbox"/>	<input type="checkbox"/>	<input type="checkbox"/>	<input type="checkbox"/>	<input type="checkbox"/>	<input type="checkbox"/>	<input type="checkbox"/>	<input type="checkbox"/>								
ANTI-CORROSION PERFORATION: ALL PANELS															
OUTER PANELS															
FED. EMISSION WARR.															
FEDERAL EMISSION WARRANTY - SPECIFIED COMPONENTS															
CALIFORNIA EMISSION WARRANTY															
CALIFORNIA EMISSION WARRANTY - SPECIFIED COMPONENTS															
							80eee94a								

MOPAR® PARTS

Mopar® fluids, lubricants, parts, and accessories are available from your dealer. They will help you keep your vehicle operating at its best.

REPORTING SAFETY DEFECTS

In the 50 United States and Washington D.C.: If you believe that your vehicle has a defect which could cause a crash or cause injury or death, you should immediately inform the National Highway Traffic Safety Administration (NHTSA) in addition to notifying the manufacturer.

If NHTSA receives similar complaints, it may open an investigation, and if it finds that a safety defect exists in a group of vehicles, it may order a recall and remedy campaign. However, NHTSA cannot become involved in individual problems between you, your dealer, and the manufacturer.

To contact NHTSA, you may either call the Auto Safety Hotline toll free at 1-800-424-9393 (or 366-0123 in Washington DC area) or write to: NHTSA, U.S. Dept. of Transportation, Washington DC 20590. You can also obtain other information about motor vehicle safety from the Hotline.

In Canada:

If you believe that your vehicle has a safety defect, you should contact the Customer Service Department immediately. Canadian customers who wish to report a safety defect to the Canadian government should write to Transport Canada, Motor Vehicle Defect Investigations and Recalls, 2780 Sheffield Road, Ottawa, Ontario K1B 3V9.

PUBLICATION ORDER FORMS

To order the following manuals, you may use either the website or the phone numbers listed below. Visa, Mastercard, American Express, and Discover orders are accepted. If you prefer mailing your payment, please call for an order form.

NOTE: A street address is required when ordering manuals. (No P.O. Boxes).

- *Service Manuals.*

These comprehensive service manuals provide the information that students and professional technicians need in diagnosing/troubleshooting, problem solving, maintaining, servicing and repairing DaimlerChrysler Corporation vehicles. A complete working knowledge of the vehicle, system and/or components is written in straightforward language with illustrations, diagrams and charts.

- *Diagnostic Procedure Manuals.*

Filled with diagrams, charts and detailed illustrations, these practical manuals make it easy for students and technicians to find and fix problems on computer-controlled vehicle systems and features. They show exactly how to find and correct problems the first time, using step-by-step troubleshooting and driveability procedures, proven diagnostic tests and a complete list of all tools and equipment.

- *Owner's Manuals.*

These manuals have been prepared with the assistance of service and engineering specialists to acquaint you with specific Chrysler group vehicles. Included are starting, operating, emergency and maintenance procedures as well as specifications, capabilities and safety tips.

Call Toll Free at **1-800-890-4038 (U.S.)** or **1-800-387-1143 (Canada)**

Or

Visit us on the World Wide Web at:

www.techauthority.daimlerchrysler.com

DEPARTMENT OF TRANSPORTATION UNIFORM TIRE QUALITY GRADES

The following describes the tire grading categories established by the National Highway Traffic Safety Administration. The specific grade rating assigned by the tire's manufacturer in each category is shown on the sidewall of the tires on your car.

All Passenger Car Tires Must Conform to Federal Safety Requirements in Addition to These Grades.

Treadwear

The treadwear grade is a comparative rating based on the wear rate of the tire when tested under controlled conditions on a specified government test course. For example, a tire graded 150 would wear one and a half (1 1/2) times as well on the government course as a tire graded 100. The relative performance of tires depends upon the actual conditions of their use, however, and

may depart significantly from the norm due to variations in driving habits, service practices and differences in road characteristics and climate.

Traction Grades

The traction grades, from highest to lowest, are A, B, and C, and they represent the tire's ability to stop on wet pavement as measured under controlled conditions on specified government test surfaces of asphalt and concrete. A tire marked C may have poor traction performance.

WARNING!

The traction grade is based on braking (straight-ahead) traction tests and does not include cornering (turning) performance.

Temperature Grades

The temperature grades are A (highest), B, and C, representing the tire's resistance to the generation of heat and its ability to dissipate heat when tested under controlled conditions on a specified indoor laboratory test wheel. Sustained high temperature can cause the material of the tire to degenerate and reduce tire life, and excessive temperature can lead to sudden tire failure. The grade C corresponds to a level of performance which all passenger car tires must meet under the Federal Motor Vehicle Safety Standard No. 109. Grades B and A represent higher levels of performance on the laboratory test wheel than the minimum required by law.

WARNING!

The temperature grade is established for a tire that is properly inflated and not overloaded. Excessive speed, underinflation, or excessive loading, either separately or in combination, can cause heat buildup and possible tire failure.

INDEX

Adding Fuel	270	Alarm Light	154
Adding Washer Fluid	221,316	Alarm System	26
Additives, Fuel	268	Alignment and Balance	258
Adjustable Pedals	106	All Wheel Drive	235,259,329
Air Conditioner Maintenance	312	Alterations/Modifications, Vehicle	7
Air Conditioning	199,203	Antifreeze Disposal	321
Air Conditioning Controls	199	Antifreeze (Engine Coolant)	319,320
Air Conditioning Filter	219,313	Anti-Lock Brake System	237
Air Conditioning, Operating Tips	218	Anti-Lock Warning Light	153
Air Conditioning, Rear Zone	206,214	Anti-Theft Security Alarm	26
Air Conditioning Refrigerant	312	Appearance Care	330
Air Conditioning System	199,203,208,312	Ashtray	130
Air Conditioning System, Zone Control	200	Auto Down Power Windows	37
Air Pressure, Tires	252	Automatic Dimming Mirror	77
Airbag	48	Automatic Door Locks	19
Airbag Deployment	55	Automatic Headlights	100
Airbag Light	52,57,72,152	Automatic Temperature Control	208
Airbag Maintenance	57	Automatic Transaxle	231,326
Airbag, Side	54	Adding Fluid	345

Filter	328	Brake, Parking	235
Fluid and Filter Changes	328	Brake System	237,323
Fluid Level Check	327	Anti-Lock	237
Interlock System	232	Fluid Check	324,345
Reset Mode	233	Hoses	323
Selection Of Lubricant	326,345	Warning Light	151
Shifting	233	Brake/Transmission Interlock	232
Special Additives	329	Break-In Recommendations, New Vehicle	70
Ball Joints	314	Bulb Replacement	339
Battery	311	Bulbs, Light	338
Gas Caution	311	Calibration, Compass	112
Jump Starting	288	Capacities, Fluid	343
Keyless Transmitter Replacement	25	Caps, Filler	
Saving Feature	101	Fuel	270
Bearings	330	Radiator	320
Belts, Drive	307	Car Washes	331
Body Mechanism Lubrication	315	Carbon Monoxide Warning	269
B-Pillar Location	247	Cargo	135

Cargo Compartment		
Luggage Carrier	139	
Cassette Tape and Player Maintenance	197	
Cassette Tape Player	161	
Catalytic Converter	309	
CD Changer	170,182,187	
CD Player	167,171,174,178,180,187	
Center High Mounted Stop Light	343	
Center Lap Belts	47	
Chains, Tire	263	
Changing A Flat Tire	282	
Child Restraint	58	
Child Restraint Tether Anchors	62	
Child Safety Locks	32	
Child Seat	58,64	
Clean Air Gasoline	266	
Climate Control	199	
Clock	159	
Compact Disc Maintenance	198	
Compact Disc Player	161,167	
Compact Spare Tire	255	
Compass	111	
Compass Calibration	112	
Compass Variance	112	
Computer, Trip/Travel	114	
Console, Overhead	110	
Console, Removable	132	
Contract, Service	374	
Coolant Pressure Cap	320	
Cooling System	318	
Adding Coolant (Antifreeze)	320	
Coolant Capacity	343	
Coolant Level	321	
Disposal of Used Coolant	321	
Drain, Flush, and Refill	319	
Inspection	318	
Points to Remember	321	
Pressure Cap	320	

Radiator Cap	320	Door Locks	17
Selection of Coolant	319,344	Door Locks, Automatic	19
Cruise Control	107	Door Opener, Garage	119
Cruise Light	157	Drive Belts	307
Cup Holder	129,334	Drive Shaft Universal Joints	315
Customer Assistance	372	Driving	
		On Slippery Surfaces	290
Daytime Running Lights	101	DVD Player	187
Dealer Service	302		
Defroster, Rear Window	222	Electric Remote Mirrors	79
Defroster, Windshield	72,203,213	Electrical Power Outlets	127
Digital Video Disc Player	187	Electronic Speed Control	107
Dimmer Control	99	Electronic Vehicle Information Center	115
Dipsticks		Emergency, In Case of	
Automatic Transaxle	327	Jacking	282
Disposal		Overheating	281
Antifreeze	321	Emission Control System Maintenance	301,348
Domelight	99	Engine	298,299
Door Ajar Light	151	Air Cleaner	309

Air Cleaner Filter	308	Filters	
Block Heater	230	Air Cleaner	308
Break-In Recommendations	70	Air Conditioning	219,313
Checking Oil Level	303	Automatic Transaxle	328
Compartment	298,299	Engine Fuel	309
Coolant	344	Engine Oil	307,344
Cooling	318	Engine Oil Disposal	307
Exhaust Gas Caution	36,269	Flashers	
Fails to Start	227,229	Hazard Warning	280
Fuel Requirements	266	Turn Signal	158,159,340,342
Oil	303,344	Fluid Capacities	343
Oil Change Interval	305	Fluid Leaks	72
Oil Selection	305	Fluid Level Checks	
Oil Synthetic	307	Automatic Transaxle	327
Overheating	281	Brake	345
Temperature Gauge	154	Power Steering	314,345
Exhaust Gas Caution	36,71,269,317	Fog Light Service	341
Exhaust System	317	Fog Lights	102,341
Exterior Folding Mirrors	78	Freeing A Stuck Vehicle	291

Fuel	266	Gasoline, Clean Air	266
Adding	270	Gasoline, Reformulated	267
Additives	268	Gauges	
Clean Air	266	Coolant Temperature	154
Filler Cap	270	Fuel	151
Filter	309	Speedometer	151
Gasoline	266	Tachometer	153
Gauge	151	Gearshift	233
Hoses	326	General Information	16,25,263
Light	151	Glass Cleaning	333
Octane Rating	266,344	Grocery Bag Retainer	91
Requirements	266	Gross Axle Weight Rating	273
Tank Capacity	343	Gross Vehicle Weight Rating	273
Fueling	270	Hazard Warning Flasher	280
Fuses	336	Head Phones	192
Garage Door Opener	119	Head Restraints	82
Gas Cap	270	Headlights	99
Gasoline	266	Bulb Replacement	339

High Beam/Low Beam Select Switch	103	Inside Rearview Mirror	77
Lights On Reminder	101	Instrument Cluster	149,150,151
Replacing	339	Instrument Panel and Controls	148
Time Delay	101	Instrument Panel Lens Cleaning	334
Heated Seats	82	Integrated Child Seat	58
Heater	199	Integrated Power Module	336
Heater, Engine Block	230	Interior Appearance Care	333
Homelink Transmitter	119	Interior Fuses	336
Hood Release	96	Interior Lights	98,99
Hoses	322,326	Intermittent Wipers	104,219,220
		Introduction	4
Ignition		Jack Location	283
Key	12	Jack Operation	282,285
Illuminated Entry	16	Jump Starting	288
Immobilizer	13		
Indicator, Traction Control	156	Key, Programming	15
Infant Restraint	59	Key, Replacement	15
Information Center	115,159	Key, Sentry	13
Information Center, Vehicle	115,159		

Key-In Reminder	13	Bulb Replacement	338,339
Keyless Entry System	20	Center Mounted Stop	343
Keys	12	Cruise	157
Knee Bolster	52,54	Dimmer Switch, Headlight	99
Lap/Shoulder Belts	39	Door Ajar	151
LATCH (Lower Anchors and Tether for Children)	62	Engine Temperature Warning	154
Latches		Fog	102,341
Hood	96	Hazard Warning Flasher	280
Lead Free Gasoline	266	Headlight Switch	99
Liftgate	33	Headlights	339
Lights	72,98	Headlights On Reminder	101
Airbag	52,57,72,152	High Beam Indicator	158,159
Alarm	154	High Beam/Low Beam Select	103
Anti-Lock	153	Illuminated Entry	16
Automatic Headlights	100	Interior	98,99
Back-Up	342	License	343
Battery Saver	101	Liftgate Ajar	151
Brake Warning	151	Lights On Reminder	101
		Low Fuel	151

Malfunction Indicator	155	Tires	247
Oil Pressure	155	Locks	
Park	99,340	Door	17
Passing	103	Lower Anchors and Tether for CHildren (LATCH)	62
Reading	110	Lubrication, Body	315
Rear Servicing	342	Luggage Rack	139
Rear Tail	342	Lumbar Support	84
Seat Belt Reminder	153	Maintenance Free Battery	311
Security Alarm	154	Maintenance Procedures	303
Service	338,339	Maintenance Schedule	348
Service Engine Soon	155	Light Duty Schedule "A"	363
Side Marker	342	Light Duty Schedule "B"	351
Theft Alarm	154	Schedule "A"	363
Turn Signal	102,340,342	Schedule "B"	351
Voltage	153	Malfunction Indicator Light	155,301
Washer Fluid	155	Manual, Service	376
Load Leveling System	141	Mini-Trip Computer	114
Loading Vehicle	135,272,274	Mirrors	77
Capacities	274		

Automatic Dimming	77	Change Interval	305
Electric Remote	79	Checking	303
Exterior Folding	78	Disposal	307
Heated	80	Filter	307,344
Outside	78	Filter Disposal	307
Rearview	77	Identification Logo	306
Vanity	80	Materials Added to	307
Modifications/Alterations, Vehicle	7	Recommendation	305
Monitor, Tire Pressure System	259	Synthetic	307
Mopar Parts	302,375	Viscosity	306
Multi-Function Control Lever	102	Onboard Diagnostic System	300,301
New Vehicle Break-In Period	70	Opener, Garage Door	119
Occupant Restraints	38	Operator Manuals	4
Octane Rating, Gasoline	266	Outside Rearview Mirrors	77
Odometer	157	Overdrive	234
Oil, Engine	303,344	Overhead Console	110
Capacity	343	Overhead Travel Information Center	110
		Overheating, Engine	154,281
		Owner's Manual	4,376

Panic Alarm	22	Windows	37
Parking Brake	235	Pregnant Women and Seat Belts	48
Parking On Hill	236	Pretensioners	
Passing Light	103	Seat Belts	47
Pedals, Adjustable	106	Programmable Electronic Features	116,120,124
Pets	66	Programming Transmitters	23,120,124
Placard, Tire and Loading Information	247		
Power		Radial Ply Tires	255
Brakes	237	Radiator Cap	319,320
Distribution Center	336	Radio	161,171,178
Door Locks	18	Radio Broadcast Signals	160
Lift Gate	34	Radio Operation	198
Mirrors	79	Radio Remote Controls	189,195
Outlet	127	Rear Air Conditioning	206,214
Seats	81	Rear Cup Holder	130
Sliding Door	29	Rear Heater	206
Steering	240	Rear Seat Removal	88,90
Steering, Checking	314	Rear Seating Flexibility	92,94
Sunroof	125	Rear Window Defroster	222

Rear Window Features	219	Safety Checks Outside Vehicle	72
Rear Wiper/Washer	219,220,221	Safety, Exhaust Gas	36
Rearview Mirrors	77	Safety Information, Tire	242
Reclining Front Seats	83	Safety Tips	71
Recommended Fluids, Lubricants and Genuine Parts	344	Schedule, Maintenance	348
Remote Keyless Entry	20	Seat Belt Maintenance	334
Remote Sound System Controls	195	Seat Belts	38
Removable Floor Console	132	Adjustable Shoulder Belt	44
Replacement Tires	257,259	Adjustable Upper Shoulder Anchorage	44
Reporting Safety Defects	376	And Pregnant Women	48
Restraint, Head	82	Center Lap Belt	47
Restraints, Child	58,64	Child Restraint	58
Restraints, Infant	59	Extender	48
Rocking Vehicle When Stuck	291	Front Seat	39
Roof Rack	139	Pretensioners	47
Rotation, Tires	265	Rear Seat	39
Safety Checks Inside Vehicle	71	Untwisting Procedure	45
		Seats	80
		Adjustment	80

Bench	90,92	Side Airbag	54
Easy Entry	85	Signals, Turn	102,158,159,340,342
Easy-Out Roller	90	Sliding Door	28
Heated	82	Slippery Surfaces, Driving On	290
Integrated, Child	58	Snow Chains	263
Lumbar Support	84	Snow Tires	264
Power	81	Spare Tire	283
Reclining	83,84	Spark Plugs	308
Removal	86,88,90	Speed Control	107
Tilting	85	Speedometer	151
Security Alarm	26	Starting	226
Selection of Coolant	344	Engine Fails to Start	227,229
Sentry Key	13	Starting and Operating	226
Service Assistance	372	Steering	
Service Contract	374	Column Controls	102
Service Engine Soon Light	155	Linkage	315
Service Manuals	376	Power	240,314
Setting the Clock	159	Shaft Seal	314
Shoulder Belts	39	Tilt Column	104

Steering Wheel Mounted Sound System		Tilt Steering Column	104
Controls	195	Tire and Loading Information Placard	247
Storage	132,337	Tire Markings	242
Storage Bin	132	Tire Safety Information	242
Storage, Vehicle	217,337	Tires	72,251,378
Storing Your Vehicle	337	Alignment	258
Sulfur in Gasoline	268	Chains	263
Sun Roof	125	Changing	282
Sun Visor Extension	80	Compact Spare	255
Sunglass Storage	111	High Speed	254
Supplemental Restraint System - Airbag	48	Inflation Pressures	252
Synthetic Engine Oil	307	Jacking	282
		Load Capacity	247,248
Tachometer	153	Pressure Monitor System	259
Temperature Control, Automatic	208	Quality Grading	378
Temperature Gauge, Engine Coolant	154,281	Radial	255
Tether Anchor, Child Restraint	62	Replacement	257,259
Theft Alarm	26	Rotation	265
Theft System	26	Safety	242,251

Sizes	244	Transmitter Battery Service	25
Snow Tires	264	Transmitter, Garage Door Opener	119
Spare Tire	283	Transmitter Programming	23
Spinning	256	Transmitter, Remote Keyless Entry	20
Tread Wear Indicators	256	Transporting Pets	66
Towing	275	Tread Wear Indicators	256
Disabled Vehicle	291	Trip Odometer	157
Trailer	275	Trip Odometer Reset Button	157
Traction Control	105,156,241	Turn Signals	102,158,159,340,342
Trailer Towing	275	Uniform Tire Quality Grades	378
Minimum Requirements	275	Universal Joints	315
Trailer and Tongue Weight	276	Universal Transmitter	119
Transaxle	231,326	Unleaded Gasoline	266
Automatic	231,326	Vanity Mirrors	80
Filter	328	Variance, Compass	112
Operation	231	Vehicle Certification Label	272
Overdrive	234	Vehicle Identification Number	6
Selection of Lubricant	326,345		
Transmission	<i>See Transaxle</i>		

Vehicle Information Center	115	Wheel Bearings	330
Vehicle Loading	272,274	Wind Buffeting	38,127
Vehicle Modifications/Alterations	7	Window Fogging	218
Vehicle Storage	217,337	Windows	36
Vehicle Theft Alarm	26	Power	37
Video Entertainment System	187	Rear Vent	36
Warning Flasher, Hazard	280	Windshield Washers	103,316
Warnings and Cautions	6	Windshield Wiper Blades	316
Warranty Information	375	Windshield Wipers	103
Washer, Adding Fluid	221,316	Wiper Blade Replacement	316
Washer, Rear	219,221	Wiper, Rear	220
Washing Vehicle	331	Wipers, Intermittent	104
Wheel Alignment and Balance	258	Zone Control	200
Wheel and Wheel Trim	332		