

## TABLE OF CONTENTS

SECTION		PAGE
<b>1</b>	INTRODUCTION .....	<b>3</b>
<b>2</b>	THINGS TO KNOW BEFORE STARTING YOUR VEHICLE .....	<b>9</b>
<b>3</b>	UNDERSTANDING THE FEATURES OF YOUR VEHICLE .....	<b>73</b>
<b>4</b>	UNDERSTANDING YOUR INSTRUMENT PANEL .....	<b>159</b>
<b>5</b>	STARTING AND OPERATING .....	<b>223</b>
<b>6</b>	WHAT TO DO IN EMERGENCIES .....	<b>319</b>
<b>7</b>	MAINTAINING YOUR VEHICLE .....	<b>345</b>
<b>8</b>	MAINTENANCE SCHEDULES .....	<b>407</b>
<b>9</b>	IF YOU NEED CONSUMER ASSISTANCE .....	<b>427</b>
<b>10</b>	INDEX .....	<b>435</b>



---

# INTRODUCTION

## CONTENTS

---

■ Introduction . . . . .	4	■ Van Conversions/Campers . . . . .	5
■ How To Use This Manual . . . . .	5	■ Vehicle Identification Number . . . . .	6
■ Warnings And Cautions . . . . .	5	■ Vehicle Modifications / Alterations . . . . .	7

#### 4 INTRODUCTION

##### INTRODUCTION

This manual has been prepared with the assistance of service and engineering specialists to acquaint you with the operation and maintenance of your new vehicle. It is supplemented by a Warranty Information Booklet and various customer oriented documents. You are urged to read these publications carefully. Following the instructions and recommendations in this manual will help assure safe and enjoyable operation of your vehicle.

**NOTE:** After you read the manual, it should be stored in the vehicle for convenient reference and remain with the vehicle when sold, so that the new owner will be aware of all safety warnings.

When it comes to service, remember that your dealer knows your vehicle best, has the factory-trained technicians and genuine Mopar® parts, and is interested in your satisfaction.

##### WARNING!

**Engine exhaust, some of its constituents, and certain vehicle components contain or emit chemicals known to the State of California to cause cancer and birth defects or other reproductive harm. In addition, certain fluids contained in vehicles and certain products of component wear contain or emit chemicals known to the State of California to cause cancer and birth defects or other reproductive harm.**



**HOW TO USE THIS MANUAL**

Consult the table of contents to determine which section contains the information you desire.

The detailed index, at the rear of this manual, contains a complete listing of all subjects.

**WARNINGS AND CAUTIONS**

This manual contains **WARNINGS** against operating procedures which could result in an accident or bodily injury. It also contains **CAUTIONS** against procedures which could result in damage to your vehicle. If you do not read this entire manual you may miss important information. Observe all Warnings and Cautions.

**VAN CONVERSIONS/CAMPERS**

The Manufacturer's Warranty does not apply to body modifications or special equipment installed by van conversion/camper manufacturers/ body builders. See the Warranty information book, Section 2.1.C. Such equipment includes video monitors, VCRs, heaters, stoves, refrigerators, etc. For warranty coverage and service on these items, contact the applicable manufacturer.

Operating instructions for the special equipment installed by the conversion/camper manufacturer should also be supplied with your vehicle. If these instructions are missing, please contact your selling dealer for assistance in obtaining replacement documents from the applicable manufacturer.

### VEHICLE IDENTIFICATION NUMBER

The vehicle identification number (VIN) is found on a stamped plate located on the left front corner of the instrument panel pad, visible from outside of the vehicle through the windshield. This number also appears on the Automobile Information Disclosure Label affixed to a window on your vehicle. Save this label for a convenient record of your vehicle identification number and optional equipment.

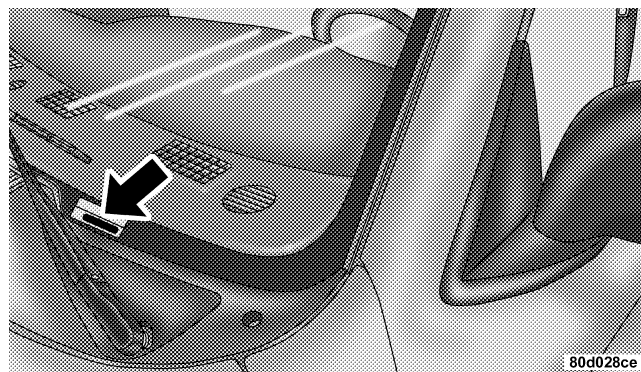

**NOTE:** It is illegal to remove the VIN plate.

**VEHICLE MODIFICATIONS / ALTERATIONS****WARNING!**

Any modifications or alterations to this vehicle could seriously affect its roadworthiness and safety and may lead to an accident resulting in serious injury or death.



---

# THINGS TO KNOW BEFORE STARTING YOUR VEHICLE

## CONTENTS

---

■ A Word About Your Keys . . . . .	.11	□ Power Door Locks — If Equipped . . . . .	.16
□ Key-In-Ignition Reminder . . . . .	.11	□ Child Protection Door Lock . . . . .	.20
□ Sentry Key — If Equipped . . . . .	.11	■ Remote Keyless Entry — If Equipped . . . . .	.22
■ Ignition And Steering Lock . . . . .	.13	□ To Unlock The Doors . . . . .	.22
□ Manual Transmissions . . . . .	.13	□ To Lock The Doors . . . . .	.23
□ Automatic Transmissions . . . . .	.14	□ Using The Panic Alarm . . . . .	.25
■ Door Key . . . . .	.15	□ Programming Additional Transmitters . . . . .	.26
■ Door Locks . . . . .	.15	□ General Information . . . . .	.27
□ Manual Locks . . . . .	.15	□ Transmitter Battery Service . . . . .	.28

**10 THINGS TO KNOW BEFORE STARTING YOUR VEHICLE**

■ Security Alarm System — If Equipped . . . . .	29	□ Enhanced Driver Seat Belt Reminder System (BeltAlert) . . . . .	43
□ Rearming Of The System . . . . .	29	□ Seat Belts And Pregnant Women . . . . .	45
□ To Set The Alarm . . . . .	29	□ Seat Belt Extender . . . . .	45
□ To Disarm The System . . . . .	30	□ Driver And Right Front Passenger Supplemental Restraint System (SRS)—Airbag . . . . .	45
■ Windows . . . . .	31	□ Child Restraint . . . . .	56
□ Power Windows—If Equipped . . . . .	31	■ Engine Break-In Recommendations . . . . .	68
□ Sliding Rear Window—If Equipped . . . . .	32	■ Safety Tips . . . . .	69
□ Wind Buffeting . . . . .	33	□ Transporting Passengers . . . . .	69
■ Occupant Restraints . . . . .	33	□ Lock Your Vehicle . . . . .	70
□ Lap/Shoulder Belts . . . . .	34	□ Exhaust Gas . . . . .	70
□ Adjustable Upper Shoulder Belt Anchorage . . . . .	41	□ Safety Checks You Should Make Inside The Vehicle . . . . .	71
□ Automatic Locking Mode (If Equipped) . . . . .	42	□ Safety Checks You Should Make Outside The Vehicle . . . . .	71
□ Center Lap Belts . . . . .	42		
□ Seat Belt Pretensioners . . . . .	43		

**A WORD ABOUT YOUR KEYS**

The double sided keys may be inserted into the locks with either side up. The keys for your new vehicle are enclosed in a plastic bag with a bar code label affixed to the front. The bar code can be used to order duplicate keys from your dealer or a locksmith. If you received your keys without the bag, ask your dealer to give you the number.

**Key-In-Ignition Reminder**

If you open the driver's door when the key is in the ignition switch, a chime will sound to remind you to remove the key.

**CAUTION!**

**An unlocked vehicle is an invitation to thieves. Always remove the key from the ignition and lock all the doors when leaving the vehicle unattended.**

**SENTRY KEY — IF EQUIPPED**

With this system, an electronically coded ignition key sends a signal to the vehicle electronics. If the electronics recognizes the signal, the vehicle will start and continue to run. If the system does not recognize the signal the vehicle will start and run for a maximum of 2 seconds after the initial key ON. After six unsuccessful attempts at starting, the system will shut down until the correct key is used.

**NOTE:** The Sentry Key Immobilizer System is not compatible with remote starting systems. Use of these systems may result in vehicle starting problems and a loss of security protection. Additional Sentry Keys or Mobil Speed-pass™ devices held against or immediately adjacent to the ignition key when starting the engine may cause vehicle starting problems. If a problem occurs, remove the Sentry Key from the key-ring and attempt to start the vehicle again. Pagers, cell phones, walkman, etc. will have no effect on this system.

## 12 THINGS TO KNOW BEFORE STARTING YOUR VEHICLE

The "Security Light", located in the instrument cluster, will illuminate for about 2 seconds when the ignition switch is first turned to the ON position. If the vehicle electronics do not receive a valid signal from the ignition key, the "Security Light" will flash continuously to signal that the vehicle has been immobilized. If the "Security Light" remains on during vehicle operation, it indicates a fault in the system electronics. If this option was ordered, all of the keys provided with your new vehicle have been programmed to the vehicle electronics.

### Replacement Keys

**NOTE:** Only keys that have been programmed to the vehicle electronics can be used to start the vehicle. Once a Sentry Key has been programmed to a vehicle, it cannot be programmed to any other vehicle.

At the time of purchase, the original owner is provided with a four digit PIN. This number is required for dealer

replacement of keys. Duplication of keys may be performed at an authorized dealer or by using the Customer Key Programming procedure. This procedure consists of programming a blank key to the vehicle electronics. A blank key is one which has never been programmed and needs to be cut.

**NOTE:** When having the Sentry Key System serviced, bring all vehicle keys to the dealer.

### Customer Key Programming

You can program new keys to the system if you have two valid keys by doing the following:

1. Insert the first valid key into the ignition and turn the ignition to the ON position for at least 3 seconds but no longer than 15 seconds. Turn the ignition back to the OFF position and remove the first key.
2. Insert the second valid key and switch the ignition to the ON position within 15 seconds. After 10 seconds the



"Security Light" will begin to flash. Turn the ignition back to the OFF position and remove the second key.

3. Insert a blank Sentry Key into the ignition and switch the ignition to the ON position within 60 seconds of having removed the second key. After 10 seconds the "Security Light" will stop flashing, then turn on for 3 seconds; then turn off.

The new Sentry Key has been programmed. Repeat this process to program up to an additional 6 keys. A maximum of 8 keys can be programmed to the system, including the original keys provided with the vehicle.

**General Information**

This device complies with part 15 of FCC rules and with RS-210 of Industry Canada. Operation is subject to the following conditions:

1. This device may not cause harmful interference.

2. This device must accept any interference that may be received including interference that may cause undesired operation.

**NOTE:** Changes or modifications not expressly approved by the party responsible for compliance could void the user's authority to operate the equipment.

**IGNITION AND STEERING LOCK**

Insert the key fully, and then turn the switch to one of the five illustrated positions. The key can be inserted or withdrawn only in the LOCK position.

**Manual Transmissions**

When the steering wheel is in the LOCK position, the steering and ignition systems are locked to provide antitheft protection for your vehicle. It may be difficult to turn the key from the LOCK position when starting your vehicle. Move the steering wheel left and right while turning the key until it turns easily. To remove the key,

## 14 THINGS TO KNOW BEFORE STARTING YOUR VEHICLE

depress and hold the release button located between the ignition switch and the instrument panel. Turn the ignition key to LOCK and remove the key.

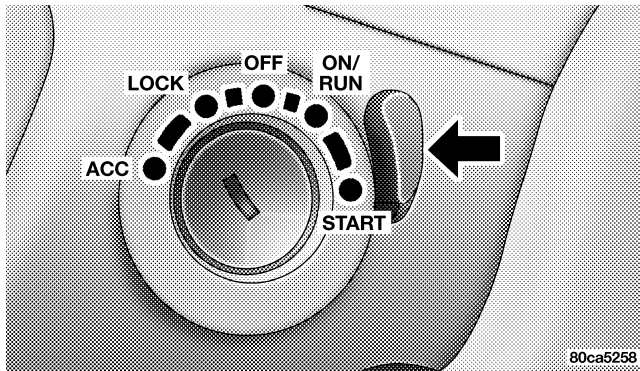

Manual Transmissions

### Automatic Transmissions

In the LOCK position, the steering and ignition systems are locked to provide antitheft protection for your vehicle. It may be difficult to turn the key from the LOCK position when starting your vehicle. Move the steering wheel left and right while turning the key until it turns easily. The key can be inserted or withdrawn only in the LOCK position. Push in on the key in the ignition lock cylinder to rotate to the LOCK position.

**NOTE:** The steering wheel will lock when the key is removed, and the steering wheel is turned around 115 degrees from center clockwise and around 65 degrees counterclockwise.

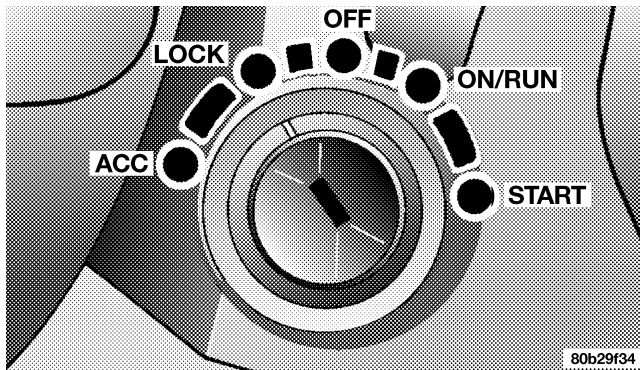

**Automatic Transmissions**

**NOTE:** On vehicles equipped with an automatic transmission, the key cannot be turned to LOCK until the selector is in the PARK position. Do not attempt to pull the shift lever out of PARK after the key is in the LOCK position.

**DOOR KEY**

The same key used to start the vehicle is also used to unlock the doors. To unlock the vehicle doors, insert the key into the lock and turn.

To lock the doors, insert the key and turn.

**DOOR LOCKS**

**Manual Locks**

Front and Rear doors may be locked, by moving the lock plunger up or down.

All doors may be opened with the inside door handle without lifting the lock plunger. Doors locked before closing will remain locked when closed.

The ignition key will unlock all the locks on your vehicle.

**WARNING!**

For personal security and safety in the event of an accident, lock the vehicle doors when you drive as well as when you park and leave the vehicle.

**WARNING!**

When leaving the vehicle always remove the key from the ignition lock, and lock your vehicle. Do not leave children unattended in the vehicle, or with access to an unlocked vehicle. Unsupervised use of vehicle equipment may cause severe personal injuries and death.

**Power Door Locks — If Equipped**

**NOTE:** Vehicles equipped with remote keyless entry do not have a passenger side door lock cylinder.

Vehicles equipped with power door locks can be locked or unlocked from inside by either the use of the door lock switches located on the front doors or by pressing the LOCK or UNLOCK buttons on the Remote Keyless Entry key fob (if equipped).

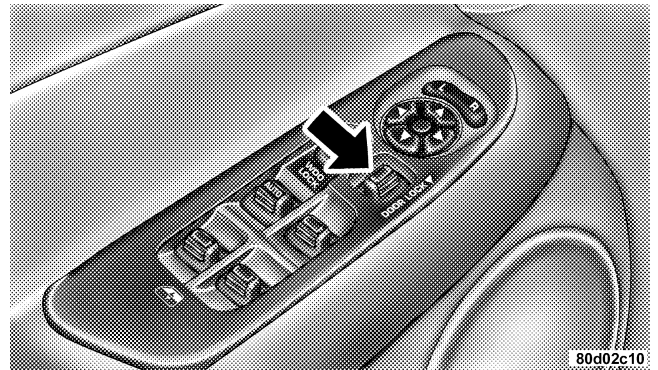
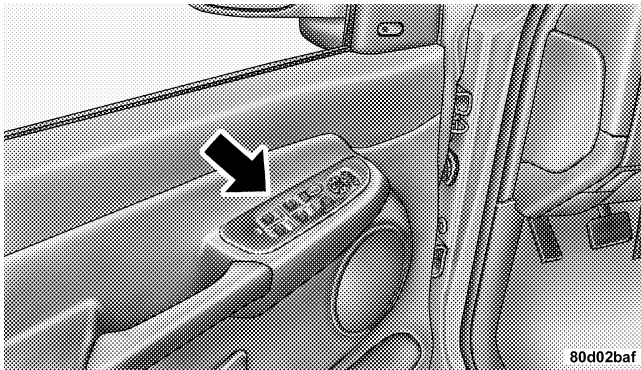

As a safety feature the doors will not lock when using the door lock switches during the following condition:

1. The driver's door is open while the key is in the ignition.

### Central Locking — If Equipped

Vehicles with security will have a feature called "Central Locking". When the key is placed in the door cylinder and turned to the "Unlock" position, the security will be disarmed, the illuminated entry will be turned on and that door will be mechanically unlocked. If the key is once again turned to the unlock position within 5 seconds of the first unlock, the remaining doors will unlock. If the key is turned to the "Lock" position while all doors are closed, illuminated entry will be canceled, security will begin arming, and all doors will lock.

### Automatic Door Locks

If this feature is enabled, your door locks will lock automatically when the vehicle's speed exceeds 15 mph.

This feature is enabled when your vehicle is shipped from the assembly plant and can be disabled by using the following procedure:

1. Enter your vehicle and close all doors.

2. Fasten your seat belt (Fastening the seat belt will cancel any chiming that may confuse you during this programming procedure).

3. Place the key into the ignition.

4. Within 10 seconds cycle the key from the OFF position to the ON position four times; ending in the ON position ( **Do not start the engine** ).

5. Within 30 seconds, press the driver's door lock switch in the LOCK direction.

6. A single chime will be heard to indicate the feature has been disabled.

7. To reactivate this feature, repeat the above steps.

8. If a chime is not heard, program mode was canceled before the feature could be disabled. If necessary, repeat the above procedure.

**Auto Unlock Feature**

This feature unlocks all the doors of the vehicle when the driver's door is opened first. The following conditions must be met:

- The driver's door must be opened first.
- The Automatic Door Lock feature must be enabled.
- The doors of the vehicle must be locked automatically by the Automatic Door Lock feature.
- The vehicle is in P (Park) and the ignition switch is in the Off position.

This feature will not operate if any of the conditions above are not met or following has occurred:

- Any manual operation of a door lock switch has occurred.

**Auto Unlock Feature Programming**

This feature is enabled when your vehicle is shipped from the assembly plant and can be disabled by using the following procedure:

Customer Programming sequence to disable or enable:

1. Enter your vehicle and close all doors.
2. Fasten your seat belt (fastening the seat belt will cancel any chiming that may be confusing during this programming procedure).
3. Insert the key into the ignition.
4. Within 4 seconds, cycle the key from the OFF position to the ON position four times ending in the ON position (**do not start the engine**).

## 20 THINGS TO KNOW BEFORE STARTING YOUR VEHICLE

5. Within 30 seconds, press the driver's door lock switch in the UNLOCK direction.
6. A single chime will sound to indicate the feature has been changed.
7. To reactivate the feature, repeat the above steps.
8. If a chime is not heard, program mode was canceled before the feature could be changed. If necessary repeat the above procedure.

### **Child Protection Door Lock**

To provide a safer environment for children riding in the rear seat, the rear doors of your vehicle have the child-protection door lock system.

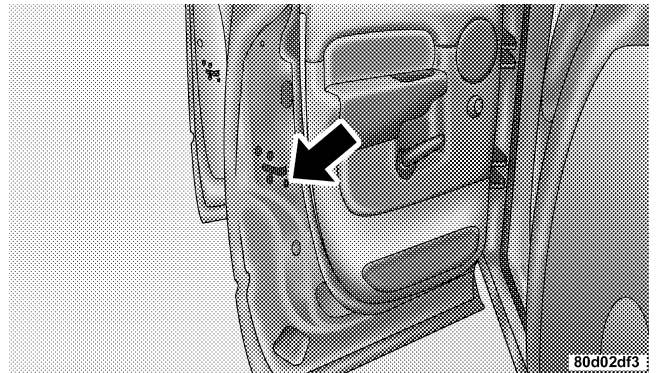



To use the system, open each rear door and slide the control UP to engage the locks and DOWN to disengage the child-protection locks. When the system on a door is engaged, that door can only be opened by using the outside door handle even if the inside door lock is in the unlocked position.

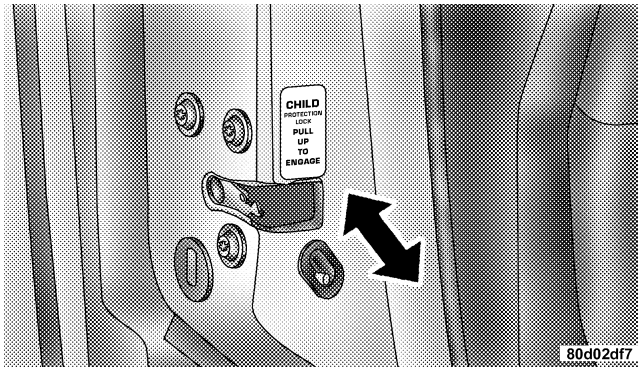

### WARNING!

**Avoid trapping anyone in a vehicle in a collision. Remember that the rear doors can only be opened from the outside when the child protection locks are engaged.**

2

**NOTE:** After setting the child protection door lock system, always test the door from the inside to make certain it is in the desired position.

**NOTE:** For emergency exit with the system engaged, move the door lock switch to the UNLOCK position, roll down the window and open the door with the outside door handle.

### REMOTE KEYLESS ENTRY — IF EQUIPPED

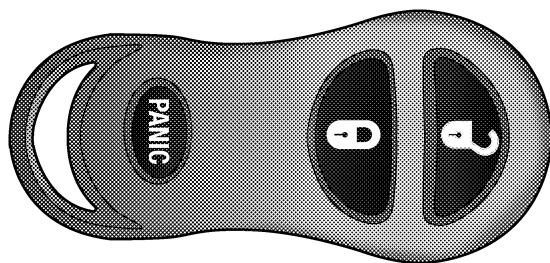

80b6f052

This system allows you to lock or unlock the doors from distances up to about 23 feet (7 meters) using a hand held radio transmitter. The transmitter need not be pointed at the vehicle to activate the system.

#### To unlock the doors:

Press and release the UNLOCK button on the key fob once to unlock only the driver's door or twice to unlock all the doors. When the UNLOCK button is pressed, the illuminated entry will initiate, the parking lights will flash on twice and if installed, the cargo lamp will turn on for 30 seconds.

The system can be programmed to unlock all the doors upon the first UNLOCK button press by using the following procedure:

1. Enter your vehicle and close all doors.
2. Fasten your seat belt.(Fastening the seat belt will cancel any chiming that may confuse you during this programming procedure).
3. Place the key into the ignition.

4. Turn the ignition to the ON position ( **Do not start the engine** ).
5. Press and hold the UNLOCK button on a programmed (i.e. functional) key fob.
6. Continue to hold the UNLOCK button, wait at least 4 seconds, but no longer than 10 seconds, then press and hold the LOCK button.
7. When a single chime is heard, release both buttons.
8. Turn the ignition to the OFF position or wait 60 seconds.
9. To reactivate this feature, repeat the above steps.
10. If a chime is not heard, program mode was canceled before the feature could be changed. If necessary, repeat the above procedure.

**To lock the doors:**

Press and release the LOCK button on the transmitter to lock all doors. If the ignition is OFF, when the doors are locked, the parking lights will flash on once and the horn will chirp once.

The horn chirp feature will be shipped from the assembly plants activated. If desired this feature can be disabled by using the following procedure:

1. Enter your vehicle and close all doors.
2. Fasten your seat belt (fastening the seat belt will cancel any chiming that may confuse you during this programming procedure).
3. Place the key into the ignition.

## 24 THINGS TO KNOW BEFORE STARTING YOUR VEHICLE

4. Turn the ignition to the ON position ( **Do not start the engine** ).
5. Press and hold the LOCK button on a programmed (i.e. functional) key fob.
6. Continue to hold the LOCK button, wait at least 4 seconds, but no longer than 10 seconds, then press and hold the UNLOCK button.
7. When a single chime is heard, release both buttons.
8. Turn the ignition to the OFF position or wait 60 seconds.
9. Test the horn chirp feature by pressing the LOCK button on the key fob with the ignition in the OFF position, or the key removed.
10. To reactivate this feature, repeat the above steps.

Vehicles will be shipped from the assembly plants with the park lamp flash feature activated. If desired, this feature can be disabled by using the following procedure:

1. Enter your vehicle and close all doors.
2. Fasten your seat belt (fastening the seat belt will cancel any chiming that may confuse you during this programming procedure).
3. Place the key into the ignition.
4. Turn the ignition to the ON position ( **Do not start the engine** ).
5. Press and hold the LOCK button on a programmed (i.e. functional) key fob.

6. Continue to hold the LOCK button, wait at least 4 seconds, but no longer than 10 seconds, then press and hold the PANIC button.
7. When a single chime is heard, release both buttons.
8. Turn the ignition to the OFF position or wait 60 seconds.
9. Test the park lamp flash feature by pressing the LOCK button on the key fob with the ignition in the OFF position or the key removed.
10. To reactivate this feature, repeat the above steps.
11. If a chime is not heard, program mode was canceled before the feature could be disabled. If necessary, repeat the above procedure.

### Using the Panic Alarm

To activate the Panic mode while the ignition is OFF press and release the PANIC button on the transmitter once. When the Panic mode is activated, the interior lights will illuminate, the headlamps and parking lights will flash, and the horn will sound.

To cancel the Panic mode press and release the PANIC button on the transmitter a second time. Panic mode will automatically cancel after 3 minutes or if the vehicle is started and exceeds 15 mph. During the Panic Mode, the door locks and remote keyless entry systems will function normally. Panic mode will not disarm the security system on vehicles so equipped.

**Programming Additional Transmitters**

Vehicles with the keyless entry option will be shipped from the assembly plants with two key fob transmitters programmed only for that vehicle. A total of four fobs can be programmed for your vehicle. Additional fobs can be programmed to your vehicle through the use of a currently programmed fob.

**NOTE:** When entering program mode using that fob, ALL currently programmed fobs will be erased and you will have to reprogram them for your vehicle. However, if program mode is entered and no action is performed, the previously programmed fobs will continue to function.

1. Enter your vehicle and close all doors.
2. Fasten your seat belt (fastening the seat belt will cancel any chiming that may confuse you during this programming procedure).
3. Place the key into the ignition.
4. Turn the ignition to the ON position ( **Do not start the engine** ).
5. Press and hold the UNLOCK button on a programmed (i.e. functional) key fob.
6. Continue to hold the UNLOCK button, wait at least 4 seconds, but no longer than 10 seconds, then press and hold the PANIC button.
7. When a single chime is heard, release both buttons. The chime indicates that the system is in program mode.
8. Press and release both the LOCK and UNLOCK buttons, simultaneously on the fob to be programmed.
9. A single chime will be heard. The chime indicates that the fob has been recognized.
10. Within 4 seconds of hearing the chime, press and release any button on the fob being programmed.

11. A single chime will be heard. The chime indicates that the fob has been programmed.
12. Repeat steps 8 to 11 for a total of 4 fobs.
13. Turn the ignition to the OFF position or wait 60 seconds to exit program mode.
14. Your vehicle will remain in program mode for up to 60 seconds from when the original chime (i.e. Step #7) was heard. After 60 seconds, all programmed fobs will function normally.

**NOTE:** If you do not have a programmed transmitter, contact your dealer for details.

**General Information**

This device complies with part 15 of FCC rules and with RS-210 of Industry Canada. Operation is subject to the following conditions:

1. This device may not cause harmful interference.

2. This device must accept any interference that may be received including interference that may cause undesired operation.

**NOTE:** Changes or modifications not expressly approved by the party responsible for compliance could void the user’s authority to operate the equipment.

If your Keyless Entry Transmitter fails to operate from a normal distance, check for these two conditions.

1. Weak batteries in transmitter. The expected life of the batteries is from one to two years.
2. Closeness to a radio transmitter such as a radio station tower, airport transmitter, and some mobile or CB radios.

### Transmitter Battery Service

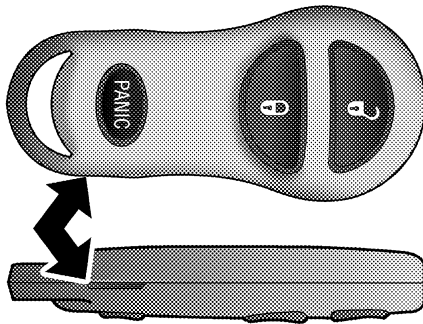

The recommended replacement battery is a 3V lithium 2016 cell. This transmitter requires two batteries.

**NOTE:** Do not touch the battery terminals that are on the back housing or the printed circuit board.

1. With transmitter buttons facing down, use a flat blade or dime to pry the two halves of the transmitter apart. Make sure not to damage the rubber gasket during removal.

2. Remove and replace the batteries. Be careful not to disturb the metal terminal near the batteries. Install the batteries with the positive terminal up, reference the note "+ SIDE UP" on the inside of the bottom half of the transmitter case. Avoid touching the new batteries with your fingers. Skin oils may cause battery deterioration. If you touch a battery, clean it with rubbing alcohol.

3. To reassemble the transmitter case snap the two halves together. Make sure there is an even gap between the two halves. Test transmitter operation.



**SECURITY ALARM SYSTEM — IF EQUIPPED**

This system monitors the vehicle doors and ignition for unauthorized operation. When the alarm is activated, the system provides both audible and visual signals. For the first 3 minutes the horn will sound and the headlights and security telltale will flash repeatedly. For an additional 15 minutes only the headlights and security telltale will flash. The engine will run only if a valid Sentry Key is used to start the vehicle. Use of the Sentry Key will disable the alarm.

**Rearming of the System:**

The security system will rearm itself after the 15 additional minutes of headlights and security telltale flashing, if the system has not been disabled. If the condition which initiated the alarm is still present, the system will ignore that condition and monitor the remaining doors and ignition.

**To Set the Alarm:**

The alarm will set when you use the power door locks, turn the key in the driver's door lock cylinder, or use the Keyless Entry transmitter to lock the doors. After all the doors are locked and closed the SECURITY light in the instrument cluster will flash rapidly to signal that the system is arming. The security light in the instrument panel cluster will flash rapidly for about 16 seconds to indicate that the alarm is being set. After the alarm is set, the security light will flash at a slower rate to indicate that the system is armed.

**NOTE:** If the SECURITY light stays on continuously during vehicle operation, have the system checked by your dealer.

**To Disarm the System:**

Use the Keyless Entry transmitter or the key to turn the driver's door lock to the unlock position. If something has triggered the system in your absence, the horn will sound three times when you unlock the doors and the security lamp will flash for 30 seconds. Check the vehicle for tampering.

The Security system will also disarm, if the vehicle is started with a programmed Sentry Key. If an unprogrammed Sentry Key is used to start a vehicle, the engine will run for 2 seconds and then the security alarm will be initiated. To exit alarming mode, press the transmitter Unlock button, unlock the driver's door using the key cylinder, or start the vehicle with a programmed Sentry Key.

The Security Alarm System is designed to protect your vehicle; however, you can create conditions where the system will arm unexpectedly. If you remain in the vehicle and lock the doors with the transmitter, the alarm will sound when you pull the door handle to exit. You may also accidentally disarm the system by unlocking the driver's door with the door key and then locking it manually with the lock plunger. The door will be locked but the Security Alarm will not arm.

**WINDOWS**

**Power Windows—If Equipped**

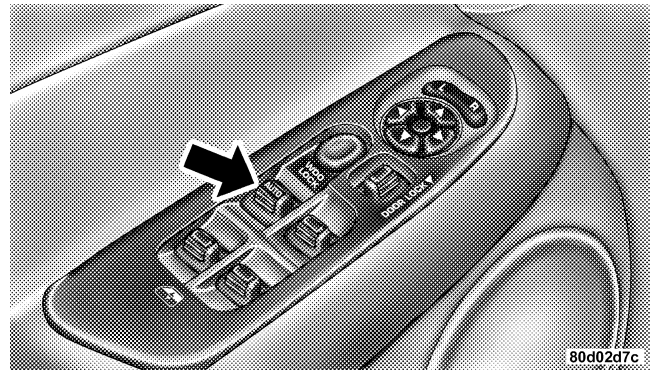
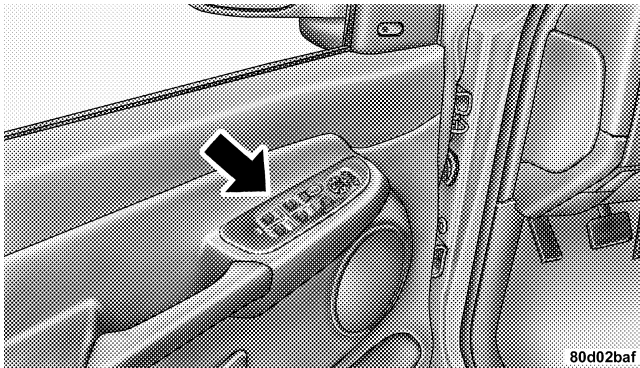

The control on the left front door panel has up-down switches that give you fingertip control of all power windows. There is a single opening and closing switch on the front passenger door for passenger window control and on the rear doors of Quad Cab models. The windows will operate only when the ignition switch is turned to the ON or ACC (Accessory) position.

**Auto Down (Driver's Side Only)**

The driver's window switch has an Auto Down feature. Press the window switch past the detent, release, and the window will go down automatically.

**Window Lockout Switch (4 Door Models Only)**

The window lockout switch on the driver's door allows you to disable the window control on the other doors. To disable the window controls on the other doors, press the window lock button. To enable the window controls, press the window control button again.

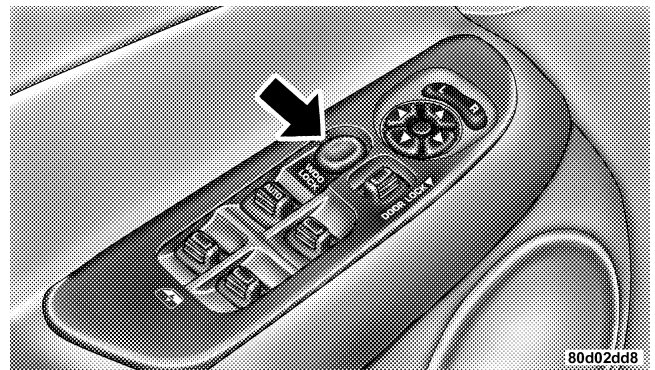

**Sliding Rear Window—If Equipped**

A locking device in the center of the window helps to prevent entry from the rear of the vehicle. Squeeze the lock to release the window.

**WIND BUFFETING**

Wind buffeting can be described as the perception of pressure on the ears or a helicopter type sound in the ears. Your vehicle may exhibit wind buffeting with the windows down or partially open positions. This is a normal occurrence and can be minimized. If the buffeting occurs with the rear windows open, open the front and rear windows together to minimize the buffeting.

**OCCUPANT RESTRAINTS**

Some of the most important safety features in your vehicle are the restraint systems. These include the front and rear seat belts for the driver and all passengers, front airbags for both the driver and front passenger and, if so equipped, window bags for the driver and passengers seated next to a window. If you will be carrying children too small for adult-size belts, your seat belts also can be used to hold infant and child restraint systems.

Please pay close attention to the information in this section. It tells you how to use your restraint system properly to keep you and your passengers as safe as possible.

**WARNING!**

**In a collision, you and your passengers can suffer much greater injuries if you are not properly buckled up. You can strike the interior of your vehicle or other passengers, or you can be thrown out of the vehicle. Always be sure you and others in your vehicle are buckled up properly.**

Buckle up even though you are an excellent driver, even on short trips. Someone on the road may be a poor driver and cause a collision that includes you. This can happen far away from home or on your own street.

Research has shown that seat belts save lives, and that they can reduce the seriousness of injuries in a collision. Some of the worst injuries happen when people are thrown from the vehicle. Seat belts reduce the possibility of ejection and the risk of injury caused by striking the inside of the vehicle. **Everyone** in a motor vehicle should be belted at all times.

**Lap/Shoulder Belts**

All seating positions except the Quad Cab front center seating position have combination lap/shoulder belts. The belt webbing retractor is designed to lock during very sudden stops or collisions. This feature allows the shoulder part of the belt to move freely with you under normal conditions. But in a collision, the belt will lock and reduce the risk of your striking the inside of the vehicle or being thrown out.

**WARNING!**

**It is extremely dangerous to ride in a cargo area, inside or outside of a vehicle. In a collision, people riding in these areas are more likely to be seriously injured or killed.**

**Do not allow people to ride in any area of your vehicle that is not equipped with seats and seat belts.**

**Be sure everyone in your vehicle is in a seat and using a seat belt properly.**

**WARNING!**

- Wearing a seat belt incorrectly is dangerous. Seat belts are designed to go around the large bones of your body. These are the strongest parts of your body and can take the forces of a collision the best. Wearing your belt in the wrong place could make your injuries in a collision much worse. You might suffer internal injuries, or you could even slide out of part of the belt. Follow these instructions to wear your seat belt safely and to keep your passengers safe, too.
- Two people should never be belted into a single seat belt. People belted together can crash into one another in an accident, hurting one another badly. Never use a lap/shoulder belt or a lap belt for more than one person, no matter what their size.

**Lap/Shoulder Belt Operating Instructions**

1. Enter the vehicle and close the door. Sit back and adjust the seat.

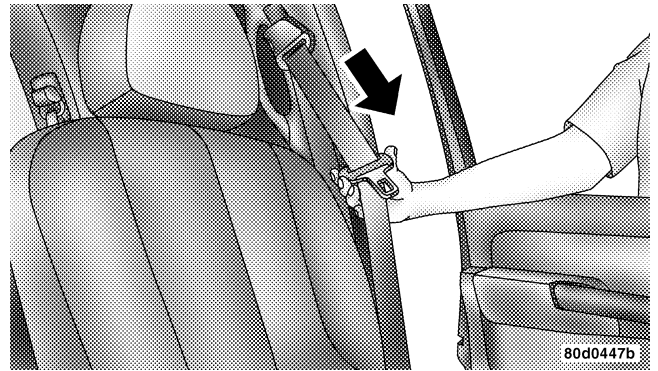

### 36 THINGS TO KNOW BEFORE STARTING YOUR VEHICLE

2. The seat belt latch plate is above the back of the front seat, next to your arm in the rear seat. Grasp the latch plate and pull out the belt. Slide the latch plate up the webbing as far as necessary to allow the belt to go around your lap.

3. When the belt is long enough to fit, insert the latch plate into the buckle until you hear a "click."

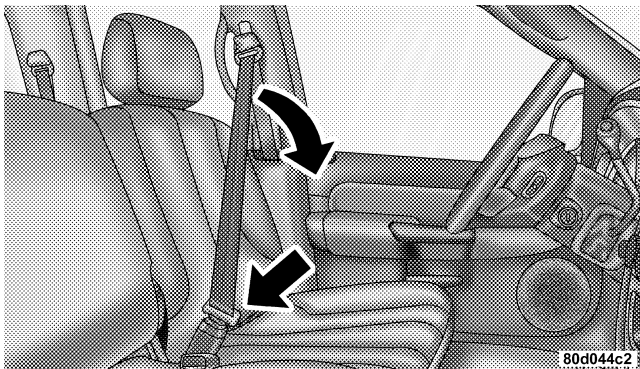

#### WARNING!

- A belt buckled into the wrong buckle will not protect you properly. The lap portion could ride too high on your body, possibly causing internal injuries. Always buckle your belt into the buckle nearest you.
- A belt that is too loose will not protect you as well. In a sudden stop you could move too far forward, increasing the possibility of injury. Wear your seat belt snugly.
- A belt that is worn under your arm is very dangerous. Your body could strike the inside surfaces of the vehicle in a collision, increasing head and neck injury. And a belt worn under the arm can cause internal injuries. Ribs aren't as strong as shoulder bones. Wear the belt over your shoulder so that your strongest bones will take the force in a collision.
- A shoulder belt placed behind will not protect you from injury during a collision. You are more likely to hit your head in a collision if you do not wear your shoulder belt. The lap and shoulder belt are meant to be used together.



4. Position the lap belt across your thighs, below your abdomen. To remove slack in the lap belt portion, pull up on the shoulder belt. To loosen the lap belt if it is too tight, tilt the latch plate and pull on the lap belt. A snug belt reduces the risk of sliding under the belt in a collision.

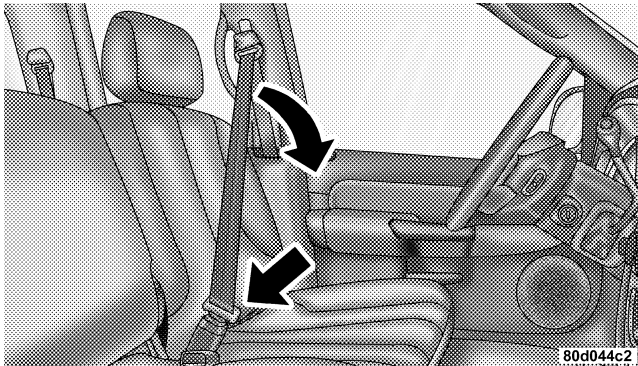

### WARNING!

- A lap belt worn too high can increase the risk of internal injury in a collision. The belt forces won't be at the strong hip and pelvic bones, but across your abdomen. Always wear the lap belt as low as possible and keep it snug.
- A twisted belt can't do its job as well. In a collision it could even cut into you. Be sure the belt is straight. If you can't straighten a belt in your vehicle, take it to your dealer and have it fixed.

**38 THINGS TO KNOW BEFORE STARTING YOUR VEHICLE**

5. Position the shoulder belt on your chest so that it is comfortable and not resting on your neck. The retractor will withdraw any slack in the belt.
6. To release the belt, push the red button on the buckle. The belt will automatically retract to its stowed position. If necessary, slide the latch plate down the webbing to allow the belt to retract fully.

**WARNING!**

**A frayed or torn belt could rip apart in a collision and leave you with no protection. Inspect the belt system periodically, checking for cuts, frays, or loose parts. Damaged parts must be replaced immediately. Do not disassemble or modify the system. Seat belt assemblies must be replaced after a collision if they have been damaged (bent retractor, torn webbing, etc.) or if the airbag deployed.**

### Standard Cab Front Center Three Point Belt

1. The front center seat belt on the Standard Cab may be disconnected to open up utilization of the storage areas behind the front seats. The black latch plate can be detached from the black keyed seat belt buckle located on the inboard side of the passenger seat. Insert the vehicle ignition key into the center white slot on the black buckle. The black buckle latch plate can be removed when the key is pressed into the buckle. Allow the retractor to take up the surplus webbing, and the buckles will hang vertically from the cab back exit bezel, thus freeing up all the area behind the front seats.

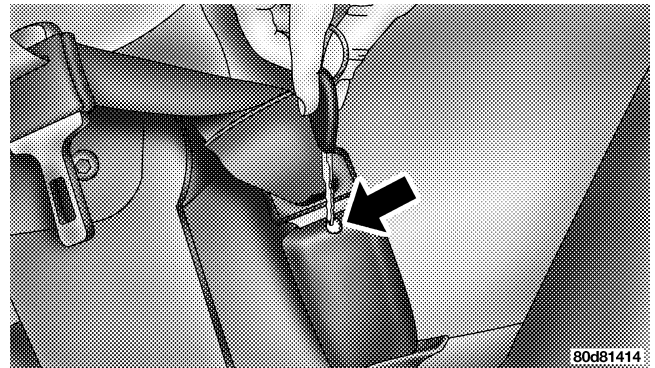

Detaching Buckle with Key

#### 40 THINGS TO KNOW BEFORE STARTING YOUR VEHICLE

2. To reattach the seat belt to the front center seat, pull the black buckle latch plate forward from the cab back panel and insert it into the black keyed buckle until there is an audible click. Refer to the previous section for the proper seat belt usage.

#### WARNING!

- If the black latch and black buckle are not properly connected when the seat belt is used by an occupant, the seat belt will not be able to provide proper restraint and will increase the risk of injury in a collision.
- When reattaching the black latch and black buckle, ensure the seat belt webbing is not twisted. If the webbing is twisted, follow the preceding procedure to detach the black latch and black buckle, untwist the webbing, and reattach the black latch and black buckle.

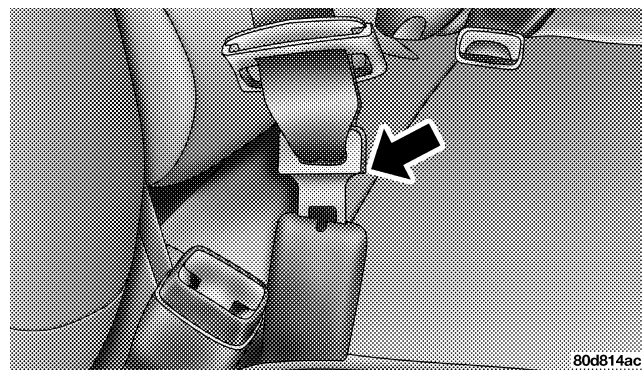

Inserting Latch Plate

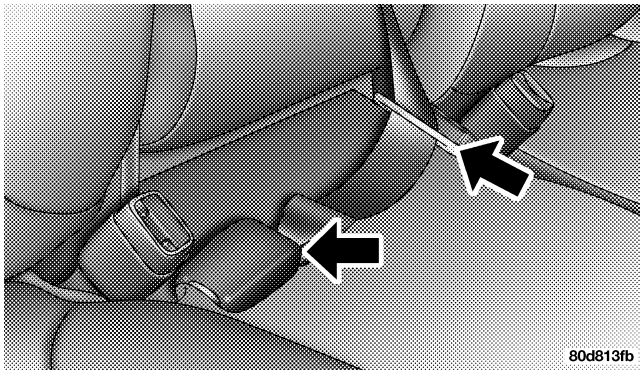

80d813fb

In Use Position

**WARNING!**

If the black latch and buckle are not connected when the seat belt is used by an occupant, the seat belt will not restrain you properly.

**Adjustable Upper Shoulder Belt Anchorage**

In the front row outboard seats, the shoulder belt can be adjusted upward or downward to help position the belt away from your neck. Press the button located on the upper belt guide, and then move it up or down to the position that serves you best.

2

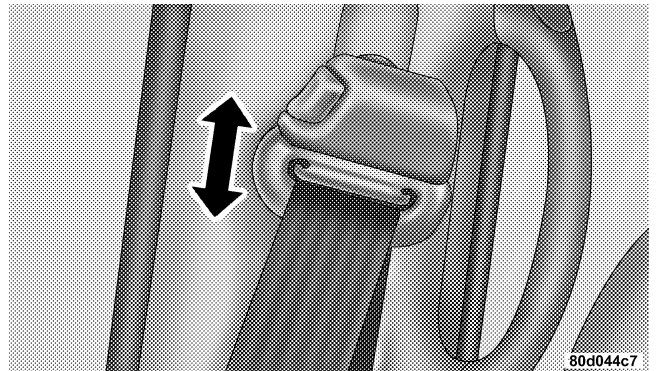

80d044c7

As a guide, if you are shorter than average, you will prefer a lower position, and if you are taller than average, you'll prefer a higher position. When you release the anchorage, try to move it up or down to make sure that it is locked in position.

**Automatic Locking Mode (if Equipped)**

In this mode, the shoulder belt is automatically pre-locked. The belt will still retract to remove any slack in the shoulder belt. The automatic locking mode is only available on the front passenger side belt.

**When To Use The Automatic Locking Mode**

Anytime a child safety seat is installed in a passenger front seating position. Children 12 years old and under should be properly restrained in the rear seat whenever possible.

**How To Use The Automatic Locking Mode**

1. Buckle the combination lap and shoulder belt.

2. Grasp the shoulder portion and pull downward until the entire belt is extracted.

3. Allow the belt to retract. As the belt retracts, you will hear a clicking sound. This indicates the safety belt is now in the automatic locking mode.

**How To Disengage The Automatic Locking Mode**

Disconnect the combination lap/shoulder belt and allow it to retract completely to disengage the automatic locking mode and activate the vehicle sensitive (emergency) locking mode.

**Center Lap Belts**

The center seating position for the Quad Cab front seat has a lap belt only. To fasten the lap belt, slide the latch plate into the buckle until you hear a "click." To lengthen the lap belt, tilt the latch plate and pull. To remove slack, pull the loose end of the webbing. Wear the lap belt snug against the hips. Sit back and erect in the seat, then adjust the belt as tightly as is comfortable.

**WARNING!**

- A lap belt worn too loose or too high is dangerous.
- A belt worn too loose can allow you to slip down and under the belt in a collision.
- A belt that is too loose or too high will apply crash forces to the abdomen, not to the stronger hip bones. In either case, the risk of internal injuries is greater. Wear a lap belt low and snug.

**Seat Belt Pretensioners**

The seat belts for both front seating positions are equipped with pretensioning devices that are designed to remove slack from the seat belt system in the event of a collision. These devices improve the performance of the seat belt by assuring that the belt is tight about the occupant early in a collision. Pretensioners work for all size occupants, including those in child restraints.

**NOTE:** These devices are not a substitute for proper seat belt placement by the occupant. The seat belt still must be worn snugly and positioned properly.

The pretensioners are triggered by the airbag control module. Like the airbags, the pretensioners are single use items. After a collision that is severe enough to deploy the airbags and pretensioners, both must be replaced.

**Enhanced Driver Seat Belt Reminder System (BeltAlert)**

If the driver's seat belt has not been buckled within 60 seconds of starting the vehicle and if the vehicle speed is greater than 5 mph (8 km/h), the Enhanced Warning System (BeltAlert) will alert the driver to buckle their seat belt. The driver should also instruct all other occupants to buckle their seat belts. Once the warning is triggered, the Enhanced Warning System (BeltAlert) will continue to chime and flash the Seat Belt Warning Light for 96 seconds or until the driver's seat belt is buckled. The

#### 44 THINGS TO KNOW BEFORE STARTING YOUR VEHICLE

Enhanced Warning System (BeltAlert) will be reactivated if the driver's seat belt is unbuckled for more than 10 seconds and the vehicle speed is greater than 5 mph (8 km/h).

The Enhanced Warning System (BeltAlert) can be enabled or disabled by your authorized dealer or by following these steps:

**NOTE:** The following steps must occur within the first 60 seconds of the ignition switch being turned to the ON or START position. DaimlerChrysler does not recommend deactivating the Enhanced Warning System (BeltAlert).

1. Turn the ignition switch to the OFF position and buckle the driver's seat belt.
2. Start the engine and wait for the Seat Belt Warning Light to turn off.

3. Within 60 seconds of starting the vehicle, unbuckle and then re-buckle the driver's seat belt at least three times within 10 seconds, ending with the seat belt buckled.

4. Turn off the engine. A single chime will sound to signify that you have successfully completed the programming.

The Enhanced Warning System (BeltAlert) can be reactivated by repeating this procedure.

**NOTE:** Although the Enhanced Warning System (BeltAlert) has been deactivated, the Seat Belt Warning Light will continue to illuminate while the driver's seat belt remains unbuckled.



**Seat Belts and Pregnant Women**

We recommend that pregnant women use seat belts throughout their pregnancies. Keeping the mother safe is the best way to keep the baby safe.

Pregnant women should wear the lap part of the belt across the thighs and as snug against the hips as possible. Keep the belt low so that it does not come across the abdomen. That way the strong bones of the hips will take the force if there is a collision.

**Seat Belt Extender**

If a seat belt is too short, even when fully extended, your dealer can provide you with a seat belt extender. This extender should be used only if the existing belt is not long enough. When it is not required, remove the extender and store it.

**WARNING!**

Using a seat belt extender when not needed can increase the risk of injury in a collision. Only use the seat belt extender when the lap belt is not long enough when it is worn low and snug, and in the recommended seating positions. Remove and store the extender when not needed.

**2****Driver And Right Front Passenger Supplemental Restraint System (SRS)—Airbag**

This vehicle has front airbags for both the driver and front passenger as a supplement to the seat belt restraint systems. The driver's front airbag is mounted in the center of the steering wheel. The passenger's front airbag is mounted in the instrument panel, above the glove compartment. The words SRS AIRBAG are embossed on the airbag covers.

#### 46 THINGS TO KNOW BEFORE STARTING YOUR VEHICLE

These airbags are certified to the new Federal regulations that allow less forceful deployments.

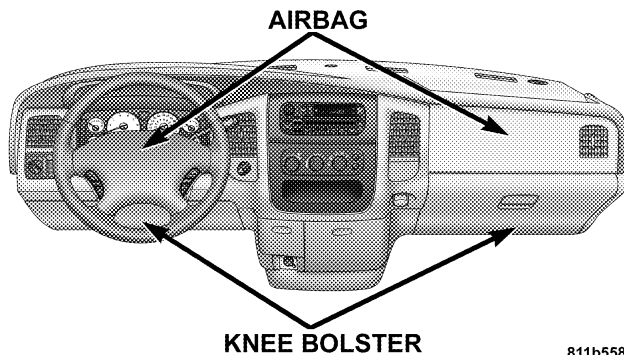

This vehicle may also be equipped with window bags to protect the driver and passengers in the first and second row sitting next to a window. If the vehicle is equipped with window bags, they are located above the side windows. Their covers are also labeled SRS AIRBAG.

#### WARNING!

- Do not put anything on or around the airbag covers or attempt to manually open them. You may damage the airbags and you could be injured because the airbags are not there to protect you. These protective covers for the airbag cushions are designed to open only when the airbags are inflating.
- Do not mount any aftermarket equipment such as trailer brake controllers, snowplow controllers, auxiliary light switches, radios, etc. on or behind the knee bolster. Knee bolsters are designed to work with the air bag and seat belt to protect you. Mounting any additional equipment on or behind the knee bolster can cause injury during a crash.
- If your vehicle is equipped with window bags, do not stack luggage or other cargo up high enough to block the location of the window bag. The area where the window bag is located should remain free from any obstructions.
- If your vehicle is equipped with window bags, do not have any accessory items installed which will alter the roof, including adding a sunroof to your vehicle. Do not add roof racks that require permanent attachments (bolts or screws) for installation on the vehicle roof. Do not drill into the roof of the vehicle for any reason.

Airbags inflate in moderate to high speed impacts. Along with the seatbelts, front airbags work with the instrument panel knee bolsters to provide improved protection for the driver and front passenger. Window bags also work with seat belts to improve occupant protection.

The seat belts are designed to protect you in many types of collisions. The front airbags deploy in moderate to severe frontal collisions. If your vehicle is so equipped, the window bag on the crash side of the vehicle is triggered in moderate to severe side collisions. In certain types of collisions, both the front and side airbags may be triggered. But even in collisions where the airbags work, you need the seat belts to keep you in the right position for the airbags to protect you properly.

Here are some simple steps you can follow to minimize the risk of harm from a deploying airbag.

- Children 12 years and under should ride buckled up in a rear seat, if available.
- Infants in rear facing child restraints must **NEVER** ride in the front seat of a vehicle with a passenger front airbag **unless the airbag is turned off** (Standard Cab Vehicles Only). An airbag deployment can cause severe injury or death to infants in that position. See the Passenger Airbag On/Off Switch section.
- If your vehicle does not have a rear seat, see the Passenger Airbag On/Off Switch section.
- Children that are not big enough to properly wear the vehicle seat belt (see section on Child Restraints) should be secured in the rear seat in child restraints or belt-positioning booster seats. Older children who do not use child restraints or belt-positioning booster seats should ride properly buckled up in the rear seat. Never allow children to slide the shoulder belt behind them or under their arm.
- All occupants should use their seat belts properly.

- The driver and front passenger seats should be moved back as far as practical to allow the airbag room to inflate.

**WARNING!**

- Relying on the airbags alone could lead to more severe injuries in a collision. The airbags work with your seat belt to restrain you properly. In some collisions the airbags won't deploy at all. Always wear your seat belts even though you have airbags.
- Being too close to the steering wheel or instrument panel during airbag deployment could cause serious injury. Airbags need room to inflate. Sit back, comfortably extending your arms to reach the steering wheel or instrument panel.
- If the vehicle has window airbags, they also need room to inflate. Do not lean against the door or window. Sit upright in the center of the seat.

**Airbag System Components**

The airbag system consists of the following:

- Airbag Control Module
- AIRBAG Readiness Light
- Driver Airbag
- Passenger Airbag
- Steering Wheel and Column
- Instrument Panel
- Crash Sensor
- Interconnecting Wiring
- Knee Impact Bolsters
- Passenger Side Frontal Airbag ON/OFF Switch (Standard Cab Vehicles Only)

**The Window Airbag System, on vehicles equipped, consists of the following:**

- AIRBAG Readiness Light (shared with the front airbag system)
- Window Bags Above the Side Windows.
- Airbag Control Module (shared with the front airbag system)
- Side impact sensors
- Interconnecting Wiring

**How The Airbag System Works**

- The airbag control module determines if a frontal collision is severe enough to require the airbags to inflate.
- The airbag control module will not detect roll over, or rear collisions.

- The airbag control module also monitors the readiness of the electronic parts of the system whenever the ignition switch is in the START or RUN positions. These include all of the items listed above except the knee bolsters, the instrument panel, and the steering wheel and column. If the key is in the "Off" position, in the ACC position or not in the ignition, the airbags are not on and will not inflate

- The airbag control module also turns on the AIR BAG light in the instrument panel for 6 to 8 seconds when the ignition is first turned on, then turns the light off.

**AIR BAG**

- If it detects a malfunction in any part of the system, it turns on the light either momentarily or continuously. The instrument cluster will flash the seat belt indicator if it detects a fault with the airbag indicator.

**WARNING!**

**Ignoring the AIR BAG light in your instrument panel could mean you won't have the airbags to protect you in a collision. If the light does not come on, stays on after you start the vehicle, or if it comes on as you drive, have the airbag system checked right away.**

- When the airbag control module detects a collision requiring the airbags, it signals the inflator units. A large quantity of nontoxic gas is generated to inflate the airbags. The airbag covers separate and fold out of
- The way as the airbags inflate to their full size. The airbags fully inflate in milliseconds. This is less time than it takes you to blink your eyes. The airbags then quickly deflate while helping to restrain the driver and front passenger. The driver's front airbag deflates through vents towards the instrument panel. The passenger's front airbag is deflated through vent holes in the sides of the airbag. In this way the airbags do not interfere with your control of the vehicle.
- The knee impact bolsters help protect the knees and position you for the best interaction with the front airbag.

**Passenger Airbag On/Off Switch – (Standard Cab Vehicles Only)**

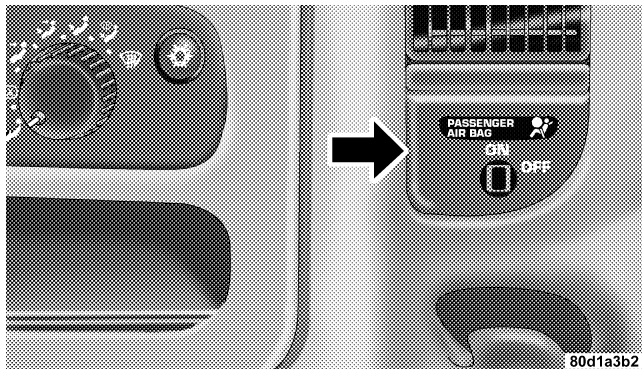

The passenger front airbag is to be turned off only if the passenger:

- is an infant (less than 1 year old) who must ride in the front seat because there is no rear seat, because the rear seat is too small for a rear-facing infant restraint or

because the infant has a medical condition which makes it necessary for the driver to be able to see the infant,

- is a child, age 1 to 12 who must ride in the front seat because there is no rear seat, because there is no rear seat position available, or because the child has a medical condition which makes it necessary for the driver to be able to see the child,
- has a medical condition which makes passenger airbag inflation (deployment) a greater risk for the passenger than the risk of hitting the dashboard (instrument panel) or windshield in a crash.

**WARNING!**

Whenever an airbag is turned off, even a lap/shoulder belted passenger may hit their head, neck, or chest on the dashboard (instrument panel) or windshield in a crash. This may result in serious injury or death.

**To Shut Off the Passenger Airbag (Standard Cab Vehicles Only)**

Place the ignition key in the Passenger Airbag On/Off Switch, push the key in and turn clockwise, and remove the key from the switch. This will shut off the passenger side airbag. The "Off" light near the switch will illuminate when the ignition switch is turned to the ON position.

**To Turn On the Passenger Airbag (Standard Cab Vehicles Only)**

Place the ignition key in the Passenger Airbag On/Off Switch, push the key in and turn counterclockwise, and remove the key from the switch. This will turn on the passenger airbag. The "Off" light near the switch will be off when the ignition switch is turned to the ON position.

**If A Deployment Occurs**

The airbag system is designed to deploy when the air bag control module detects a moderate-to-severe frontal collision, and then immediately to deflate.

**NOTE:** A frontal collision that is not severe enough to need airbag protection will not activate the system. This does not mean something is wrong with the airbag system.



If you do have a collision which deploys the airbags, any or all of the following may occur:

- The nylon airbag material may sometimes cause abrasions and/or skin reddening to the driver and front passenger as the airbags deploy and unfold. The abrasions are similar to friction rope burns or those you might get sliding along a carpet or gymnasium floor. They are not caused by contact with chemicals. They are not permanent and normally heal quickly. However, if you haven't healed significantly within a few days, or if you have any blistering, see your doctor immediately.
- As the airbags deflate you may see some smoke-like particles. The particles are a normal by-product of the process that generates the nontoxic gas used for airbag inflation. These airborne particles may irritate the skin, eyes, nose, or throat. If you have skin or eye irritation,

rinse the area with cool water. For nose or throat irritation, move to fresh air. If the irritation continues, see your doctor. If these particles settle on your clothing, follow the garment manufacturer's instructions for cleaning.

- It is not advisable to drive your vehicle after the airbags have deployed. If you are involved in another collision, the airbags will not be in place to protect you.

**WARNING!**

**Deployed airbags can't protect you in another collision. Have the airbags replaced by an authorized dealer as soon as possible.**

**Window Airbags Supplemental Restraint System (SRS)—If Equipped**

The window airbag control module determines if a side collision is severe enough to require the side airbags to inflate. The window airbag control module will not detect roll over, front or rear collisions.

The airbag control module monitors the readiness of the electronic parts of the system whenever the ignition switch is in the "START" or "RUN" positions. These include all of the items listed above. The airbag control module also turns on the AIRBAG light in the instrument panel for 6 to 8 seconds when the ignition is first turned on as a diagnostic or system check, then turns the light off. If it detects a malfunction in any part of the system, it turns on the light either momentarily or continuously.

The side (window) impact SRS Airbags are designed to activate only in certain side collisions. When the airbag control module detects a collision requiring the window

bags to inflate, it signals the inflators on the crash side of the vehicle. A quantity of nontoxic gas is generated to inflate the window bag. The inflating window bag pushes the side pillar molding out of the way and covers the window. The airbag inflates in about 30 milliseconds (about one-quarter of the time it takes to blink your eyes) with enough force to injure you if you are not belted and seated properly, or if items are positioned in the area where the window bag inflates. This especially applies to children. The window bag is only about 3 ½ inches (8.9 cm) thick when it is inflated.

**Enhanced Accident Response System**

If the airbags deploy after an impact and the electrical system remains functional, vehicles equipped with power door locks will unlock automatically. In addition, approximately 10 seconds after the vehicle has stopped moving, the interior lights will light until the ignition switch is turned off.

### Maintaining Your Airbag Systems

#### WARNING!

- Modifications to any part of the airbag system could cause it to fail when you need it. You could be injured because the airbags are not there to protect you. Do not modify the components or wiring, including adding any kind of badges or stickers to the steering wheel hub trim cover or the upper right side of the instrument panel. Do not modify the front bumper, vehicle body structure, or frame.
- You need proper knee impact protection in a collision. Do not mount or locate any aftermarket equipment on or behind the knee bolster.
- It is dangerous to try to repair any part of the airbag system yourself. Be sure to tell anyone who works on your vehicle that it has airbags.

### Airbag Light

You will want to have the airbags ready to inflate for your protection in an impact. While the airbag system is designed to be maintenance free, if any of the following occurs, have an authorized dealer service the system promptly:

- The airbag light does not come on or flickers during the 6 to 8 seconds when the ignition switch is first turned on.
- The light remains on or flickers after the 6 to 8 second interval.
- The light flickers or comes on and remains on while driving.

**NOTE:** If the speedometer, tachometer or any engine related gauges are not working, the airbag control module may also be disabled. The airbags may not be ready to inflate for your protection. Promptly check fuse numbers 52 and 53 in the fuse and relay center. See your dealer if the fuse is good.

### **Child Restraint**

Everyone in your vehicle needs to be buckled up all the time — babies and children, too. Every state in the United States and all Canadian provinces require that small children ride in proper restraint systems. This is the law, and you can be prosecuted for ignoring it.

Children 12 years and under should ride properly buckled up in a rear seat, if available. According to crash statistics, children are safer when properly restrained in the rear seats rather than in the front.

### **WARNING!**

**In a collision, an unrestrained child, even a tiny baby, can become a missile inside the vehicle. The force required to hold even an infant on your lap can become so great that you could not hold the child, no matter how strong you are. The child and others could be badly injured. Any child riding in your vehicle should be in a proper restraint for the child's size.**

### **Infants and Small Children**

There are different sizes and types of restraints for children from newborn size to the child almost large enough for an adult safety belt. Use the restraint that is correct for your child:

- Safety experts recommend that children ride rearward-facing in the vehicle until they are at least one year old and weigh at least 20 lbs (9 kg). Two types

of child restraints can be used rearward-facing: infant carriers and "convertible" child seats. Both types of child restraints are held in the vehicle by the lap/shoulder belt.

- The infant carrier is only used rearward-facing in the vehicle. It is recommended for children who weigh up to about 20 lbs (9 kg). "Convertible" child seats can be used either rearward-facing or forward-facing in the vehicle. Convertible child seats often have a higher weight limit in the rearward-facing direction than infant carriers do, so they can be used rearward-facing by children who weigh more than 20 lbs (9 kg) but are less than one year old.
- Rearward-facing child seats must **NEVER** be used in the front seat of a vehicle with a front passenger airbag unless the airbag is turned off. An airbag deployment could cause severe injury or death to infants in this position.
- Children who weigh more than 20 lbs (9 kg) and who are older than one year can ride forward-facing in the vehicle. Forward-facing child seats and convertible child seats used in the forward-facing direction are for children who weigh 20 to 40 lbs (9 to 18 kg) and who are older than one year. These child seats are also held in the vehicle by the lap/shoulder belt.
- The belt-positioning booster seat is for children weighing more than 40 lbs (18 kg), but who are still too small to fit the vehicle's seat belts properly. If the child cannot sit with knees bent over the vehicle's seat cushion while the child's back is against the seat back, they should use a belt-positioning-booster seat. The child and booster seat are held in the vehicle by the lap/shoulder belt. (Some booster seats are equipped with a front shield and are held in the vehicle by the lap portion.) For further information refer to [www.seatcheck.org](http://www.seatcheck.org).

**WARNING!**

- **Improper installation can lead to failure of an infant or child restraint. It could come loose in a collision. The child could be badly injured or killed. Follow the manufacturer's directions exactly when installing an infant or child restraint.**
- **A rearward facing child restraint should only be used in a rear seat, or in the front seat if the passenger's front airbag is Off. If the airbag is left On, a rearward facing child restraint in the front seat may be struck by a deploying passenger airbag which may cause severe or fatal injury to the infant.**

**Here are some tips for getting the most out of your child restraint:**

- Before buying any restraint system, make sure that it has a label certifying that it meets all applicable Safety Standards. We also recommend that you make sure that you can install the child restraint in the vehicle where you will use it before you buy it.
- The restraint must be appropriate for your child's weight and height. Check the label on the restraint for weight and height limits.
- Carefully follow the instructions that come with the restraint. If you install the restraint improperly, it may not work when you need it.

- The passenger seat belts are equipped with either cinching latch plates or switchable seat belt retractors, which are designed to keep the lap portion tight around the child restraint so that it is not necessary to use a locking clip.

If the seat belt has a cinching latch plate, pulling up on the shoulder portion of the lap/shoulder belt will tighten the belt. The cinching latch plate will keep the belt tight, however, any seat belt system will loosen with time, so check the belt occasionally and pull it tight if necessary.

If the seat belt has a switchable retractor, it will have a distinctive label: Pull the belt from the retractor until there is enough to allow you to pass through the child restraint and slide the latch plate into the buckle. Then pull on the belt until it is all removed from the retractor. Allow the belt to return to the retractor, pulling on the

excess webbing to tighten the lap portion about the child restraint. Refer to the "Automatic Locking Mode" earlier in this section.

- In the rear seat, you may have trouble tightening the lap/shoulder belt on the child restraint because the buckle or latch plate is too close to the belt path opening on the restraint. Disconnect the latch plate from the buckle and twist the short buckle-end belt several times to shorten it. Insert the latch plate into the buckle with the release button facing out.
- If the belt still can't be tightened, or if pulling and pushing on the restraint loosens the belt, disconnect the latch plate from the buckle, turn the buckle around, and insert the latch plate into the buckle again. If you still can't make the child restraint secure, try a different seating position.
- Buckle the child into the seat according to the child restraint manufacturer's directions.

- When your child restraint is not in use, secure it in the vehicle with the seat belt or remove it from the vehicle. Do not leave it loose in the vehicle. In a sudden stop or collision, it could strike the occupants or seat backs and cause serious personal injury.

**WARNING!**

**Improper installation can lead to failure of an infant or child restraint. It could come loose in a collision. The child could be badly injured or killed. Follow the manufacturer's directions exactly when installing an infant or child restraint.**

**Lower Anchors and Tether for Children (LATCH)**

Each vehicle is equipped with the child restraint anchorage system called LATCH, which stands for Lower Anchors and Tether for Children. LATCH child restraint anchorage systems are installed in the Standard Cab passenger seat position and the Quad Cab rear seat outboard positions. LATCH equipped seating positions feature both lower anchor bars, located at the back of the seat cushion, and tether strap anchorages, located behind the seatback (refer to Child Restraint Tether Anchor later in this section).

Identification dots are located above the standard cab front seat lower anchorages as a guide for locating lower anchors.



**NOTE:** For children riding in the front seat of a Standard Cab model refer to the "Passenger Airbag On/Off Switch" located in this section.

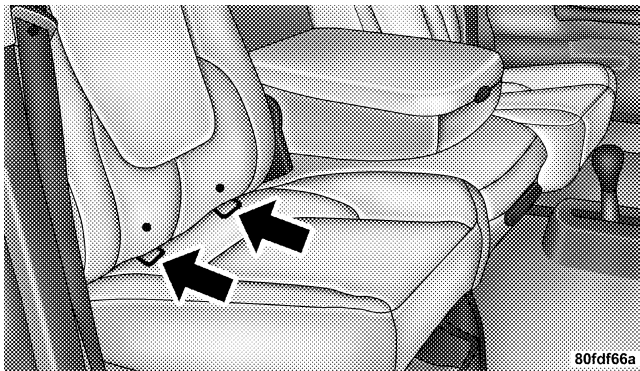

Standard Cab Passenger Seat

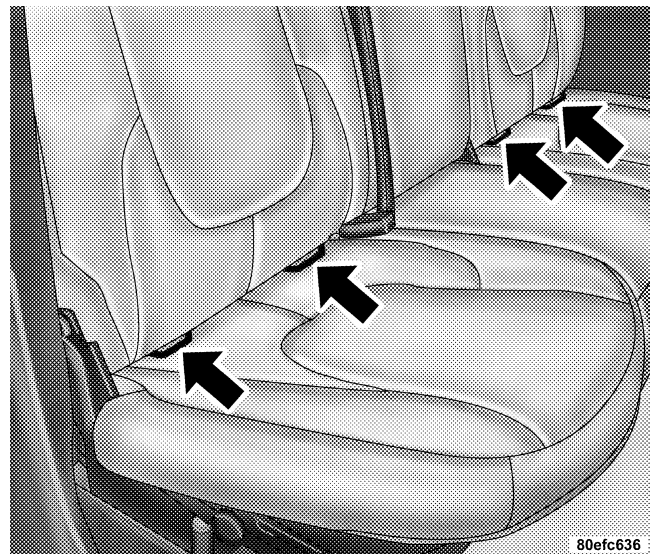

Quad Cab Outboard Seat

Child restraint systems having attachments designed to connect to the lower anchorages are now available. Child restraints having tether straps and hooks for connection to the seatback tether anchorage have been available for some time. In fact, many child restraint manufacturers will provide add-on tether strap kits for some of their older products.

Because the lower anchorages are to be introduced to passenger carrying vehicles over a period of years, child restraint systems having attachments for those anchorages will continue to have features for installation in vehicles using the lap or lap/shoulder belt. They will also have tether straps, and you are urged to take advantage of all of the available attachments provided with your child restraint in any vehicle.

**NOTE:** If your child restraint seat is not LATCH compatible, install the restraint using the vehicle seat belting.

### Installing the Child Restraint System

#### **WARNING!**

**Do not install child restraint systems equipped with LATCH attachments in the center position of a Quad Cab model rear seat. The LATCH anchorages in this seat are designed for the two outboard seating positions only. A child may be placed in the rear center seating position of a Quad Cab model using the seat belt and child tether anchorage. Failure to follow this may result in serious or fatal injury.**

We urge that you carefully follow the directions of the manufacturer when installing your child restraint. Many, but not all, restraint systems will be equipped with separate straps on each side, with each having a hook or connector and a means for adjusting the tension in the strap. Forward-facing toddler restraints and some rearward-facing infant restraints will also be equipped with a tether strap, a hook and means for adjusting the tension in the strap.

In general, you will first loosen the adjusters on the lower straps and tether straps so that you can more easily attach the hook or connector to the lower anchorages and tether anchorages. Then tighten all three straps as you push the child restraint rearward and downward into the seat.

Not all child restraint systems will be installed as we have described here. Again, carefully follow the instructions that come with the child restraint system.

**WARNING!**

**Improper installation of a child restraint to the LATCH anchorages can lead to failure of an infant or child restraint. The child could be badly injured or killed. Follow the manufacturer's directions exactly when installing an infant or child restraint.**

### **Child Restraint Tether Anchor**

Child restraints having tether straps and hooks for connection to tether anchors have been available for some time. In fact, many child restraint manufacturers will provide add-on tether strap kits for their older products. Regular Cab models of Ram Pickups have two tether anchorages, one each behind the front center and right seats. Quad Cab models have three anchorages, one behind each of the rear seats.

### **WARNING!**

**An incorrectly anchored tether strap could lead to seat failure and injury to the child. In a collision, the seat could come loose and allow the child to crash into the inside of the vehicle or other passengers, or even be thrown from the vehicle. Use only the anchor positions directly behind the child seat to secure a child restraint top tether strap. Follow the instructions below. See your dealer for help if necessary.**

**Tether Anchorage Points at the Right and Center Front Seat (Regular Cab - All Seats)**

1. Place the child restraint on the seat and adjust the tether strap so that it will reach over the seat back under the head restraint to the tether anchor directly behind the seat.
2. Lift the cover (if so equipped), and attach the hook to the square opening in the sheet metal.
3. Install the child restraint and remove the slack in the tether strap according to the manufacturer's instructions.

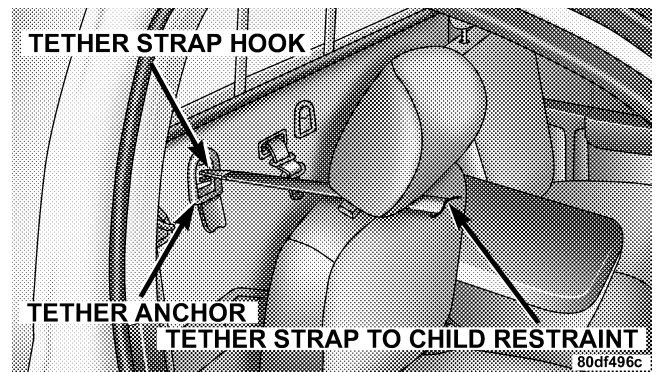
**Regular Cab With Any Bench Seat**

**Multiple Child Restraint Installation Sequence -  
(Quad Cab Rear Seats)**

1. Obtain tether straps by raising the head restraints and reaching between the rear glass and rear seat. The tether strap may be retained with an elastic band. Accessibility to the tether strap is greatly improved by raising the seat cushion to the "up" position. Remove the elastic before use.
2. Place a child restraint on each outboard rear seat and adjust the tether strap so that it will reach under the head restraint to the tether anchor directly behind the seat and then to the anchor directly behind the center rear seat.
3. Pass each tether strap hook under the head restraint and through the loop of webbing behind the child seat.
4. Route each tether strap to the anchor behind the center seat, and attach the hooks to the metal ring.
5. Place a child restraint on the center rear seat and adjust the tether strap so that it will reach under the head restraint to the tether anchor directly behind the seat and to the anchor directly behind the right seat.
6. Install each child restraint and remove the slack in the tether strap according to the child restraint manufacturer's instructions.

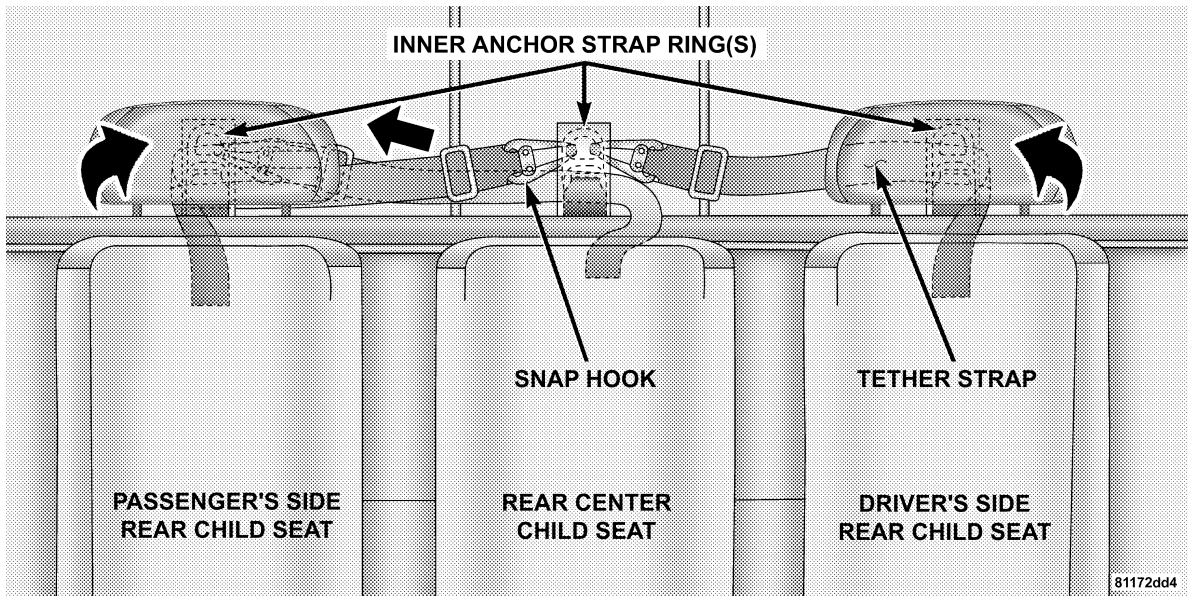

Multiple Child Restraints

**Children Too Large for Booster Seats**

Children who are large enough to wear the shoulder belt comfortably, and whose legs are long enough to bend over the front of the seat when their back is against the seat back should use the lap/shoulder belt in a rear seat.

- Make sure that the child is upright in the seat.
- The lap portion should be low on the hips and as snug as possible.
- Check belt fit periodically. A child's squirming or slouching can move the belt out of position.

If the shoulder belt contacts the face or neck, move the child closer to the center of the vehicle. Never allow a child to put the shoulder belt under an arm or behind their back.

**ENGINE BREAK-IN RECOMMENDATIONS**

A long break-in period is not required for the engine in your new vehicle. Drive moderately during the first 300 miles (500 km). After the initial 60 miles (100 km), speeds up to 50 or 55 mph (80 or 90 km/h) are desirable. While cruising, brief full-throttle acceleration, within the limits of local traffic laws, contributes to a good break-in.

Avoid wide open throttle acceleration in low gear.

The engine oil installed in the engine at the factory is a high quality, energy conserving type lubricant. Oil changes should be consistent with the anticipated climatic conditions under which vehicle operation will occur. The recommended viscosity and quality grades are discussed in Section 7 under Maintenance Procedures, Engine Oil.



NON-DETERGENT OR STRAIGHT MINERAL OILS MUST NEVER BE USED.

A new engine may consume some oil during its first few thousand miles of operation. This is a normal part of the break-in and is not an indication of difficulty.

**CAUTION!**

- During the first 500 miles (805 km) your new vehicle is driven, do not tow a trailer. Doing so may damage your vehicle.
- Limit your speed to 50 mph (80 km/h) during the first 500 miles (805 km) of towing.

**SAFETY TIPS**

**Transporting Passengers**

This vehicle is designed to carry passengers in the cab only. For safety reasons, NEVER TRANSPORT PASSENGERS IN THE CARGO AREA.

2

**WARNING!**

It is extremely dangerous to ride in a cargo area, inside or outside of a vehicle. In a collision, people riding in these areas are more likely to be seriously injured or killed.

Do not allow people to ride in any area of your vehicle that is not equipped with seats and seat belts.

Be sure everyone in your vehicle is in a seat and using a seat belt properly.

### Lock Your Vehicle

Always remove the keys from the ignition and lock all doors when leaving the vehicle unattended, even in your own driveway or garage. Try to park your vehicle in a well-lighted area and never invite theft by leaving articles of value exposed.

### Exhaust Gas

**WARNING!**

**Exhaust gases contain carbon monoxide, a potentially toxic gas that by itself is colorless and odorless. To avoid inhaling these gases, the following precautions should be observed:**

- Do not run the engine in a closed garage or in confined areas any longer than needed to move your vehicle in or out of the area.

- If it is necessary to sit in a parked vehicle with the engine running for more than a short period, adjust your climate control system to force outside air into the vehicle. Set the blower at high speed and the controls in any position except OFF or MAX A/C.
- The best protection against carbon monoxide entry into the vehicle body is a properly maintained engine exhaust system.

Be aware of changes in the sound of the exhaust system; exhaust fumes detected inside the vehicle; or damage to the underside or rear of the vehicle. Have a competent mechanic inspect the complete exhaust system and adjacent body areas for broken, damaged, deteriorated or mispositioned parts. Open seams or loose connections could permit exhaust fumes to seep into the passenger compartment. In addition, inspect the exhaust system each time the vehicle is raised for lubrication or oil change. Replace or adjust as required.

**Safety Checks You Should Make Inside The Vehicle****Seat Belts**

Inspect the belt system periodically, checking for cuts, frays and loose parts. Damaged parts must be replaced immediately. Do not disassemble or modify the system.

Seat belt assemblies must be replaced after an accident if they have been damaged (bent retractor, torn webbing, etc.) or if the front airbags have deployed. If there is any question regarding belt or retractor condition, replace the belt.

**Airbag Light**

The light should come on and remain on for 6 to 8 seconds as a bulb check when the ignition switch is first turned ON. If the light is not lit during starting, see you authorized dealer. If the light stays on, flickers or comes

on while driving, have the system checked by an authorized dealer. If there is a problem with the airbag light the seatbelt light will flash.

**Safety Checks You Should Make Outside The Vehicle****Tires**

Examine tires for tread wear or uneven wear patterns. Check for stones, nails, glass or other objects lodged in the tread.

Inspect for tread cuts or sidewall cracks. Check wheel nuts for tightness and tires for proper pressure.

**Lights**

Check the operation of all exterior lights. Check turn signal and high beam indicator lights on the instrument panel.

**Door Latches**

Check for positive closing, latching and locking.

**Fluid Leaks**

Check area under vehicle after overnight parking for fuel, water, oil, or other fluid leaks. Also, if fuel fumes are detected the cause should be located and corrected.

---

# UNDERSTANDING THE FEATURES OF YOUR VEHICLE

## CONTENTS

---

■ Mirrors . . . . .	.78	■ Hands-Free Communication (UConnect™) — If Equipped . . . . .	.83
□ Inside Mirror . . . . .	.78	□ Operation . . . . .	.85
□ Automatic Dimming Mirror— If Equipped . . . . .	.79	□ Phone Call Features . . . . .	.92
□ Outside Mirrors . . . . .	.79	□ UConnect™ System Features . . . . .	.95
□ Exterior Mirrors Folding Feature . . . . .	.80	□ Advanced Phone Connectivity . . . . .	.99
□ Electronic Power Mirrors — If Equipped . . . . .	.80	□ Things You Should Know About Your UConnect™ System . . . . .	.101
□ Electric Rear Window Defroster And Heated Sideview Mirrors — If Equipped . . . . .	.81		
□ Trailer Towing Mirrors — If Equipped . . . . .	.81		

**74 UNDERSTANDING THE FEATURES OF YOUR VEHICLE**

■ Seats . . . . .	107	□ Headlights, Parking Lights, Panel Lights . . . . .	117
□ 40-20-40 Front Seat . . . . .	108	□ Daytime Running Lights (Canada And Fleet Vehicles Only) . . . . .	118
□ Reclining Seats . . . . .	109	□ Lights-On Reminder . . . . .	118
□ Adjustable Head Restraints . . . . .	109	□ Fog Lights — If Equipped . . . . .	118
□ Manual Rotary Lumbar Support Adjustment — If Equipped . . . . .	110	□ Cargo Light . . . . .	119
□ Power Seats — If Equipped . . . . .	111	■ Multifunction Control Lever . . . . .	119
□ Heated Seats — If Equipped . . . . .	112	□ Turn Signals . . . . .	119
■ To Open And Close The Hood . . . . .	113	□ Passing Light . . . . .	120
■ Lights . . . . .	115	□ High Beam / Low Beam Select Switch . . . . .	120
□ Interior Lights . . . . .	115	□ Windshield Wipers . . . . .	121
□ Battery Saver . . . . .	116	□ Windshield Washers . . . . .	122
□ Headlamp Delay — If Equipped . . . . .	117	■ Tilt Steering Column . . . . .	123

<hr/>		<b>UNDERSTANDING THE FEATURES OF YOUR VEHICLE 75</b>	
■ Driver Adjustable Pedals — If Equipped . . . . .	124	□ US/M Button . . . . .	130
□ Adjustment . . . . .	124	□ Reset Button . . . . .	131
■ Electronic Speed Control — If Equipped . . . . .	125	□ Global Reset . . . . .	131
□ To Activate . . . . .	125	□ Step Button . . . . .	131
□ To Set At A Desired Speed . . . . .	126	□ Average Fuel Economy (AVG ECO) . . . . .	132
□ To Deactivate . . . . .	126	□ Distance To Empty (DTE) . . . . .	132
□ To Resume Speed . . . . .	126	□ Trip Odometer (ODO) . . . . .	133
□ To Vary The Speed Setting . . . . .	127	□ Elapsed Time (ET) . . . . .	133
□ To Accelerate For Passing . . . . .	128	□ C/T Button . . . . .	133
■ Overhead Console— If Equipped . . . . .	129	□ Automatic Compass Calibration . . . . .	134
□ Courtesy/Reading Lights . . . . .	129	□ Manual Compass Calibration . . . . .	134
■ Overhead Console With Compass/Temperature Mini-Trip Computer — If Equipped . . . . .	130	□ Recalibrating The Compass . . . . .	135
		□ Outside Temperature . . . . .	137

**76 UNDERSTANDING THE FEATURES OF YOUR VEHICLE**

■ Garage Door Opener — If Equipped . . . . .	137	□ Venting Sunroof - Express . . . . .	145
□ Programming Homelink . . . . .	138	□ Sunshade Operation . . . . .	145
□ Canadian Programming/Gate Programming . .	141	□ Wind Buffeting . . . . .	146
□ Using Homelink . . . . .	142	□ Sunroof Maintenance . . . . .	146
□ Erasing Homelink Buttons . . . . .	142	□ Ignition Off Operation . . . . .	146
□ Reprogramming a Single Homelink Button . .	142	□ Sunroof Fully Closed . . . . .	146
□ Security . . . . .	143	■ Electrical Power Outlets . . . . .	147
■ Power Sunroof — If Equipped . . . . .	143	■ Cigar Lighter And Ash Receiver . . . . .	148
□ Opening Sunroof - Express . . . . .	144	■ Cupholders . . . . .	149
□ Closing Sunroof - Express . . . . .	144	□ Front Instrument Panel Cupholders — Automatic Transmission Only . . . . .	149
□ Pinch Protect Feature . . . . .	145	□ Rear Cupholder — Quad Cab — If Equipped . . . . .	149
□ Pinch Protect Override . . . . .	145		



■ Storage . . . . .	150	■ Pickup Box . . . . .	155
□ Center Storage Compartment — If Equipped . . .	150	■ Slide-In Campers . . . . .	157
□ Storage And Seats — If Equipped . . . . .	151	□ Camper Applications . . . . .	157
■ Fold Flat Load Floor — If Equipped . . . . .	152	■ Easy-Off Tailgate . . . . .	157
□ Fold Flat Load Floor — If Equipped . . . . .	152		

## MIRRORS

### Inside Mirror

The mirror should be adjusted to center on the view through the rear window.

Annoying headlight glare can be reduced by moving the small control under the mirror to the night position (toward rear of vehicle). The mirror should be adjusted while set in the day position (toward windshield).

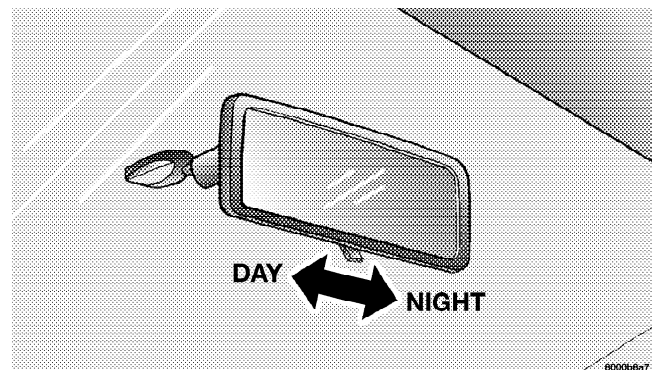

**Automatic Dimming Mirror— If Equipped**

This mirror automatically adjusts for annoying headlight glare from vehicles behind you. You can turn the feature on or off by pressing the button at the base of the mirror. A light in the button will indicate when the dimming feature is activated.

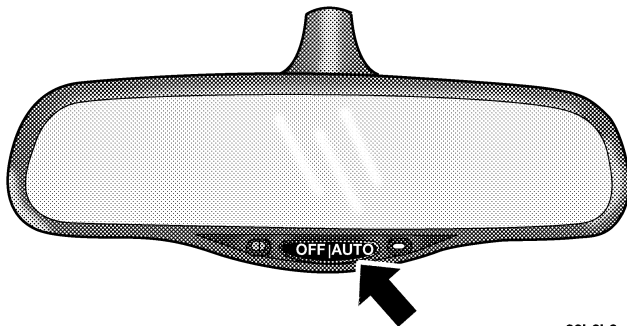

80b6b3a6

**CAUTION!**

To avoid damage to the mirror during cleaning, never spray any cleaning solution directly onto the mirror. Apply the solution onto a clean cloth and wipe the mirror clean.

3

**Outside Mirrors**

To receive maximum benefit, adjust the outside mirror(s) to center on the adjacent lane of traffic with a slight overlap of the view obtained on the inside mirror.

**WARNING!**

Vehicles and other objects seen in a right side convex mirror will look smaller and farther away than they really are. Relying too much on your right side convex mirror could cause you to collide with another vehicle or other object. Use your inside mirror when judging the size or distance of a vehicle seen in the right side convex mirror. Some vehicles will not have a convex right side mirror.

**Exterior Mirrors Folding Feature**

All 6 x 9 inch exterior mirrors are hinged and may be moved either forward or rearward to resist damage. The hinges have three detent positions; full forward, full rearward, and normal.

**Electronic Power Mirrors — If Equipped**

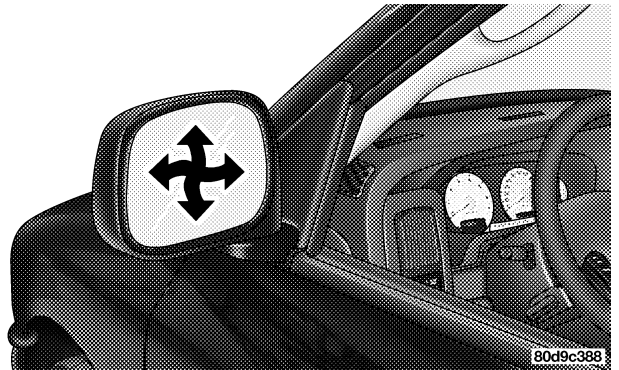

The controls for the power mirrors are located on the driver's door trim panel.

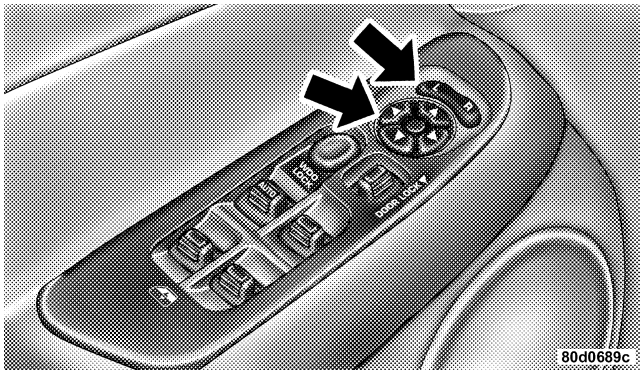

Set the top switch to the left or right for the left or right mirror, and set it to the center off position to prevent accidentally moving a mirror when you are finished adjusting the mirror. To adjust a mirror, select left or right with the top switch, and press one of the four arrows for the direction you want the mirror to move.

### Electric Rear Window Defroster and Heated Sideview Mirrors — If Equipped

 The Electric Rear Window Defroster and Heated side view mirrors are activated by pressing the heated grid button, located on the Climate Control panel, with the ignition On. Turning Off the ignition will deactivate the Electric Rear Window Defroster and Heated side view mirrors feature. These features also turn off after activation, when 15 minutes have elapsed. To reactivate, simply press the button again.

### Trailer Towing Mirrors — If Equipped

These mirrors are designed with an adjustable mirror head to provide a greater vision range when towing extra-wide loads. To change position inboard or outboard, the mirror head should be rotated (flipped Out or In). A small blindspot mirror is integrated onto the main mirror surface.

82 UNDERSTANDING THE FEATURES OF YOUR VEHICLE

**NOTE:** Fold the 7 x 10 inch trailer towing mirrors rearward prior to entering an automated car wash.

**CAUTION!**

Do not attempt to fold the 7 x 10 inch trailer towing mirrors forward. The 7 x 10 inch trailer towing mirrors are not designed to be folded forward and doing so will damage the mirrors and/or vehicle.

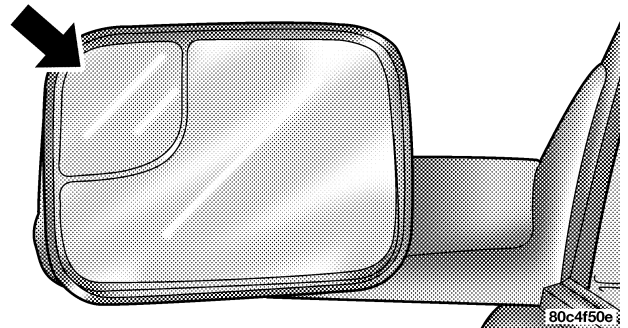

80c4f50e

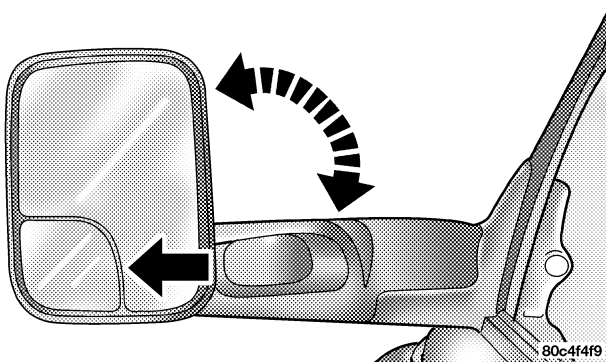

### HANDS-FREE COMMUNICATION (UConnect™) — IF EQUIPPED

UConnect™ is a voice-activated, hands-free, in vehicle communications system. UConnect™ allows you to dial a phone number with your cellular phone\* using simple voice commands (e.g., "Call ... Mike ...Work" or "Dial ... 248-555-1212"). Your cellular phone's audio is transmitted through your vehicle's audio system; the system will automatically mute your radio when using the UConnect™ system.

**NOTE:** The UConnect™ system use requires a cellular phone equipped with the Bluetooth "Hands-Free Profile," version 0.96 or higher.

For UConnect Customer Support call 1-877-855-8400 or visit the UConnect website ([www.chrysler.com/uconnect](http://www.chrysler.com/uconnect)).

## 84 UNDERSTANDING THE FEATURES OF YOUR VEHICLE

UConnect™ allows you to transfer calls between the system and your cellular phone as you enter or exit your vehicle, and enables you to mute the system's microphone for private conversation.

The UConnect™ phonebook enables you to store up to 32 names and four numbers per name. Each language has a separate 32 name phonebook accessible only in that language. This system is driven through your Bluetooth™ Hands-Free profile cellular phone. UConnect™ features Bluetooth™ technology - the global standard that enables different electronic devices to connect to each other without wires or a docking station, so UConnect works no matter where you stow your cellular phone (be it your purse, pocket, or briefcase), as long as your phone is turned on and has been paired to the vehicle's UConnect™ system. The UConnect™ system allows up to seven cellular phones to be linked to system. Only one linked (or paired) cellular phone can be used

with the system at a time. The system is available in English, Spanish, or French languages (as equipped).

The rearview mirror contains the microphone for the system and the control buttons that will enable you to access the system. The diagram below shows the mirror with the appropriate buttons. Individual button behavior is discussed in the "Operation" section.



UConnect™ Switches

8105b20d



The UConnect™ system can be used with any Hands-Free Profile certified Bluetooth™ cellular phone. If your cellular phone supports a different profile (eg., Headset Profile), you may not be able to use any UConnect™ features. Refer to your cellular service provider or the phone manufacturer for details.

The UConnect™ system is fully integrated with the vehicle's audio system. The volume of the UConnect™ system can either be adjusted from the radio volume control knob, or from the steering wheel radio control (right switch), if so equipped.

The radio display will be used for visual prompts from the UConnect™ system such as "CELL" or caller ID on certain radios.

### Operation

Voice commands can be used to operate the UConnect™ system and to navigate through the UConnect™ menu structure. Voice commands are required after most UConnect™ system prompts. You will be prompted for a specific command and then guided through the available options.

- Prior to giving a voice command, one must wait for the voice on beep, which follows the "Ready" prompt or another prompt.
- For certain operations, compound commands can be used. For example, instead of saying "Setup" and then "Phone Pairing," the following compound command can be said: "Setup Phone Pairing."

- For each of the feature explanation in this section, only the combined form of the voice command is given. You can also break the commands into parts and say each part of the command, when you are asked for it. For example, you can either use the combined form voice command "Phonebook New Entry," or you can break the combined form command into two voice commands: "Phonebook" and "New Entry." Please remember, the UConnect™ system works best when you talk in a normal conversational tone, as if speaking to someone sitting eight feet away from you.

**Voice Command Tree**

Refer to "Voice Tree" at the end of this section.

**Help Command**

If you need assistance at any prompt or if you want to know what your options are at any prompt, say "Help" following the voice on beep. The UConnect™ system will play all the options at any prompt if you ask for help.

To activate the UConnect™ system from idle, simply press the 'Phone' button and follow audible prompts for directions. All UConnect™ system sessions begin with a press of the 'Phone' button on the mirror.

**Cancel Command**

At any prompt, after the voice on beep, you can say "Cancel" and you will be returned to the main menu. However, in a few instances the system will take you back to the previous menu.

**Pair (Link) UConnect™ System to a Cellular Phone**

To begin using your UConnect™ system, you must pair your compatible Bluetooth™ enabled cellular phone (refer to "Introduction" section to learn about the phone type). To complete the pairing process, you will need to reference your cellular phone owner's manual. One of the following vehicle specific websites may also provide detailed instructions for pairing with the brand of phone that you have:

**NOTE:**

- [www.chrysler.com/uconnect](http://www.chrysler.com/uconnect)
- [www.dodge.com/uconnect](http://www.dodge.com/uconnect)
- [www.jeep.com/uconnect](http://www.jeep.com/uconnect)

The following are general phone to UConnect™ System pairing instructions:

- Press the 'Phone' button to begin.

- After the "Ready" prompt and the following beep, say "Setup Phone Pairing."
- When prompted, after the voice on beep, say "Pair a Phone."
- You will be asked to say a four-digit pin number which you will later need to enter into your cellular. You can enter any four-digit pin number. You will not need to remember this pin number after the initial pairing process.
- The UConnect™ system will then prompt you to begin the cellular phone pairing process on your cellular phone. Before attempting to pair phone, please see your cellular phone's user manual (Bluetooth section) for instructions on how to complete this step.

- For identification purposes, you will be prompted to give the UConnect™ system a name for your cellular phone. Each cellular phone that is paired should be given a unique phone name.
- You will then be asked to give your cellular phone a priority level between 1 and 7, 1 being the highest priority. You can pair up to seven cellular phones to your UConnect™ system. However, at any given time, only one cellular phone can be in use, connected to your UConnect™ System. The priority allows the UConnect™ system to know which cellular phone to use if multiple cellular phones are in the vehicle at the same time. For example, if priority 3 and priority 5 phones are present in the vehicle, the UConnect™ system will use the priority 3 cellular phone when you make a call. You can select to use a lower priority cellular phone at any time (refer to "Advanced Phone Connectivity" section).

#### Dial by Saying a Number

- Press the 'Phone' button to begin.
- After the "Ready" prompt and the following beep, say "Dial."
- System will prompt you to say the number you want call.
- For example, you can say "234-567-8901." The phone number that you enter must be of valid length and combination. The UConnect™ limits the user from dialing invalid combination of numbers. For example, 234-567-890 is nine digits long, which is not a valid phone number - the closest valid phone number has ten digits.
- The UConnect™ system will confirm the phone number and then dial. The number will appear in the display of certain radios.

### Call by Saying a Name

- Press the "Phone" button to begin.
- After the "Ready" prompt and the following beep, say "Call."
- System will prompt you to say the name of the person you want call.
- After the "Ready" prompt and the following beep, say the name of the person you want to call. For example, you can say "John Doe," where John Doe is a previously stored name entry in the UConnect™ phonebook. Refer to section "Add Names to Your UConnect™ Phonebook," to learn how to store a name in the phonebook.
- The UConnect™ system will confirm the name and then dial the corresponding phone number, which may appear in the display of certain radios.

### Add Names to Your UConnect™ Phonebook

**NOTE:** Adding names to phonebook is recommended when vehicle is not in motion.

- Press the "Phone" button to begin.
- After the "Ready" prompt and the following beep, say "Phonebook New Entry."
- When prompted, say the name of the new entry. Use of long names helps the voice recognition and is recommended. For example, say "Robert Smith" or "Robert" instead of "Bob."
- When prompted, enter the number designation (e.g.: "Home," "Work," "Mobile," or "Pager"). This will allow you to store multiple numbers for each phonebook entry, if desired.
- When prompted, recite the phone number for the phonebook entry that you are adding.

After you are finished adding an entry into the phonebook, you will be given the opportunity to add more phone numbers to the current entry or to return to the main menu.

The UConnect™ system will allow you to enter up to 32 names in the phonebook with each name having up to four associated phone numbers and designations. Each language has a separate 32 name phonebook accessible only in that language.

#### **Edit Entries in the UConnect™ Phonebook**

**NOTE:** Adding names to phonebook is recommended when vehicle is not in motion.

- Press the 'Phone' button to begin.
- After the "Ready" prompt and the following beep, say "Phonebook Edit."

- You will then be asked for the name of the phonebook entry that you wish to edit.
- Next, choose the number designation (home, work, mobile, or pager) that you wish to edit.
- When prompted, recite the new phone number for the phonebook entry that you are editing.

After you are finished editing an entry in the phonebook, you will be given the opportunities to edit another entry in the phonebook, call the number you just edited, or return to the main menu.

"Phonebook Edit" can be used to add another phone number to a name entry that already exists in the phonebook. For example, the entry John Doe may have a mobile and a home number, but you can add John Doe's work number later using the "Phonebook Edit" feature.

**Delete Entries in the UConnect™ Phonebook**

- Press the 'Phone' button to begin.
- After the "Ready" prompt and the following beep, say "Phonebook Delete."
- After you enter the Phonebook Delete menu, you will then be asked for the name of the entry that you wish to delete. You can either say the name of a phonebook entry that you wish to delete or you can say "List Names" to hear a list of the entries in the phonebook from which you choose. To select one of the entries from the list, press the "Voice Recognition" button while the UConnect™ system is playing the desired entry and say "Delete."
- After you enter the name, the UConnect™ system will ask you which designation you wish to delete: home, work, mobile or pager. Say the designation you wish to delete.

After confirmation, the phonebook entries will be deleted. Note that only the phonebook in the current language is deleted.

**Delete All Entries in the UConnect™ Phonebook**

- Press the 'Phone' button to begin.
- After the "Ready" prompt and the following beep, say "Phonebook Erase All."
- The UConnect™ system will ask you to verify that you wish to delete all the entries from the phonebook.
- After confirmation, the phonebook entries will be deleted.

**List All Names in the UConnect™ Phonebook**

- Press the 'Phone' button to begin.
- After the "Ready" prompt and the following beep, say "Phonebook List Names."

- The UConnect™ system will play the names of all the phonebook entries.
- To call one of the names in the list, press the "Voice Recognition" button during the playing of the desired name and say "Call". NOTE: the user can also exercise "Edit" or "Delete" operations at this point.
- The UConnect™ system will then prompt you as to number designation you wish to call.
- The selected number will be dialed.

#### **Phone Call Features**

The following features can be accessed through the UConnect™ system if the feature(s) are available on your cellular service plan. For example, if your cellular service plan provides three-way calling, this feature can be accessed through the UConnect™ system. Check with your cellular service provider for the features that you have.

#### **Answer or Reject an Incoming Call - No Call Currently in Progress**

When you receive a call on your cellular phone, the UConnect™ system will interrupt the vehicle audio system, if on, and will ask if you would like to answer the call. To reject the call, press and hold the 'Phone' button until you hear a single beep indicating that the incoming call was rejected.

#### **Answer or Reject an Incoming Call - Call Currently in Progress**

If a call is currently in progress and you have another incoming call, you will hear the same network tones for call waiting that you normally hear when using your cell phone. Press the 'Phone' button to place the current call on hold and answer the incoming call. NOTE: The UConnect™ system compatible phones in market today do not support rejecting an incoming call when another call is in progress. Therefore, the user can only either answer an incoming call or ignore it.



**Making a Second Call while Current Call in Progress**

To make a second call while you are currently in a call, press the 'Voice Recognition' button and say "Dial" or "Call" followed by the phone number or phonebook entry you wish to call. The first call will be on hold while the second call is in progress. To go back to the first call, refer to section "Toggling Between Two Calls." To combine two calls, refer to section "Conference Call."

**Place/Retrieve a Call from Hold**

To put a call on hold, press the 'Phone' button until you hear a single beep which will indicate that the call has been placed on hold. To bring the call back from hold, press and hold the 'Phone' button until you hear a single beep.

**Toggling Between Calls**

If two calls are in progress (one active and one on hold), press the 'Phone' button until you hear a single beep

indicating that the active and hold status of the two calls have switched. Only one call can be placed on hold at one time.

**Conference Call**

When two calls are in progress (one active and one on hold), press and hold the 'Phone' button until you hear a double beep indicating that the two calls have been joined into one conference call.

**Three-Way Calling**

To initiate three-way calling, press the 'Voice Recognition' button while a call is in progress and make a second phone call as described in section "Making a Second Call while Current Call in Progress." After the second call has established, press and hold the 'Phone' button until you hear a double beep indicating that the two calls have been joined into one conference call.

**Call Termination**

To end a call in progress, momentarily press the 'Phone' button. Only the active call(s) will be terminated and if there is a call on hold, it will become the new active call.

**Redial**

- Press the 'Phone' button to begin.
- After the "Ready" prompt and the following beep, say "Redial."
- The UConnect™ system will call the last number that was dialed on your cellular phone. Note: this may not be the last number dialed from the UConnect™ system.

**Call Continuation**

Call continuation is progression of a phone call on UConnect™ system after the vehicle ignition key has been switched to off. Call continuation functionality available on the vehicle can be any one of three types:

- After ignition key is switched off, a call can continue on the UConnect™ system either until the call ends or until the vehicle battery condition dictates cessation of the call on the UConnect™ system and transfer of the call to the mobile phone.
- After ignition key is switched to off, a call can continue on the UConnect™ system for certain duration, after which the call is automatically transferred from the UConnect™ system to the mobile phone.
- An active call is automatically transferred to the mobile phone after ignition key is switched to off.

## UConnect™ System Features

### Language Selection

To change the language that the UConnect™ system is using,

- Press the 'Phone' button to begin.
- After the "Ready" prompt and the following beep, say the name of the language you wish to switch to (English, Espanol, or Francais, if so equipped).
- Continue to follow the system prompts to complete language selection.

After selecting one of the languages, all prompts and voice commands will be in that language.

**NOTE:** After every UConnect™ language change operation, only the language specific 32 name phonebook is usable. The phone pairing is not language specific and usable across all languages.

### Emergency Assistance

If you are in an emergency and the mobile phone is reachable:

- Pick up the phone and manually dial the emergency number for your area.

If the phone is not reachable and the UConnect™ system is operational, you may reach the emergency number as follows:

- Press the 'Phone' button to begin.
- After the "Ready" prompt and the following beep, say "Emergency" and the UConnect™ system will instruct the paired cellular phone to call the emergency number. This feature is only supported in the USA.

**NOTE:** The emergency number dialed is based on the Country where the vehicle is purchased (911 for USA/Canada and 060 for Mexico). The number called may not be applicable with the available cellular service and area.

The UConnect™ system does slightly lower your chances of successfully making a phone call as to that for the cell phone directly.

Your phone must be turned on and paired to the UConnect™ system to allow use of this vehicle feature in emergency situations when the cell phone has network coverage and stays paired to the UConnect™ system.

#### **Towing Assistance**

If you need towing assistance,

- Press the 'Phone' button to begin.
- After the "Ready" prompt and the following beep, say "Towing Assistance."

**NOTE:** The Towing Assistance number dialed is based on the Country where the vehicle is purchased (1-800-528-2069 for USA, 1-877-213-4525 for Canada, 55-14-3454 for Mexico city and 1-800-712-3040 for outside Mexico city in Mexico).

Please refer to the 24-Hour Towing Assistance coverage details in the DaimlerChrysler Corporation 24-Hour Towing Assistance Program Guide.

#### **Paging**

To learn how to page, refer to section "Working with Automated Systems." Paging works properly except for pagers of certain companies which time-out a little too soon to work properly with the UConnect™ system.

#### **Voice Mail Calling**

To learn how to access your voice mail, refer to section "Working with Automated Systems."

#### **Working with Automated Systems**

This method is designed to be used in instances where one generally has to press numbers on the cellular phone keypad while navigating through an automated telephone system.

You can use your UConnect™ system to access a voice-mail system or an automated service, such as, paging service or automated customer service. Some services require immediate response selection, in some instances, that may be too quick for use of UConnect™ system.

When calling a number with your UConnect™ system that normally requires you to enter in a touch-tone sequence on your cellular phone keypad, you can push the 'Voice Recognition' button and say the sequence you wish to enter followed by the word "Send." For example, if required to enter your pin number followed with a pound 3 7 4 6 #, you can press the 'Voice Recognition' button and say "3 7 4 6 # Send." Saying a number, or sequence of numbers, followed by "Send" is also to be used to navigate through an automated customer service center menu structure and to leave a number on a pager.

### **Barge In - Overriding Prompts**

The 'Voice Recognition' button can be used when you wish to skip part of a prompt and issue your voice recognition command immediately. For example, if a prompt is playing "Would you like to pair a phone, clear a...," you could press the 'Voice Recognition' button and say "Pair a Phone" to select that option without having to listen to the rest of the voice prompt.

### **Turning Confirmation Prompts On/Off**

Turning confirmation prompts off will stop the system from confirming your choices (e.g. the UConnect™ system will not repeat a phone number before you dial it).

- Press the 'Phone' button to begin.
- After the "Ready" prompt and the following beep, say "Setup Confirmations." The UConnect™ system will play the current confirmation prompt status and you will be given the choice to change it.

**Phone and Network Status Indicators**

The UConnect™ system will provide notification to inform you if your cellular phone is in roaming status, has low signal strength, or has a low battery when you are trying to place a phone call.

**Dialing Using the Cellular Phone Keypad**

You can dial a phone number with your cellular phone keypad and still use the UConnect™ system (while dialing via the cell phone keypad, the user must exercise caution and take precautionary safety measures). By dialing a number with your paired Bluetooth™ cellular phone, the audio will be played through your vehicle's audio system. The UConnect™ system will work the same as if you dial the number using voice recognition.

**NOTE:** Certain brands of mobile phones do not send the dial ring to the UConnect™ system to play it on the vehicle audio system, so you will not hear it. Under this situation, after successfully dialing a number, the user

may feel that the call did not go through even though the call is in progress. Once your call is answered, you will hear the audio.

**Mute/Un-mute (Mute off)**

When you mute the UConnect™ system, you will still be able to hear the conversation coming from the other party, but the other party will not be able to hear you. In order to mute the UConnect™ system:

- Press the 'Voice Recognition' button.
- After the "Ready" prompt and the following beep, say "Mute."

In order to un-mute the UConnect™ system:

- Press the 'Voice Recognition' button.
- After the "Ready" prompt and the following beep, say "Mute-off."

**Information Service**

When using AT&T Wireless Service, dialing to phone number "#121," you can access voice activated automated system to receive news, weather, stocks, traffic, etc. related information.

**Advanced Phone Connectivity****Transfer Call to and from Cellular Phone**

The UConnect™ system allows on going calls to be transferred to your cellular phone to the UConnect™ system without terminating the call. To transfer an ongoing call from your UConnect™ paired cellular phone to the UConnect™ system or vice-versa, press the 'Voice Recognition' button and say "Transfer Call."

**Connect or Disconnect Link Between the UConnect™ System and Cellular Phone**

Your cellular phone can be paired with many different electronic devices, but can only be actively "connected" with one electronic device at a time.

If you would like to connect or disconnect the Bluetooth™ connection between a UConnect™ paired cellular phone and the UConnect™ system, follow the instruction described in your cellular phone user's manual.

**List Paired Cellular Phone Names**

- Press the 'Phone' button to begin.
- After the "Ready" prompt and the following beep, say "Setup Phone pairing".
- When prompted, say "List Phones".
- The UConnect™ system will play the phone names of all paired cellular phones in order from the highest to the lowest priority. To "select" or "delete" a paired phone being announced, press the 'Voice recognition' button and say "Select" or "Delete". Also, see next two sections for alternate way of doing this.

**Select another Cellular Phone**

This feature allows you to select and start using another phone with the UConnect™ system. The phone must have been previously paired to the UConnect™ system that you want to use it with.

- Press the 'Phone' button to begin.
- After the "Ready" prompt and the following beep, say "Setup Select Phone."
- The phone names (along with priority numbers) will be played.
- When prompted say the priority number of the cellular phone you wish to select. You can also press the 'Voice Recognition' button anytime while the list is being played and say the priority number.

- The selected phone will be used for the next phone call. If the selected phone is not available, the UConnect™ system will return to using the highest priority phone present in or near (approximately within 30 feet) the vehicle.

**Delete UConnect™ Paired Cellular Phones**

- Press the 'Phone' button to begin.
- After the "Ready" prompt and the following beep, say "Setup Phone Pairing."
- At the next prompt, say "Delete."
- The phone names (along with priority numbers) will be played.



- When prompted say the priority number of the cellular phone (or "All" to delete all phones) you wish to delete. You can also press the 'Voice Recognition' button anytime while the list is being played and say the priority number.

### **Things You Should Know About Your UConnect™ System**

#### **Voice Recognition (VR)**

- Always wait for the beep before speaking.
  - Speak normally, without pausing, just as you would speak to a person sitting approximately eight (8) feet away from you.
  - Make sure that no one other than you is speaking during a voice recognition period.
- Performance is maximized under:
    - low-to-medium blower setting,
    - low-to-medium vehicle speed,
    - low road noise,
    - smooth road surface,
    - fully closed windows,
    - dry weather condition.
  - Even though the system is designed for users speaking in North American English and Spanish accents, the system may not always work for some.
  - When navigating through an automated system, such as, voice mail, or when sending a page, at the end of speaking the digit string, make sure to say "send."

- Storing names in phonebook when vehicle is not in motion is recommended.
- It is not recommended to store similar sounding names in the UConnect™ phonebook.
- UConnect™ phonebook name tag recognition rate is optimized for the person who stored the name in the phonebook.
- You can say "O" (letter "O") for "0" (zero). "800" must be spoken "eight-zero-zero."
- Even though international dialing for most number combinations is supported, some shortcut dialing number combinations may not be supported.

#### **Far End Audio Performance**

- Audio quality is maximized under:
  - low-to-medium blower setting,
  - low-to-medium vehicle speed,
  - low road noise,
  - smooth road surface,
  - fully closed windows, and
  - dry weather condition.
- Operation from driver seat.

- Performance, such as, audio clarity, echo, and loudness to a large degree, rely on the phone and network, and not the UConnect™ system.
- Echo at far end can sometime be reduced by lowering the in-vehicle audio volume.

**Bluetooth Communication Link**

Cellular phones have been found to occasionally lose connection to the UConnect™ system. When this happens, the connection can generally be re-established by switching the phone off/on. Your cell phone is recommended to remain in Bluetooth "on" mode.

**Reset**

In rare instances, it may be necessary to reset the UConnect™ system. The reset feature is exercised by pressing and holding the 'UConnect™' and 'Voice Recognition' buttons simultaneously for 15 seconds. Normally, you do not need to exercise this feature.

**Power-Up**

After switching ignition key from off to either On or ACC position, or after a reset, you must wait at least five (5) seconds prior to using the system.

**Voice Command Tree**

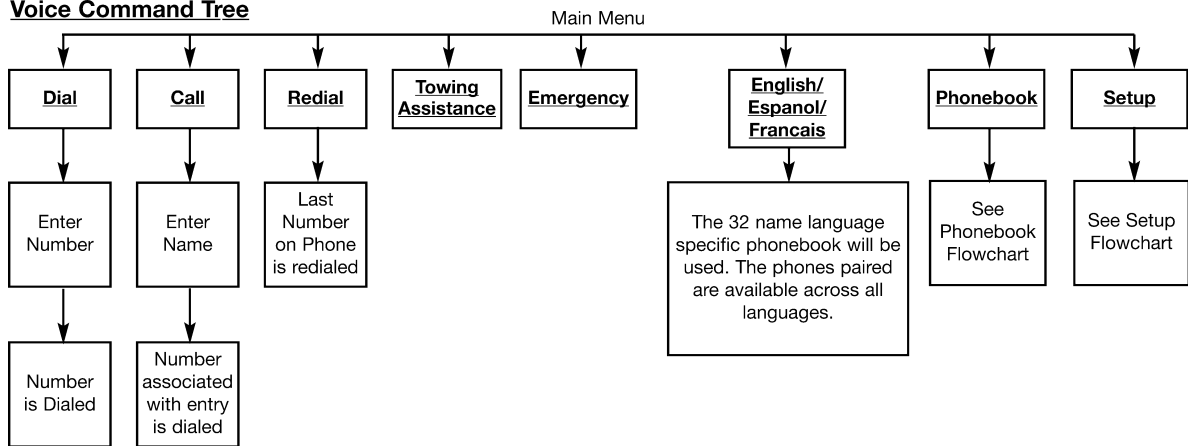

**Note:** Available Voice commands are shown in bold face and are underlined.

**Voice Tree – Phonebook**

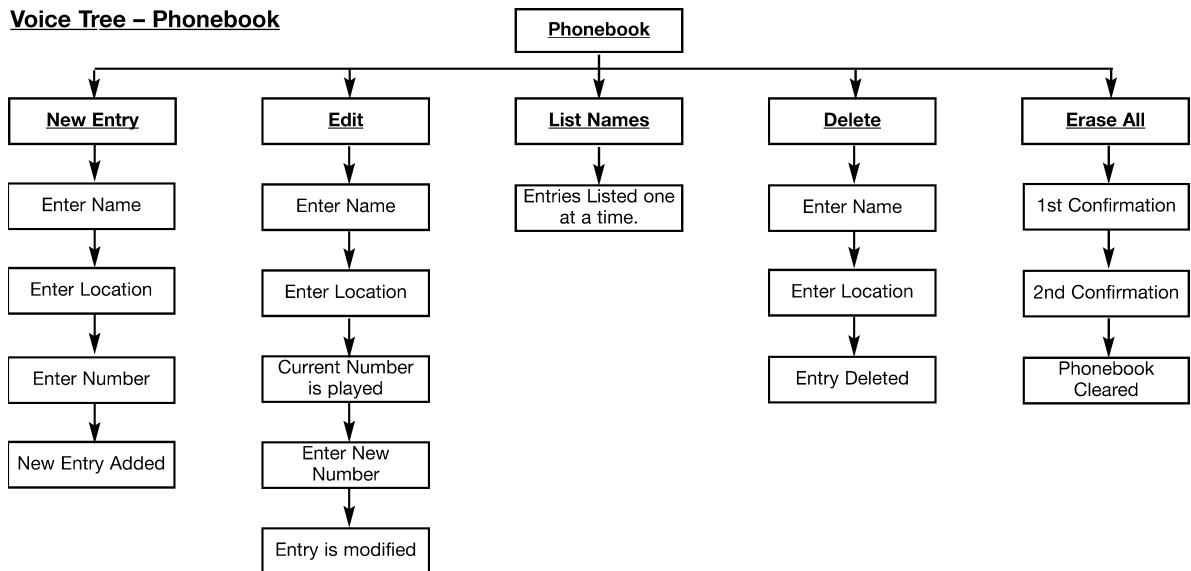

**Note:** Available Voice commands are shown in bold face and are underlined.

8131b294

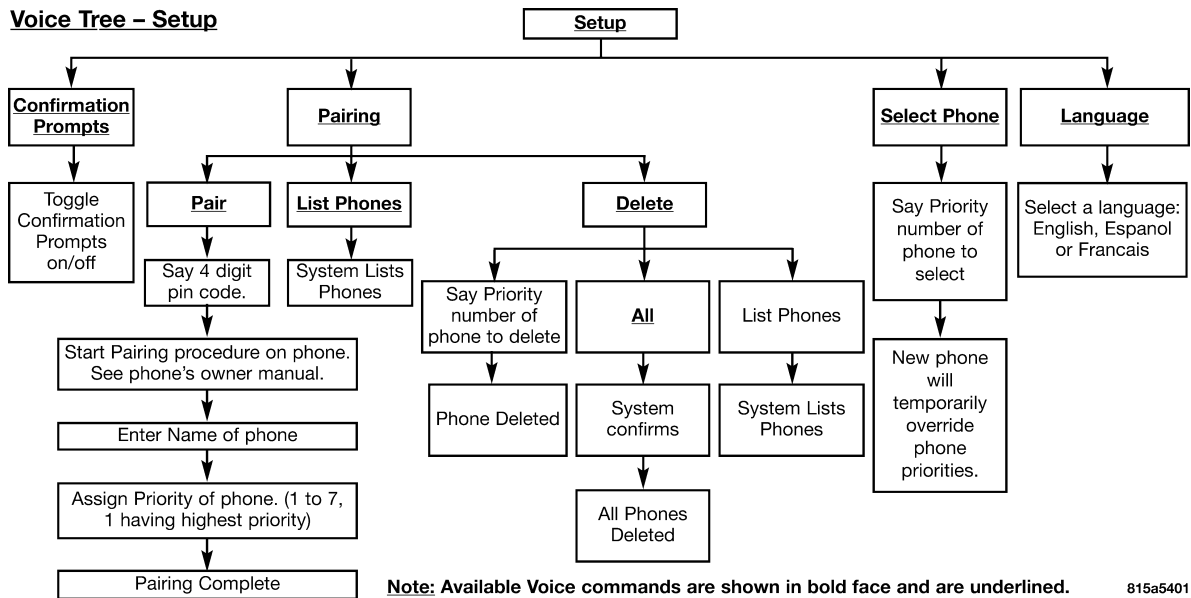

	North American English
Primary	Alternate(s)
Zero	Oh
Add location	Add new
All	All of them
Confirmation prompts	Confirmations prompts
Delete a name	Delete
Language	Select language
List names	List all
List paired phones	List phones
Pager	Beeper
Phone pairing	Pairing
Phonebook	Phone book
Return to main menu	Return. Main menu
Select phone	select
Set up	Phone settings phone set up

**SEATS**

The seating options available in this truck are the result of extensive customer research and evaluations.

Seats are also a primary part of the Occupant Restraint (protection) System of the vehicle. They need to be used properly for safe operation of the vehicle.

**3**

WARNING!
<p><b>It is extremely dangerous to ride in a cargo area, inside or outside of a vehicle. In a collision, people riding in these areas are more likely to be seriously injured or killed.</b></p> <p><b>Do not allow people to ride in any area of your vehicle that is not equipped with seats and seat belts.</b></p> <p><b>Be sure everyone in your vehicle is in a seat and using a seat belt properly.</b></p>

### 40-20-40 Front Seat

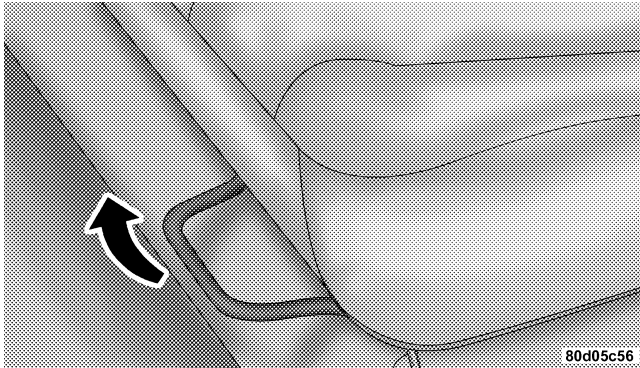

#### Manual Forward and Rearward Adjustment

As the name implies, the seat is divided into 3 segments. The outboard seat portions are each 40% of the total width of the seat. The back of the center portion (20%) easily folds down to provide an armrest/center storage compartment (if equipped).

Each outboard seat is independently adjustable forward or rearward and is equipped with a back recliner. The manual forward or rearward seat adjustment handle is found at the front edge of each seat cushion. Pull up on the handle and slide the seat to get the most comfortable position.

#### WARNING!

Adjusting a seat while the vehicle is moving is dangerous. The sudden movement of the seat could cause you to lose control. The seat belt might not be properly adjusted and you could be injured. Adjust any seat only while the vehicle is parked.



### Reclining Seats

The recliner handle is on the outside of the seat cushion. Pull up on the handle, as shown, to release the seat back and adjust for comfort.

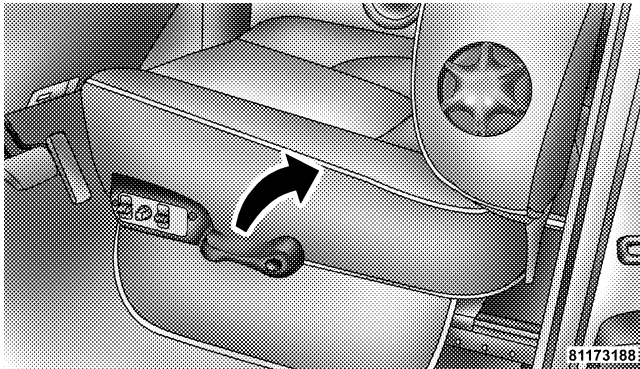

Seat Recliner Handle

### WARNING!

You can be seriously, even fatally, injured riding in a seat with the seatback reclined. Do not ride with the seatback reclined so that the shoulder belt is no longer resting against your chest. If you ride in this position, the shoulder harness will no longer be restraining you. In a collision you could slide under the seat belt and receive serious or fatal injuries. Recline in a seat only when the vehicle is parked.

3

### Adjustable Head Restraints

Head restraints can reduce the risk of neck injury in the event of impact from the rear. Pull up or push down on the restraints so that the upper edge is as high as practical, at least to the level of the ears.

To lower the head restraint, push in the button and then push down on the head restraint.

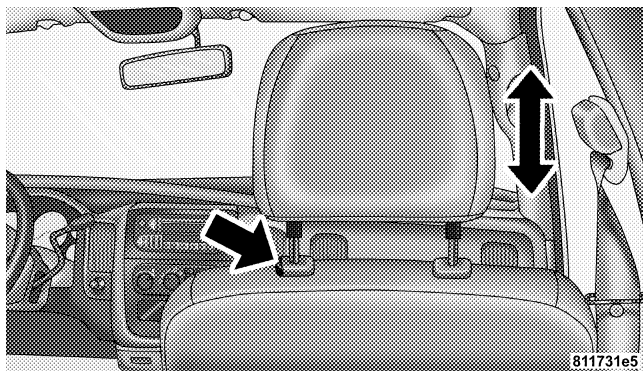

Head Restraint Adjustment

**Manual Rotary Lumbar Support Adjustment — If Equipped**

Rotating the lumbar control knob on the left side of the driver's seatback and on the right side of the passenger's seatback increases or decreases the lumbar (lower back) support.

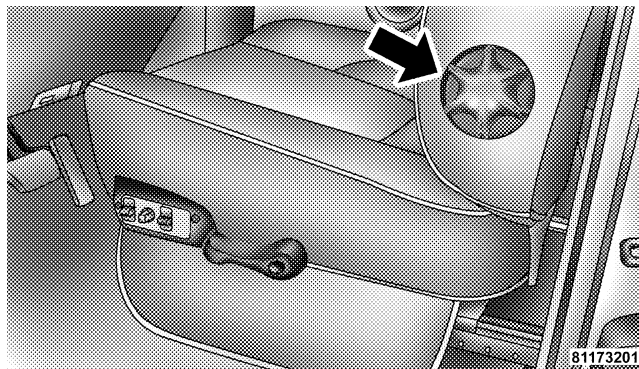

Manual Lumbar Adjustment

**Power Seats — If Equipped**

<b>CAUTION!</b>
Don't put anything under a power seat. It may cause damage to the seat controls.

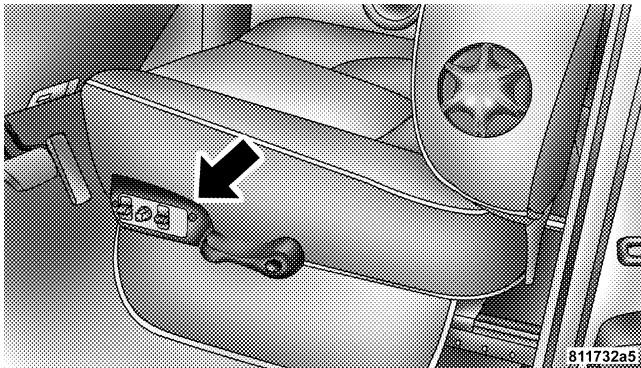

**Power Seat Control Location**

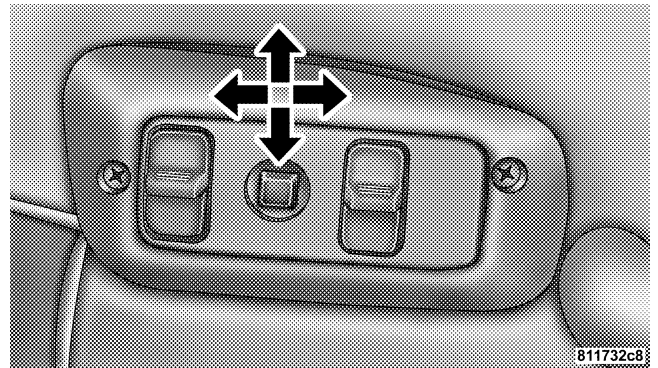

**3**

**Up, Down, Forward, and Rearward**

The power seat controls are on the outboard side of the front seat cushions. Three switches control the seat movement. The four-way switch in the center can be moved forward or backwards to get the most comfortable position. The same switch can be moved up and down to

control seat height. Change the seat angle by using the two toggle switches, tilting it up or down.

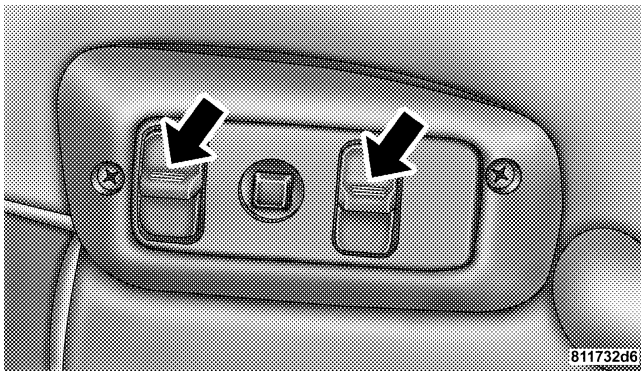

Tilt Adjustment

### Heated Seats — If Equipped

The heated seat switches are located in the instrument panel under the climate controls. The engine must be running for the heated seats to operate.

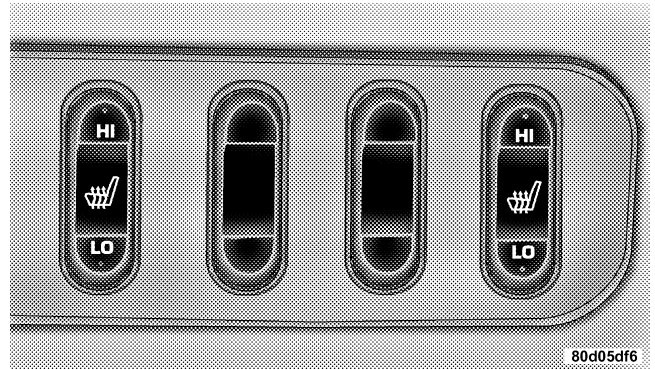

Heated Seat Switches

Each heated seat switch has two settings (HI and LOW). Press the switch once to obtain the desired heating position and press a second time in the same direction to turn the heated seats OFF. If you do not purposefully turn the switch OFF, the heating element in the seat will remain activated until the ignition is turned off. The indicators on the switch will illuminate when the heated seats are in the (HI or LOW) position. Flashing telltale lights on the switch indicate that the Heated Seat system needs servicing.

### TO OPEN AND CLOSE THE HOOD

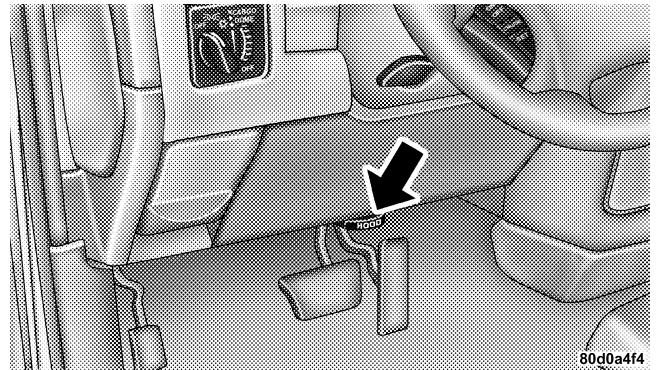

To open the hood, two latches must be released. First pull the hood release lever located below the steering wheel at the base of the instrument panel. Once the hood is released you must reach into the opening beneath the center of the grille and push up the latch to release the safety catch before raising the hood.

114 UNDERSTANDING THE FEATURES OF YOUR VEHICLE

To prevent possible damage, do not slam the hood to close it. Use a firm downward push at the front center of the hood to ensure that both latches engage.

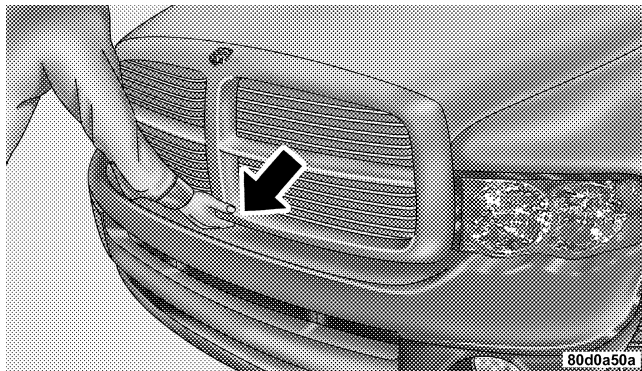

**WARNING!**

If the hood is not fully latched, it could fly up when the vehicle is moving and block your forward vision. Be sure all hood latches are latched fully before driving.

**LIGHTS**

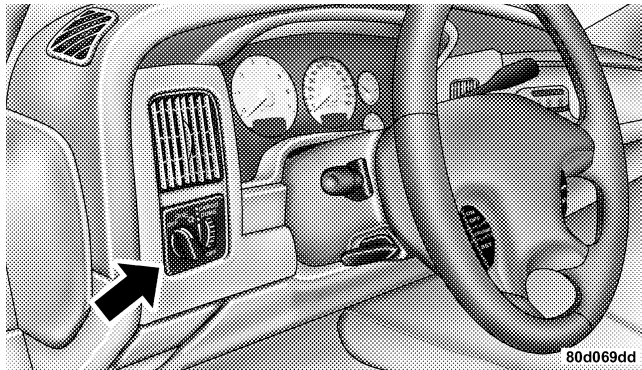

**Interior Lights**

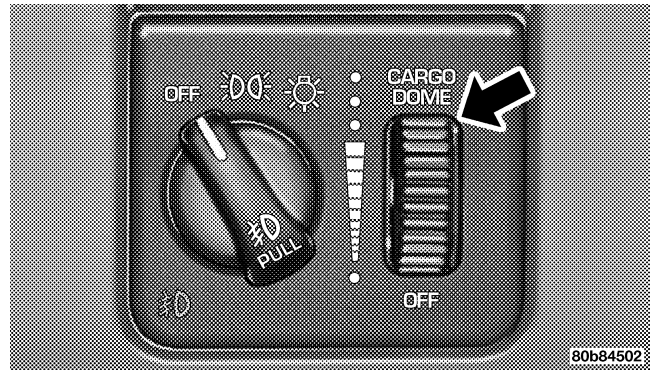

Courtesy/ dome lights are turned on when the front doors are opened, when the dimmer control (rotating wheel on the right side of the switch) is rotated to the second upward detent position, or if equipped, when the UNLOCK button is pressed on the key fob. Rotating the dimmer control to the optional fully upward position will

turn on the cargo light located on the back of the cab. When a door is open and the interior lights are on, rotating the dimmer control all the way down to the OFF detent will cause all the interior lights to go out. This is also known as the "Party" mode because it allows the doors to stay open for extended periods of time without discharging the vehicle's battery.

The brightness of the instrument panel lighting can be regulated by rotating the dimmer control up (brighter) or down (dimmer). When the headlights are ON you can supplement the brightness of the odometer, trip odometer, radio and overhead console by rotating the control up until you hear a click. This feature is termed the "Parade" mode and is useful when headlights are required during the day.

### **Battery Saver**

To protect the life of your vehicle's battery, Load Shedding is provided for both the interior and exterior lights.

If the ignition is off and any door is left ajar for 15 minutes or the dimmer control is rotated upwards for 15 minutes, the interior lights will automatically turn off.

If the headlamps remain on while the ignition is cycled off, the exterior lights will automatically turn off after 5 minutes. After 5 minutes timeout, if the headlamp switch is turned off and then turned on, the exterior lights will automatically turn off after 15 minutes.

If the dimmer control is rotated to the cargo lamp position with the ignition off, the cargo lamps will automatically turn off after 15 minutes.

**NOTE:** Battery Saver mode is cancelled if the ignition is ON.



### Headlamp Delay — If Equipped

To aid in your exit, your vehicle, if equipped, can be programmed by your dealer with a headlamp delay that will leave the headlamps on for 0, 30, 60, or 90 seconds. This delay is initiated when the ignition is turned OFF while the headlamp switch is on, and then the headlamp switch is cycled off. The headlamps will remain on for 60 seconds. Headlamp delay can be cancelled by either turning the headlamp switch ON then OFF or by turning the ignition ON.

### Headlights, Parking Lights, Panel Lights

 When the headlight switch is rotated to the first position, the parking lights, taillights, side marker lights, license plate light and instrument panel lights are all turned on. Rotating the headlight switch to the first position will also turn on the cab top clearance lights, flare lights, and tailgate lights if the vehicle is equipped with these lights. The headlights will turn ON when the switch is rotated to the second position. The

"LAMP OUT" indicator will be illuminated in the instrument cluster if a defective bulb or wiring circuit is detected for the headlamp system.

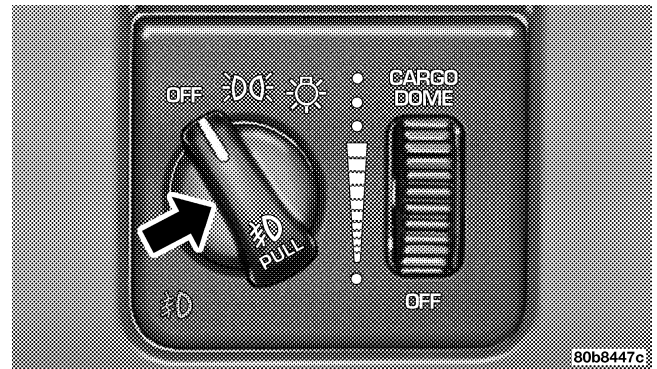

Your vehicle is equipped with plastic headlight lenses that are lighter and less susceptible to stone breakage than glass headlights.

Plastic is not as scratch resistant as glass and therefore different lens cleaning procedures must be followed.

To minimize the possibility of scratching the lenses and reducing light output, avoid wiping with a dry cloth. To remove road dirt, wash with a mild soap solution followed by rinsing.

Do not use abrasive cleaning components, solvents, steel wool or other abrasive materials to clean the lenses.

#### **Daytime Running Lights (Canada and Fleet Vehicles Only)**

The headlights on your vehicle will illuminate when the engine is started. This provides a constant "Lights ON" condition until the ignition is turned OFF. The lights illuminate at less than normal intensity. If the parking brake is applied the Daytime Running Lights will turn off.

#### **Lights-on Reminder**

If the headlights, parking lights, courtesy lights or cargo lights are left on, after the ignition is turned off, a continuous chime will sound when the driver's door is opened.

#### **Fog Lights — If Equipped**

The foglights are turned ON by placing the headlight rotary control in the parking light or headlight position and pulling out the headlight rotary control. The fog lights will operate only when the parking lights are ON or when the vehicle headlights are ON low beam. An indicator light located left of the switch will illuminate when the fog lights are on. The fog lights will turn off when the switch is pressed in, when the headlight switch is rotated to the OFF position or the high beam is selected.

**CARGO LIGHT**

The cargo lights are turned on by rotating the dimmer control to the optional fully upward position. The cargo lights will also turn on for 30 seconds when a key fob Unlock is pressed, as part of the illuminated entry feature.

**MULTIFUNCTION CONTROL LEVER**

The multifunction control lever is located on the left side of the steering column.

**Turn Signals**

Move the lever up or down to signal a right-hand or left-hand turn.

The arrow on either side of the instrument cluster flashes to indicate the direction of the turn, and proper operation of the front and rear turn signal lights. If a defective bulb or wiring circuit is detected for the turn signal system, the arrow indicators will flash at a faster rate. Also, the "LAMP OUT" indicator in the instrument cluster will be

illuminated and a chime will be heard. If an indicator fails to light when the lever is moved, it would suggest that the switch or indicator lamp is defective.

You can signal a lane change by moving the lever partially up or down.

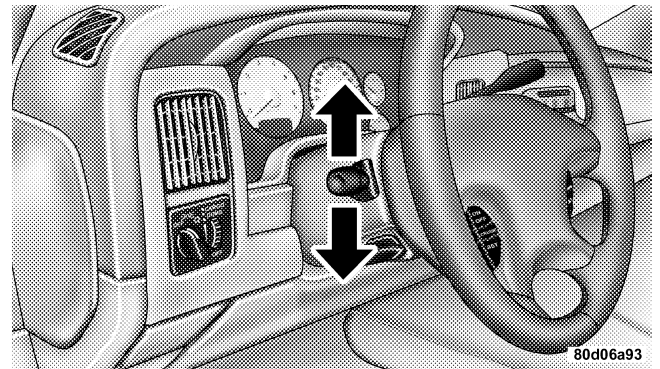

**Passing Light**

You can signal another vehicle with your headlights by partially pulling the multifunction lever toward the steering wheel. This will cause the high beam headlights to turn on until the lever is released.

**High Beam / Low Beam Select Switch**

Pull the multifunction control lever fully toward the steering wheel to switch the headlights from HIGH or LOW beam.

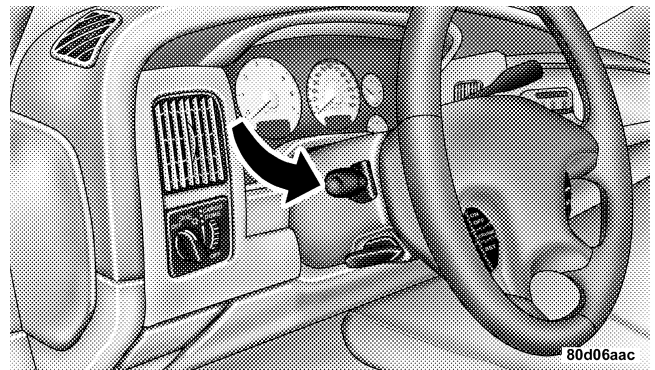

**Windshield Wipers**

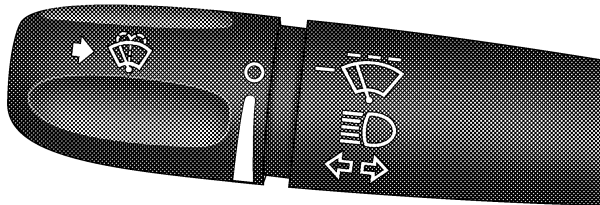

80d06ac5

The wipers and washers are operated by a switch in the multifunction control lever. Turn the end of the handle to select the desired wiper speed.

**Intermittent Wiper System**

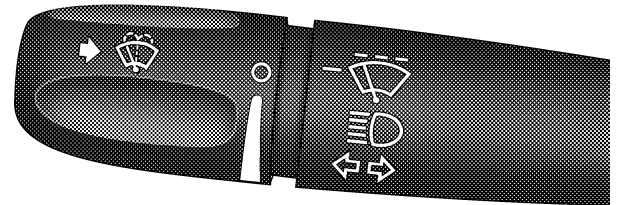

3

80d06ac5

The intermittent feature of this system was designed for use when weather conditions make a single wiping cycle, with a variable pause between cycles, desirable. For maximum delay between cycles, rotate the control knob into the upper end of the delay range.

The delay interval decreases as you rotate the knob until it enters the LO continual speed position. The delay can be regulated from a maximum of about 15 seconds between cycles, to a cycle every 2 seconds. The delay intervals will double in duration when the vehicle speed is 10 mph (16 km) or less.

**WARNING!**

**Sudden loss of visibility through the windshield could lead to an accident. You might not see other vehicles or other obstacles. To avoid sudden icing of the windshield during freezing weather, warm the windshield with defroster before and during windshield washer use.**

**Windshield Washers**

To use the washer, push in on the washer knob on the end of the multifunction control lever and hold while spray is desired. If the washer knob is depressed while in the delay range, the wiper will operate for several seconds after the washer knob is released. It will then resume the intermittent interval previously selected. If the washer knob is pushed, for a period greater than 1 second, while in the OFF position, the wiper will wipe approximately three wipes, after the wash knob is released.

To prevent freeze-up of your windshield washer system in cold weather, select a solution or mixture that meets or exceeds the temperature range of your climate. This rating information can be found on most washer fluid containers.

**TILT STEERING COLUMN**

To tilt the column, push down on the lever below the turn signal control and move the wheel up or down, as desired. Push the lever back up to lock the column firmly in place.

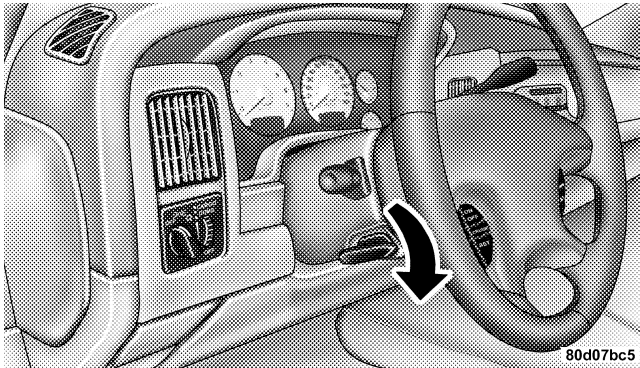
**WARNING!**

Tilting the steering column while the vehicle is moving is dangerous. Without a stable steering column, you could lose control of the vehicle and have an accident. Adjust the column only while the vehicle is stopped. Be sure it is locked before driving.

### DRIVER ADJUSTABLE PEDALS — IF EQUIPPED

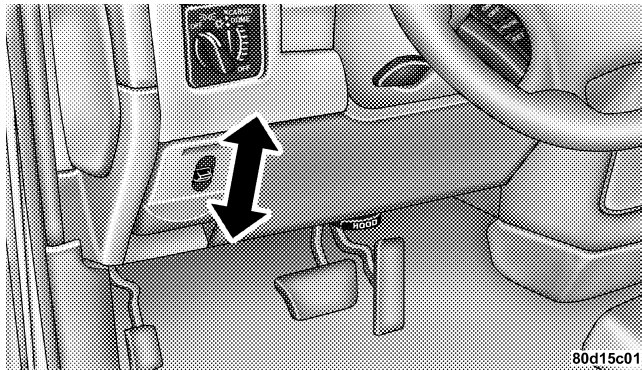

The power adjustable accelerator and brake pedals allow the driver to establish a comfortable position relative to the steering wheel and pedals.

### Adjustment

1. Position the driver seat so that you are at least 10 inches (254 mm) away from the airbag located in the center of the steering wheel.
2. Fasten and adjust the seatbelts.
3. Move the adjustable pedal switch, located to the left of the steering column near the parking brake release, in the direction you desire to move the pedals.
4. The pedals **cannot** be adjusted when the vehicle is in R (Reverse) or when the Speed Control is SET.



**CAUTION!**

Do not place any article under the adjustable pedals or impede its ability to move as it may cause damage to the pedal controls. Pedal travel may become limited if movement is stopped by an obstruction in the adjustable pedal's path.

**ELECTRONIC SPEED CONTROL — IF EQUIPPED**

When engaged, this device takes over accelerator operation at speeds greater than (refer to the table below for the speed for your specific engine). The controls are mounted on the steering wheel.



8147b086

**To Activate**

Push the ON/OFF button to the ON position. In the instrument cluster, the word "CRUISE" illuminates when the system is on.

**To Set At A Desired Speed**

When the vehicle has reached the desired speed, press and release the SET button. Release the accelerator and the vehicle will operate at the selected speed.

**To Deactivate**

A soft tap on the brake pedal, normal braking, clutch pressure while slowing the vehicle, or pressing the CANCEL button will deactivate speed control without erasing the memory. Pushing the ON/OFF button to the OFF position or turning off the ignition erases the memory.

**WARNING!**

Leaving the Speed Control ON when not in use is dangerous. You could accidentally set the system to cause it to go faster than you want. You could lose control and have an accident. Always leave the system OFF when you aren't using it.

**To Resume Speed**

To resume a previously set speed, push and release the RESUME button. Resume can be used at any speed above (refer to the table below for the speed for your specific engine).

**To Vary The Speed Setting**

When the speed control is on, speed can be increased by pressing and holding the ACCEL button. When the button is released, a new set speed will be established.

Tapping the ACCEL button once will result in a speed increase (refer to the table below for the speed for your specific engine). Each time the button is tapped, speed increases so that tapping the button three times will increase speed by three increments.

Tapping the DECEL button once will result in a speed decrease (refer to the table below for the speed for your

specific engine). Each time the button is tapped, speed will decrease. For example, tapping the button 3 times will decrease the speed by 3 times the speed listed in the table below (refer to the table below for the speed for your specific engine).

To decrease speed while the speed control is on, press and hold the DECEL button. Release the button when the desired speed is reached, and the new speed will be set.

Functions	3.7L	4.7L	5.7L
Engage Speed	35 mph (56 km/h)	35 mph (56 km/h)	25 mph (40 km/h)
Minimum RESUME Speed	30 mph (50 km/h)	30 mph (50 km/h)	20 mph (32 km/h)
ACCEL Increase	2 mph (3km/h)	2 mph (3km/h)	1 mph (2 km/h)
DECEL Decrease	1 mph (2 km/h)	1 mph (2 km/h)	1 mph (2 km/h)
Dropout Speed	30 mph (50 km/h)	30 mph (50 km/h)	20 mph (32 km/h)

**To Accelerate For Passing**

Depress the accelerator as you would normally. When the pedal is released, the vehicle will return to the set speed.

**NOTE:** When driving uphill, at elevations above 2,000 feet (610 meters), or when the vehicle is heavily loaded (especially when towing) the vehicle may slow below the SET speed. If the vehicle speed drops below (refer to the table below for the speed for your specific engine), the speed control will automatically disengage. If this happens, you can push down on the accelerator pedal to maintain the desired speed.

Vehicles equipped with a 5-speed-manual transmission should be operated in 4th gear or lower under the above conditions.

Vehicles equipped with a Automatic transmission may exhibit several downshifts under the above conditions.

To reduce the frequency of the downshifts and to improve vehicle performance, it is advisable to lock out overdrive by pressing the "TOW/HAUL" button located at the end of the gear shifter.

**WARNING!**

**Speed Control can be dangerous where the system can't maintain a constant speed. Your vehicle could go too fast for the conditions, and you could lose control. An accident could be the result. Don't use Speed Control in heavy traffic or on roads that are winding, icy, snow-covered, or slippery.**

**OVERHEAD CONSOLE— IF EQUIPPED**

The two optional overhead consoles may consist of the following features:

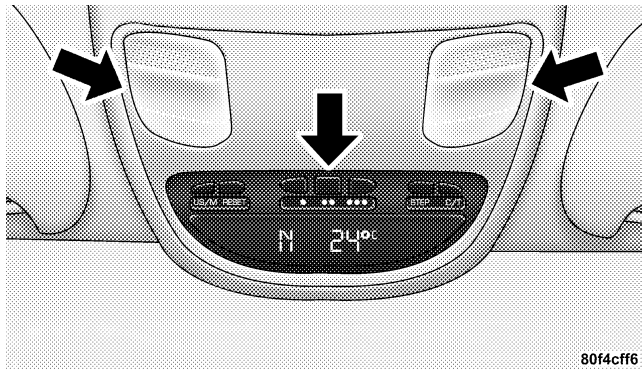

- Courtesy/Reading Lights
- Compass/Temperature Mini-Trip Computer (CMTC) — If Equipped

- Universal Garage Door Opener — If Equipped

**Courtesy/Reading Lights**

In the middle of the console are two courtesy/reading lights.

Both lights illuminate as courtesy lights when a door is opened, when the dimmer control is rotated to the courtesy light position (fully upward position), or when the UNLOCK button is pressed on the Remote Keyless Entry transmitter, if so equipped. These lights are also operated individually as reading lights by pressing the recessed area of the corresponding lens.

**NOTE:** The courtesy/reading lights will remain on until the switch is pressed a second time, so be sure they have been turned off before leaving the vehicle. If the interior lights are left on after the vehicle is turned off, they will extinguish after 15 minutes.

**OVERHEAD CONSOLE WITH  
COMPASS/TEMPERATURE MINI-TRIP  
COMPUTER — IF EQUIPPED**

This optional overhead console consists of the following:

- Courtesy Lights
- Compass/Temperature Mini-Trip Computer (CMTC)

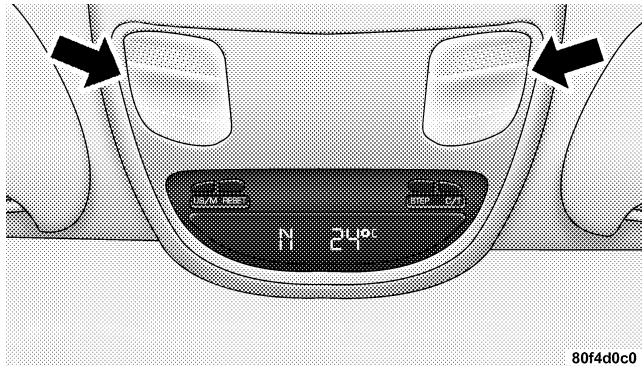

This overhead console allows you to choose between a compass/temperature display and one of four trip conditions being monitored.

**US/M Button**

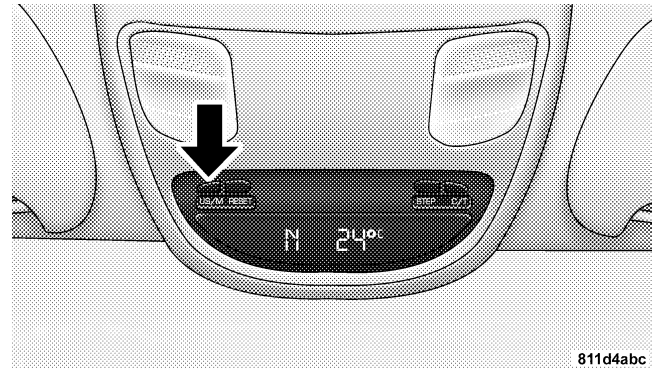

Use this button to change the display from U.S. to metric measurement units.

**RESET Button**

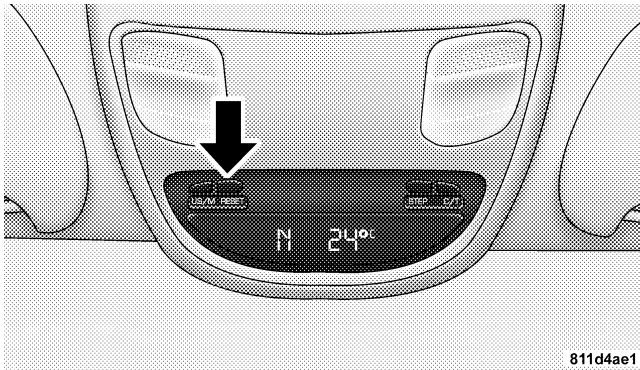

Use this button to reset the following displays to zero:  
 Average Fuel Economy  
 Trip Odometer  
 Elapsed time

**Global Reset**

If the RESET button is pressed twice within 2 seconds while in any of the 3 resettable displays, the Global Reset will reset all 3 displays.

**Step Button**

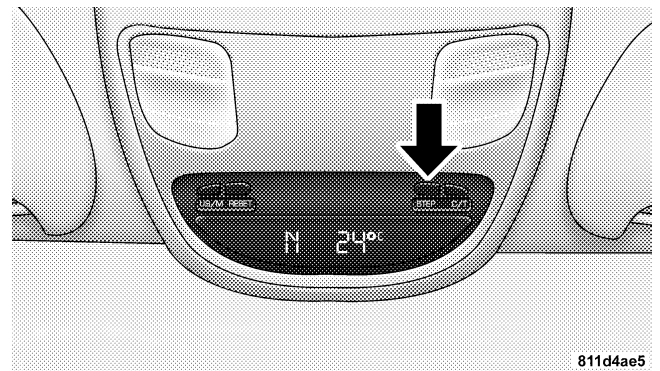

Use this button to choose or cycle through the four trip conditions.

**Average Fuel Economy (AVG ECO)**

Shows the average fuel economy since the last reset. This display mode becomes less sensitive to instantaneous changes in fuel consumption as the number of total vehicle miles since the last reset increases. It is suggested that this mode be reset periodically for general operation or when driving conditions change significantly (for example, at the end of a trip or when a trailer is connected or disconnected).

**Distance To Empty (DTE)**

Shows the estimated distance that can be travelled with the fuel remaining in the tank. The estimated distance is determined by a weighted average of the instantaneous and average fuel economy, according to the current fuel tank level.

When Distance To Empty = 0, the fuel gauge pointer will initially be on the red "E" marker. At this point (fuel gauge pointer on the red "E" marker) there is reserve fuel capacity, which corresponds to approximately 8% of tank volume. This reserve capacity was put in place to prevent the likelihood of customers running out of fuel when operating at maximum load conditions in areas where there aren't many gas stations.

**NOTE:** The Distance To Empty will remain equal to zero, until the vehicle runs out of fuel or is refueled.



*Ram fuel tank volumes are as follows:*

- 26 gallons - 1500 short box models
- 34 gallons - 1500 Quad Cab (if equipped)/2500/3500 short box models
- 35 gallons - 1500/2500/3500 long box models

#### **Trip Odometer (ODO)**

This display shows the distance traveled since the last reset.

#### **Elapsed Time (ET)**

This display shows the accumulated ignition ON time since the last reset.

#### **C/T Button**

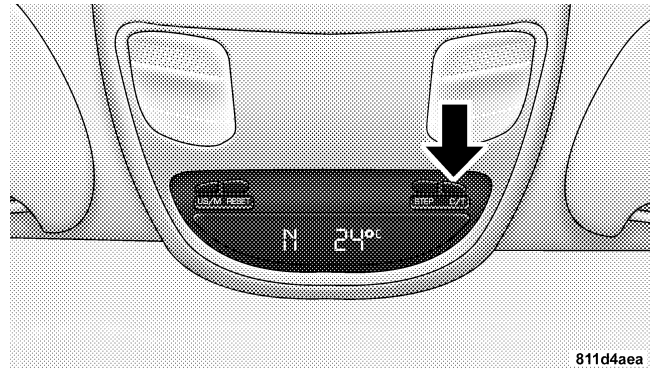

Use this button to select a readout of the outside temperature and one of eight compass headings that indicate the direction in which the vehicle is facing.

**WARNING!**

Even if the display still reads a few degrees above 32°F ( 0°C), the road surface may be icy, particularly in woods or on bridges. Drive carefully under such conditions to prevent an accident and possible personal injury or property damage.

**Automatic Compass Calibration**

This compass is self-calibrating which eliminates the need to manually set the compass. When the vehicle is new, the compass may appear erratic and the CAL symbol will be displayed.

After completing up to three 360° turns, with the vehicle traveling less than 5 mph (8 km/h), in an area free from large metal or metallic objects, the CAL symbol will turn off and the compass will function normally.

**Manual Compass Calibration**

**NOTE:** To ensure proper compass calibration, make sure the compass variance is properly set before manually calibrating the compass.

If the compass appears erratic and the CAL symbol does not appear, you must manually put the compass into the "Calibration" mode.

### Recalibrating The Compass

Turn on the ignition and set the display to “Compass/ Temperature.” Press and hold the RESET button to change the display between VAR (compass variance) and CAL (compass calibration) modes. When the CAL symbol is displayed complete one 360° turn in an area free from large metal objects or power lines. The CAL symbol will turn off and the compass will function normally.

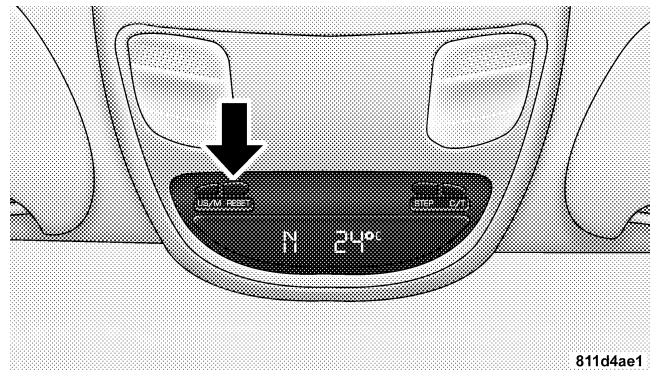

**Compass Variance** is the difference between magnetic north and geographic north. In some areas of the country, the difference between magnetic and geographic north is great enough to cause the compass to give false readings. If this occurs, the compass variance must be set according to the Compass Variance Map.

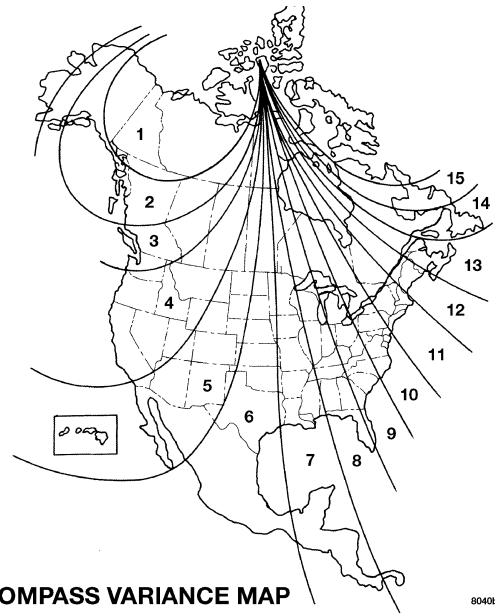

To set the variance: Turn the ignition ON and set the display to “Compass/Temperature.” Press the RESET button approximately five seconds. The last variance zone number will be displayed. Press the STEP button to select the new variance zone and press the RESET button to resume normal operation.

### Outside Temperature

Because the ambient temperature sensor is located underhood, engine temperature can influence the displayed temperature, therefore, temperature readings are slowly updated when the vehicle speed is below 20 mph (30 km/h) or during stop and go driving.

### GARAGE DOOR OPENER — IF EQUIPPED

The HomeLink® Universal Transceiver replaces up to three remote controls (hand held transmitters) that operate devices such as garage door openers, motorized gates, or home lighting. It triggers these devices at the push of a button. The Universal Transceiver operates off your vehicle’s battery and charging system; no batteries are needed.

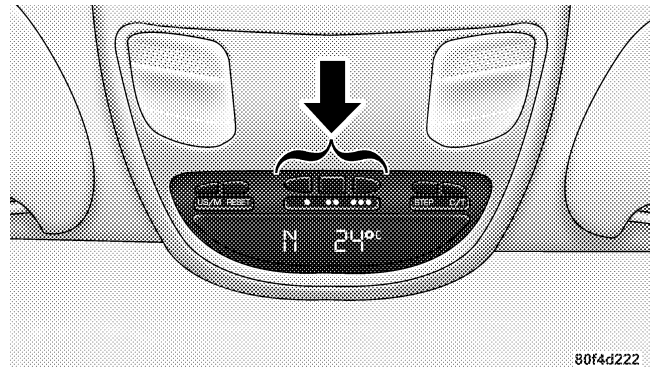

80f4d222

For additional information on HomeLink®, call 1-800-355-3515, or on the internet at [www.homelink.com](http://www.homelink.com).

**WARNING!**

A moving garage door can cause injury to people and pets in the path of the door. People or pets could be seriously or fatally injured. Only use this transceiver with a garage door opener that has a "stop and reverse" feature as required by federal safety standards. This includes most garage door opener models manufactured after 1982. Do not use a garage door opener without these safety features it could cause injury or death. Call toll-free 1-800-355-3515 or, on the Internet at [www.homelink.com](http://www.homelink.com) for safety information or assistance.

**Programming HomeLink**

**NOTE:** When programming a garage door opener, it is advised to park outside the garage. It is also recommended that a new battery be placed in the hand-held transmitter of the device being programmed to HomeLink for quicker training and accurate transmission of the radio-frequency signal.

1. Press and hold the two outer HomeLink buttons, and release only when the indicator light begins to flash (after 20 seconds). **Do not** hold the buttons for longer than 30 seconds and **do not** repeat step one to program a second and/or third hand-held transmitter to the remaining two HomeLink buttons.

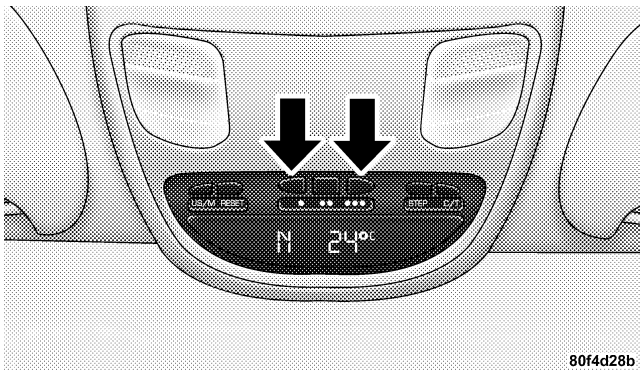
**WARNING!**

Vehicle exhaust contains carbon monoxide, a dangerous gas. Do not run the vehicle's exhaust while training the transceiver. Exhaust gas can cause serious injury or death.

**WARNING!**

Your motorized door or gate will open and close while you are training the Universal Transceiver. Do not train the transceiver if people or pets are in the path of the door or gate. A moving door or gate can cause serious injury or death to people and pets or damage to objects.

**3**

2. Position the end of your hand-held transmitter 1-3 inches (3-8 cm) away from the HomeLink buttons while keeping the indicator light in view.
3. Simultaneously press and hold both the HomeLink button that you want to train and the hand-held transmitter buttons. Do not release the buttons until step 4 has been completed.

**NOTE:** Some gate operators and garage door openers may require you to replace this Programming Step 3 with procedures noted in the "Gate Operator/Canadian Programming" section.

4. The HomeLink indicator light will flash slowly and then rapidly after HomeLink successfully receives the frequency signal from the hand-held transmitter. Release both buttons after the indicator light changes from the slow to the rapid flash.

5. Press and hold the just trained HomeLink button and observe the indicator light. If the indicator light **stays on constantly, programming is complete** and your device should activate when the HomeLink button is pressed and released.

**NOTE:** To program the remaining two HomeLink buttons, begin with "Programming" **step two. Do not repeat step one.**

If the indicator light blinks **rapidly for two seconds and then turns to a constant light, continue with "Programming" steps 6-8** to complete the programming of a rolling code equipped device (most commonly a garage door opener).

6. At the garage door opener receiver (motor-head unit) in the garage, locate the "learn" or "smart" button. This can usually be found where the hanging antenna wire is attached to the motor-head unit.

7. Firmly press and release the "learn" or "smart" button. (The name and color of the button may vary by manufacturer.)

**NOTE:** There are 30 seconds in which to initiate step eight.



8. Return to the vehicle and firmly **press, hold for two seconds and release** the programmed HomeLink button. Repeat the "**press/hold/release**" sequence a second time, and, depending on the brand of the garage door opener (or other rolling code equipped device), repeat this sequence a third time to complete the programming.

HomeLink should now activate your rolling code equipped device.

**NOTE:** To program the remaining two HomeLink buttons, begin with "Programming" **step two**. **Do not repeat step one**. For questions or comments, please contact HomeLink at [www.homelink.com](http://www.homelink.com) or 1-800-355-3515.

#### **Canadian Programming/Gate Programming**

Canadian radio-frequency laws require transmitter signals to "time-out" (or quit) after several seconds of transmission which may not be long enough for HomeLink to pick up the signal during programming.

Similar to this Canadian law, some U.S. gate operators are designed to "time-out" in the same manner.

If you live in Canada or you are having difficulties programming a gate operator by using the "Programming" procedures (regardless of where you live), **replace "Programming HomeLink" step 3** with the following:

**NOTE:** If programming a garage door opener or gate operator, it is advised to unplug the device during the "cycling" process to prevent possible overheating.

3. Continue to press and hold the HomeLink button while you **press and release every two seconds** ("cycle") your hand-held transmitter until the frequency signal has successfully been accepted by HomeLink. (The indicator light will flash slowly and then rapidly.) Proceed with "Programming" step four to complete.

**Using HomeLink**

To operate, simply press and release the programmed HomeLink button. Activation will now occur for the trained device (i.e. garage door opener, gate operator, security system, entry door lock, home/office lighting, etc.). For convenience, the hand-held transmitter of the device may also be used at any time. In the event that there are still programming difficulties or questions, contact HomeLink at: [www.homelink.com](http://www.homelink.com) or 1-800-355-3515.

**Erasing HomeLink Buttons**

To erase programming from the three buttons (individual buttons cannot be erased but can be "reprogrammed" - note below), follow the step noted:

- Press and hold the two outer HomeLink buttons until the indicator light begins to flash-after 20 seconds. Release both buttons. Do not hold for longer than 30

seconds. HomeLink is now in the train (or learning) mode and can be programmed at any time beginning with "Programming" - step 2.

**Reprogramming a Single HomeLink Button**

To program a device to HomeLink using a HomeLink button previously trained, follow these steps:

1. Press and hold the desired HomeLink button. **DO NOT** release the button.
2. The indicator light will begin to flash after 20 seconds. Without releasing the HomeLink button, proceed with "Programming" step 2

For questions or comments, contact HomeLink at: [www.homelink.com](http://www.homelink.com) or 1-800-355-3515.

**Security**

If you sell your vehicle, be sure to erase the frequencies.

To erase all of the previously trained frequencies, hold down both outside buttons until the green light begins to flash.

This device complies with part 15 of FCC rules and with RSS-210 of Industry Canada. Operation is subject to the following conditions:

- This device may not cause harmful interference.
- This device must accept any interference that may be received including interference that may cause undesired operation.

**NOTE:** Changes or modifications not expressly approved by the party responsible for compliance could void the user's authority to operate the equipment.

HomeLink® is a trademark owned by Johnson Controls, Inc.

**POWER SUNROOF — IF EQUIPPED**

The power sunroof switch is located between the sun visors on the overhead console.

**WARNING!**

- **Never leave children in a vehicle, with the keys in the ignition switch. Occupants, particularly unattended children, can become entrapped by the power sunroof while operating the power sunroof switch. Such entrapment may result in serious injury or death.**
- **In an accident, there is a greater risk of being thrown from a vehicle with an open sunroof. You could also be seriously injured or killed. Always fasten your seat belt properly and make sure all passengers are properly secured too.**
- **Do not allow small children to operate the sunroof. Never allow fingers or other body parts, or any object to project through the sunroof opening. Injury may result.**

**Opening Sunroof - Express**

Press the switch rearward and release, and the sunroof will open automatically from any position. The sunroof will open fully, then stop automatically. This is called Express Open. During Express Open operation, any movement of the sunroof switch will stop the sunroof.

**Closing Sunroof - Express**

Press the switch forward and release, and the sunroof will close automatically from any position. The sunroof will close fully and stop automatically. This is called Express Close. During Express Close operation, any movement of the switch will stop the sunroof.

**Pinch Protect Feature**

This feature will detect an obstruction in the opening of the sunroof during Express Close operation. If an obstruction in the path of the sunroof is detected, the sunroof will automatically retract. Remove the obstruction if this occurs. Next, press the switch forward and release to Express Close.

**Pinch Protect Override**

If a known obstruction (ice, debris, etc.) prevents closing, press the switch forward and hold for two seconds after the reversal occurs. This allows the sunroof to move towards the closed position.

**NOTE:** Pinch protection is disabled while the switch is pressed.

**Venting Sunroof - Express**

Press and release the "V" button, and the sunroof will open to the vent position. This is called Express Vent, and will occur regardless of sunroof position. During Express Vent operation, any movement of the switch will stop the sunroof.

**Sunshade Operation**

The sunshade can be opened manually. However, the sunshade will open automatically as the sunroof opens.

**NOTE:** The sunshade cannot be closed if the sunroof is open.

### **Wind Buffeting**

Wind buffeting can be described as the perception of pressure on the ears or a helicopter type sound in the ears. Your vehicle may exhibit wind buffeting with the windows down, or the sunroof (if equipped) in certain open or partially open positions. This is a normal occurrence and can be minimized. If the buffeting occurs with the rear windows open, open the front and rear windows together to minimize the buffeting. If the buffeting occurs with the sunroof open, adjust the sunroof opening to minimize the buffeting or open any window.

### **Sunroof Maintenance**

Use only a non-abrasive cleaner and a soft cloth to clean the glass panel.

### **Ignition Off Operation**

The power sunroof switches remain active for 10 minutes after the ignition switch has been turned off. Opening either front door will cancel this feature.

### **Sunroof Fully Closed**

Press the switch forward and release to ensure that the sunroof is fully closed.

### ELECTRICAL POWER OUTLETS

The auxiliary electrical outlet can provide power for in cab accessories designed for use with the standard “cigar lighter” plug. The outlet is located in the instrument panel below the ash receiver. A cap is attached to the outlet base indicating “Power Outlet” 12V-20A.

There is an additional Power Outlet in the center console of a 40/20/40 seat (if equipped).

The outlet(s) has/have a fused direct feed from the battery so it/they receive power whether the ignition is ON or OFF.

All accessories connected to this/these outlet(s) should be removed or turned OFF when the vehicle is not in use to protect the battery against discharge.

### CAUTION!

#### Electrical Outlet Use With Engine Off

- Many accessories that can be plugged in draw power from the vehicle’s battery, even when not in use (i.e. cellular phones, etc.). Eventually, if plugged in long enough, the vehicle’s battery will discharge sufficiently to degrade battery life and/or prevent engine starting.
- Accessories that draw higher power (i.e. coolers, vacuum cleaners, lights, etc.), will discharge the battery even more quickly. Only use these intermittently and with greater caution.
- After the use of high power draw accessories, or long periods of the vehicle not being started (with accessories still plugged in), the vehicle must be driven a sufficient length of time to allow the generator to recharge the vehicle’s battery.

### CIGAR LIGHTER AND ASH RECEIVER

The ash receiver is opened and closed by **pushing** on the front surface of the receiver and then allowing the receiver to open.

The cigar lighter is located above and to the left of the ash receiver.

As a child safety precaution, the lighter only operates with the ignition switch ON. It heats when pushed in and pops out automatically when ready for use. **To preserve the heating element, do not hold the lighter in the heating position.**

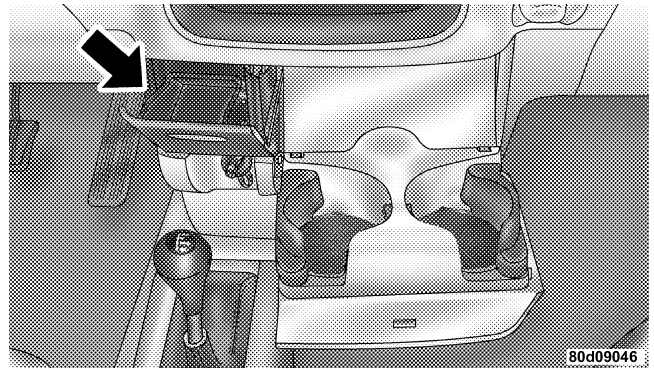



## CUPHOLDERS

### Front Instrument Panel Cupholders — Automatic Transmission Only

Your new Ram truck is equipped with dual-opening adjustable cupholders. The cupholder is opened and closed by pushing on the front surface. Each opening in the cupholder is adjustable and will hold cups and mugs of various sizes.

To secure the cup, place the cup to be held into one of the cup wells and then push the cupholder arm toward the cup until it is held stable.

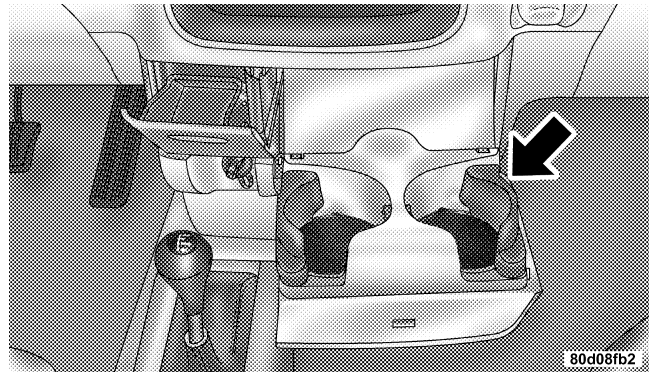

3

### Cupholders with Automatic

### Rear Cupholder — Quad Cab — If Equipped

Quad Cab vehicles may be equipped with a rear cupholder that consists of two cupwells for rear passenger convenience.

## STORAGE

### Center Storage Compartment — If Equipped

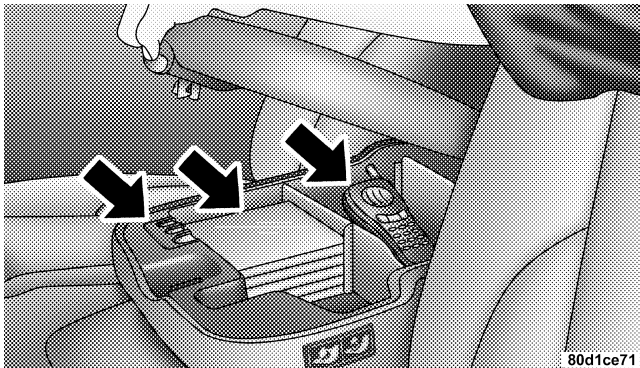

The center portion of the seat folds down to provide an armrest with unique storage compartments under the lid. Push the button on the front of the armrest to raise the cover. Inside there is a power outlet (if equipped), removable coin holder (if equipped), and two dividers to

configure the storage area into compartments. For example, compartments can be configured to hold a lap-top computer, a cellular telephone, CD's and miscellaneous items. The top of the cover provides a generous firm surface to serve as a desktop for your "mobile office."

#### WARNING!

- This armrest is not a seat. Anyone seated on the armrest could be seriously injured during vehicle operation, or an accident. Only use the center seating position when the armrest is fully upright.
- In an accident, the latch may open if the total weight of the items stored exceeds about 10 lbs (4.5 kg). These items could be thrown about endangering occupants of the vehicle. Items stored should not exceed a total of 10 lbs (4.5 kg).

**Storage and Seats — If Equipped**

Located in the center of the front 40/20/40 seat cushion there is a storage compartment.

Standard cab models also have storage behind the seat.

The Quad Cab models provide additional storage under the rear seat. Lift the seat to access the storage compartment.

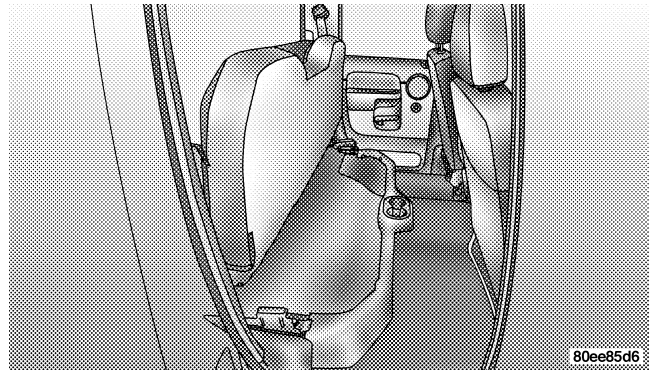

### FOLD FLAT LOAD FLOOR — IF EQUIPPED

#### Fold Flat Load Floor — If Equipped

Quad Cab models with a 60/40 rear seat, may be equipped with a folding steel load floor.

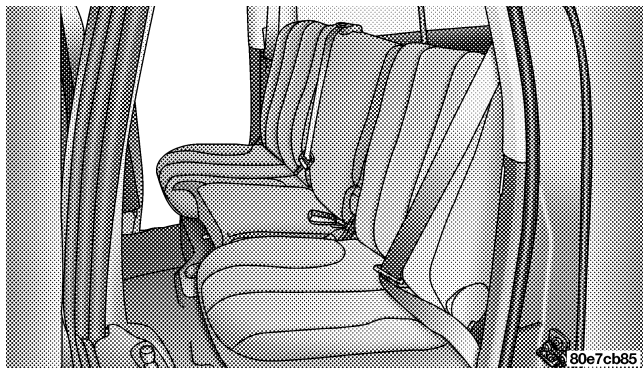

#### WARNING!

Do not operate the vehicle with loose items stored on the load floor. While driving or in an accident you may experience, abrupt stopping, rapid acceleration, or sharp turns. Loose objects stored on the load floor may move around with force and strike occupants, resulting in serious or fatal injury.

*Unfolding the Load Floor*

1. Lift the 60/40 seat cushion(s) to the upward position.

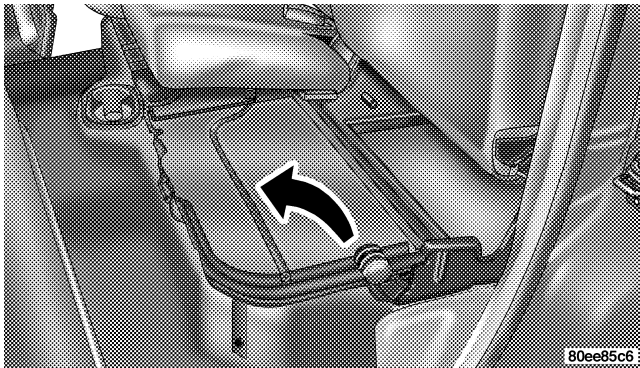

2. Grasp the knob on the load floor and lift the knob until the load floor unfolds into position.



3. Reverse the procedure to store the load floor.

*Positioning the Load Floor for Storage Access Under the Seat*

1. Lift the 60/40 seat cushion(s) to the upward position.
2. Unsnap the securing snap located at either side of the load floor.
3. Lift the load floor up to access storage under the load floor.

**WARNING!**

**Do not drive with the load floor in the up position. When stopping fast or in an accident, the load floor could move to the down position causing serious injury.**

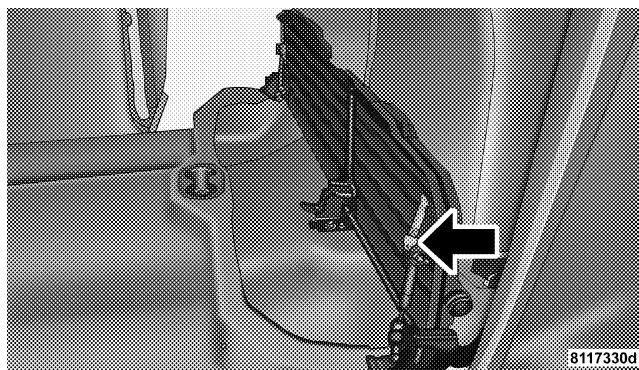

4. Reverse the procedure to put the load floor back in the secured down position before you operate the vehicle.

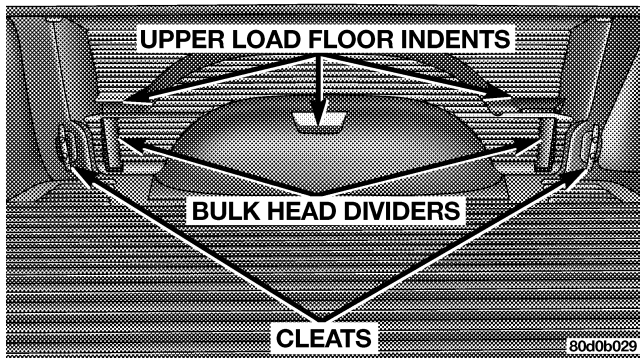
**PICKUP BOX**

The pickup box on your new Ram has many features designed for utility and convenience.

**NOTE:** If you are installing a toolbox to the front of the pickup box, you must use Mopar® toolbox brackets available from your dealer.

You can carry wide building materials (sheets of plywood, etc.) by building a raised load floor. Place lumber across the box in the indentations provided above the wheel housings and in the bulkhead dividers to form the floor.

**3****WARNING!**

The pickup box is intended for load carrying purposes only, not for passengers, who should sit in seats and use seat belts.

**WARNING!**

- Care should always be exercised when operating a vehicle with unrestrained cargo. Vehicle speeds may need to be reduced. Severe turns or rough roads may cause shifting or bouncing of the cargo that may result in vehicle damage. If wide building materials are to be frequently carried, the installation of a support is recommended. This will restrain the cargo and transfer the load to the pickup box floor.
- If you wish to carry more than 600 lbs (272 kg) of material suspended above the wheelhouse, supports must be installed to transfer the weight of the load to the pickup box floor or vehicle damage may result. The use of proper supports will permit loading up to the rated payload.
- Unrestrained cargo may be thrown forward in an accident causing serious or fatal injury.

There are stampings in the sheet metal on the inner side bulkheads of the box in front of and behind both wheel housings. Place wooden boards across the box from side to side to create separate load compartments in the pickup box.

There are four tie-down cleats bolted to the lower sides of the pickup box that can sustain loads up to 1000 lbs (450 kg) total.



## SLIDE-IN CAMPERS

### Camper Applications

Certain truck models are not recommended for slide-in campers. To determine if your vehicle is excluded, please refer to the “Consumer Information Truck-Camper Loading” document available from your dealer. For safety reasons, follow all instructions in this important document.

**NOTE:** When a cap or pickup camper is installed on a vehicle, an alternate CHMSL (Center High Mounted Stop Light) must be provided.

## EASY-OFF TAILGATE

To simplify mounting of a camper unit with an overhang, the tailgate can be removed quickly. If the truck is a 3500 dual rear wheel model, unplug the tailgate wire harness from under the rear of the truck and pull the harness out of the cargo box access hole. Unlatch the tailgate and remove the support cables by releasing the lock tang from the pivot, then rotate and pull away from the box. Once the cables are free, move to the right side of the tailgate hinge bracket.

Raise the right side of the tailgate until the right side pivot clears the hanger bracket. Slide the entire tailgate to the right to free the left side pivot. Remove the tailgate from the vehicle entirely. Do not carry the tailgate loose in the truck pickup box.

158 UNDERSTANDING THE FEATURES OF YOUR VEHICLE

**NOTE:** Dual rear wheel pickup models require properly spaced rear clearance lights. If such a vehicle is operated without a tailgate, suitable lights must be installed.

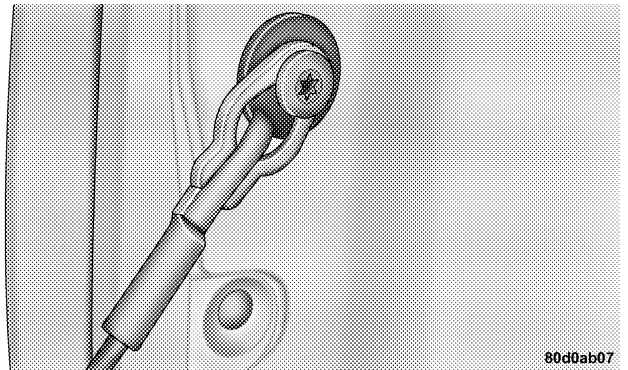
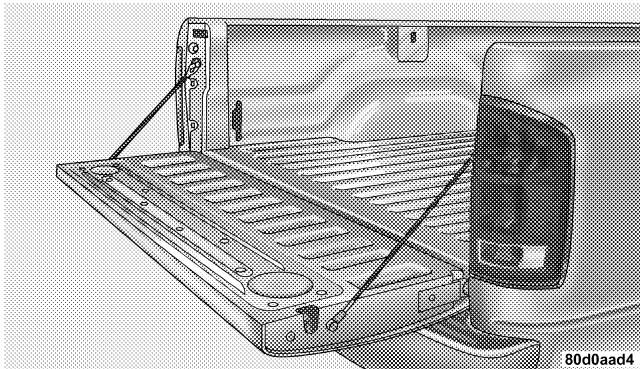

**WARNING!**

To avoid inhaling carbon monoxide, which is deadly, the exhaust system on vehicles equipped with "Cap or Slide-In Campers" should extend beyond the overhanging camper compartment and be free of leaks.

---

## UNDERSTANDING YOUR INSTRUMENT PANEL

### CONTENTS

---

■ Instruments And Controls . . . . .	163	□ Scan Button (Radio Mode) . . . . .	176
■ Instrument Cluster . . . . .	164	□ Cassette Player Features . . . . .	177
■ Instrument Cluster Description . . . . .	165	□ CD Changer Control Capability — If Equipped . . . . .	178
■ Electronic Digital Clock . . . . .	173	■ Sales Code RAZ—AM/ FM Stereo Radio With Cassette Tape Player, CD Player And CD Changer Controls . . . . .	180
□ Clock Setting Procedure . . . . .	173	□ Operating Instructions — Radio . . . . .	180
■ Sales Code RBB—AM/FM Stereo Radio With Cassette Tape Player And CD Changer Capability . . . . .	174	□ Power Switch, Volume Control . . . . .	181
□ Radio Operation . . . . .	174	□ Seek Button (Radio Mode) . . . . .	181
□ Mode Button . . . . .	176		

**160 UNDERSTANDING YOUR INSTRUMENT PANEL**

□ Tuning . . . . .	181	□ Rewind (RW) . . . . .	185
□ Radio Data System (RDS) . . . . .	181	□ Tape Eject . . . . .	186
□ PTY (Program Type) Button . . . . .	181	□ Scan Button . . . . .	186
□ Balance . . . . .	183	□ Changing Tape Direction . . . . .	186
□ Fade . . . . .	183	□ Metal Tape Selection . . . . .	186
□ Tone Control . . . . .	183	□ Pinch Roller Release . . . . .	186
□ AM/FM Selection . . . . .	184	□ Noise Reduction . . . . .	186
□ Scan Button . . . . .	184	□ Operating Instructions — CD Player . . . . .	187
□ To Set The Radio Push-Button Memory . . . . .	184	□ Inserting The Compact Disc . . . . .	187
□ To Change From Clock To Radio Mode . . . . .	185	□ Seek Button . . . . .	188
□ Operating Instructions — Tape Player . . . . .	185	□ EJT CD (Eject) Button . . . . .	188
□ Seek Button . . . . .	185	□ FF/Tune/RW . . . . .	188
□ Fast Forward (FF) . . . . .	185	□ Program Button 4 (Random Play) . . . . .	188

<ul style="list-style-type: none"> <li><input type="checkbox"/> Mode . . . . .189</li> <li><input type="checkbox"/> Tape CD Button . . . . .189</li> <li><input type="checkbox"/> Time Button . . . . .189</li> <li><input type="checkbox"/> Scan Button . . . . .189</li> <li><input type="checkbox"/> CD Changer Control Capability — If Equipped . . . . .189</li> <li>■ Sales Code RBK—AM/ FM Stereo Radio With CD Player And CD Changer Controls . . . . .191             <ul style="list-style-type: none"> <li><input type="checkbox"/> Radio Operation . . . . .191</li> <li><input type="checkbox"/> CD Player Operation . . . . .193</li> <li><input type="checkbox"/> CD Changer Control Capability — If Equipped . . . . .195</li> </ul> </li> <li>■ Sales Code RBQ—AM/FM Stereo Radio With 6 - Disc CD Changer . . . . .197             <ul style="list-style-type: none"> <li><input type="checkbox"/> Radio Operation . . . . .198</li> <li><input type="checkbox"/> CD Player Operation . . . . .200</li> </ul> </li> </ul>	<ul style="list-style-type: none"> <li>■ Remote Sound System Controls — If Equipped . . .205             <ul style="list-style-type: none"> <li><input type="checkbox"/> Radio Operation . . . . .205</li> <li><input type="checkbox"/> Tape Player . . . . .206</li> <li><input type="checkbox"/> CD Player . . . . .206</li> </ul> </li> <li>■ Cassette Tape And Player Maintenance . . . . .206</li> <li>■ Compact Disc Maintenance . . . . .207</li> <li>■ Radio Operation And Cellular Phones . . . . .208</li> <li>■ Climate Controls . . . . .208             <ul style="list-style-type: none"> <li><input type="checkbox"/> Heater Only — Fleet Vehicles . . . . .209</li> <li><input type="checkbox"/> Air Conditioning—If Equipped . . . . .211</li> </ul> </li> </ul>
---	---

**162 UNDERSTANDING YOUR INSTRUMENT PANEL**

---

- Electric Rear Window Defroster And Heated Sideview Mirrors — If Equipped .....214
- Air Conditioning With Dual Zone Temperature Control — If Equipped .....215

- Operating Tips .....219
- Operating Tips Chart .....221

**INSTRUMENTS AND CONTROLS**

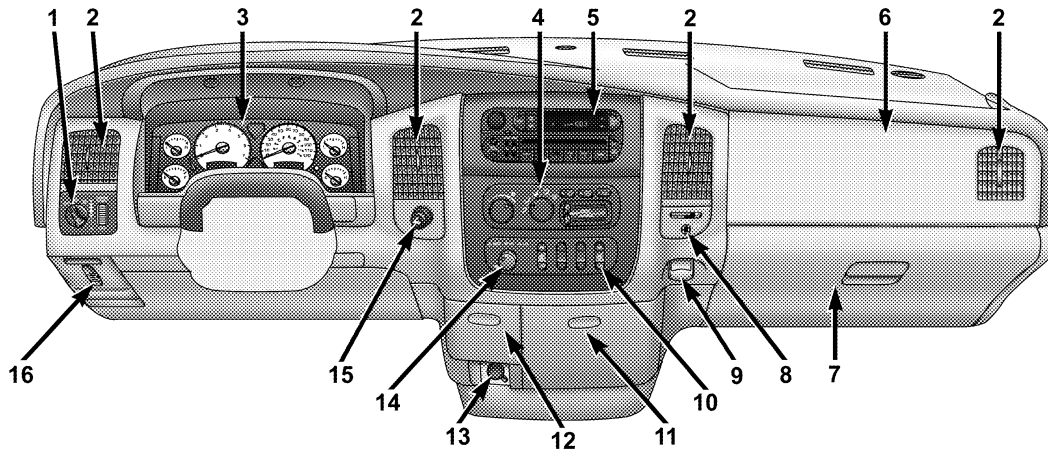

- |                       |   |  |
|-----------------------|---|--|
| 1. Headlight Switch   | 7. Glove Box  | 12. Ash Tray                                   |
| 2. Air Outlets        | 8. Passenger Airbag Disable Switch<br>(Standard Cab Only) | 13. Power Outlet                               |
| 3. Instrument Cluster | 9. Bag Hook   | 14. Transfer Case Control Switch (If Equipped) |
| 4. Climate Control    | 10. Heated Seat Switch (If Equipped)                      | 15. Cigar Lighter                              |
| 5. Radio              | 11. Cup Holders   | 16. Adjustable Pedals Switch (If Equipped)     |
| 6. Airbag             |   |  |

811b556f

**INSTRUMENT CLUSTER**

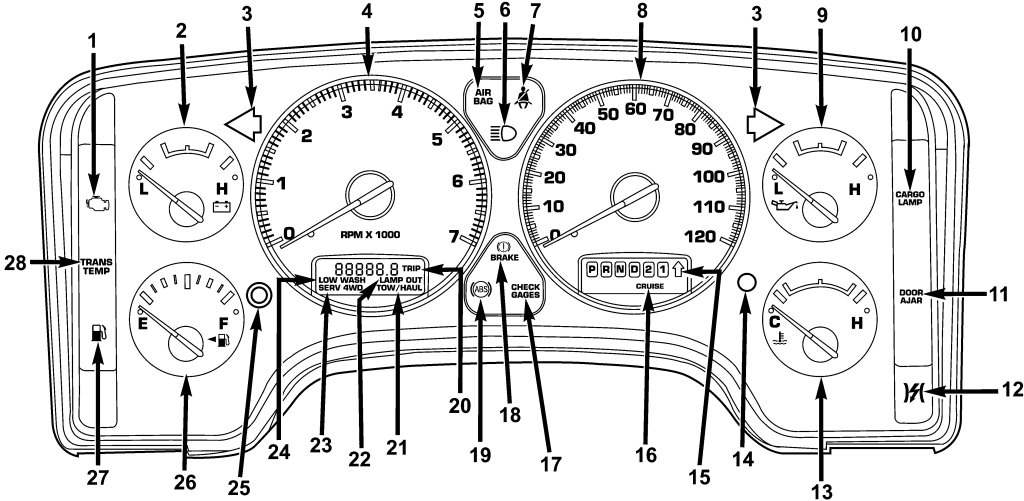



## INSTRUMENT CLUSTER DESCRIPTION

### 1. *Malfunction Indicator Light*



This light is part of an onboard diagnostic system which monitors the emissions and engine control system. If the vehicle is ready for emissions testing the light will come on when the ignition is first turned on and remain on, as a bulb check, until the engine is started. If the vehicle is not ready for emissions testing the light will come on when the ignition is first turned on and remain on for 15 seconds, then blink for 5 seconds, and remain on until the vehicle is started. If the bulb does not come on during starting, have the condition investigated promptly.

If this light comes on and remains on while driving, it suggests a potential engine control problem and the need for system service.

Although your vehicle will usually be drivable and not need towing, see your dealer for service as soon as possible.

### CAUTION!

**Prolonged driving with the MIL on could cause damage to the engine control system. It also could affect fuel economy and driveability.**

**If the MIL is flashing, severe catalytic converter damage and power loss will soon occur. Immediate service is required.**

### 2. Voltage Gauge



When the engine is running, the gauge indicates the electrical system voltage. The pointer should stay within the normal range if the battery is charged. If the pointer moves to either extreme left or right and remains there during normal driving, the electrical system should be serviced.

**NOTE:** If the gauge pointer moves to either extreme of the gauge, the “Check Gages” indicator will illuminate and a single chime will sound.

### 3. Turn Signal Indicators

Lights in instrument cluster flash when outside turn signals are operating.

### 4. Tachometer

The tachometer indicates engine speed in revolutions per minute.

### CAUTION!

**Do not operate the engine with the tachometer pointer at high rpm for extended periods. Engine damage may occur.**

### 5. Airbag Indicator Light

The indicator lights and remains lit for 6 to 8 seconds when the ignition is first turned on. If the light stays on, flickers or comes on while driving, have the airbag system checked by an authorized dealer.

### 6. High Beam Indicator



This indicator shows that headlights are on high beam.

### 7. Seat Belt Reminder Light



When the ignition switch is first turned ON, this light will turn on for 5 to 8 seconds as a bulb check. During the bulb check, if the driver’s seat belt is

unbuckled, a chime will sound. After the bulb check or when driving, if the driver seat belt remains unbuckled, the Seat Belt Warning Light will flash or remain on continuously. Refer to "Enhanced Driver Seat Belt Reminder System (BeltAlert™)" in the Occupant Restraints section for more information. (See page 33 for more information.)

#### 8. Speedometer

The speedometer shows the vehicle speed in miles per hour and/or kilometers per hour.

#### 9. Oil Pressure Gauge

 The pointer should always indicate some oil pressure when the engine is running. A continuous high or low reading, under normal driving conditions, may indicate a lubrication system malfunction. Immediate service should be obtained. (See page 353 for more information.)

**NOTE:** If the gauge pointer moves to either extreme of the gauge, the "Check Gages" indicator will illuminate and a single chime will sound.

#### 10. Cargo Lamp

The Cargo Lamp light will illuminate when the Cargo Lamp is activated from the dimmer control switch, located next to the headlight switch.

#### 11. Door Ajar

**DOOR AJAR** The Door Ajar light will illuminate when any door is opened. When the ignition is ON the Door Ajar light will stay illuminated until the open door is closed. When the ignition is OFF the Door Ajar light will stay illuminated until the open door is closed or the battery saver feature automatically turns the light off.

### 12. *Electronic Throttle Control (ETC) Light 5.7L Engines Only*

 This light informs you of a problem with the Electronic Throttle Control system. If a problem is detected the light will come on while the engine is running. If the light remains lit with the engine running your vehicle will usually be drivable, however, see your dealer for service as soon as possible. If the light is flashing when the engine is running, immediate service is required and you may experience reduced performance, an elevated/rough idle or engine stall and your vehicle may require towing. The light will come on when the ignition is first turned on and remain on briefly as a bulb check. If the light does not come on during starting, have the system checked by an authorized dealer.

### 13. *Temperature Gauge*

 The temperature gauge indicates engine coolant temperature. Any reading within the normal range indicates that the cooling system is operating satisfactorily. The gauge needle will likely indicate a higher temperature when driving in hot weather, up mountain grades, in heavy traffic, or when towing a trailer. If the needle rises to the "H" mark, stop the vehicle, shift into N (Neutral), and increase the engine idle speed for 2 to 3 minutes. If the temperature reading does not return to normal, shut your engine OFF and allow it to cool. Seek authorized service immediately. See Cooling System information in the section on "Maintaining Your Vehicle."

**NOTE:** If the gauge pointer moves to either extreme of the gauge, the "Check Gages" indicator will illuminate and a single chime will sound.

**CAUTION!**

**Do not leave your vehicle unattended with the engine running as you would not be able to react to the temperature indicator if the engine overheats.**

**14. Security**

The light will flash rapidly for approximately 16 seconds when the vehicle theft alarm is arming. The light will flash at a slower rate after the alarm is set. The security light will also come on for about two seconds when the ignition is first turned ON.

**15. Transmission Range Indicator (Automatic Transmissions Only)**

When the gear selector lever is moved, this indicator shows the automatic transmission gear range selected.

**16. Cruise Light**

This indicator lights when the electronic speed control system is turned on.

**17. Check Gages**

**CHECK GAGES** This light illuminates when the Voltmeter, Engine Oil Pressure or Engine Coolant Temperature gages indicate a reading either too high or too low. Examine the gages carefully, and follow the instructions above for each indicated problem.

**NOTE:** When the ignition switch is turned to OFF, the Fuel Gage, Voltmeter, Oil Pressure and Engine Coolant Temperature gages may not show accurate readings. When the engine is not running, turn the ignition switch to ON to obtain accurate readings.

### 18. Brake System Warning Light

This light illuminates when the ignition key is turned to the ON position and remains on for a few seconds. If the light stays on longer, it may be an indication that the parking brake has not been released. This light will illuminate if the brake fluid is low, especially when braking or accelerating hard. This light will illuminate if the ABS indicator light has a malfunction. This light will flash if the engine is running and the parking brake is on. If the light remains on when the parking brake is released, it indicates a possible brake hydraulic system malfunction. In this case, the light will remain on until the cause is corrected.

If brake failure is indicated, immediate repair is necessary and continued operation of the vehicle in this condition is dangerous.

Acceleration which causes the rear wheels to slip for a period of time may result in the red brake light illuminating and a brake switch code being set on ABS equipped vehicles. Depressing the brake pedal should extinguish the red brake light.

### 19. ABS Warning Light

 This light monitors the Anti-Lock Brake System which is described elsewhere in this manual. This light will come on when the ignition key is turned to the ON position and may stay on for five seconds. If the ABS light remains on or comes on during driving, it indicates that the anti-lock portion of the brake system is not functioning and that service is required. See your authorized dealer immediately. The ABS light could also illuminate during loss of traction and remain illuminated until the brake pedal is pressed.

### 20. *Odometer/Trip Odometer*

The odometer shows the total distance the vehicle has been driven.

If the odometer reading is changed during repair or replacement, be sure to keep a record of the reading before and after the service so that the correct mileage can be determined.

The trip odometer shows individual trip mileage. To toggle between the odometer and the trip odometer, press the Odometer/Trip Odometer Button. To reset the Trip Odometer, press and hold the button while in trip mode, until the Trip Odometer resets.

**NOTE:** There is also an engine hour function. This indicates the number of hours the engine has been running. To display the engine hours perform the following: Place the ignition in RUN, but do not start the engine. With the odometer value displayed, hold the trip button down for a period of 6 seconds. The odometer will

change to trip value first, then it will display the engine hour value. The engine hours will be displayed for a period of 30 seconds until the ignition is turned off or the engine is started.

### 21. *TOW/HAUL (Automatic Transmissions Only)*

The TOW/HAUL button is located at the end of the gear shift lever. This light will illuminate when the TOW/HAUL button has been selected. (See page 236 for more information.)

### 22. *LAMP OUT Light*

The LAMP OUT indicator in the instrument cluster alerts the driver if a defective bulb or wiring circuit is detected for most of the exterior lamps - headlamps, turn signal lamps, and stop lamps.

**23. SERV 4WD Indicator**

The 4WD indicator will be illuminated whenever the 4WD mode is engaged for either the manual or electric shift 4WD systems. The SERV 4WD indicator monitors the electric shift 4WD system. If the SERV 4WD light stays on or comes on during driving, it means that the 4WD system is not functioning properly and that service is required.

**24. Low Wash Light**

This light comes on when the washer fluid level falls below approximately 1/4 filled. The light will remain on until fluid is added and one minute has elapsed.

**25. Odometer/Trip Odometer Button**

Press this button to toggle between the odometer and the trip odometer display. Holding the button in resets the trip odometer reading when in trip mode.

**26. Fuel Gauge**

Shows level of fuel in tank when ignition switch is in the ON position.

**27. Low Fuel Warning Light**

Glows when the pointer is between “E” and 1/8 indication mark (approximately 15% of tank volume) on the fuel gauge. When the fuel gauge pointer is on “E” (equivalent to Distance To Empty [DTE] = 0 on the overhead console if so equipped) there is reserve fuel capacity, which corresponds to approximately 8% of tank volume. This reserve capacity was put in place to prevent the likelihood of customers running out of fuel when operating at maximum load conditions in areas where there aren’t many gas stations. (See page 282 for more information.)



*Ram fuel tank volumes are as follows:*

- 26 gallons (98L) - 1500 short box models
- 34 gallons (129L) - 1500/2500/3500 short box models
- 35 gallons (132L) - 1500/2500/3500 long box models

#### 28. *Transmission Oil Temperature Warning Light*

**TRANS  
TEMP**

This light indicates that there is excessive transmission fluid temperature that might occur with severe usage such as trailer towing. If this light comes on, stop the vehicle and run the engine at idle or faster, with the transmission in NEUTRAL until the light goes off.

#### **ELECTRONIC DIGITAL CLOCK**

The clock and radio each use the display panel built into the radio. A digital readout shows the time in hours and minutes whenever the ignition switch is in the "ON" or "ACC" position.

When the ignition switch is in the "OFF" position, or when the radio frequency is being displayed, time keeping is accurately maintained.

#### **Clock Setting Procedure**

1. Turn the ignition switch to the "ON" or "ACC" position. Using the point of a ballpoint pen or similar object, press either the "H" (Hour) or "M" (Minute) buttons on the radio. The display will show the time.
2. Press the "H" button to set hours or the "M" button to set minutes. The time setting will increase each time you press a button.

**SALES CODE RBB—AM/FM STEREO RADIO  
WITH CASSETTE TAPE PLAYER AND CD  
CHANGER CAPABILITY**

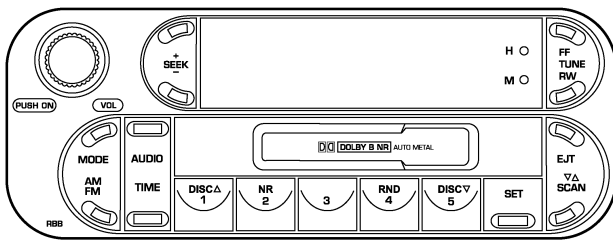

**RBB Radio**

813eb6b2

**Radio Operation**

**Power/Volume Control**

Press the ON/VOL control to turn the radio on. Turn the volume control clockwise to increase the volume.

**NOTE:** Power to operate the radio is supplied through the ignition switch. It must be in the ON or ACC position to operate the radio.

**Electronic Volume Control**

The electronic volume control turns continuously (360 degrees) in either direction without stopping. Turning the volume control to the right increases the volume and to the left decreases it.

When the audio system is turned on, the sound will be set at the same volume level as last played.

For your convenience, the volume can be turned down, but not up, when the audio system is off and the ignition is ON.

**Seek**

Press and release the SEEK button to search for the next station in either the AM or FM mode. Press the top of the button to seek up and the bottom to seek down. The radio will remain tuned to the new station until you make another selection. Holding the button will bypass stations without stopping until you release it.

**Tune**

Press the TUNE control up or down to increase or decrease the frequency. If the button is pushed and held, the radio will continue to tune until the button is released. The frequency will be displayed and continuously updated while the button is pushed.

**To Set The Push-Button Memory**

When you are receiving a station that you wish to commit to push-button memory, press the SET button. The symbol SET 1 will now show in the display window. Select the "1-5" button you wish to lock onto this station

and press and release that button. If a button is not selected within 5 seconds after pressing the SET button, the station will continue to play but will not be locked into push-button memory.

You may add a second station to each push-button by repeating the above procedure with this exception: Press the SET button twice and SET 2 will show in the display window. Each button can be set for SET 1 and SET 2 in both AM and FM. This allows a total of 10 AM and 10 FM stations to be locked into push-button memory. The stations stored in SET 2 memory can be selected by pressing the push-button twice.

Every time a preset button is used a corresponding button number will be displayed.

**Audio**

The audio button controls the BASS, TREBLE, BALANCE, and FADE.

Press the AUDIO button and BASS will be displayed. Press the SEEK + or SEEK - to increase or decrease the Bass tones.

Press the AUDIO button a second time and TREB will be displayed. Press the SEEK + or SEEK - to increase or decrease the Treble tones.

Press the AUDIO button a third time and BAL will be displayed. Press the SEEK + or SEEK - to adjust the sound level from the right or left side speakers.

Press the AUDIO button a fourth time and FADE will be displayed. Press the SEEK + or SEEK - to adjust the sound level between the front and rear speakers.

Press the AUDIO button again or wait 5 seconds to exit setting tone, balance, and fade.

**AM/FM Selection**

Press the AM/FM button to change from AM to FM. The operating mode will be displayed next to the station frequency. The display will show ST when a stereo station is received in the FM mode.

**Mode Button**

Press the MODE button to select between the cassette tape player, CD changer, or the Satellite Radio (if equipped). When the Satellite Radio (if equipped) is selected "SAT" will appear in your radio display.

A CD or tape may remain in the player while in the Satellite or radio mode.

**SCAN Button (Radio Mode)**

Pressing the SCAN button causes the tuner to search for the next listenable station, in either AM, FM or Satellite (if equipped) frequencies, pausing for 5 seconds at each listenable station before continuing to the next. To stop the search, press SCAN a second time.

**Cassette Player Features**

With ignition OFF and the sound system OFF, you can eject the tape cassette by pushing the EJECT button.

You can turn the tape player ON by inserting a cassette or activating the MODE button (with a cassette in the radio), but only when the ignition and radio are on.

Each time a cassette is inserted the tape player will begin playing on the side of the cassette that is facing up in the player.

**Music Search**

Pressing the SEEK button while playing a tape will start the Music Search mode. Press the SEEK button up for the next selection on the tape and down to return to the beginning of the current selection, or return to the beginning of the previous selection if the tape is within the first 5 seconds of the current selection.

The SEEK symbol appears on the display when Music Search is in operation. Music Search shuts off automatically when a selection has been located.

**Selective Music Search**

Press the SEEK button up or down to move the track number to skip forward or backward 1 to 7 selections. Press the SEEK button once to move 1 selection, twice to move 2 selections, etc.

**Fast Forward And Rewind Buttons**

Pressing the TUNE button up or down momentarily activates Fast Forward or Rewind and makes the directional arrows appear on the display.

To stop Fast Forward or Rewind, press the TUNE button again.

**Time Button**

Press the time button to toggle between station frequency and time of day.

**SCAN Button (Cassette Mode)**

Pressing this button while playing a cassette tape will change the side of the tape being played.

**NR (Noise Reduction)**

Pushing the Number 2 Pre-set button when a tape is playing deactivates the Dolby Noise Reduction System\*. When Dolby is ON, the NR symbol appears on the display. Each time a tape is inserted the Dolby will turn ON.

\* "Dolby" noise reduction manufactured under license from Dolby Laboratories Licensing Corporation. Dolby and the double-D symbol are trademarks of Dolby Laboratories Licensing Corporation.

**CD Changer Control Capability — If Equipped**

This radio is compatible with a remote mounted CD changer available through Mopar Accessories. The following instructions are for the radio controls that operate this CD changer.

**Mode Button**

To activate the CD changer, press the MODE button until CD information appears on the display.

**Push-Button**

While the CD changer is playing, press the NUMBER 1 push-button or the NUMBER 5 push-button to select a disc numbered higher or lower than the one currently being played.

**Seek Button**

Press the SEEK up or down to select another track on the same disc. A SEEK symbol will appear on the display.

**Fast Forward And Rewind Buttons**

Press and hold the FF button for fast forward. Press and hold the RW button for fast reverse.

The audio output can be heard when fast forward and fast reverse are activated.

**Random Play (RND)**

Press the Random button to play the tracks on the selected disc in random order for an interesting change of pace.

Random can be cancelled by pressing the button a second time or by ejecting the CD from the changer.

**SCAN Button (CD Mode)**

Press this button to play the first 10 seconds of each track. To stop the scan function, press the button a second time.

**Operating Instructions - Satellite Radio Mode (If Equipped)**

Refer to the Satellite Radio section of the Owner's Manual.

**CD Diagnostic Indicators**

When driving over a very rough road, the CD player may skip momentarily. Skipping will not damage the disc or the player, and play will resume automatically.

As a safeguard and to protect your CD player, one of the following warning symbols may appear on your display.

A CD HOT symbol indicates the player is too hot.

CD HOT will pause the operation. Play can be resumed when the operating temperature is corrected or another MODE is selected.

An ERR symbol will appear on the display if the laser is unable to read the Disc data for the following reasons:

- Excessive vibration
- Disc inserted upside down
- Damaged disc
- Water condensation on optics

**SALES CODE RAZ—AM/ FM STEREO RADIO WITH CASSETTE TAPE PLAYER, CD PLAYER AND CD CHANGER CONTROLS**

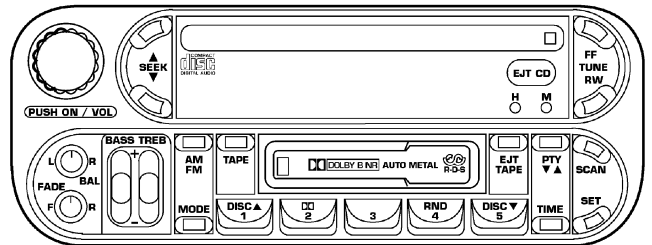

80ef1609

**RAZ Radio**

**Operating Instructions — Radio**

**NOTE:** Power to operate the radio is controlled by the ignition switch. It must be in the ON or ACC position to operate the radio.



**Power Switch, Volume Control**

Press the ON/VOL control to turn the radio on. Turn the volume control clockwise to increase the volume. The volume will be displayed and continuously updated while the button is pressed.

**Seek Button (Radio Mode)**

Press and release the Seek button to search for the next station in either the AM or FM mode. Press the top of the button to seek up and the bottom to seek down. Holding the button will by pass stations until you release the button.

**Tuning**

Press the TUNE control up or down to increase or decrease the frequency. If you press and hold the button, the radio will continue to tune until you release the button. The frequency will be displayed and continuously updated while the button is pressed.

**Radio Data System (RDS)**

The Radio Data System allows radio broadcasting stations to send data signals on a subcarrier frequency which is added to the stereo signal. RDS was developed to give FM receivers user-friendly features, such as Program Service name (PS) and Program Type (PTY). Program Service name is typically used by the broadcaster to display the station's name or call letters, for example "WNIC". Typically these are 8 characters in length and are displayed by the radio for those stations which are broadcasting this information. PTY (Program Type) is used to characterize the station's program material, for example "Rock Music".

**PTY (Program Type) Button**

Pressing this button once will turn on the PTY mode for 5 seconds. If no action is taken during the 5 second time out the PTY icon will turn off. Pressing the PTY button

**182 UNDERSTANDING YOUR INSTRUMENT PANEL**

within 5 seconds will allow the program format type to be selected. Many radio stations do not currently broadcast PTY information.

Toggle the PTY button to select the following format types:

<b>Program Type</b>	<b>Radio Display</b>
Adult Hits	Adlt Hit
Classical	Classicl
Classic Rock	Cls Rock
College	College
Country	Country
Information	Inform
Jazz	Jazz
Foreign Language	Language
News	News
Nostalgia	Nostalga

<b>Program Type</b>	<b>Radio Display</b>
Oldies	Oldies
Personality	Persnlty
Public	Public
Rhythm and Blues	R & B
Religious Music	Rel Musc
Religious Talk	Rel Talk
Rock	Rock
Soft	Soft
Soft Rock	Soft Rck
Soft Rhythm and Blues	Soft R&B
Sports	Sports
Talk	Talk
Top 40	Top 40
Weather	Weather

By pressing the SEEK button when the PTY icon is displayed, the radio will be tuned to the next frequency station with the same selected PTY name. The PTY function only operates when in the FM mode.

The radio display will flash "SEEK" and the selected PTY program type when searching for the next PTY station. If no station is found with the selected PTY program type, the radio will return to the last preset station.

If a preset button is activated while in the PTY (Program Type) mode, the PTY mode will be exited and the radio will tune to the preset station.

Pressing PTY, then SCAN will scan the FM Band and stop at all RDS stations. Each RDS station will be played for a 5 second scan once around the FM Band and stop at the last station. The PTY icon will then turn off.

### **Balance**

The Balance control adjusts the left-to-right speaker balance. Push in the button and it will pop out. Adjust the balance and push the button back in. The balance will be displayed and continuously updated while the button is turned.

### **Fade**

The Fade control provides for balance between the front and rear speakers. Push in the button and it will pop out. Adjust the balance and push the button back in. The fade will be displayed and continuously updated while the button is turned.

### **Tone Control**

Slide the Bass and/or Treble controls up or down to adjust the sound for the desired tone. The treble, and bass will be displayed and continuously updated while the slide is moved.

**AM/FM Selection**

Press the AM/FM button to change from AM to FM. The operating mode will be displayed next to the station frequency. The display will show ST when a stereo station is received.

**Scan Button**

Pressing the SCAN button causes the tuner to search for the next station, in either AM or FM, pausing for 5 seconds at each listenable station before continuing to the next.

Pressing the AM/FM button continues the search in the alternate frequency band.

To stop the search, press SCAN a second time.

**To Set The Radio Push-button Memory**

When you are receiving a station that you wish to commit to push-button memory, press the SET button. SET 1 will show in the display window. Select the push-button you wish to lock onto this station and press and release that button. If a station is not selected within 5 seconds after pressing the SET button, the station will continue to play but will not be locked into push-button memory.

You may add a second station to each push-button by repeating the above procedure with this exception: Press the SET button twice and SET 2 will show in the display window. Each button can be set for SET 1 and SET 2 in both AM and FM. This allows a total of 10 AM and 10 FM stations to be locked into memory. You can recall the stations stored in SET 2 memory by pressing the push-button twice.

**To Change From Clock To Radio Mode**

Press the Time button to change the display between radio frequency and time.

**Operating Instructions — Tape Player**

Insert the cassette with the exposed tape side toward the right and the mechanical action of the player will gently pull the cassette into the play position.

**NOTE:** When subjected to extremely cold temperatures, the tape mechanism may require a few minutes to warm up for proper operation. Sometimes poor playback may be experienced due to a defective cassette tape. Clean and demagnetize the tape heads at least twice a year.

**Seek Button**

Press the SEEK button up for the next selection on the tape and down to return to the beginning of the current selection.

Press the SEEK button up or down to move the track number to skip forward or backward 1 to 6 selections. Press the SEEK button once to move 1 selection, twice to move 2 selections, etc.

**Fast Forward (FF)**

Press the FF button up momentarily to advance the tape in the direction that it is playing. The tape will advance until the button is pressed again or the end of the tape is reached. At the end of the tape, the tape will play in the opposite direction.

**Rewind (RW)**

Press the RW button momentarily to reverse the tape direction. The tape will reverse until the button is pressed again or until the end of the tape is reached. At the end of the tape, the tape will play in the opposite direction.

**Tape Eject**

Press the EJT Tape button and the cassette will disengage and eject from the radio.

**Scan Button**

Press this button to play 10 seconds of each selection. Press the scan button a second time to cancel the feature.

**Changing Tape Direction**

If you wish to change the direction of tape travel (side being played), press the PTY button. The lighted arrow in the display window will show the new direction.

**Metal Tape Selection**

If a standard metal tape is inserted into the player, the player will automatically select the correct equalization and the 70 symbol will appear in the display window.

**Pinch Roller Release**

If ignition power or the radio ON/OFF switch are turned off, the pinch roller will automatically retract to protect the tape from any damage. When power is restored to the tape player, the pinch roller will automatically reengage and the tape will resume play.

**Noise Reduction**

The Dolby Noise Reduction System\* is on whenever the tape player is on, but may be switched off.

To turn off the Dolby Noise reduction System: Press the Dolby button (button 2) after you insert the tape. The NR light in the display will go off when the Dolby System is off. The Dolby System is automatically reactivated each time a tape is inserted.

\* "Dolby" noise reduction manufactured under license from Dolby Laboratories Licensing Corporation. Dolby and the double-D symbol are trademarks of Dolby Laboratories Licensing Corporation.

**Operating Instructions — CD Player**

**NOTE:** The ignition switch must be in the ON or ACC position and the volume control ON before the CD player will operate.

**CAUTION!**

This CD player will accept 4 ¾ inch (12 cm) discs only. The use of other sized discs may damage the CD player mechanism.

**Inserting The Compact Disc**

The CD player contained within the radio is not a multi-disc changer, and will only accept one CD. Gently insert one CD into the CD player with the CD label facing up. The CD will automatically be pulled into the CD Player.

If the volume control is ON, the unit will switch from radio to CD mode and begin to play. The display will show the track number and index time in minutes and seconds. Play will begin at the start of track one.

**NOTE:**

- You may eject a disc with the radio OFF. The ignition switch must be in the ON or ACC position to insert a disc with the radio OFF.
- If you insert a disc with the ignition ON and the radio OFF, the CD will automatically be pulled into the CD Player and the display will show the time of day. If you insert a disc with the ignition OFF, the display will show the time of day for about 5 seconds, then go out.

**Seek Button**

Press the top of the SEEK button for the next selection on the CD. Press the bottom of the button to return to the beginning of the current selection, or return to the beginning of the previous selection if the CD is within the first 10 seconds of the current selection.

**EJT CD (Eject) Button**

Press this button and the disc will unload and move to the entrance for easy removal. The unit will switch to the radio mode.

If you do not remove the disc within 15 seconds, it will be reloaded. The radio mode will continue to appear.

The disc can be ejected with the radio OFF.

**FF/TUNE/RW**

Press FF (Fast Forward) and the CD player will begin to fast forward until FF is released. The RW (Reverse) button works in a similar manner.

**Program Button 4 (Random Play)**

Press this button while the CD is playing to activate Random Play. This feature plays the tracks on the selected disc in random order to provide an interesting change of pace.

Press the SEEK button to move to the next randomly selected track.

Press TUNE FF to fast forward through the tracks. Press the FF button a second time to stop the fast forward feature. If TUNE RW is pressed, the current track will reverse to the beginning of the track and begin playing.

Press button 4 a second time to stop Random Play.



**MODE**

Press the MODE button to select between the tape player, CD player, or satellite radio (if equipped).

To select Satellite Radio (if equipped), press the MODE button until the word SIRIUS appears. The following will be displayed in this order: After three seconds, the current channel name and number will be displayed for five seconds. The current program type and channel number will then be displayed for five seconds. The current channel name and number will then be displayed until an action occurs. A CD or tape may remain in the player while in the Satellite Radio mode.

**Tape CD Button**

Press this button to select between CD player and Tape player.

**Time Button**

Press this button to change the display from elapsed CD playing time to time of day.

**Scan Button**

Press this button to play the first 10 seconds of each track. To stop the scan function, press the button a second time.

**CD Changer Control Capability — If Equipped**

This radio is compatible with a remote mounted CD changer available through Mopar Accessories. The following instructions are for the radio controls that operate this CD changer.

**Mode Button**

To activate the CD changer, press the MODE button until CD information appears on the display.

**Disc Up/Program Button 1**

Press the DISC up (button 1) button to play the next available disc.

**Disc Down/Program Button 5**

Press the DISC down (button 5) button to play the previous disc.

**Seek Button**

Press the SEEK up or down to select another track on the same disc. A SEEK symbol will appear on the display.

**Fast Forward And Rewind Buttons**

Press and hold the FF button for fast forward. Press and hold the RW button for fast reverse.

The audio output can be heard when fast forward and fast reverse are activated.

**Random Play (RND)**

Press the Random button to play the tracks on the selected disc in random order for an interesting change of pace.

Random can be cancelled by pressing the button a second time or by ejecting the CD from the changer.

**CD Diagnostic Indicators**

When driving over a very rough road, the CD player may skip momentarily. Skipping will not damage the disc or the player, and play will resume automatically.

As a safeguard and to protect your CD player, one of the following warning symbols may appear on your display.

A CD HOT symbol indicates the player is too hot.

CD HOT will pause the operation. Play can be resumed when the operating temperature is corrected or another MODE is selected.

An ERR symbol will appear on the display if the laser is unable to read the Disc data for the following reasons:

- Excessive vibration
- Disc inserted upside down
- Damaged disc
- Water condensation on optics

**SALES CODE RBK—AM/ FM STEREO RADIO WITH CD PLAYER AND CD CHANGER CONTROLS**

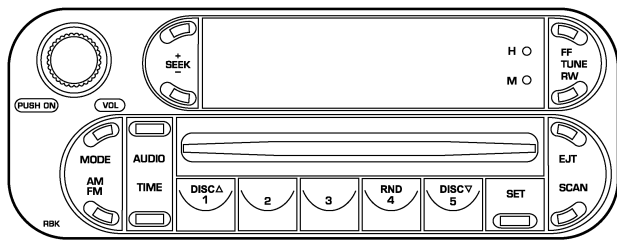

813ebac3

**RBK Radio**

**Radio Operation**

**Power/Volume Control**

Press the ON/VOL control to turn the radio on. Turn the volume control clockwise to increase the volume.

**NOTE:** Power to operate the radio is supplied through the ignition switch. It must be in the ON or ACC position to operate the radio.

**Seek**

Press and release the SEEK button to search for the next station in either the AM or FM mode. Press the top of the button to seek up or the bottom to seek down. The radio will remain tuned to the new station until you make another selection. Holding the button in will bypass stations without stopping until you release it.

**Tune**

Press the TUNE control up or down to increase or decrease the frequency. If you press and hold the button, the radio will continue to tune until you release the button. The frequency will be displayed and continuously updated while the button is pressed.

**To Set The Radio Push-Button Memory**

When you are receiving a station that you wish to commit to push-button memory, press the SET button. SET 1 will show in the display window. Select the "1-5" button you wish to lock onto this station and press and release that button. If a button is not selected within 5 seconds after pressing the SET button, the station will continue to play but will not be locked into push-button memory.

You may add a second station to each push-button by repeating the above procedure with this exception: Press the SET button twice and SET 2 will show in the display

window. Each button can be set for SET 1 and SET 2 in both AM and FM. This allows a total of 10 AM and 10 FM stations to be locked into push-button memory. The stations stored in SET 2 memory can be selected by pressing the push-button twice. Every time a preset button is used a corresponding button number will be displayed.

**Audio**

The audio button controls the BASS, TREBLE, BALANCE, and FADE.

Press the AUDIO button and BASS will be displayed. Press the SEEK + or SEEK - to increase or decrease the Bass tones.

Press the AUDIO button a second time and TREB will be displayed. Press the SEEK + or SEEK - to increase or decrease the Treble tones.

Press the AUDIO button a third time and BAL will be displayed. Press the SEEK + or SEEK – to adjust the sound level from the right or left side speakers.

Press the AUDIO button a fourth time and FADE will be displayed. Press the SEEK + or SEEK – to adjust the sound level between the front and rear speakers.

Press the AUDIO button again or wait 5 seconds to exit setting tone, balance, and fade.

#### **AM/FM Selection**

Press the AM/FM button to change from AM to FM. The operating mode will be displayed next to the station frequency. The display will show ST when a stereo station is received.

#### **Time**

Press the TIME button to change the display between radio frequency and time.

#### **General Information**

This radio complies with Part 15 of FCC rules and with RSS-210 of Industry Canada. Operation is subject to the following conditions:

1. This device may not cause harmful interference,
2. This device must accept any interference received, including interference that may cause undesired operation.

**NOTE:** Changes or modifications not expressly approved by the party responsible for compliance could void the user's authority to operate the equipment.

#### **CD Player Operation**

**NOTE:** The ignition switch must be in the ON or ACC position and the volume control ON before the CD player will operate.

### Inserting The Compact Disc

**CAUTION!**

This CD player will accept 4 ¾ inch (12 cm) discs only. The use of other sized discs may damage the CD player mechanism.

You may either insert or eject a disc with the radio OFF.

If you insert a disc with the ignition ON and the radio OFF, the display will show the time of day.

If the power is ON, the unit will switch from radio to CD mode and begin to play when you insert the disc. The display will show the track number and index time in minutes and seconds. Play will begin at the start of track one.

**Seek**

Press the top of the SEEK button for the next selection on the CD. Press the bottom of the button to return to the beginning of the current selection, or return to the beginning of the previous selection if the CD is within the first second of the current selection.

**EJT — Eject**

Press the EJT button and the disc will unload and move to the entrance for easy removal. The unit will switch to the radio mode.

If you do not remove the disc within 15 seconds, it will be reloaded. The unit will continue in radio mode.

The disc can be ejected with the radio and ignition OFF (except on convertibles).

**FF/TUNE/RW**

Press FF (Fast Forward) and the CD player will begin to fast forward until FF is released. The RW (Reverse) button works in a similar manner.

**Random Play — RND/Program Button 4**

Press the RND (button 4) button while the CD is playing to activate Random Play. This feature plays the tracks on the selected disc in random order to provide an interesting change of pace.

Press the SEEK button to move to the next randomly selected track.

Press the RND (button 4) button a second time to stop Random Play.

**Mode**

Press the MODE button repeatedly to select between the CD player, the optional remote CD changer and the

Satellite Radio (if equipped). When Satellite Radio (if equipped) is selected “SAT” will appear in your radio display.

A CD or tape may remain in the player while in the Satellite mode.

**Time**

Press the TIME button to change the display from elapsed CD playing time to time of day.

**CD Changer Control Capability — If Equipped**

This radio is compatible with a remote mounted CD changer available through Mopar Accessories. The following instructions are for the radio controls that operate this CD changer.

**Mode Button**

To activate the CD changer, press the MODE button until CD information appears on the display.

**Disc Up/Program Button 1**

Press the DISC up (button 1) button to play the next available disc.

**Disc Down/Program Button 5**

Press the DISC down (button 5) button to play the previous disc.

**Seek Button**

Press the SEEK up or down to select another track on the same disc. A SEEK symbol will appear on the display.

**Fast Forward And Rewind Buttons**

Press and hold the FF button for fast forward. Press and hold the RW button for fast reverse.

The audio output can be heard when fast forward and fast reverse are activated.

**Random Play (RND)**

Press the Random button to play the tracks on the selected disc in random order for an interesting change of pace.

Random can be cancelled by pressing the button a second time or by ejecting the CD from the changer.

**Operating Instructions - Satellite Radio Mode (If Equipped)**

Refer to the Satellite Radio section of the Owner's Manual.

**CD Diagnostic Indicators**

When driving over a very rough road, the CD player may skip momentarily. Skipping will not damage the disc or the player, and play will resume automatically.

As a safeguard and to protect your CD player, one of the following warning symbols may appear on your display.

A CD HOT symbol indicates the player is too hot.



CD HOT will pause the operation. Play can be resumed when the operating temperature is corrected or another MODE is selected.

An ERR symbol will appear on the display if the laser is unable to read the Disc data for the following reasons:

- Excessive vibration
- Disc inserted upside down
- Damaged disc
- Water condensation on optics

**SALES CODE RBQ—AM/FM STEREO RADIO WITH 6 - DISC CD CHANGER**

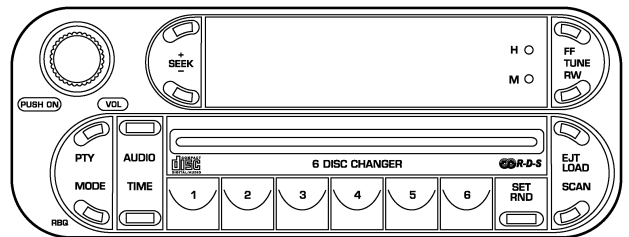

813ebacd

**RBQ Radio**

## Radio Operation

### Power/Volume Control

Press the PWR/VOL control to turn the radio on. Turn the volume control clockwise to increase the volume.

**NOTE:** Power to operate the radio is controlled by the ignition switch. It must be in the ON or ACC position to operate the radio.

### Mode

Press the MODE button repeatedly to select between AM, FM, the CD changer and Sirius Satellite Radio™ (if equipped). The display will show ST when a stereo station is received.

To select Sirius Satellite Radio™ (if equipped), press the MODE button until the word SIRIUS appears. The following will be displayed in this order: After three seconds, the current channel name and number will be displayed for five seconds. The current program type and

channel number will then be displayed for five seconds. The current channel name and number will then be displayed until an action occurs. CD's may remain in the player while in the Satellite Radio mode.

### Seek

Press and release the SEEK button to search for the next station in either the AM or FM mode. Press the top of the button to seek up and the bottom to seek down. The radio will remain tuned to the new station until you make another selection. Holding the button in will bypass stations without stopping until you release it.

### Tune

Press the TUNE control up or down to increase or decrease the frequency. If the button is pressed and held, the radio will continue to tune until the button is released. The frequency will be displayed and continuously updated while the button is pressed.

### To Set The Radio Push-Button Memory

When you are receiving a station that you wish to commit to push-button memory, press the SET RND button. SET 1 will show in the display window. Select the “1–6” button you wish to lock onto this station and press and release that button. If a button is not selected within 5 seconds after pressing the SET RND button, the station will continue to play but will not be locked into push-button memory.

You may add a second station to each push-button by repeating the above procedure with this exception: Press the SET button twice and SET 2 will show in the display window. Each button can be set for SET 1 and SET 2 in both AM and FM. This allows a total of 12 AM and 12 FM stations to be locked into push-button memory. The stations stored in SET 2 memory can be selected by pressing the corresponding push-button twice. Every time a preset button is used, a corresponding button number will be displayed.

### Audio

The audio button controls the BASS, TREBLE, BALANCE, and FADE.

Press the AUDIO button and BASS will be displayed. Press the SEEK + or SEEK – to increase or decrease the Bass tones.

Press the AUDIO button a second time and TREB will be displayed. Press the SEEK + or SEEK – to increase or decrease the Treble tones.

Press the AUDIO button a third time and BAL will be displayed. Press the SEEK + or SEEK – to adjust the sound level from the right or left side speakers.

Press the AUDIO button a fourth time and FADE will be displayed. Press the SEEK + or SEEK – to adjust the sound level between the front and rear speakers.

Press the AUDIO button again or wait 5 seconds to exit setting tone, balance, and fade.

**Time Button**

Press the TIME button to change the display between radio frequency and time.

**General Information**

This radio complies with Part 15 of FCC rules and with RSS-210 of Industry Canada. Operation is subject to the following conditions:

1. This device may not cause harmful interference,
2. This device must accept any interference received, including interference that may cause undesired operation.

**NOTE:** Changes or modifications not expressly approved by the party responsible for compliance could void the user's authority to operate the equipment.

**CD Player Operation**

**NOTE:** The ignition switch must be in the ON or ACC position and the Power / Volume control pushed ON before the CD player will operate.

**Inserting The Compact Disc**

<b>CAUTION!</b>
<b>This CD player will accept 4 ¾ inch (12 cm) discs only. The use of other sized discs may damage the CD player mechanism.</b>

You may either insert or eject a disc with the radio OFF. If you insert a disc with the ignition ON and the radio OFF, the display will show the time of day. If you insert a disc with the ignition OFF, the display will show the time of day for about 5 seconds, then go out.

If you insert a disc with the ignition ON and the radio ON, the unit will switch from radio to CD mode and begin to play when you insert the disc. The display will show the disc number, the track number, and index time in minutes and seconds. Play will begin at the start of track 1.

**LOAD/ EJT — Load**

Press the LOAD/ EJT button and the button with the corresponding number where the CD is being loaded. After the radio displays "load" insert the CD into the player.

Radio display will show "loading" when it is being loaded.

**LOAD / EJT — Eject**

Press the LOAD/ EJT button and the button with the corresponding number where the CD was loaded and the disc will unload and move to the entrance for easy removal.

Radio display will show "ejecting" when it is being ejected.

If you have ejected a disc and have not removed it within 15 seconds, it will be reloaded. If the CD is not removed, the radio will continue to play the non-removed CD. If the CD is removed and there are other CD's in the radio, the radio will play the next CD. If the CD is removed and there are no other CD's in the radio, the radio will return to the last selected AM or FM mode.

The disc can be ejected with the radio and ignition OFF.

**Seek**

Press the top of the SEEK button for the next selection on the CD. Press the bottom of the button to return to the beginning of the current selection, or return to the beginning of the previous selection if the CD is within the first second of the current selection.

**Scan**

Press the Scan button to scan through each track on the CD currently playing.

**FF/TUNE/RW**

Press FF (Fast Forward) and the CD player will begin to fast forward until FF is released. The RW (Reverse) button works in a similar manner.

**Random Play — SET / RND**

Press the RND button while the CD is playing to activate Random Play. This feature plays the tracks on the disc in random order to provide an interesting change of pace.

Press the SEEK button to move to the next randomly selected track.

Press the SET / RND button a second time to stop Random Play.

**PTY (Program Type) Button**

Pressing this button once will turn on the PTY mode for 5 seconds. If no action is taken during the 5 second time out the PTY icon will turn off. Pressing the PTY button repeatedly within 5 seconds will allow the program format type to be selected. Many radio stations do not currently broadcast PTY information.

Toggle the PTY button to select the following format types:

Program Type	Radio Display
Adult Hits	Adlt Hit
Classical	Classicl
Classic Rock	Cls Rock
College	College
Country	Country
Emergency	ALERT!
Emergency Test	Test
Information	Inform
Jazz	Jazz

Program Type	Radio Display
Foreign Language	Language
News	News
Nostalgia	Nostalga
Oldies	Oldies
Personality	Persnlty
Public	Public
Rhythm and Blues	R & B
Religious Music	Rel Musc
Religious Talk	Rel Talk
Rock	Rock
Soft	Soft
Soft Rock	Soft Rck
Soft Rhythm and Blues	Soft R&B
Sports	Sports
Talk	Talk
Top 40	Top 40
Weather	Weather

By pressing the SEEK button when the PTY icon is displayed, the radio will be tuned to the next frequency station with the same selected PTY name. The PTY function only operates when in the FM mode.

The radio display will flash "SEEK" and the selected PTY program type when searching for the next PTY station. If no station is found with the selected PTY program type, the radio will return to the last station.

If a preset button is activated while in the PTY (Program Type) mode, the PTY mode will be exited and the radio will tune to the preset station.

By pressing the SCAN button when the PTY icon is displayed, the radio will stop at every PTY station on the band and list each corresponding program type in the radio display.

**Time**

Press the TIME button to change the display from elapsed CD playing time to time of day.

**Operating Instructions - Satellite Radio Mode (If Equipped)**

Refer to the Satellite Radio section of the Owner's Manual.

**CD Diagnostic Indicators**

When driving over a very rough road, the CD player may skip momentarily. Skipping will not damage the disc or the player, and play will resume automatically.

As a safeguard and to protect your CD player, one of the following warning symbols may appear on your display.

A CD HOT symbol indicates the player is too hot.

CD HOT will pause the operation. Play can be resumed when the operating temperature is corrected or another MODE is selected.

CD ERROR will appear on the display if the laser is unable to read the Disc data for the following reasons:

- Warped disc
- Excessive vibration
- Disc inserted upside down
- Damaged disc
- Water condensation on optics



### REMOTE SOUND SYSTEM CONTROLS — IF EQUIPPED

The remote sound system controls are located on the rear surface of the steering wheel. Reach behind the wheel to access the switches.

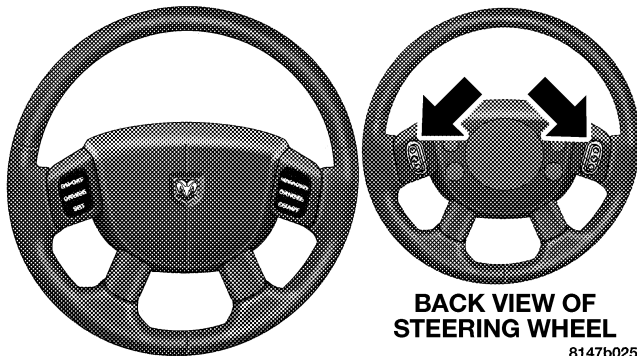

The right hand control is a rocker type switch with a button in the center. Pressing the top of the switch will

increase the volume and pressing the bottom of the switch will decrease the volume. The center button of the right hand control will allow you to change the mode.

The left hand control is a rocker type switch with a push button in the center. The function of the left hand control is different depending on which mode you are in.

The following describes the left hand control operation in each mode.

#### Radio Operation

Pressing the top of the left side switch will SEEK up for the next listenable station and pressing the bottom of the switch will SEEK down for the next listenable station.

The button located in the center of the left hand control will tune to the next pre-set station that you have programmed in the radio pre-set push-buttons.

**Tape Player**

Pressing the top of the switch once will go to the next selection on the cassette. Pressing the bottom of the switch once will go to the beginning of the current selection or to the beginning of the previous selection if it is within the first 5 seconds of the current selection.

If you press the switch up or down twice it plays the second selection, three times, it will play the third, etc.

The button in the center of the left hand switch has no function in this mode.

**CD Player**

Pressing the top of the switch once will go to the next track on the CD. Pressing the bottom of the switch once will go to the beginning of the current track or to the beginning of the previous track if it is within one second after the current track begins to play.

If you press the switch up or down twice it plays the second track, three times, it will play the third, etc.

The button in the center of the left hand switch has no function in this mode.

**CASSETTE TAPE AND PLAYER MAINTENANCE**

To keep the cassette tapes and player in good condition, take the following precautions:

1. Do not use cassette tapes longer than C-90; otherwise, sound quality and tape durability will be greatly diminished.
2. Keep the cassette tape in its case to protect from slackness and dust when it is not in use.
3. Keep the cassette tape away from direct sunlight, heat and magnetic fields such as the radio speakers.

4. Before inserting a tape, make sure that the label is adhering flatly to the cassette.
5. A loose tape should be corrected before use. To rewind a loose tape, insert the eraser end of a pencil into the tape drive gear and twist the pencil in the required directions.

Maintain your cassette tape player. The head and capstan shaft in the cassette player can pick up dirt or tape deposits each time a cassette is played. The result of deposits on the capstan shaft may cause the tape to wrap around and become lodged in the tape transport. The other adverse condition is low or "muddy" sound from one or both channels, as if the treble tone control were turned all the way down. To prevent this, you should periodically clean the head with a commercially available WET cleaning cassette.

As preventive maintenance, clean the head about every 30 hours of use. If you wait until the head becomes very

dirty (noticeably poor sound), it may not be possible to remove all deposits with a simple WET cleaning cassette.

#### **COMPACT DISC MAINTENANCE**

To keep the compact discs in good condition, take the following precautions:

1. Handle the disc by its edge; avoid touching the surface.
2. If the disc is stained, clean the surface with a soft cloth, wiping from center to edge.
3. Do not apply paper or tape to the disc; avoid scratching the disc.
4. Do not use solvents such as benzene, thinner, cleaners, or antistatic sprays.
5. Store the disc in its case after playing.
6. Do not expose the disc to direct sunlight.

7. Do not store the disc where temperatures may become too high.

**NOTE:** If you experience difficulty in playing a particular disc, it may be damaged, oversized, or have theft protection encoding. Try a known good disc before considering disc player service.

#### **RADIO OPERATION AND CELLULAR PHONES**

Under certain conditions, the operation of a cellular phone in your vehicle can cause erratic or noisy performance from your radio. This condition may be lessened or eliminated by relocating the cellular phone antenna. This condition is not harmful to the radio. If your radio performance does not satisfactorily “clear” by the repositioning of the antenna, it is recommended that the radio volume be turned down or off during cellular phone operation.

#### **CLIMATE CONTROLS**

The controls for the heating and ventilation system in this vehicle consist of a series of rotary knobs. These comfort controls can be set to obtain desired interior conditions.

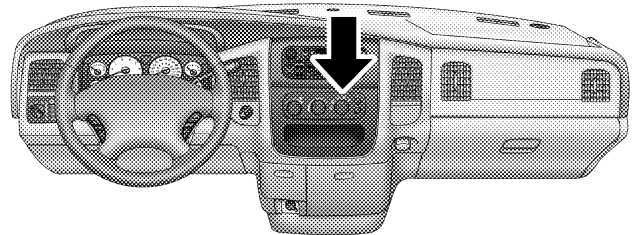

80d0b313

**Heater Only — Fleet Vehicles**



811b8605



811b8660

The mode control (at the right of the control panel) can be set in any of the following positions:

**NOTE:** To improve your selection choices, the system allows you to operate at intermediate positions between the major modes. These intermediate positions are identified by the small dots.

**Panel**

 Outside air flows through the outlets located in the instrument panel.

**Recirculation Modes (Panel or Bi-Level )**

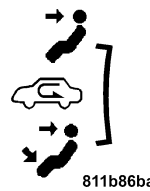

811b86ba

Select the recirculation modes when the outside air contains smoke or odors. This feature allows for recirculation of interior air only. Air flows through the panel outlets in this mode. Air flows through the panel only or through both the panel and floor vents depending on the selected mode (panel vs bi-level).

**Bi-Level**

 Outside air flows through the outlets located in the instrument panel and at the floor.

**Mix**

 Outside air flows in equal proportions through the floor and defroster outlets.

**Defrost**

 Outside air is primarily directed to the windshield through the defroster outlets located at the base of the windshield, and the demister outlets located at the edge of each side of the instrument panel.

**Blower Control**

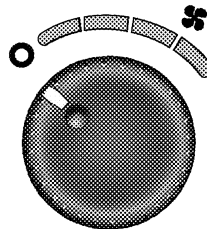

80a01359

The rotary knob on the left of the control panel is the blower control. Turn the knob clockwise to one of the four positions to obtain the blower speed you desire. To turn the blower off, turn the knob to the far left position.

**Temperature Control**

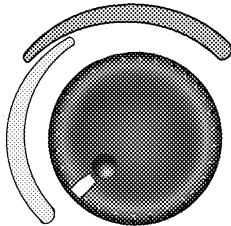

80a0135a

The rotary knob at the center of the control panel controls the temperature of the interior air. You can choose your degree of comfort by rotating the knob. The coldest temperature setting is to the extreme left (blue region) and the warmest setting is to the extreme right (red region) of the rotation.

**Air Conditioning—If Equipped**



4

811b8638

**Air Conditioning Operation**



To turn on the Air Conditioning, set the fan control at any speed and press the snowflake button located at the right of the control panel. Conditioned air will be directed through the outlets selected by the mode control. A light in the

snowflake button shows that the air conditioning is on. Press the button a second time to turn the air conditioning off.

Slight changes in engine speed or power may be noticed when the air conditioning compressor is on. This is a normal occurrence as the compressor will cycle on and off to maintain comfort and increase fuel economy.



The mode control (at the right of the control panel) can be set in any of the following positions:

**NOTE:** To improve your selection choices, the system allows you to operate at intermediate positions between the major modes. These intermediate positions are identified by the small dots.

**Recirculation Modes (Panel or Bi-Level )**

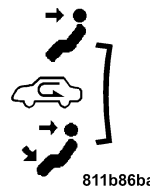

Select the recirculation modes when the outside air contains smoke, odors, high humidity, or if rapid cooling is desired. This feature allows for recirculation of interior air only. Air flows through the panel only or through both the panel and floor vents depend-

ing on the selected mode (panel vs bi-level).

**NOTE:** Selecting a “Recirculation Mode” mode does not necessarily consume more fuel than normal A/C mode.

**Panel**

Outside air flows through the outlets located in the instrument panel.

**Bi-Level**

Outside air flows through the outlets located in the instrument panel and at the floor.



**Floor**

 Outside air flows primarily through the floor outlets located under the instrument panel.

**Mix**

 Outside air flows in equal proportions through the floor and defroster outlets, and the air conditioning may be on.

**Defrost**

 Outside air is primarily directed to the windshield through the defroster outlets located at the base of the windshield, and the demister outlets located at the edge of each side of the instrument panel, and the air conditioning may be on.

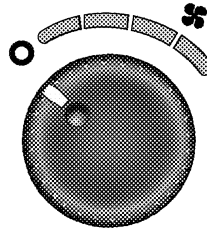
**Blower Control**

80a01359

The rotary knob on the left of the control panel is the blower control. Turn the knob clockwise to one of the four positions to obtain the blower speed you desire. To turn the blower off, turn the knob to the far left position.

### Temperature Control

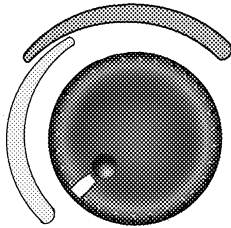

80a0135a

The rotary knob at the center of the control panel controls the temperature of the interior air. You can choose your degree of comfort by rotating the knob. The coldest temperature setting is to the extreme left (blue region) and the warmest setting is to the extreme right (red region) of the rotation.

### Circulation

The cab is designed with features to promote outside air circulation. There are grilles in the cab back panel. These are air exhausters that provide the means for regular exchange of cab air.

Side window demisters direct air flow specifically to the window glass to help prevent interior fogging of the glass. They are located in the extreme outside upper

edges of the instrument panel. The demisters also provide extra air ducts for circulation. They are in operation whenever the Floor, Mix or Defrost modes are in use. To remove frost from the side windows, it is best to use the full defrost mode.

**NOTE:** When you turn off the engine you may hear a hissing sound from under the hood for a short period of time. This is a normal condition that occurs if the air conditioning system has been on. It is not an indication of a problem with the air conditioning system.

### Electric Rear Window Defroster and Heated Sideview Mirrors — If Equipped



The Electric Rear Window Defroster and Heated side view mirrors are activated by pressing the heated grid button, located on the Climate Control panel, with the ignition On. Turning Off the ignition will deactivate the Electric Rear Window Defroster and Heated side view mirrors feature. These features also

turn off after activation, when 15 minutes have elapsed. To reactivate, simply press the button again.

### Air Conditioning with Dual Zone Temperature Control — If Equipped

With the Dual Zone Temperature Control System, each front seat occupant can independently control the temperature of air coming from the outlets on their side of the vehicle.

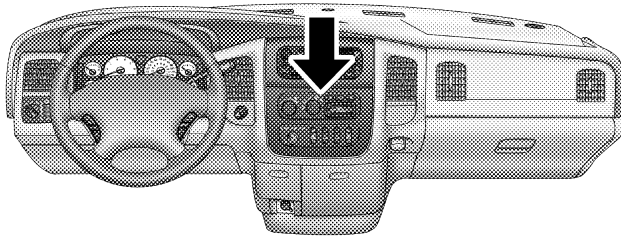

80d0ba9c

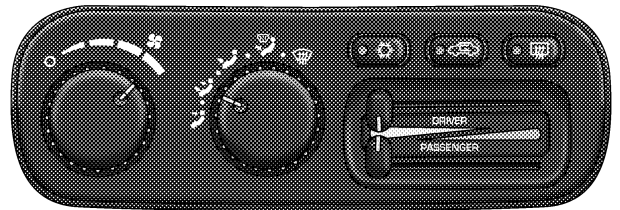

4

811b8652

### Air Conditioning Operation

To turn on the Air Conditioning, set the fan control at any speed and press the snowflake button located on the control panel. Conditioned air will be directed through the outlets selected by the mode control. A light in the snowflake button shows that the air conditioning is on. Press the button a second time to turn the air conditioning off.

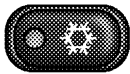
**A/C Pushbutton**

80d0bd96

With the fan control in the ON position, pushing the A/C button turns on the air conditioning compressor. An indicator light on the button shows that the Air Conditioning compressor is on. Conditioned air is now directed through the mode outlets selected.

Pushing the button a second time turns the compressor OFF.

**Recirculation Pushbutton**

811b86fe

Pushing the Recirculation button allows interior air to recirculate continuously in any position except defrost and defrost/floor mode for rapid cool down of the interior. See "Fast Cooldown" later in this section.

**Mode Control**

80d0c02d

The mode control allows you to choose from several patterns of air distribution.

**NOTE:** To improve your selection choices, the system allows you to operate at intermediate positions between the major modes. These intermediate positions are identified by the small dots and give an even blend of both modes.

**Panel**

➔ Outside air flows through the outlets located in the instrument panel. These outlets can be adjusted to direct the airflow.

**Bi-Level**

 Air flows through the outlets located in the instrument panel and those located on the floor.

**NOTE:** There is a difference in temperature between the upper and lower outlets for added comfort. The warmer air goes to the floor outlets. This feature gives improved comfort during sunny but cool conditions.

**Heat**

 Outside air flows primarily through the floor outlets located under the instrument panel.

**Mix**

 Outside air flows in equal proportions through the floor and defroster outlets.

**Defrost**

 Outside air is primarily directed to the windshield through the defroster outlets located at the base of the windshield and side window demist outlets.

**NOTE:** The air conditioning compressor operates in both Mix and Defrost or a blend of these modes, even if the A/C button has not been pressed. This dehumidifies the air to help dry the windshield.

**Blower Control**

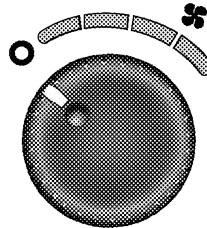

80a01359

The rotary knob on the left of the control panel is the blower control. Turn the knob clockwise to one of the four positions to obtain the blower speed you desire. To turn the blower off, turn the knob to the far left position.

### Dual Zone Temperature Control

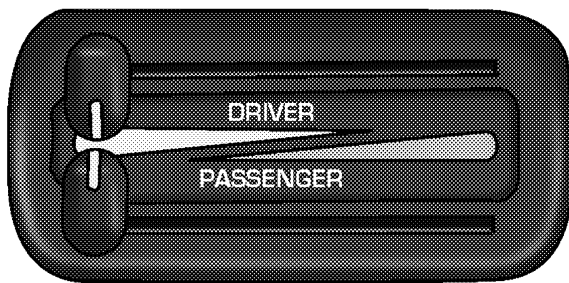

80d0bcce

Use this control to regulate the temperature of the air inside the passenger compartment. This is accomplished by having separate temperature control slides for both the driver and front passenger. The blue area of the scale indicates cooler temperatures while the red area indicates warmer temperatures.

### Electric Rear Window Defroster and Heated Sideview Mirrors — If Equipped



The Electric Rear Window Defroster and Heated side view mirrors are activated by pressing the heated grid button, located on the Climate Control panel, with the ignition On. Turning Off the ignition will deactivate the Electric Rear Window Defroster and Heated side view mirrors feature. These features also turn off after activation, when 15 minutes have elapsed. To reactivate, simply press the button again.

### Circulation

The cab is designed with features to promote outside air circulation. There are grilles in the cab back panel. These are air exhausters that provide the means for regular exchange of cab air.

Side window demisters direct air flow specifically to the window glass to help prevent interior fogging of the glass. They are located in the extreme outside upper

edges of the instrument panel. The demisters also provide extra air ducts for circulation. They are in operation whenever the Floor, Mix or Defrost modes are in use.

**NOTE:** When you turn off the engine you may hear a hissing sound from under the hood for a short period of time. This is a normal condition that occurs if the air conditioning system has been on. It is not an indication of a problem with the air conditioning system.

### **Operating Tips**

#### **Fast Cooldown**

For a fast cooldown, turn the blower fan rotary knob to the extreme right position, turn the mode control to the panel fresh position, press the snowflake button to turn on the air conditioning, and drive with the windows open for the first few minutes. Once the hot air has been expelled, close the windows and press the Recirculation pushbutton. When a comfortable condition has been

reached, choose a mode position and adjust the temperature control slide and blower speed as necessary to maintain comfort. For high humidity conditions it may be necessary to remain in the Recirculation mode to maintain comfort.

#### **Window Fogging**

Windows will fog on the inside when the humidity inside the vehicle is high. This often occurs in mild or cool temperatures when it's rainy or humid. In most cases turning on the Air-conditioning (pressing the snowflake button) will clear the fog. Adjust the temperature control, air direction and blower speed to maintain comfort.

As the temperature gets colder it may be necessary to direct air onto the windshield by using MIX Mode position on the control. Adjust the temperature control and blower speed to maintain comfort. Higher blower

speeds will reduce fogging. Interior fogging on the windshield can be quickly removed by selecting the defrost mode.

Regular cleaning of the inside of the windows with a non-filming cleaning solution (vinegar and water works very well) will help prevent contaminants (cigarette smoke, perfumes, etc.) from sticking to the windows. Contaminates increase the rate of window fogging.

#### **Summer Operation**

Air conditioned vehicles must be protected with a high quality antifreeze coolant during summer to provide proper corrosion protection and to raise the boiling point of the coolant for protection against overheating. A 50 % concentration is recommended. Refer to Recommended Fluids and Genuine Parts for the proper coolant type.

When using the air conditioner in extremely heavy traffic in hot weather especially when towing a trailer, additional engine cooling may be required. If this situation is

encountered, operate the transmission in a lower gear to increase engine RPM, coolant flow and fan speed. When stopped in heavy traffic, it may be necessary to shift into NEUTRAL and depress the accelerator slightly for fast idle operation to increase coolant flow and fan speed.

**NOTE:** On models equipped with Diesel engines, the idle speed will automatically increase to 1000 rpm at elevated coolant temperatures to improve engine cooling.











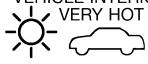







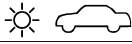



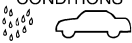





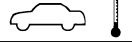





Your air conditioning system is also equipped with an automatic recirculation system. When the system senses a heavy load or high heat conditions, it may use partial Recirculation A/C mode to provide additional comfort.

#### **Winter Operation**

When operating the system during the winter months, make sure the air intake, located directly in front of the windshield, is free of ice, slush, snow, or other obstructions.



Operating Tips Chart

WEATHER	CONTROL SETTINGS
<p>HOT WEATHER AND VEHICLE INTERIOR IS VERY HOT</p> 	<p>Start the vehicle, open the windows and turn the blower control knob to the high position (full clockwise). Set Mode control knob at or between  and . Set temperature control to full cold and press the  button on. After the hot air has been expelled, close the windows and turn the mode control knob to the  setting (counterclockwise) at either  or , or press the  button (if so equipped). Once comfortable, choose a mode position and adjust temperature control and blower speed as necessary for comfort.</p>
<p>WARM WEATHER</p> 	<p>If sunny, set the Mode control at or near  and press the  button on. If cloudy or dark, set the Mode control at or near . No  is necessary.</p>
<p>COOL OR COLD HUMID CONDITIONS</p> 	<p>If sunny, set the Mode control at or between  and , then press the  button on. If cloudy or dark set the Mode control at or near . No  is necessary.</p>
<p>COLD DRY CONDITIONS</p> 	<p>In cloudy or dark weather set the Mode control at or near . If sunny, set the Mode control at or between  and , and for snowy or very cold weather requiring extra heat to the windshield, use .</p>
<p>EXTREME COLD CONDITIONS (DIESEL)</p> 	<p>Using re-circulated air can aid initial warm-up in extreme cold conditions. <b>NOTICE: Running in  /MAX for long periods of time will result in window fogging. When this occurs, use  until windows clear. This will deactivate  /MAX. SINGLE ZONE VEHICLES:</b> Set the mode control at  +  /MAX, close the panel vents and set the temperature control to full hot. Turn blower control knob to low and gradually increase as air and engine temperature increase. <b>DUAL ZONE VEHICLES:</b> Set the mode control at , set both temperature controls to full hot and press the  /MAX button. Turn blower control knob to low and gradually increase as air and engine temperature increase.</p>
<p>WINDOW FOGGING</p>	<p>In most cases turning on the Air-Conditioning (press the  button) will clear the fog, then adjust temperature control, air direction and blower speed to maintain comfort. As it gets colder it may be necessary to direct air onto the windshield. If so, set the Mode control at  or  and adjust temperature control and blower speed to maintain comfort. Higher blower speeds will reduce fogging.</p>

8159dfbc



---

# STARTING AND OPERATING

## CONTENTS

---

■ Ignition/Starter Switch . . . . .	228	□ Manual Transmission . . . . .	229
□ Lock . . . . .	228	□ Automatic Transmission . . . . .	230
□ Off . . . . .	228	□ If Engine Fails To Start . . . . .	230
□ On . . . . .	228	□ Engine Block Heater— If Equipped . . . . .	231
□ Start . . . . .	228	□ After Starting . . . . .	232
□ ACC . . . . .	229	■ Transmission Shifting . . . . .	232
□ Manual Transmission Key Release Button . . . . .	229	□ Automatic Transmission With Overdrive . . . . .	232
□ Key Reminder . . . . .	229	□ Manual Transmission . . . . .	238
■ Starting Procedures . . . . .	229	■ Four-Wheel- Drive Operation — If Equipped . . . . .	241

**224 STARTING AND OPERATING**

<input type="checkbox"/> Manually Shifted Transfer Case Operating Information/Precautions . . . . .	242	<input type="checkbox"/> Rear Wheel Anti-Lock Brake System — RWAL . . . . .	256
<input type="checkbox"/> Shifting Procedure - Manually Shifted Transfer Case . . . . .	244	<input type="checkbox"/> Four-Wheel Anti-Lock Brake System — If Equipped . . . . .	257
<input type="checkbox"/> Transfer Case Reminder Light . . . . .	245	<input checked="" type="checkbox"/> Power Steering . . . . .	259
<input type="checkbox"/> Electronically Shifted Transfer Case Operating Information/Precautions . . . . .	246	<input checked="" type="checkbox"/> Tire Safety Information . . . . .	259
<input type="checkbox"/> Shifting Procedure - Electronically Shifted Transfer Case . . . . .	250	<input type="checkbox"/> Tire Markings . . . . .	259
<input checked="" type="checkbox"/> Limited-Slip Differential — If Equipped . . . . .	253	<input type="checkbox"/> Tire Identification Number (TIN) . . . . .	263
<input checked="" type="checkbox"/> Parking Brake . . . . .	254	<input type="checkbox"/> Tire Loading And Tire Pressure . . . . .	264
<input checked="" type="checkbox"/> Brake System . . . . .	255	<input checked="" type="checkbox"/> Tires—General Information . . . . .	268
<input type="checkbox"/> 3500 Dual Rear Wheel Models Only . . . . .	256	<input type="checkbox"/> Tire Pressure . . . . .	268
<input type="checkbox"/> Brake Noise . . . . .	256	<input type="checkbox"/> Tire Inflation Pressures . . . . .	269
		<input type="checkbox"/> Radial-Ply Tires . . . . .	272

□ Compact Spare Tire — If Equipped . . . . .	272	□ Gasoline/Oxygenate Blends . . . . .	284
□ Limited Use Spare — If Equipped . . . . .	273	□ MMT In Gasoline . . . . .	284
□ Tire Spinning . . . . .	274	□ Materials Added To Fuel . . . . .	285
□ Tread Wear Indicators . . . . .	275	□ Adding Fuel . . . . .	285
□ Replacement Tires . . . . .	276	□ Fuel System Cautions . . . . .	287
□ Alignment And Balance . . . . .	277	□ Carbon Monoxide Warnings . . . . .	288
■ Supplemental Tire Pressure Information . . . . .	277	■ Flexible Fuel—(Fleet Vehicles Only) . . . . .	289
■ Tire Chains . . . . .	278	□ E-85 General Information . . . . .	289
■ Snow Tires . . . . .	280	□ Ethanol Fuel (E-85) . . . . .	289
■ Tire Rotation Recommendations . . . . .	280	□ Fuel Requirements . . . . .	290
□ Dual Rear Wheels . . . . .	281	□ Selection Of Engine Oil For Flexible Fuel Vehicles (E-85) And Gasoline Vehicles . . . . .	290
■ Fuel Requirements . . . . .	282	□ Starting . . . . .	290
□ Reformulated Gasoline . . . . .	283		

**226 STARTING AND OPERATING**

- Cruising Range . . . . .291
- Replacement Parts . . . . .291
- Maintenance . . . . .291
- Catalytic Converter . . . . .291
- Vehicle Loading . . . . .293
  - Certification Label . . . . .293
- Trailer Towing . . . . .296
  - Definitions . . . . .296
  - Axle Lubricant And Trailer Towing . . . . .298
  - Trailer Towing Recommendations . . . . .298
  - Trailer Towing — Hitches . . . . .299
  - Connecting Trailer Lighting And Electric Trailer Brakes . . . . .300
  - Trailer Weight And Trailer Tongue Weight . . . . .301
  - Trailer Towing Information (Maximum Trailer Weight Ratings) . . . . .302
  - Trailer Towing Mirrors — If Equipped . . . . .303
  - Cooling System Tips — Trailer Towing . . . . .303
  - Automatic Transmission Oil Temperature Warning Light . . . . .304
  - Towing With An Automatic Transmission . . . . .304
- Snowplow . . . . .305
  - Dodge Ram 1500 Models . . . . .305
  - Before Plowing . . . . .306
  - Snowplow Model Prep Package Availability . . . . .306
  - Over The Road Operation With Snowplow Attached . . . . .307

□ Methods For Removing Snow . . . . .	308	□ Returning To Normal Operation — Manual Shift Transfer Case . . . . .	311
□ Operating Tips . . . . .	308	□ Recreational Towing Procedure — Electronic Shift Transfer Case — If Equipped . . . . .	313
□ General Maintenance . . . . .	308	□ Returning To Normal Operation — Electronic Shift Transfer Case . . . . .	315
■ Recreational Towing — 4 Wheel Drive Vehicles (Behind Motorhome, Etc.) . . . . .	309	■ Driving Off-Road . . . . .	317
□ Recreational Towing — 2 Wheel Drive Models . . . . .	309	■ Traction . . . . .	318
□ Recreational Towing Procedure — Manual Shift Transfer Case — If Equipped . . . . .	310	■ Equipment Identification Plate . . . . .	318

### IGNITION/STARTER SWITCH

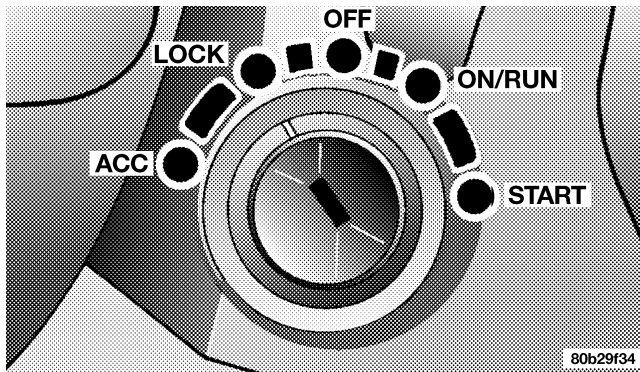

#### **LOCK**

Locks the automatic transmission shift control into the PARK position. It also engages the steering wheel lock (if equipped) when the steering wheel is turned.

**NOTE:** This vehicle is equipped with a transmission shift interlocking system. The brake pedal must be depressed to shift out of Park (P).

#### **OFF**

Unlocks the steering wheel (if equipped with locking wheel) and the automatic transmission shift control with engine off.

#### **ON**

This is the normal running position.

#### **START**

Starts the engine. When the engine starts, release the key. The ignition key will return to the ON position for normal driving.



**ACC**

Allows the electrical accessories to be used when the engine is not running.

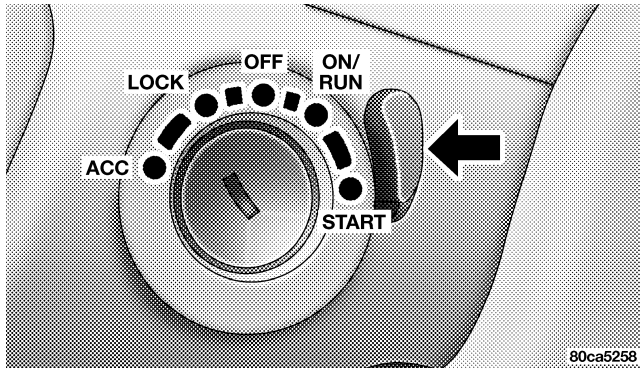
**Manual Transmission Key Release Button**

To remove the key on vehicles equipped with manual transmissions, turn the key to the Lock position and press the button to remove the ignition key.

**Key Reminder**

An alarm will sound to remind you if the key is left in the ignition and the driver's door is opened.

**STARTING PROCEDURES**

The starter should not be operated for more than 15-second intervals. Waiting a few seconds between such intervals will protect the starter from overheating.

**Manual Transmission**

Apply the parking brake, place the gearshift control lever in NEUTRAL and depress the clutch pedal to the floor before starting the vehicle. This vehicle is equipped with a clutch interlocking ignition system. It will not start unless the clutch is fully depressed.

**Automatic Transmission**

Start the engine with the selector lever in NEUTRAL or PARK position. Apply the brake before shifting to any driving range.

**Normal Starting** of either a warm or cold engine is obtained without pumping or depressing the accelerator pedal. Turn the key to the START position and release when the engine starts. If the engine fails to start within 10 seconds, turn the key to the OFF position, wait 5 seconds, then repeat the starting procedure.

**NOTE:** This vehicle is equipped with a transmission shift interlocking system. The brake pedal must be depressed to shift out of Park (P).

**If Engine Fails To Start**

If the engine fails to start after you have followed the normal starting procedure, it may be flooded. Push the accelerator pedal all the way to the floor and hold it there while cranking the engine. This should clear any excess fuel in case the engine is flooded.

**CAUTION!**

To prevent damage to the starter, do not crank the engine for more than 15-seconds at a time. Wait 10 to 15 seconds before trying again.

If the engine has been flooded, it may start to run, but not have enough power to continue running when the key is released. If this occurs, continue cranking with the accelerator pedal pushed all the way to the floor. Release the accelerator pedal and the key once the engine is running smoothly.

If the engine shows no sign of starting after two 15 second periods of cranking with the accelerator pedal held to the floor, the normal starting procedure should be repeated.

**WARNING!**

Never pour fuel or other flammable liquids into the throttle body air inlet opening in an attempt to start the vehicle. This could result in a flash fire causing serious personal injury.

**Engine Block Heater— If Equipped**

The engine block heater warms the engine coolant and permits quicker starts in cold weather. Connect the cord to a standard 110-115 volt AC electrical outlet with grounded, three-wire extension cord.

The engine block heater cord is routed under the hood to the right side of the vehicle and held to the body with removable clips.

**WARNING!**

Remember to disconnect the cord before driving. Damage to the 110-115 volt electrical cord could cause electrocution.

**After Starting**

The idle speed is automatically controlled and will decrease as the engine warms up.

**CAUTION!**

Long periods of engine idling, especially at high engine speeds can cause excessive exhaust temperatures which can damage your vehicle. Do not leave your vehicle unattended with the engine running.

**WARNING!**

Do not leave children or animals inside parked vehicles in hot weather. Interior heat build up may cause serious injury or death.

**TRANSMISSION SHIFTING****Automatic Transmission with Overdrive**

The gear shift selector display, located in the instrument panel cluster, indicates the transmission gear range (the selector is illuminated for night driving). The selector lever is mounted on the right side of the steering column. You must depress the brake pedal, to pull the selector lever out of park (P) position (Brake Interlock System). To drive, move the selector lever from Park or Neutral to the desired drive position. Pull the selector lever toward you when shifting into Reverse, Second, First or Park, or when shifting out of Park.

**Gear Ranges**

DO NOT race the engine when shifting from Park or Neutral position into another gear range.

***“P” Park***

This gear position supplements the parking brake by locking the transmission. The engine can be started in this range. Never use Park while the vehicle is in motion. Apply the parking brake when leaving the vehicle in this range. Always apply parking brake first, then place the selector in Park position. On 4-wheel-drive vehicles be sure that the transfer case is in a drive position!

**WARNING!**

**Never use Park position on an automatic transmission as a substitute for the parking brake. Always apply parking brake fully when parked to guard against vehicle movement and possible injury or damage.**

**WARNING!**

**Your vehicle could move and injure you and others if it is not completely in P (Park). Check by trying to move the gearshift lever back and forth without first pulling it toward you after you have set it in P. Make sure it is in Park before leaving the vehicle.**

**WARNING!**

It is dangerous to shift the selector lever out of "P" or "N" if the engine speed is higher than idle speed. If your foot is not firmly on the brake pedal, the vehicle could accelerate quickly forward or in reverse. You could lose control of the vehicle and hit someone or something. Only shift into gear when the engine is idling normally and when your right foot is firmly on the brake pedal.

**"R" Reverse**

Use this range only after the vehicle has come to a complete stop.

**"N" Neutral**

Shift to Neutral when the vehicle is standing for prolonged periods with the engine running. The engine may be started in this range. Set the parking brake if you must leave the vehicle.

**NOTE:** Towing the vehicle, coasting, or driving, with the transmission in neutral (N) position, can cause severe damage to the transmission.

**"D" Drive**

This position provides all forward gears, including 3rd gear direct and 4th or 5th (if equipped) gear overdrive (see Overdrive Operation). Use this range for most city and highway driving.

**"2" Second**

Use this position for driving slowly in heavy city traffic or on mountain roads where more precise speed control is desirable. Use it also when climbing long grades, and for engine braking when descending moderately steep grades.

**NOTE:** Do not exceed maximum engine speed.

**"1" First**

Use this position for driving up very steep hills and for engine braking at low speeds (20 mph [32 km/h] or less) when going downhill.

**NOTE:** Do not exceed maximum engine speed.

**Overdrive Operation**

The overdrive automatic transmission contains an electronically controlled fourth and fifth (if equipped) speed (Overdrive). The transmission will automatically shift from Drive to Overdrive if the following conditions are present:

- the transmission selector is in Drive;
- the engine coolant has reached normal operating temperature;
- vehicle speed is above approximately 30 mph (48 km/h);
- the "TOW/HAUL" switch has not been activated;
- transmission has reached normal operating temperature.

**NOTE:** If the vehicle is started in extremely cold temperatures, the transmission may not shift into Overdrive and will automatically select the most desirable gear for operation at this temperature. Normal operation will resume when the transmission fluid temperature has risen to a suitable level. Refer also to the Note under torque converter clutch, later in this section.

If the transmission temperature gets extremely hot, the transmission will automatically select the most desirable gear for operation at this temperature. If the transmission temperature becomes hot enough the TRANS TEMP light may illuminate and the transmission may downshift out of Overdrive until the transmission cools down. After cooldown, the transmission will resume normal operation.

The transmission will downshift from Overdrive to Drive if the accelerator pedal is fully depressed at vehicle speeds above approximately 35 mph (56 km/h).

#### When To Use "TOW/HAUL" Mode

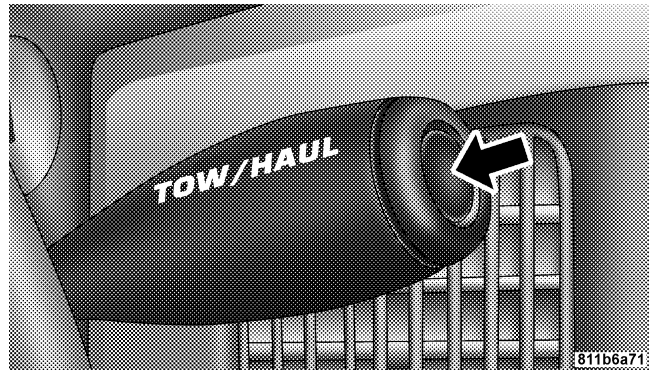

When driving in hilly areas, towing a trailer, carrying a heavy load, etc., and frequent transmission shifting occurs, press the "TOW/HAUL" button. This will improve performance and reduce the potential for transmission overheating or failure due to excessive shifting. When operating in "TOW/HAUL" mode, 5th gear (if



equipped) is disabled and 2-3 and 3-4 shift patterns are modified. Shifts into Overdrive (4th gear) are allowed during steady cruise (for improved fuel economy) and automatic closed-throttle downshifts to 3rd gear (for improved braking) will occur during steady braking.

The "TOW/HAUL" light will illuminate in the instrument cluster to indicate when the switch has been activated. Pressing the switch a second time restores normal operation. If the "TOW/HAUL" mode is desired, the button must be pressed each time the engine is started.

#### **Torque Converter Clutch**

A feature, designed to improve fuel economy, has been included in the automatic transmission on your vehicle. A clutch within the torque converter engages automatically at calibrated speeds. This may result in a slightly different feeling or response during normal operation in

high gear. When the vehicle speed drops or during acceleration when the transmission downshifts to second gear, the clutch automatically disengages.

**NOTE:** The torque converter clutch will not engage until the transmission fluid and engine coolant are warm [usually after 1-3 miles (1.6 - 4.8 km) of driving]. Because the engine speed is higher when the torque converter clutch is not engaged, it may seem as if the transmission is not shifting into Overdrive when cold. This is normal. Pressing the "TOW/HAUL" button, when the transmission is sufficiently warm, will demonstrate that the transmission is able to shift into and out of overdrive.

**NOTE:** If the vehicle has not been driven in several days, the first few seconds of operation after shifting the transmission into gear may seem sluggish. This is due to the fluid partially draining from the torque converter into the transmission. This condition is normal and will not

cause damage to the transmission. The torque converter will refill within five seconds of shifting from Park into any other gear position.

### **Manual Transmission**

**NOTE:** The parking brake should be engaged before leaving the vehicle, especially on an incline.

Truck models with manual transmission are equipped with a clutch interlocking ignition system. The clutch pedal must be fully depressed to start the vehicle.

Fully depress the clutch pedal before shifting gears. As you release the clutch pedal, lightly depress the accelerator pedal.

To shift into Reverse, come to a complete stop. Depress the clutch and pause briefly to allow the gear train to stop. Move the shift lever from the Neutral position straight across and back into Reverse.

Never drive with your foot resting on the clutch pedal, or attempt to hold the vehicle on a hill with the clutch pedal partially engaged, as this will cause abnormal wear on the clutch.

### **Recommended Vehicle Shift Speeds**

To utilize your manual transmission efficiently for both fuel economy and performance, it should be upshifted as listed in recommended shift speed chart. Shift at the vehicle speeds listed for acceleration. Earlier upshifts during cruise conditions (steady speeds) will result in increased fuel economy, and may be used as indicated.

### **Manual Transmission – 5-Speed (NV4500)**

2500 and 3500 models are equipped with the NV4500 manual transmission. This transmission has a “creeper” 1st gear which should be used to start from a standing position when carrying a payload or towing a trailer. Damage to the clutch can result from starting in 2nd or

3rd gear with a loaded vehicle. An unloaded vehicle may be launched in 2nd gear. Use each gear in numerical order – do not skip a gear.

For most city driving you may find it easier to use only 1st through 4th gear ranges. For steady highway driving with light accelerations, 5th gear is recommended. To shift into 5th gear, move the shift lever to the right beyond the spring pressure point and push it forward. When shifting from 5th to 4th gear, pull the lever down toward you in one motion. Do not pull the lever sharply left as you may shift accidentally into 2nd gear and damage the transmission.

5 Speed Manual Transmission Shift Speeds in mph (km/h)							
Engine	Model	Axle	Mode	1 to 2	2 to 3	3 to 4	4 to 5
5.7L	2500/ 3500	ALL	Accel & Cruise	15 (24)	25 (40)	40 (65)	45 (72)

#### Manual Transmission — 6-Speed

**NOTE:** The parking brake should be engaged before leaving the vehicle, especially on an incline.

This model is equipped with a clutch interlocking ignition system. The clutch pedal must be fully depressed to start the vehicle.

Fully depress the clutch pedal before shifting gears. As you release the clutch pedal, lightly depress the accelerator pedal. When launching a stationary vehicle, keep the engine speed low until the clutch is fully engaged.

Damage to the clutch can result from starting in 2nd or 3rd gear with a loaded vehicle. Use each gear in numerical order – do not skip a gear.

For improved clutch life, all six forward gears should be used. For steady highway driving with light acceleration, 6th gear is recommended. When shifting from 4th to 5th gear, apply side effort away and forward without pushing hard enough to engage Reverse gear. Shifting from 5th to 6th requires the same side effort or the lever will return to center resulting in a shift into 4th gear and damage the transmission, clutch, or engine.

You should use low gear when starting from a standing position if under a heavy load.

To shift into Reverse, come to a complete stop. Depress the clutch and pause briefly to allow the gear train to stop. Move the shift lever from the Neutral position straight across and up into Reverse.

Never drive with your foot resting on the clutch pedal, or attempt to hold the vehicle on a hill with the clutch pedal partially engaged, as this will cause abnormal wear on the clutch.

#### **Recommended Shift Speeds**

To use your manual transmission for fuel economy it should be upshifted as listed below. Shift at the vehicle speeds listed for acceleration. Earlier upshifts during cruise conditions (relatively steady speeds) will result in increased fuel economy, and may be used as indicated.

Higher upshift speeds may be used to obtain a desired acceleration rate.

6 Speed Manual Transmission Shift Speed in mph (km/h)								
Engine	Model	Axle	Accel- eration Rate	1 to 2	2 to 3	3 to 4	4 to 5	5 to 6
3.7L	1500	ALL	ACCEL & CRUISE	15 (24) 10 (16)	24 (39) 19 (31)	34 (55) 27 (44)	47 (76) 37 (60)	56 (90) 41 (66)
4.7L/ 5.7L	1500/ 2500/ 3500	ALL	ACCEL & CRUISE	15 (24)	25 (40)	40 (65)	45 (72)	50 (81)

### Downshifting

Moving from a high gear down to a lower gear is recommended to preserve brakes when driving down steep hills. In addition, downshifting at the right time provides better acceleration when you desire to resume speed. For acceleration at speeds less than 20 mph (30 km/h), 2nd gear is recommended.

### CAUTION!

When descending a hill, be very careful to downshift one gear at a time to prevent overspeeding the engine which can cause valve damage.

### FOUR-WHEEL- DRIVE OPERATION — IF EQUIPPED

- Four-Wheel-Drive Dodge Ram Trucks are equipped with either a Manually Shifted transfer case or an Electronically Shifted transfer case. See the operating instructions for your transfer case, located within this section.

**Manually Shifted Transfer Case Operating Information/Precautions**

The transfer case provides 4 mode positions - 2 (rear)-wheel-drive high range, 4-wheel-drive high range, neutral, and 4-wheel-drive low range.

This transfer case is intended to be driven in the 2-wheel-drive position (2H) for normal street and highway conditions such as dry hard surfaced roads.

When additional traction is required the transfer case 4H and 4L positions can be used to lock the front and rear driveshafts together and force the front and rear wheels to rotate at the same speed. This is accomplished by simply moving the shift lever to the desired positions. The 4H and 4L positions are intended for loose, slippery road surfaces only. Driving in the 4H and 4L positions on dry hard surfaced roads may cause increased tire wear and damage to the driveline components.

The 4-wheel-drive light (4WD), located in the instrument cluster, alerts the driver that the vehicle is in 4-wheel drive and that the front and rear driveshafts are locked together. This light illuminates when the transfer case is shifted to either the 4H or 4L positions. There is no light for the 2H or N (Neutral) positions.

When operating your vehicle in 4L, the engine speed is approximately three times that of the 2H or 4H positions at a given road speed. Take care not to overspeed the engine and do not exceed 25 mph (40 km/h).

Proper operation of 4-wheel-drive vehicles depends on tires of equal size, type and circumference on each wheel. Any difference will adversely affect shifting and can cause damage to the transfer case.

**NOTE:** Do not attempt to make a shift while only the front or rear wheels are spinning. The transfer case is not equipped with a synchronizer and therefore the front and rear driveshaft speeds must be equal for the shift to take place. Shifting while only the front or rear wheels are spinning can cause damage to the transfer case.

Because 4-wheel drive provides improved traction, there is a tendency to exceed safe turning and stopping speeds. Do not go faster than road conditions permit.

**NOTE:** Delayed shifts out of four-wheel drive may be experienced due to uneven tire wear, low or uneven tire pressures, excessive vehicle loading, or cold temperatures.

### WARNING!

**You or others could be injured if you leave the vehicle unattended with the transfer case in the Neutral (N) position without first fully engaging the parking brake. The transfer case Neutral (N) position disengages both the front and rear driveshafts from the powertrain and will allow the vehicle to move regardless of the transmission position. The parking brake should always be applied when the driver is not in the vehicle.**

**5**

For additional information on the appropriate use of each transfer case mode position see the information below:

#### **2H**

Rear Wheel Drive High Range - Normal street and highway driving. Dry hard surfaced roads.

**4H**

4-Wheel-Drive High Range - Locks the front and rear driveshafts together. Forces the front and rear wheels to rotate at the same speed. Additional traction for loose, slippery road surfaces only.

**N**

Neutral - Disengages both the front and rear driveshafts from the powertrain. To be used for flat towing behind another vehicle. See Recreational Towing for more information.

**4L**

4-Wheel-Drive Low Range - Low speed 4-wheel-drive. Locks the front and rear driveshafts together. Forces the front and rear wheels to rotate at the same speed. Additional traction and maximum pulling power for loose, slippery road surfaces only. Do not exceed 25 mph (40 km/h).

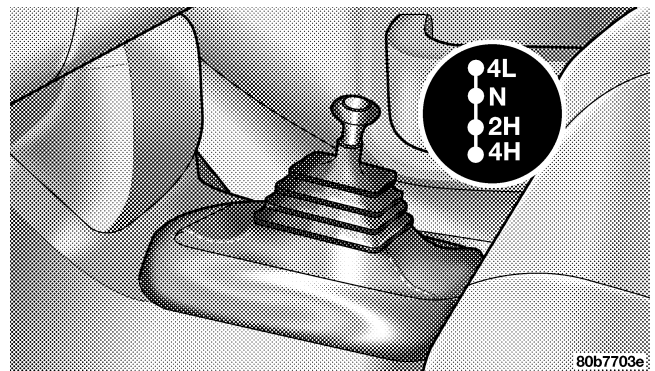
**Shifting Procedure - Manually Shifted Transfer Case****2H ↔ 4H**

Shifting between 2H and 4H can be made with the vehicle stopped or in motion. If the vehicle is in motion, shifts can be made up to 55 mph (88 km/h). With the



vehicle in motion, the transfer case will engage / disengage faster if you momentarily release the accelerator pedal after completing the shift. Apply a constant force when shifting the transfer case lever.

**2H or 4H ⇔ 4L**

With the vehicle rolling at 2 to 3 mph (3 to 5 km/h), shift an automatic transmission to N (Neutral) or depress the clutch on a manual transmission. While the vehicle is coasting at 2 to 3 mph (3 to 5 km/h), shift the transfer case lever firmly to the desired position. Do not pause in transfer case N (Neutral).

**NOTE:** Pausing in transfer case N (Neutral) in vehicles equipped with an automatic transmission may require shutting the engine OFF to avoid gear clash while completing the shift. If difficulty occurs, shift automatic transmission to N (Neutral), hold foot on brake, and turn engine OFF. Make shift to the desired mode.

**NOTE:** Shifting into or out of 4L is possible with the vehicle completely stopped, however difficulty may occur due to the mating clutch teeth not being properly aligned. Several attempts may be required for clutch teeth alignment and shift completion to occur. The preferred method is with the vehicle rolling 2 to 3 mph (3 to 5 km/h). Avoid attempting to engage or disengage 4L with the vehicle moving faster than 2 to 3 mph (3 to 5 km/h).

**NOTE:** Do not attempt to shift to or from 4L while the transmission is in gear or clutch is engaged.

**Transfer Case Reminder Light**

The four-wheel-drive operating light (4WD), located in the instrument cluster, is used to alert the driver that the front axle is fully engaged and all four wheels are driving.

**Electronically Shifted Transfer Case Operating Information/Precautions**

This is an electric shift transfer case and is operated by the 4WD Control Switch (Transfer Case Switch), which is located on the instrument panel.

The Electronically Shifted transfer case provides 4 mode positions: 2 (rear) wheel drive high range or all wheel drive high range, 4 wheel drive high range, 4 wheel drive low range, and neutral.

The Electronically Shifted transfer case is designed to be driven in the 2 wheel drive position (2WD) or all wheel drive position (AWD) for normal street and highway conditions (dry hard surfaced roads).

When additional traction is required, the transfer case 4HI and 4LO positions can be used to lock the front and rear driveshafts together and force the front and rear wheels to rotate at the same speed. This is accomplished by rotating the 4WD Control Switch to the desired

position - see Shifting Procedure section for specific shifting instructions. The 4HI and 4LO positions are designed for loose, slippery road surfaces only. Driving in the 4HI and 4LO positions on dry hard surfaced roads may cause increased tire wear and damage to the driveline components.

**NOTE:** The transfer case Neutral (N) position is selected by depressing the recessed button located on the lower left hand corner of the 4WD Control Switch. The transfer case Neutral (N) position is to be used for recreational towing only. See the Recreational Towing section for specific procedures on shifting into and out of Neutral (N).

**Transfer Case Position Indicator Lights — Electronically Shifted Transfer Case Only**

Transfer case position indicator lights are located on the Four-Wheel-Drive Control Switch, found on your instrument panel, and indicate the current and desired transfer

case selection. When you select a different transfer case position, the indicator lights will do the following:

**If All Shift Conditions are Met**

1. The current position indicator light will turn OFF.
2. The selected position indicator light will flash until the transfer case completes the shift.
3. When the shift is complete, the indicator light for the selected position will stop flashing and remain ON.

**If One or More Shift Conditions are not Met**

1. The indicator light for the current position will remain ON.
2. The newly selected position indicator light will continue to flash.
3. The transfer case **will not** shift.

**NOTE:** Before retrying a selection, make certain that all the necessary requirements for selecting a new transfer case position have been met. To retry the selection, turn the control knob back to the current position, wait five (5) seconds, and retry selection. To find the shift requirements, refer to the "Shifting Procedure" for your transfer case, located in this section of the owner's manual.

The "SERVICE 4WD" warning light monitors the electric shift 4WD system. If this light remains on after engine start up or illuminates during driving, it means that the 4WD system is not functioning properly and that service is required.

**WARNING!**

Always engage the parking brake when powering down the vehicle if the "Service 4WD" light is illuminated. Not engaging the parking brake may allow the vehicle to roll which may cause personal injury.

**NOTE:** Do not attempt to make a shift while only the front or rear wheels are spinning. The transfer case is not equipped with a synchronizer and therefore the front and rear driveshaft speeds must be equal for the shift to take place. Shifting while only the front or rear wheels are spinning can cause damage to the transfer case.

When operating your vehicle in 4LO, the engine speed is approximately three times that of the 2WD/AWD or 4HI positions at a given road speed. Take care not to overspeed the engine and do not exceed 25 mph (40 km/h).

Proper operation of 4 wheel drive vehicles depends on tires of equal size, type and circumference on each wheel. Any difference in tire size can cause damage to the transfer case.

Because 4 wheel drive provides improved traction, there is a tendency to exceed safe turning and stopping speeds. Do not go faster than road conditions permit.

**WARNING!**

**You or others could be injured if you leave the vehicle unattended with the transfer case in the Neutral (N) position without first fully engaging the parking brake. The transfer case Neutral (N) position disengages both the front and rear driveshafts from the powertrain and will allow the vehicle to move regardless of the transmission position. The parking brake should always be applied when the driver is not in the vehicle.**

For additional information on the appropriate use of each transfer case mode position see the information below:

**2WD/AWD**

Rear Wheel Drive High Range - Normal street and highway driving. Dry hard surfaced roads.

**4HI**

4 Wheel Drive High Range - Locks the front and rear driveshafts together. Forces the front and rear wheels to rotate at the same speed. Additional traction for loose, slippery road surfaces only.

**4LO**

4 Wheel Drive Low Range - Low speed 4 wheel drive. Locks the front and rear driveshafts together. Forces the front and rear wheels to rotate at the same speed. Additional traction and maximum pulling power for loose, slippery road surfaces only. Do not exceed 25 mph (40 km/h).

**N**

Neutral - Disengages both the front and rear driveshafts from the powertrain. To be used for flat towing behind another vehicle. See Recreational Towing for more information.

### Shifting Procedure - Electronically Shifted Transfer Case

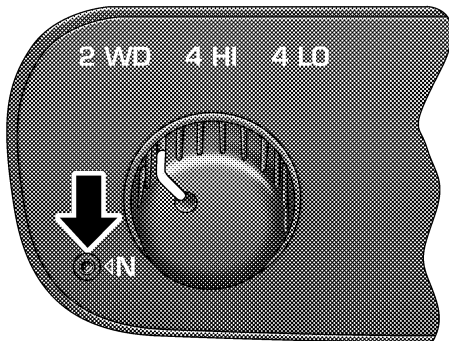

80ce404b

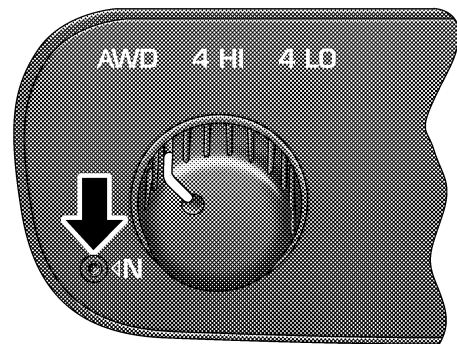

811b6e2e

**NOTE:** If any of the requirements to select a new transfer case position have not been met, the transfer case will not shift. The indicator light for the previous position will remain ON and the newly selected position indicator light will continue to flash until all the requirements for the selected position have been met. To retry a shift:

return the control knob back to the original position, make certain all shift requirements have been met, wait five (5) seconds and try the shift again.

**NOTE:** If all the requirements to select a new transfer case position have been met, the current position indicator light will turn OFF, the selected position indicator light will flash until the transfer case completes the shift. When the shift is complete, the indicator light for the selected position will stop flashing and remain ON.

#### **2WD/AWD ⇔ 4HI**

Rotate the 4WD Control Switch to the desired position. Shifts between 2WD/AWD and 4HI can be done with the vehicle stopped or in motion. With the vehicle in motion,

the transfer case will engage / disengage faster if you momentarily release the accelerator pedal after turning the control switch. If the vehicle is stopped, the ignition key must be in the ON position with the engine either RUNNING or OFF. This shift cannot be completed if the key is in the accessory position.

**NOTE:** The 4x4 system will not allow shifts between (2WD/AWD)/4HI if the front and/or rear wheels are spinning (no traction). In this situation the selected position indicator light will flash and the original position indicator light will remain ON. At this time, reduce speed and stop spinning the wheels to complete the shift.

**2WD/AWD or 4HI ⇔ 4LO**

**NOTE:** When shifting into or out of 4LO some gear noise may be heard. This noise is normal and is not detrimental to the vehicle or occupants.

Shifting can be performed with the vehicle rolling 2 to 3 mph (3 to 5 km/h) or completely stopped. USE EITHER OF THE FOLLOWING PROCEDURES:

**Preferred Procedure**

1. With engine RUNNING, slow vehicle to 2 to 3 mph (3 to 5 km/h).
2. Shift the transmission into NEUTRAL (depress clutch on manual transmissions).
3. While still rolling, rotate the transfer case control switch to the desired position.
4. After the desired position indicator light is ON (not flashing), shift transmission back into gear (release clutch on manual transmissions).

**Alternate Procedure**

1. Bring the vehicle to complete stop.
2. With the key ON and the engine either OFF or RUNNING, shift the transmission into NEUTRAL (depress clutch on manual transmissions).
3. Rotate the transfer case control switch to the desired position.
4. After the desired position indicator light is ON (not flashing), shift transmission back into gear (release clutch on manual transmissions).

**NOTE:** If steps 1 or 2 of either the Preferred or Alternate Procedure are not satisfied prior to attempting the shift or if they no longer are being met while the shift attempt is in process then the desired position indicator light will flash continuously while the original position indicator light is ON, until all requirements have been met.



**NOTE:** The ignition key must be ON for a shift to take place and for the position indicator lights to be operable. If the key is not ON then the shift will not take place and no position indicator lights will be on or flashing.

**NOTE:** If you are leaving your vehicle stored for longer than 21 days, refer to the section on "Vehicle Storage."

#### **LIMITED-SLIP DIFFERENTIAL — IF EQUIPPED**

The limited-slip differential provides additional traction on snow, ice, mud, sand and gravel, particularly when there is a difference between the traction characteristics of the surface under the right and left rear wheels. During normal driving and cornering, the limited-slip unit performs similarly to a conventional differential. On slippery surfaces, however, the differential delivers more of the driving effort to the rear wheel having the better traction.

The limited-slip differential is especially helpful during slippery driving conditions. With both rear wheels on a slippery surface, a slight application of the accelerator will supply maximum traction. When starting with only one rear wheel on an excessively slippery surface, slight momentary application of the parking brake may be necessary to gain maximum traction.

#### **WARNING!**

**On vehicles equipped with a limited-slip differential, never run the engine with one rear wheel off the ground, since the vehicle may drive through the rear wheel remaining on the ground. You could lose control of the vehicle.**

Care should be taken to avoid sudden accelerations when both rear wheels are on a slippery surface. This could cause both rear wheels to spin, and allow the vehicle to slide sideways on the crowned surface of a road or in a turn.

### PARKING BRAKE

The foot operated parking brake is positioned below the lower left corner of the instrument panel. To release the parking brake, pull the parking brake release handle.

**NOTE:** The instrument cluster red brake warning light will come on and flash to indicate that the parking brake is applied. You must be sure that the parking brake is fully applied before leaving the vehicle.

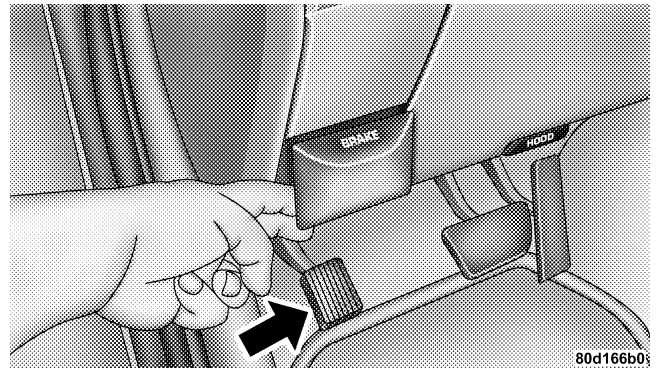

Be sure the parking brake is firmly set when parked and the gear shift lever is in the PARK position. When parking on a hill you should apply the parking brake before placing the gear shift lever in PARK, otherwise the load on the transmission locking mechanism may make it difficult to move the selector out of PARK.

**WARNING!**

- Always fully apply the parking brake when leaving your vehicle, or it may roll and cause damage or injury. Also be certain to leave an automatic transmission in Park, a manual transmission in Reverse or first gear. Failure to do so may allow the vehicle to roll and cause damage or injury.
- Leaving children in a vehicle unattended is dangerous for a number of reasons. A child or others could be injured. Children should be warned not to touch the parking brake or the gear selector lever. Don't leave the keys in the ignition. A child could operate power windows, other controls, or move the vehicle.
- Be sure the parking brake is fully disengaged before driving, failure to do so can lead to brake problems due to excessive heating of the rear brakes.

When parking on a hill, turn the front wheels toward the curb on a downhill grade and away from the curb on an uphill grade.

The parking brake should always be applied whenever the driver is not in the vehicle.

**BRAKE SYSTEM**

If power assist is lost for any reason (for example, repeated brake applications with the engine off), the brakes will still function. However, you will experience a substantial increase in braking effort to stop the vehicle.

If either the front or rear hydraulic systems lose normal capability, the remaining system will still function with some loss of overall braking effectiveness. This will be evident by increased pedal travel during application, greater pedal force required to slow or stop, and activation of the BRAKE warning lamp and the ABS lamp (if equipped) during brake use.

**3500 Dual Rear Wheel Models Only**

The brake system power assist is provided by a hydro-boost unit which shares fluid with the power steering system. You may experience some clicking or hissing noises from the hydro-boost system during hard braking conditions.

**NOTE:** Under cold temperatures, pedal effort will be higher than normal until the power steering oil reaches operating temperature.

**Brake Noise**

During normal operation of the brake system certain noises may be present from time to time. Occasional "groan" or "squeal" noises may occur during normal operation of the brake system which may not be indicative of a problem. These noises may be heard at any time the brakes are applied but may be more noticeable during the first few brake applications in the morning. Moisture, hot or cold temperature, dust, and or other debris may

also contribute to the noise condition. Repeated or continuous noises during braking may be an indication that the brake linings are worn and in need of replacement.

**Rear Wheel Anti-Lock Brake System — RWAL**

The Anti-lock Brake System provides increased vehicle stability and brake performance under most braking conditions. The system automatically controls the operation of the rear brakes to prevent rear wheel lockup.

The system remains operational in the four-wheel drive mode. The level of performance is reduced when the front brakes are locked up. This may cause the rear brakes to lockup through the drivetrain, which may reduce the effectiveness of the Anti-lock Brake System.

During severe braking conditions, particularly with changing road surfaces, such as ice to concrete, a slight drop or minor pulsation may be felt in the brake pedal.

**WARNING!**

Both Anti-Lock Brake Systems contain sophisticated electronic equipment. It may be susceptible to interference caused by improperly installed or high output radio transmitting equipment. This interference can cause possible loss of anti-lock braking capability. Installation of such equipment should be performed by qualified professionals.

**Four-Wheel Anti-Lock Brake System — If Equipped**

This Anti-lock Brake System is designed to aid the driver in maintaining vehicle control under adverse braking conditions. The system operates with a separate computer to modulate hydraulic pressure to prevent wheel lockup and help avoid skidding on slippery surfaces.

The system's pump motor runs during an ABS stop to provide regulated hydraulic pressure. The pump motor makes a low humming noise during operation. This is normal.

When you are in a severe braking condition involving use of the Anti-lock Brake System, you will experience some pedal drop as the vehicle comes to a complete stop. This is the result of the system reverting to the base brake system and is normal.

Engagement of the Anti-lock Brake System may be accompanied by a pulsing sensation. You may also hear a clicking noise. These occurrences are normal, and indicate that the system is functioning.

**ABS Warning Light**

The Anti-lock Brake System includes an amber warning light. When the light is illuminated, the Anti-lock Brake System is not functioning. The system reverts to standard non-anti-lock brakes.

**WARNING!**

**Pumping of the anti-lock brakes will diminish their effectiveness and may lead to an accident. Pumping makes the stopping distance longer. Just press firmly on your brake pedal when you need to slow down or stop.**

**WARNING!**

- **Anti-lock system (ABS) cannot prevent the natural laws of physics from acting on the vehicle, nor can it increase braking or steering efficiency beyond that afforded by the condition of the vehicle brakes and tires or the traction afforded.**
- **The ABS cannot prevent accidents, including those resulting from excessive speed in turns, following another vehicle too closely, or hydroplaning. Only a safe, attentive, and skillful driver can prevent accidents.**
- **The capabilities of an ABS equipped vehicle must never be exploited in a reckless or dangerous manner which could jeopardize the user's safety or the safety of others.**

**POWER STEERING**

Your power steering system will provide mechanical steering capability if power assist is lost.

If for any reason the hydraulic pressure is interrupted, it will still be possible to steer your vehicle. Under these conditions you will experience a substantial increase in steering effort.

**TIRE SAFETY INFORMATION**

**Tire Markings**

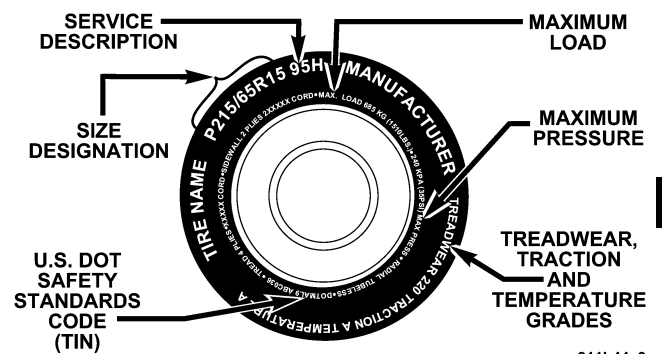

811b44e8

**NOTE:**

- P(Passenger)-Metric tire sizing is based on U.S. design standards. P-Metric tires have the letter "P" molded into the sidewall preceding the size designation. Example: P215/65R15 95H.

- European Metric tire sizing is based on European design standards. Tires designed to this standard have the tire size molded into the sidewall beginning with the section width. The letter "P" is absent from this tire size designation. Example: 215/65R15 96H
- LT(Light Truck)-Metric tire sizing is based on U.S. design standards. The size designation for LT-Metric tires is the same as for P-Metric tires except for the letters "LT" that are molded into the sidewall preceding the size designation. Example: LT235/85R16.
- Temporary Spare tires are high pressure compact spares designed for temporary emergency use only. Tires designed to this standard have the letter "T" molded into the sidewall preceding the size designation. Example: T145/80D18 103M.
- High Flotation tire sizing is based on U.S. design standards and begins with the tire diameter molded into the sidewall. Example: 31x10.5 R15 LT.



## Tire Sizing Chart

EXAMPLE:
<b>Size Designation:</b> P = Passenger car tire size based on U.S. design standards "...blank..." = Passenger car tire based on European design standards LT = Light Truck tire based on U.S. design standards T = Temporary Spare tire <b>31</b> = Overall Diameter in Inches (in)
<b>215</b> = Section Width in Millimeters (mm)
<b>65</b> = Aspect Ratio in Percent (%) —Ratio of section height to section width of tire. <b>10.5</b> = Section Width in Inches (in)
<b>R</b> = Construction Code —"R" means Radial Construction. —"D" means Diagonal or Bias Construction.
<b>15</b> = Rim Diameter in Inches (in)

<b>EXAMPLE:</b>	
<b>Service Description:</b>	
95 = Load Index	—A numerical code associated with the maximum load a tire can carry.
H = Speed Symbol	—A symbol indicating the range of speeds at which a tire can carry a load corresponding to its load index under certain operating conditions. —The maximum speed corresponding to the Speed Symbol should only be achieved under specified operating conditions. (ie. tire pressure, vehicle loading, road conditions and posted speed limits).
<b>Load Identification:</b>	
"...blank..." = Absence of any text on sidewall of the tire indicates a Standard Load (SL) Tire	
<b>Extra Load (XL)</b> = Extra Load (or Reinforced) Tire	
<b>Light Load</b> = Light Load Tire	
C,D,E = Load range associated with the maximum load a tire can carry at a specified pressure	
<b>Maximum Load</b> — Maximum Load indicates the maximum load this tire is designed to carry.	
<b>Maximum Pressure</b> — Maximum Pressure indicates the maximum permissible cold tire inflation pressure for this tire.	

**Tire Identification Number (TIN)**

The TIN may be found on one or both sides of the tire however the date code may only be on one side. Tires with white sidewalls will have the full TIN including date code located on the white sidewall side of the tire.

Look for the TIN on the outboard side of black sidewall tires as mounted on the vehicle. If the TIN is not found on the outboard side then you will find it on the inboard side of the tire.

<b>EXAMPLE:</b>
<b>DOT MA L9 ABCD 0301</b>
<b>DOT</b> = Department of Transportation —This symbol certifies that the tire is in compliance with the U.S. Department of Transportation tire safety standards, and is approved for highway use.
<b>MA</b> = Code representing the tire manufacturing location.(2 digits)
<b>L9</b> = Code representing the tire size.(2 digits)
<b>ABCD</b> = Code used by tire manufacturer.(1 to 4 digits)
<b>03</b> = Number representing the week in which the tire was manufactured.(2 digits) —03 means the 3rd week.
<b>01</b> = Number representing the year in which the tire was manufactured.(2 digits) —01 means the year 2001. —Prior to July 2000, tire manufacturers were only required to have 1 number to represent the year in which the tire was manufactured. Example: 031 could represent the 3rd week of 1981 or 1991.

### Tire Loading and Tire Pressure

#### Tire Placard Location

**NOTE:** The proper cold tire inflation pressure for passenger cars is listed on either the face of the driver's door or the driver's side "B" pillar. For vehicles other than passenger cars, the cold tire inflation pressures are listed on either the shutface of the driver's door, the "B" pillar, the Certification Label or in the Tire Inflation Pressures brochure in the glove compartment.

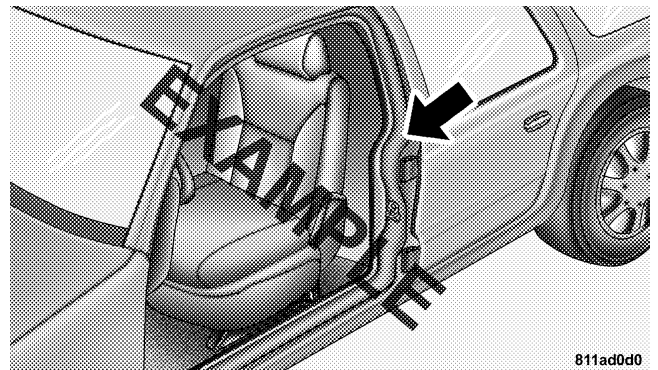

Tire Placard Location

### Tire and Loading Information Placard

TIRE AND LOADING INFORMATION			
SEATING CAPACITY - TOTAL 5 FRONT 2 REAR 3			
THE COMBINED WEIGHT OF OCCUPANTS AND CARGO SHOULD NEVER EXCEED XXX KG OR XXX LBS.			
TIRE	FRONT	REAR	SPARE
ORIGINAL TIRE SIZE	P195/70R14	P195/70R14	T125/70D15
COLD TIRE INFLATION PRESSURE	200kPa, 29PSI	200kPa, 29PSI	420kPa, 60PSI
SEE OWNER'S MANUAL FOR ADDITIONAL INFORMATION			4N109268

#### Tire and Loading Information

811b5a9a

This placard tells you important information about the:

- 1) number of people that can be carried in the vehicle
- 2) the total weight your vehicle can carry
- 3) the tire size designed for your vehicle
- 4) the cold tire inflation pressures for the front, rear and spare tires.

### Loading

The vehicle maximum load on the tire must not exceed the load carrying capacity of the tire on your vehicle. You will not exceed the tire's load carrying capacity if you adhere to the loading conditions, tire size and cold tire inflation pressures specified on the Tire and Loading Information placard and the Vehicle Loading section of this manual.

**NOTE:** Under a maximum loaded vehicle condition, gross axle weight ratings (GAWR's) for the front and rear axles must not be exceeded. For further information on GAWR's, vehicle loading and trailer towing, see the Vehicle Loading section of this manual.

To determine the maximum loading conditions of your vehicle, locate the statement "The combined weight of occupants and cargo should never exceed XXX kg or XXX lbs." on the Tire and Loading Information placard. The

combined weight of occupants, cargo/luggage and trailer tongue weight (if applicable) should never exceed the weight referenced here.

*Steps for Determining Correct Load Limit*

1. Locate the statement "The combined weight of occupants and cargo should never exceed XXX pounds" on your vehicle's placard.
2. Determine the combined weight of the driver and passengers that will be riding in your vehicle.
3. Subtract the combined weight of the driver and passengers from XXX kilograms or XXX pounds.
4. The resulting figure equals the available amount of cargo and luggage load capacity. For example, if "XXX" amount equals 1400 lbs. and there will be five 150 lb. passengers in your vehicle, the amount of available cargo and luggage load capacity is 650 lb. (since  $5 \times 150 = 750$ , and  $1400 - 750 = 650$  lb.)

5. Determine the combined weight of luggage and cargo being loaded on the vehicle. That weight may not safely exceed the available cargo and luggage load capacity calculated in step 4.

6. If your vehicle will be towing a trailer, load from your trailer will be transferred to your vehicle. Consult this manual to determine how this reduces the available cargo and luggage load capacity of your vehicle.

**NOTE:** The following table shows examples on how to calculate total load, cargo/luggage and towing capacities of your vehicle with varying seating configurations and number and size of occupants. This table is for illustration purposes only and may not be accurate for the seating and load carry capacity of your vehicle.

**NOTE:** For the following example the combined weight of occupants and cargo should never exceed 865 lbs. (392 Kg).

Occupants			Combined weight of occupants and cargo from Tire Placard	MINUS	Combined Occupant's weight	=	AVAILABLE Cargo/Luggage and Trailer Tongue Weight
TOTAL	FRONT	REAR					
<b>EXAMPLE 1</b>			865 lbs	minus	Occupant 1: 200 lbs Occupant 2: 130 lbs Occupant 3: 160 lbs Occupant 4: 100 lbs Occupant 5: 80 lbs TOTAL WEIGHT: 670 lbs	=	195 lbs
5	2	3					
<b>EXAMPLE 2</b>			865 lbs	minus	Occupant 1: 210 lbs Occupant 2: 180 lbs Occupant 3: 150 lbs TOTAL WEIGHT: 540 lbs	=	325 lbs
3	2	1					
<b>EXAMPLE 3</b>			865 lbs	minus	Occupant 1: 200 lbs Occupant 2: 200 lbs TOTAL WEIGHT: 400 lbs	=	465 lbs
2	2	0					

811a4d11

**WARNING!**

Overloading of your tires is dangerous. Overloading can cause tire failure, affect vehicle handling, and increase your stopping distance. Use tires of the recommended load capacity for your vehicle. Never overload them.

**TIRES—GENERAL INFORMATION****Tire Pressure**

Proper tire inflation pressure is essential to the safe and satisfactory operation of your vehicle. Three primary areas are affected by improper tire pressure:

**1. Safety—****WARNING!**

Improperly inflated tires are dangerous and can cause accidents.

- Under inflation increases tire flexing and can result in tire failure.
- Over inflation reduces a tire's ability to cushion shock. Objects on the road and chuck holes can cause damage that results in tire failure.
- Unequal tire pressures can cause steering problems. You could lose control of your vehicle.
- Over inflated or under inflated tires can affect vehicle handling and can fail suddenly, resulting in loss of vehicle control.
- Unequal tire pressures from one side of the vehicle to the other can cause the vehicle to drift to the right or left.

Always drive with each tire inflated to the recommended cold tire inflation pressure.



### 2. *Economy*—

Improper inflation pressures can cause uneven wear patterns to develop across the tire tread. These abnormal wear patterns will reduce tread life resulting in a need for earlier tire replacement. Underinflation also increases tire rolling resistance and results in higher fuel consumption.

### 3. *Ride Comfort and Vehicle Stability*—

Proper tire inflation contributes to a comfortable ride. Overinflation produces a jarring and uncomfortable ride.

#### **Tire Inflation Pressures**

The proper cold tire inflation pressure for passenger cars is listed on either the face of the driver's door or the driver's side "B" pillar. For vehicles other than passenger cars, the cold tire inflation pressures are listed on either the "B" pillar, the Certification Label or in the Tire Inflation Pressures brochure in the glove compartment.

Some vehicles may have Supplemental Tire Pressure Information for vehicle loads that are less than the

maximum loaded vehicle condition. These pressure conditions will be found in the "Supplemental Tire Pressure Information" section of this manual.

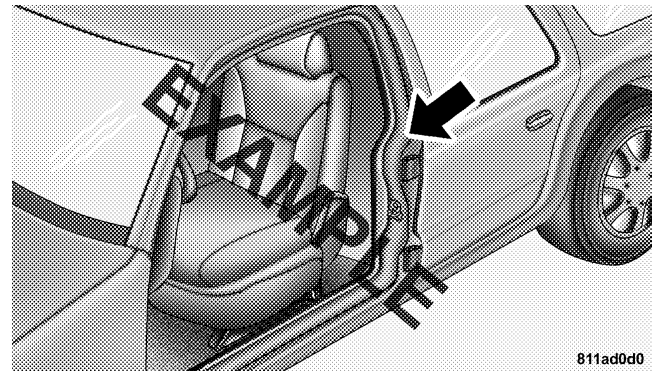

**Tire Placard Location**

The pressure should be checked and adjusted as well as inspecting for signs of tire wear or visible damage at least once a month. Use a good quality pocket-type gauge to

check tire pressure. Do not make a visual judgement when determining proper inflation. Radial tires may look properly inflated even when they are under inflated.

**CAUTION!**

**After inspecting or adjusting the tire pressure always reinstall the valve stem cap—if equipped. This will prevent moisture and dirt from entering the valve stem, which could damage the valve stem.**

Inflation pressures specified on the placard are always “cold tire inflation pressure”. Cold tire inflation pressure is defined as the tire pressure after the vehicle has not been driven for at least 3 hours, or driven less than 1 mile (1 km) after a 3 hour period. The cold tire inflation pressure must not exceed the maximum inflation pressure molded into the tire side wall.

Check tire pressures more often if subject to a wide range of outdoor temperatures, as tire pressures vary with temperature changes.

Tire pressures change by approximately 1 psi (7 kPa) per 12° F (7° C) of air temperature change. Keep this in mind when checking tire pressure inside a garage especially in the winter.

Example: If garage temperature = 68° F (20° C) and the outside temperature = 32° F (0° C) then the cold tire inflation pressure should be increased by 3 psi (21 kPa), which equals 1 psi (7 kPa) for every 12° F (7° C) for this outside temperature condition.

Tire pressure may increase from 2 to 6 psi (13 to 40 kPa) during operation. DO NOT reduce this normal pressure build up or your tire pressure will be too low.

**Tire Pressures for High Speed Operation**

The manufacturer advocates driving at safe speeds within posted speed limits. Where speed limits or conditions are such that the vehicle can be driven at high speeds, maintaining correct tire inflation pressure is very important. Increased tire pressure and reduced vehicle loading may be required for high speed vehicle operation. Refer to original equipment or an authorized tire dealer for recommended safe operating speeds, loading and cold tire inflation pressures.

**WARNING!**

**High speed driving with your vehicle under maximum load is dangerous. The added strain on your tires could cause them to fail. You could have a serious accident. Don't drive a vehicle loaded to the maximum capacity at continuous speeds above 75 mph (120 km/h).**

### Radial-Ply Tires

**WARNING!**

Combining radial ply tires with other types of tires on your vehicle will cause your vehicle to handle poorly. The instability could cause an accident. Always use radial ply tires in sets of four (or 6, in case of trucks with dual rear wheels). Never combine them with other types of tires.

Cuts and punctures in radial tires are repairable only in the tread area because of sidewall flexing. Consult your authorized tire dealer for radial tire repairs.

### Compact Spare Tire — If Equipped

The compact spare is for temporary emergency use with radial tires. It is engineered to be used on your style vehicle only. Since this tire has limited tread life, the original tire should be repaired (or replaced) and reinstalled at the first opportunity.

**WARNING!**

Temporary use spare tires are for emergency use only. With these tires, do not drive more than 50 mph (80 km/h). Temporary-use spare tires have limited tread life. When two or more tread wear indicators appear in adjacent grooves, the temporary use spare tire needs to be replaced. Be sure to follow the warnings which apply to your spare. Failure to do so could result in spare tire failure and loss of vehicle control.

Do not install a wheel cover or attempt to mount a conventional tire on the compact spare wheel, since the wheel is designed specifically for the compact spare.

Do not install more than one compact spare tire/wheel on the vehicle at any given time.

**CAUTION!**

**Because of the reduced ground clearance, do not take your vehicle through an automatic car wash with the compact spare installed. Damage to the vehicle may result.**

**Limited Use Spare — If Equipped**

The limited use spare tire is for temporary emergency use on your vehicle. This tire is identified by a limited use spare tire warning label located on the limited use spare tire and wheel assembly. This tire may look like the original equipped tire on the front or rear axle of your vehicle, but it is not. Installation of this limited use spare tire affects vehicle handling. Since it is not the same tire, replace (or repair) the original tire and reinstall on vehicle at the first opportunity.

**WARNING!**

The limited use spare tires are for emergency use only. Installation of this limited use spare tire affects vehicle handling. With this tire, do not drive more than 60 mph (100 km/h). Keep inflated to the cold tire inflation pressure listed on either your tire placard or limited use spare tire and wheel assembly. Replace (or repair) the original tire at the first opportunity and reinstall it on your vehicle. Failure to do so could result in loss of vehicle control.

**Tire Spinning**

When stuck in mud, sand, snow, or ice conditions, do not spin your vehicle's wheels above 35 mph (55 km/h).

See the paragraph on Freeing A Stuck Vehicle in Section 6 of this manual.

**WARNING!**

Fast spinning tires can be dangerous. Forces generated by excessive wheel speeds may cause tire damage or failure. A tire could explode and injure someone. Do not spin your vehicle's wheels faster than 35 mph (55 km/h) when you are stuck. And don't let anyone near a spinning wheel, no matter what the speed.

### Tread Wear Indicators

Tread wear indicators are in the original equipment tires to help you in determining when your tires should be replaced.

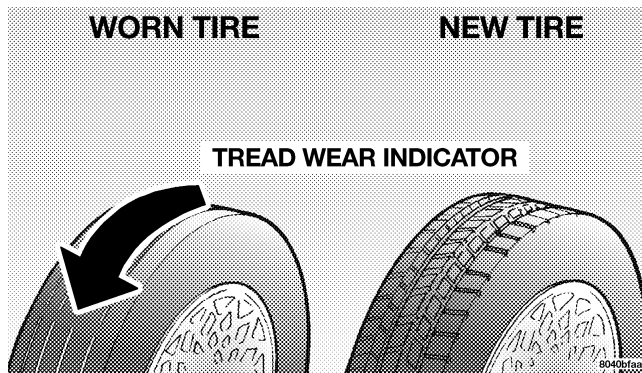

These indicators are molded into the bottom of the tread grooves and will appear as bands when the tread depth becomes 1/16 inch (2 mm). When the indicators appear in 2 or more adjacent grooves, the tire should be replaced.

Many states have laws requiring tire replacement at this point.

### Replacement Tires

The tires on your new vehicle provide a balance of many characteristics. They should be inspected regularly for wear and correct cold tire inflation pressure. The manufacturer strongly recommends that you use tires equivalent to the originals in size, quality and performance when replacement is needed (see the paragraph on tread wear indicators). Refer to the Tire and Loading Information placard for the size designation of your tire. The service description and load identification will be found on the original equipment tire. Failure to use equivalent replacement tires may adversely affect the safety, handling, and ride of your vehicle. We recommend that you contact your original equipment or an authorized tire dealer with any questions you may have on tire specifications or capability.

#### WARNING!

- Do not use a tire, wheel size or rating other than that specified for your vehicle. Some combinations of unapproved tires and wheels may change suspension dimensions and performance characteristics, resulting in changes to steering, handling, and braking of your vehicle. This can cause unpredictable handling and stress to steering and suspension components. You could lose control and have an accident resulting in serious injury or death. Use only the tire and wheel sizes with load ratings approved for your vehicle.
- Never use a tire with a smaller load index or capacity, other than what was originally equipped on your vehicle. Using a tire with a smaller load index could result in tire overloading and failure. You could lose control and have an accident.
- Failure to equip your vehicle with tires having adequate speed capability can result in sudden tire failure and loss of vehicle control.



**CAUTION!**

Replacing original tires with tires of a different size may result in false speedometer and odometer readings.

**Alignment And Balance**

Poor suspension alignment may result in:

- Fast tire wear.
- Uneven tire wear, such as feathering and one-sided wear.
- Vehicle pull to right or left.

Tires may also cause the vehicle to pull to the left or right. Alignment will not correct this condition. See your dealer for proper diagnosis.

Improper alignment will not cause vehicle vibration. Vibration may be a result of tire and wheel out-of-balance. Proper balancing will reduce vibration and avoid tire cupping and spotty wear.

**SUPPLEMENTAL TIRE PRESSURE INFORMATION****5**

A light load vehicle condition is defined as two passengers (150 lbs (68 kg) each) plus 200 lbs (91kg) of cargo. Cold tire inflation pressures for a lightly loaded vehicle will be found on a "Supplemental Tire Pressure Inflation" label located on the face of the driver's door or in the Tire Information Pressures pamphlet in the glove box.

**TIRE CHAINS**

Use "Class S" chains on 1500 Ram Trucks, or other traction aids that meet SAE Type "S" specifications.

Use "Class U" chains on 2500/3500 Ram Trucks, or other traction aids that meet SAE Type "U" specifications.

**NOTE:** Chains must be the proper size for the vehicle, as recommended by the chain manufacturer.

**CAUTION!**

To avoid damage to your vehicle, tires or chains, observe the following precautions:

- Because of limited chain clearance between tires and other suspension components, it is important that only chains in good condition are used. Broken chains can cause serious vehicle damage. Stop the vehicle immediately if noise occurs that could suggest chain breakage. Remove the damaged parts of the chain before further use.
- Install chains as tightly as possible and then retighten after driving about 1/2 mile (0.8 km).
- Do not exceed 45 mph (72 km/h).
- Drive cautiously and avoid severe turns and large bumps, especially with a loaded vehicle.
- Do not install tire chains on front wheels of 4x2 vehicles.
- Do not drive for a prolonged period on dry pavement.
- Observe the tire chain manufacturer's instructions on method of installation, operating speed, and conditions for usage. Always use the lower suggested operating speed of the chain manufacturer if different than the speed recommended by the manufacturer.

These cautions apply to all chain traction devices, including link and cable (radial) chains.

Tire chain use is permitted only on the rear tires of Ram 4X2 trucks.

**NOTE:** The use of class “S” chains is permitted on 1500 Ram Trucks with P245/70R17 tires only.

**NOTE:** The use of class “U” chains is permitted on the front and rear of 4X4, 2500 Ram Trucks with LT245/70R17E tires.

**NOTE:** The use of class “U” chains is permitted on the front and rear of 4X4, 3500 Ram Trucks with Dual Rear Wheels and LT235/80R17E tires.

**NOTE:** On 4X2 2500/3500 Ram Trucks, class “U” snow chains are permitted on the rear wheels only of vehicles equipped with LT245/70R17, LT265/70R17, and LT235/80R17 size tires.

**NOTE:** On 4x4 2500/3500 SRW (Single Rear Wheel) Ram Trucks, class “U” snow chains are permitted on the rear wheels only of vehicles equipped with LT265/70R17E.

#### CAUTION!

**Do not use tire chains on 4x4 Ram trucks equipped with P265/70R17, LT275/70R17, P275/60R20, or P275/55R20 tires. There may not be adequate clearance for the chains and you are risking structural or body damage to your vehicle. Do not use tire chains on the 4X2 front wheels of 2500/3500 SRW (Single Rear Wheels) equipped with LT245/70R17, LT265/70R17 LT235/80R17 tires or 4X4 front wheels of Ram Trucks equipped with LT265/70R17E. There may not be adequate clearance for the chains and you are risking structural or body damage to your vehicle.**

**SNOW TIRES**

Snow tires should be of the same size and type construction as the front tires. Consult the manufacturer of the snow tire to determine any maximum vehicle speed requirement associated with the tire. These tires should always be operated at the vehicle maximum capacity inflation pressures under any load condition.

While studded tires improve performance on ice, skid and traction capability on wet or dry surfaces may be poorer than that of non-studded tires. Some states prohibit studded tires; therefore, local laws should be checked before using these tire types.

**TIRE ROTATION RECOMMENDATIONS**

Tires on the front and rear axles of vehicles operate at different loads and perform different steering, driving, and braking functions. For these reasons, they wear at unequal rates, and develop irregular wear patterns. These effects can be reduced by timely rotation of tires. The benefits of rotation are especially worthwhile with aggressive tread designs such as those on On/Off Road type tires. Rotation will increase tread life, help to maintain mud, snow, and wet traction levels, and contribute to a smooth, quiet ride.

Follow the recommended tire rotation frequency for your type of driving found in the "Maintenance Schedules" Section of this manual. More frequent rotation is permissible if desired. The reasons for any rapid or unusual wear should be corrected prior to rotation being performed.

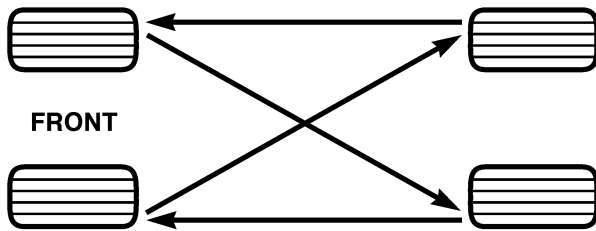

8031e864

**NOTE:** On Canadian vehicles only, if your Ram truck is equipped with All-Season type tires on the front and ON/OFF Road type tires mounted on the rear, do not use a front to back rotation pattern. Instead, rotate your tires side to side at the recommended intervals.

**Dual Rear Wheels**

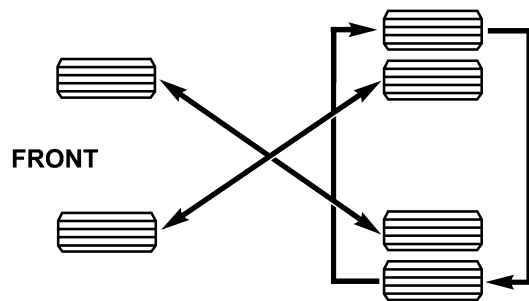

80f55fea

The tires used on dual wheel assemblies should be matched for wear to prevent overloading one tire in a set. To check if tires are even, lay a straight edge across all four tires. The straight edge should touch all the tires.

**CAUTION!**

3500 Dual Rear Tires have only one approved direction of rotation. This is to accommodate the asymmetrical design (tread pattern) of the ON/OFF road tire and the use of Outline White Letter (OWL) tires.

- When replacing a flat, the spare tire may have to be remounted on the rim or installed at a different location to maintain the correct placement of the tire on the wheel relative to the tire/wheel position on the truck. For example, if the spare is used to replace an outer rear tire it will have to be remounted on the rim so that the wheel is dished inward. That way the tread design of asymmetrical tires and the white writing of the OWL tires will maintain proper position.

**FUEL REQUIREMENTS**

3.7L/4.7L  
Engines

All engines (except 5.7L engines) are designed to meet all emissions regulations and provide excellent fuel economy and performance when using high quality unleaded "regular" gasoline having an octane rating of 87. The routine use of premium gasoline is not recommended.

Under normal conditions the use of premium fuel will not provide a benefit over high quality regular gasolines and in some circumstances may result in poorer performance.



5.7L Engines

The 5.7L engine is designed to meet all emissions regulations and provide satisfactory fuel economy and performance when using high quality unleaded gasoline having an octane range of 87 to 89. The manufacturer recommends the use of 89 octane for optimum performance. The routine use

of premium gasoline is not recommended. The use of premium gasoline will provide no benefit over high quality regular and mid-grade gasolines, and in some circumstances may result in poorer performance.

Light spark knock at low engine speeds is not harmful to your engine. However, continued heavy spark knock at high speeds can cause damage and immediate service is required.

Poor quality gasoline can cause problems such as hard starting, stalling and hesitations. If you experience these symptoms, try another brand of "regular" gasoline before considering service for the vehicle.

Over 40 auto manufacturers world-wide have issued and endorsed consistent gasoline specifications (the World-wide Fuel Charter, WWFC) to define fuel properties necessary to deliver enhanced emissions, performance

and durability for your vehicle. We recommend the use of gasolines that meet the WWFC specifications if they are available.

#### **Reformulated Gasoline**

Many areas of the country require the use of cleaner burning gasoline referred to as "Reformulated Gasoline." Reformulated gasolines contain oxygenates, and are specifically blended to reduce vehicle emissions and improve air quality.

We strongly support the use of reformulated gasolines. Properly blended reformulated gasolines will provide excellent performance and durability for the engine and fuel system components.

**Gasoline/Oxygenate Blends**

Some fuel suppliers blend unleaded gasoline with oxygenates such as 10% ethanol, MTBE and ETBE. Oxygenates are required in some areas of the country during the winter months to reduce carbon monoxide emissions. Fuels blended with these oxygenates may be used in your vehicle.

**CAUTION!**

**DO NOT use gasolines containing METHANOL. Gasoline containing methanol may damage critical fuel system components.**

**MMT In Gasoline**

MMT is a manganese-containing metallic additive that is blended into some gasoline to increase octane. Gasolines blended with MMT provide no performance advantage beyond gasolines of the same octane number without MMT. Gasolines blended with MMT reduce spark plug life and reduce emission system performance. We recommend that gasolines free of MMT be used in your vehicle. The MMT content of gasoline may not be indicated on the gasoline pump; therefore, you should ask your gasoline retailer whether or not his/her gasoline contains MMT.

It is even more important to look for gasolines without MMT in Canada because MMT can be used at levels higher than allowed in the United States. MMT is prohibited in Federal and California reformulated gasolines.



**Materials Added To Fuel**

All gasolines sold in the United States are required to contain effective detergent additives. Use of additional detergents or other additives is not needed under normal conditions and would result in unnecessary cost. Therefore, you should not have to add anything to the fuel.

**ADDING FUEL**

**NOTE:** If fuel is poured from a portable container, the container should have a flexible nozzle long enough to extend into the fuel filler tube.

**CAUTION!**

To avoid fuel spillage and overfilling, do not “top off” the fuel tank after filling.

**NOTE:** When the fuel nozzle “clicks” or shuts off, the fuel tank is full.

**NOTE:** Tighten the gas cap until you hear a “clicking” sound. This is an indication that the gas cap is properly tightened. Make sure that the gas cap is tightened each time the vehicle is refueled.

**WARNING!**

A fire may result if gasoline is pumped into a portable container that is inside of a vehicle or on a truck bed. You could be burned. Always place gas containers on the ground while filling.

**Fuel Filler Cap (Gas Cap)**

The gas cap is behind the fuel filler door. If the gas cap is lost or damaged, be sure the replacement cap is for use with this vehicle.

**NOTE:** After fuel is added, the vehicle diagnostic system can determine if the fuel filler cap is loose, improperly installed, or damaged. A loose fuel filler cap message will be displayed in the instrument cluster. Tighten the gas cap until a "clicking" sound is heard. This is an indication that the gas cap is properly tightened. Press the odometer reset button to turn the message off. If the problem persists, the message will appear the next time the vehicle is started. This might indicate a damaged cap. If the problem is detected twice in a row, the system will turn on the Malfunction Indicator Light (MIL). Resolving the problem will turn the MIL light off.

**CAUTION!**

Damage to the fuel system or emission control system could result from using an improper fuel tank filler tube cap (gas cap). A poorly fitting cap could let impurities into the fuel system.

**WARNING!**

- Remove the fuel tank filler tube cap (gas cap) slowly to prevent fuel spray from the filler neck which may cause injury.
- The volatility of some gasolines may cause a buildup of pressure in the fuel tank that may increase while you drive. This pressure can result in a spray of gasoline and/or vapors when the cap is removed from a hot vehicle. Removing the cap slowly allows the pressure to vent and prevents fuel spray.
- Never allow any lit smoking materials near the vehicles while removing the cap or filling the tank.
- Never add fuel to the vehicle when the engine is running.

**Fuel System Cautions****CAUTION!**

Follow these guidelines to maintain your vehicle's performance:

- The use of leaded gas is prohibited by Federal law. Using leaded gasoline can impair engine performance, damage the emission control system.
- An out-of-tune engine, or certain fuel or ignition malfunctions, can cause the catalytic converter to overheat. If you notice a pungent burning odor or some light smoke, your engine may be out of tune or malfunctioning and may require immediate service. Contact your dealer for service assistance.

- When pulling a heavy load or driving a fully loaded vehicle when the humidity is low and the temperature is high, use a premium unleaded fuel to help prevent spark knock. If spark knock persists, lighten the load, or engine piston damage may result.
- The use of fuel additives which are now being sold as octane enhancers is not recommended. Many of these products contain high concentrations of methanol. Fuel system damage or vehicle performance problems resulting from the use of such fuels or additives is not the responsibility of the manufacturer.

**NOTE:** Intentional tampering with emissions control systems can result in civil penalties being assessed against you.

### Carbon Monoxide Warnings

WARNING!
<p><b>Carbon monoxide (CO) in exhaust gases is deadly. Follow the precautions below to prevent carbon monoxide poisoning:</b></p>
<ul style="list-style-type: none"><li>• Do not inhale exhaust gases. They contain carbon monoxide, a colorless and odorless gas which can kill. Never run the engine in a closed area, such as a garage, and never sit in a parked vehicle with the engine running for an extended period. If the vehicle is stopped in an open area with the engine running for more than a short period, adjust the ventilation system to force fresh, outside air into the vehicle.</li></ul>

- Guard against carbon monoxide with proper maintenance. Have the exhaust system inspected every time the vehicle is raised. Have any abnormal conditions repaired promptly. Until repaired, drive with all side windows fully open.
- Keep the liftgate closed when driving your vehicle to prevent carbon monoxide and other poisonous exhaust gases from entering the vehicle.

### FLEXIBLE FUEL—(Fleet Vehicles Only)

#### E-85 General Information

The information in this section is for Flexible Fuel vehicles only. These vehicles can be identified by the unique fuel filler door label that states **Ethanol (E-85) or Unleaded Gasoline Only**. This section only covers those subjects that are unique to these vehicles. Please refer to the other sections of this manual for information on features that are common between Flexible Fuel and gasoline only powered vehicles.

#### CAUTION!

**Only vehicles with the E-85 fuel filler door label can operate on E-85.**

#### ETHANOL FUEL (E-85)

E-85 is a mixture of approximately 85% fuel ethanol and 15% unleaded gasoline.

#### WARNING!

**Ethanol vapors are extremely flammable and could cause serious personal injury. Never have any smoking materials lit in or near the vehicle when removing the fuel filler tube cap (gas cap) or filling the tank. Do not use E-85 as a cleaning agent and never use it near an open flame.**

**Fuel Requirements**

Your vehicle will operate on both unleaded gasoline with an octane rating of 87, or E-85 fuel, or any mixture of these two.

For best results, a refueling pattern that alternates between E-85 and unleaded gasoline should be avoided. When you do switch fuels, it is recommended that

- you do not switch when the fuel gauge indicates less than 1/4 full
- you do not add less than 5 gallons when refueling
- you operate the vehicle immediately after refueling for a period of at least 5 minutes

Observing these precautions will avoid possible hard starting and/or significant deterioration in drivability during warm up.

**NOTE:** When the ambient temperature is above 90°F, you may experience hard starting and rough idle following start up even if the above recommendations are followed.

**Selection Of Engine Oil For Flexible Fuel Vehicles (E-85) and Gasoline Vehicles**

Whether operating the vehicle on an E-85 ethanol fuel or unleaded gasoline the engine oil requirements are the same. Refer to the "Maintenance Procedures" section of this manual for the proper quality and viscosity engine oil. (See page 355 for more information.)

**Starting**

The characteristics of E-85 fuel make it unsuitable for use when ambient temperatures fall below 0°F. In the range of 0°F to 32°F, you may experience an increase in the time it takes for your engine to start, and a deterioration in drivability (sags and/or hesitations) until the engine is fully warmed up.

**Cruising Range**

Because E-85 fuel contains less energy per gallon than gasoline, you will experience an increase in fuel consumption. You can expect your MPG and your driving range to decrease by about 30% compared to gasoline operation.

**Replacement Parts**

Many components in your Flexible Fuel Vehicle (FFV) are designed to be compatible with ethanol. Always be sure that your vehicle is serviced with correct ethanol compatible parts.

**CAUTION!**

**Replacing fuel system components with non-ethanol compatible components can damage your vehicle.**

**Maintenance**

If you operate the vehicle using E-85 fuel, follow Schedule B in the maintenance schedule section of this manual.

**CAUTION!**

**Do not use ethanol mixture greater than 85% in your vehicle. It will cause difficulty in cold starting and may affect driveability.**

**5****CATALYTIC CONVERTER**

The catalytic converter requires the use of unleaded fuel only. Leaded gasoline will destroy the effectiveness of the catalyst as an emission control device. Under normal operating conditions, the catalytic converter will not require maintenance. However, you must keep the engine maintained to assure proper operation and prevent possible damage.

**NOTE:** Intentional tampering with emissions control systems can result in civil penalties being assessed against you.

**CAUTION!**

**Damage to the catalytic converter can result if your vehicle is not kept in proper operating condition. In the event of engine malfunction, particularly involving engine misfire or other apparent loss of performance, have your vehicle serviced promptly. Continued operation of your vehicle with a severe malfunction could cause the converter to overheat, resulting in possible damage to the converter and vehicle.**

As with any vehicle, do not park or operate this vehicle in areas where combustible materials such as grass or leaves can come in contact with a hot exhaust system.

A scorching odor may be detected if you continue to run a malfunctioning engine. The odor may indicate severe and abnormal catalyst overheating. If this occurs, the vehicle should be stopped, the engine shut off and the vehicle allowed to cool. Service, including a tune-up to manufacturer's specifications should be obtained immediately.

**To minimize the possibility of catalyst damage:**

- Do not try to start the engine by pushing or towing the vehicle.
- Do not idle the engine with any spark plug wires disconnected or removed.
- Do not idle the engine for prolonged periods during very rough idle or malfunctioning operating conditions.
- Do not allow vehicle to run out of fuel.



## VEHICLE LOADING

### Certification Label

As required by National Highway Traffic Safety Administration Regulations, your vehicle has a certification label affixed to the driver's side door or pillar.

This label contains the month and year of manufacture, Gross Vehicle Weight Rating (GVWR), Gross Axle Weight Rating (GAWR) front and rear, and Vehicle Identification Number (VIN). A Month-Day-Hour (MDH) number is included on this label and indicates the Month, Day and Hour of manufacture. The bar code that appears on the bottom of the label is your Vehicle Identification Number (VIN).

### Gross Vehicle Weight Rating (GVWR)

The GVWR is the total permissible weight of your vehicle including driver, passengers, vehicle, options and cargo. The label also specifies maximum capacities of front and

rear axle systems (GAWR). Total load must be limited so GVWR and front and rear GAWR are not exceeded.

### Payload

The payload of a vehicle is defined as the allowable load weight a truck can carry, including the weight of the driver, all passengers, options and cargo.

### Gross Axle Weight Rating (GAWR)

The GAWR is the maximum permissible load on the front and rear axles. The load must be distributed in the cargo area so that the GAWR of each axle is not exceeded.

Each axle GAWR is determined by the components in the system with the lowest load carrying capacity (axle, springs, tires or wheels). Heavier axles or suspension components sometimes specified by purchasers for increased durability does not necessarily increase the vehicle's GVWR.

**Tire Size**

This is the minimum allowable tire size for your vehicle. Replacement tires must be equal to the load capacity of this tire size.

**Rim Size**

This is the rim size that is appropriate for the tire size listed.

**Inflation Pressure**

This is the cold tire inflation pressure for your vehicle for all loading conditions up to full GAWR.

**Curb Weight**

The curb weight of a vehicle is defined as the total weight of the vehicle with all fluids, including vehicle fuel, at full capacity conditions, and with no occupants or cargo loaded into the vehicle. The front and rear curb weight values are determined by weighing your vehicle on a commercial scale before any occupants or cargo are added.

**Loading**

The actual total weight and the weight of the front and rear of your vehicle at the ground can best be determined by weighing it when it is loaded and ready for operation.

The entire vehicle should first be weighed on a commercial scale to insure that the GVWR has not been exceeded. The weight on the front and rear of the vehicle should then be determined separately to be sure that the load is properly distributed over front and rear axle. Weighing the vehicle may show that the GAWR of either the front or rear axles has been exceeded but the total load is within the specified GVWR. If so, weight must be shifted from front to rear or rear to front as appropriate until the specified weight limitations are met. Store the heavier items down low and be sure that the weight is distributed equally. Stow all loose items securely before driving.

Improper weight distributions can have an adverse effect on the way your vehicle steers and handles and the way the brakes operate.

**CAUTION!**

Do not load your vehicle any heavier than the GVWR or the maximum front and rear GAWR. If you do, parts on your vehicle can break, or it can change the way your vehicle handles. This could cause you to lose control. Also overloading can shorten the life of your vehicle.

An EXAMPLE of a loaded vehicle is shown in the following chart. Note that neither GVWR nor GAWR capabilities are exceeded. Overloading can cause potential safety hazards and shorten service life.

**NOTE:** The weights shown in this chart are not necessarily the weights for your vehicle. Also, the amount of load added to both the front and rear axles can be computed after the vehicle has been weighed both in its "curb weight" condition, and in its "loaded and ready for operation" condition.

Gross Vehicle Weight Rating (GVWR) 6500 LBS.

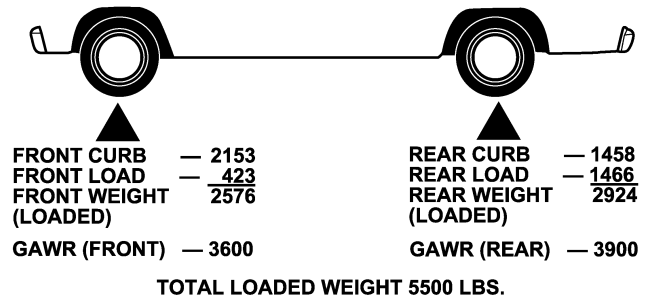

### TRAILER TOWING

All Dodge Ram Pickup trucks are intended to tow trailers up to 2,000 lbs (907 kg) without added equipment or alterations to standard equipment. Your vehicle may be factory equipped for safe towing of trailers weighing over 2,000 lbs (907 kg) with the optional Trailer Tow Prep Package. See your Dodge dealer for package content.

#### Definitions

The following trailer towing related terminology definitions will assist in understanding the subsequent sections:

#### GROSS COMBINATION WEIGHT RATING (GCWR)

is the total permissible weight of your vehicle and trailer when weighed in combination. (Note that GCWR ratings include a 150 lb (68 kg) allowance for the presence of a driver.) Tongue Weight (of a trailer) is the weight placed on a vehicle's trailer hitch by the trailer.

**GROSS TRAILER WEIGHT (GTW)** is the weight of the trailer plus the weight of all cargo, consumables and equipment (permanent or temporary) loaded in or on the trailer in its "loaded and ready for operation" condition.

**TRAILER SWAY CONTROL** is a telescoping link that can be installed between the hitch receiver and the trailer tongue that typically provides adjustable friction associated with the telescoping motion to dampen any unwanted trailer swaying motions while traveling.

#### CAUTION!

- During the first 500 miles (805 km) your new vehicle is driven, do not tow a trailer. Doing so may damage your vehicle.
- When first towing a trailer, limit your speed to 50 mph (80 km/h) during the first 500 miles (805 km) of towing.

Consider the following items when computing the weight on the rear axle:

- the tongue weight of the trailer
- the weight of any other type of cargo or equipment put in or on your vehicle

**NOTE:** Remember that everything put into or on the trailer adds to the load on your vehicle. Also, additional factory-installed options, or dealer-installed options, must be considered as part of the total load on your vehicle. Refer to the Certification label located at the driver's door for the Gross Vehicle Weight Rating.

### WARNING!

**Improper towing can lead to an injury accident. Follow these guidelines to make your trailer towing as safe as possible:**

Perform the maintenance listed in the "Maintenance Schedules" section of this manual (Section 8). When towing a trailer, never exceed the Gross Axle Weight Rating (GAWR), or Gross Combined Vehicle Weight (GCVW).

### CAUTION!

**When hauling cargo or towing a trailer, do not overload your vehicle or trailer. Overloading can cause a loss of control, poor performance or damage to brakes, axle, engine, transmission, steering, suspension, body structure or tires.**

### Axle Lubricant and Trailer Towing

#### 1500 Models

- **1500 Model** rear axles are trailer tow ready. Limited slip rear axles on 1500 models require the use of a limited slip additive (refer to the “Recommended Fluids, Lubricants, and Genuine Parts” section.)
- The limited slip additive is included with the factory fill.
- If the axle fluid is changed, 4 oz. (118 ml) of limited slip additive must be added.

#### 2500/3500 Models

- **The Axles on 2500/3500 Models** are trailer tow ready and **DO NOT REQUIRE** any special axle lubes or additives.

### Trailer Towing Recommendations

- All trailer hitches should be professionally installed on your vehicle.
- Safety chains must always be used between your vehicle and trailer.
- Do **not** interconnect the hydraulic brake system or vacuum system of your vehicle with that of the trailer. This could cause inadequate braking and possible personal injury. An electrically-actuated electric trailer brake controller is recommended.
- Trailer brakes are recommended for trailers over 1000 lbs (454 kg) and are required for trailers in excess of 2,000 lbs (907 kg)
- Use an approved wiring harness connector on the trailer. Standard equipment on all RAM pickup models provides a 4-way trailer tow connector located

under the bumper. This connector contains the following vehicle circuits: park/tail lamps, left stop/turn lamp, right stop/turn lamp, and ground. With the optional Trailer Tow Prep package a 7-way connector is provided with the following additional circuits: backup lamp, trailer battery and electric brake.

**NOTE:** Connect trailer lighting and brakes using factory harnesses only. Do not cut or splice wiring to the brake circuits.

- Be sure the trailer is loaded heavier in front, with 60% to 65% of the weight in front of the axle(s). Loads balanced over the wheels or heavier in the rear can cause the trailer to sway severely side to side which will cause loss of control of vehicle and trailer. Failure to load trailers heavier in front is the cause of many trailer accidents. (For a "5th Wheel" style trailer, this range of loading on the "King Pin" should be between 15% and 25%.)

- Make certain that the load is secured in the trailer and will not shift during travel. When towing cargo such as livestock, dynamic load shifts can occur that require the driver to maintain attention.

#### **Trailer Towing — Hitches**

With a Class I Hitch, your vehicle can be equipped to tow trailers with a Gross Trailer Weight (GTW) of 2,000 lbs (907 kg) maximum.

With a Class II Hitch, your vehicle can be equipped to tow trailers with a Gross Trailer Weight (GTW) of 3,500 lbs (1 587 kg ) maximum. Tongue weight must be equal to at least 10% of GTW, but no more than 15% of GTW.

With a Class III Hitch, your vehicle can be equipped to tow trailers with a Gross Trailer Weight (GTW) of 5,000 lbs (2 268 kg) maximum. Factory-installed rear step bumpers are rated a Class III hitch.

A frame mounted hitch of up to Class IV rating, as rated by the hitch manufacturer, may also be installed. With a Class IV Hitch, you can tow a trailer with a Gross Trailer Weight of up to 12,000 lbs (5 443 kg) maximum depending on your vehicle equipment.

#### **Connecting Trailer Lighting And Electric Trailer Brakes**

**NOTE:** A 4-way trailer tow connector, located behind the bumper, is standard equipment on all Ram pickup models. This connector contains the following vehicle circuits: park/tail lamps, left stop/turn lamp, right stop/turn lamp, and ground. With the optional Trailer Tow Prep package a 7-way connector is also provided with the following additional circuits: backup lamp, trailer battery and electric brake.

**NOTE:** There is also a 4-way connector located under the instrument panel, located to the left of the brake pedal that is used for the electric brake. This connector

contains the following vehicle circuits; power ground, battery, stop lamp switch and electric brake feed. The 4-way is optional with the trailer tow prep package.

#### **CAUTION!**

**Adding lights or electrical devices to the headlamp/park lamp circuit can be accomplished by connecting to the standard 4-way trailer tow connector located behind the rear bumper. The maximum current capacity for the park lamp circuit should not exceed 15 amps total (a typical park lamp bulb can draw from 0.5 to 1.0 amperes of current).**

**No connections can be made to the headlamp switch itself, because it is not designed for high current applications. Connections to the headlamp switch will cause the exterior lights to malfunction.**



**CAUTION!**

Connect trailer lighting and brakes using factory harnesses only. Do not cut or splice wiring to the brake circuits. Use an approved wiring harness connector on the trailer.

**Trailer Weight and Trailer Tongue Weight**

Gross Trailer Weight (GTW) means the weight of the trailer plus the weight of all cargo, consumables and equipment loaded on the trailer when in actual under-way towing condition. The recommended way to measure GTW is to put your fully loaded trailer on a vehicle scale. The entire weight of the trailer must be supported by the scale.

Tongue Weight is the weight placed on the vehicle's trailer hitch by the trailer. Always load a trailer with 60%

to 65% of the weight in the front of the trailer. This places 10% to 15% of the GTW on the tow hitch of your vehicle.

Trailer sway control and equalizing hitch are required for Class III or IV trailer hitches and tongue weights above 350 lbs (159 kg).

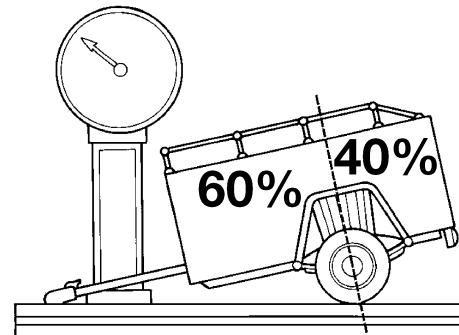

Tongue weight must be equal to at least 10% of GTW, but no more than 15% of GTW.

Also, there are maximum tongue weight ratings that are not to be exceeded, as follows:

- Class III (the bumper ball type) 500 lbs (227 kg)
- Class IV (the receiver hitch type) 1200 lbs (544 kg)

**NOTE:** When towing a trailer, the following requirements must be adhered to:

- GCWR must not be exceeded
- Total weight must be distributed between the tow vehicle and the trailer such that the following four (4) ratings are not exceeded:
  1. GVWR
  2. GTW
  3. Tongue weight rating for the trailer hitch utilized (This requirement may limit the ability to always achieve the 10% to 15% range of tongue weight [15% to 25% for a "5th Wheel" style trailer] as a percentage of total trailer weight.)
  4. GAWR ratings

#### 4. GAWR ratings

##### **Trailer Towing Information (Maximum Trailer Weight Ratings)**

##### **"Trailer Towing Guide"**

**NOTE:** For trailer towing information (maximum trailer weight ratings) refer to the following website address: [http:// www.dodge.com/towing](http://www.dodge.com/towing).

In Canada, refer to the following website address: [http:// www.dodge.ca](http://www.dodge.ca).

**NOTE:** For additional general trailer towing information refer to the following National Highway Traffic Safety Administration (NHTSA) website address: [http:// www.nhtsa.dot.gov/cars/problems/Equipment/towing/index.htm](http://www.nhtsa.dot.gov/cars/problems/Equipment/towing/index.htm).

### Trailer Towing Mirrors — If Equipped

These mirrors are designed with an adjustable mirror head to provide a greater vision range when towing extra-wide loads. To change position inboard or outboard, the mirror head should be rotated (flipped Out or In). A small blindspot mirror is integrated onto the main mirror surface.

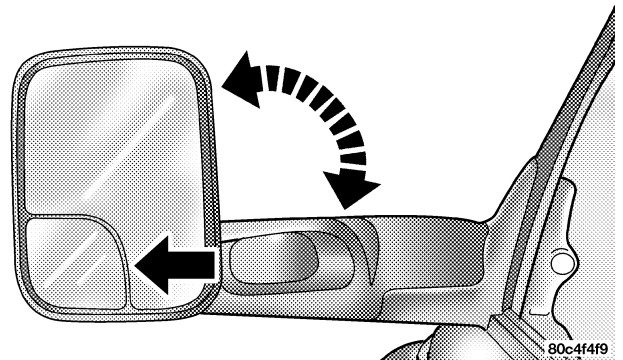
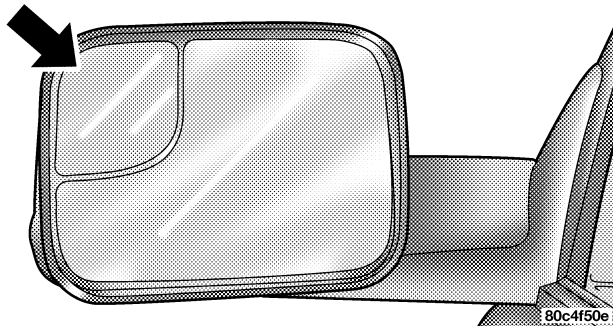

### Cooling System Tips — Trailer Towing

To reduce potential for engine and transmission overheating, take the following actions:

- **City Driving**— when stopped, put the transmission in N (Neutral) and increase the engine idle speed.
- **Highway Driving**— reduce your speed.

- **Air Conditioning**— turn it off temporarily.
- **Hilly Terrain**— Turn overdrive off.

See Cooling System Operating information in the Service and Maintenance section of this manual for more information.

### **Automatic Transmission Oil Temperature Warning Light**

All vehicles with automatic transmissions are equipped with a transmission sump oil temperature sensor and warning light. If elevated transmission temperatures are encountered, the engine controller will select the most desirable gear until the transmission temperatures are reduced. If transmission oil temperatures continue to rise, a warning light located in the instrument cluster will illuminate. If this should occur, stop the vehicle, shift to Neutral, and run the engine at idle or faster until the light goes off.

### **Towing With An Automatic Transmission**

Vehicles equipped with an automatic transmission may shift into and out of Overdrive, or a lower gear, when driving in hilly areas, when heavily loaded, or when towing into heavy winds.

When this condition occurs, select TOW/HAUL mode or shift into a lower gear to prevent excessive transmission wear and/or overheating, and to provide better engine braking.

**NOTE:** Do not exceed the following RPM while manually downshifting:

- 5800 rpm with 3.7L engines.
- 5800 rpm with 4.7L engines.
- 5600 rpm with 5.7L engines.

If your vehicle has an automatic transmission and you tow a trailer frequently, change transmission fluid and filter(s) according to Maintenance Schedule "B."

**SNOWPLOW**

Snowplow Prep Packages are available as a factory installed option. These packages include components necessary to equip your vehicle with a snowplow.

**Dodge Ram 1500 Models**

**NOTE:** Do not use Dodge Ram 1500 Models for snowplow applications.

**WARNING!**

**On 1500 Models, snowplows, winches, and other aftermarket equipment should not be added to the front end of your vehicle. The airbag crash sensors may be affected by the change in the front end structure. The airbags could deploy unexpectedly or could fail to deploy during a collision resulting in serious injury or death.**

**CAUTION!**

**Using 1500 Model vehicles for snowplow applications can cause damage to the vehicle.**

**NOTE:** Before installation of a snowplow it is highly recommended that the owner / installer obtain and follow the recommendations contained within the Dodge 2004 BODY BUILDER'S GUIDE. See your dealer, installer or snowplow manufacture for this information. There are unique electrical systems that must be connected to properly assure operator safety and prevent overloading vehicle systems.

**WARNING!**

Attaching a snowplow to this vehicle could adversely affect performance of the airbag system in an accident. Do not expect that the airbag will perform as described earlier in this manual

**CAUTION!**

The "Lamp Out" indicator could illuminate if exterior lamps are not properly installed.

**Before plowing**

- Check the hydraulic system for leaks and proper fluid level.
- Check the mounting bolts and nuts for proper tightness.

- Check the runners and cutting edge for excessive wear. The cutting edge should be 1/4 to 1/2 inch (6.4 mm to 13 mm) above ground in snow plowing position.
- Check that snowplow lighting is connected and functioning properly.

**Snowplow Model Prep Package Availability**  
For Detailed Information Visit [www.dodge.com](http://www.dodge.com) or refer to the 2004 Dodge Truck Body Builders Guide.

1. The 1500 models are NOT available for snowplow applications.
2. The maximum number of occupants in the truck should not exceed two.
3. The total GVWR or the Front GAWR or the Rear GAWR should never be exceeded.
4. The snowplow prep packages are not available with the Sport Package.

5. Cargo capacity will be reduced by the addition of options or passengers, etc.

The loaded vehicle weight, including the snowplow system, all aftermarket accessories, driver, passengers, options, and cargo, must not exceed either the Gross Vehicle Weight (GVWR) or Gross Axle Weight (GAWR) ratings. These weights are specified on the Safety Compliance Certification Label on the driver's side door opening.

**NOTE: Detach the snowplow when transporting passengers.**

Vehicle front end wheel alignment was set to specifications at the factory without consideration for the weight of the plow. Front end tow-in should be checked and reset if necessary at the beginning and end of the snowplow season. This will help prevent uneven tire wear.

The blade should be lowered whenever the vehicle is parked.

Maintain and operate your vehicle and snowplow equipment following the recommendations provided by the specific snowplow manufacturer.

#### **Over the Road Operation With Snowplow Attached**

The blade restricts air flow to the radiator and causes the engine to operate at higher than normal temperatures. Therefore, when transporting the plow, angle the blade completely and position it as low as road or surface conditions permit. Do not exceed 40 mph (64 km/h). The operator should always maintain a safe stopping distance and allow adequate passing clearance.

### Methods For Removing Snow

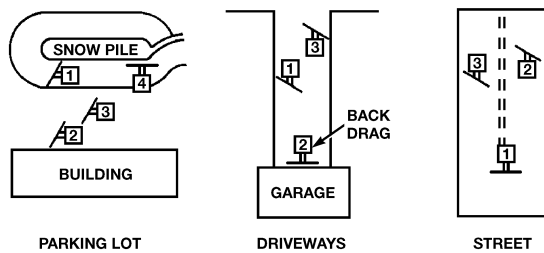

8020c-d91

### Operating Tips

Under ideal snow plowing conditions, 20 mph (32 km/h) should be maximum operating speed. The operator should be familiar with the area and surface to be cleaned. Reduce speed and use extreme caution when plowing unfamiliar areas or under poor visibility.

**NOTE:** During snowplow usage on vehicles equipped with an overhead console module, the outside temperature display will show higher temperatures than the outside ambient temperature. The higher displayed temperature is due to blocked or reduced airflow to the underhood ambient temperature sensor by the snowplow. This is common and outside temperature display operation will return to normal when the snowplow is removed.

### General Maintenance

Snowplows should be maintained in accordance with the plow manufacturer's instructions. Whenever the plow is disconnected from the vehicle, coat the exposed angling cylinder rods with chassis lubricant. The lift cylinder should be extended upward and chassis lubricant applied to the lift rod. The hydraulic hoses interconnect to keep the couplers clean.



Keep all snowplow electrical connections and battery terminals clean and free of corrosion.

When plowing snow, to avoid transmission and drivetrain damage, the following precautions should be observed.

- Operate with transfer case in 4L when plowing small or congested areas where speeds are not likely to exceed 15 mph (24 km/h). At higher speeds operate in 4H.
- Do not shift the transmission unless the engine has returned to idle and wheels have stopped. Make a practice of stepping on the brake pedal before shifting the transmission between forward and reverse.

**NOTE:** Change the automatic transmission fluid and filter(s) according to Maintenance Schedule "B."

## RECREATIONAL TOWING — 4 WHEEL DRIVE VEHICLES (BEHIND MOTORHOME, ETC.)

### Recreational Towing – 2 Wheel Drive Models

**Recreational towing 2 Wheel Drive is not allowed.** Towing with the rear wheels on the ground can result in severe transmission damage.

#### CAUTION!

**Failure to follow these requirements can cause severe damage to the transmission and/or transfer case.**

**CAUTION!**

Internal damage to the transfer case will occur if a front or rear wheel lift is used when recreational towing.

**NOTE:** Both the Manual Shift and Electronic Shift transfer cases must be shifted into Neutral (N) for recreational towing. Automatic transmissions must be placed in P (Park) position for recreational towing. Manual transmissions must be left in gear (not in neutral) for recreational towing. Refer below for the proper transfer case Neutral shifting procedure for your vehicle.

**Recreational Towing Procedure — Manual Shift Transfer Case — If Equipped**

Use the following procedure to prepare your vehicle for recreational towing:

**CAUTION!**

It is necessary to follow these steps to be certain that the transfer case is fully in N (NEUTRAL) before recreational towing to prevent damage to internal parts.

1. Bring the vehicle to a complete stop.
2. Shut OFF the engine.
3. Depress the brake pedal.
4. Shift automatic transmission to N (NEUTRAL), or depress the clutch on manual transmissions.
5. Shift transfer case lever into N (NEUTRAL).
6. Start the engine.
7. Shift automatic transmission into Reverse (R).

8. Release brake pedal for five seconds and ensure that there is no vehicle movement.
9. Repeat steps 7 and 8 with the transmission in Drive (D).
10. Shut OFF the engine and place the ignition key to the unlocked OFF position.
11. Shift automatic transmission into P (PARK).
12. Apply the parking brake.
13. Attach vehicle to tow vehicle with tow bar.
14. Release the parking brake.

**CAUTION!**

Damage to the automatic transmission may occur if the transmission is shifted into P (PARK) with the transfer case in N (NEUTRAL) and the engine RUNNING. With the transfer case in N (NEUTRAL) ensure that the engine is OFF prior to shifting the transmission into P (PARK)

**Returning to Normal Operation — Manual Shift Transfer Case**

Use the following procedure to prepare your vehicle for normal usage:

1. Bring the vehicle to a complete stop.
2. Shut OFF the engine.
3. Depress the brake pedal.

4. Shift automatic transmission to N (NEUTRAL), or depress the clutch on manual transmissions.
5. Shift transfer case lever to desired position.
6. Shift automatic transmission into P (Park).

**WARNING!**

You or others could be injured if you leave the vehicle unattended with the transfer case in the N (NEUTRAL) position without first fully engaging the parking brake. The transfer case N (NEUTRAL) position disengages both the front and rear driveshafts from the powertrain and will allow the vehicle to move regardless of the transmission position. The parking brake should always be applied when the driver is not in the vehicle.

**CAUTION!**

- Do not use a bumper mounted clamp-on tow bar on your vehicle. The bumper face bar will be damaged.
- Do not disconnect the rear driveshaft because fluid will leak from the transfer case and damage the internal parts.

**Recreational Towing Procedure — Electronic Shift Transfer Case — If Equipped**

Use the following procedure to prepare your vehicle for recreational towing.

**CAUTION!**

**It is necessary to follow these steps to be certain that the transfer case is fully in Neutral (N) before recreational towing to prevent damage to internal parts.**

1. Bring vehicle to a complete stop.
2. Shut OFF the engine.
3. Place ignition key in the ON position.
4. Depress the brake pedal.
5. Shift automatic transmission to Neutral (N) or depress clutch on manual transmission.
6. Using the point of a ballpoint pen or similar object, depress the recessed transfer case Neutral (N) button for 4 seconds.
7. After shift is completed and the Neutral (N) light comes on release Neutral (N) button.
8. Start engine.
9. Shift automatic transmission into Reverse (R).
10. Release brake pedal for five seconds and ensure that there is no vehicle movement.
11. Repeat steps 9 and 10 with the transmission in Drive (D).
12. Shut engine OFF and place ignition key to the unlocked OFF position.

13. Shift automatic transmission into Park (P).
14. Apply parking brake.
15. Attach vehicle to tow vehicle with tow bar.
16. Release parking brake.

**NOTE:** Items 1 through 5 are requirements that must be met prior to depressing the Neutral (N) selection button, and must continue to be met until the 4 seconds elapses and the shift has been completed. If any of these requirements (with the exception of 3 - Key ON) are not met prior to depressing the Neutral (N) button or are no longer met during the 4 second timer, then the Neutral (N) indicator light will flash continuously until all requirements are met or until the Neutral (N) button is released.

**NOTE:** The ignition key must be ON for a shift to take place and for the position indicator lights to be operable. If the key is not ON, the shift will not take place and no position indicator lights will be on or flashing.

**NOTE:** Flashing neutral (N) position indicator light indicates that shift requirements have not been met.

<b>CAUTION!</b>
<b>Damage to the transmission may occur if the transmission is shifted into Park (P) with the transfer case in Neutral (N) and the engine RUNNING. With the transfer case in Neutral (N) ensure that the engine is OFF prior to shifting the transmission into Park (P).</b>

**Returning to Normal Operation — Electronic Shift Transfer Case**

Use the following procedure to prepare your vehicle for normal usage.

1. Bring vehicle to a complete stop.
2. Shut OFF the engine.
3. Place ignition key in the ON position.
4. Depress the brake pedal.
5. Shift automatic transmission to Neutral (N) or depress clutch on manual transmission.
6. Using the point of a ballpoint pen or similar object, depress the recessed transfer case Neutral (N) button for 1 second.
7. After the Neutral (N) indicator light turns off release the Neutral (N) button.

8. After the Neutral (N) button has been released the transfer case will shift to the position identified by the selector switch.

9. Shift automatic transmission into P (Park).

**NOTE:** Items 1 through 5 are requirements that must be met prior to depressing the Neutral (N) selection button, and must continue to be met until 1 second elapses and the shift has been completed. If any of these requirements (with the exception of 3 - key ON) are not met prior to depressing the Neutral (N) button or are no longer met during the 1 second time, then all of the mode position indicator lights will flash continuously until all requirements are met or until the Neutral (N) button is released.

**NOTE:** The ignition key must be ON for a shift to take place and for the position indicator lights to be operable. If the key is not ON, the shift will not take place and no position indicator lights will be on or flashing.

**NOTE:** Flashing neutral (N) position indicator light indicates that shift requirements have not been met.

**WARNING!**

You or others could be injured if you leave the vehicle unattended with the transfer case in the Neutral (N) position without first fully engaging the parking brake. The transfer case Neutral (N) position disengages both the front and rear driveshafts from the powertrain and will allow the vehicle to move despite the transmission position. The parking brake should always be applied when the driver is not in the vehicle.

**CAUTION!**

- Do not use a bumper mounted clamp-on tow bar on your vehicle. The bumper face bar will be damaged.
- Do not disconnect the rear driveshaft because fluid will leak from the transfer case and fluid loss will damage internal parts.



**DRIVING OFF-ROAD**

Care should be taken when attempting to climb steep hills or driving diagonally across a hill or slope. If natural obstacles force you to travel diagonally up or down a hill, choose a mild angle and keep as little side tilt as possible. Keep the vehicle moving and make turns slowly and cautiously.

If you must back down a hill, back straight down using REVERSE gear. Never back down in NEUTRAL, or diagonally across the hill.

When driving over sand, mud, and other soft terrain, shift to low gear and drive steadily. Apply the accelerator slowly to avoid spinning the wheels.

DO NOT REDUCE the tire pressures for this type of driving.

**NOTE:** After off-road usage, particularly in sand or mud, inspect the underside of the vehicle for accumulated dirt at the propeller shaft, axles, U-joints, brake rotors and calipers.

Use a hose to clean off any accumulation of dirt or mud.

Check the exhaust system and all exposed components for any sign of damage.

If you experience unusual vibration after driving in mud, slush or similar conditions, check the wheels for impacted material. Impacted foreign material can cause a wheel imbalance. Removing the foreign material from the wheels will correct the situation.

**TRACTION**

When driving on wet or slushy roads, it is possible for a wedge of water to build up between the tire and road surface. This is known as hydroplaning and may cause partial or complete loss of vehicle control and stopping ability. To reduce this possibility, the following precautions should be observed:

1. Slow down during rainstorms or when roads are slushy.
2. Slow down if road has standing water or puddles.
3. Replace tires when tread wear indicators first become visible.
4. Keep tires properly inflated.
5. Maintain sufficient distance between your vehicle and the car in front to avoid a collision in a sudden stop.

**EQUIPMENT IDENTIFICATION PLATE**

The equipment Identification Plate is located on the hood inner surface.

The following information about your vehicle is displayed on this plate: Model, Wheelbase, Vehicle Identification Number, Truck Order Number, and code numbers with descriptions of all production and special equipment on the truck as shipped from the factory.

**NOTE:** Always refer to the Equipment Identification Plate When Ordering Parts.

---

## WHAT TO DO IN EMERGENCIES

### CONTENTS

---

■ Hazard Warning Lights . . . . .	320	■ Hoisting . . . . .	337
■ Adding Fuel . . . . .	321	■ Jump-Starting . . . . .	337
■ Jack Location . . . . .	322	■ Freeing A Stuck Vehicle . . . . .	341
□ Removal (All Models) . . . . .	322	■ Emergency Tow Hooks — If Equipped . . . . .	341
□ Reinstalling The Scissors-Type Jack And Tools (1500 Models) . . . . .	323	■ Towing A Disabled Vehicle . . . . .	342
■ Changing A Flat Tire . . . . .	326	□ 4-Wheel- Drive Vehicles . . . . .	342
□ Removing The Spare Tire . . . . .	326	□ 2-Wheel- Drive Vehicles . . . . .	342
□ Tire Changing Procedure . . . . .	327		

### HAZARD WARNING LIGHTS

The Hazard Warning switch is mounted on the top of the steering column as shown in the illustration.

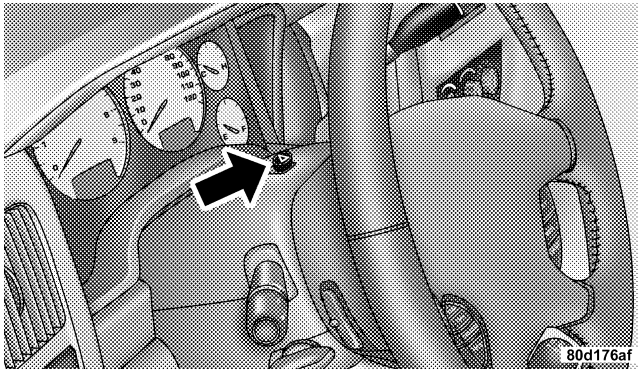

To engage the Hazard Warning lights, depress the button on the top of the steering column. When the Hazard Warning switch is activated, all directional turn signals

will flash off and on to warn oncoming traffic of an emergency. Push the button a second time to turn off the flashers.

This is an emergency warning system and should not be used when the vehicle is in motion. Use it when your vehicle is disabled and is creating a safety hazard for other motorists.

When you must leave the vehicle to seek assistance, the Hazard Warning lights will continue to operate even though the ignition switch is OFF.

**NOTE:** With extended use, the Hazard Warning lights may discharge your battery.

**ADDING FUEL**

The fuel tank filler tube has a restricting door about 2 inches (50 mm) inside the opening. If using a portable fuel container, it should have a flexible nozzle long enough to force open the restricting door.

**WARNING!**

A fire may result if gasoline is pumped into a portable container that is in a vehicle or on a truck bed. You could be burned. Always place gas containers on the ground while filling.

**WARNING!**

Remove the gas cap slowly to prevent fuel spray from the filler neck which may cause injury.

The volatility of present gasolines may cause a build up of pressure in the fuel tank that may increase while you drive. This pressure can result in a spray of gasoline and/or vapors when you remove the cap from a hot vehicle. Removing the cap slowly allows the pressure to vent and prevents fuel spray.

Never allow any lit smoking materials near the vehicles while removing the cap or filling the tank.

Never add fuel to the vehicle when the engine is running.

### JACK LOCATION

#### Removal (All Models)

The jack and jack tools are stored under the front passenger seat. Lift the flap on the side of the seat for access.

Remove the jack and tools by removing the wing bolt and sliding the assembly from under the seat.

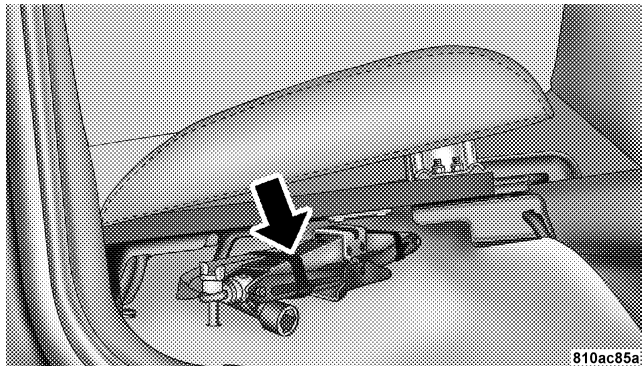

1500 Model Vehicles

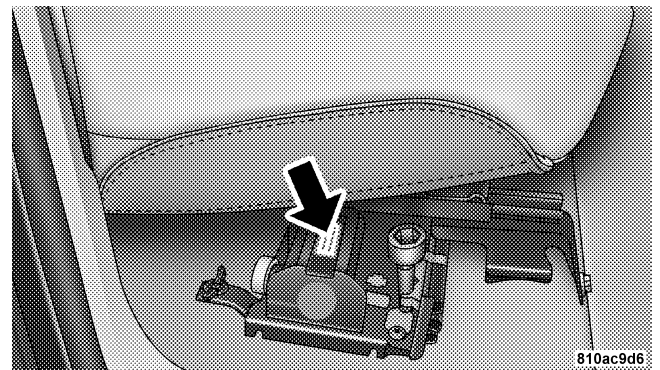

2500/3500 Model Vehicles

**WARNING!**

The jack is designed to use as a tool for changing tires only. The jack should not be used to lift the vehicle for service purposes, unless suitable supports are placed under the vehicle as a safety measure. The vehicle should be jacked on a firm level surface only. Avoid ice or slippery areas.

**WARNING!**

After using the jack and tools, always reinstall them in the original carrier and location. While driving you may experience, abrupt stopping, rapid acceleration, or sharp turns. A loose jack, tools, bracket or other objects in the vehicle may move around with force, resulting in serious injury.

**Reinstalling The Scissors-Type Jack And Tools (1500 Models)**

1. Lower the jack all the way down by turning the jack turn-screw until the jack is snug.
2. Position the jack and tool bag (unrolled). Make sure the lug wrench is under the jack near the jack turn-screw.

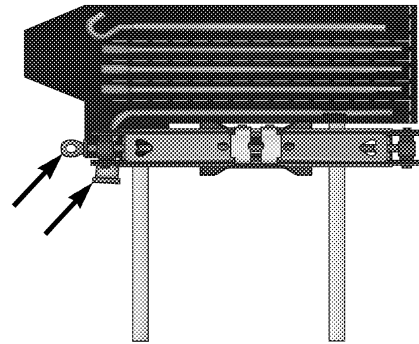

Turn Screw and Lug Wrench Position

8105e6b6

3. Fold the flap and roll the jack tool kit into a cylindrical package (in direction of arrows), and tie to the jack using the tie straps.

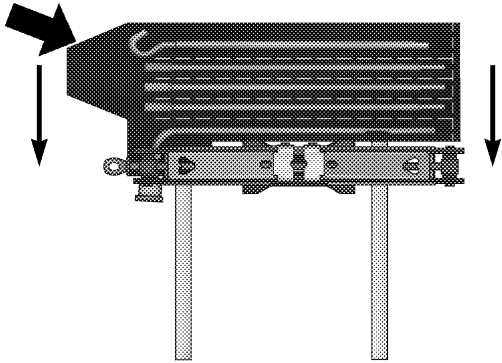

Folding Flap and Rolling Bag

81054f07

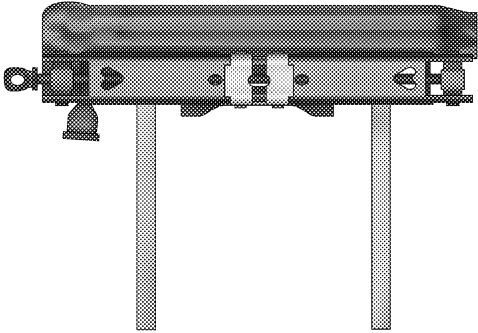

Tying Bag to Jack with Straps

81054ece



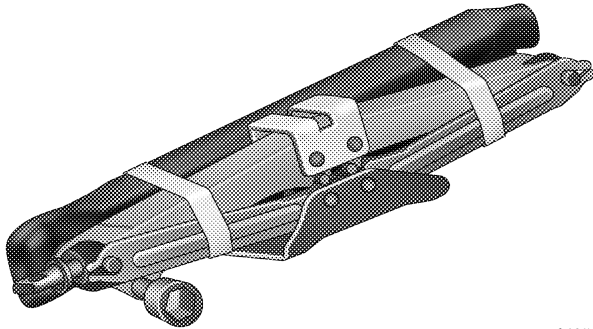

81054ed3

#### Jack and Tools Tied Together

4. Place the jack and tools in the storage position holding the jack by the jack turn-screw, slip the jack and tools under seat so that the bottom slot engages into the fastener on the floor and then secure to the floor pan using the wing bolt.

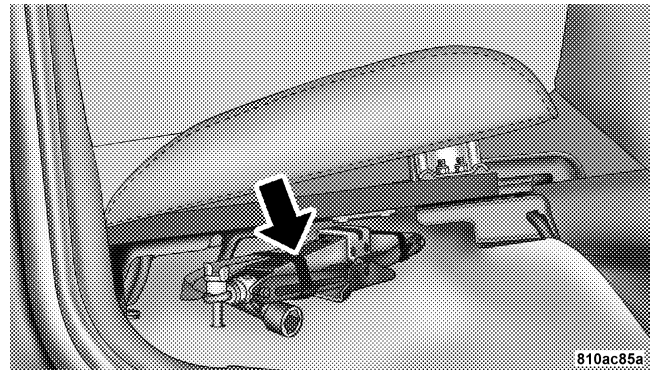

810ac85a

#### 1500 Model Vehicles

## CHANGING A FLAT TIRE

### Removing The Spare Tire

Remove the spare tire before attempting to jack the truck. Attach the wheel wrench to the jack extension tube. Insert the tube through the access hole between the lower tailgate and the top of the bumper and into the winch mechanism tube. Rotate the wheel wrench handle counterclockwise until the spare tire is on the ground with enough cable slack to allow you to pull it out from under the vehicle. When the spare is clear, tilt the retainer at the end of the cable and pull it through the center of the wheel.

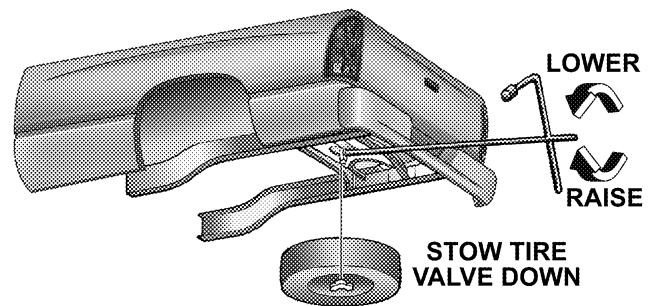

810ae782

It is recommended that you stow the flat or spare to avoid tangling the loose cable.

**NOTE:** The winch mechanism is designed for use with the jack extension tube only. Use of an air wrench or other power tools is not recommended and can damage the winch.

### Tire Changing Procedure

**WARNING!**

Getting under a jacked-up vehicle is dangerous. The vehicle could slip off the jack and fall on you. You could be crushed. Never get any part of your body under a vehicle that is on a jack. Never start or run the engine while the vehicle is on a jack. If you need to get under a raised vehicle, take it to a service center where it can be raised on a lift.

Do not raise this vehicle using a bumper jack. The jack is designed as a tool for changing tires on this vehicle only. It is not recommended that the jack be used for service purposes or to lift more than one wheel at a time.

### Preparations

Park the vehicle on a firm level surface, avoiding ice or slippery areas. Set the parking brake and place the gear selector in PARK (automatic transmission) or REVERSE (manual transmission). On four-wheel drive vehicles, shift the transfer case to the "4L" position.

**WARNING!**

Do not attempt to change a tire on the side of the vehicle close to moving traffic. Pull far enough off the road to avoid the danger of being hit when operating the jack or changing the wheel.

- Turn on the Hazard Warning Flasher.

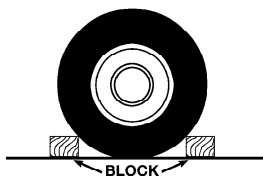

- Block both the front and rear of the wheel diagonally opposite the jacking position. For example, if the right front wheel is being changed, block the left rear wheel.
- Passengers should not remain in the vehicle when the vehicle is being jacked.

### Instructions

#### WARNING!

Carefully follow these tire changing warnings to help prevent personal injury or damage to your vehicle:

- Always park on a firm, level surface as far from the edge of the roadway as possible before raising the vehicle.
- Block the wheel diagonally opposite the wheel to be raised.
- Apply the parking brake firmly before jacking.
- Never start the engine with the vehicle on a jack.
- Do not let anyone sit in the vehicle when it is on a jack.
- Do not get under the vehicle when it is on a jack.
- Only use the jack in the positions indicated.
- If working on or near a roadway, be extremely careful of motor traffic.

1. Remove the spare wheel, jack, and tools from storage.

2. Using the wheel wrench, loosen, but do not remove, the wheel nuts by turning them counterclockwise one turn while the wheel is still on the ground.

3. Placement of the Jack:

- For 1500 series trucks, when changing a front wheel, place the scissors jack under the rear portion of the lower control arm as shown below.

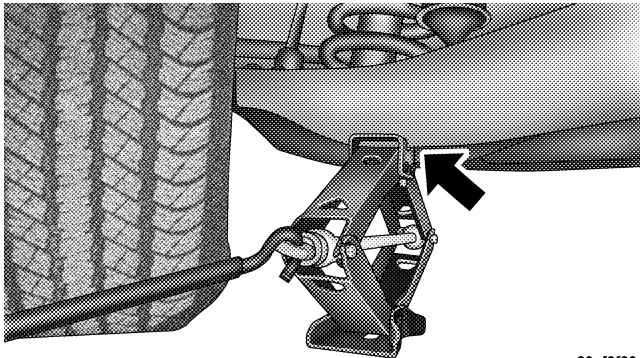

1500 4X2 Jacking Location

80ef9f80

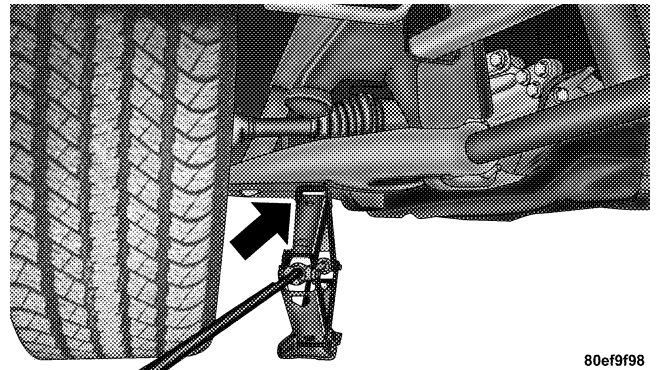

1500 4X4 Jacking Location

80ef9f98

**330 WHAT TO DO IN EMERGENCIES**

- For 2500/3500 4x2 series trucks, when changing a front wheel, place the bottle jack under the frame rail behind the wheel. Locate the jack as far forward as possible on the straight part of the frame.

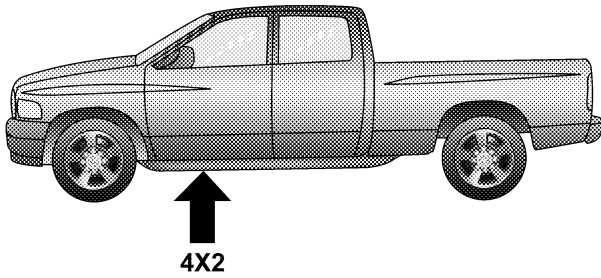

**2500/3500 4X2 Jacking Location**

810ae77d

- Operate the jack using the jack drive tube and the wheel wrench. The tube extension, may be used, but is not required.
- For 2500/3500 4x4 series trucks, when changing the front wheel, assemble the jack drive tube to the jack and connect the drive tube to the extension tube. Place the jack under the axle as close to the tire as possible with the drive tubes extending to the front. Connect the jack tube extension and wheel wrench.

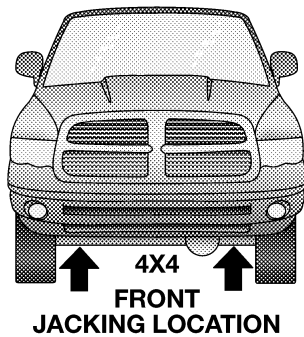

80effcef

#### 2500/3500 4X4 Jacking Location

- For all trucks, when changing a rear wheel, assemble the jack drive tube to the jack and connect the drive tube to the extension tube. Place the jack under the axle between the spring and the shock absorber with the drive tubes extending to the rear.

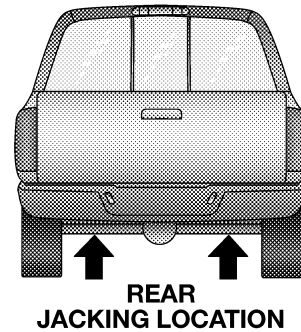

80ef9fa5

#### Rear Jacking Location (All)

- Connect the jack tube extension and wheel wrench.  
**Before raising the wheel off the ground, make sure that the jack will not damage surrounding truck parts and adjust the jack position as required.**

**NOTE:** If the 2500/3500 bottle jack will not lower by turning the dial (thumb wheel) by hand, it may be necessary to use the jack drive tube in order to lower the jack.

4. By rotating the wheel wrench clockwise, raise the vehicle until the wheel just clears the surface.

**WARNING!**

**Raising the vehicle higher than necessary can make the vehicle unstable and cause an accident. It could slip off the jack and hurt someone near it. Raise the vehicle only enough to remove the tire.**

5. Remove the wheel nuts and pull the wheel off. Install the spare wheel and wheel nuts with the cone shaped end of the nuts toward the wheel on 2500/3500 single rear wheel (SRW) models. On 3500 dual rear wheel models (DRW) the lug nuts are a two piece assembly with a flat face. Lightly tighten the nuts. To avoid risk of forcing the vehicle off the jack, do not fully tighten the nuts until the vehicle has been lowered.

6. Using the wheel wrench, finish tightening the nuts using a crisscross pattern. Correct nut tightness is 135 ft. lbs. (183 N·m) torque for 2500/3500 single rear wheel (SRW) models and 145 ft. lbs. (197 N·m) for 3500 dual rear wheel models. If in doubt about the correct tightness, have them checked with a torque wrench by your dealer or at a service station.



**WARNING!**

**A loose tire or jack thrown forward in a collision or hard stop could injure someone in the vehicle. Always stow the jack parts and the extra tire and wheel in the places provided.**

7. Install wheel center cap and remove wheel blocks. Do not install chrome or aluminum wheel center caps on the spare wheel. This may result in cap damage.
8. Lower the jack to its fully closed position. If the bottle jack will not lower by turning the dial (thumb wheel) by hand, it may be necessary to use the jack drive tube in order to lower the jack. Stow the replaced tire, jack, and tools as previously described.
9. Adjust the tire pressure when possible.

**NOTE:** Do not oil wheel studs. For chrome wheels, do not substitute with chrome plated wheel nuts.

**Hub Caps**

The hub caps must be removed before raising the vehicle off the ground.

For 2500/3500 single rear wheel (SRW) models, use the blade on the end of the lug wrench to pry the cap off.

On 3500 models with dual rear wheels (DRW), you must first remove the hub caps. The jack handle driver has a hook at one end that will fit in the pry off notch of the rear hub caps. Position the hook and pull out on the ratchet firmly. The cap should pop off. The wheel skins can now be removed. For the front hub cap on 3500 models use the blade on the end of the lug wrench to pry the caps off. The wheel skin can now be removed.

You must use the flat end of the lug wrench to pry off the wheel skins. Insert the flat tip completely and using a back and forth motion, loosen the wheel skin. Repeat this procedure around the tire until the skin pops off.

Replace the wheel skins first using a rubber mallet. When replacing the hub caps, tilt the cap retainer over the lugnut bolt circle and strike the high side down with a rubber mallet. Be sure that the hub caps and wheel skins are firmly seated around the wheel.

#### 8-Stud — Dual Rear Wheels

Dual wheels are flat mounted, center piloted. The lug nuts are a two piece assembly. When the tires are being rotated or replaced, clean these lug nuts and add 2 drops of oil at the interface between the hex and the washer.

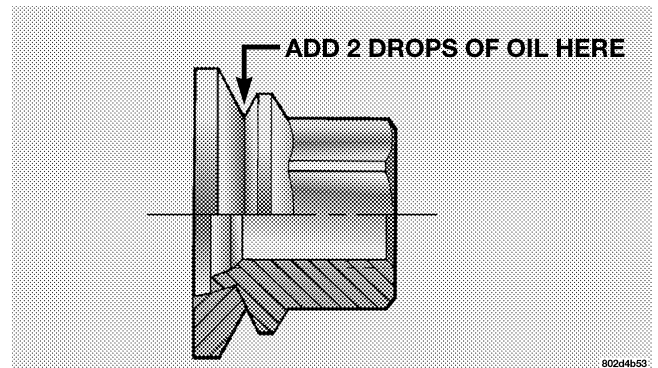

Slots in the wheels will assist in properly orienting the inner and outer wheels. Align these slots when assembling the wheels for best access to the tire valve on the inner wheel. The tires of both dual wheels must be completely off the ground when tightening to insure wheel centering and maximum wheel clamping.

Dual wheel models require a special heavy-duty lug nut tightening adapter (included with the vehicle) to correctly tighten the lug nuts. Also, when it is necessary to remove and install dual rear wheels, use a proper vehicle lifting device.

**NOTE:** When installing a spare tire as part of a dual rear wheel end combination, the tire diameter of the two individual tires must be compared. If there is a significant difference, the larger tire should be installed in a front location. Correct direction of rotation for dual tire installations must also be observed.

**These dual rear wheels should be tightened as follows:**

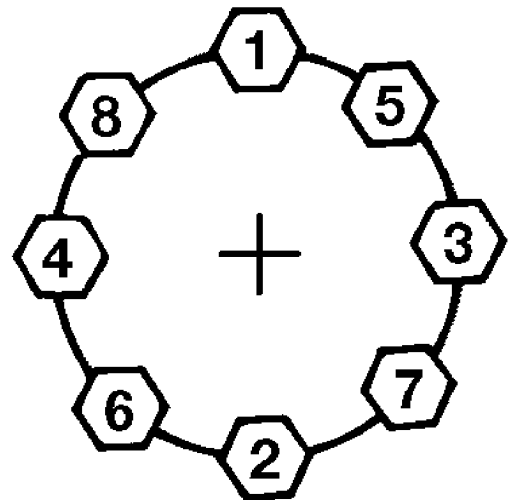

**8 STUDS**

80a58b1a

1. Tighten the wheel nuts in the numbered sequence to a snug fit.
2. Retighten the wheel nuts in the same sequence to the torques listed in the table. Go through the sequence a second time to verify that specific torque has been achieved. Retighten to specifications at 100 miles (160 km) and after 500 miles (800 km).

It is recommended that wheel stud nuts be kept torqued to specifications at all times. Torque wheel stud nuts to specifications at each lubrication interval.

#### Wheel Nuts

All wheel nuts should be tightened occasionally to eliminate the possibility of wheel studs being sheared or the bolt holes in the wheels becoming elongated. This is especially important during the first few hundred miles of operation to allow the wheel nuts to become properly set. All nuts should first be firmly seated against the

wheel. The nuts should then be tightened to recommended torque. Tighten the nuts to final torque in increments. Progress around the bolt circle, tightening the nut opposite to the nut just previously tightened until final torque is achieved. Recommended torques are shown in the following chart.

Disc Wheels	Type Nut	Stud Size	Torque Ft. Lbs.	Torque Newton Meters
	Cone	1/2-20	90-110	100-150
	Cone	9/16-18	120-150	160-200
	Flanged	9/16-18	130-160	190-220

#### To Stow The Flat Or Spare

Turn the wheel so that the valve stem is down. Slide the wheel retainer through the center of the wheel and position it properly across the wheel opening.

For convenience in checking the spare tire inflation, stow with the valve stem toward the rear of the vehicle.

Attach the wheel wrench to the extension tube. Rotate the winch mechanism until the wheel is drawn into place against the underside of the vehicle. Continue to rotate until you feel the winch mechanism slip or click 3 or 4 times. It cannot be overtightened. Push against the tire several times to be sure it is firmly in place.

### HOISTING

A conventional floor jack may be used at the jacking locations, refer to the graphics that show jacking locations. However, a floor jack or frame hoist must never be used on any other parts or the underbody.

#### CAUTION!

Never use a floor jack directly under the differential housing of a loaded truck or damage to your vehicle may result.

### JUMP-STARTING

You should not try to start your vehicle by pushing or towing. Vehicles equipped with an automatic transmission cannot be started this way and pushing or towing a vehicle equipped with a manual transmission may overheat and damage the catalytic converter. Also, there is a greater risk of an accident when a vehicle is being pushed or towed. If the vehicle has a discharged battery, booster cables may be used to obtain a start from a booster battery or the battery in another vehicle. This type of start can be dangerous if done improperly, so follow this procedure carefully.



**WARNING!**

Battery fluid is a corrosive acid solution; do not allow battery fluid to contact eyes, skin or clothing. Don't lean over battery when attaching clamps or allow the clamps to touch each other. If acid splashes in eyes or on skin, flush contaminated area immediately with large quantities of water.

A battery generates hydrogen gas which is flammable and explosive. Keep flame or spark away from the vent holes.

Do not use a booster battery or any other booster source that has a greater than 12 volt system, i.e. Do not use a 24 volt power source.

Check the Battery Test Indicator (If Equipped). If a yellow or bright colored dot is visible in the indicator (if equipped), DO NOT jump-start the battery.

BATTERY CONDITION INDICATOR	O.K. TO JUMP START		<b>DARKENED INDICATOR WITH GREEN DOT</b> <ul style="list-style-type: none"> <li>• BATTERY CHARGE OK</li> <li>• FLUID LEVEL OK</li> </ul>
			<b>DARKENED INDICATOR NO GREEN DOT</b> <ul style="list-style-type: none"> <li>• BATTERY CHARGE LOW</li> <li>• FLUID LEVEL OK</li> </ul>
	DO NOT JUMP START		<b>YELLOW OR BRIGHT INDICATOR</b> <ul style="list-style-type: none"> <li>• BATTERY CHARGE UNKNOWN</li> <li>• FLUID LEVEL LOW</li> </ul> (CHARGE MAY STILL BE SUFFICIENT TO START YOUR CAR)

8000cbce

If the indicator (if equipped) is dark or shows a green dot, proceed as follows:

1. Remove all metal jewelry such as watch bands or bracelets which might make an unintended electrical contact.
2. Park the booster vehicle within cable reach but without letting the vehicles touch. Set the parking brake on

both vehicles, place the automatic transmission in Park or the manual transmission in Neutral, and turn the ignition OFF.

3. Turn off the heater, radio, and all unnecessary electrical loads.

4. Connect one end of a jumper cable to the positive terminal of the booster battery. Connect the other end of the same cable to the positive terminal of the discharged battery.

**WARNING!**

Do not permit vehicles to touch each other as this could establish a ground connection and personal injury could result.

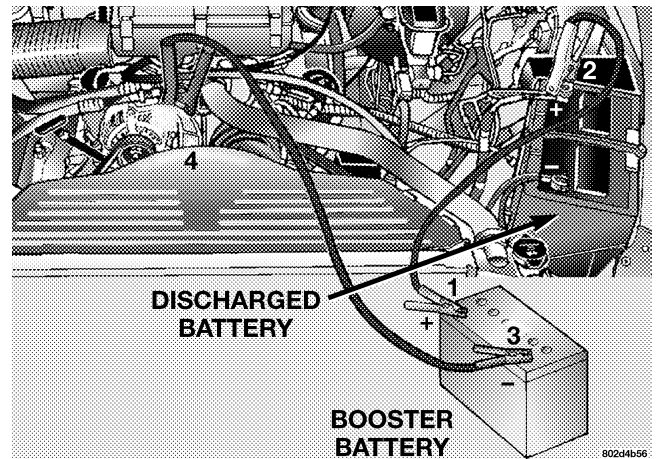

5. Connect the other cable, first to the negative terminal of the booster battery and then to the engine of the vehicle with the discharged battery. Make sure you have a good contact on the engine.

**WARNING!**

- Do not connect the cable to the negative post of the discharge battery. The resulting electrical spark could cause the battery to explode.
- During cold weather when temperatures are below freezing point, electrolyte in a discharged battery may freeze. Do not attempt jump starting because the battery could rupture or explode. The battery temperature must be brought up above freezing point before attempting jump start.

6. Start the engine in the vehicle which has the booster battery, let the engine idle a few minutes, then start the engine in the vehicle with the discharged battery.

7. When removing the jumper cables, reverse the above sequence exactly. Be careful of the moving belts and fan.

**WARNING!**

- Any procedure other than above could result in:
1. Personal injury caused by electrolyte squirting out the battery vent;
  2. Personal injury or property damage due to battery explosion;
  3. Damage to charging system of booster vehicle or of immobilized vehicle.



**FREEING A STUCK VEHICLE**

If vehicle becomes stuck in snow, sand, or mud, it can often be moved by a rocking motion. Move the gear selector rhythmically between DRIVE and REVERSE, while applying slight pressure to the accelerator.

In general, the least amount of accelerator pedal pressure to maintain the rocking motion without spinning the wheels or racing the engine is most effective. Racing the engine or spinning the wheels, due to the frustration of not freeing the vehicle, may lead to transmission overheating and failure. Allow the engine to idle with the transmission selector in NEUTRAL for at least one minute after every five rocking-motion cycles. This will minimize overheating and reduce the risk of transmission failure during prolonged efforts to free a stuck vehicle.

**EMERGENCY TOW HOOKS — IF EQUIPPED**

Your vehicle may be equipped with emergency tow hooks.

**WARNING!**

**Chains are not recommended for freeing a stuck vehicle. Chains may break, causing serious injury or death.**

**WARNING!**

**Stand clear of vehicles when pulling with tow hooks. Tow straps and chains may break, causing serious injury.**

**CAUTION!**

Tow hooks are for emergency use only, to rescue a vehicle stranded off road. Do not use tow hooks for tow truck hookup or highway towing. You could damage your vehicle.

**TOWING A DISABLED VEHICLE**

Proper towing or lifting equipment is required to prevent damage to your vehicle. Use only tow bars and other equipment designed for the purpose, following equipment manufacturer's instructions. Use of safety chains is mandatory. Attach a tow bar or other towing device to the main structural members of the vehicle—not to bumpers or associated brackets. State and local laws applying to vehicles under tow must be observed.

**4-Wheel- Drive Vehicles****CAUTION!**

To avoid damage to the transfer case while towing, always use one of the following methods.

The manufacturer recommends towing with all wheels **OFF** the ground. Acceptable methods are to tow vehicle on a flatbed or with one end of vehicle raised and the opposite end on a towing dolly.

**2-Wheel- Drive Vehicles**

Provided that the transmission is operable, tow with the transmission in Neutral and the ignition key in the OFF position along with the front wheels raised and the rear wheels on the ground. Speed must not exceed 30 mph (50 km/h) and distance must not exceed 15 miles (25 km).

**CAUTION!**

Towing faster than 30 mph (50 km/h) or for more than 15 miles (25 km) can cause severe damage to the transmission.

If the vehicle is to be towed more than 15 miles (25 km) the vehicle must be towed with the rear wheels raised and the front wheels on the ground. It may also be towed on a flatbed or with the front wheels raised and the rear wheels on a dolly.



---

## MAINTAINING YOUR VEHICLE

### CONTENTS

---

■ Engine Compartment— 3.7L/4.7L . . . . .	348	□ Engine Oil Filter . . . . .	357
■ Engine Compartment— 5.7L . . . . .	349	□ Drive Belts — Check Condition And Tensioner . . . . .	357
■ Onboard Diagnostic System (OBD II) . . . . .	350	□ Spark Plugs . . . . .	358
■ Emissions Inspection And Maintenance Programs . . . . .	351	□ Engine Air Cleaner Filter . . . . .	358
■ Dealer Service . . . . .	352	□ Engine Fuel Filter . . . . .	358
■ Replacement Parts . . . . .	353	□ Catalytic Converter . . . . .	359
■ Maintenance Procedures . . . . .	353	□ Emission-Related Components . . . . .	361
□ Engine Oil . . . . .	353	□ Maintenance Free Battery . . . . .	361

**346 MAINTAINING YOUR VEHICLE**

□ Air Conditioner Maintenance . . . . .	362	□ Brake System . . . . .	372
□ Power Steering — Fluid Check . . . . .	363	□ Clutch Hydraulic System . . . . .	374
□ Front Suspension Ball Joints . . . . .	364	□ Clutch Linkage . . . . .	374
□ Steering Linkage — Inspection . . . . .	365	□ Rear Axle And 4X4 Front Driving Axle Fluid Level . . . . .	374
□ Half-Shaft Constant Velocity Joints . . . . .	365	□ Transfer Case . . . . .	375
□ Front Prop Shaft Lubrication — 2500/3500 (4X4) Models . . . . .	365	□ Manual Transmission . . . . .	376
□ Body Lubrication . . . . .	366	□ Automatic Transmission . . . . .	377
□ Windshield Wiper Blades . . . . .	366	□ Front Wheel Bearings . . . . .	380
□ Windshield Washers . . . . .	366	□ Selection Of Lubricating Grease . . . . .	380
□ Exhaust System . . . . .	367	□ Noise Control System Required Maintenance & Warranty For 3500 2-Wheel Drive And 4-Wheel Drive Models Over 10,000 Lbs. (4 535 Kg) Gross Vehicle Weight Rating. . . . .	381
□ Cooling System . . . . .	368		
□ Hoses And Vacuum/Vapor Harnesses . . . . .	372		

<ul style="list-style-type: none"> <li>□ Appearance Care And Protection From Corrosion . . . . .385</li> <li>■ Fuse And Relay Center . . . . .389</li> <li>■ Vehicle Storage . . . . .390</li> <li>■ Replacement Light Bulbs . . . . .390</li> <li>■ Bulb Replacement . . . . .391                     <ul style="list-style-type: none"> <li>□ Headlight (Halogen)/Front Park And Turn Lights . . . . .391</li> <li>□ Tail, Stop, Turn And Backup Lights . . . . .395</li> <li>□ Center High-Mounted Stoplight With Cargo Light . . . . .397</li> </ul> </li> </ul>	<ul style="list-style-type: none"> <li>□ Cab Top Clearance Lights — If Equipped . . . .398</li> <li>□ Tailgate ID Lights (Dual Rear Wheels) . . . . .400</li> <li>□ Side Marker Lights (Dual Rear Wheels) . . . . .401</li> <li>□ Fog Lights . . . . .402</li> <li>■ Fluids And Capacities . . . . .403</li> <li>■ Recommended Fluids, Lubricants And Genuine Parts . . . . .405                     <ul style="list-style-type: none"> <li>□ Engine . . . . .405</li> <li>□ Chassis . . . . .406</li> </ul> </li> </ul>
--	--

**ENGINE COMPARTMENT— 3.7L/4.7L**

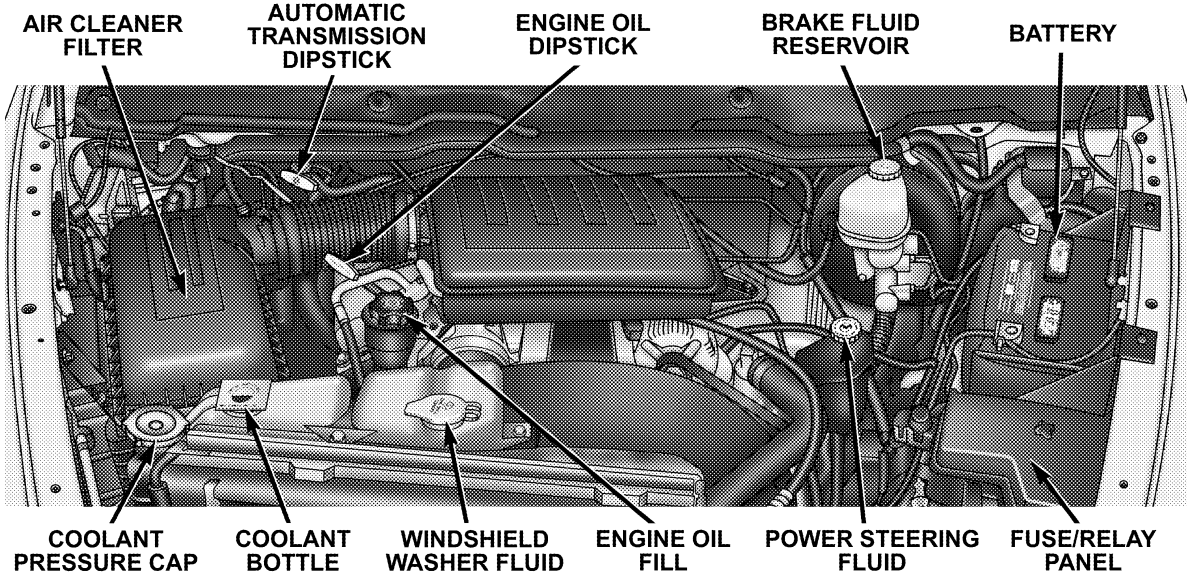

813d73da



**ENGINE COMPARTMENT— 5.7L**

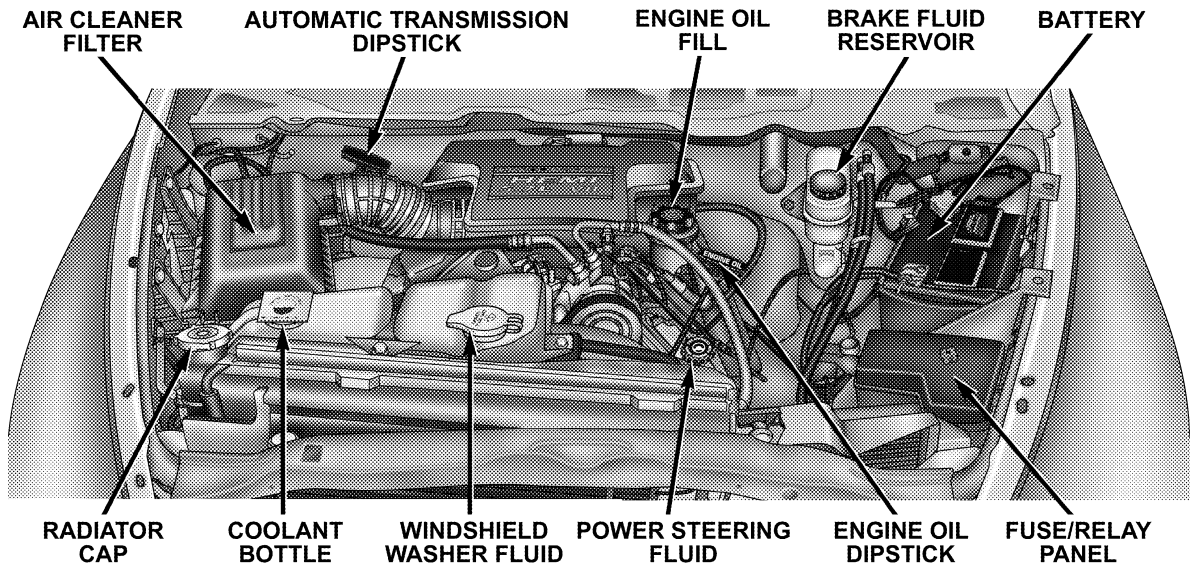

813d73f5

**ONBOARD DIAGNOSTIC SYSTEM (OBD II)**

Your vehicle is equipped with a sophisticated onboard diagnostic system called OBD II. This system monitors the performance of the emissions, engine, and automatic transmission control systems. When these systems are operating properly, your vehicle will provide excellent performance and fuel economy, as well as engine emissions well within current government regulations.

If any of these systems require service, the OBD II system will turn on the "Malfunction Indicator Light." It will also store diagnostic codes and other information to assist your service technician in making repairs. Although your vehicle will usually be driveable and not need towing, see your dealer for service as soon as possible.

**CAUTION!**

**Prolonged driving with the "Malfunction Indicator Light" on could cause further damage to the emission control system. It could also affect fuel economy and driveability. The vehicle must be serviced before any emissions tests can be performed.**

**If the "Malfunction Indicator Light" is flashing, severe catalytic converter damage and power loss will soon occur. Immediate service is required.**

### EMISSIONS INSPECTION AND MAINTENANCE PROGRAMS

In some localities, it may be a legal requirement to pass an inspection of your vehicle's emissions control system. Failure to pass could prevent vehicle registration.



For states which have an I/M (Inspection and Maintenance) requirement, this check verifies the following: the MIL (Malfunction Indicator Lamp) is functioning and is not on when the engine is running, and that the OBD (On Board Diagnostic) system is ready for testing.

Normally, the OBD system will be ready. The OBD system may **not** be ready if your vehicle was recently serviced, if you recently had a dead battery, or a battery replacement. If the OBD system should be determined not ready for the I/M test, your vehicle may fail the test.

Your vehicle has a simple ignition key actuated test which you can use prior to going to the test station. To check if your vehicle's OBD system is ready, you must do the following:

1. Insert your ignition key into the ignition switch.
2. Turn the ignition to the ON position, but do not crank or start the engine.
3. If you crank or start the engine, you will have to start this test over.
4. As soon as you turn your key to the ON position, you will see your MIL symbol come on as part of a normal bulb check.

5. Approximately 15 seconds later, one of two things will happen:

- a. The MIL light will blink for approximately 5 seconds and then remain on until the first engine crank or the key is turned off. This means that your vehicle's OBD system is **not ready** and you should **not** proceed to the I/M station.
- b. The MIL light will remain fully illuminated until the first engine crank or the key is turned off. This means that your vehicle's OBD system is **ready** and you can proceed to the I/M station.

If your OBD system is **not ready**, you should see your dealer or repair facility. If your vehicle was recently serviced or had a battery failure or replacement, you may need to do nothing more than drive your vehicle as you normally would in order for your OBD system to update. A recheck with the above test routine may then indicate that the system is now ready.

Regardless of whether your vehicle's OBD system is ready or not ready, if the MIL symbol is illuminated during normal vehicle operation, you should have your vehicle serviced before going to the I/M station. The I/M station can fail your vehicle because the MIL symbol is on with the engine running.

#### **DEALER SERVICE**

Your dealer has the qualified service personnel, special tools and equipment to perform all service operations in an expert manner. Service manuals are available which include detailed service information for your vehicle. Refer to these manuals before attempting any procedure yourself.

**NOTE:** Intentional tampering with emissions control systems can result in civil penalties being assessed against you.

**WARNING!**

You can be badly injured working on or around a motor vehicle. Do only that service work for which you have the knowledge and the proper equipment. If you have any doubt about your ability to perform a service job, take your vehicle to a competent mechanic.

**REPLACEMENT PARTS**

Use of genuine Mopar® parts for normal/scheduled maintenance and repairs is highly recommended to insure the designed performance. Damage or failures caused by the use of non-Mopar parts for maintenance and repairs will not be covered by the manufacturer's warranty.

**MAINTENANCE PROCEDURES**

The pages that follow contain the **required** maintenance services determined by the engineers who designed your vehicle.

Besides the maintenance items for which there are fixed maintenance intervals, there are other items that should operate satisfactorily without periodic maintenance. However, if a malfunction of these items does occur, it could adversely affect the engine or vehicle performance. These items should be inspected if a malfunction is observed or suspected.

**Engine Oil****Checking Oil Level**

To assure proper lubrication of your vehicle's engine, the engine oil must be maintained at the correct level. The best time to check the engine oil level is about 5 minutes after a fully warmed up engine is shut off or before starting the engine after it has sat overnight.

Checking the oil while the vehicle is on level ground will improve the accuracy of the oil level readings. Always maintain the oil level within the SAFE zone on the dipstick. Adding one quart of oil when the reading is at the bottom of the SAFE zone will result in a reading at the top of the safe zone on these engines.

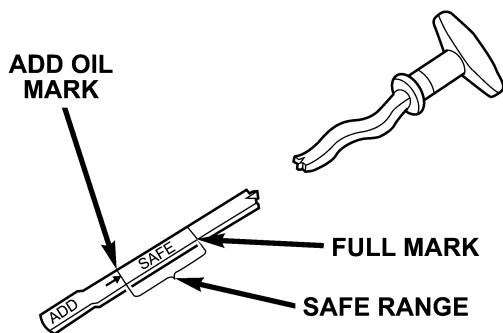

80bd0aae

### Change Engine Oil

#### CAUTION!

**Overfilling or underfilling the crankcase will cause oil aeration or loss of oil pressure. This could damage your engine.**

Road conditions as well as your kind of driving affect the interval at which your oil should be changed. Check the following to determine if any apply to you:

- Day or night temperatures are below 32°F (0°C).
- Stop and go driving.
- Extensive engine idling.
- Driving in dusty conditions
- Short trips of less than 10 miles (16.2 km)

- More than 50% of your driving is at sustained high speeds during hot weather, above 32°C (90°F)
- Trailer towing
- Heavy Loading
- Taxi, Police or delivery service (commercial service)
- Off-road or desert operation
- **If equipped for and operating with E-85 (ethanol) fuel.**

**NOTE:** If **ANY** of these apply to you then change your engine oil every 3,000 miles (5 000 km) or 3 months, whichever comes first and follow schedule "B" of the "Maintenance Schedules" section of this manual.

If none of these apply to you, then change your engine oil at every interval shown on schedule "A" of the "Maintenance Schedules" section of this manual.

### **Dusty Conditions**

Driving through dust-laden air increases the problems of keeping abrasive materials out of the engine. Under these conditions, special attention should be given to the engine air cleaner, the crankcase inlet air cleaner and the crankcase ventilation system. Make sure that these units are clean at all times. This will tend to reduce to a minimum the amount of abrasive material that may enter the engine.

### **Engine Oil Selection**

For best performance and maximum protection under all types of operating conditions, the manufacture only recommends engine oils that are API certified and meet the requirements of DaimlerChrysler Material Standard MS-6395. Use Mopar or an equivalent oil meeting the specification MS-6395.

### Engine Oil Identification (API) Symbol

There is a symbol to aid you in selecting the proper engine oil.



This symbol means that the oil has been certified by the American Petroleum Institute (API). The manufacture only recommends API Certified engine oils that meet the requirements of DaimlerChrysler Material Standard MS-6395. Use Mopar or an equivalent oil meeting the specifi-

cation MS-6395.

### Engine Oil Viscosity (SAE Grade)

For 3.7L/4.7L engines SAE 5W-30 engine oil is recommended for all operating temperatures. For 5.7L engines SAE 5W-20 engine oil is recommended for all operating temperatures. These engine oils improve low

temperature starting and vehicle fuel economy. Refer to your engine oil filler cap for the recommended engine oil viscosity for your vehicle.

For information on engine oil filler cap location, see the Engine Compartment illustration in this section.

Lubricants which do not have both, the engine oil certification mark and the correct SAE viscosity grade number should not be used.

### Synthetic Engine Oils

There are a number of engine oils being promoted as either synthetic or semi-synthetic. If you chose to use such a product, use **only** those oils that are API Certified and meet the SAE viscosity standard. Follow the service schedule that describes your driving type.

### Materials Added to Engine Oil

The manufacture strongly recommends against the addition of any additives (other than leak detection dyes) to



the engine oil. Engine oil is an engineered product and its performance may be impaired by supplemental additives.

#### **Disposing of Used Engine Oil And Oil Filters**

Care should be taken in disposing of used engine oil and oil filters from your vehicle. Used oil and oil filters, indiscriminately discarded, can present a problem to the environment. Contact your dealer, service station, or governmental agency for advice on how and where used oil and oil filters can be safely discarded in your area.

#### **Engine Oil Filter**

The engine oil filter should be replaced at every engine oil change.

#### **Engine Oil Filter Selection**

The manufacturer's engines have a full-flow type oil filter. Use a filter of this type for replacement. The quality of replacement filters varies considerably. Only high

quality filters should be used to assure most efficient service. Mopar Engine Oil Filters are a high quality oil filter and are recommended.

#### **Drive Belts — Check Condition and Tensioner**

Belt tension is controlled by means of an automatic tensioner. No belt tension adjustments are required. However, belt and belt tensioner condition should be inspected at the specified intervals and replaced if required. See your authorized dealer for service.

At the mileage indicated in the maintenance schedule, all belts and tensioner should be checked for condition. Improper belt tension can cause belt slippage and failure.

Belts should be inspected for evidence of cuts, cracks, glazing or frayed cords and replaced if there is indication of damage which could result in belt failure. Low generator belt tension can cause battery failure.

Also check belt routing to make sure there is no interference between the belts and other engine components.

### Spark Plugs

Spark plugs must fire properly to assure engine performance and emission control. New plugs should be installed at the specified mileage. The entire set should be replaced if there is any malfunction due to a faulty spark plug, malfunctioning spark plugs can damage the catalytic converter. For proper type of replacement spark plugs, refer to the "Vehicle Emission Control Information" label in the engine compartment.

### Engine Air Cleaner Filter

Under normal driving conditions, replace the air filter at the intervals shown on Schedule "A". If, however, you drive the vehicle frequently under dusty or severe conditions, the filter element should be inspected periodically and replaced if necessary at the intervals shown on Schedule "B".

### WARNING!

The air induction system (air cleaner, hoses, etc) can provide a measure of protection in the case of engine backfire. Do not remove the air induction system (air cleaner, hoses, etc) unless such removal is necessary for repair or maintenance. Make sure that no one is near the engine compartment before starting the vehicle with the air induction system (air cleaner, hoses, etc) removed. Failure to do so can result in serious personal injury.

### Engine Fuel Filter

A plugged fuel filter can cause stalling, limit the speed at which a vehicle can be driven or cause hard starting. Should an excessive amount of dirt accumulate in the fuel tank, frequent filter replacement may be necessary.

**Catalytic Converter**

The catalytic converter requires the use of unleaded fuel only. Leaded gasoline will destroy the effectiveness of the catalyst as an emission control device.

Under normal operating conditions, the catalytic converter will not require maintenance. However, it is important to keep the engine properly tuned to assure proper catalyst operation and prevent possible catalyst damage.

**CAUTION!**

**Damage to the catalytic converter can result if your vehicle is not kept in proper operating condition. In the event of engine malfunction, particularly involving engine misfire or other apparent loss of performance, have your vehicle serviced promptly. Continued operation of your vehicle with a severe malfunction could cause the converter to overheat, resulting in possible damage to the converter and the vehicle.**

**NOTE:** Intentional tampering with emissions control systems can result in civil penalties being assessed against you.

**WARNING!**

**A hot exhaust system can start a fire if you park over materials that can burn. Such materials might be grass or leaves coming into contact with your exhaust system. Do not park or operate your vehicle in areas where your exhaust system can contact anything that can burn.**

In unusual situations involving grossly malfunctioning engine operation, a scorching odor may indicate severe and abnormal catalyst overheating. If this occurs, the vehicle should be stopped, the engine shut off and the vehicle allowed to cool. Thereafter, service, including a tune-up to manufacturer's specifications, should be obtained immediately.

To minimize the possibility of catalyst damage:

- Do not shut off the engine or interrupt the ignition when the transmission is in gear and the vehicle is in motion.
- Do not try to start engine by pushing or towing the vehicle.
- Do not idle the engine with any spark plug wires disconnected or removed, such as when diagnostic testing, or for prolonged periods during very rough idling or malfunctioning operating conditions.

### Emission-Related Components



#### Positive Crankcase (PCV) Valve

Proper operation of the crankcase ventilation system requires that the PCV valve be free of sticking or plugging from deposits. Deposits can accumulate in the PCV valve and passages with increasing mileage. Have the PCV valve, hoses, and passages checked for proper operation at the intervals specified. If the valve is plugged or sticking, replace with a new valve— **do not attempt to clean the old PCV valve!** Check the ventilation hoses for indications of damage, weepage or plugging with deposits. Replace if necessary.

### Maintenance Free Battery

The top of the maintenance free battery is permanently sealed. You will never have to add water, nor is periodic maintenance required.

To determine the battery charge, check the battery test indicator (if equipped) on top of the battery. If the test indicator (if equipped) appears light or yellow, replace the battery.

BATTERY CONDITION INDICATOR	O.K. TO JUMP START	 	<b>DARKENED INDICATOR WITH GREEN DOT</b> • BATTERY CHARGE OK • FLUID LEVEL OK  <b>DARKENED INDICATOR NO GREEN DOT</b> • BATTERY CHARGE LOW • FLUID LEVEL OK
	DO NOT JUMP START		<b>YELLOW OR BRIGHT INDICATOR</b> • BATTERY CHARGE UNKNOWN • FLUID LEVEL LOW (CHARGE MAY STILL BE SUFFICIENT TO START YOUR CAR)

800cbce

**WARNING!**

Battery fluid is a corrosive acid solution and can burn or even blind you. Don't allow battery fluid to contact your eyes, skin or clothing. Don't lean over a battery when attaching clamps. If acid splashes in eyes or on skin, flush the area immediately with large amounts of water.

Battery gas is flammable and explosive. Keep flame or sparks away from the battery. Don't use a booster battery or any other booster source with an output greater than 12 volts. Don't allow cable clamps to touch each other.

Battery posts, terminals and related accessories contain lead and lead compounds. Wash hands after handling.

**CAUTION!**

It is essential when replacing the cables on the battery that the positive cable is attached to the positive post and the negative cable is attached to the negative post. Battery posts are marked (+) positive and negative (-) and identified on the battery case. Also, if a "fast charger" is used while battery is in vehicle, disconnect both vehicle battery cables before connecting the charger to battery. Do not use a "fast charger" to provide starting voltage.

**Air Conditioner Maintenance**

For best possible performance, your air conditioner should be checked and serviced by an Authorized Dealer at the start of each warm season. This service should include cleaning of the condenser fins and a performance test. Drive belt tension should also be checked at this time.

**NOTE:** Refer to Section 3 of the Warranty Information book for further warranty information.

**WARNING!**

- **Use only refrigerants and compressor lubricants approved by the manufacturer for your air conditioning system. Some unapproved refrigerants are flammable and can explode, injuring you. Other unapproved refrigerants or lubricants can cause the system to fail, requiring costly repairs.**
- **The air conditioning system contains refrigerant under high pressure. To avoid risk of personal injury or damage to the system, adding refrigerant or any repair requiring lines to be disconnected should be done by an experienced repairman.**

**Refrigerant Recovery and Recycling**

R-134a Air Conditioning Refrigerant is a hydrofluorocarbon (HFC) that is endorsed by the Environmental Protection Agency and is an ozone-saving product. However, the manufacturer recommends that air conditioning service be performed by dealers or other service facilities using recovery and recycling equipment.

**Power Steering — Fluid Check**

Checking the power steering fluid level at a defined service interval is not required. The fluid should only be checked if a leak is suspected, abnormal noises are apparent, and/or the system is not functioning as anticipated. Coordinate inspection efforts through a certified DaimlerChrysler Dealership."

**WARNING!**

**Fluid level should be checked on a level surface and with the engine off to prevent injury from moving parts and to insure accurate fluid level reading. Do not overfill. Use only manufacturers recommended power steering fluid.**

If necessary, add fluid to restore to the proper indicated level. With a clean cloth, wipe any spilled fluid from all surfaces. Refer to Recommended Fluids, Lubricants, and Genuine Parts for correct fluid type.

**Front Suspension Ball Joints****4 x 2 Models**

The ball joints and seals should be inspected whenever the vehicle is serviced for other reasons.

The ball joints originally supplied with the vehicle are permanently lubricated at the factory and do not require service. However, if the seals on the ball joints are damaged, the joints should be replaced. Serviceable replacement ball joints are available.

Front suspension ball joints should be replaced only by a qualified service technician using tools specially designed for this purpose. Damage to the joints and/or suspension components may result if improper replacement procedures are used.

If seals are damaged the ball joints should be replaced to prevent leakage or contamination of the grease.



**Steering Linkage — Inspection**

Whenever the vehicle is hoisted, all steering linkage joints should be inspected for evidence of damage. If seals are damaged, parts should be replaced to prevent leakage or contamination of the grease. Lubricate the steering linkage regularly according to the “Maintenance Schedule” in this manual.

**Half-shaft Constant Velocity Joints**

All four-wheel-drive 1500 models are equipped with four constant velocity joints. Periodic lubrication of these joints is not required. However, the joint boots should be inspected for external leakage or damage periodically. If external leakage or damage is evident, the joint boot and grease should be replaced immediately. Continued operation could result in failure of the joint due to water and dirt contamination of the grease. This would require complete replacement of the joint assembly. Refer to the Service Manual for the detailed replacement procedure.

**Front Prop Shaft Lubrication — 2500/3500 (4X4) Models**

Lubricate the front driveshaft grease fitting at each oil change listed in the appropriate Maintenance Schedule for your vehicle (Schedule “A” and “B”). Use Mopar® type MS-6560 (lithium based grease), or equivalent.

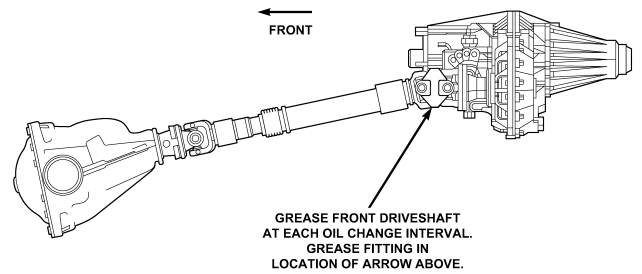

**Front Driveshaft Grease Fitting**

01550037

**Body Lubrication**

Locks and all body pivot points, including such items as seat tracks, doors, tailgate and hood hinges, should be lubricated periodically to assure quiet, easy operation and to protect against rust and wear. Prior to the application of any lubricant, the parts concerned should be wiped clean to remove dust and grit; after lubricating excess oil and grease should be removed. Particular attention should also be given to hood latching components to insure proper function. When performing other underhood services, the hood latch, release mechanism and safety catch should be cleaned and lubricated.

The external lock cylinders should be lubricated twice a year, preferably in the fall and spring. Apply a small amount of a high quality lubricant such as Mopar® Lock Cylinder Lubricant directly into the lock cylinder.

**Windshield Wiper Blades**

The rubber edges of the wiper blades and the windshield should be cleaned periodically with a sponge or soft cloth and a mild nonabrasive cleaner. This will remove accumulations of salt or road film.

Operation of the wipers on dry glass for long periods may cause deterioration of the wiper blades. Always use washer fluid when using the wipers to remove salt or dirt from a dry windshield.

Avoid using the wiper blades to remove frost or ice from the windshield. Keep the blade rubber out of contact with petroleum products such as engine oil, gasoline, etc.

**Windshield Washers**

The fluid reservoir is located under the hood and should be checked for fluid level at regular intervals. Fill the reservoir with windshield washer solvent only (not radiator antifreeze).

To prevent freeze-up of your windshield washer system in cold weather, select a solution or mixture that meets or exceeds the temperature range of your climate. This rating information can be found on most washer fluid containers.

**WARNING!**

**Commercially available windshield washer solvents are flammable. They could ignite and burn you. Care must be exercised when filling or working around the washer solution.**

After the engine has warmed, operate the defroster for a few minutes to reduce the possibility of smearing or freezing the fluid on the cold windshield. Mopar All Weather Windshield Washer Solution, used with water as

directed on the container, aids cleaning action, reduces the freezing point to avoid line clogging, and is not harmful to paint or trim.

**Exhaust System**

The best protection against carbon monoxide entry into the vehicle body is a properly maintained engine exhaust system.

Whenever a change is noticed in the sound of the exhaust system, when exhaust fumes can be detected inside the vehicle, or when the underside or rear of the vehicle is damaged, have a competent mechanic inspect the complete exhaust system and adjacent body areas for broken, damaged, deteriorated, or mispositioned parts. Open seams or loose connections could permit exhaust fumes to seep into the passenger compartment. In addition, inspect the exhaust system each time the vehicle is raised for lubrication or oil change. Replace as required.

**WARNING!**

Exhaust gases can injure or kill. They contain carbon monoxide (CO) which is colorless and odorless. Breathing it can make you unconscious and can eventually poison you. To avoid breathing CO, follow the preceding safety tips.

**Exhaust System Rubber Isolator and Loop-Type Hanger — If Equipped**

Inspect surfaces whenever the vehicle is hoisted for rubber to metal separation or deep cracks. SLIGHT CRACKING DUE TO WEATHERING DOES NOT ADVERSELY AFFECT PERFORMANCE. If, however, excessively deep localized cracks are present, or any part of the exhaust system abnormally contacts the underbody hardware, the isolator and/or hanger should be replaced.

**Cooling System****Cooling System Maintenance**

At the intervals shown in the Maintenance Schedules Section of the manual, the system should be drained, flushed and filled.

**Inspection**

Check engine coolant (antifreeze) protection every 12 months (before the onset of freezing weather, where applicable). If coolant is dirty or rusty in appearance, the system should be drained, flushed and refilled with fresh coolant as specified.

Inspect the entire cooling system for leaks. Check the face of the radiator for any accumulation of bugs, leaves, or other foreign matter. If dirty, clean the radiator core with a garden hose. With the engine OFF, gently spray water from the back of the radiator core.

For 3.7L, 4.7L, and 5.7L engines, check the coolant bottle hoses for condition and tightness of the connections at both the coolant bottle and radiator.

#### **Coolant Level ( 3.7L, 4.7L, 5.7L Engines)**

The coolant reserve system provides a quick visual method of determining that the coolant level is adequate. With the engine idling, and warmed to the normal operating temperature, the level of the coolant in the coolant bottle should be between the fluid level marks. Check the coolant level whenever the hood is raised.

The radiator normally remains completely full, so there is no longer a need to remove the coolant pressure cap except for checking coolant freeze point or replacement with new antifreeze coolant.

#### **WARNING!**

**Never add coolant to the radiator when the engine is overheated. Do not loosen or remove pressure cap to cool an overheated engine! The coolant is under pressure and severe scalding could result.**

#### **Drain, Flush And Refill**

At intervals shown on the Maintenance Schedules, the system should be drained, flushed and refilled. Refer to your dealer or consult a service manual for proper procedures.

#### **Adding Coolant**

When adding coolant, or refilling the system, a minimum solution of 50% recommended HOAT ethylene glycol engine coolant (antifreeze) and distilled water should be used. Use higher concentrations (not to exceed 70%) if temperatures below  $-34^{\circ}\text{F}$  ( $-37^{\circ}\text{C}$ ) are anticipated.

Use only high purity water such as distilled or deionized water when mixing the water/engine coolant solution. The use of lower quality water will reduce the amount of corrosion protection in the engine cooling system.

**NOTE:** It is the owner's responsibility to maintain the proper level of protection against freezing according to the temperatures occurring in the area where the vehicle is operated.

**NOTE:** Mixing coolant types will decrease the life of the engine coolant and will require more frequent coolant changes.

When additional coolant is needed to maintain the proper level, add the recommended concentration of antifreeze and water to the coolant bottle. Do not overfill.

**NOTE:** Failure to follow the antifreeze concentration and replacement recommendations, or failure to use antifreeze formulated to prevent corrosion of all cooling system metals, may result in radiator plugging, overheating, or cooling system leaks such as in core hole plugs.

**WARNING!**

**Never add coolant to the radiator when the engine is overheated. Do not loosen or remove pressure cap to cool an overheated engine. The coolant is under pressure and severe scalding could result.**

**Recommended Engine Coolant**

Refer to Recommended Fluids, Lubricants and Genuine Parts for correct fluid type.

**CAUTION!**

- **Mixing of coolants other than specified engine coolant, may result in engine damage. If a non-HOAT coolant is introduced into the cooling system in an emergency, it should be replaced with the specified coolant as soon as possible.**
- **Do not use plain water alone or alcohol base engine coolant (antifreeze) products. Do not use additional rust inhibitors or antirust products, as they may not be compatible with the radiator engine coolant and may plug the radiator.**
- **This vehicle has not been designed for use with Propylene Glycol based coolants. Use of Propylene Glycol based coolants is not recommended.**

**Disposal Of Used Engine Coolant**

Used ethylene glycol based engine coolant is a regulated substance requiring proper disposal. Check with your local authorities to determine the disposal rules for your community. Do not store ethylene glycol-based engine coolant in open containers or allow it to remain in puddles on the ground. Prevent ingestion by animals and children. If ingested by a child, contact a physician immediately. Clean up any ground spills immediately.

**Coolant Pressure Cap**

The coolant pressure cap must be fully tightened to prevent the loss of coolant and to insure that the coolant will return to the radiator from the coolant bottle. The pressure cap should be inspected and cleaned if there is any accumulation of foreign material on the sealing surfaces.

**WARNING!**

The warning words "DO NOT OPEN HOT" on the radiator pressure cap are a safety precaution. Heat causes pressure to build up in the cooling system. To prevent scalding or injury, do not remove the pressure cap.

**Hoses And Vacuum/Vapor Harnesses**

Inspect surfaces of hoses and nylon tubing for evidence of heat and mechanical damage. Hard or soft spots, brittle rubber, cracking, tears, cuts, abrasions, and excessive swelling indicate deterioration of the rubber.

Pay particular attention to those hoses nearest to high heat sources such as the exhaust manifold. Inspect hose routing to be sure hoses do not come in contact with any heat source or moving component which may cause heat damage or mechanical wear.

Insure nylon tubing in these areas has not melted or collapsed.

Inspect all hose connections such as clamps and couplings to make sure they are secure and no leaks are present.

Components should be replaced immediately if there is any evidence of wear or damage that could cause failure.

**Brake System****Power Disc Brakes (front and rear)**

Disc brakes do not require periodic adjustment.

**Brake Master Cylinder**

The fluid level of the master cylinder should be checked when performing under the hood service, or immediately if the brake system warning lamp indicates system failure.



The brake master cylinder has a translucent plastic reservoir. On the outboard side of the reservoir, there is a "MAX" dot and an "MIN" dot. The fluid level must be kept within these two dots. Do not add fluid above the MAX mark, because leakage may occur at the cap.

With disc brakes the fluid level can be expected to fall as the brake linings wear. However, an unexpected drop in fluid level may be caused by a leak and a system check should be conducted.

Refer to Recommended Fluids, Lubricants and Genuine Parts for the correct Fluid type.

#### **WARNING!**

**Use of a brake fluid that may have a lower initial boiling point, or is unidentified as to specification, may result in sudden brake failure during hard prolonged braking. You could have an accident.**

#### **WARNING!**

**Overfilling the brake fluid reservoir can result in spilling brake fluid on hot engine parts and the brake fluid catching fire.**

Use only brake fluid that has been in a tightly closed container to avoid contamination from foreign matter or moisture.

#### **CAUTION!**

**Do not allow a petroleum-base fluid to contaminate the brake fluid. Seal damage may result.**

**Brake Hoses**

Inspection should be performed whenever the brake system is serviced or at intervals specified. Inspect hydraulic brake hoses for surface cracking, scuffing or worn spots. If there is any evidence of cracking, scuffing, or worn spots, the hose should be replaced immediately! Eventual deterioration of the hose can take place with possible burst failure.

**Clutch Hydraulic System**

The clutch hydraulic system is a sealed maintenance-free system. In the event of leakage or other malfunction, the system must be replaced.

**Clutch Linkage**

If the clutch pedal linkage begins to squeak or grunt, the clutch pedal pivot bushings should be lubricated. Refer to Recommended Fluids, Lubricants and Genuine Parts for the correct lubricant type.

**Rear Axle And 4x4 Front Driving Axle Fluid Level**

Refer to Recommended Fluids, Lubricants and Genuine Parts for the correct Fluid type. For normal service, periodic fluid level checks are not required. When the vehicle is serviced for other reasons the exterior surfaces of the axle assembly should be inspected. If gear oil leakage is suspected inspect the fluid level.

This inspection should be made with the vehicle in a level position. The fluid level should be even with the bottom of the fill hole for the Manufacturer's C205F HD Front Axles. The fluid level should be 5/8" (16 mm) below on 9 1/4" Manufacturer's Rear Axles.

For all 2500/3500 Model axles, the fluid level should be 1/4" ± 1/4" (6.4 mm ± 6.4 mm) below the fill hole on the 9.25" Front and 3/4" ± 1/4" (19 mm ± 6.4 mm) on 10.5" Rear axles. The 11.5" Rear Axle level should be 1/4" ± 1/4" (6.4 mm ± 6.4 mm) below the fill hole.

**Drain and Refill**

Vehicles operated in normal service do not have regularly scheduled oil changes. If fluid has become contaminated with water or to provide the correct viscosity grade, drain and refill.

**Lubricant Selection**

Refer to Recommended Fluids, Lubricants and Genuine Parts for correct fluid type.

**NOTE:** The presence of water in the gear lubricant will result in corrosion and possible failure of differential components. Operation of the vehicle in water, as may be encountered in some off-highway types of service, will require draining and refilling the axle to avoid damage.

**Limited-Slip Differentials** in 1500 Model vehicles require that 4 oz. (118 ml) Mopar® limited slip additive be added to the gear lubricant. Refer to Recommended Fluids, Lubricants and Genuine Parts for correct fluid

type. The Mopar® limited slip additive should be added to the gear lubricant whenever a fluid change is made.

Ram 2500/3500 Model Axles **DO NOT REQUIRE** any limited slip oil additive (friction modifiers).

**Transfer Case****Fluid Level Check**

This fluid level can be checked by removing the filler plug. The fluid level should be to the bottom edge of the filler plug hole with the vehicle in a level position.

**Lubricant Selection**

Refer to Recommended Fluids, Lubricants and Genuine Parts for correct fluid type.

## Manual Transmission

### Fluid Level Check

This fluid level can be checked by removing the filler plug. If the level of the lubricant is more than 1/4" (6.4 mm) below the bottom of the filler hole while the vehicle is on level ground, enough lubricant should be added to bring the level to the bottom of the filler hole.

### Lubricant Selection NV-3500 (5-Speed Manual Transmission — If Equipped)

This transmission is filled with manual transmission fluid at the factory. This fluid does not require periodic changing. If it is necessary to add or change fluid in this transmission refer to Recommended Fluids, Lubricants and Genuine Parts for correct fluid type. This is the only lubricant recommended for use in the NV-3500 transmission.

### Lubricant Selection Getrag 238 (6-Speed Manual Transmission — If Equipped)

This transmission is filled with manual transmission fluid at the factory. This fluid does not require periodic changing. If it is necessary to add or change fluid in this transmission refer to Recommended Fluids, Lubricants and Genuine Parts for correct fluid type. This is the only lubricant recommended for use in the Getrag 238 transmission.

### Lubricant Selection NV-4500 (5-Speed Manual Transmission — If Equipped)

This transmission does not require periodic changing. If it becomes necessary to add or change the fluid in this transmission, refer to Recommended Fluids, Lubricants and Genuine Parts for correct fluid type.

**Lubricant Selection Getrag G56 (6-Speed Manual Transmission — If Equipped)**

This transmission is filled with manual transmission fluid at the factory. This fluid does not require periodic changing. If it is necessary to add or change fluid in this transmission refer to Recommended Fluids, Lubricants and Genuine Parts for correct fluid type. This is the only lubricant recommended for use in the Getrag G56 transmission.

**Automatic Transmission****Fluid Level Check**

The fluid level should be checked when the engine is fully warmed up and the fluid in the transmission is at normal operating temperature. Operation of the transmission with an improper fluid level will greatly reduce the life of the transmission and of the fluid. Check the fluid level whenever the vehicle is serviced.

**Fluid Level Check – 45RFE/545RFE**

Check the fluid level while the transmission is at normal operating temperature 82°C (180°F). This occurs after at least 15 miles (25 km) of driving. At normal operating temperature the fluid cannot be held comfortably between the fingertips.

To check the automatic transmission fluid level properly, the following procedure must be used:

1. Operate the engine at idle speed and normal operating temperature.
2. The vehicle must be on level ground.
3. Fully apply the parking brake and press the brake pedal.
4. Place the gear selector momentarily in each gear position ending with the lever in P (Park).

5. Remove the dipstick, wipe it clean and reinsert it until seated.

6. Remove the dipstick again and note the fluid level on both sides. The fluid level should be between the "HOT" (upper) reference holes on the dipstick at normal operating temperature. Verify that solid coating of oil is seen on both sides of the dipstick. If the fluid is low, add as required into the dipstick tube. **Do not overfill.** After adding any quantity of oil through the oil fill tube, wait a minimum of two (2) minutes for the oil to fully drain into the transmission before rechecking the fluid level.

**NOTE:** If it is necessary to check the transmission **below** the operating temperature, the fluid level should be between the two "COLD" (lower) holes on the dipstick with the fluid at approximately 70°F (21°C) (room temperature). If the fluid level is correctly established at room temperature, it should be between the "HOT"

(upper) reference holes when the transmission reaches 180°F (82°C). Remember it is best to check the level at the normal operating temperature.

**CAUTION!**

**Be aware that if the fluid temperature is below 50°F (10°C) it may not register on the dipstick. Do not add fluid until the temperature is elevated enough to produce an accurate reading.**

7. Check for leaks. Release parking brake.

To prevent dirt and water from entering the transmission after checking or replenishing fluid, make certain that the dipstick cap is properly reseated. It is normal for the dipstick cap to spring back slightly from its fully seated position, as long as its seal remains engaged in the dipstick tube.

**Selection Of Lubricant**

Refer to Recommended Fluids, Lubricants and Genuine Parts for correct fluid type. It is important that the transmission fluid be maintained at the prescribed level using the recommended fluid.

**CAUTION!**

**Using a transmission fluid other than the manufacturers recommended fluid may cause deterioration in transmission shift quality and/or torque converter shudder. Using a transmission fluid other than the manufacturers recommended fluid will result in more frequent fluid and filter changes. Refer to Recommended Fluids, Lubricants and Genuine Parts for correct fluid type.**

**Automatic Transmission Fluid and Filter Change**

It is important that proper lubricant is used in the transmission. Refer to Recommended Fluids, Lubricants and Genuine Parts for correct fluid type.

The fluid and filter(s) should be changed as specified in the Maintenance Schedule (Section 8).

**NOTE:** If the transmission is disassembled for any reason, the fluid and filter(s) should be changed.

**Special Additives**

The manufacturer strongly recommends against the addition of any additives to the transmission. Exception to this policy is the use of special dyes to aid in detecting fluid leaks. The use of transmission sealers should be avoided, since they may adversely affect seals.

### Front Wheel Bearings

Front wheel bearings for all Dodge Ram Trucks are sealed-for-life. They do not require greasing or seal replacement. In some instances, these bearings will “purge” excess grease and the bearing will look slightly wet. This is normal. Periodic inspection for excess play is recommended.

### Rear Wheel Bearings — Manufacturer’s Axles

These bearings are normally considered permanently lubricated. Cleaning and repacking is required only when axle shafts are removed or in case of extreme water or dust contamination.

### Selection of Lubricating Grease

The National Lubricating Grease Institute (NLGI) has developed a symbol (Certification Mark) to aid the vehicle owner in the proper selection of grease for the lubrication of wheel bearings and chassis components.

This symbol (an example is shown below) is located on the grease container and identifies the application and quality of the grease.



There are two groups identified, those for wheel bearings (Letter “G”) and those for chassis (Letter “L”) lubrication. Performance categories within these groups result in dual letter designations for each group. The letter designations shown in the example are the highest

quality level available and when combined as shown can be used for both wheel bearing and chassis lubrication. Use only those greases that have the NLGI symbol on the container along with the proper quality level for your application.



**Noise Control System Required Maintenance & Warranty For 3500 2-Wheel Drive and 4-Wheel Drive models over 10,000 lbs. (4 535 kg) Gross Vehicle Weight Rating.**

All vehicles built over 10,000 lbs (4 535 kg) Gross Vehicle Weight Rating and manufactured for sale and use in the United States are required to comply with the Federal Government's Exterior Noise Regulations. These vehicles can be identified by the Noise Emission Control Label located in the operator's compartment.

**Vehicle Noise Emission Control Information**  
Date of Vehicle Manufacture

\_\_\_\_\_

This vehicle conforms to U.S. EPA regulations for noise emission applicable to medium and heavy duty trucks.

The following acts or the causing thereof by any person are prohibited by the Noise Control Act of 1972: (A) the removal or rendering inoperative, other than for purposes of maintenance, repair, or replacement, of any noise control device or element of design (listed in the Owner's Manual) incorporated into this vehicle in compliance with the Noise Control Act (B) the use of this vehicle after such device or element of design has been removed or rendered inoperative.

802d4b72 **55216044**

**Required Maintenance for Noise Control Systems**

The following maintenance services must be performed every 6 months or 6,000 miles (9 600 km), whichever comes first, to assure proper operation of the noise control systems. In addition, inspection and service should be performed anytime a malfunction is observed or suspected. Proper maintenance of the entire vehicle will help the effectiveness of the noise control systems.

**Air Cleaner Assembly**

Inspect air cleaner housing for proper assembly and fit. Make certain that the air cleaner is properly positioned and the cover is tight. Check all hoses leading to the cleaner for tightness. The gasket between the air cleaner housing and throttle body must be intact and in good condition. The engine air cleaner filter must also be clean and serviced according to the instructions outlined in the appropriate maintenance schedule.

**Tampering with Noise Control System Prohibited**

Federal law prohibits the following acts or the causing thereof: (1) the removal or rendering inoperative by any person, other than for purposes of maintenance, repair, or replacement, of any device or element of design incorporated into any new vehicle for the purpose of noise control prior to its sale or delivery to the ultimate purchaser or while it is in use, or (2) the use of the vehicle after such device or element of design has been removed or rendered inoperative by any person.

Among those acts presumed to constitute tampering are the acts listed below.

**AIR CLEANER**

- Removal of the air cleaner.
- Inverting the air cleaner lid.
- Removal of the air ducting.

**EXHAUST SYSTEM**

- Removal or rendering inoperative exhaust system components including the muffler or tailpipe.

**ENGINE COOLING SYSTEM**

- Removal or rendering inoperative the fan clutch.
- Removal of the fan shroud.

**Noise Emission Warranty**

The manufacturer warrants that this vehicle as manufactured by the manufacturer, was designed, built and equipped to conform at the time it left the manufacturers control with all applicable U.S. EPA Noise Control Regulations.

This warranty covers this vehicle as designed, built and equipped by the manufacturer, and is not limited to any particular part, component or system of the vehicle manufactured by the manufacturer. Defects in design, assembly or in any part, component or system of the vehicle as manufactured by the manufacturer, which, at the time it left the manufacturers control, caused noise emissions to exceed Federal standards, are covered by this warranty for the life of the vehicle.

**384 MAINTAINING YOUR VEHICLE**

Noise Systems Maintenance Chart and Service Log Insert Month, Day, Year under column mileage closest to the mileage at which service was performed.

MILES	6,000	12,000	18,000	24,000	30,000	36,000	42,000	48,000
KILOMETERS	9 600	19 000	29 000	36 000	48 000	58 000	67 000	77 000
Exhaust system-inspect								
Air cleaner assembly-inspect								
ODOMETER READING								
PERFORMED BY								
PERFORMED AT								

MILES	54,000	60,000	66,000	72,000	78,000	84,000	90,000	96,000
KILOMETERS	87 000	96 000	106 000	116 000	126 000	135 000	145 000	154 000
Exhaust system-inspect								
Air cleaner assembly-inspect								
ODOMETER READING								
PERFORMED BY								
PERFORMED AT								

## Appearance Care and Protection from Corrosion

### Protection of Body and Paint from Corrosion

Vehicle body care requirements vary according to geographic locations and usage. Chemicals that make roads passable in snow and ice, and those that are sprayed on trees and road surfaces during other seasons, are highly corrosive to the metal in your vehicle. Outside parking, which exposes your vehicle to airborne contaminants, road surfaces on which the vehicle is operated, extreme hot or cold weather and other extreme conditions will have an adverse effect on paint, metal trim, and underbody protection.

The following maintenance recommendations will enable you to obtain maximum benefit from the corrosion resistance built into your vehicle.

### What Causes Corrosion?

Corrosion is the result of deterioration or removal of paint and protective coatings from your vehicle.

The most common causes are:

- Road salt, dirt and moisture accumulation.
- Stone and gravel impact.
- Insects, tree sap and tar.
- Salt in the air near seacoast localities.
- Atmospheric fallout/industrial pollutants.

### Washing

- Wash your vehicle regularly. Always wash your vehicle in the shade using a mild car wash soap, and rinse the panels completely with clear water.

**NOTE:** Fold the 7 x 10 inch trailer towing mirrors rearward prior to entering an automated car wash.

**CAUTION!**

Do not attempt to fold the 7 x 10 inch trailer towing mirrors forward. The 7 x 10 inch trailer towing mirrors are not designed to be folded forward and doing so will damage the mirrors and/or vehicle.

- If insects, tar or other similar deposits have accumulated on your vehicle, wash it as soon as possible.
- Use Mopar® auto polish to remove road film and stains and to polish your vehicle. Take care never to scratch the paint.
- Avoid using abrasive compounds and power buffing that may diminish the gloss or thin out the paint finish.

**CAUTION!**

Do not use abrasive or strong cleaning materials such as steel wool or scouring powder, which will scratch metal and painted surfaces.

**Special Care**

- If you drive on salted or dusty roads or if you drive near the ocean, hose off the undercarriage at least once a month.
- It is important that the drain holes in the lower edges of the doors, rocker panels and tailgate be kept clear and open.
- If you detect any stone chips or scratches in the paint, touch them up immediately. The cost of such repairs is considered the responsibility of the owner.

- If your vehicle is damaged due to an accident or similar cause which destroys the paint and protective coating have your vehicle repaired as soon as possible. The cost of such repairs is considered the responsibility of the owner.
- All wheels and wheel trim, especially aluminum and chrome plated wheels should be cleaned regularly with mild soap and water to prevent corrosion. To remove heavy soil, select a nonabrasive, non-acidic cleaner. Do not use scouring pads, steel wool, a bristle brush or metal polishes. Only Mopar cleaners are recommended. Do not use oven cleaner. Avoid automatic car washes that use acidic solutions or harsh brushes that may damage the wheels' protective finish.
- If you carry special cargo such as chemicals, fertilizers, de-icer salt, etc., be sure that such materials are well packaged and sealed.
- If a lot of driving is done on gravel roads, consider mud or stone shields behind each wheel.
- Use Mopar® touch up paint on scratches as soon as possible. Your dealer has touch up paint to match the color of your vehicle.

**Interior Care**

Use Mopar® Fabric Cleaner to clean fabric upholstery and carpeting.

Use Mopar® Vinyl Cleaner to clean vinyl upholstery and trim.

Mopar® Total Clean is specifically recommended for leather upholstery.

Your leather upholstery can be best preserved by regular cleaning with a damp soft cloth. Small particles of dirt can act as an abrasive and damage the leather upholstery and should be removed promptly with a damp cloth. Stubborn soils can be removed easily with a soft cloth

and Mopar® Total Clean. Care should be taken to avoid soaking your leather upholstery with any liquid. Please do not use polishes, oils, cleaning fluids, solvents, detergents, or ammonia based cleaners to clean your leather upholstery. Application of a leather conditioner is not required to maintain the original condition.

**WARNING!**

**Do not use volatile solvents for cleaning purposes. Many are potentially flammable, and if used in closed areas they may cause respiratory harm.**

**Glass Surfaces**

All glass surfaces should be cleaned on a regular basis with any commercial household-type glass cleaner. Never use an abrasive type cleaner. Use caution when cleaning inside rear windows equipped with electric defrosters or windshields equipped with a windshield wiper de-icer. Do not use scrapers or other sharp instruments which may scratch the elements.

When cleaning the rear view mirror, spray cleaner on the towel or rag that you are using. Do not spray cleaner directly on the mirror.



### Cleaning Plastic Instrument Cluster Lenses

The lenses in front of the instruments in this vehicle are molded in clear plastic. When cleaning the lenses, care must be taken to avoid scratching the plastic.

1. Clean with a wet soft rag. A mild soap solution may be used, but do not use high alcohol content or abrasive cleaners. If soap is used, wipe clean with a clean damp rag.
2. Dry with a soft tissue.

### Seat Belt Maintenance

Do not bleach, dye or clean the belts with chemical solvents or abrasive cleaners. This will weaken the fabric. Sun damage will also weaken the fabric.

If the belts need cleaning, use a mild soap solution or lukewarm water. Do not remove the belts from the car to wash them.

Replace the belts if they appear frayed or worn or if the buckles do not work properly.

### FUSE AND RELAY CENTER

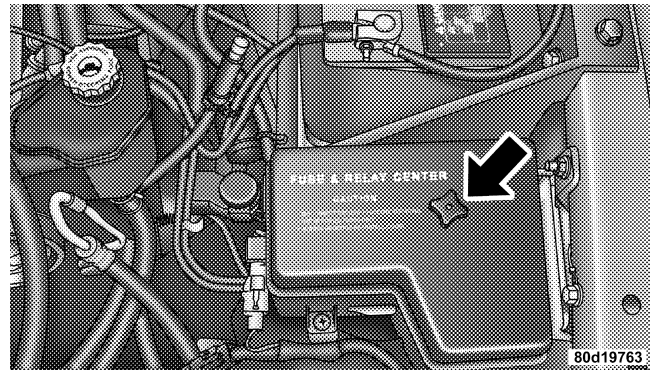

Your vehicle is equipped with a fuse and relay center located in the engine compartment near the battery. Located on the underside of the cover is a label that identifies each component.

1. Disconnect the battery negative (-) cable before removing the cover.

2. Use specified fuses only.
3. Always properly reinstall the cover.

**VEHICLE STORAGE**

If you are storing your vehicle for more than 21 days, we recommend that you take the following steps to minimize the drain on your vehicle’s battery:

- Disconnect the Ignition-Off Draw fuse (I.O.D.) fuse located in the Fuse and Relay Center, located in the engine compartment. The I.O.D. cavity includes a snap-in retainer that allows the fuse to be disconnected, without removing it from the fuse block.
- The electronic shift transfer case should be placed in the 4HI mode and kept in this position to minimize the battery drain.
- As an alternative to the above steps you may, disconnect the negative cables from both batteries.

**REPLACEMENT LIGHT BULBS**

<b>LIGHT BULBS — Inside</b>	<b>Bulb No.</b>
Overhead Console Lights . . . . .	TS 212-2
Dome Light. . . . .	7679

All of the inside bulbs are brass or glass wedge base. Aluminum base bulbs are not approved.

<b>LIGHT BULBS — Outside</b>	<b>Bulb No.</b>
Back-Up . . . . .	3057
Center High Mounted Stop Lamp . . . . .	912
Fog Lamp . . . . .	9006LL
Headlamp (Halogen) . . . . .	9007QL
Park & Turn Signal . . . . .	3157NAK
Rear License Plate Lamp . . . . .	168
Rear Cargo Light. . . . .	912
Tail & Stop . . . . .	3057
Cab Clearance Lights . . . . .	168
Dual Rear Wheel Sidemarkers Light . . . . .	168
Dual Rear Wheel Tailgate ID Lights (3) . . . . .	168

**BULB REPLACEMENT****Headlight (Halogen)/Front Park and Turn Lights****CAUTION!**

This is a halogen bulb. Avoid touching the glass with your fingers. Reduced bulb life will result.

1. Remove the expanding fastener from the headlight welt.

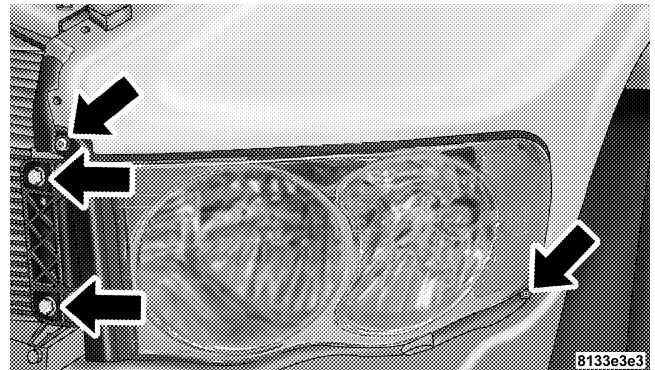

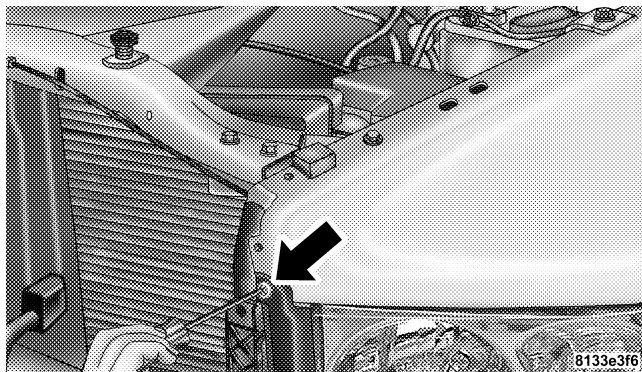

2. Remove the three (3) bolts from the headlight housing.

**NOTE:** The lower bolt on the driver side headlight also retains the ambient temperature sensor between the headlight assembly and the frame.

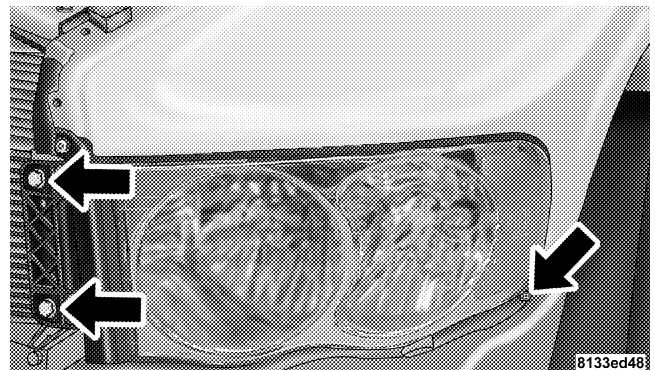

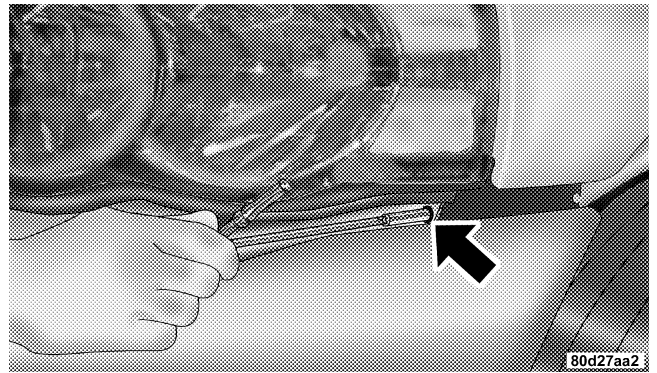
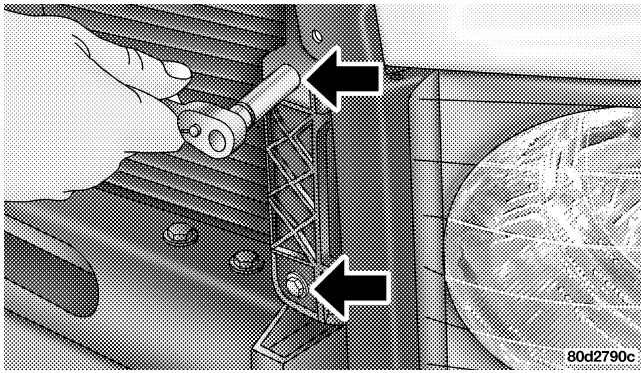

3. Pull the housing out from the fender to allow room to disconnect the electrical connectors.

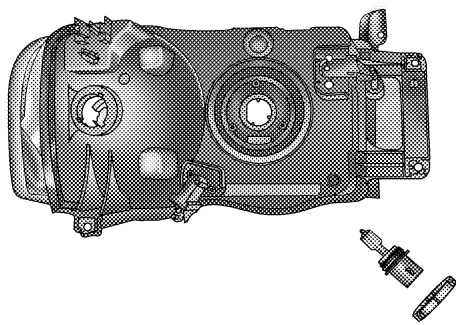

8133e3fe

4. Unlock and pull connector straight from the base of the headlight halogen bulb.

5. Twist connector on turn signal/park light bulb  $\frac{1}{4}$  turn and remove connector and bulb from housing.

6. Remove housing from vehicle with headlight halogen bulb in housing.

7. Twist collar on headlight halogen bulb  $\frac{1}{4}$  turn and remove headlight bulb from the housing.

8. Replace headlight or turn signal bulb. Do not touch the headlight halogen bulb.

9. Reverse procedure for installation of bulbs and housing.

10. Tighten the outboard fastener first.

**Tail, Stop, Turn and Backup Lights**

1. Remove the two (2) screws that pass through the bed sheetmetal.

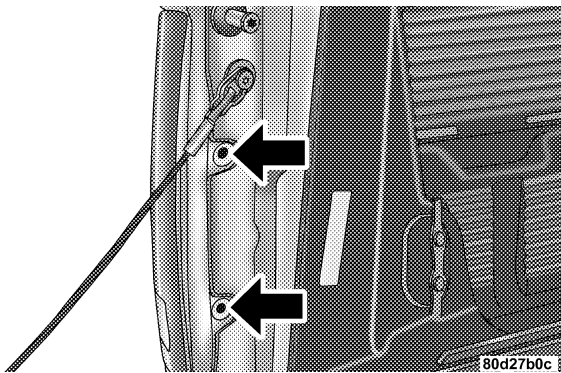

2. Pull the housing straight out from the body, with a quick motion, to separate the housing from the body. If not pulled straight, locators may be damaged.

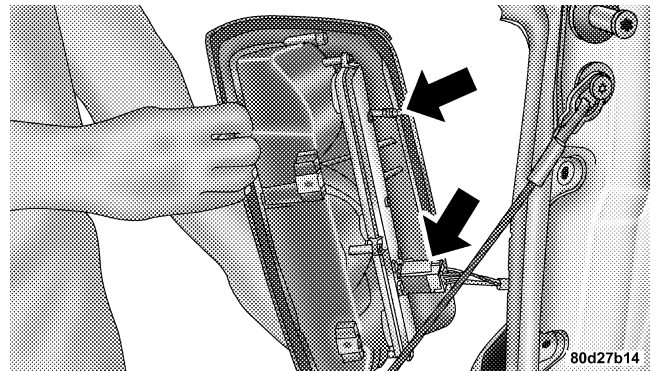

3. Push the red lock slide in on the connector and remove the housing from the vehicle.

4. Remove the four (4) screws from the bulb strip in the housing.

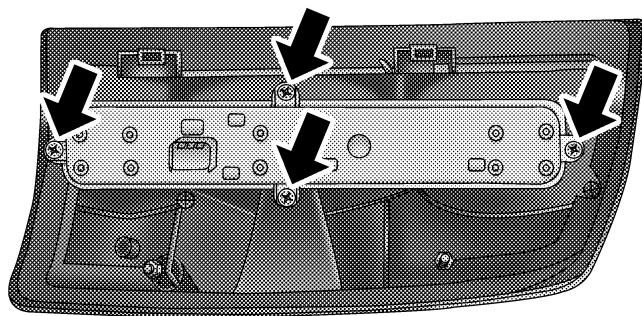

80d27b44

5. Pull the appropriate bulb straight from the bulb strip.

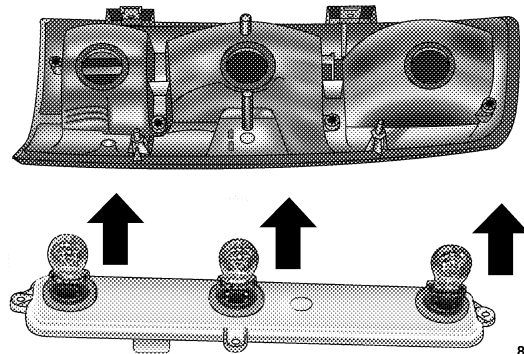

80d27b4e

- Top Bulb: Park/Turn/Hazard
- Center Bulb: Stop/Park/Sidemarker
- Bottom Bulb: Backup Lights

6. Reverse procedure for installation of bulbs and housing.



7. While holding the taillight firmly in place, fasten the top screw first.

**Center High-Mounted Stoplight With Cargo Light**

1. Remove the two (2) screws holding the housing/lens to the body as shown.

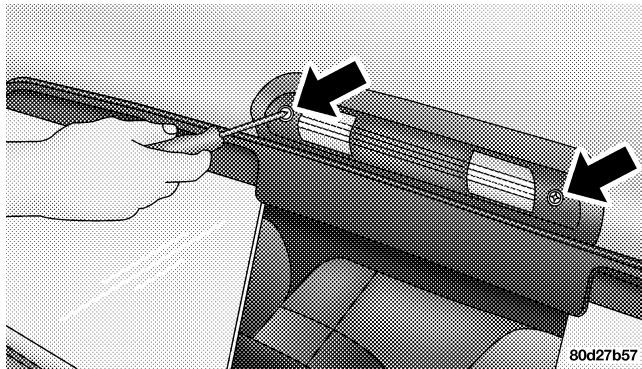

2. Separate the connector holding the housing and wiring harness to the body.

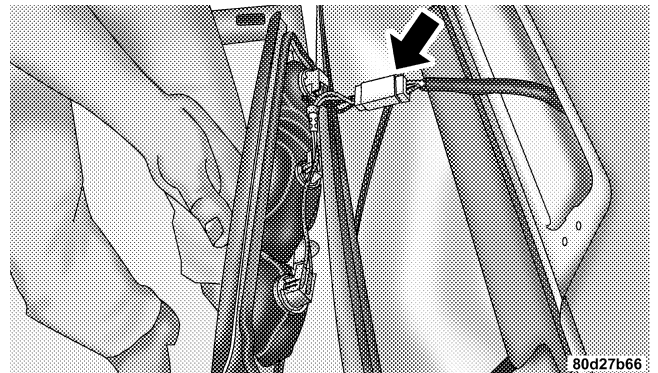

3. Turn desired bulb socket ¼ turn and remove socket and bulb from housing.

4. Pull desired bulb straight from the socket.

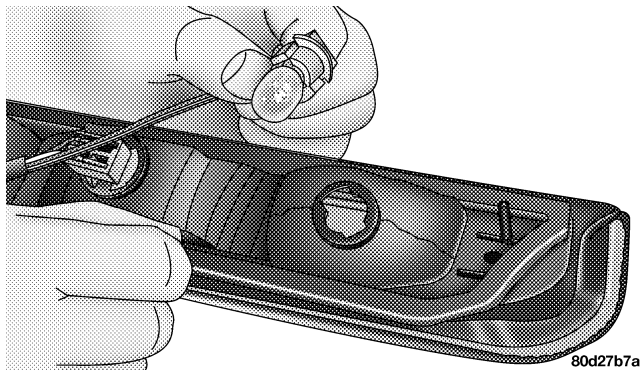

- Outside Bulbs: Cargo Lamps
- Inside Bulb: Center High Mount Stop Lamp

5. Reverse procedure for installation of bulbs and housing.

### Cab Top Clearance Lights — If Equipped

1. Remove the two screws from the top of the light.

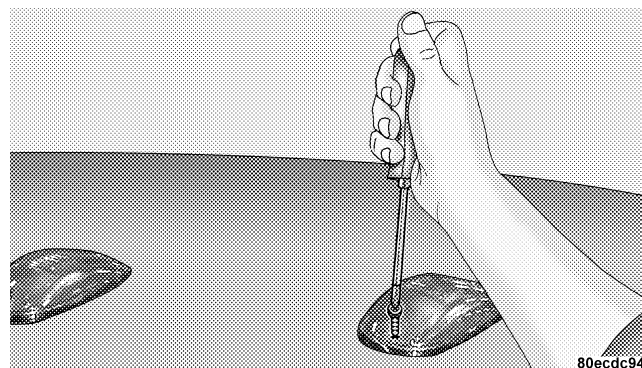

2. Rotate the socket  $\frac{1}{4}$  turn and pull it from the light assembly.

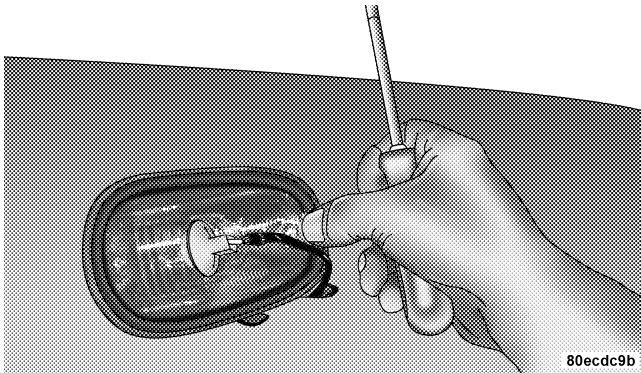

80ecd9b

3. Pull the bulb straight from its socket and replace.

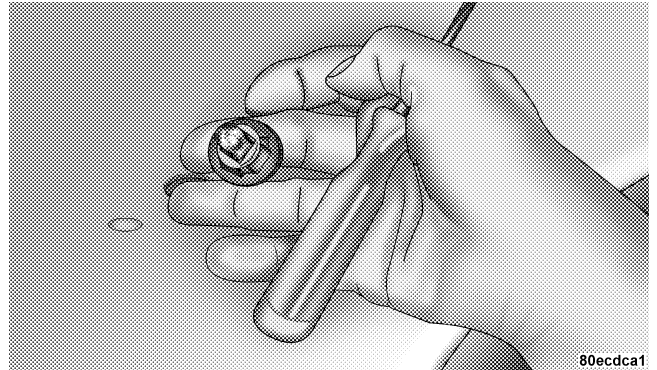

80ecdca1

### Tailgate ID Lights (Dual Rear Wheels)

1. Remove the two screws and housing and access the bulb sockets from the rear.

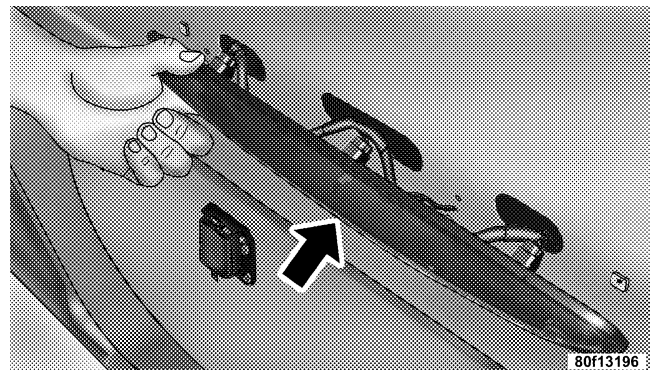
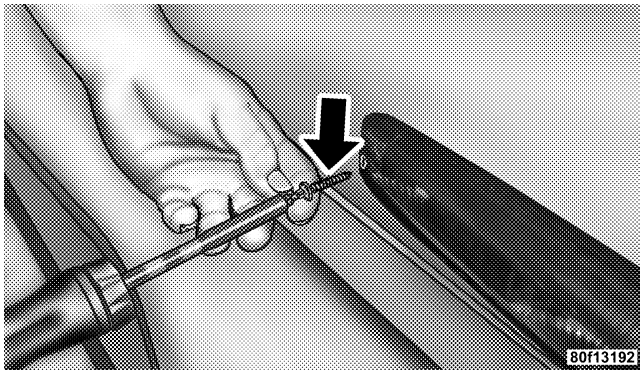

2. Turn socket ¼ turn counterclockwise to access the bulb.

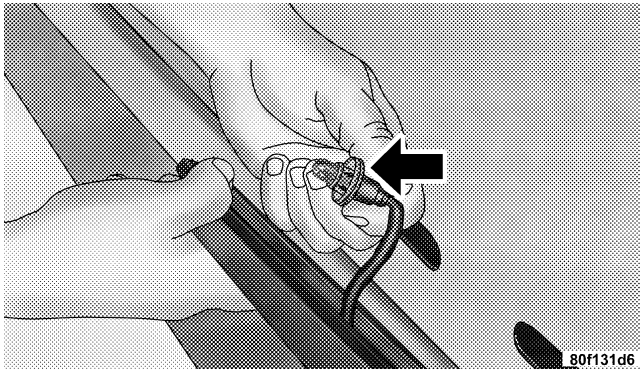

3. Pull bulb straight out from socket.
4. Reverse procedure for installation of bulbs and housing.

### Side Marker Lights (Dual Rear Wheels)

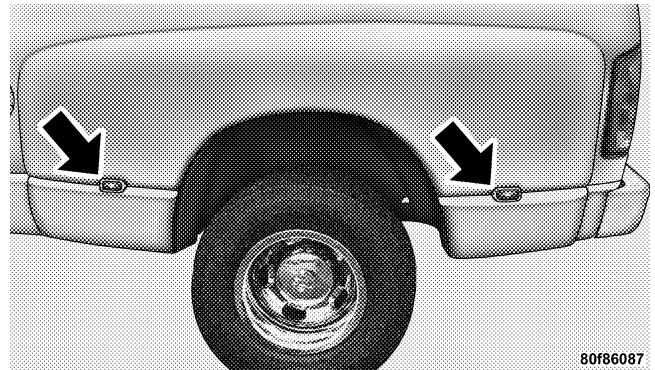

1. Push rearward on the side marker light assembly.
2. Pull the entire assembly from the fender.
3. Turn socket ¼ turn counterclockwise and remove from assembly to access the bulb.
4. Pull bulb straight out from socket.

5. Reverse procedure for installation of bulbs and housing.

### Fog Lights

1. Reach under the vehicle, unlock and twist connector counterclockwise  $\frac{1}{4}$  turn and remove connector and bulb from housing.

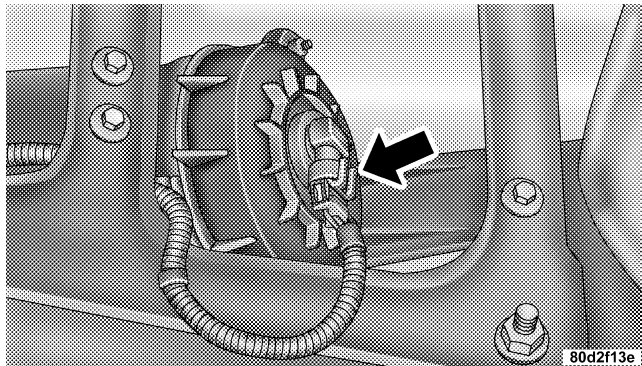

2. Pull bulb straight from the connector.

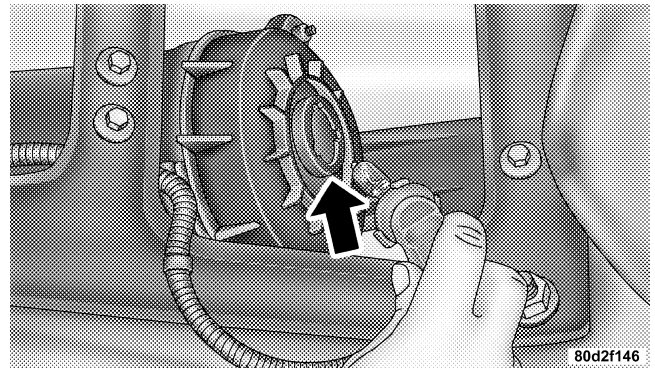

3. Reverse procedure for installation of bulbs and housing.

**FLUIDS AND CAPACITIES**

Fuel	U.S.	Metric
3.7L/4.7L, 87 Octane		
5.7L, 89 Octane		
1500 Shortbed Models	26 gal.	98L
1500 Longbed Models	35 gal.	132L
1500 Shortbed Models	34 gal.	128L
2500 Shortbed Models	34 gal.	128L
2500 Longbed Models	35 gal.	132L
3500 Shortbed Models	34 gal.	128L
3500 Longbed Models	35 gal.	132L

	U.S.	Metric
<b>Engine Oil (with filter)</b>		
3.7L Engine V-6, SAE 5W-30, API Certified	5.0 qts.	4.7L
4.7L Engine V-8, SAE 5W-30, API Certified	6.0 qts.	5.7L
5.7L Engine V-8, SAE 5W-20, API Certified	7.0 qts.	6.6L
<b>Cooling System</b>		
3.7L (Mopar® Antifreeze/Coolant 5 Year/100,000 Mile Formula)	17 qts.	16L
4.7L (Mopar® Antifreeze/Coolant 5 Year/100,000 Mile Formula)	17 qts.	16L
5.7L (Mopar® Antifreeze/Coolant 5 Year/100,000 Mile Formula)	18.7 qts.	17.7L



**RECOMMENDED FLUIDS, LUBRICANTS AND GENUINE PARTS**

**Engine**

Component	Fluids, Lubricants and Genuine Parts
Engine Coolant	Mopar® Antifreeze/Coolant 5 Year/100,000 Mile Formula HOAT (Hybrid Organic Additive Technology) P/N 5011764AB or equivalent.
3.7/4.7L Engine Oil	Use SAE 5W-30, API Certified, meeting material standard MS-6395.
5.7L Engine Oil	Use SAE 5W-20, API Certified, meeting material standard MS-6395.
Engine Oil Filter	Mopar® Engine Oil Filter, P/N 5281090 or equivalent.
Spark Plugs	Refer to the Vehicle Emission Control Information label in the engine compartment.
Fuel Selection (all except 5.7L)	87 Octane, (R+M)/2 Method
Fuel Selection (5.7L)	89 Octane, (R+M)/2 Method, Mid-Grade Preferred (87 Octane acceptable)

**Chassis**

Component	Fluids, Lubricants and Genuine Parts.
Automatic Transmission	Mopar® ATF+4, Automatic Transmission Fluid or or equivalent.
Transfer Case	Mopar® ATF+4, Automatic Transmission Fluid or equivalent.
Manual Transmission Fluid NV 4500	75W-85 Synthetic, API grade GL4, Mopar® P/N 4874459 or equivalent.
Manual Transmission Fluid (G238).	Mopar® ATF+4, Automatic Transmission Fluid or equivalent.
Manual Transmission Fluid (G-56)	Mopar® ATF+4, Automatic Transmission Fluid or equivalent.
Clutch Linkage	Multipurpose Grease, NLGI Grade 2 E.P. or equivalent.
1500 Model Front Axle (4X4)	GL-5 SAE 75W-90 or equivalent.
1500 Model Rear Axle	Mopar® Synthetic Gear Lubricant SAE 75W-140 (MS-8985). Limited-Slip Rear Axles on 1500 Models Require the addition of 118 ml (4 oz.) Mopar® limited slip additive or equivalent.
2500/3500 Model Front and Rear Axle	Synthetic, GL-5 SAE, 75W-90 or equivalent. Limited-Slip 10.5/11.5 inch Rear Axles <b>DO NOT REQUIRE</b> a limited slip additive.
Brake Master Cylinder	Mopar® DOT 3 and SAE J1703 should be used or equivalent. If DOT 3 brake fluid is not available, then DOT 4 is acceptable. Use only recommended brake fluids.
Power Steering Reservoir	Mopar® ATF+4, Automatic Transmission Fluid or equivalent.

---

# MAINTENANCE SCHEDULES

## CONTENTS

---

■ Emission Control System Maintenance . . . . .	408	□ Schedule "B" . . . . .	411
■ Maintenance Schedules . . . . .	408	□ Schedule "A" . . . . .	422

**EMISSION CONTROL SYSTEM MAINTENANCE**

The “Scheduled” maintenance services, listed in **bold type** in this section (Section 8) must be done at the times or mileages specified to assure the continued proper functioning of the emission control system. These, and all other maintenance services included in this manual, should be done to provide best vehicle performance and reliability. More frequent maintenance may be needed for vehicles in severe operating conditions such as dusty areas and very short trip driving.

Inspection and service also should be done any time a malfunction is suspected.

**NOTE:** Maintenance, replacement, or repair of the emission control devices and systems on your vehicle may be performed by any automotive repair establishment or individual using any automotive part which has been certified pursuant to U.S. EPA or, in the State of California, California Air Resources Board regulations.

**MAINTENANCE SCHEDULES**

There are two maintenance schedules that show the **required** service for your vehicle.

First is Schedule “**B**”. It is for vehicles that are operated under the conditions that are listed below and at the beginning of the schedule.

- Day or night temperatures are below 32° F (0° C).
- Stop and go driving.
- Extensive engine idling.
- Driving in dusty conditions.
- Short trips of less than 10 miles (16 km).
- More than 50% of your driving is at sustained high speeds during hot weather, above 90° F (32°C).
- Trailer towing.
- Snowplowing.

- Heavy Loading.
- Taxi, police, or delivery service (commercial service).
- Off-road or desert operation.
- **If equipped for and operating with E-85 (ethanol) fuel.**

**NOTE:** If **ANY** of these apply to you then change your engine oil every 3,000 miles (5 000 km) or 3 months, whichever comes first and follow schedule "B" of the "Maintenance Schedules" section of this manual.

**NOTE:** If **ANY** of these apply to you then flush and replace your engine coolant every 102,000 miles (163 000 km) or 60 months, whichever comes first and follow schedule "B" of the "Maintenance Schedules" section of this manual.

**NOTE:** Most vehicles are operated under the conditions listed for Schedule "B".

Second is Schedule "A". It is for vehicles that are not operated under any of the conditions listed under Schedule "B".

Use the schedule that best describes your driving conditions. Where time and mileage are listed, follow the interval that occurs first.

**NOTE:** Under no circumstances should oil change intervals exceed 6000 miles (10 000 km) or 6 months whichever comes first.

**CAUTION!**

**Failure to perform the required maintenance items may result in damage to the vehicle.**

**410 MAINTENANCE SCHEDULES**

*At Each Stop for Fuel*

- Check the engine oil level about 5 minutes after a fully warmed engine is shut off. Checking the oil level while the vehicle is on level ground will improve the accuracy of the oil level reading. Add oil only when the level is at or below the ADD or MIN mark.
- Check the windshield washer solvent and add if required.

*Once a Month*

- Check tire pressure and look for unusual wear or damage.
- Inspect the battery and clean and tighten the terminals as required.
- Check the fluid levels of coolant bottle, brake master cylinder, and transmission and add as needed.

- Check all lights and all other electrical items for correct operation.

*At Each Oil Change*

- Change the engine oil filter.
- Lubricate Drivetrain/Steering/Suspension Grease Fittings (if equipped)
- Inspect the exhaust system.
- Inspect the brake hoses.
- Inspect the CV joints (if equipped) and front suspension components.
- Check the automatic transmission fluid level.
- Check the manual transmission fluid level.
- Check the coolant level, hoses, and clamps.

**Schedule "B"**

Follow schedule "B" if you usually operate your vehicle under one or more of the following conditions.

- Day or night temperatures are below 32° F (0° C).
- Stop and go driving.
- Extensive engine idling.
- Driving in dusty conditions.
- Short trips of less than 10 miles (16 km).
- More than 50% of your driving is at sustained high speeds during hot weather, above 90° F C (32°).
- Trailer towing.
- Snowplowing.
- Heavy Loading.
- Taxi, police, or delivery service (commercial service).

- Off-road or desert operation.
- **If equipped for and operating with E-85 (ethanol) fuel.**

**NOTE:** If ANY of these apply to you then change your engine oil every 3,000 miles (5 000 km) or 3 months, whichever comes first and follow schedule "B" of the "Maintenance Schedules" section of this manual.

**NOTE:** If ANY of these apply to you then flush and replace your engine coolant every 102,000 miles (163 000 km) or 60 months, whichever comes first and follow schedule "B" of the "Maintenance Schedules" section of this manual.

**NOTE:** If none of these apply to you, then change your engine oil at every interval shown on schedule "A" of the "Maintenance Schedules" section of this manual.

412 SCHEDULE "B"

Miles (Kilometers)	3,000 (5 000)	6,000 (10 000)	9,000 (14 000)	12,000 (19 000)	15,000 (24 000)
Change engine oil and engine oil filter at interval shown or 3 months, whichever comes first.	X	X	X	X	X
Lubricate Front Drive Shaft Fitting (2500/3500, 4X4).	X	X	X	X	X
Rotate tires.		X		X	
Lubricate outer tie rod ends 2500/3500 (4X4) models only.		X		X	
Change rear axle fluid.					X
Change front axle fluid (4X4).					X
Inspect brake linings.				X	
Inspect engine air cleaner filter, replace if necessary.					X



Miles (Kilometers)	18,000 (29 000)	21,000 (34 000)	24,000 (38 000)	27,000 (43 000)	30,000 (48 000)
Change engine oil and engine oil filter at interval shown or 3 months, whichever comes first.	X	X	X	X	X
Lubricate Front Drive Shaft Fitting (2500/3500, 4X4).	X	X	X	X	X
Rotate tires.	X		X		X
Lubricate outer tie rod ends 2500/3500 (4X4) models only.	X		X		X
Change rear axle fluid.					X
Change front axle fluid (4X4).					X
Check transfer case fluid level (4X4).					X
Inspect brake linings.			X		
Inspect engine air cleaner filter, replace if necessary.					X
Replace spark plugs.					X
Inspect PCV valve, replace as necessary. **					X

414 SCHEDULE "B"

Miles (Kilometers)	33,000 (53 000)	36,000 (58 000)	39,000 (62 000)	42,000 (67 000)	45,000 (72 000)
Change engine oil and engine oil filter at interval shown or 3 months, whichever comes first.	X	X	X	X	X
Lubricate Front Drive Shaft Fitting (2500/3500, 4X4).	X	X	X	X	X
Rotate tires.		X		X	
Lubricate outer tie rod ends 2500/3500 (4X4) models only.		X		X	
Change rear axle fluid.					X
Change front axle fluid (4X4).					X
Inspect brake linings.		X			
Inspect engine air cleaner filter, replace if necessary.					X

Miles (Kilometers)	48,000 (77 000)	51,000 (82 000)	54,000 (86 000)	57,000 (91 000)	60,000 (96 000)
Change engine oil and engine oil filter at interval shown or 3 months, whichever comes first.	X	X	X	X	X
Lubricate Front Drive Shaft Fitting (2500/3500, 4X4).	X	X	X	X	X
Rotate tires.	X		X		X
Lubricate outer tie rod ends 2500/3500 (4X4) models only.	X		X		X
Flush and replace engine coolant at 60 months, or 102, 000 miles (163 000 km) whichever comes first.					X
Drain and refill transfer case fluid (4X4).					X
Change rear axle fluid.					X
Change front axle fluid (4X4).					X
Change 6-spd manual transmission fluid 2500/3500 models only.					X
Inspect brake linings.	X				X

**416 SCHEDULE "B"**

Miles (Kilometers)	48,000 (77 000)	51,000 (82 000)	54,000 (86 000)	57,000 (91 000)	60,000 (96 000)
Inspect engine air cleaner filter, replace if necessary.					X
Replace spark plugs.					X
Replace ignition cables.					X
Inspect PCV valve, replace as necessary. **					X
Drain and refill automatic transmission fluid and change main sump filter*.					X

Miles (Kilometers)	63,000 (101 000)	66,000 (106 000)	69,000 (110 000)	72,000 (115 000)	75,000 (120 000)
Change engine oil and engine oil filter at interval shown or 3 months, whichever comes first.	X	X	X	X	X
Lubricate Front Drive Shaft Fitting (2500/3500, 4X4).	X	X	X	X	X
Rotate tires.		X		X	
Lubricate outer tie rod ends 2500/3500 (4X4) models only.		X		X	
<b>Inspect engine air cleaner filter. Replace if necessary.</b>					X
Change rear axle fluid.					X
Change front axle fluid (4X4).					X
Inspect brake linings.				X	
Inspect auto tension drive belt and replace if required. (3.7L/4.7L/5.7L).					X

418 SCHEDULE "B"

Miles (Kilometers)	78,000 (125 000)	81,000 (130 000)	84,000 (134 000)	87,000 (139 000)	90,000 (144 000)
Change engine oil and engine oil filter at interval shown or 3 months, whichever comes first.	X	X	X	X	X
Lubricate Front Drive Shaft Fitting (2500/3500, 4X4).	X	X	X	X	X
Rotate tires.	X		X		X
Lubricate outer tie rod ends 2500/3500 (4X4) models only.	X		X		X
Change rear axle fluid.					X
Change front axle fluid (4X4).					X
Check transfer case fluid level (4X4).					X
Inspect brake linings.			X		
Inspect engine air cleaner filter, replace if necessary.					X
Replace spark plugs.					X
Inspect PCV valve, replace as necessary. **					X
Inspect auto tension drive belt and replace if required (3.7L/4.7L/5.7L).					X

Miles (Kilometers)	93,000 (149 000)	96,000 (154 000)	99,000 (158 000)	100,000 (160 000)	102,000 (163 000)
Change engine oil and engine oil filter at interval shown or 3 months, whichever comes first.	X	X	X		X
Lubricate Front Drive Shaft Fitting (2500/3500, 4X4).	X	X	X	X	X
Rotate tires.		X			X
Lubricate outer tie rod ends 2500/3500 (4X4) models only.		X			X
Flush and replace engine coolant, if not replaced at 60 months.					X
Flush and replace Power Steering Fluid.				X	
Inspect brake linings.		X			

**420 SCHEDULE "B"**

Miles (Kilometers)	105,000 (168 000)	108,000 (173 000)	111,000 (178 000)	114,000 (182 000)	117,000 (187 000)	120,000 (192 000)
Change engine oil and engine oil filter at interval shown or 3 months, whichever comes first.	X	X	X	X	X	X
Lubricate Front Drive Shaft Fitting (2500/3500, 4X4).	X	X	X	X	X	X
Rotate tires.		X		X		X
Lubricate outer tie rod ends 2500/3500 (4X4) models only.		X		X		X
Drain and refill transfer case fluid (4X4).						X
Change rear axle fluid.	X					X
Change front axle fluid (4X4).	X					X
Change 6-spd manual transmission fluid 2500/3500 models only.						X
Inspect brake linings.		X				X
Inspect engine air cleaner filter, replace if necessary.	X					X



Miles (Kilometers)	105,000 (168 000)	108,000 (173 000)	111,000 (178 000)	114,000 (182 000)	117,000 (187 000)	120,000 (192 000)
Replace spark plugs.						X
Replace ignition cables.						X
Inspect PCV valve, replace as necessary. **						X
Inspect auto tension drive belt and replace if required (3.7L/4.7L/5.7L).	X					X
Drain and refill automatic transmission fluid and change main sump and spin-on cooler return filter (if equipped)*.						X
Flush and replace engine coolant at 120 months if not replaced at 102,000 miles (192 000 km).						X

\* This applies only if the vehicle is used for frequent trailer towing, snowplowing, fleet vehicle or commercial service.

\*\* This maintenance is recommended by the manufacturer to the owner, but not required to maintain the emissions warranty.

Inspection and service should also be performed anytime a malfunction is observed or suspected. Retain all receipts.

**422 SCHEDULE "A"**

**Schedule "A"**

Miles (Kilometers) [Months]	6,000 (10 000) [6]	12,000 (19 000) [12]	18,000 (29 000) [18]	24,000 (38 000) [24]	30,000 (48 000) [30]
Change engine oil and engine oil filter.	X	X	X	X	X
Rotate tires.	X	X	X	X	X
Check transfer case fluid level (4X4).					X
Lubricate outer tie rod ends 2500/3500 (4X4) models only.	X	X	X	X	X
Inspect brake linings.			X		
Inspect engine air cleaner filter. Replace if necessary.					X
Replace spark plugs.					X

Miles (Kilometers) [Months]	36,000 (58 000) [36]	42,000 (67 000) [42]	48,000 (77 000) [48]	54,000 (84 000) [54]	60,000 (96 000) [60]	66,000 (106 000) [66]
Change engine oil and engine oil filter.	X	X	X	X	X	X
Rotate tires.	X	X	X	X	X	X
Check transfer case fluid level (4X4).					X	
Lubricate outer tie rod ends 2500/3500 (4X4) models only.	X	X	X	X	X	X
Flush and replace engine coolant at 60 months, if not replaced at 102,000 miles (163 000 km).					X	
Inspect brake linings.	X			X		
Inspect engine air cleaner filter. Replace if necessary.					X	
Replace spark plugs.					X	
Inspect PCV valve, replace as necessary. **					X	
Replace ignition cables.					X	

424 SCHEDULE "A"

Miles (Kilometers) [Months]	72,000 (115000) [72]	78,000 (125 000) [78]	84,000 (134 000) [84]	90,000 (144 000) [90]	96,000 (154 000) [96]	100,000 160 000
Change engine oil and engine oil filter.	X	X	X	X	X	
Rotate tires.	X	X	X	X	X	
Lubricate outer tie rod ends 2500/3500 (4X4) models only.	X	X	X	X	X	
Check transfer case fluid level (4X4).				X		
Flush and replace Power Steering Fluid.						X
Inspect brake linings.	X			X		
Inspect engine air cleaner filter. Replace if necessary.				X		
Replace spark plugs.				X		
Inspect PCV valve, replace as necessary. **				X		
Inspect auto tension drive belt and replace if required (3.7L/4.7L/5.7L).				X		

Miles (Kilometers) [Months]	102,000 (163 000) [102]	108,000 (173 000) [108]	114,000 (182 000) [114]	120,000 (192 000) [120]
Change engine oil and engine oil filter.	X	X	X	X
Rotate tires.	X	X	X	X
Drain and refill transfer case fluid (4X4).				X
Flush and replace engine coolant, if not replaced at 60 months.	X			
Flush and replace engine coolant at 120 months, if not replaced at 102,000 miles (163 000 km).				X
Lubricate outer tie rod ends 2500/3500 (4X4) models only.	X	X	X	X
Inspect brake linings.		X		
Inspect auto tension drive belt and replace if required (3.7L/4.7L/5.7L).	X			X
<b>Replace ignition cables.</b>				X

**426 SCHEDULE "A"**

Miles (Kilometers) [Months]	102,000 (163 000) [102]	108,000 (173 000) [108]	114,000 (182 000) [114]	120,000 (192 000) [120]
Inspect engine air cleaner filter. Replace if necessary.				X
Replace spark plugs.				X
Inspect PCV Valve, replace as necessary. **				X

\*\* This maintenance is recommended by the manufacturer to the owner, but not required to maintain the emissions warranty.

Inspection and service should also be performed anytime a malfunction is observed or suspected. Retain all receipts.

<b>WARNING!</b>
<p><b>You can be badly injured working on or around a motor vehicle. Do only that service work for which you have the knowledge and the right equipment. If you have any doubt about your ability to perform a service job, take your vehicle to a competent mechanic.</b></p>

---

## IF YOU NEED CONSUMER ASSISTANCE

### CONTENTS

---

■ Suggestions For Obtaining Service For Your Vehicle . . . . .	428	■ Warranty Information . . . . .	430
□ Prepare For The Appointment . . . . .	428	■ Mopar® Parts . . . . .	432
□ Prepare A List . . . . .	428	■ Reporting Safety Defects . . . . .	432
□ Be Reasonable With Requests . . . . .	428	□ In Canada . . . . .	432
■ If You Need Assistance . . . . .	428	■ Publication Order Forms . . . . .	433

**SUGGESTIONS FOR OBTAINING SERVICE FOR YOUR VEHICLE****Prepare For The Appointment**

If you're having warranty work done, be sure to have the right papers with you. Take your warranty folder. All work to be performed may not be covered by the warranty, discuss additional charges with the service manager. Keep a maintenance log of your vehicle's service history. This can often provide a clue to the current problem.

**Prepare A List**

Make a written list of your vehicle's problems or the specific work you want done. If you've had an accident, or work done that is not on your maintenance log, let the service advisor know.

**Be Reasonable With Requests**

If you list a number of items, and you must have your vehicle by the end of the day, discuss the situation with the service advisor and list the items in order of priority. At many dealers you may obtain a rental vehicle at a minimal daily charge. If you need a rental, it is advisable to make these arrangements when you call for an appointment.

**IF YOU NEED ASSISTANCE**

The manufacturer and its dealers are vitally interested in your satisfaction. We want you to be happy with our products and services.

Warranty service must be done by an authorized Chrysler, Dodge, or Jeep dealer. We strongly recommend that you take your vehicle to your selling dealer. They know you and your vehicle best, and are most concerned that you get prompt and high quality service. The manufacturer's dealers have the facilities, factory-trained technicians, special tools, and the latest information to assure your vehicle is fixed correctly and in a timely manner.



This is why you should always talk to your dealer's service manager first. Most matters can be resolved with this process.

- If for some reason you are still not satisfied, talk to the general manager or owner of the dealership. They want to know if you need assistance.
- If your dealership is unable to resolve the concern, you may contact the Manufacturer's Customer Center.

Any communication to the Manufacturer's Customer Center should include the following information:

- Owner's name and address
- Owner's telephone number (home and office)
- Dealership name
- Vehicle identification number
- Vehicle delivery date and mileage

*DaimlerChrysler Motors Corporation Customer Center*  
P.O. Box 21-8004  
Auburn Hills, MI 48321-8004  
Phone: (800) 992-1997

*DaimlerChrysler Canada Inc. Customer Center*  
P.O. Box 1621  
Windsor, Ontario N9A 4H6  
Phone —(800) 465-2001

*In Mexico contact:*

Av. Prolongacion Paseo de la Reforma, 1240  
Sante Fe C.P. 05109  
Mexico, D. F.  
In Mexico (915) 729-1248 or 729-1240  
Outside Mexico (525) 729-1248 or 729-1240

*Customer Assistance For The Hearing Or Speech Impaired (TDD/TTY)*

To assist customers who have hearing difficulties, the manufacturer has installed special TDD (Telecommunication Devices for the Deaf) equipment at its Customer

Center. Any hearing or speech impaired customer who has access to a TDD or a conventional teletypewriter (TTY) in the United States can communicate with the manufacturer by dialing 1-800-380-CHRY.

***Service Contract***

You may have purchased a service contract for your vehicle to help protect you from the high cost of unexpected repairs after your manufacturer's new vehicle limited warranty expires. The manufacturer stands behind only the manufacturer's Service Contracts. If you purchased a manufacturer's Service Contract, you will receive Plan Provisions and an Owner Identification Card in the mail within three weeks of your vehicle delivery date. If you have any questions about your service contract, call the manufacturer's Service Contract National Customer Hotline at 1-800-521-9922.

The manufacturer will not stand behind any service contract that is not the manufacturer's Service Contract. It is not responsible for any service contract other than the manufacturer's Service Contract. If you purchased a

service contract that is not a manufacturer's Service Contract, and you require service after your manufacturer's new vehicle limited warranty expires, please refer to your contract documents, and contact the person listed in those documents.

We appreciate that you have made a major investment when you purchased your new vehicle. Your dealer has also made a major investment in facilities, tools, and training to assure that you are absolutely delighted with your ownership experience. You'll be pleased with their sincere efforts to resolve any warranty issues or related concerns.

**WARRANTY INFORMATION**

See your manufacturer's Warranty Information Booklet for information on warranty coverage and transfer of warranty.

DESCRIPTION	1 Yr/ 12,000	2 Yr/ 24,000	3 Yr/ 36,000	3 Yr/ 50,000	3 Yr/ Unlimtd	5 Yr/ 50,000	5 Yr/ 100,000	7 Yr/ 70,000	7 Yr/ 100,000	8 Yr/ 80,000	Lifetime
<b>Basic Limited Warranty Coverage</b>											
<b>Special Extended Warranty Coverage</b>											
Powertrain Limited Warranty: (\$100 Deductible)				1st Owner & 2nd Owner with Paid Powertrain Transfer							
			2nd Owner if Powertrain Not Transferred & 3rd (and After) Owners								
Anti-Corrosion Perforation Limited Warranty: All Panels											
Outer Panels											
Federal Emission Warranty: Light Duty Truck											
Federal Emission Warranty: Specified Components Light Duty Truck											
Federal Emission Warranty: Heavy Duty Truck											
California Emission Warranty: Light & Medium Duty Truck											
California Emission Warranty: Specified Components Light/Med Duty & Med Duty Diesel											
Cummins Diesel Engine Components Limited Warranty: (\$100 Deductible after 5 Years)								1st Owner & 2nd Owner w/Paid Powertrain Transfer			
			2nd Owner if Powertrain Not Transferred and 3rd (and After) Owners								
Noise Emission Warranty: Heavy Duty											

8132e455

Note: Vehicles used as a police vehicle, taxi, limousine, postal delivery vehicle, ambulance or rental vehicle are covered only under the 3 years/36,000 mile Basic Limited Warranty.

**U.S. Vehicles Only**

### **MOPAR® PARTS**

Mopar® fluids, lubricants, parts, and accessories are available from your dealer. They will help you keep your vehicle operating at its best.

### **REPORTING SAFETY DEFECTS**

In the 50 United States and Washington D.C.: If you believe that your vehicle has a defect which could cause a crash or cause injury or death, you should immediately inform the National Highway Traffic Safety Administration (NHTSA) in addition to notifying the manufacturer.

If NHTSA receives similar complaints, it may open an investigation, and if it finds that a safety defect exists in a group of vehicles, it may order a recall and remedy campaign. However, NHTSA cannot become involved in individual problems between you, your dealer, and the manufacturer.

To contact NHTSA, you may either call the Auto Safety Hotline toll free at 1-800-424-9393 (or 366-0123 in Washington DC area) or write to: NHTSA, U.S. Dept. of Transportation, Washington DC 20590. You can also obtain other information about motor vehicle safety from the Hotline.

### **In Canada:**

If you believe that your vehicle has a safety defect, you should contact the Customer Service Department immediately. Canadian customers who wish to report a safety defect to the Canadian government should write to Transport Canada, Motor Vehicle Defect Investigations and Recalls, 2780 Sheffield Road, Ottawa, Ontario K1B 3V9.

### PUBLICATION ORDER FORMS

To order the following manuals, you may use either the website or the phone numbers listed below. Visa, Mastercard, American Express, and Discover orders are accepted. If you prefer mailing your payment, please call for an order form.

**NOTE:** A street address is required when ordering manuals. (No P.O. Boxes).

- *Service Manuals.*

These comprehensive service manuals provide the information that students and professional technicians need in diagnosing/troubleshooting, problem solving, maintaining, servicing and repairing DaimlerChrysler Corporation vehicles. A complete working knowledge of the vehicle, system and/or components is written in straightforward language with illustrations, diagrams and charts.

- *Diagnostic Procedure Manuals.*

Filled with diagrams, charts and detailed illustrations, these practical manuals make it easy for students and technicians to find and fix problems on computer-controlled vehicle systems and features. They show exactly how to find and correct problems the first time, using step-by-step troubleshooting and driveability procedures, proven diagnostic tests and a complete list of all tools and equipment.

- *Owner's Manuals.*

These manuals have been prepared with the assistance of service and engineering specialists to acquaint you with specific Chrysler group vehicles. Included are starting, operating, emergency and maintenance procedures as well as specifications, capabilities and safety tips.

*Call Toll Free at:*

- 1-800-890-4038 (U.S.)
- 1-800-387-1143 (Canada)

Or

*Visit us on the World Wide Web at:*

- [www.techauthority.daimlerchrysler.com](http://www.techauthority.daimlerchrysler.com)
- [www.daimlerchrysler.ca/manuals](http://www.daimlerchrysler.ca/manuals)

---

## INDEX

- Adding Fuel . . . . . 285,321  
Air Cleaner, Engine (Engine Air Cleaner Filter) . 358,382  
Air Conditioner Maintenance . . . . . 362  
Air Conditioning Refrigerant . . . . . 362,363  
Air Conditioning System . . . . . 211,362  
Air Conditioning System, Zone Control . . . . . 215  
Air Pressure, Tires . . . . . 269,277  
Airbag . . . . . 45,51  
Airbag Light . . . . . 71,166  
Airbag On/Off Switch . . . . . 51  
Airbag, Side . . . . . 54  
Alarm . . . . . 29,169  
Alignment and Balance . . . . . 277  
Alterations/Modifications, Vehicle . . . . . 7  
Antifreeze (Engine Coolant) . . . . . 370,403  
Anti-Lock Brake System (ABS) . . . . . 256  
Anti-Lock Warning Light . . . . . 170,258  
Anti-Theft System . . . . . 29,169  
Appearance Care . . . . . 385  
Ashtray . . . . . 148  
Automatic Transmission  
  Adding Fluid . . . . . 378  
  Fluid and Filter Changes . . . . . 379  
  Fluid Level Check . . . . . 377  
  Fluid Type . . . . . 379,406  
  Shift Indicator . . . . . 169  
  Shifting . . . . . 232  
  Special Additives . . . . . 379  
Axle Fluid . . . . . 298,374,406  
Axle Lubrication . . . . . 298,374  
Ball Joints . . . . . 364  
Battery . . . . . 361  
  Emergency Starting . . . . . 337  
Bearings . . . . . 380  
Belts, Drive . . . . . 357  
Belts, Seat . . . . . 34  
Body Mechanism Lubrication . . . . . 366



B-Pillar Location	264	Oil (Engine)	356
Brake Fluid	406	Power Steering	363
Brake System	255,372	Car Washes	385
Anti-Lock	256,257	Carbon Monoxide Warning	70,158,288
Disc Brakes	372	Cargo Light	119
Hoses	374	Cassette Tape and Player Maintenance	206
Master Cylinder	372	Cassette Tape Player	174,177,180
Parking	254	Catalytic Converter	291,359
Warning Light	170	CD Changer	178,189,195
Break-In Recommendations, New Vehicle	68	CD Player	187,191,193,197,200
Bulb Replacement	391	Cellular Phone	83
Bulbs, Light	390	Center High Mounted Stop Light	397
		Center Lap Belts	42
Cab Top Clearance Lights	398	Center Seat Storage Compartment	150
Calibration, Compass	134	Certification Label	293
Camper	157	Chart, Tire Sizing	261
Capacities, Fluid	403	Check Engine Light (Malfunction Indicator Light)	165
Caps, Filler		Child Restraint	56
Fuel	285,286	Child Restraint Tether Anchors	60,64

Child Seat	56,62	Disposal of Used Coolant	371
Cigar Lighter	148	Drain, Flush, and Refill	369
Climate Control	208	Inspection	368
Clock	173	Radiator Cap	369,371
Clutch	374	Selection of Coolant	370,403,405
Clutch Linkage Maintenance	374	Temperature Gauge	168
Compact Disc Maintenance	207	Cruise Control (Speed Control)	125
Compact Disc Player	180,187	Cup Holder	149
Compact Spare Tire	272	Customer Assistance	428
Compass	133,134	Daytime Running Lights	118
Compass Calibration	134	Dealer Service	352
Compass Variance	136	Defroster, Rear Window	81,214,218
Computer, Trip/Travel	130	Defroster, Windshield	210,213
Console, Overhead	129	Delay (Intermittent) Wipers	121
Contract, Service	430	Differential, Limited-Slip	253
Converter, Catalytic	291	Dipsticks	
Cooling System	368	Automatic Transmission	377
Coolant Capacity	403	Power Steering	363
Coolant Level	369		

Disc Brakes . . . . .	372	Jump Starting . . . . .	337
Disposal		Tow Hooks . . . . .	341
Engine Oil . . . . .	371	Towing . . . . .	342
Door Ajar . . . . .	167	Emission Control System Maintenance . . . . .	408
Door Locks . . . . .	15	Emission Related Components . . . . .	361
Door Opener, Garage . . . . .	137	Engine . . . . .	348,349
Drive Belts . . . . .	357	Air Cleaner . . . . .	358
Drive Shaft Universal Joints . . . . .	365	Break-In Recommendations . . . . .	68
Dual Rear Wheels . . . . .	281,334	Compartment Identification . . . . .	348,349
E-85 Fuel . . . . .	289	Coolant (Antifreeze) . . . . .	370,405
Electric Rear Window Defrost . . . . .	81,214,218	Exhaust Gas Caution . . . . .	288
Electrical Power Outlets . . . . .	147	Flooded, Starting . . . . .	230
Electronic Speed Control . . . . .	125	Fuel Requirements . . . . .	403
Emergency Brake . . . . .	254	Oil . . . . .	353,403,405
Emergency, In Case of		Oil Filler Cap . . . . .	356
Freeing Vehicle When Stuck . . . . .	341	Oil Selection . . . . .	355,403
Hazard Warning Flasher . . . . .	320	Oil Synthetic . . . . .	356
Jacking . . . . .	327	Temperature Gauge . . . . .	168
		Equipment Identification Plate . . . . .	318

Ethylene Glycol Antifreeze	370	Starting	290
Exhaust Gas Caution	70,158,288,368	Flooded Engine Starting	230
Exhaust System	70,367,368	Fluid, Brake	406
Exterior Lighting	117	Fluid Capacities	403
Filters		Fluid Level Checks	
Air Cleaner	358,382	Automatic Transmission	377
Engine Fuel	358	Power Steering	363
Engine Oil	357,405	Fog Lights	118,402
Engine Oil Disposal	357	Fold Flat Load Floor	152
Flashers		Four Wheel Drive	241
Turn Signal	119	Four-Way Hazard Flasher	320
Flat Tire Stowage	326,336	Freeing A Stuck Vehicle	341
Flexible Fuel Vehicles		Front Axle	374
Cruising Range	291	Front Wheel Bearings	380
Engine Oil	290	Fuel	282
Fuel Requirements	289,290	Adding	285
Maintenance	291	Filter	358
Replacement Parts	291	Gauge	172
		Octane Rating	282,405

Requirements	282,403	GVWR	293
Tank Capacity	403	Hands-Free Phone	83
Fuel, Flexible	<i>See Flexible Fuel Vehicles</i>	Hazard Warning Flasher	320
Fueling	285	Head Restraints	109
Fuses	389	Headlights	117,391
Garage Door Opener	137	High Beam	120
Gas Cap	286	High Beam/Low Beam Select Switch	120
Gasoline	282	Lights On Reminder	118
Gasoline, Reformulated	283	Passing	120
Gauges	169	Switch	117
Coolant Temperature	168	Heated Mirrors	81,214,218
Fuel	172	Heated Seats	112
Oil Pressure	167	Heater	211
Speedometer	167	High Beam/Low Beam Select (Dimmer) Switch	120
Tachometer	166	Hitches	
Voltmeter	166	Trailer Towing	299
Gear Ranges	232,238	Hoisting	337
Glass Cleaning	388	Homelink Transmitter	137

Hood Release	113	Jump Starting	337
Hoses	372	Key, Replacement	12
Hub Caps	333	Key, Sentry	11
Ignition	13,228	Key-In Reminder	11
Key	11,13	Keyless Entry System	22
Lock	13	Keys	11,15
Infant Restraint	56	Lane Change and Turn Signals	119
Inflation Pressure Tires	277	Lap Belts	42
Inside Rearview Mirror	78	Lap/Shoulder Belts	34
Instrument Cluster	164,165	LATCH (Lower Anchors and Tether for Children)	60
Instrument Panel and Controls	163	Lights	71,115
Instrument Panel Lens Cleaning	389	Airbag	55,166
Interior Appearance Care	387	Anti-Lock Warning	170,258
Intermittent Wipers	121	Battery Saver	116
Introduction	4	Brake Warning	170
Jack Location	322	Bulb Replacement	390,391
Jack Operation	327	Cap Top Clearance	398

Center Mounted Stop	397	Seat Belt Reminder	166
Check Engine	165	Service	390,391
Courtesy/Reading	129	Side Marker	401
Cruise	169	Transfer Case	245
Daytime Running	118	Transmission Warning	173,304
Dual Wheel Assembly Rear	400	Turn Signal	119,166,391,395
Fog	118,402	Warning (Instrument Cluster Description)	165
Four-Wheel Drive Indicator	245	Limited-Slip Differential	253,375
Hazard Warning Flasher	320	Loading Vehicle	293
Headlights	117	Tires	264
High Beam	120,166	Locks	15
High Beam Indicator	166	Child Protection	20
High Beam/Low Beam Select	120	Door	15
Instrument Cluster	165	Ignition	13
Intensity Control	116	Keys	11
Interior	115,129	Power Door	16
Lights On Reminder	118	Steering Wheel	13
Low Washer Fluid	172	Lower Anchors and Tether for CHildren (LATCH)	60
Passing	120	Lubricants	380

444 INDEX

Lubrication, Body	366	Outside	79
Lug Nuts	332	Rearview	78
Lumbar Support	110	Trailer Towing	81,303
Maintenance	353	Modifications/Alterations, Vehicle	7
Maintenance Free Battery	361	Mopar Parts	353,432
Maintenance Procedures	353	Multi-Function Control Lever	119
Maintenance Schedule	408	Noise Control	
Schedule "A"	422	Maintenance	381
Schedule "B"	411	Tampering Prohibited	381,382
Malfunction Indicator Light	351	Noise Emission Warranty	383
Manual, Service	433	Occupant Restraints	33
Manual Transmission	238,239,376	Octane Rating, Gasoline	282
Fluid Level Check	375,376	Odometer	171,172
Lubricant Selection	376,377,406	Trip	171,172
Shift Speeds	238	Off-Pavement Driving	317
Mirrors	78	Off-Road Driving	317
Automatic Dimming	79	Oil, Engine	353,405
Electric Powered	80		



Capacity	403	Overhead Travel Information Center	130
Change Interval	354	Owner's Manual	433
Dipstick	353	Parking Brake	254
Disposal	357	Passenger Airbag On/Off Switch	51
Filter	357,405	Passing Light	120
Filter Disposal	357	Pedals, Adjustable	124
Identification Logo	356	Phone, Cellular	83
Materials Added to	356	Phone, Hands-Free	83
Pressure Gauge	167	Pickup Box	155
Recommendation	355,403	Placard, Tire and Loading Information	265
Synthetic	356	Positive Crankcase Valve	361
Viscosity	356,403	Power	
Onboard Diagnostic System	350,351	Distribution Center	389
Opener, Garage Door	137	Door Locks	16
Operating Precautions	350	Mirrors	80
Outside Rearview Mirrors	79	Outlet	147
Overdrive	235	Seats	111
Overdrive OFF Switch	235	Steering	259,363
Overhead Console	129,130		

Sunroof	143	Recreational Towing	309
Windows	31	Shifting into Transfer Case Neutral (N)	310,313
Power Steering Fluid	406	Shifting out of Transfer Case Neutral (N)	311,315
Pregnant Women and Seat Belts	45	Reformulated Gasoline	283
Pretensioners		Refrigerant	363
Seat Belts	43	Relays and Flashers	389
Programmable Electronic Features	138,142	Reminder, Seat Belt	43
Programming Transmitters	138,142	Remote Keyless Entry	22
Radial Ply Tires	272	Remote Sound System Controls	205
Radiator Cap (Coolant Pressure Cap)	369,371	Replacement Tires	276
Radio Operation	174,191	Reporting Safety Defects	432
Radio Remote Controls	205	Restraint, Head	109
Radio (Sound Systems)	174,180,191,197	Restraints, Child	56,62
Rear Axle	374	Rotation, Tires	280
Rear Wheel Bearings	380	Safety Checks Inside Vehicle	71
Reclining Front Seats	109	Safety Checks Outside Vehicle	71
Recommended Fluids, Lubricants and Genuine		Safety Defects, Reporting	432
Parts	405	Safety Information, Tire	259

Safety Tips	69	Reclining	109
Schedule, Maintenance	408	Security Alarm (Theft Alarm)	29,169
Seat Belt Maintenance	389	Selection of Coolant	405
Seat Belt Reminder	43	Sentry Key	11
Seat Belts	33,34,71	Service Assistance	428
Adjustable Upper Shoulder Anchorage	41	Service Contract	430
And Pregnant Women	45	Service Manuals	433
Child Restraint	56,68	Setting the Clock	173
Extender	45	Shift Speeds	240
Front Seat	34	Shifting	232
Pretensioners	43	Automatic Transmission	232
Reminder	166	Manual Transmission	238,239
Seats	107,108	Transfer Case	244
Adjustment	107	Transfer Case, Shifting into Transfer	
Child	68	Case Neutral (N)	310,313
Folding Floor	152	Transfer Case, Shifting out of Transfer	
Heated	112	Case Neutral (N)	311,315
Lumbar Support	110	Shoulder Belt Upper Anchorage	41
Power	111	Shoulder Belts	34

Side Airbag	54	Wheel, Tilt	123
Signals, Turn	119	Storage, Behind the Seat	150
Snow Chains (Tire Chains)	278	Storage Compartment, Center Seat	150
Snow Plow	305	Storage, Vehicle	390
Snow Tires	280	Storing Your Vehicle	390
Spare Tire	272,273	Sun Roof	143
Spark Plugs	358	Supplemental Tire Pressure Information	277
Speed Control	125	Synthetic Engine Oil	356
Speedometer	167	Tachometer	166
Starting	229	Tailgate	157
Automatic Transmission	230	Tether Anchor, Child Restraint	60,64
Engine Block Heater	231	Tilt Steering Column	123
Engine Fails to Start	230	Tire and Loading Information Placard	264,265,277
Manual Transmission	229	Tire Identification Number (TIN)	263
Steering		Tire Markings	259
Column Controls	119	Tire Safety Information	259
Column Lock	13	Tires	71,268
Linkage	365	Air Pressure	268
Power	259,363		

Alignment . . . . .	277	Wheel Mounting . . . . .	327
Chains . . . . .	278	Wheel Nut Torque . . . . .	332
Changing . . . . .	326	Tongue Weight/Trailer Weight . . . . .	301
Compact Spare . . . . .	272	Torque Converter Clutch . . . . .	237
Dual . . . . .	281,334	Tow Hooks, Emergency . . . . .	341
General Information . . . . .	268	Towing	
High Speed . . . . .	271	Disabled Vehicle . . . . .	342
Inflation Pressures . . . . .	269	Guide . . . . .	302
Jacking . . . . .	327	Recreational . . . . .	309
Load Capacity . . . . .	264,265	Trailerling . . . . .	297
Radial . . . . .	272	Weight . . . . .	302
Replacement . . . . .	276	Traction . . . . .	318
Rotation . . . . .	280	Trailer Towing . . . . .	296
Safety . . . . .	259,268	Hitches . . . . .	299
Sizes . . . . .	261	Mirrors . . . . .	81,303
Snow Tires . . . . .	280	Tips . . . . .	303
Spare Tire . . . . .	326	Trailer and Tongue Weight . . . . .	301
Spinning . . . . .	274	Trailer Towing Guide . . . . .	302
Tread Wear Indicators . . . . .	275	Trailer Weight . . . . .	302

450 INDEX

Transfer Case . . . . .	375	Vehicle Loading . . . . .	265,293
Fluid . . . . .	406	Vehicle Modifications/Alterations . . . . .	7
Transmission		Vehicle Storage . . . . .	390
Automatic . . . . .	232,377	Voltmeter . . . . .	166
Fluid . . . . .	406	Warning Lights (Instrument Cluster Description) . . . . .	165
Maintenance . . . . .	376,377	Warnings and Cautions . . . . .	5
Manual . . . . .	229,238,239,376	Warranty Information . . . . .	430
Shifting . . . . .	232,240	Washers, Windshield . . . . .	122,366
Transmitter, Garage Door Opener . . . . .	137	Washing Vehicle . . . . .	385
Tread Wear Indicators . . . . .	275	Wheel Alignment and Balance . . . . .	277
Trip Computer . . . . .	130	Wheel and Wheel Trim . . . . .	387
Trip Odometer . . . . .	171,172	Wheel Changing . . . . .	326
Turn Signals . . . . .	119,166,391,395	Wheel Mounting . . . . .	327
Underhood Fuses . . . . .	389	Wheel Nut Torque . . . . .	332,336
Universal Transmitter . . . . .	137	Wind Buffeting . . . . .	33,146
Variance, Compass . . . . .	136	Window Airbag . . . . .	54
Vehicle Identification Number . . . . .	6	Window Fogging . . . . .	219
		Windows . . . . .	31

Power .....	31	Windshield Wiper Blades .....	366
Rear Sliding .....	32	Windshield Wipers .....	121
Windshield Defroster .....	210,213	Wiper Blade Replacement .....	366
Windshield Washers .....	121,122,366	Wipers, Intermittent .....	121
Fluid .....	121,366		





# NOTES

---

---

---

---

---

---

---

---

---

---

---

---

## NOTES

---

---

---

---

---

---

---

---

---

---

---

---

---

---

---

## **NOTES**

---

---

---

---

---

---

---

---

---

---

---

---

---

