

TABLE OF CONTENTS

SECTION		PAGE
1	INTRODUCTION	3
2	THINGS TO KNOW BEFORE STARTING YOUR VEHICLE	9
3	UNDERSTANDING THE FEATURES OF YOUR VEHICLE	77
4	UNDERSTANDING YOUR INSTRUMENT PANEL	173
5	STARTING AND OPERATING	249
6	WHAT TO DO IN EMERGENCIES	353
7	MAINTAINING YOUR VEHICLE	375
8	MAINTENANCE SCHEDULES	449
9	IF YOU NEED CONSUMER ASSISTANCE	469
10	INDEX	477

INTRODUCTION

CONTENTS

■ Introduction	4	■ Van Conversions/Campers	7
■ A Message From DaimlerChrysler Corporation . . .	5	■ Vehicle Identification Number	8
■ How To Use This Manual	5	■ Vehicle Modifications / Alterations	8
■ Warnings And Cautions	7		

INTRODUCTION

This manual has been prepared with the assistance of service and engineering specialists to acquaint you with the operation and maintenance of your new vehicle. It is supplemented by a Warranty Information Booklet and various customer oriented documents. You are urged to read these publications carefully. Following the instructions and recommendations in this manual will help assure safe and enjoyable operation of your vehicle.

NOTE: After you read the manual, it should be stored in the vehicle for convenient reference and remain with the vehicle when sold, so that the new owner will be aware of all safety warnings.

When it comes to service, remember that your dealer knows your vehicle best, has the factory-trained technicians and genuine Mopar® parts, and is interested in your satisfaction.

WARNING!

Engine exhaust, some of its constituents, and certain vehicle components contain or emit chemicals known to the State of California to cause cancer and birth defects or other reproductive harm. In addition, certain fluids contained in vehicles and certain products of component wear contain or emit chemicals known to the State of California to cause cancer and birth defects or other reproductive harm.

A MESSAGE FROM DAIMLERCHRYSLER CORPORATION

DaimlerChrysler Corporation and Cummins welcome you as a new Dodge Ram Cummins Turbo Diesel-powered truck owner.

Almost 100% of the heavy duty trucks in the United States are diesel powered because of the fuel economy, rugged durability, and high torque which permits pulling heavy loads. Cummins engines power well over half of these trucks. Now this same technology and proven performance is yours in your new Dodge Ram truck equipped with the Cummins 5.9 liter, Turbocharged, Charge Air Cooled, Diesel engine.

Your diesel truck will sound, feel, drive, and operate differently from a gasoline-powered truck. It is important that you read and understand this manual. You may find that some of the starting, operating, and maintenance

procedures are different. However, they are simple to follow and careful adherence to them will ensure that you take full advantage of the features of this engine.

Thank you for choosing the Dodge Ram truck with Cummins Turbo Diesel power.

HOW TO USE THIS MANUAL

Consult the table of contents to determine which section contains the information you desire.

The detailed index, at the rear of this manual, contains a complete listing of all subjects.

Consult the following table for a description of the symbols that may be used on your vehicle or throughout this owner's manual:

6 INTRODUCTION

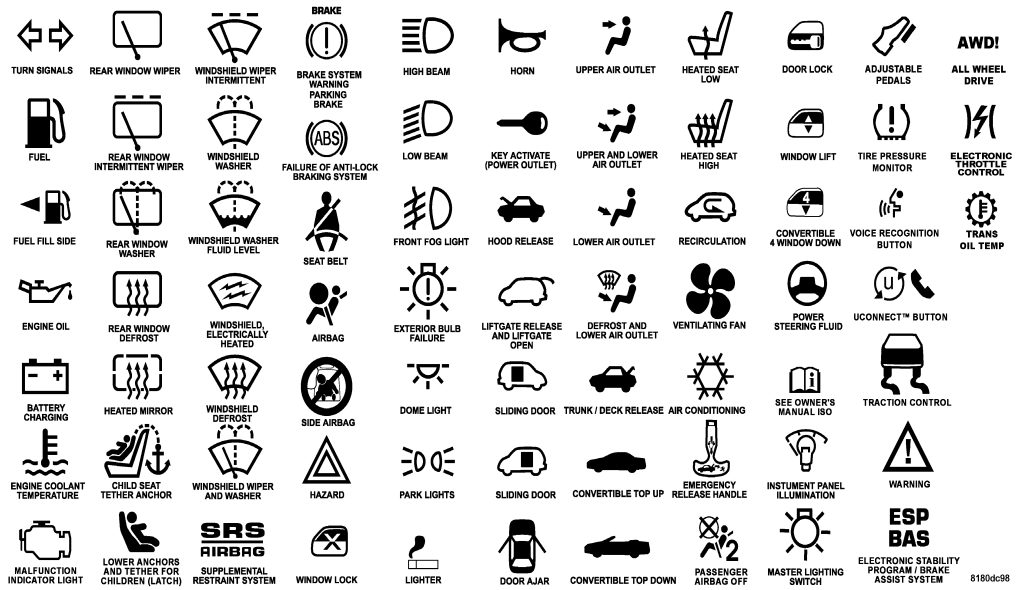

WARNINGS AND CAUTIONS

This manual contains **WARNINGS** against operating procedures which could result in an accident or bodily injury. It also contains **CAUTIONS** against procedures which could result in damage to your vehicle. If you do not read this entire manual you may miss important information. Observe all Warnings and Cautions.

VAN CONVERSIONS/CAMPERS

The Manufacturer's Warranty does not apply to body modifications or special equipment installed by van conversion/camper manufacturers/ body builders. See the Warranty information book, Section 2.1.C. Such equipment includes video monitors, VCRs, heaters, stoves, refrigerators, etc. For warranty coverage and service on these items, contact the applicable manufacturer.

Operating instructions for the special equipment installed by the conversion/camper manufacturer should also be supplied with your vehicle. If these instructions are missing, please contact your selling dealer for assistance in obtaining replacement documents from the applicable manufacturer.

VEHICLE IDENTIFICATION NUMBER

The vehicle identification number (VIN) is found on the left front corner of the instrument panel, visible through the windshield. This number also appears on the Automobile Information Disclosure Label affixed to a window on your vehicle, the vehicle registration and title.

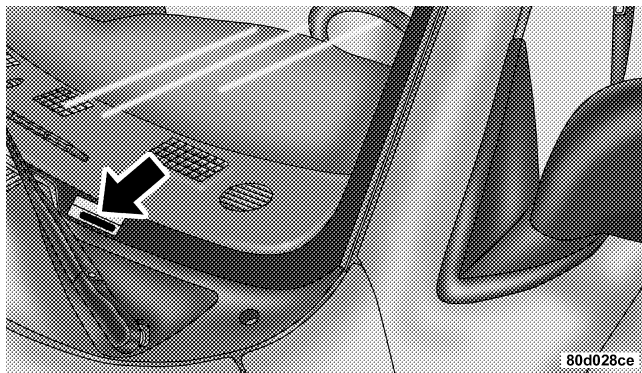

Vehicle Identification Number

NOTE: It is illegal to remove the VIN.

VEHICLE MODIFICATIONS / ALTERATIONS

WARNING!

Any modifications or alterations to this vehicle could seriously affect its roadworthiness and safety and may lead to an accident resulting in serious injury or death.

THINGS TO KNOW BEFORE STARTING YOUR VEHICLE

CONTENTS

■ A Word About Your Keys12	□ Replacement Keys16
□ Ignition Key Removal12	□ Customer Key Programming17
□ Locking Doors With The Key14	□ General Information18
■ Steering Wheel Lock — If Equipped15	■ Security Alarm System — If Equipped18
□ If You Wish To Manually Lock The Steering Wheel15	□ Rearming Of The System18
□ To Release The Steering Wheel Lock15	□ To Set The Alarm18
□ Automatic Transmission Ignition Interlock System15	□ To Disarm The System19
■ Sentry Key — If Equipped15	■ Illuminated Entry System — If Equipped19
		■ Remote Keyless Entry — If Equipped20

10 THINGS TO KNOW BEFORE STARTING YOUR VEHICLE

□ To Unlock The Doors	20	□ Wind Buffeting	31
□ To Lock The Doors	21	■ Occupant Restraints (2500/3500/Mega Cab Only)	31
□ Using The Panic Alarm	22	□ Lap/Shoulder Belts	32
□ General Information	22	□ Adjustable Upper Shoulder Belt Anchorage	40
□ Transmitter Battery Service	23	□ Automatic Locking Restraint (ALR) Mode – If Equipped	41
■ Door Locks	24	□ Center Lap Belts	42
□ Manual Door Locks	24	□ Seat Belt Pretensioners	42
□ Power Door Locks — If Equipped	25	□ Enhanced Driver Seat Belt Reminder System (BeltAlert)	43
□ Child Protection Door Lock	27	□ Seat Belts And Pregnant Women	44
■ Windows	29	□ Seat Belt Extender	44
□ Power Windows—If Equipped	29		
□ Power Sliding Rear Window—If Equipped	30		
□ Sliding Rear Window—If Equipped	31		

<ul style="list-style-type: none"> □ Driver And Right Front Passenger Supplemental Restraint System (SRS)—Airbag45 □ Event Data Recorder (EDR)56 □ Child Restraint57 ■ New Engine Break-In71 ■ Safety Tips72 <ul style="list-style-type: none"> □ Transporting Passengers72
--

THINGS TO KNOW BEFORE STARTING YOUR VEHICLE 11

<ul style="list-style-type: none"> □ Lock Your Vehicle72 □ Exhaust Gas73 □ Safety Checks You Should Make Inside The Vehicle74 □ Safety Checks You Should Make Outside The Vehicle74

A WORD ABOUT YOUR KEYS

The dealer that sold you your new vehicle has the key code numbers for your vehicle locks. These numbers can be used to order duplicate keys from your dealer. Ask your dealer for these numbers and keep them in a safe place.

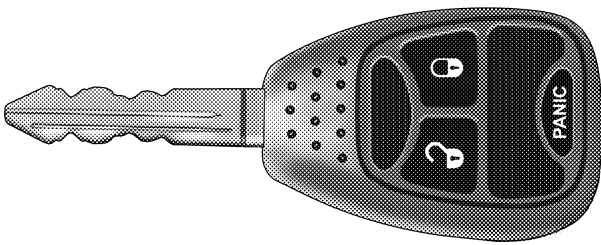

8163e6a8

Ignition Key

Ignition Key Removal

Automatic Transmission

Place the shift lever in PARK. Turn the ignition switch to the ACC position, push the key and cylinder inward, rotate the key to the LOCK position, and remove the key.

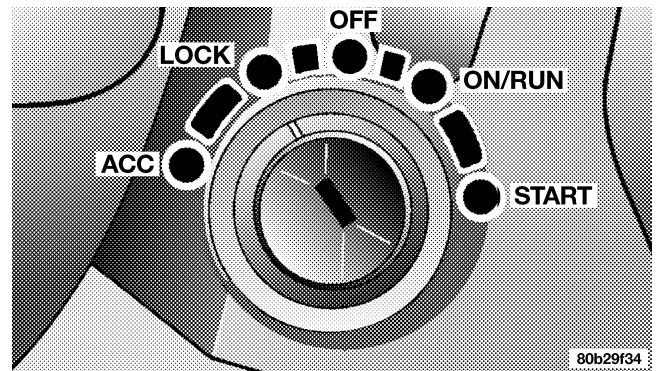

80b29f34

Ignition Switch Positions

NOTE: If you try to remove the key before you place the lever in PARK, the key may become trapped temporarily in the ignition cylinder. If this occurs, rotate the key to the right slightly, then remove the key as described. If a malfunction occurs, the system will trap the key in the ignition cylinder to warn you that this safety feature is inoperable. The engine can be started and stopped but the key cannot be removed until you obtain service.

NOTE: The power window switches, radio, power sunroof (if equipped), and power outlets will remain active for 10 minutes after the ignition switch is turned off. Opening either front door will cancel this feature.

WARNING!

Never leave children alone in a vehicle. Leaving children in a vehicle unattended is dangerous for a number of reasons. A child or others could be seriously or fatally injured. Don't leave the keys in the ignition. A child could operate power windows, other controls, or move the vehicle.

2**CAUTION!**

An unlocked car is an invitation to thieves. Always remove key from the ignition and lock all doors when leaving the vehicle unattended.

Manual Transmission—If Equipped

When the steering wheel is in the LOCK position, the steering and ignition systems are locked to provide antitheft protection for your vehicle. It may be difficult to turn the key from the LOCK position when starting your vehicle. Move the steering wheel left and right while turning the key until it turns easily. To remove the key, depress and hold the release button located between the ignition switch and the instrument panel. Turn the ignition key to LOCK and remove the key.

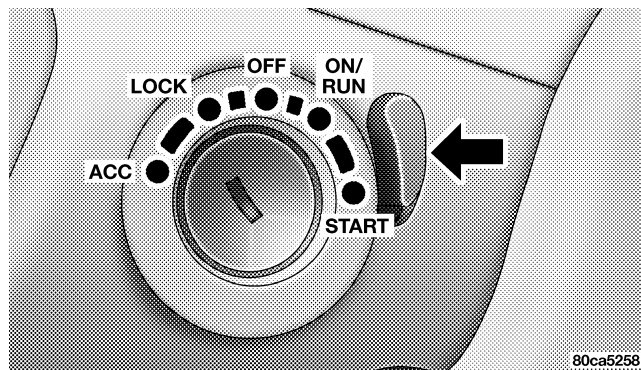

Ignition Switch Positions

Locking Doors With The Key

You can insert the key with either side up. To lock the door, turn the key rearward, to unlock the door, turn the key forward. See Section 7 of this manual for door lock lubrication.

STEERING WHEEL LOCK — IF EQUIPPED

Your vehicle may be equipped with a passive steering wheel lock. This lock prevents steering the vehicle without the ignition key. If the steering wheel is moved no more than 1/2 turn in either direction and the key is not in the ignition switch, the steering wheel will lock.

If You Wish To Manually Lock The Steering Wheel:

With the engine running, turn the steering wheel upside down, turn off the engine and remove the key. Turn the steering wheel slightly in either direction until the lock engages.

To Release The Steering Wheel Lock:

Insert the key in the ignition switch and start the engine. If the key is difficult to turn, move the wheel slightly to the right or left to disengage the lock.

NOTE: If you turned the wheel to the right to engage the lock, you must turn the wheel slightly to the right to

disengage it. If you turned the wheel to the left to engage the lock, turn the wheel slightly to the left to disengage it.

Automatic Transmission Ignition Interlock System

This system prevents the key from being removed unless the shift lever is in PARK. It also prevents shifting out of PARK unless the key is in the ON positions, and the brake pedal is depressed.

SENTRY KEY — IF EQUIPPED

The Sentry Key Immobilizer System prevents unauthorized vehicle operation by disabling the engine. The system does not need to be armed or activated. Operation is automatic, regardless of whether the vehicle is locked or unlocked.

The system uses ignition keys, which have an embedded electronic chip (transponder), to prevent unauthorized vehicle operation. Therefore, only keys that are programmed to the vehicle can be used to start and operate

16 THINGS TO KNOW BEFORE STARTING YOUR VEHICLE

the vehicle. The system will shut the engine off in two (2) seconds if someone uses an invalid key to start the engine.

NOTE: A key, which has not been programmed, is also considered an invalid key even if it is cut to fit the ignition lock cylinder for that vehicle.

During normal operation, after turning on the ignition switch, the Vehicle Security Alarm Indicator Light will turn on for three (3) seconds for a bulb check. If the light remains on after the bulb check, it indicates that there is a problem with the electronics. In addition, if the light begins to flash after the bulb check, it indicates that someone used an invalid key to start the engine. Either of these conditions will result in the engine being shut off after two (2) seconds.

If the Vehicle Security Alarm Indicator Light turns on during normal vehicle operation (vehicle running for

longer than 10 seconds), it indicates that there is a fault in the electronics. Should this occur, have the vehicle serviced as soon as possible.

Replacement Keys

NOTE: Only keys that have been programmed to the vehicle electronics can be used to start the vehicle. Once a Sentry Key has been programmed to a vehicle, it cannot be programmed to any other vehicle.

At the time of purchase, the original owner is provided with a four digit PIN. This number is required for dealer replacement of keys. Duplication of keys may be performed at an authorized dealer or by using the Customer Key Programming procedure. This procedure consists of programming a blank key to the vehicle electronics. A blank key is one which has never been programmed and needs to be cut.

NOTE: When having the Sentry Key System serviced, bring all vehicle keys to the dealer.

Customer Key Programming

You can program new keys to the system if you have two valid keys by doing the following:

1. Cut the additional Sentry Key Transponder blank(s) to match the ignition switch lock cylinder key code.
2. Insert the first valid key into the ignition switch and turn the ignition switch ON for at least 3 seconds but no longer than 15 seconds. Turn the ignition switch OFF and remove the first key.
3. Insert the second valid key and turn the ignition switch ON within 15 seconds. After ten seconds a chime will sound and the Vehicle Theft Alarm Indicator Light will begin to flash. Turn the ignition switch OFF and remove the second key.

4. Insert a blank Sentry Key into the ignition switch and turn the ignition switch ON within 60 seconds. After 10 seconds a single chime will sound and the Vehicle Theft Alarm Indicator Light will stop flashing, turn on again for 3 seconds, and then turn off.

The new Sentry Key has been programmed. **The Keyless Entry Transmitter will also be programmed during this procedure.** Repeat this procedure to program up to a total of 8 keys. If you do not have a programmed sentry key, contact your dealer for details.

NOTE: If a programmed key is lost, see your dealer to have all remaining keys erased from the systems memory. This will prevent the lost key from starting your vehicle. The remaining keys must then be reprogrammed. All vehicle keys must be taken to the dealer at the time of service to be reprogrammed.

General Information

The Sentry Key system complies with FCC rules part 15 and with RSS-210 of Industry Canada. Operation is subject to the following conditions:

- This device may not cause harmful interference.
- This device must accept any interference that may be received, including interference that may cause undesired operation.

SECURITY ALARM SYSTEM — IF EQUIPPED

This system monitors the vehicle doors and ignition for unauthorized operation. When the alarm is activated, the system provides both audible and visual signals. For the first 3 minutes the horn will sound and the headlights and security telltale will flash repeatedly. For an additional 15 minutes only the headlights and security telltale will flash. The engine will run only if a valid Sentry Key is used to start the vehicle. Use of the Sentry Key will disable the alarm.

Rearming of the System:

The security system will rearm itself after the 15 additional minutes of headlights and security telltale flashing, if the system has not been disabled. If the condition which initiated the alarm is still present, the system will ignore that condition and monitor the remaining doors and ignition.

To Set the Alarm:

The alarm will set when you use the power door locks, or use the Keyless Entry transmitter to lock the doors. After all the doors are locked and closed the SECURITY light in the instrument cluster will flash rapidly to signal that the system is arming. The security light in the instrument panel cluster will flash rapidly for about 16 seconds to indicate that the alarm is being set. After the alarm is set, the security light will flash at a slower rate to indicate that the system is armed.

NOTE: If the SECURITY light stays on continuously during vehicle operation, have the system checked by your dealer.

To Disarm the System:

Use the Keyless Entry transmitter to unlock the door. If something has triggered the system in your absence, the horn will sound three times when you unlock the doors and the security lamp will flash for 30 seconds. Check the vehicle for tampering.

The Security system will also disarm, if the vehicle is started with a programmed Sentry Key. If an unprogrammed Sentry Key is used to start a vehicle, the engine will run for 2 seconds and then the security alarm will be initiated. To exit alarming mode, press the transmitter Unlock button, or start the vehicle with a programmed Sentry Key.

The Security Alarm System is designed to protect your vehicle; however, you can create conditions where the

system will arm unexpectedly. If you remain in the vehicle and lock the doors with the transmitter, the alarm will sound when you pull the door handle to exit. The door will be locked but the Security Alarm will not arm.

2

ILLUMINATED ENTRY SYSTEM — IF EQUIPPED

The courtesy lights will turn on when you use the keyless entry transmitter or open the doors. This feature is only available if you have Remote Keyless Entry.

The lights will fade to off after about 30 seconds or they will immediately fade to off once the ignition switch is turned on.

NOTE:

- The front courtesy overhead console, door courtesy lights do not turn on if the dimmer control is in the interior lights ON position (extreme top position).
- The illuminated entry system will not operate if the dimmer control is in the “defeat” position (extreme downward position).

REMOTE KEYLESS ENTRY — IF EQUIPPED

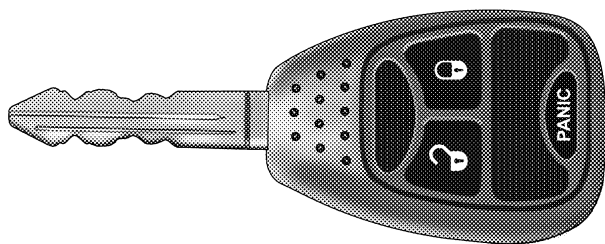

8163e6a8

Three Button Transmitter

This system allows you to lock or unlock the doors from distances up to about 23 feet (7 meters) using a hand held radio transmitter. The transmitter need not be pointed at the vehicle to activate the system.

To unlock the doors:

Press and release the UNLOCK button on the key fob once to unlock only the driver's door or twice to unlock all the doors. When the UNLOCK button is pressed, the illuminated entry will initiate, the parking lights will flash on twice and if installed, the cargo lamp will turn on for 30 seconds.

The system can be programmed to unlock all the doors or drivers door only upon the first UNLOCK button press by using the following procedure:

1. Perform this operation while standing outside the vehicle.
2. Press and hold the LOCK button on your key.
3. Continue to hold the LOCK button at least 4 seconds, but no longer than 10 seconds, then press and hold the UNLOCK button while still holding the LOCK button.
4. Release both buttons at the same time.

5. This will enable you to unlock all doors on the first press of the UNLOCK button.

To lock the doors:

Press and release the LOCK button on the transmitter to lock all doors. If the ignition is OFF, when the doors are locked, the parking lights will flash on once and the horn will chirp once.

The horn chirp feature will be shipped from the assembly plants activated. If desired this feature can be disabled by using the following procedure:

1. Perform this operation while standing outside the vehicle.
2. Press and hold the LOCK button on a programmed (i.e. functional) key fob.

3. Continue to hold the LOCK button, wait at least 4 seconds, but no longer than 10 seconds, then press and hold the PANIC button. Release both buttons at the same time.

4. To reactivate this feature, repeat the above steps.

Vehicles will be shipped from the assembly plants with the park lamp flash feature activated. If desired, this feature can be disabled by using the following procedure:

1. Perform this operation while standing outside the vehicle.
2. Press and hold the UNLOCK button on a programmed (i.e. functional) key fob.
3. Continue to hold the UNLOCK button, wait at least 4 seconds, but no longer than 10 seconds, then press and hold the LOCK button. Release both buttons at the same time.
4. To reactivate this feature, repeat the above steps.

Using the Panic Alarm

To activate the Panic mode while the ignition is OFF press and release the PANIC button on the transmitter once. When the Panic mode is activated, the interior lights will illuminate, the headlamps and parking lights will flash, and the horn will sound.

To cancel the Panic mode press and release the PANIC button on the transmitter a second time. Panic mode will automatically cancel after 3 minutes or if the vehicle is started and exceeds 15 mph. During the Panic Mode, the door locks and remote keyless entry systems will function normally. Panic mode will not disarm the security system on vehicles so equipped.

General Information

This device complies with part 15 of FCC rules and with RS-210 of Industry Canada. Operation is subject to the following conditions:

1. This device may not cause harmful interference.

2. This device must accept any interference that may be received including interference that may cause undesired operation.

NOTE: Changes or modifications not expressly approved by the party responsible for compliance could void the user's authority to operate the equipment.

If your Keyless Entry Transmitter fails to operate from a normal distance, check for these two conditions.

1. Weak batteries in transmitter. The expected life of the batteries is from one to two years.
2. Closeness to a radio transmitter such as a radio station tower, airport transmitter, and some mobile or CB radios.

Transmitter Battery Service

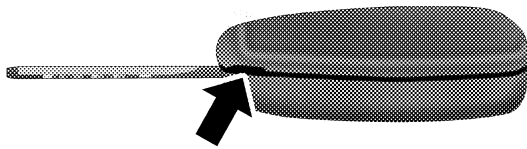

81182c72

Transmitter Battery Replacement

The recommended replacement battery is a 3V lithium 2016 cell. This transmitter requires two batteries.

NOTE: Do not touch the battery terminals that are on the back housing or the printed circuit board.

1. With transmitter buttons facing down, use a flat blade or dime to pry the two halves of the transmitter apart. Make sure not to damage the rubber gasket during removal.

2. Remove and replace the batteries. Be careful not to disturb the metal terminal near the batteries. Install the batteries with the positive terminal up, reference the note "+ SIDE UP" on the inside of the bottom half of the transmitter case. Avoid touching the new batteries with your fingers. Skin oils may cause battery deterioration. If you touch a battery, clean it with rubbing alcohol.

3. To reassemble the transmitter case snap the two halves together. Make sure there is an even gap between the two halves. Test transmitter operation.

DOOR LOCKS

Manual Door Locks

Front and Rear doors may be locked, by moving the lock plunger up or down.

All doors may be opened with the inside door handle without lifting the lock plunger. Doors locked before closing will remain locked when closed.

The ignition key will unlock all the locks on your vehicle.

WARNING!

- For personal security and safety in the event of an accident, lock the vehicle doors when you drive as well as when you park and leave the vehicle.
- Never leave children alone in a vehicle. Leaving children in a vehicle unattended is dangerous for a number of reasons. A child or others could be seriously or fatally injured. Don't leave the keys in the ignition. A child could operate power windows, other controls, or move the vehicle.

Power Door Locks — If Equipped

A power door lock switch is on each front door trim panel. Use this switch to lock or unlock the doors.



Power Door Lock Switch Location

If you press the power door lock switch while the key is in the ignition, and any front door is open, the power

locks will not operate. This prevents you from accidentally locking your keys in the vehicle. Removing the key or closing the door will allow the locks to operate. A chime will sound if the key is in the ignition switch and a door is open, as a reminder to remove the key.

If you press the power door lock switch while the sliding door is open, the sliding door will lock.

Automatic Door Locks – If Equipped

If this feature is enabled, your door locks will lock automatically when the vehicle's speed exceeds 15 mph.

Automatic Door Lock Programming

This feature is enabled when your vehicle is shipped from the assembly plant and can be disabled by using the following procedure:

1. Enter your vehicle and close all doors.

2. Fasten your seat belt (Fastening the seat belt will cancel any chiming that may confuse you during this programming procedure).
3. Place the key into the ignition.
4. Within 15 seconds cycle the key from the LOCK position to the ON/RUN position a minimum of four times; ending in the LOCK position (**do not start the engine**)
5. Within 30 seconds, press the driver's door lock switch in the LOCK direction.
6. A single chime will be heard to indicate the feature has been disabled.
7. To reactivate this feature, repeat the above steps.
8. If a chime is not heard, program mode was canceled before the feature could be disabled. If necessary, repeat the above procedure.

Auto Unlock On Exit — If Equipped

This feature unlocks all of the doors of the vehicle when any door is opened. This will occur only after the vehicle has been shifted into the Park position after the vehicle has been driven (shifted out of Park and all doors closed).

This feature will not operate if there is any manual operation of the power door locks (Lock or Unlock).

Auto Unlock On Exit Programming — If Equipped

Customer Programming sequence to enable or disable the Auto Unlock Feature:

1. Enter your vehicle and close all doors.
2. Fasten your seat belt (fastening the seat belt will cancel any chimes that may be confusing during this programming procedure).
3. Insert the key into the ignition.

4. Within 15 seconds, cycle the key from the LOCK position to the ON/RUN position a minimum of four times ending in the LOCK position (**do not start the engine**).
5. Within 30 seconds, press the driver's door lock switch in the UNLOCK direction.
6. A single chime will sound to indicate the feature has been changed.
7. Repeat the above steps to alternate the availability of this feature.
8. If a chime is not heard, program mode was canceled before the feature could be changed. If necessary repeat the above procedure.

Child Protection Door Lock

To provide a safer environment for children riding in the rear seat, the rear doors of your vehicle have the child-protection door lock system.

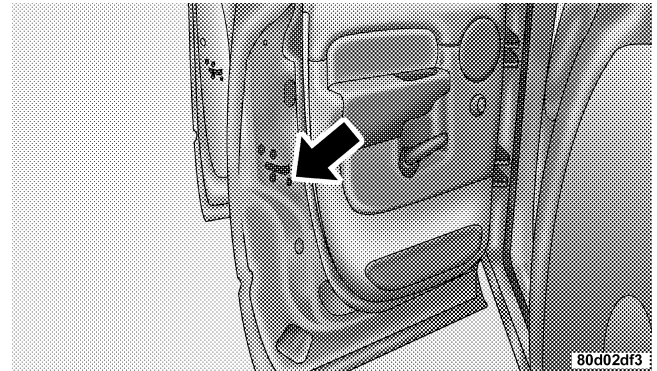

Child Protection Door Lock Location

To use the system, open each rear door, insert the tip of the ignition key or alike object into the lock control lever,

28 THINGS TO KNOW BEFORE STARTING YOUR VEHICLE

slide the lever UP to engage the locks and DOWN to disengage the child-protection locks. When the system on a door is engaged, that door can only be opened by using the outside door handle even if the inside door lock is in the unlocked position.

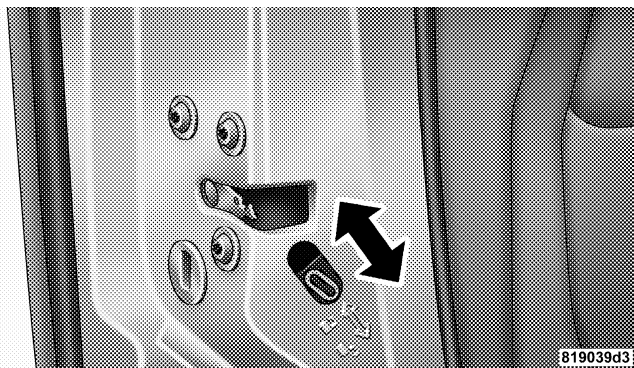

Child Lock Control

WARNING!

Avoid trapping anyone in a vehicle in a collision. Remember that the rear doors can only be opened from the outside when the child protection locks are engaged.

NOTE: After setting the child protection door lock system, always test the door from the inside to make certain it is in the desired position.

NOTE: For emergency exit with the system engaged, move the door lock switch to the UNLOCK position, roll down the window and open the door with the outside door handle.

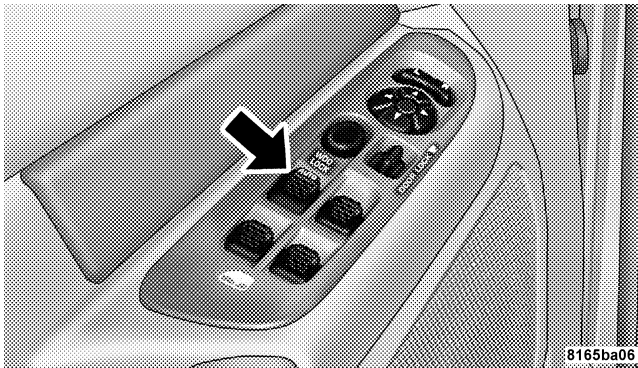
WINDOWS**Power Windows—If Equipped****Power Window Switches**

The control on the left front door panel has up-down switches that give you fingertip control of all power windows. There is a single opening and closing switch on the front passenger door for passenger window control

and on the rear doors of Quad Cab and Mega Cab models. The windows will operate only when the ignition switch is turned to the ON or ACC (Accessory) position.

WARNING!

Never leave children alone in a vehicle. Leaving children in a vehicle unattended is dangerous for a number of reasons. A child or others could be seriously or fatally injured. Don't leave the keys in the ignition. A child could operate power windows, other controls, or move the vehicle.

Auto Down (Driver's Side Only)

The driver's window switch has an Auto Down feature. Press the window switch past the detent, release, and the window will go down automatically.

Window Lockout Switch (4 Door Models Only)

The window lockout switch on the driver's door allows you to disable the window control on the other doors. To disable the window controls on the other doors, press the window lock button. To enable the window controls, press the window control button again.

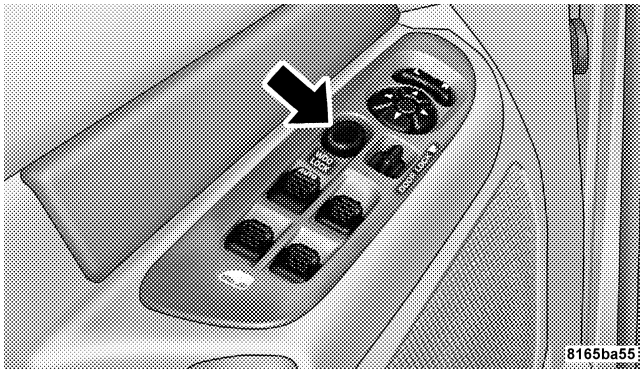

Window Lockout Switch

Power Sliding Rear Window—If Equipped

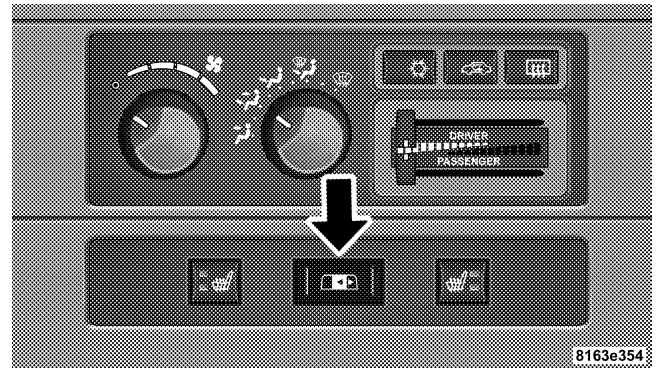

Power Sliding Rear Window Switch

The power sliding rear window switch is located on the instrument panel below the climate controls. Press the right side of the switch to open the glass and the left side of the switch to close the glass.

Sliding Rear Window—If Equipped

A locking device in the center of the window helps to prevent entry from the rear of the vehicle. Squeeze the lock to release the window.

Wind Buffeting

Wind buffeting can be described as the perception of pressure on the ears or a helicopter type sound in the ears. Your vehicle may exhibit wind buffeting with the windows down or partially open positions. This is a normal occurrence and can be minimized. If the buffeting occurs with the rear windows open, open the front and rear windows together to minimize the buffeting.

OCCUPANT RESTRAINTS (2500/3500/MEGA CAB ONLY)

Some of the most important safety features in your vehicle are the restraint systems. These include the front and rear seat belts for the driver and all passengers, front airbags for both the driver and front passenger and, if so equipped, window bags for the driver and passengers seated next to a window. If you will be carrying children too small for adult-size belts, your seat belts also can be used to hold infant and child restraint systems.

Please pay close attention to the information in this section. It tells you how to use your restraint system properly to keep you and your passengers as safe as possible.

WARNING!

In a collision, you and your passengers can suffer much greater injuries if you are not properly buckled up. You can strike the interior of your vehicle or other passengers, or you can be thrown out of the vehicle. Always be sure you and others in your vehicle are buckled up properly.

Buckle up even though you are an excellent driver, even on short trips. Someone on the road may be a poor driver and cause a collision that includes you. This can happen far away from home or on your own street.

Research has shown that seat belts save lives, and that they can reduce the seriousness of injuries in a collision. Some of the worst injuries happen when people are thrown from the vehicle. Seat belts reduce the possibility

of ejection and the risk of injury caused by striking the inside of the vehicle. **Everyone** in a motor vehicle should be belted at all times.

Lap/Shoulder Belts

All seating positions except the Quad Cab front center seating position have combination lap/shoulder belts. The belt webbing retractor is designed to lock during very sudden stops or collisions. This feature allows the shoulder part of the belt to move freely with you under normal conditions. But in a collision, the belt will lock and reduce the risk of your striking the inside of the vehicle or being thrown out.

WARNING!

It is extremely dangerous to ride in a cargo area, inside or outside of a vehicle. In a collision, people riding in these areas are more likely to be seriously injured or killed.

Do not allow people to ride in any area of your vehicle that is not equipped with seats and seat belts.

Be sure everyone in your vehicle is in a seat and using a seat belt properly.

WARNING!

- Wearing a seat belt incorrectly is dangerous. Seat belts are designed to go around the large bones of your body. These are the strongest parts of your body and can take the forces of a collision the best. Wearing your belt in the wrong place could make your injuries in a collision much worse. You might suffer internal injuries, or you could even slide out of part of the belt. Follow these instructions to wear your seat belt safely and to keep your passengers safe, too.
- Two people should never be belted into a single seat belt. People belted together can crash into one another in an accident, hurting one another badly. Never use a lap/shoulder belt or a lap belt for more than one person, no matter what their size.

Lap/Shoulder Belt Operating Instructions

1. Enter the vehicle and close the door. Sit back and adjust the seat.
2. The seat belt latch plate is above the back of the front seat, next to your arm in the rear seat. Grasp the latch plate and pull out the belt. Slide the latch plate up the webbing as far as necessary to allow the belt to go around your lap.

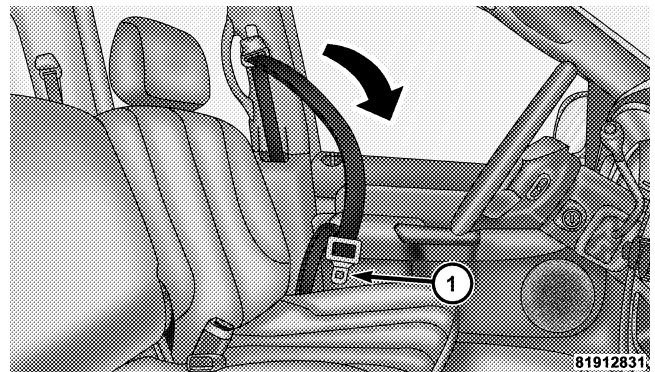

1 — Latch Plate

3. When the belt is long enough to fit, insert the latch plate into the buckle until you hear a "click."



Latch Plate To Buckle

WARNING!

- A belt buckled into the wrong buckle will not protect you properly. The lap portion could ride too high on your body, possibly causing internal injuries. Always buckle your belt into the buckle nearest you.
- A belt that is too loose will not protect you as well. In a sudden stop you could move too far forward, increasing the possibility of injury. Wear your seat belt snugly.
- A belt that is worn under your arm is very dangerous. Your body could strike the inside surfaces of the vehicle in a collision, increasing head and neck injury. And a belt worn under the arm can cause internal injuries. Ribs aren't as strong as shoulder bones. Wear the belt over your shoulder so that your strongest bones will take the force in a collision.
- A shoulder belt placed behind will not protect you from injury during a collision. You are more likely to hit your head in a collision if you do not wear your shoulder belt. The lap and shoulder belt are meant to be used together.

4. Position the lap belt across your thighs, below your abdomen. To remove slack in the lap belt portion, pull up on the shoulder belt. To loosen the lap belt if it is too tight, tilt the latch plate and pull on the lap belt. A snug belt reduces the risk of sliding under the belt in a collision.

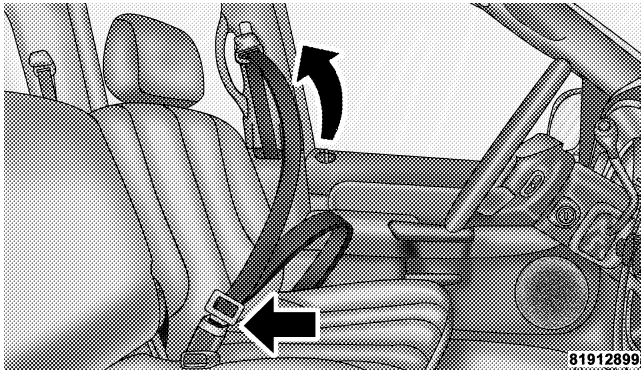

Removing Slack From Belt

WARNING!

- A lap belt worn too high can increase the risk of internal injury in a collision. The belt forces won't be at the strong hip and pelvic bones, but across your abdomen. Always wear the lap belt as low as possible and keep it snug.
- A twisted belt can't do its job as well. In a collision it could even cut into you. Be sure the belt is straight. If you can't straighten a belt in your vehicle, take it to your dealer and have it fixed.

5. Position the shoulder belt on your chest so that it is comfortable and not resting on your neck. The retractor will withdraw any slack in the belt.
6. To release the belt, push the red button on the buckle. The belt will automatically retract to its stowed position. If necessary, slide the latch plate down the webbing to allow the belt to retract fully.

WARNING!

A frayed or torn belt could rip apart in a collision and leave you with no protection. Inspect the belt system periodically, checking for cuts, frays, or loose parts. Damaged parts must be replaced immediately. Do not disassemble or modify the system. Seat belt assemblies must be replaced after a collision if they have been damaged (bent retractor, torn webbing, etc.) or if the airbag deployed.

2**Standard Cab Front Center Three Point Belt**

1. The front center seat belt on the Standard Cab may be disconnected to open up utilization of the storage areas behind the front seats. The black latch plate can be detached from the black keyed seat belt buckle located on the inboard side of the passenger seat. Insert the vehicle ignition key into the center white slot on the black buckle.

38 THINGS TO KNOW BEFORE STARTING YOUR VEHICLE

The black buckle latch plate can be removed when the key is pressed into the buckle. Allow the retractor to take up the surplus webbing, and the buckles will hang vertically from the cab back exit bezel, thus freeing up all the area behind the front seats.

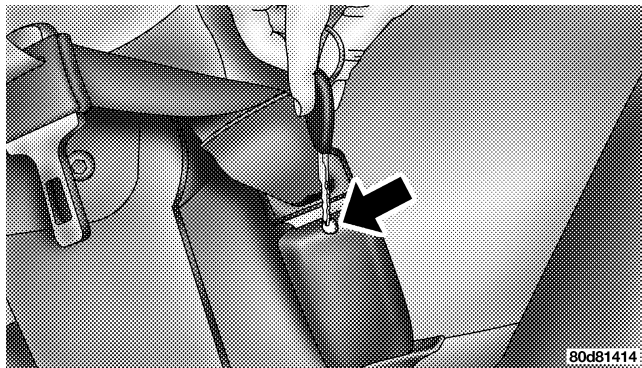

Detaching Buckle with Key

2. To reattach the seat belt to the front center seat, pull the black buckle latch plate forward from the cab back panel and insert it into the black keyed buckle until there is an audible click. Refer to the previous section for the proper seat belt usage.

WARNING!

- If the black latch and black buckle are not properly connected when the seat belt is used by an occupant, the seat belt will not be able to provide proper restraint and will increase the risk of injury in a collision.
- When reattaching the black latch and black buckle, ensure the seat belt webbing is not twisted. If the webbing is twisted, follow the preceding procedure to detach the black latch and black buckle, untwist the webbing, and reattach the black latch and black buckle.

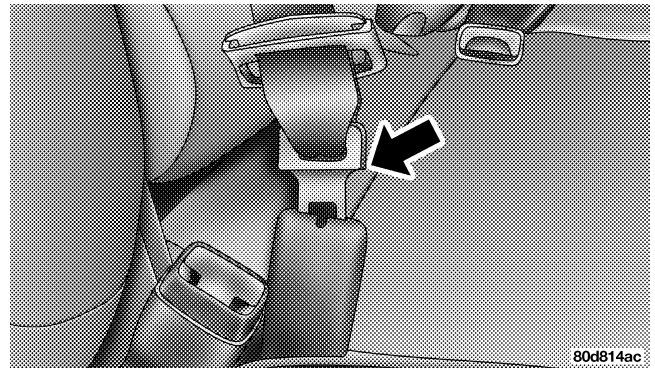

Inserting Latch Plate

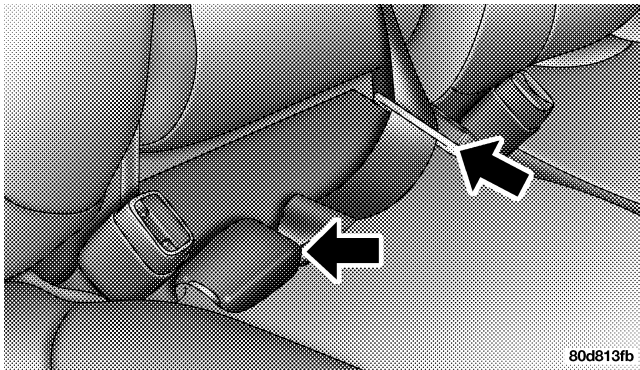

In Use Position

WARNING!

If the black latch and buckle are not connected when the seat belt is used by an occupant, the seat belt will not restrain you properly.

Adjustable Upper Shoulder Belt Anchorage

In the front row outboard seats, the shoulder belt can be adjusted upward or downward to help position the belt away from your neck. Press the button located on the upper belt guide, and then move it up or down to the position that serves you best.

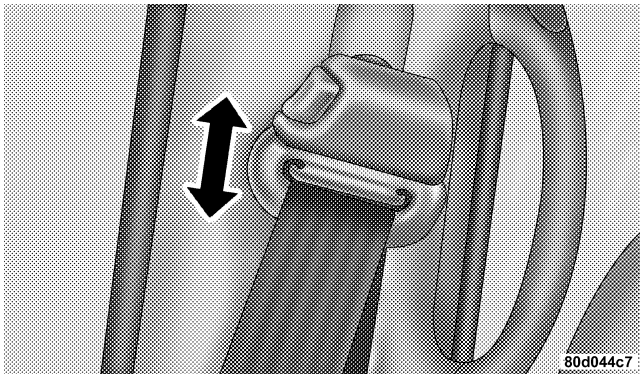

Adjusting Upper Shoulder Belt

As a guide, if you are shorter than average, you will prefer a lower position, and if you are taller than average, you'll prefer a higher position. When you release the anchorage, try to move it up or down to make sure that it is locked in position.

Automatic Locking Restraint (ALR) Mode – If Equipped

In this mode, the shoulder belt is automatically pre-locked. The belt will still retract to remove any slack in the shoulder belt. The automatic locking mode is available on all passenger seating positions with a combination lap/shoulder belt.

When To Use The Automatic Locking Mode

Anytime a child safety seat is installed in a passenger seating position. Children 12 years old and under should be properly restrained in the rear seat whenever possible.

How To Use The Automatic Locking Mode

1. Buckle the combination lap/shoulder belt.
2. Grasp the shoulder portion and pull downward until the entire belt is extracted.

3. Allow the belt to retract. As the belt retracts, you will hear a clicking sound. This indicates the safety belt is now in the automatic locking mode.

How To Disengage The Automatic Locking Mode

Disconnect the combination lap/shoulder belt and allow it to retract completely to disengage the automatic locking mode and activate the vehicle sensitive (emergency) locking mode.

Center Lap Belts

The center seating position for the Quad Cab front seat has a lap belt only. To fasten the lap belt, slide the latch plate into the buckle until you hear a "click." To lengthen the lap belt, tilt the latch plate and pull. To remove slack, pull the loose end of the webbing. Wear the lap belt snug against the hips. Sit back and erect in the seat, then adjust the belt as tightly as is comfortable.

WARNING!

- A lap belt worn too loose or too high is dangerous.
- A belt worn too loose can allow you to slip down and under the belt in a collision.
- A belt that is too loose or too high will apply crash forces to the abdomen, not to the stronger hip bones. In either case, the risk of internal injuries is greater. Wear a lap belt low and snug.

Seat Belt Pretensioners

The seat belts for both front seating positions are equipped with pretensioning devices that are designed to remove slack from the seat belt system in the event of a collision. These devices improve the performance of the seat belt by assuring that the belt is tight about the occupant early in a collision. Pretensioners work for all size occupants, including those in child restraints.

NOTE: These devices are not a substitute for proper seat belt placement by the occupant. The seat belt still must be worn snugly and positioned properly.

The pretensioners are triggered by the airbag control module. Like the airbags, the pretensioners are single use items. After a collision that is severe enough to deploy the airbags and pretensioners, both must be replaced.

Enhanced Driver Seat Belt Reminder System (BeltAlert)

If the driver's seat belt has not been buckled within 60 seconds of starting the vehicle and if the vehicle speed is greater than 5 mph (8 km/h), the Enhanced Warning System (BeltAlert) will alert the driver to buckle their seat belt. The driver should also instruct all other occupants to buckle their seat belts. Once the warning is triggered, the Enhanced Warning System (BeltAlert) will continue to chime and flash the Seat Belt Warning Light for 96 seconds or until the driver's seat belt is buckled. The

Enhanced Warning System (BeltAlert) will be reactivated if the ignition is cycled, driver's seat belt is unbuckled for more than 10 seconds and the vehicle speed is greater than 5 mph (8 km/h).

The Enhanced Warning System (BeltAlert) can be enabled or disabled by your authorized dealer or by following these steps:

NOTE: The following steps must occur within the first 60 seconds of the ignition switch being turned to the ON or START position. DaimlerChrysler does not recommend deactivating the Enhanced Warning System (BeltAlert).

1. With all doors closed and the ignition switch in any position except On or Start, buckle the driver's seat belt.
2. Turn the ignition switch to the ON position and wait for the Seat Belt Warning Light to turn off.

3. Within 60 seconds of starting the vehicle, unbuckle and then re-buckle the driver's seat belt at least three times within 10 seconds, ending with the seat belt buckled.

4. Turn off the engine. A single chime will sound to signify that you have successfully completed the programming.

The Enhanced Warning System (BeltAlert) can be reactivated by repeating this procedure.

NOTE: Although the Enhanced Warning System (BeltAlert) has been deactivated, the Seat Belt Warning Light will continue to illuminate while the driver's seat belt remains unbuckled.

Seat Belts and Pregnant Women

We recommend that pregnant women use seat belts throughout their pregnancies. Keeping the mother safe is the best way to keep the baby safe.

Pregnant women should wear the lap part of the belt across the thighs and as snug against the hips as possible. Keep the belt low so that it does not come across the abdomen. That way the strong bones of the hips will take the force if there is a collision.

Seat Belt Extender

If a seat belt is too short, even when fully extended, your dealer can provide you with a seat belt extender. This extender should be used only if the existing belt is not long enough. When it is not required, remove the extender and store it.

WARNING!

Using a seat belt extender when not needed can increase the risk of injury in a collision. Only use the seat belt extender when the lap belt is not long enough when it is worn low and snug, and in the recommended seating positions. Remove and store the extender when not needed.

Driver And Right Front Passenger Supplemental Restraint System (SRS)—Airbag

This vehicle has front airbags for both the driver and front passenger as a supplement to the seat belt restraint systems. The driver’s front airbag is mounted in the center of the steering wheel. The passenger’s front airbag is mounted in the instrument panel, above the glove compartment. The words SRS AIRBAG are embossed on the airbag covers.

These airbags are certified to the new Federal regulations that allow less forceful deployments.

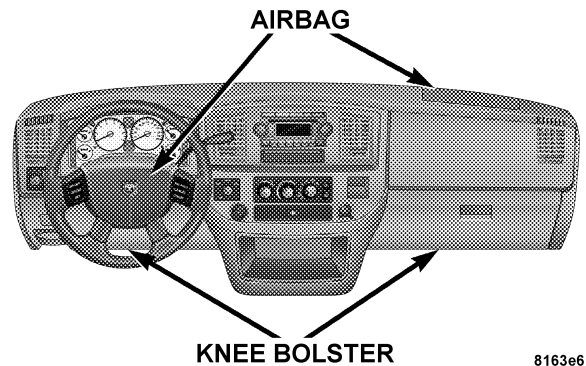

8163e6b8

This vehicle may also be equipped with window bags to protect the driver and passengers in the first and second row sitting next to a window. If the vehicle is equipped with window bags, they are located above the side windows. Their covers are also labeled SRS AIRBAG.

WARNING!

- Do not put anything on or around the airbag covers or attempt to manually open them. You may damage the airbags and you could be injured because the airbags are not there to protect you. These protective covers for the airbag cushions are designed to open only when the airbags are inflating.
- Do not mount any aftermarket equipment such as trailer brake controllers, snowplow controllers, auxiliary light switches, radios, etc. on or behind the knee bolster. Knee bolsters are designed to work with the air bag and seat belt to protect you. Mounting any additional equipment on or behind the knee bolster can cause injury during a crash.
- If your vehicle is equipped with window bags, do not stack luggage or other cargo up high enough to block the location of the window bag. The area where the window bag is located should remain free from any obstructions.
- If your vehicle is equipped with window bags, do not have any accessory items installed which will alter the roof, including adding a sunroof to your vehicle. Do not add roof racks that require permanent attachments (bolts or screws) for installation on the vehicle roof. Do not drill into the roof of the vehicle for any reason.

NOTE: Do not use a clothing bar mounted to the coat hooks in this vehicle. A clothing bar will impede the proper performance of the window bags.

Airbags inflate in moderate to high speed impacts. Along with the seatbelts, front airbags work with the instrument panel knee bolsters to provide improved protection for the driver and front passenger. Window bags also work with seat belts to improve occupant protection.

The seat belts are designed to protect you in many types of collisions. The front airbags deploy in moderate to severe frontal collisions. If your vehicle is so equipped, the window bag on the crash side of the vehicle is triggered in moderate to severe side collisions. In certain types of collisions, both the front and side airbags may be triggered. But even in collisions where the airbags work, you need the seat belts to keep you in the right position for the airbags to protect you properly.

Here are some simple steps you can follow to minimize the risk of harm from a deploying airbag.

- Children 12 years and under should ride buckled up in a rear seat, if available.
- Infants in rear facing child restraints must **NEVER** ride in the front seat of a vehicle with a passenger front airbag **unless the airbag is turned off** (Standard Cab Vehicles Only). An airbag deployment can cause severe injury or death to infants in that position. See the Passenger Airbag On/Off Switch section.
- If your vehicle does not have a rear seat, see the Passenger Airbag On/Off Switch section.
- Children that are not big enough to properly wear the vehicle seat belt (see section on Child Restraints) should be secured in the rear seat in child restraints or belt-positioning booster seats. Older children who do not use child restraints or belt-positioning booster seats should ride properly buckled up in the rear seat. Never allow children to slide the shoulder belt behind them or under their arm.

- All occupants should use their seat belts properly.
- The driver and front passenger seats should be moved back as far as practical to allow the airbag room to inflate.

WARNING!

- Relying on the airbags alone could lead to more severe injuries in a collision. The airbags work with your seat belt to restrain you properly. In some collisions the airbags won't deploy at all. Always wear your seat belts even though you have airbags.
- Being too close to the steering wheel or instrument panel during airbag deployment could cause serious injury. Airbags need room to inflate. Sit back, comfortably extending your arms to reach the steering wheel or instrument panel.
- If the vehicle has window airbags, they also need room to inflate. Do not lean against the door or window. Sit upright in the center of the seat.

Airbag System Components

The airbag system consists of the following:

- Airbag Control Module
- AIRBAG Readiness Light
- Driver Airbag
- Passenger Airbag
- Steering Wheel and Column
- Instrument Panel
- Crash Sensor
- Interconnecting Wiring
- Knee Impact Bolsters
- Passenger Side Frontal Airbag ON/OFF Switch (Standard Cab Vehicles Only)

The Window Airbag System, on vehicles equipped, consists of the following:

- AIRBAG Readiness Light (shared with the front airbag system)
- Window Bags Above the Side Windows.
- Airbag Control Module (shared with the front airbag system)
- Side impact sensors
- Interconnecting Wiring

How The Airbag System Works

- The airbag control module determines if a frontal collision is severe enough to require the airbags to inflate.
- The airbag control module will not detect roll over, or rear collisions.

- The airbag control module also monitors the readiness of the electronic parts of the system whenever the ignition switch is in the START or RUN positions. These include all of the items listed above except the knee bolsters, the instrument panel, and the steering wheel and column. If the key is in the "Off" position, in the ACC position or not in the ignition, the airbags are not on and will not inflate

- The airbag control module also turns on the AIR BAG light in the instrument panel for 6 to 8 seconds when the ignition is first turned on, then turns the light off.



- If it detects a malfunction in any part of the system, it turns on the light either momentarily or continuously. The instrument cluster will flash the seat belt indicator if it detects a fault with the airbag indicator.

WARNING!

Ignoring the AIR BAG light in your instrument panel could mean you won't have the airbags to protect you in a collision. If the light does not come on, stays on after you start the vehicle, or if it comes on as you drive, have the airbag system checked right away.

- When the airbag control module detects a collision requiring the airbags, it signals the inflator units. A large quantity of nontoxic gas is generated to inflate the airbags. The airbag covers separate and fold out of the way as the airbags inflate to their full size. The airbags fully inflate in milliseconds. This is less time than it takes you to blink your eyes. The airbags then quickly deflate while helping to restrain the driver and front passenger. The driver's front airbag deflates through vents towards the instrument panel. The

passenger's front airbag is deflated through vent holes in the sides of the airbag. In this way the airbags do not interfere with your control of the vehicle.

- The knee impact bolsters help protect the knees and position you for the best interaction with the front airbag.

Passenger Airbag On/Off Switch – (Standard Cab Vehicles Only)



The passenger front airbag is to be turned off only if the passenger:

- is an infant (less than 1 year old) who must ride in the front seat because there is no rear seat, because the rear seat is too small for a rear-facing infant restraint or

because the infant has a medical condition which makes it necessary for the driver to be able to see the infant,

- is a child, age 1 to 12 who must ride in the front seat because there is no rear seat, because there is no rear seat position available, or because the child has a medical condition which makes it necessary for the driver to be able to see the child,
- has a medical condition which makes passenger airbag inflation (deployment) a greater risk for the passenger than the risk of hitting the dashboard (instrument panel) or windshield in a crash.

WARNING!

Whenever an airbag is turned off, even a lap/shoulder belted passenger may hit their head, neck, or chest on the dashboard (instrument panel) or windshield in a crash. This may result in serious injury or death.

To Shut Off the Passenger Airbag (Standard Cab Vehicles Only)

Place the ignition key in the Passenger Airbag On/Off Switch, push the key in and turn clockwise, and remove the key from the switch. This will shut off the passenger side airbag. The "Off" light near the switch will illuminate when the ignition switch is turned to the ON position.

To Turn On the Passenger Airbag (Standard Cab Vehicles Only)

Place the ignition key in the Passenger Airbag On/Off Switch, push the key in and turn counterclockwise, and remove the key from the switch. This will turn on the passenger airbag. The "Off" light near the switch will be off when the ignition switch is turned to the ON position.

If A Deployment Occurs

The airbag system is designed to deploy when the air bag control module detects a moderate-to-severe frontal collision, and then immediately to deflate.

NOTE: A frontal collision that is not severe enough to need airbag protection will not activate the system. This does not mean something is wrong with the airbag system.

If you do have a collision which deploys the airbags, any or all of the following may occur:

- The nylon airbag material may sometimes cause abrasions and/or skin reddening to the driver and front passenger as the airbags deploy and unfold. The abrasions are similar to friction rope burns or those you might get sliding along a carpet or gymnasium floor. They are not caused by contact with chemicals. They are not permanent and normally heal quickly. However, if you haven't healed significantly within a few days, or if you have any blistering, see your doctor immediately.
- As the airbags deflate you may see some smoke-like particles. The particles are a normal by-product of the process that generates the nontoxic gas used for airbag inflation. These airborne particles may irritate the skin, eyes, nose, or throat. If you have skin or eye irritation, rinse the area with cool water. For nose or throat

irritation, move to fresh air. If the irritation continues, see your doctor. If these particles settle on your clothing, follow the garment manufacturer's instructions for cleaning.

- It is not advisable to drive your vehicle after the airbags have deployed. If you are involved in another collision, the airbags will not be in place to protect you.

WARNING!

Deployed airbags can't protect you in another collision. Have the airbags replaced by an authorized dealer as soon as possible.

Window Airbags Supplemental Restraint System (SRS)—If Equipped

The window airbag control module determines if a side collision is severe enough to require the side airbags to inflate. The window airbag control module will not detect roll over, front or rear collisions.

The airbag control module monitors the readiness of the electronic parts of the system whenever the ignition switch is in the "START" or "RUN" positions. These include all of the items listed above. The airbag control module also turns on the AIRBAG light in the instrument panel for 6 to 8 seconds when the ignition is first turned on as a diagnostic or system check, then turns the light off. If it detects a malfunction in any part of the system, it turns on the light either momentarily or continuously.

The side (window) impact SRS Airbags are designed to activate only in certain side collisions. When the airbag control module detects a collision requiring the window

bags to inflate, it signals the inflators on the crash side of the vehicle. A quantity of nontoxic gas is generated to inflate the window bag. The inflating window bag pushes the side pillar molding out of the way and covers the window. The airbag inflates in about 30 milliseconds (about one-quarter of the time it takes to blink your eyes) with enough force to injure you if you are not belted and seated properly, or if items are positioned in the area where the window bag inflates. This especially applies to children. The window bag is only about 3 ½ inches (8.9 cm) thick when it is inflated.

Enhanced Accident Response System

If the airbags deploy after an impact and the electrical system remains functional, vehicles equipped with power door locks will unlock automatically. In addition, approximately 10 seconds after the vehicle has stopped moving, the interior lights will light until the ignition switch is turned off.

Maintaining Your Airbag Systems

WARNING!
<ul style="list-style-type: none"> • Modifications to any part of the airbag system could cause it to fail when you need it. You could be injured because the airbags are not there to protect you. Do not modify the components or wiring, including adding any kind of badges or stickers to the steering wheel hub trim cover or the upper right side of the instrument panel. Do not modify the front bumper, vehicle body structure, or frame. • You need proper knee impact protection in a collision. Do not mount or locate any aftermarket equipment on or behind the knee bolster. • It is dangerous to try to repair any part of the airbag system yourself. Be sure to tell anyone who works on your vehicle that it has airbags.

Airbag Light



You will want to have the airbags ready to inflate for your protection in an impact. While the airbag system is designed to be maintenance free, if any of the following occurs, have an authorized dealer service the system promptly:

- The airbag light does not come on or flickers during the 6 to 8 seconds when the ignition switch is first turned on.
- The light remains on or flickers after the 6 to 8 second interval.
- The light flickers or comes on and remains on while driving.

NOTE: If the speedometer, tachometer or any engine related gauges are not working, the airbag control module may also be disabled. The airbags may not be ready to inflate for your protection. Promptly check fuse block

for blown fuses. Refer to the label located on the inside of the fuse block cover for the proper airbag fuses. See your dealer if the fuse is good.

Event Data Recorder (EDR)

In the event of an airbag deployment, your vehicle is designed to record up to 2-seconds of specific vehicle data parameters (see the following list) in the event data recorder prior to the moment of airbag deployment. Please note that such data are ONLY recorded if an airbag deploys, and are otherwise unavailable. In conjunction with other data gathered during a complete accident investigation, the electronic data may be used by DaimlerChrysler Corporation and others to learn more about the possible causes of crashes and associated injuries in order to assess and improve vehicle performance. In addition to crash investigations initiated by DaimlerChrysler Corporation, such investigations may

be requested by customers, insurance carriers, government officials, and professional crash researchers, such as those associated with universities, and with hospital and insurance organizations.

In the event that an investigation is undertaken by DaimlerChrysler Corporation (regardless of initiative), the company or its designated representative will first obtain permission of the appropriate custodial entity for the vehicle (usually the vehicle owner or lessee) before accessing the electronic data stored, unless ordered to download data by a court with legal jurisdiction (i.e., pursuant to a warrant). A copy of the data will be provided to the custodial entity upon request. General data that does not identify particular vehicles or crashes may be released for incorporation in aggregate crash databases, such as those maintained by the US government and various states. Data of a potentially sensitive

nature, such as would identify a particular driver, vehicle, or crash, will be treated confidentially. Confidential data will not be disclosed by DaimlerChrysler Corporation to any third party except when:

1. Used for research purposes, such as to match data with a particular crash record in an aggregate database, provided confidentiality of personal data is thereafter preserved
2. Used in defense of litigation involving a DaimlerChrysler Corporation product
3. Requested by police under a legal warrant
4. Otherwise required by law

Data Parameters that May Be Recorded:

- Diagnostic trouble code(s) and warning lamp status for electronically-controlled safety systems, including the airbag system

- Airbag disable lamp status (if equipped)
- "Time" of airbag deployment (in terms of ignition cycles and vehicle mileage)
- Airbag deployment level (if applicable)
- Seatbelt status
- Brake status (service and parking brakes)
- Accelerator status (including vehicle speed)
- Engine control status (including engine speed)
- Cruise control status

Child Restraint

Everyone in your vehicle needs to be buckled up all the time — babies and children, too. Every state in the United States and all Canadian provinces require that small children ride in proper restraint systems. This is the law, and you can be prosecuted for ignoring it.

Children 12 years and under should ride properly buckled up in a rear seat, if available. According to crash statistics, children are safer when properly restrained in the rear seats rather than in the front.

WARNING!

In a collision, an unrestrained child, even a tiny baby, can become a missile inside the vehicle. The force required to hold even an infant on your lap can become so great that you could not hold the child, no matter how strong you are. The child and others could be badly injured. Any child riding in your vehicle should be in a proper restraint for the child's size.

Infants and Small Children

There are different sizes and types of restraints for children from newborn size to the child almost large enough for an adult safety belt. Use the restraint that is correct for your child:

- Safety experts recommend that children ride rearward-facing in the vehicle until they are at least one year old and weigh at least 20 lbs (9 kg). Two types of child restraints can be used rearward-facing: infant carriers and "convertible" child seats. Both types of child restraints are held in the vehicle by the lap/shoulder belt.
- The infant carrier is only used rearward-facing in the vehicle. It is recommended for children who weigh up to about 20 lbs (9 kg). "Convertible" child seats can be used either rearward-facing or forward-facing in the vehicle. Convertible child seats often have a higher weight limit in the rearward-facing direction than

infant carriers do, so they can be used rearward-facing by children who weigh more than 20 lbs (9 kg) but are less than one year old.

- Rearward-facing child seats must **NEVER** be used in the front seat of a vehicle with a front passenger airbag unless the airbag is turned off. An airbag deployment could cause severe injury or death to infants in this position.
- Children who weigh more than 20 lbs (9 kg) and who are older than one year can ride forward-facing in the vehicle. Forward-facing child seats and convertible child seats used in the forward-facing direction are for children who weigh 20 to 40 lbs (9 to 18 kg) and who are older than one year. These child seats are also held in the vehicle by the lap/shoulder belt.
- The belt-positioning booster seat is for children weighing more than 40 lbs (18 kg), but who are still too small to fit the vehicle's seat belts properly. If the child cannot sit with knees bent over the vehicle's seat cushion while the child's back is against the seat back, they should use a belt-positioning-booster seat. The child and booster seat are held in the vehicle by the lap/shoulder belt. (Some booster seats are equipped with a front shield and are held in the vehicle by the lap portion.) For further information refer to www.seatcheck.org.

WARNING!

- **Improper installation can lead to failure of an infant or child restraint. It could come loose in a collision. The child could be badly injured or killed. Follow the manufacturer's directions exactly when installing an infant or child restraint.**
- **A rearward facing child restraint should only be used in a rear seat, or in the front seat if the passenger's front airbag is Off. If the airbag is left On, a rearward facing child restraint in the front seat may be struck by a deploying passenger airbag which may cause severe or fatal injury to the infant.**

Here are some tips for getting the most out of your child restraint:

- Before buying any restraint system, make sure that it has a label certifying that it meets all applicable Safety Standards. We also recommend that you make sure that you can install the child restraint in the vehicle where you will use it before you buy it.
- The restraint must be appropriate for your child's weight and height. Check the label on the restraint for weight and height limits.
- Carefully follow the instructions that come with the restraint. If you install the restraint improperly, it may not work when you need it.
- The passenger seat belts are equipped with Automatic Locking Retractors (ALR), which are designed to keep the lap portion tight around the child restraint so that it is not necessary to use a locking clip.

Pull the belt from the retractor until there is enough to allow you to pass through the child restraint and slide the latch plate into the buckle. Then pull on the belt until it is all removed from the retractor. Allow the belt to return to the retractor, pulling on the excess webbing to tighten the lap portion about the child restraint. Refer to the "Automatic Locking Retractors (ALR) Mode" earlier in this section.

- In the rear seat, you may have trouble tightening the lap/shoulder belt on the child restraint because the buckle or latch plate is too close to the belt path opening on the restraint. Disconnect the latch plate from the buckle and twist the short buckle-end belt several times to shorten it. Insert the latch plate into the buckle with the release button facing out.
- If the belt still can't be tightened, or if pulling and pushing on the restraint loosens the belt, disconnect the latch plate from the buckle, turn the latch plate

around, and insert the latch plate into the buckle again. If you still can't make the child restraint secure, try a different seating position.

- Buckle the child into the seat according to the child restraint manufacturer's directions.
- When your child restraint is not in use, secure it in the vehicle with the seat belt or remove it from the vehicle. Do not leave it loose in the vehicle. In a sudden stop or collision, it could strike the occupants or seat backs and cause serious personal injury.

WARNING!

Improper installation can lead to failure of an infant or child restraint. It could come loose in a collision. The child could be badly injured or killed. Follow the manufacturer's directions exactly when installing an infant or child restraint.

Lower Anchors and Tether for Children (LATCH)

Each vehicle is equipped with the child restraint anchorage system called LATCH, which stands for Lower Anchors and Tether for Children. LATCH child restraint anchorage systems are installed in the Standard Cab passenger seat position and the Quad Cab rear seat outboard positions. LATCH equipped seating positions feature both lower anchor bars, located at the back of the seat cushion, and tether strap anchorages, located behind the seatback (refer to Child Restraint Tether Anchor later in this section).

Identification dots are located above the standard cab front seat lower anchorages as a guide for locating lower anchors.

NOTE: For children riding in the front seat of a Standard Cab model refer to the "Passenger Airbag On/Off Switch" located in this section.

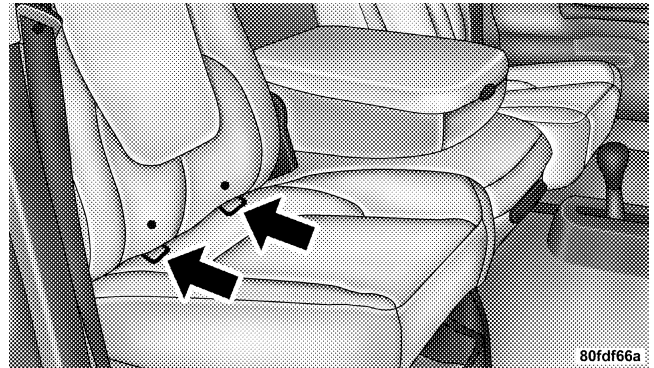

Standard Cab Passenger Seat

80fdf66a

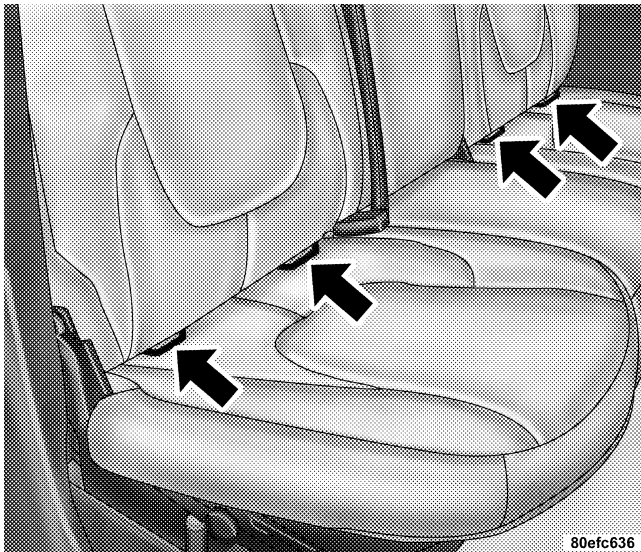

Quad Cab Rear Outboard Seats

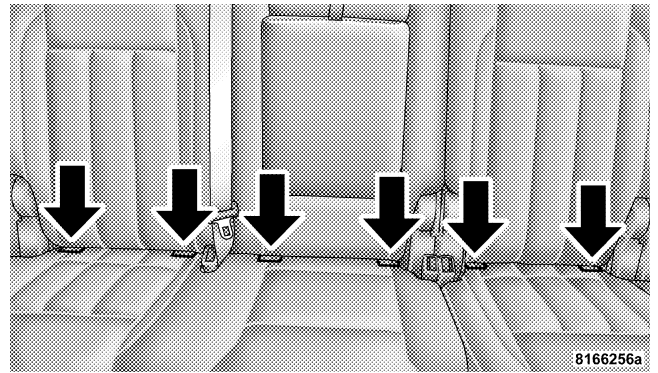

Mega Cab Rear Seats

Child restraint systems having attachments designed to connect to the lower anchorages are now available. Child restraints having tether straps and hooks for connection to the seatback tether anchorage have been available for

some time. In fact, many child restraint manufacturers will provide add-on tether strap kits for some of their older products.

Because the lower anchorages are to be introduced to passenger carrying vehicles over a period of years, child restraint systems having attachments for those anchorages will continue to have features for installation in vehicles using the lap or lap/shoulder belt. They will also have tether straps, and you are urged to take advantage of all of the available attachments provided with your child restraint in any vehicle.

NOTE: When using the LATCH attaching system to install a child restraint, please ensure that all seat belts not being used for occupant restraints are stowed and out of reach of children. It is recommended that before installing the child restraint, buckle the seat belt so the seat belt is tucked behind the child restraint and out of reach. If the buckled seat belt interferes with the child

restraint installation, instead of tucking the seat belt behind the child restraint, route the seat belt through the child restraint belt path and then buckle it. This should stow the seat belt out of the reach of an inquisitive child. Remind all children in the vehicle that the seat belts are not toys and should not be played with, and never leave your child unattended in the vehicle.

NOTE: If your child restraint seat is not LATCH compatible, install the restraint using the vehicle seat belting.

Installing the Child Restraint System

WARNING!

Do not install child restraint systems equipped with LATCH attachments in the center position of a Quad Cab model rear seat. The LATCH anchorages in this seat are designed for the two outboard seating positions only. A child may be placed in the rear center seating position of a Quad Cab model using the seat belt and child tether anchorage. Failure to follow this may result in serious or fatal injury.

We urge that you carefully follow the directions of the manufacturer when installing your child restraint. Many, but not all, restraint systems will be equipped with separate straps on each side, with each having a hook or connector and a means for adjusting the tension in the strap. Forward-facing toddler restraints and some

rearward-facing infant restraints will also be equipped with a tether strap, a hook and means for adjusting the tension in the strap.

In general, you will first loosen the adjusters on the lower straps and tether straps so that you can more easily attach the hook or connector to the lower anchorages and tether anchorages. Then tighten all three straps as you push the child restraint rearward and downward into the seat.

Not all child restraint systems will be installed as we have described here. Again, carefully follow the instructions that come with the child restraint system.

WARNING!

Improper installation of a child restraint to the LATCH anchorages can lead to failure of an infant or child restraint. The child could be badly injured or killed. Follow the manufacturer's directions exactly when installing an infant or child restraint.

Child Restraint Tether Anchor

Child restraints having tether straps and hooks for connection to tether anchors have been available for some time. In fact, many child restraint manufacturers will provide add-on tether strap kits for their older products. Regular Cab models of Ram Pickups have two tether anchorages, one each behind the front center and right seats. Quad Cab and Mega Cab models have three anchorages, one behind each of the rear seats.

WARNING!

An incorrectly anchored tether strap could lead to seat failure and injury to the child. In a collision, the seat could come loose and allow the child to crash into the inside of the vehicle or other passengers, or even be thrown from the vehicle. Use only the anchor positions directly behind the child seat to secure a child restraint top tether strap. Follow the instructions below. See your dealer for help if necessary.

Tether Anchorage Points at the Right and Center Front Seat (Regular Cab - All Seats)

1. Place the child restraint on the seat and adjust the tether strap so that it will reach over the seat back under the head restraint to the tether anchor directly behind the seat.

2. Lift the cover (if so equipped), and attach the hook to the square opening in the sheet metal.
3. Install the child restraint and remove the slack in the tether strap according to the manufacturer's instructions.

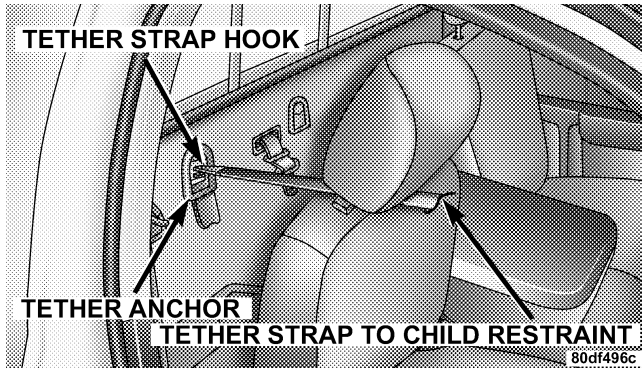

Regular Cab Tether Strap Mounting

Multiple Child Restraint Installation Sequence - (Quad Cab Rear Seats)

2

1. Obtain tether straps by raising the head restraints and reaching between the rear glass and rear seat. The tether strap may be retained with an elastic band. Accessibility to the tether strap is greatly improved by raising the seat cushion to the "up" position. Remove the elastic before use.
2. Place a child restraint on each outboard rear seat and adjust the tether strap so that it will reach under the head restraint to the tether anchor directly behind the seat and then to the anchor directly behind the center rear seat.
3. Pass each tether strap hook under the head restraint and through the loop of webbing behind the child seat.
4. Route each tether strap to the anchor behind the center seat, and attach the hooks to the metal ring.

68 THINGS TO KNOW BEFORE STARTING YOUR VEHICLE

5. Place a child restraint on the center rear seat and adjust the tether strap so that it will reach under the head restraint to the tether anchor directly behind the seat and to the anchor directly behind the right seat.

6. Install each child restraint and remove the slack in the tether strap according to the child restraint manufacturer's instructions.

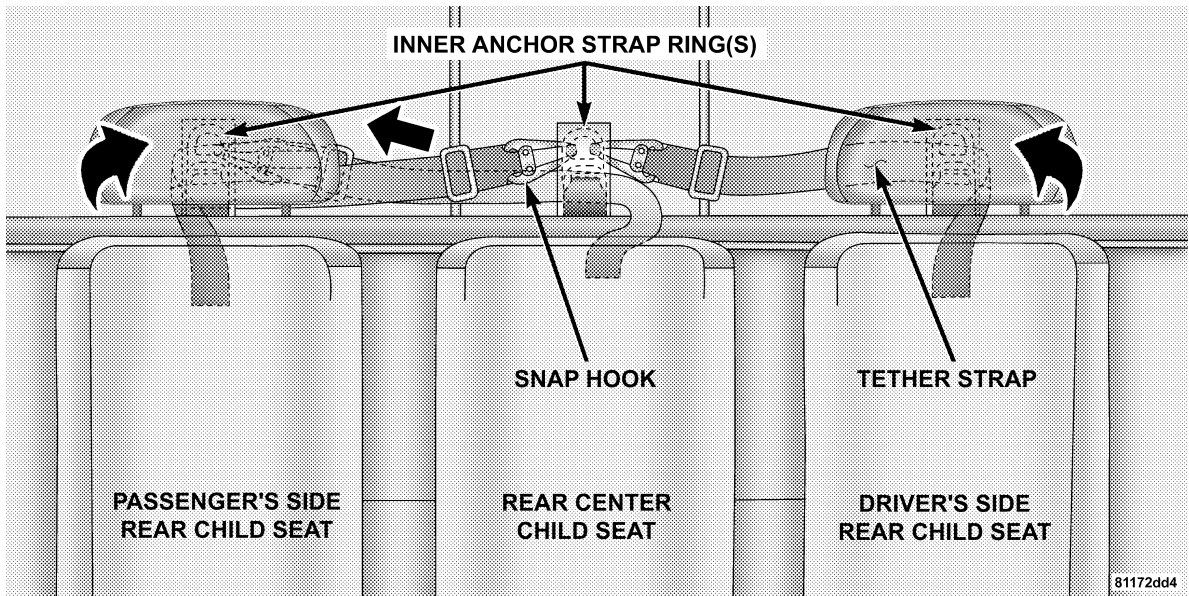

Multiple Child Restraint Quad Cab

Tether Anchorage Points at All Three Seating Positions (Mega Cab)

1. Place the child restraint on the seat and adjust the tether strap so that it will reach over the seat back under the head restraint to the tether anchor directly behind the seat.
2. Lift the cover, and attach the hook to the square opening in the sheet metal.
3. Install the child restraint and remove the slack in the tether strap according to the manufacturer's instructions.

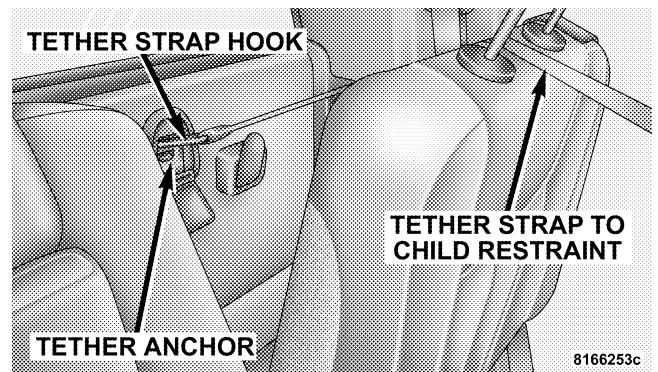

Mega Cab Tether Strap Mounting

Children Too Large for Booster Seats

Children who are large enough to wear the shoulder belt comfortably, and whose legs are long enough to bend over the front of the seat when their back is against the seat back should use the lap/shoulder belt in a rear seat.

- Make sure that the child is upright in the seat.

- The lap portion should be low on the hips and as snug as possible.
- Check belt fit periodically. A child's squirming or slouching can move the belt out of position.

If the shoulder belt contacts the face or neck, move the child closer to the center of the vehicle. Never allow a child to put the shoulder belt under an arm or behind their back.

NEW ENGINE BREAK-IN

Your Cummins 24 Valve Turbo Diesel engine does not require a break-in period due to its construction. Normal operation is allowed, provided the following recommendations are followed:

NOTE: Light duty operation such as light trailer towing or no load operation, will extend the time before the engine is at full efficiency. Reduced fuel economy and power may be seen at this time.

- Warm up the engine before placing it under load.
- Do not operate the engine at idle for prolonged periods.
- Use the appropriate transmission gear to prevent engine lugging.
- Observe vehicle oil pressure and temperature indicators.
- Check the coolant and oil levels frequently.
- Vary throttle position at highway speeds when carrying or towing significant weight.

Because of the construction of the Cummins Diesel engine, engine run-in is enhanced by loaded operating conditions which allow the engine parts to achieve final finish and fit during the first 6,000 miles (10 000 km).

CAUTION!

- During the first 500 miles (805 km) your new vehicle is driven, do not tow a trailer. Doing so may damage your vehicle.
- Limit your speed to 50 mph (80 km/h) during the first 500 miles (805 km) of towing.

SAFETY TIPS

Transporting Passengers

This vehicle is designed to carry passengers in the cab only. For safety reasons, NEVER TRANSPORT PASSENGERS IN THE CARGO AREA.

WARNING!

It is extremely dangerous to ride in a cargo area, inside or outside of a vehicle. In a collision, people riding in these areas are more likely to be seriously injured or killed.

Do not allow people to ride in any area of your vehicle that is not equipped with seats and seat belts.

Be sure everyone in your vehicle is in a seat and using a seat belt properly.

Lock Your Vehicle

Always remove the keys from the ignition and lock all doors when leaving the vehicle unattended, even in your own driveway or garage. Try to park your vehicle in a well-lighted area and never invite theft by leaving articles of value exposed.

Exhaust Gas**WARNING!**

Exhaust gases contain carbon monoxide, a potentially toxic gas that by itself is colorless and odorless. To avoid inhaling these gases, the following precautions should be observed:

- Do not run the engine in a closed garage or in confined areas any longer than needed to move your vehicle in or out of the area.
- If it is necessary to sit in a parked vehicle with the engine running for more than a short period, adjust your climate control system to force outside air into the vehicle. Set the blower at high speed and the controls in any position except OFF or MAX A/C.

- The best protection against carbon monoxide entry into the vehicle body is a properly maintained engine exhaust system.

Be aware of changes in the sound of the exhaust system; exhaust fumes detected inside the vehicle; or damage to the underside or rear of the vehicle. Have a competent mechanic inspect the complete exhaust system and adjacent body areas for broken, damaged, deteriorated or mispositioned parts. Open seams or loose connections could permit exhaust fumes to seep into the passenger compartment. In addition, inspect the exhaust system each time the vehicle is raised for lubrication or oil change. Replace or adjust as required.

Safety Checks You Should Make Inside The Vehicle

Heater Defroster Ducts

Inspect the heater defroster ducts for proper operation. Check for proper air flow through all defroster ducts. If there are any question regarding the operation of your heater defroster ducts, have the system checked by an authorized dealer

Seat Belts

Inspect the belt system periodically, checking for cuts, frays and loose parts. Damaged parts must be replaced immediately. Do not disassemble or modify the system.

Seat belt assemblies must be replaced after an accident if they have been damaged (bent retractor, torn webbing, etc.) or if the front airbags have deployed. If there is any question regarding belt or retractor condition, replace the belt.

Airbag Light

The light should come on and remain on for 6 to 8 seconds as a bulb check when the ignition switch is first turned ON. If the light is not lit during starting, see your authorized dealer. If the light stays on, flickers or comes on while driving, have the system checked by an authorized dealer. If there is a problem with the airbag light the seatbelt light will flash.

Safety Checks You Should Make Outside The Vehicle

Tires

Examine tires for tread wear or uneven wear patterns. Check for stones, nails, glass or other objects lodged in the tread.

Inspect for tread cuts or sidewall cracks. Check wheel nuts for tightness and tires for proper pressure.

Lights

Check the operation of all exterior lights. Check turn signal and high beam indicator lights on the instrument panel.

Door Latches

Check for positive closing, latching and locking.

Fluid Leaks

Check area under vehicle after overnight parking for fuel, water, oil, or other fluid leaks. Also, if fuel fumes are detected the cause should be located and corrected.

UNDERSTANDING THE FEATURES OF YOUR VEHICLE

CONTENTS

■ Mirrors82	■ Hands-Free Communication (UConnect™) — If Equipped87
□ Inside Mirror82	□ Operations88
□ Automatic Dimming Mirror— If Equipped83	□ Phone Call Features95
□ Outside Mirrors83	□ UConnect™ System Features97
□ Exterior Mirrors Folding Feature84	□ Advanced Phone Connectivity102
□ Electronic Power Mirrors — If Equipped84	□ Things You Should Know About Your UConnect™ System103
□ Electric Rear Window Defroster And Heated Sideview Mirrors — If Equipped85	■ Seats109
□ Trailer Towing Mirrors — If Equipped85	□ 40-20-40 Front Seat110

78 UNDERSTANDING THE FEATURES OF YOUR VEHICLE

<input type="checkbox"/> Reclining Seats	111	<input type="checkbox"/> Daytime Running Lights (Canada Only And Fleet Vehicles)	125
<input type="checkbox"/> Adjustable Head Restraints	111	<input type="checkbox"/> Lights-On Reminder	126
<input type="checkbox"/> Manual Rotary Lumbar Support Adjustment — If Equipped	112	<input type="checkbox"/> Fog Lights — If Equipped	126
<input type="checkbox"/> Power Seats — If Equipped	113	<input type="checkbox"/> Cargo Light — If Equipped	126
<input type="checkbox"/> Rear Seat Features — Mega Cab Models	114	<input type="checkbox"/> Multifunction Control Lever	127
<input type="checkbox"/> Heated Seats — If Equipped	119	<input checked="" type="checkbox"/> Windshield Wipers And Washers	129
<input checked="" type="checkbox"/> To Open And Close The Hood	121	<input type="checkbox"/> Windshield Wipers	129
<input checked="" type="checkbox"/> Lights	122	<input type="checkbox"/> Windshield Washers	130
<input type="checkbox"/> Interior Lights	123	<input checked="" type="checkbox"/> Tilt Steering Column	130
<input type="checkbox"/> Battery Saver	124	<input checked="" type="checkbox"/> Driver Adjustable Pedals — If Equipped	132
<input type="checkbox"/> Headlamp Delay	124	<input type="checkbox"/> Adjustment	132
<input type="checkbox"/> Headlights, Parking Lights, Panel Lights	124		

<hr/>		UNDERSTANDING THE FEATURES OF YOUR VEHICLE 79
■ Electronic Speed Control — If Equipped	133	□ Global Reset 138
□ To Activate	133	□ Step Button 138
□ To Set At A Desired Speed	134	□ Average Fuel Economy (AVG ECO) 139
□ To Deactivate	134	□ Distance To Empty (DTE) 139
□ To Resume Speed	134	□ Trip Odometer (ODO) 140
□ To Vary The Speed Setting	134	□ Elapsed Time (ET) 140
□ To Accelerate For Passing	135	□ C/T Button 140
■ Overhead Console— If Equipped	136	□ Automatic Compass Calibration 141
□ Courtesy/Reading Lights	136	□ Manual Compass Calibration 141
■ Overhead Console With Compass/Temperature Mini-Trip Computer — If Equipped	137	□ Recalibrating The Compass 141
□ US/M Button	137	□ Outside Temperature 143
□ Reset Button	138	■ Garage Door Opener — If Equipped 143
		□ Programming HomeLink 145

80 UNDERSTANDING THE FEATURES OF YOUR VEHICLE

□ Canadian Programming/Gate Programming . . .	147	□ Sunroof Maintenance	152
□ Using HomeLink	148	□ Sunroof Fully Closed	152
□ Erasing HomeLink Buttons	148	■ Electrical Power Outlets	152
□ Reprogramming a Single HomeLink Button . . .	148	■ Cigar Lighter And Ash Receiver	154
□ Security	149	■ Cupholders	155
■ Power Sunroof — If Equipped	149	□ Front Instrument Panel Cupholders (40–20–40 Seats) — Automatic Transmission	155
□ Open Sunroof - Express Mode	150	□ Front Instrument Panel Cupholders (Bucket Seats) — Automatic Transmission	157
□ Comfort Stop	150	□ Front Instrument Panel Cupholders — Manual Transmission	157
□ Closing Sunroof - Express	151	□ Rear Cupholder — Quad Cab — If Equipped	158
□ Pinch Protect Feature	151	□ Rear Cupholder — Mega Cab	158
□ Pinch Protect Override	151		
□ Venting Sunroof - Express	151		
□ Sunshade Operation	151		
□ Wind Buffeting	152		

<ul style="list-style-type: none"> ■ Storage159 <ul style="list-style-type: none"> □ Center Storage Compartment (40–20–40 Seat) — If Equipped159 □ Center Storage Compartment (Bucket Seats)— If Equipped160 □ Storage And Seats (Quad Cab Models)162 □ Storage And Seats (Mega Cab Models)162 □ Plastic Grocery Bag Retainers (Mega Cab Models)164 ■ Rear Window Features164 	<ul style="list-style-type: none"> □ Electric Rear Window Defroster And Heated Side View Mirrors — If Equipped164 □ Power Sliding Rear Window—If Equipped ...165 □ Sliding Rear Window—If Equipped165 ■ Fold Flat Load Floor — If Equipped166 ■ Pickup Box169 ■ Slide-In Campers170 <ul style="list-style-type: none"> □ Camper Applications170 ■ Easy-Off Tailgate171
---	---

MIRRORS

Inside Mirror

The mirror should be adjusted to center on the view through the rear window.

Annoying headlight glare can be reduced by moving the small control under the mirror to the night position (toward rear of vehicle). The mirror should be adjusted while set in the day position (toward windshield).

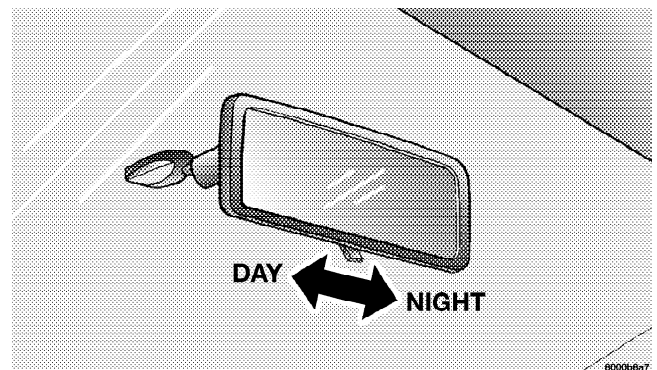

Adjusting Rear View Mirror

Automatic Dimming Mirror— If Equipped

This mirror automatically adjusts for annoying headlight glare from vehicles behind you. You can turn the feature on or off by pressing the button at the base of the mirror. A light in the button will indicate when the dimming feature is activated.

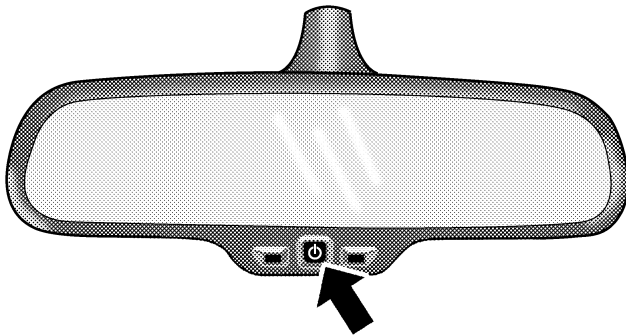

Automatic Dimming Mirror

817892c4

CAUTION!

To avoid damage to the mirror during cleaning, never spray any cleaning solution directly onto the mirror. Apply the solution onto a clean cloth and wipe the mirror clean.

3

Outside Mirrors

To receive maximum benefit, adjust the outside mirror(s) to center on the adjacent lane of traffic with a slight overlap of the view obtained on the inside mirror.

WARNING!

Vehicles and other objects seen in a right side convex mirror will look smaller and farther away than they really are. Relying too much on your right side convex mirror could cause you to collide with another vehicle or other object. Use your inside mirror when judging the size or distance of a vehicle seen in the right side convex mirror. Some vehicles will not have a convex right side mirror.

Exterior Mirrors Folding Feature

All 6 x 9 inch exterior mirrors are hinged and may be moved either forward or rearward to resist damage. The hinges have three detent positions; full forward, full rearward, and normal.

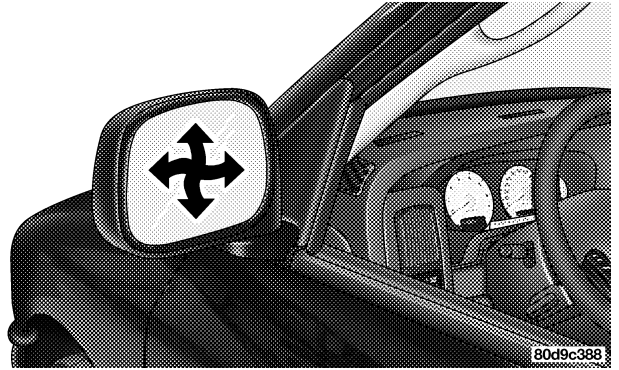
Electronic Power Mirrors — If Equipped**Power Mirror Movement**

The controls for the power mirrors are located on the driver's door trim panel.

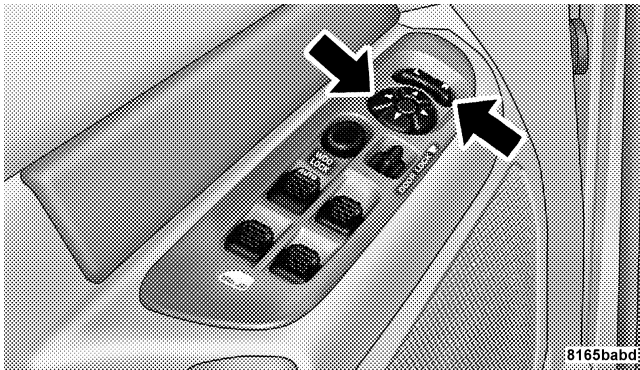

Power Mirror Switches

Set the top switch to the left or right for the left or right mirror, and set it to the center off position to prevent accidentally moving a mirror when you are finished adjusting the mirror. To adjust a mirror, select left or right with the top switch, and press one of the four arrows for the direction you want the mirror to move.

Electric Rear Window Defroster and Heated Sideview Mirrors — If Equipped

 The Electric Rear Window Defroster and Heated side view mirrors are activated by pressing the heated grid button, located on the Climate Control panel, with the ignition On. Turning Off the rear window defroster or the ignition will deactivate the Electric Rear Window Defroster and Heated side view mirrors feature. These features also turn off after activation, when 15 minutes have elapsed. To reactivate, simply press the button again.

Trailer Towing Mirrors — If Equipped

These mirrors are designed with an adjustable mirror head to provide a greater vision range when towing extra-wide loads. To change position inboard or outboard, the mirror head should be rotated (flipped Out or In). A small blindspot mirror is integrated onto the main mirror surface.

NOTE: Fold the 7 x 10 inch trailer towing mirrors rearward prior to entering an automated car wash.

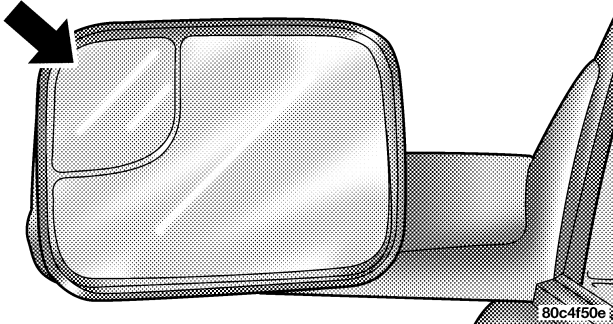

Blindspot Mirror

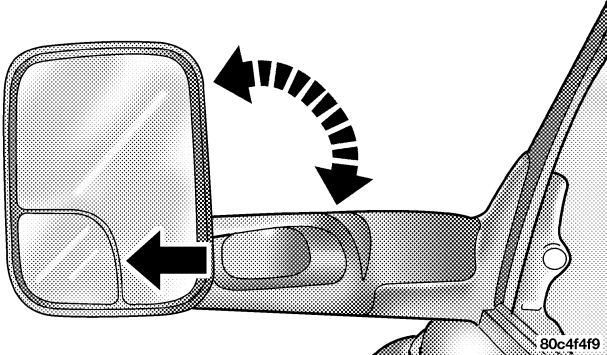

Trailer Towing Position

HANDS-FREE COMMUNICATION (UConnect™) — IF EQUIPPED

UConnect™ is a voice-activated, hands-free, in-vehicle communications system. UConnect™ allows you to dial a phone number with your cellular phone using simple voice commands (e.g., "Call" ... "Mike" ... "Work" or "Dial" ... "248-555-1212"). Your cellular phone's audio is transmitted through your vehicle's audio system; the system will automatically mute your radio when using the UConnect™ system.

NOTE: The UConnect™ system use requires a cellular phone equipped with the Bluetooth "Hands-Free Profile," version 0.96 or higher. See www.chrysler.com/uconnect for supported phones.

UConnect™ allows you to transfer calls between the system and your cellular phone as you enter or exit your vehicle, and enables you to mute the system's microphone for private conversation.

The UConnect™ phonebook enables you to store up to 32 names and four numbers per name. Each language has a separate 32-name phonebook accessible only in that language. This system is driven through your Bluetooth™ Hands-Free profile cellular phone. UConnect™ features Bluetooth™ technology - the global standard that enables different electronic devices to connect to each other without wires or a docking station, so UConnect works no matter where you stow your cellular phone (be it your purse, pocket, or briefcase), as long as your phone is turned on and has been paired to the vehicle's UConnect™ system. The UConnect™ system allows up to seven cellular phones to be linked to system. Only one linked (or paired) cellular phone can be used with the system at a time. The system is available in English, Spanish, or French languages (as equipped).

The rearview mirror contains the microphone for the system and the control buttons that will enable you to access the system.

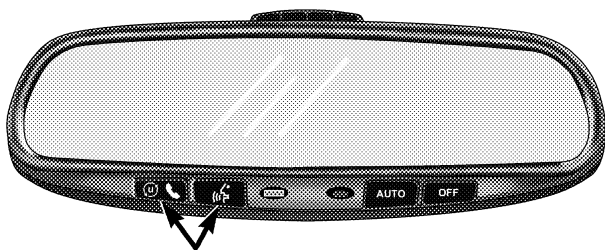

8105b20d

UConnect™ Switches

The UConnect™ system can be used with any Hands-Free Profile certified Bluetooth™ cellular phone. See www.chrysler.com/uconnect for supported phones. If

your cellular phone supports a different profile (e.g., Headset Profile), you may not be able to use any UConnect™ features. Refer to your cellular service provider or the phone manufacturer for details.

The UConnect™ system is fully integrated with the vehicle's audio system. The volume of the UConnect™ system can be adjusted either from the radio volume control knob, or from the steering wheel radio control (right switch), if so equipped.

The radio display will be used for visual prompts from the UConnect™ system such as "CELL" or caller ID on certain radios.

Operations

Voice commands can be used to operate the UConnect™ system and to navigate through the UConnect™ menu structure. Voice commands are required after most UConnect™ system prompts. You will be prompted for a specific command and then guided through the available options.

- Prior to giving a voice command, one must wait for the voice on beep, which follows the "Ready" prompt or another prompt.
- For certain operations, compound commands can be used. For example, instead of saying "Setup" and then "Phone Pairing," the following compound command can be said: "Setup Phone Pairing."
- For each feature explanation in this section, only the combined form of the voice command is given. You can also break the commands into parts and say each part of the command, when you are asked for it. For example, you can use the combined form voice command "Phonebook New Entry," or you can break the combined form command into two voice commands: "Phonebook" and "New Entry." Please remember, the UConnect™ system works best when you talk in a normal conversational tone, as if speaking to someone sitting eight feet away from you.

Voice Command Tree

Refer to "Voice Tree" at the end of this section.

Help Command

If you need assistance at any prompt, or if you want to know your options are at any prompt, say "Help" following the voice on beep. The UConnect™ system will play all the options at any prompt if you ask for help.

To activate the UConnect™ system from idle, simply press the 'Phone' button and follow audible prompts for directions. All UConnect™ system sessions begin with a press of the 'Phone' button on the mirror.

Cancel Command

At any prompt, after the voice on beep, you can say "Cancel" and you will be returned to the main menu. However, in a few instances the system will take you back to the previous menu.

Pair (Link) UConnect™ System to a Cellular Phone

To begin using your UConnect™ system, you must pair your compatible Bluetooth™ enabled cellular phone.

NOTE: The UConnect™ system use requires a cellular phone equipped with the Bluetooth "Hands-Free Profile," version 0.96 or higher. See www.chrysler.com/uconnect for supported phones.

To complete the pairing process, you will need to reference your cellular phone owner's manual. One of the following vehicle specific websites may also provide detailed instructions for pairing with the brand of phone that you have:

NOTE:

- www.chrysler.com/uconnect
- www.dodge.com/uconnect
- www.jeep.com/uconnect

The following are general phone to UConnect™ System pairing instructions:

- Press the 'Phone' button to begin.
- After the "Ready" prompt and the following beep, say "Setup Phone Pairing" and follow the audible prompts.
- When prompted, after the voice on beep, say "Pair a Phone" and follow the audible prompts.
- You will be asked to say a four-digit pin number, which you will later need to enter into your cellular. You can enter any four-digit pin number. You will not need to remember this pin number after the initial pairing process.
- For identification purposes, you will be prompted to give the UConnect™ system a name for your cellular phone. Each cellular phone that is paired should be given a unique phone name.

- You will then be asked to give your cellular phone a priority level between 1 and 7, 1 being the highest priority. You can pair up to seven cellular phones to your UConnect™ system. However, at any given time, only one cellular phone can be in use, connected to your UConnect™ System. The priority allows the UConnect™ system to know which cellular phone to use if multiple cellular phones are in the vehicle at the same time. For example, if priority 3 and priority 5 phones are present in the vehicle, the UConnect™ system will use the priority 3 cellular phone when you make a call. You can select to use a lower priority cellular phone at any time (refer to "Advanced Phone Connectivity").
- After the "Ready" prompt and the following beep, say "Dial."
- System will prompt you to say the number you want call.
- For example, you can say "234-567-8901."
- The UConnect™ system will confirm the phone number and then dial. The number will appear in the display of certain radios.

Call/Dial by Saying a Number

- Press the 'Phone' button to begin.

Call/Dial by Saying a Name

- Press the "Phone" button to begin.
- After the "Ready" prompt and the following beep, say "Dial" or Call."
- System will prompt you to say the name of the person you want call.

- After the "Ready" prompt and the following beep, say the name of the person you want to call. For example, you can say "John Doe," where John Doe is a previously stored name entry in the UConnect™ phonebook. Refer to "Add Names to Your UConnect™ Phonebook," to learn how to store a name in the phonebook.
- The UConnect™ system will confirm the name and then dial the corresponding phone number, which may appear in the display of certain radios.
- When prompted, say the name of the new entry. Use of long names helps the voice recognition and is recommended. For example, say "Robert Smith" or "Robert" instead of "Bob."
- When prompted, enter the number designation (e.g., "Home," "Work," "Mobile," or "Pager"). This will allow you to store multiple numbers for each phonebook entry, if desired.
- When prompted, recite the phone number for the phonebook entry that you are adding.

Add Names to Your UConnect™ Phonebook

NOTE: Adding names to phonebook is recommended when vehicle is not in motion.

- Press the "Phone" button to begin.
- After the "Ready" prompt and the following beep, say "Phonebook New Entry."

After you are finished adding an entry into the phonebook, you will be given the opportunity to add more phone numbers to the current entry or to return to the main menu.

The UConnect™ system will allow you to enter up to 32 names in the phonebook with each name having up to

four associated phone numbers and designations. Each language has a separate 32-name phonebook accessible only in that language.

Edit Entries in the UConnect™ Phonebook

NOTE: Editing phonebook entries is recommended when vehicle is not in motion.

- Press the 'Phone' button to begin.
- After the "Ready" prompt and the following beep, say "Phonebook Edit."
- You will then be asked for the name of the phonebook entry that you wish to edit.
- Next, choose the number designation (home, work, mobile, or pager) that you wish to edit.
- When prompted, recite the new phone number for the phonebook entry that you are editing.

After you are finished editing an entry in the phonebook, you will be given the opportunities to edit another entry in the phonebook, call the number you just edited, or return to the main menu.

"Phonebook Edit" can be used to add another phone number to a name entry that already exists in the phonebook. For example, the entry John Doe may have a mobile and a home number, but you can add John Doe's work number later using the "Phonebook Edit" feature.

Delete Entries in the UConnect™ Phonebook

NOTE: Editing phonebook entries is recommended when vehicle is not in motion.

- Press the 'Phone' button to begin.
- After the "Ready" prompt and the following beep, say "Phonebook Delete."

- After you enter the Phonebook Delete menu, you will then be asked for the name of the entry that you wish to delete. You can either say the name of a phonebook entry that you wish to delete or you can say "List Names" to hear a list of the entries in the phonebook from which you choose. To select one of the entries from the list, press the "Voice Recognition" button while the UConnect™ system is playing the desired entry and say "Delete."
- After you enter the name, the UConnect™ system will ask you which designation you wish to delete, home, work, mobile, or pager. Say the designation you wish to delete.
- Note that only the phonebook entry in the current language is deleted.

After confirmation, the phonebook entries will be deleted. Note that only the phonebook in the current language is deleted.

Delete All Entries in the UConnect™ Phonebook

- Press the 'Phone' button to begin.
- After the "Ready" prompt and the following beep, say "Phonebook Erase All."
- The UConnect™ system will ask you to verify that you wish to delete all the entries from the phonebook.
- After confirmation, the phonebook entries will be deleted.

List All Names in the UConnect™ Phonebook

- Press the 'Phone' button to begin.
- After the "Ready" prompt and the following beep, say "Phonebook List Names."
- The UConnect™ system will play the names of all the phonebook entries.

- To call one of the names in the list, press the "Voice Recognition" button during the playing of the desired name, and then say "Call." NOTE: the user can also exercise "Edit" or "Delete" operations at this point.
- The UConnect™ system will then prompt you as to number designation you wish to call.
- The selected number will be dialed.

Phone Call Features

The following features can be accessed through the UConnect™ system if the feature(s) are available on your cellular service plan. For example, if your cellular service plan provides three-way calling, this feature can be accessed through the UConnect™ system. Check with your cellular service provider for the features that you have.

**Answer or Reject an Incoming Call - No Call
Currently in Progress**

When you receive a call on your cellular phone, the UConnect™ system will interrupt the vehicle audio system, if on, and will ask if you would like to answer the call. To reject the call, press and hold the 'Phone' button until you hear a single beep indicating that the incoming call was rejected.

**Answer or Reject an Incoming Call - Call
Currently in Progress**

If a call is currently in progress and you have another incoming call, you will hear the same network tones for call waiting that you normally hear when using your cell phone. Press the 'Phone' button to place the current call on hold and answer the incoming call. NOTE: The UConnect™ system compatible phones in market today do not support rejecting an incoming call when another call is in progress. Therefore, the user can only either answer an incoming call or ignore it.

Making a Second Call while Current Call in Progress

To make a second call while you are currently in a call, press the 'Voice Recognition' button and say "Dial" or "Call" followed by the phone number or phonebook entry you wish to call. The first call will be on hold while the second call is in progress. To go back to the first call, refer to "Toggling Between Calls." To combine two calls, refer to "Conference Call."

Place/Retrieve a Call from Hold

To put a call on hold, press the 'Phone' button until you hear a single beep. This indicates that the call is on hold. To bring the call back from hold, press and hold the 'Phone' button until you hear a single beep.

Toggling Between Calls

If two calls are in progress (one active and one on hold), press the 'Phone' button until you hear a single beep

indicating that the active and hold status of the two calls have switched. Only one call can be placed on hold at one time.

Conference Call

When two calls are in progress (one active and one on hold), press and hold the 'Phone' button until you hear a double beep indicating that the two calls have been joined into one conference call.

Three-Way Calling

To initiate three-way calling, press the 'Voice Recognition' button while a call is in progress and make a second phone call as described under "Making a Second Call while Current Call in Progress." After the second call has established, press and hold the 'Phone' button until you hear a double beep indicating that the two calls have been joined into one conference call.

Call Termination

To end a call in progress, momentarily press the 'Phone' button. Only the active call(s) will be terminated and if there is a call on hold, it will become the new active call.

Redial

- Press the 'Phone' button to begin.
- After the "Ready" prompt and the following beep, say "Redial."
- The UConnect™ system will call the last number that was dialed on your cellular phone. Note: this may not be the last number dialed from the UConnect™ system.

Call Continuation

Call continuation is progression of a phone call on UConnect™ system after the vehicle ignition key has been switched to off. Call continuation functionality available on the vehicle can be any one of three types:

- After ignition key is switched off, a call can continue on the UConnect™ system either until the call ends or until the vehicle battery condition dictates cessation of the call on the UConnect™ system and transfer of the call to the mobile phone.
- After ignition key is switched to off, a call can continue on the UConnect™ system for certain duration, after which the call is automatically transferred from the UConnect™ system to the mobile phone.
- An active call is automatically transferred to the mobile phone after ignition key is switched to off.

UConnect™ System Features**Language Selection**

To change the language that the UConnect™ system is using,

- Press the 'Phone' button to begin.

- After the "Ready" prompt and the following beep, say the name of the language you wish to switch to (English, Espanol, or Francais, if so equipped).
- Continue to follow the system prompts to complete language selection.

After selecting one of the languages, all prompts and voice commands will be in that language.

NOTE: After every UConnect™ language change operation, only the language specific 32-name phonebook is usable. The paired phone name is not language specific and usable across all languages.

Emergency Assistance

If you are in an emergency and the mobile phone is reachable:

- Pick up the phone and manually dial the emergency number for your area.

If the phone is not reachable and the UConnect™ system is operational, you may reach the emergency number as follows:

- Press the 'Phone' button to begin.
- After the "Ready" prompt and the following beep, say "Emergency" and the UConnect™ system will instruct the paired cellular phone to call the emergency number. This feature is only supported in the USA.

NOTE: The emergency number dialed is based on the Country where the vehicle is purchased (911 for USA and Canada and 060 for Mexico). The number dialed may not be applicable with the available cellular service and area.

The UConnect™ system does slightly lower your chances of successfully making a phone call as to that for the cell phone directly.

Your phone must be turned on and paired to the UConnect™ system to allow use of this vehicle feature in emergency situations when the cell phone has network coverage and stays paired to the UConnect™ system.

Towing Assistance

If you need towing assistance,

- Press the 'Phone' button to begin.
- After the "Ready" prompt and the following beep, say "Towing Assistance."

NOTE: The Towing Assistance number dialed is based on the Country where the vehicle is purchased (1-800-528-2069 for USA, 1-877-213-4525 for Canada, 55-14-3454 for Mexico city and 1-800-712-3040 for outside Mexico city in Mexico).

Please refer to the 24-Hour "Towing Assistance" coverage details in the Warranty information booklet and on the 24-Hour Towing Assistance Card.

Paging

To learn how to page, refer to "Working with Automated Systems." Paging works properly except for pagers of certain companies which time-out a little too soon to work properly with the UConnect™ system.

Voice Mail Calling

To learn how to access your voice mail, refer to "Working with Automated Systems."

Working with Automated Systems

This method is designed to be used in instances where one generally has to press numbers on the cellular phone keypad while navigating through an automated telephone system.

You can use your UConnect™ system to access a voice-mail system or an automated service, such as, paging service or automated customer service. Some services require immediate response selection, in some instances, that may be too quick for use of UConnect™ system.

When calling a number with your UConnect™ system that normally requires you to enter in a touch-tone sequence on your cellular phone keypad, you can push the 'Voice Recognition' button and say the sequence you wish to enter followed by the word "Send." For example, if required to enter your pin number followed with a pound 3 7 4 6 #, you can press the 'Voice Recognition' button and say "3 7 4 6 # Send." Saying a number, or sequence of numbers, followed by "Send" is also to be used to navigate through an automated customer service center menu structure and to leave a number on a pager.

Barge In - Overriding Prompts

The 'Voice Recognition' button can be used when you wish to skip part of a prompt and issue your voice recognition command immediately. For example, if a prompt is playing "Would you like to pair a phone, clear a...," you could press the 'Voice Recognition' button and say "Pair a Phone" to select that option without having to listen to the rest of the voice prompt.

Turning Confirmation Prompts On/Off

Turning confirmation prompts off will stop the system from confirming your choices (e.g., the UConnect™ system will not repeat a phone number before you dial it).

- Press the 'Phone' button to begin.
- After the "Ready" prompt and the following beep, say "Setup Confirmations." The UConnect™ system will play the current confirmation prompt status and you will be given the choice to change it.

Phone and Network Status Indicators

If available on the radio and/or on a premium display such as the instrument panel cluster, and supported by your cell phone, the UConnect™ system will provide notification to inform you of your phone and network status when you are attempting to make a phone call using UConnect™. The status is given for roaming network signal strength, phone battery strength, etc.

Dialing Using the Cellular Phone Keypad

You can dial a phone number with your cellular phone keypad and still use the UConnect™ system (while dialing via the cell phone keypad, the user must exercise caution and take precautionary safety measures). By dialing a number with your paired Bluetooth™ cellular phone, the audio will be played through your vehicle's audio system. The UConnect™ system will work the same as if you dial the number using voice recognition.

NOTE: Certain brands of mobile phones do not send the dial ring to the UConnect™ system to play it on the vehicle audio system, so you will not hear it. Under this situation, after successfully dialing a number, the user may feel that the call did not go through even though the call is in progress. Once your call is answered, you will hear the audio.

Mute/Un-mute (Mute off)

When you mute the UConnect™ system, you will still be able to hear the conversation coming from the other party, but the other party will not be able to hear you. In order to mute the UConnect™ system:

- Press the 'Voice Recognition' button.
- After the "Ready" prompt and the following beep, say "Mute."

In order to un-mute the UConnect™ system:

- Press the 'Voice Recognition' button.
- After the "Ready" prompt and the following beep, say "Mute-off."

Information Service

When using AT&T Wireless Service, dialing to phone number "#121," you can access voice activated automated system to receive news, weather, stocks, traffic, etc. related information.

Advanced Phone Connectivity

Transfer Call to and from Cellular Phone

The UConnect™ system allows on going calls to be transferred from your cellular phone to the UConnect™ system without terminating the call. To transfer an ongoing call from your UConnect™ paired cellular phone to the UConnect™ system or vice-versa, press the 'Voice Recognition' button and say "Transfer Call."

Connect or Disconnect Link Between the UConnect™ System and Cellular Phone

Your cellular phone can be paired with many different electronic devices, but can only be actively "connected" with one electronic device at a time.

If you would like to connect or disconnect the Bluetooth™ connection between a UConnect™ paired cellular phone and the UConnect™ system, then follow the instruction described in your cellular phone user's manual.

List Paired Cellular Phone Names

- Press the 'Phone' button to begin.
- After the "Ready" prompt and the following beep, say "Setup Phone pairing".
- When prompted, say "List Phones."
- The UConnect™ system will play the phone names of all paired cellular phones in order from the highest to the lowest priority. To "select" or "delete" a paired phone being announced, press the 'Voice recognition' button and say "Select" or "Delete." Also, see the next two sections for an alternate way to "select" or "delete" a paired phone.

Select another Cellular Phone

This feature allows you to select and start using another phone with the UConnect™ system. The phone must have been previously paired to the UConnect™ system that you want to use it with.

- Press the 'Phone' button to begin.
- After the "Ready" prompt and the following beep, say "Setup Select Phone" and follow the prompts.
- You can also press the 'Voice Recognition' button anytime while the list is being played, and then choose the phone that you wish to select.
- The selected phone will be used for the next phone call. If the selected phone is not available, the UConnect™ system will return to using the highest priority phone present in or near (approximately within 30 feet) the vehicle.

Delete UConnect™ Paired Cellular Phones

- Press the 'Phone' button to begin.
- After the "Ready" prompt and the following beep, say "Setup Phone Pairing."
- At the next prompt, say "Delete" and follow the prompts.
- You can also press the 'Voice Recognition' button anytime while the list is being played and then choose the phone you wish to delete.

Things You Should Know About Your UConnect™ System**Voice Recognition (VR)**

- Always wait for the beep before speaking.

- Speak normally, without pausing, just as you would speak to a person sitting approximately eight (8) feet away from you.
- Make sure that no one other than you is speaking during a voice recognition period.
- Performance is maximized under:
 - low-to-medium blower setting,
 - low-to-medium vehicle speed,
 - low road noise,
 - smooth road surface,
 - fully closed windows,
 - dry weather condition.
- Even though the system is designed for users speaking in North American English, French, and Spanish accents, the system may not always work for some.
- When navigating through an automated system, such as voice mail, or when sending a page at the end of speaking the digit string, make sure to say "send."
- Storing names in phonebook when vehicle is not in motion is recommended.
- It is not recommended to store similar sounding names in the UConnect™ phonebook.
- UConnect™ phonebook nametag recognition rate is optimized for the voice of the person who stored the name in the phonebook.
- You can say "O" (letter "O") for "0" (zero). "800" must be spoken "eight-zero-zero."
- Even though international dialing for most number combinations is supported, some shortcut dialing number combinations may not be supported.

Far End Audio Performance

- Audio quality is maximized under:
 - low-to-medium blower setting,
 - low-to-medium vehicle speed,
 - low road noise,
 - smooth road surface,
 - fully closed windows, and
 - dry weather condition.
 - Operation from driver seat.
- Performance, such as audio clarity, echo, and loudness to a large degree rely on the phone and network, and not the UConnect™ system.
- Echo at far end can sometime be reduced by lowering the in-vehicle audio volume.

Bluetooth Communication Link

Occasionally, Cellular phones have been found to lose connection to the UConnect™ system. When this happens, the connection can generally be re-established by switching the phone off/on. Your cell phone is recommended to remain in Bluetooth "on" mode.

Power-Up

After switching the ignition key from OFF to either ON or ACC position, or after a reset, you must wait at least five (5) seconds prior to using the system.

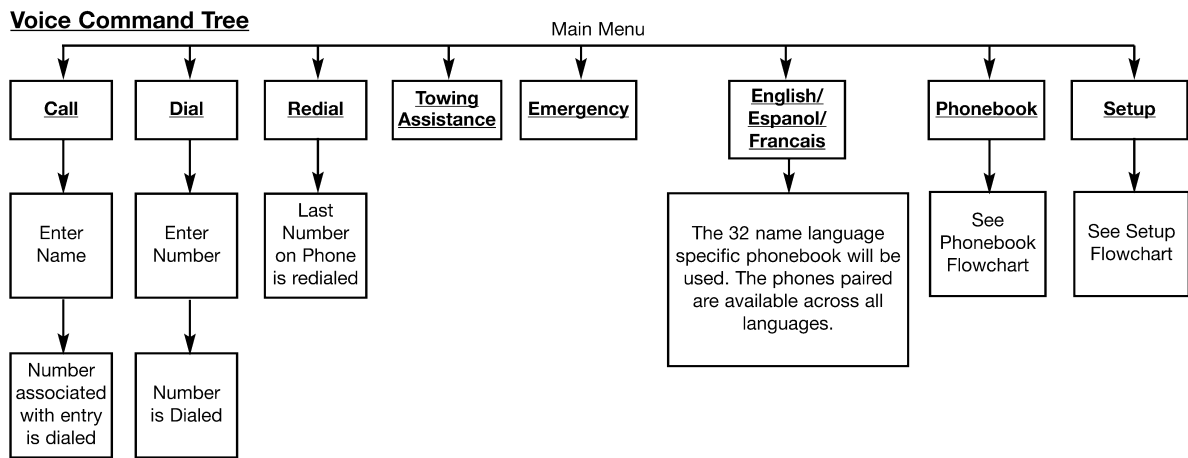

Note: Available Voice commands are shown in bold face and are underlined.

Voice Tree – Phonebook

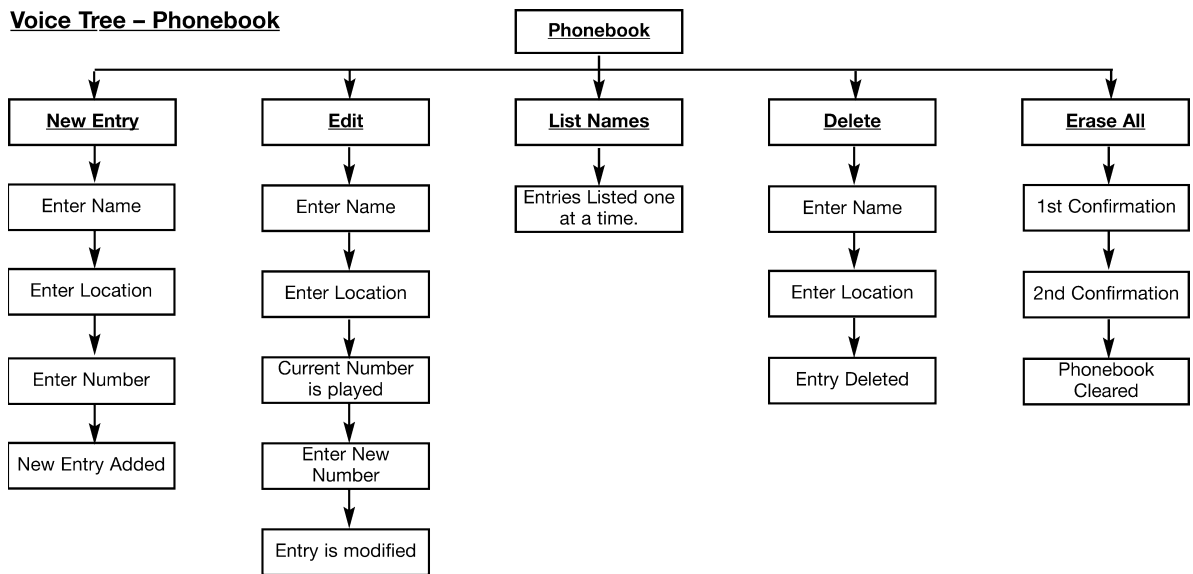

Note: Available Voice commands are shown in bold face and are underlined.

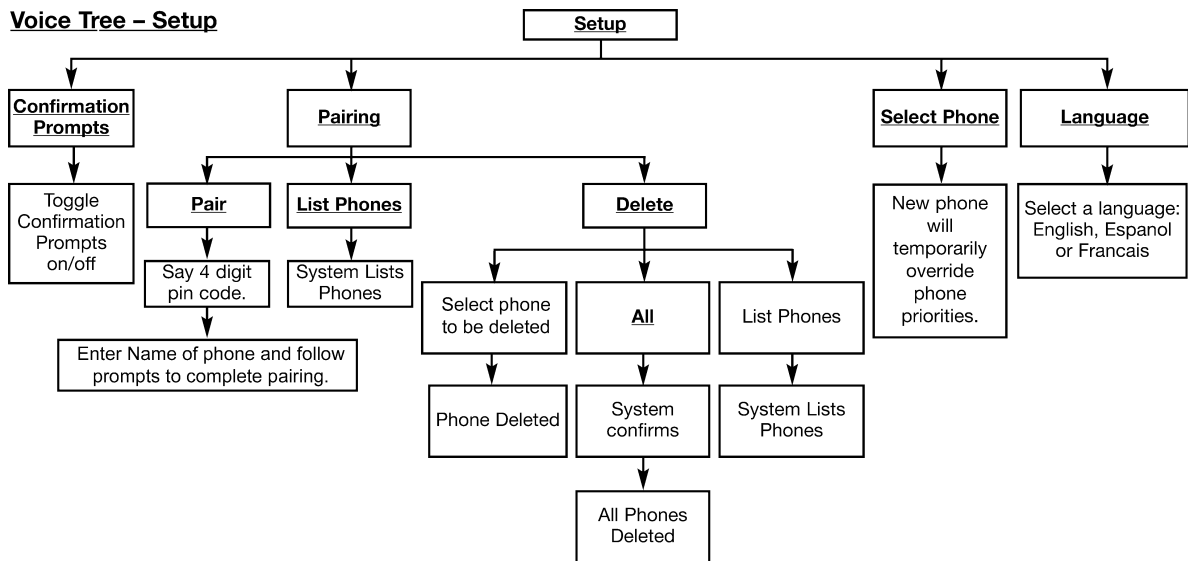

Note: Available Voice commands are shown in bold face and are underlined.

	North American English
Primary	Alternate(s)
Zero	Oh
Add location	Add new
All	All of them
Confirmation prompts	Confirmations prompts
Delete a name	Delete
Language	Select language
List names	List all
List paired phones	List phones
Pager	Beeper
Phone pairing	Pairing
Phonebook	Phone book
Return to main menu	Return. Main menu
Select phone	select
Set up	Phone settings phone set up

SEATS

The seating options available in this truck are the result of extensive customer research and evaluations.

Seats are also a primary part of the Occupant Restraint (protection) System of the vehicle. They need to be used properly for safe operation of the vehicle.

3

WARNING!
<p>It is extremely dangerous to ride in a cargo area, inside or outside of a vehicle. In a collision, people riding in these areas are more likely to be seriously injured or killed.</p> <p>Do not allow people to ride in any area of your vehicle that is not equipped with seats and seat belts.</p> <p>Be sure everyone in your vehicle is in a seat and using a seat belt properly.</p>

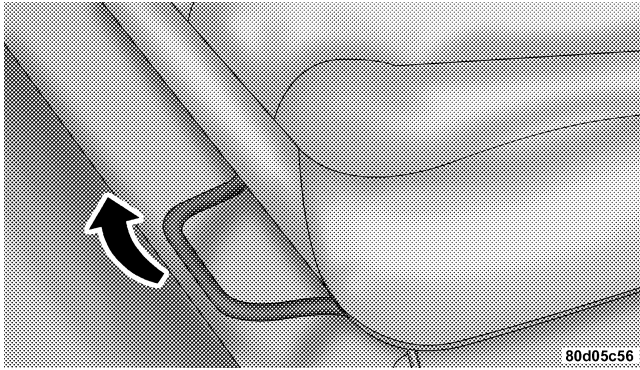
40-20-40 Front Seat**Manual Seat Adjuster**

As the name implies, the seat is divided into 3 segments. The outboard seat portions are each 40% of the total width of the seat. The back of the center portion (20%) easily folds down to provide an armrest/center storage compartment (if equipped).

Each outboard seat is independently adjustable forward or rearward and is equipped with a back recliner. The manual forward or rearward seat adjustment handle is found at the front edge of each seat cushion. Pull up on the handle and slide the seat to get the most comfortable position.

WARNING!

Adjusting a seat while the vehicle is moving is dangerous. The sudden movement of the seat could cause you to lose control. The seat belt might not be properly adjusted and you could be injured. Adjust any seat only while the vehicle is parked.

Reclining Seats

The recliner handle is on the outside of the seat cushion. Pull up on the handle, as shown, to release the seat back and adjust for comfort.

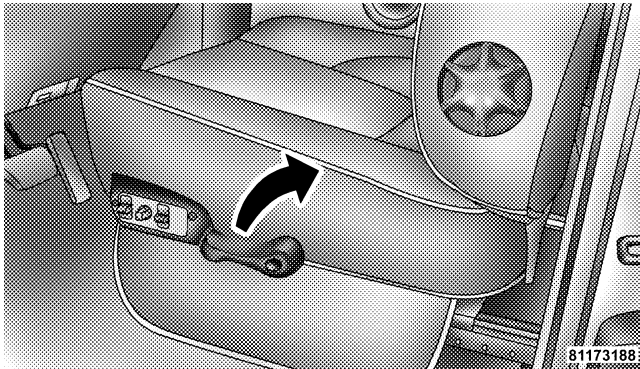

Manual Recline Lever

WARNING!

You can be seriously, even fatally, injured riding in a seat with the seatback reclined. Do not ride with the seatback reclined so that the shoulder belt is no longer resting against your chest. If you ride in this position, the shoulder harness will no longer be restraining you. In a collision you could slide under the seat belt and receive serious or fatal injuries. Recline in a seat only when the vehicle is parked.

3

Adjustable Head Restraints

Head restraints can reduce the risk of neck injury in the event of impact from the rear. Pull up or push down on the restraints so that the upper edge is as high as practical, at least to the level of the ears.

To lower the head restraint, push in the button and then push down on the head restraint.

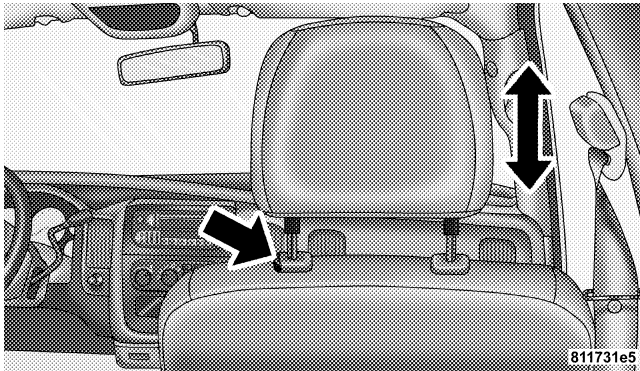

Head Restraints

Manual Rotary Lumbar Support Adjustment — If Equipped

Rotating the lumbar control knob on the left side of the driver's seatback and on the right side of the passenger's seatback increases or decreases the lumbar (lower back) support.

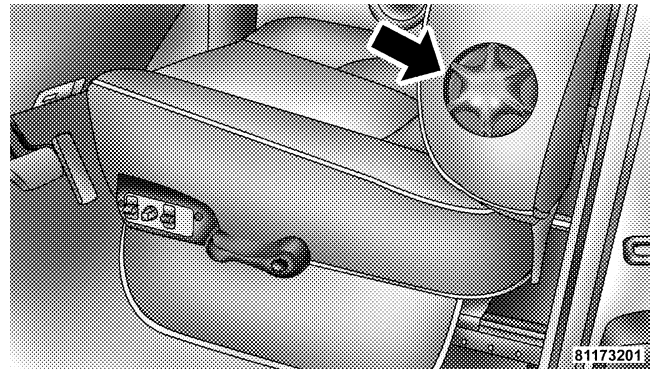

Manual Lumbar Adjustment

Power Seats — If Equipped

CAUTION!
Don't put anything under a power seat. It may cause damage to the seat controls.

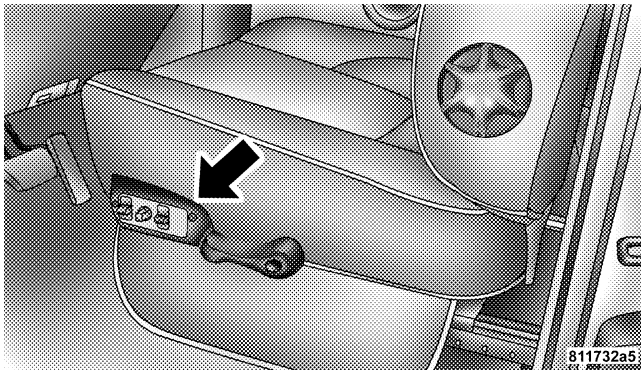

Power Seat Switch

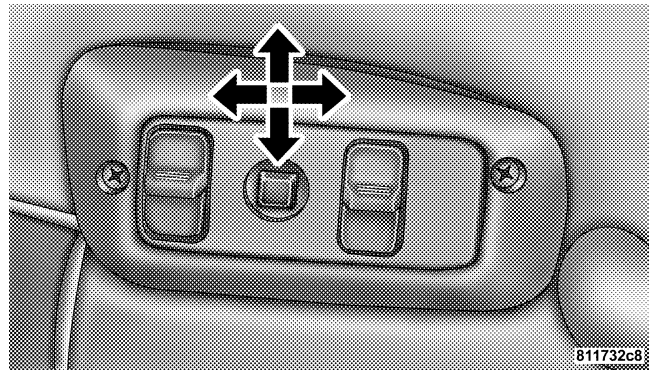

3

Up, Down, Forward, and Rearward

The power seat controls are on the outboard side of the front seat cushions. Three switches control the seat movement. The four-way switch in the center can be moved forward or backwards to get the most comfortable position. The same switch can be moved up and down to

control seat height. Change the seat angle by using the two toggle switches, tilting it up or down.

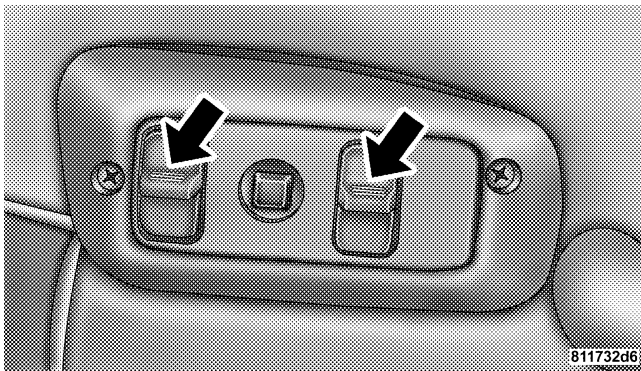

Tilt Adjustment

Rear Seat Features — Mega Cab Models

Reclining Rear Seats — Mega Cab Models

The recliner handle is on the outside of the seat cushion. Pull up on the handle, as shown, to release the seat back and adjust for comfort.

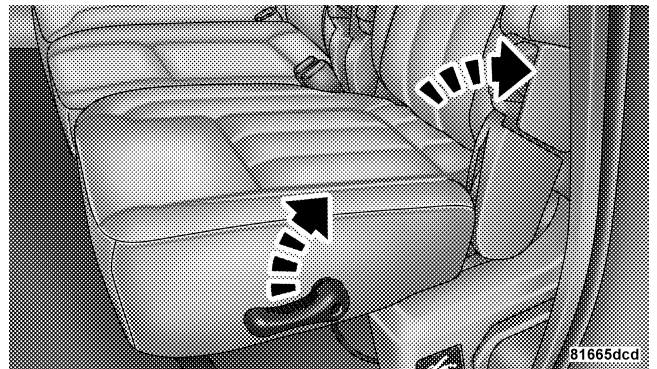

Rear Seat Recliner Handle

Folding Rear Seat (Table Mode) — Mega Cab Models

Both the left and right rear seat backs can be folded down and used as a table.

To fold either rear seat back down (Table Mode), lift the handle and fold the seat back forward. Simply lift the seat back to return the seat to the upright position. Verify that it is locked in place.

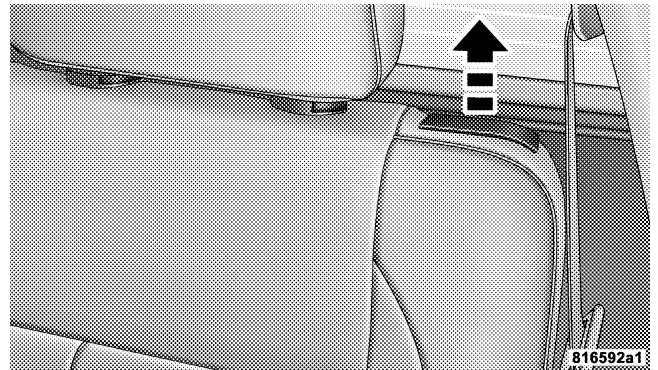

Table Mode Handle

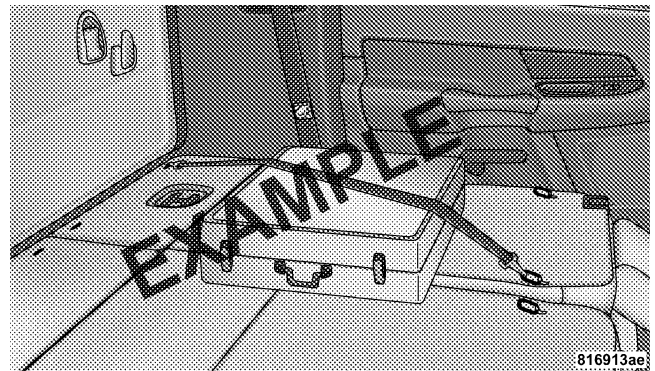

Table Mode

Folding Rear Seat (Kneel Mode) — Mega Cab Models

Both the left and right rear seats can be folded flat (Kneel Mode) and used for carrying cargo. Each of the rear seat

backs provide 2 D-rings and each of the rear storage bin lids provide 2 slotted cutouts. Use a cargo tie down to secure cargo in the cargo carrying area.



Securing Cargo

WARNING!

- It is extremely dangerous to ride in a cargo area, inside or outside of a vehicle. In a collision, people riding in these areas are more likely to be seriously injured or killed.
- Do not allow people to ride in any area of your vehicle that is not equipped with seats and seat belts.
- Be sure everyone in your vehicle is in a seat and using a seat belt properly.

WARNING!

Cargo must be securely tied down before driving your vehicle. Improperly secured cargo can fly around in a sudden stop and strike someone in the vehicle, causing serious injury or possible death. Secure cargo with a cargo tie down using the D-Rings provided on the back of the seats and the slotted cutouts in the rear storage bin lid.

NOTE: The rear seat will drop and move forward in Kneel Mode.

118 UNDERSTANDING THE FEATURES OF YOUR VEHICLE

To fold either rear seat flat (Kneel Mode), lift the handle and fold the seat forward. Simply lift the seat back to return the seat to the upright position. Verify that it is locked in place.

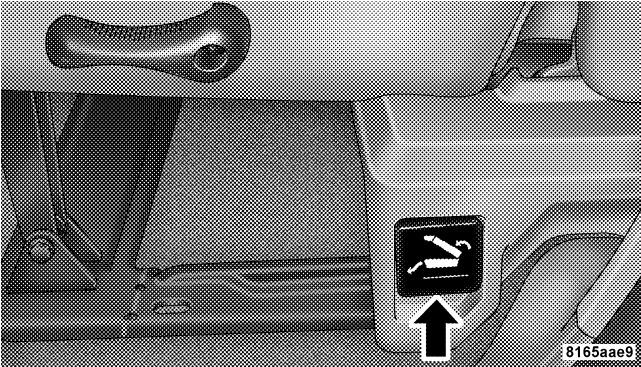

Kneel Mode Handle

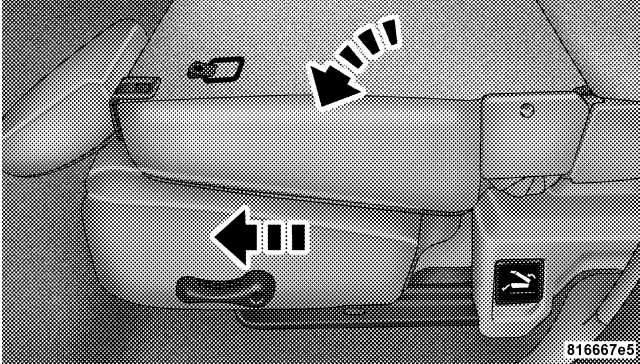

Kneel Mode

WARNING!

Be certain that the seatback is securely locked into position. If the seatback is not securely locked into position the seat will not provide the proper stability for child seats and/or passengers. An improperly latched seat could cause serious injury.

Heated Seats — If Equipped

The heated seat switches are located in the instrument panel under the climate controls.

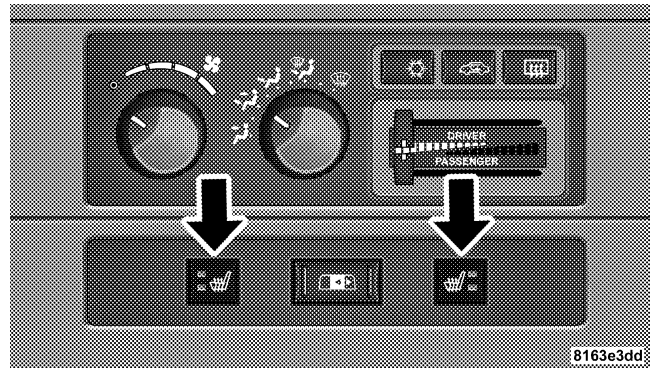
**Heated Seat Switches**

Each heated seat switch has two settings (HI and LOW). Press the switch once to obtain High heat level, then press the switch again to obtain Low heat level. Pressing the switch a third time will turn the heated seats OFF. If you do not purposefully turn the switch OFF, the seat heating level will automatically change to the next lower

level, or OFF. The High heat level operates for 30 minutes (approximate), the Low heat level operates for 30 minutes (approximate). The seat heat will also turn OFF when the ignition is turned OFF. Both of the indicators ON identifies High heat level. The lower indicator On only, identifies Low heat level. Flashing indicator lights on the switch indicate that the Heated Seat System needs servicing.

WARNING!

Persons who are unable to feel pain to the skin because of advanced age, chronic illness, diabetes, spinal cord injury, medication, alcohol use, exhaustion or other physical condition must exercise care when using the seat heater. It may cause burns even at low temperatures, especially if used for long periods of time.

Do not place anything on the seat that insulates against heat, such as a blanket or cushion. This may cause the seat heater to overheat.

TO OPEN AND CLOSE THE HOOD

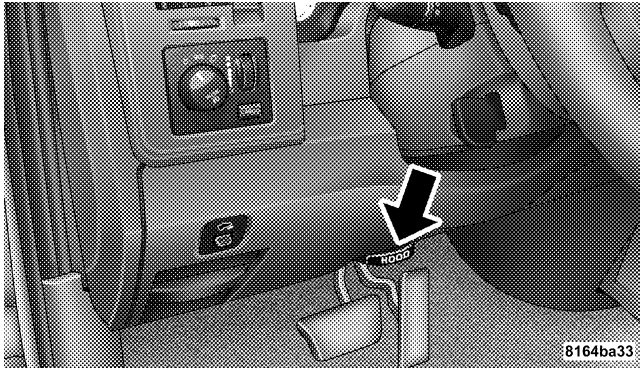

Hood Release Lever

To open the hood, two latches must be released. First pull the hood release lever located below the steering wheel at the base of the instrument panel. Once the hood is

released you must reach into the opening beneath the center of the grille and push up the latch to release the safety catch before raising the hood.

To prevent possible damage, do not slam the hood to close it. Use a firm downward push at the front center of the hood to ensure that both latches engage.

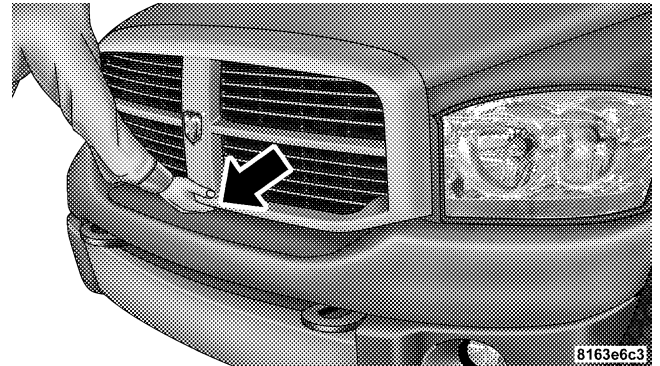

Secondary Latch

WARNING!

If the hood is not fully latched, it could fly up when the vehicle is moving and block your forward vision. Be sure all hood latches are latched fully before driving.

LIGHTS

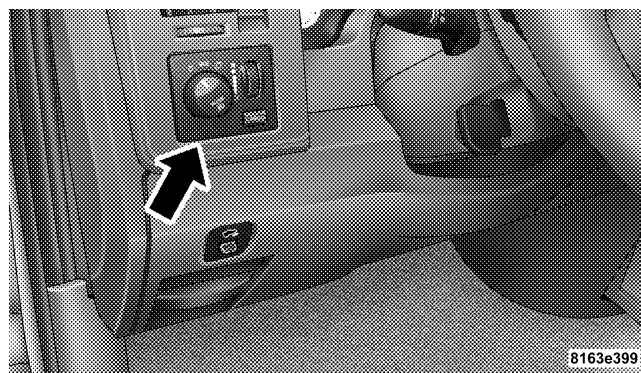

Headlight Switch Location

Interior Lights



81482f6a

Dimmer Control

Courtesy and dome lights are turned on when the front doors are opened, when the dimmer control (rotating wheel on the right side of the switch) is rotated to the upward detent position, or if equipped, when the UNLOCK button is pressed on the key fob. When a door is

open and the interior lights are on, rotating the dimmer control all the way down to the OFF detent will cause all the interior lights to go out. This is also known as the "Party" mode because it allows the doors to stay open for extended periods of time without discharging the vehicle's battery.

The brightness of the instrument panel lighting can be regulated by rotating the dimmer control up (brighter) or down (dimmer). When the headlights are ON you can supplement the brightness of the odometer, trip odometer, radio and overhead console by rotating the control up until you hear a click. This feature is termed the "Parade" mode and is useful when headlights are required during the day.

Club Cab/Quad Cab models may have an optional switched dome lamp that may be operated by pressing the lens.

Battery Saver

To protect the life of your vehicle's battery, Load Shedding is provided for both the interior and exterior lights.

If the ignition is off and any door is left ajar for 10 minutes or the dimmer control is rotated upwards for 10 minutes, the interior lights will automatically turn off.

If the headlamps remain on while the ignition is cycled off, the exterior lights will automatically turn off after 8 minutes. If the headlamps are turned on and left on for 8 minutes while the ignition is off, the exterior lights will automatically turn off.

NOTE: Battery Saver mode is cancelled if the ignition is ON.

Headlamp Delay

To aid in your exit, your vehicle is equipped with a headlamp delay that will leave the headlamps on for 90 seconds. This delay is initiated when the ignition is turned OFF while the headlamp switch is on, and then the headlamp switch is cycled off. Headlamp delay can be cancelled by either turning the headlamp switch ON then OFF or by turning the ignition ON.

Headlights, Parking Lights, Panel Lights

When the headlight switch is rotated to the first position, the parking lights, taillights, side marker lights, license plate light and instrument panel lights are all turned on. The headlights will turn ON when the switch is rotated to the second position.

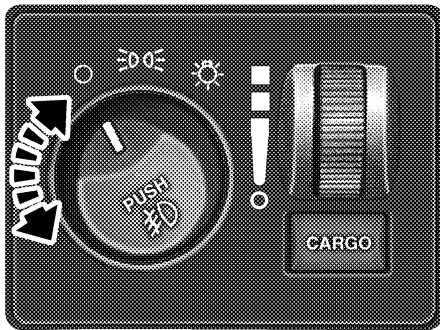

81482f22

Light Switch Rotation

Your vehicle is equipped with plastic headlight lenses that are lighter and less susceptible to stone breakage than glass headlights.

Plastic is not as scratch resistant as glass and therefore different lens cleaning procedures must be followed.

To minimize the possibility of scratching the lenses and reducing light output, avoid wiping with a dry cloth. To remove road dirt, wash with a mild soap solution followed by rinsing.

Do not use abrasive cleaning components, solvents, steel wool or other abrasive materials to clean the lenses.

Daytime Running Lights (Canada Only and Fleet Vehicles)

The headlights on your vehicle will illuminate when the engine is started. This provides a constant "Lights ON" condition until the ignition is turned OFF. The lights illuminate at less than 50% of normal intensity. If the parking brake is applied the Daytime Running Lights will turn off.

Lights-on Reminder

If the headlights, parking lights, or cargo lights are left on, after the ignition is turned off, a chime will sound when the driver's door is opened.

Fog Lights — If Equipped

 The foglights are turned ON by placing the headlight rotary control in the parking light or headlight position and pushing in the headlight rotary control. The fog lights will operate only when the parking lights are ON or when the vehicle headlights are ON low beam. An indicator light located in the instrument cluster will illuminate when the fog lights are on. The fog lights will turn off when the switch is pushed a second time, when the headlight switch is rotated to the OFF position, or the high beam is selected.

Cargo Light — If Equipped

814830fd

Cargo Light Switch

The cargo lights are turned on by pressing on the CARGO button. The interior lights will also turn on when the cargo lights are on. The cargo lights will also turn on for 30 seconds when a key fob Unlock is pressed, as part of the illuminated entry feature.

Multifunction Control Lever

The multifunction control lever is located on the left side of the steering column.

Turn Signals

Move the lever up or down to signal a right-hand or left-hand turn.

The arrow on either side of the instrument cluster flashes to indicate the direction of the turn, and proper operation of the front and rear turn signal lights. If a defective bulb or wiring circuit is detected for the turn signal system, the arrow indicators will flash at a faster rate. If an indicator fails to light when the lever is moved, it would suggest that the switch or indicator lamp is defective.

You can signal a lane change by moving the lever partially up or down.

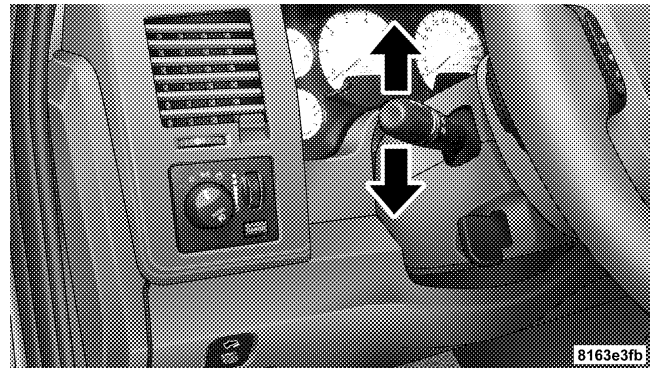

Turn Signal Lever

Turn Signal Auto-Mode

Tap the multi-function control lever once and the turn signal (left or right) will flash 3 times, and automatically turn off.

Passing Light

You can signal another vehicle with your headlights by partially pulling the multifunction lever toward the steering wheel. This will cause the high beam headlights to turn on until the lever is released.

High Beam / Low Beam Select Switch

Pull the multifunction control lever fully toward the steering wheel to switch the headlights from HIGH or LOW beam.



High Beam / Low Beam

WINDSHIELD WIPERS AND WASHERS

Windshield Wipers

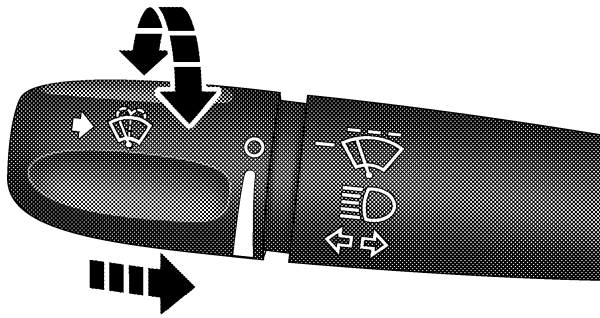

815be820

Windshield Wiper / Washer Switch

The wipers and washers are operated by a switch in the multifunction control lever. Turn the end of the handle to select the desired wiper speed.

Intermittent Wiper System

The intermittent feature of this system was designed for use when weather conditions make a single wiping cycle, with a variable pause between cycles, desirable. For maximum delay between cycles, rotate the control knob into the upper end of the delay range.

The delay interval decreases as you rotate the knob until it enters the LOW continual speed position. The delay can be regulated from a maximum of about 15 seconds between cycles, to a cycle every 2 seconds. The delay intervals will double in duration when the vehicle speed is 10 mph (16 km) or less.

WARNING!

Sudden loss of visibility through the windshield could lead to an accident. You might not see other vehicles or other obstacles. To avoid sudden icing of the windshield during freezing weather, warm the windshield with defroster before and during windshield washer use.

Windshield Washers

To use the washer, push in on the washer knob on the end of the multifunction control lever and hold while spray is desired. If the washer knob is depressed while in the delay range, the wiper will operate for several seconds after the washer knob is released. It will then resume the intermittent interval previously selected. If the washer knob is pushed, for a period greater than 1 second, while in the OFF position, the wiper will wipe approximately three wipes, after the wash knob is released.

To prevent freeze-up of your windshield washer system in cold weather, select a solution or mixture that meets or exceeds the temperature range of your climate. This rating information can be found on most washer fluid containers.

TILT STEERING COLUMN

To tilt the column, pull rearward on the lever below the turn signal control and move the wheel up or down, as desired. Push the lever forward to lock the column firmly in place.

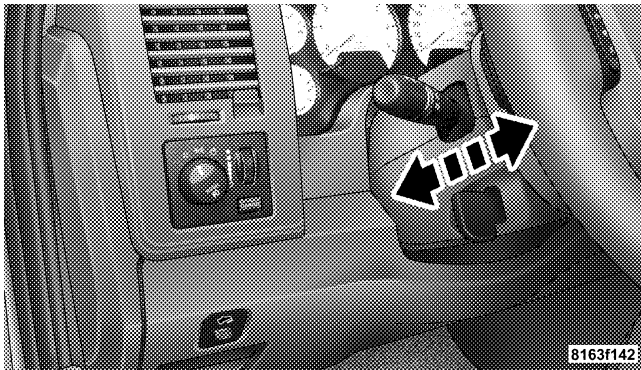

Tilt Steering Control Lever

WARNING!

Tilting the steering column while the vehicle is moving is dangerous. Without a stable steering column, you could lose control of the vehicle and have an accident. Adjust the column only while the vehicle is stopped. Be sure it is locked before driving.

DRIVER ADJUSTABLE PEDALS — IF EQUIPPED

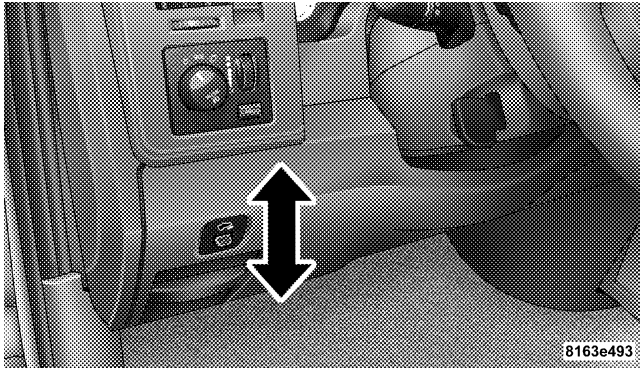

Adjustable Pedals Switch

The power adjustable accelerator and brake pedals allow the driver to establish a comfortable position relative to the steering wheel and pedals.

Adjustment

1. Position the driver seat so that you are at least 10 inches (254 mm) away from the airbag located in the center of the steering wheel.
2. Fasten and adjust the seatbelts.
3. Move the adjustable pedal switch, located to the left of the steering column near the parking brake release, in the direction you desire to move the pedals.
4. The pedals **cannot** be adjusted when the vehicle is in R (Reverse) or when the Speed Control is SET.

CAUTION!

Do not place any article under the adjustable pedals or impede its ability to move as it may cause damage to the pedal controls. Pedal travel may become limited if movement is stopped by an obstruction in the adjustable pedal's path.

ELECTRONIC SPEED CONTROL — IF EQUIPPED

When engaged, this device takes over accelerator operation at speeds greater than 35 mph (56 km/h). The controls are mounted on the steering wheel.



8147b086

To Activate

Push the ON/OFF button to the ON position. An indicator light in the instrument cluster illuminates when the system is on.

To Set At A Desired Speed

When the vehicle has reached the desired speed, press and release the SET button. Release the accelerator and the vehicle will operate at the selected speed.

To Deactivate

A soft tap on the brake pedal, normal braking, clutch pressure while slowing the vehicle, or pressing the CANCEL button will deactivate speed control without erasing the memory. Pushing the ON/OFF button to the OFF position or turning off the ignition erases the memory.

WARNING!

Leaving the Speed Control ON when not in use is dangerous. You could accidentally set the system to cause it to go faster than you want. You could lose control and have an accident. Always leave the system OFF when you aren't using it.

To Resume Speed

To resume a previously set speed, push and release the RESUME button. Resume can be used at any speed above 30 mph (50 km/h).

To Vary The Speed Setting

When the speed control is on, speed can be increased by pressing and holding the ACCEL button. When the button is released, a new set speed will be established.

Tapping the ACCEL button once will result in a 2 mph (3km/h) speed increase. Each time the button is tapped, speed increases so that tapping the button three times will increase speed by 6 mph (10 km/h), etc.

Tapping the DECEL button once will result in a 1 mph (2 km/h) speed decrease. Each time the button is tapped, speed will decrease. For example, tapping the button 3 times will decrease the speed by 3 mph (5 km/h), etc.

To decrease speed while the speed control is on, press and hold the DECEL button. Release the button when the desired speed is reached, and the new speed will be set.

To Accelerate For Passing

Depress the accelerator as you would normally. When the pedal is released, the vehicle will return to the set speed.

NOTE: When driving uphill, at elevations above 2,000 ft. (610 meters), or when the vehicle is heavily loaded (especially when towing) the vehicle may slow below the SET speed. If the vehicle speed drops below 35 mph (56 km/h), the speed control will automatically disengage. If this happens, you can push down on the accelerator pedal to maintain the desired speed.

Vehicles equipped with a 6-speed manual transmission should be operated in 4th or 5th gear under the above conditions.

Vehicles equipped with a 4-speed automatic transmission may exhibit several 4-3 downshifts under the above conditions. To reduce the frequency of the downshifts and to improve vehicle performance, it is advisable to lock out overdrive by pressing the O/D OFF button located at the end of the gear shifter.

WARNING!

Speed Control can be dangerous where the system can't maintain a constant speed. Your vehicle could go too fast for the conditions, and you could lose control. An accident could be the result. Don't use Speed Control in heavy traffic or on roads that are winding, icy, snow-covered, or slippery.

OVERHEAD CONSOLE— IF EQUIPPED

The two optional overhead consoles may consist of the following features:

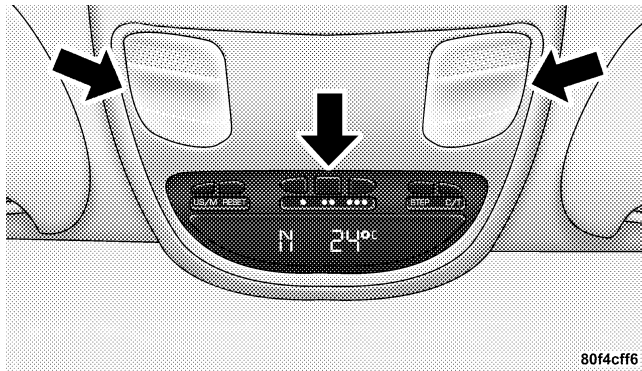

Overhead Console Features

- Courtesy/Reading Lights
- Compass/Temperature Mini-Trip Computer (CMTC)
— If Equipped

- Universal Garage Door Opener — If Equipped

Courtesy/Reading Lights

In the middle of the console are two courtesy/reading lights.

Both lights illuminate as courtesy lights when a door is opened, when the dimmer control is rotated to the courtesy light position (fully upward position), or when the UNLOCK button is pressed on the Remote Keyless Entry transmitter, if so equipped. These lights are also operated individually as reading lights by pressing the recessed area of the corresponding lens.

NOTE: The courtesy/reading lights will remain on until the switch is pressed a second time, so be sure they have been turned off before leaving the vehicle. If the interior lights are left on after the vehicle is turned off, they will extinguish after 15 minutes.

OVERHEAD CONSOLE WITH COMPASS/TEMPERATURE MINI-TRIP COMPUTER — IF EQUIPPED

This optional overhead console consists of the following:

- Courtesy Lights
- Compass/Temperature Mini-Trip Computer (CMTC)

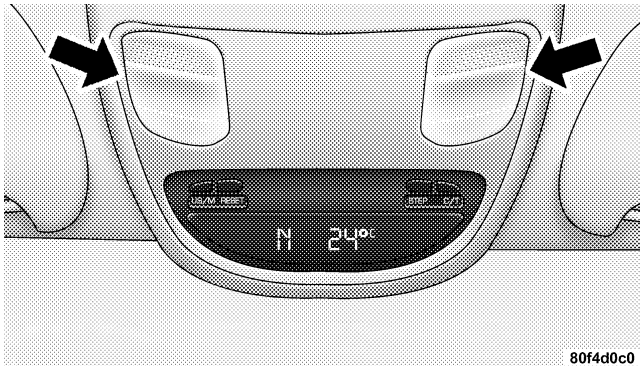

This overhead console allows you to choose between a compass/temperature display and one of four trip conditions being monitored.

US/M Button

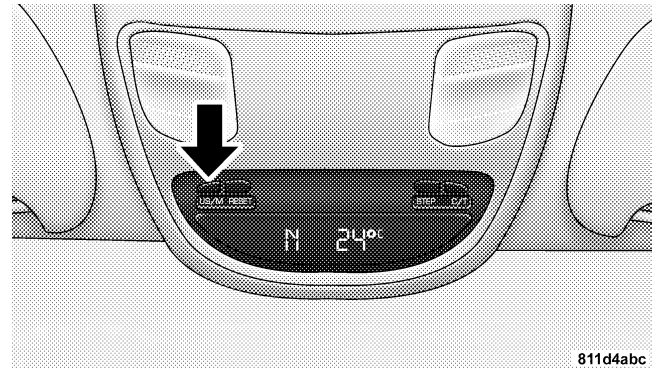

Use this button to change the display from U.S. to metric measurement units.

RESET Button

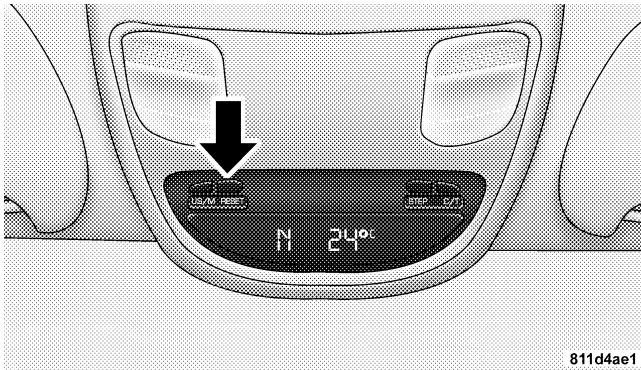

Use this button to reset the following displays:
Average Fuel Economy (AVG ECO)
Trip Odometer (ODO)
Elapsed time (ET)

Global Reset

If the RESET button is pressed twice within 2 seconds while in any of the 3 resettable displays (AVG ECO, ODO, ET), the Global Reset will reset all 3 displays.

Step Button

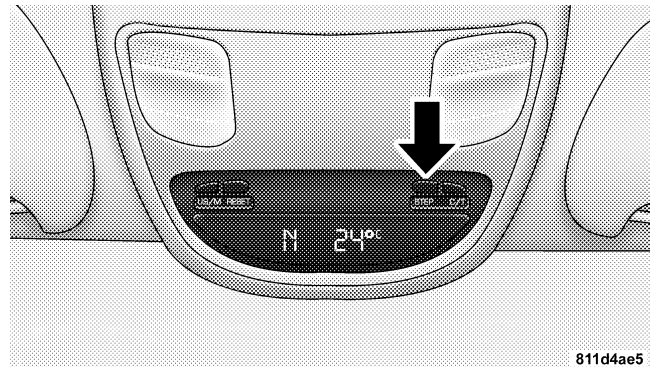

Use this button to choose or cycle through the four trip conditions.

Average Fuel Economy (AVG ECO)

Shows the average fuel economy since the last reset. Average fuel economy is a running average of the amount of fuel used and the distance the vehicle has traveled.

When the fuel economy is reset, the display will momentarily blank. Then, the history information will be erased, and the averaging will continue from where it was before the reset. The reset value is based on a minimal amount of fuel used and the distance traveled from the previous drive cycle. The display may take several miles for this value to change dependent upon driving habits.

Distance To Empty (DTE)

Shows the estimated distance that can be traveled with the fuel remaining in the tank. This estimated distance is determined by weighted average of the instantaneous and average fuel economy, according to the current fuel tank level. This is not resettable

NOTE: Significant changes in driving style or vehicle loading will greatly affect the actual drivable distance of the vehicle, regardless of the DTE displayed value.

When the DTE value is less than 30 miles estimated driving distance, the DTE display will change to an alternating test display of "LO" and "FUEL". This display will continue until the vehicle runs out of fuel. Adding a significant amount of fuel to the vehicle will turn off the "LO FUEL" text and a new DTE value will be displayed, based on the current values in the DTE calculation and the current fuel tank level.

NOTE: It is possible for DTE to display "LO FUEL" before the low fuel warning light turns on in the instrument cluster. This could occur because low fuel warning is set to a specified fuel tank volume and DTE is an estimated distance calculation based on fuel economy and remaining fuel tank volume.

Ram fuel tank volumes are as follows:

- 26 gallons - 1500 short box models
- 34 gallons - 1500 Quad Cab (if equipped)/2500/3500 short box models
- 35 gallons - 1500/2500/3500 long box models

Trip Odometer (ODO)

This display shows the distance traveled since the last reset. Resetting of this screen will cause the trip odometer to change to Zero.

Elapsed Time (ET)

This display shows the accumulated ignition ON time since the last reset. Resetting the Elapsed Time will cause the display to change to Zero.

C/T Button

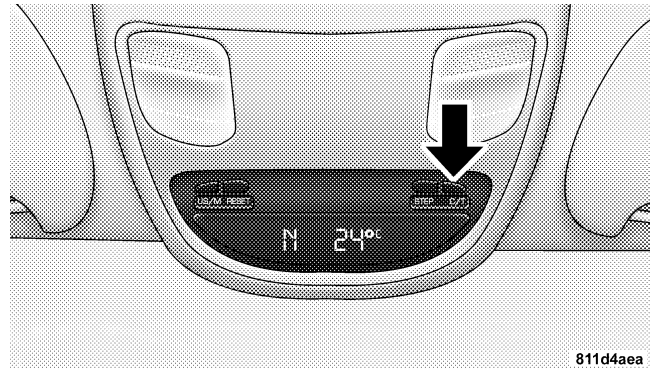

811d4aea

Use this button to select a readout of the outside temperature and one of eight compass headings that indicate the direction in which the vehicle is facing.

WARNING!

Even if the display still reads a few degrees above 32°F (0°C), the road surface may be icy, particularly in woods or on bridges. Drive carefully under such conditions to prevent an accident and possible personal injury or property damage.

Automatic Compass Calibration

This compass is self-calibrating which eliminates the need to manually set the compass. When the vehicle is new, the compass may appear erratic and the CAL symbol will be displayed.

After completing up to three 360° turns, with the vehicle traveling less than 5 mph (8 km/h), in an area free from large metal or metallic objects, the CAL symbol will turn off and the compass will function normally.

Manual Compass Calibration

NOTE: To ensure proper compass calibration, make sure the compass variance is properly set before manually calibrating the compass.

If the compass appears erratic and the CAL symbol does not appear, you must manually put the compass into the “Calibration” mode.

Recalibrating The Compass

Turn on the ignition and set the display to “Compass/ Temperature.” Press and hold the RESET button to change the display between VAR (compass variance) and CAL (compass calibration) modes. When the CAL symbol is displayed complete one 360° turn in an area free from large metal objects or power lines. The CAL symbol will turn off and the compass will function normally.

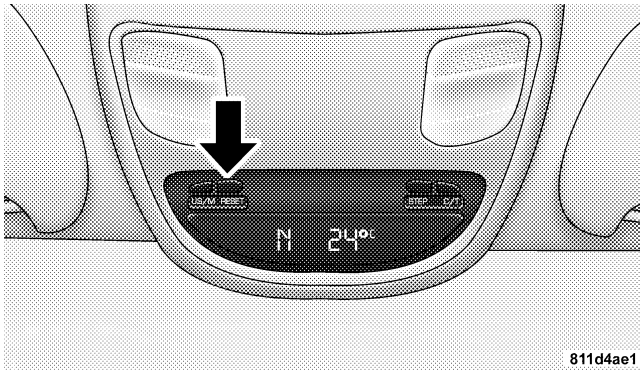

811d4ae1

Compass Variance is the difference between magnetic north and geographic north. In some areas of the country, the difference between magnetic and geographic north is great enough to cause the compass to give false readings. If this occurs, the compass variance must be set according to the Compass Variance Map.

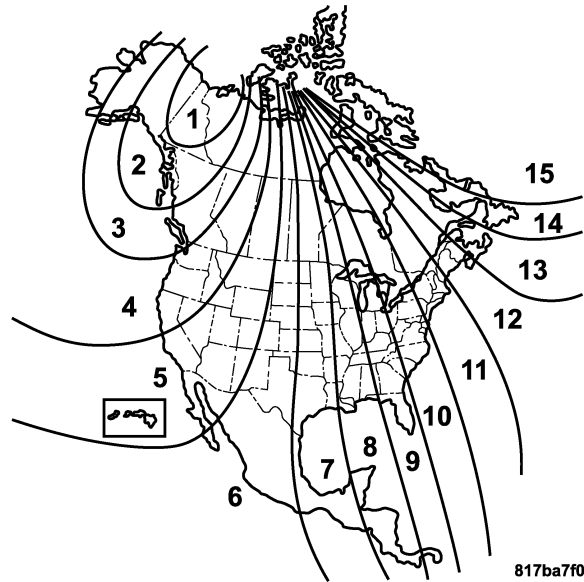

817ba7f0

NOTE: The default for the compass variance is zone 8.

To set the variance: Turn the ignition ON and set the display to “Compass/Temperature.” Press and hold the RESET button approximately five seconds. The last variance zone number will be displayed. Press the STEP button to select the new variance zone and press the RESET button to resume normal operation.

Outside Temperature

Because the ambient temperature sensor is located underhood, engine temperature can influence the displayed temperature, therefore, temperature readings are slowly updated when the vehicle speed is below 20 mph (30 km/h) or during stop and go driving.

GARAGE DOOR OPENER — IF EQUIPPED

The HomeLink® Universal Transceiver replaces up to three remote controls (hand held transmitters) that operate devices such as garage door openers, motorized gates, or home lighting. It triggers these devices at the push of a button. The Universal Transceiver operates off your vehicle’s battery and charging system; no batteries are needed.

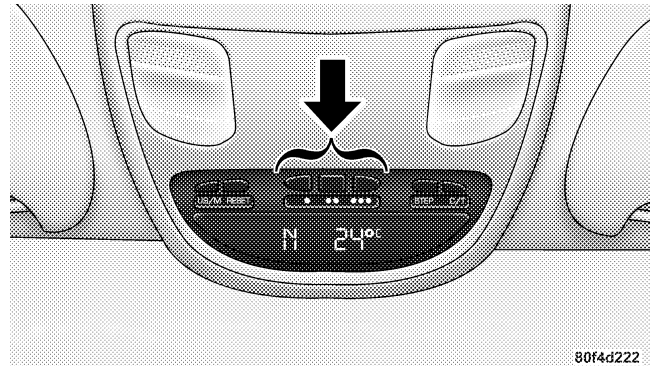

HomeLink® Programming Buttons

144 UNDERSTANDING THE FEATURES OF YOUR VEHICLE

For additional information on HomeLink®, call 1-800-355-3515, or on the internet at www.homelink.com.

WARNING!

A moving garage door can cause injury to people and pets in the path of the door. People or pets could be seriously or fatally injured. Only use this transceiver with a garage door opener that has a "stop and reverse" feature as required by federal safety standards. This includes most garage door opener models manufactured after 1982. Do not use a garage door opener without these safety features it could cause injury or death. Call toll-free 1-800-355-3515 or, on the Internet at www.homelink.com for safety information or assistance.

WARNING!

Vehicle exhaust contains carbon monoxide, a dangerous gas. Do not run the vehicle's exhaust while training the transceiver. Exhaust gas can cause serious injury or death.

WARNING!

Your motorized door or gate will open and close while you are training the Universal Transceiver. Do not train the transceiver if people or pets are in the path of the door or gate. A moving door or gate can cause serious injury or death to people and pets or damage to objects.

Programming HomeLink

NOTE: When programming a garage door opener, it is advised to park outside the garage. It is also recommended that a new battery be placed in the hand-held transmitter of the device being programmed to HomeLink for quicker training and accurate transmission of the radio-frequency signal.

1. Press and hold the two outer HomeLink buttons, and release only when the indicator light begins to flash (after 20 seconds). **Do not** hold the buttons for longer than 30 seconds and **do not** repeat step one to program a second and/or third hand-held transmitter to the remaining two HomeLink buttons.

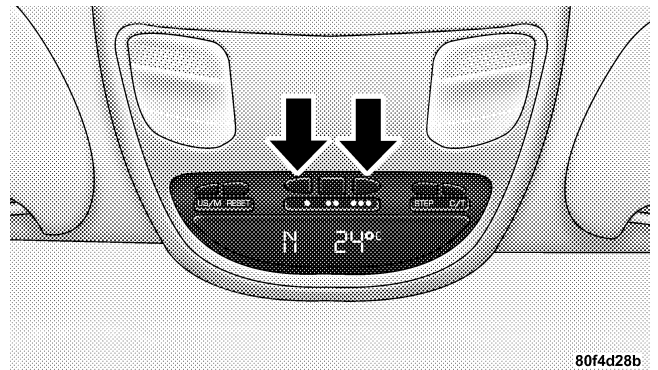

Outer HomeLink buttons

2. Position the end of your hand-held transmitter 1-3 inches (3-8 cm) away from the HomeLink buttons while keeping the indicator light in view.

3. Simultaneously press and hold both the HomeLink button that you want to train and the hand-held transmitter buttons. **Do not release the buttons until step 4 has been completed.**

NOTE: Some gate operators and garage door openers may require you to replace this Programming Step 3 with procedures noted in the "Gate Operator/Canadian Programming" section.

4. The HomeLink indicator light will flash slowly and then rapidly after HomeLink successfully receives the frequency signal from the hand-held transmitter. Release both buttons after the indicator light changes from the slow to the rapid flash.

5. Press and hold the just trained HomeLink button and observe the indicator light. If the indicator light **stays on constantly, programming is complete** and your device should activate when the HomeLink button is pressed and released.

NOTE: To program the remaining two HomeLink buttons, begin with "Programming" **step two. Do not repeat step one.**

If the indicator light blinks **rapidly for two seconds and then turns to a constant light, continue with "Programming" steps 6-8** to complete the programming of a rolling code equipped device (most commonly a garage door opener).

6. At the garage door opener receiver (motor-head unit) in the garage, locate the "learn" or "smart" button. This can usually be found where the hanging antenna wire is attached to the motor-head unit.

7. Firmly press and release the "learn" or "smart" button. (The name and color of the button may vary by manufacturer.)

NOTE: There are 30 seconds in which to initiate step eight.

8. Return to the vehicle and firmly **press, hold for two seconds and release** the programmed HomeLink button. Repeat the "**press/hold/release**" sequence a second time, and, depending on the brand of the garage door opener (or other rolling code equipped device), repeat this sequence a third time to complete the programming.

HomeLink should now activate your rolling code equipped device.

NOTE: To program the remaining two HomeLink buttons, begin with "Programming" **step two**. **Do not repeat step one**. For questions or comments, please contact HomeLink at www.homelink.com or 1-800-355-3515.

Canadian Programming/Gate Programming

Canadian radio-frequency laws require transmitter signals to "time-out" (or quit) after several seconds of transmission which may not be long enough for HomeLink to pick up the signal during programming.

Similar to this Canadian law, some U.S. gate operators are designed to "time-out" in the same manner.

If you live in Canada or you are having difficulties programming a gate operator by using the "Programming" procedures (regardless of where you live), **replace "Programming HomeLink" step 3** with the following:

NOTE: If programming a garage door opener or gate operator, it is advised to unplug the device during the "cycling" process to prevent possible overheating.

3. Continue to press and hold the HomeLink button while you **press and release every two seconds** ("cycle") your hand-held transmitter until the frequency signal has successfully been accepted by HomeLink. (The indicator light will flash slowly and then rapidly.) Proceed with "Programming" step four to complete.

Using HomeLink

To operate, simply press and release the programmed HomeLink button. Activation will now occur for the trained device (i.e. garage door opener, gate operator, security system, entry door lock, home/office lighting, etc.). For convenience, the hand-held transmitter of the device may also be used at any time. In the event that there are still programming difficulties or questions, contact HomeLink at: www.homelink.com or 1-800-355-3515.

Erasing HomeLink Buttons

To erase programming from the three buttons (individual buttons cannot be erased but can be "reprogrammed" - note below), follow the step noted:

- Press and hold the two outer HomeLink buttons until the indicator light begins to flash-after 20 seconds. Release both buttons. Do not hold for longer than 30

seconds. HomeLink is now in the train (or learning) mode and can be programmed at any time beginning with "Programming" - step 2.

Reprogramming a Single HomeLink Button

To program a device to HomeLink using a HomeLink button previously trained, follow these steps:

1. Press and hold the desired HomeLink button. **DO NOT** release the button.
2. The indicator light will begin to flash after 20 seconds. Without releasing the HomeLink button, proceed with "Programming" step 2

For questions or comments, contact HomeLink at: www.homelink.com or 1-800-355-3515.

Security

If you sell your vehicle, be sure to erase the frequencies.

To erase all of the previously trained frequencies, hold down both outside buttons until the green light begins to flash.

This device complies with part 15 of FCC rules and with RSS-210 of Industry Canada. Operation is subject to the following conditions:

- This device may not cause harmful interference.
- This device must accept any interference that may be received including interference that may cause undesired operation.

NOTE: Changes or modifications not expressly approved by the party responsible for compliance could void the user's authority to operate the equipment.

HomeLink® is a trademark owned by Johnson Controls, Inc.

POWER SUNROOF — IF EQUIPPED

The power sunroof switch is located between the sun visors on the overhead console.

NOTE: The Power Accessory Delay feature will allow the power sunroof to operate for ten minutes after the ignition is turned off.

WARNING!

- **Never leave children alone in a vehicle. Leaving children in a vehicle unattended is dangerous for a number of reasons. A child or others could be seriously or fatally injured. Don't leave the keys in the ignition. A child could operate power windows, other controls, or move the vehicle.**
- **In an accident, there is a greater risk of being thrown from a vehicle with an open sunroof. You could also be seriously injured or killed. Always fasten your seat belt properly and make sure all passengers are properly secured too.**
- **Do not allow small children to operate the sunroof. Never allow fingers or other body parts, or any object to project through the sunroof opening. Injury may result.**

Open Sunroof - Express Mode

Momentarily pressing the switch rearward will activate the Express Open Feature, causing the sunroof to open automatically. During the Express Open operation, any movement of the switch will stop the sunroof and it will remain in a partial open position. Again, momentarily pressing the switch rearward will activate the Express Open Feature.

Comfort Stop

The sunroof is equipped with an intermediate "Comfort Stop" position. This is the first stop that express open reaches. This is designed to reduce wind buffeting at vehicle speeds between 20 - 40 mph (32 - 64 km/h). Pressing the switch momentarily rearward again will open the sunroof to its full open position however wind buffeting can occur at full open.

Closing Sunroof - Express

Press the switch forward and release, and the sunroof will close automatically from any position. The sunroof will close fully and stop automatically. This is called Express Close. During Express Close operation, any movement of the switch will stop the sunroof.

Pinch Protect Feature

This feature will detect an obstruction in the opening of the sunroof during Express Close operation. If an obstruction in the path of the sunroof is detected, the sunroof will automatically retract. Remove the obstruction if this occurs. Next, press the switch forward and release to Express Close.

Pinch Protect Override

If a known obstruction (ice, debris, etc.) prevents closing, press the switch forward and hold for two seconds after the reversal occurs. This allows the sunroof to move towards the closed position.

NOTE: Pinch protection is disabled while the switch is pressed.

Venting Sunroof - Express

Press and release the "V" button, and the sunroof will open to the vent position. This is called Express Vent, and will occur regardless of sunroof position. During Express Vent operation, any movement of the switch will stop the sunroof.

Sunshade Operation

The sunshade can be opened manually. However, the sunshade will open automatically as the sunroof opens.

NOTE: The sunshade cannot be closed if the sunroof is open.

Wind Buffeting

Wind buffeting can be described as the perception of pressure on the ears or a helicopter type sound in the ears. Your vehicle may exhibit wind buffeting with the windows down, or the sunroof (if equipped) in certain open or partially open positions. This is a normal occurrence and can be minimized. If the buffeting occurs with the rear windows open, open the front and rear windows together to minimize the buffeting. If the buffeting occurs with the sunroof open, adjust the sunroof opening to minimize the buffeting or open any window.

Sunroof Maintenance

Use only a non-abrasive cleaner and a soft cloth to clean the glass panel.

Sunroof Fully Closed

Press the switch forward and release to ensure that the sunroof is fully closed.

ELECTRICAL POWER OUTLETS

The auxiliary electrical outlet can provide power for in cab accessories designed for use with the standard "cigar lighter" plug. The outlet is located in the instrument panel below and to the right of the Climate Control Panel. A cap is attached to the outlet base indicating "Power Outlet" 12V-20A.

There is an additional Power Outlet inside the center console of vehicles equipped with 40/20/40, or Bucket front seats. There is also a Power Outlet located on the rear of the center console for Quad Cab or Mega Cab vehicles (only) equipped with bucket seats.

The outlet(s) has/have a fused direct feed from the battery so it/they receive power whether the ignition is ON or OFF.

All accessories connected to this/these outlet(s) should be removed or turned OFF when the vehicle is not in use to protect the battery against discharge.

NOTE: If desired, all of the power outlets can be converted by your authorized dealer to provide power with the ignition switch in the ON position only.

CAUTION!

Electrical Outlet Use With Engine Off

- Many accessories that can be plugged in draw power from the vehicle's battery, even when not in use (i.e. cellular phones, etc.). Eventually, if plugged in long enough, the vehicle's battery will discharge sufficiently to degrade battery life and/or prevent engine starting.
- Accessories that draw higher power (i.e. coolers, vacuum cleaners, lights, etc.), will discharge the battery even more quickly. Only use these intermittently and with greater caution.
- After the use of high power draw accessories, or long periods of the vehicle not being started (with accessories still plugged in), the vehicle must be driven a sufficient length of time to allow the generator to recharge the vehicle's battery.

CIGAR LIGHTER AND ASH RECEIVER

The removable ash receiver is located in the instrument panel cup holder tray.

The cigar lighter is located on the instrument panel, above and to the left of the ash receiver.

As a child safety precaution, the lighter only operates with the ignition switch ON. It heats when pushed in and pops out automatically when ready for use. **To preserve the heating element, do not hold the lighter in the heating position.**



Ash Tray Automatic Transmission

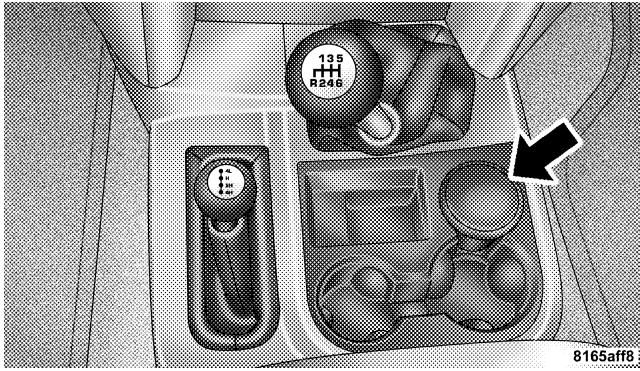

Ash Tray Manual Transmission

CUPHOLDERS

Front Instrument Panel Cupholders (40–20–40 Seats) — Automatic Transmission

Your new Ram truck is equipped with two adjustable cupholders. The cupholder is opened by pulling on the cup holder door handle, on the front surface. Each opening in the cupholder is adjustable and will hold cups and mugs of various sizes.

To secure the cup, place the cup to be held into one of the cup wells and then push the cupholder arm toward the cup until it is held stable.

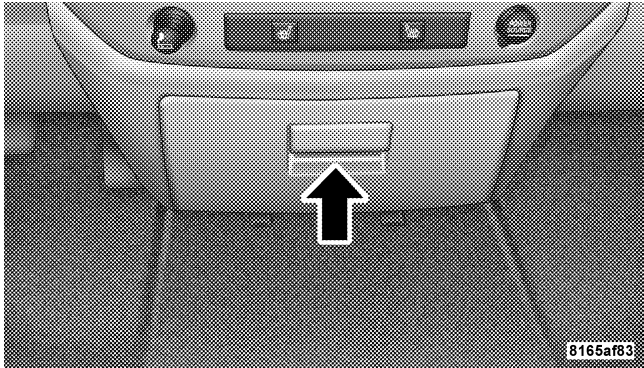

Cup Holder Door Handle

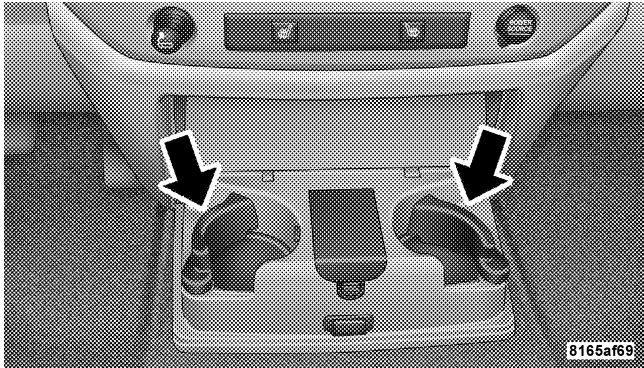

Cup Holders Automatic Transmission

Front Instrument Panel Cupholders (Bucket Seats) — Automatic Transmission

If your new Ram truck is equipped with bucket seats there are three cup holders located on the front of the center console.

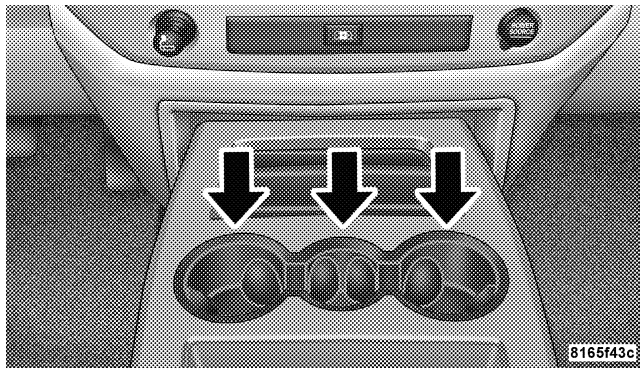

Cup Holders Bucket Seat

Front Instrument Panel Cupholders — Manual Transmission

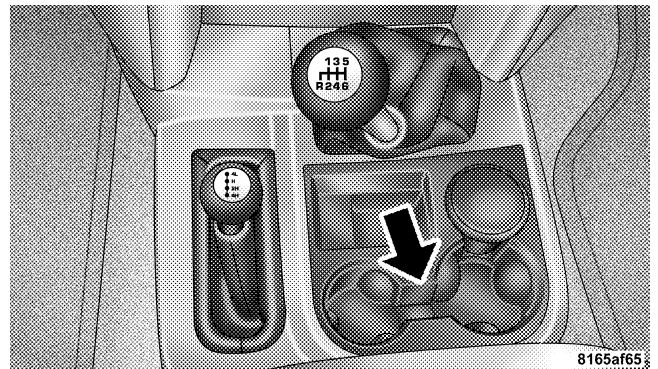

Cup Holders Manual Transmission

Rear Cupholder — Quad Cab — If Equipped

Quad Cab vehicles may be equipped with a rear cupholder that consists of two cupwells for rear passenger convenience.

Rear Cupholder — Mega Cab

Mega Cab vehicles are equipped with rear cupholders located in the center armrest.

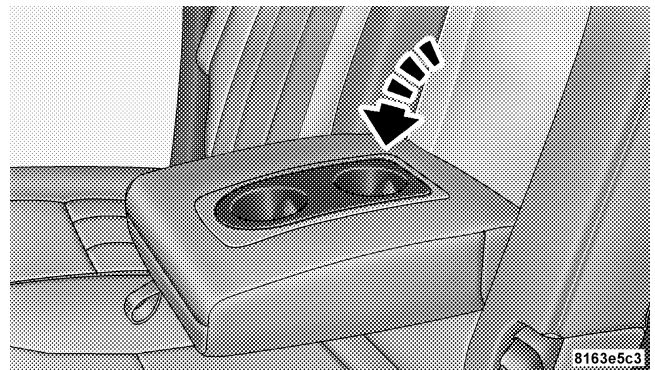

Mega Cab Rear Armrest Cup Holder

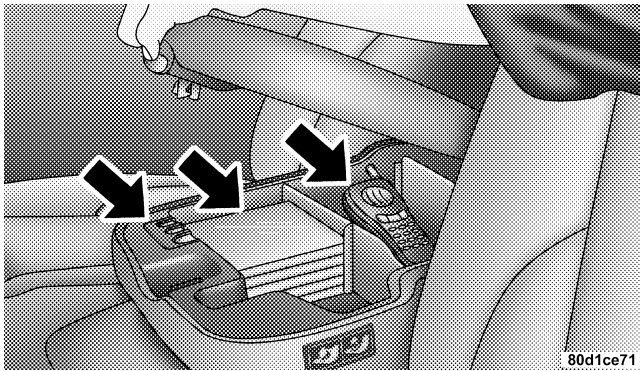
STORAGE**Center Storage Compartment (40–20–40 Seat) — If Equipped**

The center portion of the seat folds down to provide an armrest with unique storage compartments under the lid. Push the button on the front of the armrest to raise the cover. Inside there is a power outlet (if equipped),

removable coin holder (if equipped), and two dividers to configure the storage area into compartments. For example, compartments can be configured to hold a lap-top computer, a cellular telephone, CD's and miscellaneous items. The top of the cover provides a generous firm surface to serve as a desktop for your "mobile office."

3**WARNING!**

- This armrest is not a seat. Anyone seated on the armrest could be seriously injured during vehicle operation, or an accident. Only use the center seating position when the armrest is fully upright.
- In an accident, the latch may open if the total weight of the items stored exceeds about 10 lbs (4.5 kg). These items could be thrown about endangering occupants of the vehicle. Items stored should not exceed a total of 10 lbs (4.5 kg).

CAUTION!

- Many accessories that can be plugged in draw power from the vehicle's battery, even when not in use (i.e. cellular phones, etc.). Eventually, if plugged in long enough, the vehicle's battery will discharge sufficiently to degrade battery life and/or prevent engine starting.
- Accessories that draw higher power (i.e. coolers, vacuum cleaners, lights, etc.), will degrade the battery even more quickly. Only use these intermittently and with greater caution.
- After the use of high power draw accessories, or long periods of the vehicle not being started (with accessories still plugged in), the vehicle must be driven a sufficient length of time to allow the generator to recharge the vehicle's battery.

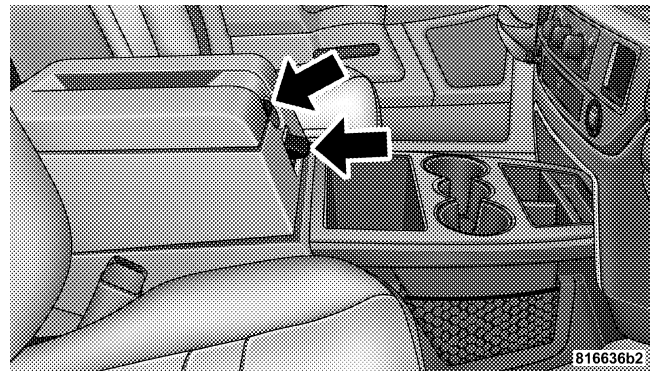
Center Storage Compartment (Bucket Seats)— If Equipped**Center Storage Compartment**

Push the upper button on the front of the armrest to raise the upper cover. Inside is a power outlet (if equipped), a cut out for a cell phone charger cord, removable coin holder (if equipped), and a divider to configure the

storage area into separate compartments. Lift the lower handle on the front of the armrest, and raise the armrest for access to the lower storage bin. On Quad Cab and Mega Cab models the rear of the floor console offers a power outlet, a tip out bin and a rear air duct (Mega Cab Only).

WARNING!

- This armrest is not a seat. Anyone seated on the armrest could be seriously injured during vehicle operation, or an accident. Only use the center seating position when the armrest is fully upright.
- In an accident, the latch may open if the total weight of the items stored exceeds about 10 lbs (4.5 kg). These items could be thrown about endangering occupants of the vehicle. Items stored should not exceed a total of 10 lbs (4.5 kg).

CAUTION!

- Many accessories that can be plugged in draw power from the vehicle's battery, even when not in use (i.e. cellular phones, etc.). Eventually, if plugged in long enough, the vehicle's battery will discharge sufficiently to degrade battery life and/or prevent engine starting.
- Accessories that draw higher power (i.e. coolers, vacuum cleaners, lights, etc.), will degrade the battery even more quickly. Only use these intermittently and with greater caution.
- After the use of high power draw accessories, or long periods of the vehicle not being started (with accessories still plugged in), the vehicle must be driven a sufficient length of time to allow the generator to recharge the vehicle's battery.

Storage and Seats (Quad Cab Models)

Located in the center of the front 40/20/40 seat cushion there is a storage compartment.

Standard cab models also have storage behind the seat.

The Quad Cab models provide additional storage under the rear seat. Lift the seat to access the storage compartment.

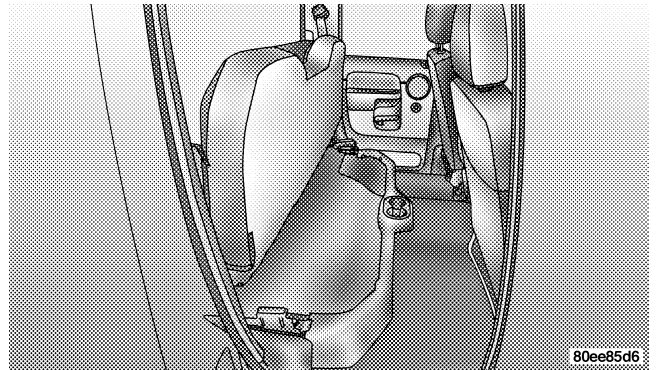

Quad Cab Storage

Storage and Seats (Mega Cab Models)

The Mega Cab models provide additional storage behind the rear seat.

To gain access to the Mega Cab rear storage, fold the rear seats to the "kneel position". (See page 116 for more information.)

Push down on the front of the storage compartment handle and lift the storage compartment cover.

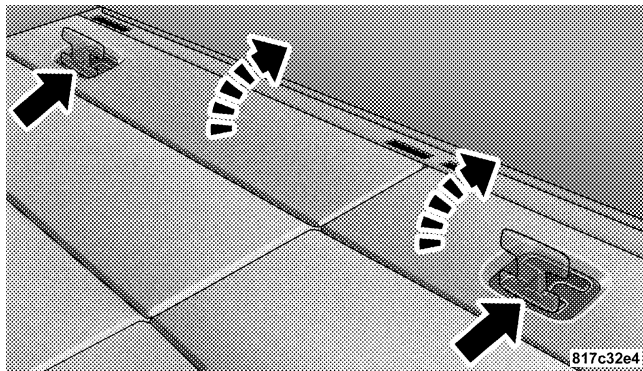

Mega Cab Rear Storage Compartment Handle

The rear storage compartment can be divided into three separate compartments by using the divider doors inside the storage compartment.

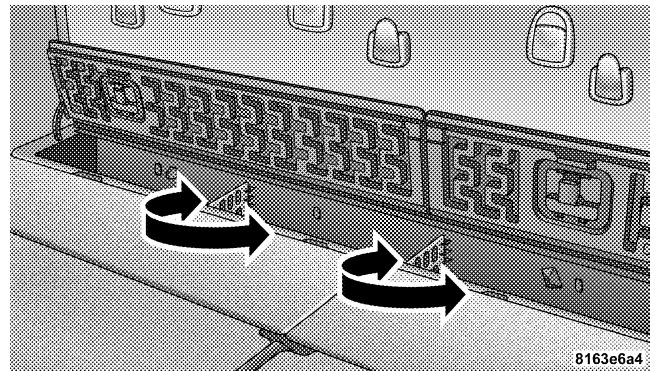

Mega Cab Rear Storage Dividers

Plastic Grocery Bag Retainers (Mega Cab Models)

Retainer hooks which will hold plastic grocery bag handles are built into the back panel of the cab, behind the rear seat.

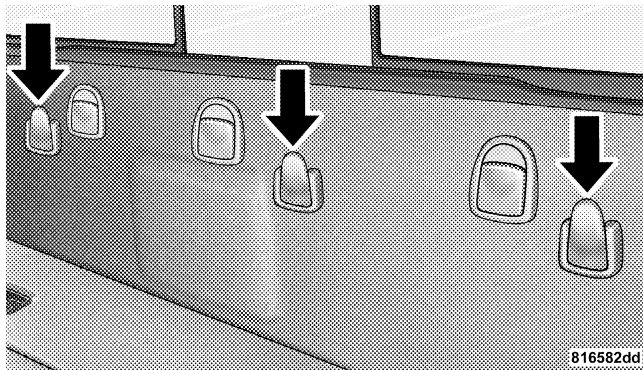

Grocery Bag Hooks

REAR WINDOW FEATURES

Electric Rear Window Defroster and Heated Side view Mirrors — If Equipped

 The Electric Rear Window Defroster and Heated side view mirrors are activated by pressing the heated grid button, located on the Climate Control panel, with the ignition On. Turning Off the ignition will deactivate the Electric Rear Window Defroster and Heated side view mirrors feature. These features also turn off after activation, when 15 minutes have elapsed. To reactivate, simply press the button again.

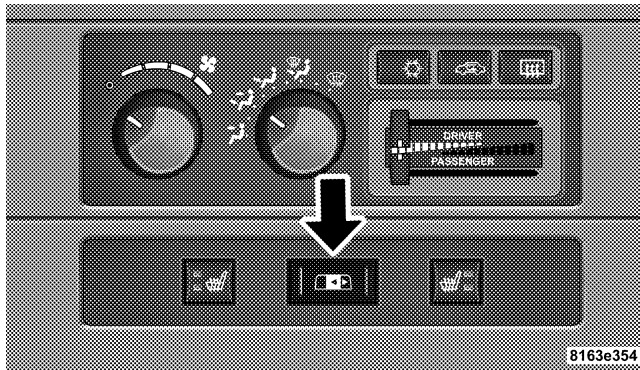
Power Sliding Rear Window—If Equipped

Power Sliding Rear Window Switch

The power sliding rear window switch is located on the instrument panel below the climate controls. Press the right side of the switch to open the glass and the left side of the switch to close the glass.

Sliding Rear Window—If Equipped

A locking device in the center of the window helps to prevent entry from the rear of the vehicle. Squeeze the lock to release the window.

FOLD FLAT LOAD FLOOR — IF EQUIPPED

Quad Cab models with a 60/40 rear seat, may be equipped with a folding load floor.

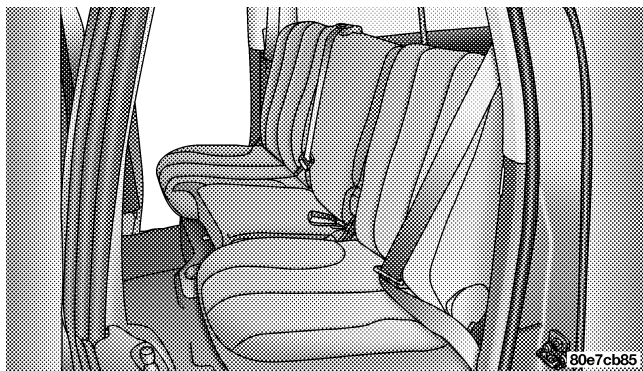

Quad Cab Rear 60/40 Seat

WARNING!

Do not operate the vehicle with loose items stored on the load floor. While driving or in an accident you may experience, abrupt stopping, rapid acceleration, or sharp turns. Loose objects stored on the load floor may move around with force and strike occupants, resulting in serious or fatal injury.

Unfolding the Load Floor

1. Lift the 60/40 seat cushion(s) to the upward position.

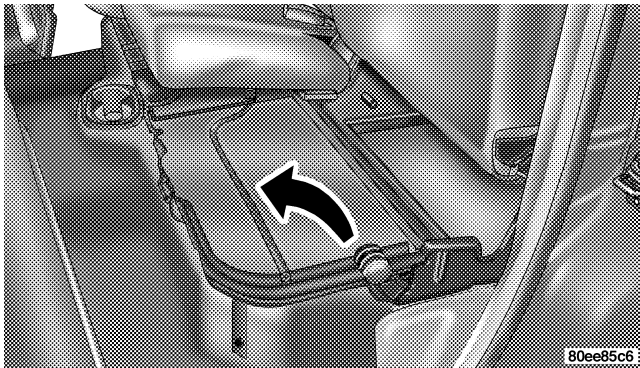

Unfolding The Load Floor

2. Grasp the knob on the load floor and lift the knob until the load floor unfolds into position.



Load Floor In Open Position

3. Reverse the procedure to store the load floor.

Positioning the Load Floor for Storage Access Under the Seat

1. Lift the 60/40 seat cushion(s) to the upward position.
2. Unsnap the securing snap located at either side of the load floor.
3. Lift the load floor up to access storage under the load floor.

WARNING!

Do not drive with the load floor in the up position. When stopping fast or in an accident, the load floor could move to the down position causing serious injury.

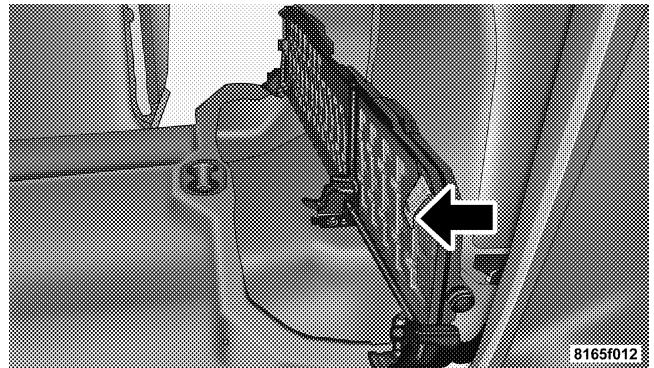

Load Floor Securing Straps

4. Reverse the procedure to put the load floor back in the secured down position before you operate the vehicle.

PICKUP BOX

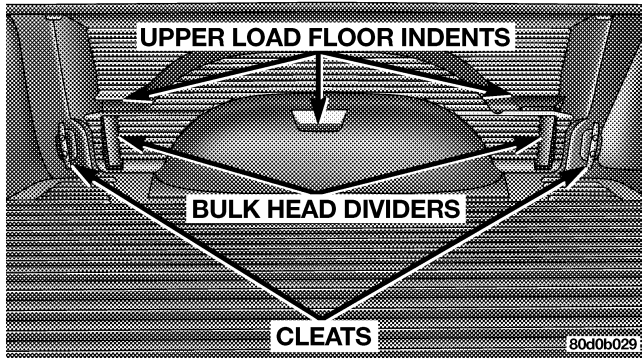

Pickup Box Features

The pickup box on your new Ram has many features designed for utility and convenience.

NOTE: If you are installing a toolbox to the front of the pickup box, you must use Mopar® toolbox brackets available from your dealer.

You can carry wide building materials (sheets of plywood, etc.) by building a raised load floor. Place lumber across the box in the indentations provided above the wheel housings and in the bulkhead dividers to form the floor.

3

WARNING!

The pickup box is intended for load carrying purposes only, not for passengers, who should sit in seats and use seat belts.

WARNING!

- Care should always be exercised when operating a vehicle with unrestrained cargo. Vehicle speeds may need to be reduced. Severe turns or rough roads may cause shifting or bouncing of the cargo that may result in vehicle damage. If wide building materials are to be frequently carried, the installation of a support is recommended. This will restrain the cargo and transfer the load to the pickup box floor.
- If you wish to carry more than 600 lbs (272 kg) of material suspended above the wheelhouse, supports must be installed to transfer the weight of the load to the pickup box floor or vehicle damage may result. The use of proper supports will permit loading up to the rated payload.
- Unrestrained cargo may be thrown forward in an accident causing serious or fatal injury.

There are stampings in the sheet metal on the inner side bulkheads of the box in front of and behind both wheel

housings. Place wooden boards across the box from side to side to create separate load compartments in the pickup box.

There are four tie-down cleats bolted to the lower sides of the pickup box that can sustain loads up to 1000 lbs (450 kg) total.

SLIDE-IN CAMPERS**Camper Applications**

Certain truck models are not recommended for slide-in campers. To determine if your vehicle is excluded, please refer to the "Consumer Information Truck-Camper Loading" document available from your dealer. For safety reasons, follow all instructions in this important document.

NOTE: When a cap or pickup camper is installed on a vehicle, an alternate CHMSL (Center High Mounted Stop Light) must be provided.

EASY-OFF TAILGATE

To simplify mounting of a camper unit with an overhang, the tailgate can be removed quickly. If the truck is a 3500 dual rear wheel model, unplug the tailgate wire harness from under the rear of the truck and pull the harness out of the cargo box access hole. Unlatch the tailgate and remove the support cables by releasing the lock tang from the pivot, then rotate and pull away from the box. Once the cables are free, move to the right side of the tailgate hinge bracket.

Raise the right side of the tailgate until the right side pivot clears the hanger bracket. Slide the entire tailgate to the right to free the left side pivot. Remove the tailgate from the vehicle entirely. Do not carry the tailgate loose in the truck pickup box.

NOTE: Dual rear wheel pickup models require properly spaced rear clearance lights. If such a vehicle is operated without a tailgate, suitable lights must be installed.

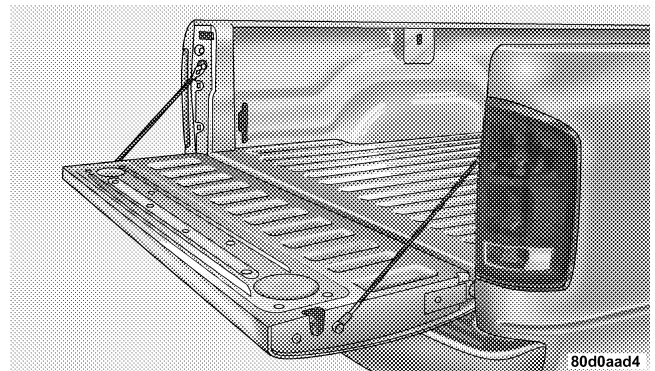

TAILGATE OPEN

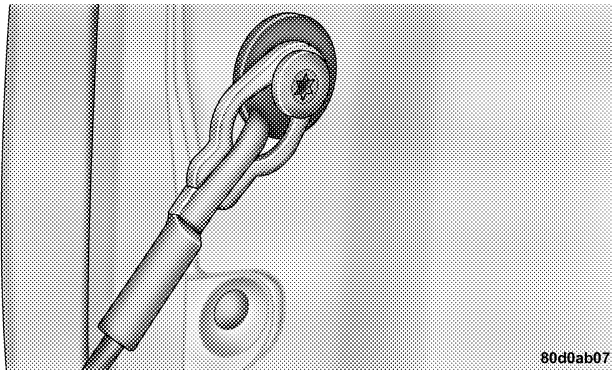

TAILGATE SUPPORT STRAP ATTACHMEN

WARNING!

To avoid inhaling carbon monoxide, which is deadly, the exhaust system on vehicles equipped with "Cap or Slide-In Campers" should extend beyond the overhanging camper compartment and be free of leaks.

UNDERSTANDING YOUR INSTRUMENT PANEL

CONTENTS

■ Instruments And Controls	177	□ AM Reception	189
■ Instrument Cluster	178	□ FM Reception	189
■ Instrument Cluster Description	179	■ Sales Code REF — AM/FM/CD (Single Disc) Radio With Optional Satellite Radio And Hands Free Phone Capability	190
■ Electronic Digital Clock	187	□ Operating Instructions - Radio Mode	190
□ Clock Setting Procedure	188	□ Operation Instructions - CD Mode	194
■ Radio General Information	188	□ Operation Instructions - Auxiliary Mode	196
□ Radio Broadcast Signals	188	□ Operating Instructions - Hands Free Phone — If Equipped	197
□ Two Types Of Signals	188		
□ Electrical Disturbances	189		

174 UNDERSTANDING YOUR INSTRUMENT PANEL

<input type="checkbox"/> Operating Instructions - Satellite Radio — If Equipped	197	<input checked="" type="checkbox"/> Sales Code RAK – AM/FM/Cassette/CD (6-Disc) Radio With Optional Satellite Radio, Hands Free Phone, Video, MP3, And WMA Capabilities	211
<input checked="" type="checkbox"/> Sales Code RAQ – AM/FM/CD (6-Disc) Radio With Optional Satellite Radio, Hands Free Phone, And Vehicle Entertainment Systems (VES) Capabilities	198	<input type="checkbox"/> Operating Instructions - Radio Mode	212
<input type="checkbox"/> Operating Instructions - Radio Mode	198	<input type="checkbox"/> Operating Instructions — Tape Player	216
<input type="checkbox"/> Operation Instructions - (CD Mode For CD Audio Play)	203	<input type="checkbox"/> Seek Button	216
<input type="checkbox"/> Load/Eject Button (CD Mode For CD Audio Play)	205	<input type="checkbox"/> Fast Forward (FF)	216
<input type="checkbox"/> Notes On Playing MP3 Files	207	<input type="checkbox"/> Rewind (RW)	216
<input type="checkbox"/> Operation Instructions - (CD Mode For MP3 Audio Play)	209	<input type="checkbox"/> Tape Eject	216
<input type="checkbox"/> Load/Eject Button (CD Mode For MP3 Play)	209	<input type="checkbox"/> Scan Button	217
		<input type="checkbox"/> Changing Tape Direction	217
		<input type="checkbox"/> Metal Tape Selection	217
		<input type="checkbox"/> Pinch Roller Release	217

□ Noise Reduction	217	■ Video Entertainment System (Sales Code XRV) — If Equipped	226
□ Operation Instructions - (CD Mode For CD Audio Play)	217	■ Satellite Radio — If Equipped	226
□ Load/Eject Button (CD Mode For CD Audio Play)	218	□ System Activation	227
□ Notes On Playing MP3 Files	220	□ Electronic Serial Number/Sirius Identification Number (ESN/SID)	227
□ Operation Instructions - (CD Mode For MP3 And WMA Audio Play)	223	□ Selecting Satellite Mode In REF, RAQ, And RAK Radios	228
□ Load/Eject Button (CD Mode For MP3 And WMA Play)	223	□ Selecting a Channel	229
■ Sales Code REC — AM/FM/CD (6-Disc) Radio With Navigation System	225	□ Storing And Selecting Pre-Set Channels	229
□ Operating Instructions — Satellite Radio (If Equipped)	226	□ Using The PTY (Program Type) Button (If Equipped)	229
□ Clock Setting Procedure	226	□ PTY Button "Scan"	229
		□ PTY Button "Seek"	230

176 UNDERSTANDING YOUR INSTRUMENT PANEL

<input type="checkbox"/> Satellite Antenna	230	■ Radio Operation And Cellular Phones	234
<input type="checkbox"/> Reception Quality	230	■ Climate Controls	234
■ Remote Sound System Controls — If Equipped	231	<input type="checkbox"/> Heater Only — If Equipped	235
<input type="checkbox"/> Radio Operation	231	<input type="checkbox"/> Air Conditioning And Heating — If Equipped	237
<input type="checkbox"/> Tape Player	232	<input type="checkbox"/> Air Conditioning With Dual Zone Temperature Control — If Equipped	240
<input type="checkbox"/> CD Player	232	<input type="checkbox"/> Operating Tips	244
■ Cassette Tape And Player Maintenance	232	<input type="checkbox"/> Operating Tips Chart	247
■ Compact Disc Maintenance	233		

INSTRUMENTS AND CONTROLS

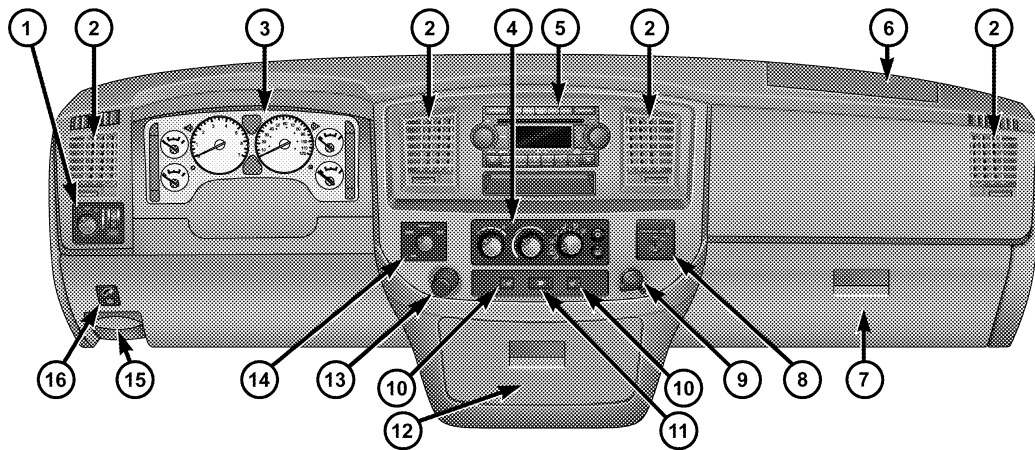

- 1. Headlight Switch
- 2. Air Outlets
- 3. Instrument Cluster
- 4. Climate Controls
- 5. Radio
- 6. Passenger Airbag

- 7. Glove Box
- 8. Passenger Airbag On/Off Switch*
- 9. Power Outlet
- 10. Heated Seat Switch
- 11. Power Sliding Back Glass (mega-cab only)
- 12. Cup Holders

- 13. Cigar Lighter
- 14. Transfer Case Control Switch*
- 15. Parking Brake Release Lever
- 16. Adjustable Pedal Control Switch*

*If Equipped

81934e80

INSTRUMENT CLUSTER

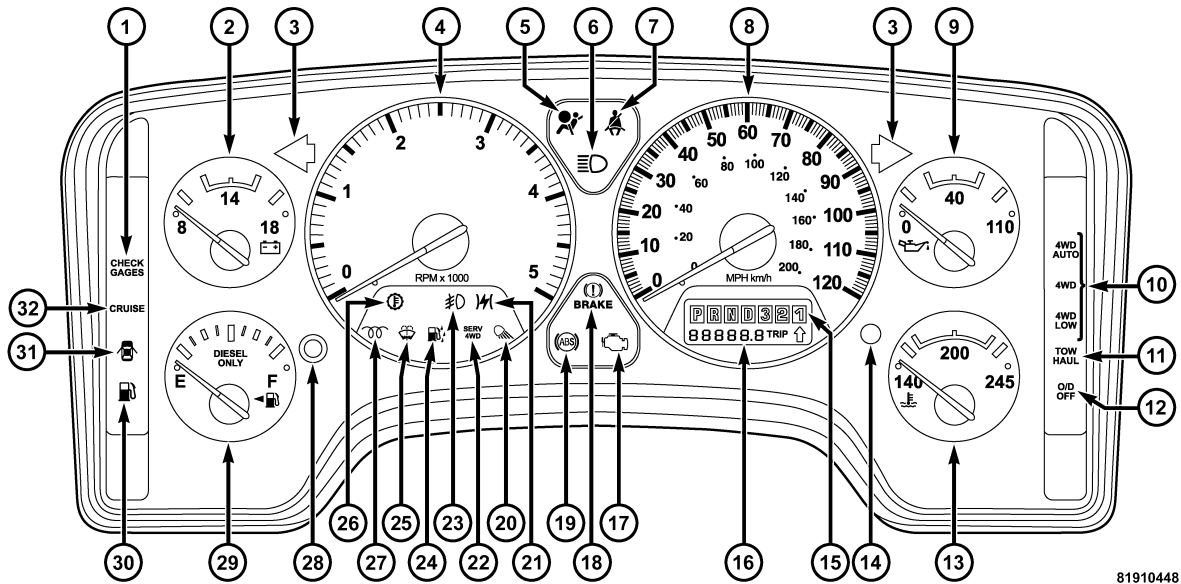

INSTRUMENT CLUSTER DESCRIPTION

1. Check Gages

**CHECK
GAGES**

This light illuminates when the Voltmeter, Engine Oil Pressure or Engine Coolant Temperature gages indicate a reading either too high or too low. Examine the gages carefully, and follow the instructions above for each indicated problem.

NOTE: When the ignition switch is turned to OFF, the Fuel Gage, Voltmeter, Oil Pressure and Engine Coolant Temperature gages may not show accurate readings. When the engine is not running, turn the ignition switch to ON to obtain accurate readings.

2. Voltage Gauge



When the engine is running, the gauge indicates the electrical system voltage. The pointer should stay within the normal range if the battery is charged. If

the pointer moves to either extreme left or right and remains there during normal driving, the electrical system should be serviced.

NOTE: If the gauge pointer moves to either extreme of the gauge, the “Check Gages” indicator will illuminate and a single chime will sound.

3. Turn Signal Indicators

Lights in instrument cluster flash when outside turn signals are operating.

4. Tachometer

The tachometer indicates engine speed in revolutions per minute.

CAUTION!

Do not operate the engine with the tachometer pointer at high rpm for extended periods. Engine damage may occur.

5. Airbag Indicator Light

The indicator lights and remains lit for 6 to 8 seconds when the ignition is first turned on. If the light stays on, flickers or comes on while driving, have the airbag system checked by an authorized dealer.

6. High Beam Indicator

This indicator shows that headlights are on high beam.

7. Seat Belt Reminder Light

When the ignition switch is first turned ON, this light will turn on for 5 to 8 seconds as a bulb check. During the bulb check, if the driver's seat belt is

unbuckled, a chime will sound. After the bulb check or when driving, if the driver seat belt remains unbuckled, the Seat Belt Warning Light will flash or remain on continuously. Refer to "Enhanced Driver Seat Belt Reminder System (BeltAlert™)" in the Occupant Restraints section for more information. (See page 31 for more information.)

8. Speedometer

The speedometer shows the vehicle speed in miles per hour and/or kilometers per hour.

9. Oil Pressure Gauge

The pointer should always indicate some oil pressure when the engine is running. A continuous high or low reading, under normal driving conditions, may indicate a lubrication system malfunction. Immediate service should be obtained. (See page 383 for more information.)

NOTE: If the gauge pointer moves to either extreme of the gauge, the “Check Gages” indicator will illuminate and a single chime will sound.

10. Transfer Case Position

(See page 273 for more information.)

11. TOW HAUL

The TOW HAUL button is located at the end of the gear shift lever. This light will illuminate when the TOW HAUL OD/OFF button is pushed once. (See page 269 for more information.)

12. OD/OFF

the OD/OFF button is located at the end of the gear shift lever. This light will illuminate when the TOW HAUL OD/OFF button is pushed twice. (See page 269 for more information.)

13. Temperature Gauge



The temperature gauge indicates engine coolant temperature. Any reading within the normal range indicates that the cooling system is operating satisfactorily. The gauge needle will likely indicate a higher temperature when driving in hot weather, up mountain grades, in heavy traffic, or when towing a trailer. If the needle rises to the “245°F” mark, stop the vehicle, shift into N (Neutral), and increase the engine idle speed for 2 to 3 minutes. If the temperature reading does not return to normal, shut your engine OFF and allow it to cool. Seek authorized service immediately. See Cooling System information in the section on “Maintaining Your Vehicle.”

CAUTION!

Do not leave your vehicle unattended with the engine running as you would not be able to react to the temperature indicator if the engine overheats.

NOTE: Engine idle speed will automatically increase to 1000 rpm at elevated coolant temperatures to improve engine cooling.

NOTE: If the gauge pointer moves to either extreme of the gauge, the "Check Gages" indicator will illuminate and a single chime will sound.

14. Security Light

The light will flash rapidly for approximately 16 seconds when the vehicle theft alarm is arming. The light will flash at a slower rate after the alarm is set. The security light will also come on for about two seconds when the ignition is first turned ON.

15. Transmission Range Indicator (Automatic Transmissions Only)

When the gear selector lever is moved, this indicator shows the automatic transmission gear range selected.

16. Odometer/Trip Odometer

The odometer shows the total distance the vehicle has been driven.

If the odometer reading is changed during repair or replacement, be sure to keep a record of the reading before and after the service so that the correct mileage can be determined.

The trip odometer shows individual trip mileage. To toggle between the odometer and the trip odometer, press the Odometer/Trip Odometer Button. To reset the Trip Odometer, press and hold the button while in trip mode, until the Trip Odometer resets.

NOTE: There is also an engine hour function. This indicates the total number of hours the engine has been running. To display the engine hours perform the following: Place the ignition in RUN, but do not start the engine. With the odometer value displayed, hold the trip button down for a period of 6 seconds. The odometer will change to trip value first, then it will display the engine hour value. The engine hours will be displayed for a period of 30 seconds until the ignition is turned off or the engine is started.

17. Check Gages Light



This light is part of an onboard diagnostic system which monitors the emissions and engine control system. If the vehicle is ready for emissions testing the light will come on when the ignition is first

turned on and remain on, as a bulb check, until the engine is started. If the vehicle is not ready for emissions testing the light will come on when the ignition is first turned on and remain on for 15 seconds, then blink for 5 seconds, and remain on until the vehicle is started. If the bulb does not come on during starting, have the condition investigated promptly.

If this light comes on and remains on while driving, it suggests a potential engine control problem and the need for system service.

Although your vehicle will usually be drivable and not need towing, see your dealer for service as soon as possible.

CAUTION!

Prolonged driving with the MIL on could cause damage to the engine control system. It also could affect fuel economy and driveability.

If the MIL is flashing, severe catalytic converter damage and power loss will soon occur. Immediate service is required.

18. Brake System Warning Light

This light illuminates when the ignition key is turned to the ON position and remains on for a few seconds. If the light stays on longer, it may be an indication that the parking brake has not been released. This light will illuminate if the brake fluid is low, especially when braking or accelerating hard. This light will illuminate if the ABS indicator light has a malfunction. This light will flash if the engine is running and the parking brake is on.

If the light remains on when the parking brake is released, it indicates a possible brake hydraulic system malfunction. In this case, the light will remain on until the cause is corrected.

If brake failure is indicated, immediate repair is necessary and continued operation of the vehicle in this condition is dangerous.

Acceleration which causes the rear wheels to slip for a period of time may result in the red brake light illuminating and a brake switch code being set on ABS equipped vehicles. Depressing the brake pedal should extinguish the red brake light.

19. ABS Warning Light

 This light monitors the Anti-Lock Brake System which is described elsewhere in this manual. This light will come on when the ignition key is turned to the ON position and may stay on for five seconds. If the ABS light remains on or comes on during driving, it indicates

that the anti-lock portion of the brake system is not functioning and that service is required. See your authorized dealer immediately. The ABS light could also illuminate during loss of traction and remain illuminated until the brake pedal is pressed.

20. *Cargo Light*

The Cargo Lamp light will illuminate when the Cargo Lamp is activated by pressing the Cargo Light Button on the headlight switch.

21. *Electronic Throttle Control (ETC)*



This light informs you of a problem with the Electronic Throttle Control system. If a problem is detected the light will come on while the engine is running. If the light remains lit with the engine running your vehicle will usually be drivable, however, see your dealer for service as soon as possible. If the light is flashing when the engine is running, immediate service is required and you may experience

reduced performance, an elevated/rough idle or engine stall and your vehicle may require towing. The light will come on when the ignition is first turned on and remain on for 15 seconds as a bulb check. If the light does not come on during starting, have the system checked by an authorized dealer.

22. *SERV 4WD Indicator*

The 4WD indicator will be illuminated whenever the 4WD mode is engaged for either the manual or electric shift 4WD systems. The SERV 4WD indicator monitors the electric shift 4WD system. If the SERV 4WD light stays on or comes on during driving, it means that the 4WD system is not functioning properly and that service is required.

23. *Front Fog Light Indicator — If Equipped*

 This light shows when the front fog lights are ON.

24. Water In Fuel Indicator

Indicates there is water detected in the fuel filter. Refer to the Maintenance section, Draining Fuel/Water Separator Filter, for water drain procedure. (See page 391 for more information.)

25. Low Washer Fluid Light

This light comes on when the washer fluid level falls below approximately 1/4 full. The light will remain on until fluid is added and ignition switch is cycled.

26. Transmission Oil Temperature Warning Light (Automatic Transmissions Only)

This light indicates that there is excessive transmission fluid temperature that might occur with severe usage such as trailer towing. It may also occur when operating the vehicle in a high torque converter slip condition, such as 4-wheel-drive operation (e.g. snow plowing, off- road operation). If this light

comes on, stop the vehicle and run the engine at idle or faster, with the transmission in NEUTRAL until the light goes off.

27. Wait To Start Indicator

The Wait To Start Indicator will illuminate when the ignition is turned to the run position and the ambient temperature is below 66 degrees F. Follow engine starting procedure for proper engine starting and operating. Wait until the Wait To Start Indicator turns OFF then start the vehicle.

28. Odometer/Trip Odometer Button

Press this button to toggle between the odometer and the trip odometer display. Holding the button in resets the trip odometer reading when in trip mode.

29. Fuel Gauge

Shows level of fuel in tank when ignition switch is in the ON position.

30. Low Fuel Warning Light

Glows when the pointer is between “E” and 1/8 indication mark (approximately 15% of tank volume) on the fuel gauge. When the fuel gauge pointer is on “E” (equivalent to Distance To Empty [DTE] = 0 on the overhead console if so equipped) there is reserve fuel capacity, which corresponds to approximately 8% of tank volume. This reserve capacity was put in place to prevent the likelihood of customers running out of fuel when operating at maximum load conditions in areas where there aren’t many gas stations. (See page 139 for more information.)

Ram fuel tank volumes are as follows:

- 34 gallons - 2500/3500 short box models
- 35 gallons - 2500/3500 long box models

31. Door Ajar**DOOR
AJAR**

The Door Ajar light will illuminate when any door is opened. When the ignition is ON the Door Ajar light will stay illuminated until the open door is closed. When the ignition is OFF the Door Ajar light will stay illuminated until the open door is closed or the battery saver feature automatically turns the light off.

32. CRUISE Light

This indicator lights when the electronic speed control system is turned on.

ELECTRONIC DIGITAL CLOCK

The clock and radio each use the display panel built into the radio. A digital readout shows the frequency and/or time in hours and minutes (depending on your radio model) whenever the ignition switch is in the “ON” or “ACC” position.

When the ignition switch is in the "OFF" position, or when the radio frequency is being displayed, time keeping is accurately maintained.

On the RAQ radio the time button alternates the location of the time and frequency on the display. On the REF only one of the two, time or frequency is displayed at a time.

Clock Setting Procedure

1. Press and hold the time button until the hours blink.
2. Adjust the hours by turning the right side Tune / Audio control.
3. After the hours are adjusted, press the right side Tune / Audio control to set the minutes.
4. Adjust the minutes using the right side Tune / Audio control.
5. To exit, press any button/knob or wait approximately 5 seconds.

RADIO GENERAL INFORMATION

Radio Broadcast Signals

Your new radio will provide excellent reception under most operating conditions. Like any system, however, car radios have performance limitations, due to mobile operation and natural phenomena, which might lead you to believe your sound system is malfunctioning. To help you understand and save you concern about these "apparent" malfunctions, you must understand a point or two about the transmission and reception of radio signals.

Two Types of Signals

There are two basic types of radio signals... AM or Amplitude Modulation, in which the transmitted sound causes the amplitude, or height, of the radio waves to vary... and FM or Frequency Modulation, in which the frequency of the wave is varied to carry the sound.

Electrical Disturbances

Radio waves may pick up electrical disturbances during transmission. They mainly affect the wave amplitude, and thus remain a part of the AM reception. They interfere very little with the frequency variations that carry the FM signal.

AM Reception

AM sound is based on wave amplitude, so AM reception can be disrupted by such things as lightning, power lines and neon signs.

FM Reception

Because FM transmission is based on frequency variations, interference that consists of amplitude variations can be filtered out, leaving the reception relatively clear, which is the major feature of FM radio.

NOTE: The radio, steering wheel radio controls (if equipped), and 6 disc CD/DVD changer (if equipped) will remain active for up to 10 minutes after the ignition switch has been turned off. Opening a vehicle front door will cancel this feature.

SALES CODE REF — AM/FM/CD (SINGLE DISC) RADIO WITH OPTIONAL SATELLITE RADIO AND HANDS FREE PHONE CAPABILITY

NOTE: The radio sales code is located on the lower right side of your radio faceplate.

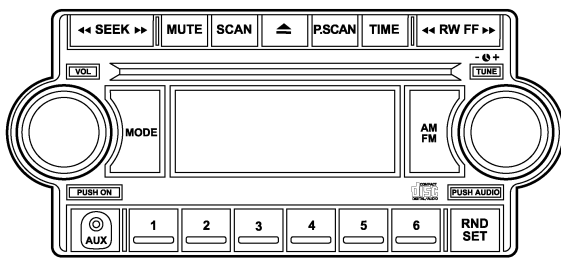

REF Radio

815eb156

Operating Instructions - Radio Mode

NOTE: The ignition switch must be in the ON or ACC position to operate the radio.

Power Switch/Volume Control (Rotary)

Press the ON/VOL control to turn the radio ON. Press the ON/VOL a second time to turn OFF the radio.

Electronic Volume Control

The electronic volume control turns continuously (360 degrees) in either direction without stopping. Turning the volume control to the right increases the volume and to the left decreases it.

When the audio system is turned on, the sound will be set at the same volume level as last played.

For your convenience, the volume can be turned down, but not up, when the audio system is off and the ignition is ON.

Mode Button (Radio Mode)

Press the mode button repeatedly to select between the CD player and Satellite Radio (if equipped).

SEEK Button (Radio Mode)

Press and release the SEEK button to search for the next listenable station in either AM/FM or Satellite (if equipped) mode. Press the right side of the button to seek up and the left side to seek down. The radio will remain tuned to the new station until you make another selection. Holding the button will bypass stations without stopping until you release it.

MUTE Button (Radio Mode)

Press the MUTE button to cancel the sound from the speakers. "MUTE" will display. Press the MUTE button a second time and the sound from the speakers will return. Rotating the volume control, turning the radio ON/OFF, or turning ON/OFF the ignition, will cancel the MUTE feature.

NOTE: In Hands Free Phone (if equipped) mode, the MUTE button mutes the microphone.

SCAN Button (Radio Mode)

Pressing the SCAN button causes the tuner to search for the next listenable station in either, AM, FM, or Satellite (if equipped) frequencies, pausing for 5 seconds at each listenable station before continuing to the next. To stop the search, press SCAN a second time.

PSCAN Button (Radio Mode)

Pressing the PSCAN button causes the tuner to scan through preset stations in either, AM, FM, or Satellite (if equipped) frequencies, pausing for 5 seconds at each preset station before continuing to the next. To stop the search, press PSCAN a second time.

Time Button

Press the time button and the time of day will display for 5 seconds.

Clock Setting Procedure

1. Press and hold the time button until the hours blink.
2. Adjust the hours by turning the right side Tune/Audio control.
3. After the hours are adjusted, press the right side Tune/Audio control to set the minutes. The minutes will begin to blink.
4. Adjust the minutes using the right side Tune/Audio control.
5. To exit, press any button/knob or wait 5 seconds.

RW/FF (Radio Mode)

Pressing the rewind/fast forward button causes the tuner to search for the next frequency in the direction of the arrows. This feature operates in either AM, FM or Satellite (if equipped) frequencies.

TUNE Control (Radio Mode)

Turn the right side rotary control clockwise to increase or counter-clockwise to decrease the frequency.

AM/FM Button (Radio Mode)

Press the button to select AM or FM Modes.

Setting the Tone, Balance, and Fade

Press the rotary TUNE control and BASS will display. Turn the TUNE control to the right or left to increase or decrease the Bass tones.

Press the rotary TUNE control a second time and MID will display. Turn the TUNE control to the right or left to increase or decrease the Mid Range tones.

Press the rotary TUNE control a third time and TREB will display. Turn the TUNE control to the right or left to increase or decrease the Treble tones.

Press the rotary TUNE control a fourth time and BAL will display. Turn the TUNE control to the right or left to adjust the sound level from the right or left side speakers.

Press the rotary TUNE control a fifth time and FADE will display. Turn the TUNE control to the left or right to adjust the sound level between the front and rear speakers.

Press the tune control again or wait 5 seconds to exit setting tone, balance, and fade.

RND/SET Button (Radio Mode) To SET The Push-Button Memory

When you are receiving a station that you wish to commit to push-button memory, press the SET button. The symbol SET 1 will now show in the display window. Select the button (1-6) you wish to lock onto this station and press and release that button. If a button is not

selected within 5 seconds after pressing the SET button, the station will continue to play but will not be stored into push-button memory.

You may add a second station to each push-button by repeating the above procedure with this exception: Press the SET button twice and SET 2 will show in the display window. Each button can be set for SET 1 and SET 2 in both AM and FM. This allows a total of 12 AM, 12 FM, and 12 Satellite (if equipped) stations to be stored into push-button memory. The stations stored in SET 2 memory can be selected by pressing the push-button twice.

Every time a preset button is used, a corresponding button number will display.

Preset Buttons 1 - 6 (Radio Mode)

These buttons tune the Radio to the stations that you commit to push-button memory {12 AM, 12 FM, and 12 Satellite (if equipped) stations}.

Operation Instructions - CD Mode

NOTE: The ignition switch must be in the ON or ACC position to operate the radio.

Inserting The Compact Disc (Single CD Player)

Gently insert one CD into the CD player with the CD label facing up. The CD will automatically be pulled into the CD Player and the CD icon will illuminate on the radio display.

If the volume control is ON, the unit will switch to CD mode and begin to play. The display will show the track number and play time in minutes and seconds. Play will begin at the start of track one.

NOTE:

- On some vehicles, you may insert or eject a disc with the radio or ignition switch OFF.

- If you insert a disc with the ignition ON and the radio OFF, the CD will automatically be pulled into the CD Player.
- This radio does not play discs with MP3 tracks.

SEEK Button (CD Mode)

Press the right side of the SEEK button for the next track on the CD. Press the left side of the button to return to the beginning of the current track, or return to the beginning of the previous track if the CD is within the first 10 seconds of the current selection.

MUTE Button (CD Mode)

Press the MUTE button to cancel the sound from the speakers. "MUTE" will display. Press the MUTE button a second time and the sound from the speakers will return. Rotating the volume control or turning OFF the ignition will also return the sound from the speakers.

SCAN Button (CD Mode)

Press this button to play the first 10 seconds of each track. To stop the scan function, press the button a second time.

EJECT Button (CD Mode)

Press this button and the disc will unload and move to the entrance for easy removal. The unit will switch to the last selected mode.

If you do not remove the disc within 15 seconds, it will be reloaded. The radio mode will continue to appear.

TIME Button (CD Mode)

Press this button to change the display from elapsed CD playing time to time of day. The time of day will display for 5 seconds.

RW/FF (CD Mode)

Press and hold the FF (Fast Forward) and the CD player will begin to fast forward until FF is released. The RW (Reverse) button works in a similar manner.

RND/SET Button (Random Play Button) (CD Mode)

Press this button while the CD is playing to activate Random Play. This feature plays the selections on the compact disc in random order to provide an interesting change of pace.

Press the SEEK button to move to the next randomly selected track.

Press and hold the FF button to fast forward through the tracks. Release the FF button to stop the fast forward feature. If the RW button is pressed, the current track will reverse to the beginning of the track and begin playing.

Press the RND button a second time to stop Random Play.

Operation Instructions - Auxiliary Mode

The auxiliary (AUX) jack is an audio input jack, which allows the user to plug in a portable device such as an MP3 player, cassette player, or microphone and utilize the vehicle's audio system to amplify the source and play through the vehicle speakers.

The auxiliary mode becomes active when an electrical device is plugged into the AUX jack using a standard 3.5 mm stereo audio cable and the user presses and releases the MODE button until AUX appears on the display.

NOTE: The radio will return to the last stored mode if the ignition switch is turned from the OFF/LOCK position to the ACC position, the radio is turned on, and the radio was previously in the AUX mode.

SEEK Button (Auxiliary Mode)

No function.

MUTE Button (Auxiliary Mode)

Press the MUTE button to cancel the sound from the speakers. "MUTE" will display. Press the MUTE button a second time and the sound from the speakers will return. Rotating the volume control or turning OFF the ignition will also return the sound from the speakers.

SCAN Button (Auxiliary Mode)

No function.

EJECT Button (Auxiliary Mode)

No function.

**PSCAN Button (Auxiliary Mode)**

No function.

TIME Button (Auxiliary Mode)

Press this button to change the display from elapsed playing time to time of day. The time of day will display for 5 seconds.

RW/FF (Auxiliary Mode)

No function.

RND/SET Button (Auxiliary Mode)

No function.

Mode Button (Auxiliary Mode)

Press the mode button repeatedly to select between the CD player and Satellite Radio (if equipped).

Operating Instructions - Hands Free Phone — If Equipped

Refer to the "HANDS FREE PHONE (UConnect™)" section of the Owner's Manual.

Operating Instructions - Satellite Radio — If Equipped

Refer to the "Satellite Radio" section of the Owner's Manual.

SALES CODE RAQ – AM/FM/CD (6-DISC) RADIO WITH OPTIONAL SATELLITE RADIO, HANDS FREE PHONE, AND VEHICLE ENTERTAINMENT SYSTEMS (VES) CAPABILITIES

NOTE: The radio sales code is located on the lower right side of your radio faceplate.

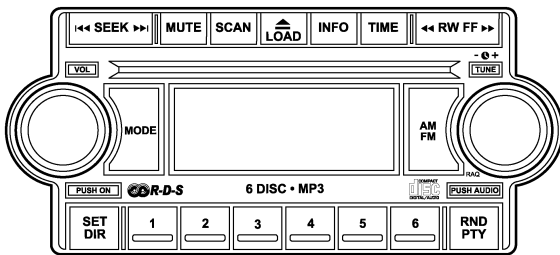

81365bb1

RAQ Radio

Operating Instructions - Radio Mode

NOTE: The ignition switch must be in the ON or ACC position to operate the radio.

Power Switch/Volume Control (Rotary)

Press the ON/VOL control to turn the radio ON. Press the ON/VOL a second time to turn OFF the radio.

Electronic Volume Control

The electronic volume control turns continuously (360 degrees) in either direction without stopping. Turning the volume control to the right increases the volume and to the left decreases it.

When the audio system is turned on, the sound will be set at the same volume level as last played.

For your convenience, the volume can be turned down, but not up, when the audio system is off and the ignition is ON.

Mode Button (Radio Mode)

Press the mode button repeatedly to select between the CD player, Satellite Radio, or Vehicle Entertainment System (VES) (if equipped).

SEEK Button (Radio Mode)

Press and release the SEEK button to search for the next listenable station in either AM/FM or Satellite (if equipped) mode. Press the right side of the button to seek up and the left side to seek down. The radio will remain tuned to the new station until you make another selection. Holding the button will bypass stations without stopping until you release it.

MUTE Button (Radio Mode)

Press the MUTE button to cancel the sound from the speakers. "MUTE" will be displayed. Press the MUTE button a second time and the sound from the speakers

will return. Rotating the volume control, turning the radio ON/OFF, or turning OFF the ignition will also return the sound from the speakers

NOTE: In Hands Free Phone (if equipped) mode, the MUTE button mutes the microphone.

SCAN Button (Radio Mode)

Pressing the SCAN button causes the tuner to search for the next listenable station, in either AM, FM or Satellite (if equipped) frequencies, pausing for 5 seconds at each listenable station before continuing to the next. To stop the search, press SCAN a second time.

MSG or INFO Button (Radio Mode)

Press the MSG or INFO button for an RBDS station (one with call letters displayed). The radio will return a Radio Text message broadcast from an FM station (FM mode only).

Time Button

Press the time button and the time of day will be displayed for 5 seconds.

Clock Setting Procedure

1. Press and hold the time button until the hours blink.
2. Adjust the hours by turning the right side Tune / Audio control.
3. After the hours are adjusted, press the right side Tune / Audio control to set the minutes. The minutes will begin to blink.
4. Adjust the minutes using the right side Tune / Audio control.
5. To exit, press any button/knob or wait 5 seconds.

RW/FF (Radio Mode)

Pressing the rewind/fast forward button causes the tuner to search for the next frequency in the direction of the arrows. This feature operates in either AM, FM or Satellite (if equipped) frequencies.

TUNE Control (Radio Mode)

Turn the right side rotary control clockwise to increase or counter-clockwise to decrease the frequency.

AM/FM Button (Radio Mode)

Press the button to select AM or FM Modes.

Setting the Tone, Balance, and Fade

Press the rotary TUNE control and BASS will display. Turn the TUNE control to the right or left to increase or decrease the Bass tones.

Press the rotary TUNE control a second time and MID will display. Turn the TUNE control to the right or left to increase or decrease the Mid Range tones.

Press the rotary TUNE control a third time and TREBLE will display. Turn the TUNE control to the right or left to increase or decrease the Treble tones.

Press the rotary TUNE control a fourth time and BALANCE will display. Turn the TUNE control to the right or left to adjust the sound level from the right or left side speakers.

Press the rotary TUNE control a fifth time and FADE will display. Turn the TUNE control to the left or right to adjust the sound level between the front and rear speakers.

Press the rotary TUNE control again to exit setting tone, balance and fade.

RND/PTY Button (Radio Mode)

Pressing this button once will turn on the PTY mode for 5 seconds. If no action is taken during the 5 second time out the PTY icon will turn off. Pressing the PTY button or

turning the TUNE rotary knob within 5 seconds will allow the program format type to be selected. Many radio stations do not currently broadcast PTY information.

Toggle the PTY button to select the following format types:

Program Type	16 Digit-Character Display
No program type or undefined	None
Adult Hits	Adult_Hits
Alert Alert	Alert Alert
Classical	Classical
Classic Rock	Classic_Rock
College	College
Country	Country
Emergency Test	Emergency Test
Foreign Language	Foreign_Language
Information	Information

Jazz	Jazz
News	News
Nostalgia	Nostalgia
Oldies	Oldies
Personality	Personality
Public	Public
Rhythm and Blues	Rhythm_and_Blues
Religious Music	Religious_Music
Religious Talk	Religious_Talk
Rock	Rock
Soft	Soft
Soft Rock	Soft_Rock
Soft Rhythm and Blues	Soft_R_&_B
Sports	Sports
Talk	Talk
Top 40	Top_40
Weather	Weather

By pressing the SEEK button when the PTY icon is displayed, the radio will be tuned to the next frequency station with the same selected PTY name. The PTY function only operates when in the FM mode.

If a preset button is activated while in the PTY (Program Type) mode, the PTY mode will be exited and the radio will tune to the preset station.

SET/DIR Button (Radio Mode) — To Set the Push-Button Memory

When you are receiving a station that you wish to commit to push-button memory, press the SET/DIR button. The symbol SET 1 will now show in the display window. Select the button (1-6) you wish to lock onto this station and press and release that button. If a button is not selected within 5 seconds after pressing the SET/DIR button, the station will continue to play but will not be stored into push-button memory.

You may add a second station to each push-button by repeating the above procedure with this exception: Press the SET/DIR button twice and SET 2 will show in the display window. Each button can be set for SET 1 and SET 2 in both AM and FM. This allows a total of 12 AM, 12 FM and 12 Satellite (if equipped) stations to be stored into push-button memory. The stations stored in SET 2 memory can be selected by pressing the push-button twice.

Every time a preset button is used a corresponding button number will be displayed.

Buttons 1 - 6 (Radio Mode)

These buttons tune the Radio to the stations that you commit to push-button memory {12AM, 12 FM, and 12 Satellite (if equipped) stations}.

Operation Instructions - (CD MODE for CD Audio Play)

NOTE: The ignition switch must be in the ON or ACC position to operate the radio.

NOTE: Note: This Radio is capable of playing compact discs (CD), recordable compact discs (CD-R), rewritable compact discs (CD-RW) compact discs with MP3 tracks and multisession compact discs with CD and MP3 tracks.

Inserting Compact Disc(s)

Gently insert one CD into the CD player with the CD label facing up. The CD will automatically be pulled into the CD Player and the CD icon will illuminate on the radio display.

CAUTION!

This CD player will accept 4 3/4 inch (12 cm) discs only. The use of other sized discs may damage the CD player mechanism.

You may eject a disc with the radio OFF.

If you insert a disc with the ignition ON and the radio ON, the unit will switch from radio to CD mode and begin to play when you insert the disc. The display will show the disc number, the track number, and index time in minutes and seconds. Play will begin at the start of track 1.

SEEK Button (CD MODE for CD Audio Play)

Press the right side of the SEEK button for the next selection on the CD. Press the left side of the button to return to the beginning of the current selection, or return

to the beginning of the previous selection if the CD is within the first 10 seconds of the current selection.

MUTE Button (CD MODE for CD Audio Play)

Press the MUTE button to cancel the sound from the speakers. "MUTE" will be displayed. Press the MUTE button a second time and the sound from the speakers will return. Rotating the volume control, turning the radio ON/OFF, or turning OFF the ignition will also return the sound from the speakers.

SCAN Button (CD MODE for CD Audio Play)

Press the Scan button to scan through each track on the CD currently playing.

LOAD/EJECT Button (CD Mode for CD Audio Play)**LOAD/ EJECT - Load**

Press the LOAD/ EJECT button and the push-button with the corresponding number where the CD is being loaded. The radio will display PLEASE WAIT and prompt when to INSERT DISC. After the radio displays "LOAD DISC" insert the CD into the player.

Radio display will show "LOADING DISC" when the disc is loading, and "READING DISC" when the radio is reading the disc.

LOAD / EJT - Eject

Press the LOAD/ EJT button and the push-button with the corresponding number where the CD was loaded and the disc will unload and move to the entrance for easy removal.

Radio display will show "EJECTING DISC" when the disc is being ejected and prompt the user to remove the disc.

Press and hold the LOAD/ EJT button for 5 seconds and all CDs will be ejected from the radio.

If you have ejected a disc and have not removed it within 15 seconds, it will be reloaded. If the CD is not removed, the radio will continue to play the non-removed CD. If the CD is removed and there are other CD's in the radio, the radio will play the next CD after a 2 minute timeout. If the CD is removed and there are no other CD's in the radio, the radio will remain in CD mode and display "INSERT DISC" for 10 seconds. If no discs are inserted within 10 seconds "NO DISCS LOADED" will be displayed.

On some vehicles a disc can be ejected with the radio and ignition OFF.

TIME Button (CD MODE for CD Audio Play)

Press this button to change the display from a large CD playing time display to a small CD playing time display.

RW/FF (CD MODE for CD Audio Play)

Press and hold FF (Fast Forward) and the CD player will begin to fast forward until FF is released or RW or another CD button is pressed. The RW (Reverse) button works in a similar manner.

TUNE Control (CD MODE for CD Audio Play)

Pressing the TUNE control allows the setting of the Tone, Fade, and Balance. See Radio Mode.

AM/FM Button (CD MODE for CD Audio Play)

Switches the Radio to the Radio mode.

RND/PTY Button (Random Play Button) (CD MODE for CD Audio Play)

Press this button while the CD is playing to activate Random Play. This feature plays the selections on the compact disc in random order to provide an interesting change of pace.

Press the SEEK button to move to the next randomly selected track.

Press and hold the FF button to fast forward through the tracks. Release the FF button to stop the fast forward feature.

Press the RND button a second time to stop Random Play.

Buttons 1 - 6 (CD MODE for CD Audio Play)

Selects disc positions 1 - 6 for Play/Load/Eject.

Notes On Playing MP3 Files

The radio can play MP3 files, however, acceptable MP3 file recording media and formats are limited. When writing MP3 files, pay attention to the following restrictions.

Supported Media (Disc Types)

The MP3 file recording media supported by the radio are CD-ROM, CD-R and CD-RW.

Supported Medium Formats (File Systems)

The medium formats supported by the radio are ISO 9660 Level 1 and Level 2 and includes the Joliet extension. When reading discs recorded using formats other than ISO 9660 Level 1 and Level 2, the radio may fail to read files properly and may be unable to play the file normally. UDF and Apple HFS formats are not supported.

The radio uses the following limits for file systems:

- Maximum number of directory levels: 15

- Maximum number of files: 255
- Maximum number of folders: 100
- Maximum number of characters in file/folder names:
 - Level 1: 12 (including a separator "." and a 3-character extension)
 - Level 2: 31 (including a separator "." and a 3-character extension)

Multisession disc formats are supported by the radio. Multisession discs may contain combinations of normal CD audio tracks and computer files (including MP3 files). Discs created with an option such as "keep disc open after writing" are most likely multisession discs. The use of multisession for CD audio or MP3 playback may result in longer disc loading times.

Supported MP3 File Formats

The radio will recognize only files with the *.mp3 extension as MP3 files. Non-MP3 files named with the *.mp3 extension may cause playback problems. The radio is designed to recognize the file as an invalid MP3 and will not play the file.

When using the MP3 encoder to compress audio data to an MP3 file, the bit rate and sampling frequencies in the following table are supported. In addition, variable bit rates (VBR) are also supported. The majority of MP3 files use a 44.1 kHz sampling rate and a 192, 160, 128, 96 or VBR bit rates.

MPEG Specification	Sampling Frequency (kHz)	Bit rate (kbps)
MPEG-1 Audio Layer 3	48, 44.1, 32	320, 256, 224, 192, 160, 128, 112, 96, 80, 64, 56, 48, 40, 32

MPEG-2 Audio Layer 3	24, 22.05, 16	160, 128, 144, 112, 96, 80, 64, 56, 48, 40, 32, 24, 16, 8
----------------------	---------------	---

ID3 Tag information for artist, song title and album title are supported for version 1 ID3 tags. ID3 version 2 is not supported by the radios.

Playlist files are not supported. MP3 Pro files are not supported.

Playback of MP3 Files

When a medium containing MP3 data is loaded, the radio checks all files on the medium. If the medium contains a lot of folders or files, the radio will take more time to start playing the MP3 files.

Loading times for playback of MP3 files may be affected by the following:

- Media - CD-RW media may take longer to load than CD-R media
- Medium formats - Multisession discs may take longer to load than non-multisession discs
- Number of files and folders - Loading times will increase with more files and folders

To increase the speed of disc loading, it is recommended to use CD-R media and single-session discs. To create a single-session disc, enable the Disc at Once option before writing to the disc.

Operation Instructions - (CD Mode for MP3 Audio Play)

SEEK Button (CD Mode for MP3 Play)

Pressing the right side of the SEEK button plays the next MP3 File. Pressing the left side of the SEEK button plays the beginning of the MP3 file. Pressing the button within the first ten seconds plays the previous file.

LOAD/EJECT Button (CD Mode for MP3 Play)

LOAD/ EJECT - Load



Press the LOAD/ EJECT button and the push-button with the corresponding number where the CD is being loaded. The radio will display PLEASE WAIT and prompt when to INSERT DISC. After the radio displays "LOAD DISC" insert the CD into the player.

Radio display will show "LOADING DISC" when the disc is loading.

LOAD / EJECT - Eject



Press the LOAD/ EJECT button and the push-button with the corresponding number where the CD was loaded and the disc will unload and move to the entrance for easy removal. Radio display will show "EJECTING DISC" when the disc is being ejected and prompt the user to remove the disc.

If you have ejected a disc and have not removed it within 15 seconds, it will be reloaded. If the CD is not removed, the radio will continue to play the non-removed CD. If the CD is removed and there are other CD's in the radio, the radio will play the next CD after a 2 minute timeout. If the CD is removed and there are no other CD's in the radio, the radio will remain in CD mode and display "INSERT DISC" for 2 minutes. After 2 minutes the radio will go to the previous tuner mode.

MSG or INFO Button (CD Mode for MP3 Play)

Press and MSG or INFO button while playing MP3 disc. The radio scrolls through the following TAG information: Song Title, Artist, File Name, and Folder Name (if available).

Press the MSG or INFO button once more to return to "elapsed time" priority mode.

Press and hold the MSG or INFO button while in the message display priority mode or elapsed time display priority mode will display the song title for each file.

RW/FF (CD Mode for MP3 Play)

Press the FF side of the button to move forward through the MP3 selection.

TUNE Control (CD Mode for MP3 Play)

Pressing the TUNE Control allows the adjustment of Tone, Balance, and Fade.

AM/FM Button (CD Mode for MP3 Play)

Switches back to Radio mode.

RND/ PTY Button (CD Mode for MP3 Play)

Pressing this button plays files randomly.

SET/DIR Button (CD Mode for MP3 Play)

Press the SET/DIR Button to display folders, when playing an MP3 discs that have a file/folder structure.

Turn the TUNE control to display available folders or move through available folders. Press the TUNE control to select a folder.

Buttons 1 - 6 (CD Mode for MP3 Play)

Selects disc positions 1 - 6 for Play/Load/Eject.

Operating Instructions - Hands Free Phone (If Equipped)

Refer to Hands Free Phone in Section 3 of the Owner's Manual.

Operating Instructions - Satellite Radio Mode (If Equipped)

Refer to the Satellite Radio section of the Owner's Manual.

Operating Instructions - Video Entertainment System (VES®) (If Equipped)

Refer to separate Video Entertainment System (VES®) Guide.

SALES CODE RAK – AM/FM/CASSETTE/CD (6-DISC) RADIO WITH OPTIONAL SATELLITE RADIO, HANDS FREE PHONE, VIDEO, MP3, and WMA CAPABILITIES

NOTE: The radio sales code is located on the lower right side of your radio faceplate.

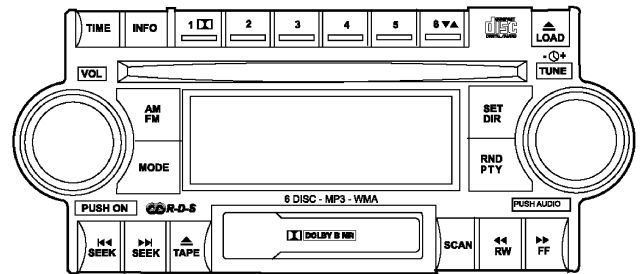

8132a436

RAK Radio

Operating Instructions - Radio Mode

NOTE: The ignition switch must be in the ON or ACC position to operate the radio.

Power Switch/Volume Control (Rotary)

Press the ON/VOL control to turn the radio ON. Press the ON/VOL a second time to turn OFF the radio.

Electronic Volume Control

The electronic volume control turns continuously (360 degrees) in either direction without stopping. Turning the volume control to the right increases the volume and to the left decreases it.

When the audio system is turned on, the sound will be set at the same volume level as last played.

Mode Button (Radio Mode)

Press the mode button repeatedly to select between the CD player, Cassette, Satellite, or Vehicle Entertainment System (VES) (if equipped).

SEEK Button (Radio Mode)

Press and release the SEEK button to search for the next station in either AM/FM or Satellite (if equipped) mode. Press the right side of the button to seek up and the left side to seek down. The radio will remain tuned to the new station until you make another selection. Holding the button will bypass stations without stopping until you release it.

SCAN Button (Radio Mode)

Pressing the SCAN button causes the tuner to search for the next station, in either AM, FM or Satellite (if equipped) frequencies, pausing for 5 seconds (satellite scan 8 seconds) at each listenable station before continuing to the next. To stop the search, press SCAN a second time.

Time Button

Press the time button and the time of day will display for 5 seconds.

Clock Setting Procedure

1. Press and hold the time button until the hours blink.
2. Adjust the hours by turning the right side Tune/Audio control.
3. After the hours are adjusted, press the right side Tune/Audio control to set the minutes. The minutes will begin to blink.
4. Adjust the minutes using the right side Tune/Audio control.
5. To exit, press any button/knob or wait 5 seconds.

INFO Button (Radio Mode)

Press the INFO button for an RBDS station (one with call letters displayed). The radio will return a Radio Text message broadcast (if available) from an FM station (FM mode only).

RW/FF (Radio Mode)

Pressing the rewind/fast forward button causes the tuner to search for the next frequency in the direction of the arrows. This feature operates in either AM, FM or Satellite (if equipped) frequencies.

TUNE Control (Radio Mode)

Turn the right side rotary control to increase or decrease the frequency.

AM/FM Button (Radio Mode)

Press the button to select AM or FM Modes.

Setting the Tone, Balance, and Fade

Press the rotary TUNE control and BASS will display. Turn the TUNE control to the right or left to increase or decrease the Bass tones.

Press the rotary TUNE control a second time and MID will display. Turn the TUNE control to the right or left to increase or decrease the Mid Range tones.

Press the rotary TUNE control a third time and TREBLE will display. Turn the TUNE control to the right or left to increase or decrease the Treble tones.

Press the rotary TUNE control a fourth time and BAL will display. Turn the TUNE control to the right or left to adjust the sound level from the right or left side speakers.

Press the rotary TUNE control a fifth time and FADE will display. Turn the TUNE control to the right or left to adjust the sound level between the front and rear speakers.

Press the rotary TUNE control again to exit setting tone, balance, and fade.

RND/PTY Button (Radio Mode)

Pressing this button once will turn on the PTY mode for 5 seconds. If no action is taken during the 5-second time out, the PTY icon will turn off. Turning the tune knob

within 5 seconds will allow the program format type to be selected. Many radio stations do not currently broadcast PTY information.

Turn the tune knob to select the following format types:

Program Type	16 Digit-Character Display
No program type or undefined	None
News	News
Information	Information
Sports	Sports
Talk	Talk
Rock	Rock
Classic Rock	Classic_Rock
Adult Hits	Adult_Hits
Soft Rock	Soft_Rock
Top 40	Top_40

Country	Country
Oldies	Oldies
Soft	Soft
Nostalgia	Nostalgia
Jazz	Jazz
Classical	Classical
Rhythm and Blues	Rhythm_and_Blues
Soft Rhythm and Blues	Soft_R_&_B
Foreign Language	Foreign_Language
Religious Music	Religious_Music
Religious Talk	Religious_Talk
Personality	Personality
Public	Public
College	College
Unassigned	
Weather	Weather

By pressing the SEEK button when the PTY icon is displayed, the radio will be tuned to the next frequency station with the same selected PTY name. The PTY function only operates when in the FM mode.

If a preset button is activated while in the PTY (Program Type) mode, the PTY mode will be exited and the radio will tune to the preset station.

NOTE: If you have selected a PTY with the tune knob, simply pressing the tune button in will go directly to a “PTY seek”.

Buttons 1 - 6 (Radio Mode)

These buttons tune the Radio to the stations that you commit to push-button memory (12 AM, 12 FM, and 12 Satellite (if equipped) stations).

Operating Instructions — Tape Player

Insert the cassette with the exposed tape side toward the left and the mechanical action of the player will gently pull the cassette into the play position.

NOTE: When subjected to extremely cold temperatures, the tape mechanism may require a few minutes to warm up for proper operation. Sometimes poor playback may be experienced due to a defective cassette tape. Clean and demagnetize the tape heads at least twice a year.

Seek Button

Press the SEEK button up for the next selection on the tape and down to return to the beginning of the current selection.

Press the SEEK button up or down to move the track number to skip forward or backward 1 to 6 selections. Press the SEEK button once to move 1 selection, twice to move 2 selections, etc.

Fast Forward (FF)

Press the FF button up momentarily to advance the tape in the direction that it is playing. The tape will advance until the button is pressed again or the end of the tape is reached. At the end of the tape, the tape will play in the opposite direction.

Rewind (RW)

Press the RW button momentarily to reverse the tape direction. The tape will reverse until the button is pressed again or until the end of the tape is reached. At the end of the tape, the tape will play in the opposite direction.

Tape Eject

Press this button and the cassette will disengage and eject from the radio.

Scan Button

Press this button to play 10 seconds of each selection. Press the scan button a second time to cancel the feature.

Changing Tape Direction

If you wish to change the direction of tape travel (side being played), press Preset 6. The lighted arrow in the display window will show the new direction.

Metal Tape Selection

If a standard metal tape is inserted into the player, the player will automatically select the correct equalization.

Pinch Roller Release

If ignition power or the radio ON/OFF switch is turned off, the pinch roller will automatically retract to protect the tape from any damage. When power is restored to the tape player, the pinch roller will automatically reengage and the tape will resume play.

Noise Reduction

The Dolby Noise Reduction System* is on whenever the tape player is on, but may be switched off.

To turn off the Dolby Noise reduction System: Press Preset 1 after you insert the tape. The NR light in the display will go off when the Dolby System is off.

* "Dolby" noise reduction is manufactured under license from Dolby Laboratories Licensing Corporation. Dolby and the double-D symbol are trademarks of Dolby Laboratories Licensing Corporation.

Operation Instructions - (CD MODE for CD Audio Play)

NOTE: The ignition switch must be in the ON or ACC position to operate the radio.

NOTE: Note: This Radio is capable of playing compact discs (CD), recordable compact discs (CD-R), rewritable

compact discs (CD-RW) compact discs with MP3 tracks and multisession compact discs with CD and MP3 tracks and WMA.

Inserting Compact Disc(s)

CAUTION!

This CD player will accept 4 3/4 inch (12 cm) discs only. The use of other sized discs may damage the CD player mechanism.

You may eject a disc with the radio OFF.

If you insert a disc with the ignition ON and the radio ON, the unit will switch from radio to CD mode and begin to play when you insert the disc. The display will show the disc number, the track number, and index time in minutes and seconds. Play will begin at the start of track 1.

SEEK Button (CD MODE for CD Audio Play)

Press the right side of the SEEK button for the next selection on the CD. Press the left side of the button to return to the beginning of the current selection, or return to the beginning of the previous selection if the CD is within the first 5 seconds of the current selection.

SCAN Button (CD MODE for CD Audio Play)

Press the Scan button to scan through each track on the CD currently playing.

LOAD/EJECT Button (CD Mode for CD Audio Play)

LOAD/EJECT - Load



LOAD

Press the LOAD/EJT button and the push-button with the corresponding number where the CD is being loaded. The radio will display PLEASE WAIT and prompt when to INSERT DISC. After the radio displays "INSERT DISC," insert the CD into the player.

Radio display will show "LOADING DISC" when the disc is loading and "READING DISC" when the radio is reading the disc.

LOAD/EJT - Eject



Press the LOAD/EJT button and the push-button with the corresponding number where the CD was loaded and the disc will unload and move to the entrance for easy removal.

Radio display will show "EJECTING DISC" when the disc is being ejected and prompt the user to remove the disc.

Press and hold the LOAD/EJT button for 5 seconds and all CDs will be ejected from the radio.

If you have ejected a disc and have not removed it within 15 seconds, it will be reloaded. If the CD is not removed, the radio will continue to play the non-removed CD. If the CD is removed and there are other CD's in the radio, the radio will play the next CD after a 2-minute timeout. If the CD is removed and there are no other CD's in the

radio, the radio will remain in CD mode and display "INSERT DISC" for 2 minutes. After 2 minutes, the radio will go to the previous tuner mode.

The disc can be ejected with the radio and ignition OFF.

TIME Button (CD MODE for CD Audio Play)

Press this button to change the display from a large CD playing time display to a small CD playing time display.

RW/FF (CD MODE for CD Audio Play)

Press and hold FF (Fast Forward) and the CD player will begin to fast forward until FF is released or RW or another CD button is pressed. The RW (Reverse) button works in a similar manner.

TUNE Control (CD MODE for CD Audio Play)

Pressing the TUNE control allows the setting of the Tone, Fade, and Balance. See Radio Mode.

AM/FM Button (CD MODE for CD Audio Play)

Switches the Radio to the Radio mode.

RND/PTY Button (Random Play Button) (CD MODE for CD Audio Play)

Press this button while the CD is playing to activate Random Play. This feature plays the selections on the compact disc in random order to provide an interesting change of pace.

NOTE: MP3 and WMA Random Play are for file folders only.

Press the SEEK button to move to the next randomly selected track.

Press and hold the FF button to fast forward through the tracks. Release the FF button to stop the fast forward feature. If the RW button is pressed, the current track will reverse to the beginning of the track and begin playing.

Press the RND button a second time to stop Random Play.

Buttons 1 - 6 (CD MODE for CD Audio Play)

Selects disc positions 1 - 6 for Play/Load/Eject.

Notes On Playing MP3 Files

The radio can play MP3 files; however, acceptable MP3 file recording media and formats are limited. When writing MP3 files, pay attention to the following restrictions.

Supported Media (Disc Types)

The MP3 file recording media supported by the radio are CD-ROM, CD-R, and CD-RW.

Supported Medium Formats (File Systems)

The medium formats supported by the radio are ISO 9660 Level 1 and Level 2 and includes the Joliet extension. When reading discs recorded using formats other than ISO 9660 Level 1 and Level 2, the radio may fail to read files properly and may be unable to play the file normally. UDF and Apple HFS formats are not supported.

The radio uses the following limits for file systems:

- Maximum number of directory levels: 15
- Maximum number of files: 255
- Maximum number of folders: 100
- Maximum number of characters in file/folder names:
 - Level 1: 12 (including a separator "." and a 3-character extension)
 - Level 2: 31 (including a separator "." and a 3-character extension)

Multisession disc formats are supported by the radio.

Multisession discs may contain combinations of normal CD audio tracks and computer files (including MP3 files). Discs created with an option such as "keep disc open after writing" are most likely multisession discs. The use of multisession for CD audio or MP3 playback may result in longer disc loading times.

Supported MP3 File Formats

The radio will recognize only files with the *.mp3 extension as MP3 files. Non-MP3 files named with the *.mp3 extension may cause playback problems. The radio is designed to recognize the file as an invalid MP3 and will not play the file.

When using the MP3 encoder to compress audio data to an MP3 file, the bit rate and sampling frequencies in the following table are supported. In addition, variable bit rates (VBR) are also supported. The majority of MP3 files use a 44.1 kHz sampling rate and a 192, 160, 128, 96 or VBR bit rates.

MPEG Specification	Sampling Frequency (kHz)	Bit rate (kbps)
MPEG-1 Audio Layer 3	48, 44.1, 32	320, 256, 224, 192, 160, 128, 112, 96, 80, 64, 56, 48, 40, 32
MPEG-2 Audio Layer 3	24, 22.05, 16	160, 128, 144, 112, 96, 80, 64, 56, 48, 40, 32, 24, 16, 8

ID3 Tag information for artist, song title, and album title are supported for version 1 ID3 tags. ID3 version 2 is not supported by the radios.

Playlist files are not supported. MP3 Pro files are not supported.

Playback of MP3 and WMA Files

When a medium containing MP3 data is loaded, the radio checks all files on the medium. If the medium contains a lot of folders or files, the radio will take more time to start playing the MP3 files.

Loading times for playback of MP3 and WMA files may be affected by the following:

- Media - CD-RW media may take longer to load than CD-R media
- Medium formats - Multisession discs may take longer to load than non-multisession discs
- Number of files and folders - Loading times will increase with more files and folders

To increase the speed of disc loading, it is recommended to use CD-R media and single-session discs. To create a single-session disc, enable the Disc at Once option before writing to the disc.

Operation Instructions - (CD Mode for MP3 and WMA Audio Play)

SEEK Button (CD Mode for MP3 and WMA Play)

Pressing the right side of the SEEK button plays the next file. Pressing the left side of the SEEK button plays the beginning of the file. Pressing the button within the first ten seconds plays the previous file.

LOAD/EJECT Button (CD Mode for MP3 and WMA Play)

LOAD/EJT - Load



Press the LOAD/EJT button and the push-button with the corresponding number where the CD is being loaded. The radio will display

PLEASE WAIT and prompt when to INSERT DISC. After the radio displays "INSERT DISC," insert the CD into the player.

The radio display will show "LOADING DISC" when the disc is loading.

LOAD/EJT - Eject



Press the LOAD/EJT button and the push-button with the corresponding number where the CD was loaded and the disc will unload and move to the entrance for easy removal. Radio display will show "EJECTING DISC" when the disc is being ejected and prompt the user to remove the disc.

If you have ejected a disc and have not removed it within 15 seconds, it will be reloaded. If the CD is not removed, the radio will continue to play the non-removed CD. If the CD is removed and there are other CD's in the radio, the radio will play the next CD after a 2-minute timeout. If the CD is removed and there are no other CD's in the

radio, the radio will remain in CD mode and display "INSERT DISC" for 2 minutes. After 2 minutes, the radio will go to the previous tuner mode.

INFO Button (CD Mode for MP3 Play)

Press and INFO button while playing MP3 or WMA disc. The radio scrolls through the following TAG information: Song Title, Artist, File Name, and Folder Name (if available).

Press the INFO button once more to return to "elapsed time" priority mode.

Press and hold the INFO button while in the message display priority mode or elapsed time display priority mode will display the song title for each file.

RW/FF (CD Mode for MP3 and WMA Play)

Press the FF side of the button to move forward through the file or MP3 and WMA selection.

TUNE Control (CD Mode for MP3 Play)

Pressing the TUNE Control allows the adjustment of Tone, Balance, and Fade.

AM/FM Button (CD Mode for MP3 Play)

Switches back to Radio mode.

RND/PTY Button (CD Mode for MP3 Play)

Pressing this button plays files randomly.

SET/DIR Button (CD Mode for MP3 Play)

Press the SET/DIR Button to display folders, when playing an MP3 discs that have a file/folder structure. Turn the TUNE control to display available folders or move through available folders. Press the TUNE control to select a folder.

Buttons 1 - 6 (CD Mode for MP3 Play)

Selects disc positions 1 - 6 for Play/Load/Eject.

Operating Instructions - Hands Free Phone (If Equipped)

Refer to "Hands-Free Phone" in Section 3 of the Owner's Manual.

Operating Instructions - Satellite Radio Mode (If Equipped)

Refer to the "Satellite Radio" section of the Owner's Manual.

Operating Instructions - Video Entertainment System (VES) (If Equipped)

Refer to separate "Video Entertainment System (VES) Guide."

SALES CODE REC — AM/FM/CD (6-DISC) RADIO WITH NAVIGATION SYSTEM

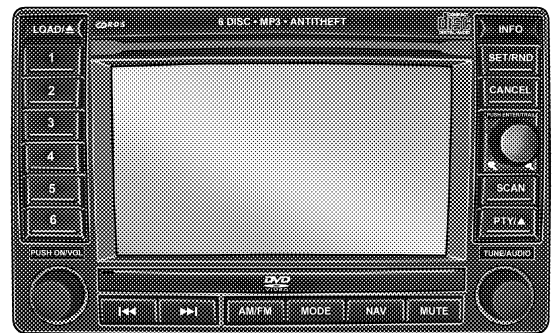

8125e256

REC Radio

Satellite Navigation Radio with CD Player with MP3 Capability (REC) - combines a Global-Positioning System-based navigation system with an integrated color screen to provide maps, turn identification, selection

menus and instructions for selecting a variety of destinations and routes, AM/FM stereo radio and six-disc CD changer with MP3 capability.

Mapping information for navigation is supplied on a DVD that is loaded into the unit. One map DVD covers all of North America. Refer to your "Navigation User's Manual" for detailed operating instructions.

Operating Instructions — Satellite Radio (If Equipped)

Refer to your "Navigation User's Manual" for detailed operating instructions.

Clock Setting Procedure

Refer to "Setting the Clock" under "System Settings" in your Navigation User's Manual for details about setting the clock.

VIDEO ENTERTAINMENT SYSTEM (SALES CODE XRV) — IF EQUIPPED

The optional VES™ (Video Entertainment System) consists of a DVD player and LCD (liquid crystal display) screen, a battery-powered remote control, and two headsets. The system is located in the headliner behind the front row seat. Refer to your VES™ User's Manual for detailed operating instructions.

SATELLITE RADIO — IF EQUIPPED

Satellite radio uses direct satellite to receiver broadcasting technology to provide clear digital sound, coast to coast. The subscription service provider is Sirius™ Satellite Radio. This service offers over 100 channels of music, sports, news, entertainment, and programming for children, directly from its satellites and broadcasting studios.

System Activation

NOTE: Your vehicle's radio must be on and in satellite mode when the activation process takes place.

To activate your Sirius Satellite Radio service, call the toll-free number 888-539-7474, or visit the Sirius web site at www.sirius.com. Please have the following information available when activating your system:

1. The Electronic Serial Number/Sirius Identification Number (ESN/SID).
2. Credit card information.
3. Your Vehicle Identification Number.

Electronic Serial Number/Sirius Identification Number (ESN/SID)

The Electronic Serial Number/Sirius Identification Number is needed to activate your Sirius Satellite Radio system. To access the ESN/SID, refer to the following steps:

ESN/SID Access With REF Radios

With the ignition switch in the ACCESSORY position and the radio OFF, press the CD Eject and Time buttons simultaneously for 3 seconds. The first four digits of the twelve-digit ESN/SID number will display. Press the SEEK UP button to display the next four digits. Continue to press the SEEK UP button until all twelve ESN/SID digits display. The SEEK DOWN will page down until the first four digits display. The radio will exit the ESN/SID mode when any other button is pushed, the ignition is turned OFF, or 5 minutes has passed since any button was pushed.

ESN/SID Access With RAQ and RAK Radios

With the ignition switch in the ACCESSORY position and the radio OFF, press the CD Eject and TIME buttons simultaneously for 3 seconds. All twelve ESN/SID numbers will display. The radio will exit the ESN/SID mode when any other button is pushed, the ignition is turned OFF, or 5 minutes has passed since any button was pushed.

ESN/SID Access With REC Navigation Radios

Please refer to your Navigation User's Manual.

With the ignition in the ACCESSORY position and the radio off, press the CD Eject and Set buttons simultaneously until the 12 digits of the ESN/SID appear on the screen.

Selecting Satellite Mode in REF, RAQ, and RAK Radios**Selecting Satellite Mode — REF Radio**

Press the MODE button repeatedly until the word "SAT" appears in the display.

A CD may remain in the radio while in the Satellite radio mode.

Selecting Satellite Mode — RAQ and RAK Radio

Press the MODE button repeatedly until the word "SAT" appears in the display.

These radios will also display the current station name and program type. For more information, such as song title and artist press the MSG or INFO button.

A CD or tape may remain in the radio while in the Satellite radio mode.

Selecting a Channel

Press and release the SEEK or TUNE knob to search for the next channel. Press the top of the button to search up and the bottom of the button to search down. Holding the TUNE button causes the radio to bypass channels until the button is released.

Press and release the SCAN button (if equipped) to automatically change channels every 7 seconds. The radio will pause on each channel for 7 seconds before moving on to the next channel. The word "SCAN" will appear in the display between each channel change. Press the SCAN button a second time to stop the search.

NOTE: Channels that may contain objectionable content can be blocked. Contact Sirius Customer Care at 888-539-7474 to discuss options for channel blocking or unblocking. Please have your ESN/SID information available.

Storing and Selecting Pre-Set Channels

In addition to the 12 AM and 12 FM pre-set stations, you may also commit 12 satellite stations to push button memory. These satellite channel pre-set stations will not erase any AM or FM pre-set memory stations. Follow the memory pre-set procedures that apply to your radio.

Using the PTY (Program Type) Button (if equipped)

Follow the PTY button instructions that apply to your radio.

PTY Button "SCAN"

When the desired program type is obtained, press the "SCAN" button within five seconds. The radio will play 7 seconds of the selected channel before moving to the next channel of the selected program type. Press the "SCAN" button a second time to stop the search.

NOTE: Pressing the "SEEK" or "SCAN" button, while performing a music type scan, will change the channel by one and stop the search. Pressing a pre-set memory button during a music type scan, will call up the memory channel and stop the search.

PTY Button "SEEK"

When the desired program is obtained, press the "SEEK" button within five seconds. The channel will change to the next channel that matches the program type selected.

Satellite Antenna

To ensure optimum reception, do not place items on the roof around the rooftop antenna location. Metal objects placed within the line of sight of the antenna will cause decreased performance. Larger luggage items should be placed as far forward as possible. Do not place items directly on or above the antenna.

Reception Quality

Satellite reception may be interrupted due to one of the following reasons.

- The vehicle is parked in an underground parking structure or under a physical obstacle.
- Dense tree coverage may interrupt reception in the form of short audio mutes.
- Driving under wide bridges or along tall buildings can cause intermittent reception.
- Placing objects over or too close to the antenna can cause signal blockage.

REMOTE SOUND SYSTEM CONTROLS — IF EQUIPPED

The remote sound system controls are located on the rear surface of the steering wheel. Reach behind the wheel to access the switches.

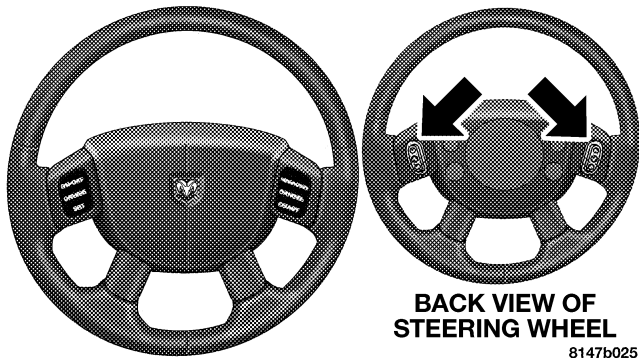

BACK VIEW OF STEERING WHEEL

8147b025

Remote Sound System Controls

The right hand control is a rocker type switch with a button in the center. Pressing the top of the switch will increase the volume and pressing the bottom of the switch will decrease the volume. The center button of the right hand control will allow you to change the mode.

The left hand control is a rocker type switch with a push button in the center. The function of the left hand control is different depending on which mode you are in.

The following describes the left hand control operation in each mode.

Radio Operation

Pressing the top of the left side switch will SEEK up for the next listenable station and pressing the bottom of the switch will SEEK down for the next listenable station.

The button located in the center of the left hand control will tune to the next pre-set station that you have programmed in the radio pre-set push-buttons.

Tape Player

Pressing the top of the switch once will go to the next selection on the cassette. Pressing the bottom of the switch once will go to the beginning of the current selection or to the beginning of the previous selection if it is within the first 5 seconds of the current selection.

If you press the switch up or down twice it plays the second selection, three times, it will play the third, etc.

The button in the center of the left hand switch has no function in this mode.

CD Player

Pressing the top of the switch once will go to the next track on the CD. Pressing the bottom of the switch once will go to the beginning of the current track or to the beginning of the previous track if it is within one second after the current track begins to play.

If you press the switch up or down twice it plays the second track, three times, it will play the third, etc.

The button in the center of the left hand switch has no function in this mode.

CASSETTE TAPE AND PLAYER MAINTENANCE

To keep the cassette tapes and player in good condition, take the following precautions:

1. Do not use cassette tapes longer than C-90; otherwise, sound quality and tape durability will be greatly diminished.
2. Keep the cassette tape in its case to protect from slackness and dust when it is not in use.
3. Keep the cassette tape away from direct sunlight, heat and magnetic fields such as the radio speakers.
4. Before inserting a tape, make sure that the label is adhering flatly to the cassette.

5. A loose tape should be corrected before use. To rewind a loose tape, insert the eraser end of a pencil into the tape drive gear and twist the pencil in the required directions.

Maintain your cassette tape player. The head and capstan shaft in the cassette player can pick up dirt or tape deposits each time a cassette is played. The result of deposits on the capstan shaft may cause the tape to wrap around and become lodged in the tape transport. The other adverse condition is low or “muddy” sound from one or both channels, as if the treble tone control were turned all the way down. To prevent this, you should periodically clean the head with a commercially available WET cleaning cassette.

As preventive maintenance, clean the head about every 30 hours of use. If you wait until the head becomes very dirty (noticeably poor sound), it may not be possible to remove all deposits with a simple WET cleaning cassette.

COMPACT DISC MAINTENANCE

To keep the compact discs in good condition, take the following precautions:

1. Handle the disc by its edge; avoid touching the surface.
2. If the disc is stained, clean the surface with a soft cloth, wiping from center to edge.
3. Do not apply paper or tape to the disc; avoid scratching the disc.
4. Do not use solvents such as benzene, thinner, cleaners, or antistatic sprays.
5. Store the disc in its case after playing.
6. Do not expose the disc to direct sunlight.
7. Do not store the disc where temperatures may become too high.

NOTE: If you experience difficulty in playing a particular disc, it may be damaged, oversized, or have theft protection encoding. Try a known good disc before considering disc player service.

RADIO OPERATION AND CELLULAR PHONES

Under certain conditions, the operation of a cellular phone in your vehicle can cause erratic or noisy performance from your radio. This condition may be lessened or eliminated by relocating the cellular phone antenna. This condition is not harmful to the radio. If your radio performance does not satisfactorily “clear” by the repositioning of the antenna, it is recommended that the radio volume be turned down or off during cellular phone operation.

CLIMATE CONTROLS

The controls for the heating and ventilation system in this vehicle consist of a series of rotary knobs. These comfort controls can be set to obtain desired interior conditions.

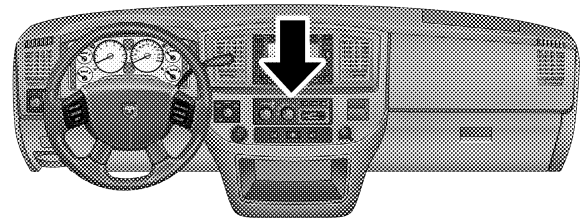

8164639b

Climate Control Location

Heater Only — If Equipped

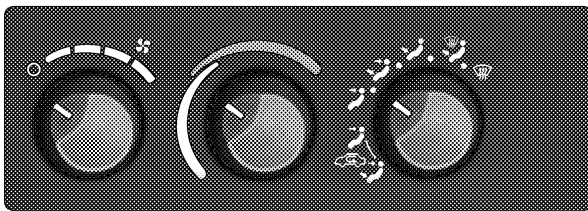

Manual Heating Controls

81646397



816463c5

The mode control (at the right of the control panel) can be set in any of the following positions:

NOTE: To improve your selection choices, the system allows you to operate at intermediate positions between the major modes. These intermediate positions are identified by the small dots.

Panel

 Outside air flows through the outlets located in the instrument panel.

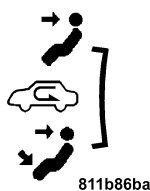
Recirculation Modes (Panel or Bi-Level)

Select the recirculation modes when the outside air contains smoke or odors. This feature allows for recirculation of interior air only. Air flows through the panel outlets in this mode. Air flows through the panel only or through both the panel and floor vents

depending on the selected mode (panel vs bi-level).

Bi-Level

 Outside air flows through the outlets located in the instrument panel and at the floor.

Mix

 Outside air flows in equal proportions through the floor and defroster outlets.

Defrost

 Outside air is primarily directed to the windshield through the defroster outlets located at the base of

the windshield, and the demister outlets located at the edge of each side of the instrument panel.

Blower Control

The rotary knob on the left of the control panel is the blower control. Turn the knob clockwise to one of the four positions to obtain the blower speed you desire. To turn the blower off, turn the knob to the far left position.

816463cd

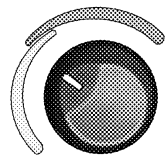
Temperature Control

The rotary knob at the center of the control panel controls the temperature of the interior air. You can choose your degree of comfort by rotating the knob. The coldest temperature setting is to the extreme left (blue region) and the warmest setting is to the extreme right (red region) of the rotation.

816463c9

Air Conditioning and Heating — If Equipped

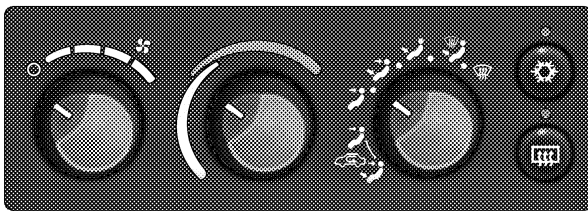

81646393

Air Conditioning And Heating

Air Conditioning Operation



To turn on the Air Conditioning, set the fan control at any speed and press the snowflake button located at the right of the control panel. Conditioned air will be directed through the

outlets selected by the mode control. A light in the snowflake button shows that the air conditioning is on. Press the button a second time to turn the air conditioning off.

Slight changes in engine speed or power may be noticed when the air conditioning compressor is on. This is a normal occurrence as the compressor will cycle on and off to maintain comfort and increase fuel economy.



816463c5

The mode control (at the right of the control panel) can be set in any of the following positions:

NOTE: To improve your selection choices, the system allows you to operate at intermediate positions between the major modes. These intermediate positions are identified by the small dots.

Recirculation Modes (Panel or Bi-Level)



Select the recirculation modes when the outside air contains smoke, odors, high humidity, or if rapid cooling is desired. This feature allows for recirculation of interior air only. Air flows through the panel only or through both the panel and floor vents depending on the selected mode (panel vs bi-level).

NOTE: Selecting a “Recirculation Mode” mode does not necessarily consume more fuel than normal A/C mode.

Panel

 Outside air flows through the outlets located in the instrument panel.

Bi-Level

 Outside air flows through the outlets located in the instrument panel and at the floor.

Floor

 Outside air flows primarily through the floor outlets located under the instrument panel.

Mix

 Outside air flows in equal proportions through the floor and defroster outlets, and the air conditioning may be on.

Defrost

 Outside air is primarily directed to the windshield through the defroster outlets located at the base of the windshield, and the demister outlets located at the edge of each side of the instrument panel, and the air conditioning may be on.

Blower Control

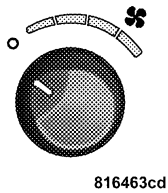

The rotary knob on the left of the control panel is the blower control. Turn the knob clockwise to one of the four positions to obtain the blower speed you desire. To turn the blower off, turn the knob to the far left position.

Temperature Control

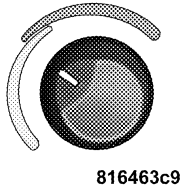

The rotary knob at the center of the control panel controls the temperature of the interior air. You can choose your degree of comfort by rotating the knob. The coldest temperature setting is to the extreme left (blue region) and the warmest setting is to the extreme right (red region) of the rotation.

Circulation

The cab is designed with features to promote outside air circulation. There are grilles in the cab back panel. These are air exhausters that provide the means for regular exchange of cab air.

Side window demisters direct air flow specifically to the window glass to help prevent interior fogging of the glass. They are located in the extreme outside upper edges of the instrument panel. The demisters also provide extra air ducts for circulation. They are in operation whenever the Floor, Mix or Defrost modes are in use. To remove frost from the side windows, it is best to use the full defrost mode.

NOTE: When you turn off the engine you may hear a hissing sound from under the hood for a short period of time. This is a normal condition that occurs if the air conditioning system has been on. It is not an indication of a problem with the air conditioning system.

Air Conditioning with Dual Zone Temperature Control — If Equipped

With the Dual Zone Temperature Control System, each front seat occupant can independently control the temperature of air coming from the outlets on their side of the vehicle.

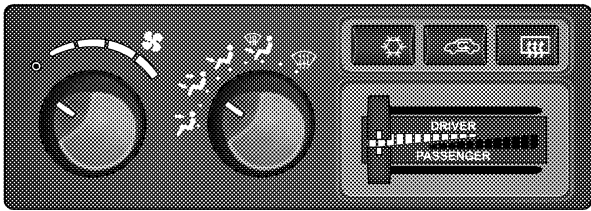

Dual Zone Control Head

8164638f

Air Conditioning and Heating Operation

To turn on the Air Conditioning, set the fan control at any speed and press the snowflake button located on the control panel. Conditioned air will be directed through the outlets selected by the mode control. A light in the snowflake button shows that the air conditioning is on. Press the button a second time to turn the air conditioning off.

A/C Pushbutton

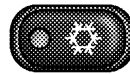

80d0bd96

With the fan control in the ON position, pushing the A/C button turns on the air conditioning compressor. An indicator light on the button shows that the Air Conditioning compressor is on. Conditioned air is now directed through the mode outlets selected. Pushing the button a second time turns the compressor OFF.

Recirculation Pushbutton

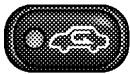

811b86fe

Pushing the Recirculation button allows interior air to recirculate continuously in any position except defrost and defrost/floor mode for rapid cool down of the interior. See “Fast Cooldown” later in this section.

Mode Control



816463c5

The mode control allows you to choose from several patterns of air distribution.

NOTE: To improve your selection choices, the system allows you to operate at intermediate positions between

the major modes. These intermediate positions are identified by the small dots and give an even blend of both modes.

Panel

➔ Outside air flows through the outlets located in the instrument panel. These outlets can be adjusted to direct the airflow.

Bi-Level

➔ Air flows through the outlets located in the instrument panel and those located on the floor.

NOTE: There is a difference in temperature between the upper and lower outlets for added comfort. The warmer air goes to the floor outlets. This feature gives improved comfort during sunny but cool conditions.

Heat

➔ Outside air flows primarily through the floor outlets located under the instrument panel.

Mix

 Outside air flows in equal proportions through the floor and defroster outlets.

Defrost

 Outside air is primarily directed to the windshield through the defroster outlets located at the base of the windshield and side window demist outlets.

NOTE: The air conditioning compressor operates in both Mix and Defrost or a blend of these modes, even if the A/C button has not been pressed. This dehumidifies the air to help dry the windshield.

Blower Control

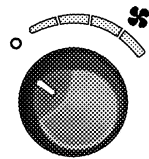

816463cd

The rotary knob on the left of the control panel is the blower control. Turn the knob clockwise to one of the four positions to obtain the blower speed you desire. To turn the blower off, turn the knob to the far left position.

Dual Zone Temperature Control

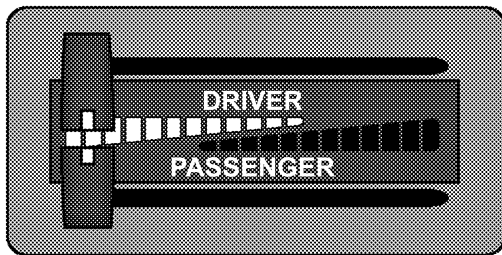

816463c0

Dual Zone Temperature Control

Use this control to regulate the temperature of the air inside the passenger compartment. This is accomplished by having separate temperature control slides for both

the driver and front passenger. The blue area of the scale indicates cooler temperatures while the red area indicates warmer temperatures.

Circulation

The cab is designed with features to promote outside air circulation. There are grilles in the cab back panel. These are air exhausters that provide the means for regular exchange of cab air.

Side window demisters direct air flow specifically to the window glass to help prevent interior fogging of the glass. They are located in the extreme outside upper edges of the instrument panel. The demisters also provide extra air ducts for circulation. They are in operation whenever the Floor, Mix or Defrost modes are in use.

NOTE: When you turn off the engine you may hear a hissing sound from under the hood for a short period of time. This is a normal condition that occurs if the air

conditioning system has been on. It is not an indication of a problem with the air conditioning system.

Rear Air Duct—Mega Cab Only

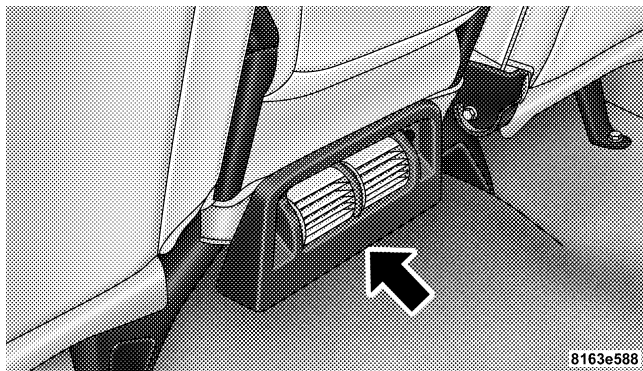

Mega Cab Rear Air Duct

The rear seat will receive air flow in all modes except for Defrost.

The rear air duct is designed to be pointed up when in A/C mode, and pointed down in Heat mode.

Operating Tips

Fast Cooldown

For a fast cooldown, turn the blower fan rotary knob to the extreme right position, turn the mode control to the panel fresh position, press the snowflake button to turn on the air conditioning, and drive with the windows open for the first few minutes. Once the hot air has been expelled, close the windows and press the Recirculation push-button. When a comfortable condition has been reached, choose a mode position and adjust the temperature control slide and blower speed as necessary to maintain comfort. For high humidity conditions it may be necessary to remain in the Recirculation mode to maintain comfort.

Window Fogging

Windows will fog on the inside when the humidity inside the vehicle is high. This often occurs in mild or cool temperatures when it's rainy or humid. In most cases turning on the Air-conditioning (pressing the snowflake button) will clear the fog. Adjust the temperature control, air direction and blower speed to maintain comfort.

As the temperature gets colder it may be necessary to direct air onto the windshield by using MIX Mode position on the control. Adjust the temperature control and blower speed to maintain comfort. Higher blower speeds will reduce fogging. Interior fogging on the windshield can be quickly removed by selecting the defrost mode.

Regular cleaning of the inside of the windows with a non-filming cleaning solution (vinegar and water works very well) will help prevent contaminants (cigarette

smoke, perfumes, etc.) from sticking to the windows. Contaminates increase the rate of window fogging.

Summer Operation

Air conditioned vehicles must be protected with a high quality antifreeze coolant during summer to provide proper corrosion protection and to raise the boiling point of the coolant for protection against overheating. A 50 % concentration is recommended. Refer to Recommended Fluids and Genuine Parts for the proper coolant type.

When using the air conditioner in extremely heavy traffic in hot weather especially when towing a trailer, additional engine cooling may be required. If this situation is encountered, operate the transmission in a lower gear to increase engine RPM, coolant flow and fan speed. When stopped in heavy traffic, it may be necessary to shift into NEUTRAL and depress the accelerator slightly for fast idle operation to increase coolant flow and fan speed.











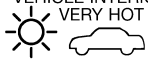







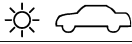



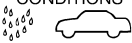





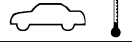





NOTE: On models equipped with Diesel engines, the idle speed will automatically increase to 1000 rpm at elevated coolant temperatures to improve engine cooling.

Your air conditioning system is also equipped with an automatic recirculation system. When the system senses a heavy load or high heat conditions, it may use partial Recirculation A/C mode to provide additional comfort.

Winter Operation

When operating the system during the winter months, make sure the air intake, located directly in front of the windshield, is free of ice, slush, snow, or other obstructions.

Operating Tips Chart

WEATHER	CONTROL SETTINGS
<p>HOT WEATHER AND VEHICLE INTERIOR IS VERY HOT</p> 	<p>Start the vehicle, open the windows and turn the blower control knob to the high position (full clockwise). Set Mode control knob at or between  and . Set temperature control to full cold and press the  button on. After the hot air has been expelled, close the windows and turn the mode control knob to the  setting (counterclockwise) at either  or , or press the  button (if so equipped). Once comfortable, choose a mode position and adjust temperature control and blower speed as necessary for comfort.</p>
<p>WARM WEATHER</p> 	<p>If sunny, set the Mode control at or near  and press the  button on. If cloudy or dark, set the Mode control at or near . No  is necessary.</p>
<p>COOL OR COLD HUMID CONDITIONS</p> 	<p>If sunny, set the Mode control at or between  and , then press the  button on. If cloudy or dark set the Mode control at or near . No  is necessary.</p>
<p>COLD DRY CONDITIONS</p> 	<p>In cloudy or dark weather set the Mode control at or near . If sunny, set the Mode control at or between  and , and for snowy or very cold weather requiring extra heat to the windshield, use .</p>
<p>EXTREME COLD CONDITIONS (DIESEL)</p> 	<p>Using re-circulated air can aid initial warm-up in extreme cold conditions. NOTICE: Running in  /MAX for long periods of time will result in window fogging. When this occurs, use  until windows clear. This will deactivate  /MAX. SINGLE ZONE VEHICLES: Set the mode control at  +  /MAX, close the panel vents and set the temperature control to full hot. Turn blower control knob to low and gradually increase as air and engine temperature increase. DUAL ZONE VEHICLES: Set the mode control at , set both temperature controls to full hot and press the  /MAX button. Turn blower control knob to low and gradually increase as air and engine temperature increase.</p>
<p>WINDOW FOGGING</p>	<p>In most cases turning on the Air-Conditioning (press the  button) will clear the fog, then adjust temperature control, air direction and blower speed to maintain comfort. As it gets colder it may be necessary to direct air onto the windshield. If so, set the Mode control at  or  and adjust temperature control and blower speed to maintain comfort. Higher blower speeds will reduce fogging.</p>

8159dfbc

STARTING AND OPERATING

CONTENTS

■ Starting Procedures – Diesel Engines	253	□ Engine Idling — In Cold Weather	263
□ Manual Transmission – If Equipped	253	□ Stopping The Engine	264
□ Automatic Transmission – If Equipped	253	□ Engine Speed Control	265
□ Normal Starting Procedure — Engine Manifold Airtemperature Above 66°F (19°C)	254	□ Operating Precautions	265
□ Starting Procedure — Engine Manifold Air Temperature Below 66°F (19°C)	255	□ Cooling System Tips — Automatic Transmission	266
□ Starting Fluids	259	■ Transmission Shifting	267
■ Normal Operation (Diesel Engine)	259	□ Automatic Transmission With Overdrive— If Equipped	267
□ Cold Weather Precautions	260		

250 STARTING AND OPERATING

■ Manual Transmission	274	■ Driving Off-Road	289
□ Downshifting	275	■ Parking Brake	290
■ Four-Wheel- Drive Operation — If Equipped . . .	276	■ Brake System	291
□ Manually Shifted Transfer Case Operating Information/Precautions	276	□ Brake Noise	292
□ Shifting Procedure - Manually Shifted Transfer Case	279	□ Four-Wheel Anti-Lock Brake System	292
□ Transfer Case Reminder Light	280	■ Power Steering	294
□ Electronically Shifted Transfer Case Operating Information/Precautions-If Equipped	280	■ Tire Safety Information	295
□ Shifting Procedure - Electronically Shifted Transfer Case	285	□ Tire Markings	295
■ Limited-Slip Differential — If Equipped	287	□ Tire Identification Number (TIN)	299
■ Driving On Slippery Surfaces	288	□ Tire Loading And Tire Pressure	300
		■ Tires — General Information	304
		□ Tire Pressure	304
		□ Tire Inflation Pressures	305

□ Radial-Ply Tires	307	■ Tire Rotation Recommendations	315
□ Compact Spare Tire — If Equipped	308	□ Dual Rear Wheels	316
□ Limited Use Spare — If Equipped	309	■ Engine Runaway	317
□ Tire Spinning	309	■ Fuel Requirements (Diesel Engines)	318
□ Tread Wear Indicators	310	□ Fuel Specifications	318
□ Life Of Tire	311	■ Adding Fuel (Diesel Engines)	320
□ Replacement Tires	311	□ Fuel Filler Cap (Gas Cap)	321
□ Alignment And Balance	312	□ Bulk Fuel Storage	322
■ Supplemental Tire Pressure Information – If Equipped	313	■ Vehicle Loading	323
■ Tire Chains	313	□ Certification Label	323
■ Snow Tires	315		

252 STARTING AND OPERATING

■ Trailer Towing	327	□ Snowplow Prep Package Model Availability . .	342
□ Common Towing Definitions	327	□ Over The Road Operation With Snowplow Attached	343
□ Trailer Hitch Classification	331	□ Methods For Removing Snow	343
□ Trailer Towing Weights (Maximum Trailer Weight Ratings)	332	□ Operating Tips	343
□ Trailer And Tongue Weight	332	□ General Maintenance	344
□ Towing Requirements	333	■ Recreational Towing (Behind Motorhome, Etc.) . .	345
□ Towing Tips	338	□ Recreational Towing – 2 Wheel Drive Models	345
□ Trailer Towing Mirrors — If Equipped	339	□ Recreational Towing – 4 Wheel Drive Models	345
■ Snowplow	341		
□ Before Plowing	342		

STARTING PROCEDURES – DIESEL ENGINES

The starter should not be operated for more than 15-second intervals. Waiting a few seconds between such intervals will protect the starter from overheating.

WARNING!

Be sure to turn off the engine if you want to rest or sleep in your car. Accidents can be caused by inadvertently moving the gear selection lever or by pressing the accelerator pedal. This may cause excessive heat in the exhaust system, resulting in overheating and vehicle fire which may cause serious or fatal injuries.

WARNING!

Do not leave children or animals inside parked vehicles in hot weather. Interior heat build up may cause serious injury or death.

Manual Transmission – If Equipped

Apply the parking brake, place the gearshift control lever in NEUTRAL and depress the clutch pedal to the floor before starting the vehicle. This vehicle is equipped with a clutch interlocking ignition system. It will not start unless the clutch is fully depressed.

Automatic Transmission – If Equipped

Start the engine with the selector lever in NEUTRAL or PARK position. Apply the brake before shifting to any driving range.

The Cummins Diesel engine is equipped with several features designed to assist cold weather starting and operation:

- The engine block heater is a resistance heater installed in the water jacket of the engine just above and behind the oil filter. It requires a 110–115 volt AC electrical outlet with a grounded, three-wire extension cord.

NOTE: The engine block heater cord is a factory installed option. If your vehicle is not equipped, heater cords are available from your authorized Mopar® dealer.

- A 12-volt heater built into the fuel filter housing aids in preventing fuel gelling. It is controlled by a built-in thermostat.
- A heated intake air system both improves engine starting and reduces the amount of white smoke generated by a warming engine.

Normal Starting Procedure — Engine Manifold Air Temperature Above 66°F (19°C)

Observe the Instrument Panel Cluster lights when starting the engine.

1. Always apply the parking brake.
2. Shift into PARK for an automatic transmission. Fully depress and hold the clutch and shift into NEUTRAL for a manual transmission. Models with manual transmission are equipped with a clutch interlocking cranking system. The clutch must be fully depressed to start the vehicle.
3. Turn the ignition key to the ON position and look at the instrument panel cluster lamps.

CAUTION!

If **WATER IN FUEL** indicator light remains on **DO NOT START** engine before you drain water from the fuel filter to avoid engine damage. See Section 7 — Maintaining Your Vehicle, for water drain procedures.

4. Turn the ignition key to START and crank the engine. Do not press the accelerator during starting.

CAUTION!

Do not crank engine for more than 15 seconds at a time as starter motor damage may result. Turn key to OFF and wait at least two minutes before trying again.

5. When the engine starts, release the key.
6. Check to see that there is oil pressure.
7. Release the parking brake.

Starting Procedure — Engine Manifold Air Temperature Below 66°F (19°C)

NOTE: The temperature displayed on the overhead console (if equipped) does not necessarily reflect the engine manifold air temperature. When certain engine temperatures fall below 66°F (19°C) the lamp will remain on indicating the intake manifold heater system is active.

Follow the steps in the Normal Starting Procedure except:

CAUTION!

Do not crank engine for more than 15 seconds at a time or starter motor damage may result. Turn key to OFF and wait at least 2 minutes for starter to cool before repeating start procedure.

- The WAIT TO START light will remain on for a period of time (length of time depends on engine temperature).
- After the WAIT TO START light goes off, turn the ignition key to START. Do not press the accelerator during starting.
- After engine start-up, check to see that there is oil pressure.

- Allow the engine to idle about three minutes until the manifold heaters have completed the post-heat cycle.
- Release the parking brake and drive.

NOTE: Engine idle speed will automatically increase to 1000 rpm at low coolant temperatures to improve engine warm-up.

NOTE: If the engine stalls or if the ignition switch is left On for more than 2 minutes after the WAIT TO START light goes out, reset the grid heaters by turning the ignition switch to Off for at least 5 seconds and then back On. Repeat steps 3 through 7 of the normal starting procedure.

For Extremely Cold Weather Starting — Engine Manifold Air Temperature Below 0°F (- 18°C)

In extremely cold weather below 0°F (- 18°C) it may be beneficial to cycle the manifold heaters twice before

attempting to start the engine. This can be accomplished by turning the ignition OFF for at least 5 seconds and then back ON after the WAIT TO START light has gone off, but before the engine is started. However, repeated cycling of the manifold heaters will result in damage to the heater elements or reduced battery voltage.

NOTE: If multiple pre-heat cycles are used before starting, additional engine run time may be required to maintain battery state of charge at a satisfactory level.

- If the engine stalls after the initial start, the ignition must be turned to the OFF position for at least 5 seconds and then to the ON position to recycle the manifold heaters.

NOTE: Excessive white smoke and poor engine performance will result if manifold heaters are not recycled.

- Heat generated by the manifold heaters dissipates rapidly in a cold engine. If more than two minutes

pass between the time the WAIT TO START light goes OFF and the engine is started, recycle the manifold heaters by turning the ignition OFF for at least 5 seconds and then back ON.

- If the vehicle is driven and vehicle speed exceeds 19 mph (31 km) before the manifold heater post-heat (after start) cycle is complete, the manifold heaters will shut off.
- If the engine is started before the WAIT TO START light turns off, the preheat cycle will turn off.
- If the engine is cranked for more than 10 seconds, the post-heat cycle will turn off.

NOTE: Engine idle speed will automatically increase to 1000 rpm at low coolant temperatures to improve engine warm-up.

NOTE: When a diesel engine is allowed to run out of fuel or the fuel gels at low temperatures, air is pulled into the fuel system.

You may try priming as described below.

1. Add a substantial quantity of fuel to the tank (5 to 10 gallons) or eliminate the gelled fuel condition.
2. Crank the engine for 1 to 2 seconds. If the engine does not start, then release the key or starter button back to the RUN position (do not turn the key back to the OFF position). The electric fuel transfer pump will continue to run and purge air from the system for about 20 seconds. After 20 seconds, attempt to start the engine again.
3. Start the engine using the Normal Starting Procedure.
4. Repeat the procedure if the engine does not start.

WARNING!

Do not open the high pressure fuel system when cranking the engine or with the engine running. Engine operation causes high fuel pressure. High pressure fuel spray can cause serious injury or death.

NOTE: The engine may run rough until the air is forced from all the fuel lines.

Starting Fluids**WARNING!**

STARTING FLUIDS or flammable liquids are **NEVER TO BE USED** in the Cummins Diesel (see Warning label). Never pour diesel fuel, flammable liquid, starting fluids (ether) into the air cleaner canister, air intake piping, or turbocharger inlet in an attempt to start the vehicle. This could result in a flash fire and explosion causing serious personal injury and engine damage.

The engine is equipped with an automatic electric air preheating system. If the instructions in this manual are followed, the engine should start in all conditions.

WARNING!

Do not leave children or animals inside parked vehicles in hot weather. Interior heat build up may cause serious injury or death.

NORMAL OPERATION (DIESEL ENGINE)

Observe the following when the engine is operating.

- All message center lights are off.
- Check Engine Lamp is off.
- Engine Oil Pressure is above 10 psi (69 kPa) at idle.
- Low Oil Pressure light is off.

- Voltmeter Operation:
 - The voltmeter may show a gauge fluctuation if certain engine temperatures are below 66°F (19°C). This cycling operation is caused by the post-heat cycle of the intake manifold heater system. The number of cycles and the length of the cycling operation is controlled by the engine control module, this time will not exceed 150 seconds. The needle should then stabilize at the approximate operation point.
 - The cycling action will cause temporary dimming of the headlamps, interior lamps, and also a noticeable reduction in blower motor speed.

Cold Weather Precautions

Operation in ambient temperature below 32°F (0°C) may require special considerations. The following charts suggest these options:

Fuel Operating Range

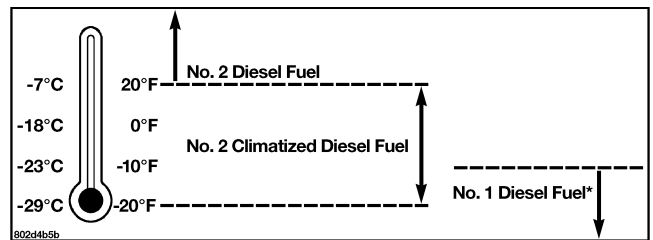

* No. 1 diesel fuel should only be used where extended arctic conditions (-10°F/-23°C) exist.

NOTE:

- Use of Climatized Diesel Fuel or Number 1 Diesel Fuel results in a noticeable decrease in fuel economy.
- Climatized Diesel Fuel is a blend of Number 2 and Number 1 Diesel Fuels which reduces the temperature at which wax crystals form in fuel.

NOTE: Refer to Fuel Requirements in this section for further details on fuel recommendations.

Engine Block Heater

The engine block heater warms engine coolant and permits quicker starts in cold weather. Connect the heater cord to a ground-fault interrupter protected 110–115 volt AC electrical outlet with a grounded, three-wire extension cord.

The engine block heater cord is routed under the hood to the right side and can be located just behind the grille near the headlamp.

NOTE: The engine block heater cord is a factory installed option. If your vehicle is not equipped, heater cords are available from your authorized Mopar® dealer.

The block heater must be plugged in at least one hour to have an adequate warming effect on the coolant.

WARNING!

Remember to disconnect the cord before driving. Damage to the 110–115 volt electrical cord could cause electrocution.

NOTE: The block heater will require 110 Volts AC and 6.5 Amps to activate the heater element.

Block Heater Usage**A. Temperatures below 0°F (-18°C)**

- Block Heater Required for 15W-40
- Block Heater Recommended for 5W-40

B. Temperatures below -20°F (-29°C)

- Block Heater Required for 5W-40

Winter Front Usage

If a winter front or cold weather cover is to be used, a percentage of the total grille opening area must be left uncovered to provide sufficient air flow to the charge air cooler and automatic transmission oil cooler. The percentage of opening must be increased with the increasing ambient air temperature and/or engine load. If the cooling fan can be heard cycling frequently, increase the size of the opening in the winter front. A suitable cold weather cover is available from your Mopar® dealer.

Battery Blanket Usage

A battery loses 60% of its cranking power as the battery temperature decreases to 0°F (-18°). For the same decrease in temperature, the engine requires twice as much power to crank at the same RPM. The use of 120 VAC powered battery blankets will greatly increase starting capability at low temperatures. Suitable battery blankets are available from your authorized Mopar® dealer.

Arctic Operation

Where there are no provisions to keep the engine warm when it is operating in ambient temperatures consistently below (-10°F/-23°C), use 5W-40 **synthetic** engine oil and fuel that meets the requirements in Section 7, "Maintenance Procedures," Engine Oil Selection.

Engine Warm-Up

Avoid full throttle operation when the engine is cold. When starting a cold engine, bring the engine up to operating speed slowly to allow the oil pressure to stabilize as the engine warms up.

NOTE: High-speed, no-load running of a cold engine can result in excessive white smoke and poor engine performance. No-load engine speeds should be kept under 1,200 rpm during the warm-up period, especially in cold ambient temperature conditions.

If temperatures are below 32°F (0°C), operate the engine at moderate speeds for 5 minutes before full loads are applied.

Engine Idling — In Cold Weather

Avoid prolonged idling in ambient temperatures below 0°F. Long periods of idling may be harmful to your engine because combustion chamber temperatures can drop so low that the fuel may not burn completely. Incomplete combustion allows carbon and varnish to form on piston rings and injector nozzles. Also, the unburned fuel can enter the crankcase, diluting the oil and causing rapid wear to the engine.

NOTE: An optional driver-controlled high idle speed is available on automatic transmission equipped vehicles with speed control. This feature allows the driver to select an elevated idle speed between 1100 and 1500 rpms. Your dealer can enable this feature.

NOTE:

- If ambient temperatures are low and the coolant temperature is below 200°F (93°C), the engine idle

speed will slowly increase to 1000 RPM after 2 minutes of idle, if the following conditions are met:

- foot is off brake pedal and throttle pedal
- automatic transmission is in Park (P)
- vehicle speed is zero
- Applying the throttle will cancel fast idle
- If the engine is equipped with an aftermarket exhaust brake (manual transmissions only), operating the exhaust brake at idle will greatly improve warm up rate and will help keep the engine close to operating temperature during extended idle.

Stopping The Engine

Idle the engine a few minutes before routine shutdown. After full load operation, idle the engine 3 to 5 minutes before shutting it down. This idle period will allow the lubricating oil and coolant to carry excess heat away from

the combustion chamber, bearings, internal components, and turbocharger. This is especially important for turbocharged, charge air cooled engines.

NOTE: During engine shutdown on vehicles equipped with manual transmissions, it is normal for the diesel engine to resonate heavily for a moment during engine shut off. When the engine is connected to a manual transmission, this resonance causes load gear rattle from the transmission. This is commonly referred to as “shut down rattle”. The manufacturer recommends performing engine shut down with the clutch pedal pushed to the floor (clutch disengaged). When engine shut down is performed in this manner the rattle is reduced (not eliminated).

Driving Condition	Load	Turbo-charger Temperature	Idle Time (min.) Before Engine Shutdown
Stop and Go	Empty	Cool	Less than One
Stop and Go	Medium		One
Highway Speeds	Medium	Warm	Two
City Traffic	Maximum GCWR		Three
Highway Speeds	Maximum GCWR		Four
Uphill Grade	Maximum GCWR	Hot	Five

Engine Speed Control

CAUTION!

Prevent overspeeding the engine going down hill. When descending steep grades, use a combination of gears and service brakes to control vehicle/engine speed. Overspeed can cause severe engine damage.

5

Operating Precautions

Avoid Overheating The Engine

The temperature of the coolant (a mixture of 50% ethylene-glycol and 50% water) must not exceed the normal range of the temperature gauge (240°F/116°C) with a 16 psi (110 kPa) radiator cap.

Usually the coolant temperature indicated during operation will be to the left of center in the normal range of the gauge.

Avoid Low Coolant Temperature Operation

Continual operation at low coolant temperature below the normal range on the gauge (140°F/60°C) can be harmful to the engine. Low coolant temperature can cause incomplete combustion which allows carbon and varnish to form on piston rings and injector nozzles. Also, the unburned fuel can enter the crankcase, diluting the lubricating oil and causing rapid wear to the engine.

Cooling System Tips — Automatic Transmission

To reduce potential for engine and transmission overheating in high ambient temperature conditions, take the following actions:

- *City Driving* — when stopped, put transmission in neutral and increase engine idle speed.

- *Highway Driving* — reduce your speed.

- *Up Steep Hills* — select a lower transmission gear, but try and keep the torque converter locked.

- *Air Conditioning* — turn it off temporarily.

Do Not Operate The Engine With Low Oil Pressure

When the engine is at normal operating temperature, the minimum oil pressures required are:

- Idle 700 to 800 RPM. 10 psi (69 kPa)
- Full speed and load 30 psi (207 kPa)

CAUTION!

If oil pressure falls to less than normal readings, shut the engine off immediately. Failure to do so could result in immediate and severe engine damage.

Do Not Operate The Engine With Failed Parts

Practically all failures give some warning before the parts fail. Be on the alert for changes in performance, sounds, and visual evidence that the engine requires service. Some important clues are:

- engine misfiring or vibrating severely
- sudden loss of power
- unusual engine noises
- fuel, oil or coolant leaks

- sudden change, outside the normal operating range, in the engine operating temperature
- excessive smoke
- oil pressure drop

TRANSMISSION SHIFTING**Automatic Transmission with Overdrive— If Equipped**

The gear shift selector display, located in the instrument panel cluster, indicates the transmission gear range (the selector is illuminated for night driving). The selector lever is mounted on the right side of the steering column. You must depress the brake pedal, to pull the selector lever out of park (P) position (Brake Interlock System). To drive, move the selector lever from Park or Neutral to the desired drive position. Pull the selector lever toward you when shifting into Reverse, Second, First or Park, or when shifting out of Park.

Gear Ranges

DO NOT race the engine when shifting from Park or Neutral position into another gear range.

“P” Park

This gear position supplements the parking brake by locking the transmission. The engine can be started in this range. Never use Park while the vehicle is in motion. Apply the parking brake when leaving the vehicle in this range. Always apply parking brake first, then place the selector in Park position. On 4-wheel drive vehicles be sure that the transfer case is in a drive position!

WARNING!

Your vehicle could move and injure you and others if it is not completely in P (Park). Check by trying to move the gearshift lever back and forth without first pulling it toward you after you have set it in P. Make sure it is in Park before leaving the vehicle.

WARNING!

It is dangerous to shift the selector lever out of "P" or "N" if the engine speed is higher than idle speed. If your foot is not firmly on the brake pedal, the vehicle could accelerate quickly forward or in reverse. You could lose control of the vehicle and hit someone or something. Only shift into gear when the engine is idling normally and when your right foot is firmly on the brake pedal.

"R" Reverse

Use this range only after the vehicle has come to a complete stop.

"N" Neutral

Shift to Neutral when the vehicle is standing for prolonged periods with the engine running. The engine may be started in this range. Set the parking brake if you must leave the vehicle.

"D" Drive

This position provides all forward gears, including 3rd gear direct and 4th or 5th (if equipped) gear overdrive (see Overdrive Operation). Use this range for most city and highway driving.

"2" Second

Use this position for driving slowly in heavy city traffic or on mountain roads where more precise speed control is desirable. Use it also when climbing long grades, and for engine braking when descending moderately steep grades. To prevent excessive engine speed do not exceed 45 mph (72 km/h) in this range.

"1" First

Use this position for driving up very steep hills and for engine braking at low speeds 20 mph (32 km/h) or less when going downhill. To prevent excessive engine speed, do not exceed 25 mph (40 km/h) in this range.

NOTE: Use caution when operating a heavily loaded vehicle in "2" Second or "1" First gear selections in high ambients as torque converter slip can impose significant additional heat load on the cooling system.

WARNING!

Never use Park position on an automatic transmission as a substitute for the parking brake. Always apply parking brake fully when parked to guard against vehicle movement and possible injury or damage.

Overdrive Operation

The overdrive automatic transmission contains an electronically controlled fourth and fifth (if equipped) speed (Overdrive). The transmission will automatically shift from Drive to Overdrive if the following conditions are present:

- the transmission selector is in Drive;
- the engine coolant has reached normal operating temperature;
- vehicle speed is above approximately 30 mph (48 km/h);
- the "TOW HAUL O/D OFF" switch has not been activated;
- transmission has reached normal operating temperature.

NOTE: If the vehicle is started in extremely cold temperatures, the transmission may not shift into Overdrive and will automatically select the most desirable gear for operation at this temperature. Normal operation will resume when the transmission fluid temperature has risen to a suitable level. Refer also to the Note under torque converter clutch, later in this section.

If the transmission temperature gets extremely hot, the transmission will automatically select the most desirable gear for operation at this temperature. If the transmission temperature becomes hot enough the TRANS TEMP light may illuminate and the transmission may downshift out of Overdrive until the transmission cools down. After cooldown, the transmission will resume normal operation.

The transmission will downshift from Overdrive to Drive if the accelerator pedal is fully depressed at vehicle speeds above approximately 35 mph (56 km/h).

When To Use "TOW HAUL" and "O/D OFF" Modes



Tow Haul O/D Off Switch

When driving in hilly areas, towing a trailer, carrying a heavy load, etc., and frequent transmission shifting occurs, press the "TOW HAUL O/D OFF" button once to select TOW HAUL. This will improve performance and

reduce the potential for transmission overheating or failure due to excessive shifting. When operating in "TOW HAUL" mode, 5th gear (if equipped) is disabled and 2-3 and 3-4 shift patterns are modified. Shifts into Overdrive (4th gear) are allowed during steady cruise (for improved fuel economy) and automatic closed-throttle downshifts to 3rd gear (for improved braking) will occur during steady braking. Pressing the "TOW HAUL O/D OFF" button a second time to select O/D OFF will disable 4th and 5th gear completely, which should eliminate any excessive transmission shifting.

The "TOW HAUL" or "O/D OFF" light will illuminate in the instrument cluster to indicate when the switch has been activated. Pressing the switch a third time restores normal operation. If the "TOW HAUL" or "O/D OFF" modes are desired, the button must be pressed each time the engine is started.

When To Lock Out Overdrive

When driving in hilly areas, towing a trailer, carrying a heavy load, etc., and frequent 4-3-4 transmission shifting occurs, press the "TOW/HAUL" button. This will improve performance and reduce the potential for transmission overheating or failure due to excessive shifting.

Torque Converter Clutch

A feature, designed to improve fuel economy, has been included in the automatic transmission on your vehicle. A clutch within the torque converter engages automatically at calibrated speeds. This may result in a slightly different feeling or response during normal operation in high gear. When the vehicle speed drops or during acceleration when the transmission downshifts to second gear, the clutch automatically disengages.

NOTE: The torque converter clutch will not engage until the transmission fluid and engine coolant are warm [usually after 1-3 miles (1.6 - 4.8 km) of driving]. Because

the engine speed is higher when the torque converter clutch is not engaged, it may seem as if the transmission is not shifting into Overdrive when cold. This is normal. Pressing the "TOW/HAUL" button, when the transmission is sufficiently warm, will demonstrate that the transmission is able to shift into and out of overdrive.

NOTE: If the vehicle has not been driven in several days, the first few seconds of operation after shifting the transmission into gear may seem sluggish. This is due to the fluid partially draining from the torque converter into the transmission. This condition is normal and will not cause damage to the transmission. The torque converter will refill within five seconds of shifting from Park into any other gear position.

Out of Park Sense Alarm

Vehicles with a Diesel Engine and 4 speed hydraulic Automatic Transmission are equipped with an Alarm that warns the customer, upon exiting the vehicle, that

the transmission is not in the Park position. This feature will only be functional under following conditions:

- engine running
- foot off the brake pedal
- driver's seat belt is unbuckled
- driver's door is open.

When this feature is triggered the horn will sound, the high beams and turn signal lamps will flash, and the PRNDL position will flash. This will continue until one of the following conditions is met:

- engine is turned off
- transmission is in Park
- driver's seat belt is buckled
- brakes applied.

The alarm will continue for 3 minutes if the driver's door is closed but none of the other conditions listed above are met.

MANUAL TRANSMISSION

WARNING!

You or others could be injured if you leave the vehicle unattended without having the parking brake fully applied. The parking brake should always be applied when the driver is not in the vehicle, especially on an incline.

Truck models with manual transmission are equipped with a clutch interlocking ignition system. The clutch pedal must be fully depressed to start the vehicle.

Fully depress the clutch pedal before shifting gears. As you release the clutch pedal, lightly depress the accelerator pedal.

This transmission has a "creeper" 1st gear which should be used to start from a standing position when carrying a payload or towing a trailer. Damage to the clutch can result from starting in 2nd or 3rd gear with a loaded vehicle. An unloaded vehicle may be launched in 2nd gear. Use each gear in numerical order – do not skip a gear.

For most city driving you may find it easier to use only 1st through 5th gear ranges. For steady highway driving with light accelerations, 6th gear is recommended. To shift into 5th gear, move the shift lever to the right beyond the spring pressure point and push it forward. When shifting from 5th to 4th gear, pull the lever down

toward you in one motion. Do not pull the lever sharply left as you may shift accidentally into 2nd gear and damage the transmission.

You should use 1st gear when starting from a standing position if under heavy load or when pulling a trailer.

To shift into Reverse, come to a complete stop. Depress the clutch and pause briefly to allow the gear train to stop. Move the shift lever from the Neutral position straight across and back into Reverse.

Never drive with your foot resting on the clutch pedal, or attempt to hold the vehicle on a hill with the clutch pedal partially engaged, as this will cause abnormal wear on the clutch.

Downshifting

Moving from a high gear down to a lower gear is recommended to preserve brakes when driving down steep hills. In addition, downshifting at the right time provides better acceleration when you desire to resume speed. Downshift progressively. Do not skip gears to avoid overspeeding the engine and clutch. For acceleration at speeds less than 15 mph (25 km/h), 2nd gear is recommended.

CAUTION!

When descending a hill, be very careful to downshift one gear at a time to prevent overspeeding the engine which can cause valve damage.

To prevent clutch and transmission damage, your vehicle should be downshifted at speeds no greater than those listed in the Maximum Recommended Downshifting Speed chart.

Maximum Recommended Downshifting Speeds

Gear Selection	1st	2nd	3rd	4th	5th
Maximum Speed	10 mph (16 km/h)	19 mph (31 km/h)	32 mph (51 km/h)	50 mph (80 km/h)	68 mph (109 km/h)

FOUR-WHEEL- DRIVE OPERATION — IF EQUIPPED

Four-Wheel-Drive Dodge Ram Trucks are equipped with either a Manually Shifted transfer case or an Electronically Shifted transfer case. See the operating instructions for your transfer case, located within this section.

Manually Shifted Transfer Case Operating Information/Precautions

The transfer case provides 4 mode positions - 2 (rear)-wheel-drive high range, 4-wheel-drive high range, neutral, and 4-wheel-drive low range.

This transfer case is intended to be driven in the 2-wheel-drive position (2H) for normal street and highway conditions such as dry hard surfaced roads.

When additional traction is required the transfer case 4H and 4L positions can be used to lock the front and rear driveshafts together and force the front and rear wheels to rotate at the same speed. This is accomplished by simply moving the shift lever to the desired positions. The 4H and 4L positions are intended for loose, slippery road surfaces only. Driving in the 4H and 4L positions on dry hard surfaced roads may cause increased tire wear and damage to the driveline components.

The 4-wheel-drive light (4WD), located in the instrument cluster, alerts the driver that the vehicle is in 4-wheel drive and that the front and rear driveshafts are locked together. This light illuminates when the transfer case is shifted to either the 4H or 4L positions. There is no light for the 2H or N (Neutral) positions.

When operating your vehicle in 4L, the engine speed is approximately three times that of the 2H or 4H positions at a given road speed. Take care not to overspeed the engine and do not exceed 25 mph (40 km/h).

Proper operation of 4-wheel-drive vehicles depends on tires of equal size, type and circumference on each wheel. Any difference will adversely affect shifting and can cause damage to the transfer case.

NOTE: Do not attempt to make a shift while only the front or rear wheels are spinning. The transfer case is not equipped with a synchronizer and therefore the front and rear driveshaft speeds must be equal for the shift to take place. Shifting while only the front or rear wheels are spinning can cause damage to the transfer case.

Because 4-wheel drive provides improved traction, there is a tendency to exceed safe turning and stopping speeds. Do not go faster than road conditions permit.

NOTE: Delayed shifts out of four-wheel drive may be experienced due to uneven tire wear, low or uneven tire pressures, excessive vehicle loading, or cold temperatures.

WARNING!

You or others could be injured if you leave the vehicle unattended with the transfer case in the Neutral (N) position without first fully engaging the parking brake. The transfer case Neutral (N) position disengages both the front and rear driveshafts from the powertrain and will allow the vehicle to move regardless of the transmission position. The parking brake should always be applied when the driver is not in the vehicle.

For additional information on the appropriate use of each transfer case mode position see the information below:

2H

Rear Wheel Drive High Range - Normal street and highway driving. Dry hard surfaced roads.

4H

4-Wheel-Drive High Range - Locks the front and rear driveshafts together. Forces the front and rear wheels to rotate at the same speed. Additional traction for loose, slippery road surfaces only.

N

Neutral - Disengages both the front and rear driveshafts from the powertrain. To be used for flat towing behind another vehicle. See Recreational Towing for more information.

4L

4-Wheel-Drive Low Range - Low speed 4-wheel-drive. Locks the front and rear driveshafts together. Forces the front and rear wheels to rotate at the same speed. Additional traction and maximum pulling power for loose, slippery road surfaces only. Do not exceed 25 mph (40 km/h).

Shifting Procedure - Manually Shifted Transfer Case

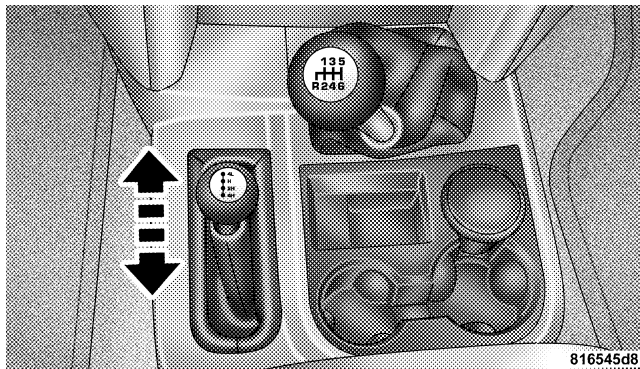

Manual Transfer Case Shifter

2H ⇔ 4H

Shifting between 2H and 4H can be made with the vehicle stopped or in motion. If the vehicle is in motion, shifts can be made up to 55 mph (88 km/h). With the

vehicle in motion, the transfer case will engage / disengage faster if you momentarily release the accelerator pedal after completing the shift. Apply a constant force when shifting the transfer case lever.

2H or 4H ⇔ 4L

With the vehicle rolling at 2 to 3 mph (3 to 5 km/h), shift an automatic transmission to N (Neutral) or depress the clutch on a manual transmission. While the vehicle is coasting at 2 to 3 mph (3 to 5 km/h), shift the transfer case lever firmly to the desired position. Do not pause in transfer case N (Neutral).

NOTE: Pausing in transfer case N (Neutral) in vehicles equipped with an automatic transmission may require shutting the engine OFF to avoid gear clash while completing the shift. If difficulty occurs, shift automatic transmission to N (Neutral), hold foot on brake, and turn engine OFF. Make shift to the desired mode.

NOTE: Shifting into or out of 4L is possible with the vehicle completely stopped, however difficulty may occur due to the mating clutch teeth not being properly aligned. Several attempts may be required for clutch teeth alignment and shift completion to occur. The preferred method is with the vehicle rolling 2 to 3 mph (3 to 5 km/h). Avoid attempting to engage or disengage 4L with the vehicle moving faster than 2 to 3 mph (3 to 5 km/h).

NOTE: Do not attempt to shift to or from 4L while the transmission is in gear or clutch is engaged.

Transfer Case Reminder Light

The four-wheel-drive operating light (4WD), located in the instrument cluster, is used to alert the driver that the front axle is fully engaged and all four wheels are driving.

Electronically Shifted Transfer Case Operating Information/Precautions–If Equipped



8164733

Transfer Case Switch

This is an electric shift transfer case and is operated by the 4WD Control Switch (Transfer Case Switch), which is located on the instrument panel.

This Electronically Shifted transfer case provides 4 mode positions: 2 (rear) wheel drive high range, 4 wheel drive high range, 4 wheel drive low range, and neutral.

The Electronically Shifted transfer case is designed to be driven in the 2 wheel drive position (2WD) for normal street and highway conditions (dry hard surfaced roads).

When additional traction is required, the transfer case 4HI and 4LO positions can be used to lock the front and rear driveshafts together and force the front and rear wheels to rotate at the same speed. This is accomplished by rotating the 4WD Control Switch to the desired position - see Shifting Procedure section for specific shifting instructions. The 4HI and 4LO positions are designed for loose, slippery road surfaces only. Driving in the 4HI and 4LO positions on dry hard surfaced roads may cause increased tire wear and damage to the drive-line components.

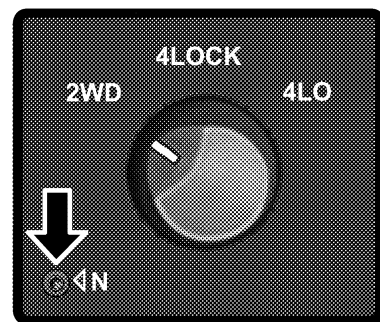

Neutral Button

NOTE: The transfer case Neutral (N) position is selected by depressing the recessed button located on the lower left hand corner of the 4WD Control Switch. The transfer case Neutral (N) position is to be used for recreational towing only. See the Recreational Towing section for specific procedures on shifting into and out of Neutral (N).

816473a

**Transfer Case Position Indicator Lights —
Electronically Shifted Transfer Case Only**

Transfer case position indicator lights are located in the instrument cluster and indicate the current and desired transfer case selection. When you select a different transfer case position, the indicator lights will do the following:

If All Shift Conditions are Met

1. The current position indicator light will turn OFF.
2. The selected position indicator light will flash until the transfer case completes the shift.
3. When the shift is complete, the indicator light for the selected position will stop flashing and remain ON.

If One or More Shift Conditions are not Met

1. The indicator light for the current position will remain ON.

2. The newly selected position indicator light will continue to flash.

3. The transfer case **will not** shift.

NOTE: Before retrying a selection, make certain that all the necessary requirements for selecting a new transfer case position have been met. To retry the selection, turn the control knob back to the current position, wait five (5) seconds, and retry selection. To find the shift requirements, refer to the "Shifting Procedure" for your transfer case, located in this section of the owner's manual.

The "SERVICE 4WD" warning light monitors the electric shift 4WD system. If this light remains on after engine start up or illuminates during driving, it means that the 4WD system is not functioning properly and that service is required.

WARNING!

Always engage the parking brake when powering down the vehicle if the "Service 4WD" light is illuminated. Not engaging the parking brake may allow the vehicle to roll which may cause personal injury.

NOTE: Do not attempt to make a shift while only the front or rear wheels are spinning. The transfer case is not equipped with a synchronizer and therefore the front and rear driveshaft speeds must be equal for the shift to take place. Shifting while only the front or rear wheels are spinning can cause damage to the transfer case.

When operating your vehicle in 4LO, the engine speed is approximately three times that of the 2WD or 4HI positions at a given road speed. Take care not to over-speed the engine and do not exceed 25 mph (40 km/h).

Proper operation of 4 wheel drive vehicles depends on tires of equal size, type and circumference on each wheel. Any difference in tire size can cause damage to the transfer case.

Because 4 wheel drive provides improved traction, there is a tendency to exceed safe turning and stopping speeds. Do not go faster than road conditions permit.

WARNING!

You or others could be injured if you leave the vehicle unattended with the transfer case in the Neutral (N) position without first fully engaging the parking brake. The transfer case Neutral (N) position disengages both the front and rear driveshafts from the powertrain and will allow the vehicle to move regardless of the transmission position. The parking brake should always be applied when the driver is not in the vehicle.

For additional information on the appropriate use of each transfer case mode position see the information below:

2WD

Rear Wheel Drive High Range - Normal street and highway driving. Dry hard surfaced roads.

4HI

4 Wheel Drive High Range - Locks the front and rear driveshafts together. Forces the front and rear wheels to rotate at the same speed. Additional traction for loose, slippery road surfaces only.

4LO

4 Wheel Drive Low Range - Low speed 4 wheel drive. Locks the front and rear driveshafts together. Forces the front and rear wheels to rotate at the same speed. Additional traction and maximum pulling power for loose, slippery road surfaces only. Do not exceed 25 mph (40 km/h).

N

Neutral - Disengages both the front and rear driveshafts from the powertrain. To be used for flat towing behind another vehicle. See Recreational Towing for more information.

Shifting Procedure - Electronically Shifted Transfer Case



8164733

Transfer Case Switch

NOTE: If any of the requirements to select a new transfer case position have not been met, the transfer case will not shift. The indicator light for the previous position will remain ON and the newly selected position indicator

light will continue to flash until all the requirements for the selected position have been met. To retry a shift: return the control knob back to the original position, make certain all shift requirements have been met, wait five (5) seconds and try the shift again.

NOTE: If all the requirements to select a new transfer case position have been met, the current position indicator light will turn OFF, the selected position indicator light will flash until the transfer case completes the shift. When the shift is complete, the indicator light for the selected position will stop flashing and remain ON.

2WD ⇌ 4HI

Rotate the 4WD Control Switch to the desired position. Shifts between 2WD and 4HI can be done with the vehicle stopped or in motion. With the vehicle in motion, the transfer case will engage / disengage faster if you momentarily release the accelerator pedal after turning the control switch. If the vehicle is stopped, the ignition

key must be in the ON position with the engine either RUNNING or OFF. This shift cannot be completed if the key is in the accessory position.

NOTE: The 4x4 system will not allow shifts between 2WD/4HI if the front and/or rear wheels are spinning (no traction). In this situation the selected position indicator light will flash and the original position indicator light will remain ON. At this time, reduce speed and stop spinning the wheels to complete the shift.

2WD or 4HI ⇔ 4LO

NOTE: When shifting into or out of 4LO some gear noise may be heard. This noise is normal and is not detrimental to the vehicle or occupants.

Shifting can be performed with the vehicle rolling 2 to 3 mph (3 to 5 km/h) or completely stopped. USE EITHER OF THE FOLLOWING PROCEDURES:

Preferred Procedure

1. With engine RUNNING, slow vehicle to 2 to 3 mph (3 to 5 km/h).
2. Shift the transmission into NEUTRAL (depress clutch on manual transmissions).
3. While still rolling, rotate the transfer case control switch to the desired position.
4. After the desired position indicator light is ON (not flashing), shift transmission back into gear (release clutch on manual transmissions).

Alternate Procedure

1. Bring the vehicle to complete stop.
2. With the key ON and the engine either OFF or RUNNING, shift the transmission into NEUTRAL (depress clutch on manual transmissions).

3. Rotate the transfer case control switch to the desired position.
4. After the desired position indicator light is ON (not flashing), shift transmission back into gear (release clutch on manual transmissions).

NOTE: If steps 1 or 2 of either the Preferred or Alternate Procedure are not satisfied prior to attempting the shift then the desired position indicator light will flash continuously while the original position indicator light is ON, until all requirements have been met.

NOTE: The ignition key must be ON for a shift to take place and for the position indicator lights to be operable. If the key is not ON then the shift will not take place and no position indicator lights will be on or flashing.

NOTE: If you are leaving your vehicle stored for longer than 21 days, refer to the section on "Vehicle Storage."

LIMITED-SLIP DIFFERENTIAL — IF EQUIPPED

The limited-slip differential provides additional traction on snow, ice, mud, sand and gravel, particularly when there is a difference between the traction characteristics of the surface under the right and left rear wheels. During normal driving and cornering, the limited-slip unit performs similarly to a conventional differential. On slippery surfaces, however, the differential delivers more of the driving effort to the rear wheel having the better traction.

The limited-slip differential is especially helpful during slippery driving conditions. With both rear wheels on a slippery surface, a slight application of the accelerator will supply maximum traction. When starting with only one rear wheel on an excessively slippery surface, slight momentary application of the parking brake may be necessary to gain maximum traction.

WARNING!

On vehicles equipped with a limited-slip differential, never run the engine with one rear wheel off the ground, since the vehicle may drive through the rear wheel remaining on the ground. You could lose control of the vehicle.

Care should be taken to avoid sudden accelerations when both rear wheels are on a slippery surface. This could cause both rear wheels to spin, and allow the vehicle to slide sideways on the crowned surface of a road or in a turn.

DRIVING ON SLIPPERY SURFACES

When driving on wet or slushy roads, it is possible for a wedge of water to build up between the tire and road surface. This is known as hydroplaning and may cause partial or complete loss of vehicle control and stopping ability. To reduce this possibility, the following precautions should be observed:

1. Slow down during rainstorms or when roads are slushy.
2. Slow down if road has standing water or puddles.
3. Replace tires when tread wear indicators first become visible.
4. Keep tires properly inflated.
5. Maintain sufficient distance between your vehicle and the car in front to avoid a collision in a sudden stop.

DRIVING OFF-ROAD

Care should be taken when attempting to climb steep hills or driving diagonally across a hill or slope. If natural obstacles force you to travel diagonally up or down a hill, choose a mild angle and keep as little side tilt as possible. Keep the vehicle moving and make turns slowly and cautiously.

If you must back down a hill, back straight down using REVERSE gear. Never back down in NEUTRAL, or diagonally across the hill.

When driving over sand, mud, and other soft terrain, shift to low gear and drive steadily. Apply the accelerator slowly to avoid spinning the wheels.

DO NOT REDUCE the tire pressures for this type of driving.

NOTE: After off-road usage, particularly in sand or mud, inspect the underside of the vehicle for accumulated dirt at the propeller shaft, axles, U-joints, brake rotors and calipers.

Use a hose to clean off any accumulation of dirt or mud.

Check the exhaust system and all exposed components for any sign of damage.

If you experience unusual vibration after driving in mud, slush or similar conditions, check the wheels for impacted material. Impacted foreign material can cause a wheel imbalance. Removing the foreign material from the wheels will correct the situation.

PARKING BRAKE

The foot operated parking brake is positioned below the lower left corner of the instrument panel. To release the parking brake, pull the parking brake release handle.

NOTE: The instrument cluster red brake warning light will come on and flash to indicate that the parking brake is applied. You must be sure that the parking brake is fully applied before leaving the vehicle.

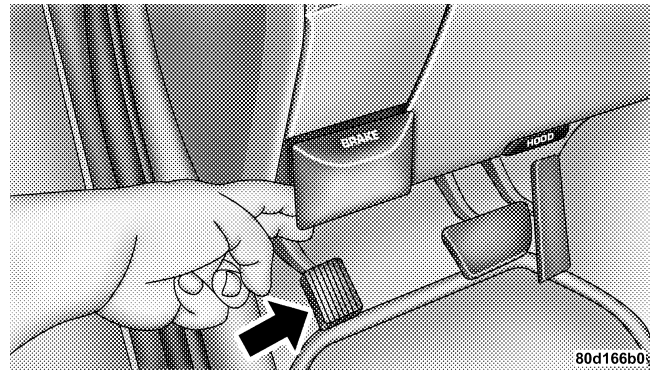

Parking Brake Release

Be sure the parking brake is firmly set when parked and the gear shift lever is in the PARK position. When parking on a hill you should apply the parking brake before placing the gear shift lever in PARK, otherwise the load on the transmission locking mechanism may make it difficult to move the selector out of PARK.

WARNING!

- Always fully apply the parking brake when leaving your vehicle, or it may roll and cause damage or injury. Also be certain to leave an automatic transmission in Park, a manual transmission in Reverse or First gear. Failure to do so may allow the vehicle to roll and cause damage or injury.
- Never leave children alone in a vehicle. Leaving children in a vehicle unattended is dangerous for a number of reasons. A child or others could be seriously or fatally injured. Don't leave the keys in the ignition. A child could operate power windows, other controls, or move the vehicle.
- Be sure the parking brake is fully disengaged before driving, failure to do so can lead to brake problems due to excessive heating of the rear brakes.

When parking on a hill, turn the front wheels toward the curb on a downhill grade and away from the curb on an uphill grade.

The parking brake should always be applied whenever the driver is not in the vehicle.

BRAKE SYSTEM

If power assist is lost for any reason (for example, repeated brake applications with the engine off), the brakes will still function. However, you will experience a substantial increase in braking effort to stop the vehicle.

If either the front or rear hydraulic systems lose normal capability, the remaining system will still function with some loss of overall braking effectiveness. This will be evident by increased pedal travel during application, greater pedal force required to slow or stop, and activation of the BRAKE warning lamp and the ABS lamp (if equipped) during brake use.

Brake Noise

During normal operation of the brake system certain noises may be present from time to time. Occasional "groan" or "squeal" noises may occur during normal operation of the brake system which may not be indicative of a problem. These noises may be heard at any time the brakes are applied but may be more noticeable during the first few brake applications in the morning. Moisture, hot or cold temperature, dust, and or other debris may also contribute to the noise condition. Repeated or continuous noises during braking may be an indication that the brake linings are worn and in need of replacement.

Four-Wheel Anti-Lock Brake System**WARNING!**

Anti-Lock Brake Systems contain sophisticated electronic equipment. It may be susceptible to interference caused by improperly installed or high output radio transmitting equipment. This interference can cause possible loss of anti-lock braking capability. Installation of such equipment should be performed by qualified professionals.

WARNING!

- Anti-lock system (ABS) cannot prevent the natural laws of physics from acting on the vehicle, nor can it increase braking or steering efficiency beyond that afforded by the condition of the vehicle brakes and tires or the traction afforded.
- The ABS cannot prevent accidents, including those resulting from excessive speed in turns, following another vehicle too closely, or hydroplaning. Only a safe, attentive, and skillful driver can prevent accidents.
- The capabilities of an ABS equipped vehicle must never be exploited in a reckless or dangerous manner which could jeopardize the user's safety or the safety of others.

This Anti-lock Brake System is designed to aid the driver in maintaining vehicle control under adverse braking conditions. The system operates with a separate computer to modulate hydraulic pressure to prevent wheel lockup and help avoid skidding on slippery surfaces.

The system's pump motor runs during an ABS stop to provide regulated hydraulic pressure. The pump motor makes a low humming noise during operation. This is normal.

When you are in a severe braking condition involving use of the Anti-lock Brake System, you will experience some pedal drop as the vehicle comes to a complete stop. This is the result of the system reverting to the base brake system and is normal.

Engagement of the Anti-lock Brake System may be accompanied by a pulsing sensation. You may also hear a clicking noise. These occurrences are normal, and indicate that the system is functioning.

ABS Warning Light

The Anti-lock Brake System includes an amber warning light, located in the instrument cluster. When the light is illuminated, the Anti-lock Brake System is not functioning. The system reverts to standard non-anti-lock brakes.

WARNING!

Pumping of the anti-lock brakes will diminish their effectiveness and may lead to an accident. Pumping makes the stopping distance longer. Just press firmly on your brake pedal when you need to slow down or stop.

POWER STEERING

The standard power steering system will give you good vehicle response and increased ease of maneuverability in tight spaces. The system will provide mechanical steering capability if power assist is lost.

If for some reason, the power assist is interrupted, it will still be possible to steer your vehicle. Under these conditions you will observe a substantial increase in steering effort, especially at very low vehicle speeds and during parking maneuvers.

NOTE: Increased noise levels at the end of the steering wheel travel are considered normal and does not indicate that there is a problem with the power steering system.

Upon initial start-up in cold weather, the power steering pump may make noise for a short period of time. This is due to the cold, thick fluid in the steering system. This noise should be considered normal, and does not in any way damage the steering system.

WARNING!

Continued operation with reduced power steering assist could pose a safety risk to yourself and others. Service should be obtained as soon as possible.

CAUTION!

Prolong operation of the steering system at the end of the steering wheel travel will increase the steering fluid temperature and should be avoided when possible. Damage to the power steering pump may occur.

TIRE SAFETY INFORMATION

Tire Markings

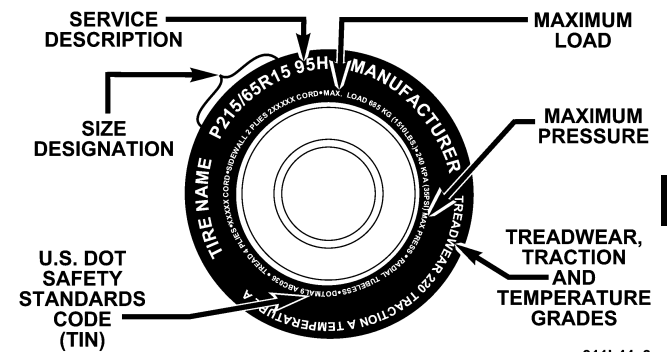

NOTE:

- P (Passenger)-Metric tire sizing is based on U.S. design standards. P-Metric tires have the letter "P" molded into the sidewall preceding the size designation. Example: P215/65R15 95H.

811b44e8

- European Metric tire sizing is based on European design standards. Tires designed to this standard have the tire size molded into the sidewall beginning with the section width. The letter "P" is absent from this tire size designation. Example: 215/65R15 96H
- LT (Light Truck)-Metric tire sizing is based on U.S. design standards. The size designation for LT-Metric tires is the same as for P-Metric tires except for the letters "LT" that are molded into the sidewall preceding the size designation. Example: LT235/85R16.
- Temporary Spare tires are high-pressure compact spares designed for temporary emergency use only. Tires designed to this standard have the letter "T" molded into the sidewall preceding the size designation. Example: T145/80D18 103M.
- High Flotation tire sizing is based on U.S. design standards and it begins with the tire diameter molded into the sidewall. Example: 31x10.5 R15 LT.

Tire Sizing Chart

EXAMPLE:
Size Designation: P = Passenger car tire size based on U.S. design standards "...blank..." = Passenger car tire based on European design standards LT = Light Truck tire based on U.S. design standards T = Temporary Spare tire 31 = Overall Diameter in Inches (in)
215 = Section Width in Millimeters (mm)
65 = Aspect Ratio in Percent (%) —Ratio of section height to section width of tire. 10.5 = Section Width in Inches (in)
R = Construction Code —"R" means Radial Construction. —"D" means Diagonal or Bias Construction.
15 = Rim Diameter in Inches (in)

EXAMPLE:	
Service Description:	
95 = Load Index	—A numerical code associated with the maximum load a tire can carry.
H = Speed Symbol	—A symbol indicating the range of speeds at which a tire can carry a load corresponding to its load index under certain operating conditions. —The maximum speed corresponding to the Speed Symbol should only be achieved under specified operating conditions. (i.e. tire pressure, vehicle loading, road conditions, and posted speed limits).
Load Identification:	
"...blank..." = Absence of any text on sidewall of the tire indicates a Standard Load (SL) Tire	
Extra Load (XL) = Extra Load (or Reinforced) Tire	
Light Load = Light Load Tire	
C,D,E = Load range associated with the maximum load a tire can carry at a specified pressure	
Maximum Load — Maximum Load indicates the maximum load this tire is designed to carry.	
Maximum Pressure — Maximum Pressure indicates the maximum permissible cold tire inflation pressure for this tire.	

Tire Identification Number (TIN)

The TIN may be found on one or both sides of the tire; however, the date code may only be on one side. Tires with white sidewalls will have the full TIN including date code located on the white sidewall side of the tire.

Look for the TIN on the outboard side of black sidewall tires as mounted on the vehicle. If the TIN is not found on the outboard side then you will find it on the inboard side of the tire.

EXAMPLE:
DOT MA L9 ABCD 0301
<p>DOT = Department of Transportation —This symbol certifies that the tire is in compliance with the U.S. Department of Transportation tire safety standards, and is approved for highway use.</p>
<p>MA = Code representing the tire manufacturing location. (2 digits)</p>
<p>L9 = Code representing the tire size. (2 digits)</p>
<p>ABCD = Code used by tire manufacturer. (1 to 4 digits)</p>
<p>03 = Number representing the week in which the tire was manufactured. (2 digits) —03 means the 3rd week.</p>
<p>01 = Number representing the year in which the tire was manufactured. (2 digits) —01 means the year 2001. —Prior to July 2000, tire manufacturers were only required to have 1 number to represent the year in which the tire was manufactured. Example: 031 could represent the 3rd week of 1981 or 1991.</p>

Tire Loading and Tire Pressure

Tire Placard Location

NOTE: The proper cold tire inflation pressure is listed on either the face of the driver's door or the driver's side "B" pillar.

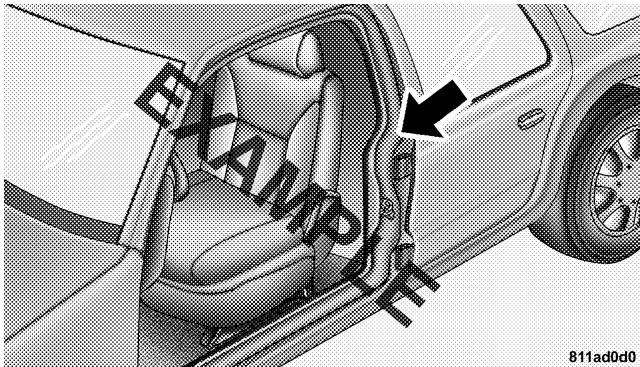

Tire Placard Location

Tire and Loading Information Placard

TIRE AND LOADING INFORMATION			
SEATING CAPACITY - TOTAL 5 FRONT 2 REAR 3			
THE COMBINED WEIGHT OF OCCUPANTS AND CARGO SHOULD NEVER EXCEED XXX KG OR XXX LBS.			
TIRE	FRONT	REAR	SPARE
ORIGINAL TIRE SIZE	P195/70R14	P195/70R14	T125/70D15
COLD TIRE INFLATION PRESSURE	200kPa, 29PSI	200kPa, 29PSI	420kPa, 60PSI
SEE OWNER'S MANUAL FOR ADDITIONAL INFORMATION			4N109268

811b5a9a

Tire and Loading Information

This placard tells you important information about the:

- 1) number of people that can be carried in the vehicle
- 2) the total weight your vehicle can carry

- 3) the tire size designed for your vehicle
- 4) the cold tire inflation pressures for the front, rear and spare tires.

Loading

The vehicle maximum load on the tire must not exceed the load carrying capacity of the tire on your vehicle. You will not exceed the tire's load carrying capacity if you adhere to the loading conditions, tire size, and cold tire inflation pressures specified on the "Tire and Loading Information" placard and in the "Vehicle Loading" section of this manual.

NOTE: Under a maximum loaded vehicle condition, gross axle weight ratings (GAWR's) for the front and rear axles must not be exceeded. For further information on GAWR's, vehicle loading, and trailer towing, refer to the "Vehicle Loading" section of this manual.

To determine the maximum loading conditions of your vehicle, locate the statement "The combined weight of

occupants and cargo should never exceed XXX kg or XXX lbs." on the Tire and Loading Information placard. The combined weight of occupants, cargo/luggage and trailer tongue weight (if applicable) should never exceed the weight referenced here.

Steps for Determining Correct Load Limit

1. Locate the statement "The combined weight of occupants and cargo should never exceed XXX pounds" on your vehicle's placard.
2. Determine the combined weight of the driver and passengers that will be riding in your vehicle.
3. Subtract the combined weight of the driver and passengers from XXX kilograms or XXX pounds.
4. The resulting figure equals the available amount of cargo and luggage load capacity. For example, if "XXX" amount equals 1400 lbs. and there will be five 150 lb.

passengers in your vehicle, the amount of available cargo and luggage load capacity is 650 lbs. (since $5 \times 150 = 750$, and $1400 - 750 = 650$ lbs.)

5. Determine the combined weight of luggage and cargo being loaded on the vehicle. That weight may not safely exceed the available cargo and luggage load capacity calculated in Step 4.

6. If your vehicle will be towing a trailer, load from your trailer will be transferred to your vehicle. Consult this manual to determine how this reduces the available cargo and luggage load capacity of your vehicle.

NOTE: The following table shows examples on how to calculate total load, cargo/luggage, and towing capacities of your vehicle with varying seating configurations and number and size of occupants. This table is for illustration purposes only and may not be accurate for the seating and load carry capacity of your vehicle.

NOTE: For the following example, the combined weight of occupants and cargo should never exceed 865 lbs. (392 Kg).

Occupants			Combined weight of occupants and cargo from Tire Placard	MINUS	Combined Occupant's weight	=	AVAILABLE Cargo/Luggage and Trailer Tongue Weight
TOTAL	FRONT	REAR					
EXAMPLE 1			865 lbs	minus	Occupant 1: 200 lbs Occupant 2: 130 lbs Occupant 3: 160 lbs Occupant 4: 100 lbs Occupant 5: 80 lbs TOTAL WEIGHT: 670 lbs	=	195 lbs
5	2	3					
EXAMPLE 2			865 lbs	minus	Occupant 1: 210 lbs Occupant 2: 180 lbs Occupant 3: 150 lbs TOTAL WEIGHT: 540 lbs	=	325 lbs
3	2	1					
EXAMPLE 3			865 lbs	minus	Occupant 1: 200 lbs Occupant 2: 200 lbs TOTAL WEIGHT: 400 lbs	=	465 lbs
2	2	0					

811a4d11

WARNING!

Overloading of your tires is dangerous. Overloading can cause tire failure, affect vehicle handling, and increase your stopping distance. Use tires of the recommended load capacity for your vehicle. Never overload them.

TIRES — GENERAL INFORMATION**Tire Pressure**

Proper tire inflation pressure is essential to the safe and satisfactory operation of your vehicle. Three primary areas are affected by improper tire pressure:

1. Safety—**WARNING!**

- Improperly inflated tires are dangerous and can cause accidents.
- Under inflation increases tire flexing and can result in tire failure.
- Over inflation reduces a tire's ability to cushion shock. Objects on the road and chuckholes can cause damage that result in tire failure.
- Unequal tire pressures can cause steering problems. You could lose control of your vehicle.
- Over inflated or under inflated tires can affect vehicle handling and can fail suddenly, resulting in loss of vehicle control.
- Unequal tire pressures from one side of the vehicle to the other can cause the vehicle to drift to the right or left.
- Always drive with each tire inflated to the recommended cold tire inflation pressure.

2. *Economy*—

Improper inflation pressures can cause uneven wear patterns to develop across the tire tread. These abnormal wear patterns will reduce tread life resulting in a need for earlier tire replacement. Under inflation, also increases tire rolling resistance and results in higher fuel consumption.

3. *Ride Comfort and Vehicle Stability*—

Proper tire inflation contributes to a comfortable ride. Over inflation produces a jarring and uncomfortable ride.

Tire Inflation Pressures

The proper cold tire inflation pressure is listed either on the face of the driver's door or on the driver's side "B" pillar.

Some vehicles may have Supplemental Tire Pressure Information for vehicle loads that are less than the maximum loaded vehicle condition. These pressure conditions will be found in the "Supplemental Tire Pressure Information" section of this manual.

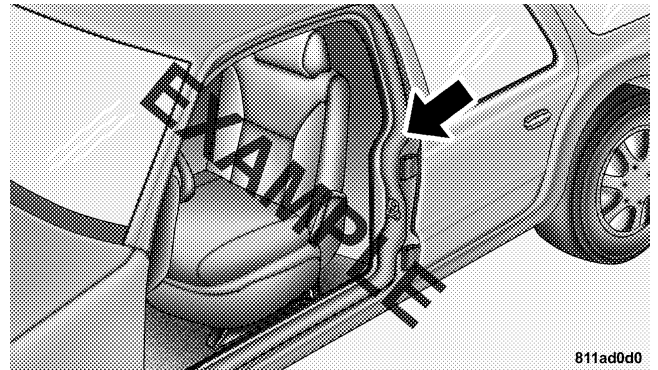

Tire Placard Location

The pressure should be checked and adjusted as well as inspecting for signs of tire wear or visible damage at least once a month. Use a good quality pocket-type gauge to check tire pressure. Do not make a visual judgement when determining proper inflation. Radial tires may look properly inflated even when they are under inflated.

CAUTION!

After inspecting or adjusting the tire pressure, always reinstall the valve stem cap (if equipped). This will prevent moisture and dirt from entering the valve stem, which could damage the valve stem.

Inflation pressures specified on the placard are always “cold tire inflation pressure.” Cold tire inflation pressure is defined as the tire pressure after the vehicle has not been driven for at least 3 hours, or driven less than 1 mile (1 km) after a 3 hour period. The cold tire inflation pressure must not exceed the maximum inflation pressure molded into the tire sidewall.

Check tire pressures more often if subject to a wide range of outdoor temperatures, as tire pressures vary with temperature changes.

Tire pressures change by approximately 1 psi (7 kPa) per 12° F (7° C) of air temperature change. Keep this in mind when checking tire pressure inside a garage, especially in the winter.

Example: If garage temperature = 68° F (20° C) and the outside temperature = 32° F (0° C) then the cold tire inflation pressure should be increased by 3 psi (21 kPa), which equals 1 psi (7 kPa) for every 12° F (7° C) for this outside temperature condition.

Tire pressure may increase from 2 to 6 psi (13 to 40 kPa) during operation. DO NOT reduce this normal pressure build up or your tire pressure will be too low.

Tire Pressures for High Speed Operation

The manufacturer advocates driving at safe speeds within posted speed limits. Where speed limits or conditions are such that the vehicle can be driven at high speeds, maintaining correct tire inflation pressure is very important. Increased tire pressure and reduced vehicle

loading may be required for high-speed vehicle operation. Refer to original equipment or an authorized tire dealer for recommended safe operating speeds, loading and cold tire inflation pressures.

WARNING!

High speed driving with your vehicle under maximum load is dangerous. The added strain on your tires could cause them to fail. You could have a serious accident. Don't drive a vehicle loaded to the maximum capacity at continuous speeds above 75 mph (120 km/h).

Radial-Ply Tires**WARNING!**

Combining radial ply tires with other types of tires on your vehicle will cause your vehicle to handle poorly. The instability could cause an accident. Always use radial ply tires in sets of four (or 6, in case of trucks with dual rear wheels). Never combine them with other types of tires.

Cuts and punctures in radial tires are repairable only in the tread area because of sidewall flexing. Consult your authorized tire dealer for radial tire repairs.

Compact Spare Tire — If Equipped

The compact spare is for temporary emergency use with radial tires. It is engineered to be used on your style vehicle only. Since this tire has limited tread life, the original tire should be repaired (or replaced) and reinstalled at the first opportunity.

WARNING!

Temporary use spare tires are for emergency use only. With these tires, do not drive more than 50 mph (80 km/h). Temporary-use spare tires have limited tread life. When the tread is worn to the tread wear indicators, the temporary use spare tire needs to be replaced. Be sure to follow the warnings, which apply to your spare. Failure to do so could result in spare tire failure and loss of vehicle control.

Do not install a wheel cover or attempt to mount a conventional tire on the compact spare wheel, since the wheel is designed specifically for the compact spare.

Do not install more than one compact spare tire/wheel on the vehicle at any given time.

CAUTION!

Because of the reduced ground clearance, do not take your vehicle through an automatic car wash with the compact spare installed. Damage to the vehicle may result.

Limited Use Spare — If Equipped

The limited use spare tire is for temporary emergency use on your vehicle. This tire is identified by a limited use spare tire warning label located on the limited use spare tire and wheel assembly. This tire may look like the original equipped tire on the front or rear axle of your vehicle, but it is not. Installation of this limited use spare tire affects vehicle handling. Since it is not the same tire, replace (or repair) the original tire and reinstall on the vehicle at the first opportunity.

WARNING!

The limited use spare tires are for emergency use only. Installation of this limited use spare tire affects vehicle handling. With this tire, do not drive more than 60 mph (100 km/h). Keep inflated to the cold tire inflation pressure listed on either your tire placard or limited use spare tire and wheel assembly. Replace (or repair) the original tire at the first opportunity and reinstall it on your vehicle. Failure to do so could result in loss of vehicle control.

5**Tire Spinning**

When stuck in mud, sand, snow, or ice conditions, do not spin your vehicle's wheels above 35 mph (55 km/h).

Refer to the paragraph on "Freeing A Stuck Vehicle" in Section 6 of this manual.

WARNING!

Fast spinning tires can be dangerous. Forces generated by excessive wheel speeds may cause tire damage or failure. A tire could explode and injure someone. Do not spin your vehicle's wheels faster than 30 mph (48 km/h) for more than 30 seconds continuously when you are stuck, and don't let anyone near a spinning wheel, no matter what the speed.

Tread Wear Indicators

Tread wear indicators are in the original equipment tires to help you in determining when your tires should be replaced.

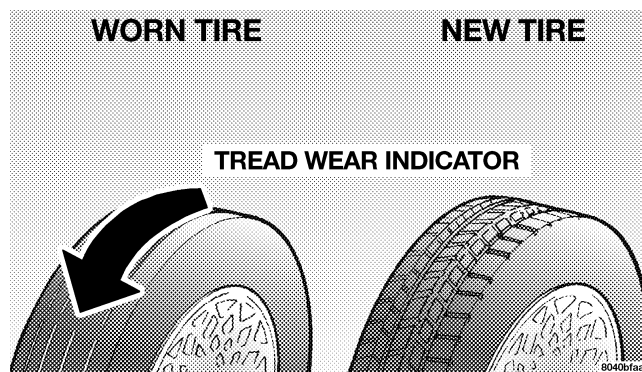

These indicators are molded into the bottom of the tread grooves. They will appear as bands when the tread depth becomes 1/16 inch (2 mm). When the tread is worn to the tread wear indicators, the tire should be replaced.

Many states have laws requiring tire replacement at this point.

Life of Tire

The service life of a tire is dependent upon varying factors including but not limited to:

- Driving style
- Tire pressure
- Distance driven

WARNING!

Tires and spare tire should be replaced after six years, regardless of the remaining tread. Failure to follow this warning can result in sudden tire failure. You could lose control and have an accident resulting in serious injury or death.

Keep dismantled tires in a cool, dry place with as little exposure to light as possible. Protect tires from contact with oil, grease, and gasoline.

Replacement Tires

The tires on your new vehicle provide a balance of many characteristics. They should be inspected regularly for wear and correct cold tire inflation pressure. The manufacturer strongly recommends that you use tires equivalent to the originals in size, quality and performance when replacement is needed (refer to the paragraph on "Tread Wear Indicators"). Refer to the "Tire and Loading Information" placard for the size designation of your tire. The service description and load identification will be found on the original equipment tire. Failure to use equivalent replacement tires may adversely affect the safety, handling, and ride of your vehicle. We recommend that you contact your original equipment or an authorized tire dealer with any questions you may have on tire specifications or capability.

WARNING!

- Do not use a tire, wheel size or rating other than that specified for your vehicle. Some combinations of unapproved tires and wheels may change suspension dimensions and performance characteristics, resulting in changes to steering, handling, and braking of your vehicle. This can cause unpredictable handling and stress to steering and suspension components. You could lose control and have an accident resulting in serious injury or death. Use only the tire and wheel sizes with load ratings approved for your vehicle.
- Never use a tire with a smaller load index or capacity, other than what was originally equipped on your vehicle. Using a tire with a smaller load index could result in tire overloading and failure. You could lose control and have an accident.
- Failure to equip your vehicle with tires having adequate speed capability can result in sudden tire failure and loss of vehicle control.

CAUTION!

Replacing original tires with tires of a different size may result in false speedometer and odometer readings.

Alignment And Balance

Poor suspension alignment may result in:

- Fast tire wear.
- Uneven tire wear, such as feathering and one-sided wear.
- Vehicle pull to right or left.

Tires may also cause the vehicle to pull to the left or right. Alignment will not correct this condition. See your dealer for proper diagnosis.

Improper alignment will not cause vehicle vibration. Vibration may be a result of tire and wheel out-of-balance. Proper balancing will reduce vibration and avoid tire cupping and spotty wear.

SUPPLEMENTAL TIRE PRESSURE INFORMATION – IF EQUIPPED

A light load vehicle condition is defined as two passengers {150 lbs (68 kg) each} plus 200 lbs (91kg) of cargo. Cold tire inflation pressures for a lightly loaded vehicle will be found on the face of the driver's door.

TIRE CHAINS

Use "Class U" chains on 2500/3500 Ram Trucks, or other traction aids that meet SAE Type "U" specifications.

NOTE: Chains must be the proper size for the vehicle, as recommended by the chain manufacturer.

CAUTION!

To avoid damage to your vehicle, tires or chains, observe the following precautions:

- Because of limited chain clearance between tires and other suspension components, it is important that only chains in good condition are used. Broken chains can cause serious vehicle damage. Stop the vehicle immediately if noise occurs that could suggest chain breakage. Remove the damaged parts of the chain before further use.
- Install chains as tightly as possible and then retighten after driving about 1/2 mile (0.8 km).
- Do not exceed 45 mph (72 km/h).
- Drive cautiously and avoid severe turns and large bumps, especially with a loaded vehicle.
- Do not install tire chains on front wheels of 4x2 vehicles.
- Do not drive for a prolonged period on dry pavement.
- Observe the tire chain manufacturer's instructions on method of installation, operating speed, and conditions for usage. Always use the lower suggested operating speed of the chain manufacturer if different than the speed recommended by the manufacturer.

These cautions apply to all chain traction devices, including link and cable (radial) chains.

Tire chain use is permitted only on the rear tires of Ram 4X2 trucks.

NOTE: The use of class “U” chains is permitted on the front and rear of 4X4, 2500 Ram Trucks with LT245/70R17E tires.

NOTE: The use of class “U” chains is permitted on the front and rear of 4X4, 3500 Ram Trucks with Dual Rear Wheels and LT235/80R17E tires.

NOTE: On 4X2 2500/3500 Ram Trucks, class “U” snow chains are permitted on the rear wheels only of vehicles equipped with LT245/70R17, LT265/70R17, and LT235/80R17 size tires.

NOTE: On 4X4 2500/3500 Single Rear Wheel (SRW) Ram Trucks, class “U” snow chains are permitted on the rear wheels only of vehicles equipped with LT265/70R17.

CAUTION!
<p>Do not use tire chains on 4x4 Ram trucks equipped with P265/70R17, LT275/70R17 tires. There may not be adequate clearance for the chains and you are risking structural or body damage to your vehicle. Do not use tire chains on the 4X2 front wheels of 2500/3500 SRW (Single Rear Wheels) equipped with LT245/70R17, LT265/70R17 tires or 4X4 front tires of Ram Trucks equipped with LT265/70R17 tires. There may not be adequate clearance for the chains and you are risking structural or body damage to your vehicle.</p>

SNOW TIRES

Snow tires should be of the same size and type construction as the front tires. Consult the manufacturer of the snow tire to determine any maximum vehicle speed requirement associated with the tire. These tires should always be operated at the vehicle maximum capacity inflation pressures under any load condition.

While studded tires improve performance on ice, skid and traction capability on wet or dry surfaces may be poorer than that of non-studded tires. Some states prohibit studded tires; therefore, local laws should be checked before using these tire types.

TIRE ROTATION RECOMMENDATIONS

Tires on the front and rear axles of vehicles operate at different loads and perform different steering, driving, and braking functions. For these reasons, they wear at unequal rates, and develop irregular wear patterns. These effects can be reduced by timely rotation of tires. The benefits of rotation are especially worthwhile with aggressive tread designs such as those on On/Off Road type tires. Rotation will increase tread life, help to maintain mud, snow, and wet traction levels, and contribute to a smooth, quiet ride.

Follow the recommended tire rotation frequency for your type of driving found in the "Maintenance Schedules" Section of this manual. More frequent rotation is permissible if desired. The reasons for any rapid or unusual wear should be corrected prior to rotation being performed.

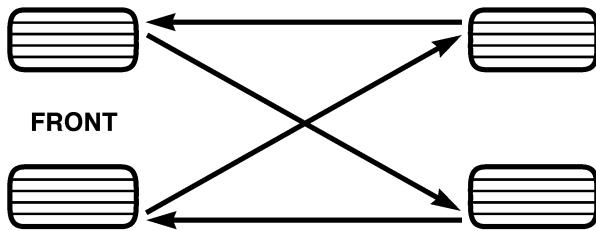

8031e864

NOTE: On Canadian vehicles only, if your Ram truck is equipped with All-Season type tires on the front and ON/OFF Road type tires mounted on the rear, do not use a front to back rotation pattern. Instead, rotate your tires side to side at the recommended intervals.

Dual Rear Wheels

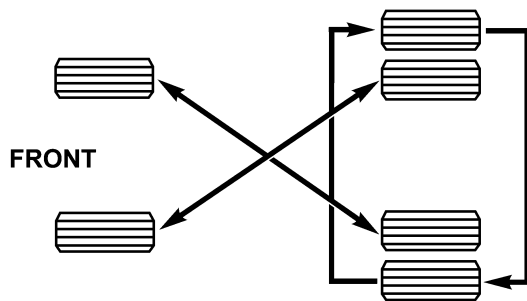

80f55fea

The tires used on dual wheel assemblies should be matched for wear to prevent overloading one tire in a set. To check if tires are even, lay a straight edge across all four tires. The straight edge should touch all the tires.

CAUTION!

3500 Dual Rear Tires have only one approved direction of rotation. This is to accommodate the asymmetrical design (tread pattern) of the ON/OFF road tire and the use of Outline White Letter (OWL) tires.

- When replacing a flat, the spare tire may have to be remounted on the rim or installed at a different location to maintain the correct placement of the tire on the wheel relative to the tire/wheel position on the truck. For example, if the spare is used to replace an outer rear tire it will have to be remounted on the rim so that the wheel is dished inward. That way the tread design of asymmetrical tires and the white writing of the OWL tires will maintain proper position.

ENGINE RUNAWAY**WARNING!**

In case of engine runaway due to flammable fumes from gasoline spills or turbocharger oil leaks being sucked into the engine do the following to help avoid personal injury and/or vehicle damage:

1. Shut off engine ignition switch.
2. Using a CO₂ or dry chemical type fire extinguisher, direct the spray from the fire extinguisher into the grille on the passenger side so that the spray enters the engine air intake.

The inlet for the engine air intake is located behind the passenger side headlamp and receives air through the grille

FUEL REQUIREMENTS (DIESEL ENGINES)

Use good quality diesel fuel from a reputable supplier in your Dodge truck. For most year-round service, No. 2 diesel fuel meeting ASTM specification D-975 will provide good performance. If the vehicle is exposed to extreme cold (below 20°F or -7°C), or is required to operate at colder-than-normal conditions for prolonged periods, use climatized No. 2 diesel fuel or dilute the No. 2 diesel fuel with 50% No. 1 diesel fuel. This will provide better protection from fuel gelling or wax-plugging of the fuel filters.

WARNING!

Do not use alcohol or gasoline as a fuel blending agent. They can be unstable under certain conditions and hazardous or explosive when mixed with diesel fuel.

Diesel fuel is seldom completely free of water. To prevent fuel system trouble, drain the accumulated water from the fuel/water separator using the fuel/water separator drain provided. Use an approved fuel container to catch drainage and dispose of per local and governmental regulations. If you buy good quality fuel and follow the cold weather advice above, fuel conditioners should not be required in your vehicle. If available in your area, a high cetane "premium" diesel fuel may offer improved cold-starting and warm-up performance.

Fuel Specifications

The Cummins Turbocharged, Charge Air Cooled, Diesel engine has been developed to take advantage of the high energy content and generally lower cost No. 2 diesel fuel or No. 2 climatized diesel fuels. Experience has shown that it also operates on No. 1 diesel fuels or other fuels within the specifications in the following chart.

NOTE: A maximum blend of 5% biodiesel may be used with your Cummins Diesel equipped Dodge Ram Truck.

NOTE: In addition, commercially available fuel additives are not necessary for the proper operation of your Cummins Diesel equipped Dodge Ram Truck.

NOTE: No. 1 diesel fuel should only be used where extended arctic conditions (-10°F or -23°C) exist.

Number 2 Diesel Fuel Specifications

Fuel Properties - No. 2 - Diesel	Reference
Viscosity - 1.9 to 4.1 centistokes	(ASTM D-445)
Cetane Number - 40 min.	(ASTM D613)
Sulfur Content -.05% by weight	(ASTM D-2622)
Water & Sediment - less than 0.05 % by volume	(ASTM D-2709)
Carbon Residue - Less than.35%	(Ramsbottom ASTM D-524)
Flash Point - 125°F min.	(ASTM D-93)

Fuel Properties - No. 2 - Diesel	Reference
Density - 40-34 API gravity	(ASTM D-287)
Cloud Point 15°F	(ASTM D-97)
Active Sulfur	(ASTM D-130)
Copper Strip	
Corrosion - #3 rating	
Ash - 0.01% by mass	(ASTM D-482)
Distillation - curve is smooth & cont.	(ASTM D-86)

Number 1 Diesel Fuel Specifications

Fuel Properties - No. 1 - Diesel	Reference
Viscosity - 1.3 to 2.4 centistokes	(ASTM D-445)
Cetane Number - 40 min.	(ASTM D613)
Sulfur Content - maximum of.05% by weight	(ASTM D-2622)
Water & Sediment - less than 0.05 % by volume	(ASTM D-2709)

320 STARTING AND OPERATING

Fuel Properties - No. 1 - Diesel	Reference
Carbon Residue - Less than.15%	(Ramsbottom ASTM D-524)
Flash Point - 100°F min.	(ASTM D-93)
Density - 40-34 API gravity	(ASTM D-287)
Cloud Point - (- 30F°)	(ASTM D-97)
Active Sulfur	(ASTM D-130)
Copper Strip	
Corrosion - #3 rating	

ADDING FUEL (DIESEL ENGINES)

CAUTION!
To avoid fuel spillage and overfilling, do not “top off” the fuel tank after filling.

NOTE:

- When the fuel nozzle “clicks” or shuts off, the fuel tank is full.
- Tighten the gas cap until you hear a “clicking” sound. This is an indication that the gas cap is properly tightened.
- Make sure that the gas cap is tightened each time the vehicle is refueled.

WARNING!
A fire may result if fuel is pumped into a portable container that is on a truck bed. You could be burned. Always place fuel containers on the ground while filling.

Fuel Filler Cap (Gas Cap)

The gas cap is behind the fuel filler door. If the gas cap is lost or damaged, be sure the replacement cap is for use with this vehicle.

CAUTION!

Damage to the fuel system or emission control system could result from using an improper fuel tank filler tube cap (gas cap). A poorly fitting cap could let impurities into the fuel system.

WARNING!

- Never have any smoking materials lit in or near the vehicle when the gas cap is removed or the tank filled.
- Never add fuel to the vehicle when the engine is running.

Avoid Using Contaminated Fuel

Fuel that is contaminated by water or dirt can cause severe damage to the engine fuel system. Proper maintenance of the engine fuel filter and fuel tank is essential. (See Section 7 for Maintenance Procedures).

NOTE: Climatized diesel fuel is a blend of Number 2 and Number 1 Diesel fuel which reduces the temperature at which wax crystals form in the fuel.

Bulk Fuel Storage

If you store quantities of fuel, good maintenance of the stored fuel is also essential. Fuel contaminated with water will promote the growth of “microbes.” These microbes form “slime” that will clog fuel filters and lines. Drain condensation from the supply tank and change the line filter on a regular basis.

NOTE: When a diesel engine is allowed to run out of fuel, air is pulled into the fuel system.

You may try priming as described below. However, if the engine will not start, refer to the fuel priming procedure in the Service Manual or have the vehicle towed to an authorized Dodge dealer.

WARNING!

Do not open the high pressure fuel system with the engine running. Engine operation causes high fuel pressure. High pressure fuel spray can cause serious injury or death.

Priming if the engine has run out of fuel

1. Add a substantial quantity of fuel to the tank 5 to 10 gallons (19 to 38L).
2. Crank the engine for 1 to 2 seconds. If the engine does not start, then release the key or starter button back to the RUN position (do not turn the key back to the OFF position). The electric fuel transfer pump will continue to run and purge air from the system for about 20 seconds. After 20 seconds, attempt to start the engine again.
3. Start the engine using the Normal Starting Procedure.

4. Repeat the procedure if the engine does not start.

CAUTION!

Do not engage the starter motor for more than 15 seconds at a time. Allow two minutes between the cranking intervals.

NOTE: The engine may run rough until the air is forced from all the fuel lines.

VEHICLE LOADING

Certification Label

As required by National Highway Traffic Safety Administration Regulations, your vehicle has a certification label affixed to the driver's side door or pillar.

This label contains the month and year of manufacture, Gross Vehicle Weight Rating (GVWR), Gross Axle Weight

Rating (GAWR) front and rear, and Vehicle Identification Number (VIN). A Month-Day-Hour (MDH) number is included on this label and indicates the Month, Day and Hour of manufacture. The bar code that appears on the bottom of the label is your Vehicle Identification Number (VIN).

Gross Vehicle Weight Rating (GVWR)

The GVWR is the total permissible weight of your vehicle including driver, passengers, vehicle, options and cargo. The label also specifies maximum capacities of front and rear axle systems (GAWR). Total load must be limited so GVWR and front and rear GAWR are not exceeded.

Payload

The payload of a vehicle is defined as the allowable load weight a truck can carry, including the weight of the driver, all passengers, options and cargo.

Gross Axle Weight Rating (GAWR)

The GAWR is the maximum permissible load on the front and rear axles. The load must be distributed in the cargo area so that the GAWR of each axle is not exceeded.

Each axle GAWR is determined by the components in the system with the lowest load carrying capacity (axle, springs, tires or wheels). Heavier axles or suspension components sometimes specified by purchasers for increased durability does not necessarily increase the vehicle's GVWR.

Tire Size

The tire size on the Label represents the actual tire size on your vehicle. Replacement tires must be equal to the load capacity of this tire size.

Rim Size

This is the rim size that is appropriate for the tire size listed.

Inflation Pressure

This is the cold tire inflation pressure for your vehicle for all loading conditions up to full GAWR.

Curb Weight

The curb weight of a vehicle is defined as the total weight of the vehicle with all fluids, including vehicle fuel, at full capacity conditions, and with no occupants or cargo loaded into the vehicle. The front and rear curb weight values are determined by weighing your vehicle on a commercial scale before any occupants or cargo are added.

Loading

The actual total weight and the weight of the front and rear of your vehicle at the ground can best be determined by weighing it when it is loaded and ready for operation.

The entire vehicle should first be weighed on a commercial scale to insure that the GVWR has not been exceeded. The weight on the front and rear of the vehicle should

then be determined separately to be sure that the load is properly distributed over front and rear axle. Weighing the vehicle may show that the GAWR of either the front or rear axles has been exceeded but the total load is within the specified GVWR. If so, weight must be shifted from front to rear or rear to front as appropriate until the specified weight limitations are met. Store the heavier items down low and be sure that the weight is distributed equally. Stow all loose items securely before driving.

Improper weight distributions can have an adverse effect on the way your vehicle steers and handles and the way the brakes operate.

CAUTION!

Do not load your vehicle any heavier than the GVWR or the maximum front and rear GAWR. If you do, parts on your vehicle can break, or it can change the way your vehicle handles. This could cause you to lose control. Also overloading can shorten the life of your vehicle.

An EXAMPLE of a loaded vehicle is shown in the following chart. Note that neither GVWR nor GAWR capabilities are exceeded. Overloading can cause potential safety hazards and shorten service life.

NOTE: The weights shown in this chart are not necessarily the weights for your vehicle. Also, the amount of load added to both the front and rear axles can be computed after the vehicle has been weighed both in its "curb weight" condition, and in its "loaded and ready for operation" condition.

Gross Vehicle Weight Rating (GVWR) 6500 LBS.

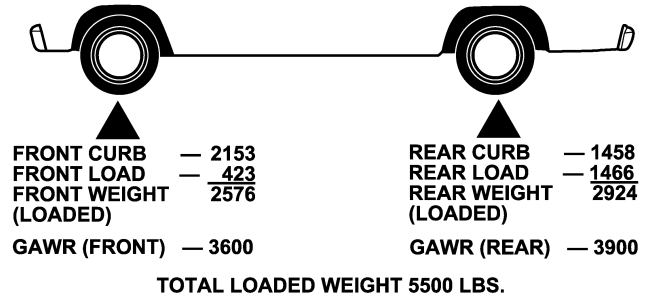

TRAILER TOWING

In this section you will find safety tips and information on limits to the type of towing you can reasonably do with your vehicle. Before towing a trailer carefully review this information to tow your load as efficiently and safely as possible.

To maintain warranty coverage, follow the requirements and recommendations in this manual concerning vehicles used for trailer towing.

Common Towing Definitions

The following trailer towing related definitions will assist you in understanding the following information:

Gross Vehicle Weight Rating (GVWR)

The GVWR is the total allowable weight of your vehicle. This includes driver, passengers, cargo and tongue weight. The total load must be limited so that you do not exceed the GVWR.

Gross Trailer Weight (GTW)

The gross trailer weight (GTW) is the weight of the trailer plus the weight of all cargo, consumables and equipment (permanent or temporary) loaded in or on the trailer in its "loaded and ready for operation" condition. The recommended way to measure GTW is to put your fully loaded trailer on a vehicle scale. The entire weight of the trailer must be supported by the scale.

Gross Combination Weight Rating (GCWR)

The gross combination weight rating (GCWR) is the total permissible weight of your vehicle and trailer when weighed in combination. (Note that GCWR ratings include a 68 kg (150 lbs) allowance for the presence of a driver).

Gross Axle Weight Rating (GAWR)

The GAWR is the maximum capacity of the front and rear axles. Distribute the load over the front and rear axles evenly. Make sure that you do not exceed either front or rear GAWR.

WARNING!

It is important that you do not exceed the maximum front or rear GAWR. A dangerous driving condition can result if either rating is exceeded. You could lose control of the vehicle and have an accident.

Tongue Weight (TW)

The downward force exerted on the hitch ball by the trailer. In most cases it should not be less than 10% or more than 15% of the trailer load. You must consider this as part of the load on your vehicle.

Frontal Area

The maximum height and maximum width of the front of a trailer.

Trailer Sway Control

The trailer sway control is a telescoping link that can be installed between the hitch receiver and the trailer tongue that typically provides adjustable friction associated with the telescoping motion to dampen any unwanted trailer swaying motions while traveling.

Weight-Carrying Hitch

A weight-carrying hitch supports the trailer tongue weight, just as if it were luggage located at a hitch ball or some other connecting point of the truck. These kind of hitches are the most popular on the market today and they're commonly used to tow small- and medium-sized trailers.

Weight-Distributing Hitch

A weight-distributing system works by applying leverage through spring (load) bars. They are typically used for heavier loads, to distribute trailer tongue weight to the tow vehicle's front axle and the trailer axle(s). When used in accordance with the manufacturers' directions, it provides for a more level ride, offering more consistent steering and brake control thereby enhancing towing safety. The addition of a friction / hydraulic sway control also dampens sway caused by traffic and crosswinds and contributes positively to tow vehicle and trailer stability. Trailer sway control and a weight distributing (load equalizing) hitch are recommended for heavier Tongue Weights (TW) and may be required depending on Vehicle and Trailer configuration / loading to comply with gross axle weight rating (GAWR) requirements.

WARNING!

An improperly adjusted Weight Distributing Hitch system may reduce handling, stability, braking performance, and could result in an accident.

Weight Distributing Systems may not be compatible with Surge Brake Couplers. Consult with your hitch and trailer manufacturer or a reputable Recreational Vehicle dealer for additional information.

EXAMPLE ONLY

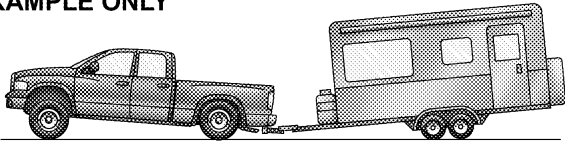

FIG. 1 WITHOUT WEIGHT DISTRIBUTION (INCORRECT)

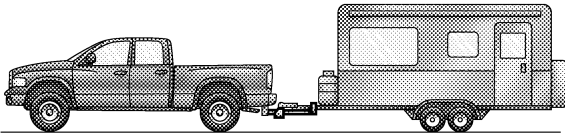

FIG. 2. WITH WEIGHT DISTRIBUTION (CORRECT) 8181F965

Weight Distributing Hitch System

EXAMPLE ONLY

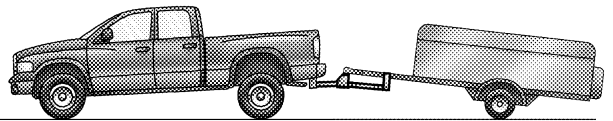

FIG. 3 IMPROPER ADJUSTMENT (INCORRECT)

8181F96F

Improper Adjustment of Weight Distributing System

Fifth-Wheel Hitch

A special high platform with a coupling that mounts over the rear axle of the tow vehicle in the truck bed. Connects a vehicle and fifth-wheel trailer with a coupling king pin.

Gooseneck Hitch

The gooseneck hitch employs a pivoted coupling arm which attaches to a ball mounted in the bed of a pickup truck. The coupling arm connects to the hitch mounted over the rear axle in the truck bed.

Trailer Hitch Classification

The rear bumper is intended to tow trailers up to 2,000 lbs (907 kg) without added equipment or alterations to the standard equipment. Your vehicle may be factory equipped for safe towing of trailers weighing over 2,000 lbs (907 kg) with the optional Trailer Tow Prep Package. See your dealer for package content.

The following chart provides the industry standard for the maximum trailer weight a given trailer hitch class can tow and should be used to assist you in selecting the correct trailer hitch for your intended towing condition. Refer to "Trailer Towing Weights (Maximum Trailer

Weight Ratings)" for the website address that contains the necessary information for your specific drivetrain.

Trailer Hitch Classification	
Class	Max. GTW (Gross Trailer Wt.)
Class I - Light Duty	2,000 lbs (907 kg)
Class II - Medium Duty	3,500 lbs (1587 kg)
Class III - Heavy Duty	5,000 lbs (2268 kg)
Class IV - Extra Heavy Duty	10,000 lbs (4540 kg)
Fifth Wheel/ Gooseneck	Greater than 10,000 lbs (4540 kg)

All trailer hitches should be professionally installed on your vehicle.

Trailer Towing Weights (Maximum Trailer Weight Ratings)

NOTE: For additional trailer towing information (maximum trailer weight ratings) refer to the following website addresses:

- [http:// www.dodge.com/towing](http://www.dodge.com/towing).
- [http:// www.dodge.ca](http://www.dodge.ca) (Canada).

Trailer and Tongue Weight

Always load a trailer with 60% to 65% of the weight in the front of the trailer. This places 10% to 15% of the Gross Trailer Weight (GTW) on the tow hitch of your vehicle. Loads balanced over the wheels or heavier in the rear can cause the trailer to sway **severely** side to side which will cause loss of control of vehicle and trailer. Failure to load trailers heavier in front is the cause of many trailer accidents.

Never exceed the maximum tongue weight stamped on your bumper or trailer hitch.

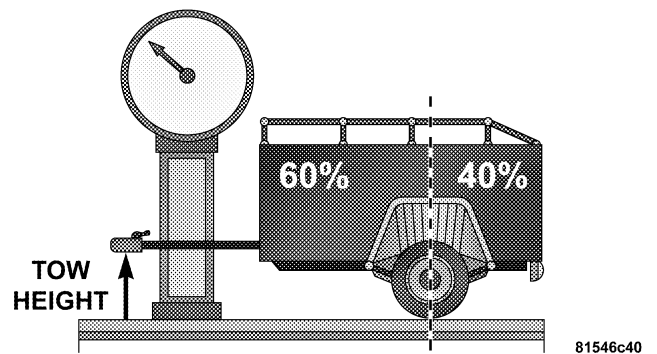

Consider the following items when computing the weight on the rear axle of the vehicle:

- The tongue weight of the trailer.

- The weight of any other type of cargo or equipment put in or on your vehicle.
- The weight of the driver and all passengers.

NOTE: Remember that everything put into or on the trailer adds to the load on your vehicle. Also, additional factory-installed options, or dealer-installed options, must be considered as part of the total load on your vehicle. Refer to the Tire and Loading Information placard in the Tire Safety Information Section of this manual.

Towing Requirements

To promote proper break-in of your new vehicle drivetrain components the following guidelines are recommended:

CAUTION!

- **Avoid towing a trailer for the first 500 miles (805 km) of vehicle operation. Doing so may damage your vehicle.**
- **During the first 500 miles (805 km) of trailer towing, limit your speed to 50 mph (80 km/h).**

WARNING!

Your vehicle may require special axle lubricant. Please refer to the fluids section of this manual.

Perform the maintenance listed in Section 8 of this manual. When towing a trailer, never exceed the GAWR, or GCWR, ratings.

WARNING!

Improper towing can lead to an injury accident. Follow these guidelines to make your trailer towing as safe as possible:

Make certain that the load is secured in the trailer and will not shift during travel. When trailering cargo that is not fully secured, dynamic load shifts can occur that may be difficult for the driver to control. You could lose control of your vehicle and have an accident.

- When hauling cargo or towing a trailer, do not overload your vehicle or trailer. Overloading can cause a loss of control, poor performance or damage to brakes, axle, engine, transmission, steering, suspension, chassis structure or tires.
- Safety chains must always be used between your vehicle and trailer. Always connect the chains to the frame or hook retainers of the vehicle hitch. Cross the chains under the trailer tongue and allow enough slack for turning corners.
- Vehicles with trailers should not be parked on a grade. When parking, apply the parking brake on the tow vehicle. Put the tow vehicle automatic transmission in P for Park. With a manual transmission, shift the transmission into reverse. And with four-wheel-drive vehicles, make sure the transfer case is not in neutral. Always, block or "chock" the trailer wheels.
- GCWR must not be exceeded.
- **Total weight must be distributed between the tow vehicle and the trailer such that the following four ratings are not exceeded:**
 1. GVWR

2. GTW
3. GAWR
4. Tongue weight rating for the trailer hitch utilized (This requirement may limit the ability to always achieve the 10% to 15% range of tongue weight as a percentage of total trailer weight).

Towing Requirements — Tires

- Do not attempt to tow a trailer while using a compact spare tire.
- Proper tire inflation pressures are essential to the safe and satisfactory operation of your vehicle. Refer to the Tires–General Information section of this manual on Tire Pressures for proper tire inflation procedures.
- Also, check the trailer tires for proper tire inflation pressures before trailer usage.

- Check for signs of tire wear or visible tire damage before towing a trailer. Refer to the Tires–General Information section of this manual on Tread Wear Indicators for the proper inspection procedure.
- When replacing tires refer to the Tires–General Information section of this manual on Replacement Tires for proper tire replacement procedures. Replacing tires with a higher load carrying capacity will not increase the vehicle’s GVWR and GAWR limits.

Towing Requirements — Trailer Brakes

- Do **not** interconnect the hydraulic brake system or vacuum system of your vehicle with that of the trailer. This could cause inadequate braking and possible personal injury.
- An electronically actuated trailer brake controller is required when towing a trailer with electronically

actuated brakes. When towing a trailer equipped with a hydraulic surge actuated brake system, an electronic brake controller is not required.

- Trailer brakes are recommended for trailers over 1,000 lbs (454 kg) and required for trailers in excess of 2,000 lbs (907 kg).

CAUTION!

If the trailer weighs more than 1,000 lbs (454 kg) loaded, it should have its own brakes and they should be of adequate capacity. Failure to do this could lead to accelerated brake lining wear, higher brake pedal effort, and longer stopping distances.

WARNING!

Do not connect trailer brakes to your vehicle's hydraulic brake lines. It can overload your brake system and cause it to fail. You might not have brakes when you need them and could have an accident.

Towing any trailer will increase your stopping distance. When towing you should allow for additional space between your vehicle and the vehicle in front of you. Failure to do so could result in an accident.

Towing Requirements — Trailer Lights & Wiring

Whenever you pull a trailer, regardless of the trailer size, stop lights and turn signals on the trailer are required for motoring safety.

The Trailer Tow Package may include a 4 and 7 pin wiring harness. Use a factory approved trailer harness and connector.

NOTE: Do not cut or splice wiring into the vehicles wiring harness.

The electrical connections are all complete to the vehicle but you must mate the harness to a trailer connector. Refer to the following illustrations.

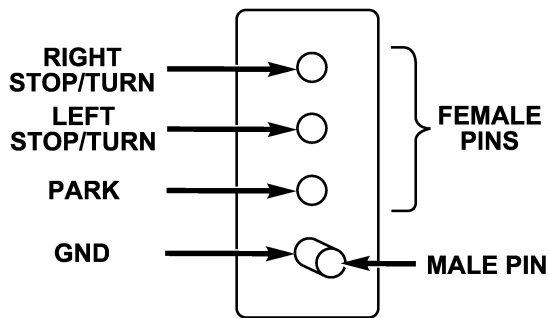

4 - Pin Connector

813262be

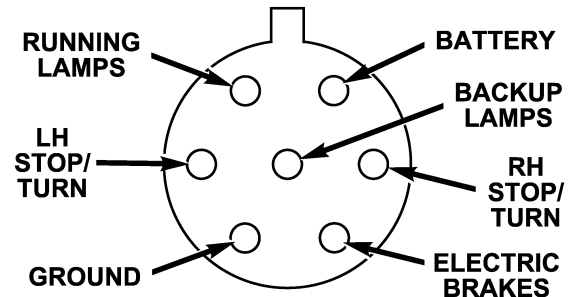

7- Pin Connector

812634c6

Towing Tips

Before setting out on a trip, practice turning, stopping and backing the trailer in an area away from heavy traffic.

If using a manual transmission vehicle for trailer towing, all starts must be in FIRST gear to avoid excessive clutch slippage.

Towing Tips — Automatic Transmission

The “D” range can be selected when towing. However, if frequent shifting occurs while in this range, the “TOW HAUL” or “OD/OFF” range should be selected.

NOTE: Using the “TOW HAUL” or “OD/OFF” range while operating the vehicle under heavy operating conditions will improve performance and extend transmission life by reducing excessive shifting and heat build up. This action will also provide better engine braking.

The automatic transmission fluid and filter should be changed if you REGULARLY tow a trailer for more than 45 minutes of continuous operation. See Schedule “B” in section 8 of this manual for transmission fluid change intervals.

NOTE: Check the automatic transmission fluid level before towing.

Towing Tips — Tow/Haul (If Equipped)

To reduce potential for automatic transmission overheating, turn the “TOW HAUL OD/OFF” feature ON when driving in hilly areas or shift the transmission to Drive position 2 on more severe grades.

Towing Tips — Electronic Speed Control (If Equipped)

– Don’t use in hilly terrain or with heavy loads.

- When using the speed control, if you experience speed drops greater than 10 mph (16 km/h), disengage until you can get back to cruising speed.
- Use speed control in flat terrain and with light loads to maximize fuel efficiency.

Towing Tips — Cooling System

To reduce potential for engine and transmission overheating, take the following actions:

– City Driving

When stopped for short periods of time, put transmission in neutral and increase engine idle speed.

– Highway Driving

Reduce speed.

– Air Conditioning

Turn off temporarily.

- refer to Cooling System Operating information in the Maintenance section of this manual for more information.

Trailer Towing Mirrors — If Equipped

These mirrors are designed with an adjustable mirror head to provide a greater vision range when towing extra-wide loads. To change position inboard or outboard, the mirror head should be rotated (flipped Out or In). A small blindspot mirror is integrated onto the main mirror surface.

NOTE: Fold the 7 x 10 inch trailer towing mirrors rearward prior to entering an automated car wash.

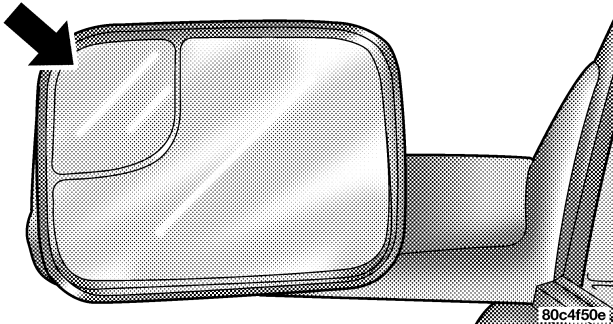

Blindspot Mirror

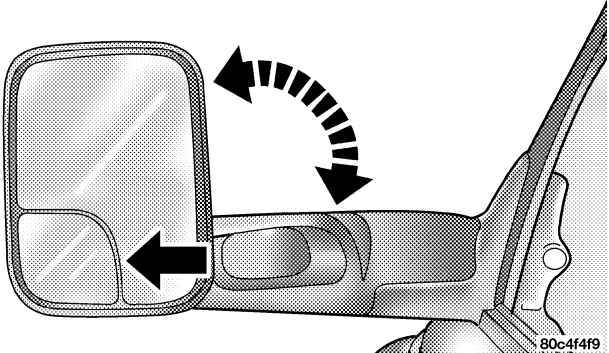

Trailer Towing Position

SNOWPLOW

Snowplow Prep Packages are available as a factory installed option. These packages include components necessary to equip your vehicle with a snowplow.

NOTE: Before installation of a snowplow it is highly recommended that the owner / installer obtain and follow the recommendations contained within the current Dodge BODY BUILDER'S GUIDE. See your dealer, installer or snowplow manufacture for this information. There are unique electrical systems that must be connected to properly assure operator safety and prevent overloading vehicle systems.

WARNING!

Attaching a snowplow to this vehicle could adversely affect performance of the airbag system in an accident. Do not expect that the airbag will perform as described earlier in this manual

CAUTION!

The "Lamp Out" indicator could illuminate if exterior lamps are not properly installed.

Before plowing

- Check the hydraulic system for leaks and proper fluid level.
- Check the mounting bolts and nuts for proper tightness.
- Check the runners and cutting edge for excessive wear. The cutting edge should be 1/4 to 1/2 inch above ground in snow plowing position.
- Check that snowplow lighting is connected and functioning properly.

Snowplow Prep Package Model Availability

For information about snowplow applications visit www.dodge.com or refer to the current Dodge Body Builders Guide.

1. The maximum number of occupants in the truck should not exceed two.

2. The total GVWR or the Front GAWR or the Rear GAWR should never be exceeded.

3. The snowplow prep packages are not available with the Sport Package.

4. Cargo capacity will be reduced by the addition of options or passengers, etc.

The loaded vehicle weight, including the snowplow system, all aftermarket accessories, driver, passengers, options, and cargo, must not exceed either the Gross Vehicle Weight (GVWR) or Gross Axle Weight (GAWR) ratings. These weights are specified on the Safety Compliance Certification Label on the driver's side door opening.

NOTE: Detach the snowplow when transporting passengers.

Vehicle front end wheel alignment was set to specifications at the factory without consideration for the weight

of the plow. Front end tow-in should be checked and reset if necessary at the beginning and end of the snowplow season. This will help prevent uneven tire wear.

The blade should be lowered whenever the vehicle is parked.

Maintain and operate your vehicle and snowplow equipment following the recommendations provided by the specific snowplow manufacturer.

Over the Road Operation With Snowplow Attached

The blade restricts air flow to the radiator and causes the engine to operate at higher than normal temperatures. Therefore, when transporting the plow, angle the blade completely and position it as low as road or surface conditions permit. Do not exceed 40 mph (64 km/h). The operator should always maintain a safe stopping distance and allow adequate passing clearance.

Methods For Removing Snow

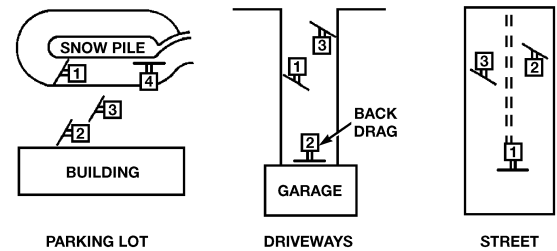

Operating Tips

Under ideal snow plowing conditions, 20 mph (32 km/h) should be maximum operating speed. The operator should be familiar with the area and surface to be cleaned. Reduce speed and use extreme caution when plowing unfamiliar areas or under poor visibility.

8020cd91

NOTE: During snowplow usage on vehicles equipped with an overhead console module, the outside temperature display will show higher temperatures than the outside ambient temperature. The higher displayed temperature is due to blocked or reduced airflow to the underhood ambient temperature sensor by the snowplow. This is common and outside temperature display operation will return to normal when the snowplow is removed.

General Maintenance

Snowplows should be maintained in accordance with the plow manufacturer's instructions.

Keep all snowplow electrical connections and battery terminals clean and free of corrosion.

When plowing snow, to avoid transmission and drivetrain damage, the following precautions should be observed.

- Operate with transfer case in 4L when plowing small or congested areas where speeds are not likely to exceed 15 mph (24 km/h). At higher speeds operate in 4H.
- Vehicles with 48RE transmissions should use 4L range when plowing deep or heavy snow for extended periods of time to avoid transmission overheating.
- Do not shift the transmission unless the engine has returned to idle and wheels have stopped. Make a practice of stepping on the brake pedal before shifting the transmission.

RECREATIONAL TOWING (BEHIND MOTORHOME, ETC.)**Recreational Towing – 2 Wheel Drive Models**

Recreational towing 2 Wheel Drive is not allowed. Towing with the rear wheels on the ground can result in severe transmission damage.

Recreational Towing – 4 Wheel Drive Models**CAUTION!**

Failure to follow these requirements can cause severe damage to the transmission and/or transfer case.

CAUTION!

Internal damage to the transfer case will occur if a front or rear wheel lift is used when recreational towing.

NOTE: Both the Manual Shift and Electronic Shift transfer cases must be shifted into Neutral (N) for recreational towing. Automatic transmissions must be placed in P (Park) position for recreational towing. Manual transmissions must be left in gear (not in neutral) for recreational towing. Refer below for the proper transfer case Neutral shifting procedure for your vehicle.

Recreational Towing Procedure — Manual Shift Transfer Case — If Equipped

Use the following procedure to prepare your vehicle for recreational towing:

CAUTION!

It is necessary to follow these steps to be certain that the transfer case is fully in N (NEUTRAL) before recreational towing to prevent damage to internal parts.

1. Bring the vehicle to a complete stop.
2. Shut OFF the engine.
3. Depress the brake pedal.
4. Shift automatic transmission to N (NEUTRAL), or depress the clutch on manual transmissions.
5. Shift transfer case lever into N (NEUTRAL).
6. Start the engine.
7. Shift automatic transmission into Reverse (R).
8. Release brake pedal for five seconds and ensure that there is no vehicle movement.
9. Repeat steps 7 and 8 with the transmission in Drive (D).
10. Shut OFF the engine and place the ignition key to the unlocked OFF position.
11. Shift automatic transmission into P (PARK).
12. Apply the parking brake.
13. Attach vehicle to tow vehicle with tow bar.
14. Release the parking brake.

CAUTION!

Damage to the automatic transmission may occur if the transmission is shifted into P (PARK) with the transfer case in N (NEUTRAL) and the engine RUNNING. With the transfer case in N (NEUTRAL) ensure that the engine is OFF prior to shifting the transmission into P (PARK)

Returning to Normal Operation — Manual Shift Transfer Case

Use the following procedure to prepare your vehicle for normal usage:

1. Bring the vehicle to a complete stop.
2. Apply the parking brake.
3. Shut OFF the engine.
4. Depress the brake pedal.

5. Shift automatic transmission to N (NEUTRAL), or depress the clutch on manual transmissions.
6. Shift transfer case lever to desired position.
7. Shift automatic transmission into P (Park).

WARNING!

You or others could be injured if you leave the vehicle unattended with the transfer case in the N (NEUTRAL) position without first fully engaging the parking brake. The transfer case N (NEUTRAL) position disengages both the front and rear drive-shafts from the powertrain and will allow the vehicle to move regardless of the transmission position. The parking brake should always be applied when the driver is not in the vehicle.

CAUTION!

- Do not use a bumper mounted clamp-on tow bar on your vehicle. The bumper face bar will be damaged.
- Do not disconnect the rear driveshaft because fluid will leak from the transfer case and damage the internal parts.

Recreational Towing Procedure — Electronic Shift Transfer Case — If Equipped

Use the following procedure to prepare your vehicle for recreational towing.

CAUTION!

It is necessary to follow these steps to be certain that the transfer case is fully in Neutral (N) before recreational towing to prevent damage to internal parts.

1. Bring vehicle to a complete stop.
2. Shut OFF the engine.
3. Turn the ignition key to the ON position, but do not start the engine.
4. Depress the brake pedal.
5. Shift automatic transmission to Neutral (N) or depress clutch on manual transmission.

6. Using the point of a ballpoint pen or similar object, depress the recessed transfer case Neutral (N) button for 4 seconds.
7. After shift is completed and the Neutral (N) light comes on release Neutral (N) button.
8. Start engine.
9. Shift automatic transmission into Reverse (R).
10. Release brake pedal for five seconds and ensure that there is no vehicle movement.
11. Repeat steps 9 and 10 with the transmission in Drive (D).
12. Shut engine OFF and place ignition key to the unlocked OFF position.
13. Shift automatic transmission into Park (P).
14. Apply parking brake.

15. Attach vehicle to tow vehicle with tow bar.

16. Release parking brake.

NOTE: Items 1 through 5 are requirements that must be met prior to depressing the Neutral (N) selection button, and must continue to be met until the 4 seconds elapses and the shift has been completed. If any of these requirements (with the exception of 3 - Key ON) are not met prior to depressing the Neutral (N) button or are no longer met during the 4 second timer, then the Neutral (N) indicator light will flash continuously until all requirements are met or until the Neutral (N) button is released.

NOTE: The ignition key must be ON for a shift to take place and for the position indicator lights to be operable. If the key is not ON, the shift will not take place and no position indicator lights will be on or flashing.

NOTE: Flashing neutral (N) position indicator light indicates that shift requirements have not been met.

CAUTION!

Damage to the transmission may occur if the transmission is shifted into Park (P) with the transfer case in Neutral (N) and the engine RUNNING. With the transfer case in Neutral (N) ensure that the engine is OFF prior to shifting the transmission into Park (P).

Returning to Normal Operation — Electronic Shift Transfer Case

Use the following procedure to prepare your vehicle for normal usage.

1. Bring vehicle to a complete stop.
2. Shut OFF the engine.

3. Turn the ignition key to the ON position, but do not start the engine.

4. Depress the brake pedal.

5. Shift automatic transmission to Neutral (N) or depress clutch on manual transmission.

6. Using the point of a ballpoint pen or similar object, depress the recessed transfer case Neutral (N) button for 1 second.

7. After the Neutral (N) indicator light turns off release the Neutral (N) button.

8. After the Neutral (N) button has been released the transfer case will shift to the position identified by the selector switch.

9. Shift automatic transmission into P (Park).

NOTE: The transfer case can not be shifted into Neutral (N) from the 4Auto (if equipped) position.

NOTE: Items 1 through 5 are requirements that must be met prior to depressing the Neutral (N) selection button, and must continue to be met until 1 second elapses and the shift has been completed. If any of these requirements (with the exception of 3 - key ON) are not met prior to depressing the Neutral (N) button or are no longer met during the 1 second time, then all of the mode position indicator lights will flash continuously until all requirements are met or until the Neutral (N) button is released.

NOTE: The ignition key must be ON for a shift to take place and for the position indicator lights to be operable. If the key is not ON, the shift will not take place and no position indicator lights will be on or flashing.

NOTE: Flashing neutral (N) position indicator light indicates that shift requirements have not been met.

WARNING!

You or others could be injured if you leave the vehicle unattended with the transfer case in the Neutral (N) position without first fully engaging the parking brake. The transfer case Neutral (N) position disengages both the front and rear driveshafts from the powertrain and will allow the vehicle to move despite the transmission position. The parking brake should always be applied when the driver is not in the vehicle.

CAUTION!

- Do not use a bumper mounted clamp-on tow bar on your vehicle. The bumper face bar will be damaged.
- Do not disconnect the rear driveshaft because fluid will leak from the transfer case and fluid loss will damage internal parts.

WHAT TO DO IN EMERGENCIES

CONTENTS

■ Hazard Warning Flasher354	■ Jump-Starting367
■ Jacking And Tire Changing355	□ With Portable Starting Unit370
□ All Models355	■ Freeing A Stuck Vehicle370
■ Jacking Instructions356	■ Emergency Tow Hooks — If Equipped371
□ Removing The Spare Tire356	■ Towing A Disabled Vehicle372
□ Tire Changing Procedure357	□ 4-Wheel- Drive Vehicles372
■ Hoisting366	□ 2-Wheel- Drive Vehicles373

HAZARD WARNING FLASHER

The Hazard Warning switch is mounted on the top of the steering column as shown in the illustration.

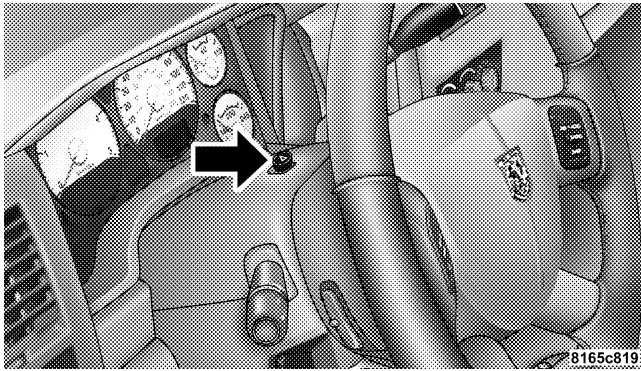

Hazard Light Warning Switch

To engage the Hazard Warning lights, depress the button on the top of the steering column. When the Hazard Warning switch is activated, all directional turn signals will flash off and on to warn oncoming traffic of an emergency. Push the button a second time to turn off the flashers.

This is an emergency warning system and should not be used when the vehicle is in motion. Use it when your vehicle is disabled and is creating a safety hazard for other motorists.

When you must leave the vehicle to seek assistance, the Hazard Warning lights will continue to operate even though the ignition switch is OFF.

NOTE: With extended use, the Hazard Warning lights may discharge your battery.

JACKING AND TIRE CHANGING**WARNING!**

- Being under a jacked-up vehicle is dangerous. The vehicle could slip off the jack and fall on you. You could be crushed. Never put any part of your body under a vehicle that is on a jack. Never start or run the engine while the vehicle is on a jack. If you need to get under a raised vehicle, take it to a service center where it can be raised on a lift.
- The jack is designed to use as a tool for changing tires only. The jack should not be used to lift the vehicle for service purposes. The vehicle should be jacked on a firm level surface only. Avoid ice or slippery areas.

All Models

The jack and jack tools are stored under the front passenger seat. Lift the flap on the side of the seat for access.

Remove the jack and tools by removing the wing bolt and sliding the assembly from under the seat.

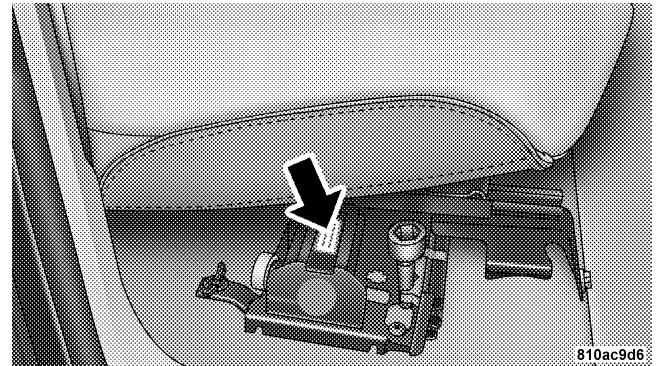

WARNING!

After using the jack and tools, always reinstall them in the original carrier and location. While driving you may experience, abrupt stopping, rapid acceleration, or sharp turns. A loose jack, tools, bracket or other objects in the vehicle may move around with force, resulting in serious injury.

JACKING INSTRUCTIONS**Removing The Spare Tire**

Remove the spare tire before attempting to jack the truck. Attach the wheel wrench to the jack extension tube. Insert the tube through the access hole between the lower tailgate and the top of the bumper and into the winch mechanism tube. Rotate the wheel wrench handle counterclockwise until the spare tire is on the ground with enough cable slack to allow you to pull it out from under

the vehicle. When the spare is clear, tilt the retainer at the end of the cable and pull it through the center of the wheel.

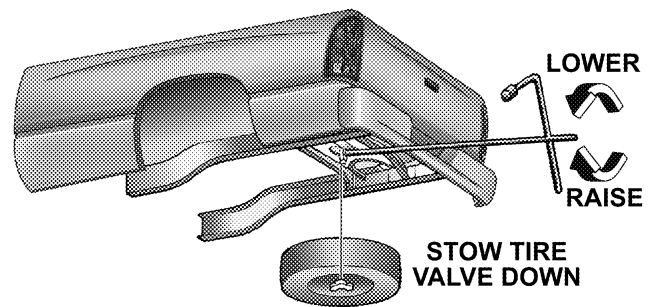

810ae782

It is recommended that you stow the flat or spare to avoid tangling the loose cable.

NOTE: The winch mechanism is designed for use with the jack extension tube only. Use of an air wrench or other power tools is not recommended and can damage the winch.

Tire Changing Procedure

WARNING!

Getting under a jacked-up vehicle is dangerous. The vehicle could slip off the jack and fall on you. You could be crushed. Never get any part of your body under a vehicle that is on a jack. Never start or run the engine while the vehicle is on a jack. If you need to get under a raised vehicle, take it to a service center where it can be raised on a lift.

Do not raise this vehicle using a bumper jack. The jack is designed as a tool for changing tires on this vehicle only. It is not recommended that the jack be used for service purposes or to lift more than one wheel at a time.

Preparations

Park the vehicle on a firm level surface, avoiding ice or slippery areas. Set the parking brake and place the gear selector in PARK (automatic transmission) or REVERSE (manual transmission). On four-wheel drive vehicles, shift the transfer case to the "4L" position.

WARNING!

Do not attempt to change a tire on the side of the vehicle close to moving traffic. Pull far enough off the road to avoid the danger of being hit when operating the jack or changing the wheel.

- Turn on the Hazard Warning Flasher.

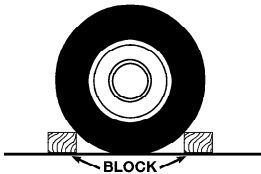

- Block both the front and rear of the wheel diagonally opposite the jacking position. For example, if the right front wheel is being changed, block the left rear wheel.
- Passengers should not remain in the vehicle when the vehicle is being jacked.

Instructions

WARNING!

Carefully follow these tire changing warnings to help prevent personal injury or damage to your vehicle:

- Always park on a firm, level surface as far from the edge of the roadway as possible before raising the vehicle.
- Block the wheel diagonally opposite the wheel to be raised.
- Apply the parking brake firmly before jacking.
- Never start the engine with the vehicle on a jack.
- Do not let anyone sit in the vehicle when it is on a jack.
- Do not get under the vehicle when it is on a jack.
- Only use the jack in the positions indicated.
- If working on or near a roadway, be extremely careful of motor traffic.

1. Remove the spare wheel, jack, and tools from storage.
2. Using the wheel wrench, loosen, but do not remove, the wheel nuts by turning them counterclockwise one turn while the wheel is still on the ground.
3. For 2500/3500 4x2 series trucks, when changing a front wheel, place the bottle jack under the frame rail behind the wheel. Locate the jack as far forward as possible on the straight part of the frame.

For 2500/3500 4x4 series trucks, when changing the front wheel, assemble the jack drive tube to the jack and connect the drive tube to the extension tube. Place the jack under the axle as close to the tire as possible with the drive tubes extending to the front. Connect the jack tube extension and wheel wrench.

When changing a rear wheel, assemble the jack drive tube to the jack and connect the drive tube to the extension tube. Place the jack under the axle between the spring and the shock absorber with the drive tubes extending to the rear. Connect the jack tube extension and wheel wrench.

Before raising the wheel off the ground, make sure that the jack will not damage surrounding truck parts and adjust the jack position as required.

NOTE: If the jack will not lower by turning the dial (thumb wheel) by hand, it may be necessary to use the jack drive tube in order to lower the jack.

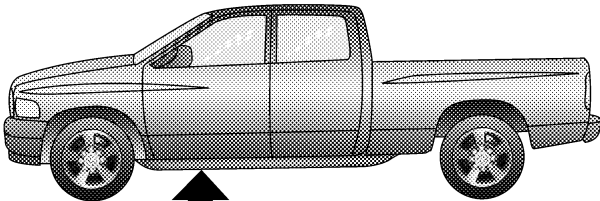

4X2

4X2 Jacking

810ae77d

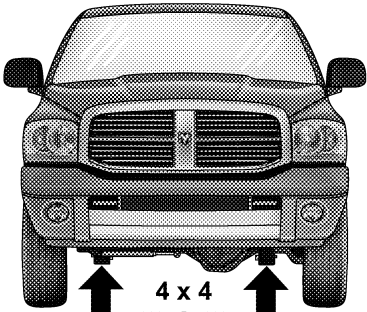

4 x 4
FRONT

JACKING LOCATION

817d213a

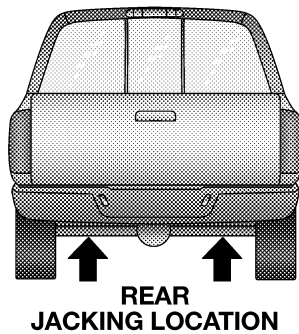

80ef9fa5

4. By rotating the wheel wrench clockwise, raise the vehicle until the wheel just clears the surface.

WARNING!

Raising the vehicle higher than necessary can make the vehicle unstable and cause an accident. It could slip off the jack and hurt someone near it. Raise the vehicle only enough to remove the tire.

5. Remove the wheel nuts and pull the wheel off. Install the spare wheel and wheel nuts with the cone shaped end of the nuts toward the wheel on 2500/3500 single rear wheel (SRW) models. On 3500 dual rear wheel models (DRW) the lug nuts are a two piece assembly with a flat face. Lightly tighten the nuts. To avoid risk of forcing the vehicle off the jack, do not fully tighten the nuts until the vehicle has been lowered.

6. Using the wheel wrench, finish tightening the nuts using a crisscross pattern. Correct nut tightness is 135 ft. lbs. (183 N·m) torque for 2500/3500 single rear wheel

(SRW) models and 145 ft. lbs. (197 N·m) for 3500 dual rear wheel models. If in doubt about the correct tightness, have them checked with a torque wrench by your dealer or at a service station.

WARNING!

A loose tire or jack thrown forward in a collision or hard stop could injure someone in the vehicle. Always stow the jack parts and the extra tire and wheel in the places provided.

7. Install wheel center cap and remove wheel blocks. Do not install chrome or aluminum wheel center caps on the spare wheel. This may result in cap damage.

8. Lower the jack to its fully closed position. If the jack will not lower by turning the dial (thumb wheel) by

hand, it may be necessary to use the jack drive tube in order to lower the jack. Stow the replaced tire, jack, and tools as previously described.

9. Adjust the tire pressure when possible.

NOTE: Do not oil wheel studs. For chrome wheels, do not substitute with chrome plated wheel nuts.

Hub Caps/Wheel Covers

The hub caps must be removed before raising the vehicle off the ground.

For 2500/3500 single rear wheel (SRW) models, use the blade on the end of the lug wrench to pry the hub cap off. Insert the blade end into the pryoff notch and carefully pop off the hub cap with a back and forth motion.

On 3500 models with dual rear wheels (DRW), you must first remove the hub caps. The jack handle driver has a hook at one end that will fit in the pry off notch of the rear hub caps. Position the hook and pull out on the

ratchet firmly. The hub cap should pop off. The wheel skins can now be removed. For the front hub cap on 3500 models use the blade on the end of the lug wrench to pry the caps off. The wheel skin can now be removed.

CAUTION!

Use a back and forth motion to remove the hub cap. Do not use a twisting motion when removing the hub cap, damage to the hub cap finish may occur.

CAUTION!

The rear hub caps on the dual rear wheel has two pry off notches. Make sure that the hook of the jack handle driver is located squarely in the cap notch before attempting to pull off.

You must use the flat end of the lug wrench to pry off the wheel skins. Insert the flat tip completely and using a back and forth motion, loosen the wheel skin. Repeat this procedure around the tire until the skin pops off.

Replace the wheel skins first using a rubber mallet. When replacing the hub caps, tilt the cap retainer over the lugnut bolt circle and strike the high side down with a rubber mallet. Be sure that the hub caps and wheel skins are firmly seated around the wheel.

8-Stud — Dual Rear Wheels

Dual wheels are flat mounted, center piloted. The lug nuts are a two piece assembly. When the tires are being rotated or replaced, clean these lug nuts and add 2 drops of oil at the interface between the hex and the washer.

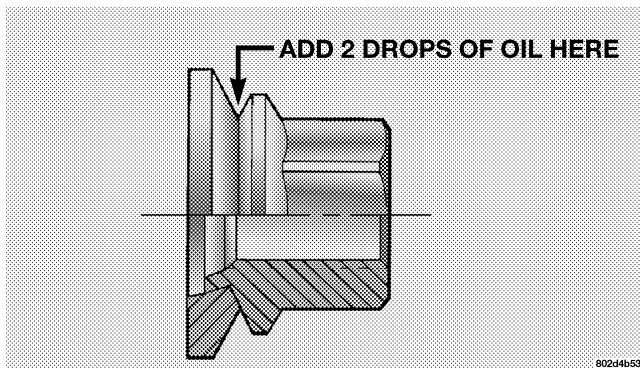

Slots in the wheels will assist in properly orienting the inner and outer wheels. Align these slots when assembling the wheels for best access to the tire valve on the inner wheel. The tires of both dual wheels must be completely off the ground when tightening to insure wheel centering and maximum wheel clamping.

Dual wheel models require a special heavy-duty lug nut tightening adapter (included with the vehicle) to correctly tighten the lug nuts. Also, when it is necessary to remove and install dual rear wheels, use a proper vehicle lifting device.

NOTE: When installing a spare tire as part of a dual rear wheel end combination, the tire diameter of the two individual tires must be compared. If there is a significant difference, the larger tire should be installed in a front location. Correct direction of rotation for dual tire installations must also be observed.

These dual rear wheels should be tightened as follows:

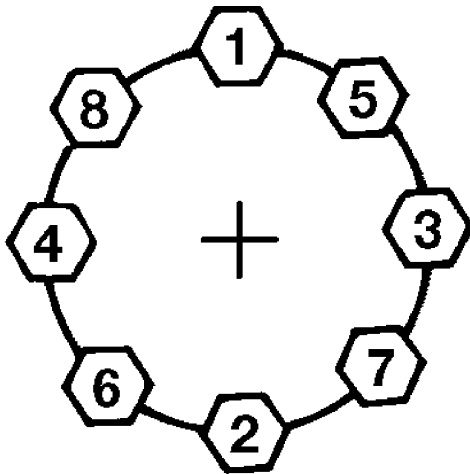

8 STUDS

80a58b1a

1. Tighten the wheel nuts in the numbered sequence to a snug fit.
2. Retighten the wheel nuts in the same sequence to the torques listed in the table. Go through the sequence a second time to verify that specific torque has been achieved. Retighten to specifications at 100 miles (160 km) and after 500 miles (800 km).

It is recommended that wheel stud nuts be kept torqued to specifications at all times. Torque wheel stud nuts to specifications at each lubrication interval.

Wheel Nuts

All wheel nuts should be tightened occasionally to eliminate the possibility of wheel studs being sheared or the bolt holes in the wheels becoming elongated. This is especially important during the first few hundred miles of operation to allow the wheel nuts to become properly set. All nuts should first be firmly seated against the

wheel. The nuts should then be tightened to recommended torque. Tighten the nuts to final torque in increments. Progress around the bolt circle, tightening the nut opposite to the nut just previously tightened until final torque is achieved. Recommended torques are shown in the following chart.

Disc Wheels	Type Nut	Stud Size	Torque Ft. Lbs.	Torque Newton Meters
	Cone	9/16-18	120-150	160-200
	Flanged	9/16-18	130-160	190-220

To Stow The Flat Or Spare

Turn the wheel so that the valve stem is down. Slide the wheel retainer through the center of the wheel and position it properly across the wheel opening.

For convenience in checking the spare tire inflation, stow with the valve stem toward the rear of the vehicle.

Attach the wheel wrench to the extension tube. Rotate the winch mechanism until the wheel is drawn into place against the underside of the vehicle. Continue to rotate until you feel the winch mechanism slip or click 3 or 4 times. It cannot be overtightened. Push against the tire several times to be sure it is firmly in place.

HOISTING

A conventional floor jack may be used at the jacking locations, refer to the graphics that show jacking locations. However, a floor jack or frame hoist must never be used on any other parts or the underbody.

CAUTION!

Never use a floor jack directly under the differential housing of a loaded truck or damage to your vehicle may result.

JUMP-STARTING**WARNING!**

To prevent personal injury or damage to clothing, do not allow battery fluid to contact eyes, skin or fabrics. Do not lean over a battery when connecting jumper cables or allow cable clamps to touch each other. Keep open flames or sparks away from battery vent holes. Always wear eye protection when working with batteries.

Do not use a booster battery or any other booster source that has a greater than 12 volt system, i.e. do not use a 24 volt power source.

NOTE: Replacement batteries should both be of equal size to prevent damage to the vehicles charging system.

Your vehicle is equipped with two 12-volt batteries. If it becomes necessary to use a booster battery, with jumper cables, to start a vehicle's engine because its batteries are discharged, the following procedure should be followed:

Set the parking brake and place an automatic transmission in PARK (or NEUTRAL for a manual transmission). Turn off lights, heater and other electrical loads. Observe charge indicator (if equipped) in both batteries. If indicator (if equipped) is light or yellow on either battery, replace that battery.

CAUTION!

Use the Jump Start Procedure only when the charge indicator (if equipped) in both batteries is dark in the center. Do not attempt jump starting when either battery charge indicator (if equipped) is bright or yellow. If charge indicator (if equipped) has a green dot in the center, failure to start is not due to a discharged battery and cranking system should be checked.

1. Attach one jumper cable to the positive terminal of booster battery and the other end of the same cable to the positive terminal of the discharged battery.

WARNING!

Do not permit vehicles to touch each other as this could establish a ground connection and personal injury could result.

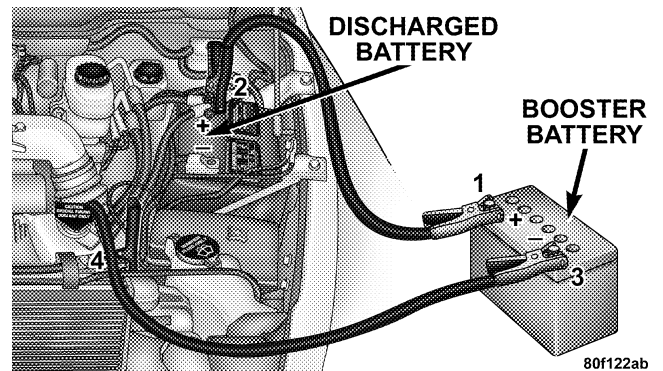

2. Connect one end of the other jumper cable to negative (-) post of booster battery. Connect the other end of the jumper cable to a good ground on the engine block of the vehicle with the discharged battery. Make sure a good connection is made, free of dirt and grease.

WARNING!

- Do not connect the cable to the negative post of the discharge battery. The resulting electrical spark could cause the battery to explode.
- During cold weather when temperatures are below freezing point, electrolyte in a discharged battery may freeze. Do not attempt jump starting because the battery could rupture or explode. The battery temperature must be brought up above freezing point before attempting jump start.

3. Take care that the clamps from one cable do not inadvertently touch clamps from the other cable. Do not lean over the battery when making connection. The negative connection must provide good electrical conductivity and current carrying capacity.

4. After the engine is started or if the engine fails to start, cables must be disconnected in the following order:

- a. Disconnect the negative cable at the engine ground.
- b. Disconnect the negative cable at the negative post on booster battery.
- c. Disconnect the cable from the positive post of both batteries.

WARNING!

Any procedure other than above could result in:

1. Personal injury caused by electrolyte squirting out the battery vent;
2. Personal injury or property damage due to battery explosion;
3. Damage to charging system of booster vehicle or of immobilized vehicle.

With Portable Starting Unit

There are many types of these units available. Follow the manufacturer's instructions for necessary precautions and operation.

CAUTION!

It is very important that the starting unit operating voltage does not exceed 12 Volts D.C. or damage to battery, starter motor, alternator, or electrical system may occur.

FREEING A STUCK VEHICLE

If vehicle becomes stuck in snow, sand, or mud, it can often be moved by a rocking motion. Move the gear selector rhythmically between DRIVE and REVERSE (automatic transmissions) and between 1st and REVERSE (manual transmissions), while applying slight pressure to the accelerator.

In general, the least amount of accelerator pedal pressure to maintain the rocking motion without spinning the wheels or racing the engine is most effective. Racing the engine or spinning the wheels, due to the frustration of

not freeing the vehicle, may lead to transmission overheating and failure. Allow the engine to idle with the transmission selector in NEUTRAL for at least one minute after every five rocking-motion cycles. This will minimize overheating and reduce the risk of transmission failure during prolonged efforts to free a stuck vehicle.

EMERGENCY TOW HOOKS — IF EQUIPPED

Your vehicle may be equipped with emergency tow hooks.

NOTE: For off-road recovery, it is recommended to use both of the front tow hooks to minimize the risk of damage to the vehicle.

WARNING!

Chains are not recommended for freeing a stuck vehicle. Chains may break, causing serious injury or death.

WARNING!

Stand clear of vehicles when pulling with tow hooks. Tow straps and chains may break, causing serious injury.

CAUTION!

Tow hooks are for emergency use only, to rescue a vehicle stranded off road. Do not use tow hooks for tow truck hookup or highway towing. You could damage your vehicle.

TOWING A DISABLED VEHICLE

Proper towing or lifting equipment is required to prevent damage to your vehicle. Use only tow bars and other equipment designed for the purpose, following equipment manufacturer's instructions. Use of safety chains is mandatory. Attach a tow bar or other towing device to the main structural members of the vehicle—not to bumpers or associated brackets. State and local laws applying to vehicles under tow must be observed.

4-Wheel- Drive Vehicles**CAUTION!**

To avoid damage to the transfer case while towing, always use one of the following methods.

NOTE: The Transfer Case must be in the neutral position, and the transmission must be in Park (Automatic Transmission), or in gear (Manual Transmission) to tow a 4WD vehicle with one end of the vehicle raised.

The manufacturer recommends towing with all wheels **OFF** the ground. Acceptable methods are to tow vehicle on a flatbed or with one end of vehicle raised and the opposite end on a towing dolly.

2-Wheel- Drive Vehicles

Provided that the transmission is operable, tow with the transmission in Neutral and the ignition key in the OFF position along with the front wheels raised and the rear wheels on the ground. Speed must not exceed 30 mph (50 km/h) and distance must not exceed 15 miles (25 km).

If the vehicle is to be towed faster than 30 mph (50 km/h) or more than 15 miles (25 km) the vehicle must be towed with the rear wheels raised and the front wheels on the ground. It may also be towed on a flatbed or with the front wheels raised and the rear wheels on a dolly.

CAUTION!

Towing faster than 30 mph (50 km/h) or for more than 15 miles (25 km) can cause severe damage to the transmission.

MAINTAINING YOUR VEHICLE

CONTENTS

■ Engine Compartment	378	□ Drive Belt	389
□ 5.9L HO Cummins Turbo Diesel	378	□ Engine Air Cleaner Filter	389
■ Onboard Diagnostic System (OBD II)	379	□ Draining Fuel/Water Separator Filter	391
■ Replacement Parts	379	□ Maintenance Free Batteries	394
■ Engine Data Plate	380	□ Air Conditioner Maintenance	396
■ Dealer Service	380	□ Power Steering — Fluid Check	397
■ Service Information	380	□ Front Suspension Ball Joints	397
■ Maintenance Procedures	383	□ Steering Linkage — Inspection	398
□ Engine Oil	383	□ Front Prop Shaft Lubrication	398

376 MAINTAINING YOUR VEHICLE

□ Front Axle Universal Drive Joints And Pivot Bearings	398	□ Rear Axle And 4X4 Front Driving Axle Fluid Level	411
□ Body Lubrication	399	□ Transfer Case — If Equipped	412
□ Windshield Wiper Blades	399	□ Manual Transmission — If Equipped	412
□ Windshield Washers	399	□ Automatic Transmission	413
□ Exhaust System	400	□ Front Wheel Bearings	415
□ Cooling System	401	□ Selection Of Lubricating Grease	416
□ Fan	407	□ Noise Control System Required Maintenance & Warranty	417
□ Charge Air Cooler (Inter-Cooler)	408	□ Appearance Care And Protection From Corrosion	422
□ Hoses And Vacuum/Vapor Harnesses	408	■ Fuses (Integrated Power Module)	426
□ Brake System	409	■ Vehicle Storage	431
□ Clutch Linkage	411	■ Replacement Light Bulbs	432
□ Clutch Hydraulic System	411		

■ Bulb Replacement	433	□ Rear Light Bar ID Marker (Dual Rear Wheel) – If Equipped	444
□ Headlight (Halogen)/Front Park And Turn Lights	433	□ Side Marker Lights (Dual Rear Wheels)	445
□ Fog Lights	436	■ Fluid Capacities	445
□ Tail, Stop, Turn And Backup Lights	437	■ Fluids, Lubricants And Genuine Parts	446
□ Center High-Mounted Stoplight (CHMSL) With Cargo Light	440	□ Engine	446
□ Cab Top Clearance Lights — If Equipped	441	□ Chassis	447
□ Tailgate ID Lights (Dual Rear Wheels) — If Equipped	443		

ENGINE COMPARTMENT

5.9L HO CUMMINS TURBO DIESEL

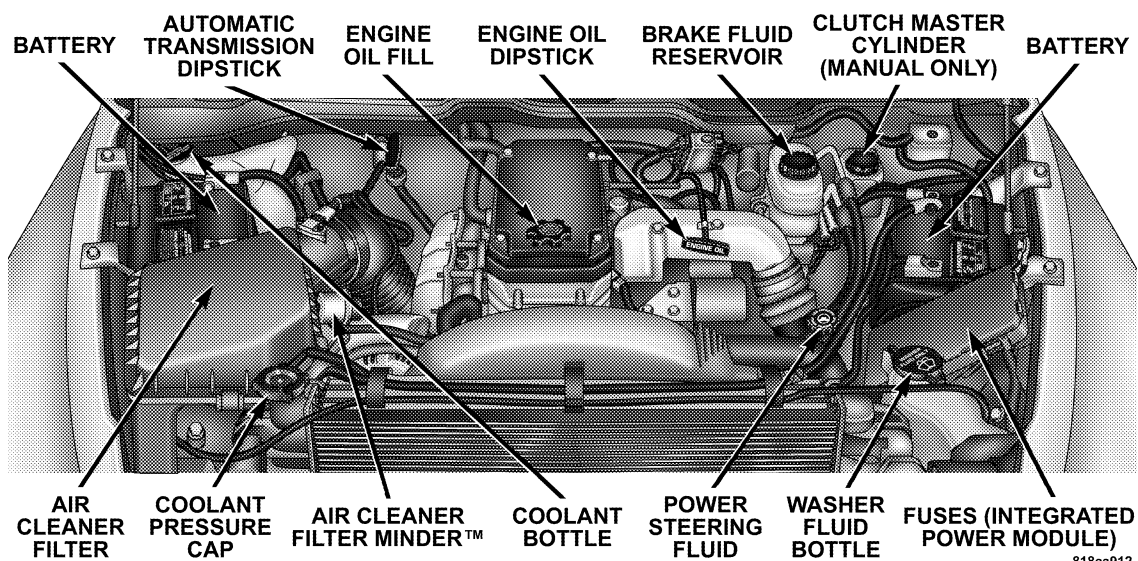

ONBOARD DIAGNOSTIC SYSTEM (OBD II)

Vehicles equipped with California emissions controls have a sophisticated onboard diagnostic system called OBDII. This system monitors the performance of the emissions, engine, and automatic transmission control systems. When these systems are operating properly, your vehicle will provide excellent performance and fuel economy, as well as engine emissions well within current government regulations.

If any of these systems require service, the OBD II system will turn on the "Malfunction Indicator Light." It will also store diagnostic codes and other information to assist your service technician in making repairs. Although your vehicle will usually be driveable and not need towing, see your dealer for service as soon as possible.

CAUTION!

Prolonged driving with the "Malfunction Indicator Light" on could cause further damage to the emission control system. It could also affect fuel economy and driveability. The vehicle must be serviced before any emissions tests can be performed.

If the "Malfunction Indicator Light" is flashing, severe catalytic converter damage and power loss will soon occur. Immediate service is required.

REPLACEMENT PARTS

Use of genuine Mopar® parts for normal/scheduled maintenance and repairs is highly recommended to insure the designed performance. Damage or failures caused by the use of non-Mopar parts for maintenance and repairs will not be covered by the manufacturer's warranty.

ENGINE DATA PLATE

Use the information from the engine data plate when discussing service or sourcing parts for your engine. The engine data plate is located on the intake side of the breather cover.

DEALER SERVICE

Your dealer has the qualified service personnel, special tools and equipment to perform all service operations in an expert manner. Service manuals are available which include detailed service information for your vehicle. Refer to these manuals before attempting any procedure yourself.

NOTE: Intentional tampering with emissions control systems can result in civil penalties being assessed against you.

WARNING!

You can be badly injured working on or around a motor vehicle. Do only that service work for which you have the knowledge and the proper equipment. If you have any doubt about your ability to perform a service job, take your vehicle to a competent mechanic.

SERVICE INFORMATION

Mopar Fluids, Lubricants and Parts are available from your dealer and will help you keep your vehicle operating at its best. Your dealer also has the qualified service personnel, special tools and equipment to perform all service operations in an expert manner. Service manuals are available which include detailed service information for your vehicle. Refer to these manuals before attempting any procedure yourself. See Service Publications information at the back of this manual.

CAUTION!

To maintain your vehicle safely follow these guidelines:

- Watch your vehicle’s mileage and check your **Maintenance Schedules** regularly for required servicing. Excessive wear or damage to certain vehicle components can result if required services are not performed.
- If you have your vehicle undercoated, inspect for undercoating material on the propeller shafts. Such material could cause the shafts to become unbalanced and result in drivetrain vibrations. Remove any undercoating with solvent.
- If you have your vehicle undercoated, make sure no undercoating material is sprayed on the exhaust system or components of the seat belt system.

NOTE: It is not possible for the manufacturer and Cummins, Inc. to anticipate every possible circumstance that can involve a potential hazard.

WARNING!

To maintain your vehicle safely and avoid personal injury, follow these guidelines:

- Never spray or pour diesel fuel, flammable liquid or starting fluids (ether) into the air cleaner assembly, air intake piping or turbocharger inlet in an attempt to start the vehicle, unintended engine acceleration may occur.
- Do not use alcohol or gasoline as a fuel blending agent. They can be unstable under certain conditions and be hazardous or explosive when mixed with diesel fuel.

- If an engine has been operating and the coolant is hot, allow the engine to cool before you slowly loosen the filler cap and relieve the pressure from the cooling system.
- To avoid burns, remember that the engine components will stay hot after the engine is shut off.
- Do not use gasoline or other flammable materials to clean parts. Always use approved cleaning solvents.
- Relieve all pressure in the fuel, oil and cooling systems before any lines, fittings or related items are removed or disconnected. Be alert for possible pressure when disconnecting any device from a system that utilizes pressure. Do not check for pressure leaks with your hand. High pressure oil or fuel can cause personal injury.

WARNING!

Do not open the high pressure fuel system with the engine running. Engine operation causes high fuel pressure. High pressure fuel spray can cause serious injury or death.

- **Important:** All maintenance other than that listed in this manual, as well as some procedures listed here, **MUST** be performed by your local Dodge Truck Dealer. Your authorized Dodge Dealer has been trained and has the necessary parts to maintain your engine.

MAINTENANCE PROCEDURES

The pages that follow contain the **required** maintenance services determined by the engineers who designed your vehicle.

Besides the maintenance items for which there are fixed maintenance intervals, there are other items that should operate satisfactorily without periodic maintenance. However, if a malfunction of these items does occur, it could adversely affect the engine or vehicle performance. These items should be inspected if a malfunction is observed or suspected.

Engine Oil

Checking Oil Level

To assure proper lubrication of your vehicle's engine, the engine oil must be maintained at the correct level. Check the oil level at regular intervals. The best time to check the oil level is before starting the engine after it has been parked overnight. When checking oil after operating the

engine, first ensure the engine is at full operating temperature, then wait at least 15 minutes after engine shutdown to check the oil.

Checking the vehicle while it's on level ground will also improve the accuracy of the oil level readings. Add oil only when the level on the dipstick is below the "ADD" mark. The total capacity from the low mark to the high mark is 2 quarts (1.9 liters).

CAUTION!

Overfilling or underfilling the crankcase will cause oil aeration or loss of oil pressure. This could damage your engine.

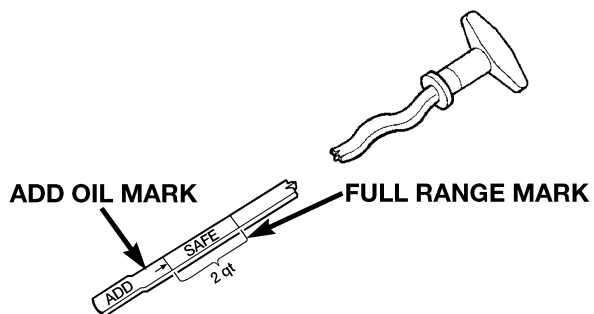

80698712

Never operate the engine with oil level below the “ADD” mark or above the upper “SAFE” mark.

Change Engine Oil

Road conditions as well as your kind of driving affect the interval at which your oil should be changed. Check the following to determine if any apply to you:

- Frequent short trips where the engine does not achieve full operating temperature (operating temperature defined as 190° F (66° C) coolant temperature).
- Extensive engine idling (over 10 minutes per hour of operation) at ambient temperatures less than 32° F (0° C).
- Driving in dusty conditions.
- Frequent trailer towing.
- Taxi, police, or delivery service (commercial service).
- Off-road or desert operation.
- Extensive operation at high engine speeds (greater than 2900 rpm) and loads (greater than 70% throttle).

If **ANY** of these apply to you, then change your engine oil at every interval shown in schedule "B" of the "Maintenance Schedules" section of this manual.

If none of these apply to you, then change your engine oil at every interval shown on schedule "A" of the "Maintenance Schedules" section of this manual.

NOTE: Most vehicles are operated under the conditions listed for Schedule "B."

Engine Oil Selection

1. Engine Oil Quality



Use only oils conforming to API Service CI-4. A sulfated ash limit is specified for lubrication oil used in Cummins engines. Oils with a high ash content may produce deposits on valves that can progress to guttering

and valve burning. A maximum sulfated ash content of 1.85 mass % is recommended for all oil used in the engine.

2. Engine Oil Viscosity (SAE Grade)

The proper SAE viscosity of engine oil for the expected ambient temperature range should be selected, as indicated in the following chart:

NOTE: The same oil change interval is to be followed for synthetic oil as for petroleum based oil. Also, synthetic oil must meet the same performance specifications as petroleum oil.

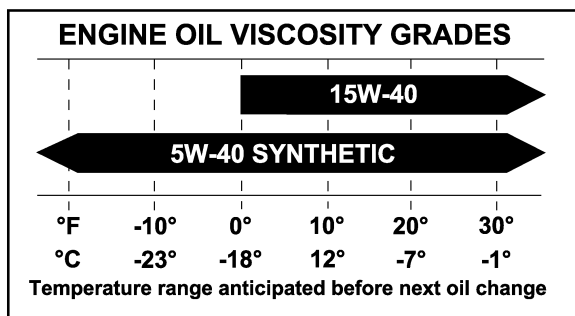

80F2247d

You may use synthetic engine oils provided the recommended oil quality requirements are met, and the recommended maintenance intervals for oil and filter changes are followed.

Materials Added to Engine Oil

The manufacture strongly recommends against the addition of any additives (other than leak detection dyes or

lube odorants) to the engine oil. Engine oil is an engineered product and it's performance may be impaired by supplemental additives.

NOTE: The manufacturer offers a lube odorant (Mopar Diesel Fresh) for diesel engines crankcases. The lube odorant is recommended by the manufacturer to reduce the sulfur smell that may occur during engine idling.

Engine Oil Filter

Refer to Fluids, Lubricants and Genuine Parts for the correct part number. The engine oil filter should be changed at **every** engine oil change.

Engine Oil And Filter — Change

Operate the engine until the coolant temperature reaches 140°F (60°C). Shut the engine off. Remove the oil drain plug.

Use a container that can hold at least 12 quarts (11.3 Liters) to hold the used oil.

Always check the condition of the used oil. This can give you an indication of some engine problems that might exist.

- Thin, black oil indicates fuel dilution.
- Milky discoloration indicates coolant dilution.

Clean the area around the oil filter base. Remove the filter from the underside of the vehicle using a cap style oil filter wrench.

Clean the gasket surface of the filter mount. The filter gasket can stick on the filter mount. Make sure it is removed.

Change the engine oil filter with every engine oil change.

Only a high quality MOPAR filter should be used to assure most efficient service.

CAUTION!

The filtering medium of other aftermarket filters may disintegrate. Debris from failed filters may plug the piston oil cooling nozzles, resulting in scuffed pistons and engine failure.

CAUTION!

Fill the oil filter element with clean oil before installation. Use the same type oil that will be used in the engine. When filling the oil filter, prevent foreign material from falling into the filter. Severe engine damage may occur.

Apply a light film of lubricating oil to the sealing surface of the filter gasket before installing the filter.

CAUTION!

Overtightening may distort the threads or damage the filter element seal.

Install the filter as specified by the filter manufacturer. Turn the filter 3/4 to one full turn after making contact with the gasket.

Check the condition of the threads and sealing surface on the oil pan and drain plug.

Install the drain plug and sealing washer and tighten to 37 ft-lbs. (50 N·m).

Use only high-quality multi-grade lubricating oil in your Cummins Diesel Engine. Choose the correct oil for your operating conditions as outlined in the Selection of Engine Oil.

Cummins Turbo Diesel

Fill the engine with the correct grade of new oil. The engine capacity is 11 quarts (10.4 liters) in the crankcase and 1 quart (.95 liter) in the lubricating oil filter.

Start the engine and operate it at idle for several minutes. Check for leaks at the lubricating oil filter and oil pan drain plug.

Run the engine until it has reached operating temperature, stop the engine. Wait approximately 15 minutes to let the oil in the upper parts of the engine drain back to the pan. Check the oil level again.

Add oil as necessary to bring the level to the "SAFE" mark on the dipstick.

Disposing Of Used Engine Oil And Filter

Care should be taken in disposing of the used engine fluids from your vehicle. Used fluids, indiscriminately discarded, can present a problem to the environment. Contact your local dealer, service station, or governmental agency for advice on recycling programs and where used fluids and filters can be safely discarded in your area.

Drive Belt**Inspection**

Check the belt for intersecting cracks.

- Transverse (across the belt width) cracks are acceptable.
- Longitudinal (direction of belt length) cracks that intersect with transverse cracks are NOT acceptable.

Replace the belt if it has unacceptable cracks, is frayed or has pieces of material missing.

The engine speed sensor, located near the damper, should be inspected for damage if a belt is frayed.

Engine Air Cleaner Filter**CAUTION!**

All air entering the engine intake must be filtered. The abrasive particles in unfiltered air will cause rapid wear to engine components.

The air filter housing on your Diesel Ram is equipped with a Filter Minder™. This is an air flow restriction gauge that will indicate when the filter element needs to be replaced.

Do not remove the top of the air filter housing to inspect the filter element on your diesel engine under normal operating conditions.

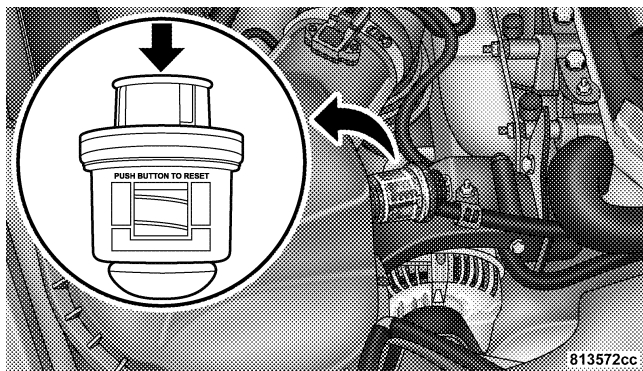

The clear plastic housing on the Filter Minder™ allows you to view the amount of air pressure drop across the filter element. It consists of a diaphragm and a calibrated spring sealed inside the plastic housing. As the air

cleaner filter becomes clogged and air pressure drop across the filter element increases, a yellow disc travels along a graduated scale on the side of the Filter Minder™.

The yellow disc will always show the greatest restriction experienced by the filter element. When the disc reaches the red zone, the filter element may need to be replaced. There is no other time or mileage interval for changing the air cleaner filter element.

If the vehicle experiences a sudden loss of engine power when being driven in heavy snow or rain or when plowing snow, check the Filter Minder™

- If the Filter Minder™ is showing a plugged filter, the filter should be visually inspected for snow/ice build up or extreme water saturation.
- The filter is not damaged, remove all snow/ice, reinstall filter and reset the Filter Minder™.

A visual inspection of the air cleaner filter element is never recommended under normal circumstances. A badly restricted element may appear clean while a soiled element may be quite effective in filtering particles without restricting air flow. Rely on the Filter Minder™ to determine when a filter change is necessary.

After a new filter element is inserted, press the rubber button on the top of the Filter Minder™. This action will reset the yellow disc to the clean position.

CAUTION!

Many aftermarket performance air filter elements do not adequately filter the air entering the engine. Use of such filters can severely damage your engine.

CAUTION!

When using an engine cleaner or a degreaser, be sure to wrap and tape the Filter Minder™ to protect the plastic housing from damage and discoloration.

Draining Fuel/Water Separator Filter

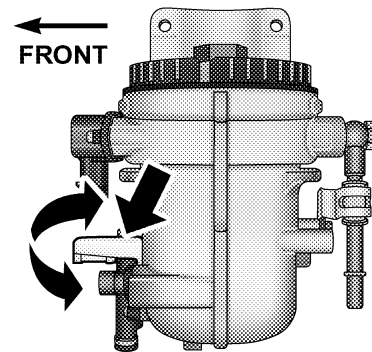

CAUTION!

Do not drain the fuel/water separator filter when the engine is running.

NOTE: Care should be taken in disposing of used fluids from your vehicle. Used fluids, indiscriminately discarded, can present a problem to the environment. Contact your local authorized dealer, service station, or government agency for advice on recycling programs and for where used fluids and filters can be properly disposed of in your area.

Drain a small amount from the fuel/water separator filter periodically or when the WATER IN FUEL indicator lamp is on. Pull outward on the drain valve lever, located on the side of the filter, and allow any accumulated water to drain. Hold the drain valve open until all water and

contaminants have been removed. Close the drain release valve, by returning it to the inward position, when clean fuel is visible.

NOTE: The Fuel / Water separator drain valve is identified by its yellow handle and is located on the inboard side of the fuel filter housing.

If more than a couple ounces of fuel has been drained, follow the directions below for "Priming if the engine has run out of fuel."

WARNING!

Do not open the high pressure fuel system with the engine running. Engine operation causes high fuel pressure. High pressure fuel spray can cause serious injury or death.

Priming if the engine has run out of fuel

1. Add a substantial quantity of fuel to the tank 5 to 10 gallons (19L to 38L).
2. Crank the engine for 1 to 2 seconds. If the engine does not start, then release the key or starter button back to the RUN position (do not turn the key back to the OFF position). The electric fuel transfer pump will continue to run and purge air from the system for about 25 seconds. After 25 seconds, attempt to start the engine again.
3. Start the engine using the Normal Starting Procedure.
4. Repeat the procedure if the engine does not start.

CAUTION!

Do not engage the starter motor for more than 15 seconds at a time. Allow two minutes between the cranking intervals.

NOTE: The engine may run rough until the air is forced from all the fuel lines.

CAUTION!

Diesel fuel will damage black top paving surfaces. Drain the filter into an appropriate container.

WARNING!

Do not use alcohol or gasoline as a fuel blending agent. They can be unstable under certain conditions and be hazardous or explosive when mixed with diesel fuel.

CAUTION!

Due to lack of lubricants in alcohol or gasoline, the use of these fuels can cause damage to the fuel system.

NOTE: A maximum blend of 5% biodiesel may be used with your Cummins Diesel equipped Dodge Ram Truck

NOTE: As sufficient testing as not been completed, ethanol blends are not recommended or approved for use with your Cummins Diesel equipped Dodge Ram Truck.

NOTE: In addition, commercially available fuel additives are not necessary for the proper operation of your Cummins Diesel equipped Dodge Ram Truck.

Maintenance Free Batteries

The top of the maintenance free batteries are permanently sealed. You will never have to add water, nor is periodic maintenance required.

NOTE: Replacement batteries should both be of equal capacity to prevent damage to the vehicle's charging system.

WARNING!

- Battery fluid is a corrosive acid solution and can burn or even blind you. Don't allow battery fluid to contact your eyes, skin or clothing. Don't lean over a battery when attaching clamps. If acid splashes in eyes or on skin, flush the area immediately with large amounts of water.
- Battery gas is flammable and explosive. Keep flame or sparks away from the battery. Don't use a booster battery or any other booster source with an output greater than 12 volts. Don't allow cable clamps to touch each other.
- Battery posts, terminals and related accessories contain lead and lead compounds. Wash hands after handling.

CAUTION!

- It is essential when replacing the cables on the battery that the positive cable is attached to the positive post and the negative cable is attached to the negative post. Battery posts are marked (+) positive and negative (-) and identified on the battery case.
- If a "fast charger" is used while battery is in vehicle, disconnect both vehicle battery cables before connecting the charger to battery. Do not use a "fast charger" to provide starting voltage.

Battery Blanket Usage

A battery loses 60% of its cranking power as the battery temperature decreases to 0°F (-18°). For the same decrease in temperature, the engine requires twice as much power to crank at the same RPM. The use of 120 VAC powered battery blankets will greatly increase starting capability at low temperatures. Suitable battery blankets are available from your authorized Mopar® dealer.

Air Conditioner Maintenance

For best possible performance, your air conditioner should be checked and serviced by an Authorized Dealer at the start of each warm season. This service should include cleaning of the condenser fins and a performance test. Drive belt tension should also be checked at this time.

WARNING!

- Use only refrigerants and compressor lubricants approved by the manufacturer for your air conditioning system. Some unapproved refrigerants are flammable and can explode, injuring you. Other unapproved refrigerants or lubricants can cause the system to fail, requiring costly repairs. Refer to Section 3 of the Warranty Information book for further warranty information.
- The air conditioning system contains refrigerant under high pressure. To avoid risk of personal injury or damage to the system, adding refrigerant or any repair requiring lines to be disconnected should be done by an experienced repairman.

Refrigerant Recovery and Recycling

R-134a Air Conditioning Refrigerant is a hydrofluorocarbon (HFC) that is endorsed by the Environmental Protection Agency and is an ozone-saving product. However, the manufacturer recommends that air conditioning service be performed by dealers or other service facilities using recovery and recycling equipment.

Power Steering — Fluid Check

Checking the power steering fluid level at a defined service interval is not required. The fluid should only be checked if a leak is suspected, abnormal noises are apparent, and/or the system is not functioning as anticipated. Coordinate inspection efforts through a certified DaimlerChrysler Dealership."

WARNING!

Fluid level should be checked on a level surface and with the engine off to prevent injury from moving parts and to insure accurate fluid level reading. Do not overfill. Use only manufacturers recommended power steering fluid.

If necessary, add fluid to restore to the proper indicated level. With a clean cloth, wipe any spilled fluid from all surfaces. Refer to Fluids, Lubricants, and Genuine Parts for correct fluid type.

Front Suspension Ball Joints

The ball joints originally supplied with the vehicle are permanently lubricated at the factory and do not require service. The ball joints and seals should be inspected whenever the vehicle is serviced for other reasons.

Steering Linkage — Inspection

Whenever the vehicle is hoisted, all steering linkage joints should be inspected for evidence of damage. If seals are damaged, parts should be replaced to prevent leakage or contamination of the grease.

Front Prop Shaft Lubrication

Lubricate the front driveshaft grease fitting at each oil change listed in the appropriate Maintenance Schedule for your vehicle (Schedule "A" and "B"). Use Mopar® type MS-6560 (lithium based grease), or equivalent.

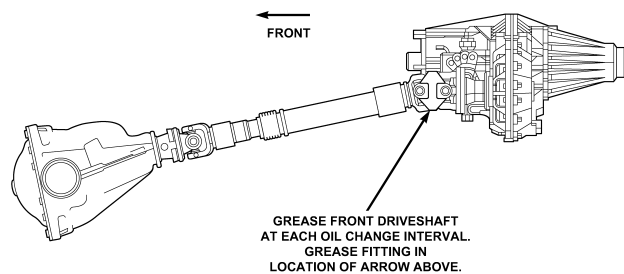

81550037

Front Driveshaft Grease Fitting Front Axle Universal Drive Joints And Pivot Bearings

The front axle universal joint and pivot bearings are permanently lubricated and do not require servicing.

Body Lubrication

Locks and all body pivot points, including such items as seat tracks, doors, liftgate and hood hinges, should be lubricated periodically to assure quiet, easy operation and to protect against rust and wear. Prior to the application of any lubricant, the parts concerned should be wiped clean to remove dust and grit; after lubricating excess oil and grease should be removed. Particular attention should also be given to hood latching components to insure proper function. When performing other underhood services, the hood latch, release mechanism and safety catch should be cleaned and lubricated.

The external lock cylinders should be lubricated twice a year, preferably in the fall and spring. Apply a small amount of a high quality lubricant such as Mopar® Lock Cylinder Lubricant directly into the lock cylinder.

Windshield Wiper Blades

The rubber edges of the wiper blades and the windshield should be cleaned periodically with a sponge or soft cloth and a mild nonabrasive cleaner. This will remove accumulations of salt or road film.

Operation of the wipers on dry glass for long periods may cause deterioration of the wiper blades. Always use washer fluid when using the wipers to remove salt or dirt from a dry windshield.

Avoid using the wiper blades to remove frost or ice from the windshield. Keep the blade rubber out of contact with petroleum products such as engine oil, gasoline, etc.

Windshield Washers

The fluid reservoir is located under the hood and should be checked for fluid level at regular intervals. Fill the reservoir with windshield washer solvent only (not radiator antifreeze).

When refilling the washer fluid reservoir, take some washer fluid and apply it to a cloth or towel and wipe clean the wiper blades, this will help blade performance.

To prevent freeze-up of your windshield washer system in cold weather, select a solution or mixture that meets or exceeds the temperature range of your climate. This rating information can be found on most washer fluid containers.

WARNING!

Commercially available windshield washer solvents are flammable. They could ignite and burn you. Care must be exercised when filling or working around the washer solution.

After the engine has warmed, operate the defroster for a few minutes to reduce the possibility of smearing or

freezing the fluid on the cold windshield. Mopar All Weather Windshield Washer Solution, used with water as directed on the container, aids cleaning action, reduces the freezing point to avoid line clogging, and is not harmful to paint or trim.

Exhaust System

The best protection against carbon monoxide entry into the vehicle body is a properly maintained engine exhaust system.

Whenever a change is noticed in the sound of the exhaust system, when exhaust fumes can be detected inside the vehicle, or when the underside or rear of the vehicle is damaged, have a competent mechanic inspect the complete exhaust system and adjacent body areas for broken, damaged, deteriorated, or mispositioned parts. Open seams or loose connections could permit exhaust fumes to seep into the passenger compartment. In addition,

inspect the exhaust system each time the vehicle is raised for lubrication or oil change. Replace as required.

WARNING!

Exhaust gases can injure or kill. They contain carbon monoxide (CO) which is colorless and odorless. Breathing it can make you unconscious and can eventually poison you. To avoid breathing CO, follow the preceding safety tips.

Exhaust System Rubber Isolator and Loop-Type Hanger — If Equipped

Inspect surfaces whenever the vehicle is hoisted for rubber to metal separation or deep cracks. If, however, excessively deep localized cracks are present, or any part of the exhaust system abnormally contacts the underbody hardware, the isolator and/or hanger should be replaced.

Cooling System

WARNING!

You or others can be badly burned by hot coolant or steam from your radiator. If you see or hear steam coming from under the hood, don't open the hood until the radiator has had time to cool. Never try to open a cooling system pressure cap when the radiator is hot.

Engine Coolant Checks

Check the engine coolant (antifreeze) protection every 12 months (before the onset of freezing weather, where applicable). If coolant is dirty or rusty in appearance, the system should be drained, flushed and refilled with fresh coolant. Check the front of the A/C condenser for any

accumulation of bugs, leaves, etc. If dirty, clean by gently spraying water from a garden hose vertically down the face of the condenser.

Check the coolant recovery bottle tubing for brittle rubber, cracking, tears, cuts and tightness of the connection at the bottle and radiator. Inspect the entire system for leaks.

Extremely cold ambient temperature may require the addition of a "winter front" for effective operation of the cab heating/cooling system. Make certain that a percentage of the radiator is exposed for adequate air flow through the charge air cooler and automatic transmission oil cooler. The percentage of opening must be increased with the increasing ambient air temperature and/or engine load. If the cooling fan can be heard cycling frequently, increase the size of the opening in the winter front.

Coolant bottle level check

The coolant reserve system provides a quick visual method of determining that the coolant level is adequate. With the engine idling, and warmed to the normal operating temperature, the level of the coolant on the coolant bottle should be between the fluid level marks. Check the coolant level whenever the hood is raised.

The radiator normally remains completely full, so there is no longer a need to remove the coolant pressure cap except for checking coolant freeze point or replacement with new antifreeze coolant.

WARNING!

Never add coolant to the radiator when the engine is overheated. Do not loosen or remove pressure cap to cool overheated engine! The coolant is under pressure and severe scalding could result.

Selection Of Coolant

Use only the manufacturers recommended coolant, refer to Fluids, Lubricants and Genuine Parts for correct coolant type.

Cooling System — Drain, Flush and Refill

At the intervals shown on the Maintenance Schedules, the system should be drained, flushed and refilled.

If the solution is dirty or contains a considerable amount of sediment, clean and flush with a reliable cooling system cleaner. Follow with a thorough rinsing to remove all deposits and chemicals. Properly dispose of old antifreeze solution.

CAUTION!

Mixing of coolants other than specified HOAT engine coolants, may result in engine damage and may decrease corrosion protection. If a non-HOAT coolant is introduced into the cooling system in an emergency, it should be replaced with the specified coolant as soon as possible.

Do not use plain water alone or alcohol base engine coolant (antifreeze) products. Do not use additional rust inhibitors or antirust products, as they may not be compatible with the radiator engine coolant and may plug the radiator.

This vehicle has not been designed for use with Propylene Glycol based coolants. Use of Propylene Glycol based coolants is not recommended.

Adding Coolant

Your vehicle has been built with an improved engine coolant that allows extended maintenance intervals. This coolant can be used up to 5 Years or 100,000 miles before replacement. To prevent reducing this extended maintenance period, it is important that you use the same coolant throughout the life of your vehicle. Please review these recommendations for using Hybrid Organic Additive Technology (HOAT) coolant.

When adding coolant, a minimum solution of 50% recommended Mopar Antifreeze/ Coolant 5 Year/100,000 Mile Formula HOAT (Hybrid Organic Additive Technology), or equivalent, in water should be used. Use higher concentrations (not to exceed 70%) if temperatures below -34°F (-37°C) are anticipated.

Use only high purity water such as distilled or deionized water when mixing the water/engine coolant solution.

The use of lower quality water will reduce the amount of corrosion protection in the engine cooling system.

Please note that it is the owner's responsibility to maintain the proper level of protection against freezing according to the temperatures occurring in the area where the vehicle is operated.

NOTE: Mixing coolant types will decrease the life of the engine coolant and will require more frequent coolant changes.

Cooling System Pressure Cap

The cap must be fully tightened to prevent loss of coolant, and to insure that coolant will return to the radiator from the coolant recovery bottle.

The cap should be inspected and cleaned if there is any accumulation of foreign material on the sealing surfaces.

WARNING!

- The warning words "DO NOT OPEN HOT" on the cooling system pressure cap are a safety precaution. Never add coolant when the engine is overheated. Do not loosen or remove the cap to cool an overheated engine. Heat causes pressure to build up in the cooling system. To prevent scalding or injury, do not remove the pressure cap while the system is hot or under pressure.
- Do not use a pressure cap other than the one specified for your vehicle. Personal injury or engine damage may result.

Disposal Of Used Engine Coolant

Used ethylene glycol based engine coolant is a regulated substance requiring proper disposal. Check with your local authorities to determine the disposal rules for your community. Do not store ethylene glycol-based engine coolant in open containers or allow it to remain in puddles on the ground. Prevent ingestion by animals and children. If ingested by a child, contact a physician immediately. Clean up any ground spills immediately.

Coolant Level

The coolant bottle provides a quick visual method for determining that the coolant level is adequate. With the engine cold, the level of the coolant in the coolant recovery bottle should be between the ranges indicated on the bottle.

The radiator normally remains completely full, so there is no need to remove the radiator cap unless checking for coolant freeze point or replacing coolant. Advise your

service attendant of this. As long as the engine operating temperature is satisfactory, the coolant bottle need only be checked once a month.

When additional coolant is needed to maintain the proper level, it should be added to the coolant bottle. Do not overfill.

Points To Remember

NOTE: When the vehicle is stopped after a few miles (a few kilometers) of operation, you may observe vapor coming from the front of the engine compartment. This is normally a result of moisture from rain, snow, or high humidity accumulating on the radiator and being vaporized when the thermostat opens, allowing hot coolant to enter the radiator.

If an examination of your engine compartment shows no evidence of radiator or hose leaks, the vehicle may be safely driven. The vapor will soon dissipate.

- Do not overfill the coolant recovery bottle.
- Check coolant freeze point in the radiator and in the coolant recovery bottle. If antifreeze needs to be added, contents of coolant recovery bottle must also be protected against freezing.
- If frequent coolant additions are required, or if the level in the coolant recovery bottle does not drop when the engine cools, the cooling system should be pressure tested for leaks.
- Maintain coolant concentration at 50% HOAT engine coolant (minimum) and distilled water for proper corrosion protection of your engine which contains aluminum components.
- Make sure that the radiator and coolant recovery bottle overflow hoses are not kinked or obstructed.
- Keep the front of the radiator clean. If your vehicle is equipped with air conditioning, keep the front of the condenser clean, also.
- Do not change the thermostat for summer or winter operation. If replacement is ever necessary, install **ONLY** the correct type thermostat. Other designs may result in unsatisfactory coolant performance, poor gas mileage, and increased emissions.

Fan

Inspection

Check the fan for cracks and bent or broken blades. If any of these conditions exist, you must replace the fan. Make sure it is securely mounted.

NOTE: This service procedure must be performed by a trained service technician. Make arrangements with your authorized Dodge Truck Dealer for this inspection.

Charge Air Cooler (Inter-Cooler)

The charge air cooler is positioned between the radiator and the air conditioner condenser. Air enters the engine through the air cleaner and passes through the turbo-charger where it is pressurized. This pressurized air rapidly reaches high temperature. The air is then directed through a hose to the charge air cooler and through another hose to the intake manifold of the engine. The air entering the engine has been cooled by about 50 to 100 degrees Fahrenheit. This cooling process enables more efficient burning of fuel resulting in fewer emissions.

To guarantee optimum performance of the system, keep the surfaces of the charge air cooler, condenser and radiator clean and free of debris. Periodically check the hoses leading to and from the charge air cooler for cracks or loose clamps resulting in loss of pressure and reduced engine performance.

Hoses And Vacuum/Vapor Harnesses

Inspect surfaces of hoses and nylon tubing for evidence of heat and mechanical damage. Hard or soft spots, brittle rubber, cracking, tears, cuts, abrasions, and excessive swelling indicate deterioration of the rubber.

Pay particular attention to those hoses nearest to high heat sources such as the exhaust manifold. Inspect hose routing to be sure hoses do not come in contact with any heat source or moving component which may cause heat damage or mechanical wear.

Insure nylon tubing in these areas has not melted or collapsed.

Inspect all hose connections such as clamps and couplings to make sure they are secure and no leaks are present.

Components should be replaced immediately if there is any evidence of wear or damage that could cause failure.

Brake System

Power Disc Brakes (Front and Rear)

Disc brakes do not require adjustment; however, several hard stops during the break-in period are recommended to seat the linings and wear off any foreign material.

Brake Master Cylinder

The fluid level of the master cylinder should be checked when performing under the hood service, or immediately if the brake system warning lamp indicates system failure.

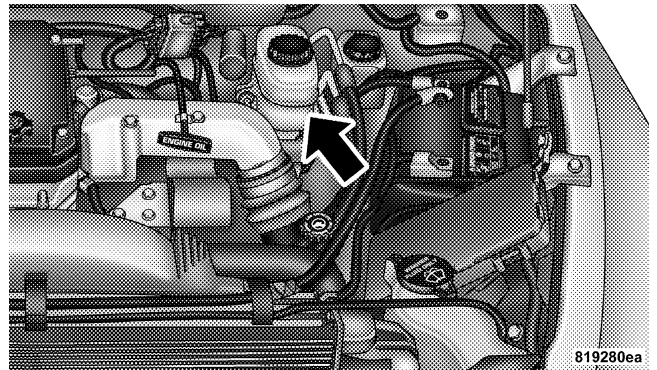

The brake master cylinder has a translucent plastic reservoir. On the outboard side of the reservoir, there is a "FULL" dot and an "ADD" dot. The fluid level must be kept within these two dots. Do not add fluid above the full mark because leakage may occur at the cap.

With disc brakes the fluid level can be expected to fall as the brake linings wear. However, an unexpected drop in fluid level may be caused by a leak and a system check should be conducted.

Refer to Fluids, Lubricants and Genuine Parts for the correct Fluid type.

WARNING!

Use of a brake fluid that may have a lower initial boiling point, or unidentified as to specification, may result in sudden brake failure during hard prolonged braking. You could have an accident.

WARNING!

Overfilling the brake fluid reservoir can result in spilling brake fluid on hot engine parts and the brake fluid catching fire.

Use only brake fluid that has been in a tightly closed container to avoid contamination from foreign matter or moisture.

CAUTION!

Do not allow a petroleum-base fluid to contaminate the brake fluid. Seal damage and loss of brake performance may result.

Brake Hoses

Inspection should be performed whenever the brake system is serviced or at intervals specified. Inspect hydraulic brake hoses for surface cracking, scuffing or worn spots. If there is any evidence of cracking, scuffing, or worn spots, the hose should be replaced immediately! Eventual deterioration of the hose can take place with possible burst failure.

Clutch Linkage

If the clutch pedal linkage begins to squeak or grunt, the clutch pedal pivot bushings should be lubricated. Refer to Fluids, Lubricants and Genuine Parts for the correct lubricant type. Multipurpose Grease, NLGI Grade 2 E.P.

Clutch Hydraulic System

The clutch hydraulic system is a sealed maintenance-free system. In the event of leakage or other malfunction, the system must be replaced.

Rear Axle And 4x4 Front Driving Axle Fluid Level

For Model 9.25 Front Axles and 10.5"/11.5" Rear Axles refer to Fluids, Lubricants and Genuine Parts for the correct lubricant type. For normal service, periodic fluid level checks are not required. When the vehicle is serviced for other reasons, the exterior surfaces of the axle assembly should be inspected.

When checking the fluid level, the vehicle should be in a level position. The fluid level should be $1/4" \pm 1/4"$ (6.4 mm \pm 6.4 mm) below the fill hole on the 9.25" Front Axle. The fluid level should be $3/4" \pm 1/4"$ (19 mm \pm 6.4 mm) below the fill hole on all 10.5" and $1/4" \pm 1/4"$ (6.4 mm \pm 6.4 mm) on 11.5" Rear Axles.

Drain And Refill

Vehicles operated in normal service do not have regularly scheduled oil changes. If fluid has become contaminated

with water or subjected to severe service, follow the recommended change intervals in Maintenance Schedule "B" in Section 8 of this manual.

Lubricant Selection

Refer to Fluids, Lubricants and Genuine Parts for the correct lubricant type.

NOTE: The presence of water in the gear lubricant will result in corrosion and possible failure of differential components. Operation of the vehicle in water, as may be encountered in some off-highway types of service, will require draining and refilling the axle to avoid damage.

Limited-Slip Differentials in vehicles equipped with 10.5"/11.5" Axles **DO NOT REQUIRE** any limited slip oil additive (friction modifiers).

Transfer Case — If Equipped**Fluid Level Check**

This fluid level can be checked by removing the filler plug. The fluid level should be to the bottom edge of the filler plug hole with the vehicle in a level position.

Lubricant Selection

Refer to Fluids, Lubricants and Genuine Parts for the correct lubricant type.

Manual Transmission — If Equipped**Fluid Level Check**

This fluid level can be checked by removing the filler plug. If the level of the lubricant is more than 1/4" below the bottom of the filler hole while the vehicle is on level ground, enough lubricant should be added to bring the level to the bottom of the filler hole.

Lubricant Selection for 6-Speed Manual Transmission — If Equipped

If it becomes necessary to add fluid or change the fluid, be sure to use the same lubricant or equivalent. Refer to Fluids, Lubricants and Genuine Parts for the correct lubricant type.

Automatic Transmission**Fluid Level Check**

The fluid level should be checked when the engine is fully warmed up and the fluid in the transmission is at normal operating temperature. Operation of the transmission with an improper fluid level will greatly reduce the life of the transmission and of the fluid. Check the fluid level whenever the vehicle is serviced.

Procedure For Checking Fluid Level

To properly check the automatic transmission fluid level, the following procedure must be used:

1. The vehicle must be on level ground.
2. The engine should be running at curb idle speed for a minimum of 60 seconds.
3. Fully apply parking brake.
4. Place the gear selector briefly in each gear position ending with the lever in N (Neutral).
5. Remove the dipstick and determine if the fluid is hot or warm. Hot fluid is approximately 180°F (82°C) which is the normal operating temperature after the vehicle has been driven at least 15 miles. The fluid can not be comfortably held between the finger tips. Warm is when fluid is between 85° - 125°F (29° - 52°C).
6. Wipe the dipstick clean and reinsert until seated. Remove dipstick and note reading.
 - a. If the fluid is hot, the reading should be in the crosshatched area marked "OK".

- b. If the fluid is warm, the reading should be between the two holes. If the fluid level indicates low, add sufficient fluid to bring to the proper level.

Fluid is added through the dipstick tube.

NOTE: To prevent dirt and water from entering the transmission after checking or replenishing fluid, make certain that the dipstick cap is properly seated.

Selection Of Lubricant

Refer to Fluids, Lubricants and Genuine Parts for the correct lubricant type. It is important that the transmission fluid be maintained at the prescribed level using the recommended fluid.

CAUTION!

Using a transmission fluid other than the manufacturers recommended fluid may cause deterioration in transmission shift quality and/or torque converter shudder. Using a transmission fluid other than the manufacturers recommended fluid will result in more frequent fluid and filter changes. Refer to Fluids, Lubricants and Genuine Parts for correct fluid type.

Automatic Transmission Fluid and Filter Change

To obtain best performance and long life for automatic transmissions, the manufacturer recommends that they be given regular maintenance service by an Authorized Dodge Dealer or Service Center. It is important that the transmission be adjusted periodically, the fluid maintained at the correct level, and that it be drained and refilled as specified.

It is important that proper lubricant is used in the transmission. Refer to Fluids, Lubricants and Genuine Parts for the correct lubricant type. A band adjustment and filter change should be made at the time of the oil change.

The fluid and filter(s) should be changed and the bands adjusted (if equipped)) as specified in the Maintenance Schedule (Section 8). Vehicles having severe usage should follow Maintenance Schedule "B" of the Maintenance Schedule (Section 8).

Severe usage consists of:

- Off-the-highway operation;
- Trailer towing;
- Snow plow operation;
- Prolonged operation with heavy loading, especially in hot weather.

NOTE: If the transmission is disassembled for any reason, the fluid and filter should be changed, and the bands adjusted (if equipped).

Special Additives

The manufacturer recommends against the addition of any additives to the transmission. Exception to this policy is the use of special dyes to aid in detecting fluid leaks. The use of transmission sealers should be avoided, since they may adversely affect seals.

Front Wheel Bearings

Front wheel bearings for all Dodge Ram Trucks are sealed-for-life. They do not require greasing or seal replacement. In some instances, these bearings will "purge" excess grease and the bearing housing will look slightly wet. This is normal.

- Periodic inspection for excess play is recommended.

- If a bearing assembly is accidentally separated when servicing the brake rotors, it should be replaced.

Rear Wheel Bearings

Clean and repack when brake linings are replaced or rotors resurfaced.

Selection Of Lubricating Grease

The National Lubricating Grease Institute (NLGI) has developed a symbol (Certification Mark) to aid the vehicle owner in the proper selection of grease for the lubrication of wheel bearings and chassis components. This symbol (an example shown below) is located on the grease container and identifies the application and quality of the grease.



There are two groups identified: those for wheel bearings (Letter "G") and those for chassis (Letter "L") lubrication. Performance categories within these groups result in dual letter designations for each group. The letter designations shown in the example are the highest quality level available and when combined as shown can be used for both wheel bearing and chassis lubrication. Use only those greases that have the NLGI symbol on the container along with the proper quality level for your application.

Noise Control System Required Maintenance & Warranty

For 3500 Two-Wheel Drive and Four-Wheel Drive models over 10,000 lbs. (4 535 kg) Gross Vehicle Weight Rating.

All vehicles built over 10,000 lbs. (4 535 kg) Gross Vehicle Weight Rating and manufactured for sale and use in the United States are required to comply with the Federal Government’s Exterior Noise Regulations. These vehicles can be identified by the Noise Emission Control Label located in the operator’s compartment.

Vehicle Noise Emission Control Information
Date of Vehicle Manufacture

This vehicle conforms to U.S. EPA regulations for noise emission applicable to medium and heavy duty trucks.

The following acts or the causing thereof by any person are prohibited by the Noise Control Act of 1972: (A) the removal or rendering inoperative, other than for purposes of maintenance, repair, or replacement, of any noise control device or element of design (listed in the Owner’s Manual) incorporated into this vehicle in compliance with the Noise Control Act (B) the use of this vehicle after such device or element of design has been removed or rendered inoperative.

802d4b72

55216044

Required Maintenance For Noise Control Systems

The following maintenance services must be performed every 6 months or 6,000 miles (9 600 km), whichever comes first, to assure proper operation of the noise control systems. In addition, inspection and service should be performed anytime a malfunction is observed

or suspected. Proper maintenance of the entire vehicle will help the effectiveness of the noise control systems.

Exhaust System

Inspect the entire exhaust system for leaks and damaged parts. Devices such as hangers, clamps, and U-bolts should be tight and in good condition. Damaged components, burned or blown out mufflers, burned or rusted out exhaust pipes should be replaced according to the procedures and specifications outlined in the appropriate service manual.

Air Cleaner Assembly

Inspect air cleaner housing for proper assembly and fit. Make certain that the air cleaner is properly positioned and that the cover is tight. Check all hoses leading to the air cleaner for tightness. The air filter element must also be clean and serviced according to the instructions outlined in the Maintenance Schedule Section of this manual.

Tampering With Noise Control System Prohibited

Federal law prohibits the following acts or the causing thereof: (1) the removal or rendering inoperative by any person, other than for purposes of maintenance, repair, or replacement, of any device or element of design incorporated into any new vehicle for the purpose of noise control prior to its sale or delivery to the ultimate purchaser or while it is in use, or (2) the use of the vehicle after such device or element of design has been removed or rendered inoperative by any person.

Among those acts presumed to constitute tampering are the acts listed below.

• **AIR CLEANER**

- Removal of the air cleaner.
- Removal of the air cleaner filter element from the air cleaner housing.
- Removal of the air ducting.

- **EXHAUST SYSTEM**
 - Removal or rendering inoperative exhaust system components including the muffler or tailpipe.
- **ENGINE COOLING SYSTEM**
 - Removal or rendering inoperative the fan clutch.
 - Removal of the fan shroud.

Noise Emission Warranty

The manufacturer warrants that this vehicle as manufactured by the manufacturer, was designed, built and equipped to conform at the time it left the manufacturer's control with all applicable U.S. EPA Noise Control Regulations.

This warranty covers this vehicle as designed, built and equipped by the manufacturer, and is not limited to any particular part, component or system of the vehicle manufactured by the manufacturer. Defects in design, assembly or in any part, component or system of the vehicle as manufactured by the manufacturer, which, at the time it left the manufacturer's control, caused noise emissions to exceed Federal standards, are covered by this warranty for the life of the vehicle.

Noise Systems Maintenance Chart and Service Log — Insert Month, Day, Year under column mileage closest to the mileage at which service was performed.

MILES	67,500	75,000	82,500	90,000	97,500	84,000	105,00	112,500
KILOMETERS	108 000	120 000	132 000	144 000	126 000	156 000	168 000	181 000
Exhaust system- inspect								
Air cleaner assembly-inspect								
ODOMETER READING								
PERFORMED BY								
PERFORMED AT								

Appearance Care and Protection from Corrosion

Protection of Body and Paint from Corrosion

Vehicle body care requirements vary according to geographic locations and usage. Chemicals that make roads passable in snow and ice, and those that are sprayed on trees and road surfaces during other seasons, are highly corrosive to the metal in your vehicle. Outside parking, which exposes your vehicle to airborne contaminants, road surfaces on which the vehicle is operated, extreme hot or cold weather and other extreme conditions will have an adverse effect on paint, metal trim, and underbody protection.

The following maintenance recommendations will enable you to obtain maximum benefit from the corrosion resistance built into your vehicle.

What Causes Corrosion?

Corrosion is the result of deterioration or removal of paint and protective coatings from your vehicle.

The most common causes are:

- Road salt, dirt and moisture accumulation.
- Stone and gravel impact.
- Insects, tree sap and tar.
- Salt in the air near seacoast localities.
- Atmospheric fallout/industrial pollutants.

Washing

- Wash your vehicle regularly. Always wash your vehicle in the shade using Mopar Car Wash or a mild car wash soap, and rinse the panels completely with clear water.
- If insects, tar or other similar deposits have accumulated on your vehicle, use Mopar Super Kleen Bug and Tar Remover to remove.

- Use Mopar Cleaner Wax to remove road film, stains and to protect your paint finish. Take care never to scratch the paint.
- Avoid using abrasive compounds and power buffing that may diminish the gloss or thin out the paint finish.
- It is important that the drain holes in the lower edges of the doors, rocker panels and trunk be kept clear and open.
- If you detect any stone chips or scratches in the paint, touch them up immediately. The cost of such repairs is considered the responsibility of the owner.

CAUTION!
Do not use abrasive or strong cleaning materials such as steel wool or scouring powder, which will scratch metal and painted surfaces.

Special Care

- If your vehicle is damaged due to an accident or similar cause which destroys the paint and protective coating, have your vehicle repaired as soon as possible. The cost of such repairs is considered the responsibility of the owner.
- If you carry special cargo such as chemicals, fertilizers, de-icer salt, etc., be sure that such materials are well packaged and sealed.
- If a lot of driving is done on gravel roads, consider mud or stone shields behind each wheel.

- Use Mopar touch up paint on scratches as soon as possible. Your dealer has touch up paint to match the color of your vehicle.

Wheel and Wheel Trim Care

All wheels and wheel trim, especially aluminum and chrome plated wheels should be cleaned regularly with a mild soap and water to prevent corrosion. To remove heavy soil, use Mopar Wheel Cleaner or select a nonabrasive, non-acidic cleaner. Do not use scouring pads, steel wool, a bristle brush or metal polishes. Only Mopar cleaners are recommended. Do not use oven cleaner. Avoid automatic car washes that use acidic solutions or harsh brushes that may damage the wheels' protective finish.

Interior Care

Use Mopar Total Clean to clean fabric upholstery and carpeting.

Use Mopar Total Clean to clean vinyl upholstery.

Mopar Total Clean is specifically recommended for leather upholstery.

Your leather upholstery can be best preserved by regular cleaning with a damp soft cloth. Small particles of dirt can act as an abrasive and damage the leather upholstery and should be removed promptly with a damp cloth. Stubborn soils can be removed easily with a soft cloth and Mopar Total Clean. Care should be taken to avoid soaking your leather upholstery with any liquid. Please do not use polishes, oils, cleaning fluids, solvents, detergents, or ammonia based cleaners to clean your leather upholstery. Application of a leather conditioner is not required to maintain the original condition.

WARNING!

Do not use volatile solvents for cleaning purposes. Many are potentially flammable, and if used in closed areas they may cause respiratory harm.

Glass Surfaces

All glass surfaces should be cleaned on a regular basis with Mopar Glass Cleaner or any commercial household-type glass cleaner. Never use an abrasive type cleaner. Use caution when cleaning the inside rear window equipped with electric defrosters or the right rear quarter window equipped with the radio antenna. Do not use scrapers or other sharp instruments which may scratch the elements. When cleaning the rear view mirror, spray cleaner on the towel or rag that you are using. Do not spray cleaner directly on the mirror.

Cleaning Plastic Instrument Cluster Lenses

The lenses in front of the instruments in this vehicle are molded in clear plastic. When cleaning the lenses, care must be taken to avoid scratching the plastic.

1. Clean with a wet soft rag. A mild soap solution may be used, but do not use high alcohol content or abrasive cleaners. If soap is used, wipe clean with a clean damp rag.
2. Dry with a soft tissue.

Seat Belt Maintenance

Do not bleach, dye or clean the belts with chemical solvents or abrasive cleaners. This will weaken the fabric. Sun damage can also weaken the fabric.

If the belts need cleaning, use a mild soap solution or lukewarm water. Do not remove the belts from the car to wash them.

Replace the belts if they appear frayed or worn or if the buckles do not work properly.

Dry with a soft tissue.

FUSES (INTEGRATED POWER MODULE)

An integrated Power Module is located in the engine compartment near the battery. This center contains cartridge fuses and mini fuses. A description of each fuse and component may be stamped on the inside cover otherwise the cavity number of each fuse is stamped on the inside cover that corresponds to the following chart.

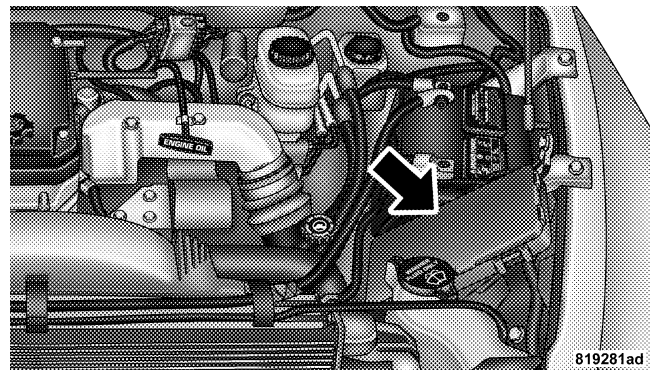

Integrated Power Module Location

Cavity	Cartridge Fuse	Mini Fuse	Description
1		20 Amp Yellow	Power Outlet Console
2		20 Amp Yellow	Cabin Compartment Node (CCN) Door Locks/Brake Transmission Shift Interlock (BTSI)
3		20 Amp Yellow	Spare
4		20 Amp Yellow	Spare
5		20 Amp Yellow	Power Sunroof
6		10 Amp Red	Occupant Classification Module (OCM)/VIST Fan/Wastegate

Cavity	Cartridge Fuse	Mini Fuse	Description
7		15 Amp Blue	Reverse Lockout Solenoid Battery (SRT-10 Only)
8		10 Amp Red	Heated Mirrors
9	30 Amp Pink		Off Road Module Power
10		5 Amp Orange	Trx-Off Rd Pkg Sen (Gas Engine Only)

Cavity	Cartridge Fuse	Mini Fuse	Description
11		20 Amp Yellow	Ignition Off Draw (IOD)-Cabin Compartment Node (CCN)/Radio/Under Hood Lamp/Wireless Control Module (WCM)/Satellite Digital Audio Receiver (SDARS)/Hands Free Module (HFM)
12	30 Amp Pink		Electric Brake
13		25 Amp Natural	Power-Battery RWAL/ABS Module Feed
14		15 Amp Blue	Park Lamps Left

Cavity	Cartridge Fuse	Mini Fuse	Description
15		20 Amp Yellow	Trailer Park Lamps
16		15 Amp Blue	Park Lamps Right
17		15 Amp Blue	Spare
18	40 Amp Green		ABS Pump
19	30 Amp Pink		Trailer Tow
20		10 Amp Red	Occupant Restraints Controller (ORC) 2
21		10 Amp Red	Occupant Restraints Controller (ORC) Pre-set Carrier
22		2 Amp Gray	IGN Switch Feed

Cavity	Cartridge Fuse	Mini Fuse	Description
23		10 Amp Red	Engine Control Module (ECM)/Wireless Control Module (WCM)/HVC
24	20 Amp Blue		Subwoofer Amplifier (SRT-10 Only)
25		10 Amp Red	Power Mirror
26		20 Amp Yellow	Brake Switch/Center High Mount Stop Lamp (CHMSL)
27	40 Amp Green		Power Seats
28		10 Amp Red	Power Run/Start-NCC/Wireless Control Module (WCM)/ABS/RWAL

Cavity	Cartridge Fuse	Mini Fuse	Description
29		10 Amp Red	Switches/EC Mirror/Smart Bar
30		15 Amp Blue	Spare
31		10 Amp Red	PCM/Transfer Case Brake
32		10 Amp Red	HVAC/Ajustable Pedals/Heated Seats Switch LED/Exhaust Brake
33		10 Amp Red	Power-IGN Run Misc
34		10 Amp Red	Spare
35		15 Amp Blue	Cabin Compartment Node (CCN) Illumination

Cavity	Cartridge Fuse	Mini Fuse	Description
36		25 Amp Natural	Audio_Amplifier
37		15 Amp Blue	Spare
38		20 Amp Yellow	Power Outlet IP
39		10 Amp Red	Sunroof/Seatbelt Tensioner
40		20 Amp Yellow	Cigar Lighter
41		25 Amp Natural	Spare
42	30 Amp Pink		Diesel PCM (Diesel Only)

CAUTION!

- When installing the Integrated Power Module cover, it is important to ensure the cover is properly positioned and fully latched. Failure to do so may allow water to get into the Integrated Power Module, and possibly result in a electrical system failure.
- When replacing a blown fuse, it is important to use only a fuse having the correct amperage rating. The use of a fuse with a rating other than indicated may result in a dangerous electrical system overload. If a properly rated fuse continues to blow, it indicates a problem in the circuit that must be corrected.

VEHICLE STORAGE

If you are storing your vehicle for more than 21 days, we recommend that you take the following steps to minimize the drain on your vehicle's battery:

- Disconnect the Ignition-Off Draw fuse (I.O.D.) fuse located in the Integrated Power Module, located in the engine compartment. The I.O.D. cavity includes a snap-in retainer that allows the fuse to be disconnected, without removing it from the fuse block.
- The electronic shift transfer case should be placed in the 4HI mode and kept in this position to minimize the battery drain.
- As an alternative to the above steps you may, disconnect the negative cables from both batteries.
- Anytime you store your vehicle, or keep it out of service (i.e. vacation) for two weeks or more, run the air conditioning system at idle for about five minutes in the fresh air and high blower setting. This will insure adequate system lubrication to minimize the possibility of compressor damage when the system is started again.

NOTE: When reinstalling the IOD fuse push firmly until fully seated, the gages in the Instrument Cluster will do a full sweep, when the ignition key is cycled to RUN. This is a normal condition.

REPLACEMENT LIGHT BULBS

LIGHT BULBS — Inside

Bulb No.

- Overhead Console Lights TS 212-2
- Dome Light 7679

All of the inside bulbs are brass or glass wedge base. Aluminum base bulbs are not approved.

LIGHT BULBS — Outside

Bulb No.

- Back-Up 3057
- Center High Mounted Stop Lamp 912
- Fog Lamp 9006LL
- Headlamp (Halogen) H13
- Side Marker Bulb W5W

- Park & Turn Signal 3157NAK
- Rear License Plate Lamp 168
- Rear Cargo Light 912
- Tail & Stop 3057
- Cab Clearance Lights 168
- Dual Rear Wheel Sidemarker Light 168
- Dual Rear Wheel Tailgate ID Lights (3) 168

BULB REPLACEMENT**Headlight (Halogen)/Front Park and Turn Lights****CAUTION!**

This is a halogen bulb. Avoid touching the glass with your fingers. Reduced bulb life will result.

1. Open the hood
2. Remove the two (2) bolts from the front of the headlight housing.

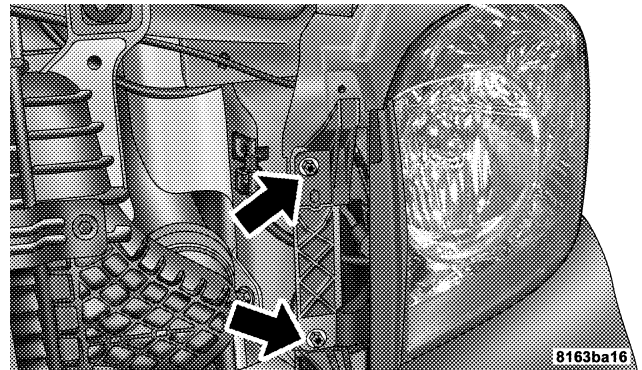

Front Headlight Housing Bolts

3. Remove the plug from the inner fender well and remove the nut through the access hole.

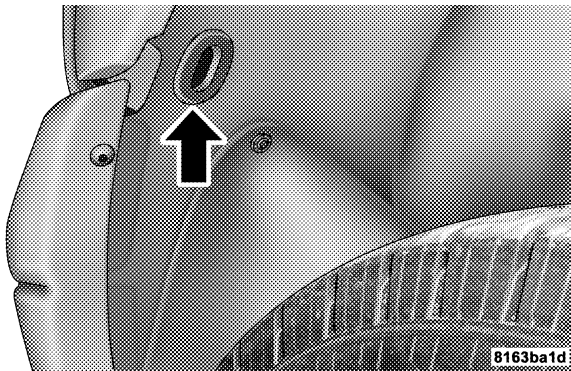

Inner Fender Plug

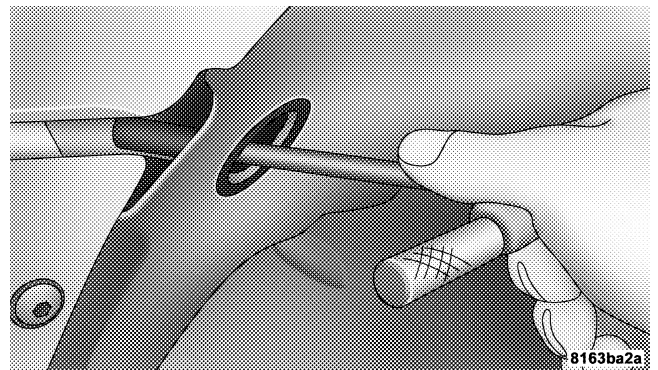

Rear Headlight Housing Nut Access

4. Pull the housing out from the fender to allow room to disconnect the electrical connectors.

NOTE: For easier removal, pull the headlight assembly straight forward, applying the greatest amount of force to the outer edge of the headlight assembly.

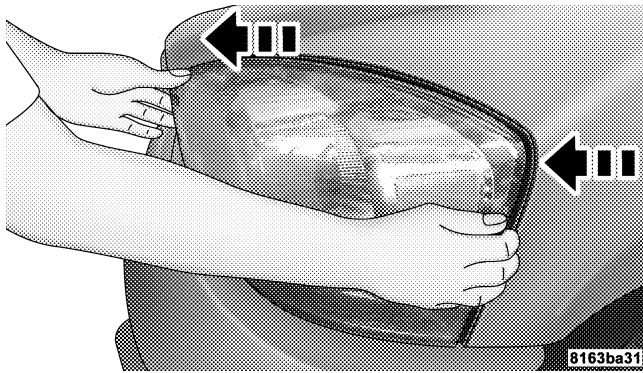

Headlight Removal

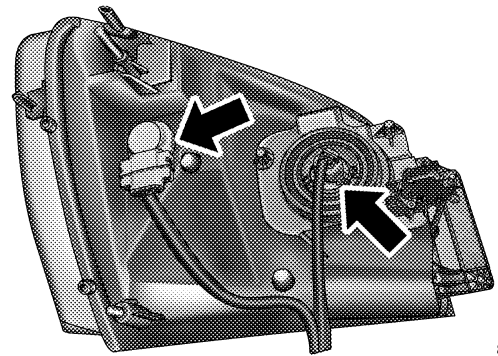

81906efb

Bulb Removal

5. Unlock and pull connector straight from the base of the headlight halogen bulb.
6. Twist connector on the side marker/turn signal/park light bulb ¼ turn and remove connector and bulb from housing.

7. Remove housing from vehicle with headlight halogen bulb in housing.
8. Twist the headlight halogen bulb $\frac{1}{4}$ turn and remove headlight bulb from the housing.
9. Replace headlight or side marker/turn signal/park light bulb. Do not touch the headlight halogen bulb.
10. Reverse procedure for installation of bulbs and housing.

Fog Lights

1. Reach under the vehicle, unlock and twist connector counterclockwise $\frac{1}{4}$ turn and remove connector and bulb from housing.

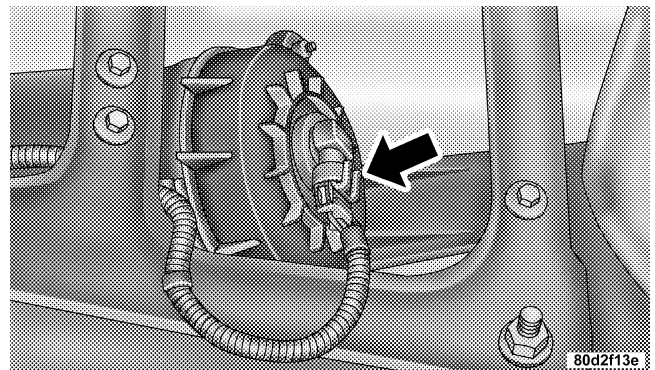

2. Pull bulb straight from the connector.

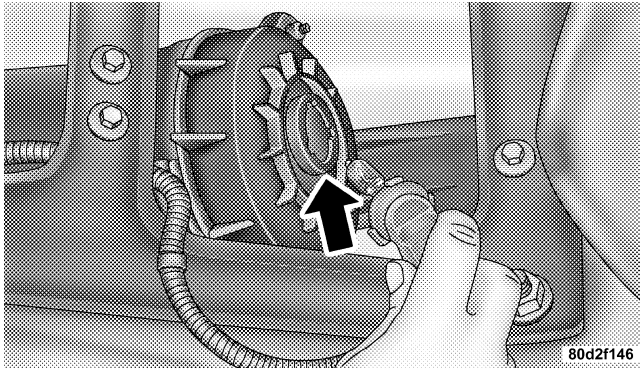

3. Reverse procedure for installation of bulbs and housing.

Tail, Stop, Turn and Backup Lights

1. Remove the two (2) screws that pass through the bed sheetmetal.

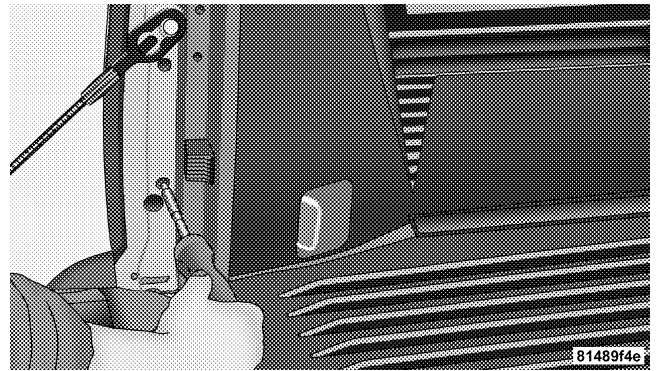

Removing the Two (2) Screws

2. Pull the housing straight out from the body, with a quick motion, to separate the housing from the body. If not pulled straight, locators may be damaged.

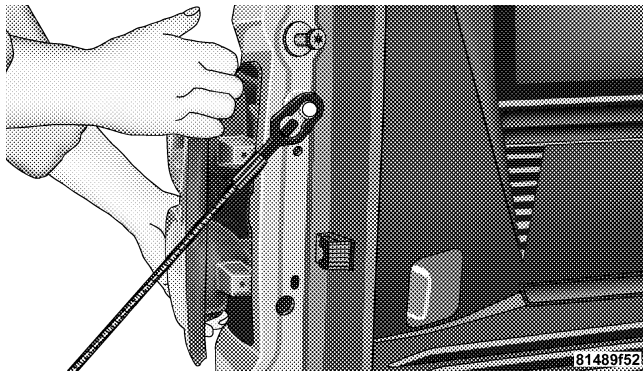

Pulling Housing From Body

3. Rotate the bulb socket counterclockwise to remove from the housing.



Rotating Bulb Socket From Housing

4. Pull bulb straight out of socket.

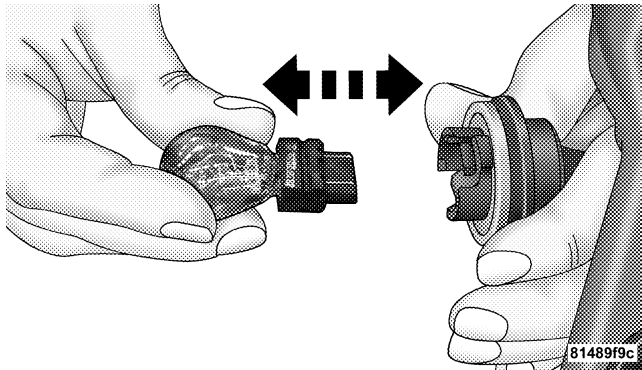

Pulling Bulb From Socket

5. Reverse Procedure to install bulb and housing. Place the two raised blocks passed the body.

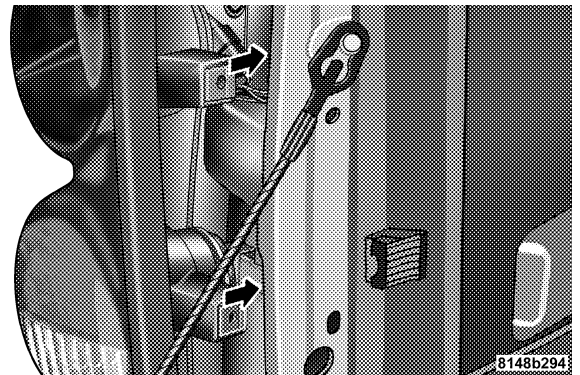

Sliding Raised Blocks Past Body

Center High-Mounted Stoplight (CHMSL) With Cargo Light

1. Remove the two (2) screws holding the housing/lens to the body as shown.

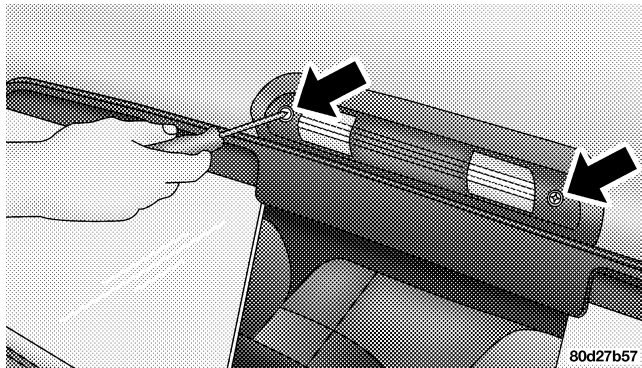

2. Separate the connector holding the housing and wiring harness to the body.

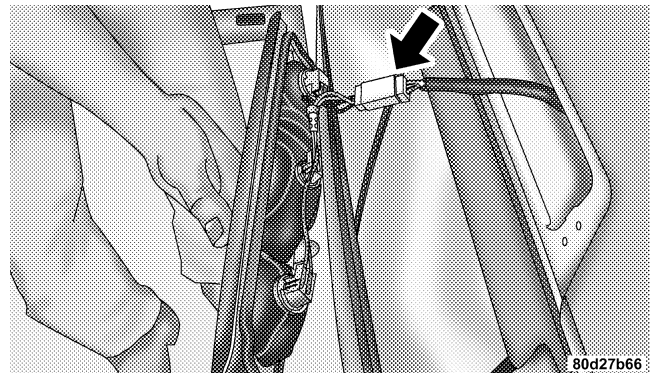

3. Turn desired bulb socket $\frac{1}{4}$ turn and remove socket and bulb from housing.
4. Pull desired bulb straight from the socket.

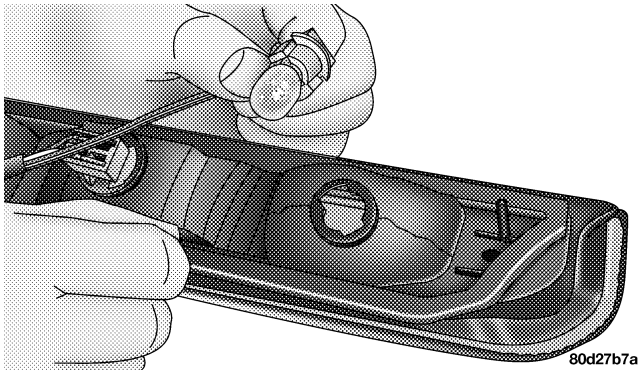

- Outside Bulbs: Cargo Lamps
- Inside Bulb: Center High Mount Stop Lamp

5. Reverse procedure for installation of bulbs and housing.

Cab Top Clearance Lights — If Equipped

1. Remove the two screws from the top of the light.

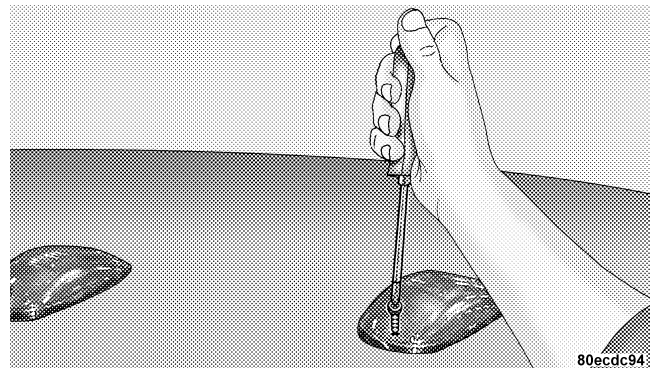

442 MAINTAINING YOUR VEHICLE

2. Rotate the socket $\frac{1}{4}$ turn and pull it from the light assembly.

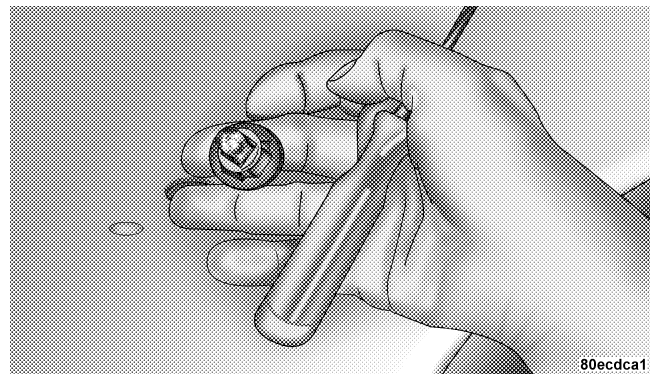
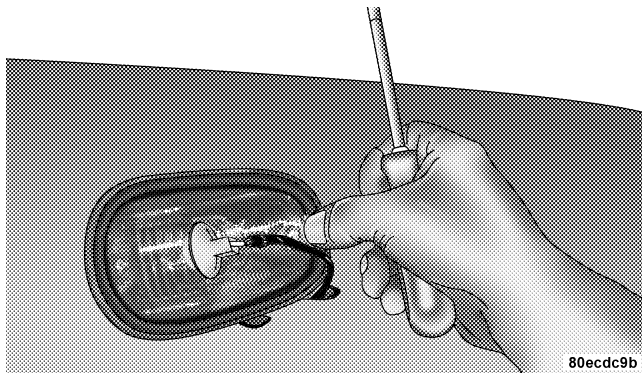

3. Pull the bulb straight from it's socket and replace.

Tailgate ID Lights (Dual Rear Wheels) — If Equipped

1. Remove the two screws and housing and access the bulb sockets from the rear.

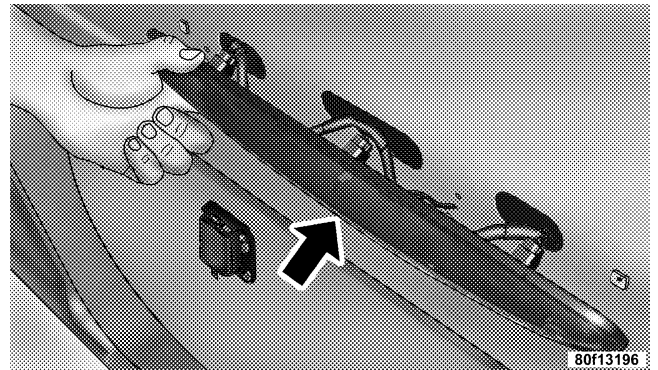
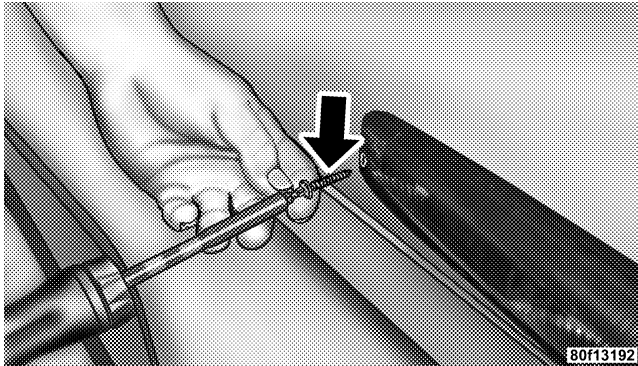

2. Turn socket $\frac{1}{4}$ turn counterclockwise to access the bulb.

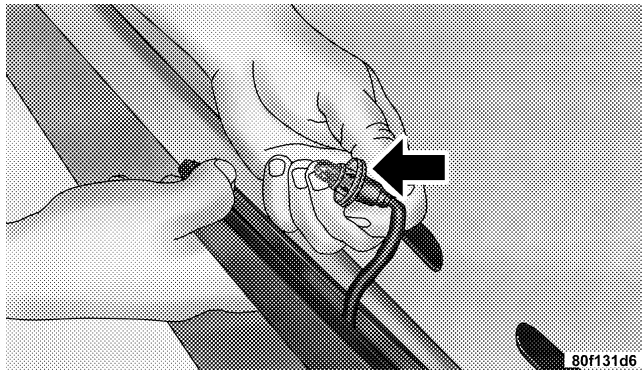

3. Pull bulb straight out from socket.
4. Reverse procedure for installation of bulbs and housing.

Rear Light Bar ID Marker (Dual Rear Wheel) – If Equipped

1. Loosen the two screws and the housing to gain access to the bulb sockets.

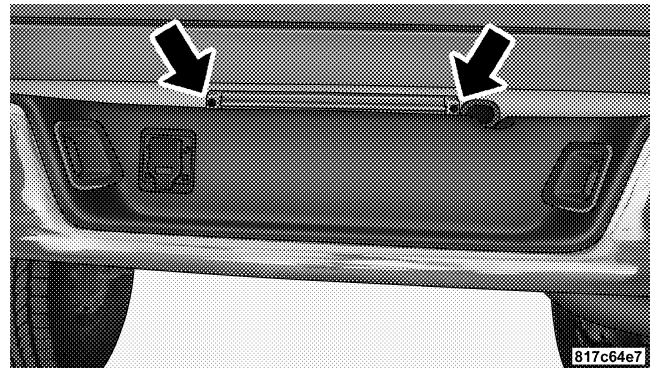

2. Turn the socket 1/4 turn counterclockwise to access the bulb.

3. Pull the bulb straight out from the socket.
4. Reverse procedure for installation of bulbs and housing.

Side Marker Lights (Dual Rear Wheels)

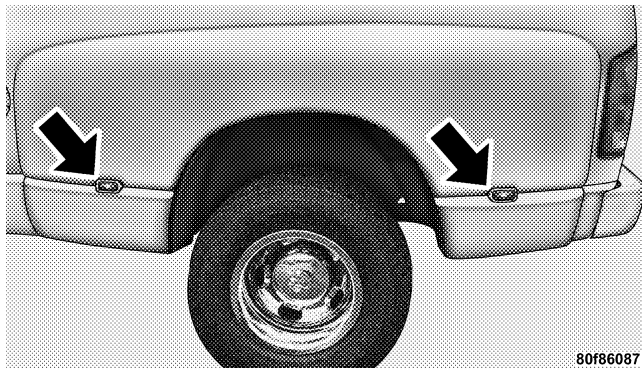

1. Push rearward on the side marker light assembly.
2. Pull the entire assembly from the fender.

3. Turn socket ¼ turn counterclockwise and remove from assembly to access the bulb.
4. Pull bulb straight out from socket.
5. Reverse procedure for installation of bulbs and housing.

FLUID CAPACITIES

FLUID CAPACITIES	U.S.	Metric
Fuel		
2500 Shortbed Models	34 gal.	128L
2500 Longbed Models	35 gal.	132L
3500 Shortbed Models	34 gal.	128L
3500 Longbed Models	35 gal.	132L
Engine Oil		
5.9L Diesel Engine I-6	12.0 qts.	11.4L
Cooling System		
5.9L Diesel Engine I-6	7 gal.	26.5L

FLUIDS, LUBRICANTS AND GENUINE PARTS**Engine**

Component	Fluids, Lubricants and Genuine Parts
Engine Coolant	Mopar® Antifreeze/Coolant 5 Year/100,000 Mile Formula HOAT (Hybrid Organic Additive Technology) or equivalent.
Engine Oil	For the proper quality and SAE Grade oil for your engine, refer to the section "Maintenance Procedures."
Engine Oil Filter	Mopar® Engine Oil Filter, P/N 05083285AA or equivalent.
Engine Fuel Filter	Mopar® Fuel Filter, P/N 05015581AB or equivalent.
Fuel Selection	Use good quality diesel fuel from a reputable supplier. For most year-round service, No. 2 diesel fuel meeting ASTM specification D-975 will provide good performance. This vehicle is fully compatible with biodiesel blends up to 5% biodiesel meeting ASTM specification D-975. (See page 318 for more information.)

Chassis

Component	Fluids, Lubricants and Genuine Parts.
Automatic Transmission	Mopar® ATF+4, Automatic Transmission Fluid.
Transfer Case	Mopar® ATF+4, Automatic Transmission Fluid.
Manual Transmission Fluid G-56	Mopar® ATF+4, Automatic Transmission Fluid.
Clutch Linkage	Multipurpose Grease, NLGI Grade 2 E.P. or equivalent.
Front and Rear Axle Fluid 2500/3500 Models	GL-5 SAE 75W-90 Synthetic or equivalent. 2500/3500 axels do not require limited slip additive.
Brake Master Cylinder	Mopar® DOT 3 and SAE J1703 should be used or equivalent. If DOT 3 brake fluid is not available, then DOT 4 is acceptable. Use only recommended brake fluids.
Power Steering Reservoir	Mopar® ATF+4, Automatic Transmission Fluid.

MAINTENANCE SCHEDULES

CONTENTS

■ Emission Control System Maintenance	450	□ Schedule "B"	453
■ Maintenance Schedules — 5.9L Cummins Turbo Diesel	450	□ Schedule "A"	463

EMISSION CONTROL SYSTEM MAINTENANCE

The “Scheduled” maintenance services, listed in **bold type** in this section (Section 8) must be done at the times or mileages specified to assure the continued proper functioning of the emission control system. These, and all other maintenance services included in this manual, should be done to provide best vehicle performance and reliability. More frequent maintenance may be needed for vehicles in severe operating conditions such as dusty areas and very short trip driving.

Inspection and service also should be done any time a malfunction is suspected.

NOTE: Maintenance, replacement, or repair of the emission control devices and systems on your vehicle may be performed by any automotive repair establishment or individual using any automotive part which has been certified pursuant to U.S. EPA or, in the State of California, California Air Resources Board regulations.

MAINTENANCE SCHEDULES — 5.9L CUMMINS TURBO DIESEL

There are two maintenance schedules that show the **required** service for your vehicle.

First is Schedule “**B**”. It is for vehicles that are operated under one or more of the following conditions that are listed below and at the beginning of the schedule.

- Frequent short trips where the engine does not achieve full operating temperature (operating temperature defined as 190° F (66° C) coolant temperature).
- Extensive engine idling (over 10 minutes per hour of operation) at ambient temperatures less than 32° F (0° C).
- Driving in dusty conditions.
- Frequent trailer towing.
- Taxi, police, or delivery service (commercial service).

- Off-road or desert operation.
- Extensive operation at high engine speeds (greater than 2900 rpm) and loads (greater than 70% throttle).

NOTE: Most vehicles are operated under the conditions listed for Schedule "B".

NOTE: If **ANY** of these apply to you then change your coolant every 101,250 miles (162 000 km) or 60 months, whichever comes first and follow schedule "B" of the "Maintenance Schedules" section of this manual.

Second is Schedule "A". It is for vehicles that are not operated under any of the conditions listed under Schedule "B".

Use the schedule that best describes your driving conditions. Where time and mileage are listed, follow the interval that occurs first.

CAUTION!

Failure to perform the required maintenance items may result in damage to the vehicle.

At Each Stop for Fuel

- Check the engine oil level about 15 minutes after a fully warmed engine is shut off. Checking the oil level while the vehicle is on level ground will improve the accuracy of the oil level reading. Add oil only when the level is at or below the ADD or MIN mark.
- Check the windshield washer solvent and add if required. When refilling the washer fluid reservoir, take some washer fluid and apply it to a cloth or towel and wipe clean the wiper blades, this will help blade performance.

452 MAINTENANCE SCHEDULES

Once a Month

- Check tire pressure and look for unusual wear or damage.
- Inspect the batteries and clean and tighten the terminals as required.
- Check the fluid levels of coolant reservoir, brake master cylinder, and transmission and transfer case (if equipped), add as needed.
- **Check Filter Minder™. Replace air cleaner filter element if necessary.**
- Check all lights and all other electrical items for correct operation.
- Drain water from the fuel filter.

At Each Oil Change

- Change the engine oil filter.
- Inspect the exhaust system.
- Inspect the brake hoses.
- Inspect the U-Joints (if equipped) and front suspension components.
- Check the automatic transmission fluid level.
- Check the manual transmission fluid level.
- Check the coolant level, hoses, and clamps.
- Lubricate outer tie rod ends.
- Lubricate Front Drive Shaft Fittin

Schedule "B"

Follow schedule "B" if you usually operate your vehicle under one or more of the following conditions.

- Frequent short trips where the engine does not achieve full operating temperature (operating temperature defined as 190° F (66° C) coolant temperature).
- Extensive engine idling (over 10 minutes per hour of operation) at ambient temperatures less than 32° F (0° C).
- Driving in dusty conditions.

- Frequent trailer towing.
- Taxi, police, or delivery service (commercial service).
- Off-road or desert operation.
- Extensive operation at high engine speeds (greater than 2900 rpm) and loads (greater than 70% throttle).

NOTE: If **ANY** of these apply to you then change your coolant every 101,250 miles (162 000 km) or 60 months, whichever comes first and follow schedule "B" of the "Maintenance Schedules" section of this manual.

454 SCHEDULE "B"

Miles (Kilometers)	3,750 (6 000)	7,500 (12 000)	11,250 (18 000)	15,000 (24 000)	18,750 (30 000)
Change engine oil and engine oil filter.		X		X	
Lubricate Front Drive Shaft Fitting (2500/3500, 4X4).	X	X	X	X	X
Rotate tires.		X		X	
Check spare tire for proper pressure and correct stowage.		X		X	
Lubricate outer tie rod ends 2500/3500 (4X4) models.		X		X	
Replace fuel filter element.				X	
Change rear axle fluid.				X	
Change front axle fluid (4X4).				X	
Inspect brake linings.				X	
Inspect and adjust parking brake if necessary.				X	

Miles (Kilometers)	22,500 (36 000)	26,250 (42 000)	30,000 (48 000)	33,750 (54 000)	37,500 (60 000)
Change engine oil and engine oil filter.	X		X		X
Lubricate Front Drive Shaft Fitting (2500/3500, 4X4).	X	X	X	X	X
Rotate tires.	X		X		X
Check spare tire for proper pressure and correct stowage.	X		X		X
Lubricate outer tie rod ends 2500/3500 (4X4) models.	X		X		X
Inspect drive belt, replace as required.	X				
Replace fuel filter element.			X		
Change rear axle fluid.			X		
Change front axle fluid (4X4).			X		
Check transfer case fluid level (4X4).			X		
Drain and refill automatic transmission fluid. Replace filter and adjust bands (48RE only).			X		

456 SCHEDULE "B"

Miles (Kilometers)	41,250 (66 000)	45,000 (72 000)	48,750 (78 000)	52,500 (84 000)	56,250 (90 000)
Change engine oil and engine oil filter.		X		X	
Lubricate Front Drive Shaft Fitting (2500/3500, 4X4) models.	X	X	X	X	X
Rotate tires.		X		X	
Check spare tire for proper pressure and correct stowage.		X		X	
Lubricate outer tie rod ends 2500/3500 (4X4).		X		X	
Inspect drive belt, replace as required.		X			
Replace fuel filter element.		X			
Inspect brake linings.		X			
Inspect and adjust parking brake if necessary.		X			
Change rear axle fluid.		X			
Change front axle fluid (4X4).		X			

Miles (Kilometers)	60,000 (96 000)	63,750 (102 000)	67,500 (108 000)	71,250 (114 000)	75,000 (120 000)
Change engine oil and engine oil filter.	X		X		X
Lubricate Front Drive Shaft Fitting (2500/3500, 4X4).	X	X	X	X	X
Flush and replace engine coolant at 60 months, if not replaced at 102,000 miles (163 000 km).	X				
Rotate tires.	X		X		X
Check spare tire for proper pressure and correct stowage.	X		X		X
Lubricate outer tie rod ends 2500/3500 (4X4) models.	X		X		X
Inspect drive belt, replace as required.			X		
Replace fuel filter element.	X				X
Inspect front wheel bearings.	X				
Change rear axle fluid.	X				X
Change front axle fluid (4X4).	X				X

458 SCHEDULE "B"

Miles (Kilometers)	60,000 (96 000)	63,750 (102 000)	67,500 (108 000)	71,250 (114 000)	75,000 (120 000)
Change 6-spd manual transmission (G-56) fluid 2500/3500.	X				
Inspect brake linings.	X				X
Inspect and adjust parking brake if necessary.	X				X
Drain and refill transfer case fluid (4X4).	X				
Drain and refill automatic transmission fluid and change main sump filter (545 RFE only).	X				
Drain and refill automatic transmission fluid. Replace filter and adjust bands (48RE only).	X				

Miles (Kilometers)	78,750 (126 000)	82,500 (132 000)	86,250 (138 000)	90,000 (144 000)	93,750 (150 000)
Change engine oil and engine oil filter.		X		X	
Lubricate Front Drive Shaft Fitting (2500/3500, 4X4).	X	X	X	X	X
Rotate tires.		X		X	
Check spare tire for proper pressure and correct stowage.		X		X	
Lubricate outer tie rod ends 2500/3500 (4X4) models.		X		X	
Inspect drive belt, replace as required.				X	
Change rear axle fluid.				X	
Change front axle fluid (4X4).				X	
Check transfer case fluid level (4X4).				X	
Replace fuel filter element.				X	
Inspect front wheel bearings.				X	
Inspect brake linings.				X	
Inspect and adjust parking brake if necessary.				X	
Drain and refill automatic transmission fluid. Replace filter and adjust bands (48RE only).				X	

460 SCHEDULE "B"

Miles (Kilometers)	97,500 (156 000)	100,000 (160 000)	101,250 (162 000)	105,000 (168 000)	108,750 (174 000)	112,500 (180 000)
Change engine oil and engine oil filter.	X			X		X
Lubricate Front Drive Shaft Fitting (2500/3500, 4X4).	X	X	X	X	X	X
Flush and replace engine coolant, if not replaced at 60 months.			X			
Rotate tires.	X			X		X
Check spare tire for proper pressure and correct stowage.	X			X		X
Lubricate outer tie rod ends 2500/3500 (4X4) models.	X			X		X
Flush and replace engine coolant.			X			
Inspect drive belt, replace as required.						X
Replace fuel filter element.				X		
Change rear axle fluid.				X		
Change front axle fluid (4X4).				X		
Inspect brake linings.				X		
Inspect and adjust parking brake if necessary.				X		

Miles (Kilometers)	116,250 (186 000)	120,000 (192 000)	123,750 (198 000)	127,500 (204 000)	131,250 (210 000)	135,000 (216 000)
Change engine oil and engine oil filter.		X		X		X
Lubricate Front Drive Shaft Fitting (2500/ 3500, 4X4).	X	X	X	X	X	X
Rotate tires.		X		X		X
Check spare tire for proper pressure and cor- rect stowage.		X		X		X
Flush and replace engine coolant at 120 months, if not replaced at 102,000 miles (163 000 km).	X					
Lubricate outer tie rod ends 2500/3500 (4X4) models.		X		X		X
Clean engine air filter assembly.						X
Adjust valve lash clearance.						X
Inspect drive belts, replace as required.						X
Drain and refill transfer case fluid (4X4).		X				
Replace fuel filter element.		X				X

462 SCHEDULE "B"

Miles (Kilometers)	116,250 (186 000)	120,000 (192 000)	123,750 (198 000)	127,500 (204 000)	131,250 (210 000)	135,000 (216 000)
Inspect front wheel bearings.		X				
Change rear axle fluid.		X				X
Change front axle fluid (4X4).		X				X
Change 6-spd manual transmission (G-56) fluid 2500/3500.		X				
Inspect brake linings.		X				X
Inspect and adjust parking brake if necessary.		X				X
Drain and refill automatic transmission fluid and change main sump and spin-on cooler return filter (if equipped) (545 RFE only).		X				
Drain and refill automatic transmission fluid. Replace filter and adjust bands (48RE only).		X				

Inspection and service should also be performed anytime a malfunction is observed or suspected. Retain all receipts.

Schedule "A"

Miles (Kilometers) [Months]	7,500 (12 000) [6]	15,000 (24 000) [12]	22,500 (36 000) [18]	30,000 (48 000) [24]	37,500 (60 000) [30]
Change engine oil and engine oil filter.		X		X	
Lubricate Front Drive Shaft Fitting (2500/3500, 4X4).	X	X	X	X	X
Rotate tires.	X	X	X	X	X
Check spare tire for proper pressure and correct stowage.	X	X	X	X	X
Lubricate outer tie rod ends 2500/3500 (4X4) models.	X	X	X	X	X
Check transfer case fluid level (4X4).				X	
Replace fuel filter element.		X		X	
Inspect drive belts, replace as necessary.			X		
Inspect brake linings.			X		
Inspect and adjust parking brake if necessary.			X		
Inspect front wheel bearings.				X	

464 SCHEDULE "A"

Miles (Kilometers) [Months]	45,000 (72 000) [36]	52,500 (84 000) [42]	60,000 (96 000) [48]	67,500 (108 000) [54]	75,000 (120 000) [60]
Change engine oil and engine oil filter.	X		X		X
Lubricate Front Drive Shaft Fitting (2500/3500, 4X4).	X	X	X	X	X
Rotate tires.	X	X	X	X	X
Check spare tire for proper pressure and correct stowage.	X	X	X	X	X
Lubricate outer tie rod ends 2500/3500 (4X4) models.	X	X	X	X	X
Check transfer case fluid level.			X		
Flush and replace engine coolant at 60 months, if not replaced at 102,000 miles (163 000 km).					X
Inspect drive belts, replace as necessary.	X			X	
Replace fuel filter element.	X		X		X
Inspect brake linings.	X			X	
Inspect and adjust parking brake if necessary.	X			X	
Inspect front wheel bearings.			X		
Replace fuel filter element.			X		

Miles (Kilometers) [Months]	82,500 (132 000) [66]	90,000 (144 000) [72]	97,500 (156 000) [78]	100,000 (160 000)	105,000 (168 000) [84]
Change engine oil and engine oil filter.		X			X
Lubricate Front Drive Shaft Fitting (2500/3500, 4X4).	X	X	X	X	X
Rotate tires.	X	X	X	X	X
Check spare tire for proper pressure and correct stowage.	X	X	X	X	X
Lubricate outer tie rod ends 2500/3500 (4X4) models.	X	X	X	X	X
Flush and replace engine coolant, if not replaced at 60 mos.				X	
Check transfer case fluid level (4X4).		X			
Inspect drive belt, replace as required.		X			
Replace fuel filter element.		X			X
Inspect front wheel bearings.		X			
Inspect brake linings.		X			
Inspect and adjust parking brake if necessary.		X			
Drain and refill automatic transmission fluid. Replace filter and adjust bands (48 RE only).				X	

466 SCHEDULE "A"

Miles (Kilometers) [Months]	112,500 (181 000) [90]	120,000 (193 000) [96]	127,500 (205 000) [102]	135,000 (217 000) [108]	142,500 (229 000) [114]	150,000 (241 000) [120]
Change engine oil and engine oil filter.		X		X		X
Lubricate Front Drive Shaft Fitting (2500/ 3500, 4X4).	X	X	X	X	X	X
Rotate tires.	X	X	X	X	X	X
Check spare tire for proper pressure and cor- rect stowage.	X	X	X	X	X	X
Lubricate outer tie rod ends 2500/3500 (4X4) models.	X	X	X	X	X	X
Flush and replace engine coolant at 120 months, if not replaced at 100,000 miles (160 000 km).					X	
Inspect drive belt, replace as required.	X			X		
Drain and refill transfer case fluid (4X4).		X				
Check tranfer case fluid level (4X4).						X
Replace fuel filter element.		X		X		X

Miles (Kilometers) [Months]	112,500 (181 000) [90]	120,000 (193 000) [96]	127,500 (205 000) [102]	135,000 (217 000) [108]	142,500 (229 000) [114]	150,000 (241 000) [120]
Inspect front wheel bearings.		X			X	
Inspect brake linings.	X			X		
Inspect and adjust parking brake if necessary.	X			X		
Adjust valve lash clearance.						X

Inspection and service should also be performed anytime a malfunction is observed or suspected. Retain all receipts.

WARNING!
You can be badly injured working on or around a motor vehicle. Do only that service work for which you have the knowledge and the right equipment. If you have any doubt about your ability to perform a service job, take your vehicle to a competent mechanic.

IF YOU NEED CONSUMER ASSISTANCE

CONTENTS

■ Suggestions For Obtaining Service For Your Vehicle	470	■ Reporting Safety Defects	473
□ Prepare For The Appointment	470	□ In Canada	473
□ Prepare A List	470	■ Publication Order Forms	474
□ Be Reasonable With Requests	470	■ Department Of Transportation Uniform Tire Quality Grades	475
■ If You Need Assistance	470	□ Treadwear	475
■ Warranty Information (U.S. Vehicles Only)	473	□ Traction Grades	475
■ Mopar® Parts	473	□ Temperature Grades	476

SUGGESTIONS FOR OBTAINING SERVICE FOR YOUR VEHICLE**Prepare For The Appointment**

If you're having warranty work done, be sure to have the right papers with you. Take your warranty folder. All work to be performed may not be covered by the warranty, discuss additional charges with the service manager. Keep a maintenance log of your vehicle's service history. This can often provide a clue to the current problem.

Prepare A List

Make a written list of your vehicle's problems or the specific work you want done. If you've had an accident, or work done that is not on your maintenance log, let the service advisor know.

Be Reasonable With Requests

If you list a number of items, and you must have your vehicle by the end of the day, discuss the situation with the service advisor and list the items in order of priority. At many dealers you may obtain a rental vehicle at a minimal daily charge. If you need a rental, it is advisable to make these arrangements when you call for an appointment.

IF YOU NEED ASSISTANCE

The manufacturer and its dealers are vitally interested in your satisfaction. We want you to be happy with our products and services.

Warranty service must be done by an authorized Chrysler, Dodge, or Jeep dealer. We strongly recommend that you take your vehicle to your selling dealer. They know you and your vehicle best, and are most concerned that you get prompt and high quality service. The manufacturer's dealers have the facilities, factory-trained

technicians, special tools, and the latest information to assure your vehicle is fixed correctly and in a timely manner.

This is why you should always talk to your dealer's service manager first. Most matters can be resolved with this process.

- If for some reason you are still not satisfied, talk to the general manager or owner of the dealership. They want to know if you need assistance.
- If your dealership is unable to resolve the concern, you may contact the Manufacturer's Customer Center.

Any communication to the Manufacturer's Customer Center should include the following information:

- Owner's name and address
- Owner's telephone number (home and office)
- Dealership name

- Vehicle identification number
- Vehicle delivery date and mileage

DaimlerChrysler Motors Corporation Customer Center

P.O. Box 21-8004
 Auburn Hills, MI 48321-8004
 Phone: (800) 992-1997

DaimlerChrysler Canada Inc. Customer Center

P.O. Box 1621
 Windsor, Ontario N9A 4H6
 Phone —(800) 465-2001

In Mexico contact:

Av. Prolongacion Paseo de la Reforma, 1240
 Sante Fe C.P. 05109
 Mexico, D. F.
 In Mexico (915) 729-1248 or 729-1240
 Outside Mexico (525) 729-1248 or 729-1240

Customer Assistance For The Hearing Or Speech Impaired (TDD/TTY)

To assist customers who have hearing difficulties, the manufacturer has installed special TDD (Telecommunication Devices for the Deaf) equipment at its Customer Center. Any hearing or speech impaired customer who has access to a TDD or a conventional teletypewriter (TTY) in the United States can communicate with the manufacturer by dialing 1-800-380-CHRY.

Service Contract

You may have purchased a service contract for your vehicle to help protect you from the high cost of unexpected repairs after your manufacturer's new vehicle limited warranty expires. The manufacturer stands behind only the manufacturer's Service Contracts. If you purchased a manufacturer's Service Contract, you will receive Plan Provisions and an Owner Identification Card in the mail within three weeks of your vehicle delivery date. If you have any questions about your service

contract, call the manufacturer's Service Contract National Customer Hotline at 1-800-521-9922.

The manufacturer will not stand behind any service contract that is not the manufacturer's Service Contract. It is not responsible for any service contract other than the manufacturer's Service Contract. If you purchased a service contract that is not a manufacturer's Service Contract, and you require service after your manufacturer's new vehicle limited warranty expires, please refer to your contract documents, and contact the person listed in those documents.

We appreciate that you have made a major investment when you purchased your new vehicle. Your dealer has also made a major investment in facilities, tools, and training to assure that you are absolutely delighted with your ownership experience. You'll be pleased with their sincere efforts to resolve any warranty issues or related concerns.

WARRANTY INFORMATION (U.S. Vehicles Only)

See the Warranty Information Booklet for the terms and provisions of DaimlerChrysler's warranties applicable to this vehicle.

MOPAR® PARTS

Mopar® fluids, lubricants, parts, and accessories are available from your dealer. They will help you keep your vehicle operating at its best.

REPORTING SAFETY DEFECTS

In the 50 United States and Washington D.C.: If you believe that your vehicle has a defect, which could cause a crash or cause injury or death, you should immediately inform the National Highway Traffic Safety Administration (NHTSA) in addition to notifying the manufacturer.

If NHTSA receives similar complaints, it may open an investigation, and if it finds that a safety defect exists in a group of vehicles, it may order a recall and remedy

campaign. However, NHTSA cannot become involved in individual problems between you, your dealer, and the manufacturer.

To contact NHTSA, you may either call the Auto Safety Hotline toll free at 1-888-327-4236 (TTY: 1-800-424-9153), or go to <http://www.NHTSA.gov>. or write to: NHTSA, U.S. Dept. of Transportation, Washington DC 20590. You can also obtain other information about motor vehicle safety from the Hotline.

In Canada:

If you believe that your vehicle has a safety defect, you should contact the Customer Service Department immediately. Canadian customers who wish to report a safety defect to the Canadian government should write to Transport Canada, Motor Vehicle Defect Investigations and Recalls, 2780 Sheffield Road, Ottawa, Ontario K1B 3V9.

PUBLICATION ORDER FORMS

To order the following manuals, you may use either the website or the phone numbers listed below. Visa, Mastercard, American Express, and Discover orders are accepted. If you prefer mailing your payment, please call for an order form.

NOTE: A street address is required when ordering manuals. (No P.O. Boxes).

- *Service Manuals.*

These comprehensive service manuals provide the information that students and professional technicians need in diagnosing/troubleshooting, problem solving, maintaining, servicing, and repairing DaimlerChrysler Corporation vehicles. A complete working knowledge of the vehicle, system, and/or components is written in straightforward language with illustrations, diagrams, and charts.

- *Diagnostic Procedure Manuals.*

Filled with diagrams, charts and detailed illustrations, these practical manuals make it easy for students and technicians to find and fix problems on computer-controlled vehicle systems and features. They show exactly how to find and correct problems the first time, using step-by-step troubleshooting and driveability procedures, proven diagnostic tests and a complete list of all tools and equipment.

- *Owner's Manuals.*

These manuals have been prepared with the assistance of service and engineering specialists to acquaint you with specific Chrysler group vehicles. Included are starting, operating, emergency and maintenance procedures as well as specifications, capabilities and safety tips.

Call Toll Free at:

- 1-800-890-4038 (U.S.)
- 1-800-387-1143 (Canada)

Or

Visit us on the World Wide Web at:

- www.techauthority.daimlerchrysler.com
- www.daimlerchrysler.ca/manuals

DEPARTMENT OF TRANSPORTATION UNIFORM TIRE QUALITY GRADES

The following describes the tire grading categories established by the National Highway Traffic Safety Administration. The specific grade rating assigned by the tire's manufacturer in each category is shown on the sidewall of the tires on your car.

All Passenger Car Tires Must Conform to Federal Safety Requirements in Addition to These Grades.

Treadwear

The treadwear grade is a comparative rating based on the wear rate of the tire when tested under controlled conditions on a specified government test course. For example, a tire graded 150 would wear one and a half (1 1/2) times as well on the government course as a tire graded 100. The relative performance of tires depends upon the actual conditions of their use, however, and may depart significantly from the norm due to variations in driving habits, service practices and differences in road characteristics and climate.

Traction Grades

The traction grades, from highest to lowest, are AA, A, B, and C. Those grades represent the tire's ability to stop on wet pavement as measured under controlled conditions

on specified government test surfaces of asphalt and concrete. A tire marked C may have poor traction performance.

WARNING!

The traction grade assigned to this tire is based on straight-ahead braking traction tests, and does not include acceleration, cornering, hydroplaning, or peak traction characteristics.

Temperature Grades

The temperature grades are A (the highest), B, and C, representing the tire's resistance to the generation of heat and its ability to dissipate heat when tested under controlled conditions on a specified indoor laboratory test wheel. Sustained high temperature can cause the material of the tire to degenerate and reduce tire life, and excessive temperature can lead to sudden tire failure. The

grade C corresponds to a level of performance which all passenger car tires must meet under the Federal Motor Vehicle Safety Standard No. 109. Grades B and A represent higher levels of performance on the laboratory test wheel than the minimum required by law.

WARNING!

The temperature grade for this tire is established for a tire that is properly inflated and not overloaded. Excessive speed, under inflation, or excessive loading, either separately or in combination, can cause heat buildup and possible tire failure.

INDEX

- Adding Fuel 320
Adjustable Pedals 132
Air Cleaner, Engine (Engine Air Cleaner Filter) . 389,418
Air Conditioner Maintenance 396
Air Conditioning Refrigerant 396,397
Air Conditioning System 237,396
Air Conditioning System, Zone Control 240
Air Filter 389
Air Pressure, Tires 305,313
Airbag 45,51
Airbag Light 74,180
Airbag On/Off Switch 51
Airbag, Side 54
Alarm, Out of Park Sense 273
Alarm, Panic 22
Alarm (Security Alarm) 18,182
Alarm System (Security Alarm) 18
Alignment and Balance 312
Alterations/Modifications, Vehicle 8
Antenna, Satellite Radio 230
Antifreeze (Engine Coolant) 403,404
 Capacities 445
Anti-Lock Warning Light 184,294
Anti-Theft Security Alarm (Theft Alarm) 18
Anti-Theft System 18,182
Appearance Care 422
Ashtray 154
Automatic Dimming Mirror 83
Automatic Transaxle 12
 Interlock System 15
Automatic Transmission 413
 Adding Fluid 413
 Fluid and Filter Changes 414
 Fluid Level Check 413
 Fluid Type 414,447
 Shift Indicator 182
 Shifting 267
 Special Additives 415

Axle Fluid	412,447	Hoses	411
Axle Lubrication (Axle Fluid)	412	Master Cylinder	409
Ball Joints	397	Parking	290
Battery	394	Warning Light	184
Blanket	262,396	Bulb Replacement	433
Emergency Starting	367	Bulbs, Light	432
Keyless Transmitter Replacement (RKE)	23	Cab Top Clearance Lights	441
Saving Feature (Protection)	124	Calibration, Compass	141
Bearings	415	Camper	170
Belts, Drive	389	Capacities, Antifreeze (Engine Coolant)	445
Belts, Seat	32	Capacities, Fluid	445
Body Mechanism Lubrication	399	Caps, Filler	
B-Pillar Location	300	Power Steering	397
Brake Fluid	447	Radiator (Coolant Pressure)	405
Brake System	291,409	Car Washes	422
Anti-Lock (ABS)	292	Carbon Monoxide Warning	73,172
Disc Brakes	409	Cargo Light	126
Fluid Check	409	Cassette Tape and Player Maintenance	232

- CD (Compact Disc) Player 190,198,211
- Cellular Phone 87
- Center High Mounted Stop Light 440
- Center Lap Belts 42
- Center Seat Storage Compartment 159,160
- Certification Label 323
- Charge Air Cooler 408
- Chart, Tire Sizing 297
- Check Engine Light (Malfunction Indicator Light) . 183
- Child Restraint 57,58
- Child Restraint Tether Anchors 62,66
- Child Seat 58,65
- Cigar Lighter 154
- Cleaning
- Wheels 424
- Climate Control 234
- Clock 187,192,200,213,226
- Clutch Linkage Maintenance 411
- Compact Disc (CD) Maintenance 233
- Compact Spare Tire 308
- Compass 140,141
- Compass Calibration 141
- Compass Variance 142
- Computer, Trip/Travel 137
- Console, Overhead 136
- Contract, Service 472
- Coolant Pressure Cap (Radiator Cap) 405
- Cooling System 401
- Adding Coolant (Antifreeze) 404
- Coolant Capacity 445
- Coolant Level 401,402,406
- Disposal of Used Coolant 406
- Drain, Flush, and Refill 403
- Inspection 406
- Points to Remember 406
- Pressure Cap 405
- Radiator Cap 405
- Selection of Coolant (Antifreeze) 403,446

Temperature Gauge	181	Used Coolant (Antifreeze)	406
Cruise Control (Speed Control)	133	Door Ajar	187
Cup Holder	155	Door Locks	24
Customer Assistance	470	Door Opener, Garage	143
Data Recorder, Event	56	Draining Fuel/Water Separator Filter	391
Daytime Running Lights	125	Drive Belts	389
Dealer Service	380	Dual Rear Wheels	316,364
Defroster, Rear Window	85,164	DVD Player (Video Entertainment System)	226
Defroster, Windshield	74,236,238	Electric Rear Window Defrost	85,164
Delay (Intermittent) Wipers	129	Electrical Power Outlets	152
Diesel Fuel	318	Electronic Speed Control (Cruise Control)	133
Diesel Fuel Requirements	318	Electronically Shifted Transfer Case	280
Differential, Limited-Slip	287	Emergency Brake	290
Dipsticks	383	Emergency, In Case of	
Power Steering	397	Freeing Vehicle When Stuck	370
Disc Brakes	409	Hazard Warning Flasher	354
Disposal	389	Jacking	357
Engine Oil	389	Jump Starting	367

Tow Hooks	371	Exhaust Gas Caution	73,172,401
Towing	372	Exhaust System	73,400,401,418
Emission Control System Maintenance	450	Exterior Lighting	124
Engine	378	Fan	407
Air Cleaner	389	Filters	
Block Heater	254,261	Engine Oil	383,386,446
Break-In Recommendations	71	Flashers	
Compartment	378	Turn Signal	127
Coolant (Antifreeze)	446	Flat Tire Stowage	356,366
Cooling	401	Fluid, Brake	447
Data Plate	380	Fluid Capacities	445
Identification	378	Fluid Level Checks	
Idling	263	Brake	409
Jump Starting	367	Manual Transmission	412
Oil	383,446	Power Steering	397
Oil Synthetic	262	Transfer Case	412
Runaway	317	Fluids, Lubricants and Genuine Parts	446
Temperature Gauge	181	Fog Lights	126,185,436
Event Data Recorder	56		

Fold Flat Load Floor	166	Oil Pressure	180
Four Wheel Drive	276	Speedometer	180
Four-Way Hazard Flasher	354	Tachometer	179
Freeing A Stuck Vehicle	370	Voltmeter	179
Front Axle (Differential)	398,411	Gear Ranges	268
Fuel	318,320	General Information	18
Adding	320	Glass Cleaning	425
Diesel	318,320,446	Grocery Bag Retainer	164
Gauge	186	Gross Axle Weight Rating	328
Light	187	Gross Vehicle Weight Rating	327
Requirements	318	GVWR	323
Specifications	318	Hands-Free Phone (UConnect™)	87
Tank Capacity	445	Hazard Warning Flasher	354
Fuses	426	Head Restraints	111
Garage Door Opener (HomeLink®)	143	Headlights	433
Gauges	179	High Beam	128
Coolant Temperature	181	High Beam/Low Beam Select Switch	128
Fuel	186	Lights On Reminder	126

Passing	128	Infant Restraint	57,58
Switch	124	Inflation Pressure Tires	313
Heated Mirrors	85,164	Inside Rearview Mirror	82
Heated Seats	119	Instrument Cluster	178,179
Heater	237	Instrument Panel and Controls	177
High Beam/Low Beam Select (Dimmer) Switch	128	Instrument Panel Lens Cleaning	425
Hitches		Integrated Power Module (Fuses)	426
Trailer Towing	331	Interior Appearance Care	424
Hoisting	366	Interior Lights	123
HomeLink® (Garage Door Opener) Transmitter	143	Intermittent Wipers (Delay Wipers)	129
Hood Release	121	Introduction	4
Hoses	408,411	Jack Location	355
Hub Caps	362	Jack Operation	357
Hydraulic Clutch Fluid	411	Jump Starting	367
Ignition	12	Key, Replacement	16
Key	12	Key, Sentry (Immobilizer)	15
Ignition Key Removal	12	Keyless Entry System	20
Illuminated Entry	19		

Keys	12	Dual Wheel Assembly Rear	443
Lane Change and Turn Signals	127	Fog	126,185,436
Lap Belts	42	Four-Wheel Drive Indicator	280
Lap/Shoulder Belts	32	Hazard Warning Flasher	354
LATCH (Lower Anchors and Tether for Children)	62	Headlights	124
Life of Tires	311	High Beam	128,180
Lights	75,122	High Beam Indicator	180
Airbag	55,180	High Beam/Low Beam Select	128
Anti-Lock Warning	184,294	Illuminated Entry	19
Brake Warning	184	Instrument Cluster	179
Bulb Replacement	432,433	Intensity Control	123
Cap Top Clearance	441	Interior	123,136
Cargo	126	Lights On Reminder	126
Center Mounted Stop	440	Passing	128
Check Engine (Malfunction Indicator)	183	Seat Belt Reminder	180
Courtesy/Reading	136	Service	432,433
Cruise	187	Side Marker	445
Daytime Running	125	Transfer Case	280
		Transmission Warning	186

Turn Signal	127,179,433,437	Maintenance Schedule	450
Warning (Instrument Cluster Description)	179	Schedule "A"	463
Limited-Slip Differential	287,412	Manual, Service	474
Loading Vehicle	323	Manual Transmission	274,412
Tires	300	Fluid Level Check	412
Locks	24	Lubricant Selection	447
Child Protection	27	Mirrors	82
Door	24	Automatic Dimming	83
Keys	12	Electric Powered	84
Power Door	25	Outside	83
Steering Wheel	15	Rearview	82
Lower Anchors and Tether for CHildren (LATCH)	62	Trailer Towing	85,339
Lubricants	416	Modifications/Alterations, Vehicle	8
Lubrication, Body	399	Mopar Parts	379,473
Lug Nuts	361	Multi-Function Control Lever	127
Lumbar Support	112		
		Navigation Radio	225
Maintenance	380	Navigation System	225
Maintenance Procedures	383	New Vehicle Break-In Period	71

Noise Control		Recommendation	385
Maintenance	417	Viscosity	385
Tampering Prohibited	418	Oil Filter, Change	386
Noise Emission Warranty	417,419	Onboard Diagnostic System	379
Occupant Restraints	31	Opener, Garage Door (HomeLink®)	143
Occupant Restraints (2500/3500/Mega Cab Only)	31	Operating Precautions	379
Odometer	182,186	Out of Park Sense Alarm	273
Trip	182,186	Outside Rearview Mirrors	83
Off-Pavement Driving (Off-Road)	289	Overdrive	270
Off-Road Driving (Off-Pavement)	289	Overdrive OFF Switch	270
Oil, Engine	446	Overhead Console	136,137
Capacity	445	Overhead Travel Information Center	137
Change Interval	384	Owner's Manual (Operator Manual)	474
Dipstick	383	Panic Alarm	22
Disposal	389	Parking Brake	290
Filter	383,386,446	Passenger Airbag On/Off Switch	51
Materials Added to	386	Passing Light	128
Pressure Gauge	180	Pedals, Adjustable	132

Phone, Cellular	87	Programming Transmitters	
Phone, Hands-Free (UConnect™)	87	(Remote Keyless Entry)	145,148
Pickup Box	169	Radial Ply Tires	307
Placard, Tire and Loading Information	300	Radiator Cap (Coolant Pressure Cap)	405
Power		Radio Broadcast Signals	188
Distribution Center (Fuses)	426	Radio, Navigation	225
Door Locks	25	Radio Operation	190,198,211
Mirrors	84	Radio Remote Controls	231
Outlet (Auxiliary Electrical Outlet)	152	Radio, Satellite	226
Seats	113	Radio (Sound Systems)	190,198,211
Sliding Rear Window	30,165	Rear Axle (Differential)	411,412
Steering	294,397	Rear Seat, Folding	115,116
Sunroof	149	Rear Wheel Bearings	416
Windows	29	Rear Window Features	164
Power Steering Fluid	447	Rear Window, Sliding	31,165
Pregnant Women and Seat Belts	44	Reclining Front Seats	111
Pretensioners		Reclining Rear Seats	114
Seat Belts	42	Recorder, Event Data	56
Programmable Electronic Features	145,148		

Recreational Towing	345	Satellite Radio Antenna	230
Shifting into Transfer Case Neutral (N)	345,348	Seat Belt Maintenance	425
Shifting out of Transfer Case Neutral (N)	347,350	Seat Belt Reminder	43
Refrigerant	397	Seat Belts	31,32,74
Reminder, Seat Belt	43	Adjustable Upper Shoulder Anchorage	40
Remote Keyless Entry (RKE)	20	And Pregnant Women	44
Remote Sound System (Radio) Controls	231	Child Restraint	57,70
Replacement Tires	311	Extender	44
Reporting Safety Defects	473	Front Seat	32
Restraint, Head	111	Pretensioners	42
Restraints, Child	57,65	Reminder	180
Rotation, Tires	315	Seats	109,110
Safety Checks Inside Vehicle	74	Adjustment	109
Safety Checks Outside Vehicle	74	Child	70
Safety Defects, Reporting	473	Folding Floor	166
Safety Information, Tire	295	Heated	119
Safety Tips	72	Lumbar Support	112
Satellite Radio	226	Power	113
		Rear Folding	115,116

Reclining	111	Shoulder Belts	32
Reclining Rear	114	Side Airbag	54
Security Alarm (Theft Alarm)	18,182	Signals, Turn	127
Selection of Coolant (Antifreeze)	403,446	Sliding Rear Window	
Sentry Key (Immobilizer)	15	Power	30,165
Service Assistance	470	Slippery Surfaces, Driving On	288
Service Contract	472	Snow Chains (Tire Chains)	313
Service Information	380	Snow Plow	341
Service Manuals	474	Snow Tires	315
Setting the Clock	188,192,200,213,226	Spare Tire	308,309
Shifting	267	Speed Control (Cruise Control)	133
Automatic Transmission	267	Speedometer	180
Manual Transmission	274	Starting	253
Transfer Case	279	Automatic Transmission	253
Transfer Case, Shifting into Transfer		Engine Block Heater	254,261
Case Neutral (N)	345,348	Manual Transmission	253
Transfer Case, Shifting out of Transfer		Starting Procedures	253
Case Neutral (N)	347,350	Starting Procedures (Diesel Engines)	253
Shoulder Belt Upper Anchorage	40		

Steering		Tilt Steering Column	130
Linkage	398	Tire and Loading Information Placard	300,313
Power	294,397	Tire Identification Number (TIN)	299
Wheel Lock	15	Tire Markings	295
Wheel, Tilt	130	Tire Safety Information	295
Steering Wheel Mounted Sound System		Tires	74,304,475
Controls	231	Aging (Life of Tires)	311
Storage, Behind the Seat	159	Air Pressure	304
Storage Compartment, Center Seat	159,160	Alignment	312
Storage, Vehicle	431	Chains	313
Storing Your Vehicle	431	Changing	356
Sun Roof	149	Compact Spare	308
Supplemental Tire Pressure Information	313	Dual	316,364
Synthetic Engine Oil	262	General Information	304
System, Navigation	225	High Speed	306
		Inflation Pressures	305
Tachometer	179	Jacking	357
Tailgate	171	Life of Tires	311
Tether Anchor, Child Restraint	62,66	Load Capacity	300,301

Quality Grading	475	Weight	332
Radial	307	Traction	288
Replacement	311	Traction Control	412
Rotation	315	Trailer Towing	327
Safety	295,304	Cooling System Tips	339
Sizes	297	Hitches	331
Snow Tires	315	Minimum Requirements	333
Spare Tire	356	Mirrors	85,339
Spinning	309	Trailer and Tongue Weight	332
Tread Wear Indicators	310	Wiring	336
Wheel Mounting	357	Trailer Towing Guide	332
Wheel Nut Torque	361	Trailer Weight	332
Tongue Weight/Trailer Weight	332	Transaxle	
Torque Converter Clutch	272	Automatic	12
Tow Hooks, Emergency	371	Manual	14
Towing	327	Transfer Case	
Disabled Vehicle	372	Electronically Shifted	280
Guide	332	Fluid	447
Recreational	345		

Transmission		Vehicle Identification Number (VIN)	8
Automatic	267,413	Vehicle Loading	301,323
Fluid	447	Vehicle Modifications/Alterations	8
Maintenance	413	Vehicle Storage	431
Manual	253,274,412	Video Entertainment System	
Shifting	267	(Rear Seat Video System)	226
Transmitter Battery Service (Remote Keyless Entry) .	23	Voltmeter	179
Transmitter, Garage Door Opener (HomeLink®) . .	143	Warning Lights (Instrument Cluster Description) .	179
Tread Wear Indicators	310	Warnings and Cautions	7
Trip Computer	137	Warranty Information	473
Trip Odometer	182,186	Washers, Windshield	130,399
Turn Signals	127,179,433,437	Washing Vehicle	422
UConnect™ (Hands-Free Phone)	87	Wheel Alignment and Balance	312
Underhood Fuses	426	Wheel and Wheel Trim	424
Uniform Tire Quality Grades	475	Wheel and Wheel Trim Care	424
Universal Transmitter	143	Wheel Changing	356
Variance, Compass	142	Wheel Cover	362
		Wheel Mounting	357

494 INDEX

Wheel Nut Torque	361,365	Windshield Defroster	236,238
Wind Buffeting	31,152	Windshield Washers	129,130,399
Window Airbag (Side Curtain)	54	Fluid	129,399
Window Fogging	245	Windshield Wiper Blades	399
Windows	29	Windshield Wipers	129
Power	29	Wiper Blade Replacement	399
Rear Sliding	31,165	Wipers, Intermittent	129

NOTES
