



2009

OWNER'S MANUAL



DODGE

RAM TRUCK
CHASSIS CAB

VEHICLES SOLD IN CANADA

With respect to any Vehicles Sold in Canada, the name Chrysler LLC shall be deemed to be deleted and the name Chrysler Canada Inc. used in substitution therefor.

DRIVING AND ALCOHOL

Drunken driving is one of the most frequent causes of accidents.

Your driving ability can be seriously impaired with blood alcohol levels far below the legal minimum. If you are drinking, don't drive. Ride with a designated non-drinking driver, call a cab, a friend, or use public transportation.

WARNING!

Driving after drinking can lead to an accident. Your perceptions are less sharp, your reflexes are slower, and your judgment is impaired when you have been drinking. Never drink and then drive.

This manual illustrates and describes the operation of features and equipment that are either standard or optional on this vehicle. This manual may also include a description of features and equipment that are no longer available or were not ordered on this vehicle. Please disregard any features and equipment described in this manual that are not on this vehicle.

Chrysler LLC reserves the right to make changes in design and specifications, and/or make additions to or improvements to its products without imposing any obligation upon itself to install them on products previously manufactured.

Copyright © 2008 Chrysler LLC



TABLE OF CONTENTS

SECTION

PAGE

1	INTRODUCTION	3	1
2	THINGS TO KNOW BEFORE STARTING YOUR VEHICLE	9	2
3	UNDERSTANDING THE FEATURES OF YOUR VEHICLE	77	3
4	UNDERSTANDING YOUR INSTRUMENT PANEL	157	4
5	STARTING AND OPERATING	217	5
6	WHAT TO DO IN EMERGENCIES	313	6
7	MAINTAINING YOUR VEHICLE	333	7
8	MAINTENANCE SCHEDULES	381	8
9	IF YOU NEED CONSUMER ASSISTANCE	399	9
10	INDEX	409	10

INTRODUCTION

CONTENTS

■ Introduction	4	■ Van Conversions/Campers	6
■ How To Use This Manual	4	■ Vehicle Identification Number	7
■ Warnings And Cautions	6	■ Vehicle Modifications/Alterations	7

INTRODUCTION

This Owner's Manual has been prepared with the assistance of service and engineering specialists to acquaint you with the operation and maintenance of your vehicle. It is supplemented by a Warranty Information Booklet and various customer-oriented documents. You are urged to read these publications carefully. Following the instructions and recommendations in this manual will help assure safe and enjoyable operation of your vehicle.

NOTE: After you read the manual, it should be stored in the vehicle for convenient referencing and remain with the vehicle when sold, so that the new owner will be aware of all safety warnings.

















































































When it comes to service, remember that your authorized dealer knows your vehicle best, has the factory-trained technicians and genuine Mopar® parts, and is interested in your satisfaction.

HOW TO USE THIS MANUAL

Consult the Table of Contents to determine which section contains the information you desire.

The detailed index at the back of this Owner's Manual contains a complete listing of all subjects.

Consult the following table for a description of the symbols that may be used on your vehicle or throughout this Owner's Manual:

 WATER IN FUEL	 REAR WINDOW WIPER	 WINDSHIELD WIPER (INTERMITTENT)	 EXTERIOR BULB FAILURE	 HIGH BEAM	 TURN SIGNALS	 UPPER AIR OUTLET	 HEATED SEAT	 COLOR LOCK	 ADJUSTABLE PEDALS	 ELECTRONIC SPEED CONTROL	 ESP BAS ELECTRONIC STABILITY PROGRAM / BRAKE ASSIST SYSTEM
 FUEL	 REAR WINDOW WIPER (INTERMITTENT WIPER)	 WINDSHIELD WIPER WASHES	 MASTER LIGHTING SWITCH	 LOW BEAM	 KEY (ACTIVE / PASSIVE ENTRY)	 TRUNK AND LOWER AIR OUTLET	 HEATED SEAT	 WINDOW LIFT	 TIRES (PRESSURE MONITOR)	 HILL DESCENT CONTROL	 BRAKE SYSTEM WARNING LAMP
 FUEL FILLER DOOR	 REAR WINDOW WASHES	 WINDSHIELD WASHES FLUID LEVEL	 DOME LIGHT	 FRONT FOG LIGHT	 HOOD RELEASE	 LOWER AIR OUTLET	 RECIRCULATION	 CONVERTIBLE WINDOW DOWN	 TRACTION CONTROL	 AWD	 ABS FAILURE OF ANTI-LOCK BRAKING SYSTEM
 ENGINE OIL	 REAR WINDOW DEFROST	 WINDSHIELD ELECTRICALLY HEATED	 PARK LIGHTS	 REAR FOG LAMP	 LIFTGATE RELEASE AND LIFTGATE LOCK	 DEFROST AND DEFOG (FRONT AND REAR)	 VENTS/FANS	 WINDOW LOCK	 ELECTRONIC THROTTLE CONTROL	 4WD	 BRAKE BRAKE SYSTEM WARNING LAMP
 BATTERY CHARGING	 HEATER MIRROR	 WINDSHIELD DEFROST	 INSTRUMENT PANEL ILLUMINATION	 SEAT BELT	 SLIDING DOOR	 TRUNK / DECK RELEASE	 AIR CONDITIONING	 CHILD SEAT TETHER ANCHOR	 VOICE RECOGNITION BUTTON	 WARNING	 TOW/HAUL
 RINSE CYCLE	 POWER STEERING LOCK	 WINDSHIELD WIPER AND WASHES	 DO NOT PARK	 AIRBAG	 SLIDING DOOR	 EMERGENCY RELEASE HANDLE	 LIGHTS	 LOWER ANCHORS AND TETHER FOR CHILD SEAT(S)	 POWER LOCK BUTTON	 HAZARD	 4 LOW FOUR WHEEL DRIVE LOW
 MALFUNCTION INDICATOR LIGHT	 TRANSMISSION	 ENGINE COOLANT TEMPERATURE	 SRS AIRBAG	 FUEL SHUT-OFF VALVE OFF	 DOOR AJAR	 CONVERTIBLE TOP DOWN	 CONVERTIBLE TOP UP	 HORN	 SEE CHASSIS LABEL (SEE)		

010505550

WARNINGS AND CAUTIONS

This Owner's Manual contains **WARNINGS** against operating procedures that could result in an accident or bodily injury. It also contains **CAUTIONS** against procedures that could result in damage to your vehicle. If you do not read this entire manual, you may miss important information. Observe all Warnings and Cautions.

VAN CONVERSIONS/CAMPERS

The Manufacturer's Warranty does not apply to body modifications or special equipment installed by van conversion/camper manufacturers/body builders. Refer to the Warranty information book, Section 2.1.C. Such equipment includes video monitors, VCRs, heaters, stoves, refrigerators, etc. For warranty coverage and service on these items, contact the applicable manufacturer.

Operating instructions for the special equipment installed by the conversion/camper manufacturer should also be supplied with your vehicle. If these instructions are missing, please contact your authorized dealer for assistance in obtaining replacement documents from the applicable manufacturer.

For information on the Body Builders Guide refer to: www.dodgebodybuilder.com. This website contains dimensional and technical specifications for your vehicle. It is intended for Second Stage Manufacturer's technical support. For service issues, contact your authorized dealer.

VEHICLE IDENTIFICATION NUMBER

The Vehicle Identification Number (VIN) is found on the left front corner of the instrument panel, visible through the windshield. This number also appears on the Automobile Information Disclosure Label affixed to a window on your vehicle, the vehicle registration and title.

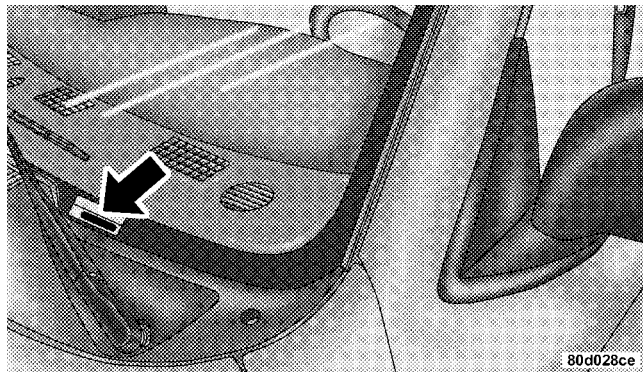

Vehicle Identification Number

NOTE: It is illegal to remove the VIN.

VEHICLE MODIFICATIONS/ALTERATIONS

WARNING!

Any modifications or alterations to this vehicle could seriously affect its roadworthiness and safety and may lead to an accident resulting in serious injury or death.

THINGS TO KNOW BEFORE STARTING YOUR VEHICLE

CONTENTS

■ A Word About Your Keys	12	□ Customer Key Programming	17
□ Ignition Key Removal	12	□ General Information	18
□ Locking Doors With The Key	14	■ Vehicle Security Alarm System — If Equipped . . .	19
■ Steering Wheel Lock — If Equipped	14	□ Rearming Of The System	19
□ If You Wish To Manually Lock The Steering Wheel	14	□ To Set The Alarm	19
□ To Release The Steering Wheel Lock	15	□ To Disarm The System	20
■ Sentry Key®	15	■ Illuminated Entry System — If Equipped	20
□ Replacement Keys	16	■ Remote Keyless Entry (RKE) — If Equipped . . .	21
		□ To Unlock The Doors	22

10 THINGS TO KNOW BEFORE STARTING YOUR VEHICLE

<input type="checkbox"/> To Lock The Doors	22	<input type="checkbox"/> Sliding Rear Window – If Equipped	34
<input type="checkbox"/> Using The Panic Alarm	23	<input type="checkbox"/> Wind Buffeting	34
<input type="checkbox"/> Programming Additional RKE Transmitters	24	■ Occupant Restraints	35
<input type="checkbox"/> General Information	24	<input type="checkbox"/> Lap/Shoulder Belts	36
<input type="checkbox"/> RKE Transmitter Battery Service	25	<input type="checkbox"/> Adjustable Upper Shoulder Belt Anchorage	44
■ Remote Starting System — If Equipped	26	<input type="checkbox"/> Automatic Locking Restraint (ALR) Mode – If Equipped	44
■ Door Locks	27	<input type="checkbox"/> Center Lap Belts	45
<input type="checkbox"/> Manual Door Locks	27	<input type="checkbox"/> Enhanced Driver Seat Belt Reminder System (BeltAlert®)	46
<input type="checkbox"/> Power Door Locks — If Equipped	28	<input type="checkbox"/> Seat Belts And Pregnant Women	47
<input type="checkbox"/> Child Protection Door Lock	30	<input type="checkbox"/> Seat Belt Extender	47
■ Windows	32		
<input type="checkbox"/> Power Windows – If Equipped	32		
<input type="checkbox"/> Power Sliding Rear Window – If Equipped	34		

- Driver And Right Front Passenger Supplemental Restraint System (SRS) – Airbag 48
- Event Data Recorder (EDR) 57
- Child Restraint 60
- New Engine Break-In 72
 - 5.7L Gas Engine – 3500 Models Only 72

- Safety Tips 73
 - Exhaust System 73
 - Safety Checks You Should Make Inside The Vehicle 74
 - Safety Checks You Should Make Outside The Vehicle 75

A WORD ABOUT YOUR KEYS

The authorized dealer that sold you your vehicle has the key code numbers for your vehicle locks. These numbers can be used to order duplicate keys from your authorized dealer. Ask your authorized dealer for these numbers and keep them in a safe place.

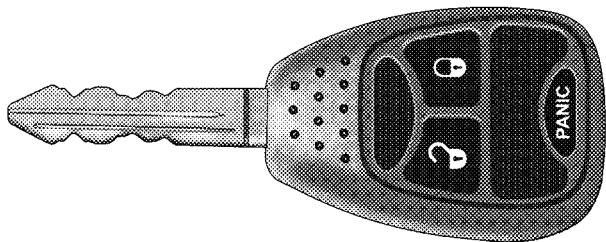

8163e6a8

Ignition Key

Ignition Key Removal

Automatic Transmission

Place the shift lever in PARK. Turn the ignition switch to the LOCK position, and remove the key.

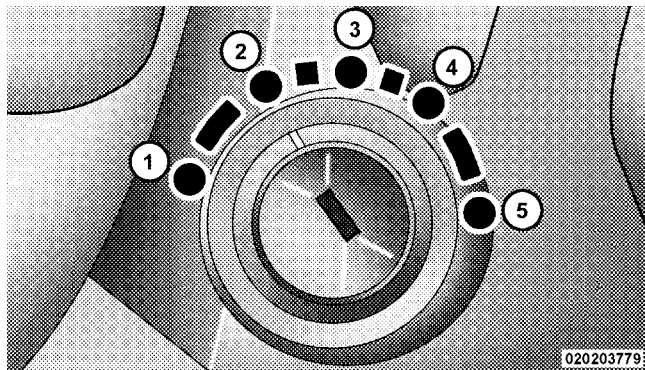

Ignition Switch Positions

- | | |
|---------------------|------------|
| 1 — ACC (ACCESSORY) | 4 — ON/RUN |
| 2 — LOCK | 5 — START |
| 3 — OFF | |

NOTE:

- If you try to remove the key before you place the shift lever in PARK, the key may become trapped temporarily in the ignition cylinder. If this occurs, rotate the key to the right slightly, then remove the key as described. If a malfunction occurs, the system will trap the key in the ignition cylinder to warn you that this safety feature is inoperable. The engine can be started and stopped but the key cannot be removed until you obtain service.
- The power window switches, radio, power sunroof (if equipped), and power outlets will remain active for 10 minutes after the ignition switch is turned OFF. Opening either front door will cancel this feature.

WARNING!

Never leave children alone in a vehicle. Leaving unattended children in a vehicle is dangerous for a number of reasons. A child or others could be seriously or fatally injured. Don't leave the key in the ignition. A child could operate power windows, other controls, or move the vehicle.

CAUTION!

An unlocked car is an invitation to thieves. Always remove key from the ignition and lock all doors when leaving the vehicle unattended.

Locking Doors with the Key

You can insert the key with either side up. To lock the door, turn the key rearward. To unlock the door, turn the key forward. For door lock lubrication, see "Body Lubrication" in Section 7 of this manual.

STEERING WHEEL LOCK — IF EQUIPPED

Your vehicle may be equipped with a passive steering wheel lock. This lock prevents steering the vehicle without the ignition key. If the steering wheel is moved approximately a half turn in either direction and the key is not in the ignition switch, the steering wheel will lock.

If You Wish to Manually Lock the Steering Wheel

With the engine running, turn the steering wheel upside down, turn off the engine and remove the key. Turn the steering wheel slightly in either direction until the lock engages.

To Release the Steering Wheel Lock

Insert the key in the ignition switch and start the engine. If the key is difficult to turn, move the wheel slightly to the right or left to disengage the lock.

NOTE: If you turned the wheel to the right to engage the lock, you must turn the wheel slightly to the right to disengage it. If you turned the wheel to the left to engage the lock, turn the wheel slightly to the left to disengage it.

SENTRY KEY®

The Sentry Key® Immobilizer System prevents unauthorized vehicle operation by disabling the engine. The system does not need to be armed or activated. Operation is automatic, regardless of whether the vehicle is locked or unlocked.

The system uses ignition keys that have an embedded electronic chip (transponder) to prevent unauthorized vehicle operation. Therefore, only keys that are programmed to the vehicle can be used to start and operate the vehicle. The system will shut the engine off in two seconds if someone uses an invalid key to try to start the engine.

NOTE: A key that has not been programmed is also considered an invalid key, even if it is cut to fit the ignition switch lock cylinder for that vehicle.

During normal operation, after turning on the ignition switch, the Vehicle Security Light will turn on for three seconds for a bulb check. If the light remains on after the bulb check, it indicates that there is a problem with the electronics. In addition, if the Vehicle Security Light begins to flash after the bulb check, it indicates that someone used an invalid key to try to start the engine. Either of these conditions will result in the engine being shut off after two seconds.

If the Vehicle Security Light turns on during normal vehicle operation (vehicle running for longer than 10 seconds), it indicates that there is a fault in the electronics. Should this occur, have the vehicle serviced as soon as possible.

NOTE:

- The Sentry Key® Immobilizer System is not compatible with some aftermarket remote starting systems.

Use of these systems may result in vehicle starting problems and loss of security protection.

- Exxon/Mobil Speedpass™, additional Sentry Keys®, or any other transponder-equipped components on the same key chain will **not** cause a key-related (transponder) fault unless the additional part is **physically held against the ignition key** being used when starting the vehicle. Cell phones, pagers, or other Radio Frequency (RF) electronics will not cause interference with this system.

All of the keys provided with your new vehicle have been programmed to the vehicle electronics.

Replacement Keys

NOTE: Only keys that are programmed to the vehicle electronics can be used to start and operate the vehicle. Once a Sentry Key® is programmed to a vehicle, it cannot be programmed to any other vehicle.

CAUTION!

Always remove the Sentry Keys® from the vehicle and lock all doors when leaving the vehicle unattended.

At the time of purchase, the original owner is provided with a four-digit Personal Identification Number (PIN). Keep the PIN in a secure location. This number is required for authorized dealer replacement of keys. Duplication of keys may be performed at an authorized dealer or by following the customer key programming procedure. This procedure consists of programming a blank key to the vehicle electronics. A blank key is one that has never been programmed.

NOTE: When having the Sentry Key® Immobilizer System serviced, bring all vehicle keys with you to an authorized dealer.

Customer Key Programming

If you have two valid Sentry Keys®, you can program new Sentry Keys® to the system by performing the following procedure:

1. Cut the additional Sentry Key® Transponder blank(s) to match the ignition switch lock cylinder key code.
2. Insert the first valid key into the ignition switch. Turn the ignition switch to the ON position for at least three seconds, but no longer than 15 seconds. Then, turn the ignition switch to the LOCK position and remove the first key.
3. Insert the second valid key into the ignition switch. Turn the ignition switch to the ON position within 15 seconds. After 10 seconds, a chime will sound. In addition, the Vehicle Security Light will begin to flash. Turn the ignition switch to the LOCK position and remove the second key.

4. Insert a blank Sentry Key® into the ignition switch. Turn the ignition switch to the ON position within 60 seconds. After 10 seconds, a single chime will sound. In addition, the Vehicle Security Light will stop flashing. To indicate that programming is complete, the Vehicle Security Light will turn on again for three seconds and then turn off.

The new Sentry Key® is programmed. **The Remote Keyless Entry (RKE) transmitter will also be programmed during this procedure.**

Repeat this procedure to program up to eight keys. If you do not have a programmed Sentry Key®, contact your authorized dealer for details.

NOTE: If a programmed key is lost, see your authorized dealer to have all remaining keys erased from the system's memory. This will prevent the lost key from starting your vehicle. The remaining keys must then be reprogrammed. All vehicle keys must be taken to an authorized dealer at the time of service to be reprogrammed.

General Information

The Sentry Key® system complies with FCC rules Part 15 and with RSS-210 of Industry Canada. Operation is subject to the following conditions:

- This device may not cause harmful interference.
- This device must accept any interference that may be received, including interference that may cause undesired operation.

VEHICLE SECURITY ALARM SYSTEM — IF EQUIPPED

This Vehicle Security Alarm system monitors the vehicle doors and ignition for unauthorized operation. When the alarm is activated, the system provides both audible and visible signals. For the first three minutes the horn will sound and the headlights and security light will flash repeatedly. For an additional 15 minutes only, the headlights and security light will flash. The engine will run only if a valid Sentry Key® is used to start the vehicle. Use of the Sentry Key® will disable the alarm.

Rearming of the System

The Vehicle Security Alarm system will rearm itself after the 15 additional minutes of headlights and security light flashing, if the system has not been disabled. If the condition which initiated the alarm is still present, the system will ignore that condition and monitor the remaining doors and ignition.

To Set the Alarm

The Vehicle Security Alarm will set when you use the power door locks, or use the Remote Keyless Entry (RKE) transmitter to lock the doors. After all the doors are locked and closed, the Vehicle Security Light in the instrument cluster will flash rapidly to signal that the system is arming. The Vehicle Security Light in the instrument panel cluster will flash rapidly for about 16 seconds to indicate that the alarm is being set. After the alarm is set, the Vehicle Security Light will flash at a slower rate to indicate that the system is armed.

NOTE: If the Vehicle Security Light stays on continuously during vehicle operation, have the system checked by an authorized dealer.

To Disarm the System

Use the RKE transmitter to unlock the door. If something has triggered the system in your absence, the horn will sound three times when you unlock the doors and the Vehicle Security Light will flash for 30 seconds. Check the vehicle for tampering.

The Vehicle Security Alarm system will also disarm if the vehicle is started with a programmed Sentry Key[®]. If an unprogrammed Sentry Key[®] is used to start a vehicle, the engine will run for two seconds and then the Security Alarm will be initiated. To exit the alarming mode, press the RKE transmitter UNLOCK button, or start the vehicle with a programmed Sentry Key[®].

The Vehicle Security Alarm system is designed to protect your vehicle; however, you can create conditions where the system will arm unexpectedly. If you remain in the vehicle and lock the doors with the RKE transmitter, the

alarm will sound when you pull the door handle to exit. The door will be locked, but the Vehicle Security Alarm system will not arm.

ILLUMINATED ENTRY SYSTEM — IF EQUIPPED

The courtesy lights will turn on when you use the Remote Keyless Entry (RKE) transmitter or open the doors. This feature is only available if you have Remote Keyless Entry.

The lights will fade to off after about 30 seconds, or they will immediately fade to off once the ignition switch is turned ON.

NOTE:

- The front courtesy overhead console and door courtesy lights do not turn off if the dimmer control is in the interior lights on position (extreme top position).
- The Illuminated Entry system will not operate if the dimmer control is in the extreme downward position.

REMOTE KEYLESS ENTRY (RKE) — IF EQUIPPED

The system allows you to lock or unlock the doors from distances up to about 23 ft (7 m) using a Remote Keyless Entry (RKE) transmitter. The RKE transmitter does not need to be pointed at the vehicle to activate the system.

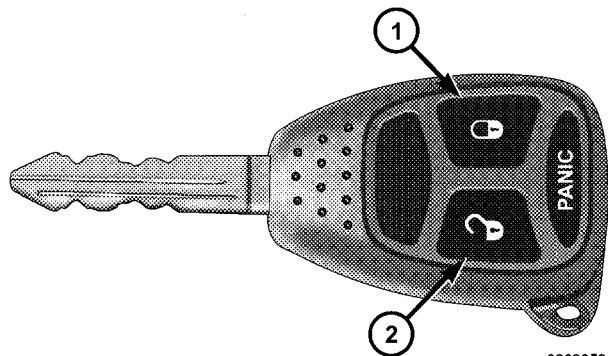

020205844

Three Button RKE Transmitter

- 1 — Lock
- 2 — Unlock

To Unlock the Doors

Press and release the UNLOCK button on the RKE transmitter once to unlock only the driver's door or twice to unlock all the doors. When the UNLOCK button is pressed, the illuminated entry will initiate, the parking lights will flash on twice and, if installed, the cargo lamp will turn on for 30 seconds.

The system can be programmed to unlock all the doors or the driver's door only upon the first UNLOCK button press by using the following procedure:

1. Perform this operation while standing outside the vehicle.
2. Press and hold the LOCK button on your RKE transmitter.

3. Continue to hold the LOCK button at least four seconds, but no longer than 10 seconds, then press and hold the UNLOCK button while still holding the LOCK button.

4. Release both buttons at the same time.

5. This will allow you to unlock all doors on the first press of the UNLOCK button.

6. To reactivate this feature, repeat the above steps.

To Lock the Doors

Press and release the LOCK button on the RKE transmitter to lock all doors. If the ignition is OFF, when the doors are locked, the parking lights will flash on once and the horn will chirp once.

The Horn Chirp feature is activated when shipped from the assembly plant. If desired, this feature can be disabled by using the following procedure:

1. Perform this operation while standing outside the vehicle.
2. Press and hold the LOCK button on a programmed (i.e., functional) RKE transmitter.
3. Continue to hold the LOCK button, wait at least four seconds, but no longer than 10 seconds, then press and hold the PANIC button. Release both buttons at the same time.
4. To reactivate this feature, repeat the above steps.

This vehicle is shipped from the assembly plant with the park lamp flash feature activated. If desired, this feature can be disabled by using the following procedure:

1. Perform this operation while standing outside the vehicle.
2. Press and hold the UNLOCK button on a programmed (i.e., functional) RKE transmitter.
3. Continue to hold the UNLOCK button, wait at least four seconds, but no longer than 10 seconds, then press and hold the LOCK button. Release both buttons at the same time.
4. To reactivate this feature, repeat the above steps.

Using the Panic Alarm

To activate the Panic Mode while the ignition is OFF, press and release the PANIC button on the RKE transmitter once. When the Panic Mode is activated, the interior lights will illuminate, the headlights and parking lights will flash, and the horn will sound.

To cancel the Panic Mode, press and release the PANIC button on the transmitter a second time, after five seconds. Panic Mode will automatically cancel after three minutes, or if the vehicle is started and exceeds 15 mph (24 km/h). During the Panic Mode, the door locks and RKE systems will function normally. Panic Mode will not disarm the Vehicle Security Alarm System on vehicles so equipped.

Programming Additional RKE Transmitters

Refer to “Sentry Key® Programming” under “Sentry Key®” in this section.

If you do not have a programmed RKE transmitter, contact your authorized dealer for details.

General Information

This device complies with part 15 of FCC rules and with RS-210 of Industry Canada. Operation is subject to the following conditions:

1. This device may not cause harmful interference.
2. This device must accept any interference that may be received including interference that may cause undesired operation.

NOTE: Changes or modifications not expressly approved by the party responsible for compliance could void the user’s authority to operate the equipment.

If your RKE transmitter fails to operate from a normal distance, check for these two conditions:

1. Weak batteries in RKE transmitter. The expected life of the batteries is from one to two years.
2. Closeness to a radio transmitter such as a radio station tower, airport transmitter, and some mobile or CB radios.

RKE Transmitter Battery Service

1. With RKE transmitter buttons facing down, use a flat blade or dime to pry the two halves of the RKE transmitter apart. Make sure not to damage the rubber gasket during removal.

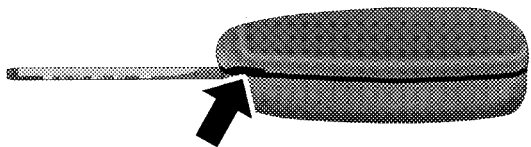

RKE Transmitter Battery Replacement

81182c72

2. Remove and replace the battery. When replacing the battery, match the + sign on battery to the + sign on the inside of the battery clip, located on back cover. Avoid touching the new battery with your fingers. Skin oils may cause battery deterioration. If you touch a battery, clean it with rubbing alcohol.

3. To reassemble the RKE transmitter case, snap the two halves of the case together. Make sure there is an even “gap” between the two halves. If equipped, install and tighten the screw until snug. Test the RKE transmitter operation.

NOTE:

- Perchlorate Material – special handling may apply, see www.dtsc.ca.gov/hazardouswaste/perchlorate
- The recommended replacement battery is CR2032.
- Do not touch the battery terminals that are on the back housing or the printed circuit board.

REMOTE STARTING SYSTEM — IF EQUIPPED

Your vehicle may be equipped with a remote starting system, which will allow the vehicle to be started from distances up to approximately 300 ft (91 m) away from the vehicle using the Remote Keyless Entry (RKE) transmitter, which is part of your ignition key.

In order to remote start your vehicle, the hood and all the doors must be closed.



Press and release the REMOTE START button on the RKE transmitter twice, within five seconds. The parking lights will flash and the horn will honk twice (if programmed). Then, the engine will start and the vehicle will remain in the Remote Start mode for a 15-minute cycle.

To cancel remote start, press the REMOTE START button once.

The parking lamps will remain illuminated to indicate that the vehicle has remote started and the engine is

running. The lamps will turn off when the ignition is turned to RUN or the remote start is cancelled.

To enter the vehicle while the engine is running during a remote start, you must first unlock the vehicle using the UNLOCK button on the RKE transmitter. After the vehicle is unlocked, you have 15 minutes to enter the vehicle, insert the key in the ignition and move it to the RUN position, otherwise the engine will cancel remote start and automatically turn off.

Remote start will also cancel if any of the following occur:

- The engine stalls or RPM exceeds 2500
- Any engine warning lamps come on
- The hood is opened
- The hazard switch is pressed
- The transmission is moved out of PARK
- The brake pedal is pressed

The vehicle can be started remotely up to a maximum of two times. The vehicle is also allowed a maximum of one failed start, where the remote start sequence was initiated but the engine stopped cranking without starting. After either of these conditions, or if the Vehicle Security Alarm is alarming, or if the PANIC button was pressed, the vehicle must be reset by inserting a valid key into the ignition and moving it to the RUN position, then back to LOCK.

DOOR LOCKS

Manual Door Locks

Front and rear doors may be locked by moving the lock plunger up or down.

All doors may be opened with the inside door handle without lifting the lock plunger. Doors locked before closing will remain locked when closed.

The ignition key will unlock all the locks on your vehicle.

WARNING!

- For personal security and safety in the event of an accident, lock the vehicle doors when you drive as well as when you park and leave the vehicle.
- Never leave children alone in a vehicle. Leaving unattended children in a vehicle is dangerous for a number of reasons. A child or others could be seriously or fatally injured. Don't leave the key in the ignition. A child could operate power windows, other controls, or move the vehicle.

Power Door Locks — If Equipped

A power door lock switch is on each front door trim panel. Use this switch to lock or unlock the doors.

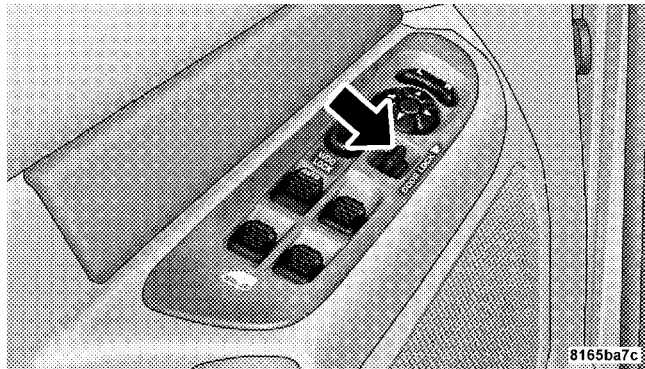

Power Door Lock Switch Location

If you press the power door lock switch while the key is in the ignition, and any front door is open, the power

locks will not operate. This prevents you from accidentally locking your keys in the vehicle. Removing the key or closing the door will allow the locks to operate. A chime will sound if the key is in the ignition switch and a door is open, as a reminder to remove the key.

Automatic Door Locks – If Equipped

If this feature is enabled, your door locks will lock automatically when the vehicle's speed exceeds 15 mph (24 km/h).

Automatic Door Lock Programming

This feature is enabled when your vehicle is shipped from the assembly plant and can be disabled by using the following procedure:

1. Enter your vehicle and close all doors.
2. Fasten your seat belt. (Fastening the seat belt will cancel any chiming that may confuse you during this programming procedure.)

3. Place the key into the ignition.
4. Within 15 seconds, cycle the key from the LOCK position to the ON/RUN position a minimum of four times, ending in the LOCK position. **(Do not start the engine.)**
5. Within 30 seconds, press the driver's door LOCK switch in the LOCK direction.
6. A single chime will be heard to indicate the feature has been disabled.
7. To reactivate this feature, repeat the above steps.
8. If a chime is not heard, program mode was canceled before the feature could be disabled. If necessary, repeat the above procedure.

Auto Unlock On Exit — If Equipped

This feature unlocks all of the doors of the vehicle when any door is opened. This will occur only after the vehicle

has been shifted into the PARK position after the vehicle has been driven (shifted out of PARK and all doors closed).

Auto Unlock On Exit Programming — If Equipped
Customer programming sequence to enable or disable the Auto Unlock on Exit feature:

1. Enter your vehicle and close all doors.
2. Fasten your seat belt. (Fastening the seat belt will cancel any chimes that may be confusing during this programming procedure.)
3. Insert the key into the ignition.
4. Within 15 seconds, cycle the key from the LOCK position to the ON/RUN position a minimum of four times, ending in the LOCK position. **(Do not start the engine).**

30 THINGS TO KNOW BEFORE STARTING YOUR VEHICLE

5. Within 30 seconds, press the driver's door LOCK switch in the UNLOCK direction.
6. A single chime will sound to indicate the feature has been changed.
7. Repeat the above steps to alternate the availability of this feature.
8. If a chime is not heard, the program mode was canceled before the feature could be changed. If necessary, repeat the above procedure.

Child Protection Door Lock

To provide a safer environment for children riding in the rear seat, the rear doors of your vehicle have the Child Protection Door Lock system.

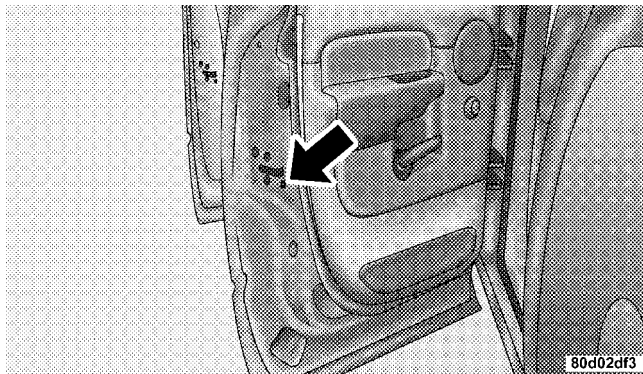

Child Protection Door Lock Location

To use the system, open each rear door, slide the lever UP to engage the locks and DOWN to disengage the child protection door locks. When the system on a door is engaged, that door can only be opened by using the outside door handle even, if the inside door LOCK is in the UNLOCKED position.

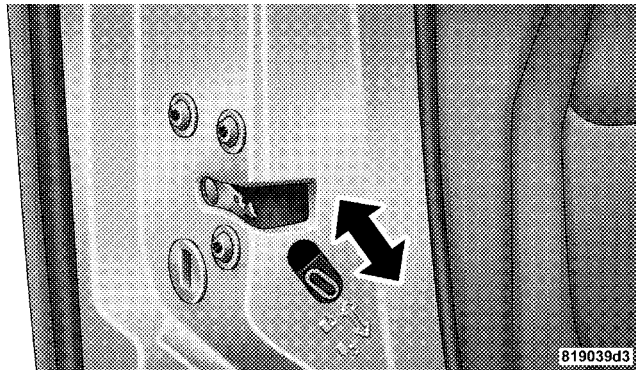

Child Door Lock Control

WARNING!

Avoid trapping anyone in a vehicle in a collision. Remember that the rear doors can only be opened from the outside when the child protection locks are engaged.

2

NOTE: After setting the Child Protection Door Lock system, always test the door from the inside to make certain it is in the desired position.

For emergency exit with the system engaged, move the door lock switch to the UNLOCK position, roll down the window and open the door with the outside door handle.

WINDOWS

Power Windows – If Equipped

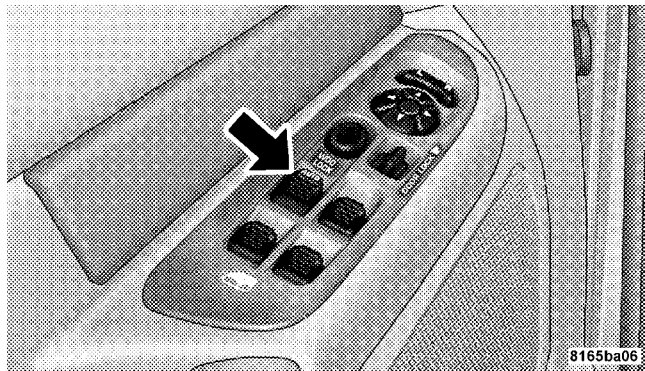

Power Window Switches

The control on the left front door panel has up-down switches that give you fingertip control of all power windows. There is a single opening and closing switch on the front passenger door for passenger window control

and on the rear doors of Quad Cab® models. The windows will operate when the ignition switch is turned to the ON or ACC (Accessory) position and for ten minutes after the ignition is turned OFF or a front door is opened.

NOTE: The Power Accessory Delay feature will allow the power windows to operate for 10 minutes after the ignition is turned OFF.

WARNING!

Never leave children alone in a vehicle. Leaving unattended children in a vehicle is dangerous for a number of reasons. A child or others could be seriously or fatally injured. Don't leave the key in the ignition. A child could operate power windows, other controls, or move the vehicle.

Auto Down (Driver's Side Only)

The driver's window switch has an Auto Down feature. Press the window switch past the detent, release, and the window will go down automatically.

Window Lockout Switch (4-Door Models Only)

The window lockout switch on the driver's door allows you to disable the window control on the other doors. To disable the window controls on the other doors, press the window lockout switch. To enable the window controls, press the window lockout switch again.

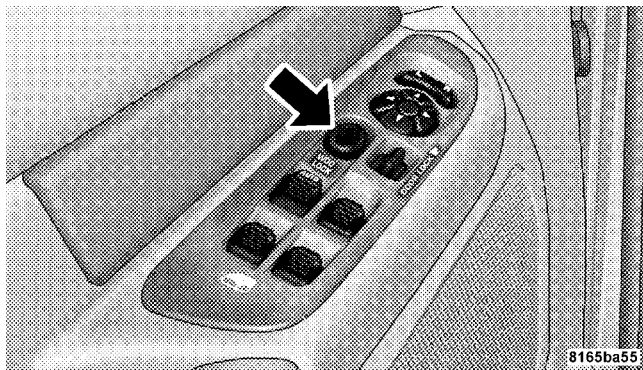

2

Window Lockout Switch

8165ba55

Power Sliding Rear Window – If Equipped

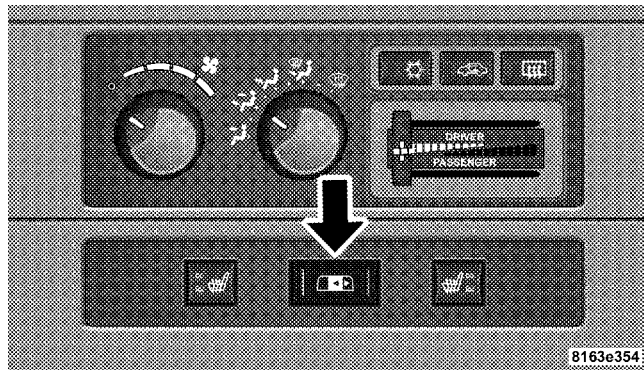

Power Sliding Rear Window Switch

The power sliding rear window switch is located on the instrument panel below the climate controls. Press the right side of the switch to open the glass and the left side of the switch to close the glass.

Sliding Rear Window – If Equipped

A locking device in the center of the window helps to prevent entry from the rear of the vehicle. Squeeze the lock to release the window.

Wind Buffeting

Wind buffeting can be described as the perception of pressure on the ears or a helicopter type sound in the ears. Your vehicle may exhibit wind buffeting with the windows down or in partially open positions. This is a normal occurrence and can be minimized. If the buffeting occurs with the rear windows open, open the front and rear windows together to minimize the buffeting.

OCCUPANT RESTRAINTS

Some of the most important safety features in your vehicle are the restraint systems. These include the front and rear seat belts for the driver and all passengers, and front airbags for both the driver and front passenger. If you will be carrying children too small for adult-size belts, your seat belts also can be used to hold infant and child restraint systems.

Please pay close attention to the information in this section. It tells you how to use your restraint system properly to keep you and your passengers as safe as possible.

WARNING!

In a collision, you and your passengers can suffer much greater injuries if you are not properly buckled up. You can strike the interior of your vehicle or other passengers, or you can be thrown out of the vehicle. Always be sure you and others in your vehicle are buckled up properly.

Buckle up even though you are an excellent driver, even on short trips. Someone on the road may be a poor driver and cause a collision that includes you. This can happen far away from home or on your own street.

Research has shown that seat belts save lives, and that they can reduce the seriousness of injuries in a collision. Some of the worst injuries happen when people are thrown from the vehicle. Seat belts reduce the possibility

of ejection and the risk of injury caused by striking the inside of the vehicle. **Everyone** in a motor vehicle should be belted at all times.

Lap/Shoulder Belts

All seating positions except the Quad Cab® front center seating position have combination lap/shoulder belts. The belt webbing retractor is designed to lock during very sudden stops or collisions. This feature allows the shoulder part of the belt to move freely with you under normal conditions. But in a collision, the belt will lock and reduce the risk of your striking the inside of the vehicle or being thrown out.

WARNING!

It is extremely dangerous to ride in a cargo area, inside or outside of a vehicle. In a collision, people riding in these areas are more likely to be seriously injured or killed.

Do not allow people to ride in any area of your vehicle that is not equipped with seats and seat belts. Be sure everyone in your vehicle is in a seat and using a seat belt properly.

WARNING!

- Wearing a seat belt incorrectly is dangerous. Seat belts are designed to go around the large bones of your body. These are the strongest parts of your body and can take the forces of a collision best. Wearing your belt in the wrong place could make your injuries in a collision much worse. You might suffer internal injuries, or you could even slide out of part of the belt. Follow these instructions to wear your seat belt safely and to keep your passengers safe, too.

(Continued)

WARNING! (Continued)

- Two people should never be belted into a single seat belt. People belted together can crash into one another in an accident, hurting one another badly. Never use a lap/shoulder belt or a lap belt for more than one person, no matter what their size.

Lap/Shoulder Belt Operating Instructions

1. Enter the vehicle and close the door. Sit back and adjust the seat.

38 THINGS TO KNOW BEFORE STARTING YOUR VEHICLE

2. The seat belt latch plate is above the back of the front seat, next to your arm in the rear seat. Grasp the latch plate and pull out the belt. Slide the latch plate up the webbing as far as necessary to allow the belt to go around your lap.

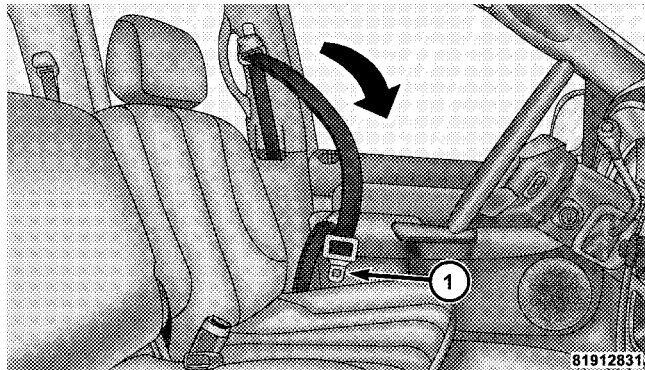

1 — Latch Plate

3. When the belt is long enough to fit, insert the latch plate into the buckle until you hear a “click.”

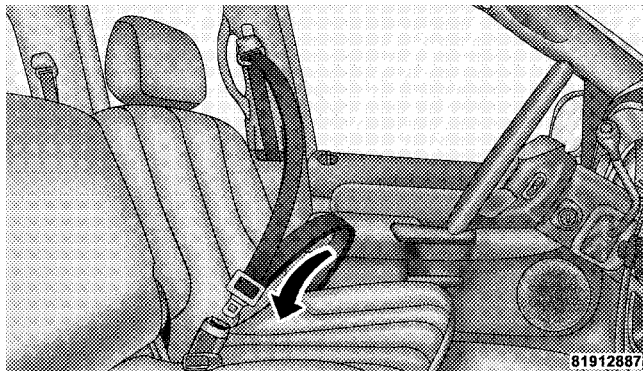

Latch Plate To Buckle

WARNING!

- A belt buckled into the wrong buckle will not protect you properly. The lap portion could ride too high on your body, possibly causing internal injuries. Always buckle your belt into the buckle nearest you.
- A belt that is too loose will not protect you as well. In a sudden stop you could move too far forward, increasing the possibility of injury. Wear your seat belt snugly.
- A belt that is worn under your arm is very dangerous. Your body could strike the inside surfaces of the vehicle in a collision, increasing head and neck injury. And a belt worn under the arm can cause internal injuries. Ribs aren't as strong as shoulder bones. Wear the belt over your shoulder so that your strongest bones will take the force in a collision.

(Continued)

WARNING! (Continued)

- A shoulder belt placed behind you will not protect you from injury during a collision. You are more likely to hit your head in a collision if you do not wear your shoulder belt. The lap and shoulder belt are meant to be used together.

4. Position the lap belt across your thighs, below your abdomen. To remove slack in the lap belt portion, pull up on the shoulder belt. To loosen the lap belt if it is too tight, tilt the latch plate and pull on the lap belt. A snug belt reduces the risk of sliding under the belt in a collision.

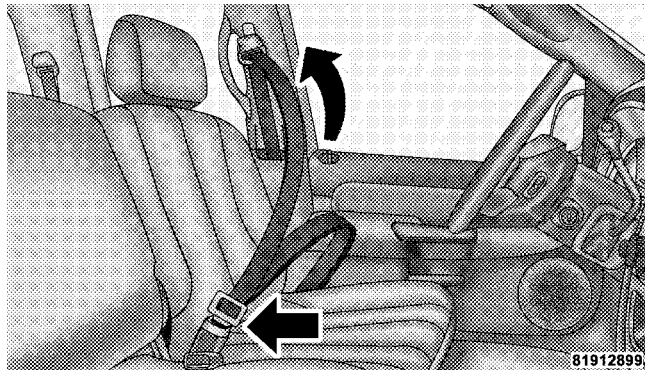

Removing Slack From Belt

WARNING!

- A lap belt worn too high can increase the risk of internal injury in a collision. The belt forces won't be at the strong hip and pelvic bones, but across your abdomen. Always wear the lap belt as low as possible and keep it snug.
- A twisted belt can't do its job as well. In a collision it could even cut into you. Be sure the belt is straight. If you can't straighten a belt in a vehicle, take it to your authorized dealer and have it fixed.

5. Position the shoulder belt on your chest so that it is comfortable and not resting on your neck. The retractor will withdraw any slack in the belt.

6. To release the belt, push the red button on the buckle. The belt will automatically retract to its stowed position. If necessary, slide the latch plate down the webbing to allow the belt to retract fully.

WARNING!

A frayed or torn belt could rip apart in a collision and leave you with no protection. Inspect the belt system periodically, checking for cuts, frays, or loose parts. Damaged parts must be replaced immediately. Do not disassemble or modify the system. Seat belt assemblies must be replaced after a collision if they have been damaged (bent retractor, torn webbing, etc.) or if the airbag deployed.

Regular Cab Front Center Three Point Belt

1. The front center seat belt on the Regular Cab may be disconnected to open up utilization of the storage areas behind the front seats. The black latch plate can be detached from the black keyed seat belt buckle located on the inboard side of the passenger seat. Insert the vehicle ignition key into the center white slot on the black buckle. The black buckle latch plate can be removed when the

key is pressed into the buckle. Allow the retractor to take up the surplus webbing, and the buckles will hang vertically from the cab back exit bezel, thus freeing up all the area behind the front seats.

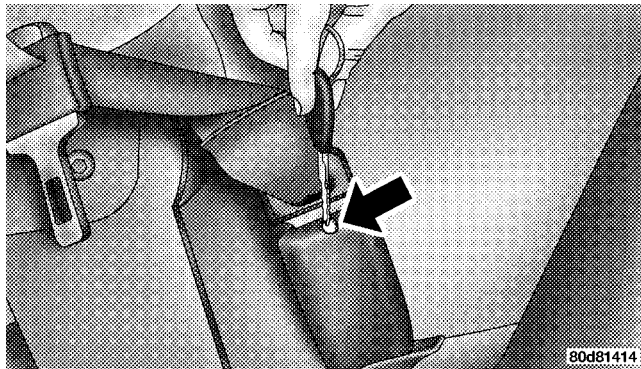

Detaching Buckle With Key

2. To reattach the seat belt to the front center seat, pull the black buckle latch plate forward from the cab back panel and insert it into the black keyed buckle until there is an audible “click”. For proper seatbelt usage, refer “Lap/Shoulder Belt Operating Instructions” in this section.

WARNING!

- If the black latch and black buckle are not properly connected when the seat belt is used by an occupant, the seat belt will not be able to provide proper restraint and will increase the risk of injury in a collision.
- When reattaching the black latch and black buckle, ensure the seat belt webbing is not twisted. If the webbing is twisted, follow the preceding procedure to detach the black latch and black buckle, untwist the webbing, and reattach the black latch and black buckle.

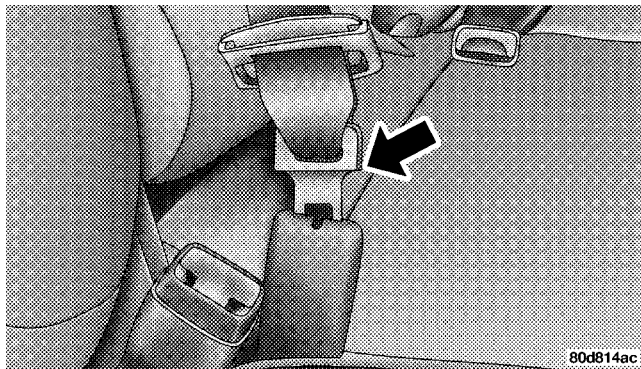

Inserting Latch Plate

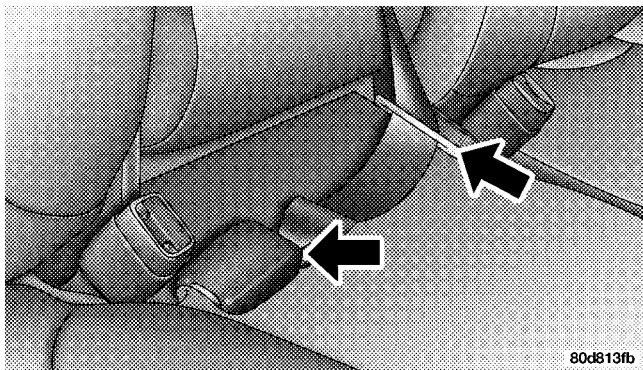

In Use Position

WARNING!

- If the black latch and black buckle are not properly connected when the seat belt is used by an occupant, the seat belt will not be able to provide proper restraint and will increase the risk of injury in a collision.
- When reattaching the black latch and black buckle, ensure the seat belt webbing is not twisted. If the webbing is twisted, follow the preceding procedure to detach the black latch and black buckle, untwist the webbing, and reattach the black latch and black buckle.

Adjustable Upper Shoulder Belt Anchorage

In the front row outboard seats, the shoulder belt can be adjusted upward or downward to help position the belt away from your neck. Press the button located on the upper belt guide, and then move it up or down to the position that fits you best.

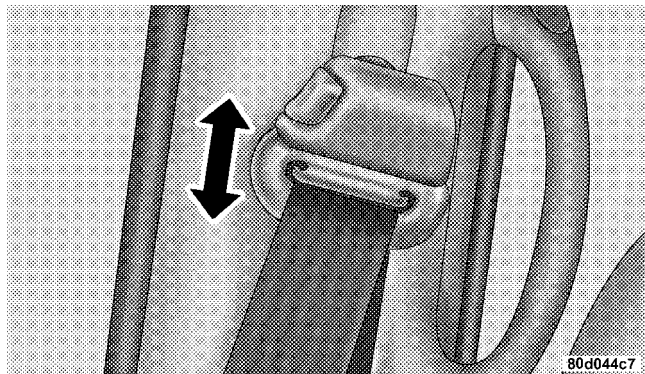

Adjusting Upper Shoulder Belt

As a guide, if you are shorter than average you will prefer a lower position, and if you are taller than average you'll prefer a higher position. When you release the anchorage, try to move it up or down to make sure that it is locked in position.

Automatic Locking Restraint (ALR) Mode – If Equipped

In this mode, the shoulder belt is automatically pre-locked. The belt will still retract to remove any slack in the shoulder belt. The automatic locking mode is available on all passenger seating positions with a combination lap/shoulder belt.

When To Use The Automatic Locking Mode

Use the automatic locking mode any time a child safety seat is installed in a passenger seating position. Children 12 years old and under should be properly restrained in the rear seat whenever possible.

How To Use The Automatic Locking Mode

1. Buckle the combination lap/shoulder belt.
2. Grasp the shoulder portion and pull downward until the entire belt is extracted.
3. Allow the belt to retract. As the belt retracts, you will hear a clicking sound. This indicates the safety belt is now in the automatic locking mode.

How To Disengage The Automatic Locking Mode

Disconnect the combination lap/shoulder belt and allow it to retract completely to disengage the automatic locking mode and activate the vehicle sensitive (emergency) locking mode.

Center Lap Belts

The center seating position for the Quad Cab® front seat has a lap belt only. To fasten the lap belt, slide the latch plate into the buckle until you hear a "click." To lengthen the lap belt, tilt the latch plate and pull. To remove slack, pull the loose end of the webbing. Wear the lap belt snug against the hips. Sit back and erect in the seat, then adjust the belt as tightly as is comfortable.

WARNING!

- A lap belt worn too loose or too high is dangerous.
- A belt worn too loose can allow you to slip down and under the belt in a collision.
- A belt that is too loose or too high will apply crash forces to the abdomen, not to the stronger hip bones. In either case, the risk of internal injuries is greater. Wear a lap belt low and snug.

Enhanced Driver Seat Belt Reminder System (BeltAlert®)

If the driver's seat belt has not been buckled within 60 seconds of starting the vehicle and if the vehicle speed is greater than 5 mph (8 km/h), the Enhanced Warning System (BeltAlert®) will alert the driver to buckle their seat belt. The driver should also instruct all other occupants to buckle their seat belts. If the driver unbuckles the seat belt while the vehicle is in motion an immediate chime will be heard and the Enhanced Warning System (BeltAlert®) will continue to chime and flash the Seat Belt Warning Light for 96 seconds or until the driver's seat belt is buckled. The Enhanced Warning System (BeltAlert®) will be reactivated if the ignition is cycled, the driver's seat belt is unbuckled for more than 10 seconds and the vehicle speed is greater than 5 mph (8 km/h).

The Enhanced Warning System (BeltAlert®) can be enabled or disabled by your authorized dealer or by following these steps:

NOTE: The following steps must occur within the first 60 seconds of the ignition switch being turned to the ON or START position. Chrysler LLC does not recommend deactivating the Enhanced Warning System (BeltAlert®).

1. With all doors closed and the ignition switch in any position except ON or START, buckle the driver's seat belt.
2. Turn the ignition switch to the ON position and wait for the Seat Belt Warning Light to turn off.
3. Within 60 seconds of starting the vehicle, unbuckle and then re-buckle the driver's seat belt at least three times within 10 seconds, ending with the seat belt buckled.

4. Turn off the engine. A single chime will sound to signify that you have successfully completed the programming.

The Enhanced Warning System (BeltAlert®) can be reactivated by repeating this procedure.

NOTE: Although the Enhanced Warning System (BeltAlert®) has been deactivated, the Seat Belt Warning Light will continue to illuminate while the driver's seat belt remains unbuckled.

Seat Belts and Pregnant Women

We recommend that pregnant women use seat belts throughout their pregnancies. Keeping the mother safe is the best way to keep the baby safe.

Pregnant women should wear the lap part of the belt across the thighs and as snug against the hips as possible.

Keep the belt low so that it does not come across the abdomen. That way the strong bones of the hips will take the force if there is a collision.

Seat Belt Extender

If a seat belt is too short even when fully extended, your authorized dealer can provide you with a seat belt extender. This extender should be used only if the existing belt is not long enough. When it is not required, remove the extender and store it.

WARNING!

Using a seat belt extender when not needed can increase the risk of injury in a collision. Only use the seat belt extender when the lap belt is not long enough when it is worn low and snug, and in the recommended seating positions. Remove and store the extender when not needed.

Driver And Right Front Passenger Supplemental Restraint System (SRS) – Airbag

This vehicle may have front airbags for both the driver and front passenger (if equipped) as a supplement to the seat belt restraint systems. The driver's front airbag is mounted in the center of the steering wheel. The passenger's front airbag (if equipped) is mounted in the instrument panel, above the glove compartment. The words SRS AIRBAG are embossed on the airbag covers.

These airbags are certified to the new Federal regulations that allow less forceful deployments.

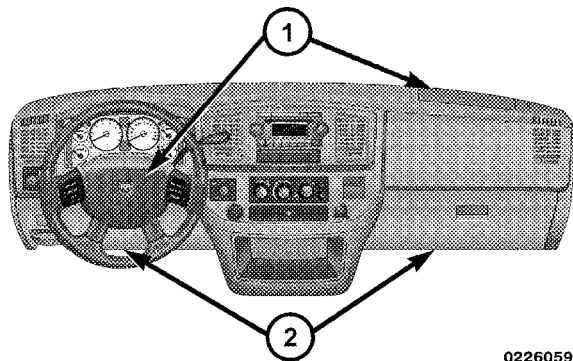

022605988

- 1 — Driver and Passenger Airbags
2 — Knee Bolsters

This vehicle may also be equipped **without** a passenger's front airbag. In this case the passenger's side airbag will be replaced with a storage bin.

WARNING!

- **Do not put anything on or around the airbag covers or attempt to manually open them. You may damage the airbags and you could be injured because the airbags are not there to protect you. These protective covers for the airbag cushions are designed to open only when the airbags are inflating.**
- **Do not mount any aftermarket equipment such as trailer brake controllers, snowplow controllers, auxiliary light switches, radios, etc. on or behind the knee bolster. Knee bolsters are designed to work with the airbag and seat belt to protect you. Mounting any additional equipment on or behind the knee bolster can cause injury during a crash.**

Airbags inflate in moderate to high speed impacts. Along with the seat belts, front airbags work with the instrument panel knee bolsters to provide improved protection for the driver and front passenger.

The seat belts are designed to protect you in many types of collisions. The front airbags deploy in moderate to severe frontal collisions. In certain types of collisions, the front airbags may be triggered. But even in collisions where the airbags work, you need the seat belts to keep you in the right position for the airbags to protect you properly.

Here are some simple steps you can follow to minimize the risk of harm from a deploying airbag.

- Children 12 years and under should ride buckled up in a rear seat, if available.

- Infants in rear-facing child restraints must **NEVER** ride in the front seat of a vehicle with a passenger front airbag **unless the airbag is turned off** (Regular Cab Vehicles Only). An airbag deployment can cause severe injury or death to infants in that position. Refer to the “Passenger Airbag On/Off Switch (if equipped)” in this section.
- If your vehicle does not have a rear seat, refer to the “Passenger Airbag On/Off Switch (if equipped)” in this section
- Children that are not big enough to properly wear the vehicle seat belt (refer to “Child Restraints” in this section) should be secured in the rear seat in child restraints or belt-positioning booster seats. Older children who do not use child restraints or belt-positioning booster seats should ride properly buckled up in the rear seat. Never allow children to slide the shoulder belt behind them or under their arms.
- All occupants should use their seat belts properly.
- The driver and front passenger seats should be moved back as far as practical to allow the airbag room to inflate.

WARNING!

- **Relying on the airbags alone could lead to more severe injuries in a collision. The airbags work with your seat belt to restrain you properly. In some collisions the airbags won't deploy at all. Always wear your seat belts even though you have airbags.**
- **Being too close to the steering wheel or instrument panel during airbag deployment could cause serious injury. Airbags need room to inflate. Sit back, comfortably extending your arms to reach the steering wheel or instrument panel.**

Airbag System Components

The airbag system consists of the following:

- Occupant Restraint Controller (ORC)
- AIRBAG Readiness Light
- Driver Airbag
- Passenger Airbag (if equipped)
- Steering Wheel and Column
- Instrument Panel
- Crash Sensor
- Interconnecting Wiring
- Knee Impact Bolsters
- Passenger's Side Front Airbag ON/OFF Switch (Regular Cab Vehicles Only) (if equipped)

How The Airbag System Works

- The Occupant Restraint Controller (ORC) determines if a frontal collision is severe enough to require the airbags to inflate.
- The ORC will not detect rollover, or rear collisions.
- The ORC also monitors the readiness of the electronic parts of the system whenever the ignition switch is in the START or RUN positions. These include all of the items listed above except the knee bolsters, the instrument panel, and the steering wheel and column. If the key is in the OFF position, in the ACC position, or not in the ignition, the airbags are not on and will not inflate.
- The ORC also turns on the Airbag Warning Light in the instrument panel for 6 to 8 seconds when the ignition is first turned on, and then turns the light off.



- If it detects a malfunction in any part of the system, it turns on the light either momentarily or continuously. The instrument cluster will flash the seat belt indicator if it detects a fault with the airbag indicator.

WARNING!

Ignoring the Airbag Warning Light in your instrument panel could mean you won't have the airbags to protect you in a collision. If the light does not come on, stays on after you start the vehicle, or if it comes on as you drive, have the airbag system checked right away.

- When the ORC detects a collision requiring the airbags, it signals the inflator units. A large quantity of nontoxic gas is generated to inflate the airbags. The airbag covers separate and fold out of the way as the airbags inflate to their full size. The airbags fully inflate in milliseconds. This is less time than it takes you to blink your eyes. The airbags then quickly deflate while helping to restrain the driver and front passenger (if equipped with passenger side airbag). The driver's front airbag deflates through vents toward the instrument panel. The passenger's front airbag (if equipped) is deflated through vent holes in the sides of the airbag. In this way the airbags do not interfere with your control of the vehicle.
- The knee impact bolsters help protect the knees and position you for the best interaction with the front airbag.

Passenger Airbag On/Off Switch (Regular Cab Vehicles Only) – If Equipped



Passenger Airbag On/Off Switch

The passenger front airbag is to be turned off only if the passenger:

- is an infant (less than one year old) who must ride in the front seat because there is no rear seat, because the rear seat is too small for a rear-facing infant restraint or because the infant has a medical condition which makes it necessary for the driver to be able to see the infant,
- is a child, age one to 12 who must ride in the front seat because there is no rear seat, because there is no rear seat position available, or because the child has a medical condition which makes it necessary for the driver to be able to see the child,
- has a medical condition which makes passenger airbag (if equipped) inflation (deployment) a greater risk for the passenger than the risk of hitting the dashboard (instrument panel) or windshield in a crash.

WARNING!

Whenever an airbag is turned off, even a lap/shoulder belted passenger may hit their head, neck, or chest on the dashboard (instrument panel) or windshield in a crash. This may result in serious injury or death.

To Shut Off the Passenger Airbag (Regular Cab Vehicles Only) – If Equipped

Place the ignition key in the Passenger Airbag On/Off Switch (if equipped), push the key in and turn clockwise, and remove the key from the switch. This will shut off the passenger airbag (if equipped). The OFF light near the switch will illuminate when the ignition switch is turned to the ON position.

To Turn On the Passenger Airbag (Regular Cab Vehicles Only) – If Equipped

Place the ignition key in the Passenger Airbag On/Off Switch (If Equipped), push the key in and turn counter-clockwise, and remove the key from the switch. This will turn on the passenger airbag (if equipped). The OFF light near the switch will be off when the ignition switch is turned to the ON position.

If A Deployment Occurs

The airbag system is designed to deploy when the ORC detects a moderate-to-severe frontal collision, and then immediately to deflate.

NOTE: A frontal collision that is not severe enough to need airbag protection will not activate the system. This does not mean something is wrong with the airbag system.

If you do have a collision which deploys the airbags, any or all of the following may occur:

- The nylon airbag material may sometimes cause abrasions and/or skin reddening to the driver and front passenger as the airbags deploy and unfold. The abrasions are similar to friction rope burns or those you might get sliding along a carpet or gymnasium floor. They are not caused by contact with chemicals. They are not permanent and normally heal quickly. However, if you haven't healed significantly within a few days, or if you have any blistering, see your doctor immediately.
- As the airbags deflate you may see some smoke-like particles. The particles are a normal by-product of the process that generates the nontoxic gas used for airbag inflation. These airborne particles may irritate the skin,

eyes, nose, or throat. If you have skin or eye irritation, rinse the area with cool water. For nose or throat irritation, move to fresh air. If the irritation continues, see your doctor. If these particles settle on your clothing, follow the garment manufacturer's instructions for cleaning.

- It is not advisable to drive your vehicle after the airbags have deployed. If you are involved in another collision, the airbags will not be in place to protect you.

WARNING!

Deployed airbags can't protect you in another collision. Have the airbags replaced by an authorized dealer as soon as possible.

Enhanced Accident Response System

If the airbags deploy after an impact and the electrical system remains functional, vehicles equipped with power door locks will unlock automatically. In addition, approximately 10 seconds after the vehicle has stopped moving, the interior lights will light until the ignition switch is turned off.

Maintaining Your Airbag Systems

WARNING!

- **Modifications to any part of the airbag system could cause it to fail when you need it. You could be injured because the airbags are not there to protect you. Do not modify the components or wiring, including adding any kind of badges or stickers to the steering wheel hub trim cover or the upper right side of the instrument panel. Do not modify the front bumper, vehicle body structure, or frame.**
- **You need proper knee impact protection in a collision. Do not mount or locate any aftermarket equipment on or behind the knee bolster.**
- **It is dangerous to try to repair any part of the airbag system yourself. Be sure to tell anyone who works on your vehicle that it has airbags.**

NOTE: Perchlorate Material – special handling may apply: Refer to www.dtsc.ca.gov/hazardouswaste/perchlorate.

Airbag Warning Light



You will want to have the airbags ready to inflate for your protection in an impact. While the airbag system is designed to be maintenance free, if any of the following occurs, have an authorized dealer service the system promptly:

- The Airbag Warning Light does not come on or flickers during the six to eight seconds when the ignition switch is first turned ON.
- The light remains on or flickers after the six to eight second interval.
- The light flickers or comes on and remains on while driving.

NOTE: If the speedometer, tachometer or any engine related gauges are not working, the ORC may also be disabled. The airbags may not be ready to inflate for your protection. Promptly check the fuse block for blown fuses. For proper location of airbag fuses, refer to “Fuses (Integrated Power Module)” in Section 7. See your authorized dealer if the fuse is good.

Event Data Recorder (EDR)

In the event of an accident, your vehicle is designed to record up to approximately five seconds of specific vehicle data parameters (see the following list) in an event data recorder prior to the moment of airbag deployment, or near deployment, and up to a quarter-second of high-speed deceleration data during and/or after airbag deployment. EDR data are ONLY recorded if an airbag deploys, or nearly deploys, and are otherwise unavailable.

NOTE:

- A near-deployment event occurs when the airbag sensor detects severe vehicle deceleration usually indicative of a crash, but not severe enough to warrant airbag deployment.
- Under certain circumstances, EDR data may not be recorded (e.g., loss of battery power).

In conjunction with other data gathered during a complete accident investigation, the electronic data may be used by Chrysler LLC and others to learn more about the possible causes of crashes and associated injuries in order to assess and improve vehicle performance. In addition to crash investigations initiated by Chrysler LLC, such investigations may be requested by customers, insurance carriers, government officials, and professional crash researchers, such as those associated with universities, and with hospital and insurance organizations.

In the event that an investigation is undertaken by Chrysler LLC (regardless of initiative), the company or its designated representative will first obtain permission of the appropriate custodial entity for the vehicle (usually the vehicle owner or lessee) before accessing the electronic data stored, unless ordered to download data by a court with legal jurisdiction (i.e., pursuant to a warrant). A copy of the data will be provided to the custodial entity upon request. General data that does not identify particular vehicles or crashes may be released for incorporation in aggregate crash databases, such as those maintained by the US government and various states. Data of a potentially sensitive nature, such as would identify a particular driver, vehicle, or crash, will be treated confidentially. Confidential data will not be disclosed by Chrysler LLC to any third party except when:

1. Used for research purposes, such as to match data with a particular crash record in an aggregate database, provided confidentiality of personal data is thereafter preserved
2. Used in defense of litigation involving a Chrysler LLC product
3. Requested by police under a legal warrant
4. Otherwise required by law

Data parameters that may be recorded:

- Diagnostic trouble code(s) and warning lamp status for electronically-controlled safety systems, including the airbag system
- Airbag disable lamp status (if equipped)
- "Time" of airbag deployment (in terms of ignition cycles and vehicle mileage)
- Airbag deployment level (if applicable)
- Impact acceleration and angle
- Seat belt status
- Brake status (service and parking brakes)
- Accelerator status (including vehicle speed)
- Engine control status (including engine speed)
- Transmission gear selection
- Cruise control status
- Traction/stability control status
- Tire pressure monitoring system status (if equipped)

Child Restraint

Everyone in your vehicle needs to be buckled up all the time — babies and children, too. Every state in the United States and all Canadian provinces require that small children ride in proper restraint systems. This is the law, and you can be prosecuted for ignoring it.

Children 12 years and under should ride properly buckled up in a rear seat, if available. According to crash statistics, children are safer when properly restrained in the rear seats rather than in the front.

WARNING!

In a collision, an unrestrained child, even a tiny baby, can become a missile inside the vehicle. The force required to hold even an infant on your lap can become so great that you could not hold the child, no matter how strong you are. The child and others could be badly injured. Any child riding in your vehicle should be in a proper restraint for the child's size.

Infants and Small Children

There are different sizes and types of restraints for children from newborn size to the child almost large enough for an adult safety belt. Use the restraint that is correct for your child:

- Safety experts recommend that children ride rearward-facing in the vehicle until they are at least one year old and weigh at least 20 lbs (9 kg). Two types

of child restraints can be used rearward-facing: infant carriers and "convertible" child seats. Both types of child restraints are held in the vehicle by the lap/shoulder belt.

- The infant carrier is only used rearward-facing in the vehicle. It is recommended for children who weigh up to about 20 lbs (9 kg). "Convertible" child seats can be used either rearward-facing or forward-facing in the vehicle. Convertible child seats often have a higher weight limit in the rearward-facing direction than infant carriers do, so they can be used rearward-facing by children who weigh more than 20 lbs (9 kg) but are less than one year old.
- Rearward-facing child seats must **NEVER** be used in the front seat of a vehicle with a front passenger airbag (if equipped) unless the airbag is turned off. An airbag deployment could cause severe injury or death to infants in this position.
- Children who weigh more than 20 lbs (9 kg) and who are older than one year can ride forward-facing in the vehicle. Forward-facing child seats and convertible child seats used in the forward-facing direction are for children who weigh 20 to 40 lbs (9 to 18 kg) and who are older than one year. These child seats are also held in the vehicle by the lap/shoulder belt.
- The belt-positioning booster seat is for children weighing more than 40 lbs (18 kg), but who are still too small to fit the vehicle's seat belts properly. If the child cannot sit with knees bent over the vehicle's seat cushion while the child's back is against the seat back, they should use a belt-positioning booster seat. The child and booster seat are held in the vehicle by the lap/shoulder belt. (Some booster seats are equipped with a front shield and are held in the vehicle by the lap portion.) For further information, refer to www.seatcheck.org.

WARNING!

- **Improper installation can lead to failure of an infant or child restraint. It could come loose in a collision. The child could be badly injured or killed. Follow the manufacturer's directions exactly when installing an infant or child restraint.**
- **A rearward-facing child restraint should only be used in a rear seat, or in the front seat if the passenger's front airbag is Off (if equipped). If the airbag is left On, a rearward-facing child restraint in the front seat may be struck by a deploying passenger airbag (if equipped) which may cause severe or fatal injury to the infant.**

Here are some tips for getting the most out of your child restraint:

- Before buying any restraint system, make sure that it has a label certifying that it meets all applicable Safety

Standards. We also recommend that you make sure that you can install the child restraint in the vehicle where you will use it before you buy it.

- The restraint must be appropriate for your child's weight and height. Check the label on the restraint for weight and height limits.
- Carefully follow the instructions that come with the restraint. If you install the restraint improperly, it may not work when you need it.
- The passenger seat belts are equipped with Automatic Locking Retractors (ALR), which are designed to keep the lap portion tight around the child restraint so that it is not necessary to use a locking clip.

Pull the belt from the retractor until there is enough to allow you to pass through the child restraint and slide the latch plate into the buckle. Then pull on the belt until it is completely extended from the retractor.

Allow the belt to return to the retractor, pulling on the excess webbing to tighten the lap portion about the child restraint. Refer to "Automatic Locking Retractors (ALR) Mode" in this section.

- In the rear seat, you may have trouble tightening the lap/shoulder belt on the child restraint because the buckle or latch plate is too close to the belt path opening on the restraint. Disconnect the latch plate from the buckle and twist the short buckle-end belt several times to shorten it. Insert the latch plate into the buckle with the release button facing out.
- If the belt still can't be tightened, or if pulling and pushing on the restraint loosens the belt, disconnect the latch plate from the buckle, turn the latch plate around, and insert the latch plate into the buckle again. If you still can't make the child restraint secure, try a different seating position.

- Buckle the child into the seat according to the child restraint manufacturer's directions.
- When your child restraint is not in use, secure it in the vehicle with the seat belt or remove it from the vehicle. Do not leave it loose in the vehicle. In a sudden stop or collision, it could strike the occupants or seat backs and cause serious personal injury.

WARNING!

Improper installation can lead to failure of an infant or child restraint. It could come loose in a collision. The child could be badly injured or killed. Follow the manufacturer's directions exactly when installing an infant or child restraint.

Lower Anchors and Tether for Children (LATCH)

Each vehicle is equipped with the child restraint anchorage system called LATCH, which stands for Lower Anchors and Tether for Children. LATCH child restraint anchorage systems are installed in the Regular Cab passenger seat position and the Quad Cab® rear seat outboard positions. LATCH equipped seating positions feature both lower anchor bars, located at the back of the seat cushion, and tether strap anchorages, located behind the seat back (refer to “Child Restraint Tether Anchor” in this section).

Identification dots are located above the Regular Cab front seat lower anchorages as a guide for locating lower anchors.

NOTE: For children riding in the front seat of a Regular Cab model, refer to the “Passenger Airbag On/Off Switch (if equipped)” in this section.

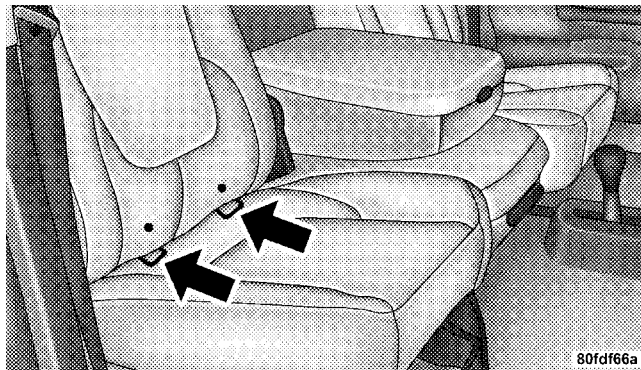

Regular Cab Passenger Seat

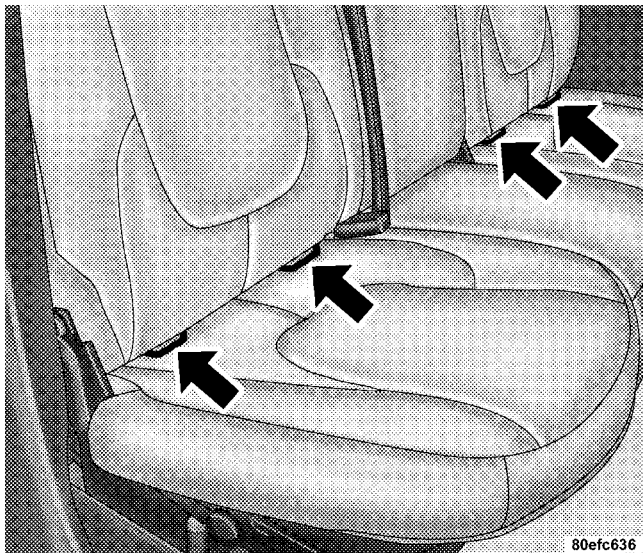

Quad Cab® Rear Outboard Seats

Child restraint systems having attachments designed to connect to the lower anchorages are now available. Child restraints having tether straps and hooks for connection to the seat back tether anchorage have been available for some time. In fact, many child restraint manufacturers will provide add-on tether strap kits for some of their older products.

Because the lower anchorages are to be introduced to passenger carrying vehicles over a period of years, child restraint systems having attachments for those anchorages will continue to have features for installation in vehicles using the lap or lap/shoulder belt. They will also have tether straps, and you are urged to take advantage of all of the available attachments provided with your child restraint in any vehicle.

NOTE: When using the LATCH attaching system to install a child restraint, please ensure that all seat belts not being used for occupant restraints are stowed and out of reach of children. It is recommended that before installing the child restraint, buckle the seat belt so the seat belt is tucked behind the child restraint and out of reach. If the buckled seat belt interferes with the child restraint installation, instead of tucking the seat belt behind the child restraint, route the seat belt through the child restraint belt path and then buckle it. This should stow the seat belt out of the reach of an inquisitive child. Remind all children in the vehicle that the seat belts are not toys and should not be played with, and never leave your child unattended in the vehicle.

NOTE: If your child restraint seat is not LATCH compatible, install the restraint using the vehicle seat belting.

Installing the Child Restraint System

WARNING!

Do not install child restraint systems equipped with LATCH attachments in the center position of a Quad Cab® model rear seat. The LATCH anchorages in this seat are designed for the two outboard seating positions only. A child may be placed in the rear center seating position of a Quad Cab® model using the seat belt and child tether anchorage. Failure to follow this may result in serious or fatal injury.

We urge that you carefully follow the directions of the manufacturer when installing your child restraint. Many, but not all, restraint systems will be equipped with separate straps on each side, with each having a hook or connector and a means for adjusting the tension in the strap. Forward-facing toddler restraints and some

rearward-facing infant restraints will also be equipped with a tether strap, a hook and means for adjusting the tension in the strap.

In general, you will first loosen the adjusters on the lower straps and tether straps so that you can more easily attach the hook or connector to the lower anchorages and tether anchorages. Then tighten all three straps as you push the child restraint rearward and downward into the seat.

Not all child restraint systems will be installed as we have described here. Again, carefully follow the instructions that come with the child restraint system.

WARNING!

Improper installation of a child restraint to the LATCH anchorages can lead to failure of an infant or child restraint. The child could be badly injured or killed. Follow the manufacturer's directions exactly when installing an infant or child restraint.

Child Restraint Tether Anchor

Child restraints having tether straps and hooks for connection to tether anchors have been available for some time. In fact, many child restraint manufacturers will provide add-on tether strap kits for their older products. Regular Cab models have two tether anchorages, one each behind the front center and right seats. Quad Cab® models have three anchorages, one behind each of the rear seats.

WARNING!

An incorrectly anchored tether strap could lead to seat failure and injury to the child. In a collision, the seat could come loose and allow the child to crash into the inside of the vehicle or other passengers, or even be thrown from the vehicle. Use only the anchor positions directly behind the child seat to secure a child restraint top tether strap. Follow the instructions below. See your authorized dealer for help if necessary.

Tether Anchorage Points at the Right and Center Front Seat (Regular Cab - All Seats)

1. Place the child restraint on the seat and adjust the tether strap so that it will reach over the seat back under the head restraint to the tether anchor directly behind the seat.
2. Lift the cover (if so equipped), and attach the hook to the square opening in the sheet metal.
3. Install the child restraint and remove the slack in the tether strap according to the manufacturer's instructions.

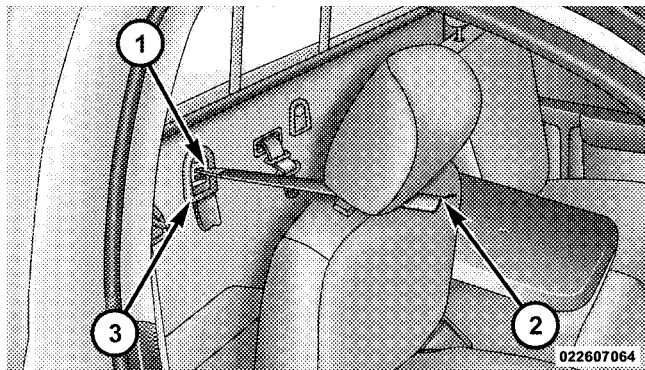

Regular Cab with Any Bench Seat

- 1 — Tether Strap Hook
- 2 — Tether Anchor
- 3 — Tether Strap to Child Restraint

Multiple Child Restraint Installation Sequence (Quad Cab® - Rear Seats)

1. Obtain tether straps by raising the head restraints and reaching between the rear glass and rear seat. The tether strap may be retained with an elastic band. Accessibility to the tether strap is greatly improved by raising the seat cushion to the “up” position. Remove the elastic before use.

2. Place a child restraint on each outboard rear seat and adjust the tether strap so that it will reach under the head restraint to the tether anchor directly behind the seat and then to the anchor directly behind the center rear seat.

3. Pass each tether strap hook under the head restraint and through the loop of webbing behind the child seat.

4. Route each tether strap to the anchor behind the center seat, and attach the hooks to the metal ring.

70 THINGS TO KNOW BEFORE STARTING YOUR VEHICLE

5. Place a child restraint on the center rear seat and adjust the tether strap so that it will reach under the head restraint to the tether anchor directly behind the seat and to the anchor directly behind the right seat.

6. Install each child restraint and remove the slack in the tether strap according to the child restraint manufacturer's instructions.

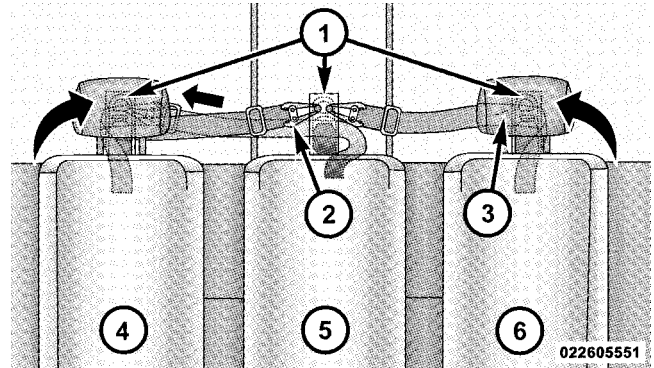

Multiple Child Restraints

- 1 — Inner Anchor Strap Ring(s)
- 2 — Snap Hook
- 3 — Tether Strap
- 4 — Passenger's Side Rear Child Seat
- 5 — Rear Center Child Seat
- 6 — Driver's Side Rear Child Seat

Tether Anchorage Points at All Three Seating Positions

1. Place the child restraint on the seat and adjust the tether strap so that it will reach over the seat back under the head restraint to the tether anchor directly behind the seat.
2. Lift the cover, and attach the hook to the square opening in the sheet metal.
3. Install the child restraint and remove the slack in the tether strap according to the manufacturer's instructions.

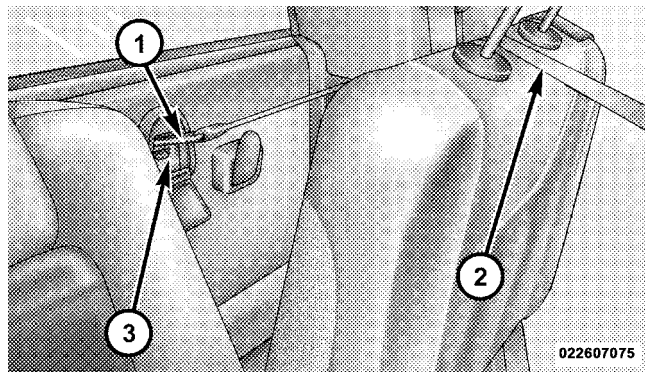

Tether Anchor

- 1 — Tether Strap Hook
- 2 — Tether Strap to Child Restraint
- 3 — Tether Anchor

Children Too Large for Booster Seats

Children who are large enough to wear the shoulder belt comfortably, and whose legs are long enough to bend over the front of the seat when their back is against the seat back should use the lap/shoulder belt in a rear seat.

- Make sure that the child is upright in the seat.
- The lap portion should be low on the hips and as snug as possible.
- Check belt fit periodically. A child's squirming or slouching can move the belt out of position.

If the shoulder belt contacts the face or neck, move the child closer to the center of the vehicle. Never allow a child to put the shoulder belt under an arm or behind their back.

Transporting Pets

Airbags deploying in the front seat could harm your pet. An unrestrained pet will be thrown about and possibly

injured, or injure a passenger during panic braking or in a collision. Pets should be restrained in the rear seat in pet harnesses or pet carriers that are secured by seat belts.

NEW ENGINE BREAK-IN

5.7L Gas Engine – 3500 Models Only

A long break-in period is not required for the engine in your new vehicle. Drive moderately during the first 300 mi (500 km). After the initial 60 mi (100 km), speeds up to 50 or 55 mph (80 or 90 km/h) are desirable. While cruising, brief full-throttle acceleration within the limits of local traffic laws contributes to a good break-in.

Avoid wide open throttle acceleration in low gear.

The engine oil installed in the engine at the factory is a high quality, energy conserving type lubricant. Oil changes should be consistent with the anticipated climatic conditions under which vehicle operation will

occur. For recommended viscosity and quality grades, refer to “Engine Oil” under “Maintenance Procedures” in Section 7.

NON-DETERGENT OR STRAIGHT MINERAL OILS MUST NEVER BE USED.

A new engine may consume some oil during its first few thousand miles (kilometers) of operation. This is a normal part of the break-in and is not an indication of difficulty.

CAUTION!

- **During the first 500 mi (805 km) your new vehicle is driven, do not tow a trailer. Doing so may damage your axles, driveline and vehicle.**
- **Limit your speed to 50 or 55 mph (80 or 90 km/h) during the first 500 mi (805 km) of towing.**

SAFETY TIPS

Exhaust System

WARNING!

Exhaust gases contain carbon monoxide, an extremely toxic gas that by itself is colorless and odorless. To avoid inhaling these gases, the following precautions should be observed:

- Do not run the engine in a closed garage or in confined areas any longer than needed to move your vehicle in or out of the area.
- It may be necessary to sit in a parked vehicle with the engine running for more than a short period. If so, adjust your climate control system to force outside air into the vehicle. Set the blower at high speed and the controls in any position except Off or Recirculation.

- The best protection against carbon monoxide entry into the vehicle body is a properly maintained engine exhaust system.

Be aware of changes in the sound of the exhaust system, exhaust fumes detected inside the vehicle, or damage to the underside or rear of the vehicle. Have a competent mechanic inspect the complete exhaust system and adjacent body areas for broken, damaged, deteriorated or mispositioned parts. Open seams or loose connections could permit exhaust fumes to seep into the passenger compartment. In addition, inspect the exhaust system each time the vehicle is raised for lubrication or oil change. Replace or adjust as required.

Safety Checks You Should Make Inside The Vehicle

Heater Defroster Ducts

Inspect the heater defroster ducts for proper operation. Check for proper airflow through all defroster ducts. If there is any question regarding the operation of your heater defroster ducts, have the system checked by an authorized dealer

Seat Belts

Inspect the seat belt system periodically, checking for cuts, frays and loose parts. Damaged parts must be replaced immediately. Do not disassemble or modify the system.

Seat belt assemblies must be replaced after an accident if they have been damaged (bent retractor, torn webbing, etc.) or if the front airbags have deployed. If there is any question regarding seat belt or retractor condition, replace the seat belt.

Airbag Warning Light

The airbag warning light should come on, and remain on, for six to eight seconds as a bulb check when the ignition switch is first turned ON. If the light is not lit during starting, see your authorized dealer. If the light stays on, flickers or comes on while driving, have the system checked by an authorized dealer. If there is a problem with the airbag warning light, the seat belt light will flash.

Safety Checks You Should Make Outside The Vehicle

Tires

Examine tires for tread wear or uneven wear patterns. Check for stones, nails, glass or other objects lodged in the tread.

Inspect for tread cuts or sidewall cracks. Check wheel nuts for tightness and tires for proper pressure.

Lights

Check the operation of all exterior lights. Check turn signal and high beam indicator lights on the instrument panel.

Door Latches

Check for positive closing, latching and locking.

Fluid Leaks

Check area under vehicle after overnight parking for fuel, water, oil, or other fluid leaks. Also, if fuel fumes are detected the cause should be located and corrected.

UNDERSTANDING THE FEATURES OF YOUR VEHICLE

CONTENTS

■ Mirrors	81	■ Hands-Free Communication (UConnect®) — If Equipped	86
□ Inside Day/Night Mirror	81	□ Operation	88
□ Automatic Dimming Mirror — If Equipped	82	□ Phone Call Features	96
□ Outside Mirrors	82	□ UConnect® System Features	99
□ Outside Mirrors Folding Feature	83	□ Advanced Phone Connectivity	104
□ Power Mirrors — If Equipped	83	□ Things You Should Know About Your UConnect® System	105
□ Heated Power Mirrors — If Equipped	84	□ General Information	114
□ Trailer Towing Mirrors — If Equipped	84		

- Seats 114
 - 40-20-40 Front Seat 115
 - Reclining Seats 116
 - Adjustable Head Restraints 117
 - Manual Rotary Lumbar Support Adjustment — If Equipped 118
 - Power Seats — If Equipped 118
 - Heated Seats — If Equipped 120
- To Open And Close The Hood 121
- Lights 123
 - Interior Lights 123
 - Battery Saver 124
 - Headlight Delay 124
 - Headlights, Parking Lights And Panel Lights 125
 - Daytime Running Lights — If Equipped 126
 - Lights-On Reminder 126
 - Fog Lights — If Equipped 126
 - Multifunction Lever 126
- Windshield Wipers And Washers 129
 - Intermittent Wiper System 129
 - Windshield Washers 130
- Tilt Steering Column 130
- Driver Adjustable Pedals — If Equipped 131
 - Adjustment 132

- Electronic Speed Control — If Equipped 133
 - To Activate 134
 - To Set At A Desired Speed 134
 - To Deactivate 134
 - To Resume Speed 135
 - To Vary The Speed Setting 135
 - To Accelerate For Passing 135
- Overhead Console With Compass/Temperature Mini-Trip Computer — If Equipped 136
 - US/M Button 137
 - Reset Button 137
 - Step Button 138
 - Average Fuel Economy (AVG ECO) 138

- Distance To Empty (DTE) 139
- Trip Odometer (ODO) 139
- Elapsed Time (ET) 140
- C/T Button 140
- Global Reset 141
- Automatic Compass Calibration 141
- Manual Compass Calibration 142
- Recalibrating The Compass 142
- Outside Temperature 143
- Electrical Power Outlets 144
- Cigar Lighter And Ash Receiver 145

- Cupholders 146
 - Front Instrument Panel Cupholders (40–20–40 Seats) 146
 - Front Instrument Panel Cupholders (Bucket Seats) 147
 - Rear Cupholder (Quad Cab®) — If Equipped 147
- Storage 148
 - Center Storage Compartment (40–20–40 Seat) — If Equipped 148
 - Center Storage Compartment (Bucket Seats) — If Equipped 150
 - Storage And Seats (Quad Cab® Models) 152
 - Plastic Grocery Bag Retainers 153
- Rear Window Features 153
 - Rear Window Defroster And Heated Sideview Mirrors — If Equipped 153
 - Power Sliding Rear Window — If Equipped 154
 - Sliding Rear Window — If Equipped 154
- Fold Flat Load Floor — If Equipped 154

MIRRORS

Inside Day/Night Mirror

Headlight glare can be reduced by moving the small control under the mirror to the night position (toward the rear of the vehicle). The mirror should be adjusted while set in the day position (toward the windshield). The mirror should be adjusted to center on the view through the rear window.

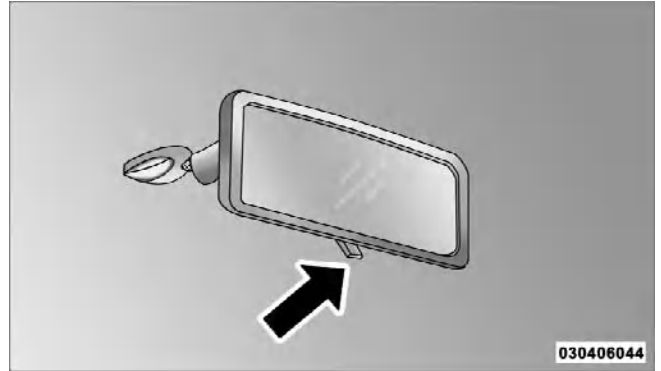

Adjusting Rearview Mirror

Automatic Dimming Mirror — If Equipped

This mirror automatically adjusts for headlight glare from vehicles behind you. You can turn the feature on or off by pressing the button at the base of the mirror. A light in the button will illuminate to indicate when the dimming feature is activated.

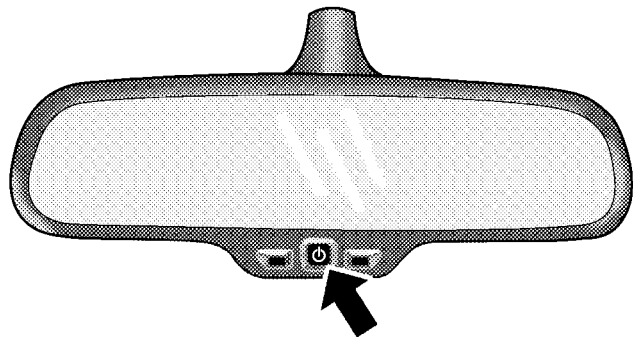

Automatic Dimming Mirror

CAUTION!

To avoid damage to the mirror during cleaning, never spray any cleaning solution directly onto the mirror. Apply the solution onto a clean cloth and wipe the mirror clean.

Outside Mirrors

To receive maximum benefit, adjust the outside mirror(s) to center on the adjacent lane of traffic with a slight overlap of the view obtained on the inside mirror.

817892c4

WARNING!

Vehicles and other objects seen in a right side convex mirror will look smaller and farther away than they really are. Relying too much on your right side convex mirror could cause you to collide with another vehicle or other object. Use your inside mirror when judging the size or distance of a vehicle seen in the right side convex mirror. Some vehicles will not have a convex right side mirror.

Outside Mirrors Folding Feature

All 6 x 9 in exterior mirrors are hinged and may be moved either forward or rearward to resist damage. The hinges have three detent positions; full forward, full rearward and normal.

Power Mirrors — If Equipped

The controls for the power mirrors are located on the driver's door trim panel.

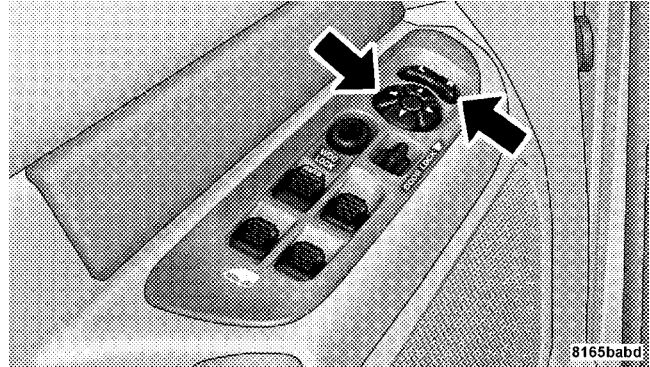
**Power Mirror Switches**

Set the top switch to the left or right for the left or right mirror, and set it to the center off position to prevent accidentally moving a mirror when you are finished adjusting the mirror. To adjust a mirror, select left or right with the top switch, and press one of the four arrows for the direction you want the mirror to move.

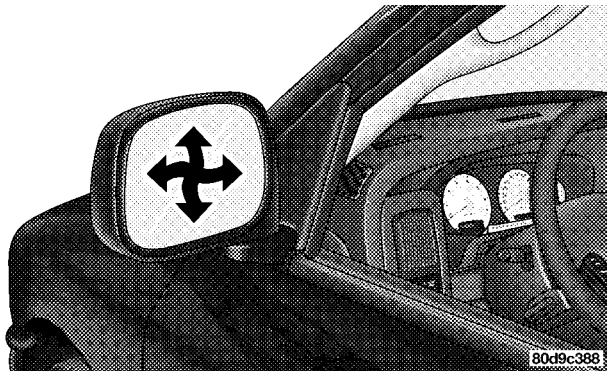

Power Mirror Movement

Heated Power Mirrors — If Equipped

Heated mirrors are automatically activated when you depress the rear window defroster switch located on the instrument panel. Refer to “Rear Window Features” in this Section, for further information.

Trailer Towing Mirrors — If Equipped

These mirrors are designed with an adjustable mirror head to provide a greater vision range when towing extra-wide loads. To change position inboard or outboard, the mirror head should be rotated (flipped in or out).

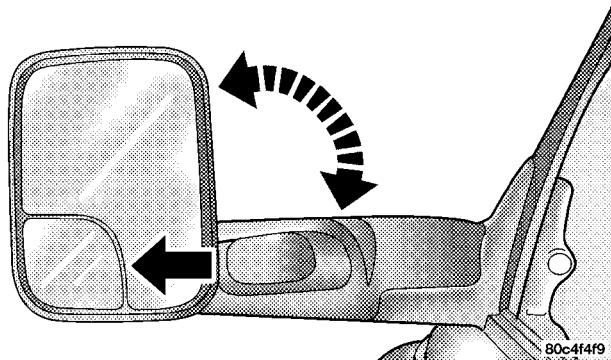

Trailer Towing Position

NOTE: Fold the trailer towing mirrors rearward prior to entering an automated car wash.

A small blindspot mirror is integrated onto the main mirror surface.

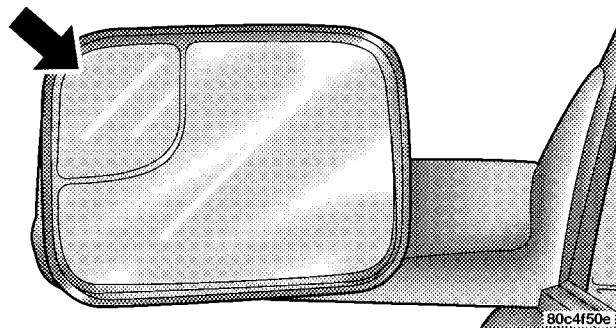

Blindspot Mirror

HANDS-FREE COMMUNICATION (UConnect®) — IF EQUIPPED

NOTE: The sales code RER and REU radios contain an integrated Hands-Free Communication (UConnect®) system. Refer to your “Navigation User’s Manual” for UConnect® system operating instructions for these radios. Radio sales code can be located on the lower right corner of the Radio faceplate.

UConnect® is a voice-activated, hands-free, in-vehicle communications system. UConnect® allows you to dial a phone number with your cellular phone using simple voice commands (e.g., “Call” ... “Mike” ... “Work” or “Dial” ... “248-555-1212”). Your cellular phone’s audio is transmitted through your vehicle’s audio system; the system will automatically mute your radio when using the UConnect® system.

NOTE: The UConnect® system requires a cellular phone equipped with the Bluetooth® “Hands-Free Profile,” Version 0.96 or higher. See the UConnect® website for supported phones.

NOTE: For UConnect® customer support, visit the following websites:

- www.chrysler.com/uconnect
- www.dodge.com/uconnect
- www.jeep.com/uconnect
- or call 1-877-855-8400

UConnect® allows you to transfer calls between the system and your cellular phone as you enter or exit your vehicle and enables you to mute the system’s microphone for private conversation.

The UConnect® system is driven through your Bluetooth® “Hands-Free Profile” cellular phone. UConnect® features Bluetooth® technology - the global standard that enables different electronic devices to connect to each other without wires or a docking station, so UConnect® works no matter where you stow your cellular phone (be it your purse, pocket, or briefcase), as long as your phone is turned on and has been paired to the vehicle’s UConnect® system. The UConnect® system allows up to seven cellular phones to be linked to the system. Only one linked (or paired) cellular phone can be used with the system at a time. The system is available in English, Spanish, or French languages.

Phone Button



The rearview mirror contains the microphone for the system (depending on the type of mirror and radio equipped), and either the

radio or the mirror has the two control buttons (PHONE Button and VOICE RECOGNITION button) that will enable you to access the system.

Voice Recognition Button



Actual button location may vary with the radio. The individual buttons are described in the “Operation” section.

The UConnect® system can be used with any Hands-Free Profile certified Bluetooth® cellular phone. See the UConnect® website for supported phones. If your cellular phone supports a different profile (e.g., Headset Profile) you may not be able to use any UConnect® features. Refer to your cellular service provider or the phone manufacturer for details.

The UConnect® system is fully integrated with the vehicle's audio system. The volume of the UConnect® system can be adjusted either from the radio volume control knob or from the steering wheel radio control (right switch), if so equipped.

The radio display will be used for visual prompts from the UConnect® system such as "CELL" or caller ID on certain radios.

Operation

Voice commands can be used to operate the UConnect® system and to navigate through the UConnect® menu structure. Voice commands are required after most UConnect® system prompts. You will be prompted for a specific command and then guided through the available options.

- Prior to giving a voice command, one must wait for the beep, which follows the "Ready" prompt or another prompt.

- For certain operations, compound commands can be used. For example, instead of saying "Setup" and then "Phone Pairing," the following compound command can be said: "Setup Phone Pairing."
- For each feature explanation in this section, only the combined form of the voice command is given. You can also break the commands into parts and say each part of the command when you are asked for it. For example, you can use the combined form voice command "Phonebook New Entry," or you can break the combined form command into two voice commands: "Phonebook" and "New Entry." Please remember, the UConnect® system works best when you talk in a normal conversational tone, as if speaking to someone sitting a few feet/meters away from you.

Voice Command Tree

Refer to "Voice Tree" in this section.

Help Command

If you need assistance at any prompt, or if you want to know your options at any prompt, say "Help" following the beep. The UConnect® system will play all the options at any prompt if you ask for help.

To activate the UConnect® system from idle, simply press the PHONE button and follow the audible prompts for directions. All UConnect® system sessions begin with a press of the PHONE button on the radio control head.

Cancel Command

At any prompt, after the beep, you can say "Cancel" and you will be returned to the main menu. However, in a few instances the system will take you back to the previous menu.

Pair (Link) UConnect® System to a Cellular Phone

To begin using your UConnect® system, you must pair your compatible Bluetooth® enabled cellular phone.

To complete the pairing process, you will need to reference your cellular phone Owner's Manual. The UConnect® website may also provide detailed instructions for pairing.

The following are general phone to UConnect® system pairing instructions:

- Press the PHONE button to begin.
- After the "Ready" prompt and the following beep, say "Setup Phone Pairing."
- When prompted, after the beep, say "Pair a Phone" and follow the audible prompts.
- You will be asked to say a four-digit Personal Identification Number (PIN), which you will later need to enter into your cellular phone. You can enter any four-digit PIN. You will not need to remember this PIN after the initial pairing process.

- For identification purposes, you will be prompted to give the UConnect® system a name for your cellular phone. Each cellular phone that is paired should be given a unique phone name.
- You will then be asked to give your cellular phone a priority level between one and seven, with one being the highest priority. You can pair up to seven cellular phones to your UConnect® system. However, at any given time, only one cellular phone can be in use, connected to your UConnect® system. The priority allows the UConnect® system to know which cellular phone to use if multiple cellular phones are in the vehicle at the same time. For example, if priority three and priority five phones are present in the vehicle, the UConnect® system will use the priority three cellular phone when you make a call. You can select to use a lower priority cellular phone at any time (refer to "Advanced Phone Connectivity" in this section).

Dial by Saying a Number

- Press the PHONE button to begin.
- After the "Ready" prompt and the following beep, say "Dial."
- The system will prompt you to say the number you want to call.
- For example, you can say "234-567-8901".
- The UConnect® system will confirm the phone number and then dial. The number will appear in the display of certain radios.

Call by Saying a Name

- Press the PHONE button to begin.
- After the "Ready" prompt and the following beep, say "Call."

- The system will prompt you to say the name of the person you want to call.
- After the "Ready" prompt and the following beep, say the name of the person you want to call. For example, you can say "John Doe," where John Doe is a previously stored name entry in the UConnect® phonebook or downloaded phonebook. To learn how to store a name in the phonebook, refer to "Add Names to Your UConnect® Phonebook," in the phonebook.
- The UConnect® system will confirm the name and then dial the corresponding phone number, which may appear in the display of certain radios.
- After the "Ready" prompt and the following beep, say "Phonebook New Entry."
- When prompted, say the name of the new entry. Use of long names helps the voice recognition and it is recommended. For example, say "Robert Smith" or "Robert" instead of "Bob."
- When prompted, enter the number designation (e.g., "Home," "Work," "Mobile," or "Pager"). This will allow you to store multiple numbers for each phonebook entry, if desired.
- When prompted, recite the phone number for the phonebook entry that you are adding.

Add Names to Your UConnect® Phonebook

NOTE: Adding names to the UConnect® phonebook is recommended when the vehicle is not in motion.

- Press the PHONE button to begin.

After you are finished adding an entry into the phonebook, you will be given the opportunity to add more phone numbers to the current entry or to return to the main menu.

The UConnect® system will allow you to enter up to 32 names in the phonebook with each name having up to four associated phone numbers and designations. Each language has a separate 32-name phonebook accessible only in that language. In addition, if equipped and supported by your phone, UConnect® automatically downloads your mobile phone's phonebook.

Phonebook Download – Automatic Phonebook Transfer From Mobile Phone

If equipped and specifically supported by your phone, UConnect® automatically downloads names (text names) and number entries from the mobile phone's phonebook. Specific Bluetooth® Phones with Phone Book Access Profile may support this feature. See UConnect® website for supported phones.

- To call a name from downloaded (or UConnect®) Phonebook, follow the procedure in "Call by Saying a Name" section.
- Automatic download and update, if supported, begins as soon as the Bluetooth® wireless phone connection is made to the UConnect®, for example, after you start the vehicle.
- A maximum of 1000 entries per phone will be downloaded and updated every time a phone is connected to the UConnect®.
- Depending on the maximum number of entries downloaded, there may be a short delay before the latest downloaded names can be used. Until then, if available, the previous downloaded phonebook is available for use.
- Only the phonebook of the currently connected mobile phone is accessible.
- Only the mobile phone's phonebook is downloaded. SIM card phonebook is not part of the Mobile phonebook.

- This downloaded phonebook cannot be edited or deleted on the UConnect®. These can only be edited on the mobile phone. The changes are transferred and updated to UConnect® on the next phone connection.

Phonebook Download — Single Entry

If equipped and supported by your phone, UConnect® allows the user to download entries from their phone via Bluetooth®. To use this feature, press the PHONE button and say “Phonebook Download.” The system prompts, “Ready to accept “V” card entry via Bluetooth®...” The system is now ready to accept phonebook entries from your phone using the Bluetooth® Object Exchange Profile (OBEX). Please see your phone Owner’s Manual for specific instructions on how to send these entries from your phone.

NOTE:

- The phone handset must support Bluetooth® OBEX transfers of phonebook entries to use this feature.
- Some phones cannot send phonebook entries if they are already connected to any system via Bluetooth®, and you may see a message on the phone display that the Bluetooth® link is busy. In this case, the user must first disconnect or drop the Bluetooth® connection to the UConnect® system, and then send the address book entry via Bluetooth®. Please see your phone Owner’s Manual for specific instructions on how to drop the Bluetooth® connection.
- If the phonebook entry is longer than 24 characters, it will only use the first 24 characters.

Edit UConnect® Phonebook Entries

NOTE:

- Editing names in the phonebook is recommended when the vehicle is not in motion.
- Automatic downloaded phonebook entries cannot be deleted or edited.

- Press the PHONE button to begin.
- After the "Ready" prompt and the following beep, say "Phonebook Edit."
- You will then be asked for the name of the phonebook entry that you wish to edit.
- Next, choose the number designation (home, work, mobile, or pager) that you wish to edit.
- When prompted, recite the new phone number for the phonebook entry that you are editing.

After you are finished editing an entry in the phonebook, you will be given the opportunity to edit another entry in the phonebook, call the number you just edited, or return to the main menu.

"Phonebook Edit" can be used to add another phone number to a name entry that already exists in the phonebook. For example, the entry John Doe may have a mobile

and a home number, but you can add "John Doe's" work number later using the "Phonebook Edit" feature.

Delete UConnect® Phonebook Entry

NOTE: Editing phonebook entries is recommended when the vehicle is not in motion.

- Press the PHONE button to begin.
- After the "Ready" prompt and the following beep, say "Phonebook Delete."
- After you enter the Phonebook Delete menu, you will then be asked for the name of the entry that you wish to delete. You can either say the name of a phonebook entry that you wish to delete or you can say "List Names" to hear a list of the entries in the phonebook from which you choose. To select one of the entries from the list, press the VOICE RECOGNITION button while the UConnect® system is playing the desired entry and say "Delete."

- After you enter the name, the UConnect® system will ask you which designation you wish to delete: home, work, mobile, pager, or all. Say the designation you wish to delete.
- Note that only the phonebook entry in the current language is deleted.
- Automatic downloaded phonebook entries cannot be deleted or edited.

Delete/Erase "All" UConnect® Phonebook Entries

- Press the PHONE button to begin.
- After the "Ready" prompt and the following beep, say "Phonebook Erase All."
- The UConnect® system will ask you to verify that you wish to delete all the entries from the phonebook.
- After confirmation, the phonebook entries will be deleted.

- Note that only the phonebook in the current language is deleted.
- Automatic downloaded phonebook entries cannot be deleted or edited.

List All Names in the UConnect® Phonebook

- Press the PHONE button to begin.
- After the "Ready" prompt and the following beep, say "Phonebook List Names."
- The UConnect® system will play the names of all the phonebook entries, including the downloaded phonebook entries, if available.
- To call one of the names in the list, press the VOICE RECOGNITION button during the playing of the desired name, and say "Call."

NOTE: The user can also exercise "Edit" or "Delete" operations at this point.

- The UConnect® system will then prompt you as to the number designation you wish to call.
- The selected number will be dialed.

Phone Call Features

The following features can be accessed through the UConnect® system if the feature(s) are available on your cellular service plan. For example, if your cellular service plan provides three-way calling, this feature can be accessed through the UConnect® system. Check with your cellular service provider for the features that you have.

Answer or Reject an Incoming Call - No Call Currently in Progress

When you receive a call on your cellular phone, the UConnect® system will interrupt the vehicle audio system, if on, and will ask if you would like to answer the call. Press the PHONE button to accept the call. To reject the call, press and hold the PHONE button until you hear a single beep, indicating that the incoming call was rejected.

Answer or Reject an Incoming Call - Call Currently in Progress

If a call is currently in progress and you have another incoming call, you will hear the same network tones for call waiting that you normally hear when using your cellular phone. Press the PHONE button to place the current call on hold and answer the incoming call.

NOTE: The UConnect® system compatible phones in the market today do not support rejecting an incoming call when another call is in progress. Therefore, the user can only answer an incoming call or ignore it.

Making a Second Call While Current Call is in Progress

To make a second call while you are currently on a call, press the VOICE RECOGNITION button and say "Dial" or "Call" followed by the phone number or phonebook entry you wish to call. The first call will be on hold while the second call is in progress. To go back to the first call, refer to "Toggling Between Calls" in this section. To combine two calls, refer to "Conference Call" in this section.

Place/Retrieve a Call From Hold

To put a call on hold, press the PHONE button until you hear a single beep. This indicates that the call is on hold. To bring the call back from hold, press and hold the PHONE button until you hear a single beep.

Toggling Between Calls

If two calls are in progress (one active and one on hold), press the PHONE button until you hear a single beep, indicating that the active and hold status of the two calls have switched. Only one call can be placed on hold at a time.

Conference Call

When two calls are in progress (one active and one on hold), press and hold the PHONE button until you hear a double beep indicating that the two calls have been joined into one conference call.

Three-Way Calling

To initiate three-way calling, press the VOICE RECOGNITION button while a call is in progress, and make a second phone call, as described under "Making a Second Call While Current Call is in Progress." After the second call has established, press and hold the PHONE button until you hear a double beep, indicating that the two calls have been joined into one conference call.

Call Termination

To end a call in progress, momentarily press the PHONE button. Only the active call(s) will be terminated and if there is a call on hold, it will become the new active call. If the active call is terminated by the far end, a call on hold may not become active automatically. This is cell phone-dependent. To bring the call back from hold, press and hold the PHONE button until you hear a single beep.

Redial

- Press the PHONE button to begin.

- After the "Ready" prompt and the following beep, say "Redial."
- The UConnect® system will call the last number that was dialed from your cellular phone.

NOTE: This may not be the last number dialed from the UConnect® system.

Call Continuation

Call continuation is the progression of a phone call on the UConnect® system after the vehicle ignition key has been switched to OFF. Call continuation functionality available on the vehicle can be any one of three types:

- After the ignition key is switched to OFF, a call can continue on the UConnect® system either until the call ends, or until the vehicle battery condition dictates cessation of the call on the UConnect® system and transfer of the call to the mobile phone.

- After the ignition key is switched to OFF, a call can continue on the UConnect® system for a certain duration, after which the call is automatically transferred from the UConnect® system to the mobile phone.
- An active call is automatically transferred to the mobile phone after the ignition key is switched to OFF.

UConnect® System Features

Language Selection

To change the language that the UConnect® system is using:

- Press the PHONE button to begin.
- After the "Ready" prompt and the following beep, say the name of the language you wish to switch to English, Espanol, or Francais.
- Continue to follow the system prompts to complete the language selection.

After selecting one of the languages, all prompts and voice commands will be in that language.

NOTE: After every UConnect® language change operation, only the language-specific 32-name phonebook is usable. The paired phone name is not language-specific and usable across all languages.

Emergency Assistance

If you are in an emergency and the mobile phone is reachable:

- Pick up the phone and manually dial the emergency number for your area.

If the phone is not reachable and the UConnect® system is operational, you may reach the emergency number as follows:

- Press the PHONE button to begin.

- After the "Ready" prompt and the following beep, say "Emergency" and the UConnect® system will instruct the paired cellular phone to call the emergency number. This feature is supported in the U.S., Canada, and Mexico.

NOTE:

- The emergency number dialed is based on the country where the vehicle is purchased (911 for the U.S. and Canada and 060 for Mexico). The number dialed may not be applicable with the available cellular service and area.
- If supported, this number may be programmable on some systems. To do this, press the PHONE button and say 'Setup', followed by 'Emergency'.
- The UConnect® system does slightly lower your chances of successfully making a phone call as to that for the cell phone directly.

WARNING!

Your phone must be turned on and paired to the UConnect® system to allow use of this vehicle feature in emergency situations, when the cell phone has network coverage and stays paired to the UConnect® system.

Towing Assistance

If you need towing assistance:

- Press the PHONE button to begin.
- After the "Ready" prompt and the following beep, say "Towing Assistance."

NOTE:

- The towing assistance number dialed is based on the country where the vehicle is purchased (1-800-528-2069 for the U.S., 1-877-213-4525 for Canada, 55-14-3454 for Mexico City and 1-800-712-3040 for outside Mexico City in Mexico).
- If supported, this number may be programmable on some systems. To do this, press the PHONE button and say "Setup", followed by "Towing Assistance".

Paging

To learn how to page, refer to "Working with Automated Systems." Paging works properly except for pagers of certain companies, which time out a little too soon to work properly with the UConnect® system.

Voice Mail Calling

To learn how to access your voice mail, refer to "Working with Automated Systems."

Working with Automated Systems

This method is used in instances where one generally has to press numbers on the cellular phone keypad while navigating through an automated telephone system.

You can use your UConnect® system to access a voice mail system or an automated service, such as a paging service or automated customer service line. Some services require immediate response selection. In some instances, that may be too quick for use of the UConnect® system.

When calling a number with your UConnect® system that normally requires you to enter in a touch-tone sequence on your cellular phone keypad, you can press the VOICE RECOGNITION button and say the sequence you wish to enter, followed by the word "Send." For example, if required to enter your PIN followed with a pound, (3 7 4 6 #), you can press the VOICE RECOGNITION button and say, "3 7 4 6 # Send." Saying a number,

or sequence of numbers, followed by "Send," is also to be used for navigating through an automated customer service center menu structure, and to leave a number on a pager.

You can also send stored UConnect® phonebook entries as tones for fast and easy access to voice mail and pager entries. To use this feature, dial the number you wish to call and then press the VOICE RECOGNITION button and say, "Send." The system will prompt you to enter the name or number and say the name of the phonebook entry you wish to send. The UConnect® system will then send the corresponding phone number associated with the phonebook entry, as tones over the phone.

NOTE:

- You may not hear all of the tones due to cellular phone network configurations. This is normal.
- Some paging and voice mail systems have system time out settings that are too short and may not allow the use of this feature.

Barge In - Overriding Prompts

The "Voice Recognition" button can be used when you wish to skip part of a prompt and issue your voice recognition command immediately. For example, if a prompt is asking "Would you like to pair a phone, clear a...," you could press the VOICE RECOGNITION button and say, "Pair a Phone" to select that option without having to listen to the rest of the voice prompt.

Turning Confirmation Prompts ON/OFF

Turning confirmation prompts off will stop the system from confirming your choices (e.g., the UConnect® system will not repeat a phone number before you dial it).

- Press the PHONE button to begin.

- After the "Ready" prompt and the following beep, say "Setup Confirmations." The UConnect® system will play the current confirmation prompt status and you will be given the choice to change it.

Phone and Network Status Indicators

If available on the radio and/or on a premium display such as the instrument panel cluster, and supported by your cellular phone, the UConnect® system will provide notification to inform you of your phone and network status when you are attempting to make a phone call using UConnect®. The status is given for roaming, network signal strength, phone battery strength, etc.

Dialing Using the Cellular Phone Keypad

You can dial a phone number with your cellular phone keypad and still use the UConnect® system (while dialing via the cellular phone keypad, the user must exercise caution and take precautionary safety measures). By dialing a number with your paired Bluetooth® cellular

phone, the audio will be played through your vehicle's audio system. The UConnect® system will work the same as if you dial the number using voice recognition.

NOTE: Certain brands of cellular phones do not send the dial ring to the UConnect® system to play it on the vehicle audio system, so you will not hear it. Under this situation, after successfully dialing a number the user may feel that the call did not go through even though the call is in progress. Once your call is answered, you will hear the audio.

Mute/Un-Mute (Mute OFF)

When you mute the UConnect® system, you will still be able to hear the conversation coming from the other party, but the other party will not be able to hear you. In order to mute the UConnect® system:

- Press the VOICE RECOGNITION button.
- Following the beep, say "Mute."

In order to un-mute the UConnect® system:

- Press the VOICE RECOGNITION button.
- Following the beep, say "Mute off."

Advanced Phone Connectivity

Transfer Call to and from Cellular Phone

The UConnect® system allows ongoing calls to be transferred from your cellular phone to the UConnect® system without terminating the call. To transfer an ongoing call from your UConnect® paired cellular phone to the UConnect® system or vice versa, press the VOICE RECOGNITION button and say "Transfer Call."

Connect or Disconnect Link Between the UConnect® System and Cellular Phone

Your cellular phone can be paired with many different electronic devices, but can only be actively "connected" with one electronic device at a time.

If you would like to connect or disconnect the Bluetooth® connection between a UConnect® paired cellular phone and the UConnect® system, follow the instructions described in your cellular phone User's Manual.

List Paired Cellular Phone Names

- Press the PHONE button to begin.
- After the "Ready" prompt and the following beep, say "Setup Phone Pairing."
- When prompted, say "List Phones."
- The UConnect® system will play the phone names of all paired cellular phones in order from the highest to the lowest priority. To "select" or "delete" a paired phone being announced, press the VOICE RECOGNITION button and say "Select" or "Delete." Also, see the next two sections for an alternate way to "select" or "delete" a paired phone.

Select Another Cellular Phone

This feature allows you to select and start using another phone paired with the UConnect® system.

- Press the PHONE button to begin.
- After the "Ready" prompt and the following beep, say "Setup Select Phone" and follow the prompts.
- You can also press the VOICE RECOGNITION button at any time while the list is being played, and then choose the phone that you wish to select.
- The selected phone will be used for the next phone call. If the selected phone is not available, the UConnect® system will return to using the highest priority phone present in or near (approximately within 30 ft (9 m)) the vehicle.

Delete UConnect® Paired Cellular Phones

- Press the PHONE button to begin.
- After the "Ready" prompt and the following beep, say "Setup Phone Pairing."
- At the next prompt, say "Delete" and follow the prompts.
- You can also press the VOICE RECOGNITION button at any time while the list is being played, and then choose the phone you wish to delete.

Things You Should Know About Your UConnect® System

UConnect® Tutorial

To hear a brief tutorial of the system features, press the PHONE button and say "UConnect® Tutorial."

Voice Training

For users experiencing difficulty with the system recognizing their voice commands or numbers, the UConnect® system Voice Training feature may be used. To enter this training mode, follow one of the two following procedures:

From outside the UConnect® mode (e.g., from radio mode):

- Press and hold the VOICE RECOGNITION button for five seconds until the session begins, or,
- Press the VOICE RECOGNITION button and say the "Setup, Voice Training" command.

Repeat the words and phrases when prompted by the UConnect® system. For best results, the Voice Training session should be completed when the vehicle is parked with the engine running, all windows closed, and the blower fan switched off.

This procedure may be repeated with a new user. The system will adapt to the last trained voice only.

To restore the Voice Recognition system to factory default settings, enter the Voice Training session via the above procedure and follow the prompts.

Voice Recognition (VR)

- For best performance, adjust the rearview mirror to provide at least ½ in (1 cm) gap between the overhead console (if equipped) and the mirror.
- Always wait for the beep before speaking.
- Speak normally, without pausing, just as you would speak to a person sitting a few feet/meters away from you.
- Make sure that no one other than you is speaking during a voice recognition period.
- Performance is maximized under:

- low-to-medium blower setting,
 - low-to-medium vehicle speed,
 - low road noise,
 - smooth road surface,
 - fully closed windows,
 - dry weather condition.
- Even though the system is designed for users speaking in North American English, French, and Spanish accents, the system may not always work for some.
 - When navigating through an automated system such as voice mail, or when sending a page, at the end of speaking the digit string, make sure to say "Send."
 - Storing names in the phonebook when the vehicle is not in motion is recommended.

- It is not recommended to store similar sounding names in the UConnect® phonebook.
- Phonebook (Downloaded and UConnect® Local) name recognition rate is optimized when the entries are not similar.
- You can say "O" (letter "O") for "0" (zero). "800" must be spoken "eight-zero-zero."
- Even though international dialing for most number combinations is supported, some shortcut dialing number combinations may not be supported.
- In a convertible vehicle, system performance may be compromised with the convertible top down.

Far End Audio Performance

- Audio quality is maximized under:
 - low-to-medium blower setting,

- low-to-medium vehicle speed,
 - low road noise,
 - smooth road surface,
 - fully closed windows,
 - dry weather conditions, and
 - operation from the driver's seat.
- Performance, such as audio clarity, echo, and loudness to a large degree rely on the phone and network, and not the UConnect® system.
 - Echo at the far end can sometimes be reduced by lowering the in-vehicle audio volume.

- In a convertible vehicle, system performance may be compromised with the convertible top down.

Bluetooth® Communication Link

Cellular phones have been found to lose connection to the UConnect® system. When this happens, the connection can generally be re-established by switching the phone off/on. Your cellular phone is recommended to remain in Bluetooth® ON mode.

Power-Up

After switching the ignition key from OFF to either the ON or ACC position, or after a language change, you must wait at least five seconds prior to using the system.

Voice Tree

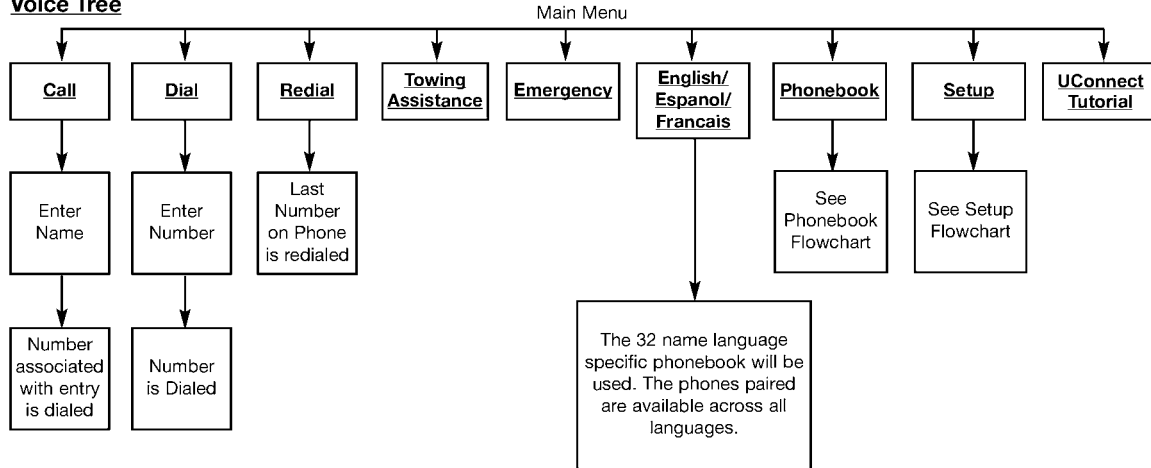

Note: Available Voice commands are shown in bold face and are underlined.

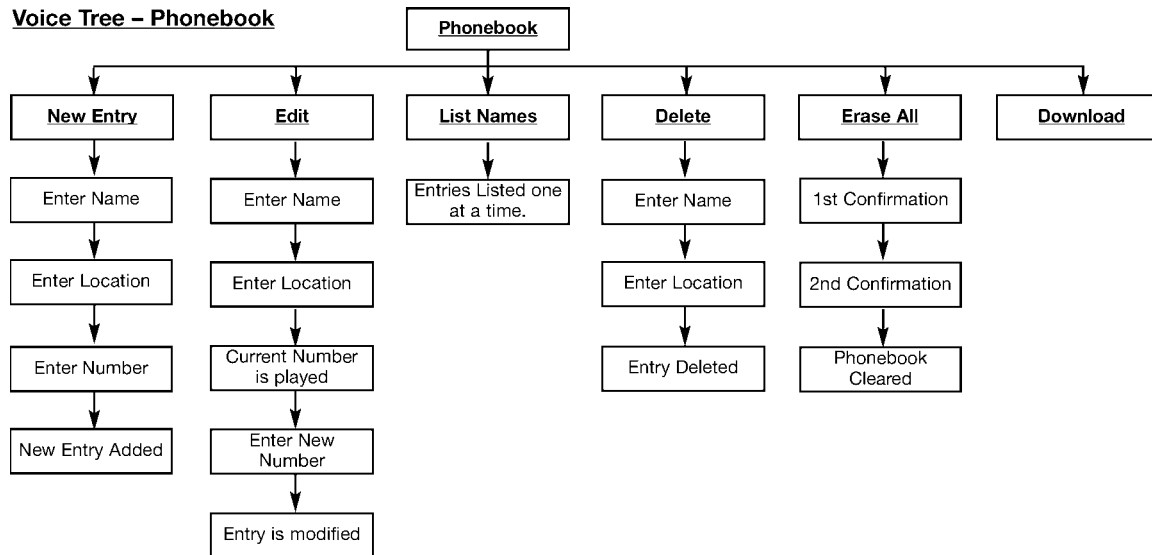
Voice Tree – Phonebook

Note: Available Voice commands are shown in bold face and are underlined.

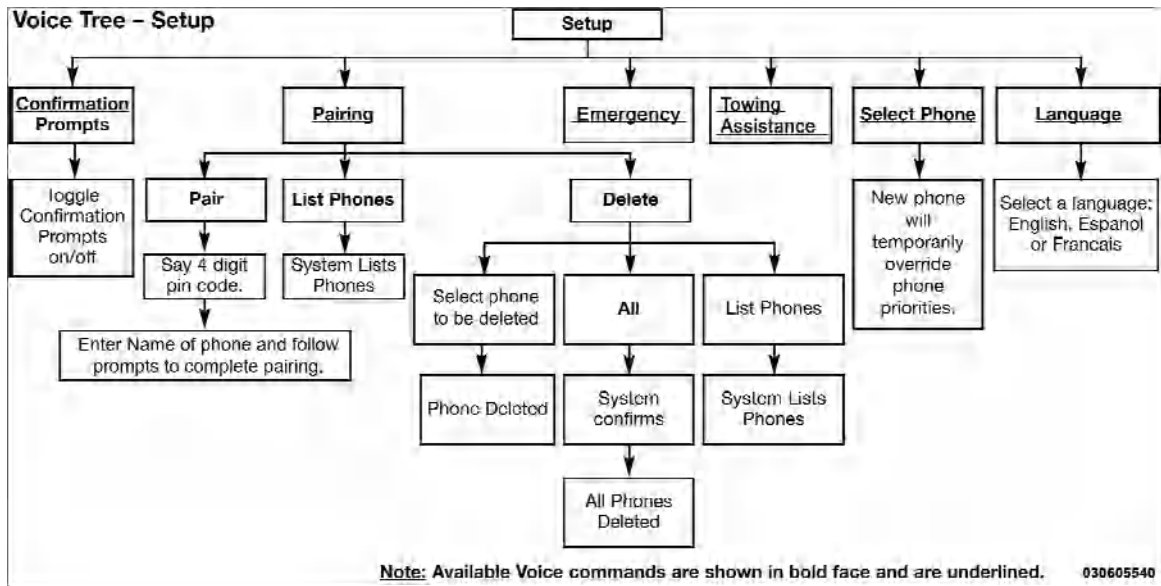

Voice Commands	
Primary	Alternate(s)
zero	
one	
two	
three	
four	
five	
six	
seven	
eight	
nine	
star (*)	
plus (+)	
pound (#)	
add location	
all	

Voice Commands	
Primary	Alternate(s)
call	
cancel	
confirmation prompts	
continue	
delete	
dial	
download	
edit	
emergency	
English	
erase all	
Espanol	
Francais	
help	
home	

Voice Commands	
Primary	Alternate(s)
language	
list names	
list phones	
mobile	
mute	
mute off	
new entry	
no	
pager	
pair a phone	
phone pairing	pairing
phonebook	phone book
previous	
record again	
redial	

Voice Commands	
Primary	Alternate(s)
return to main menu	return or main menu
select phone	select
send	
set up	phone settings or phone set up
towing assistance	
transfer call	
UConnect® Tutorial	
try again	
voice training	
work	
yes	

General Information

This device complies with Part 15 of the FCC rules and RSS 210 of Industry Canada. Operation is subject to the following conditions:

- Changes or modifications not expressly approved by the party responsible for compliance could void the user's authority to operate the equipment.
- This device may not cause harmful interference.
- This device must accept any interference received, including interference that may cause undesired operation.

SEATS

Seats are also a primary part of the Occupant Restraint System of the vehicle. They need to be used properly for safe operation of the vehicle.

WARNING!

- It is extremely dangerous to ride in a cargo area, inside or outside of a vehicle. In a collision, people riding in these areas are more likely to be seriously injured or killed.
- Do not allow people to ride in any area of your vehicle that is not equipped with seats and seat belts.
- Be sure everyone in your vehicle is in a seat and using a seat belt properly.

40-20-40 Front Seat

The outboard seat portions are each 40% of the total width of the seat. The back of the center portion (20%) easily folds down to provide an armrest/center storage compartment (if equipped).

Each outboard seat is independently adjustable forward or rearward and is equipped with a back recliner. The manual forward or rearward seat adjustment handle is found at the front edge of each seat cushion. Pull up on the handle and slide the seat to get the most comfortable position.

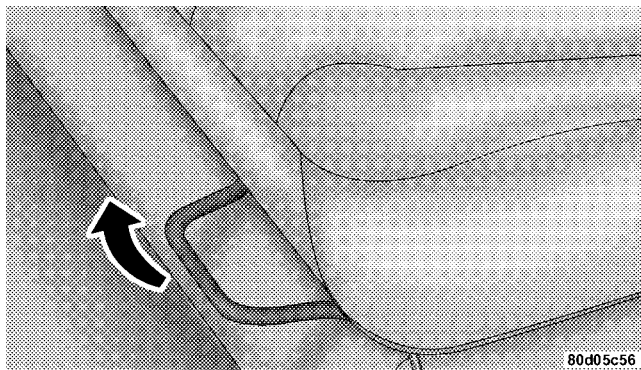

Manual Seat Adjuster

WARNING!

Adjusting a seat while the vehicle is moving is dangerous. The sudden movement of the seat could cause you to lose control. The seat belt might not be properly adjusted and you could be injured. Adjust any seat only while the vehicle is parked.

Reclining Seats

The recliner handle is on the outside of the seat cushion. Pull up on the handle, as shown, to release the seatback and adjust for comfort.

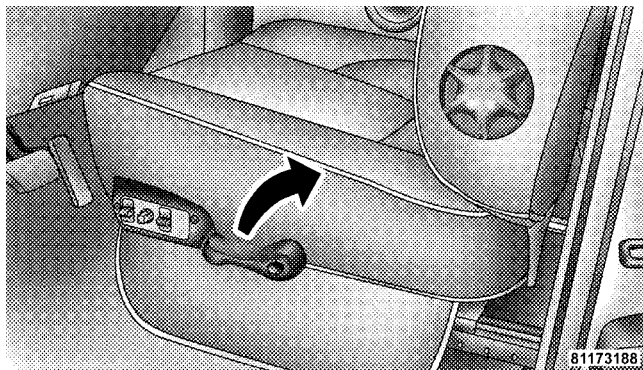

Seat Recliner Handle

WARNING!

You can be seriously, even fatally, injured riding in a seat with the seatback reclined. Do not ride with the seatback reclined so that the shoulder belt is no longer resting against your chest. If you ride in this position, the shoulder harness will no longer be restraining you. In a collision you could slide under the seat belt and receive serious or fatal injuries. Recline in a seat only when the vehicle is parked.

Adjustable Head Restraints

Head restraints can reduce the risk of neck injury in the event of impact from the rear. Pull up or push down on the restraints so that the upper edge is as high as practical, at least to the level of the ears.

To lower the head restraint, push in the button and then push down on the head restraint.

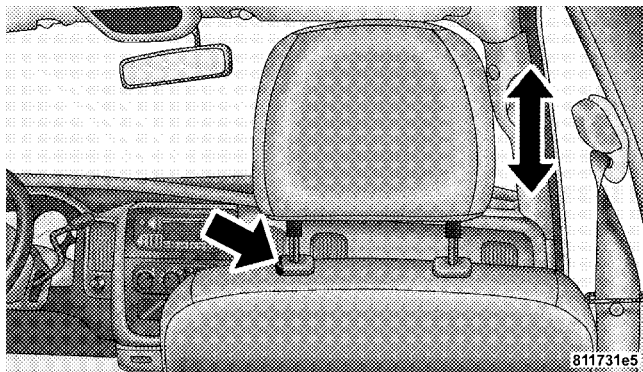
**Head Restraints**

Manual Rotary Lumbar Support Adjustment — If Equipped

Rotating the lumbar control knob on the left side of the driver's seatback and on the right side of the passenger's seatback increases or decreases the lumbar (lower back) support.

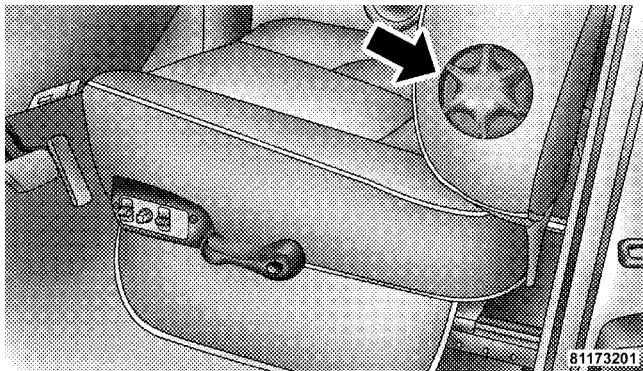

Manual Lumbar Adjustment

Power Seats — If Equipped

The power seat controls are on the outboard side of the front seat cushions. Three switches control the seat movement.

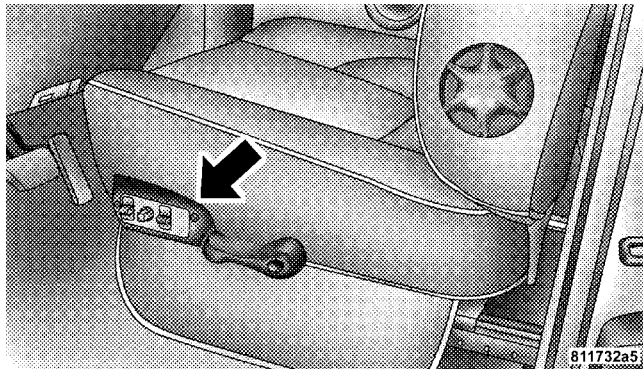

Power Seat Switch

CAUTION!

Do not put anything under a power seat. It may cause damage to the seat or seat controls.

The four-way switch in the center can be moved forward or backward to get the most comfortable position. The same switch can be moved up and down to control seat height.

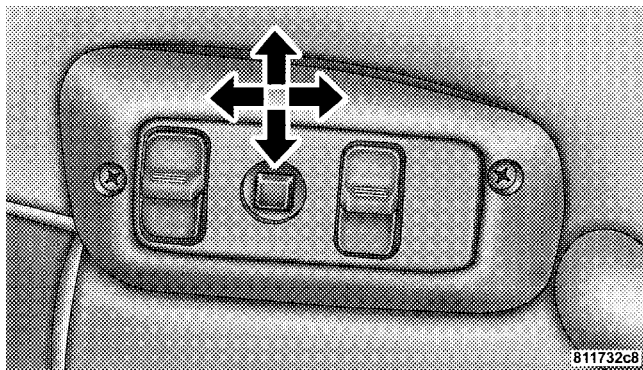

Up, Down, Forward, and Rearward

Change the seat angle by using the two toggle switches, tilting it up or down.

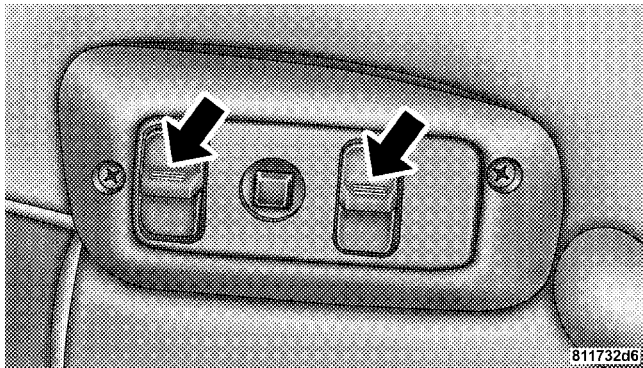

Tilt Adjustment

Heated Seats — If Equipped

The heated seat switches are located in the instrument panel under the climate controls.

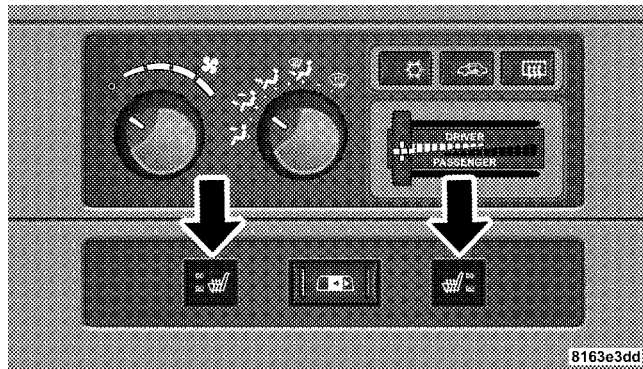

Heated Seat Switches

Press the switch once for High heat. Press the switch a second time for Low heat. Pressing the switch a third time will turn the heated seats Off.

The heaters will operate for approximately 30 minutes and automatically change to the next lower level, or Off. When High is selected both indicators will illuminate, if

Low is selected just the lower light will illuminate. Flashing indicator lights on the switch indicate that the heated seat system needs servicing. See your authorized dealer.

WARNING!

- Persons who are unable to feel pain to the skin because of advanced age, chronic illness, diabetes, spinal cord injury, medication, alcohol use, exhaustion or other physical condition must exercise care when using the seat heater. It may cause burns even at low temperatures, especially if used for long periods of time.
- Do not place anything on the seat that insulates against heat, such as a blanket or cushion. This may cause the seat heater to overheat.

TO OPEN AND CLOSE THE HOOD

To open the hood, two latches must be released.

1. Pull the hood release lever located below the steering wheel at the base of the instrument panel.

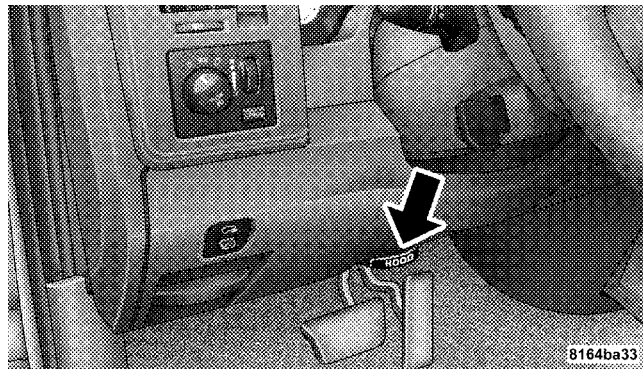

Hood Release Lever

2. Reach into the opening beneath the center of the grille and push upward on the safety latch to release it before raising the hood.

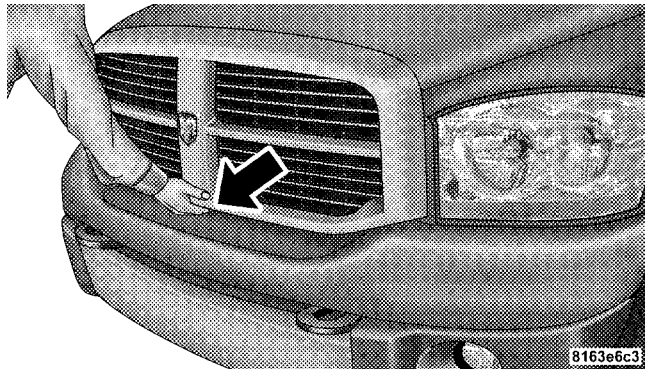

Safety Latch

CAUTION!

To prevent possible damage, do not slam the hood to close it. Use a firm downward push at the front center of the hood to ensure that both latches engage.

WARNING!

If the hood is not fully latched, it could fly up when the vehicle is moving and block your forward vision. Be sure all hood latches are latched fully before driving.

LIGHTS

The headlight switch is located on the left side of the instrument panel next to the steering wheel.

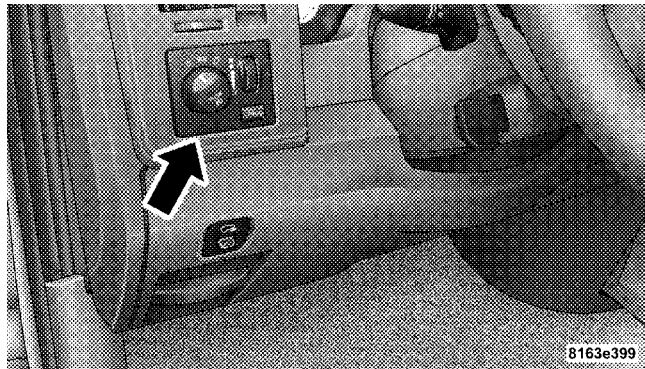

Headlight Switch Location

Interior Lights

Courtesy and dome lights are turned on when the front doors are opened, when the dimmer control (rotating

wheel on the right side of the switch) is rotated to the upward detent position, or if equipped, when the UNLOCK button is pressed on the Remote Keyless Entry (RKE) transmitter. When a door is open and the interior lights are on, rotating the dimmer control all the way down to the OFF detent will cause all the interior lights to go out. This is also known as the "Party" mode because it allows the doors to stay open for extended periods of time without discharging the vehicle's battery.

The brightness of the instrument panel lighting can be regulated by rotating the dimmer control up (brighter) or down (dimmer). When the headlights are on you can supplement the brightness of the odometer, trip odometer, radio and overhead console by rotating the control up until you hear a click. This feature is termed the "Parade" mode and is useful when headlights are required during the day.

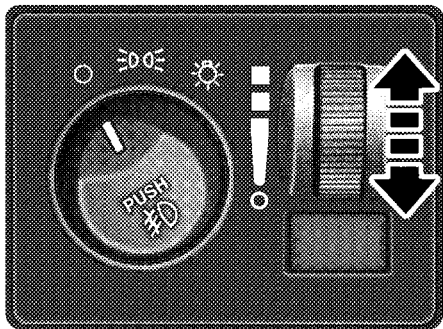

81948414

Dimmer Control

NOTE: Quad Cab® models may have an optional switched dome lamp that may be operated by pressing the lens.

Battery Saver

To protect the life of your vehicle's battery, load shedding is provided for both the interior and exterior lights.

If the ignition is OFF and any door is left ajar for 10 minutes or the dimmer control is rotated upwards for 10 minutes, the interior lights will automatically turn off.

If the headlights remain on while the ignition is cycled OFF, the exterior lights will automatically turn off after eight minutes.

NOTE: Battery saver mode is cancelled if the ignition is ON.

Headlight Delay

To aid in your exit, your vehicle is equipped with a headlight delay that will leave the headlights on for 90 seconds. This delay is initiated when the ignition is turned OFF while the headlight switch is on, and then the headlight switch is cycled off. Headlight delay can be cancelled by either turning the headlight switch on then off, or by turning the ignition ON.

The headlight delay time is programmable on vehicles equipped with the Electronic Vehicle Information Center (EVIC). For details, refer to “Personal Settings (Customer-Programmable Features)” under “Overhead Console with Electronic Vehicle Information Center (EVIC) – If Equipped” in Section 3.

Headlights, Parking Lights and Panel Lights



When the headlight switch is rotated to the first position, the parking lights, tail lights, side marker lights, license plate light and instrument panel lights are all turned on. The headlights will turn on when the switch is rotated to the second position.

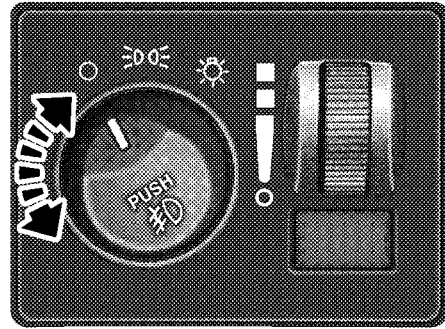

81948502

Light Switch Rotation

Your vehicle is equipped with plastic headlight lenses that are lighter and less susceptible to stone breakage than glass headlights.

Plastic is not as scratch resistant as glass and therefore different lens cleaning procedures must be followed.

To minimize the possibility of scratching the lenses and reducing light output, avoid wiping with a dry cloth. To remove road dirt, wash with a mild soap solution followed by rinsing.

Do not use abrasive cleaning components, solvents, steel wool or other abrasive materials to clean the lenses.

Daytime Running Lights — If Equipped

The headlights on your vehicle will illuminate when the engine is started and the transmission is in any gear except PARK. This provides a constant "lights on" condition until the ignition is turned OFF. The lights illuminate at less than 50% of normal intensity. If the parking brake is applied the Daytime Running Lights (DRL) will turn OFF. Also, if a turn signal is activated, the DRL lamp on the same side of the vehicle will turn off for the duration of the turn signal activation. Once the turn signal is no longer active, the DRL lamp will illuminate.

Lights-on Reminder

If the headlights, parking lights, or cargo lights are left on after the ignition is turned OFF, a chime will sound when the driver's door is opened.

Fog Lights — If Equipped

 The fog lights are turned on by placing the headlight rotary control in the parking light or headlight position and pushing in the headlight rotary control. The fog lights will operate only when the parking lights are on or when the vehicle headlights are on Low beam. An indicator light located in the instrument cluster will illuminate when the fog lights are on. The fog lights will turn off when the switch is pushed a second time, when the headlight switch is rotated to the off position, or the High beam is selected.

Multifunction Lever

The multifunction lever is located on the left side of the steering column.

Turn Signals

Move the lever up or down to signal a right-hand or left-hand turn.

The arrow on either side of the instrument cluster flashes to indicate the direction of the turn, and proper operation of the front and rear turn signal lights. If a defective bulb or wiring circuit is detected for the turn signal system, the arrow indicators will flash at a faster rate. If an indicator fails to light when the lever is moved, it would suggest that the switch or indicator lamp is defective.

You can signal a lane change by moving the lever partially up or down.

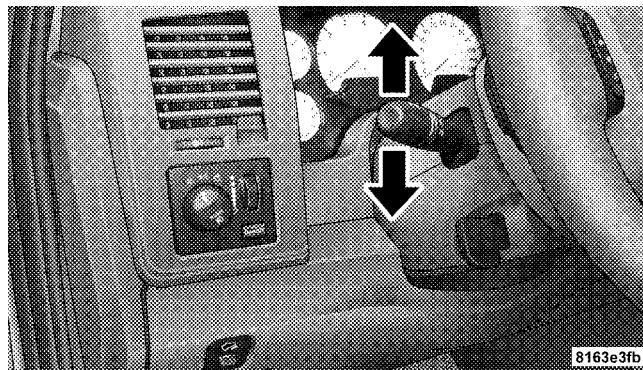

Turn Signal Lever

Turn Signal Auto-Mode

Tap the multifunction lever once and the turn signal (left or right) will flash three times, and automatically turn off.

Flash-to-Pass

You can signal another vehicle with your headlights by partially pulling the multifunction lever toward the steering wheel. This will cause the High beam headlights to turn on until the lever is released.

High Beam/Low Beam Select Switch

Pull the multifunction lever fully toward the steering wheel to switch the headlights from High or Low beam.



High Beam/Low Beam

WINDSHIELD WIPERS AND WASHERS

The wipers and washers are operated by a switch in the multifunction lever. Turn the end of the handle to select the desired wiper speed.

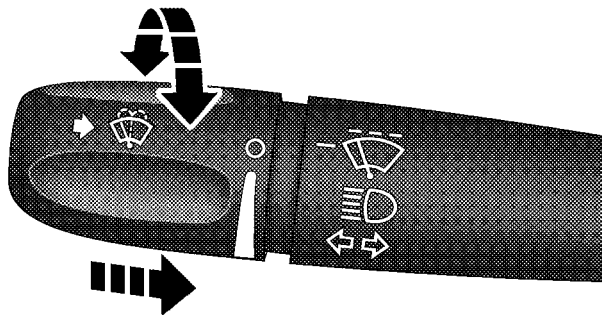

815be820

Windshield Wiper/Washer Switch

Intermittent Wiper System

The intermittent feature of this system was designed for use when weather conditions make a single wiping cycle, with a variable pause between cycles, desirable. For maximum delay between cycles, rotate the control knob into the upper end of the delay range.

The delay interval decreases as you rotate the knob until it enters the low continual speed position. The delay can be regulated from a maximum of about 15 seconds between cycles, to a cycle every two seconds. The delay intervals will double in duration when the vehicle speed is 10 mph (16 km/h) or less.

WARNING!

Sudden loss of visibility through the windshield could lead to an accident. You might not see other vehicles or other obstacles. To avoid sudden icing of the windshield during freezing weather, warm the windshield with the defroster before and during windshield washer use.

Windshield Washers

To use the washer, push in on the washer knob on the end of the multifunction lever and hold while spray is desired. If the washer knob is depressed while in the delay range, the wiper will operate for several seconds after the washer knob is released. It will then resume the intermittent interval previously selected. If the washer knob is pushed for a period greater than one second while in the off position, the wiper will cycle approximately three times after the wash knob is released.

TILT STEERING COLUMN

To tilt the column, pull rearward on the lever below the turn signal control and move the wheel up or down, as desired. Push the lever forward to lock the column firmly in place.

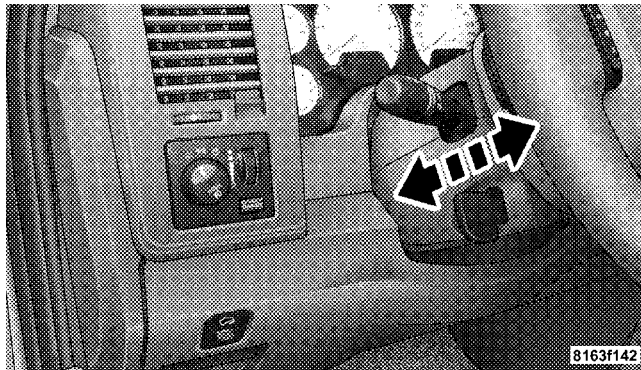

Tilt Steering Control Lever

WARNING!

Tilting the steering column while the vehicle is moving is dangerous. Without a stable steering column, you could lose control of the vehicle and have an accident. Adjust the column only while the vehicle is stopped. Be sure it is locked before driving.

DRIVER ADJUSTABLE PEDALS — IF EQUIPPED

The power adjustable accelerator and brake pedals allow the driver to establish a comfortable position relative to the steering wheel and pedals.

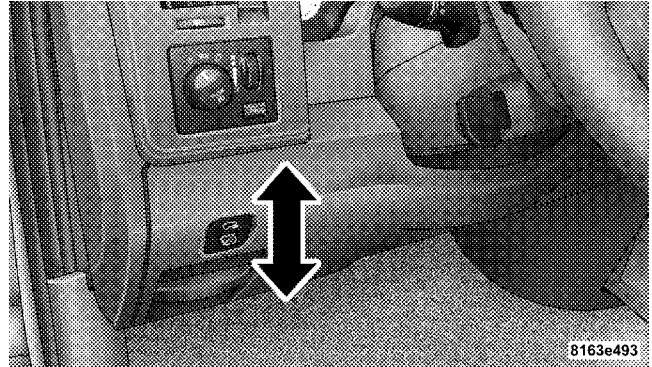

Adjustable Pedals Switch

Adjustment

1. Position the driver seat so that you are at least 10 in (254 mm) away from the airbag located in the center of the steering wheel.
2. Fasten and adjust the seatbelts.
3. Move the adjustable pedal switch, located to the left of the steering column near the parking brake release, in the direction you desire to move the pedals.
4. The pedals **cannot** be adjusted when the vehicle is in REVERSE or when the Electronic Speed Control is set.

CAUTION!

Do not place any article under the adjustable pedals or impede its ability to move as it may cause damage to the pedal controls. Pedal travel may become limited if movement is stopped by an obstruction in the adjustable pedal's path.

ELECTRONIC SPEED CONTROL — IF EQUIPPED

When engaged, Electronic Speed Control takes over accelerator operation at speeds greater than 25 mph (40 km/h). The controls are mounted on the steering wheel.

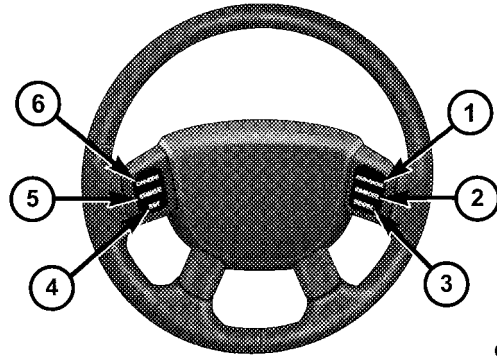

032205246

Electronic Speed Control Buttons

- | | |
|------------|------------|
| 1 — Resume | 4 — Set |
| 2 — Cancel | 5 — Cruise |
| 3 — Decel | 6 — On/Off |

NOTE: The Electronic Speed Control system has been designed to shut down if multiple speed control switch buttons (i.e., SET and CANCEL) are operated simultaneously, in order to ensure proper operation. The system can be reactivated by pushing the Electronic Speed Control switch ON/OFF button and reestablishing the desired vehicle SET speed.

To Activate

Push the ON/OFF button to the ON position. An indicator light in the instrument cluster illuminates when the system is on.

To Set At A Desired Speed

When the vehicle has reached the desired speed, press and release the SET button. Release the accelerator and the vehicle will operate at the selected speed.

To Deactivate

A soft tap on the brake pedal, normal braking, clutch pressure while slowing the vehicle, or pressing the CANCEL button will deactivate the Electronic Speed Control without erasing the memory. Pushing the ON/OFF button to the OFF position or turning off the ignition erases the memory.

WARNING!

Leaving the Electronic Speed Control on when not in use is dangerous. You could accidentally set the system to cause it to go faster than you want. You could lose control and have an accident. Always leave the system off when you are not using it.

To Resume Speed

To resume a previously set speed, push and release the RESUME button. Resume can be used at any speed above 30 mph (50 km/h).

To Vary The Speed Setting

When the Electronic Speed Control is on, speed can be increased by pressing and holding the RESUME/ACCEL button. When the button is released, a new set speed will be established.

Tapping the ACCEL button once will result in a speed increase of 1 mph (2 km/h). Each time the button is tapped, speed increases so that tapping the button three times will increase speed by 3 mph (4.8 km/h).

Tapping the DECEL button once will result in a speed decrease of 1 mph (2 km/h). Each time the button is tapped, speed will decrease. For example, tapping the button three times will decrease the speed by 3 mph (4.8 km/h)

To decrease speed while the speed control is on, press and hold the DECEL button. Release the button when the desired speed is reached, and the new speed will be set.

To Accelerate For Passing

Depress the accelerator as you would normally. When the pedal is released, the vehicle will return to the set speed.

NOTE: When driving uphill, at elevations above 2,000 ft (610 m), or when the vehicle is heavily loaded (especially when towing) the vehicle may slow below the SET speed. If the vehicle speed drops below 25 mph (40 km/h), the speed control will automatically disengage. If this happens, you can push down on the accelerator pedal to maintain the desired speed.

Vehicles equipped with a 6-speed manual transmission should be operated in 4th or 5th gear under the above conditions.

WARNING!

Electronic Speed Control can be dangerous where the system cannot maintain a constant speed. Your vehicle could go too fast for the conditions, and you could lose control. An accident could be the result. Do not use Electronic Speed Control in heavy traffic or on roads that are winding, icy, snow-covered, or slippery.

**OVERHEAD CONSOLE WITH COMPASS/
TEMPERATURE MINI-TRIP COMPUTER — IF
EQUIPPED**

This optional overhead console consists of the following:

- Courtesy Lights
- Compass/Temperature Mini-Trip Computer (CMTC)

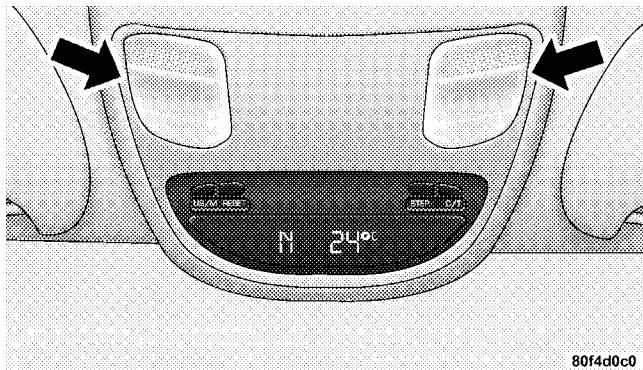
**Courtesy Lights**

This overhead console allows you to choose between a compass/temperature display and one of four trip conditions being monitored.

US/M Button

Use this button to change the display from U.S. to metric measurement units.

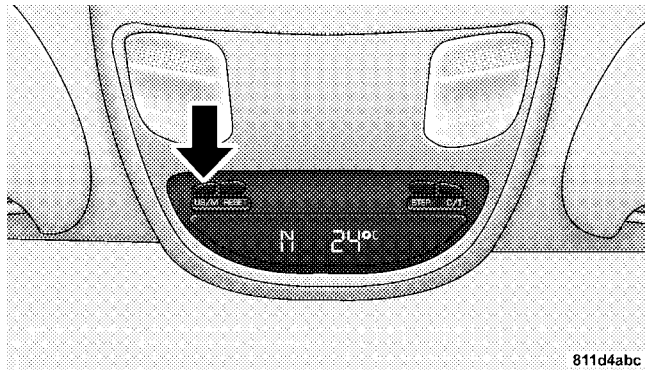
**US/M Button****Reset Button**

Use this button to reset the following displays:

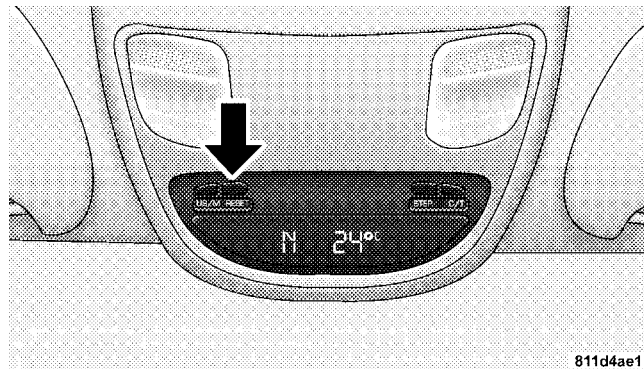
**Reset Button**

Average Fuel Economy (AVG ECO)
 Trip Odometer (ODO)
 Elapsed Time (ET)

Step Button

Use this button to choose or cycle through the four trip conditions.

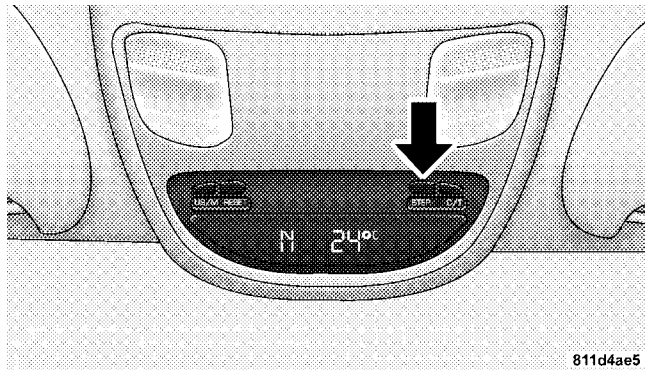

Step Button

Average Fuel Economy (AVG ECO)

Shows the average fuel economy since the last reset. Average fuel economy is a running average of the amount of fuel used and the distance the vehicle has traveled.

When the fuel economy is reset, the display will momentarily blank. Then the history will be erased and the AVERAGING WILL CONTINUE FROM WHERE IT WAS BEFORE THE RESET. The reset value is based on a minimal amount of fuel used and the distance traveled from the previous drive cycle. The display **may take several miles/kilometers** for this value to change, dependent upon driving habits.

Distance To Empty (DTE)

Shows the estimated distance that can be traveled with the fuel remaining in the tank. This estimated distance is determined by weighted average of the instantaneous and average fuel economy, according to the current fuel tank level. This is not resettable.

NOTE: Significant changes in driving style or vehicle loading will greatly affect the actual drivable distance of the vehicle, regardless of the DTE displayed value.

When the DTE value is less than 30 miles (48 km) estimated driving distance, the DTE display will change to an alternating text display of “LO” and “FUEL.” This display will continue until the vehicle runs out of fuel. Adding a significant amount of fuel to the vehicle will turn off the “LO FUEL” text and a new DTE value will be displayed, based on the current values in the DTE calculation and the current fuel tank level.

NOTE: It is possible for DTE to display “LO FUEL” before the low fuel warning light turns on in the instrument cluster. This could occur because low fuel warning is set to a specified fuel tank volume and DTE is an estimated distance calculation based on fuel economy and remaining fuel tank volume.

Ram fuel tank volumes are as follows:

- 52 gal (196 L) - Standard rear tank
- 22 gal (83 L) - Optional midship tank

Trip Odometer (ODO)

NOTE: The maximum value is approximately 6,000 miles (9,657 km). Then the trip odometer must be reset in order to update the trip odometer miles/kilometers.

This display shows the distance traveled since the last reset. Resetting of this screen will cause the trip odometer to change to zero.

Elapsed Time (ET)

This display shows the accumulated ignition ON time since the last reset. Resetting the elapsed time will cause the display to change to zero.

C/T Button

Use this button to select a readout of the outside temperature and one of eight compass headings that indicate the direction in which the vehicle is facing.

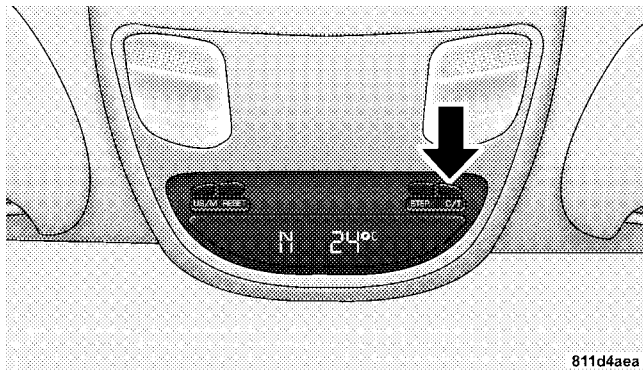

C/T Button

WARNING!

Even if the display still reads a few degrees above 32°F (0°C), the road surface may be icy, particularly in woods or on bridges. Drive carefully under such conditions to prevent an accident and possible personal injury or property damage.

Global Reset

If the RESET button is pressed twice within two seconds while in any of the three resettable displays (AVG, ECO, ODO, ET), the Global Reset will reset all three displays.

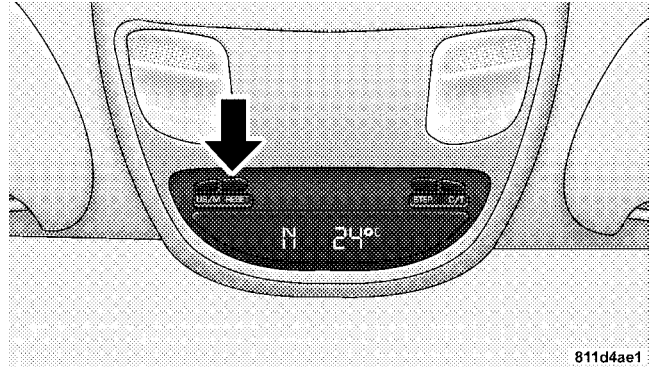

Reset Button

Automatic Compass Calibration

This compass is self-calibrating, which eliminates the need to manually set the compass. When the vehicle is new the compass may appear erratic and the CAL symbol will be displayed.

After completing up to three 360 degree turns, with the vehicle traveling less than 5 mph (8 km/h), in an area free from large metal or metallic objects, the CAL symbol will turn off and the compass will function normally.

Manual Compass Calibration

NOTE: To ensure proper compass calibration, make sure the compass variance is properly set before manually calibrating the compass.

If the compass appears erratic and the CAL symbol does not appear, you must manually put the compass into the “Calibration” mode.

Recalibrating The Compass

Start the engine and leave the transmission in the PARK position. Then set the display to “Compass/Temperature.” Press and hold the RESET button to change the display between VAR (compass variance) and

CAL (compass calibration) modes. When the CAL symbol is displayed, slowly drive the vehicle 5 mph (8 km/h) in a complete 360° circle in an area free from large metal objects or power lines. The CAL symbol will turn off and the compass will function normally.

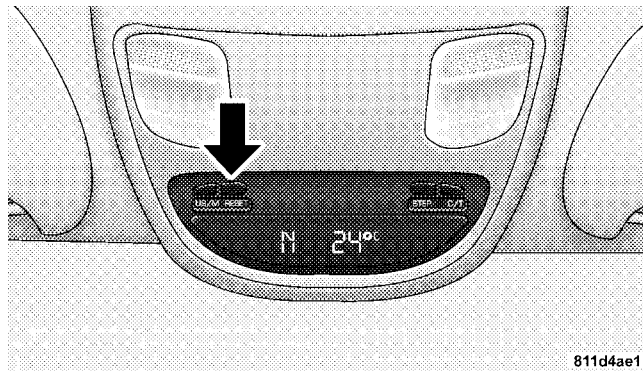

811d4ae1

Reset Button

Compass Variance is the difference between magnetic North and geographic North. In some areas of the country, the difference between magnetic and geographic North is great enough to cause the compass to give false readings. If this occurs, the compass variance must be set according to the Compass Variance Map.

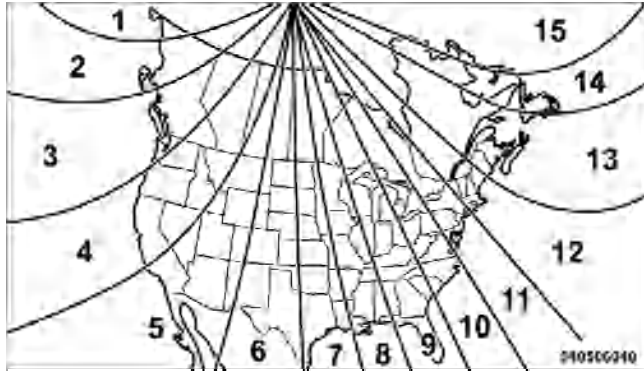

Compass Variance Map

NOTE: The default for the compass variance is Zone 8.

To set the variance: Turn the ignition ON and set the display to “Compass/Temperature.” Press and hold the RESET button approximately five seconds. The last variance zone number will be displayed. Press the STEP button to select the new variance zone and press the RESET button to resume normal operation.

3

Outside Temperature

Because the ambient temperature sensor is located underhood, engine temperature can influence the displayed temperature. Therefore, temperature readings are slowly updated when the vehicle speed is below 20 mph (30 km/h) or during stop-and-go driving.

ELECTRICAL POWER OUTLETS

The auxiliary electrical outlet can provide power for in-cab accessories designed for use with the standard “cigar lighter” plug. The outlet is located in the instrument panel below and to the right of the climate control panel. A cap is attached to the outlet base indicating “Power Outlet” 12-Volt/20 A.

There is an additional power outlet inside the center console of vehicles equipped with 40-20-40, or bucket front seats. There is also a power outlet located on the rear of the center console (if equipped with bucket seats).

The outlet(s) has/have a fused direct feed from the battery so it/they receive power whether the ignition is ON or OFF.

All accessories connected to this/these outlet(s) should be removed or turned off when the vehicle is not in use to protect the battery against discharge.

NOTE: If desired, all of the power outlets can be converted by your authorized dealer to provide power with the ignition switch in the ON position only.

WARNING!

To avoid serious injury or death:

- **Do not use a three-prong adapter.**
- **Do not insert any objects into the receptacles.**
- **Do not touch with wet hands.**
- **Close the lid when not in use and while driving the vehicle.**
- **If this outlet is mishandled, it may cause an electric shock and failure.**

CAUTION!

- Many accessories that can be plugged in draw power from the vehicle's battery, even when not in use (i.e., cellular phones, etc.). Eventually, if plugged in long enough, the vehicle's battery will discharge sufficiently to degrade battery life and/or prevent engine starting.
- Accessories that draw higher power (i.e., coolers, vacuum cleaners, lights, etc.), will discharge the battery even more quickly. Only use these intermittently and with greater caution.
- After the use of high power draw accessories, or long periods of the vehicle not being started (with accessories still plugged in), the vehicle must be driven a sufficient length of time to allow the generator to recharge the vehicle's battery.

CIGAR LIGHTER AND ASH RECEIVER

The removable ash receiver is located in the instrument panel cupholder tray.

The cigar lighter is located on the instrument panel, above and to the left of the ash receiver.

As a child safety precaution, the lighter only operates with the ignition switch ON. It heats when pushed in and pops out automatically when ready for use. **To preserve the heating element, do not hold the lighter in the heating position.**

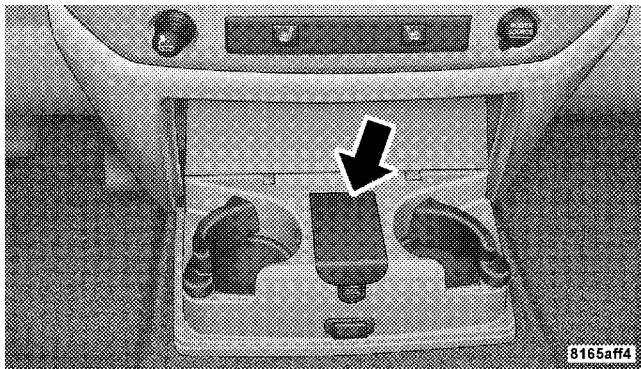

Ash Receiver

CUPHOLDERS

Front Instrument Panel Cupholders (40–20–40 Seats)

Your new vehicle is equipped with two adjustable cupholders. The cupholder is opened by pulling on the

cupholder door handle, on the front surface. Each opening in the cupholder is adjustable and will hold cups and mugs of various sizes.

To secure the cup, place the cup to be held into one of the cup wells and then push the cupholder arm toward the cup until it is held stable.

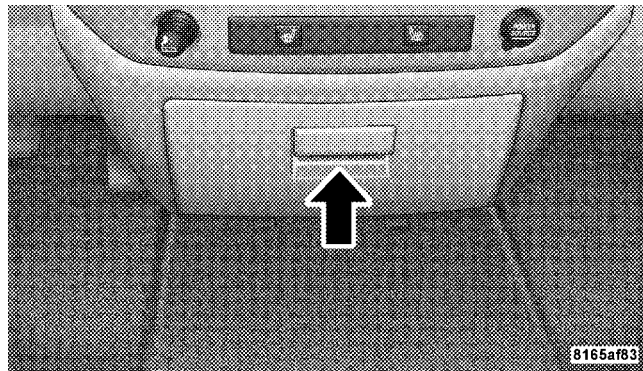

Cupholder Door Handle

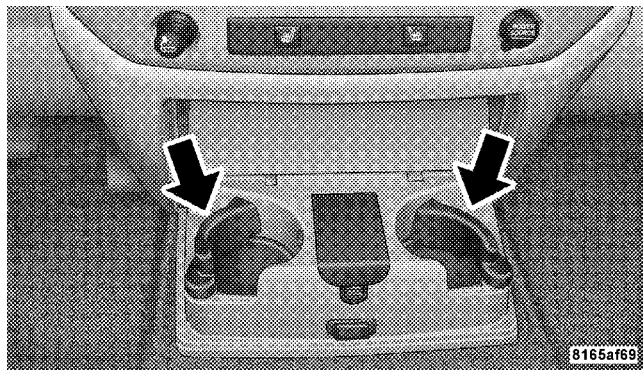

Cupholders

Front Instrument Panel Cupholders (Bucket Seats)

If your new vehicle is equipped with bucket seats there are three cupholders located on the front of the center console.

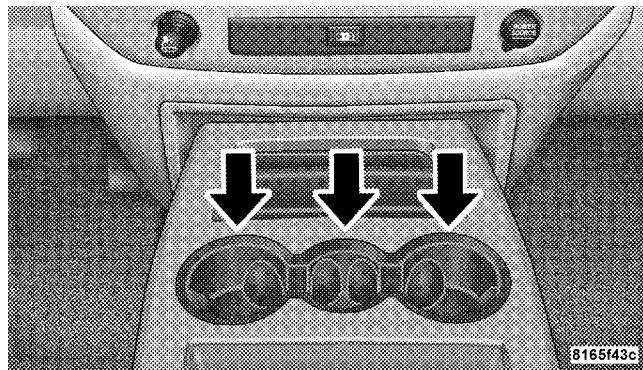

Cupholders Bucket Seat

Rear Cupholder (Quad Cab®) — If Equipped

Quad Cab® vehicles may be equipped with a rear cupholder that consists of two cupwells for rear passenger convenience.

STORAGE

Center Storage Compartment (40–20–40 Seat) — If Equipped

The center portion of the seat folds down to provide an armrest with unique storage compartments under the lid. Push the button on the front of the armrest to raise the cover. Inside there is a power outlet (if equipped), removable coin holder (if equipped), and two dividers to configure the storage area into compartments. For example, compartments can be configured to hold a laptop computer, a cellular telephone, CDs and miscellaneous items. The top of the cover provides a generous firm surface to serve as a desktop for your “mobile office.”

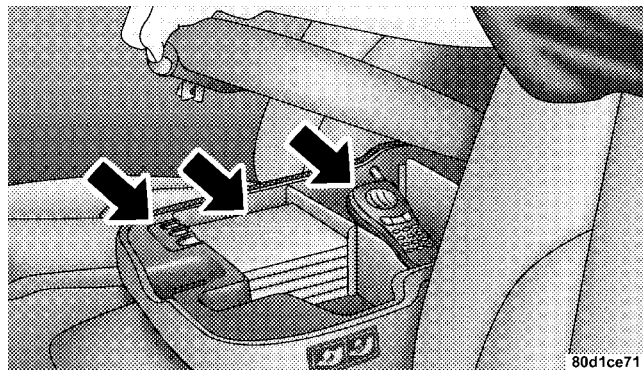

Center Storage Compartment

WARNING!

- This armrest is not a seat. Anyone seated on the armrest could be seriously injured during vehicle operation, or an accident. Only use the center seating position when the armrest is fully upright.
- In an accident, the latch may open if the total weight of the items stored exceeds about 10 lbs (4.5 kg). These items could be thrown about endangering occupants of the vehicle. Items stored should not exceed a total of 10 lbs (4.5 kg).

CAUTION!

- Many accessories that can be plugged in draw power from the vehicle's battery, even when not in use (i.e., cellular phones, etc.). Eventually, if plugged in long enough, the vehicle's battery will discharge sufficiently to degrade battery life and/or prevent engine starting.
- Accessories that draw higher power (i.e. coolers, vacuum cleaners, lights, etc.), will degrade the battery even more quickly. Only use these intermittently and with greater caution.
- After the use of high power draw accessories, or long periods of the vehicle not being started (with accessories still plugged in), the vehicle must be driven a sufficient length of time to allow the generator to recharge the vehicle's battery.

Center Storage Compartment (Bucket Seats) — If Equipped

Push the upper button on the front of the armrest to raise the upper cover. Inside is a power outlet (if equipped), a cut out for a cell phone charger cord, removable coin holder (if equipped), and a divider to configure the storage area into separate compartments. Lift the lower handle on the front of the armrest, and raise the armrest for access to the lower storage bin. On Quad Cab® models the rear of the floor console offers a power outlet, and a tip out bin.

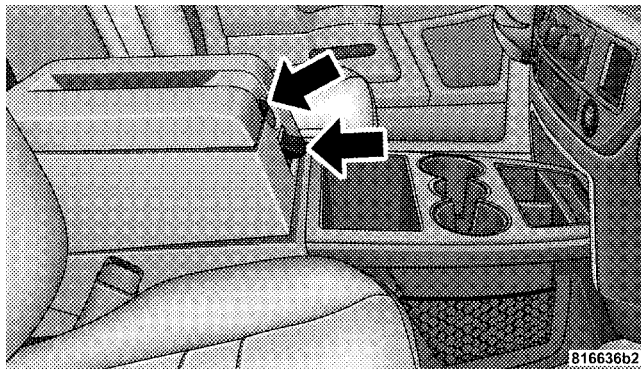

Center Storage Compartment

WARNING!

- This armrest is not a seat. Anyone seated on the armrest could be seriously injured during vehicle operation, or an accident. Only use the center seating position when the armrest is fully upright.
- In an accident, the latch may open if the total weight of the items stored exceeds about 10 lbs (4.5 kg). These items could be thrown about endangering occupants of the vehicle. Items stored should not exceed a total of 10 lbs (4.5 kg).

CAUTION!

- Many accessories that can be plugged in draw power from the vehicle's battery, even when not in use (i.e., cellular phones, etc.). Eventually, if plugged in long enough, the vehicle's battery will discharge sufficiently to degrade battery life and/or prevent engine starting.
- Accessories that draw higher power (i.e. coolers, vacuum cleaners, lights, etc.), will degrade the battery even more quickly. Only use these intermittently and with greater caution.
- After the use of high power draw accessories, or long periods of the vehicle not being started (with accessories still plugged in), the vehicle must be driven a sufficient length of time to allow the generator to recharge the vehicle's battery.

Storage and Seats (Quad Cab® Models)

Located in the center of the front 40–20–40 seat cushion there is a storage compartment.

Regular Cab models also have storage behind the seat.

The Quad Cab® models provide additional storage under the rear seat. Lift the seat to access the storage compartment.

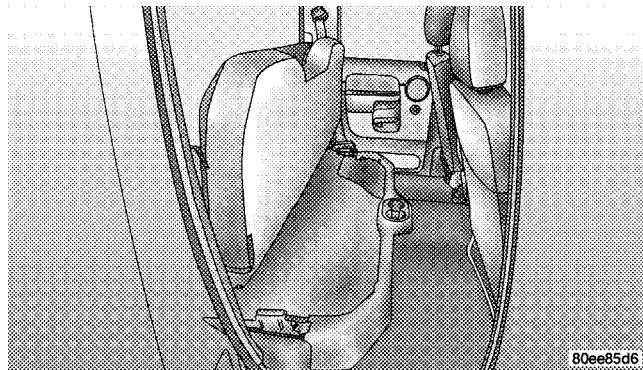

Quad Cab® Storage

Plastic Grocery Bag Retainers

Retainer hooks which will hold plastic grocery bag handles are built into the back panel of the cab, behind the rear seat.

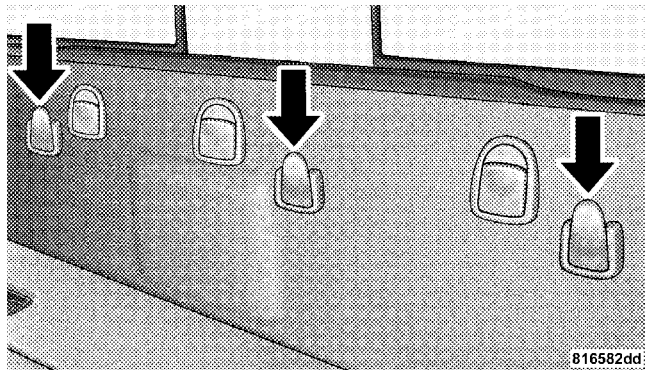

Grocery Bag Hooks

REAR WINDOW FEATURES

Rear Window Defroster and Heated Sideview Mirrors — If Equipped

 The electric rear window defroster and heated sideview mirrors are activated by pressing the heated grid button, located on the climate control panel, with the ignition ON. Turning OFF the ignition will deactivate the electric rear window defroster and heated sideview mirrors feature. These features also turn off after activation, when 15 minutes have elapsed. For an additional 10 minutes of operation, push the button a second time.

Power Sliding Rear Window — If Equipped

The power sliding rear window switch is located on the instrument panel below the climate controls. Press the right side of the switch to open the glass and the left side of the switch to close the glass.

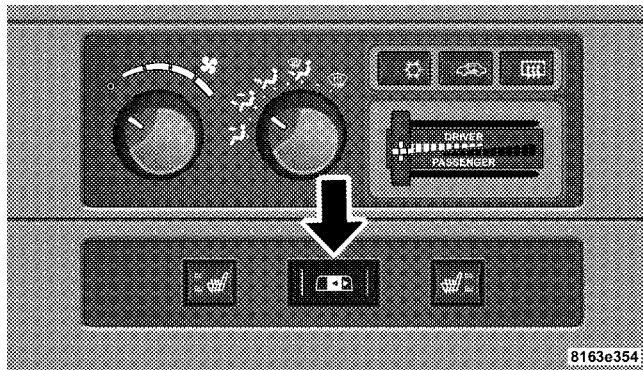

Power Sliding Rear Window Switch

Sliding Rear Window — If Equipped

A locking device in the center of the window helps to prevent entry from the rear of the vehicle. Squeeze the lock to release the window.

FOLD FLAT LOAD FLOOR — IF EQUIPPED

Quad Cab® models with a 60/40 rear seat may be equipped with a folding load floor.

WARNING!

Do not operate the vehicle with loose items stored on the load floor. While driving or in an accident you may experience abrupt stopping, rapid acceleration, or sharp turns. Loose objects stored on the load floor may move around with force and strike occupants, resulting in serious or fatal injury.

Unfolding the Load Floor

1. Lift the 60/40 seat cushion(s) to the upward position.

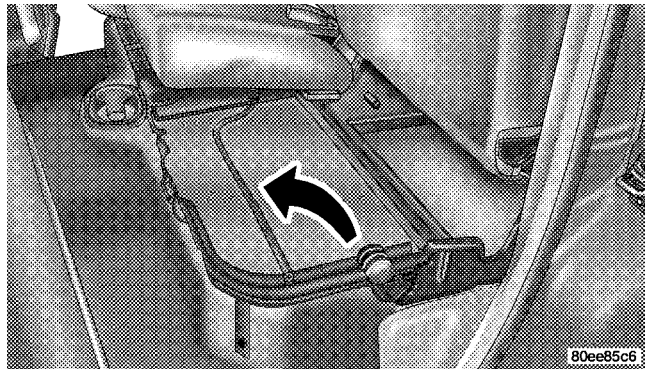

Unfolding The Load Floor

2. Grasp the knob on the load floor and lift the knob until the load floor unfolds into position.

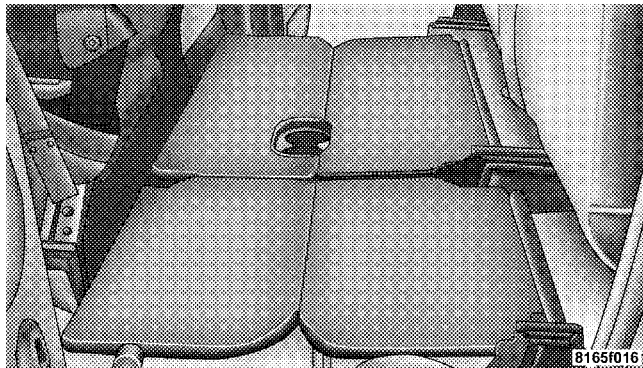

Load Floor In Open Position

3. Reverse the procedure to store the load floor.

Positioning the Load Floor for Storage Access Under the Seat

1. Lift the 60/40 seat cushion(s) to the upward position.
2. Unsnap the securing snap located at either side of the load floor.
3. Lift the load floor up to access storage under the load floor.

WARNING!

Do not drive with the load floor in the up position. When stopping fast or in an accident, the load floor could move to the down position causing serious injury.

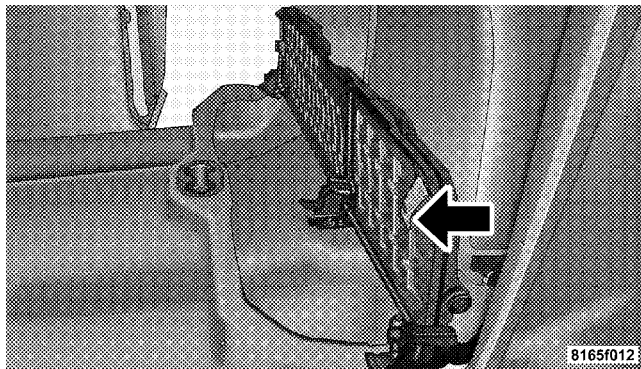

Load Floor Securing Straps

4. Reverse the procedure to put the load floor back in the secured down position before you operate the vehicle.

UNDERSTANDING YOUR INSTRUMENT PANEL

CONTENTS

■ Instrument Panel Features	160	□ Operation Instructions - (CD Mode For CD Audio Play)	179
■ Instrument Cluster	161	□ Load/Eject Button (CD Mode For CD Audio Play)	180
■ Instrument Cluster Description	162	□ Notes On Playing MP3 Files	182
■ Electronic Digital Clock	172	□ Operation Instructions - (CD Mode For MP3 Audio Play)	184
□ Clock Setting Procedure	172	□ Load/Eject Button (CD Mode For MP3 Play)	185
■ Sales Code RAQ – AM/FM/CD (6-Disc) Radio With Optional Satellite Radio, Hands Free Phone, And Video Entertainment Systems (VES) [™] Capabilities	173		
□ Operating Instructions - Radio Mode	173		

- Sales Code REF — AM/FM/CD (Single-Disc) Radio With Optional Satellite Radio And Hands-Free Phone Capability 187
 - Operating Instructions - Radio Mode 187
 - Operating Instructions - CD Mode 191
 - Operating Instructions - Auxiliary Mode 192
 - Operating Instructions - Hands-Free Phone — If Equipped 194
 - Operating Instructions - Satellite Radio — If Equipped 194
- Sales Code REC — AM/FM/CD (6-Disc) Radio With Navigation System. 194
 - Operating Instructions — Satellite Radio — If Equipped 195
 - REC Setting The Clock 195
- Satellite Radio — If Equipped 197
 - System Activation 197
 - Electronic Serial Number/Sirius Identification Number (ESN/SID) 198
 - Selecting Satellite Mode In REF, RAQ, And RAK Radios 199
 - Selecting A Channel 199
 - Storing And Selecting Preset Channels 200
 - Using The PTY (Program Type) Button — If Equipped 200
 - PTY Button Scan 200
 - PTY Button Seek 200
 - Satellite Antenna 200
 - Reception Quality 201

- Video Entertainment System™ (Sales Code XRV) — If Equipped 201
- Remote Sound System Controls — If Equipped 201
 - Radio Operation 202
 - Tape Player 202
 - CD Player 202
- CD/DVD Maintenance 203
- Radio Operation And Cellular Phones 203

- Climate Controls 204
 - Heater Only — If Equipped 204
 - Air Conditioning And Heating — If Equipped 207
 - Air Conditioning With Dual Zone Temperature Control — If Equipped 210
 - Operating Tips 214
 - Operating Tips Chart 216

INSTRUMENT PANEL FEATURES

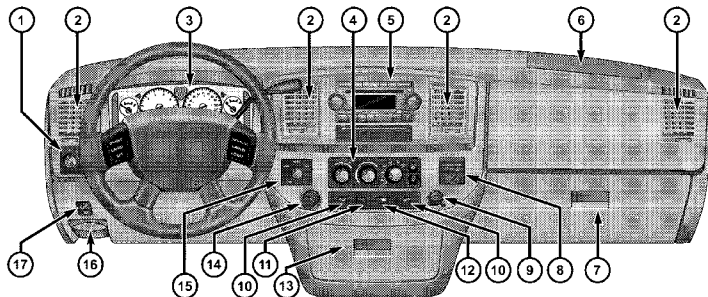

040105637

- 1 - Headlight Switch
- 2 - Air Outlets
- 3 - Instrument Cluster
- 4 - Climate Controls
- 5 - Radio

- 6 - Passenger Airbag
- 7 - Glove Compartment
- 8 - Passenger Airbag On/Off Switch*
- 9 - Power Outlet
- 10 - Heated Seat Switch

- 11 - Exhaust Brake Switch*
- 12 - Power Sliding Back Glass Switch*
- 13 - Cupholders
- 14 - Cigar Lighter
- 15 - Transfer Case Control Switch*

- 16 - Parking Brake Release Lever
 - 17 - Adjustable Pedal Control Switch*
- * If Equipped

INSTRUMENT CLUSTER

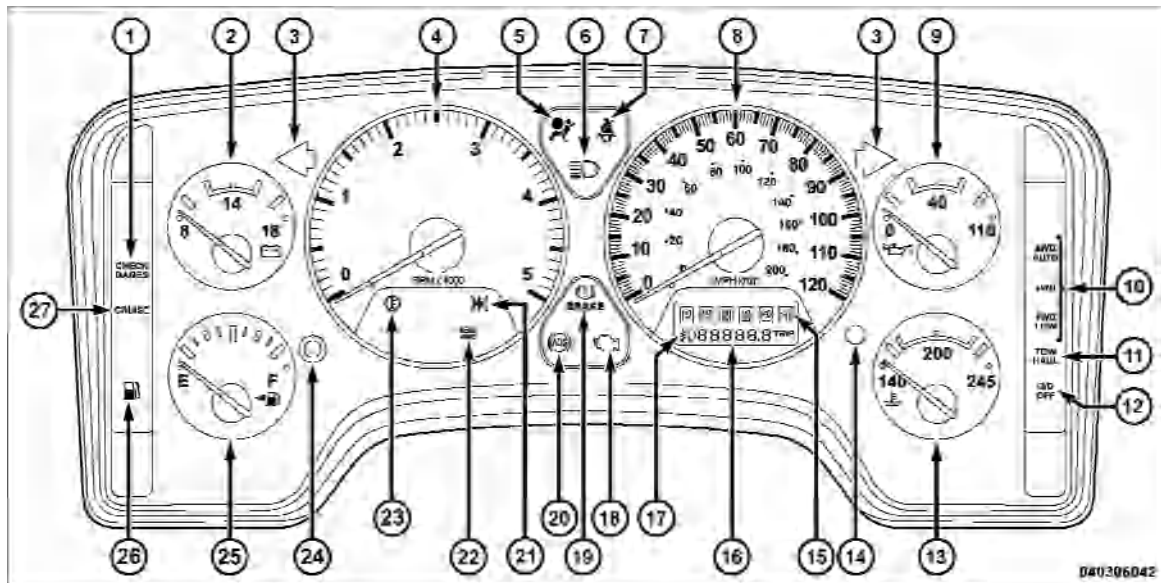

INSTRUMENT CLUSTER DESCRIPTION

1. Check Gauges

 This light illuminates when the Voltmeter, Engine Oil Pressure or Engine Coolant Temperature gauges indicate a reading either too high or too low. Examine the gauges carefully, and follow the instructions contained below for each indicated problem.

NOTE: When the ignition switch is turned to OFF, the Fuel Gauge, Voltmeter, Oil Pressure and Engine Coolant Temperature gauges may not show accurate readings. When the engine is not running, turn the ignition switch to ON to obtain accurate readings.

2. Voltmeter

 When the engine is running, the gauge indicates the electrical system voltage. The pointer should stay within the normal range if the battery is charged. If

the pointer moves to either extreme left or right and remains there during normal driving, the electrical system should be serviced.

NOTE:

- If the gauge pointer moves to either extreme of the gauge, the “Check Gauges” indicator will illuminate and a single chime will sound.
- The voltmeter may show a gauge fluctuation at various engine temperatures. This cycling operation is caused by the post-heat cycle of the intake manifold heater system. The number of cycles and the length of the cycling operation is controlled by the engine control module. Post-heat operation can run for several minutes, and then the electrical system and voltmeter needle will stabilize.

3. Turn Signal Indicators

 Lights in instrument cluster flash when outside turn signals are operating.

4. Tachometer

The tachometer indicates engine speed in revolutions per minute.

CAUTION!

Do not operate the engine with the tachometer pointer at high rpm for extended periods. Engine damage may occur.

5. Airbag Warning Light



The indicator lights and remains lit for six to eight seconds when the ignition is first turned on. If the light stays on, flickers or comes on while driving, have the airbag system checked by an authorized dealer.

6. High Beam Indicator



This indicator shows that headlights are on high beam.

7. Seat Belt Reminder Light



When the ignition switch is first turned ON, this light will turn on for five to eight seconds as a bulb check. During the bulb check, if the driver's seat belt is unbuckled, a chime will sound. After the bulb check or when driving, if the driver seat belt remains unbuckled, the Seat Belt Warning Light will flash or remain on continuously. Refer to "Enhanced Driver Seat Belt Reminder System (BeltAlert®)" under "Occupant Restraints" in section 2.

8. Speedometer

The speedometer shows the vehicle speed in miles per hour and/or kilometers per hour.

9. Oil Pressure Gauge

 The pointer should always indicate some oil pressure when the engine is running. A continuous high or low reading, under normal driving conditions, may indicate a lubrication system malfunction. Immediate service should be obtained.

NOTE: If the gauge pointer moves to either extreme of the gauge, the “Check Gauges” indicator will illuminate and a single chime will sound.

10. Transfer Case Position

This display indicator shows the transfer case position selection.

For additional information refer to “Four-Wheel Drive Operation” in Section 5 of this manual.

11. TOW HAUL

**TOW/
HAUL**

The TOW HAUL button is located at the end of the shift lever. This light will illuminate when the TOW HAUL OD/OFF button is pushed once.

12. OD/OFF

the OD/OFF button is located at the end of the shift lever. This light will illuminate when the TOW HAUL OD/OFF button is pushed twice.

13. Temperature Gauge



The temperature gauge shows engine coolant temperature. Any reading within the normal range indicates that the engine cooling system is operating satisfactorily.

The gauge pointer will likely indicate a higher temperature when driving in hot weather, up mountain grades, or when towing a trailer. It should not be allowed to exceed the upper limits of the normal operating range.

CAUTION!

Driving with a hot engine cooling system could damage your vehicle. If temperature gauge reads "H" pull over and stop the vehicle. Idle the vehicle with the air conditioner turned off until the pointer drops back into the normal range. If the pointer remains on the "H" and you hear continuous chimes, turn the engine off immediately, and call an authorized dealership for service.

WARNING!

A hot engine cooling system is dangerous. You or others could be badly burned by steam or boiling coolant. You may want to call an authorized dealership for service if your vehicle overheats. If you decide to look under the hood yourself, see Section 7 of this manual. Follow the warnings under the Cooling System Pressure Cap paragraph.

14. *Vehicle Security Light — If Equipped*



This light will flash at a fast rate for approximately 15 seconds, when the vehicle security alarm is arming, and then will flash slowly until the vehicle is disarmed.

15. Shift Lever Indicator (Automatic Transmission Only)

This display indicator shows the automatic transmission shift lever selection.

NOTE: You must apply the brake before shifting from PARK.

16. Odometer/Trip Odometer

The odometer shows the total distance the vehicle has been driven. U.S. federal regulations require that upon transfer of vehicle ownership, the seller certify to the purchaser the correct mileage that the vehicle has been driven. Therefore, if the odometer reading is changed during repair or replacement, be sure to keep a record of the reading before and after the service so that the correct mileage can be determined.

The two trip odometers show individual trip mileage. To switch from odometer to trip odometers, press and release the Trip Odometer button.

To reset a trip odometer, display the desired trip odometer to be reset then push and hold the button until the display resets (approximately two seconds).

Vehicle Warning Messages

When the appropriate conditions exist, messages such as “door” (indicates that a door(s) may be ajar), “hood” (if the hood is open or ajar, on vehicles with remote start), “gASCAP” (indicates that your gas cap is possibly loose or damaged), “Low Tire” (indicates low tire pressure), “CHANgE OIL” (indicates that the engine oil should be changed), “LoWASH” (low washer fluid), and “noFUSE” (indicates that the IOD fuse is removed from the Integrated Power Module), will display in the odometer.

NOTE: There is also an engine hour function. This indicates the total number of hours the engine has been running. To display the engine hours perform the following: Place the ignition in RUN, but do not start the engine. With the odometer value displayed, hold the trip

button down for a period of six seconds. The odometer will change to trip value first, then it will display the engine hour value. The engine hours will be displayed for a period of 30 seconds until the ignition is turned off or the engine is started.

Change Oil Message

Your vehicle is equipped with an engine oil change indicator system. The “Change Oil” message will flash in the instrument cluster odometer for approximately 12 seconds after a single chime has sounded to indicate the next scheduled oil change interval. The engine oil change indicator system is duty cycle based, which means the engine oil change interval may fluctuate dependent upon your personal driving style.

Unless reset, this message will continue to display each time you turn the ignition switch to the ON/RUN position. To turn off the message temporarily, press and release the Trip Odometer button on the instrument

cluster. To reset the oil change indicator system (after performing the scheduled maintenance) refer to the following procedure.

1. Turn the ignition switch to the ON position. (**Do not start the engine.**)
2. Fully depress the accelerator pedal slowly three times within 10 seconds.
3. Turn the ignition switch to the OFF/LOCK position.

NOTE: If the indicator message illuminates when you start the vehicle, the oil change indicator system did not reset. If necessary repeat this procedure.

17. Front Fog Light Indicator — If Equipped

 This light shows when the front fog lights are ON.

18. Malfunction Indicator Light (MIL)



The Malfunction Indicator Light (MIL) is part of an onboard diagnostic system which monitors the emissions and engine control system. If the vehicle is ready for emissions testing the light will come on when the ignition is first turned on and remain on, as a bulb check, until the engine is started. If the vehicle is not ready for emissions testing the light will come on when the ignition is first turned on and remain on for 15 seconds, then blink for five seconds, and remain on until the vehicle is started. If the bulb does not come on during starting, have the condition investigated promptly.

If this light comes on and remains on while driving, it suggests a potential engine control problem and the need for system service.

Although your vehicle will usually be drivable and not need towing, see your authorized dealer for service as soon as possible.

CAUTION!

Prolonged driving with the MIL on could cause damage to the engine control system. It also could affect fuel economy and drivability.

If the MIL is flashing, severe catalytic converter damage and power loss will soon occur. Immediate service is required.

19. Brake Warning Light

BRAKE This light monitors various brake functions, including brake fluid level and parking brake application. If the brake light turns on, it may indicate that the parking brake is applied, that the brake fluid level is low, or that there is a problem with the anti-lock brake system reservoir.

If the light remains on when the parking brake has been disengaged, and the fluid level is at the full mark on the master cylinder reservoir, it indicates a possible brake hydraulic system malfunction or a problem with the Brake Booster has been detected by the Anti-Lock Brake System (ABS) / Electronic Stability Program (ESP) system. In this case, the light will remain on until the condition has been corrected. If the problem is related to the brake booster, the ABS pump will run when applying the brake and a brake pedal pulsation may be felt during each stop.

The dual brake system provides a reserve braking capacity in the event of a failure to a portion of the hydraulic system. A leak in either half of the dual brake system is indicated by the Brake Warning Light, which will turn on when the brake fluid level in the master cylinder has dropped below a specified level.

The light will remain on until the cause is corrected.

NOTE: The light may flash momentarily during sharp cornering maneuvers, which change fluid level conditions. The vehicle should have service performed, and the brake fluid level checked.

If brake failure is indicated, immediate repair is necessary.

WARNING!

Driving a vehicle with the red brake light on is dangerous. Part of the brake system may have failed. It will take longer to stop the vehicle. You could have an accident. Have the vehicle checked immediately.

Vehicles equipped with the Anti-Lock Brake System (ABS), are also equipped with Electronic Brake Force Distribution (EBD). In the event of an EBD failure, the Brake Warning Light will turn on along with the ABS Light. Immediate repair to the ABS system is required.

Operation of the Brake Warning Light can be checked by turning the ignition switch from the OFF position to the ON position. The light should illuminate for approximately two seconds. The light should then turn off unless the parking brake is applied or a brake fault is detected. If the light does not illuminate, have the light inspected by an authorized dealer.

The light also will turn on when the parking brake is applied with the ignition switch in the ON position.

NOTE: This light shows only that the parking brake is applied. It does not show the degree of brake application.

20. *Anti-Lock Brake (ABS) Light*



This light monitors the Anti-Lock Brake System (ABS). The light will turn on when the ignition switch is turned to the ON position and may stay on for as long as four seconds.

If the ABS light remains on or turns on while driving, it indicates that the Anti-Lock portion of the brake system is not functioning and that service is required. However, the conventional brake system will continue to operate normally if the BRAKE warning light is not on.

If the ABS light is on, the brake system should be serviced as soon as possible to restore the benefits of Anti-Lock brakes. If the ABS light does not turn on when the Ignition switch is turned to the ON position, have the light inspected by an authorized dealer.

21. *Electronic Throttle Control (ETC)*



This light informs you of a problem with the Electronic Throttle Control (ETC) system. If a problem is detected, the light will come on while the engine is running. If the light remains lit with the engine running your vehicle will usually be drivable, however, see your authorized dealer for service as soon as possible. If the light is flashing when the

engine is running, immediate service is required and you may experience reduced performance, an elevated/rough idle or engine stall and your vehicle may require towing. The light will come on when the ignition is first turned on and remain on for 15 seconds as a bulb check. If the light does not come on during starting, have the system checked by an authorized dealer.

22. *SERV 4WD Indicator*

**SERV
4WD**

The 4WD indicator will be illuminated whenever the 4WD mode is engaged for either the manual or electric shift 4WD systems. The SERV 4WD indicator monitors the electric shift 4WD system. If the SERV 4WD light stays on or comes on during driving, it means that the 4WD system is not functioning properly and that service is required.

23. *Transmission Temperature Indicator (Automatic Transmissions Only)*



This light indicates that there is excessive transmission fluid temperature that might occur with severe usage such as trailer towing. It may also occur when operating the vehicle in a high torque converter slip condition, such as 4-wheel drive operation (e.g., snow plowing, off-road operation). If this light comes on, stop the vehicle and run the engine at idle or faster, with the transmission in NEUTRAL until the light goes off.

24. *Odometer/Trip Odometer Button*

Press this button to toggle between the odometer and the trip odometer display. Holding the button in resets the trip odometer reading when in trip mode.

25. *Fuel Gauge*

Shows level of fuel in tank when ignition switch is in the ON position.

26. Low Fuel Light



This light illuminates when the pointer is between “E” and 1/8 indication mark (approximately 15% of tank volume) on the fuel gauge. When the fuel gauge pointer is on “E” (equivalent to Distance To Empty [DTE] = 0 on the overhead console, if so equipped) there is reserve fuel capacity, which corresponds to approximately 8% of tank volume. This reserve capacity was put in place to prevent the likelihood of customers running out of fuel when operating at maximum load conditions in areas where there aren’t many fuel stations.

Fuel tank volumes are as follows:

- 52 gal (197 L) - Standard Rear Tank
- 22 gal (83 L) - Optional Mid Ship Tank

27. CRUISE Indicator

CRUISE This indicator lights when the electronic speed control system is turned on.

ELECTRONIC DIGITAL CLOCK

The clock and radio each use the display panel built into the radio. A digital readout shows the frequency and/or time in hours and minutes (depending on your radio model) whenever the ignition switch is in the ON or ACC position.

When the ignition switch is in the OFF position, or when the radio frequency is being displayed, time keeping is accurately maintained.

On the RAQ radio the time button alternates the location of the time and frequency on the display. On the REF only one of the two, time or frequency, is displayed at a time.

Clock Setting Procedure

1. Press and hold the time button until the hours blink.
2. Adjust the hours by turning the right side Tune/Audio control.

3. After the hours are adjusted, press the right side Tune/Audio control to set the minutes.
4. Adjust the minutes using the right side Tune/Audio control.
5. To exit, press any button/knob or wait approximately five seconds.

SALES CODE RAQ – AM/FM/CD (6-DISC) RADIO WITH OPTIONAL SATELLITE RADIO, HANDS FREE PHONE, AND VIDEO ENTERTAINMENT SYSTEMS (VES)[™] CAPABILITIES

NOTE: The radio sales code is located on the lower right side of your radio faceplate.

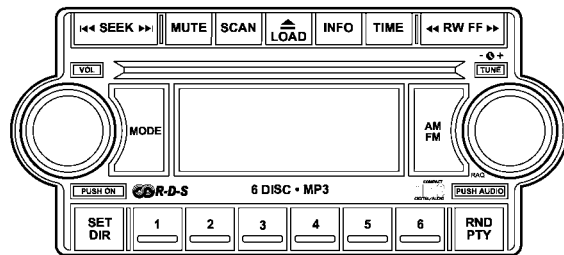

81365bb1

RAQ Radio

Operating Instructions - Radio Mode

NOTE: The ignition switch must be in the ON or ACC position to operate the radio.

Power Switch/Volume Control (Rotary)

Press the ON/VOL control to turn the radio ON. Press the ON/VOL a second time to turn OFF the radio.

Electronic Volume Control

The electronic volume control turns continuously (360 degrees) in either direction without stopping. Turning the volume control to the right increases the volume and to the left decreases it.

When the audio system is turned on, the sound will be set at the same volume level as last played.

For your convenience, the volume can be turned down, but not up, when the audio system is off and the ignition is ON.

Mode Button (Radio Mode)

Press the mode button repeatedly to select between the CD player, Satellite Radio, or Video Entertainment System (VES)TM (if equipped).

SEEK Button (Radio Mode)

Press and release the SEEK button to search for the next listenable station in either AM/FM or Satellite (if equipped) mode. Press the right side of the button to seek up and the left side to seek down. The radio will remain tuned to the new station until you make another selection. Holding the button will bypass stations without stopping until you release it.

MUTE Button (Radio Mode)

Press the MUTE button to cancel the sound from the speakers. "MUTE" will be displayed. Press the MUTE button a second time and the sound from the speakers will return. Rotating the volume control, turning the radio ON/OFF, or turning OFF the ignition will also return the sound from the speakers

NOTE: In Hands Free Phone (if equipped) mode, the MUTE button mutes the microphone.

SCAN Button (Radio Mode)

Pressing the SCAN button causes the tuner to search for the next listenable station, in either AM, FM or Satellite (if equipped) frequencies, pausing for 5 seconds at each listenable station before continuing to the next. To stop the search, press SCAN a second time.

MSG or INFO Button (Radio Mode)

Press the MSG or INFO button for an RBDS station (one with call letters displayed). The radio will return a Radio Text message broadcast from an FM station (FM mode only).

Time Button

Press the time button and the time of day will be displayed for 5 seconds.

Clock Setting Procedure

1. Press and hold the time button until the hours blink.

2. Adjust the hours by turning the right side Tune / Audio control.

3. After the hours are adjusted, press the right side Tune / Audio control to set the minutes. The minutes will begin to blink.

4. Adjust the minutes using the right side Tune / Audio control.

5. To exit, press any button/knob or wait 5 seconds.

RW/FF (Radio Mode)

Pressing the Rewind/Fast Forward button causes the tuner to search for the next frequency in the direction of the arrows. This feature operates in either AM, FM or Satellite (if equipped) frequencies.

TUNE Control (Radio Mode)

Turn the right side rotary control clockwise to increase or counter-clockwise to decrease the frequency.

AM/FM Button (Radio Mode)

Press the button to select AM or FM Modes.

Setting the Tone, Balance, and Fade

Press the rotary TUNE control and BASS will display. Turn the TUNE control to the right or left to increase or decrease the Bass tones.

Press the rotary TUNE control a second time and MID will display. Turn the TUNE control to the right or left to increase or decrease the Mid Range tones.

Press the rotary TUNE control a third time and TREBLE will display. Turn the TUNE control to the right or left to increase or decrease the Treble tones.

Press the rotary TUNE control a fourth time and BALANCE will display. Turn the TUNE control to the right or left to adjust the sound level from the right or left side speakers.

Press the rotary TUNE control a fifth time and FADE will display. Turn the TUNE control to the left or right to adjust the sound level between the front and rear speakers.

Press the rotary TUNE control again to exit setting tone, balance and fade.

RND/PTY Button (Program Type Radio Mode)

Pressing this button once will turn on the PTY mode for 5 seconds. If no action is taken during the 5 second time out the PTY icon will turn off. Pressing the PTY button or turning the TUNE rotary knob within 5 seconds will allow the program format type to be selected. Many radio stations do not currently broadcast PTY information.

Toggle the PTY button to select the following format types:

Program Type	16 Digit-Character Display
No program type or undefined	None
Adult Hits	Adult_Hits
Alert Alert	Alert Alert
Classical	Classical
Classic Rock	Classic_Rock
College	College
Country	Country
Emergency Test	Emergency Test
Foreign Language	Foreign_Language
Information	Information
Jazz	Jazz
News	News

Program Type	16 Digit-Character Display
Nostalgia	Nostalgia
Oldies	Oldies
Personality	Personality
Public	Public
Rhythm and Blues	Rhythm_and_Blues
Religious Music	Religious_Music
Religious Talk	Religious_Talk
Rock	Rock
Soft	Soft
Soft Rock	Soft_Rock
Soft Rhythm and Blues	Soft_R_&_B
Sports	Sports
Talk	Talk
Top 40	Top_40
Weather	Weather

By pressing the SEEK button when the PTY icon is displayed, the radio will be tuned to the next frequency station with the same selected PTY name. The PTY function only operates when in the FM mode.

If a preset button is activated while in the PTY (Program Type) mode, the PTY mode will be exited and the radio will tune to the preset station.

SET/DIR Button (Radio Mode) — To Set the Push-Button Memory

When you are receiving a station that you wish to commit to push-button memory, press the SET/DIR button. The symbol SET 1 will now show in the display window. Select the button (1-6) you wish to lock onto this station and press and release that button. If a button is not selected within 5 seconds after pressing the SET/DIR button, the station will continue to play but will not be stored into push-button memory.

You may add a second station to each push-button by repeating the above procedure with this exception: Press the SET/DIR button twice and SET 2 will show in the display window. Each button can be set for SET 1 and SET 2 in both AM and FM. This allows a total of 12 AM, 12 FM and 12 Satellite (if equipped) stations to be stored into push-button memory. The stations stored in SET 2 memory can be selected by pressing the push-button twice.

Every time a preset button is used a corresponding button number will be displayed.

Buttons 1 - 6 (Radio Mode)

These buttons tune the Radio to the stations that you commit to push-button memory {12 AM, 12 FM, and 12 Satellite (if equipped) stations}.

Operation Instructions - (CD MODE for CD Audio Play)

NOTE:

- The ignition switch must be in the ON or ACC position to operate the radio.
- Note: This Radio is capable of playing compact discs (CD), recordable compact discs (CD-R), rewritable compact discs (CD-RW) compact discs with MP3 tracks and multisession compact discs with CD and MP3 tracks.

Inserting Compact Disc(s)

Gently insert one CD into the CD player with the CD label facing up. The CD will automatically be pulled into the CD Player and the CD icon will illuminate on the radio display.

CAUTION!

This CD player will accept 4 3/4 inch (12 cm) discs only. The use of other sized discs may damage the CD player mechanism.

You may eject a disc with the radio OFF.

If you insert a disc with the ignition ON and the radio ON, the unit will switch from radio to CD mode and begin to play when you insert the disc. The display will show the disc number, the track number, and index time in minutes and seconds. Play will begin at the start of track 1.

SEEK Button (CD MODE for CD Audio Play)

Press the right side of the SEEK button for the next selection on the CD. Press the left side of the button to return to the beginning of the current selection, or return to the beginning of the previous selection if the CD is within the first 10 seconds of the current selection.

MUTE Button (CD MODE for CD Audio Play)

Press the MUTE button to cancel the sound from the speakers. "MUTE" will be displayed. Press the MUTE button a second time and the sound from the speakers will return. Rotating the volume control, turning the radio ON/OFF, or turning OFF the ignition will also return the sound from the speakers.

SCAN Button (CD MODE for CD Audio Play)

Press the Scan button to scan through each track on the CD currently playing.

LOAD/EJECT Button (CD Mode for CD Audio Play)**LOAD/ EJECT - Load**

Press the LOAD/ EJECT button and the push-button with the corresponding number where the CD is being loaded. The radio will display PLEASE WAIT and prompt when to INSERT DISC. After the radio displays "LOAD DISC" insert the CD into the player.

Radio display will show "LOADING DISC" when the disc is loading, and "READING DISC" when the radio is reading the disc.

LOAD/ EJECT - Eject

Press the LOAD/ EJECT button and the push-button with the corresponding number where the CD was loaded and the disc will unload and move to the entrance for easy removal.

Radio display will show "EJECTING DISC" when the disc is being ejected and prompt the user to remove the disc.

Press and hold the LOAD/ EJECT button for 5 seconds and all CDs will be ejected from the radio.

If you have ejected a disc and have not removed it within 15 seconds, it will be reloaded. If the CD is not removed, the radio will continue to play the non-removed CD. If the CD is removed and there are other CD's in the radio, the radio will play the next CD after a 2 minute timeout. If the CD is removed and there are no other CD's in the radio, the radio will remain in CD mode and display "INSERT DISC" for 10 seconds. If no discs are inserted within 10 seconds "NO DISCS LOADED" will be displayed.

On some vehicles a disc can be ejected with the radio and ignition OFF.

TIME Button (CD MODE for CD Audio Play)

Press this button to change the display from a large CD playing time display to a small CD playing time display.

RW/FF (CD MODE for CD Audio Play)

Press and hold FF (Fast Forward) and the CD player will begin to fast forward until FF is released or RW or another CD button is pressed. The RW (Rewind) button works in a similar manner.

TUNE Control (CD MODE for CD Audio Play)

Pressing the TUNE control allows the setting of the Tone, Fade, and Balance. See Radio Mode.

AM/FM Button (CD MODE for CD Audio Play)

Switches the Radio into the AM or FM Radio mode.

RND/PTY Button (Random Play Button) (CD MODE for CD Audio Play)

Press this button while the CD is playing to activate Random Play. This feature plays the selections on the compact disc in random order to provide an interesting change of pace.

Press the SEEK button to move to the next randomly selected track.

Press and hold the FF button to fast forward through the tracks. Release the FF button to stop the fast forward feature.

Press the RND button a second time to stop Random Play.

Buttons 1 - 6 (CD MODE for CD Audio Play)

Selects disc positions 1 - 6 for Play/Load/Eject.

Notes On Playing MP3 Files

The radio can play MP3 files, however, acceptable MP3 file recording media and formats are limited. When writing MP3 files, pay attention to the following restrictions.

Supported Media (Disc Types)

The MP3 file recording media supported by the radio are CD-ROM, CD-R and CD-RW.

Supported Medium Formats (File Systems)

The medium formats supported by the radio are ISO 9660 Level 1 and Level 2 and includes the Joliet extension. When reading discs recorded using formats other than ISO 9660 Level 1 and Level 2, the radio may fail to read files properly and may be unable to play the file normally. UDF and Apple HFS formats are not supported.

The radio uses the following limits for file systems:

- Maximum number of directory levels: 15
- Maximum number of files: 255

- Maximum number of folders: 100
- Maximum number of characters in file/folder names:
 - Level 1: 12 (including a separator "." and a 3-character extension)
 - Level 2: 31 (including a separator "." and a 3-character extension)

Multisession disc formats are supported by the radio. Multisession discs may contain combinations of normal CD audio tracks and computer files (including MP3 files). Discs created with an option such as "keep disc open after writing" are most likely multisession discs. The use of multisession for CD audio or MP3 playback may result in longer disc loading times.

Supported MP3 File Formats

The radio will recognize only files with the *.mp3 extension as MP3 files. Non-MP3 files named with the *.mp3

extension may cause playback problems. The radio is designed to recognize the file as an invalid MP3 and will not play the file.

When using the MP3 encoder to compress audio data to an MP3 file, the bit rate and sampling frequencies in the following table are supported. In addition, variable bit rates (VBR) are also supported. The majority of MP3 files use a 44.1 kHz sampling rate and a 192, 160, 128, 96 or VBR bit rates.

MPEG Specification	Sampling Frequency (kHz)	Bit rate (kbps)
MPEG-1 Audio Layer 3	48, 44.1, 32	320, 256, 224, 192, 160, 128, 112, 96, 80, 64, 56, 48, 40, 32
MPEG-2 Audio Layer 3	24, 22.05, 16	160, 128, 144, 112, 96, 80, 64, 56, 48, 40, 32, 24, 16, 8

ID3 Tag information for artist, song title and album title are supported for version 1 ID3 tags. ID3 version 2 is not supported by the radios.

Playlist files are not supported. MP3 Pro files are not supported.

Playback of MP3 Files

When a medium containing MP3 data is loaded, the radio checks all files on the medium. If the medium contains a lot of folders or files, the radio will take more time to start playing the MP3 files.

Loading times for playback of MP3 files may be affected by the following:

- Media - CD-RW media may take longer to load than CD-R media
- Medium formats - Multisession discs may take longer to load than non-multisession discs

- Number of files and folders - Loading times will increase with more files and folders

To increase the speed of disc loading, it is recommended to use CD-R media and single-session discs. To create a single-session disc, enable the Disc at Once option before writing to the disc.

Operation Instructions - (CD Mode for MP3 Audio Play)

SEEK Button (CD Mode for MP3 Play)

Pressing the right side of the SEEK button plays the next MP3 File. Pressing the left side of the SEEK button plays the beginning of the MP3 file. Pressing the button within the first ten seconds plays the previous file.

LOAD/EJECT Button (CD Mode for MP3 Play)

LOAD/ EJECT - Load



Press the LOAD/ EJECT button and the push-button with the corresponding number where the CD is being loaded. The radio will display PLEASE WAIT and prompt when to INSERT DISC. After the radio displays "LOAD DISC" insert the CD into the player.

Radio display will show "LOADING DISC" when the disc is loading.

LOAD/ EJECT - Eject



Press the LOAD/ EJECT button and the push-button with the corresponding number where the CD was loaded and the disc will unload and move to the entrance for easy removal. Radio display will show "EJECTING DISC" when the disc is being ejected and prompt the user to remove the disc.

If you have ejected a disc and have not removed it within 15 seconds, it will be reloaded. If the CD is not removed, the radio will continue to play the non-removed CD. If the CD is removed and there are other CD's in the radio, the radio will play the next CD after a 2 minute timeout. If the CD is removed and there are no other CD's in the radio, the radio will remain in CD mode and display "INSERT DISC" for 2 minutes. After 2 minutes the radio will go to the previous tuner mode.

MSG or INFO Button (CD Mode for MP3 Play)

Press and MSG or INFO button while playing MP3 disc. The radio scrolls through the following TAG information: Song Title, Artist, File Name, and Folder Name (if available).

Press the MSG or INFO button once more to return to "elapsed time" priority mode.

Press and hold the MSG or INFO button while in the message display priority mode or elapsed time display priority mode will display the song title for each file.

RW/FF (CD Mode for MP3 Play)

Press the FF side of the button to move forward through the MP3 selection.

TUNE Control (CD Mode for MP3 Play)

Pressing the TUNE Control allows the adjustment of Tone, Balance, and Fade.

AM/FM Button (CD Mode for MP3 Play)

Switches back to Radio mode.

RND/ PTY Button (CD Mode for MP3 Play)

Pressing this button plays files randomly.

SET/DIR Button (CD Mode for MP3 Play)

Press the SET/DIR Button to display folders, when playing an MP3 discs that have a file/folder structure.

Turn the TUNE control to display available folders or move through available folders. Press the TUNE control to select a folder.

Buttons 1 - 6 (CD Mode for MP3 Play)

Selects disc positions 1 - 6 for Play/Load/Eject.

Operating Instructions - Hands Free Phone (If Equipped)

Refer to Hands Free Phone in Section 3 of the Owner's Manual.

Operating Instructions - Satellite Radio Mode (If Equipped)

Refer to the Satellite Radio section of the Owner's Manual.

Operating Instructions - Video Entertainment System (VES)TM (If Equipped)

Refer to separate Video Entertainment System (VES)TM Guide.

SALES CODE REF — AM/FM/CD (SINGLE-DISC) RADIO WITH OPTIONAL SATELLITE RADIO AND HANDS-FREE PHONE CAPABILITY

NOTE: The radio sales code is located on the lower right side of your radio faceplate.

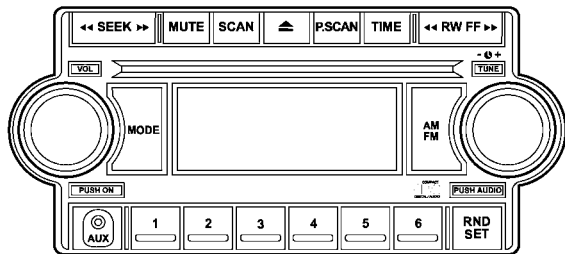

REF Radio

815eb156

Operating Instructions - Radio Mode

NOTE: The ignition switch must be in the ON or ACC position to operate the radio.

Power Switch/Volume Control (Rotary)

Press the ON/VOL control to turn the radio ON. Press the ON/VOL a second time to turn OFF the radio.

4

Electronic Volume Control

The electronic volume control turns continuously (360–degrees) in either direction without stopping. Turning the volume control to the right increases the volume and to the left decreases it.

When the audio system is turned on, the sound will be set at the same volume level as last played.

For your convenience, the volume can be turned down, but not up, when the audio system is OFF and the ignition is ON.

Mode Button (Radio Mode)

Press the MODE button repeatedly to select between the CD player and Satellite Radio (if equipped).

SEEK Button (Radio Mode)

Press and release the SEEK button to search for the next listenable station in either AM/FM or Satellite (if equipped) mode. Press the right side of the button to seek up and the left side to seek down. The radio will remain tuned to the new station until you make another selection. Holding the button will bypass stations without stopping until you release it.

MUTE Button (Radio Mode)

Press the MUTE button to cancel the sound from the speakers. MUTE will display. Press the MUTE button a second time and the sound from the speakers will return. Rotating the volume control, turning the radio ON/OFF, or turning the ignition ON/OFF, will cancel the MUTE feature.

NOTE: In Hands-Free Phone (if equipped) mode, the MUTE button mutes the microphone.

SCAN Button (Radio Mode)

Pressing the SCAN button causes the tuner to search for the next listenable station in either, AM, FM, or Satellite (if equipped) frequencies, pausing for five seconds at each listenable station before continuing to the next. To stop the search, press SCAN a second time.

PSCAN Button (Radio Mode)

Pressing the PSCAN button causes the tuner to scan through preset stations in either, AM, FM, or Satellite (if equipped) frequencies, pausing for five seconds at each preset station before continuing to the next. To stop the search, press PSCAN a second time.

TIME Button

Press the TIME button and the time of day will display for five seconds.

Clock Setting Procedure

1. Press and hold the TIME button until the hours blink.
2. Adjust the hours by turning the TUNE/AUDIO control.
3. After the hours are adjusted, press the TUNE/AUDIO control to set the minutes. The minutes will begin to blink.
4. Adjust the minutes using the TUNE/AUDIO control.
5. To exit, press any button/knob or wait five seconds.

RW/FF (Radio Mode)

Pressing the Rewind/Fast Forward button causes the tuner to search for the next frequency in the direction of the arrows. This feature operates in either AM, FM or Satellite (if equipped) frequencies.

TUNE Control (Radio Mode)

Turn the rotary TUNE control clockwise to increase or counterclockwise to decrease the frequency.

AM/FM Button (Radio Mode)

Press the button to select AM or FM modes.

Setting the Tone, Balance, and Fade

Press the rotary TUNE control, and BASS will display. Turn the TUNE control to the right or left to increase or decrease the Bass tones.

Press the rotary TUNE control a second time and MID will display. Turn the TUNE control to the right or left to increase or decrease the Mid-Range tones.

Press the rotary TUNE control a third time and TREB will display. Turn the TUNE control to the right or left to increase or decrease the Treble tones.

Press the rotary TUNE control a fourth time and BAL will display. Turn the TUNE control to the right or left to adjust the sound level from the right or left side speakers.

Press the rotary TUNE control a fifth time and FADE will display. Turn the TUNE control to the left or right to adjust the sound level between the front and rear speakers.

Press the tune control again or wait five seconds to exit setting tone, balance, and fade.

RND/SET Button (Radio Mode) To Set The Pushbutton Memory

When you are receiving a station that you wish to commit to pushbutton memory, press the SET button. The symbol SET 1 will now show in the display window. Select the button (1-6) you wish to lock onto this station and press and release that button. If a button is not

selected within five seconds after pressing the SET button, the station will continue to play but will not be stored into pushbutton memory.

You may add a second station to each pushbutton by repeating the above procedure with this exception: Press the SET button twice and SET 2 will show in the display window. Each button can be set for SET 1 and SET 2 in both AM and FM. This allows a total of 12 AM, 12 FM, and 12 Satellite (if equipped) stations to be stored into pushbutton memory. The stations stored in SET 2 memory can be selected by pressing the pushbutton twice.

Every time a preset button is used, a corresponding button number will display.

Preset Buttons 1 - 6 (Radio Mode)

These buttons tune the Radio to the stations that you commit to pushbutton memory, 12 AM, 12 FM, and 12 Satellite (if equipped) stations.

Operating Instructions - CD Mode

NOTE: The ignition switch must be in the ON or ACC position to operate the radio.

Inserting The Compact Disc (Single CD Player)

Gently insert one CD into the CD player with the CD label facing up. The CD will automatically be pulled into the CD Player and the CD icon will illuminate on the radio display.

If the volume control is ON, the unit will switch to CD mode and begin to play. The display will show the track number and play time in minutes and seconds. Play will begin at the start of track one.

NOTE:

- On some vehicles, you may insert or eject a disc with the radio or ignition switch OFF.

- If you insert a disc with the ignition ON and the radio OFF, the CD will automatically be pulled into the CD player.
- This radio does not play discs with MP3 tracks.

SEEK Button (CD Mode)

Press the right side of the SEEK button for the next track on the CD. Press the left side of the button to return to the beginning of the current track, or return to the beginning of the previous track if the CD is within the first 10 seconds of the current selection.

MUTE Button (CD Mode)

Press the MUTE button to cancel the sound from the speakers. "MUTE" will display. Press the MUTE button a second time and the sound from the speakers will return. Rotating the volume control or turning the ignition OFF/ON will also return the sound from the speakers.

SCAN Button (CD Mode)

Press this button to play the first 10 seconds of each track. To stop the scan function, press the button a second time.

EJECT Button (CD Mode)

Press this button and the disc will unload and move to the entrance for easy removal. The unit will switch to the last selected mode.

If you do not remove the disc within 15 seconds, it will be reloaded. The radio mode will continue to appear.

TIME Button (CD Mode)

Press this button to change the display from elapsed CD playing time to time of day. The time of day will display for five seconds.

RW/FF (CD Mode)

Press and hold the FF (Fast Forward) and the CD player will begin to fast forward until FF is released. The RW (Rewind) button works in a similar manner.

Press and hold the FF button to fast forward through the tracks. Release the FF button to stop the fast forward feature. If the RW button is pressed, the current track will reverse to the beginning of the track and begin playing.

RND/SET Button (Random Play Button) (CD Mode)

Press this button while the CD is playing to activate Random play. This feature plays the selections on the compact disc in random order to provide an interesting change of pace.

Press the SEEK button to move to the next randomly selected track.

Press the RND button a second time to stop Random play.

Operating Instructions - Auxiliary Mode

The auxiliary (AUX) jack is an audio input jack, which allows the user to plug in a portable device such as an

MP3 player, cassette player, or microphone and utilize the vehicle's audio system to amplify the source and play through the vehicle speakers.

The auxiliary mode becomes active when an electrical device is plugged into the AUX jack using a standard 3.5 mm stereo audio cable and the user presses and releases the MODE button until AUX appears on the display.

NOTE: The radio will return to the last stored mode if the ignition switch is turned from the OFF/LOCK position to the ACC position, the radio is turned on, and the radio was previously in the AUX mode.

SEEK Button (Auxiliary Mode)

No function.

MUTE Button (Auxiliary Mode)

Press the MUTE button to cancel the sound from the speakers. "MUTE" will display. Press the MUTE button a

second time and the sound from the speakers will return. Rotating the volume control or turning the ignition OFF/ON will also return the sound from the speakers.

SCAN Button (Auxiliary Mode)

No function.

EJECT Button (Auxiliary Mode)

No function.



PSCAN Button (Auxiliary Mode)

No function.

TIME Button (Auxiliary Mode)

Press this button to change the display from elapsed playing time to time of day. The time of day will display for five seconds.

RW/FF (Auxiliary Mode)

No function.

RND/SET Button (Auxiliary Mode)

No function.

Mode Button (Auxiliary Mode)

Press the MODE button repeatedly to select between the CD player and Satellite Radio (if equipped).

Operating Instructions - Hands-Free Phone — If Equipped

Refer to the “Hands-Free Phone (UConnect®)” section of this Owner’s Manual.

Operating Instructions - Satellite Radio — If Equipped

Refer to the “Satellite Radio” section of this Owner’s Manual.

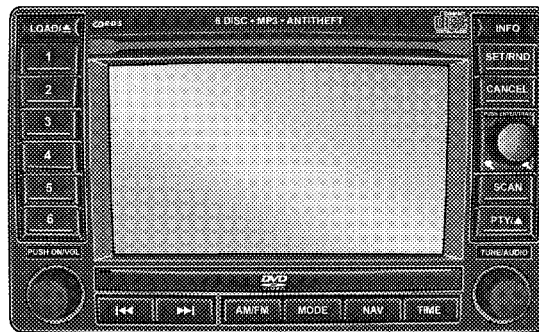
SALES CODE REC — AM/FM/CD (6-DISC) RADIO WITH NAVIGATION SYSTEM

81c704b4

Satellite Navigation Radio and CD Player with MP3 Capability (REC) - combines a Global-Positioning System-based navigation system with an integrated color screen to provide maps, turn identification, selection

menus and instructions for selecting a variety of destinations and routes, AM/FM stereo radio and six-disc CD changer with MP3 capability.

Mapping information for navigation is supplied on a DVD that is loaded into the unit. One map DVD covers all of North America. Refer to your “Navigation User’s Manual” for detailed operating instructions.

Operating Instructions — Satellite Radio — If Equipped

Refer to your “Navigation User’s Manual” for detailed operating instructions.

REC Setting the Clock

GPS Clock

The GPS receiver used in this system is synchronized to the time data being transmitted by the GPS satellites. The satellites’ clock is Greenwich Mean Time (GMT). This is

the worldwide standard for time. This makes the system’s clock very accurate once the appropriate time zone and daylight savings information is set.

1. At the **Main Menu** screen, highlight “Clock Setup” and press ENTER OR press and hold the TIME button on the unit’s faceplate for three seconds. The **Clock Setup** screen appears.

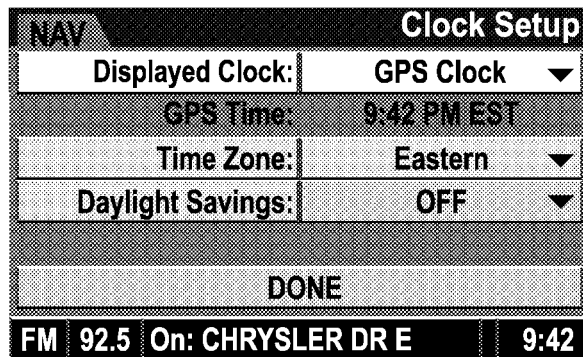

2. To show the GPS clock, select “Displayed Clock: GPS Clock” and press ENTER.
3. To adjust the time zone, Select “Time Zone” and press ENTER. Select the appropriate time zone and press ENTER.
4. To turn daylight savings on or off, select “Daylight Savings” and press ENTER. Select “On” or “Off” and press ENTER.
5. Select DONE to exit from the clock setting mode. Press ENTER to save your changes. If you press CANCEL or NAV then your changes will not be saved.

User Defined Clock

If you wish to set the clock to a time different than the system clock, you can manually adjust the time by choosing the “User Defined Clock” option.

1. At the **Clock Setup** screen highlight “Displayed Clock: User Defined Clock”.

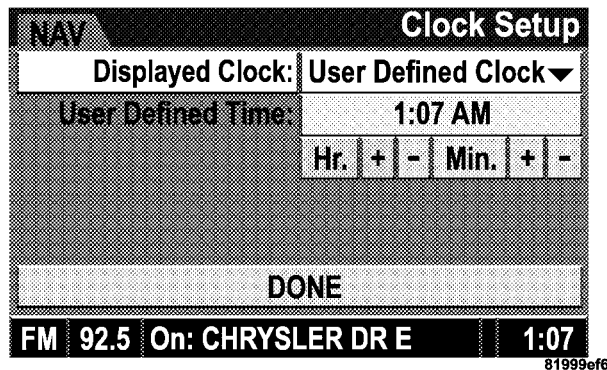

2. To increase the clock by hours, make sure “HR +” is highlighted and press ENTER. Press ENTER again to increase the clock by another hour. You will see on the “User Defined Time” display the number of hours you have increased the clock by.

3. To decrease the clock by one hour, use the Select Encoder to highlight the “-” sign. Press ENTER. Press ENTER again to decrease the clock by another hour.
4. To increase the clock by minutes, make sure “MIN +” is highlighted and press ENTER. Press ENTER again to increase the clock by another minute.
5. To decrease the clock by minutes, use the Select Encoder to highlight the “-” sign. Press ENTER. Press ENTER again to decrease the clock by another minute.
6. Select “DONE” to exit from the clock setting mode. Press ENTER to save your changes. If you press CANCEL or NAV then your changes will not be saved.

SATELLITE RADIO — IF EQUIPPED

Satellite radio uses direct satellite to receiver broadcasting technology to provide clear digital sound, coast to coast. The subscription service provider is Sirius Satellite

Radio. This service offers over 130 channels of music, sports, news, entertainment, and programming for children, directly from its satellites and broadcasting studios.

NOTE: Sirius service is not available in Hawaii and has limited coverage in Alaska.

System Activation

Sirius Satellite Radio service is pre-activated, and you may begin listening immediately to the one year of audio service that is included with the factory-installed satellite radio system in your vehicle. Sirius will supply a welcome kit that contains general information, including how to setup your on-line listening account at no additional charge. For further information, call the toll-free

number 888-539-7474, or visit the Sirius web site at www.sirius.com, or at www.siriuscanada.ca for Canadian residents.

Electronic Serial Number/Sirius Identification Number (ESN/SID)

Please have the following information available when calling:

1. The Electronic Serial Number/Sirius Identification Number (ESN/SID).
2. Your Vehicle Identification Number.

To access the ESN/SID, refer to the following procedure.

ESN/SID Access with REF Radios

With the ignition switch in the ACC position and the radio OFF, press the CD Eject and TIME buttons simultaneously for three seconds. The first four digits of the 12-digit ESN/SID number will display. Press the SEEK UP button to display the next four digits. Continue to

press the SEEK UP button until all 12 ESN/SID digits display. The SEEK DOWN will page down until the first four digits display. The radio will exit the ESN/SID mode when any other button is pushed, the ignition is turned OFF, or five minutes have passed since any button was pushed.

ESN/SID Access with RAQ and RAK Radios

With the ignition switch in the ACC position and the radio OFF, press the CD Eject and TIME buttons simultaneously for three seconds. All twelve ESN/SID numbers will display. The radio will exit the ESN/SID mode when any other button is pushed, the ignition is turned OFF, or five minutes have passed since any button was pushed.

ESN/SID Access with REC Navigation Radios

Please refer to your Navigation User's Manual.

With the ignition in the ACC position and the radio off, press the CD Eject and SET buttons simultaneously until the 12 digits of the ESN/SID appear on the screen.

Selecting Satellite Mode in REF, RAQ, And RAK Radios

Selecting Satellite Mode — REF Radio

Press the MODE button repeatedly until the word "SAT" appears in the display.

A CD may remain in the radio while in the Satellite radio mode.

Selecting Satellite Mode — RAQ and RAK Radio

Press the MODE button repeatedly until the word "SAT" appears in the display.

These radios will also display the current station name and program type. For more information, such as song title and artist, press the MSG or INFO button.

A CD or tape may remain in the radio while in the Satellite radio mode.

Selecting A Channel

Press and release the SEEK or TUNE knob to search for the next channel. Press the top of the button to search up and the bottom of the button to search down. Holding the TUNE button causes the radio to bypass channels until the button is released.

Press and release the SCAN button (if equipped) to automatically change channels every seven seconds. The radio will pause on each channel for seven seconds before moving on to the next channel. The word "SCAN" will appear in the display between each channel change. Press the SCAN button a second time to stop the search.

NOTE: Channels that may contain objectionable content can be blocked. Contact Sirius Customer Care at 888-539-7474 to discuss options for channel blocking or unblocking. Please have your ESN/SID information available.

Storing And Selecting Preset Channels

In addition to the 12 AM and 12 FM preset stations, you may also commit 12 satellite stations to pushbutton memory. These satellite channel preset stations will not erase any AM or FM preset memory stations. Follow the memory preset procedures that apply to your radio.

Using The PTY (Program Type) Button — If Equipped

Follow the PTY button instructions that apply to your radio.

PTY Button SCAN

When the desired program type is obtained, press the SCAN button within five seconds. The radio will play seven seconds of the selected channel before moving to the next channel of the selected program type. Press the SCAN button a second time to stop the search.

NOTE: Pressing the SEEK or SCAN button, while performing a music type scan, will change the channel by

one and stop the search. Pressing a preset memory button during a music type scan will call up the memory channel and stop the search.

PTY Button SEEK

When the desired program is obtained, press the SEEK button within five seconds. The channel will change to the next channel that matches the program type selected.

Satellite Antenna

To ensure optimum reception on vehicles available with a luggage rack, do not place items on the roof around the rooftop antenna location. Metal objects placed within the line of sight of the antenna will cause decreased performance. Larger luggage items should be placed as far forward as possible. Do not place items directly on or above the antenna.

Reception Quality

Satellite reception may be interrupted due to one of the following reasons:

- The vehicle is parked in an underground parking structure or under a physical obstacle.
- Dense tree coverage may interrupt reception.
- Driving under wide bridges or along tall buildings can cause intermittent reception.
- Placing objects over or too close to the antenna can cause signal blockage.

VIDEO ENTERTAINMENT SYSTEM™ (SALES CODE XRV) — IF EQUIPPED

The optional Video Entertainment System (VES)™ consists of a DVD player and LCD (liquid crystal display) screen, a battery-powered remote control, and two headsets. The system is located in the headliner behind the

front row seat. Refer to your VES™ User's Manual for detailed operating instructions.

REMOTE SOUND SYSTEM CONTROLS — IF EQUIPPED

The remote sound system controls are located on the rear surface of the steering wheel. Reach behind the wheel to access the switches.

4

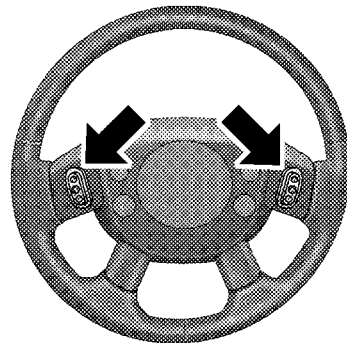

Remote Sound System Controls

The right-hand control is a rocker type switch with a button in the center. Pressing the top of the switch will increase the volume and pressing the bottom of the switch will decrease the volume. The center button of the right-hand control will allow you to change the mode.

The left-hand control is a rocker type switch with a push button in the center. The function of the left-hand control is different, depending on which mode you are in.

The following describes the left-hand control operation in each mode.

Radio Operation

Pressing the top of the left side switch will seek up for the next listenable station and pressing the bottom of the switch will seek down for the next listenable station.

The button located in the center of the left-hand control will tune to the next pre-set station that you have programmed in the radio pre-set push-buttons.

Tape Player

Pressing the top of the switch once will go to the next selection on the cassette. Pressing the bottom of the switch once will go to the beginning of the current selection or to the beginning of the previous selection if it is within the first five seconds of the current selection.

If you press the switch up or down twice it plays the second selection; three times, it will play the third, etc.

The button in the center of the left-hand switch has no function in this mode.

CD Player

Pressing the top of the switch once will go to the next track on the CD. Pressing the bottom of the switch once will go to the beginning of the current track or to the beginning of the previous track if it is within one second after the current track; begins to play.

If you press the switch up or down twice it plays the second track, three times, it will play the third, etc.

The button in the center of the left-hand switch has no function in this mode.

CD/DVD MAINTENANCE

To keep a CD/DVD in good condition, take the following precautions:

1. Handle the disc by its edge; avoid touching the surface.
2. If the disc is stained, clean the surface with a soft cloth, wiping from center to edge.
3. Do not apply paper or tape to the disc; avoid scratching the disc.
4. Do not use solvents such as benzene, thinner, cleaners, or antistatic sprays.

5. Store the disc in its case after playing.

6. Do not expose the disc to direct sunlight.

7. Do not store the disc where temperatures may become too high.

NOTE: If you experience difficulty in playing a particular disc, it may be damaged (i.e. scratched, reflective coating removed, a hair, moisture or dew on the disc) oversized, or have theft protection encoding. Try a known good disc before considering disc player service.

RADIO OPERATION AND CELLULAR PHONES

Under certain conditions, the operation of a cellular phone in your vehicle can cause erratic or noisy performance from your radio. This condition may be lessened or eliminated by relocating the cellular phone antenna. This condition is not harmful to the radio. If your radio performance does not satisfactorily “clear” by the repositioning of the antenna, it is recommended that the radio volume be turned down or off during cellular phone

CLIMATE CONTROLS

The controls for the heating and ventilation system in this vehicle consist of a series of rotary knobs. These comfort controls can be set to obtain desired interior conditions.

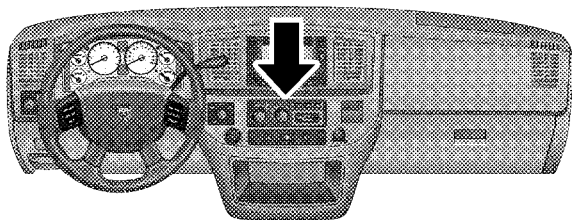

Climate Control Location

8164639b

Heater Only — If Equipped

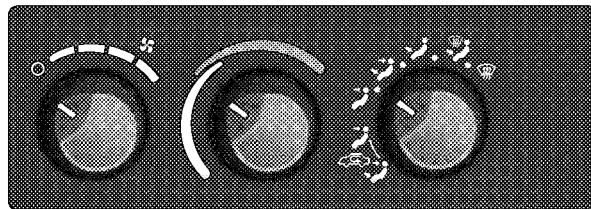

81646397

Manual Heating Controls



816463c5

The mode control (at the right of the control panel) can be set in any of the following positions:

NOTE: To improve your selection choices, the system allows you to operate at intermediate positions between the major modes. These intermediate positions are identified by the small dots.

Panel

 Outside air flows through the outlets located in the instrument panel.

Recirculation Modes (Panel or Bi-Level)

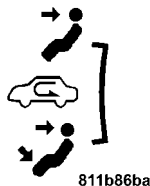

Select the recirculation modes when the outside air contains smoke or odors. This feature allows for recirculation of interior air only. Air flows through the panel outlets in this mode. Air flows through the panel only or through both the panel and floor vents depending on the selected mode (panel vs bi-level).

Bi-Level

 Outside air flows through the outlets located in the instrument panel and at the floor.

Mix

 Outside air flows in equal proportions through the floor and defroster outlets.

Defrost

 Outside air is primarily directed to the windshield through the defroster outlets located at the base of the windshield, and the demister outlets located at the edge of each side of the instrument panel.

Blower Control

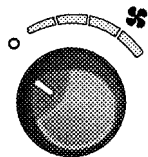

816463cd

The rotary knob on the left of the control panel is the blower control. Turn the knob clockwise to one of the four positions to obtain the blower speed you desire. To turn the blower off, turn the knob to the far left position.

NOTE: For vehicles equipped with Remote Start, the climate controls will not function during Remote Start operation if the blower control is left in the “O” (Off) position.

Temperature Control

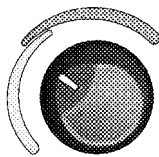

816463c9

The rotary knob at the center of the control panel controls the temperature of the interior air. You can choose your degree of comfort by rotating the knob. The coldest temperature setting is to the extreme left (blue region) and the warmest setting is to the extreme right (red region) of the rotation.

Air Conditioning and Heating — If Equipped

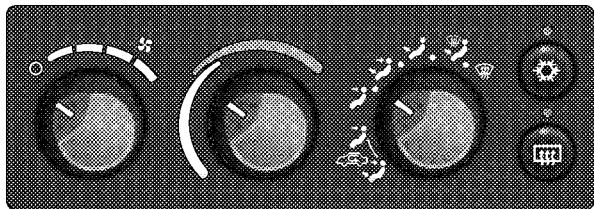

81646393

Air Conditioning And Heating

Air Conditioning Operation



To turn on the air conditioning, set the fan control at any speed and press the snowflake button located at the right of the control panel. Conditioned air will be directed through the

outlets selected by the mode control. A light in the snowflake button shows that the air conditioning is on. Press the button a second time to turn the air conditioning off.

Slight changes in engine speed or power may be noticed when the air conditioning compressor is on. This is a normal occurrence, as the compressor will cycle on and off to maintain comfort and increase fuel economy.

4



816463c5

The mode control (at the right of the control panel) can be set in any of the following positions:

NOTE: To improve your selection choices, the system allows you to operate at intermediate positions between the major modes. These intermediate positions are identified by the small dots.

Recirculation Modes (Panel or Bi-Level)

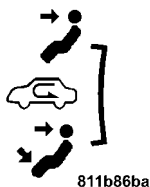

Select the recirculation modes when the outside air contains smoke, odors, high humidity, or if rapid cooling is desired. This feature allows for recirculation of interior air only. Air flows through the panel only or through both the panel and floor vents depending on the selected mode (panel vs bi-level).

depending on the selected mode (panel vs bi-level).

NOTE: Selecting a “Recirculation Mode” mode does not necessarily consume more fuel than normal A/C mode.

Panel

 Outside air flows through the outlets located in the instrument panel.

Bi-Level

 Outside air flows through the outlets located in the instrument panel and at the floor.

Floor

 Outside air flows primarily through the floor outlets located under the instrument panel.

Mix

 Outside air flows in equal proportions through the floor and defroster outlets, and the air conditioning may be on.

Defrost

 Outside air is primarily directed to the windshield through the defroster outlets located at the base of the windshield, and the demister outlets located at the edge of each side of the instrument panel, and the air conditioning may be on.

Blower Control

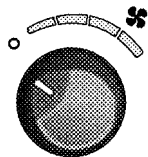

816463cd

The rotary knob on the left of the control panel is the blower control. Turn the knob clockwise to one of the four positions to obtain the blower speed you desire. To turn the blower off, turn the knob to the far left position.

Temperature Control

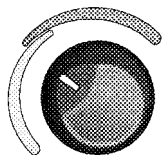

816463c9

The rotary knob at the center of the control panel controls the temperature of the interior air. You can choose your degree of comfort by rotating the knob. The coldest temperature setting is to the extreme left (blue region) and the warmest setting is to the extreme right (red region) of the rotation.

Circulation

The cab is designed with features to promote outside air circulation. There are grilles in the cab back panel. These are air exhausters that provide the means for regular exchange of cab air.

Side window demisters direct air flow specifically to the window glass to help prevent interior fogging of the glass. They are located in the extreme outside upper edges of the instrument panel. The demisters also provide extra air ducts for circulation. They are in operation whenever the Floor, Mix or Defrost modes are in use. To remove frost from the side windows, it is best to use the full defrost mode.

NOTE: When you turn off the engine you may hear a hissing sound from under the hood for a short period of time. This is a normal condition that occurs if the air conditioning system has been on. It is not an indication of a problem with the air conditioning system.

Air Conditioning With Dual Zone Temperature Control — If Equipped

With the Dual Zone Temperature Control System, each front seat occupant can independently control the temperature of air coming from the outlets on their side of the vehicle.

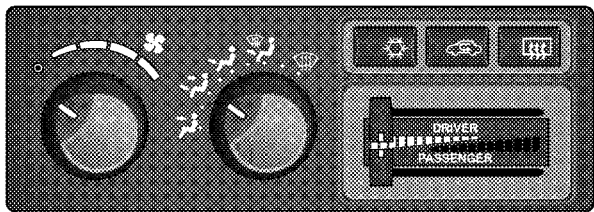

8164638f

Dual Zone Control Head

Air Conditioning and Heating Operation

To turn on the air conditioning, set the fan control at any speed and press the snowflake button located on the control panel. Conditioned air will be directed through the outlets selected by the mode control. A light in the snowflake button shows that the air conditioning is on. Press the button a second time to turn the air conditioning off.

A/C Push-button



80d0bd96

With the fan control in the ON position, pushing the A/C button turns on the air conditioning compressor. An indicator light on the button shows that the air conditioning compressor is on. Conditioned air is now directed through the mode outlets selected.

Pushing the button a second time turns the compressor OFF.

Recirculation Pushbutton



811b86fe

Pushing the Recirculation button allows interior air to recirculate continuously in any position except defrost and defrost/floor mode for rapid cool down of the interior. Refer to “Fast Cooldown” in this section.

Mode Control

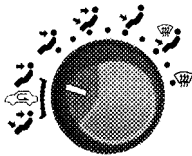

816463c5

The mode control allows you to choose from several patterns of air distribution.

NOTE: To improve your selection choices, the system allows you to operate at intermediate positions between

the major modes. These intermediate positions are identified by the small dots and give an even blend of both modes.

Panel

 Outside air flows through the outlets located in the instrument panel. These outlets can be adjusted to direct the airflow.

Bi-Level

 Air flows through the outlets located in the instrument panel and those located on the floor.

NOTE: There is a difference in temperature between the upper and lower outlets for added comfort. The warmer air goes to the floor outlets. This feature gives improved comfort during sunny but cool conditions.

Heat

 Outside air flows primarily through the floor outlets located under the instrument panel.

Mix

 Outside air flows in equal proportions through the floor and defroster outlets.

Defrost

 Outside air is primarily directed to the windshield through the defroster outlets located at the base of the windshield and side window demist outlets.

NOTE: The air conditioning compressor operates in both Mix and Defrost or a blend of these modes, even if the A/C button has not been pressed. This dehumidifies the air to help dry the windshield.

Blower Control

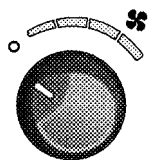

816463cd

The rotary knob on the left of the control panel is the blower control. Turn the knob clockwise to one of the four positions to obtain the blower speed you desire. To turn the blower off, turn the knob to the far left position.

Dual Zone Temperature Control

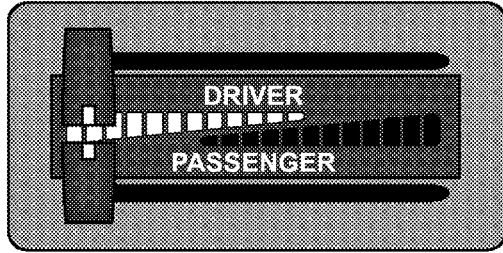

Dual Zone Temperature Control

816463c0

Use this control to regulate the temperature of the air inside the passenger compartment. This is accomplished by having separate temperature control slides for both the driver and front passenger. The blue area of the scale indicates cooler temperatures, while the red area indicates warmer temperatures.

Circulation

The cab is designed with features to promote outside air circulation. There are grilles in the cab back panel. These are air exhausters that provide the means for regular exchange of cab air.

Side window demisters direct air flow specifically to the window glass to help prevent interior fogging of the glass. They are located in the extreme outside upper edges of the instrument panel. The demisters also provide extra air ducts for circulation. They are in operation whenever the Floor, Mix or Defrost modes are in use.

NOTE: When you turn off the engine you may hear a hissing sound from under the hood for a short period of time. This is a normal condition that occurs if the air conditioning system has been on. It is not an indication of a problem with the air conditioning system.

Operating Tips

Fast Cooldown

For a fast cooldown, turn the blower fan rotary knob to the extreme right position, turn the mode control to the panel fresh position, press the snowflake button to turn on the air conditioning, and drive with the windows open for the first few minutes. Once the hot air has been expelled, close the windows and press the recirculation pushbutton on dual zone control, or switch the mode from panel/fresh to panel/recirculate on single zone control. When a comfortable condition has been reached, choose a mode position and adjust the temperature control slide and blower speed as necessary to maintain comfort. For high humidity conditions it may be necessary to remain in the Recirculation mode to maintain comfort.

Window Fogging

Windows will fog on the inside when the humidity inside the vehicle is high. This often occurs in mild or cool temperatures when it's rainy or humid. In most cases turning on the air conditioning (pressing the snowflake button) will clear the fog. Adjust the temperature control, air direction and blower speed to maintain comfort.

As the temperature gets colder it may be necessary to direct air onto the windshield by using the Mix mode position on the control. Adjust the temperature control and blower speed to maintain comfort. Higher blower speeds will reduce fogging. Interior fogging on the windshield can be quickly removed by selecting the defrost mode.

Regular cleaning of the inside of the windows with a non-filming cleaning solution (vinegar and water works very well) will help prevent contaminants (cigarette

smoke, perfumes, etc.) from sticking to the windows. Contaminates increase the rate of window fogging.

Summer Operation

Air conditioned vehicles must be protected with a high quality antifreeze coolant during summer to provide proper corrosion protection and to raise the boiling point of the coolant for protection against overheating. A 50 % concentration is recommended. Refer to "Engine Coolant" under "Fluids, Lubricants and Genuine Parts" in section 7.











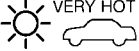











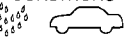





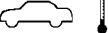





When using the air conditioner in extremely heavy traffic in hot weather, especially when towing a trailer, additional engine cooling may be required. If this situation is encountered, operate the transmission in a lower gear to increase engine RPM, coolant flow and fan speed. When stopped in heavy traffic, it may be necessary to shift into NEUTRAL and depress the accelerator slightly for fast idle operation to increase coolant flow and fan speed.

Your air conditioning system is also equipped with an automatic recirculation system. When the system senses a heavy load or high heat conditions, it may use partial Recirculation A/C mode to provide additional comfort.

Winter Operation

When operating the system during the winter months, make sure the air intake, located directly in front of the windshield, is free of ice, slush, snow, or other obstructions.

Operating Tips Chart

WEATHER	CONTROL SETTINGS
<p>HOT WEATHER AND VEHICLE INTERIOR IS VERY HOT</p> 	<p>Start the vehicle, open the windows and turn the blower control knob to the high position (full clockwise). Set Mode control knob at or between  and . Set temperature control to full cold and press the  button on. After the hot air has been expelled, close the windows and turn the mode control knob to the  setting (counterclockwise) at either  or , or press the  button (if so equipped). Once comfortable, choose a mode position and adjust temperature control and blower speed as necessary for comfort.</p>
<p>WARM WEATHER</p> 	<p>If sunny, set the Mode control at or near  and press the  button on. If cloudy or dark, set the Mode control at or near . No  is necessary.</p>
<p>COOL OR COLD HUMID CONDITIONS</p> 	<p>If sunny, set the Mode control at or between  and , then press the  button on. If cloudy or dark set the Mode control at or near . No  is necessary.</p>
<p>COLD DRY CONDITIONS</p> 	<p>In cloudy or dark weather set the Mode control at or near . If sunny, set the Mode control at or between  and , and for snowy or very cold weather requiring extra heat to the windshield, use .</p>
<p>EXTREME COLD CONDITIONS (DIESEL)</p> 	<p>Using re-circulated air can aid initial warm-up in extreme cold conditions. NOTICE: Running in  /MAX for long periods of time will result in window fogging. When this occurs, use  until windows clear. This will deactivate  /MAX. SINGLE ZONE VEHICLES: Set the mode control at  +  /MAX, close the panel vents and set the temperature control to full hot. Turn blower control knob to low and gradually increase as air and engine temperature increase. DUAL ZONE VEHICLES: Set the mode control at , set both temperature controls to full hot and press the  /MAX button. Turn blower control knob to low and gradually increase as air and engine temperature increase.</p>
<p>WINDOW FOGGING</p>	<p>In most cases turning on the Air-Conditioning (press the  button) will clear the fog, then adjust temperature control, air direction and blower speed to maintain comfort. As it gets colder it may be necessary to direct air onto the windshield. If so, set the Mode control at  or  and adjust temperature control and blower speed to maintain comfort. Higher blower speeds will reduce fogging.</p>

STARTING AND OPERATING

CONTENTS

■ Starting Procedures	221	■ Four-Wheel Drive Operation — If Equipped . . .	230
□ Normal Starting	221	□ Manually Shifted Transfer Case Operating Information/Precautions	230
□ Automatic Transmission	221	□ Shifting Procedure - Manually Shifted Transfer Case	233
□ If Engine Fails To Start	222	□ Transfer Case Reminder Light	234
□ After Starting	223	□ Electronically Shifted Transfer Case Operating Information/Precautions (5 Position Switch) — If Equipped	234
■ Engine Block Heater — If Equipped	223	□ Shifting Procedure — Electronically Shifted Transfer Case	239
■ Automatic Transmission	224		
□ Automatic Transmission With Overdrive	224		

- Electronically Shifted Transfer Case Operating Information/Precautions (4 Position Switch) — If Equipped 242
- Shifting Procedure — Electronically Shifted Transfer Case 246
- Limited-Slip Differential – If Equipped 249
- Driving On Slippery Surfaces 250
- Driving Through Water 250
 - Flowing/Rising Water 250
 - Shallow Standing Water 251
- Power Steering 252
 - Power Steering Fluid Check 253
- Parking Brake 254
- Brake System 255
 - Four-Wheel Anti-Lock Brake System 256
- Tire Safety Information 258
 - Tire Markings 258
 - Tire Identification Number (TIN) 261
 - Tire Loading And Tire Pressure 262
- Tires — General Information 266
 - Tire Pressure 266
 - Tire Inflation Pressures 267
 - Radial Ply Tires 272
 - Tire Spinning 273
 - Tread Wear Indicators 273
 - Life Of Tire 274
 - Replacement Tires 274

- Supplemental Tire Pressure Information —
If Equipped 276
- Tire Chains 276
- Snow Tires 278
- Tire Rotation Recommendations 279
 - Dual Rear Wheels 280
- Fuel Requirements 281
 - 5.7L Gas Engine 281
- Adding Fuel 285
 - Loose Fuel Filler Cap (Gas Cap) Message . . . 286
- Vehicle Loading 287
 - Certification Label 287
- Trailer Towing 289

- Common Towing Definitions 289
- Trailer Hitch Classification 292
- Trailer Towing Weights (Maximum Trailer
Weight Ratings) 293
- Trailer And Tongue Weight 294
- Towing Requirements 295
- Towing Tips 299
- Snowplow 300
 - Before Plowing 301
 - Snowplow Prep Package Model Availability . 302
 - Over The Road Operation With Snowplow
Attached 303
 - Operating Tips 303
 - General Maintenance 303

■ Recreational Towing (Behind Motorhome, Etc.) . 304

□ Recreational Towing –
2-Wheel Drive Models 304

□ Recreational Towing –
4-Wheel Drive Models 305

STARTING PROCEDURES

Before starting your vehicle, adjust your seat, adjust both inside and outside mirrors, and fasten your seat belts.

The starter should not be operated for more than 15-second intervals. Waiting a few seconds between such intervals will protect the starter from overheating.

WARNING!

- **Be sure to turn off the engine and remove the key from the ignition switch if you want to rest or sleep in your vehicle. Accidents can be caused by inadvertently moving the shift lever or by pressing the accelerator pedal. This may cause excessive heat in the exhaust system, resulting in overheating and vehicle fire which may cause serious or fatal injuries.**

(Continued)

WARNING! (Continued)

- **Do not leave children or animals inside parked vehicles in hot weather. Interior heat buildup may cause serious injury or death.**

Normal Starting

Normal starting of either a warm or cold engine is obtained without pumping or depressing the accelerator pedal. Turn the key to the START position and release when the engine starts. If the engine fails to start within 10 seconds, turn the key to the OFF position, wait five seconds, then repeat the starting procedure.

Automatic Transmission

Start the engine with the shift lever in the NEUTRAL or PARK position. Apply the brake before shifting to any driving range.

NOTE: This vehicle is equipped with a transmission shift interlocking system. The brake pedal must be depressed to shift out of PARK.

Tip Start Feature

Do not press the accelerator. Turn the ignition key briefly to START position, and release it. The starter motor will continue to run, but will automatically disengage when the engine is running.

If Engine Fails To Start

If the engine fails to start after you have followed the “Normal Starting” procedure, it may be flooded. Push the accelerator pedal all the way to the floor and hold it there while cranking the engine. This should clear any excess fuel in case the engine is flooded.

CAUTION!

To prevent damage to the starter, do not crank the engine for more than 15 seconds at a time. Wait 10 to 15 seconds before trying again.

WARNING!

- Never pour fuel or other flammable liquids into the throttle body air inlet opening in an attempt to start the vehicle. This could result in a flash fire causing serious personal injury.
- Do not attempt to push or tow your vehicle to get it started. Vehicles equipped with an automatic transmission cannot be started this way. Unburned fuel could enter the catalytic converter and once the engine has started, ignite and damage the converter and vehicle.

(Continued)

WARNING! (Continued)

- If the vehicle has a discharged battery, booster cables may be used to obtain a start from a booster battery or the battery in another vehicle. This type of start can be dangerous if done improperly. Refer to “Jump Starting” in Section 6.

If the engine has been flooded, it may start to run, but not have enough power to continue running when the key is released. If this occurs, continue cranking with the accelerator pedal pushed all the way to the floor. Release the accelerator pedal and the key once the engine is running smoothly.

If the engine shows no sign of starting after two 15-second periods of cranking with the accelerator pedal held to the floor, the “Normal Starting” procedure should be repeated.

After Starting

The idle speed is automatically controlled and will decrease as the engine warms up.

ENGINE BLOCK HEATER — IF EQUIPPED

The engine block heater warms the engine, and permits quicker starts in cold weather. Connect the cord to a standard 110-115 Volt AC electrical outlet with a grounded, three-wire extension cord.

The engine block heater cord is routed under the hood on the driver side of the vehicle. It has a removable cap that is located on the driver’s side of the Integrated Power Module.

WARNING!

Remember to disconnect the cord before driving. Damage to the 110-115 Volt electrical cord could cause electrocution.

AUTOMATIC TRANSMISSION

CAUTION!

Damage to the transmission may occur if the following precautions are not observed:

- Shift into PARK only after the vehicle has come to a complete stop.
- Shift into or out of REVERSE only after the vehicle has come to a complete stop and the engine is at idle speed.
- Do not shift from REVERSE, PARK, or NEUTRAL into any forward gear when the engine is above idle speed.
- Before shifting into any gear, make sure your foot is firmly on the brake pedal.

WARNING!

It is dangerous to move the shift lever out of PARK or NEUTRAL if the engine speed is higher than idle speed. If your foot is not firmly on the brake pedal, the vehicle could accelerate quickly forward or in reverse. You could lose control of the vehicle and hit someone or something. Only shift into gear when the engine is idling normally and when your right foot is firmly on the brake pedal.

Automatic Transmission with Overdrive

The gear shift lever display located in the instrument panel cluster indicates the transmission gear range (the selector is illuminated for night driving). The shift lever is mounted on the right side of the steering column. You must depress the brake pedal to pull the shift lever out of PARK position (Brake Interlock System). To drive, move the shift lever from PARK or NEUTRAL to the desired

DRIVE position. Pull the shift lever toward you when shifting into REVERSE, SECOND, FIRST or PARK, or when shifting out of PARK.

Gear Ranges

DO NOT race the engine when shifting from PARK or NEUTRAL position into another gear range.

PARK

This gear position supplements the parking brake by locking the transmission. The engine can be started in this range. Never use PARK while the vehicle is in motion. Apply the parking brake when leaving the vehicle in this range. Always apply parking brake first, then place the shift lever into the PARK position. On 4-wheel drive vehicles be sure that the transfer case is in a drive position!

WARNING!

- Never use the PARK position as a substitute for the parking brake. Always apply parking brake fully when parked to guard against vehicle movement and possible injury or damage.
- Your vehicle could move and injure you and others if it is not completely in PARK. Check by trying to move the shift lever back and forth without first pulling it toward you after you have set it in PARK. Make sure it is in PARK before leaving the vehicle.

(Continued)

WARNING! (Continued)

- It is dangerous to move the shift lever out of **PARK** or **NEUTRAL** if the engine speed is higher than idle speed. If your foot is not firmly on the brake pedal, the vehicle could accelerate quickly forward or in reverse. You could lose control of the vehicle and hit someone or something. Only shift into gear when the engine is idling normally and when your right foot is firmly on the brake pedal.

REVERSE

Use this range only after the vehicle has come to a complete stop.

NEUTRAL

Shift into **NEUTRAL** when the vehicle is standing for prolonged periods with the engine running. The engine may be started in this range. Set the parking brake if you must leave the vehicle.

DRIVE

This position provides all forward gears, including 3rd gear direct and 4th or 5th gear overdrive (see Overdrive Operation). Use this range for most city and highway driving.

SECOND

Use this position for driving slowly in heavy city traffic or on mountain roads where more precise speed control is desirable. Use it also when climbing long grades, and for engine braking when descending moderately steep grades. To prevent excessive engine speed do not exceed 45 mph (72 km/h) in this range.

FIRST

Use this position for driving up very steep hills and for engine braking at low speeds 20 mph (32 km/h) or less when going downhill. To prevent excessive engine speed, do not exceed 25 mph (40 km/h) in this range.

NOTE: Use caution when operating a heavily loaded vehicle in SECOND or FIRST gear selections in high ambients as torque converter slip can impose significant additional heat load on the cooling system.

Overdrive Operation

The overdrive automatic transmission contains an electronically controlled fourth and fifth (if equipped) speed (Overdrive). The transmission will automatically shift from DRIVE to Overdrive if the following conditions are present:

- the shift lever is in DRIVE;
- the engine coolant has reached normal operating temperature;
- vehicle speed is above approximately 30 mph (48 km/h);
- the “TOW HAUL O/D OFF” switch has not been activated;

- transmission has reached normal operating temperature.

NOTE: If the vehicle is started in extremely cold temperatures, the transmission may not shift into Overdrive and will automatically select the most desirable gear for operation at this temperature. Normal operation will resume when the transmission fluid temperature has risen to a suitable level. Refer to the “Note” under “Torque Converter Clutch” in this section.

If the transmission temperature gets extremely hot, the transmission will automatically select the most desirable gear for operation at this temperature. If the transmission temperature becomes hot enough the TRANS TEMP light may illuminate and the transmission may downshift out of Overdrive until the transmission cools down. After cooldown, the transmission will resume normal operation.

The transmission will downshift from Overdrive to DRIVE if the accelerator pedal is fully depressed at vehicle speeds above approximately 35 mph (56 km/h).

When To Use "TOW HAUL" and "O/D OFF" Modes

When driving in hilly areas, towing a trailer, carrying a heavy load, etc., and frequent transmission shifting occurs, press the "TOW HAUL O/D OFF" button once to select TOW HAUL.

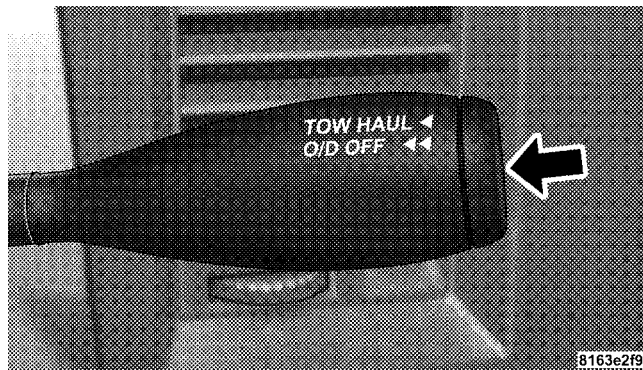

Tow Haul O/D Off Switch

This will improve performance and reduce the potential for transmission overheating or failure due to excessive shifting. When operating in "TOW HAUL" mode, 5th gear (if equipped) is disabled and 2-3 and 3-4 shift patterns are modified. Shifts into Overdrive (4th gear) are allowed during steady cruise (for improved fuel

economy) and automatic closed-throttle downshifts to 3rd gear are performed (for improved braking) when driving conditions warrant. Pressing the “TOW HAUL O/D OFF” button a second time to select O/D OFF will disable 4th and 5th gear completely, which should eliminate any excessive transmission shifting.

The “TOW HAUL” or “O/D OFF” light will illuminate in the instrument cluster to indicate when the switch has been activated. Pressing the switch a third time restores normal operation. If the “TOW HAUL” or “O/D OFF” modes are desired, the button must be pressed each time the engine is started.

Torque Converter Clutch

A feature, designed to improve fuel economy, has been included in the automatic transmission on your vehicle. A clutch within the torque converter engages automatically at calibrated speeds. This may result in a slightly different feeling or response during normal operation in

the upper gears. When the vehicle speed drops or during acceleration when the transmission downshifts to second gear, the clutch automatically disengages.

NOTE:

- The torque converter clutch will not engage until the transmission fluid and engine coolant are warm [usually after 1-3 miles (1.6 - 4.8 km) of driving]. Because the engine speed is higher when the torque converter clutch is not engaged, it may seem as if the transmission is not shifting into Overdrive when cold. This is normal. Pressing the “TOW HAUL O/D OFF” button, when the transmission is sufficiently warm, will demonstrate that the transmission is able to shift into and out of overdrive.
- If the vehicle has not been driven in several days, the first few seconds of operation after shifting the transmission into gear may seem sluggish. This is due to the fluid partially draining from the torque converter into

the transmission. This condition is normal and will not cause damage to the transmission. The torque converter will refill within five seconds of shifting from PARK into any other gear position.

FOUR-WHEEL DRIVE OPERATION — IF EQUIPPED

Four-wheel drive trucks are equipped with either a manually shifted transfer case or an electronically shifted transfer case. Refer to the operating instructions for your transfer case, located in this section.

Manually Shifted Transfer Case Operating Information/Precautions

The transfer case provides 4 mode positions - 2 (rear)-wheel drive high range, 4-wheel drive high range, neutral, and 4-wheel drive low range.

This transfer case is intended to be driven in the 2-wheel drive position (2H) for normal street and highway conditions such as dry, hard surfaced roads.

When additional traction is required, the transfer case 4H and 4L positions can be used to lock the front and rear driveshafts together and force the front and rear wheels to rotate at the same speed. This is accomplished by simply moving the shift lever to the desired positions. The 4H and 4L positions are intended for loose, slippery road surfaces only. Driving in the 4H and 4L positions on dry, hard surfaced roads may cause increased tire wear and damage to the driveline components.

The 4-wheel drive light (4WD), located in the instrument cluster, alerts the driver that the vehicle is in 4-wheel drive and that the front and rear driveshafts are locked together. This light illuminates when the transfer case is shifted to either the 4H or 4L positions. There is no light for the 2H or NEUTRAL positions.

When operating your vehicle in 4L, the engine speed is approximately three times that of the 2H or 4H positions

at a given road speed. Take care not to overspeed the engine and do not exceed 25 mph (40 km/h).

Proper operation of 4-wheel drive vehicles depends on tires of equal size, type and circumference on each wheel. Any difference will adversely affect shifting and can cause damage to the transfer case.

NOTE: Do not attempt to make a shift while only the front or rear wheels are spinning. The transfer case is not equipped with a synchronizer and therefore the front and rear driveshaft speeds must be equal for the shift to take place. Shifting while only the front or rear wheels are spinning can cause damage to the transfer case.

Because 4-wheel drive provides improved traction, there is a tendency to exceed safe turning and stopping speeds. Do not go faster than road conditions permit.

NOTE: Delayed shifts out of four-wheel drive may be experienced due to uneven tire wear, low or uneven tire pressures, excessive vehicle loading, or cold temperatures.

WARNING!

You or others could be injured if you leave the vehicle unattended with the transfer case in the NEUTRAL position without first fully engaging the parking brake. The transfer case NEUTRAL position disengages both the front and rear driveshafts from the powertrain and will allow the vehicle to move regardless of the transmission position. The parking brake should always be applied when the driver is not in the vehicle.

For additional information on the appropriate use of each transfer case mode position see the information below:

2H

Rear Wheel Drive High Range - Normal street and highway driving. Dry hard surfaced roads.

4H

4-Wheel Drive High Range - Locks the front and rear driveshafts together. Forces the front and rear wheels to rotate at the same speed. Additional traction for loose, slippery road surfaces only.

N

NEUTRAL - Disengages both the front and rear driveshafts from the powertrain. To be used for flat towing behind another vehicle. Refer to "Recreational Towing" in this section.

4L

4-Wheel Drive Low Range - Low speed 4-wheel drive. Locks the front and rear driveshafts together. Forces the front and rear wheels to rotate at the same speed. Additional traction and maximum pulling power for loose, slippery road surfaces only. Do not exceed 25 mph (40 km/h).

Shifting Procedure - Manually Shifted Transfer Case

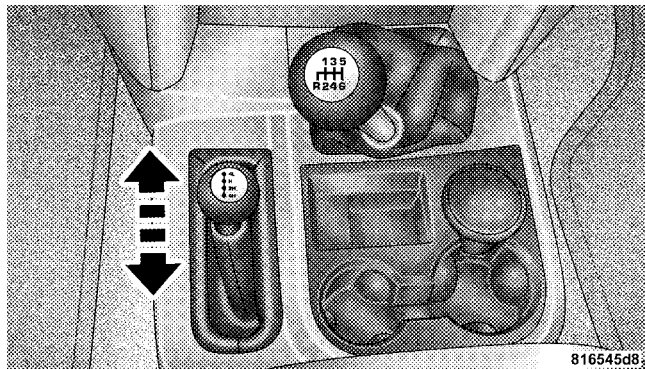

Manual Transfer Case Shifter

2H ⇔ 4H

Shifting between 2H and 4H can be made with the vehicle stopped or in motion. If the vehicle is in motion, shifts can be made up to 55 mph (88 km/h). With the

vehicle in motion, the transfer case will engage/disengage faster if you momentarily release the accelerator pedal after completing the shift. Apply a constant force when shifting the transfer case lever.

2H or 4H ⇔ 4L

With the vehicle rolling at 2 to 3 mph (3 to 5 km/h), shift the transmission into NEUTRAL. While the vehicle is coasting at 2 to 3 mph (3 to 5 km/h), shift the transfer case lever firmly to the desired position. Do not pause in transfer case NEUTRAL.

NOTE:

- Pausing in transfer case NEUTRAL in vehicles equipped with an automatic transmission may require shutting the engine OFF to avoid gear clash while completing the shift. If difficulty occurs, shift automatic transmission to NEUTRAL, hold foot on brake, and turn engine OFF. Make shift to the desired mode.

- Shifting into or out of 4L is possible with the vehicle completely stopped, however difficulty may occur due to the mating clutch teeth not being properly aligned. Several attempts may be required for clutch teeth alignment and shift completion to occur. The preferred method is with the vehicle rolling 2 to 3 mph (3 to 5 km/h). Avoid attempting to engage or disengage 4L with the vehicle moving faster than 2 to 3 mph (3 to 5 km/h).
- Do not attempt to shift to or from 4L while the transmission is in gear.

Transfer Case Reminder Light

The 4-wheel drive operating light (4WD), located in the instrument cluster, is used to alert the driver that the front axle is fully engaged and all four wheels are driving.

Electronically Shifted Transfer Case Operating Information/Precautions (5 Position Switch) — If Equipped

This is an electric shift transfer case and is operated by the 4WD Control Switch (Transfer Case Switch), which is located on the instrument panel.

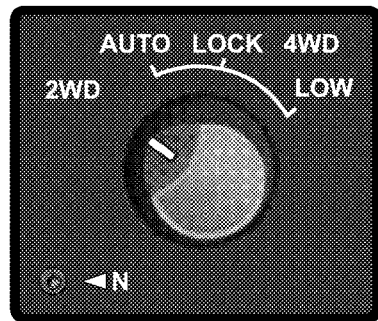

5 Position Switch

This Electronically Shifted transfer case provides 5 mode positions: 2-wheel drive (2WD), 4WD AUTO, 4WD LOCK, NEUTRAL and 4WD LOW.

The Electronically Shifted transfer case is designed to be driven in the 2 wheel drive position (2WD) or 4-wheel drive position (4WD AUTO) for normal street and highway conditions (dry hard surfaced roads). Driving the vehicle in 2WD will have greater fuel economy benefits, as the front axle is not engaged in 2WD.

For variable driving conditions the 4WD AUTO mode can be used. In this mode the front axle is engaged, but the vehicle's power is sent to the rear wheels. 4-wheel drive will be automatically engaged when the vehicle senses a loss of traction. Because the front axle is engaged, this mode will result in lower fuel economy than the 2WD mode.

When additional traction is required, the transfer case 4WD LOCK and 4WD LOW positions can be used to lock the front and rear driveshafts together and force the front and rear wheels to rotate at the same speed. This is accomplished by rotating the 4WD Control Switch to the desired position. Refer to "Shifting Procedure" for specific shifting instructions. The 4WD LOCK and 4WD LOW positions are designed for loose, slippery road surfaces only. Driving in the 4WD LOCK and 4WD LOW positions on dry hard surfaced roads may cause increased tire wear and damage to the driveline components.

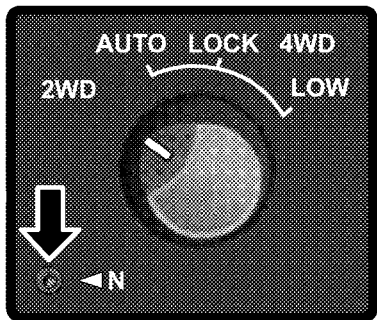

81a42c0a

NEUTRAL Button

NOTE: The transfer case NEUTRAL position is selected by depressing the recessed button located on the lower left hand corner of the 4WD Control Switch. The transfer case NEUTRAL position is to be used for recreational

towing only. Refer to “Recreational Towing” in this section for specific procedures on shifting into and out of NEUTRAL.

Transfer Case Position Indicator Lights — Electronically Shifted Transfer Case Only

Transfer case position indicator lights are located on the instrument cluster and indicate the current and desired transfer case selection. When you select a different transfer case position, the indicator lights will do the following:

If All Shift Conditions are Met

1. The current position indicator light will turn OFF.
2. The selected position indicator light will flash until the transfer case completes the shift.
3. When the shift is complete, the indicator light for the selected position will stop flashing and remain ON.

If One or More Shift Conditions are not Met

1. The indicator light for the current position will remain ON.
2. The newly selected position indicator light will continue to flash.
3. The transfer case **will not** shift.

NOTE: Before retrying a selection, make certain that all the necessary requirements for selecting a new transfer case position have been met. To retry the selection, turn the control knob back to the current position, wait five seconds, and retry selection. To find the shift requirements, refer to the "Shifting Procedure" for your transfer case, located in this section of the owner's manual.

The "SERVICE 4WD" warning light monitors the electric shift 4WD system. If this light remains on after engine

start up or illuminates during driving, it means that the 4WD system is not functioning properly and that service is required.

WARNING!

Always engage the parking brake when powering down the vehicle if the "Service 4WD" light is illuminated. Not engaging the parking brake may allow the vehicle to roll which may cause personal injury.

NOTE: Do not attempt to make a shift while only the front or rear wheels are spinning. This could cause damage to driveline components.

When operating your vehicle in 4WD LOW, the engine speed is approximately three times that of the 2WD, 4WD AUTO or 4WD LOCK positions at a given road speed. Take care not to overspeed the engine and do not exceed 25 mph (40 km/h).

Proper operation of 4-wheel drive vehicles depends on tires of equal size, type and circumference on each wheel. Any difference in tire size can cause damage to the transfer case.

Because 4-wheel drive provides improved traction, there is a tendency to exceed safe turning and stopping speeds. Do not go faster than road conditions permit.

WARNING!

You or others could be injured if you leave the vehicle unattended with the transfer case in the NEUTRAL position without first fully engaging the parking brake. The transfer case NEUTRAL position disengages both the front and rear driveshafts from the powertrain and will allow the vehicle to move regardless of the transmission position. The parking brake should always be applied when the driver is not in the vehicle.

For additional information on the appropriate use of each transfer case mode position see the information below:

2WD

Rear-Wheel Drive High Range - Normal street and highway driving. Dry hard surfaced roads.

4WD AUTO

Automatic 4-wheel drive sends power to the rear wheels. 4-wheel drive will be automatically engaged when the vehicle senses a loss of traction. Additional traction for varying road conditions.

4WD LOCK

4-Wheel Drive Lock Range - Locks the front and rear driveshafts together. Forces the front and rear wheels to rotate at the same speed. Additional traction for loose, slippery road surfaces only.

4WD LOW

4-Wheel Drive Low Range - Low speed 4-wheel drive. Locks the front and rear driveshafts together. Forces the front and rear wheels to rotate at the same speed. Additional traction and maximum pulling power for loose, slippery road surfaces only. Do not exceed 25 mph (40 km/h).

N

NEUTRAL - Disengages both the front and rear driveshafts from the powertrain. To be used for flat towing behind another vehicle. Refer to "Recreational Towing" in this section for more information.

Shifting Procedure — Electronically Shifted Transfer Case

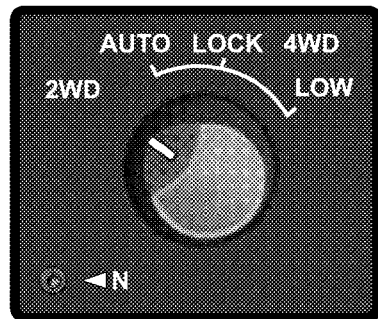

5 Position Switch

81a42c06

NOTE:

- If any of the requirements to select a new transfer case position have not been met, the transfer case will not shift. The indicator light for the previous position will

remain ON and the newly selected position indicator light will continue to flash until all the requirements for the selected position have been met. To retry a shift: return the control knob back to the original position, make certain all shift requirements have been met, wait five seconds and try the shift again.

- If all the requirements to select a new transfer case position have been met, the current position indicator light will turn OFF, the selected position indicator light will flash until the transfer case completes the shift. When the shift is complete, the indicator light for the selected position will stop flashing and remain ON.

2WD ⇔ 4WD AUTO or 4WD LOCK

Rotate the 4WD Control Switch to the desired position. Shifts between 2WD and 4WD AUTO and 4WD LOCK can be done with the vehicle stopped or in motion. With the vehicle in motion, the transfer case will engage/

disengage faster if you momentarily release the accelerator pedal after turning the control switch. If the vehicle is stopped, the ignition key must be in the ON position with the engine either RUNNING or OFF. This shift cannot be completed if the key is in the accessory position.

2WD or 4WD AUTO or 4WD LOCK ⇔ 4WD LOW

NOTE: When shifting into or out of 4WD LOW some gear noise may be heard. This noise is normal and is not detrimental to the vehicle or occupants.

Shifting can be performed with the vehicle rolling 2 to 3 mph (3 to 5 km/h) or completely stopped. USE EITHER OF THE FOLLOWING PROCEDURES:

Preferred Procedure

1. With engine RUNNING, slow vehicle to 2 to 3 mph (3 to 5 km/h).
2. Shift the transmission into NEUTRAL.

3. While still rolling, rotate the transfer case control switch to the desired position.
4. After the desired position indicator light is ON (not flashing), shift transmission back into gear.

Alternate Procedure

1. Bring the vehicle to complete stop.
2. With the key ON and the engine either OFF or RUNNING, shift the transmission into NEUTRAL.
3. Rotate the transfer case control switch to the desired position.
4. After the desired position indicator light is ON (not flashing), shift transmission back into gear.

NOTE:

- If steps 1 or 2 of either the Preferred or Alternate Procedure are not satisfied prior to attempting the shift or if they no longer are being met while the shift attempt is in process then the desired position indicator light will flash continuously while the original position indicator light is ON, until all requirements have been met.
- The ignition key must be ON for a shift to take place and for the position indicator lights to be operable. If the key is not ON then the shift will not take place and no position indicator lights will be on or flashing.
- If you are leaving your vehicle stored for longer than 21 days, refer to the section on "Vehicle Storage."

Electronically Shifted Transfer Case Operating Information/Precautions (4 Position Switch) — If Equipped

This is an electric shift transfer case and is operated by the 4WD Control Switch (Transfer Case Switch), which is located on the instrument panel.

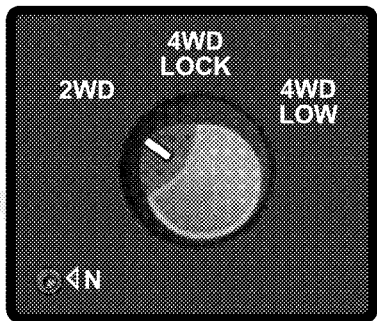

Transfer Case Switch

81a4283e

This Electronically Shifted transfer case provides four mode positions: 2 (rear)-wheel drive high range, 4-wheel drive lock range, 4-wheel drive low range, and NEUTRAL.

The Electronically Shifted transfer case is designed to be driven in the 2-wheel drive position (2WD) for normal street and highway conditions (dry, hard surfaced roads).

When additional traction is required, the transfer case 4WD LOCK and 4WD LOW positions can be used to lock the front and rear driveshafts together and force the front and rear wheels to rotate at the same speed. This is accomplished by rotating the 4WD Control Switch to the desired position. Refer to "Shifting Procedure" for specific shifting instructions. The 4WD LOCK and 4WD LOW positions are designed for loose, slippery road surfaces only. Driving in the 4WD LOCK and 4WD LOW

positions on dry hard surfaced roads may cause increased tire wear and damage to the driveline components.

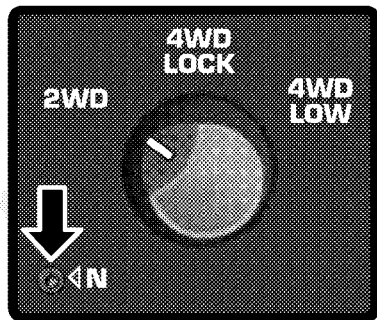

81977fda

NEUTRAL Button

NOTE: The transfer case NEUTRAL position is selected by depressing the recessed button located on the lower left hand corner of the 4WD Control Switch. The transfer

case NEUTRAL position is to be used for recreational towing only. Refer to “Recreational Towing” in this section.

Transfer Case Position Indicator Lights — Electronically Shifted Transfer Case Only

Transfer case position indicator lights are located in the instrument cluster and indicate the current and desired transfer case selection. When you select a different transfer case position, the indicator lights will do the following:

5

If All Shift Conditions Are Met:

1. The current position indicator light will turn OFF.
2. The selected position indicator light will flash until the transfer case completes the shift.
3. When the shift is complete, the indicator light for the selected position will stop flashing and remain ON.

If One or More Shift Conditions Are Not Met:

1. The indicator light for the current position will remain ON.
2. The newly selected position indicator light will continue to flash.
3. The transfer case **will not** shift.

NOTE: Before retrying a selection, make certain that all the necessary requirements for selecting a new transfer case position have been met. To retry the selection, turn the control knob back to the current position, wait five seconds, and retry selection. To find the shift requirements, refer to the "Shifting Procedure" for your transfer case, located in this section of the owner's manual.

The "SERVICE 4WD" warning light monitors the electric shift 4WD system. If this light remains on after engine

start up or illuminates during driving, it means that the 4WD system is not functioning properly and that service is required.

WARNING!

Always engage the parking brake when powering down the vehicle if the "SERVICE 4WD" light is illuminated. Not engaging the parking brake may allow the vehicle to roll, which may cause personal injury.

NOTE: Do not attempt to make a shift while only the front or rear wheels are spinning, as this can cause damage to driveline components.

When operating your vehicle in 4WD LOW, the engine speed is approximately three times that of the 2WD or

4WD LOCK positions at a given road speed. Take care not to overspeed the engine and do not exceed 25 mph (40 km/h).

Proper operation of 4-wheel drive vehicles depends on tires of equal size, type and circumference on each wheel. Any difference in tire size can cause damage to the transfer case.

Because 4-wheel drive provides improved traction, there is a tendency to exceed safe turning and stopping speeds. Do not go faster than road conditions permit.

WARNING!

You or others could be injured if you leave the vehicle unattended with the transfer case in the NEUTRAL position without first fully engaging the parking brake. The transfer case NEUTRAL position disengages both the front and rear driveshafts from the powertrain and will allow the vehicle to move regardless of the transmission position. The parking brake should always be applied when the driver is not in the vehicle.

For additional information on the appropriate use of each transfer case mode position see the information below:

2WD

Rear Wheel Drive High Range - Normal street and highway driving. Dry, hard surfaced roads.

4WD LOCK

4-Wheel Drive Lock Range - Locks the front and rear driveshafts together. Forces the front and rear wheels to rotate at the same speed. Additional traction for loose, slippery road surfaces only.

4WD LOW

4-Wheel Drive Low Range - Low speed 4-wheel drive. Locks the front and rear driveshafts together. Forces the front and rear wheels to rotate at the same speed. Additional traction and maximum pulling power for loose, slippery road surfaces only. Do not exceed 25 mph (40 km/h).

N

Neutral - Disengages both the front and rear driveshafts from the powertrain. To be used for flat towing behind another vehicle. Refer to "Recreational Towing" in this section for more information.

Shifting Procedure — Electronically Shifted Transfer Case

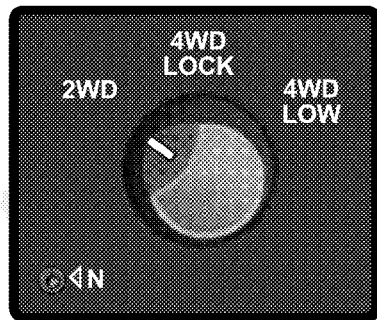

81a4283e

Transfer Case Switch

NOTE:

- If any of the requirements to select a new transfer case position have not been met, the transfer case will not shift. The indicator light for the previous position will

remain ON and the newly selected position indicator light will continue to flash until all the requirements for the selected position have been met. To retry a shift: return the control knob back to the original position, make certain all shift requirements have been met, wait five seconds and try the shift again.

- If all the requirements to select a new transfer case position have been met, the current position indicator light will turn OFF, the selected position indicator light will flash until the transfer case completes the shift. When the shift is complete, the indicator light for the selected position will stop flashing and remain ON.

2WD ⇔ 4WD LOCK

Rotate the 4WD control switch to the desired position. Shifts between 2WD and 4WD LOCK can be done with the vehicle stopped or in motion. With the vehicle in motion, the transfer case will engage/disengage faster if

you momentarily release the accelerator pedal after turning the control switch. If the vehicle is stopped, the ignition key must be in the ON position with the engine either running or off. This shift cannot be completed if the key is in the ACC position.

NOTE: The 4x4 system will not allow shifts between 2WD/4WD LOCK if the front and/or rear wheels are spinning (no traction). In this situation the selected position indicator light will flash and the original position indicator light will remain ON. At this time, reduce speed and stop spinning the wheels to complete the shift.

2WD or 4WD LOCK ⇔ 4WD LOW

NOTE: When shifting into or out of 4WD LOW some gear noise may be heard. This noise is normal and is not detrimental to the vehicle or occupants.

Shifting can be performed with the vehicle rolling 2 to 3 mph (3 to 5 km/h) or completely stopped. USE EITHER OF THE FOLLOWING PROCEDURES:

Preferred Procedure

1. With engine running, slow vehicle to 2 to 3 mph (3 to 5 km/h).
2. Shift the transmission into NEUTRAL.
3. While still rolling, rotate the transfer case control switch to the desired position.
4. After the desired position indicator light is ON (not flashing), shift transmission back into gear.

Alternate Procedure

1. Bring the vehicle to complete stop.
2. With the key ON and the engine either OFF or running, shift the transmission into NEUTRAL.

3. Rotate the transfer case control switch to the desired position.
4. After the desired position indicator light is ON (not flashing), shift transmission back into gear.

NOTE:

- If steps 1 or 2 of either the Preferred or Alternate Procedure are not satisfied prior to attempting the shift then the desired position indicator light will flash continuously while the original position indicator light is ON, until all requirements have been met.
- The ignition key must be ON for a shift to take place and for the position indicator lights to be operable. If the key is not ON then the shift will not take place and no position indicator lights will be on or flashing.
- If you are leaving your vehicle stored for longer than 21 days, refer to the section on "Vehicle Storage."

LIMITED-SLIP DIFFERENTIAL – IF EQUIPPED

The limited-slip differential provides additional traction on snow, ice, mud, sand and gravel, particularly when there is a difference between the traction characteristics of the surface under the right and left rear wheels. During normal driving and cornering, the limited-slip unit performs similarly to a conventional differential. On slippery surfaces, however, the differential delivers more of the driving effort to the rear wheel having the better traction.

The limited-slip differential is especially helpful during slippery driving conditions. With both rear wheels on a slippery surface, a slight application of the accelerator will supply maximum traction. When starting with only one rear wheel on an excessively slippery surface, slight momentary application of the parking brake may be necessary to gain maximum traction.

WARNING!

On vehicles equipped with a limited-slip differential never run the engine with one rear wheel off the ground since the vehicle may drive through the rear wheel remaining on the ground. You could lose control of the vehicle.

Care should be taken to avoid sudden accelerations when both rear wheels are on a slippery surface. This could cause both rear wheels to spin, and allow the vehicle to slide sideways on the crowned surface of a road or in a turn.

DRIVING ON SLIPPERY SURFACES

When driving on wet or slushy roads, it is possible for a wedge of water to build up between the tire and road surface. This is known as hydroplaning and may cause partial or complete loss of vehicle control and stopping ability. To reduce this possibility, the following precautions should be observed:

1. Slow down during rainstorms or when roads are slushy.
2. Slow down if the road has standing water or puddles.
3. Replace tires when tread wear indicators first become visible.
4. Keep tires properly inflated.
5. Maintain sufficient distance between your vehicle and the car in front of you to avoid a collision in a sudden stop.

DRIVING THROUGH WATER

Driving through water more than a few inches/centimeters deep will require extra caution to ensure safety and prevent damage to your vehicle.

Flowing/Rising Water

WARNING!

Do not drive on or cross a road or a path where water is flowing and/or rising (as in storm run-off). Flowing water can wear away the road or path's surface and cause your vehicle to sink into deeper water. Furthermore, flowing and/or rising water can carry your vehicle away swiftly. Failure to follow this warning may result in injuries that are serious or fatal to you, your passengers, and others around you.

Shallow Standing Water

Although your vehicle is capable of driving through shallow standing water, consider the following Caution and Warning before doing so.

CAUTION!

- Always check the depth of the standing water before driving through it. Never drive through standing water that is deeper than the bottom of the tire rims mounted on the vehicle.
- Determine the condition of the road or the path that is under water and if there are any obstacles in the way before driving through the standing water.
- Do not exceed 5 mph (8 km/h) when driving through standing water. This will minimize wave effects.

(Continued)

CAUTION! (Continued)

- Driving through standing water may cause damage to your vehicle's drivetrain components. Always inspect your vehicle's fluids (i.e., engine oil, transmission/transaxle, axle, etc.) for signs of contamination (i.e., fluid that is milky or foamy in appearance) after driving through standing water. Do not continue to operate the vehicle if any fluid appears contaminated, as this may result in further damage. Such damage is not covered by the New Vehicle Limited Warranty.
- Getting water inside your vehicle's engine can cause it to lock up and stall out, and cause serious internal damage to the engine. Such damage is not covered by the New Vehicle Limited Warranty.

WARNING!

- Driving through standing water limits your vehicle's traction capabilities. Do not exceed 5 mph (8 km/h) when driving through standing water.
- Driving through standing water limits your vehicle's braking capabilities, which increases stopping distances. Therefore, after driving through standing water, drive slowly and lightly press on the brake pedal several times to dry the brakes.
- Getting water inside your vehicle's engine can cause it to lock up and stall out, and leave you stranded.
- Failure to follow these warnings may result in injuries that are serious or fatal to you, your passengers, and others around you.

POWER STEERING

The standard power steering system will give you good vehicle response and increased ease of maneuverability in tight spaces. The system will provide mechanical steering capability if power assist is lost.

If for some reason the power assist is interrupted, it will still be possible to steer your vehicle. Under these conditions, you will observe a substantial increase in steering effort, especially at very low vehicle speeds and during parking maneuvers.

NOTE: Increased noise levels at the end of the steering wheel travel are considered normal and do not indicate that there is a problem with the power steering system.

Upon initial start-up in cold weather, the power steering pump may make noise for a short amount of time. This is due to the cold, thick fluid in the steering system. This noise should be considered normal, and it does not in any way damage the steering system.

WARNING!

Continued operation with reduced power steering assist could pose a safety risk to yourself and others. Service should be obtained as soon as possible.

CAUTION!

Prolonged operation of the steering system at the end of the steering wheel travel will increase the steering fluid temperature and it should be avoided when possible. Damage to the power steering pump may occur.

Power Steering Fluid Check

Checking the power steering fluid level at a defined service interval is not required. The fluid should only be checked if a leak is suspected, abnormal noises are

apparent, and/or the system is not functioning as anticipated. Coordinate inspection efforts through an authorized dealer.

No chemical flushes should be used in any power steering system; only the approved lubricant may be used.

WARNING!

Fluid level should be checked on a level surface and with the engine off to prevent injury from moving parts and to ensure accurate fluid level reading. Do not overfill. Use only manufacturer's recommended power steering fluid.

If necessary, add fluid to restore to the proper indicated level. With a clean cloth, wipe any spilled fluid from all surfaces. Refer to "Fluids, Lubricants, and Genuine Parts" in Section 7 for the correct fluid type.

PARKING BRAKE

The foot-operated parking brake is positioned below the lower left corner of the instrument panel. To release the parking brake, pull the parking brake release handle.

NOTE: The instrument cluster red brake warning light will come on and flash to indicate that the parking brake is applied. You must be sure that the parking brake is fully applied before leaving the vehicle.

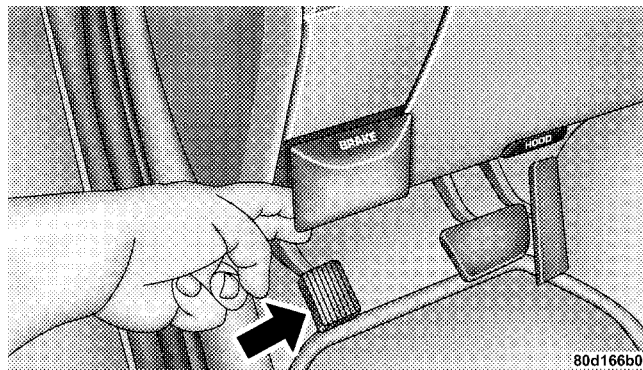

Parking Brake

Be sure the parking brake is firmly set when parked and the shift lever is in the PARK position. When parking on a hill you should apply the parking brake before placing the shift lever in PARK, otherwise the load on the transmission locking mechanism may make it difficult to move the shift lever out of PARK.

WARNING!

- Always fully apply the parking brake when leaving your vehicle, or it may roll and cause damage or injury. Also be certain to leave the transmission in PARK. Failure to do so may allow the vehicle to roll and cause damage or injury.
- Never leave children alone in a vehicle. Leaving unattended children in a vehicle is dangerous for a number of reasons. A child or others could be seriously or fatally injured. Do not leave the key in the ignition. A child could operate power windows, other controls, or move the vehicle.
- Be sure the parking brake is fully disengaged before driving, failure to do so can lead to brake problems due to excessive heating of the rear brakes.

When parking on a hill, turn the front wheels toward the curb on a downhill grade and away from the curb on an uphill grade.

The parking brake should always be applied whenever the driver is not in the vehicle.

BRAKE SYSTEM

If power assist is lost for any reason (for example, repeated brake applications with the engine off), the brakes will still function. However, you will experience a substantial increase in braking effort to stop the vehicle.

If either the front or rear hydraulic systems lose normal capability, the remaining system will still function with some loss of overall braking effectiveness. This will be evident by increased pedal travel during application, greater pedal force required to slow or stop, and activation of the BRAKE warning light and the ABS light (if equipped) during brake use.

Four-Wheel Anti-Lock Brake System

WARNING!

- Anti-Lock Brake Systems (ABS) contain sophisticated electronic equipment. It may be susceptible to interference caused by improperly installed or high output radio transmitting equipment. This interference can cause possible loss of anti-lock braking capability. Installation of such equipment should be performed by qualified professionals.
- ABS cannot prevent the natural laws of physics from acting on the vehicle, nor can it increase braking or steering efficiency beyond that afforded by the condition of the vehicle brakes and tires or the traction afforded.

(Continued)

WARNING! (Continued)

- The ABS cannot prevent accidents, including those resulting from excessive speed in turns, following another vehicle too closely, or hydroplaning. Only a safe, attentive, and skillful driver can prevent accidents.
- The capabilities of an ABS equipped vehicle must never be exploited in a reckless or dangerous manner which could jeopardize the user's safety or the safety of others.

This ABS is designed to aid the driver in maintaining vehicle control under adverse braking conditions. The system operates with a separate computer to modulate hydraulic pressure to prevent wheel lockup and help avoid skidding on slippery surfaces.

The system's pump motor runs during an ABS stop to provide regulated hydraulic pressure. The pump motor makes a low humming noise during operation. This is normal.

When you are in a severe braking condition involving use of the ABS, you will experience some pedal drop as the vehicle comes to a complete stop. This is the result of the system reverting to the base brake system and is normal.

Engagement of the ABS may be accompanied by a pulsing sensation in the brake pedal. You may also hear a clicking noise. These occurrences are normal, and indicate that the system is functioning.

ABS Warning Light

The ABS includes an amber warning light, located in the instrument cluster. When the light is illuminated, the ABS is not functioning. The system reverts to standard non-anti-lock brakes.

WARNING!

Pumping of the anti-lock brakes will diminish their effectiveness and may lead to an accident. Pumping makes the stopping distance longer. Just press firmly on your brake pedal when you need to slow down or stop.

TIRE SAFETY INFORMATION

Tire Markings

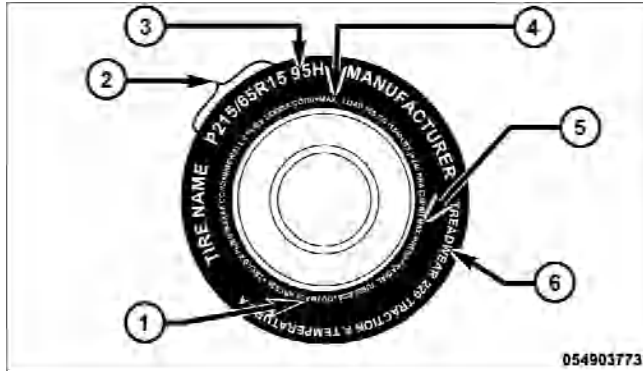

1 — U.S. DOT Safety Standards Code (TIN)

2 — Size Designation

3 — Service Description

4 — Maximum Load

5 — Maximum Pressure

6 — Treadwear, Traction and Temperature Grades

NOTE:

- P (Passenger) - Metric tire sizing is based on U.S. design standards. P-Metric tires have the letter “P” molded into the sidewall preceding the size designation. Example: P215/65R15 95H.
- European-Metric tire sizing is based on European design standards. Tires designed to this standard have the tire size molded into the sidewall beginning with the section width. The letter “P” is absent from this tire size designation. Example: 215/65R15 96H.
- LT (Light Truck) - Metric tire sizing is based on U.S. design standards. The size designation for LT-Metric tires is the same as for P-Metric tires except for the letters “LT” that are molded into the sidewall preceding the size designation. Example: LT235/85R16.
- Temporary spare tires are high-pressure compact spares designed for temporary emergency use only. Tires designed to this standard have the letter “T”

molded into the sidewall preceding the size designation. Example: T145/80D18 103M.

- High flotation tire sizing is based on U.S. design standards and it begins with the tire diameter molded into the sidewall. Example: 31x10.5 R15 LT.

Tire Sizing Chart

EXAMPLE:	
Size Designation:	
P	Passenger car tire size based on U.S. design standards
"... blank ..."	Passenger car tire based on European design standards
LT	Light truck tire based on U.S. design standards
T	Temporary spare tire
31	Overall diameter in inches (in)
215	Section width in millimeters (mm)
65	Aspect ratio in percent (%) — Ratio of section height to section width of tire
10.5	Section width in inches (in)
R	Construction code — "R" means radial construction — "D" means diagonal or bias construction
15	Rim diameter in inches (in)

EXAMPLE:**Service Description:**

95 = Load Index

— A numerical code associated with the maximum load a tire can carry

H = Speed Symbol

— A symbol indicating the range of speeds at which a tire can carry a load corresponding to its load index under certain operating conditions

— The maximum speed corresponding to the speed symbol should only be achieved under specified operating conditions (i.e., tire pressure, vehicle loading, road conditions, and posted speed limits)

Load Identification:

"...blank..." = Absence of any text on the sidewall of the tire indicates a Standard Load (SL) tire

Extra Load (XL) = Extra load (or reinforced) tire

Light Load = Light load tire

C, D, E = Load range associated with the maximum load a tire can carry at a specified pressure

Maximum Load — Maximum load indicates the maximum load this tire is designed to carry

Maximum Pressure — Maximum pressure indicates the maximum permissible cold tire inflation pressure for this tire

Tire Identification Number (TIN)

The TIN may be found on one or both sides of the tire, however, the date code may only be on one side. Tires with white sidewalls will have the full TIN, including the date code, located on the white sidewall side of the tire.

Look for the TIN on the outboard side of black sidewall tires as mounted on the vehicle. If the TIN is not found on the outboard side, then you will find it on the inboard side of the tire.

EXAMPLE:	
DOT MA L9 ABCD 0301	
DOT	= Department of Transportation — This symbol certifies that the tire is in compliance with the U.S. Department of Transportation tire safety standards and is approved for highway use
MA	= Code representing the tire manufacturing location (two digits)
L9	= Code representing the tire size (two digits)
ABCD	= Code used by the tire manufacturer (one to four digits)
03	= Number representing the week in which the tire was manufactured (two digits) —03 means the 3rd week.
01	= Number representing the year in which the tire was manufactured (two digits) —01 means the year 2001 — Prior to July 2000, tire manufacturers were only required to have one number to represent the year in which the tire was manufactured. Example: 031 could represent the 3rd week of 1981 or 1991

Tire Loading and Tire Pressure

Tire Placard Location

NOTE: The proper cold tire inflation pressure is listed on the driver's side B-Pillar.

Tire and Loading Information Placard

TIRE AND LOADING INFORMATION

SEATING CAPACITY - TOTAL 5 FRONT 2 REAR 3

THE COMBINED WEIGHT OF OCCUPANTS AND CARGO SHOULD NEVER EXCEED XXX KG OR XXX LBS.

TIRE	FRONT	REAR	SPARE
ORIGINAL TIRE SIZE	P195/70R14	P195/70R14	T125/70D15
COLD TIRE INFLATION PRESSURE	200kPa, 29PSI	200kPa, 29PSI	420kPa, 60PSI

SEE OWNER'S MANUAL FOR ADDITIONAL INFORMATION 4N109268

811b5a9a

Tire and Loading Information Placard

This placard tells you important information about the:

- 1) number of people that can be carried in the vehicle
- 2) total weight your vehicle can carry
- 3) tire size designed for your vehicle
- 4) cold tire inflation pressures for the front, rear, and spare tires.

Loading

The vehicle maximum load on the tire must not exceed the load carrying capacity of the tire on your vehicle. You will not exceed the tire's load carrying capacity if you adhere to the loading conditions, tire size, and cold tire inflation pressures specified on the Tire and Loading Information placard and in the "Vehicle Loading" section of this manual.

NOTE: Under a maximum loaded vehicle condition, gross axle weight ratings (GAWRs) for the front and rear axles must not be exceeded. For further information on GAWRs, vehicle loading, and trailer towing, refer to "Vehicle Loading" in this section.

To determine the maximum loading conditions of your vehicle, locate the statement “The combined weight of occupants and cargo should never exceed XXX lbs or XXX kg” on the Tire and Loading Information placard. The combined weight of occupants, cargo/luggage and trailer tongue weight (if applicable) should never exceed the weight referenced here.

Steps for Determining Correct Load Limit

1. Locate the statement “The combined weight of occupants and cargo should never exceed XXX lbs or XXX kg” on your vehicle’s placard.
2. Determine the combined weight of the driver and passengers that will be riding in your vehicle.

3. Subtract the combined weight of the driver and passengers from XXX lbs or XXX kg.

4. The resulting figure equals the available amount of cargo and luggage load capacity. For example, if “XXX” amount equals 1,400 lbs (635 kg) and there will be five 150 lb (68 kg) passengers in your vehicle, the amount of available cargo and luggage load capacity is 650 lbs (295 kg) (since $5 \times 150 = 750$, and $1400 - 750 = 650$ lbs [295 kg]).

5. Determine the combined weight of luggage and cargo being loaded on the vehicle. That weight may not safely exceed the available cargo and luggage load capacity calculated in step 4.

6. If your vehicle will be towing a trailer, load from your trailer will be transferred to your vehicle. Consult this manual to determine how this reduces the available cargo and luggage load capacity of your vehicle.

NOTE:

- The following table shows examples on how to calculate total load, cargo/luggage, and towing capacities of your vehicle with varying seating configurations

and number and size of occupants. This table is for illustration purposes only and may not be accurate for the seating and load carry capacity of your vehicle.

- For the following example, the combined weight of occupants and cargo should never exceed 865 lbs (392 kg).

Occupants			Combined weight of occupants and cargo from Tire Placard	MINUS	Combined Occupant's weight	=	AVAILABLE Cargo/Luggage and Trailer Tongue Weight
TOTAL	FRONT	REAR					
<u>EXAMPLE 1</u>			865 lbs	minus	670 lbs	=	195 lbs
5	2	3					
<u>EXAMPLE 2</u>			865 lbs	minus	540 lbs	=	325 lbs
3	2	1					
<u>EXAMPLE 3</u>			865 lbs	minus	400 lbs	=	465 lbs
2	2	0					

811a4d11

WARNING!

Overloading of your tires is dangerous. Overloading can cause tire failure, affect vehicle handling, and increase your stopping distance. Use tires of the recommended load capacity for your vehicle. Never overload them.

TIRES — GENERAL INFORMATION**Tire Pressure**

Proper tire inflation pressure is essential to the safe and satisfactory operation of your vehicle. Three primary areas are affected by improper tire pressure:

Safety**WARNING!**

- Improperly inflated tires are dangerous and can cause accidents.
- Under-inflation increases tire flexing and can result in tire failure.
- Over-inflation reduces a tire's ability to cushion shock. Objects on the road and chuckholes can cause damage that result in tire failure.
- Unequal tire pressures can cause steering problems. You could lose control of your vehicle.
- Over-inflated or under-inflated tires can affect vehicle handling and can fail suddenly, resulting in loss of vehicle control.

(Continued)

WARNING! (Continued)

- Unequal tire pressures from one side of the vehicle to the other can cause the vehicle to drift to the right or left.
- Always drive with each tire inflated to the recommended cold tire inflation pressure.

Economy

Improper inflation pressures can cause uneven wear patterns to develop across the tire tread. These abnormal wear patterns will reduce tread life resulting in a need for earlier tire replacement. Under-inflation also increases tire rolling resistance and results in higher fuel consumption.

Ride Comfort and Vehicle Stability

Proper tire inflation contributes to a comfortable ride. Over-inflation produces a jarring and uncomfortable ride.

Tire Inflation Pressures

The proper cold tire inflation pressure is listed on the driver's side "B" Pillar.

Some vehicles may have Supplemental Tire Pressure Information for vehicle loads that are less than the maximum loaded vehicle condition. These pressure conditions will be found in the "Supplemental Tire Pressure Information" section of this manual.

The pressure should be checked and adjusted as well as inspecting for signs of tire wear or visible damage at least once a month. Use a good quality pocket-type gauge to check tire pressure. Do not make a visual judgement when determining proper inflation. Radial tires may look properly inflated even when they are under-inflated.

CAUTION!

After inspecting or adjusting the tire pressure, always reinstall the valve stem cap (if equipped). This will prevent moisture and dirt from entering the valve stem, which could damage the valve stem.

Inflation pressures specified on the placard are always “cold tire inflation pressure.” Cold tire inflation pressure is defined as the tire pressure after the vehicle has not been driven for at least three hours, or driven less than 1 mile (1 km) after a three hour period. The cold tire inflation pressure must not exceed the maximum inflation pressure molded into the tire sidewall.

Check tire pressures more often if subject to a wide range of outdoor temperatures, as tire pressures vary with temperature changes.

Tire pressures change by approximately 1 psi (7 kPa) per 12°F (7°C) of air temperature change. Keep this in mind when checking tire pressure inside a garage, especially in the winter.

Example: If garage temperature = 68°F (20°C) and the outside temperature = 32°F (0°C) then the cold tire inflation pressure should be increased by 3 psi (21 kPa), which equals 1 psi (7 kPa) for every 12°F (7°C) for this outside temperature condition.

Tire pressure may increase from 2 to 6 psi (13 to 40 kPa) during operation. DO NOT reduce this normal pressure build up or your tire pressure will be too low.

Tire Inflation Pressure — 4500/5500 with Steel Carcass Ply Tires

This type of tire utilizes steel cords in the sidewall. As such, they cannot be treated like normal light truck tires. Adjusting tire pressure must be performed by personnel trained, supervised and equipped accordingly.

Inflation Pressure Adjustment When Mounted to Vehicle

During procedures when adding tire inflation pressure, the technician or individual must utilize a remote inflation device, and ensure that all persons are clear of the trajectory area.

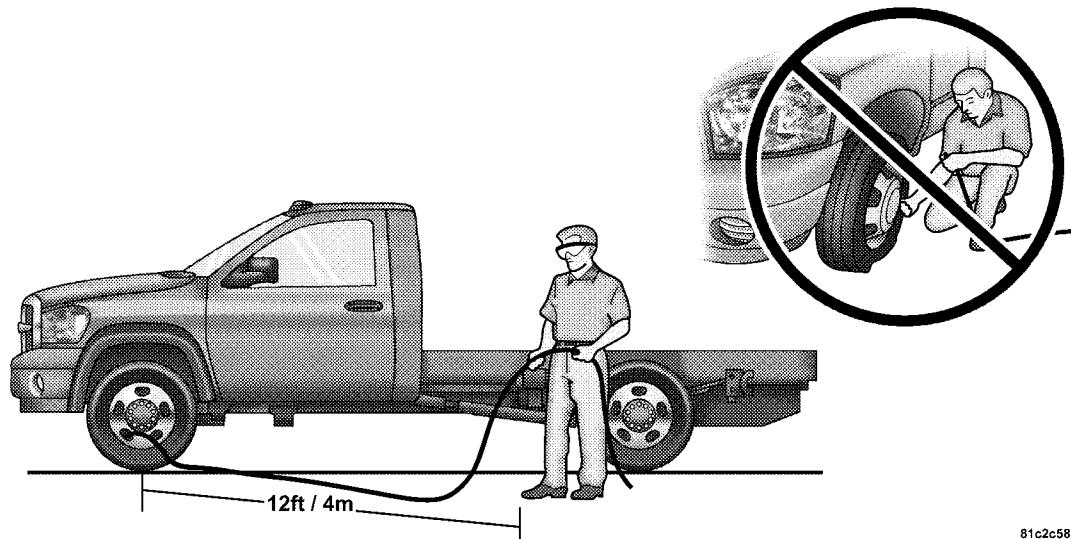

4500/5500 Tire Inflation

81c2c587

When adjusting inflation pressure to a tire and wheel assembly mounted on a vehicle, use Remote Mount Automatic Inflation Kit (similar to model number #27-cc1021234, available from TEAM PSE (PENTASTAR Service Equipment-Phone number 1-800-734-4334).

NOTE: Never attempt to re-inflate a tire and wheel assembly which has been run flat or is extremely under-inflated without first removing the tire from the wheel assembly for inspection.

Personnel trained, supervised, and equipped according to Federal Occupational Safety and Health Administration (OSHA) should perform this work.

Inflation Pressure Adjustment When Not Mounted to Vehicle

When adjusting inflation pressure to a tire and wheel assembly not mounted on a vehicle, use a Remote Mount Automatic Inflation Kit and a Tire Inflation Cage similar to model number #174-2240 available from TEAM PSE (PENTASTAR Service Equipment – 1-800-223-5623).

Tire Pressures for High Speed Operation

The manufacturer advocates driving at safe speeds within posted speed limits. Where speed limits or conditions are such that the vehicle can be driven at high speeds, maintaining correct tire inflation pressure is very important. Increased tire pressure and reduced vehicle loading may be required for high-speed vehicle operation. Refer to original equipment or an authorized tire dealer for recommended safe operating speeds, loading and cold tire inflation pressures.

WARNING!

High speed driving with your vehicle under maximum load is dangerous. The added strain on your tires could cause them to fail. You could have a serious accident resulting in serious injury or death. Don't drive a vehicle loaded to the maximum capacity at continuous speeds above 75 mph (120 km/h).

Radial Ply Tires**WARNING!**

Combining radial ply tires with other types of tires on your vehicle will cause your vehicle to handle poorly. The instability could cause an accident resulting in serious injury or death. Always use radial ply tires in sets of four (or six, in case of trucks with dual rear wheels). Never combine them with other types of tires.

Cuts and punctures in radial tires are repairable only in the tread area because of sidewall flexing. Consult your authorized tire dealer for radial tire repairs.

Tire Spinning

When stuck in mud, sand, snow, or ice conditions, do not spin your vehicle's wheels faster than 30 mph (48 km/h) or for longer than 30 seconds continuously without stopping when you are stuck.

Refer to "Freeing A Stuck Vehicle" in Section 6 of this manual.

WARNING!

Fast spinning tires can be dangerous. Forces generated by excessive wheel speeds may cause tire damage or failure. A tire could explode and injure someone. Do not spin your vehicle's wheels faster than 30 mph (48 km/h) or for more than 30 seconds continuously when you are stuck, and don't let anyone near a spinning wheel, no matter what the speed.

Tread Wear Indicators

Tread wear indicators are in the original equipment tires to help you in determining when your tires should be replaced.

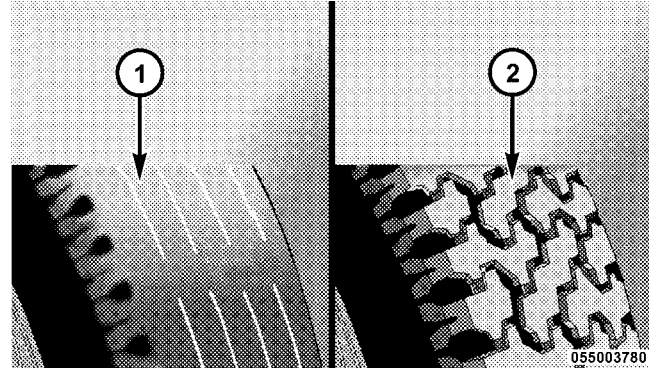

- 1 — Worn Tire
- 2 — New Tire

These indicators are molded into the bottom of the tread grooves. They will appear as bands when the tread depth becomes 1/16 in (2 mm). When the tread is worn to the tread wear indicators, the tire should be replaced.

Many states have laws requiring tire replacement at this point.

Life of Tire

The service life of a tire is dependent upon varying factors including, but not limited to:

- Driving style
- Tire pressure
- Distance driven

WARNING!

Tires and spare tire should be replaced after six years, regardless of the remaining tread. Failure to follow this warning can result in sudden tire failure. You could lose control and have an accident resulting in serious injury or death.

Keep dismantled tires in a cool, dry place with as little exposure to light as possible. Protect tires from contact with oil, grease, and gasoline.

Replacement Tires

The tires on your new vehicle provide a balance of many characteristics. They should be inspected regularly for wear and correct cold tire inflation pressure. The manufacturer strongly recommends that you use tires equivalent to the originals in size, quality and performance when replacement is needed (refer to the paragraph on "Tread Wear Indicators"). Refer to the Tire and Loading

Information placard for the size designation of your tire. The service description and load identification will be found on the original equipment tire. Failure to use equivalent replacement tires may adversely affect the safety, handling, and ride of your vehicle. We recommend that you contact your original equipment or an authorized tire dealer with any questions you may have on tire specifications or capability.

WARNING!

- **Do not use a tire, wheel size or rating other than that specified for your vehicle. Some combinations of unapproved tires and wheels may change suspension dimensions and performance characteristics, resulting in changes to steering, handling, and braking of your vehicle. This can cause unpredictable handling and stress to steering and suspension components. You could lose control and have an accident resulting in serious injury or death. Use only the tire and wheel sizes with load ratings approved for your vehicle.**

(Continued)

WARNING! (Continued)

- Never use a tire with a smaller load index or capacity, other than what was originally equipped on your vehicle. Using a tire with a smaller load index could result in tire overloading and failure. You could lose control and have an accident resulting in serious injury or death.
- Failure to equip your vehicle with tires having adequate speed capability can result in sudden tire failure and loss of vehicle control resulting in serious injury or death.

CAUTION!

Replacing original tires with tires of a different size may result in false speedometer and odometer readings.

**SUPPLEMENTAL TIRE PRESSURE INFORMATION
— IF EQUIPPED**

A light load vehicle condition is defined as two passengers [150 lbs (68 kg) each] plus 200 lbs (91 kg) of cargo. Cold tire inflation pressures for a lightly loaded vehicle will be found on the face of the driver's door.

TIRE CHAINS

Use "Class U" chains or other traction aids that meet SAE Type "U" specifications.

NOTE: Chains must be the proper size for the vehicle, as recommended by the chain manufacturer.

CAUTION!

To avoid damage to your vehicle, tires or chains, observe the following precautions:

(Continued)

CAUTION! (Continued)

- Because of limited chain clearance between tires and other suspension components, it is important that only chains in good condition are used. Broken chains can cause serious vehicle damage. Stop the vehicle immediately if noise occurs that could suggest chain breakage. Remove the damaged parts of the chain before further use.
- Install chains as tightly as possible and then retighten after driving about 1/2 mi (0.8 km).
- Do not exceed 45 mph (72 km/h).
- Drive cautiously and avoid severe turns and large bumps, especially with a loaded vehicle.
- Do not install tire chains on front wheels of 4x2 vehicles.
- Do not drive for a prolonged period on dry pavement.

(Continued)

CAUTION! (Continued)

- Observe the tire chain manufacturer's instructions on method of installation, operating speed, and conditions for usage. Always use the lower suggested operating speed of the chain manufacturer if different than the speed recommended by the manufacturer.

These cautions apply to all chain traction devices, including link and cable (radial) chains.

Tire chain use is permitted only on the rear tires of your 4X2 trucks.

NOTE:

- The use of class "U" chains is permitted on the front and rear of 4X4 vehicles, trucks with dual rear wheels and LT235/80R17E tires.

- On 4X2 vehicles, class “U” snow chains are permitted on the rear wheels only of vehicles equipped with LT245/70R17, LT265/70R17, and LT235/80R17 size tires.
- On 4X4 Single Rear Wheel (SRW) vehicles, class “U” snow chains are permitted on the rear wheels only on vehicles equipped with LT265/70R17.

CAUTION!

Do not use tire chains on the 4X2 front wheels of SRW (Single Rear Wheels) equipped with LT245/70R17, LT265/70R17 tires or 4X4 front tires of vehicles equipped with LT265/70R17 tires. There may not be adequate clearance for the chains and you are risking structural or body damage to your vehicle.

SNOW TIRES

Snow tires should be of the same size and type construction as the front tires. Consult the manufacturer of the snow tire to determine any maximum vehicle speed requirement associated with the tire. These tires should always be operated at the vehicle maximum capacity inflation pressures under any load condition.

While studded tires improve performance on ice, skid and traction capability on wet or dry surfaces may be poorer than that of non-studded tires. Some states prohibit studded tires; therefore, local laws should be checked before using these tire types.

TIRE ROTATION RECOMMENDATIONS

Tires on the front and rear axles of vehicles operate at different loads and perform different steering, driving, and braking functions. For these reasons, they wear at unequal rates, and develop irregular wear patterns. These effects can be reduced by timely rotation of tires. The benefits of rotation are especially worthwhile with aggressive tread designs such as those on On/Off Road type tires. Rotation will increase tread life, help to maintain mud, snow, and wet traction levels, and contribute to a smooth, quiet ride.

Refer to the “Maintenance Schedule” in Section 8 of this manual for the proper maintenance intervals. More frequent rotation is permissible if desired. The reasons for any rapid or unusual wear should be corrected prior to rotation being performed.

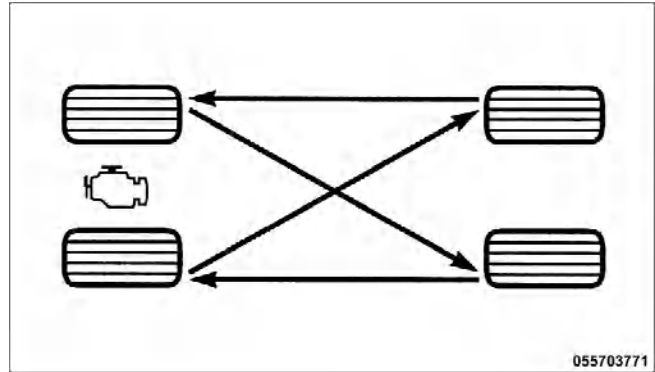

NOTE: On Canadian vehicles only, if your vehicle is equipped with All-Season type tires on the front and On/Off Road type tires mounted on the rear, do not use a front to back rotation pattern. Instead, rotate your tires side to side at the recommended intervals.

Dual Rear Wheels

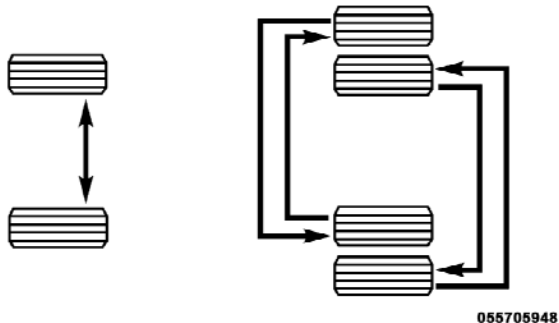

The tires used on dual wheel assemblies should be matched for wear to prevent overloading one tire in a set. To check if tires are even, lay a straight edge across all four tires. The straight edge should touch all the tires.

CAUTION!

4500/5500 Dual Rear Tires have only one approved direction of rotation. This is to accommodate the asymmetrical design (tread pattern) of the On/Off road tire.

- When replacing a flat, the spare tire may have to be remounted on the rim or installed at a different location to maintain the correct placement of the tire on the wheel relative to the tire/wheel position on the vehicle. For example, if the spare is used to replace an outer rear tire it will have to be remounted on the rim so that the wheel is dished inward. That way the tread design of asymmetrical tires will maintain proper position.

FUEL REQUIREMENTS

5.7L Gas Engine



The 5.7L engine is designed to meet all emissions regulations and provide satisfactory fuel economy and performance when using high quality unleaded gasoline having an octane range of 87 to 89. The manufacturer recommends the use of 89 octane for optimum performance. The use of premium gasoline is not recommended. Under normal conditions, the use of premium gasoline will not provide a benefit over high quality regular and mid-grade gasolines, and in some circumstances may result in poorer performance.

Light spark knock at low engine speeds is not harmful to your engine. However, continued heavy spark knock at high speeds can cause damage and immediate service is required.

Poor quality gasoline can cause problems such as hard starting, stalling and hesitations. If you experience these symptoms, try another brand of “regular” gasoline before considering service for the vehicle.

Over 40 auto manufacturers world-wide have issued and endorsed consistent gasoline specifications (the World-wide Fuel Charter, WWFC) to define fuel properties necessary to deliver enhanced emissions, performance and durability for your vehicle. We recommend the use of gasolines that meet the WWFC specifications if they are available.

Reformulated Gasoline

Many areas of the country require the use of cleaner burning gasoline referred to as “Reformulated Gasoline.” Reformulated gasolines contain oxygenates, and are specifically blended to reduce vehicle emissions and improve air quality.

We strongly support the use of reformulated gasolines. Properly blended reformulated gasolines will provide excellent performance and durability for the engine and fuel system components.

Gasoline/Oxygenate Blends

Some fuel suppliers blend unleaded gasoline with oxygenates such as 10% ethanol, MTBE, and ETBE. Oxygenates are required in some areas of the country during the winter months to reduce carbon monoxide emissions. Fuels blended with these oxygenates may be used in your vehicle.

CAUTION!

DO NOT use gasolines containing Methanol or E85 Ethanol. Use of these blends may result in starting and driveability problems and may damage critical fuel system components.

Problems that result from using methanol/gasoline or E85 ethanol blends are not the responsibility of the manufacturer. While MTBE is an oxygenate made from methanol, it does not have the negative effects of methanol.

MMT In Gasoline

MMT is a manganese containing metallic additive that is blended into some gasoline to increase octane. Gasoline blended with MMT provides no performance advantage beyond gasoline of the same octane number without MMT. Gasoline blended with MMT reduces spark plug life and reduces emission system performance in some vehicles. The manufacturer recommends that gasoline without MMT be used in your vehicle. The MMT content of gasoline may not be indicated on the gasoline pump, therefore, you should ask your gasoline retailer whether or not his/her gasoline contains MMT. It is even more important to look for gasolines without MMT in Canada, because MMT can be used at levels higher than those

allowed in the United States. MMT is prohibited in Federal and California reformulated gasoline.

Materials Added To Fuel

All gasolines sold in the United States are required to contain effective detergent additives. Use of additional detergents or other additives is not needed under normal conditions and would result in unnecessary cost. Therefore, you should not have to add anything to the fuel.

Fuel System Cautions

CAUTION!

Follow these guidelines to maintain your vehicle's performance:

- The use of leaded gas is prohibited by Federal law. Using leaded gasoline can impair engine performance, and damage the emission control system.

(Continued)

CAUTION! (Continued)

- An out-of-tune engine, or certain fuel or ignition malfunctions, can cause the catalytic converter to overheat. If you notice a pungent burning odor or some light smoke, your engine may be out of tune or malfunctioning and may require immediate service. Contact your authorized dealer for service assistance.
- When pulling a heavy load or driving a fully loaded vehicle when the humidity is low and the temperature is high, use a premium unleaded fuel to help prevent spark knock. If spark knock persists, lighten the load, or engine piston damage may result.

(Continued)

CAUTION! (Continued)

- The use of fuel additives which are now being sold as octane enhancers is not recommended. Many of these products contain high concentrations of methanol. Fuel system damage or vehicle performance problems resulting from the use of such fuels or additives is not the responsibility of the manufacturer.

NOTE: Intentional tampering with emissions control systems can result in civil penalties being assessed against you.

Carbon Monoxide Warnings**WARNING!**

Carbon monoxide (CO) in exhaust gases is deadly. Follow the precautions below to prevent carbon monoxide poisoning:

- Do not inhale exhaust gases. They contain carbon monoxide, a colorless and odorless gas which can kill. Never run the engine in a closed area, such as a garage, and never sit in a parked vehicle with the engine running for an extended period. If the vehicle is stopped in an open area with the engine running for more than a short period, adjust the ventilation system to force fresh, outside air into the vehicle.

(Continued)

WARNING! (Continued)

- Guard against carbon monoxide with proper maintenance. Have the exhaust system inspected every time the vehicle is raised. Have any abnormal conditions repaired promptly. Until repaired, drive with all side windows fully open.

ADDING FUEL

The fuel tank filler tube has a restricting door about 2 in (50 mm) inside the opening. If using a portable fuel container, it should have a flexible nozzle long enough to force open the restricting door.

CAUTION!

- Damage to the fuel system or emissions control system could result from using an improper fuel tank filler tube cap (gas cap). A poorly fitting cap could let impurities into the fuel system. Also, a poorly-fitted aftermarket cap can cause the MIL (Malfunction Indicator Light) to illuminate due to fuel vapors escaping from the system.
- A poorly fitting gas cap may cause the MIL to turn on.
- To avoid fuel spillage and overfilling, do not “top off” the fuel tank after filling.

NOTE: When the fuel nozzle “clicks” or shuts off the fuel tank is full.

WARNING!

- Never have any smoking materials lit in or near the vehicle when the gas cap is removed or the tank filled.
- Never add fuel to the vehicle when the engine is running. This is in violation of most state and federal fire regulations and will cause the MIL to turn on.

NOTE: Tighten the gas cap 1/4 turn until you hear one click. This is an indication that the cap is properly tightened.

If the gas cap is not tightened properly, the Malfunction Indicator Light will come on. Be sure the gas cap is tightened every time the vehicle is refueled.

WARNING!

A fire may result if gasoline is pumped into a portable container that is inside of a vehicle. You could be burned. Always place gas containers on the ground while filling.

Loose Fuel Filler Cap (Gas Cap) Message

If the vehicle's diagnostic system determines that the fuel filler cap is loose, improperly installed or damaged, a GASCAP message will be displayed in the instrument cluster. Tighten the gas cap until a "clicking" sound is heard. This is an indication that the gas cap is properly tightened. Press the odometer reset button to turn the message off. If the problem persists, the message will appear the next time the vehicle is started. This might indicate a damaged cap. If the problem is detected twice in a row, the system will turn on the MIL. Resolving the problem will turn the MIL off.

VEHICLE LOADING

Certification Label

As required by National Highway Traffic Safety Administration regulations, your vehicle has a certification label affixed to the driver's side door or pillar.

This label contains the month and year of manufacture, Gross Vehicle Weight Rating (GVWR), Gross Axle Weight Rating (GAWR) front and rear, and Vehicle Identification Number (VIN). A Month-Day-Hour (MDH) number is included on this label and indicates the Month, Day and Hour of manufacture. The bar code that appears on the bottom of the label is your Vehicle Identification Number (VIN).

Gross Vehicle Weight Rating (GVWR)

The GVWR is the total permissible weight of your vehicle including driver, passengers, vehicle, options and cargo. The label also specifies maximum capacities of front and

rear axle systems (GAWR). Total load must be limited so GVWR and front and rear GAWR are not exceeded.

Payload

The payload of a vehicle is defined as the allowable load weight a truck can carry, including the weight of the driver, all passengers, options and cargo.

Gross Axle Weight Rating (GAWR)

The GAWR is the maximum permissible load on the front and rear axles. The load must be distributed in the cargo area so that the GAWR of each axle is not exceeded.

Each axle GAWR is determined by the components in the system with the lowest load carrying capacity (axle, springs, tires or wheels). Heavier axles or suspension components sometimes specified by purchasers for increased durability does not necessarily increase the vehicle's GVWR.

Tire Size

The tire size on the Label represents the actual tire size on your vehicle. Replacement tires must be equal to the load capacity of this tire size.

Rim Size

This is the rim size that is appropriate for the tire size listed.

Inflation Pressure

This is the cold tire inflation pressure for your vehicle for all loading conditions up to full GAWR.

Curb Weight

The curb weight of a vehicle is defined as the total weight of the vehicle with all fluids, including vehicle fuel, at full capacity conditions, and with no occupants or cargo loaded into the vehicle. The front and rear curb weight values are determined by weighing your vehicle on a commercial scale before any occupants or cargo are added.

Loading

The actual total weight and the weight of the front and rear of your vehicle at the ground can best be determined by weighing it when it is loaded and ready for operation.

The entire vehicle should first be weighed on a commercial scale to insure that the GVWR has not been exceeded. The weight on the front and rear of the vehicle should then be determined separately to be sure that the load is properly distributed over front and rear axle. Weighing the vehicle may show that the GAWR of either the front or rear axles has been exceeded but the total load is within the specified GVWR. If so, weight must be shifted from front to rear or rear to front as appropriate until the specified weight limitations are met. Store the heavier items down low and be sure that the weight is distributed equally. Stow all loose items securely before driving.

Improper weight distributions can have an adverse effect on the way your vehicle steers and handles and the way the brakes operate.

CAUTION!

Do not load your vehicle any heavier than the GVWR or the maximum front and rear GAWR. If you do, parts on your vehicle can break, or it can change the way your vehicle handles. This could cause you to lose control. Also overloading can shorten the life of your vehicle.

TRAILER TOWING

In this section you will find safety tips and information on limits to the type of towing you can reasonably do with your vehicle. Before towing a trailer, carefully review this information to tow your load as efficiently and safely as possible.

To maintain warranty coverage, follow the requirements and recommendations in this manual concerning vehicles used for trailer towing.

Common Towing Definitions

The following trailer towing related definitions will assist you in understanding the following information:

Gross Vehicle Weight Rating (GVWR)

The GVWR is the total allowable weight of your vehicle. This includes driver, passengers, cargo and tongue weight. The total load must be limited so that you do not exceed the GVWR.

Gross Trailer Weight (GTW)

The GTW is the weight of the trailer plus the weight of all cargo, consumables and equipment (permanent or temporary) loaded in or on the trailer in its "loaded and ready for operation" condition. The recommended way to

measure GTW is to put your fully loaded trailer on a vehicle scale. The entire weight of the trailer must be supported by the scale.

Gross Combination Weight Rating (GCWR)

The GCWR is the total permissible weight of your vehicle and trailer when weighed in combination. (Note that GCWR ratings include a 150 lbs (68 kg) allowance for the presence of a driver).

Gross Axle Weight Rating (GAWR)

The GAWR is the maximum capacity of the front and rear axles. Distribute the load over the front and rear axles evenly. Make sure that you do not exceed either front or rear GAWR.

WARNING!

It is important that you do not exceed the maximum front or rear GAWR. A dangerous driving condition can result if either rating is exceeded. You could lose control of the vehicle and have an accident.

Tongue Weight (TW)

The tongue weight is the downward force exerted on the hitch ball by the trailer is the tongue weight. In most cases it should not be less than 10% or more than 15% of the trailer load. You must consider this as part of the load on your vehicle.

Frontal Area

The frontal area is the maximum height and maximum width of the front of a trailer.

Trailer Sway Control

The trailer sway control is a telescoping link that can be installed between the hitch receiver and the trailer tongue that typically provides adjustable friction associated with the telescoping motion to dampen any unwanted trailer swaying motions while traveling.

Weight-Carrying Hitch

A weight-carrying hitch supports the trailer tongue weight, just as if it were luggage located at a hitch ball or some other connecting point of the truck. These kind of hitches are the most popular on the market today and they're commonly used to tow small- and medium-sized trailers.

Weight-Distributing Hitch

A weight-distributing system works by applying leverage through spring (load) bars. They are typically used for heavier loads, to distribute trailer tongue weight to the tow vehicle's front axle and the trailer axle(s). When

used in accordance with the manufacturers' directions, it provides for a more level ride, offering more consistent steering and brake control, thereby enhancing towing safety. The addition of a friction/hydraulic sway control also dampens sway caused by traffic and crosswinds and contributes positively to tow vehicle and trailer stability. Trailer sway control and a weight distributing (load equalizing) hitch are recommended for heavier Tongue Weights (TW) and may be required depending on Vehicle and Trailer configuration/loading to comply with gross axle weight rating (GAWR) requirements.

WARNING!

An improperly adjusted weight-distributing hitch system may reduce handling, stability, braking performance, and could result in an accident.

Weight-distributing systems may not be compatible with surge brake couplers. Consult with your hitch and trailer manufacturer or an authorized recreational vehicle dealer for additional information.

Fifth-Wheel Hitch

The fifth-wheel hitch is a special high platform with a coupling that mounts over the rear axle of the tow vehicle in the truck bed. It connects a vehicle and fifth-wheel trailer with a coupling king pin.

Gooseneck Hitch

The gooseneck hitch employs a pivoted coupling arm which attaches to a ball mounted in the bed of a pickup truck. The coupling arm connects to the hitch mounted over the rear axle in the truck bed.

Trailer Hitch Classification

The rear bumper is intended to tow trailers up to 2,000 lbs (907 kg) without added equipment or alterations to the standard equipment. Your vehicle may be factory equipped for safe towing of trailers weighing over 2,000 lbs (907 kg) with the optional Trailer Tow Prep Package. See your authorized dealer for package content.

The following chart provides the industry standard for the maximum trailer weight a given trailer hitch class can tow and should be used to assist you in selecting the correct trailer hitch for your intended towing condition. Refer to “Trailer Towing Weights (Maximum Trailer Weight Ratings)” for the website address that contains the necessary information for your specific drivetrain.

Trailer Hitch Classification	
Class	Max. GTW (Gross Trailer Wt.)
Class I - Light Duty	2,000 lbs (907 kg)
Class II - Medium Duty	3,500 lbs (1587 kg)
Class III - Heavy Duty	5,000 lbs (2268 kg)
Class IV - Extra Heavy Duty	10,000 lbs (4540 kg)
Fifth Wheel/ Gooseneck	Greater than 10,000 lbs (4540 kg)
Refer to the "Trailer Towing Weights (Maximum Trailer Weight Ratings)" chart for the Maximum Gross Trailer Weight (GTW) towable for your given drivetrain.	

All trailer hitches should be professionally installed on your vehicle.

Trailer Towing Weights (Maximum Trailer Weight Ratings)

NOTE: For additional trailer towing information (maximum trailer weight ratings) refer to the following website addresses:

- [http:// www.dodge.com/towing](http://www.dodge.com/towing).
- [http:// www.dodge.ca](http://www.dodge.ca) (Canada).

Trailer and Tongue Weight

Always load a trailer with 60% to 65% of the weight in the front of the trailer. This places 10% to 15% of the Gross Trailer Weight (GTW) on the tow hitch of your vehicle. Loads balanced over the wheels or heavier in the rear can cause the trailer to sway **severely** side to side which will cause loss of control of vehicle and trailer. Failure to load trailers heavier in front is the cause of many trailer accidents.

Never exceed the maximum tongue weight stamped on your bumper or trailer hitch.

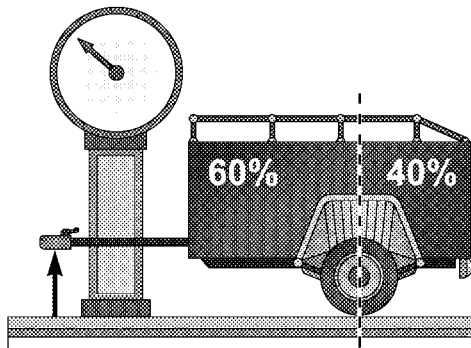

057003767

Consider the following items when computing the weight on the rear axle of the vehicle:

- The tongue weight of the trailer.
- The weight of any other type of cargo or equipment put in or on your vehicle.
- The weight of the driver and all passengers.

NOTE: Remember that everything put into or on the trailer adds to the load on your vehicle. Also, additional factory-installed options, or authorized dealer-installed options must be considered as part of the total load on your vehicle. Refer to “Tire and Loading Information placard” under “Tire Safety Information” in Section 5.

Towing Requirements

To promote proper break-in of your new vehicle drive-train components, the following guidelines are recommended:

CAUTION!

- Avoid towing a trailer for the first 500 miles (805 km) of vehicle operation. Doing so may damage your vehicle.
- During the first 500 miles (805 km) of trailer towing, limit your speed to 50 mph (80 km/h).

Perform the maintenance listed in Section 8 of this manual. When towing a trailer, never exceed the GAWR, or GCWR, ratings.

WARNING!

Improper towing can lead to an injury accident. Follow these guidelines to make your trailer towing as safe as possible:

Make certain that the load is secured in the trailer and will not shift during travel. When trailering cargo that is not fully secured, dynamic load shifts can occur that may be difficult for the driver to control. You could lose control of your vehicle and have an accident.

- When hauling cargo or towing a trailer, do not overload your vehicle or trailer. Overloading can cause a loss of control, poor performance or damage to brakes, axle, engine, transmission, steering, suspension, chassis structure or tires.
 - Safety chains must always be used between your vehicle and trailer. Always connect the chains to the frame or hook retainers of the vehicle hitch. Cross the chains under the trailer tongue and allow enough slack for turning corners.
 - Vehicles with trailers should not be parked on a grade. When parking, apply the parking brake on the tow vehicle. Put the tow vehicle automatic transmission in PARK. With 4-wheel drive vehicles, make sure the transfer case is not in NEUTRAL. Always, block or "chock" the trailer wheels.
 - GCWR must not be exceeded.
- **Total weight must be distributed between the tow vehicle and the trailer such that the following four ratings are not exceeded:**
 1. GVWR
 2. GTW
 3. GAWR
 4. Tongue weight rating for the trailer hitch utilized (This requirement may limit the ability to always achieve the 10% to 15% range of tongue weight as a percentage of total trailer weight.)

Towing Requirements — Tires

- Do not attempt to tow a trailer while using a compact spare tire.
- Proper tire inflation pressures are essential to the safe and satisfactory operation of your vehicle. Refer to "Tires-General Information" in this section.

- Also, check the trailer tires for proper tire inflation pressures before trailer usage.
- Check for signs of tire wear or visible tire damage before towing a trailer. Refer to “Tires–General Information” in this section.
- When replacing tires, refer to “Tires–General Information” in this section. Replacing tires with a higher load carrying capacity will not increase the vehicle’s GVWR and GAWR limits.

Towing Requirements — Trailer Brakes

- Do **not** interconnect the hydraulic brake system or vacuum system of your vehicle with that of the trailer. This could cause inadequate braking and possible personal injury.
- An electronically actuated trailer brake controller is required when towing a trailer with electronically

actuated brakes. When towing a trailer equipped with a hydraulic surge actuated brake system, an electronic brake controller is not required.

- Trailer brakes are recommended for trailers over 1,000 lbs (454 kg) and required for trailers in excess of 2,000 lbs (907 kg).

CAUTION!

If the trailer weighs more than 1,000 lbs (454 kg) loaded, it should have its own brakes and they should be of adequate capacity. Failure to do this could lead to accelerated brake lining wear, higher brake pedal effort, and longer stopping distances.

WARNING!

- **Do not connect trailer brakes to your vehicle's hydraulic brake lines. It can overload your brake system and cause it to fail. You might not have brakes when you need them and could have an accident.**
- **Towing any trailer will increase your stopping distance. When towing you should allow for additional space between your vehicle and the vehicle in front of you. Failure to do so could result in an accident.**

Towing Requirements — Trailer Lights & Wiring

Whenever you pull a trailer, regardless of the trailer size, stop lights and turn signals on the trailer are required for motoring safety.

Twelve trailer tow circuits are provided at the rear of the chassis. These circuits are unterminated and sealed.

Seven of the 12 circuits are the standard 7-pin trailer wiring circuits. Three of the 12 circuits are upfitter circuits used for aftermarket applications. Two of the 12 circuits are additional trailer circuits. For additional information about trailer tow circuits or other exterior lighting capabilities of your vehicle, refer to the Body Builder's Guide by accessing "www.dodge.com/bodybuilder" and choosing the appropriate links.

NOTE: Do not cut or splice wiring into the vehicles wiring harness.

WARNING!

Any work done to the vehicle's electrical system or wiring should be performed by a qualified automotive technician. If done improperly it may cause damage to the electrical system wiring and could result in serious or fatal injury.

The following chart identifies the maximum electrical loads that the trailer tow output circuits are capable of supporting.

Trailer Tow Additional Lamp Loads		
Output Functions	Maximum Current	Additional Bulbs Allowed. Example Only. Other bulb combinations can be used as long as maximum current is not exceeded.
Stop/Turn Left	16A	2 #3157 bulbs for stop/turn
Stop/Turn Right	16A	2 #3157 bulbs for stop/turn
Trailer Park Lamps	14A	2 #1157 bulbs (two filament park/stop/turn) plus up to 24 #168 or #194 peanut bulbs.

Towing Tips

Before setting out on a trip, practice turning, stopping and backing the trailer in an area away from heavy traffic.

Towing Tips — Automatic Transmission

The “DRIVE” range can be selected when towing. However, if frequent shifting occurs while in this range, the “TOW HAUL” or “OD/OFF” range should be selected.

NOTE: Using the “TOW HAUL” or “OD/OFF” range while operating the vehicle under heavy operating conditions will improve performance and extend transmission life by reducing excessive shifting and heat build up. This action will also provide better engine braking.

The automatic transmission fluid and filter should be changed if you REGULARLY tow a trailer for more than 45 minutes of continuous operation. Refer to the “Maintenance Schedule” in Section 8 of this manual for proper maintenance intervals.

NOTE: Check the automatic transmission fluid level before towing.

Towing Tips — Tow/Haul (If Equipped)

To reduce potential for automatic transmission overheating, turn the “TOW HAUL OD/OFF” feature ON when driving in hilly areas or shift the transmission to Drive position 2 on more severe grades.

Towing Tips — Electronic Speed Control (If Equipped)

- Do not use in hilly terrain or with heavy loads.
- When using the speed control, if you experience speed drops greater than 10 mph (16 km/h), disengage until you can get back to cruising speed.
- Use speed control in flat terrain and with light loads to maximize fuel efficiency.

Towing Tips — Cooling System

To reduce potential for engine and transmission overheating, take the following actions:

– City Driving

When stopped for short periods of time, put transmission in NEUTRAL and increase engine idle speed.

– Highway Driving

Reduce speed.

– Air Conditioning

Turn off temporarily.

SNOWPLOW

Snowplow Prep Packages are available as a factory installed option. These packages include components necessary to equip your vehicle with a snowplow.

NOTE: Before installation of a snowplow it is highly recommended that the owner/installer obtain and follow the recommendations contained within the current

Dodge Body Builders Guide. See your authorized dealer, installer or snowplow manufacturer for this information. There are unique electrical systems that must be connected to properly assure operator safety and prevent overloading vehicle systems.

WARNING!

Attaching a snowplow to this vehicle could adversely affect performance of the airbag system in an accident. Do not expect that the airbag will perform as described earlier in this manual

CAUTION!

The “Lamp Out” indicator could illuminate if exterior lamps are not properly installed.

Before Plowing

- Check the hydraulic system for leaks and proper fluid level.
- Check the mounting bolts and nuts for proper tightness.
- Check the runners and cutting edge for excessive wear. The cutting edge should be 1/4 to 1/2 in (6 cm to 1.2 cm) above ground in snow plowing position.
- Check that snowplow lighting is connected and functioning properly.

Snowplow Prep Package Model Availability

For information about snowplow applications visit www.dodge.com or refer to the current Dodge Body Builders Guide.

1. The maximum number of occupants in the truck should not exceed two.
2. The total GVWR or the Front GAWR or the Rear GAWR should never be exceeded.
3. The snowplow prep packages are not available with the Sport Package.
4. Cargo capacity will be reduced by the addition of options or passengers, etc.

The loaded vehicle weight, including the snowplow system, all aftermarket accessories, driver, passengers, options, and cargo, must not exceed either the Gross Vehicle Weight (GVWR) or Gross Axle Weight (GAWR)

ratings. These weights are specified on the Safety Compliance Certification Label on the driver's side door opening.

NOTE: Detach the snowplow when transporting passengers.

Vehicle front end wheel alignment was set to specifications at the factory without consideration for the weight of the plow. Front end toe-in should be checked and reset if necessary at the beginning and end of the snowplow season. This will help prevent uneven tire wear.

The blade should be lowered whenever the vehicle is parked.

Maintain and operate your vehicle and snowplow equipment following the recommendations provided by the specific snowplow manufacturer.

Over the Road Operation With Snowplow Attached

The blade restricts air flow to the radiator and causes the engine to operate at higher than normal temperatures. Therefore, when transporting the plow, angle the blade completely and position it as low as road or surface conditions permit. Do not exceed 40 mph (64 km/h). The operator should always maintain a safe stopping distance and allow adequate passing clearance.

Operating Tips

Under ideal snow plowing conditions, 20 mph (32 km/h) should be maximum operating speed. The operator should be familiar with the area and surface to be cleaned. Reduce speed and use extreme caution when plowing unfamiliar areas or under poor visibility.

NOTE: During snowplow usage on vehicles equipped with an overhead console module, the outside temperature display will show higher temperatures than the

outside ambient temperature. The higher displayed temperature is due to blocked or reduced airflow to the underhood ambient temperature sensor by the snowplow. This is common and outside temperature display operation will return to normal when the snowplow is removed.

General Maintenance

Snowplows should be maintained in accordance with the plow manufacturer's instructions.

Keep all snowplow electrical connections and battery terminals clean and free of corrosion.

When plowing snow, to avoid transmission and drivetrain damage, the following precautions should be observed.

- Operate with transfer case in 4L when plowing small or congested areas where speeds are not likely to exceed 15 mph (24 km/h). At higher speeds operate in 4H.
- Vehicles with automatic transmissions should use 4L range when plowing deep or heavy snow for extended periods of time to avoid transmission overheating.
- Do not shift the transmission unless the engine has returned to idle and wheels have stopped. Make a practice of stepping on the brake pedal before shifting the transmission.

RECREATIONAL TOWING (BEHIND MOTORHOME, ETC.)

CAUTION!

Front or rear wheel lifts should not be used. Internal damage to the transmission or transfer case will occur if a front or rear wheel lift is used when recreational towing.

Recreational Towing – 2-Wheel Drive Models

Recreational towing of 2-Wheel Drive models is not allowed. Towing with the rear wheels on the ground can result in severe transmission damage.

Recreational Towing – 4-Wheel Drive Models

CAUTION!

Failure to follow these requirements can cause severe damage to the transmission and/or transfer case.

NOTE: Both the manual shift and electronic shift transfer cases must be shifted into NEUTRAL for recreational towing. Automatic transmissions must be shifted into the PARK position for recreational towing. Refer to the following for the proper transfer case NEUTRAL shifting procedure for your vehicle.

Recreational Towing Procedure — Manual Shift Transfer Case — If Equipped

Use the following procedure to prepare your vehicle for recreational towing:

CAUTION!

It is necessary to follow these steps to be certain that the transfer case is fully in NEUTRAL before recreational towing to prevent damage to internal parts.

1. Bring the vehicle to a complete stop.
2. Shut OFF the engine.
3. Depress the brake pedal.
4. Shift transmission into NEUTRAL.
5. Shift transfer case lever into NEUTRAL.
6. Start the engine.
7. Shift transmission into REVERSE.
8. Release brake pedal for five seconds and ensure that there is no vehicle movement.

9. Repeat steps 7 and 8 with the transmission in DRIVE.
10. Shut OFF the engine and place the ignition key in the unlocked OFF position.
11. Shift transmission into PARK.
12. Apply the parking brake.
13. Attach vehicle to tow vehicle with tow bar.
14. Release the parking brake.

CAUTION!

Damage to the transmission may occur if the transmission is shifted into PARK with the transfer case in NEUTRAL and the engine running. With the transfer case in NEUTRAL ensure that the engine is OFF prior to shifting the transmission into PARK.

Returning to Normal Operation — Manual Shift Transfer Case

Use the following procedure to prepare your vehicle for normal usage:

1. Bring the vehicle to a complete stop.
2. Apply the parking brake.
3. Shut OFF the engine.
4. Depress the brake pedal.
5. Shift transmission into NEUTRAL.
6. Shift transfer case lever to desired position.
7. Shift transmission into PARK.

WARNING!

You or others could be injured if you leave the vehicle unattended with the transfer case in the NEUTRAL position without first fully engaging the parking brake. The transfer case NEUTRAL position disengages both the front and rear driveshafts from the powertrain and will allow the vehicle to move, regardless of the transmission position. The parking brake should always be applied when the driver is not in the vehicle.

CAUTION!

- Do not use a bumper-mounted clamp-on tow bar on your vehicle. The bumper face bar will be damaged.

(Continued)

CAUTION! (Continued)

- Do not disconnect the rear driveshaft because fluid will leak from the transfer case and damage the internal parts.

Recreational Towing Procedure — Electronic Shift Transfer Case — If Equipped

Use the following procedure to prepare your vehicle for recreational towing:

CAUTION!

It is necessary to follow these steps to be certain that the transfer case is fully in NEUTRAL before recreational towing, to prevent damage to internal parts.

1. Bring vehicle to a complete stop.
2. Shut OFF the engine.

3. Turn the ignition key to the ON position, but do not start the engine.
4. Depress the brake pedal.
5. Shift transmission into NEUTRAL.
6. Using the point of a ballpoint pen or similar object, depress the recessed transfer case NEUTRAL button for four seconds.
7. After shift is completed and the NEUTRAL light comes on, release the NEUTRAL button.
8. Start engine.
9. Shift transmission into REVERSE.
10. Release brake pedal for five seconds and ensure that there is no vehicle movement.
11. Repeat steps 9 and 10 with the transmission in DRIVE.
12. Shut engine OFF and place ignition key in the unlocked OFF position.
13. Shift transmission into PARK.
14. Apply parking brake.
15. Attach vehicle to tow vehicle with tow bar.
16. Release parking brake.

NOTE:

- Steps 1 through 5 are requirements that must be met prior to depressing the NEUTRAL selection button, and must continue to be met until the four seconds elapses and the shift has been completed. If any of these requirements (with the exception of 3 - Key ON) are not met prior to depressing the NEUTRAL button or are no longer met during the four second timer, then the NEUTRAL indicator light will flash continuously until all requirements are met or until the NEUTRAL button is released.

- The ignition key must be ON for a shift to take place and for the position indicator lights to be operable. If the key is not ON, the shift will not take place and no position indicator lights will be on or flashing.
- Flashing NEUTRAL position indicator light indicates that shift requirements have not been met.

CAUTION!

Damage to the transmission may occur if the transmission is shifted into PARK with the transfer case in NEUTRAL and the engine running. With the transfer case in NEUTRAL ensure, that the engine is OFF prior to shifting the transmission into PARK.

Returning to Normal Operation — Electronic Shift Transfer Case

Use the following procedure to prepare your vehicle for normal usage:

1. Bring vehicle to a complete stop.
2. Shut OFF the engine.
3. Turn the ignition key to the ON position, but do not start the engine.
4. Depress the brake pedal.
5. Shift transmission into NEUTRAL.
6. Using the point of a ballpoint pen or similar object, depress the recessed transfer case Neutral (N) button for one second.
7. After the Neutral indicator light turns off, release the Neutral (N) button.
8. After the Neutral (N) button has been released, the transfer case will shift to the position identified by the selector switch.
9. Shift transmission into PARK.

NOTE:

- The transfer case cannot be shifted into NEUTRAL from the 4AUTO (if equipped) position.
- Steps 1 through 5 are requirements that must be met prior to depressing the transfer case Neutral (N) button, and must continue to be met until one second elapses and the shift has been completed. If any of these requirements (with the exception of step 3 - key ON) are not met prior to depressing the Neutral (N) button, or are no longer met during the one second time, then all of the mode position indicator lights will flash continuously until all requirements are met, or until the Neutral (N) button is released.
- The ignition key must be ON for a transfer case shift to take place and for the position indicator lights to be operable. If the key is not ON, the shift will not take place and no position indicator lights will be on or flashing.

- Flashing Neutral position indicator light indicates that shift requirements have not been met.

WARNING!

You or others could be injured if you leave the vehicle unattended with the transfer case in the NEUTRAL position without first fully engaging the parking brake. The transfer case NEUTRAL position disengages both the front and rear driveshafts from the powertrain and will allow the vehicle to move despite the transmission position. The parking brake should always be applied when the driver is not in the vehicle.

CAUTION!

- Do not use a bumper-mounted clamp-on tow bar on your vehicle. The bumper face bar will be damaged.
- Do not disconnect the rear driveshaft because fluid will leak from the transfer case and fluid loss will damage internal parts.

WHAT TO DO IN EMERGENCIES

CONTENTS

■ Hazard Warning Flasher	314	■ Jump Starting	326
■ Jacking And Tire Changing	315	□ With Portable Starting Unit	330
□ 3500 Models — If Equipped	315	■ Freeing A Stuck Vehicle	330
□ Preparations For Jacking	316	■ Emergency Tow Hooks — If Equipped	330
□ Jacking Instructions	317	■ Towing A Disabled Vehicle	331
■ Hoisting	326	□ 4-Wheel Drive Vehicles	331
		□ 2-Wheel Drive Vehicles	332

HAZARD WARNING FLASHER

The Hazard Warning flasher switch is mounted on the top of the steering column.

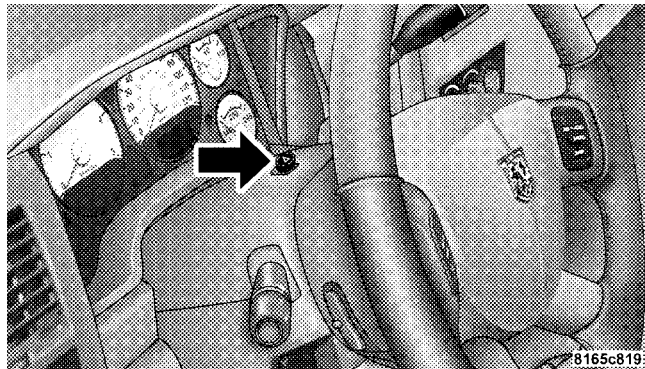

Hazard Warning Flasher Switch

Press the button on the top of the steering column to turn on the Hazard Warning flasher. When the Hazard Warning flasher is activated, all directional turn signals will flash off and on to warn oncoming traffic of an emergency. Press the button a second time to turn off the flashers.

This is an emergency warning system and should not be used when the vehicle is in motion. Use it when your vehicle is disabled and is creating a safety hazard for other motorists.

When you must leave the vehicle to seek assistance, the Hazard Warning flasher will continue to operate even though the ignition switch is OFF.

NOTE: With extended use, the Hazard Warning flasher may discharge your battery.

JACKING AND TIRE CHANGING

WARNING!

- Being under a jacked-up vehicle is dangerous. The vehicle could slip off the jack and fall on you. You could be crushed. Never put any part of your body under a vehicle that is on a jack. Never start or run the engine while the vehicle is on a jack. If you need to get under a raised vehicle, take it to a service center where it can be raised on a lift.
- The jack is designed to use as a tool for changing tires only. The jack should not be used to lift the vehicle for service purposes. The vehicle should be jacked on a firm level surface only. Avoid ice or slippery areas.

3500 Models — If Equipped

The jack and jack tools are stored under the front passenger seat. Lift the flap on the side of the seat for access.

Remove the jack and tools by removing the wing bolt and sliding the assembly from under the seat.

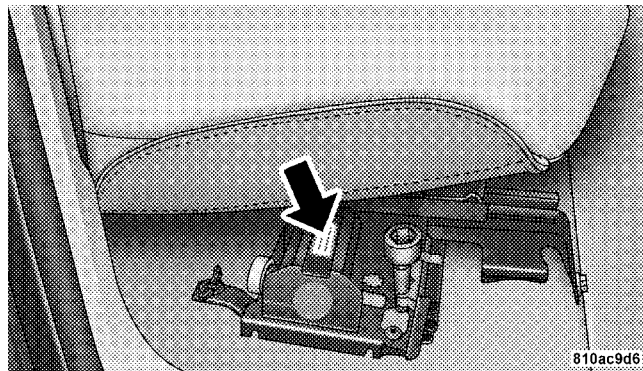

810ac9d6

Jack Location

WARNING!

After using the jack and tools, always reinstall them in the original carrier and location. While driving you may experience abrupt stopping, rapid acceleration, or sharp turns. A loose jack, tools, bracket or other objects in the vehicle may move around with force, resulting in serious injury.

4500/5500 Models

These vehicles do not come equipped with a jack.

NOTE: Jacking and tire changing on 4500/5500 models should be performed by an authorized dealer, or knowledgeable service personnel with the appropriate heavy duty equipment, like a tire service company.

Preparations For Jacking

1. Park the vehicle on a firm level surface. Avoid ice or slippery areas.

WARNING!

Do not attempt to change a tire on the side of the vehicle close to moving traffic. Pull far enough off the road to avoid the danger of being hit when operating the jack or changing the wheel.

2. Set the parking brake.
3. Place the shift lever into PARK (automatic transmission) or REVERSE (manual transmission). On 4-Wheel drive vehicles, shift the transfer case to the "4L" position.
4. Turn OFF the ignition.
5. Turn on the Hazard Warning flasher.



6. Block both the front and rear of the wheel diagonally opposite the jacking position. For example, if the right front wheel is being changed, block the left rear wheel.

NOTE: Passengers should not remain in the vehicle when the vehicle is being jacked.

Jacking Instructions

Instructions

WARNING!

Carefully follow these tire changing warnings to help prevent personal injury or damage to your vehicle:

(Continued)

WARNING! (Continued)

- Always park on a firm, level surface as far from the edge of the roadway as possible before raising the vehicle.
- Block the wheel diagonally opposite the wheel to be raised.
- Set the parking brake firmly and set an automatic transmission in **PARK**; a manual transmission in **REVERSE**.
- Never start or run the engine with the vehicle on a jack.
- Do not let anyone sit in the vehicle when it is on a jack.
- Do not get under the vehicle when it is on a jack.
- Only use the jack in the positions indicated and for lifting this vehicle during a tire change.

(Continued)

WARNING! (Continued)

- If working on or near a roadway, be extremely careful of motor traffic.
- To assure that spare tires, flat or inflated are securely stowed, spares must be stowed with the valve stem facing the ground.
- Turn on the Hazard Warning Flasher.



Jack Warning Label

1. If equipped, remove the spare wheel, jack, and tools from storage.
2. Using the wheel wrench, loosen, but do not remove, the wheel nuts by turning them counterclockwise one turn while the wheel is still on the ground.
3. When changing the front wheel, assemble the jack drive tube to the jack and connect the drive tube to the extension tube. Place the jack under the axle as close to the tire as possible with the drive tubes extending to the front. Connect the jack tube extension and wheel wrench.

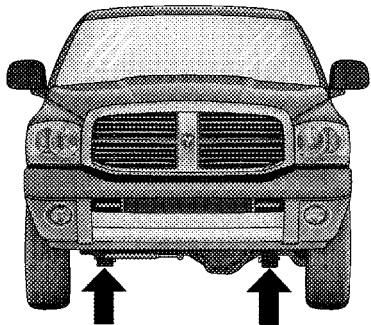

060505397

Front Jacking Locations

When changing a rear wheel, assemble the jack drive tube to the jack and connect the drive tube to the extension tube. Securely place the jack under the sway bar bracket (unless both tires are flat on one side, then place jack under shock bracket) facing forward in vehicle. Connect the jack tube extension and lug wrench.

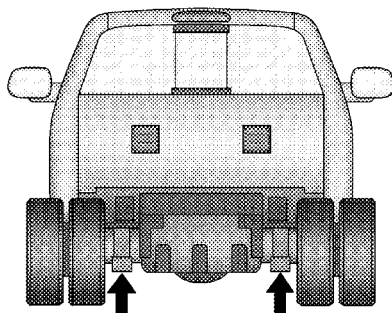

060505668

Rear Jacking Location

Before raising the wheel off the ground, make sure that the jack will not damage surrounding truck parts and adjust the jack position as required.

NOTE: If the jack will not lower by turning the dial (thumbwheel) by hand, it may be necessary to use the jack drive tube in order to lower the jack.

4. By rotating the wheel wrench clockwise, raise the vehicle until the wheel just clears the surface.

WARNING!

Raising the vehicle higher than necessary can make the vehicle unstable and cause an accident. It could slip off the jack and hurt someone near it. Raise the vehicle only enough to remove the tire.

5. Remove the wheel nuts and pull the wheel off. Install the spare wheel and wheel nuts with the cone shaped end of the nuts toward the wheel on single rear wheel (SRW) models. On dual rear wheel models (DRW) the lug nuts are a two-piece assembly with a flat face. Lightly tighten the nuts. To avoid risk of forcing the vehicle off the jack, do not fully tighten the nuts until the vehicle has been lowered.

6. Using the wheel wrench, finish tightening the nuts using a crisscross pattern. Correct nut tightness is 135 ft lbs (183 N·m) torque for single rear wheel (SRW) models and 145 ft lbs (197 N·m) for dual rear wheel models. If in doubt about the correct tightness, have them checked with a torque wrench by your authorized dealer or at a service station.

WARNING!

A loose tire or jack thrown forward in a collision or hard stop could injure someone in the vehicle. Always stow the jack parts and the extra tire and wheel in the places provided.

7. Install wheel center cap (if equipped) and remove wheel blocks. Do not install chrome or aluminum wheel center caps on the spare wheel. This may result in cap damage.
8. Lower the jack to its fully closed position. If the jack will not lower by turning the dial (thumbwheel) by hand, it may be necessary to use the jack drive tube in order to lower the jack. Stow the replaced tire, jack, and tools as previously described.
9. Adjust the tire pressure when possible.

NOTE: Do not oil wheel studs. For chrome wheels, do not substitute with chrome plated wheel nuts.

Hub Caps/Wheel Covers — If Equipped

The hub caps must be removed before raising the vehicle off the ground.

For single rear wheel (SRW) models, use the blade on the end of the lug wrench to pry the hub cap off. Insert the blade end into the pry off notch and carefully pop off the hub cap with a back and forth motion.

On 3500 models with dual rear wheels (DRW), you must first remove the hub caps. The jack handle driver has a hook at one end that will fit in the pry off notch of the rear hub caps. Position the hook and pull out on the ratchet firmly. The hub cap should pop off. The wheel skins can now be removed. For the front hub cap on models use the blade on the end of the lug wrench to pry the caps off. The wheel skin can now be removed.

CAUTION!

- Use a back and forth motion to remove the hub cap. Do not use a twisting motion when removing the hub cap, damage to the hub cap; finish may occur.
- The rear hub caps on the dual rear wheel has two pry off notches. Make sure that the hook of the jack handle driver is located squarely in the cap notch before attempting to pull off.

You must use the flat end of the lug wrench to pry off the wheel skins. Insert the flat tip completely and using a back and forth motion, loosen the wheel skin. Repeat this procedure around the tire until the skin pops off.

Replace the wheel skins first using a rubber mallet. When replacing the hub caps, tilt the cap retainer over the lug

nut bolt circle and strike the high side down with a rubber mallet. Be sure that the hub caps and wheel skins are firmly seated around the wheel.

Dual Rear Wheels

Dual wheels are flat mounted, center piloted. The lug nuts are a two-piece assembly. When the tires are being rotated or replaced, clean these lug nuts and add two drops of oil at the interface between the hex and the washer.

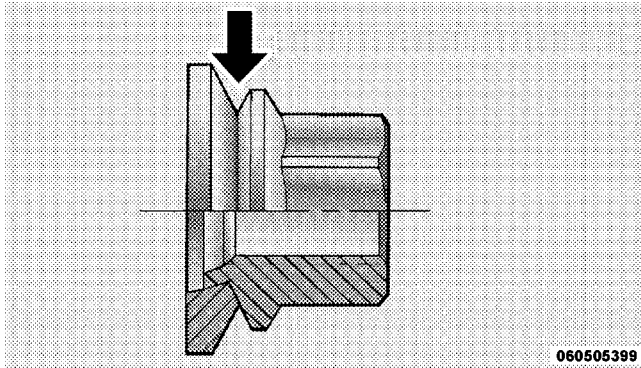

Oiling Location

Slots in the wheels will assist in properly orienting the inner and outer wheels. Align these slots when assembling the wheels for best access to the tire valve on the inner wheel. The tires of both dual wheels must be completely off the ground when tightening to insure wheel centering and maximum wheel clamping.

Dual wheel models require a special heavy-duty lug nut tightening adapter (included with the vehicle) to correctly tighten the lug nuts. Also, when it is necessary to remove and install dual rear wheels, use a proper vehicle lifting device.

NOTE: When installing a spare tire (if equipped) as part of a dual rear wheel end combination, the tire diameter of the two individual tires must be compared. If there is a significant difference, the larger tire should be installed in a front location. Correct direction of rotation for dual tire installations must also be observed.

These dual rear wheels should be tightened as follows:

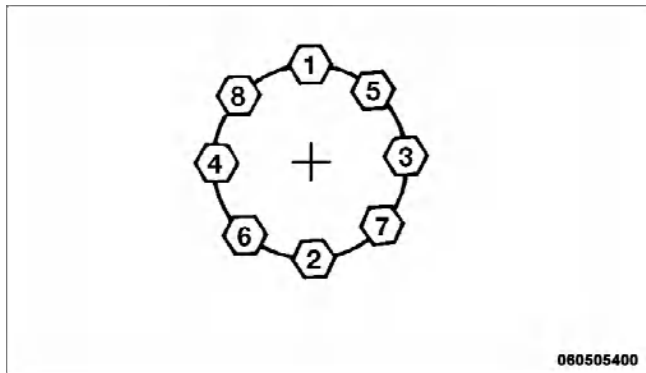

Tightening Pattern (8 Studs)

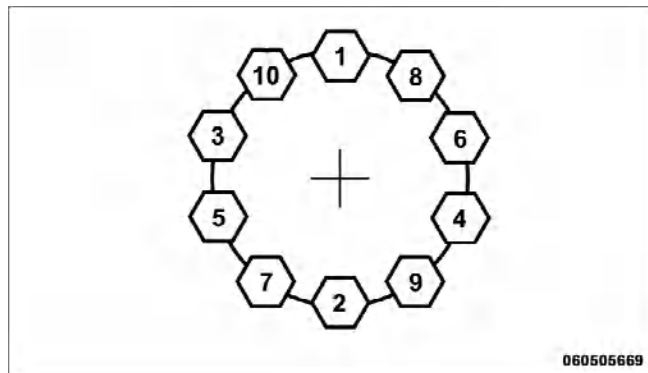

Tightening Pattern (10 Studs)

1. Tighten the wheel nuts in the numbered sequence to a snug fit.
2. Retighten the wheel nuts in the same sequence to the torques listed in the table. Go through the sequence a

second time to verify that specific torque has been achieved. Retighten to specifications at 100 miles (160 km) and after 500 miles (800 km).

It is recommended that wheel stud nuts be kept torqued to specifications at all times. Torque wheel stud nuts to specifications at each lubrication interval.

Wheel Nut Torque

All wheel nuts should be tightened occasionally to eliminate the possibility of wheel studs being sheared or the

bolt holes in the wheels becoming elongated. This is especially important during the first few hundred miles/kilometers of operation to allow the wheel nuts to become properly set. All nuts should first be firmly seated against the wheel. The nuts should then be tightened to recommended torque. Tighten the nuts to final torque in increments. Progress around the bolt circle, tightening the nut opposite to the nut just previously tightened until final torque is achieved. Recommended torques are shown in the following chart.

Disc Wheels	Type Nut	Stud Size	Torque Ft Lbs	Torque Newton Meters
	Cone	9/16-18	120-150	160-200
	Flanged	9/16-18	130-160	190-220

To Stow The Flat Or Spare — If Equipped

Refer to Upfitters Body Builders Guide for information on stowing your spare tire (if equipped).

HOISTING

A conventional floor jack may be used at the jacking locations. Refer to the graphics that show jacking locations. However, a floor jack or frame hoist must never be used on any other parts or the underbody.

CAUTION!

Never use a floor jack directly under the differential housing of a loaded truck or damage to your vehicle may result.

JUMP STARTING

WARNING!

- To prevent personal injury or damage to clothing, do not allow battery fluid to contact eyes, skin or fabrics. Do not lean over a battery when connecting jumper cables or allow cable clamps to touch each other. Keep open flames or sparks away from battery vent holes. Always wear eye protection when working with batteries.
- Do not use a booster battery or any other booster source that has a greater than 12-Volt system, i.e., do not use a 24-Volt power source.

NOTE: Replacement batteries should both be of equal size to prevent damage to the vehicle's charging system.

Your vehicle is equipped with two 12-Volt batteries. If it becomes necessary to use a booster battery with jumper cables to start a vehicle's engine because its batteries are discharged, the following procedure should be used:

Set the parking brake and place the transmission in PARK. Turn off lights, heater and other electrical loads. Observe charge indicator (if equipped) in both batteries. If the indicator (if equipped) is light or yellow on either battery, replace that battery.

CAUTION!

Use the Jump-Start Procedure only when the charge indicator (if equipped) in both batteries is dark in the center. Do not attempt jump-starting when either battery charge indicator (if equipped) is bright or yellow. If the charge indicator (if equipped) has a green dot in the center, failure to start is not due to a discharged battery and cranking system should be checked.

1. Attach one jumper cable to the positive terminal of booster battery and the other end of the same cable to the positive terminal of the discharged battery.

WARNING!

Do not permit vehicles to touch each other as this could establish a ground connection and personal injury could result.

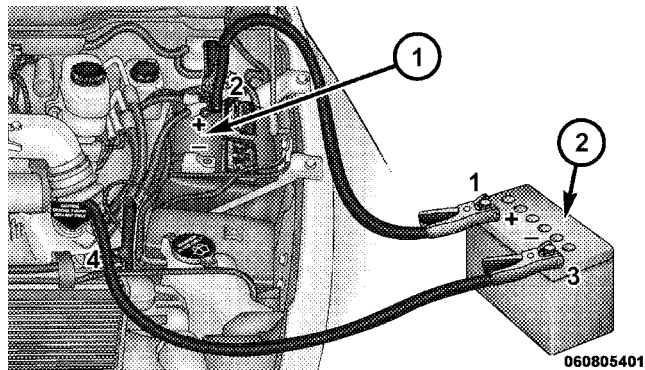
**Attaching Booster Cables**

- 1 — Discharged Battery
- 2 — Booster Battery

2. Connect one end of the other jumper cable to negative (-) post of booster battery. Connect the other end of the jumper cable to a good ground on the engine block of the

vehicle with the discharged battery. Make sure a good connection is made, free of dirt and grease.

WARNING!

- Do not connect the cable to the negative post of the discharge battery. The resulting electrical spark could cause the battery to explode.
- During cold weather when temperatures are below freezing point, electrolyte in a discharged battery may freeze. Do not attempt jump-starting because the battery could rupture or explode. The battery temperature must be brought up above freezing point before attempting to jump-start.

3. Take care that the clamps from one cable do not inadvertently touch clamps from the other cable. Do not lean over the battery when making connection. The negative connection must provide good electrical conductivity and current carrying capacity.

4. After the engine is started or if the engine fails to start, cables must be disconnected in the following order:

- a. Disconnect the negative cable at the engine ground.
- b. Disconnect the negative cable at the negative post on booster battery.
- c. Disconnect the cable from the positive post of both batteries.

WARNING!

Any procedure other than above could result in:

- Personal injury caused by electrolyte squirting out the battery vent;
- Personal injury or property damage due to battery explosion;
- Damage to charging system of booster vehicle or of immobilized vehicle.

With Portable Starting Unit

There are many types of these units available. Follow the manufacturer's instructions for necessary precautions and operation.

CAUTION!

It is very important that the starting unit operating voltage does not exceed 12-Volts DC or damage to battery, starter motor, alternator, or electrical system may occur.

FREEING A STUCK VEHICLE

If the vehicle becomes stuck in snow, sand, or mud, it can often be moved by a rocking motion. Move the shift lever rhythmically between DRIVE and REVERSE while applying slight pressure to the accelerator.

In general, the least amount of accelerator pedal pressure to maintain the rocking motion without spinning the wheels or racing the engine, is most effective. Racing the engine or spinning the wheels, due to the frustration of not freeing the vehicle, may lead to transmission overheating and failure. Allow the engine to idle with the shift lever in NEUTRAL for at least one minute after every five rocking-motion cycles. This will minimize overheating and reduce the risk of transmission failure during prolonged efforts to free a stuck vehicle.

EMERGENCY TOW HOOKS — IF EQUIPPED

Your vehicle may be equipped with emergency tow hooks.

NOTE: For off-road recovery, it is recommended to use both of the front tow hooks to minimize the risk of damage to the vehicle.

WARNING!

- Chains are not recommended for freeing a stuck vehicle. Chains may break, causing serious injury or death.
- Stand clear of vehicles when pulling with tow hooks. Tow straps and chains may break, causing serious injury.

CAUTION!

Tow hooks are for emergency use only to rescue a vehicle stranded off-road. Do not use tow hooks for tow truck hookup or highway towing. You could damage your vehicle.

TOWING A DISABLED VEHICLE

Proper towing or lifting equipment is required to prevent damage to your vehicle. Use only tow bars and other equipment designed for the purpose, following equipment manufacturer's instructions. Use of safety chains is mandatory. Attach a tow bar or other towing device to the main structural members of the vehicle—not to bumpers or associated brackets. State and local laws applying to vehicles under tow must be observed.

4-Wheel Drive Vehicles**CAUTION!**

To avoid damage to the transfer case while towing, always use one of the following methods.

NOTE: The transfer case must be in the neutral position, and the transmission must be in PARK (automatic transmission), or in gear (manual transmission) to tow a 4-Wheel Drive vehicle with one end of the vehicle raised.

The manufacturer recommends towing with all wheels **OFF** the ground. Acceptable methods are to tow the vehicle on a flatbed or with one end of vehicle raised and the opposite end on a towing dolly.

2-Wheel Drive Vehicles

Provided that the transmission is operable, tow with the transmission in NEUTRAL and the ignition key in the OFF position along with the front wheels raised and the rear wheels on the ground. Speed must not exceed 30 mph (50 km/h) and distance must not exceed 15 miles (25 km).

CAUTION!

Towing faster than 30 mph (50 km/h) or for more than 15 miles (25 km) can cause severe damage to the transmission.

If the vehicle is to be towed faster than 30 mph (50 km/h) or more than 15 miles (25 km) the vehicle must be towed with the rear wheels raised and the front wheels on the ground. It may also be towed on a flatbed or with the front wheels raised and the rear wheels on a dolly.

MAINTAINING YOUR VEHICLE

CONTENTS

■ Engine Compartment— 5.7L	335	□ Air Conditioner Maintenance	342
■ Onboard Diagnostic System (OBD II)	336	□ Body Lubrication	343
□ Loose Fuel Filler Cap Message	336	□ Windshield Wiper Blades	344
■ Replacement Parts	337	□ Adding Washer Fluid	344
■ Dealer Service	337	□ Exhaust System	345
■ Maintenance Procedures	338	□ Cooling System	348
□ Engine Oil	338	□ Brake System	353
□ Engine Air Cleaner Filter	340	□ Rear Axle And 4X4 Front Driving Axle Fluid Level	355
□ Maintenance Free Battery	341		

- Transfer Case — If Equipped 356
- Automatic Transmission 356
- Appearance Care And Protection From Corrosion 359
- Fuses 364
 - Integrated Power Module 364
- Vehicle Storage 369
- Replacement Light Bulbs 370
 - Bulb Replacement 370
 - Headlight (Halogen)/Front Park And Turn Lights 370
 - Fog Lights 374
 - Cab Top Clearance Lights — If Equipped . . . 375
 - Fluid And Capacities 377
 - Fluids, Lubricants And Genuine Parts 378
 - Engine 378
 - Chassis 379

ENGINE COMPARTMENT— 5.7L

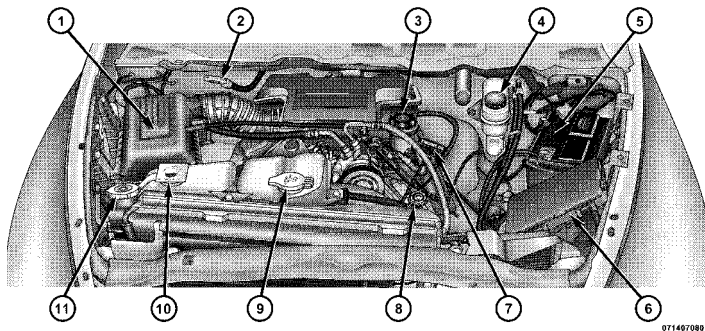

071407080

- 1 — Air Cleaner Filter
- 2 — Automatic Transmission Dipstick
- 3 — Engine Oil Fill
- 4 — Brake Fluid Reservoir
- 5 — Battery
- 6 — Integrated Power Module

- 7 — Engine Oil Dipstick
- 8 — Power Steering Fluid Reservoir
- 9 — Washer Fluid Reservoir
- 10 — Engine Coolant Reservoir
- 11 — Coolant Pressure Cap

ONBOARD DIAGNOSTIC SYSTEM (OBD II)

Vehicles with 5.7L engines are equipped with a sophisticated onboard diagnostic system called OBD II. This system monitors the performance of the emissions, engine, and automatic transmission control systems. When these systems are operating properly, your vehicle will provide excellent performance and fuel economy, as well as engine emissions well within current government regulations.

If any of these systems require service, the OBD II system will turn on the Malfunction Indicator Light (MIL). It will also store diagnostic codes and other information to assist your service technician in making repairs. Although your vehicle will usually be driveable and not need towing, see your authorized dealer for service as soon as possible.

CAUTION!

Prolonged driving with the MIL on could cause further damage to the emission control system. It could also affect fuel economy and driveability. The vehicle must be serviced before any emissions tests can be performed.

If the MIL is flashing, severe catalytic converter damage and power loss will soon occur. Immediate service is required.

Loose Fuel Filler Cap Message

If the vehicle's diagnostic system determines that the fuel filler cap is loose, improperly installed, or damaged, a gASCAP message will be displayed in the instrument cluster. Tighten the gas cap until a "clicking" sound is heard. This is an indication that the gas cap is properly tightened. Press the odometer reset button to turn the message off. If the problem persists, the message will

appear the next time the vehicle is started. This might indicate a damaged cap. If the problem is detected twice in a row, the system will turn on the Malfunction Indicator Light (MIL). Resolving the problem will turn the MIL light off.

REPLACEMENT PARTS

Use of genuine MOPAR® parts for normal/scheduled maintenance and repairs is highly recommended to ensure the designed performance. Damage or failures caused by the use of non-MOPAR® parts for maintenance and repairs will not be covered by the manufacturer's warranty.

DEALER SERVICE

Your authorized dealer has the qualified service personnel, special tools and equipment to perform all service operations in an expert manner. Service Manuals are

available which include detailed service information for your vehicle. Refer to these manuals before attempting any procedure yourself.

NOTE: Intentional tampering with emissions control systems can result in civil penalties being assessed against you.

WARNING!

You can be badly injured working on or around a motor vehicle. Do only that service work for which you have the knowledge and the proper equipment. If you have any doubt about your ability to perform a service job, take your vehicle to a competent mechanic.

MAINTENANCE PROCEDURES

The pages that follow contain the **required** maintenance services determined by the engineers who designed your vehicle.

Besides the maintenance items for which there are fixed maintenance intervals, there are other items that should operate satisfactorily without periodic maintenance. However, if a malfunction of these items does occur, it could adversely affect the engine or vehicle performance. These items should be inspected if a malfunction is observed or suspected.

Engine Oil

Checking Oil Level

To assure proper lubrication of your vehicle's engine, the engine oil must be maintained at the correct level. Check the oil level at regular intervals. The best time to check the oil level is before starting the engine after it has been parked overnight. When checking oil after operating the

engine, first ensure the engine is at full operating temperature, then wait for 15 minutes after engine shutdown to check the oil.

Checking the oil while the vehicle is on level ground will improve the accuracy of the oil level readings. Always maintain the oil level within the SAFE zone on the dipstick. Adding one quart of oil when the reading is at the bottom of the SAFE zone will result in a reading at the top of the safe zone on these engines.

CAUTION!

Overfilling or underfilling the crankcase will cause oil aeration or loss of oil pressure. This could damage your engine.

Never operate the engine with oil level below the "ADD" mark or above the upper "SAFE" mark.

Change Engine Oil

Refer to the “Maintenance Schedule” in Section 8 for the proper maintenance intervals.

Engine Oil Selection

For best performance and maximum protection under all types of operating conditions, the manufacturer only recommends engine oils that are API certified and meet the requirements of Chrysler Material Standard MS-6395.

American Petroleum Institute (API) Engine Oil Identification Symbol



This symbol means that the oil has been certified by the American Petroleum Institute (API). The manufacturer only recommends API Certified engine oils.

Engine Oil Viscosity (SAE Grade)

For trucks with a 5.7L engine operating under a gross combined weight rating of 14,000 lbs (6,350 kg) or greater, SAE 5W-30 engine oil is recommended for all operating temperatures.

For all other trucks with a 5.7L engine operating under a gross weight rating less than 14,000 lbs (6,350 kg) SAE 5W-20 engine oil is recommended for all operating temperatures. These engine oils improve low temperature starting and vehicle fuel economy. Your engine oil filler cap also shows the recommended engine oil viscosity for your vehicle.

For information on engine oil filler cap location, refer to “Engine Compartment” in this section.

Lubricants which do not have both the engine oil certification mark and the correct SAE viscosity grade number should not be used.

Synthetic Engine Oils

You may use synthetic engine oils provided the recommended oil quality requirements are met, and the recommended maintenance intervals for oil and filter changes are followed.

Materials Added to Engine Oil

Do not add supplemental materials, other than leak detection dyes, to your engine oil. Engine oil is an engineered product and its performance may be impaired by supplemental additives.

Engine Oil Filter

The engine oil filter should be changed at **every** engine oil change.

Refer to “Fluids, Lubricants, and Genuine Parts” in this section for the correct part number.

Disposing Of Used Engine Oil And Filter

Care should be taken in disposing of the used engine fluids from your vehicle. Used fluids, indiscriminately discarded, can present a problem to the environment. Contact an authorized dealer, service station, or governmental agency for advice on recycling programs and where used fluids and filters can be safely discarded in your area.

Engine Air Cleaner Filter

Refer to the “Maintenance Schedule” in Section 8 of this manual for the proper maintenance intervals.

WARNING!

The air induction system (air cleaner, hoses, etc) can provide a measure of protection in the case of engine backfire. Do not remove the air induction system (air cleaner, hoses, etc) unless such removal is necessary for repair or maintenance. Make sure that no one is near the engine compartment before starting the vehicle with the air induction system (air cleaner, hoses, etc) removed. Failure to do so can result in serious personal injury.

Engine Air Cleaner Filter Selection

The quality of replacement engine air cleaner filters varies considerably. Only high quality filters should be used to assure most efficient service. MOPAR® engine air cleaner filters are a high quality filter and are recommended.

Maintenance Free Battery

The top of the maintenance free battery is permanently sealed. You will never have to add water, nor is periodic maintenance required.

WARNING!

- Battery fluid is a corrosive acid solution and can burn or even blind you. Do not allow battery fluid to contact your eyes, skin or clothing. Do not lean over a battery when attaching clamps. If acid splashes in eyes or on skin, flush the area immediately with large amounts of water.
- Battery gas is flammable and explosive. Keep flame or sparks away from the battery. Do not use a booster battery or any other booster source with an output greater than 12 Volts. Do not allow cable clamps to touch each other.

(Continued)

WARNING! (Continued)

- Battery posts, terminals and related accessories contain lead and lead compounds. Wash hands after handling.

CAUTION!

- It is essential when replacing the cables on the battery that the positive cable is attached to the positive post and the negative cable is attached to the negative post. Battery posts are marked (+) positive and negative (-) and identified on the battery case.
- If a "fast charger" is used while battery is in vehicle, disconnect both vehicle battery cables before connecting the charger to battery. Do not use a "fast charger" to provide starting voltage.

Air Conditioner Maintenance

For best possible performance, your air conditioner should be checked and serviced by an authorized dealer at the start of each warm season. This service should include cleaning of the condenser fins and a performance test. Drive belt tension should also be checked at this time.

WARNING!

- Use only refrigerants and compressor lubricants approved by the manufacturer for your air conditioning system. Some unapproved refrigerants are flammable and can explode, injuring you. Other unapproved refrigerants or lubricants can cause the system to fail, requiring costly repairs. Refer to Section 3 of the Warranty Information Book for further warranty information.

(Continued)

WARNING! (Continued)

- **The air conditioning system contains refrigerant under high pressure. To avoid risk of personal injury or damage to the system, adding refrigerant or any repair requiring lines to be disconnected should be done by an experienced repair person.**

NOTE: Use only manufacturer approved A/C System Sealers, Stop Leak Products, Seal Conditioners, Compressor Oil, or Refrigerants.

Refrigerant Recovery and Recycling

R-134a air conditioning refrigerant is a hydrofluorocarbon (HFC) that is endorsed by the Environmental Protection Agency and is an ozone-saving product. However, the manufacturer recommends that air conditioning service be performed by authorized dealers or other service facilities using recovery and recycling equipment.

Body Lubrication

Locks and all body pivot points, including such items as seat tracks, door hinge pivot points and rollers, liftgate, tailgate, sliding doors and hood hinges, should be lubricated periodically with a lithium based grease such as MOPAR® Spray White Lube to assure quiet, easy operation and to protect against rust and wear. Prior to the application of any lubricant, the parts concerned should be wiped clean to remove dust and grit; after lubricating excess oil and grease should be removed. Particular attention should also be given to hood latching components to insure proper function. When performing other underhood services, the hood latch, release mechanism and safety catch should be cleaned and lubricated.

The external lock cylinders should be lubricated twice a year, preferably in the Fall and Spring. Apply a small amount of a high quality lubricant such as MOPAR® Lock Cylinder Lubricant directly into the lock cylinder.

Windshield Wiper Blades

Clean the rubber edges of the wiper blades and the windshield periodically with a sponge or soft cloth and a mild nonabrasive cleaner. This will remove accumulations of salt or road film.

Operation of the wipers on dry glass for long periods may cause deterioration of the wiper blades. Always use washer fluid when using the wipers to remove salt or dirt from a dry windshield.

Avoid using the wiper blades to remove frost or ice from the windshield. Keep the blade rubber out of contact with petroleum products such as engine oil, gasoline, etc.

Adding Washer Fluid

The fluid reservoir is located under the hood and should be checked for fluid level at regular intervals. Fill the reservoir with windshield washer solvent only (not radiator antifreeze). When refilling the washer fluid reservoir, take some washer fluid and apply it to a cloth or towel and wipe clean the wiper blades; this will help blade performance.

To prevent freeze-up of your windshield washer system in cold weather, select a solution or mixture that meets or exceeds the temperature range of your climate. This rating information can be found on most washer fluid containers.

The washer fluid reservoir will hold a full gallon/liter of fluid when the "Low Washer Fluid Light" illuminates.

WARNING!

Commercially available windshield washer solvents are flammable. They could ignite and burn you. Care must be exercised when filling or working around the washer solution.

After the engine has warmed, operate the defroster for a few minutes to reduce the possibility of smearing or freezing the fluid on the cold windshield. MOPAR® All Weather Windshield Washer Solution, used with water as directed on the container, aids cleaning action, reduces the freezing point to avoid line clogging, and is not harmful to paint or trim.

Exhaust System

The best protection against carbon monoxide entry into the vehicle body is a properly maintained engine exhaust system.

Whenever a change is noticed in the sound of the exhaust system, when exhaust fumes can be detected inside the vehicle, or when the underside or rear of the vehicle is damaged, have a competent mechanic inspect the complete exhaust system and adjacent body areas for broken, damaged, deteriorated, or mispositioned parts. Open seams or loose connections could permit exhaust fumes to seep into the passenger compartment. In addition, inspect the exhaust system each time the vehicle is raised for lubrication or oil change. Replace parts as required.

WARNING!

Exhaust gases can injure or kill. They contain carbon monoxide (CO) which is colorless and odorless. Breathing it can make you unconscious and can eventually poison you. To avoid breathing CO, follow the preceding safety tips.

The catalytic converter requires the use of unleaded fuel only. Leaded gasoline will destroy the effectiveness of the catalyst as an emission control device.

Under normal operating conditions, the catalytic converter will not require maintenance. However, it is important to keep the engine properly tuned to assure proper catalyst operation and prevent possible catalyst damage.

CAUTION!

Damage to the catalytic converter can result if your vehicle is not kept in proper operating condition. In the event of engine malfunction, particularly involving engine misfire or other apparent loss of performance, have your vehicle serviced promptly. Continued operation of your vehicle with a severe malfunction could cause the converter to overheat, resulting in possible damage to the converter and the vehicle.

NOTE: Intentional tampering with emissions control systems can result in civil penalties being assessed against you.

WARNING!

A hot exhaust system can start a fire if you park over materials that can burn. Such materials might be grass or leaves coming into contact with your exhaust system. Do not park or operate your vehicle in areas where your exhaust system can contact anything that can burn.

In unusual situations involving grossly malfunctioning engine operation, a scorching odor may indicate severe and abnormal catalyst overheating. If this occurs, the vehicle should be stopped, the engine shut off and the vehicle allowed to cool. Thereafter, service, including a tune-up to manufacturer's specifications, should be obtained immediately.

To minimize the possibility of catalyst damage:

- Do not shut off the engine or interrupt the ignition when the transmission is in gear and the vehicle is in motion.
- Do not try to start engine by pushing or towing the vehicle.
- Do not idle the engine with any spark plug wires disconnected or removed, such as when diagnostic testing, or for prolonged periods during very rough idling or malfunctioning operating conditions.

Cooling System

WARNING!

You or others can be badly burned by hot engine coolant (antifreeze) or steam from your radiator. If you see or hear steam coming from under the hood, do not open the hood until the radiator has had time to cool. Never try to open a cooling system pressure cap when the radiator is hot.

Engine Coolant Checks

Check the engine coolant (antifreeze) protection every 12 months (before the onset of freezing weather, where applicable). If the engine coolant (antifreeze) is dirty or rusty in appearance, the system should be drained, flushed and refilled with fresh engine coolant (antifreeze). Check the front of the A/C condenser for any

accumulation of bugs, leaves, etc. If dirty, clean by gently spraying water from a garden hose vertically down the face of the condenser.

Check the coolant recovery bottle tubing for brittle rubber, cracking, tears, cuts and tightness of the connection at the bottle and radiator. Inspect the entire system for leaks.

With the engine at normal operating temperature (but not running), check the cooling system pressure cap for proper vacuum sealing by draining a small amount of engine coolant (antifreeze) from the radiator drain cock. If the cap is sealing properly, the engine coolant (antifreeze) will begin to drain from the coolant recovery bottle. **DO NOT REMOVE THE COOLANT PRESSURE CAP WHEN THE COOLING SYSTEM IS HOT.**

Cooling System — Drain, Flush and Refill

If the engine coolant (antifreeze) is dirty or contains a considerable amount of sediment, clean and flush with a reliable cooling system cleaner. Follow with a thorough rinsing to remove all deposits and chemicals. Properly dispose of the old engine coolant (antifreeze) solution.

Refer to the “Maintenance Schedule” in Section 8 of this manual for the proper maintenance intervals.

Selection Of Coolant

Use only the manufacturers recommended engine coolant (antifreeze). Refer to “Fluids, Lubricants, and Genuine Parts” in this section for the correct fluid type.

CAUTION!

- **Mixing of engine coolant (antifreeze) other than specified HOAT engine coolant (antifreeze), may result in engine damage and may decrease corrosion protection. If a non-HOAT engine coolant (antifreeze) is introduced into the cooling system in an emergency, it should be replaced with the specified engine coolant (antifreeze) as soon as possible.**
- **Do not use water alone or alcohol-based engine coolant (antifreeze) products. Do not use additional rust inhibitors or antirust products, as they may not be compatible with the radiator engine coolant (antifreeze) and may plug the radiator.**

(Continued)

CAUTION! (Continued)

- **This vehicle has not been designed for use with Propylene Glycol based engine coolant (antifreeze). Use of Propylene Glycol based engine coolant (antifreeze) is not recommended.**

Adding Coolant

Your vehicle has been built with an improved engine coolant (antifreeze) that allows extended maintenance intervals. This engine coolant (antifreeze) can be used up to 5 Years or 102,000 miles (170 000 km) before replacement. To prevent reducing this extended maintenance period, it is important that you use the same engine coolant (antifreeze) throughout the life of your vehicle. Please review these recommendations for using Hybrid Organic Additive Technology (HOAT) engine coolant (antifreeze).

When adding engine coolant (antifreeze):

- The manufacturer recommends using MOPAR® Antifreeze/Coolant 5 Year/100,000 Mile Formula HOAT (Hybrid Organic Additive Technology).
- Mix a minimum solution of 50% HOAT engine coolant (antifreeze) and distilled water. Use higher concentrations (not to exceed 70%) if temperatures below -34°F (-37°C) are anticipated.
- Use only high purity water such as distilled or deionized water when mixing the water/engine coolant (antifreeze) solution. The use of lower quality water will reduce the amount of corrosion protection in the engine cooling system.

Please note that it is the owner's responsibility to maintain the proper level of protection against freezing according to the temperatures occurring in the area where the vehicle is operated.

NOTE: Mixing engine coolant (antifreeze) types will decrease the life of the engine coolant (antifreeze) and will require more frequent engine coolant (antifreeze) changes.

Cooling System Pressure Cap

The cap must be fully tightened to prevent loss of engine coolant (antifreeze), and to ensure that engine coolant (antifreeze) will return to the radiator from the coolant recovery bottle.

The cap should be inspected and cleaned if there is any accumulation of foreign material on the sealing surfaces.

WARNING!

- The warning words “DO NOT OPEN HOT” on the cooling system pressure cap are a safety precaution. Never add engine coolant (antifreeze) when the engine is overheated. Do not loosen or remove the cap to cool an overheated engine. Heat causes pressure to build up in the cooling system. To prevent scalding or injury, do not remove the pressure cap while the system is hot or under pressure.
- Do not use a pressure cap other than the one specified for your vehicle. Personal injury or engine damage may result.

Disposal of Used Engine Coolant

Used ethylene glycol based engine coolant (antifreeze) is a regulated substance requiring proper disposal. Check with your local authorities to determine the disposal rules for your community. To prevent ingestion by animals or children, do not store ethylene glycol based engine coolant (antifreeze) in open containers or allow it to remain in puddles on the ground. If ingested by a child, contact a physician immediately. Clean up any ground spills immediately.

Coolant Level

The coolant bottle provides a quick visual method for determining that the coolant level is adequate. With the engine cold, the level of the engine coolant (antifreeze) in the coolant recovery bottle should be between the ranges indicated on the bottle.

The radiator normally remains completely full, so there is no need to remove the radiator cap unless checking for

engine coolant (antifreeze) freeze point or replacing engine coolant (antifreeze). Advise your service attendant of this. As long as the engine operating temperature is satisfactory, the coolant bottle need only be checked once a month.

When additional engine coolant (antifreeze) is needed to maintain the proper level, it should be added to the coolant bottle. Do not overfill.

Points To Remember

NOTE: When the vehicle is stopped after a few miles (a few kilometers) of operation, you may observe vapor coming from the front of the engine compartment. This is normally a result of moisture from rain, snow, or high humidity accumulating on the radiator and being vaporized when the thermostat opens, allowing hot engine coolant (antifreeze) to enter the radiator.

If an examination of your engine compartment shows no evidence of radiator or hose leaks, the vehicle may be safely driven. The vapor will soon dissipate.

- Do not overfill the coolant recovery bottle.
- Check engine coolant (antifreeze) freeze point in the radiator and in the coolant recovery bottle. If engine coolant (antifreeze) needs to be added, contents of coolant recovery bottle must also be protected against freezing.
- If frequent engine coolant (antifreeze) additions are required, or if the level in the coolant recovery bottle does not drop when the engine cools, the cooling system should be pressure tested for leaks.
- Maintain engine coolant (antifreeze) concentration at 50% HOAT engine coolant (antifreeze) (minimum) and distilled water for proper corrosion protection of your engine, which contains aluminum components.

- Make sure that the radiator and coolant recovery bottle overflow hoses are not kinked or obstructed.
- Keep the front of the radiator clean. If your vehicle is equipped with air conditioning, keep the front of the condenser clean.
- Do not change the thermostat for Summer or Winter operation. If replacement is ever necessary, install ONLY the correct type thermostat. Other designs may result in unsatisfactory cooling performance, poor gas mileage, and increased emissions.

Brake System

Brake Master Cylinder – Brake Fluid Level Check

The fluid level of the master cylinder should be checked when performing under the hood service, or immediately if the brake system warning lamp indicates system failure.

The brake master cylinder has a translucent plastic reservoir. On the outboard side of the reservoir, there is a "MAX" mark and an "MIN" mark (4500/5500 vehicles only). The fluid level must be kept within these two marks. Do not add fluid above the full mark because leakage may occur at the cap.

With disc brakes, the fluid level can be expected to fall as the brake linings wear. However, an unexpected drop in fluid level may be caused by a leak and a system check should be conducted.

Refer to "Fluids, Lubricants, and Genuine Parts" in this section for the correct fluid type.

WARNING!

- Use of a brake fluid that may have a lower initial boiling point, or unidentified as to specification, may result in sudden brake failure during hard prolonged braking. You could have an accident.
- Overfilling the brake fluid reservoir can result in spilling brake fluid on hot engine parts and the brake fluid catching fire.

Use only brake fluid that has been in a tightly closed or sealed container to avoid contamination from foreign matter or moisture.

CAUTION!

Do not allow a petroleum-based fluid to contaminate the brake fluid. Seal damage and loss of brake performance may result.

Rear Axle And 4x4 Front Driving Axle Fluid Level

For models with 9.25 in Front Axles and 11.5 in Rear Axles, refer to “Fluids, Lubricants, and Genuine Parts” in this section for the correct fluid type. For normal service, periodic fluid level checks are not required. When the vehicle is serviced for other reasons, the exterior surfaces of the axle assembly should be inspected.

When checking the fluid level (4500/5500 only), the vehicle should be in a level position. The fluid level should be $1/4$ in \pm $1/4$ in (6.4 mm \pm 6.4 mm) below the fill hole on the front axle. The fluid level should be level with the bottom of the fill hole on the rear axle.

Drain And Refill

On 4500/5500 vehicles, remove the lower bolt to drain the axle fluid.

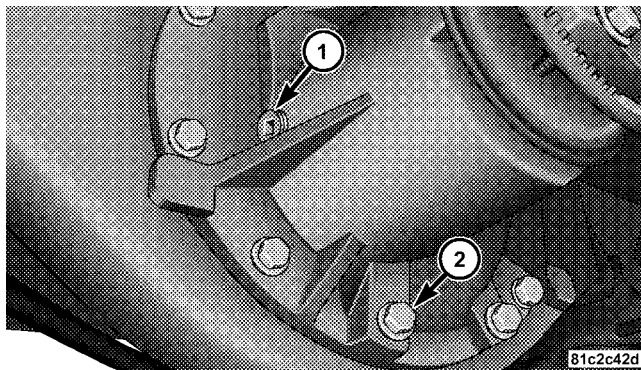

- 1 — 4500/5500 Rear Axle Fluid Fill Plug
- 2 — 4500/5500 Rear Axle Fluid Drain Plug

Refer to the “Maintenance Schedule” in Section 8 of this manual for the proper maintenance intervals.

Lubricant Selection

Refer to “Fluids, Lubricants, and Genuine Parts” in this section for the correct fluid type.

NOTE: The presence of water in the gear lubricant will result in corrosion and possible failure of differential components. Operation of the vehicle in water, as may be encountered in some off-highway types of service, will require draining and refilling the axle to avoid damage.

Limited-Slip Differentials DO NOT REQUIRE any limited slip oil additive (friction modifiers).

NOTE: Slight noise and mild shuddering may be evident while turning a vehicle with limited slip differential on concrete or dry pavement. These conditions should be considered normal operation of the limited slip differential.

Transfer Case — If Equipped

Drain And Refill

Refer to the “Maintenance Schedule” in Section 8 of this manual for the proper maintenance intervals.

Lubricant Selection

Refer to “Fluids, Lubricants, and Genuine Parts” in this section for the correct fluid type.

Fluid Level Check

This fluid level can be checked by removing the filler plug. The fluid level should be to the bottom edge of the filler plug hole with the vehicle in a level position.

Automatic Transmission

Selection Of Lubricant

It is important that the proper lubricant is used in the transmission to assure optimum transmission performance. Use only manufacturer’s recommended transmission fluid. Refer to “Fluids, Lubricants, and Genuine

Parts” in this section for the correct fluid type. It is important that the transmission fluid be maintained at the prescribed level using the recommended fluid.

CAUTION!

Using a transmission fluid other than the manufacturer’s recommended fluid may cause deterioration in transmission shift quality and/or torque converter shudder. Using a transmission fluid other than the manufacturer’s recommended fluid will result in more frequent fluid and filter changes. Refer to “Fluids, Lubricants, and Genuine Parts” in this section for the correct fluid type.

Fluid Level Check – 545RFE Transmission

Check the fluid level while the transmission is at normal operating temperature 180°F (82°C). This occurs after at least 15 miles (25 km) of driving. At normal operating

temperature, the fluid on the end of the dipstick cannot be held comfortably between the fingertips.

Procedure For Checking Fluid Level

To properly check the automatic transmission fluid level, the following procedure must be used:

1. Operate the engine at idle speed and normal operating temperature.
2. The vehicle must be on level ground.
3. Fully apply parking brake.
4. Place the shift lever momentarily in each gear position ending with the lever in PARK.
5. Remove the dipstick, wipe it clean and reinsert it until seated.

6. Remove the dipstick again and note the fluid level on both sides. The fluid level should be between the HOT (upper) reference holes on the dipstick at normal operating temperature. Verify that a solid coating of oil is seen on both sides of the dipstick. If the fluid is low, add as required into the dipstick tube. **Do not overfill.** After adding any quantity of oil through the dipstick tube, wait a minimum of two minutes for the oil to fully drain into the transmission before rechecking the fluid level.

NOTE: If it is necessary to check the transmission below the operating temperature, the fluid level should be between the two cold (lower) holes on the dipstick with the fluid at approximately 70°F (21°C) (room temperature). If the fluid level is correctly established at room temperature, it should be between the HOT (upper) reference holes when the transmission reaches 180°F (21°C). Remember it is best to check the level at the normal operating temperature.

CAUTION!

Be aware that if the fluid temperature is below 50°F (10°C), it may not register on the dipstick. Do not add fluid until the temperature is elevated enough to produce an accurate reading.

7. Check for leaks. Release the parking brake.

NOTE: To prevent dirt and water from entering the transmission after checking or replenishing fluid, make certain that the dipstick cap is properly reseated. It is normal for the dipstick cap to spring back slightly from its fully seated positions, as long as its seal remains engaged in the dipstick tube.

Automatic Transmission Fluid and Filter Change

Refer to the "Maintenance Schedule" in Section 8 of this manual for the proper maintenance intervals.

NOTE: If the transmission is disassembled for any reason, the fluid and filter should be changed.

It is important that proper lubricant is used in the transmission. Refer to “Fluids, Lubricants, and Genuine Parts” in this section for the correct fluid type.

Special Additives

Automatic Transmission Fluid (ATF) is an engineered product and its performance may be impaired by supplemental additives. Therefore, do not add any fluid additives to the transmission. The only exception to this policy is the use of special dyes to aid in detecting fluid leaks. In addition, avoid using transmission sealers as they may adversely affect seals.

Appearance Care and Protection from Corrosion

Protection of Body and Paint from Corrosion

Vehicle body care requirements vary according to geographic locations and usage. Chemicals that make roads

passable in snow and ice, and those that are sprayed on trees and road surfaces during other seasons, are highly corrosive to the metal in your vehicle. Outside parking, which exposes your vehicle to airborne contaminants, road surfaces on which the vehicle is operated, extreme hot or cold weather and other extreme conditions will have an adverse affect on paint, metal trim, and underbody protection.

The following maintenance recommendations will enable you to obtain maximum benefit from the corrosion resistance built into your vehicle.

What Causes Corrosion?

Corrosion is the result of deterioration or removal of paint and protective coatings from your vehicle.

The most common causes are:

- Road salt, dirt and moisture accumulation.
- Stone and gravel impact.

- Insects, tree sap and tar.
- Salt in the air near seacoast localities.
- Atmospheric fallout/industrial pollutants.

Washing

- Wash your vehicle regularly. Always wash your vehicle in the shade using MOPAR® Car Wash or a mild car wash soap, and rinse the panels completely with clear water.
- If insects, tar or other similar deposits have accumulated on your vehicle, use MOPAR® Super Kleen Bug and Tar Remover to remove.
- Use MOPAR® Cleaner Wax to remove road film, stains and to protect your paint finish. Take care never to scratch the paint.

- Avoid using abrasive compounds and power buffing that may diminish the gloss or thin out the paint finish.

CAUTION!

Do not use abrasive or strong cleaning materials such as steel wool or scouring powder, which will scratch metal and painted surfaces.

Special Care

- If you drive on salted or dusty roads, or if you drive near the ocean, hose off the undercarriage at least once a month.
- It is important that the drain holes in the lower edges of the doors, rocker panels and trunk be kept clear and open.

- If you detect any stone chips or scratches in the paint, touch them up immediately. The cost of such repairs is considered the responsibility of the owner.
- If your vehicle is damaged due to an accident or similar cause which destroys the paint and protective coating, have your vehicle repaired as soon as possible. The cost of such repairs is considered the responsibility of the owner.
- If you carry special cargo such as chemicals, fertilizers, de-icer salt, etc., be sure that such materials are well packaged and sealed.
- If a lot of driving is done on gravel roads, consider mud or stone shields behind each wheel.
- Use MOPAR® Touch Up Paint on scratches as soon as possible. Your authorized dealer has touch up paint to match the color of your vehicle.

Wheel and Wheel Trim Care

All wheels and wheel trim, especially aluminum and chrome plated wheels should be cleaned regularly with a mild soap and water to prevent corrosion. To remove heavy soil and/or excessive brake dust, use MOPAR® Wheel Cleaner (05066247AB) or equivalent or, select a nonabrasive, non-acidic cleaner. Do not use scouring pads, steel wool, a bristle brush, or metal polishes. Only MOPAR® or equivalent is recommended. Do not use oven cleaner. Avoid automatic car washes that use acidic solutions or harsh brushes that may damage the wheels' protective finish.

YES Essentials® Fabric Cleaning Procedure – If equipped

YES Essentials® seats may be cleaned in the following manner:

- Remove as much of the stain as possible by blotting with a clean, dry towel.

- Blot any remaining stain with a clean, damp towel.
- For tough stains, apply MOPAR® Total Clean or a mild soap solution to a clean, damp cloth and remove stain. Use a fresh, damp towel to remove soap residue.
- For grease stains, apply MOPAR® Multi-Purpose Cleaner to a clean, damp cloth and remove stain. Use a fresh, damp towel to remove soap residue.
- Do not use any solvents or protectants on YES Essentials® products.

Interior Care

Use MOPAR® Total Clean to clean fabric upholstery and carpeting.

Use MOPAR® Total Clean to clean vinyl upholstery.

MOPAR® Total Clean is specifically recommended for leather upholstery.

Your leather upholstery can be best preserved by regular cleaning with a damp soft cloth. Small particles of dirt can act as an abrasive and damage the leather upholstery and should be removed promptly with a damp cloth. Stubborn soils can be removed easily with a soft cloth and MOPAR® Total Clean. Care should be taken to avoid soaking your leather upholstery with any liquid. Please do not use polishes, oils, cleaning fluids, solvents, detergents, or ammonia-based cleaners to clean your leather upholstery. Application of a leather conditioner is not required to maintain the original condition.

WARNING!

Do not use volatile solvents for cleaning purposes. Many are potentially flammable, and if used in closed areas they may cause respiratory harm.

Cleaning Headlights

Your vehicle has plastic headlights that are lighter and less susceptible to stone breakage than glass headlights.

Plastic is not as scratch resistant as glass and therefore different lens cleaning procedures must be followed.

To minimize the possibility of scratching the lenses and reducing light output, avoid wiping with a dry cloth. To remove road dirt, wash with a mild soap solution followed by rinsing.

Do not use abrasive cleaning components, solvents, steel wool or other aggressive material to clean the lenses.

Glass Surfaces

All glass surfaces should be cleaned on a regular basis with MOPAR® Glass Cleaner or any commercial household-type glass cleaner. Never use an abrasive type cleaner. Use caution when cleaning the inside rear window equipped with electric defrosters or the right rear

quarter window equipped with the radio antenna. Do not use scrapers or other sharp instruments which may scratch the elements. When cleaning the rearview mirror, spray cleaner on the towel or rag that you are using. Do not spray cleaner directly on the mirror.

Cleaning Plastic Instrument Cluster Lenses

The lenses in front of the instruments in this vehicle are molded in clear plastic. When cleaning the lenses, care must be taken to avoid scratching the plastic.

1. Clean with a wet soft rag. A mild soap solution may be used, but do not use high alcohol content or abrasive cleaners. If soap is used, wipe clean with a clean damp rag.
2. Dry with a soft tissue.

Seat Belt Maintenance

Do not bleach, dye or clean the belts with chemical solvents or abrasive cleaners. This will weaken the fabric. Sun damage can also weaken the fabric.

If the belts need cleaning, use a mild soap solution or lukewarm water. Do not remove the belts from the vehicle to wash them.

Replace the belts if they appear frayed or worn or if the buckles do not work properly.

Dry with a soft tissue.

FUSES

Integrated Power Module

The integrated power module is located in the engine compartment near the battery. This center contains cartridge fuses and mini fuses. A description of each fuse

and component may be stamped on the inside cover, otherwise the cavity number of each fuse is stamped on the inside cover that corresponds to the following chart.

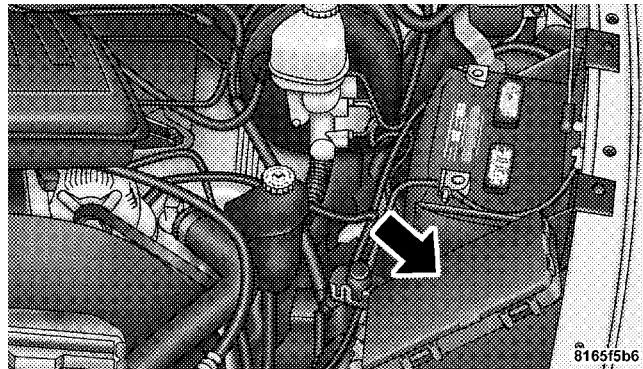

Integrated Power Module

Cavity	Cartridge Fuse	Mini Fuse	Description
1		20 Amp Yellow	Power Outlet Console
2		20 Amp Yellow	Cabin Compartment Node (CCN) Door Locks
3		—	—
4		15 Amp Blue	Aisin Transmission Controls (Diesel Only)
5		20 Amp Yellow	Power Sunroof
6		10 Amp Red	Vistronic Fan/Wastegate Solenoid
7		—	—
8		10 Amp Red	Heated Mirrors

Cavity	Cartridge Fuse	Mini Fuse	Description
9	30 Amp Pink		Off Road Module Power
10		5 Amp Orange	Trx-Off Rd Pkg Sen (Gas Engine Only) NOTE: Insert 5 amp fuse in this cavity to enable the TRX capability (If Equipped).
11		20 Amp Yellow	Ignition Off Draw (IOD)-Cabin Compartment Node (CCN)/Radio/Under Hood Lamp/Wireless Control Module (WCM)/Satellite Digital Audio Receiver (SDARS)/Hands Free Module (HFM)/EOM

Cavity	Cartridge Fuse	Mini Fuse	Description
12	30 Amp Pink		Electric Brake
13		25 Amp Natural	Power-Battery RWAL/ABS Module Feed
14		15 Amp Blue	Park Lights Left
15		20 Amp Yellow	Trailer Park Lights
16		15 Amp Blue	Park Lights Right
17		—	—
18	40 Amp Green		ABS Pump
19	30 Amp Pink		Trailer Tow Battery Feed

Cavity	Cartridge Fuse	Mini Fuse	Description
20		10 Amp Red	Occupant Restraints Controller (ORC) 2
21		10 Amp Red	Occupant Restraints/Pass Disable Switch
22		2 Amp Gray	IGN Switch Feed
23		10 Amp Red	HVAC
24	20 Amp Blue		AISIN Relay Feed (Diesel Only)
25		10 Amp Red	Power Mirror/T-Case Brake
26		20 Amp Yellow	Brake Switch/Center High Mount Stop Light (CHMSL)/Aftermarket CHMSL

Cavity	Cartridge Fuse	Mini Fuse	Description
27	40 Amp Green		Power Seats
28		10 Amp Red	Power Run/Start-PCM/Steering Angle Sensor
29		10 Amp Red	4X4 Switch/Pass Dr Switch/EC Mirror
30		15 Amp Blue	Power Run/Start-ABS/RWAL/Smart Bar/YAW Sensor/Universal Exhaust Gas Oxygen (Uego) Sensor Controller
31		10 Amp Red	PCM (Gas)/TCM (Diesel 58RFE)

Cavity	Cartridge Fuse	Mini Fuse	Description
32		10 Amp Red	Power Ignition Run — Adjustable Pedals LED
33		10 Amp Red	Power-IGN Run — HVAC
34		—	—
35		15 Amp Blue	Cabin Compartment Node (CCN) Illumination
36		25 Amp Natural	Audio_Amplifier
37		15 Amp Blue	Variable Gate Turbo (VGT) — Turbo Diesel
38		20 Amp Yellow	Power Outlet IP

Cavity	Cartridge Fuse	Mini Fuse	Description
39		10 Amp Red	Seatbelt Tension Reducer/Power IGN Run/Acc
40		20 Amp Yellow	Power IGN Run/Acc — Cigar Lighter/Rear Power Point
41		—	—
42	30 Amp Pink		Diesel PCM (Diesel Only)

CAUTION!

- When installing the Integrated Power Module cover, it is important to ensure the cover is properly positioned and fully latched. Failure to do so may allow water to get into the Integrated Power Module, and possibly result in a electrical system failure.
- When replacing a blown fuse, it is important to use only a fuse having the correct amperage rating. The use of a fuse with a rating other than indicated may result in a dangerous electrical system overload. If a properly rated fuse continues to blow, it indicates a problem in the circuit that must be corrected.

VEHICLE STORAGE

If you are storing your vehicle for more than 21 days, we recommend that you take the following steps to minimize the drain on your vehicle's battery:

- Disconnect the Ignition-Off Draw (IOD) fuse located in the Integrated Power Module, located in the engine compartment. The IOD cavity includes a snap-in retainer that allows the fuse to be disconnected without removing it from the fuse block.
- The electronic shift transfer case should be placed in the 4HI mode and kept in this position to minimize the battery drain.
- As an alternative to the above steps you may disconnect the negative cables from both batteries.
- Any time you store your vehicle or keep it out of service (i.e., vacation) for two weeks or more, run the air conditioning system at idle for about five minutes

in the fresh air and high blower setting. This will ensure adequate system lubrication to minimize the possibility of compressor damage when the system is started again.

NOTE:

- When reinstalling the IOD fuse push firmly until fully seated; the gauges in the instrument cluster will do a full sweep when the ignition key is cycled to RUN. This is a normal condition.
- When the vehicle is shipped from the factory, the IOD fuse is in the up or extracted position. If the radio, interior lamps, keyless entry or other features do not work with the key OFF, check the position of the fuse (or check to see if the fuse is blown) to ensure that it is fully seated. When the IOD fuse is extracted, the instrument cluster in the odometer window will display "NO FUSE."

REPLACEMENT LIGHT BULBS

LIGHT BULBS — Inside	Bulb No.
Overhead Console Lights	TS 212-2
Dome Light.	7679

NOTE: For lighted switches, see your authorized dealer for replacement instructions.

All of the inside bulbs are brass or glass-wedge base. Aluminum base bulbs are not approved.

LIGHT BULBS — Exterior	Bulb No.
Backup	1156
Fog Light	9006LL
Headlight (Halogen).	H13
Side Marker, Park & Turn Signal	1157
Rear License Plate Lamp.	1157
Rear Cargo Light.	912
Tail & Stop	1157

BULB REPLACEMENT**Headlight (Halogen)/Front Park and Turn Lights****CAUTION!**

This is a halogen bulb. Avoid touching the glass with your fingers. Reduced bulb life will result.

1. Open the hood.
2. Remove the two bolts from the front of the headlight housing.

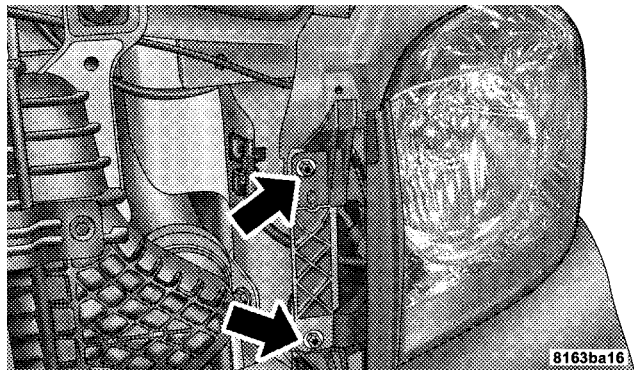

3. Remove the plug from the inner fender well.

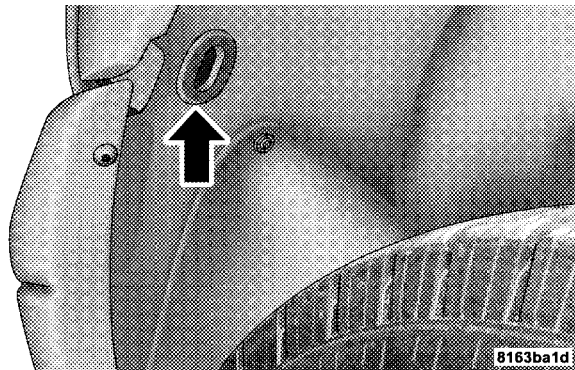

4. Remove the nut through the access hole.

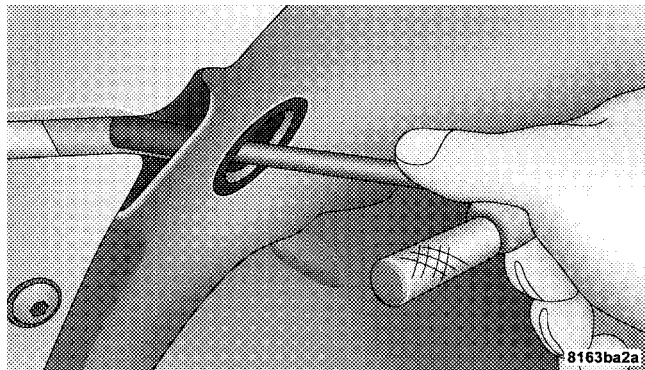

5. Pull the housing out from the fender to allow room to disconnect the electrical connectors.

NOTE: For easier removal, pull the headlight assembly straight forward, applying the greatest amount of force to the outer edge of the headlight assembly.

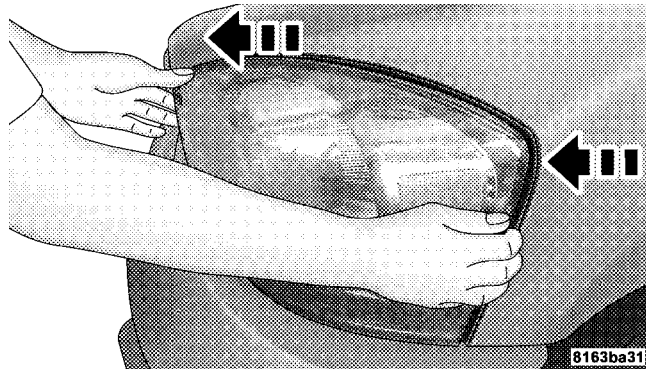

6. Unlock and pull connector straight from the base of the headlight halogen bulb.

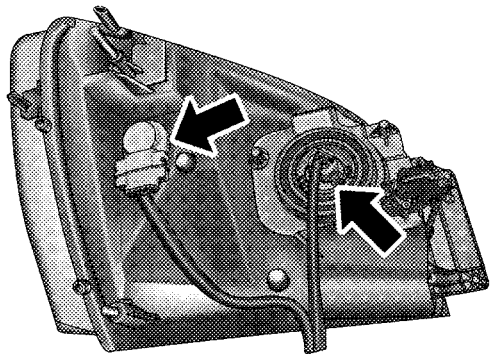

81906efb

7. Twist connector on the side marker/turn signal/park light bulb $\frac{1}{4}$ turn and remove connector and bulb from housing.

8. Remove housing from vehicle with headlight halogen bulb in housing.

9. Twist the headlight halogen bulb $\frac{1}{4}$ turn and remove headlight bulb from the housing.

10. Replace headlight or side marker/turn signal/park light bulb. Do not touch the headlight halogen bulb.

11. Reverse procedure for installation of bulbs and housing.

Fog Lights

1. Reach under the vehicle, unlock and twist connector counterclockwise $\frac{1}{4}$ turn and remove connector and bulb from housing.

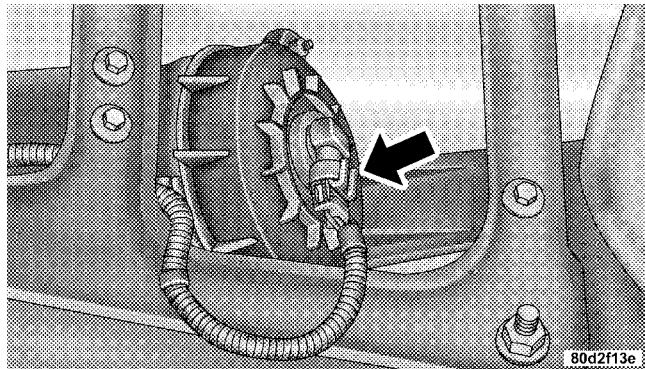

2. Pull bulb straight from the connector.

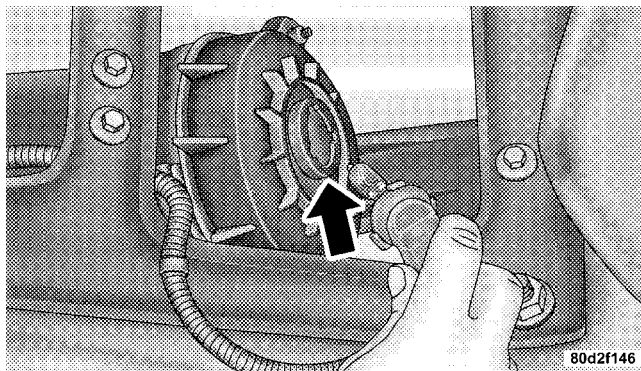

3. Reverse procedure for installation of bulbs and housing.

Cab Top Clearance Lights — If Equipped

1. Remove the two screws from the top of the light.

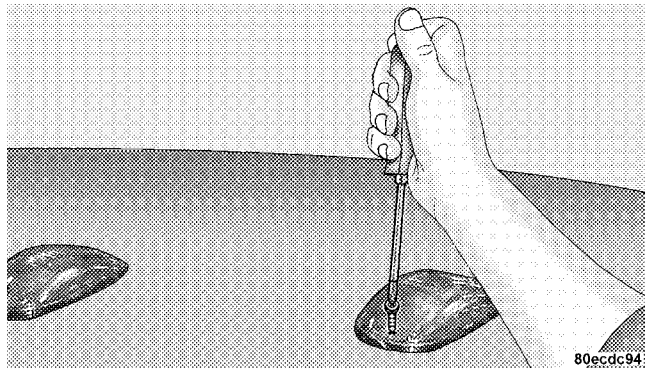

2. Rotate the socket $\frac{1}{4}$ turn and pull it from the light assembly.

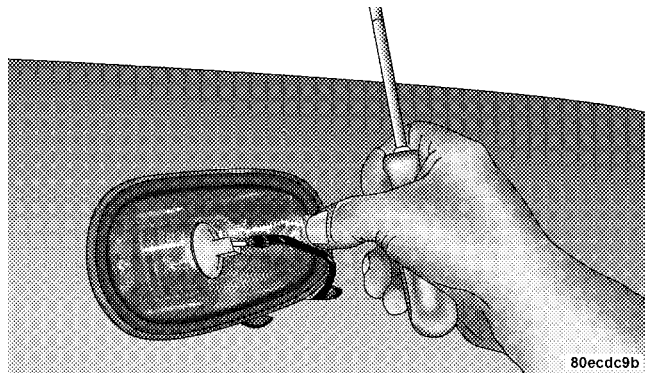

3. Pull the bulb straight from its socket and replace.

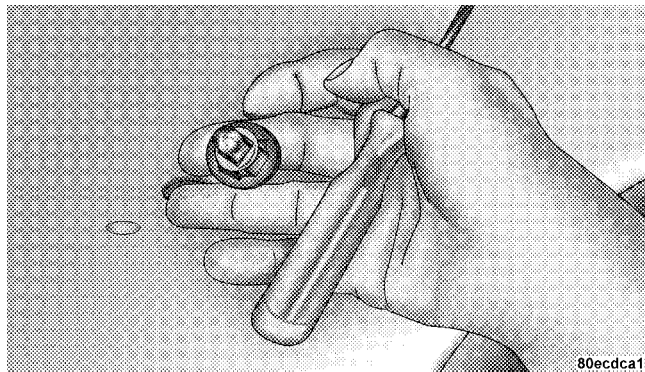

FLUID AND CAPACITIES

	U.S.	Metric
Fuel (Approximate)		
Standard Rear Tank	52 Gallons	197 Liters
Optional Midship Tank	22 Gallons	83 Liters
Engine Oil with Filter		
5.7L Engine (SAE 5W-20, API Certified) (For vehicles operating under a gross combined weight rating less than 14,000 lbs.)	7 Quarts	6.6 Liters
5.7L Engine (SAE 5W-30, API Certified) (For vehicles operating under a gross combined weight rating greater than 14,000 lbs.)	7 Quarts	6.6 Liters
Cooling System		
5.7L Engine (MOPAR® Antifreeze/Coolant 5 Year/100,000 Mile Formula) or equivalent.	18.7 Quarts	17.7 Liters

FLUIDS, LUBRICANTS AND GENUINE PARTS

Engine

Component	Fluid, Lubricant, or Genuine Part
Engine Coolant	Antifreeze/Coolant 5-Year/100,000 Mile Formula HOAT (Hybrid Organic Additive Technology)
Engine Oil (5.7L Engine) (For vehicles operating under a gross combined weight rating less than 14,000 lbs.)	Use API Certified SAE 5W-20 Engine Oil, meeting the requirements of Chrysler Material Standard MS-6395. Refer to your engine oil filler cap for correct SAE grade.
Engine Oil (5.7L Engine) (For vehicles operating under a gross combined weight rating greater than 14,000 lbs.)	Use API Certified SAE 5W-30 Engine Oil, meeting the requirements of Chrysler Material Standard MS-6395. Refer to your engine oil filler cap for correct SAE grade.
Engine Oil Filter (5.7L Engine)	MOPAR® Engine Oil Filter (P/N 04884899AB) or equivalent.
Spark Plugs (5.7L Engine)	LZFR5C-11 (Gap 0.043 in [1.09 mm])
Fuel Selection (5.7L Engine)	87 Octane Acceptable - 89 Octane Recommended

Chassis

Component	Fluid, Lubricant, or Genuine Part
Automatic Transmission (5-Speed 545RFE)	MOPAR® ATF+4 Automatic Transmission Fluid
Transfer Case	MOPAR® ATF+4 Automatic Transmission Fluid
Front and Rear Axle Fluid (4500/5500)	GL-5 SAE 75W-90 Synthetic (MS-9763) or equivalent.
Brake Master Cylinder	MOPAR® DOT 3 and SAE J1703 should be used or equivalent. If DOT 3 brake fluid is not available, then DOT 4 is acceptable. Use only recommended brake fluids.
Power Steering Reservoir	MOPAR® ATF+4 Automatic Transmission Fluid

MAINTENANCE SCHEDULES

CONTENTS

■ Emissions Control System Maintenance	382	□ 5.7L Gas Engine	382
■ Maintenance Schedule	382		

EMISSIONS CONTROL SYSTEM MAINTENANCE

The Scheduled Maintenance services listed in **bold type** must be done at the times or mileages specified to ensure the continued proper functioning of the emissions control system. These and all other maintenance services included in this manual, should be done to provide best vehicle performance and reliability. More frequent maintenance may be needed for vehicles in severe operating conditions, such as dusty areas and very short trip driving.

Inspection and service should also be done anytime a malfunction is suspected.

NOTE: Maintenance, replacement or repair of the emissions control devices and systems on your vehicle may be performed by any automotive repair establishment or individual using any automotive part that has been certified pursuant to U.S. EPA or in the State of California, California Air Resources Board regulations.

MAINTENANCE SCHEDULE

5.7L Gas Engine

The oil change indicator system will remind you that it is time to take your vehicle in for scheduled maintenance.

The “Change Oil” message will flash in the instrument cluster odometer and a single chime will sound, indicating that an oil change is necessary.

Based on engine operation conditions the oil change indicator message will illuminate, this means that service is required for your vehicle. Have your vehicle serviced as soon as possible, within the next 500 miles (805 km).

NOTE:

- The oil change indicator message will not monitor the time since the last oil change. Change your vehicles oil if it has been 6 months since your last oil change even if the oil change indicator message is **NOT** illuminated.

- Change your engine oil more often if you drive your vehicle off-road for an extended period of time.
- Under no circumstances should oil change intervals exceed 6,000 miles (10,000 km) or 6 months, whichever comes first.

Your dealer will reset the oil change indicator message after completing the scheduled oil change. If this scheduled oil change is performed by someone other than your dealer the message can be reset by referring to the steps described under “Odometer/Trip Odometer” under “Instrument Cluster Description” in Section 4 of this.

At Each Stop for Fuel

- Check the engine oil level about 5 minutes after a fully warmed engine is shut off. Checking the oil level while the vehicle is on level ground will improve the accuracy of the oil level reading. Add oil only when the level is at or below the ADD or MIN mark.

- Check the windshield washer solvent and add if required.

Once a Month

- Check tire pressure and look for unusual wear or damage.
- Inspect the battery and clean and tighten the terminals as required.
- Check the fluid levels of coolant reservoir, brake master cylinder, power steering and transmission and add as needed.
- Check all lights and other electrical items for correct operation.

At Each Oil Change

- Change the engine oil filter.
- Inspect the brake hoses and lines.
- Lubricate outer tie rod ends.

CAUTION!

Failure to perform the required maintenance items may result in damage to the vehicle.

Required Maintenance Intervals

Refer to the Maintenance Schedules on the following pages for the required maintenance intervals.

6,000 Miles (10,000 km) or 6 Months Maintenance Service Schedule

- Change the engine oil and engine oil filter.
- Rotate tires.
- Lube front drive shaft fitting (4x4 only).
- Lubricate outer tie rod ends.

Odometer Reading Date

Repair Order # Dealer Code

Signature Authorized Chrysler Dealer

12,000 Miles (20,000 km) or 12 Months Maintenance Service Schedule

- Change the engine oil and engine oil filter.
- Rotate tires.
- If using your vehicle for any of the following: Dusty or off-road conditions. Inspect the engine air cleaner filter, replace if necessary.
- Inspect the brake linings, replace if necessary.
- Lube front drive shaft fitting (4x4 only).
- Lubricate outer tie rod ends.
- Inspect the CV joints. Perform the first inspection at 12,000 miles (20 000 km) or 12 months.
- Inspect exhaust system. Perform the first inspection at 12,000 miles (20 000 km) or 12 months.

Odometer Reading Date

Repair Order # Dealer Code

Signature Authorized Chrysler Dealer

18,000 Miles (30,000 km) or 18 Months Maintenance Service Schedule

- Change the engine oil and engine oil filter.
- Rotate tires.
- Lube front drive shaft fitting (4x4 only).
- Lubricate outer tie rod ends.
- Inspect the front & rear axle fluid.
Change if using your vehicle for police, taxi, fleet, off-road or frequent trailer towing.

Odometer Reading Date

Repair Order # Dealer Code

Signature Authorized Chrysler Dealer

24,000 Miles (40,000 km) or 24 Months Maintenance Service Schedule

- Change the engine oil and engine oil filter.
- Rotate tires.
- If using your vehicle for any of the following: Dusty or off-road conditions. Inspect the engine air cleaner filter, replace if necessary.
- Inspect the brake linings, replace if necessary.
- Lubricate outer tie rod ends.
- Inspect the front suspension, tie rod ends, and boot seals, replace if necessary.
- Lube front drive shaft fitting (4x4 only).
- Inspect the CV joints.
- Inspect exhaust system.

Odometer Reading Date

Repair Order # Dealer Code

Signature Authorized Chrysler Dealer

30,000 Miles (50,000 km) or 30 Months Maintenance Service Schedule

- Change the engine oil and engine oil filter.
- Rotate tires.
- Replace the engine air cleaner filter.
- Replace the spark plugs (5.7L engine).**
- Lube front drive shaft fitting (4x4 only).
- Lubricate outer tie rod ends.
- Inspect the transfer case fluid.

Odometer Reading Date

Repair Order # Dealer Code

Signature Authorized Chrysler Dealer

36,000 Miles (60,000 km) or 36 Months Maintenance Service Schedule

- Change the engine oil and engine oil filter.
- Rotate tires.
- If using your vehicle for any of the following: Dusty or off-road conditions. Inspect the engine air cleaner filter, replace if necessary.
- Inspect the brake linings, replace if necessary.
- Lube front drive shaft fitting (4x4 only).
- Lubricate outer tie rod ends.
- Inspect the front & rear axle fluid. Change if using your vehicle for police, taxi, fleet, off-road or frequent trailer towing.

Odometer Reading Date

Repair Order # Dealer Code

Signature Authorized Chrysler Dealer

42,000 Miles (70,000 km) or 42 Months Maintenance Service Schedule

- Change the engine oil and engine oil filter.
- Rotate tires.
- Lube front drive shaft fitting (4x4 only).
- Lubricate outer tie rod ends.

 Odometer Reading Date

 Repair Order # Dealer Code

 Signature Authorized Chrysler Dealer

48,000 Miles (80,000 km) or 48 Months Maintenance Service Schedule

- Change the engine oil and engine oil filter.
- Rotate tires.
- If using your vehicle for any of the following: Dusty or off-road conditions. Inspect the engine air cleaner filter, replace if necessary.
- Inspect the brake linings, replace if necessary.
- Lubricate outer tie rod ends.
- Inspect the front suspension, tie rod ends, and boot seals, replace if necessary.
- Lube front drive shaft fitting (4x4 only).
- Inspect the CV Joints.
- Inspect exhaust system.

 Odometer Reading Date

 Repair Order # Dealer Code

 Signature Authorized Chrysler Dealer

54,000 Miles (90,000 km) or 54 Months Maintenance Service Schedule

- Change the engine oil and engine oil filter.
- Rotate tires.
- Lube front drive shaft fitting (4x4 only).
- Lubricate outer tie rod ends.
- Inspect the front & rear axle fluid.
Change if using your vehicle for police, taxi, fleet, off-road or frequent trailer towing.

Odometer Reading Date

Repair Order # Dealer Code

Signature Authorized Chrysler Dealer

60,000 Miles (100,000 km) or 60 Months Maintenance Service Schedule

- Change the engine oil and engine oil filter.
- Rotate tires.
- Replace the engine air cleaner filter.
- Replace the spark plugs (5.7L engine).**
- Inspect the brake linings, replace if necessary.
- Lube front drive shaft fitting (4x4 only).
- Lubricate outer tie rod ends.
- Change the automatic transmission fluid & filter(s) if using your vehicle for any of the following: police, taxi, fleet or frequent trailer towing.
- Inspect the transfer case fluid, add if necessary.
- Flush and replace the engine coolant at 60 months if not done at 102,000 miles (170 000 km).

Odometer Reading Date

Repair Order # Dealer Code

Signature Authorized Chrysler Dealer

66,000 Miles (110,000 km) or 66 Months Maintenance Service Schedule

- Change the engine oil and engine oil filter.
- Rotate tires.
- Lube front drive shaft fitting (4x4 only).
- Lubricate outer tie rod ends.

 Odometer Reading Date

 Repair Order # Dealer Code

 Signature Authorized Chrysler Dealer

72,000 Miles (120,000 km) or 72 Months Maintenance Service Schedule

- Change the engine oil and engine oil filter.
- Rotate tires.
- If using your vehicle for any of the following: Dusty or off-road conditions. Inspect the engine air cleaner filter, replace if necessary.
- Inspect the brake linings, replace if necessary.
- Lubricate outer tie rod ends.
- Inspect the front suspension, tie rod ends, and boot seals, replace if necessary.
- Lube front drive shaft fitting (4x4 only).
- Inspect the front & rear axle fluid. Change if using your vehicle for police, taxi, fleet, off-road or frequent trailer towing.
- Inspect the CV Joints.
- Inspect exhaust system.

 Odometer Reading Date

 Repair Order # Dealer Code

 Signature Authorized Chrysler Dealer

**78,000 Miles (130,000 km) or
78 Months Maintenance
Service Schedule**

- Change the engine oil and engine oil filter.
- Rotate tires.
- Lube front drive shaft fitting (4x4 only).
- Lubricate outer tie rod ends.

Odometer Reading Date

Repair Order # Dealer Code

Signature Authorized Chrysler Dealer

**84,000 Miles (140,000 km) or
84 Months Maintenance
Service Schedule**

- Change the engine oil and engine oil filter.
- Rotate tires.
- If using your vehicle for any of the following: Dusty or off-road conditions. Inspect the engine air cleaner filter, replace if necessary.
- Inspect the brake linings, replace if necessary.
- Lube front drive shaft fitting (4x4 only).
- Lubricate outer tie rod ends.

Odometer Reading Date

Repair Order # Dealer Code

Signature Authorized Chrysler Dealer

90,000 Miles (150,000 km) or 90 Months Maintenance Service Schedule

- Change the engine oil and engine oil filter.
- Rotate tires.
- Replace the engine air cleaner filter.
- Replace the spark plugs (5.7L engine).**
- Inspect and replace PCV valve if necessary. †**
- Lube front drive shaft fitting (4x4 only).
- Lubricate outer tie rod ends.
- Inspect the front & rear axle fluid. Change if using your vehicle for police, taxi, fleet, off-road or frequent trailer towing.
- Inspect the transfer case fluid.

_____ Date

_____ Dealer Code

Signature Authorized Chrysler Dealer

96,000 Miles (160,000 km) or 96 Months Maintenance Service Schedule

- Change the engine oil and engine oil filter.
- Rotate tires.
- If using your vehicle for any of the following: Dusty or off-road conditions. Inspect the engine air cleaner filter, replace if necessary.
- Inspect the brake linings, replace if necessary.
- Lubricate outer tie rod ends.
- Inspect the front suspension, tie rod ends, and boot seals, replace if necessary.
- Lube front drive shaft fitting (4x4 only).
- Inspect the CV Joints.
- Inspect exhaust system.

_____ Date
Odometer Reading

_____ Dealer Code
Repair Order #

Signature Authorized Chrysler Dealer

102,000 Miles (170,000 km) or 102 Months Maintenance Service Schedule

- Change the engine oil and engine oil filter.
- Rotate tires.
- Lube front drive shaft fitting (4x4 only).
- Lubricate outer tie rod ends.
- Flush and replace the engine coolant if not done at 60 months.
- Flush and replace power steering fluid.

_____ Date
Odometer Reading

_____ Dealer Code
Repair Order #

Signature Authorized Chrysler Dealer

108,000 Miles (180,000 km) or 108 Months Maintenance Service Schedule

- Change the engine oil and engine oil filter.
- Rotate tires.
- If using your vehicle for any of the following: Dusty or off-road conditions. Inspect the engine air cleaner filter, replace if necessary.
- Inspect the brake linings, replace if necessary.
- Lube front drive shaft fitting (4x4 only).
- Lubricate outer tie rod ends.
- Inspect the front & rear axle fluid. Change if using your vehicle for police, taxi, fleet, off-road or frequent trailer towing.

Odometer Reading Date

Repair Order # Dealer Code

Signature Authorized Chrysler Dealer

114,000 Miles (190,000 km) or 114 Months Maintenance Service Schedule

- Change the engine oil and engine oil filter.
- Rotate tires.
- Lube front drive shaft fitting (4x4 only).
- Lubricate outer tie rod ends.

Odometer Reading Date

Repair Order # Dealer Code

Signature Authorized Chrysler Dealer

120,000 Miles (200,000 km) or 120 Months Maintenance Service Schedule

- Change the engine oil and engine oil filter.
- Rotate tires.
- Replace the engine air cleaner filter.
- Replace the spark plugs (5.7L engine).**
- Inspect the brake linings, replace if necessary.
- Lubricate outer tie rod ends.
- Inspect the front suspension, tie rod ends, and boot seals, replace if necessary.
- Lube front drive shaft fitting (4x4 only).
- Inspect the CV Joints.
- Inspect exhaust system.
- Inspect the transfer case fluid, change if using your vehicle for any of the following: fleet, off-road, or frequent trailer towing.
- Change the automatic transmission fluid & filter(s).
- Replace accessory drive belt(s).

Odometer Reading Date

Repair Order # Dealer Code

Signature Authorized Chrysler Dealer

126,000 Miles (210,000 km) or 126 Months Maintenance Service Schedule

- Change the engine oil and engine oil filter.
- Rotate tires.
- Lube front drive shaft fitting (4x4 only).
- Lubricate outer tie rod ends.
- Inspect the front & rear axle fluid.
Change if using your vehicle for police, taxi, fleet, off-road or frequent trailer towing.

Odometer Reading Date

Repair Order # Dealer Code

Signature Authorized Chrysler Dealer

**132,000 Miles (220,000 km) or
132 Months Maintenance
Service Schedule**

- Change the engine oil and engine oil filter.
- Rotate tires.
- If using your vehicle for any of the following: Dusty or off-road conditions. Inspect the engine air cleaner filter, replace if necessary.
- Inspect the brake linings, replace if necessary.
- Lube front drive shaft fitting (4x4 only).
- Lubricate outer tie rod ends.

Odometer Reading Date

Repair Order # Dealer Code

Signature Authorized Chrysler Dealer

**138,000 Miles (230,000 km) or
138 Months Maintenance
Service Schedule**

- Change the engine oil and engine oil filter.
- Rotate tires.
- Lube front drive shaft fitting (4x4 only).
- Lubricate outer tie rod ends.

Odometer Reading Date

Repair Order # Dealer Code

Signature Authorized Chrysler Dealer

144,000 Miles (240,000 km) or 144 Months Maintenance Service Schedule

- Change the engine oil and engine oil filter.
- Rotate tires.
- If using your vehicle for any of the following: Dusty or off-road conditions. Inspect the engine air cleaner filter, replace if necessary.
- Inspect the brake linings, replace if necessary.
- Lubricate outer tie rod ends.
- Inspect the front suspension, tie rod ends, and boot seals, replace if necessary.
- Lube front drive shaft fitting (4x4 only).
- Inspect the front & rear axle fluid. Change if using your vehicle for police, taxi, fleet, off-road or frequent trailer towing.
- Inspect the CV Joints.
- Inspect exhaust system.

Odometer Reading Date

Repair Order # Dealer Code

Signature Authorized Chrysler Dealer

150,000 Miles (250,000 km) or 150 Months Maintenance Service Schedule

- Change the engine oil and engine oil filter.
- Rotate tires.
- Replace the engine air cleaner filter.
- Replace the spark plugs (5.7L engine).**
- Lube front drive shaft fitting (4x4 only).
- Lubricate outer tie rod ends.
- Inspect the transfer case fluid.

Odometer Reading Date

Repair Order # Dealer Code

Signature Authorized Chrysler Dealer

398 MAINTENANCE SCHEDULES

† This maintenance is recommended by the manufacturer to the owner, but is not required to maintain emissions warranty.

WARNING!

You can be badly injured working on or around a motor vehicle. Do only that service work for which you have the knowledge and the right equipment. If you have any doubt about your ability to perform a service job, take your vehicle to a competent mechanic.

IF YOU NEED CONSUMER ASSISTANCE

CONTENTS

■ Suggestions For Obtaining Service For Your Vehicle	401	□ Customer Assistance For The Hearing Or Speech Impaired (TDD/TTY)	403
□ Prepare For The Appointment	401	□ Service Contract	403
□ Prepare A List	401	■ Warranty Information (U.S. Vehicles Only)	404
□ Be Reasonable With Requests	401	■ MOPAR® Parts	404
■ If You Need Assistance	401	■ Reporting Safety Defects	404
□ Chrysler LLC Customer Center	402	□ In The 50 United States And Washington, D.C.	404
□ Chrysler Canada Inc. Customer Center	402	□ In Canada	405
□ In Mexico Contact	402		

400 IF YOU NEED CONSUMER ASSISTANCE

- Publication Order Forms 405
- Department Of Transportation Uniform Tire
Quality Grades 406
 - Treadwear 407

- Traction Grades 407
- Temperature Grades 408

SUGGESTIONS FOR OBTAINING SERVICE FOR YOUR VEHICLE

Prepare For The Appointment

If you're having warranty work done, be sure to have the right papers with you. Take your warranty folder. All work to be performed may not be covered by the warranty. Discuss additional charges with the service manager. Keep a maintenance log of your vehicle's service history. This can often provide a clue to the current problem.

Prepare A List

Make a written list of your vehicle's problems or the specific work you want done. If you've had an accident or work done that is not on your maintenance log, let the service advisor know.

Be Reasonable With Requests

If you list a number of items and you must have your vehicle by the end of the day, discuss the situation with

the service advisor and list the items in order of priority. At many authorized dealers, you may obtain a rental vehicle at a minimal daily charge. If you need a rental, it is advisable to make these arrangements when you call for an appointment.

IF YOU NEED ASSISTANCE

The manufacturer and its authorized dealers are vitally interested in your satisfaction. We want you to be happy with our products and services.

Warranty service must be done by an authorized dealer. We strongly recommend that you take the vehicle to an authorized dealer. They know you and the vehicle best, and are most concerned that you get prompt and high quality service. The manufacturer's authorized dealers have the facilities, factory-trained technicians, special tools, and the latest information to ensure the vehicle is fixed correctly and in a timely manner.

This is why you should always talk to an authorized dealer's service manager first. Most matters can be resolved with this process.

- If for some reason you are still not satisfied, talk to the general manager or owner of the authorized dealership. They want to know if you need assistance.
- If an authorized dealership is unable to resolve the concern, you may contact the manufacturer's customer center.

Any communication to the manufacturer's customer center should include the following information:

- Owner's name and address
- Owner's telephone number (home and office)
- Authorized dealership name
- Vehicle Identification Number (VIN)

- Vehicle delivery date and mileage

Chrysler LLC Customer Center

P.O. Box 21-8004

Auburn Hills, MI 48321-8004

Phone: (800) 992-1997

Chrysler Canada Inc. Customer Center

P.O. Box 1621

Windsor, Ontario N9A 4H6

Phone: (800) 465-2001

In Mexico contact:

Av. Prolongacion Paseo de la Reforma, 1240

Sante Fe C.P. 05109

Mexico, D. F.

In Mexico City: 5081-7568

Outside Mexico City: 1-800-505-1300

Customer Assistance For The Hearing Or Speech Impaired (TDD/TTY)

To assist customers who have hearing difficulties, the manufacturer has installed special TDD (Telecommunication Devices for the Deaf) equipment at its customer center. Any hearing or speech impaired customer, who has access to a TDD or a conventional teletypewriter (TTY) in the United States, can communicate with the manufacturer by dialing 1-800-380-CHRY.

Service Contract

You may have purchased a service contract for a vehicle to help protect you from the high cost of unexpected repairs after the manufacturer's New Vehicle Limited Warranty expires. The manufacturer stands behind only the manufacturer's service contracts. If you purchased a manufacturer's service contract, you will receive Plan Provisions and an Owner Identification Card in the mail within three weeks of the vehicle delivery date. If you

have any questions about the service contract, call the manufacturer's Service Contract National Customer Hotline at 1-800-521-9922.

The manufacturer will not stand behind any service contract that is not the manufacturer's service contract. It is not responsible for any service contract other than the manufacturer's service contract. If you purchased a service contract that is not a manufacturer's service contract, and you require service after the manufacturer's New Vehicle Limited Warranty expires, please refer to the contract documents, and contact the person listed in those documents.

We appreciate that you have made a major investment when you purchased the vehicle. An authorized dealer has also made a major investment in facilities, tools, and training to assure that you are absolutely delighted with the ownership experience. You'll be pleased with their sincere efforts to resolve any warranty issues or related concerns.

WARNING!

Engine exhaust, some of its constituents, and certain vehicle components contain, or emit, chemicals known to the State of California to cause cancer and birth defects, or other reproductive harm. In addition, certain fluids contained in vehicles and certain products of component wear contain, or emit, chemicals known to the State of California to cause cancer and birth defects, or other reproductive harm.

WARRANTY INFORMATION (U.S. Vehicles Only)

See the Warranty Information Booklet for the terms and provisions of Chrysler Motors LLC warranties applicable to this vehicle.

MOPAR® PARTS

Mopar® fluids, lubricants, parts, and accessories are available from an authorized dealer. They will help keep the vehicle operating at its best.

REPORTING SAFETY DEFECTS**In The 50 United States And Washington, D.C.**

If you believe that your vehicle has a defect that could cause a crash or cause injury or death, you should immediately inform the National Highway Traffic Safety Administration (NHTSA) in addition to notifying the manufacturer.

If NHTSA receives similar complaints, it may open an investigation, and if it finds that a safety defect exists in a group of vehicles, it may order a recall and remedy campaign. However, NHTSA cannot become involved in individual problems between you, your authorized dealer, and the manufacturer.

To contact NHTSA, you may either call the Auto Safety Hotline toll free at 1-888-327-4236 (TTY: 1-800-424-9153), or go to <http://www.safercar.gov>; or write to: Administrator, NHTSA, 400 Seventh Street, SW., Washington, D.C. 20590. You can also obtain other information about motor vehicle safety from <http://www.safercar.gov>.

In Canada

If you believe that your vehicle has a safety defect, you should contact the Customer Service Department immediately. Canadian customers who wish to report a safety defect to the Canadian government should write to: Transport Canada, Motor Vehicle Defect Investigations and Recalls, 2780 Sheffield Road, Ottawa, Ontario K1B 3V9.

PUBLICATION ORDER FORMS

To order the following manuals, you may use either the website or the phone numbers listed below. Visa, Mastercard, American Express, and Discover orders are accepted. If you prefer mailing your payment, please call for an order form.

NOTE: A street address is required when ordering manuals (no P.O. Boxes).

- *Service Manuals*

These comprehensive Service Manuals provide the information that students and professional technicians need in diagnosing/troubleshooting, problem solving, maintaining, servicing, and repairing Chrysler LLC vehicles. A complete working knowledge of the vehicle, system, and/or components is written in straightforward language with illustrations, diagrams, and charts.

- *Diagnostic Procedure Manuals*

Diagnostic Procedure Manuals are filled with diagrams, charts and detailed illustrations. These practical manuals make it easy for students and technicians to find and fix problems on computer-controlled vehicle systems and features. They show exactly how to find and correct problems the first time, using step-by-step troubleshooting and drivability procedures, proven diagnostic tests and a complete list of all tools and equipment.

- *Owner's Manuals*

These Owner's Manuals have been prepared with the assistance of service and engineering specialists to acquaint you with specific Chrysler LLC vehicles. Included are starting, operating, emergency and maintenance procedures as well as specifications, capabilities and safety tips.

Call toll free at:

- 1-800-890-4038 (U.S.)
- 1-800-387-1143 (Canada)

Or

Visit us on the Worldwide Web at:

- www.techauthority.com

DEPARTMENT OF TRANSPORTATION UNIFORM TIRE QUALITY GRADES

The following tire grading categories were established by the National Highway Traffic Safety Administration. The specific grade rating assigned by the tire's manufacturer in each category is shown on the sidewall of the tires on your vehicle.

All passenger car tires must conform to Federal safety requirements in addition to these grades.

Treadwear

The Treadwear grade is a comparative rating, based on the wear rate of the tire when tested under controlled conditions on a specified government test course. For example, a tire graded 150 would wear one and one-half times as well on the government course as a tire graded 100. The relative performance of tires depends upon the actual conditions of their use, however, and may depart significantly from the norm due to variations in driving habits, service practices, and differences in road characteristics and climate.

Traction Grades

The Traction grades, from highest to lowest, are AA, A, B, and C. These grades represent the tire's ability to stop on wet pavement, as measured under controlled conditions on specified government test surfaces of asphalt and concrete. A tire marked C may have poor traction performance.

WARNING!

The traction grade assigned to this tire is based on straight-ahead braking traction tests, and does not include acceleration, cornering, hydroplaning, or peak traction characteristics.

Temperature Grades

The temperature grades are A (the highest), B, and C, representing the tire's resistance to the generation of heat and its ability to dissipate heat, when tested under controlled conditions on a specified indoor laboratory test wheel. Sustained high temperature can cause the material of the tire to degenerate and reduce tire life, and excessive temperature can lead to sudden tire failure. The grade C corresponds to a level of performance, which all passenger car tires must meet under the Federal Motor Vehicle Safety Standard No. 109. Grades B and A represent higher levels of performance on the laboratory test wheel, than the minimum required by law.

WARNING!

The temperature grade for this tire is established for a tire that is properly inflated and not overloaded. Excessive speed, under-inflation, or excessive loading, either separately or in combination, can cause heat buildup and possible tire failure.

INDEX

- Adding Fuel 285
- Adjustable Pedals 131
- Air Cleaner, Engine (Engine Air Cleaner Filter) . . . 340
- Air Conditioner Maintenance 342
- Air Conditioning Refrigerant 342,343
- Air Conditioning System 207,342
- Air Conditioning System, Zone Control 210
- Air Pressure, Tires 267,276
- Airbag 48,53
- Airbag Light 75,163
- Airbag On/Off Switch 53
- Alarm Light 165
- Alarm (Security Alarm) 19
- Alarm System (Security Alarm) 19
- Alterations/Modifications, Vehicle 7
- Antenna, Satellite Radio 200
- Antifreeze (Engine Coolant) 349,350
- Capacities 377
- Disposal 352
- Anti-Lock Warning Light 170,257
- Anti-Theft Security Alarm (Theft Alarm) 19
- Anti-Theft System 19
- Appearance Care 359
- Ashtray 145
- Assistance Towing 100
- Automatic Dimming Mirror 82
- Automatic Transaxle 12
- Automatic Transmission 356
- Fluid and Filter Changes 358
- Fluid Level Check 357
- Fluid Type 356,379
- Shifting 224
- Special Additives 359
- Automatic Transmission (Diesel Engine Only) 356
- Axle Fluid 356,379
- Axle Lubrication (Axle Fluid) 356
- Battery 341

- Emergency Starting 326
- Saving Feature (Protection) 124
- Belts, Seat 36
- Body Builders Guide 6
- Body Mechanism Lubrication 343
- B-Pillar Location 262
- Brake Fluid 379
- Brake System 255,353
 - Anti-Lock (ABS) 256
 - Fluid Check 353
 - Master Cylinder 353
 - Parking 254
 - Warning Light 168
- Bulb Replacement 370
- Bulbs, Light 370

- Cab Top Clearance Lights 375
- Calibration, Compass 141
- Capacities, Antifreeze (Engine Coolant) 377
- Capacities, Fluid 377
- Caps, Filler
 - Oil (Engine) 339
 - Power Steering 253
 - Radiator (Coolant Pressure) 351
- Car Washes 360
- Carbon Monoxide Warning 284
- CD (Compact Disc) Player 173,187
- Cellular Phone 86
- Center Lap Belts 45
- Center Seat Storage Compartment 148,150
- Certification Label 287
- Chart, Tire Sizing 259
- Check Engine Light
 - (Malfunction Indicator Light) 168
- Child Restraint 60
- Child Restraint Tether Anchors 64,67
- Child Seat 60,66
- Cigar Lighter 145

Cleaning	
Wheels	361
Climate Control	204
Clock	172,175,189,195
Compact Disc (CD) Maintenance	203
Compass	140,141
Compass Calibration	141
Compass Variance	143
Computer, Trip/Travel	136
Contract, Service	403
Coolant Pressure Cap (Radiator Cap)	351
Cooling System	348
Adding Coolant (Antifreeze)	350
Coolant Capacity	377
Coolant Level	348,352
Disposal of Used Coolant	352
Drain, Flush, and Refill	349
Inspection	352
Points to Remember	352
Pressure Cap	351
Radiator Cap	351
Selection of Coolant (Antifreeze)	349,378
Cruise Control (Speed Control)	133
Cupholders	146
Customer Assistance	401
Data Recorder, Event	57
Daytime Running Lights	126
Dealer Service	337
Defroster, Rear Window	153
Defroster, Windshield	74,205,208
Delay (Intermittent) Wipers	129
Differential, Limited-Slip	249
Dipsticks	338
Power Steering	253
Disposal	340
Antifreeze (Engine Coolant)	352
Engine Oil	340

- Door Locks 27
- Driving
 - Through Flowing, Rising, or Shallow Standing Water 250
- Dual Rear Wheels 280,322
- DVD Player (Video Entertainment System™) 201
- Electric Rear Window Defrost 153
- Electrical Power Outlets 144
- Electronic Speed Control (Cruise Control) 133
- Electronically Shifted Transfer Case 234,242
- Emergency Brake 254
- Emergency, In Case of
 - Freeing Vehicle When Stuck 330
 - Hazard Warning Flasher 314
 - Jump Starting 326
 - Tow Hooks 330
 - Towing 331
- Emission Control System Maintenance 382
- Engine 335
 - Air Cleaner 340
 - Block Heater 223
 - Break-In Recommendations 72
 - Compartment Identification 335
 - Coolant (Antifreeze) 378
 - Exhaust Gas Caution 73,284
 - Flooded, Starting 222
 - Jump Starting 326
 - Oil 338,378
 - Oil Filler Cap 339
 - Oil Selection 339
 - Oil Synthetic 340
 - Temperature Gauge 164
- Event Data Recorder 57
- Exhaust Gas Caution 73,284,345
- Exhaust System 73,345
- Exterior Lighting 125

Fabric Care	361	Four Wheel Drive	230
Filters		Four-Way Hazard Flasher	314
Air Cleaner	340	Freeing A Stuck Vehicle	330
Engine Fuel	378	Front Axle (Differential)	355
Engine Oil	338,340,378	Fuel	281
Flashers		Adding	285
Turn Signal	127	Diesel	378
Flat Tire Stowage	326	Filler Cap (Gas Cap)	286
Flooded Engine Starting	222	Filter	378
Fluid, Brake	379	Gauge	171
Fluid Capacities	377	Light	172
Fluid Level Checks		Octane Rating	281
Brake	353	Requirements	281
Manual Transmission	356	Tank Capacity	377
Power Steering	253	Fuses	364
Transfer Case	356		
Fluids, Lubricants and Genuine Parts	378	Gas Cap (Fuel Filler Cap)	286,336
Fog Lights	126,167,374	Gasoline (Fuel)	281
Fold Flat Load Floor	154	Gasoline, Reformulated	281

Gauges	162	Hazard	
Coolant Temperature	164	Driving Through Flowing, Rising, or Shallow	
Fuel	171	Standing Water	250
Oil Pressure	164	Hazard Warning Flasher	314
Speedometer	163	Head Restraints	117
Tachometer	163	Headlights	370
Voltmeter	162	Cleaning	363
Gear Ranges	225	High Beam	128
General Information	18,114	High Beam/Low Beam Select Switch	128
Glass Cleaning	363	Lights On Reminder	126
Grocery Bag Retainer	153	Passing	128
Gross Axle Weight Rating	290	Switch	125
Gross Vehicle Weight Rating	289	Heated Mirrors	153
Guide, Body Builders	6	Heated Seats	120
GVWR	287	Heater	207
Hands-Free Phone (UConnect®)	86	Heater, Engine Block	223
		High Beam/Low Beam Select (Dimmer) Switch	128

Hitches		
Trailer Towing	292	
Hoisting	326	
Hood Release	121	
Hub Caps	321	
Ignition	12	
Key	12	
Ignition Key Removal	12	
Illuminated Entry	20	
Immobilizer (Sentry Key)	15	
Infant Restraint	60	
Inflation Pressure Tires	276	
Inside Rearview Mirror	81	
Instrument Cluster	161,162	
Instrument Panel and Controls	160	
Instrument Panel Lens Cleaning	363	
Integrated Power Module (Fuses)	364	
Interior Appearance Care	362	
Interior Lights	123	
Intermittent Wipers (Delay Wipers)	129	
Introduction	4	
Jack Location	315	
Jump Starting	326	
Key, Programming	17	
Key, Replacement	16	
Key, Sentry (Immobilizer)	15	
Keyless Entry System	21	
Keys	12	
Lane Change and Turn Signals	127	
Lap Belts	45	
Lap/Shoulder Belts	36	
LATCH (Lower Anchors and Tether for Children)	64	
Life of Tires	274	

- Lights 75,123
 - Airbag 57,163
 - Alarm 165
 - Anti-Lock 170
 - Anti-Lock Warning 257
 - Brake Warning 168
 - Bulb Replacement 370
 - Cap Top Clearance 375
 - Check Engine (Malfunction Indicator) 168
 - Cruise 172
 - Daytime Running 126
 - Fog 126,167,374
 - Four-Wheel Drive Indicator 234
 - Hazard Warning Flasher 314
 - Headlights 125
 - High Beam 128,163
 - High Beam Indicator 163
 - High Beam/Low Beam Select 128
 - Illuminated Entry 20
- Instrument Cluster 162
- Interior 123
- Lights On Reminder 126
- Passing 128
- Seat Belt Reminder 163
- Security Alarm (Theft Alarm) 165
- Service 370
- Theft Alarm (Security Alarm) 165
- Transfer Case 234
- Transmission Warning 171
- Turn Signal 127,162,370
- Warning (Instrument Cluster Description) 162
- Limited-Slip Differential 249,356
- Loading Vehicle 287
 - Tires 262
- Locks 27
 - Child Protection 30
 - Door 27
 - Keys 12

Power Door	28	Electric Powered	83
Steering Wheel	14	Outside	82
Lower Anchors and Tether for CHildren (LATCH)	64	Rearview	81
Lubrication, Body	343	Trailer Towing	84
Lug Nuts	320,322	Modifications/Alterations, Vehicle	7
Lumbar Support	118	Mopar Parts	337,404
		Multi-Function Control Lever	126
Maintenance	337	Navigation Radio	194
Maintenance Free Battery	341	Navigation System	194
Maintenance Procedures	338	New Vehicle Break-In Period	72
Maintenance Schedule	382,384	Occupant Restraints	35
Maintenance Schedules	382	Octane Rating, Gasoline (Fuel)	281
Manual, Service	405	Odometer	166,171
Manual Transmission		Trip	166,171
Fluid Level Check	356	Oil Change Indicator	167
Lubricant Selection	379	Oil, Engine	378
Mirrors	81	Capacity	377
Automatic Dimming	82		

Change Interval	339	Owner's Manual (Operator Manual)	4,405
Dipstick	338	Parking Brake	254
Disposal	340	Passenger Airbag On/Off Switch	53
Filter	338,340,378	Passing Light	128
Identification Logo	339	Pedals, Adjustable	131
Materials Added to	340	Pets	72
Pressure Gauge	164	Pets, Transporting	72
Recommendation	339	Phone, Cellular	86
Synthetic	340	Phone, Hands-Free (UConnect®)	86
Viscosity	339	Placard, Tire and Loading Information	262
Onboard Diagnostic System	336	Power	
Operating Precautions	336	Door Locks	28
Operator Manual (Owner's Manual)	4	Mirrors	83
Outside Rearview Mirrors	82	Outlet (Auxiliary Electrical Outlet)	144
Overdrive	227	Seats	118
Overdrive OFF Switch	227	Sliding Rear Window	34,154
Overhead Console	136	Steering	252,253
Overhead Travel Information Center	136	Windows	32
Overheating, Engine	165		

- Power Steering Fluid 379
- Pregnant Women and Seat Belts 47
- Programming Transmitters
(Remote Keyless Entry) 24
- Radial Ply Tires 272
- Radiator Cap (Coolant Pressure Cap) 348,351
- Radio, Navigation 194
- Radio Operation 173,187
- Radio Remote Controls 201
- Radio, Satellite 195,197
- Radio (Sound Systems) 173,187
- Rear Axle (Differential) 355,356
- Rear Window Features 153
- Rear Window, Sliding 34,154
- Reclining Front Seats 116
- Recorder, Event Data 57
- Recreational Towing 304
- Shifting into Transfer Case Neutral (N) 305,307
- Shifting out of Transfer Case
 Neutral (N) 306,309
- Reformulated Gasoline 281
- Refrigerant 343
- Reminder, Seat Belt 46
- Remote Keyless Entry (RKE) 21
- Remote Sound System (Radio) Controls 201
- Remote Starting System 26
- Replacement Keys 16
- Replacement Parts 337
- Replacement Tires 274
- Reporting Safety Defects 404
- Resetting Oil Change Indicator 167
- Restraint, Head 117
- Restraints, Child 60,66
- Restraints, Occupant 35
- Rotation, Tires 279
- Safety Checks Inside Vehicle 74

Safety Checks Outside Vehicle	75	Cleaning	361
Safety Defects, Reporting	404	Folding Floor	154
Safety Information, Tire	258	Heated	120
Safety Tips	73	Lumbar Support	118
Satellite Radio	195,197	Power	118
Satellite Radio Antenna	200	Reclining	116
Schedule, Maintenance	382	Security Alarm (Theft Alarm)	19
Seat Belt Maintenance	364	Selection of Coolant (Antifreeze)	349,378
Seat Belt Reminder	46	Sentry Key (Immobilizer)	15
Seat Belts	35,36,74	Sentry Key Programming	17
Adjustable Upper Shoulder Anchorage	44	Sentry Key Replacement	16
And Pregnant Women	47	Service Assistance	401
Child Restraint	60,72	Service Contract	403
Extender	47	Service Manuals	405
Front Seat	36	Setting the Clock	172,175,189,195
Reminder	163	Shifting	224
Seats	114,115	Automatic Transmission	224
Adjustment	114	Transfer Case	233
Child	72		

- Transfer Case, Shifting into Transfer
 - Case Neutral (N) 305,307
 - Transfer Case, Shifting out of Transfer
 - Case Neutral (N) 306,309
- Shoulder Belt Upper Anchorage 44
- Shoulder Belts 36
- Signals, Turn 127
- Sliding Rear Window
 - Power 34,154
- Snow Chains (Tire Chains) 276
- Snow Plow 300
- Snow Tires 278
- Spark Plugs 378
- Speed Control (Cruise Control) 133
- Speedometer 163
- Starting 221
 - Automatic Transmission 221
 - Engine Fails to Start 222
 - Remote 26
- Starting Procedures (Gas Engines) 221
- Steel Carcass Ply Tires 269
- Steering
 - Power 252,253
 - Wheel Lock 14
 - Wheel, Tilt 130
- Steering Wheel Mounted Sound
- System Controls 201
- Storage, Behind the Seat 148
- Storage Compartment, Center Seat 148,150
- Storage, Vehicle 369
- Storing Your Vehicle 369
- Supplemental Tire Pressure Information 276
- Synthetic Engine Oil 340
- System, Navigation 194
- System, Remote Starting 26
- Tachometer 163
- Temperature Gauge, Engine Coolant 164

Tether Anchor, Child Restraint	64,67	Replacement	274
Tilt Steering Column	130	Rotation	279
Tip Start	222	Safety	258,266
Tire and Loading Information Placard	262,276	Sizes	259
Tire Identification Number (TIN)	261	Snow Tires	278
Tire Markings	258	Spinning	273
Tire Safety Information	258	Steel Carcass Ply	269
Tires	75,266,406	Tread Wear Indicators	273
Aging (Life of Tires)	274	Wheel Nut Torque	320
Air Pressure	266	Tongue Weight/Trailer Weight	294
Chains	276	Torque Converter Clutch	229
Dual	280,322	Tow Hooks, Emergency	330
General Information	266	Towing	289
High Speed	271	24-Hour Towing Assistance	100
Inflation Pressures	267	Disabled Vehicle	331
Life of Tires	274	Guide	293
Load Capacity	262	Recreational	304
Quality Grading	406	Weight	293
Radial	272	Towing Assistance	100

Traction	250	Maintenance	356
Traction Control	356	Shifting	224
Trailer Towing	289	Transmitter Programming (Remote Keyless Entry)	24
Cooling System Tips	300	Tread Wear Indicators	273
Hitches	292	Trip Computer	136
Minimum Requirements	295	Trip Odometer	166,171
Mirrors	84	Turn Signals	127,162,370
Trailer and Tongue Weight	294	UConnect® (Hands-Free Phone)	86
Wiring	298	Uniform Tire Quality Grades	406
Trailer Towing Guide	293	Variance, Compass	143
Trailer Weight	293	Vehicle Identification Number (VIN)	7
Transaxle		Vehicle Loading	262,287
Automatic	12	Vehicle Modifications/Alterations	7
Transfer Case		Vehicle Storage	369
Electronically Shifted	234,242	Video Entertainment System™ (Rear Seat Video System)	201
Fluid	379	Voltmeter	162
Transmission			
Automatic	224,356		
Fluid	379		

Warning Lights (Instrument Cluster Description)	162	Window Fogging	214
Warnings and Cautions	6	Windows	32
Warranty Information	404	Power	32
Washers, Windshield	130,344	Rear Sliding	34,154
Washing Vehicle	360	Windshield Defroster	205,208
Water		Windshield Washers	129,130,344
Driving Through	250	Fluid	344
Wheel and Wheel Trim	361	Windshield Wiper Blades	344
Wheel and Wheel Trim Care	361	Windshield Wipers	129
Wheel Cover	321	Wiper Blade Replacement	344
Wheel Nut Torque	320,325	Wipers, Intermittent	129
Wind Buffeting	34	YES Essentials® Fabric Cleaning Procedure	361

INSTALLATION OF RADIO TRANSMITTING EQUIPMENT

Special design considerations are incorporated into this vehicle's electronic system to provide immunity to radio frequency signals. Mobile two-way radios and telephone equipment must be installed properly by trained personnel. The following must be observed during installation.

The positive power connection should be made directly to the battery and fused as close to the battery as possible. The negative power connection should be made to body sheet metal adjacent to the negative battery connection. This connection should not be fused.

Antennas for two-way radios should be mounted on the roof or the rear area of the vehicle. Care should be used in mounting antennas with magnet bases. Magnets may affect the accuracy or operation of the compass on vehicles so equipped.

The antenna cable should be as short as practical and routed away from the vehicle wiring when possible. Use only fully shielded coaxial cable.

Carefully match the antenna and cable to the radio to ensure a low Standing Wave Ratio (SWR).

Mobile radio equipment with output power greater than normal may require special precautions.

All installations should be checked for possible interference between the communications equipment and the vehicle's electronic systems.



Chrysler LLC
81-326-0926



First Edition

Printed in U.S.A.