



Bus Owner's Manual

Ford Chassis - 450/550 Series



Congratulations, and thank you for purchasing a Krystal Enterprises Vehicle

You have taken ownership of a true luxury vehicle which is in a class all its own. We are providing this manual to familiarize you with your new Krystal Enterprises Professional Bus. This manual shall serve as a reference document for the operations and maintenance procedures that shall be required throughout the life of your vehicle. This edition covers all our Ford Chassis models, and is designed to be used in conjunction with the original chassis manufacturer's owner's literature, as well as all other component manufacturers literature.

IMPORTANT: PLEASE READ CAREFULLY

For your safety and the safety of others, we ask that you completely familiarize yourself with this manual, and all other operators manuals before you operate this vehicle for the first time.

KRYSTAL ENTERPRISES 2701 East Imperial Highway Brea, California 9282
(800) KRYSTAL (579-7825) (714) 986-1200

TABLE OF CONTENTS

SAFETY

Pre-Trip Inspection (suggested minimum)_____	8
General Vehicle Safety Warnings_____	10
Vapor Door Operational Safety Check List_____	11
Air Door Emergency Release Valve_____	12
Electric Door Emergency Release Lever_____	13
Wheelchair Securement and Occupant Restraint Systems_____	14
Air Door Lock Pin Assembly_____	16
Dual Overhead Parcel Rack_____	17
Emergency Egress Window Operation_____	18
Emergency Roof Hatch Exit_____	19

OPERATION

Overhead Control Panels Assemblies_____	20
Controls and Accessory Functions_____	21
Drivers Overhead Control Panel_____	22
Audio/Video PA Control_____	23
HIC900 Throttle Controller Operating Procedures_____	24
HIC900 Throttle Controller Wiring Diagram - Deisel_____	25
HIC900 Throttle Controller Wiring Diagram - Gasoline_____	26

CLICK ON THE DESCRIPTION TO GO TO THAT PAGE

TABLE OF CONTENTS

Charge Protection System Components	27
Battery Location - Primary and Secondary	28
E-450 Heated Mirror Switch and Mirror Control Switch	29
Video Entertainment Center	30
Back-Up Camera Controls and Operation	31
Rear Step Operation	32
Rear Cargo Door Micro Switch	33
Foldaway Seating	34
Bus Passenger Seating	35
Stainless Steel Wheel Liners	36
Air Conditioning Assembly	37
Floor Heaters	38
Movable Wall - Standard	40
Movable Wall - EZ Move	42
Compressed Air Supply Assembly	45
Air Operated - Single Plug Door	46
Air Operated - Double Plug Door	48
Electric Swing Doors	50
Braun Rear Door Wheelchair Lift	52
Ricon Rear Door Wheelchair Lift	54
Braun UVL 600X Series (Under Vehicle) Wheelchair Lift	56

CLICK ON THE DESCRIPTION TO GO TO THAT PAGE

TABLE OF CONTENTS

SPECIFICATION

Standard Chassis Specification for E450 Super Duty RV Cutaway_____	58
Standard Equipment on E450 Shuttle Buses_____	60
Standard Chassis Specification for F550 Super Duty Cab & Chassis_____	61
Standard Equipment on F550 Shuttle Buses_____	63
General Vehicle Dimensional Specifications-Body & Chassis by Model_____	64
General Body Material and Construction Measurements_____	66
Air Conditioning Charging Chart_____	67
Vehicle Manufacturers Identification Label_____	68
Ridewell Air Suspension Chart_____	69

PREVENTATIVE CARE & MAINTENANCE

Preventative Maintenance Schedule_____	70
--	----

TROUBLE SHOOTING

Basic Troubleshooting Guide_____	86
----------------------------------	----

CLICK ON THE DESCRIPTION TO GO TO THAT PAGE

Krystal Enterprises

TABLE OF CONTENTS

ASSEMBLIES & SCHEMATICS - AIR & ELECTRIC

E-450 Circuit Board Assembly_____	90
E-450 Shuttle Bus-Wiring Diagram_____	92
E-450 Shuttle Bus - Drivers Side Wiring Diagram_____	93
E-450 Shuttle Bus - Passenger Side & Rear Wiring Diagram_____	94
F-550 Circuit Board Assembly Ver. 1_____	96
F-550 Circuit Board Assembly Ver. 2_____	98
E 450 & F-550 Circuit Board Assembly Ver. 3_____	100
F-550 Shuttle Bus -Wiring Diagram_____	107
Misc. Air & Electrical Diagrams and Schematics_____	108

PARTS - SERVICE - WARRANTY	112
-----------------------------------	------------

VENDOR REFERENCE LIST	116
------------------------------	------------

INDEX	118
--------------	------------

KRYSTAL ENTERPRISES VEHICLE WARRANTY	124
---	------------

CLICK ON THE DESCRIPTION TO GO TO THAT PAGE

Krystal Enterprises

Pre-Trip Inspection (suggested minimum)

Any item not passing inspection, must be reported immediately, before operating vehicle

FAILURE OF HIGHLIGHTED ITEM(S) TO PASS INSPECTION WILL CAUSE VEHICLE TO BE GROUNDED

Item	Inspection Procedure	Pass	Fail
1	Check preventative maintenance schedule: for services due at present mileage		
2	Check operation of: drivers seat and seat belt		
3	Check operation of: steering wheel and shift levers		
4	Check operation of: turn indicators		
5	Check operation of: foot pedals and parking brake		
6	Check operation of: all gauges, for normal readings with engine running		
7	Check operation of: dash indicator lights with key on, engine not started, then again with engine started		
8	Check operation of ventilation system: heating, defrosters, fans and air conditioning		
9	Check: horn, wipers, washers, and mirrors for cleanliness, adjustment, operation and damage		
10	Check condition of: fire extinguisher, warning reflectors and first aid kit		
11	Check: all doors, glass and windows: for operation, cleanliness, and damage.		
12	Check: all emergency exits for operation, warning devices, markings, to be free and clear		
13	Check interior lighting: for operation and damage		
14	Check Side Passenger Entry Door - Emergency Exit Operation & Sensitive Edge if equipped		

Pre-Trip Inspection (suggested minimum)

Any item not passing inspection, must be reported immediately, before operating vehicle

FAILURE OF HIGHLIGHTED ITEM(S) TO PASS INSPECTION WILL CAUSE VEHICLE TO BE GROUNDED

Item	Inspection Procedure	Pass	Fail
15	Check Side Passenger Entry Door: for damage and proper closing operation		
16	Check exterior lighting: for operation and damage		
17	Check exterior: for cleanliness, markings and damage		
18	Check fuel cap: in place and secure		
19	Check all tires and wheels: for tread depth, cracks & bulges, missing lug nuts, and air pressure 80 psi for E-450 and 95 psi for F-550		
20	Check: oil level		
21	Check: transmission fluid level		
22	Check: engine coolant level		
23	Check: power steering fluid level		
24	Check: brake fluid level		
25	Check: belts for tension and wear		
26	Check operation of: cameras, if applicable		
27	Check operation of: PA system, if applicable		
28	Check operation of: audio and video system, if applicable		
29	Check wheelchair lift: for proper function or damage and securement station equipment		

GENERAL VEHICLE SAFETY WARNINGS

NO STANDEES ARE ALLOWED.

AT ANY TIME, WHILE THE VEHICLE IS IN MOTION.

DISCONTINUE OPERATION OF THE VEHICLE, IF THE LOW AIR WARNING LIGHT COMES ON, OR UNTIL THE PROBLEM WITH THE SYSTEM CAN BE RESOLVED.

DISCONTINUE OPERATION OF THE VEHICLE, IF ANY CRITICAL ITEM ON THE PRE-TRIP INSPECTION LIST FAILS TO PASS, OR UNTIL ALL PROBLEMS HAVE BEEN RESOLVED.

IF A DOOR AJAR WARNING LIGHT IS LIT,

CHECK ALL DOORS FOR PROPER CLOSURE. NEVER OPERATE THIS VEHICLE UNTIL THE PROBLEM HAS BEEN RESOLVED.

THIS BUS IS NOT DESIGNED TO TOW ANOTHER VEHICLE OR TRAILER

DO NOT ATTEMPT TO TOW OR PULL ANOTHER VEHICLE WITH THIS BUS.

Vapor Air & Electric Door Operational Safety Check List

ATTENTION

WHEN OPERATING A VEHICLE WITH A VAPOR DOUBLE PANEL AIR OR ELECTRIC ACTUATED PASSENGER ENTRANCE DOORS, THE FOLLOWING PRECAUTIONS SHOULD BE TAKEN.

AIR DOORS

The Emergency Release Valve System - *(must be checked on a daily basis)*

Once the emergency release valve has been actuated (by turning the red handle counter clockwise), it should be possible to open the doors by pushing outward with your hand after about 5 seconds.

The Obstruction Sensing System (Sensitive Edge) - *(must be checked on a daily basis)*

Only when the door is closing, can reversing be actuated. The reversing motion should be shut off at about 10 to 30 mm before the final closing position. If the reversing process actuates too late, the sensitivity of the differential pressure switch should be adjusted again. Call the KRYSTAL SERVICE DEPT.

ELECTRIC DOORS

The Emergency Release Lever System - *(must be checked on a daily basis)*

Once the emergency release lever has been actuated (by pushing the red handle from right to left as indicated on the sticker), it should then be possible to open the doors by pushing the panels outward with your hand.

Air Door Emergency Release Valve



EMERGENCY USE ONLY



NOTE:

VALVE MUST BE CHECKED DAILY,
PRIOR TO VEHICLE OPERATION

CAUTION!

For Emergency Door Opening, turn the red valve counter clockwise, this will release the door after about 5 seconds, then the door can be pushed open.

Krystal Enterprises

Electric Door Emergency Release Lever

Electric Door Motor Cover

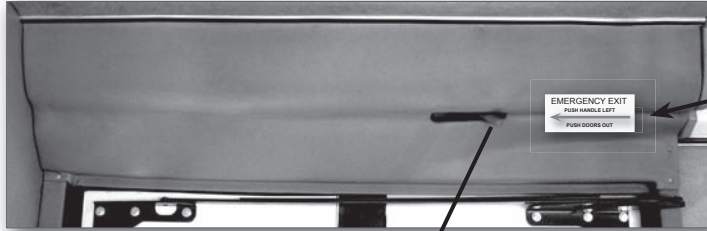

Emergency Exit Lever Decal

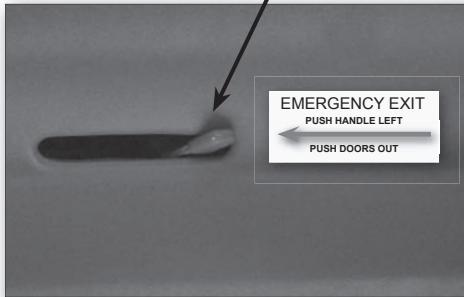

Emergency Exit Lever

NOTE:
LEVER MUST BE CHECKED DAILY,
PRIOR TO VEHICLE OPERATION

EMERGENCY USE ONLY

Wheelchair Securement and Occupant Restraint Systems

Pre-Trip Inspection

- Is each securement station properly equipped with four securement straps, a lap belt, and a shoulder belt?
- Are all straps and belts in good working condition? Any defects such as cut, frayed, contaminated or damaged webbing, improperly functioning buckles or hardware, or broken or worn parts, require replacement of the entire strap or belt assembly.
- Are all floor anchorages, (i.e., tracks or plates), clear of dirt or debris to allow for proper system fitting attachment?
- Is there a clean, dry container in the vehicle to allow for storage of the system when not in use?
- Is the vehicle equipped with a web/belt cutter for use in the event of an emergency evacuation?
- Are complete system operational instructions, in either printed or decal form, located within the vehicle compartment to serve as a reference?

CAUTION! Never utilize the Occupant Restraint System unless you are fully trained, if you're not sure what to do, always call your Kinedyne Representative for Assistance!

Krystal Enterprises

RETURN TO MENU

Typical Wheelchair Securement Methods

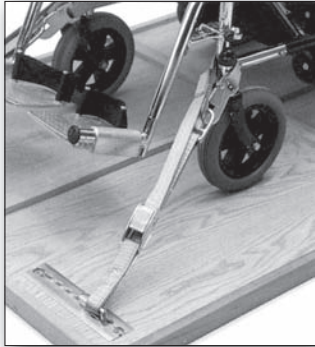

Front Strap Attachment



Lap Belt Attachment

With the wheelchair and occupant facing toward the front of the vehicle, center the wheelchair between the floor tracks or plates. As you position the wheelchair, remember that the securement straps need to have approximately a 45° angle from the floor tracks or plates to where they attach to the frame. Also, keep in mind the proper extension and placement of the occupant restraint shoulder belt. Apply the wheel locks or turn off

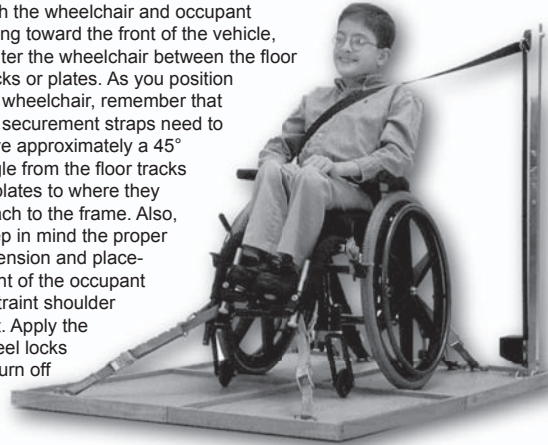

Typical 4-Point Restraint with Lap & Shoulder Belt

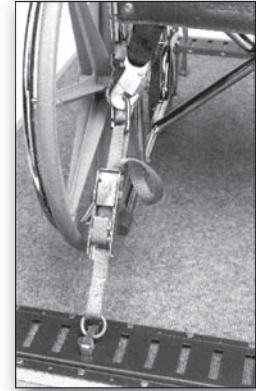

Rear Strap Attachment

For Specific Operating Instructions and System Care and Maintenance, Refer to Your Kinedyne Literature

Krystal Enterprises

RETURN TO MENU

Air Door Lock Pin Assembly



SECURITY PIN ONLY
REMOVE DURING
BUS OPERATION

CAUTION!

Security Pin must be removed during bus operation.

Pin is only to be used for security, if bus is not in operation.

Krystal Enterprises

Dual Overhead Parcel Rack



Overhead Parcel Rack (right side shown)



CAUTION!

Do not overload Parcel Racks.
Do not fasten parcels to retainer bars.

Emergency Egress Window Operation



Lift up on lever to disengage latch



Windows with Emergency Exit stickers are designated emergency exits. Follow the directions on the sticker.

Lift levers and push window out

Krystal Enterprises

Emergency Roof Hatch Exit



SEE MANUFACTURERS LITERATURE
FOR ADDITIONAL INFORMATION

This is a **Dual Purpose** hatch used for Emergency Egress and Ventilation purposes.

SUGGESTED MAINTENANCE

Periodically inspect attaching fasteners for evidence of loosening due to tampering, and regularly clean surface with a mild soap and water.

CAUTION: When removing graffiti, it is the customers responsibility to ensure cleaning solutions are compatible with the materials used on Safety Vents. Solutions containing, acetone, ether, lacquer thinner, or other solvents can destroy the high strength properties of many engineering plastics - AVOID these cleaners

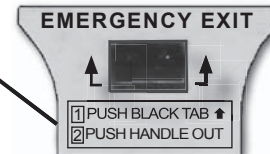

For Emergency Exit



For Ventilation

Krystal Enterprises

RETURN TO MENU

Overhead Control Panels Assemblies

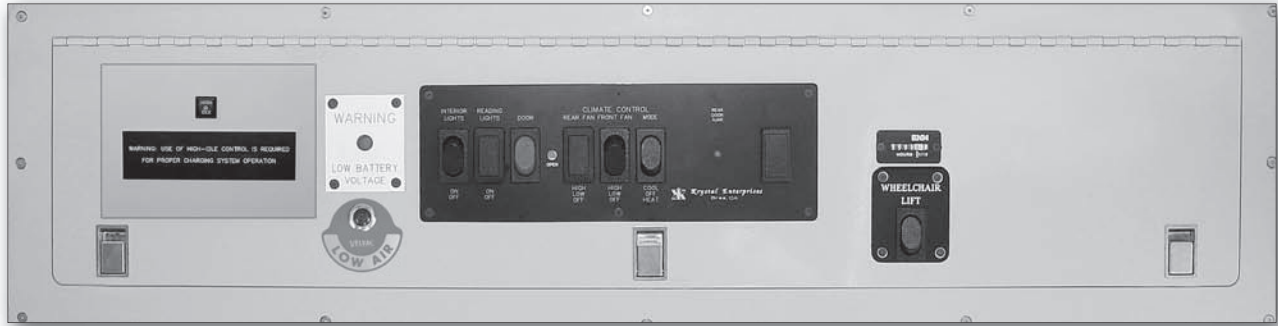

E-450 Overhead Control Panel

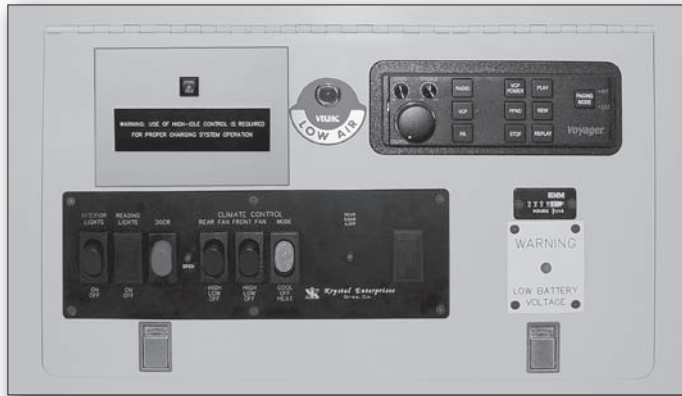

F-550 Overhead Control Panel



E-450 with PA in Console

Krystal Enterprises

Controls - Indicator and Accessory Switches



When the Low Air warning light is lit, this indicates the normal operating air supply has fallen below safe operating levels

Discontinue Operation



The Low Battery Light indicates a low battery condition exists, and the Charge Protect System needs to be engaged.



The Hour Meter accumulates the number of hours your ignition has been turned on.



This switch turns on or off, the (optional) ceiling lights.



This switch must be on to power the (optional) Wheelchair Lift.



This switch operates (optional) Destination Sign when equipped.



This switch operates the (optional) step heater when equipped.

Krystal Enterprises

[RETURN TO MENU](#)

Drivers Overhead Control Panel



1 Interior Lights	6 Front Fan Control (hi - low - off)
2 Reading Lights (optional)	7 Climate Control Mode (cool - off - heat)
3 Door Switch (open or close passenger door)	Note: Cool mode = A/C on both front & rear Heat mode = Heat from front unit only
4 Door Open Indicator Light (WARNING DEVICE)	8 Entrance Door Ajar Light (WARNING DEVICE)
5 Rear Fan Control (hi - low - off)	9 Rear Door Ajar Light (WARNING DEVICE)

Krystal Enterprises

Audio/Video PA Control

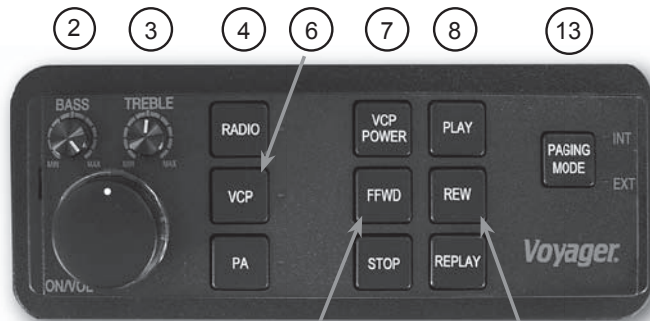

FRONT VIEW

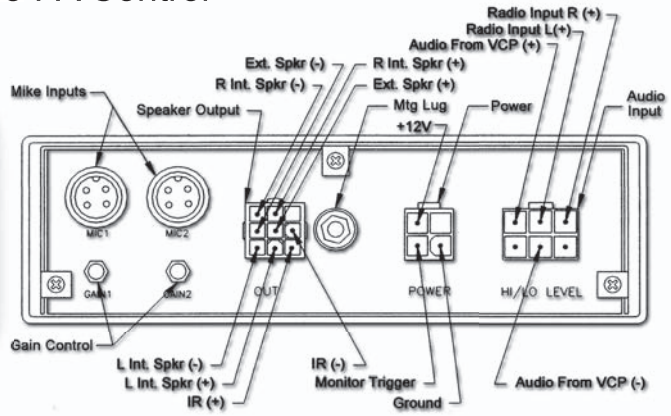

REAR VIEW

1 On/Off Volume Control - controls power and volume	8 VCP Play - starts the tape playing
2 Bass Control - increases or decreases bass	9 VCP Fast Forward - fast forwards tape
3 Treble Control - increases or decreases treble	10 VCP Stop - stops tape
4 Radio Mode - enables radio, indicator light will be on	11 VCP Replay - rewinds and replays from start of tape
5 PA Mode - enables PA, indicator light will be on	12 VCP Rewind - rewinds tape
6 VCP Mode - enables VCP, indicator light will be on	13 Paging Mode - (Internal or External) press button once to engage system, press again to toggle between internal/external
7 VCP Power	

SEE MANUFACTURERS LITERATURE FOR ADDITIONAL INFORMATION

Krystal Enterprises

RETURN TO MENU

HIC900 Throttle Controller Operating Procedures

Quick Reference Guide

BCP (Battery Charge Protection Mode)

Note: This system has been set-up for **Automatic Battery Charge Protection**, which becomes active whenever the following enabling conditions are met:

ENABLING CONDITION:

- Vehicle NOT moving (speed=0 MPH).
- Service Brake NOT pressed.
- Vehicle Transmission Range in Park/Clutch NOT pressed.
- RPM's inside of safe operating range.
- Transmission Fluid Temperature below 240° F.
- Engine Coolant Temperature below 230° F.
- Brake Lights Functional
- Foot Off Accelerator Pedal

AUTOMATIC BATTERY CHARGE PROTECTION

Any time your vehicle is Powered-up", Charge Protection is automatically engaged, ***THIS FUNCTION SHOULD NOT NORMALLY BE DISABLED.***

● Charge Protection will remain in effect until which time, any of the above stated ENABLING CONDITIONS are no longer met, or until you manually dis-engage the BCP button on the DRIVERS OVERHEAD CONTROL PANEL, see photo at right.

TO DEACTIVATE "AUTOMATIC BATTERY CHARGE PROTECTION" OR "FAST IDLE"

Do the following:

- Press the Manual Engage button on the DRIVERS OVERHEAD CONTROL PANEL and release.

Fast Idle system will only be turned off when the button is released.

- To exit "AUTOMATIC BATTERY CHARGE PROTECTION Mode", simply depress the service brake pedal. See the **Off Road Engineering** literature for specific details regarding other operating parameters.



Fast Idle Switch is shown as mounted on Driver's Overhead Control Panel (ref. page 20)

HIC900 Throttle Controller Wiring Diagram - DIESEL

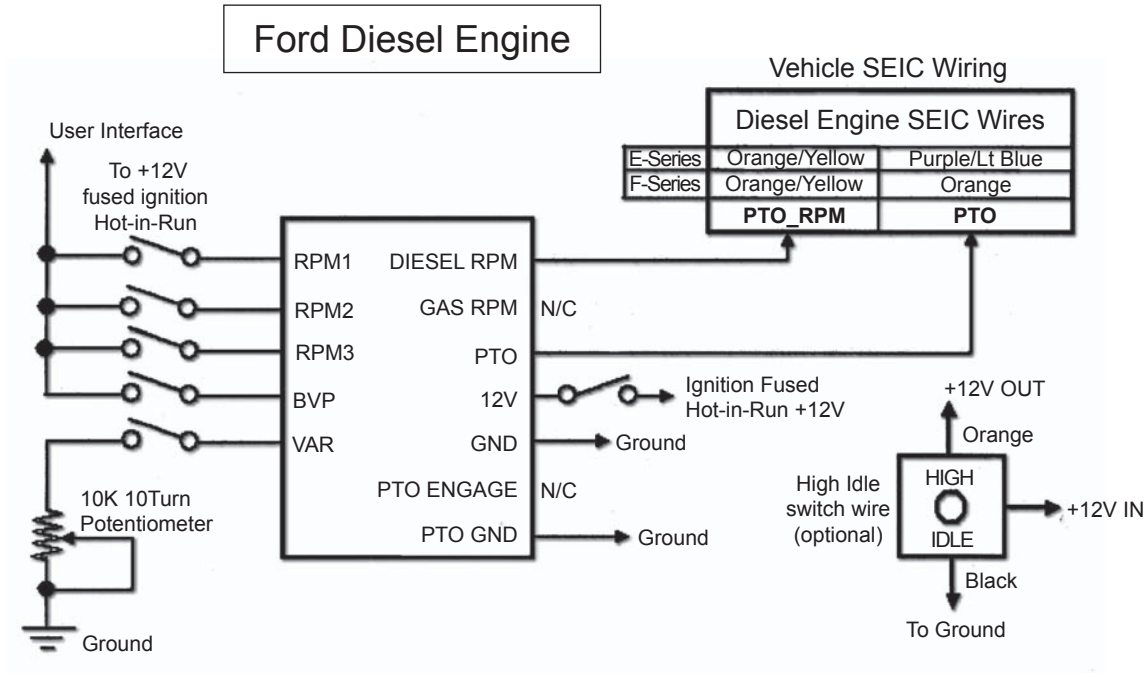

HIC900 Throttle Controller Wiring Diagram - GASOLINE

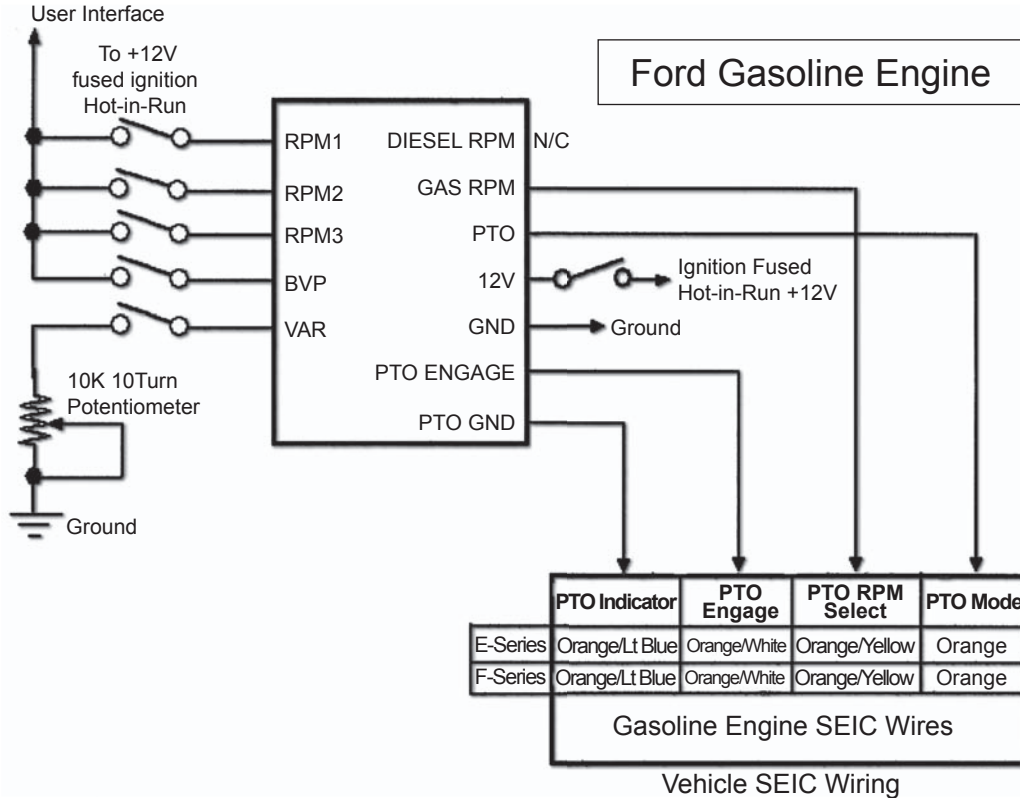

Charge Protection System Components



E-450 Charge System Fuse, located behind panel & Rear Ignition Power Fuse (shown with kick panel removed)

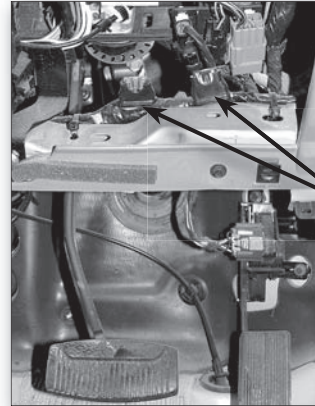

F-550 Charge System and Rear Power Fuse (located behind panel under steering column)

F-550 Charge Isolator Solenoid (located in engine compartment-drivers side)

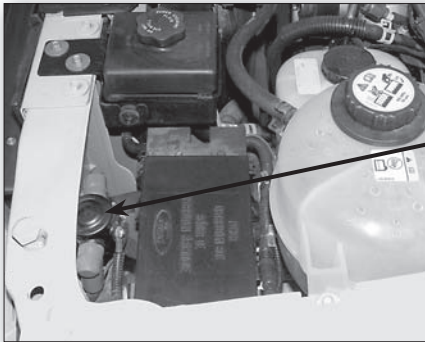

E-450 Charge Isolator Solenoid located in engine compartment -drivers side. (diesel version shown)

Gas version is located below primary battery.

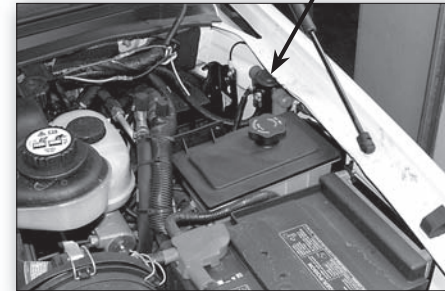

Battery Location - Primary and Secondary

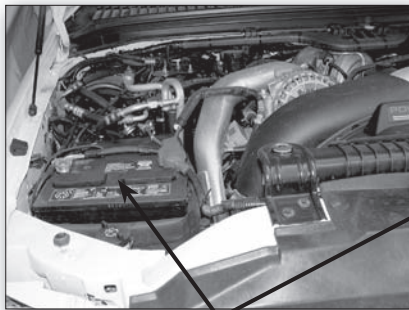

F-550 Primary Battery Location



F-550 Diesel Engine Compartment

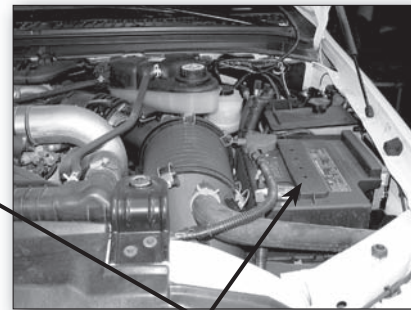

F-550 Primary Battery Location

E-450 Diesel Primary
Battery Location

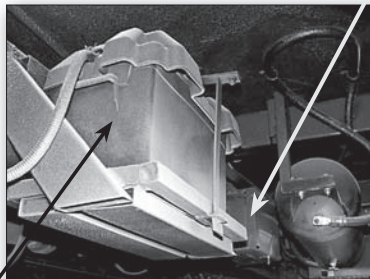

Under Floor Auxiliary Battery (curb side)
for E-450 & F-550 (E-450 diesel shown)

E-450 2004 and Older Models

E-450 2004 and Older Models

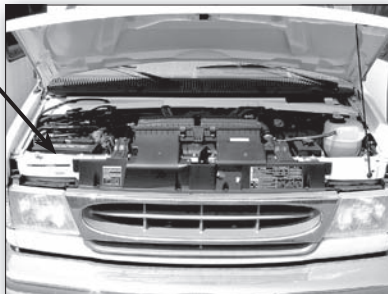

E-450 Diesel Engine Compartment

E-450 2005 and Newer Models

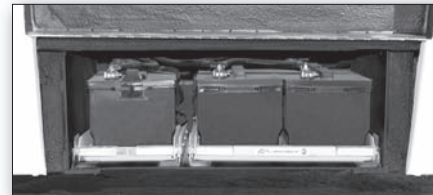

2005 E-450 Primary & Secondary
Slide Out Battery Compartment
Located on Curb Side of Vehicle

Krystal Enterprises

E-450 Heated Mirror Switch and Mirror Control Switch



CAUTION!

Leaving the heated mirror switch on in hot weather, may cause mirror to crack.

Heated Mirror Switch

This switch controls the ON/OFF activation of the heated mirror function.

Mirror Control Switch

This switch includes a center toggle switch that allows the operator to switch from right to left mirror. The center position of the toggle defeats all mirror operations.

When either the left or right mirror is engaged, the 4 arrow switches allow the mirror to move in 4 different directions for precise adjustment.

Video Entertainment Center



Bulkhead Mounted TV and DVD

Basic Operating Instruction Bulkhead mounted TV and DVD

[The TV may be viewed with
or without using the DVD]

For specific detailed information see
Manufacturers DVD Operating Instructions.

1. Turn on the TV using the power on the TV or the button on the remote (Note: TV must be set to Video #1 for DVD to work)
2. To view video, push the TV/Video button to switch between TV and DVD(Video).
3. To view tapes select VCP, then press the DVD power button on the remote.
4. The DVD buttons on the remote will now Operate all the functions of the DVD

SEE MANUFACTURERS LITERATURE
FOR ADDITIONAL INFORMATION
ON BOTH COMPONENTS

Krystal Enterprises

Back-Up Camera Controls and Operation



LCD Monitor

(located in bulkhead above passenger seat on E-450
or in dash area on passenger side of F-550)

Monitor Controls

1. **Power Button**, glows dimly when system is connected fully manual, becoming bright upon activation
2. **A/B input Select Button**, toggles active display between AV1 and AV2 inputs
3. **Day/Night Mode Button**, toggles intensity of LCD screen for day or night operation, (day=maximum intensity, night=less intensity)
4. **Picture Adjustment Menu Button**, accesses on-screen-display, to adjust (brightness, contrast, color, tint). Use the Volume control to adjust each up or down, as indicate by a bar graph at bottom on screen.
5. **Volume Button**, controls +/- output volume of built-in speaker, when feature is connected. Also used in Picture Adjustment Mode.

NOTE:

To reverse image on monitor, push button on back of camera



Back-Up Camera

(located on rear of vehicle)

System Operation

This system consists of two major components:
1. The Back-Up Camera 2. LCD Monitor

The system may be connected two ways:

1. **Fully manual**, requiring the power button on the LCD Monitor to be pushed to energize the system and activate the monitor.
2. **Automatic**, which activates the monitor whenever the ignition is turned to accessory or the engine is started.

SEE MANUFACTURERS LITERATURE
FOR ADDITIONAL INFORMATION

Rear Step Operation



Rear Step Switch Guard

SEE MANUFACTURERS LITERATURE FOR ADDITIONAL INFORMATION

For the double rear step (shown above) and the single rear step, operation is the same. The schematic (this page) explains the electrical operation of both steps. The **power switch** allows you to enable or disable step operation. When the step is enabled, opening the rear door automatically extends the step.

Note: See Manufacturers literature regarding periodic lubrication requirements.

Rear Step Operational Schematic

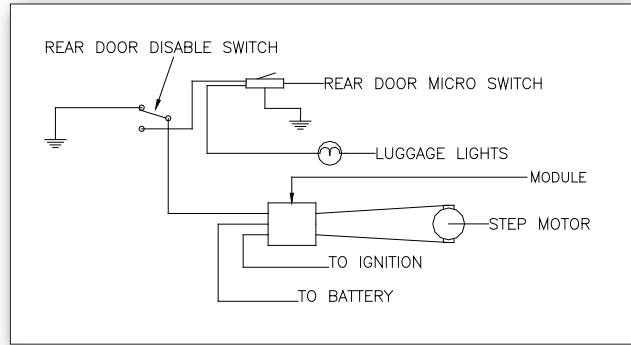

Rear Cargo Door Micro Switch



Rear Door and Hinge Assy



Cargo Door Micro Switch

The switch is located at the rear cargo door upper hinge, shown at left and above. It operates the rear interior lights and also activates the door-ajar light on the front overhead control panel.

This switch works in conjunction with the rear step, allowing the power switch (shown on previous page) to enable or disable step operation.

Foldaway Seating

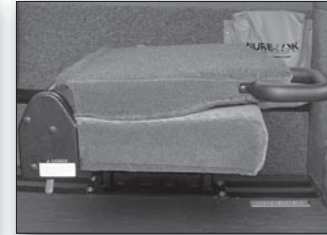
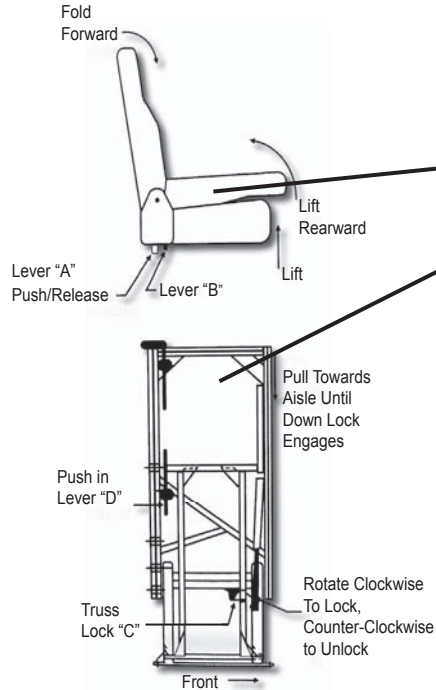

To Lower

1. Rotate the Truss Lock "C" to unlock the assembly, then push Lever "D" and pull the top of the seat toward the aisle until it is locked in the down position.
2. Push lever "A" forward, and lift the back cushion until the lever "A" has snapped back into the locked position.

To Raise

1. Push lever "A" forward, and fold the back cushion down against the seat cushion until lever has snapped back into locked position.
2. Push lever "B" upward, and lift the seat into the fold away position, and rotate the Truss Lock "C" to lock the assembly in place.

Krystal Enterprises

Bus Passenger Seating - Moving or Adding

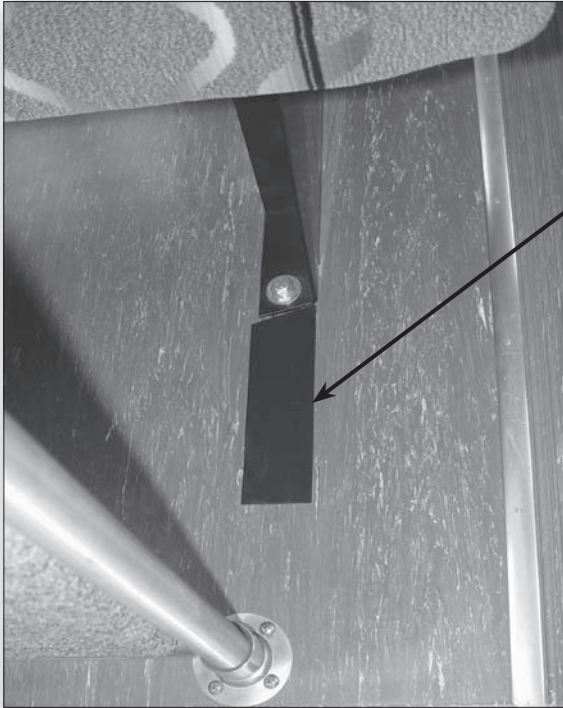

Bus seating is mounted into the floor of the vehicle as shown in the photo to the left.

To move or add seating:

1. Remove the black plastic track cover, so the track is exposed.
2. Next remove the nut from the base.

NOTE: Nut must be perpendicular to the track when the seat is re-attached to the seat track.

CAUTION: Bolts must be torqued to 35 ft.. Lbs.

Caution: When Adding Seating, Do Not Exceed Weight Distribution/ Payload Limitations.

Stainless Steel Wheel Liners



CAUTION!

Wheel liners should only be removed using the Wheel Liner Tool provided with your vehicle. Damage could occur if the supplied tool is not used.



Wheel Liner Tool

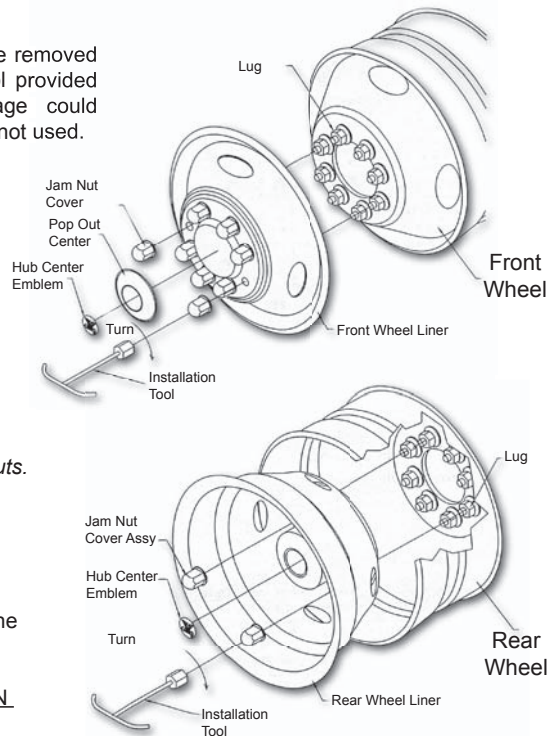

INSTALLATION - REMOVAL INSTRUCTIONS

NOTE: When removing or installing, never remove the original equipment lug nuts.

1. **TO REMOVE**, simply place the Wheel Liner Tool over the Jam Nut Covers.
2. Remove Jam Nut Covers from each wheel and remove Liners

1. **TO INSTALL**, determine the correct placement of liners for proper hand hole alignment.
2. Install Liner over studs, then install Jam Nut Covers w/built-in jam nuts onto the studs. Using the Wheel Liner Tool, tighten all Jam Nuts

SEE MANUFACTURERS LITERATURE FOR ADDITIONAL INFORMATION

Krystal Enterprises

Air Conditioning Assembly E-450 & F-550

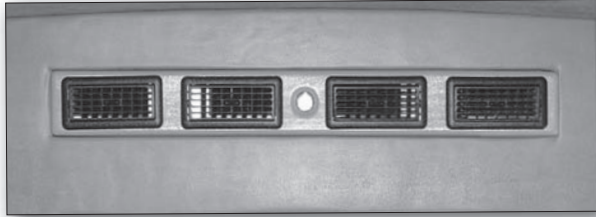

ACC Front Air Conditioning

These units also provide heat when A/C is not required, by toggling switch on the overhead control panel

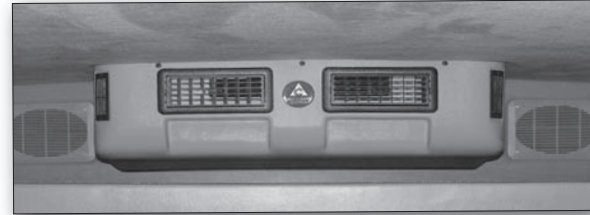

Optional ACC Rear Air Conditioning

This unit only operates when the dash A/C is turned on.
A/C only - No Heat

These units are operated by the driver, using the controls on the Overhead Control Panel , see page 22.
For information on A/C charging specifications, see the A/C Charging Chart on page 67.

Rear Floor Heater Assembly E-450 & F-550

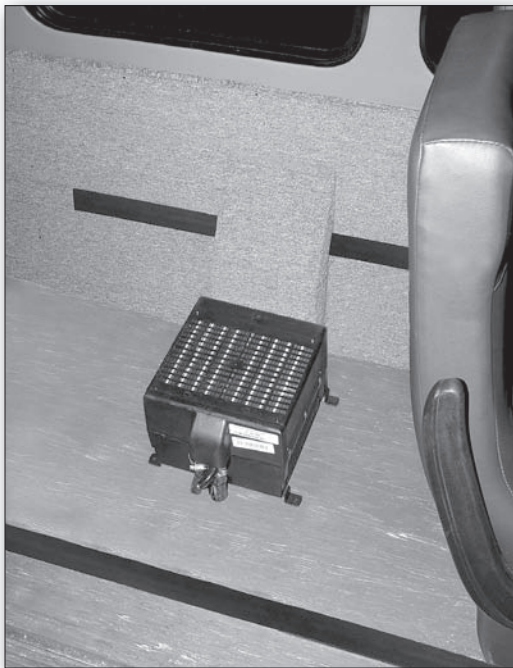

30,000 BTU Model

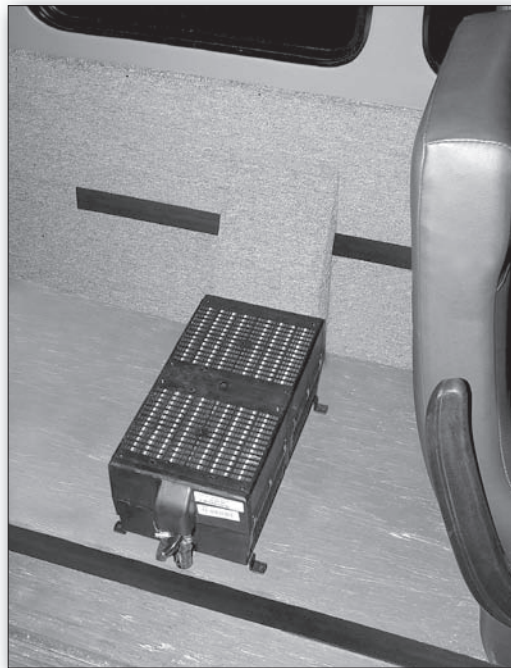

65,000 BTU Model

Both units are turned on when the heat mode is selected on the Drivers Overhead Control Panel (see page 22)

THIS PAGE IS INTENTIONALLY BLANK

Krystal Enterprises

[RETURN TO MENU](#)

Standard Movable Wall - Front View

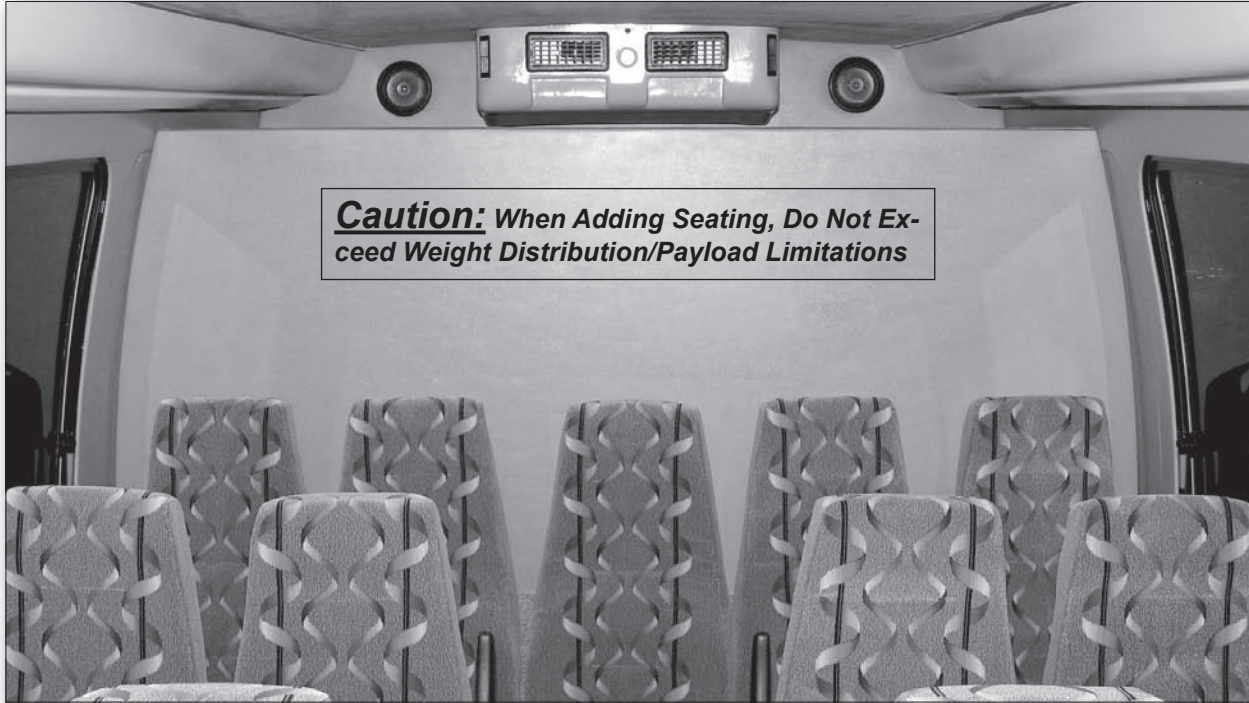

Movable Wall shown above in the forward position

Krystal Enterprises

Standard Movable Wall - Rear View



The standard movable wall can be moved by doing the following:

1. Remove the seats from in front of the wall
2. From the baggage compartment side, remove the plastic track cover on both the side wall and floor to expose the track.
3. Disengage the top latches at the outside corners of the wall.
4. From the front side of the wall, loosen the bolts.
5. With assistance on both sides of the wall, push evenly on both sides and slowly move the wall to the desired position.
6. When securing wall, make sure to re torque all bolts to 35 ft.. lbs. Note: if seats are installed, seat bolts must also be torqued to 35 ft.. lbs.
7. Replace all plastic track covers and engage top latches

Krystal Enterprises

[RETURN TO MENU](#)

E-Z Move Wall - Open Front

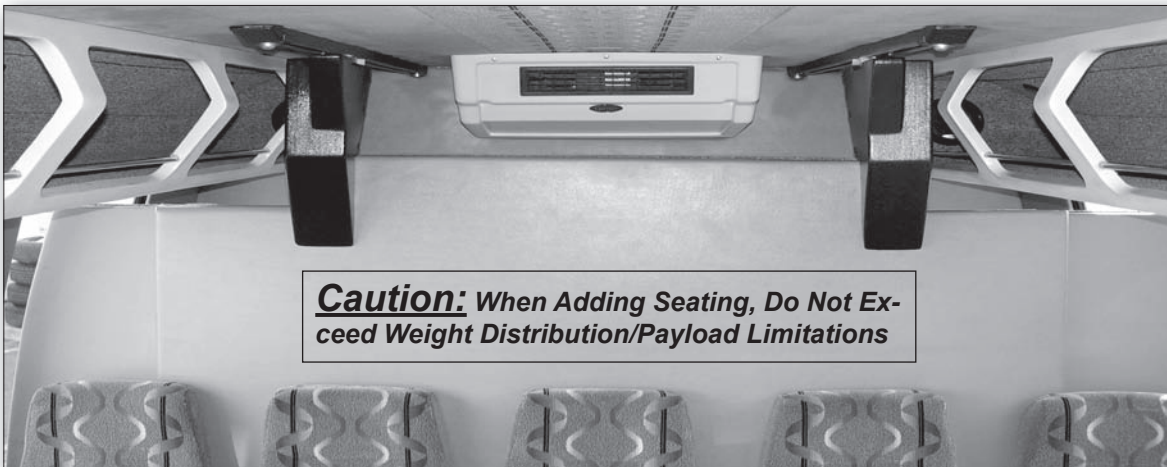

Caution: When Adding Seating, Do Not Exceed Weight Distribution/Payload Limitations

E-Z Move Wall Operating Instructions

Movable Wall to the open position (with luggage compartment)

- 1) Release the top two clamps located on the ceiling.
- 2) Enter bus through the rear door and release bottom clamp
- 3) Push the movable wall at the upper most centrally located handle to the stop
- 4) Release the divider clamp and slide out each divider half. Rotate the clamp assembly into the seat track and engage clamps. **SAFETY ALERT**
- 5) Engage the top two clamps into the locked position **SAFETY ALERT**

SAFETY ALERT

Clamps must be locked down before operating vehicle

Movable Wall to the closed position (no luggage compartment)

- 1) Release the top two clamps located on the ceiling.
- 2) Enter bus through the rear door.
- 3) Release and rotate the clamp assembly (divider) out of the seat track. Slide the divider to the stop and engage the divider clamp to lock down the dividers.
- 4) Pull the movable wall at the upper most centrally located handle to the stop.
- 5) Engage the bottom clamp into the receiver located in the floor. **SAFETY ALERT**
- 6) Close the rear door. Enter the bus, walk to the rear and engage the top two clamps into the locked position. **SAFETY ALERT**

SAFETY ALERT

Clamps must be locked down before operating vehicle.

E-Z Move Wall - Open Rear

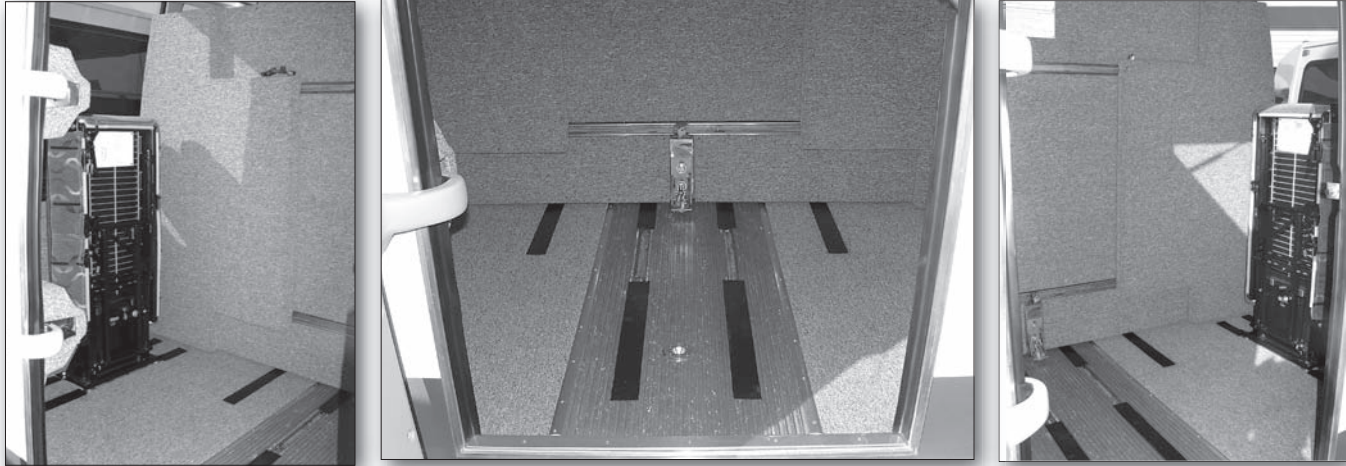

To Open and Close E-Z Move Wall

Instructions for Opening and Closing the E-Z Move Wall shown on the previous page, may also be found mounted on the back of the Movable Wall. Follow the instructions for Open Position - (with luggage compartment) or Close Position - (no luggage compartment)

SAFETY ALERT: ALL CLAMPS MUST BE LOCKED DOWN BEFORE OPERATING VEHICLE

Krystal Enterprises

RETURN TO MENU

E-Z Move Wall Clamp Assemblies

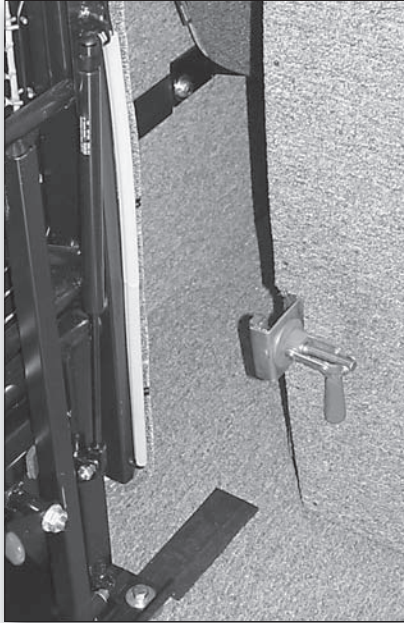

LH & RH Lower Clamp Assembly
(LH shown)

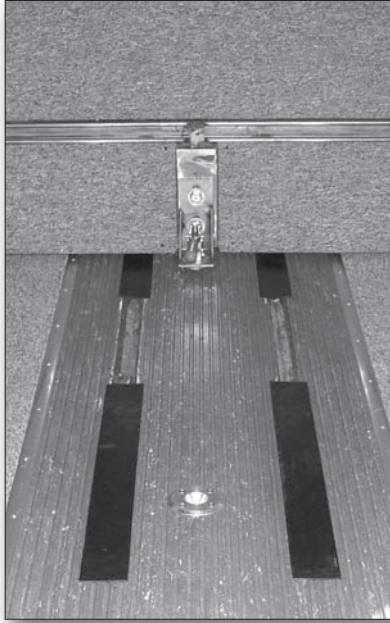

Center Lower Clamp Assembly



LH & RH Ceiling Clamp Assembly
(RH shown)

SAFETY ALERT: ALL CLAMPS MUST BE LOCKED DOWN BEFORE OPERATING VEHICLE

Krystal Enterprises

Compressed Air Supply Assembly

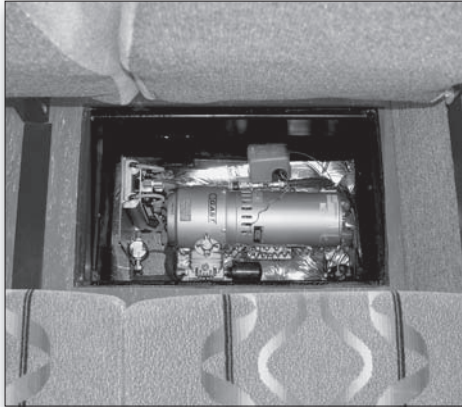

On the F-550 (shown above) The air supply compressor assembly is located beneath the floor hatch, between the passenger seats midway back on the right side of the vehicle.

On the E-450 the air supply compressor is located beneath the first right hand side passenger seat.

1	Pre-Filter
2	Air Dryer
3	Compressor
4	Check Valve
5	Pressure Switch
6	Over Temperature Sensor
7	Solenoid Switch

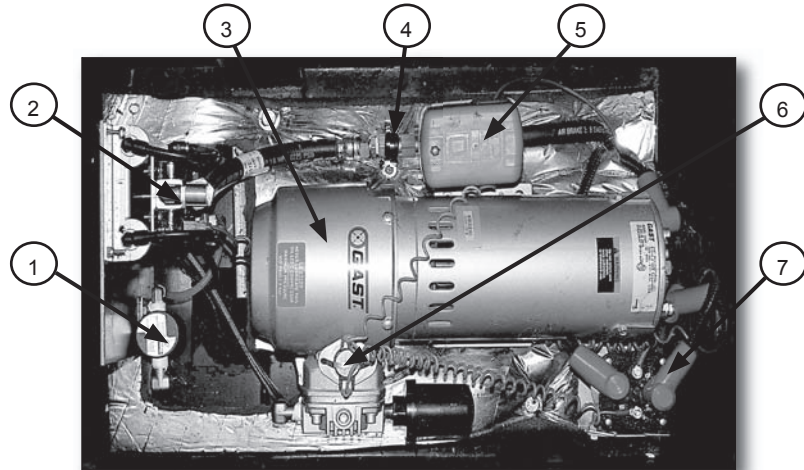

Air Operated - Single Plug Door

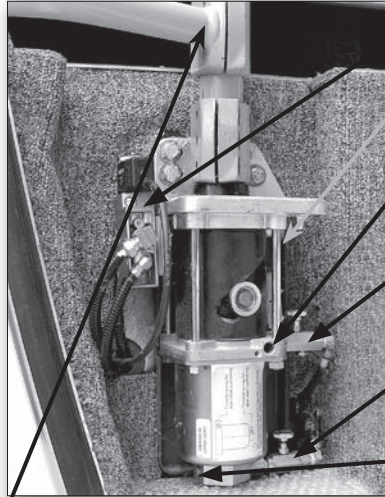

- 4-Way Valve
- Entry Door Ajar Switch
- Closing Cushioning Valve
- Closing Speed Valve
- Opening Speed Valve
- Opening Cushioning Valve



Single Plug Door System
(door shown partially open)



Secondary Entry Door Switch - used on air operated door systems, located on passenger door post

CAUTION! Never attempt adjustment of the Boomerang Arm, call KRYSTAL SERVICE

Air Door Speed Adjustment Procedure

1. Remove the air motor cover located in the stepwell.
2. Using the photo on this page, identify the speed control valves. Using a 3/8" wrench, loosen the locknuts on both valves.
3. Operate the door and adjust both valves until the opening and closing speeds are equal and acceptable. Then tighten both locknuts.
4. Using a flat blade screwdriver, adjust the opening and closing cushioning valves on the air motor, then replace cover.

Krystal Enterprises

Compressed Air Schematic - Single Plug Door

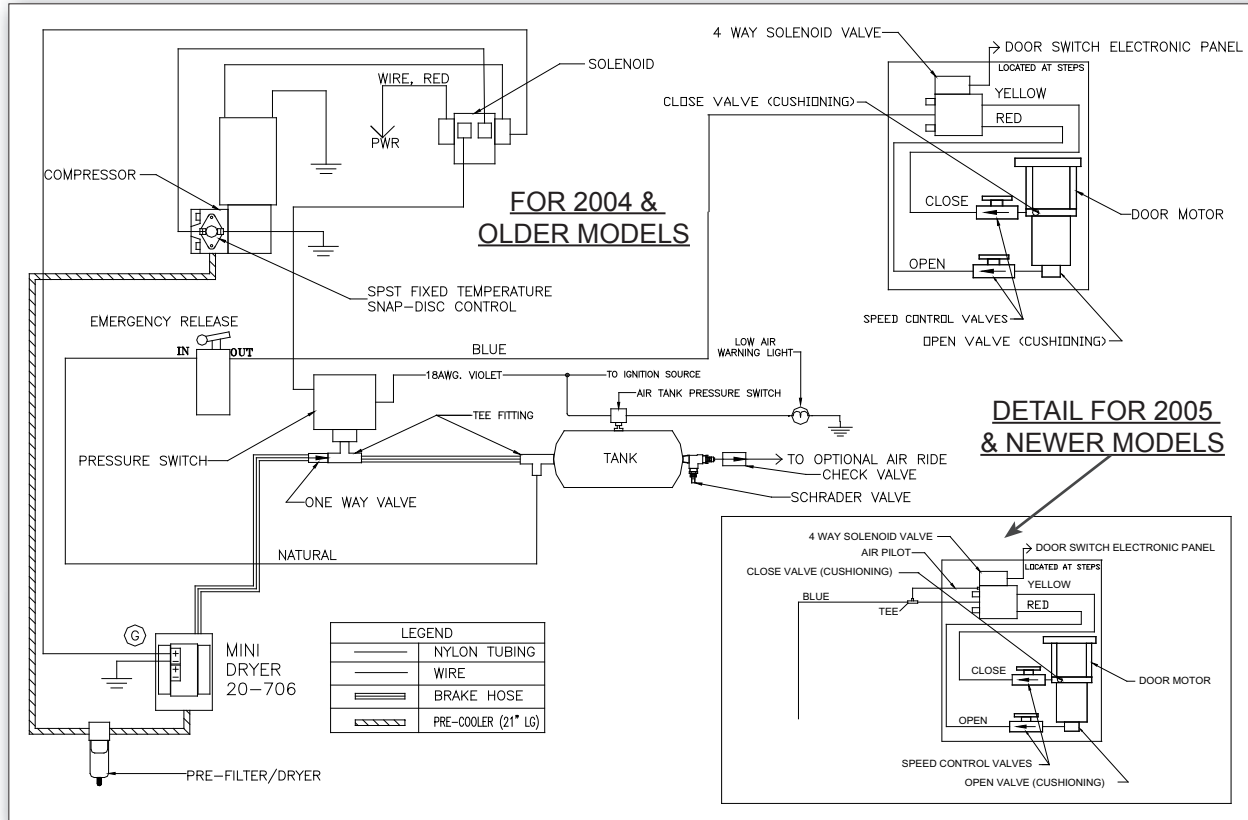

Krystal Enterprises

[RETURN TO MENU](#)

Air Operated - Double Plug Door

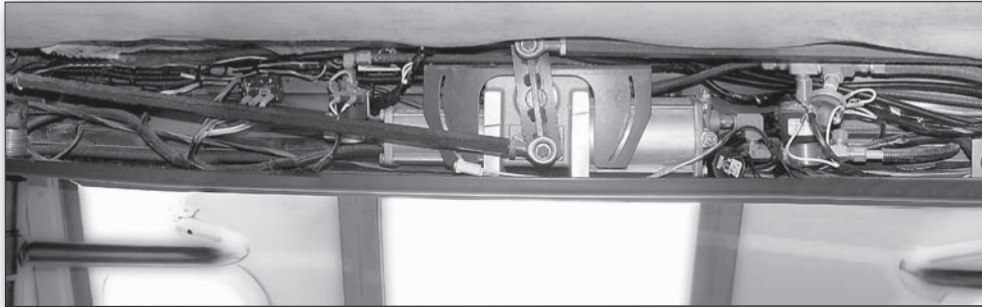

ATTN: Double Plug Air Door Speed Is Factory Set

**If adjustments become necessary, do not attempt adjustments.
Contact the Krystal Service Dept., at 1-800-Krystal (579-7825)**

CAUTION!

The Emergency Release Valve System - (must be checked on a daily basis)

Once the emergency release valve has been actuated (by turning counter clockwise), it should be possible to open the doors by pushing outward with your hand after about 5 seconds.

The Obstruction Sensing System (Sensitive Edge) - (must be checked on a daily basis)

Only when the door is closing, can reversing be actuated. The reversing motion should be shut off about 10 to 30 mm before the final closing position. If the reversing process actuates too late, the sensitivity of the differential pressure switch would require re-adjustment. Call the KRYSTAL SERVICE DEPT.

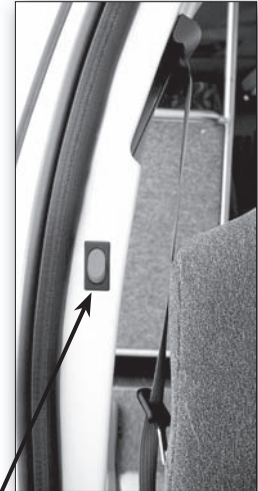

Secondary Entry Door Switch - used on air operated door systems, located on passenger door post

Compressed Air Schematic - Double Plug Doors

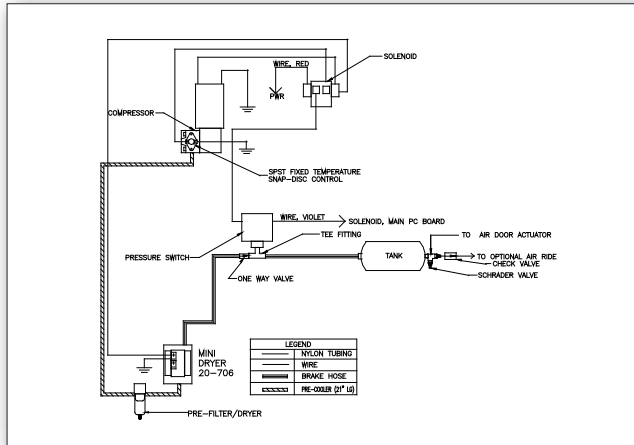

Air Schematic for Double Plug Doors

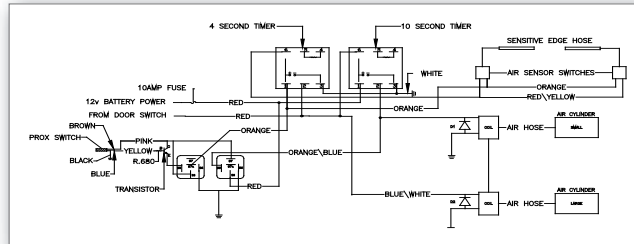

Electrical Schematic for Doors with Sensitive Edge



Double Plug Door System w/Sensitive Edge (doors shown partially open)

**For Larger Schematics See
Electrical Section pg 108-109**

Krystal Enterprises

RETURN TO MENU

Electric Swing Doors

Electric door motor Cover

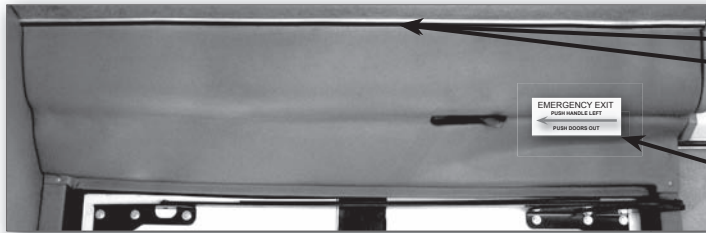

For removal of door motor cover

1. Remove black rubber strip from molding channel
2. Remove exposed screws in aluminum channel
3. Remove screws from 3 corners of cover

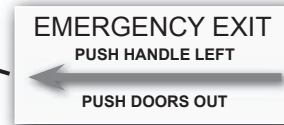

Emergency Exit Lever Decal

Electric door motor with control arm

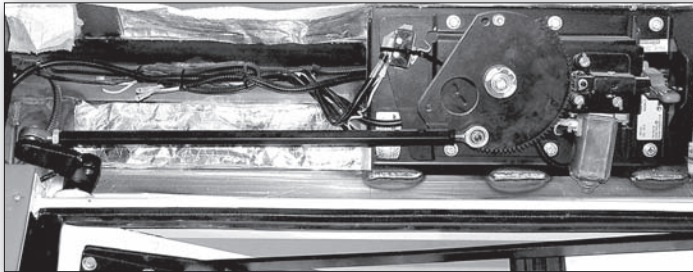

NOTE:

**LEVER MUST BE CHECKED DAILY,
PRIOR TO VEHICLE OPERATION**

**Electric Door Adjustment Procedure
Door Speed Is Factory Set**

If adjustments become necessary, do not attempt adjustments. Contact the Krystal Service Dept., at 1-800-Krystal (579-7825)

Swing Door System - Electrical Schematic



Swing Door System

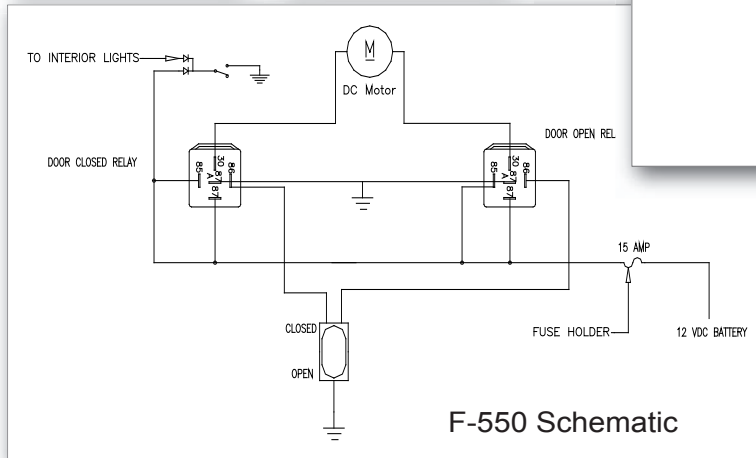
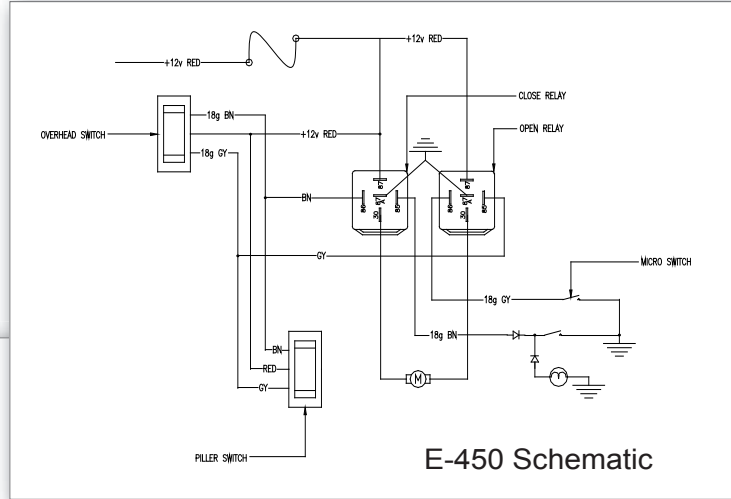

**For Larger Schematics See
Electrical Section pg110-111**

Braun Rear Door Wheelchair Lift

Lift Motor Assy



Back-up Pump

Lift Control
Pump Handle

Release Valve

User Instructions

Passenger Loading and Unloading

Do not exceed the 800 pound load capacity of the lift. Prior to lift operation, the lift should be inspected for proper function. ***If any problems exist, DO NOT USE LIFT.*** Contact Braun Corp. at 1-800-THE LIFT for repair.

Passengers loading from the ground level, should back onto the platform. All passengers loading onto the platform, should be positioned fully within the yellow boundaries, facing outward from the vehicle, with the wheelchair locks locked, gripping handrails if able. Electric wheelchairs should be turned off.



UNFOLD The UNFOLD function deploys the lift from the upright position, with the platform extended flat at floor level, with the roll stop vertical.

FOLD The FOLD function raises the lift from the horizontal floor level position, bringing the platform back to a full upright position

DOWN The DOWN function lowers the platform to the ground level, and extends the roll stop to a flat position, for wheelchair egress.

UP The UP function raises the roll stop to full vertical position, before raising the platform from ground level to the floor level position for unloading.

CAUTION! *Never raise or lower lift if roll stop is malfunctioning*

CAUTION!

YOU MUST READ AND UNDERSTAND THE MANUFACTURERS OPERATORS MANUAL BEFORE EVER OPERATING THIS LIFT

Krystal Enterprises

Braun Rear Door Wheelchair Lift



Lift Closed



Lift Extended



Lift Lowered

Emergency Back-Up Operation

In the event of an electrical system failure, this lift system provides for full manual operation. Locate the back-up pump release valve, and the hand pump handle on the motor housing.

To Unfold the Platform 1. Place the slotted end of the pump handle onto the back-up pump release valve, and

turn counterclockwise until the platform reaches floor level.

2. Turn the release valve clockwise to stop the platform (make sure valve is tight but not over tight)

To Lower Platform and Roll Stop

1. Repeat step 1 in the previous procedure to lower the lift to the ground level.

To Fold Roll Stop and Raise Platform

1. Place the slotted end of the pump handle onto the back-up pump release valve, and turn clockwise to close valve.
2. Insert handle into back-up pump, and pump until platform reaches floor level.

To Fold Platform Up

1. Repeat step 2 above until fully upright.

Note: Refer to Operator's Manual for Detailed Operating & Maintenance Procedures

Krystal Enterprises

RETURN TO MENU

Ricon Rear Door Wheelchair Lift

Lift Motor Assy



ATTENTION!

When the green light is lit, the lift needs service

Basic User Instructions

Passenger Loading and Unloading

Do not exceed the 800 pound load capacity of the lift. Prior to lift operation, the lift should be inspected for proper function. ***If any problems exist, DO NOT USE LIFT.*** Contact Ricon Corp. at 1-818-322-2884 for repair.

Passengers loading from the ground level, should back onto the platform. All passengers loading onto the platform, should be positioned centrally on the platform, facing outward from the vehicle, with the wheelchair locks locked, and restraint belt fastened. Electric wheelchairs should be turned off.



UNFOLD The UNFOLD function deploys the lift from the upright position, with the platform extended flat at floor level, with the roll stop vertical.

FOLD The FOLD function raises the lift from the horizontal floor level position, bringing the platform back to a full upright position

DOWN The DOWN function lowers the platform to the ground level, and extends the roll stop to a flat position, for wheelchair egress.

UP The UP function raises the roll stop to full vertical position, before raising the platform from ground level to the floor level position for unloading.

CAUTION! *Never raise or lower lift if roll stop is malfunctioning*

CAUTION!

YOU MUST READ AND UNDERSTAND THE MANUFACTURERS OPERATORS MANUAL BEFORE EVER OPERATING THIS LIFT

Back-up Pump
Pump Handle
(not shown)

Lift Control
Release Valve

Ricon Rear Door Wheelchair Lift



Lift Closed



Lift Extended



Lift Lowered

Emergency Back-Up Operation

In the event of an electrical system failure, this lift system provides for full manual operation. Locate the back-up pump release valve, and the hand pump handle on the motor housing.

To Deploy the Platform
1. Place the slotted end of the pump handle onto the back-up pump release valve, and turn

counterclockwise $\frac{1}{4}$ turn until the platform reaches floor level.

2. Turn the release valve clockwise to stop the platform (make sure valve is tight but not over tight)

To Lower Platform and Roll Stop

1. Repeat step 1 in the previous procedure to lower the lift to ground level.

To Fold Roll Stop and Raise Platform

1. Place the slotted end of the pump handle onto the back-up pump release valve, and turn clockwise to close valve.

2. Insert handle into back-up pump, and pump until platform reaches floor level.

To Stow Platform Up

1. Repeat step 2 above until fully upright.

Note: Refer to Operator's Manual for Detailed Operating & Maintenance Procedures

Krystal Enterprises

RETURN TO MENU

Braun UVL 600X Series Under Vehicle Wheelchair Lift

User Instructions

Passenger Loading and Unloading

Do not exceed the 750 pound load capacity of the lift. Prior to lift operation, the lift should be inspected for proper function. ***If any problems exist, DO NOT USE LIFT.*** Contact Braun Corp. at 1-800-THE LIFT for repair.

Passengers loading from the ground level should back onto the platform. All passengers loading onto the platform, should be positioned in the center of the platform, **facing outward from the vehicle**, with the wheelchair locks locked.



Pump Motor

Lift Control

Pump Handle



UP The UP function deploys the lift from stow position, and raises the platform to floor level.

DOWN The DOWN function deploys the lift from the stowed position, lowers the platform to ground level and lowers the front barrier after reaching the ground.

STOW The STOW function raises or lowers the platform to the stowed level, and then moves it inward to the stow position.

DOOR CLOSE (Optional) The DOOR CLOSE function only operates when automatic door openers are installed. The function only operates when the platform is stowed or fully extended at ground level.

CAUTION!

YOU MUST READ AND UNDERSTAND THE MANUFACTURERS OPERATORS MANUAL BEFORE EVER OPERATING THIS LIFT

Krystal Enterprises

Braun Under Vehicle Wheelchair Lift



Lift Closed



Lift Extended



Lift Lowered



Lift Raised

Emergency Back-Up Operation

In the event of an electrical system failure, the UVL system provides for full manual operation. Locate the manual release cable, manual down valve, and the hand pump on the power pack.

To move platform from STOW, pull the manual release cable. Twist the "T" handle to lock in the released position. The plat-

form can now be pulled outward.

To raise the platform, make sure the manual down valve is turned fully clockwise. Pump the hand pump handle until you reach the desired platform height.

To lower the platform, turn the manual down valve SLOWLY counter-clockwise to lower the platform. **To lower the front**

barrier, remove the release pin at the barrier actuator end. Lift will not continue operating unless release pin is re-inserted fully. **To move platform to STOW position,** first be sure the platform is at STOW height. Pull and lock the manual release cable. Push the platform inward to re-engage release cable mechanism.

Note: Refer to Service Manual for Maintenance, Adjustment, and Trouble Shooting Procedures

Krystal Enterprises

RETURN TO MENU

Standard Chassis Specification for E450 Super Duty RV Cutaway

Chassis	E-450 Super Duty RV Cutaway
GVWR - Total	14,050 lbs
Front Axle	Twin I-Beam
Front Springs	Coil - Computer Selected
Stabilizer Bar	Front & Rear
Rear Axle Type	Full Floating
Rear Axle Ratio	Gas=4.63 Diesel=4.10
Rear Springs	Leaf
Shock Absorbers	Gas Pressurized
Engines	6.8 Liter Triton EFE V-10 Gas 6.0 Liter Power Stroke V-8 Diesel
Fast Idle Controller	Gas - Penntex Diesel - Ford or InterMotive
Transmission	Torque Shift 5-Speed Automatic w/Tow Haul Mode
Alternator	Gas - Pentex 200 Amp Diesel - Ford Dual 110 Amp
Batteries - Chassis	Dual 84 & 63 AMP HR, 1400 CCA
Batteries - Coach	Single 112 AMP HR, 800 CCA Deep Cycle Marine

Standard Chassis Specification for E450 Super Duty RV Cutaway

Steering	Power Assisted
Steering Column	Locking, Energy Absorbing, Tilt w/ Cruise Control
Brakes	4 Wheel ABS Power Disc Brakes
Fuel Tank	55 Gallon
Cab Paint	Oxford White
Glass	Tinted All Windows, Power Assisted Door
Lights	Halogen Sealed Beam Headlights
Air Conditioner	8,000 BTU Cab with R-134a
Heater/Defroster	4-Speed Fan
Safety	3-Point Shoulder/ Lap Belts
Air Bags	Dual Safety Restraint System
Windshield Wipers	Intermittent
Gauges/Instrumentation	Voltmeter, Oil Pressure, Temperature, Fuel Gauge
Mirrors	Heated/ Power Remote 10" x 7"
Tires	LT225/75R16
Wheels	16.5" 8 - Hole, Stamped Steel
Wheelbase	KK22=158", KK24=176", KK28=209"

Standard Equipment on E450 Shuttle Buses

- 6.8 Liter Fuel Injected V-10 Gas Engine
- Power Steering
- 4-Wheel ABS Power Disc Brakes
- Heavy Duty Dual Batteries
- Electronic 4-Speed Auto Transmission
- Radial Tires LT225/75R16
- 50 States Emissions
- 55 Gallon Fuel Tank
- Adjustable Tilt Steering Wheel
- Cruise Control
- Engine Oil Cooler
- Transmission Oil Cooler
- Automatic High Idle Controller
- Drive Shaft Guards
- .063 Aluminum Exterior Side Walls
- Welded Steel Cage Frame
- Cab Running Boards
- Captains Chairs - Driver/Co-Pilot
- 3/4" Resin Laminated Floor
- 2" Fiberglass Insulation
- Commercial Grade Carpet
- Ribbed Rubber Aisle
- Mid-High Seats with Level 3 Fabric
- 53,000 BTU A/C System
- AM/FM Stereo Cassette w/CD & Clock
- Power Cab Door Locks
- Power Cab Windows
- Back-up Alarm
- Valance Lighting
- Air Actuated Sedan Entry Door
- Full Body Undercoating
- Base White Body Color
- Power Remote/Heated Mirrors
- 80% Tinted Windows w/UV Protection
- 200 Amp Alternator (Gas)
- Dual 110 Amp Alternator, (Diesel)
- Brake Interlock (for wheelchair only)
- S/S Wheel Inserts
- Movable Luggage Partition (KK28)
- Rear Luggage Door w/Electric Step (KK28)
- Sedan Style Wheelchair Lift Door (KK22W & KK24W)

Standard Chassis Specification for F550 Super Duty Cab & Chassis

GVWR - Total	19,000 lbs
Front Axle	Mono-Beam
Front Springs	Twin Coil
Stabilizer Bar	Front & Rear
Rear Axle Type	Full Floating
Rear Axle Ratio	4.88 (Gas & Diesel)
Rear Springs	Leaf, Single Stage, Constant Rate & Auxiliary
Shock Absorbers	HD Gas Pressurized
Engines	6.8 Liter Fuel Injected V-10 Gas Engine 6.0 Liter Power Stroke V-8 Diesel
Fast Idle Controller	Gas - Penntex
	Diesel - Ford or InterMotive
Transmission	Torque Shift 5-Speed Automatic w/Tow Haul Mode
Alternator	Gas - Pentex 200 Amp
	Diesel - Ford Dual 110 Amp
Batteries - Chassis	Dual Maintenance Free 78 Amp Hr, 1300 CCA
Batteries - Coach	Single 112 AMP HR, 800 CCA Deep Cycle Marine

Standard Chassis Specification for F550 Super Duty Cab & Chassis

Steering	Power Assisted
Steering Column	Locking, Energy Absorbing, Tilt w/ Cruise Control
Brakes	4 Wheel ABS Power Disc Brakes
Fuel Tank	40 Gallon w/19 Gallon Aux. Tank
Cab Paint	Oxford White
Glass	Tinted All Windows, Power Assisted Door
Lights	Halogen Sealed Beam Headlights
Air Conditioner	8,000 BTU Cab with R-134a
Heater/Defroster	4-Speed Fan
Safety	3-Point Shoulder/ Lap Belts w/Adjustable D-Rings
Air Bags	Dual Safety Restraint System
Windshield Wipers	Intermittent
Gauges/Instrumentation	Tachometer, Trip Odometer, Voltmeter, Oil Pressure, Coolant Temperature, Fuel Gage, Indicator Lights
Mirrors	Heated/ Power Remote 10" x 7"
Tires	LT225/70R19.5
Wheels	19.5" 8 - Hole, 8-Lug Steel
Wheelbase	KK30=218", KK33=250 $\frac{3}{8}$ "

Standard Equipment on F550 Shuttle Buses

- 6.8 Liter Fuel Injected V-10 Gas Engine
- Power Steering
- 4-Wheel ABS Power Disc Brakes
- Heavy Duty Dual Batteries
- Electronic 4-Speed Auto Transmission(gas only)
- Radial Tires LT225/70R19.5
- 50 States Emissions
- 40 Gallon Fuel Tank w/19 Gallon Aux. Tank
- All Season Radial Tires LT225/75R16F
- Adjustable Tilt Steering Wheel
- Cruise Control
- Engine Oil Cooler
- Transmission Oil Cooler
- Automatic High Idle Controller
- Drive Shaft Guards
- .063 Aluminum Exterior Side Walls
- Welded Steel Cage Frame
- Cab Running Boards
- Captains Chair Driver & Co-Pilot
- 3/4" Resin Laminated Floor
- 2" Batted Fiberglass Insulation
- Commercial Grade Carpet
- Ribbed Rubber Center Aisle
- Mid-High Seats with Level 3 Fabric
- 68,000 BTU A/C System w/Dual Compressors
- AM/FM Stereo Cassette
- Power Cab Door Locks
- Power Cab Windows
- Back-up Alarm
- Valance Lighting
- Air Actuated Sedan Style Entry Door
- Full Body Undercoating
- Base White Body Color
- Power Remote Side View Mirrors
- 80% Tinted Windows w/UV Protection
- 200 Amp Alternator (Gas)
- Dual 110 Amp Alternator, (Diesel)
- Vented Emergency Escape Hatch
- S/S Wheel Inserts
- Movable Luggage Partition (KK30/KK33)
- Rear Luggage Door w/Electric Step (KK30/KK33)
- Sedan Style Wheelchair Lift Door (KK30W & KK33W)

General Vehicle Dimensional Specifications-Body & Chassis by Model

Features ↓	Models →	KK22	KK24	KK28	KK30	KK33
GVWR		14,050 #	14,050 #	14,050 #	19,000 #	19,000 #
Wheelbase		158"	176"	209"	218"	250"
Overall Length		23' 0"	25' 6"	28' 3"	30' 8"	33' 6"
Turning Radius		28' 5"	30' 6"	35' 7"	37' 1"	37' 2"
Interior Body Length (without Luggage)		178"	204"	226"	242"	274"
Clear Door Opening - Luggage Door		30½" x 64½"	30½" x 64½"	30½" x 64½"	30½" x 64½"	30½" x 64½"
Clear Door Opening - Single Plug		29½" x 81"	29½" x 81"	29½" x 81"	29½" x 81"	29½" x 81"
Clear Door Opening - Double Plug		40½"	40½"	40½"	40½"	40½"
Clear Door Opening - Swing Doors		42"	42"	42"	42"	42"
Clear Door Opening - Wheelchair Lift Door		42" x 73¾"	42" x 73¾"	42" x 73¾"	42" x 73¾"	42" x 73¾"
Exterior Height		112"	112"	112"	114"	114"
Exterior Width (excluding Mirrors)		96"	96"	96"	96"	96"
Exterior Width (including Mirrors)		111"	111"	111"	111"	111"
Interior Width - at Floor		89½"	89½"	89½"	89½"	89½"
Interior Width - at Shoulder		92"	92"	92"	92"	92"
Aisle Width		18"	18"	18"	18"	18"

General Vehicle Dimensional Specifications-Body & Chassis by Model (cont)

Features ↓ Models →	KK22	KK24	KK28	KK30	KK33
Seat Cushion Length	18"	18"	18"	18"	18"
Floor Height from Ground at Rear	31"	31"	31"	33"	33"
1st Step from Ground	11 ³ / ₄ "	11 ³ / ₄ "	11 ³ / ₄ "	12 ¹ / ₂ "	12 ¹ / ₂ "
Riser Height	6 ³ / ₄ "	6 ³ / ₄ "	6 ³ / ₄ "	9 ¹ / ₂ "	9 ¹ / ₂ "
Step Height	10 ³ / ₄ "	10 ³ / ₄ "	10 ³ / ₄ "	12 ¹ / ₂ "	12 ¹ / ₂ "
Movable Wall Depths(approx)- E-450	36-40"	30-32"	28-36"	N/A	N/A
Movable Wall Depths(approx)- F-550	N/A	N/A	N/A	29-63"	30-54"
UVL Wheelchair Lift Door Opening	N/A	N/A	N/A	42"	42"

General Body Materials and Construction Measurements

Size of Steel Tubing used in Body Sidewall & Roof Structure	1" x 1"
Center line Spacing of Tubing used in Body Sidewall & Roof Structure	32"
Gauge of Steel Tubing used in Body Sidewall & Roof Structure	16
Aluminum Sidewall Material	.063
One Piece Aluminum Roofing Material	.040
Size of Steel Tubing used in Main Floor Structure	2" x 4"
Center line Spacing of Tubing used in Floor Structure	32" max.
Gauge of Steel Tubing used in Floor Structure	12
Thickness of Double Backed Insulated Fiberglass Batting Insulation	2"
Window Size	32 x 40"

Air Conditioning Charging Chart

MODEL BY BTU'S	VENTING	FREON CHARGE
E40 Bus 1999 with ACC A/C		
68,000 BTU	4 vents	5.50 lbs.**
86,000 BTU	6 vents	6.0 lbs.**
40,000 BTU w/ FACTORY TIE IN	w/factory tie in	11.0 lbs.**
F550 Bus 2000 with ACC skirt condenser		
68,000 BTU	4 vents	5.50 lbs.**
86,000 BTU	6 vents	6.00 lbs.**
40,000 BTU w/ FACTORY TIE IN	w/factory tie in	11.50 lbs.**
F550 ALL with ACC front condenser		
68,00 BTU	4 vents	4.25 lbs.**
40,000 BTU w/ FACTORY TIE IN	w/factory tie in	11.50 lbs.**
E450 2000 with Carrier A/C		
68,000 BTU	add on unit	5.00 lbs.**
40,000 BTU w/ FACTORY TIE IN	w/factory tie in	5.50 lbs.**
Roof Top Carrier A/C	Ducted	7.0 lbs.** per compressor
E450 w/ACC 2004-2005 Models		
68,000 BTU	4 vents	5.25 lbs**.
40,000 BTU w/ FACTORY TIE IN	2 vents	10.0 lbs.**

**NOTE: These figures may vary depending on atmospheric conditions

Krystal Enterprises

[RETURN TO MENU](#)

Vehicle Manufacturers Identification Label

E-450

MANUFACTURED BY: KRYSTAL ENTERPRISES, INC. K		INCOMPLETE VEHICLE MANUFACTURED BY: FORD MOTOR CO.	
DATE OF MANUFACTURE		DATE INC. VEH. MANUFACTURED:	
MO.	YR.	MO.	YR.
VIN			
GVWR	14050 LB /	6349 KG	THIS VEHICLE CONFORMS TO ALL APPLICABLE FEDERAL MOTOR VEHICLE SAFETY STANDARDS IN EFFECT ON THE DATE OF MANUFACTURE SHOWN ABOVE.
GAWR FRONT	4600 LB /	2086 KG, WITH	
LT225/75RX16E TIRES,			
16X6.0 RIMS, @	80 PSI /	552 KPa COLD	
GAWR REAR	9450 LB /	4286 KG, WITH	THIS VEHICLE CONFORMS TO ALL APPLICABLE FEDERAL MOTOR VEHICLE SAFETY STANDARDS IN EFFECT ON THE DATE OF MANUFACTURE SHOWN ABOVE.
LT225/RX16E TIRES, DUAL PAINT CODE			
16X6.0 RIMS, @	80 PSI /	552 KPa COLD	
VEHICLE TYPE: BUS			

F-550

MANUFACTURED BY: KRYSTAL ENTERPRISES, INC. K		INCOMPLETE VEHICLE MANUFACTURED BY: FORD MOTOR CO.	
DATE OF MANUFACTURE		DATE INC. VEH. MANUFACTURED:	
MO.	YR.	MO.	YR.
VIN			
GVWR	19000 LB /	8618 KG	THIS VEHICLE CONFORMS TO ALL APPLICABLE FEDERAL MOTOR VEHICLE SAFETY STANDARDS IN EFFECT ON THE DATE OF MANUFACTURE SHOWN ABOVE.
GAWR FRONT	6000 LB /	2721 KG, WITH	
225/70R19.5 F TIRES,			
19.5X6.0 RIMS, @	95 PSI /	655 KPa COLD	
GAWR REAR	13500 LB /	6123 KG, WITH	THIS VEHICLE CONFORMS TO ALL APPLICABLE FEDERAL MOTOR VEHICLE SAFETY STANDARDS IN EFFECT ON THE DATE OF MANUFACTURE SHOWN ABOVE.
225/70R19.5 F TIRES, DUAL PAINT CODE			
19.5X6.0 RIMS, @	95 PSI /	655 KPa COLD	
VEHICLE TYPE: BUS			

LABEL EXPLANATION

K # - This is your permanent Krystal Vehicle Identification number.

VIN # - This is your DMV Vehicle Identification Number.

GVWR - This is the gross rated weight capacity of your vehicle

GAWR Front - This is the rated weight capacity of the front axle

GAWR Rear - This is the rated weight capacity of the rear axle

Date Incomplete Vehicle Manufactured - This is the date the chassis was produced by FORD

Date Of Manufacture by Krystal - This is the date the vehicle was completed by KRYSTAL.

Paint Code - This is the master number for the paint specification and color used on your vehicle.

Tires, Rims - This indicates the required tire and rim sizes, and air capacities for your specific vehicle.

Ridewell Air Suspension Chart

Note:

All 1/2" bolt/nut assemblies joining the Ridewell hangers to the FORD frame must be torqued to 120 ft. lbs. (dry) or 90 ft. lbs (lubricated)

If any bolts are found to be loose or damaged, replace with 1/2"-20 SAE GRADE 8 hardware.

This sticker is located on your chassis suspension.



RIDEWELL SUSPENSION TORQUE CHART			
BOLT SIZE	LUBRICATED THREADS		
1 1/2"	HANGER	1,100 FT -LB	(1490 N-m)
1 1/4"	HANGER	750 FT -LB	(1020 N-m)
1 1/8"		500 FT -LB	(680 N-m)
1"	GRADE 5	360 FT -LB	(490 N-m)
1"	GRADE 8	460 FT -LB	(625 N-m)
7/8"		350 FT -LB	(475 N-m)
3/4"	GRADE 5	160 FT -LB	(220 N-m)
3/4"	GRADE 8	190 FT -LB	(260 N-m)
5/8"		100 FT -LB	(135 N-m)
*3/4"		50 FT -LB	(70 N-m)
*1/2"		25 FT -LB	(35 N-m)
*AIR SPRING CONNECTION ONLY			
After suspension has been in operation for approximately 6,000 miles (10,000 KLMS), all fasteners must be re-tightened to specified torque. Repeat every 15,000 miles (25,000 KLMS)			
DO NOT OVER TORQUE!			

PREVENTATIVE MAINTENANCE SCHEDULE

The following Maintenance Schedule is provided as a convenient reference for the specified systems and components, which require periodic service.

These schedules are not intended to be a complete list of all possible services to be performed on a regular basis, nor is it suggested that more frequent services not be considered.

Because of the different types of operations coaches are subjected to, the severity of service must be considered when establishing maintenance intervals. Therefore, any such intervals given in the following schedule must be adjusted according to the particular type of operation in which your particular vehicle will be used. The intervals given are Krystal Enterprises, Inc. recommendations and should be considered as maximum intervals. It should be noted that maintenance inspection and service operations of shorter intervals are always preferable to longer intervals.

PREVENTIVE MAINTENANCE SCHEDULE

THE FOLLOWING PAGES SPECIFY THE MINIMUM REQUIREMENTS THAT ARE NECESSARY TO PROPERLY MAINTAIN YOUR VEHICLES SYSTEMS AND COMPONENTS

CHECK EVERY DAY:

- ▶ all items on Pre-Trip inspection (see page 8)
- ▶ side passenger door emergency release valve operation
- ▶ side passenger entry door, operation, locking, damage, and adjustment
- ▶ emergency roof hatch
- ▶ emergency egress window latches
- ▶ function of all interior and exterior lights
- ▶ check all seat belts for proper operation
- ▶ tire pressure, E-450 80 psi, F-550 95 psi
- ▶ fluid leaks from, transmission, engine, power steering, engine coolant, gear oil, fuel

CHECK EVERY MONTH:

- ▶ windshield washer fluid level
- ▶ and drain fuel filter/water separator
- ▶ door linkage and pivot arm lubrication
- ▶ and lube rear Kwikiee step, (if equipped)
- ▶ and clean air intake filter for A/C system
- ▶ tires for wear, and tread depth

PREVENTIVE MAINTENANCE SCHEDULE

AT 5,000 MILES/600 HOURS DO THE FOLLOWING:

- ▶ change engine oil and replace filter
- ▶ inspect tires for wear and inspect tread depth
- ▶ rotate tires
- ▶ inspect engine air filter
- ▶ inspect torque specifications on Ridewell Suspension System
- ▶ lube door seals with silicon spray, check for proper sealing
- ▶ lube Vapor door rotary drive mechanism
- ▶ check the torque of all door hardware on Vapor door systems

AT 10,000 MILES/1200 HOURS DO THE FOLLOWING:

- ▶ change engine oil and replace oil filter
- ▶ inspect tires for wear and inspect tread depth
- ▶ rotate tires
- ▶ inspect engine air filter
- ▶ clean battery terminals
- ▶ check the torque of all door hardware on Vapor door systems

AT 15,000 MILES/1800 HOURS DO THE FOLLOWING:

- ▶ change engine oil and replace oil filter
- ▶ inspect tires for wear and inspect tread depth
- ▶ rotate tires

PREVENTIVE MAINTENANCE SCHEDULE

- ▶ inspect engine air filter
- ▶ replace engine and frame mounted fuel filters
- ▶ inspect steering linkage, suspension, ball joints, driveshafts, and driveshaft guards
- ▶ inspect engine cooling system and hoses
- ▶ inspect brake system
- ▶ inspect exhaust system and heat shields
- ▶ inspect automatic transmission fluid and external filter element
- ▶ check wheels for end play and noise
- ▶ inspect and lubricate 4 x 2 ball joints (E-450 only)
- ▶ inspect and lubricate steering idler arms
- ▶ replace cabin air filter, if equipped
- ▶ inspect half shaft boots, if equipped
- ▶ re-inspect torque settings on Ridewell Suspension System
- ▶ clean air compressor intake filter
- ▶ lube door seals with silicon spray, check for proper sealing
- ▶ check air system for leaks, and electrical connections
- ▶ lube Vapor door rotary drive mechanism
- ▶ check the torque of all door hardware on Vapor door systems

AT 20,000 MILES/2400 HOURS DO THE FOLLOWING:

- ▶ change engine oil and replace oil filter
- ▶ inspect tires for wear and inspect tread depth

PREVENTIVE MAINTENANCE SCHEDULE

- ▶ rotate tires
- ▶ inspect engine air filter
- ▶ clean battery terminals
- ▶ check the torque of all door hardware on Vapor door systems

AT 25,000 MILES/3000 HOURS DO THE FOLLOWING:

- ▶ change engine oil and replace oil filter
- ▶ inspect tires for wear and inspect tread depth
- ▶ rotate tires
- ▶ inspect engine air filter
- ▶ check the torque of all door hardware on Vapor door systems
- ▶ clean condenser coils

AT 30,000 MILES/3600 HOURS DO THE FOLLOWING:

- ▶ change engine oil and replace oil filter
- ▶ inspect tires for wear and inspect tread depth
- ▶ rotate tires
- ▶ replace engine air filter
- ▶ replace engine and frame mounted fuel filters
- ▶ inspect steering linkage, suspension, ball joints, driveshafts, and driveshaft guards
- ▶ inspect engine cooling system and hoses

PREVENTIVE MAINTENANCE SCHEDULE

- ▶ inspect brake system
- ▶ inspect exhaust system and heat shields
- ▶ change automatic transmission fluid and external filter element
- ▶ check wheels for end play and noise
- ▶ inspect and lubricate 4 x 2 ball joints (E-450 only)
- ▶ inspect and lubricate steering idler arms
- ▶ replace cabin air filter, if equipped
- ▶ inspect half shaft boots, if equipped
- ▶ clean air compressor intake filter
- ▶ clean battery terminals
- ▶ lube door seals with silicon spray, check for proper sealing
- ▶ re-inspect torque settings on Ridewell Suspension System
- ▶ check air system for leaks, and electrical connections
- ▶ lube Vapor door rotary drive mechanism
- ▶ check the torque of all door hardware on Vapor door systems
- ▶ inspect drive belts and replace if necessary

AT 35,000 MILES/4200 HOURS DO THE FOLLOWING:

- ▶ change engine oil and replace oil filter
- ▶ inspect tires for wear and inspect tread depth
- ▶ rotate tires

PREVENTIVE MAINTENANCE SCHEDULE

- ▶ inspect engine air filter
- ▶ check the torque of all door hardware on Vapor door systems

AT 40,000 MILES/4800 HOURS DO THE FOLLOWING:

- ▶ change engine oil and replace oil filter
- ▶ inspect tires for wear and inspect tread depth
- ▶ rotate tires
- ▶ inspect engine air filter
- ▶ clean battery terminals
- ▶ check the torque of all door hardware on Vapor door systems

AT 45,000 MILES/5400 HOURS DO THE FOLLOWING:

- ▶ change engine oil and replace oil filter
- ▶ inspect tires for wear and inspect tread depth
- ▶ rotate tires
- ▶ inspect engine air filter
- ▶ replace engine and frame mounted fuel filters
- ▶ inspect steering linkage, suspension, ball joints, driveshafts, and driveshaft guards
- ▶ inspect engine cooling system and hoses
- ▶ inspect brake system
- ▶ inspect exhaust system and heat shields
- ▶ check wheels for end play and noise

PREVENTIVE MAINTENANCE SCHEDULE

- ▶ inspect and lubricate 4 x 2 ball joints (E-450 only)
- ▶ inspect and lubricate steering idler arms
- ▶ replace cabin air filter, if equipped
- ▶ inspect half shaft boots, if equipped
- ▶ clean air compressor intake filter
- ▶ lube door seals with silicon spray, check for proper sealing
- ▶ re-inspect torque settings on Ridewell Suspension System
- ▶ check air system for leaks, and electrical connections
- ▶ lube Vapor door rotary drive mechanism
- ▶ check the torque of all door hardware on Vapor door systems

AT 50,000 MILES/6000 HOURS DO THE FOLLOWING:

- ▶ change engine oil and replace oil filter
- ▶ inspect tires for wear and inspect tread depth
- ▶ rotate tires
- ▶ inspect engine air filter
- ▶ clean battery terminals
- ▶ check the torque of all door hardware on Vapor door systems
- ▶ clean condenser coils

AT 55,000 MILES/6600 HOURS DO THE FOLLOWING:

- ▶ change engine oil and replace oil filter

PREVENTIVE MAINTENANCE SCHEDULE

- ▶ inspect tires for wear and inspect tread depth
- ▶ rotate tires
- ▶ inspect engine air filter
- ▶ check the torque of all door hardware on Vapor door systems

AT 60,000 MILES/7200 HOURS DO THE FOLLOWING:

- ▶ change engine oil and replace oil filter
- ▶ inspect tires for wear and inspect tread depth
- ▶ rotate tires
- ▶ inspect engine air filter
- ▶ replace engine and frame mounted fuel filters
- ▶ inspect steering linkage, suspension, ball joints, driveshafts, and driveshaft guards
- ▶ inspect engine cooling system and hoses
- ▶ inspect brake system
- ▶ inspect exhaust system and heat shields
- ▶ change automatic transmission fluid and external filter element
- ▶ check wheels for end play and noise
- ▶ lubricate 4 x 4 hub needle bearings
- ▶ lubricate 4 x 2 wheel bearings
- ▶ replace wheel bearing grease seal
- ▶ inspect and lubricate 4 x 2 ball joints (E-450 only)

PREVENTIVE MAINTENANCE SCHEDULE

- ▶ inspect and lubricate steering idler arms
- ▶ replace cabin air filter, if equipped
- ▶ inspect half shaft boots, if equipped
- ▶ clean air compressor intake filter
- ▶ clean battery terminals
- ▶ lube door seals with silicon spray, check for proper sealing
- ▶ re-inspect torque settings on Ridewell Suspension System
- ▶ check air system for leaks, and electrical connections
- ▶ lube Vapor door rotary drive mechanism
- ▶ check the torque of all door hardware on Vapor door systems
- ▶ inspect drive belts and replace if necessary

AT 65,000 MILES/7800 HOURS DO THE FOLLOWING:

- ▶ change engine oil and replace oil filter
- ▶ inspect tires for wear and inspect tread depth
- ▶ rotate tires
- ▶ inspect engine air filter
- ▶ check the torque of all door hardware on Vapor door systems

AT 70,000 MILES/8400 HOURS DO THE FOLLOWING:

- ▶ change engine oil and replace oil filter

PREVENTIVE MAINTENANCE SCHEDULE

- ▶ inspect tires for wear and inspect tread depth
- ▶ rotate tires
- ▶ inspect engine air filter
- ▶ clean battery terminals
- ▶ check the torque of all door hardware on Vapor door systems

AT 75,000 MILES/9000 HOURS DO THE FOLLOWING:

- ▶ change engine oil and replace oil filter
- ▶ inspect tires for wear and inspect tread depth
- ▶ rotate tires
- ▶ inspect engine air filter
- ▶ replace engine and frame mounted fuel filters
- ▶ inspect steering linkage, suspension, ball joints, driveshafts, and driveshaft guards
- ▶ inspect engine cooling system and hoses
- ▶ inspect brake system
- ▶ inspect exhaust system and heat shields
- ▶ check wheels for end play and noise
- ▶ inspect and lubricate 4 x 2 ball joints (E-450 only)
- ▶ inspect and lubricate steering idler arms
- ▶ replace cabin air filter, if equipped
- ▶ inspect half shaft boots, if equipped clean air compressor intake filter

PREVENTIVE MAINTENANCE SCHEDULE

- ▶ lube door seals with silicon spray, check for proper sealing
- ▶ re-inspect torque settings on Ridewell Suspension System
- ▶ lube Vapor door rotary drive mechanism
- ▶ check the torque of all door hardware on Vapor door systems
- ▶ clean condenser coils

AT 80,000 MILES/9600 HOURS DO THE FOLLOWING:

- ▶ change engine oil and replace oil filter
- ▶ inspect tires for wear and inspect tread depth
- ▶ rotate tires
- ▶ inspect engine air filter
- ▶ clean battery terminals
- ▶ check air system for leaks, and electrical connections
- ▶ check the torque of all door hardware on Vapor door systems

AT 85,000 MILES/10200 HOURS DO THE FOLLOWING:

- ▶ change engine oil and replace oil filter
- ▶ inspect tires for wear and inspect tread depth
- ▶ rotate tires
- ▶ inspect engine air filter
- ▶ check the torque of all door hardware on Vapor door systems

PREVENTIVE MAINTENANCE SCHEDULE

AT 90,000 MILES/10800 HOURS DO THE FOLLOWING:

- ▶ change engine oil and replace oil filter
- ▶ inspect tires for wear and inspect tread depth
- ▶ rotate tires
- ▶ inspect engine air filter
- ▶ replace engine and frame mounted fuel filters
- ▶ inspect steering linkage, suspension, ball joints, driveshafts, and driveshaft guards
- ▶ inspect engine cooling system and hoses
- ▶ inspect brake system
- ▶ inspect exhaust system and heat shields
- ▶ check wheels for end play and noise
- ▶ inspect and lubricate 4 x 2 ball joints (E-450 only)
- ▶ inspect and lubricate steering idler arms
- ▶ replace cabin air filter, if equipped
- ▶ inspect half shaft boots, if equipped clean air compressor intake filter
- ▶ clean battery terminals
- ▶ lube door seals with silicon spray, check for proper sealing
- ▶ re-inspect torque settings on Ridewell Suspension System
- ▶ check air system for leaks, and electrical connections
- ▶ lube Vapor door rotary drive mechanism
- ▶ check the torque of all door hardware on Vapor door systems

PREVENTIVE MAINTENANCE SCHEDULE

- ▶ inspect drive belts and replace if necessary

AT 95,000 MILES/11400 HOURS DO THE FOLLOWING:

- ▶ change engine oil and replace oil filter
- ▶ inspect tires for wear and inspect tread depth
- ▶ rotate tires
- ▶ inspect engine air filter
- ▶ check the torque of all door hardware on Vapor door systems

AT 100,000 MILES/12000 HOURS DO THE FOLLOWING:

- ▶ change engine oil and replace oil filter
- ▶ inspect tires for wear and inspect tread depth
- ▶ rotate tires
- ▶ inspect engine air filter
- ▶ clean condenser coils
- ▶ clean battery terminals
- ▶ check the torque of all door hardware on Vapor door systems

SUPPLEMENTARY PREVENTIVE MAINTENANCE INFORMATION

In addition to the required Preventative Maintenance information included in the previous schedule, the following specific exceptions should be noted.

Yellow Coolant:

Must be changed every 5 years or 100,000 miles (whichever comes first), then after initial change, every 3 years or 50,000 miles.

Rear Axle Lubricant:

Must be changed every 50,000 miles

Transfer Case Fluid:

Must be replaced every 60,000 miles

Change Rear Wheel Drive Axle Fluid:

On Dana axles using synthetic fluid, fluid must be changed every 150,000 miles

Check your FORD Owner's Guide Supplement, for special operating condition maintenance requirements, that may be applicable due to your specific vehicle operating profile.

Basic Troubleshooting Guide

The following section details basic troubleshooting techniques that will help you to understand and determine the best course of action regarding some commonly encountered problems.

PROBLEM	POSSIBLE SOLUTIONS
VIBRATION: Noises or Vibration at high speeds only, or in a certain range of speeds:	A certain range of speeds indicates a damaged or otherwise out-of-balance drive line, Contact the Service Dept. Only SELECT drive line shops that are qualified to properly balance the multiple drive line extensions used in your bus. The Krystal Service Dept. can recommend one near you.
REAR A/C BLOWER INOPERATIVE	Check to make sure the FORD front A/C unit is on. If the rear A/C is still not working, call the Krystal Service Dept.
MOVING CARGO PARTITION TO ADD ADDITIONAL SEATING <u>Caution: Do Not Exceed Weight Distribution/Payload Limitations</u>	Remove seats in front of the Partition Wall and loosen all four bolts securing the wall. Then go behind the wall and remove the channel nut on the floor, this will allow the wall to be move back and then additional seating can be installed. Note: torque Seat Bolts to 35 ft. lbs.
EXTERIOR LIGHTING	E-450: One or all exterior clearance lights inoperative, please refer to the FORD wiring schematic in the Krystal Electrical Schematic Manual F-550: Exterior running lights work off of the Krystal relay board.
SLIDER WINDOWS HARD TO OPEN AND CLOSED	If any of the windows start to stick during opening or closing, simply spray both side tracks with silicone spray and work the windows a few times to lubricate the tracks. This should be done approximately every three months.

Basic Troubleshooting Guide

PROBLEM	POSSIBLE SOLUTIONS
PAGING SYSTEM INOPERATIVE	Check the 5 amp fuse on the circuit board above the driver. Wiring schematics and instructions for the paging system are located in this manual on page 23.
NO TELEVISION RECEPTION	If the TV has power, but you cannot pickup any stations, make sure VCP mode button on the P.A. System is engaged and the VCP power button is engaged.
REAR VCP & TV INOPERATIVE	Check to make sure all connections on the back of both units are tight. Check the fuse located at the front face of the TV, and on the backside of the VCP.
EXTERIOR SEALANTS CRACKING OR LIFTING	If the exterior seams of the bus ever crack or start lifting, simply clean the area with rubbing alcohol or mineral spirits completely. After this has been done you can remove the old silicone by using a sharp knife or razor cutter. Clean the area again with the above cleaners and apply a thin bead of white exterior silicone and smooth the bead with your finger for a smooth appearance.
REAR ELECTRIC STEP INOPERATIVE	Check to make sure the step switch is turned on. This switch is located inside the cargo area on the right hand sidewall. If this will not power up the step, call the Krystal Service Dept. The rear step should be lubricated every 30 days to ensure proper operation of the step.
REAR STEREO/CD INOPERATIVE	Check to make sure all connections are tight. Also remove the stereo and check the fuse located on the backside of the stereo.

Krystal Enterprises

RETURN TO MENU

Basic Troubleshooting Guide

PROBLEM

POSSIBLE SOLUTIONS

CANNOT REMOVE WATER FROM LAVATORY	Make sure fresh water tank has water in it and the water pump switch is in the on position. NOTE: Always be sure to turn the water pump switch off when not in use. Failure to do so could cause a steady drain on the auxiliary battery or could cause damage to the water pump. The fresh water fill is located under the bus at the rear of the vehicle.
PASSENGER LIGHTS INOPERATIVE	Check to make sure the switch on the overhead control panel is turned on. NOTE: There is a 5 minute light timer for the interior lights which will automatically turn them off when the door is open. The interior light switch needs to be turned on for at least 10 seconds to reset the timer.
BACK-UP ALARM INOPERATIVE	Check to make sure reverse lights are coming on, if not, check the fuse located in the FORD fuse panels.

Troubleshooting Notes

PROBLEM	POSSIBLE SOLUTIONS

E-450 Circuit Board Assembly

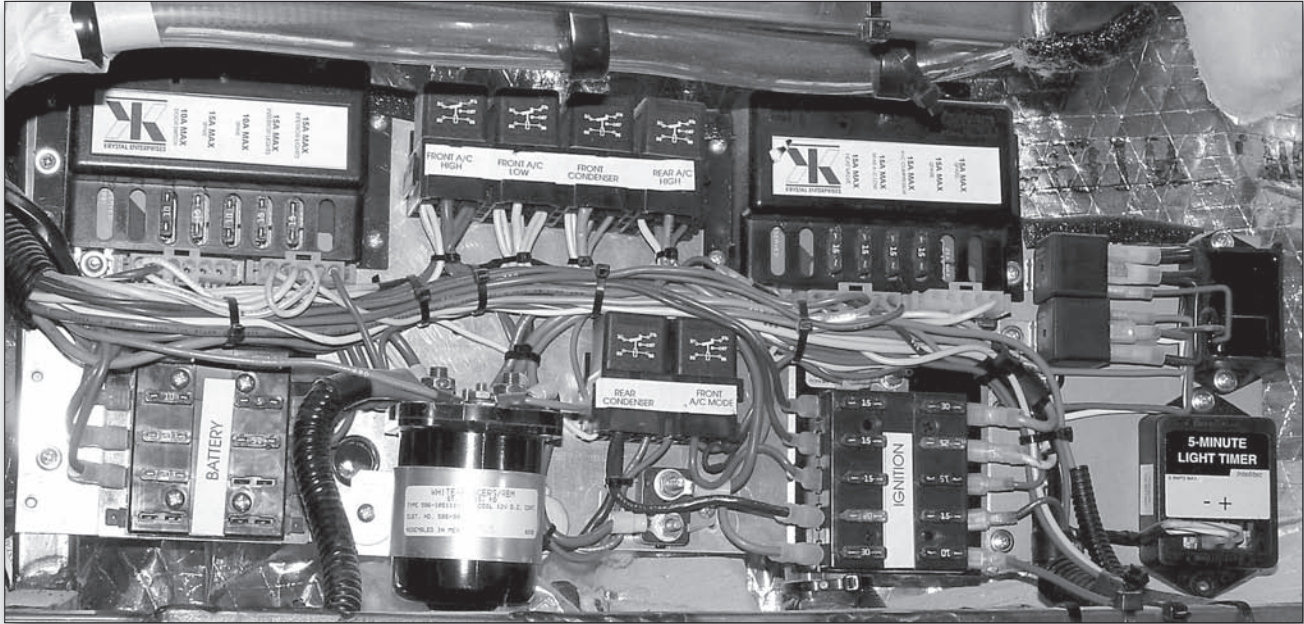

Circuit Board located in compartment above driver

See fuse & relay legend on next page

Krystal Enterprises

E-450 Circuit Board - Electrical Diagrams

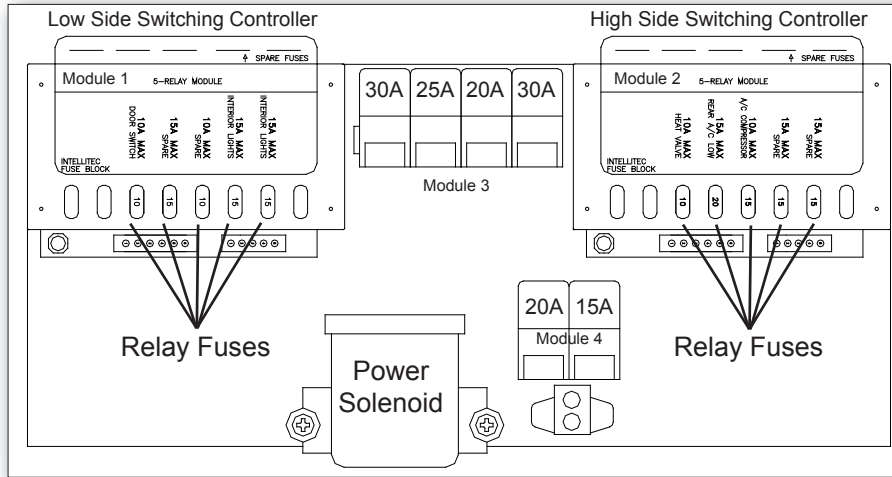

Relay Module Legend (all amperage are maximum)

Module 1 (from left to right)

1. Door Switch 10A
2. Spare 15A
3. Spare 10A
4. Interior Lights 15A
5. Interior Lights 15A

Module 2 (from left to right)

1. Heat Valve 10A
2. Rear A/C Low 15A
3. A/C Compressor 10A
4. Spare 15A
5. Spare 15A

Module 3 (from left to right)

1. Front A/C High 30A
2. Front A/C Low 25A
3. Front Condenser 20A
4. Rear A/C High 30A

Module 4 (from left to right)

1. Rear Condenser 20A
2. Front A/C Mode 15A

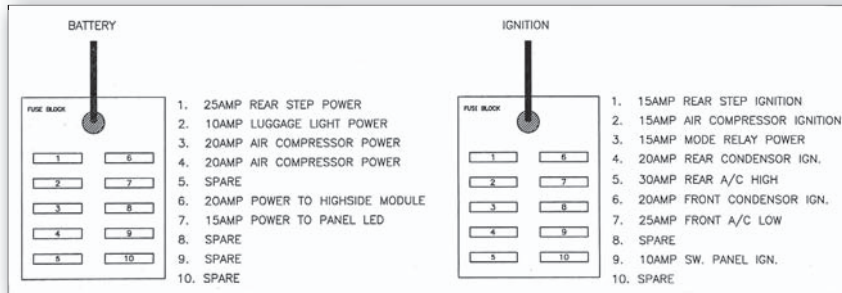

Battery & Ignition Fuse Legend

Krystal Enterprises

RETURN TO MENU

E-450 Shuttle Bus-Wiring Diagram

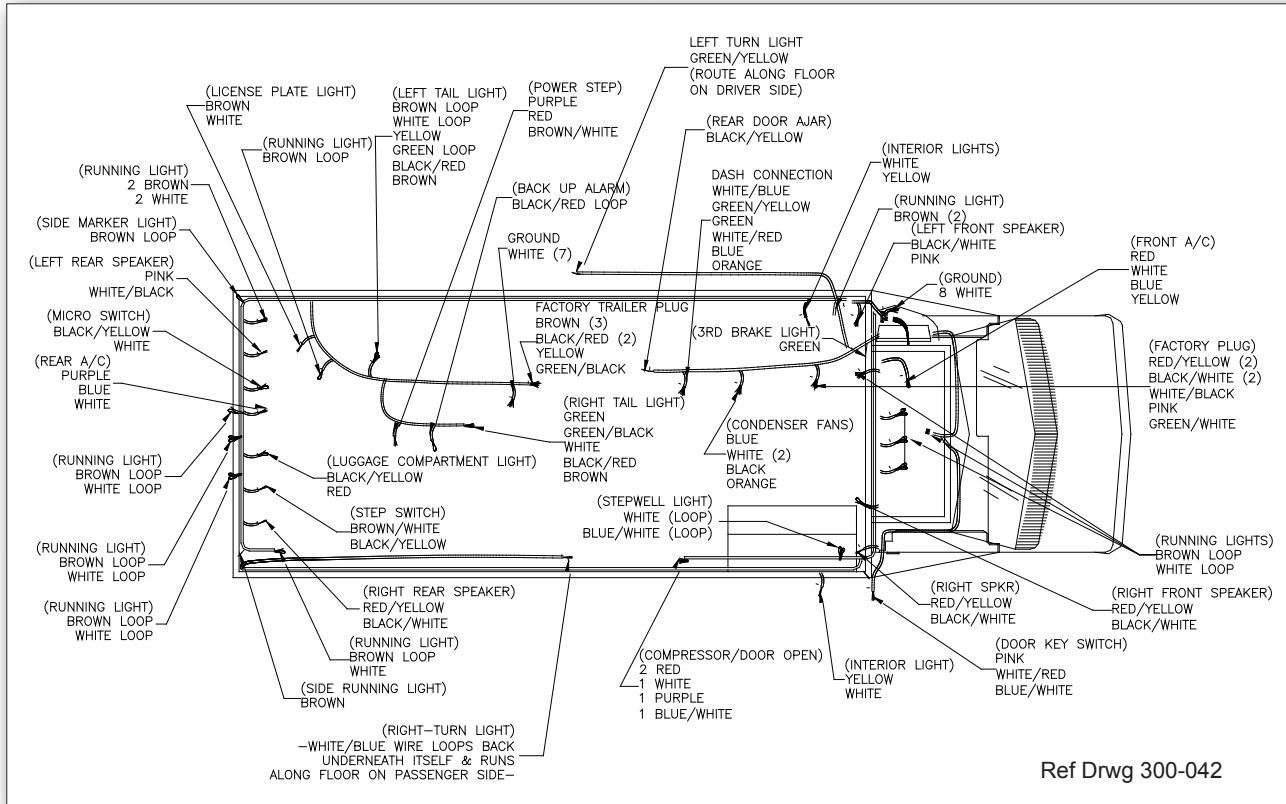

Ref Drwg 300-042

Krystal Enterprises

[RETURN TO MENU](#)

E-450 Shuttle Bus - Drivers Side Wiring Diagram

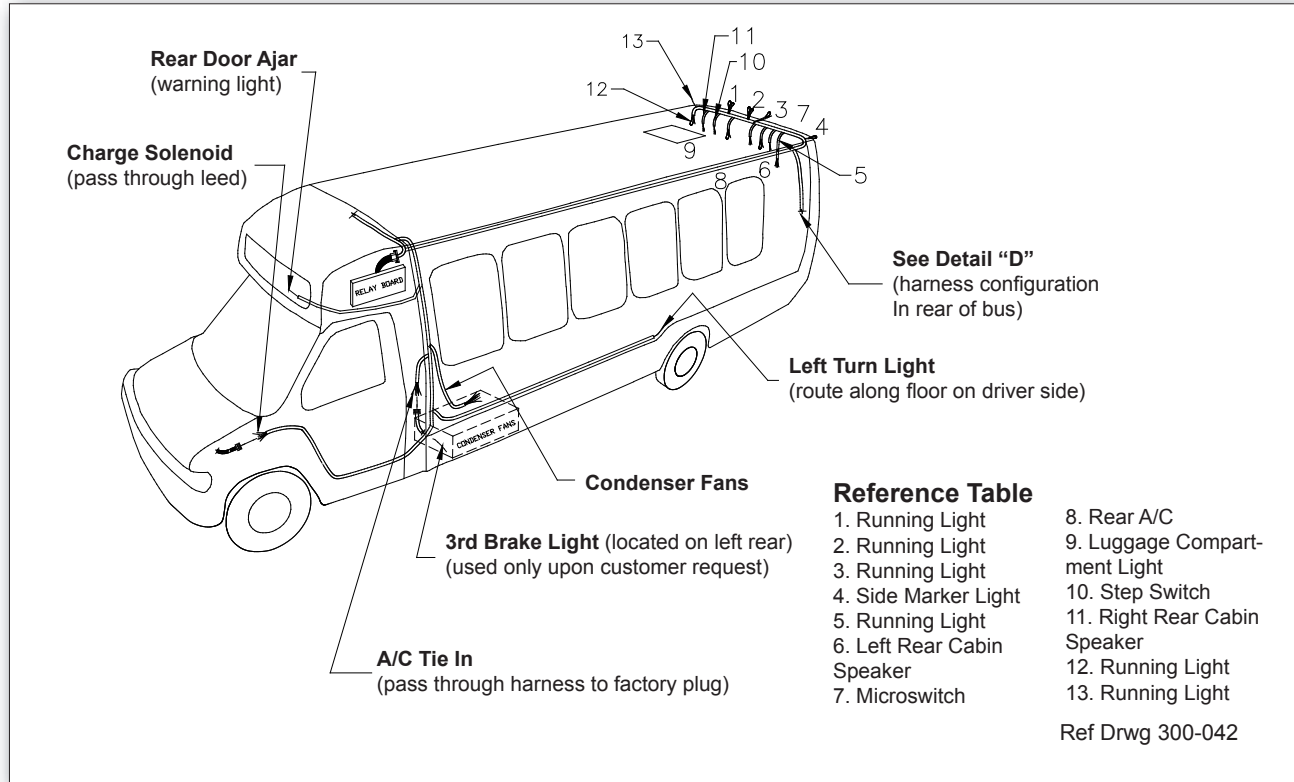

E-450 Shuttle Bus - Rear Wiring Diagram

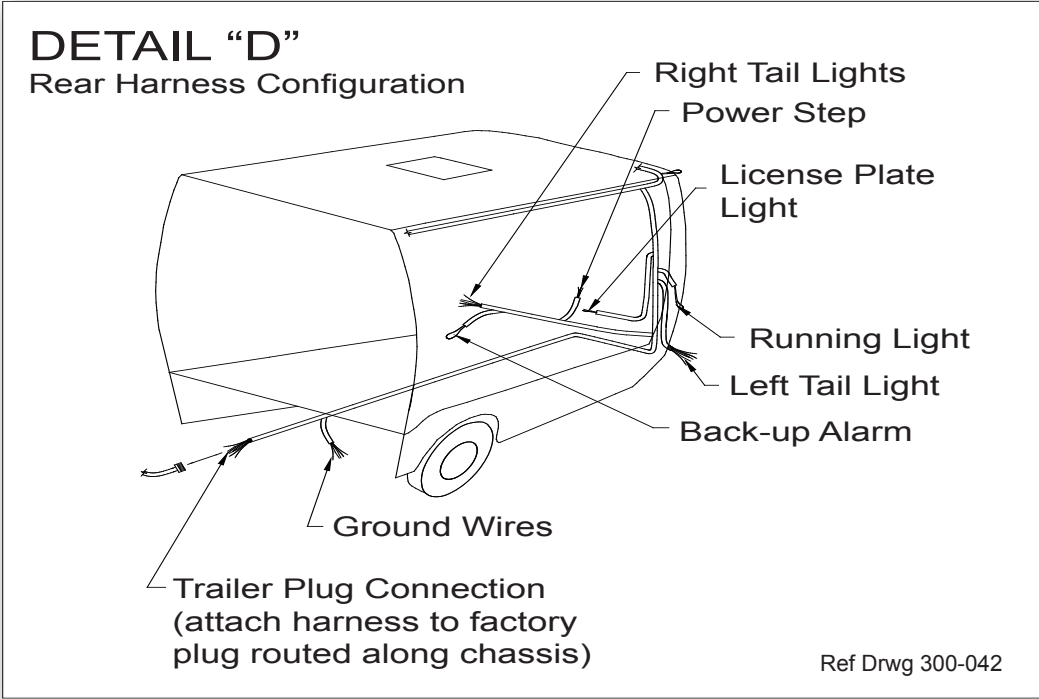

THIS PAGE IS INTENTIONALLY BLANK

F-550 Circuit Board Assembly Ver. 1

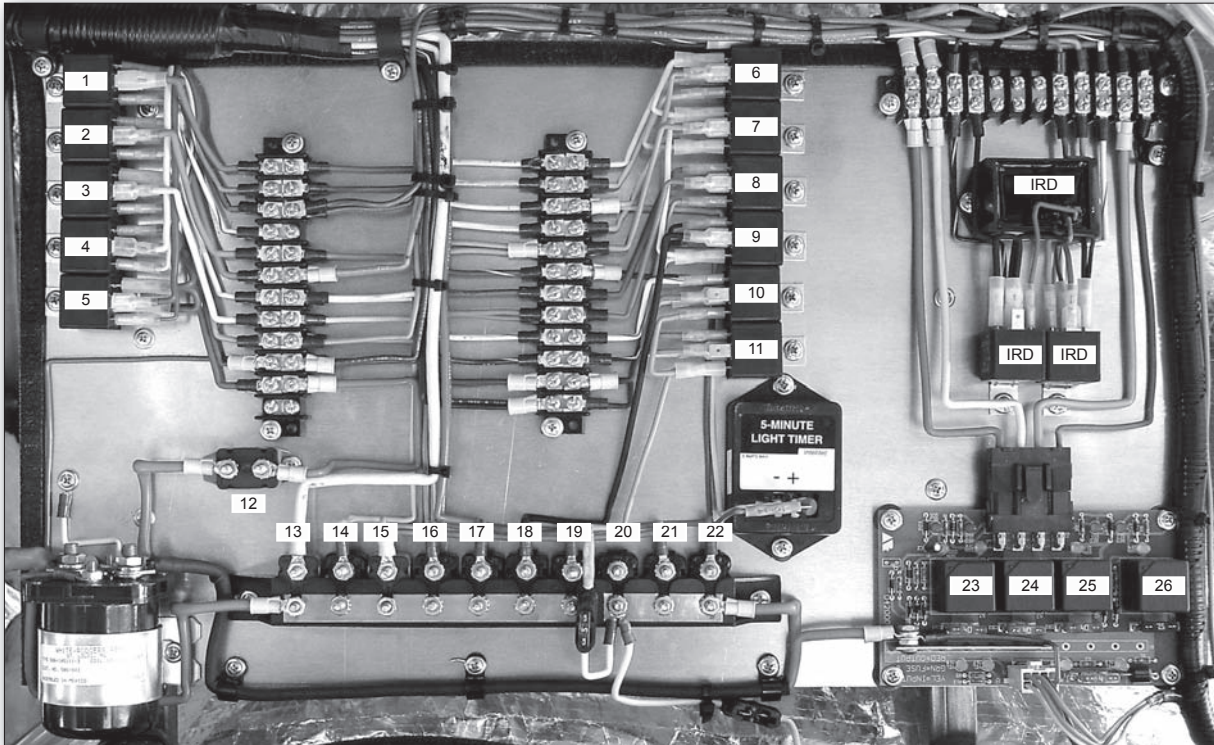

F-550 circuit board located above driver

Krystal Enterprises

F-550 Circuit Board Ver 1 - Electrical Diagram

- | | |
|---|--|
| ① | HEATER VALVE RELAY |
| ② | READING LAMP RELAY (PARCEL RACK BUSES ONLY) |
| ③ | IGNITION CIRCUIT RELAY |
| ④ | FLOOR HEATER LOW SPEED RELAY (OPTIONAL) |
| ⑤ | FLOOR HEATER HIGH SPEED RELAY (OPTIONAL) |
| ⑥ | INTERIOR LIGHT RELAY (1) |
| ⑦ | INTERIOR LIGHT RELAY (2) |
| ⑧ | ENTRY DOOR OPEN RELAY |
| ⑨ | EXTERIOR LIGHT RELAY (CLEARANCE) |
| ⑩ | TRANSMISSION INTERLOCK RELAY (1) |
| ⑪ | TRANSMISSION INTERLOCK RELAY (2) |
| ⑫ | 40 AMP DOOR COMPRESSOR & SOLENOID BREAKER |
| ⑬ | 20 AMP FOR IGNITION CIRCUIT BREAKER |
| ⑭ | 40 AMP INTERIOR LIGHT CIRCUIT BREAKER |
| ⑮ | 20 AMP ENTRY DOOR SOLENOID & STEP LIGHT |
| ⑯ | 20 AMP REAR STEP CIRCUIT BREAKER |
| ⑰ | 20 AMP EXTERIOR LIGHT BREAKER (CLEARANCE LIGHTS) |
| ⑱ | 15 AMP LUGGAGE LIGHT CIRCUIT BREAKER |
| ⑲ | 15AMP SPARE OR PA SYSTEM (OPTION) |
| ⑳ | 20 AMP READING LIGHT CIRCUIT BREAKER |
| ㉑ | 15 AMP FLOOR HEATER VALVE OR HEAT PUMP BREAKER |
| ㉒ | FRONT A/C LOW SPEED RELAY \ 20 AMP FUSE |
| ㉓ | FRONT A/C HIGH SPEED RELAY \ 35 AMP FUSE |
| ㉔ | FRONT A/C CONDENSOR RELAY \ 35 AMP FUSE |
| ㉕ | FRONT A/C COMPRESSOR RELAY \ 7.5 AMP FUSE |

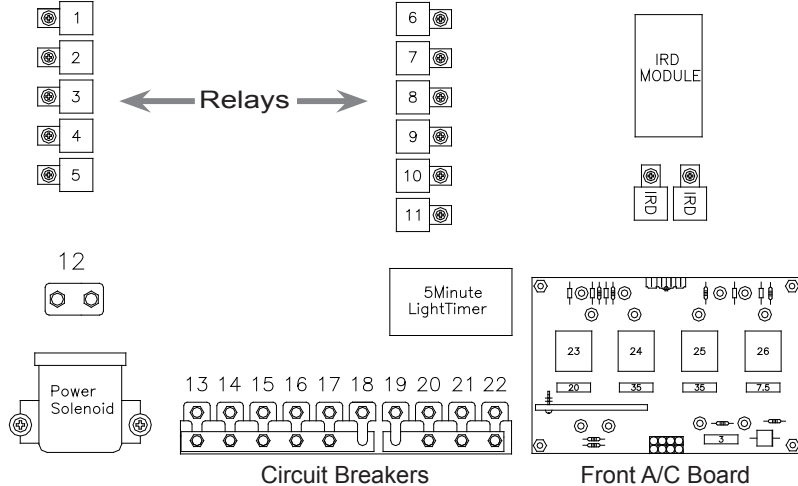

Krystal Enterprises

RETURN TO MENU

F-550 Circuit Board Assembly Ver. 2

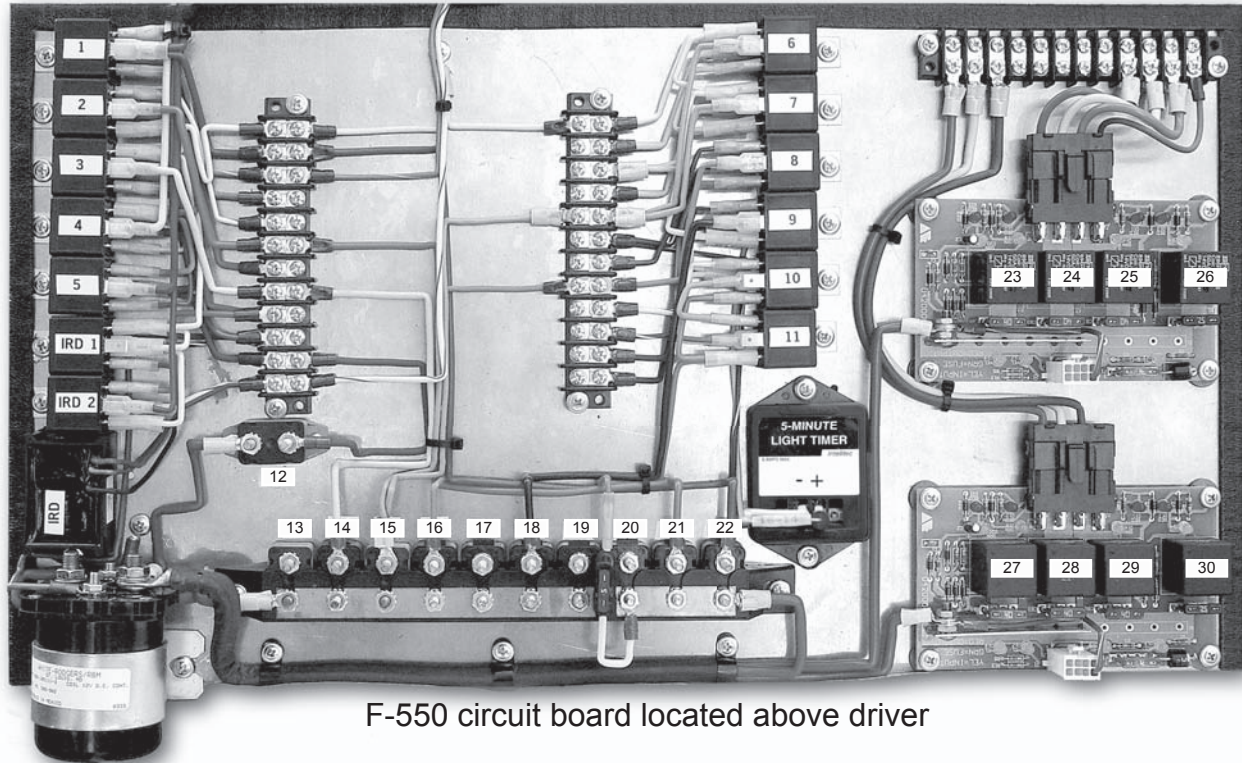

F-550 circuit board located above driver

Krystal Enterprises

F-550 Circuit Board Ver 2 - Electrical Diagram

①	HEATER VALVE REALY
②	READING LAMP RELAY (PARCEL RACK BUSSES ONLY)
③	IGNITION CIRCUIT RELAY
④	FLOOR HEATER LOW SPEED RELAY (OPTIONAL)
⑤	FLOOR HEATER HIGH SPEED RELAY (OPTIONAL)
⑥	INTERIOR LIGHT RELAY (1)
⑦	INTERIOR LIGHT RELAY (2)
⑧	ENTRY DOOR OPEN RELAY
⑨	EXTERIOR LIGHT RELAY (CLEARANCE)
⑩	TRANSMISSION INTERLOCK RELAY (1)
⑪	TRANSMISSION INTERLOCK RELAY (2)
⑫	30 AMP FLOOR HEATER RELAY POWER (OPTIONAL)
⑬	40 AMP AIR DOOR COMPRESSOR & SOLENOID
⑭	20 AMP FOR IGNITION CIRCUIT BREAKER
⑮	40 AMP INTERIOR LIGHT CIRCUIT BREAKER
⑯	20 AMP ENTRY DOOR SOLENOID & STEP LIGHT
⑰	20 AMP REAR STEP CIRCUIT BREAKER
⑱	20 AMP EXTERIOR LIGHT BREAKER (CLEARANCE LIGHTS)
⑲	15 AMP LUGGAGE LIGHT CIRCUIT BREAKER
⑳	15AMP SPARE OR PA SYSTEM (OPTION)
㉑	20 AMP READING LIGHT CIRCUIT BREAKER
㉒	15 AMP FLOOR (HEATER VALVE OR HEAT PUMP)
㉓	FRONT A/C LOW SPEED RELAY \ 20 AMP FUSE
㉔	FRONT A/C HIGH SPEED RELAY \ 35 AMP FUSE
㉕	FRONT A/C CONDENSOR RELAY \ 35 AMP FUSE
㉖	FRONT A/C COMPRESSOR RELAY \ 7.5 AMP FUSE
㉗	REAR A/C LOW SPEED RELAY \ 20 AMP FUSE
㉘	REAR A/C HIGH SPEED RELAY \ 35 AMP FUSE
㉙	REAR A/C CONDENSOR RELAY \ 35 AMP FUSE
㉚	REAR A/C COMPRESSOR RELAY \ 7.5 AMP FUSE

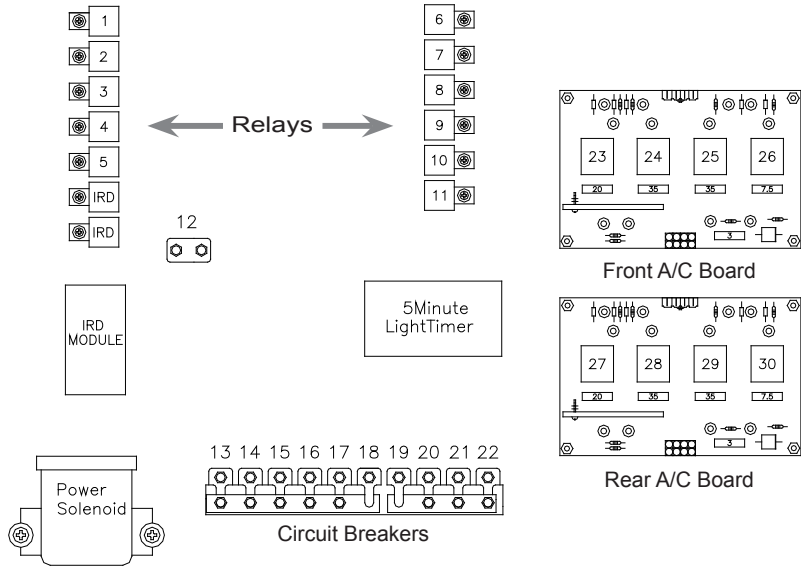

Krystal Enterprises

RETURN TO MENU

E-450 & F-550 Modular Circuit Board Assembly Ver. 3

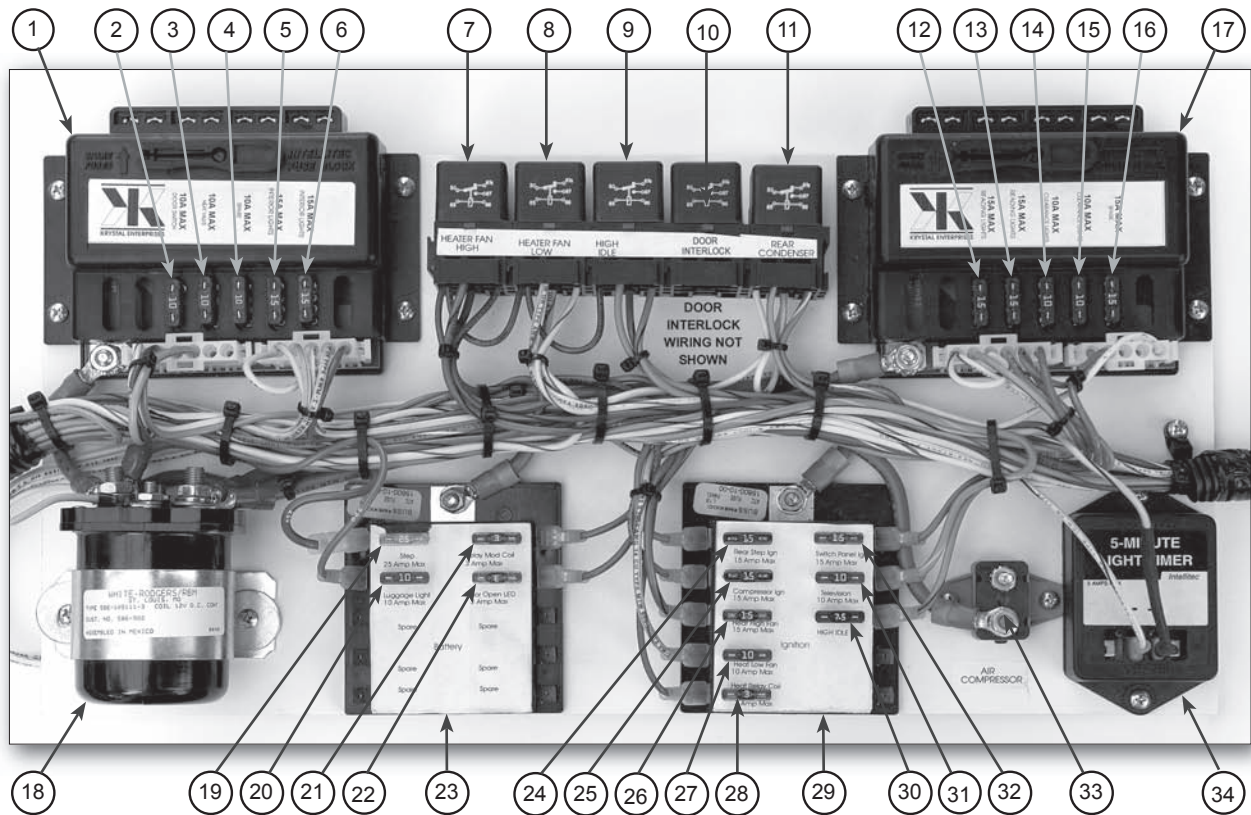

Krystal Enterprises

[RETURN TO MENU](#)

E-450 & F-550 Modular Circuit Board Assembly Ver. 3 Legend

1	Low Side Modular Switching Unit	18	Power Solenoid
2	Door - 10 amp fuse-max	19	Step- 25 amp fuse-max, 12 ga Red #260
3	Heat Valve - 15 amp fuse-max	20	Luggage Light- 10 amp fuse-max, 16 ga Red #320
4	Spare - 10 amp fuse-max	21	To High Side Module- 3 amp fuse-max, 16 ga Red
5	Interior Lights - 15 amp fuse-max	22	To Panel LED- 3 amp fuse-max, 18 ga Red/Wht
6	Interior Lights - 15 amp fuse-max	23	Battery Fuse Block Module
7	Heater Fan Relay-HIGH	24	Rear Step IGN-15 amp fuse-max, 16 ga Purple #280
8	Heater Fan Relay-LOW	25	Air Comp. IGN-15 amp fuse-max, 16 ga Purple #280
9	High Idle Relay	26	Heater Fan-HIGH, 15 amp fuse-max, 14 ga Red/Blk
10	Door Interlock Relay	27	Heater Fan-LOW, 10 amp fuse-max, 14 ga Yell/Red
11	Rear Condenser Relay	28	Heater Relay Coil, 3 amp fuse-max, 18 ga Red
12	Reading Lights- 15 amp fuse-max	29	Ignition Fuse Block Module
13	Reading Lights- 15 amp fuse-max	30	High Idle- 7.5 amp fuse-max, 14 ga Org/Blk
14	Clearance Lights- 10 amp fuse-max	31	Television- 10 amp fuse-max, 14 ga Org/Yell
15	Clearance Lights- 10 amp fuse-max	32	Switch Panel IGN- 15 amp fuse-max, 16 ga Purple #280
16	Spare- 15 amp fuse-max	33	Air Compressor Circuit Breaker
17	High Side Modular Switching Unit	34	Five (5) Minute Light Timer

See detailed diagrams of items 1 & 17
(Low/High Side Switching Modules) on pages 102-103

Krystal Enterprises

[RETURN TO MENU](#)

E-450 & F-550 LOW SIDE RELAY SWITCHING MODULE Ver. 3

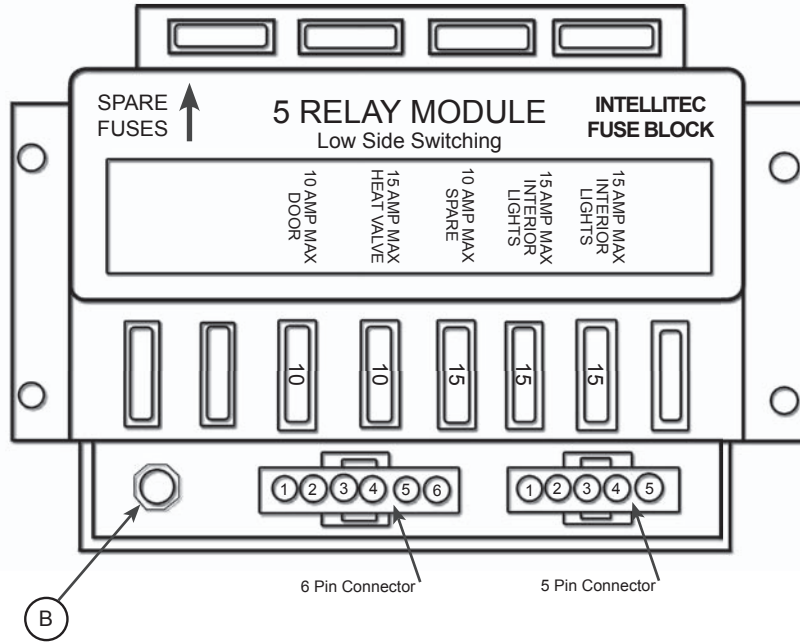

PIN	<u>6 PIN CONNECTOR</u>
1	Door Switch- 18 Ga Wht (to 5 min timer 18 ga Wht/Blk)
2	To Door- 16 Ga Blu/Wht #420C
3	Heat Valve Trigger- 18 Ga Grn/Blk
4	Heat Valve- 14 Ga Grn #400
5	Coil #3- Not Used
6	Output #3- Not Used
PIN	<u>5 PIN CONNECTOR</u>
1	To Interior Light Switch- 18 Ga Yel (to 5 min. timer+side- 18 Ga Yel/Blk with Diode)
2	Interior Lights- 14 Ga Yel- #350#B
3	To Interior Light Switch- 18 Ga Yel
4	Interior Lights- 14 Ga Yel- - #350#A
5	Coil Common- 16 Ga Red- Battery- To Pin #1 On Fuse Block
B	To Battery- 8 Ga Red

E-450 & F-550 HIGH SIDE RELAY SWITCHING MODULE Ver. 3

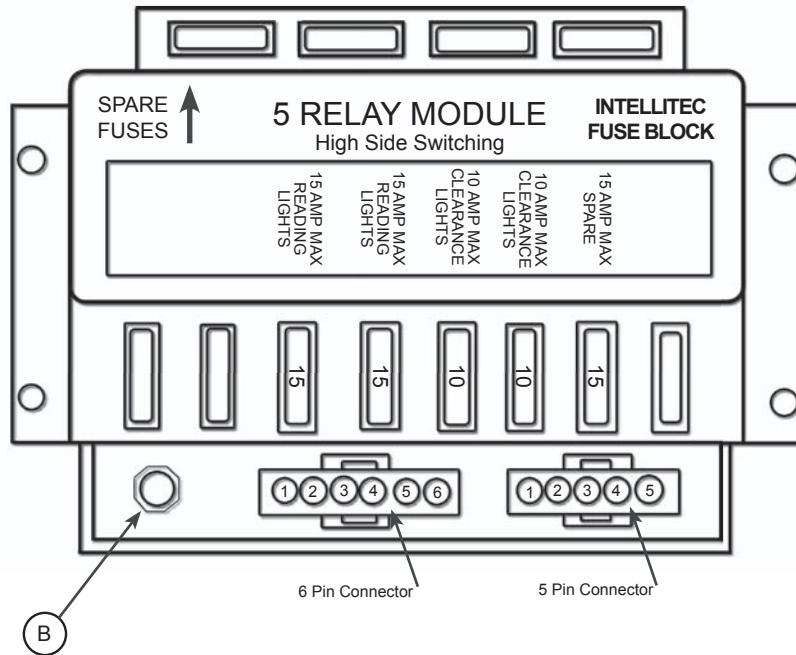

PIN	6 PIN CONNECTOR
1	From Reading Light- 18 Ga Wht/Pupl
2	To Reading Lights #D- 16 Ga Org #700
3	Jumper from Pin#1- 18 Ga Wht/Pupl
4	To Reading Lights #E- 14 Ga Org #700
5	Clearance Lights #F- 16 Ga Brn/Wht #230
6	Clearance Lights #G- 14 ga Brn #230
PIN	5 PIN CONNECTOR
1	Clearance Lights-Jumper-16 Ga Brn/Wht #230
2	Clearance Lights #H- 14 Ga Brn #230
3	Not Used
4	Not Used
5	Coil Common- 16 Ga Wht
B	To Battery- 8 Ga Red

E-450 & F-550 Front & Rear A/C Module

As used on 2004 & later models

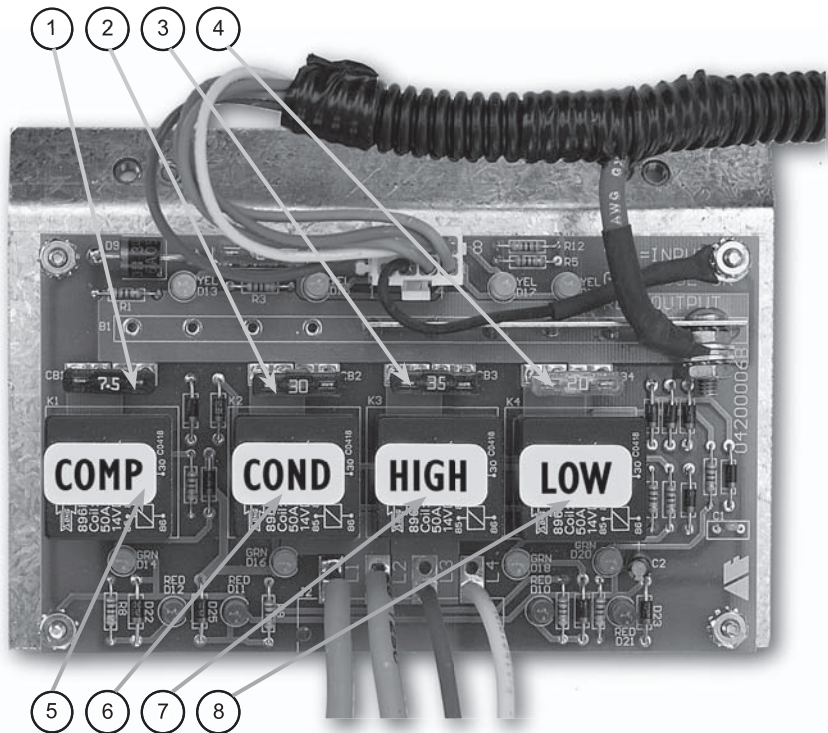

ITEM NO	DESCRIPTION	COMMENT
1	7.5 amp Compressor Fuse	
2	30 amp Condenser Fuse	
3	35 amp High Side Fuse	
4	20 amp Low Side Fuse	
5	Compressor Relay	
6	Condenser Relay	
7	High Side Relay	
8	Low Side Relay	

These modules are used to control all A/C functions for the front and rear A/C units. Each A/C unit requires one (1) module each. These modules are mounted in the header above the driver, behind the driver's control panel.

Krystal Enterprises

Front/Rear A/C Module Wiring Diagram

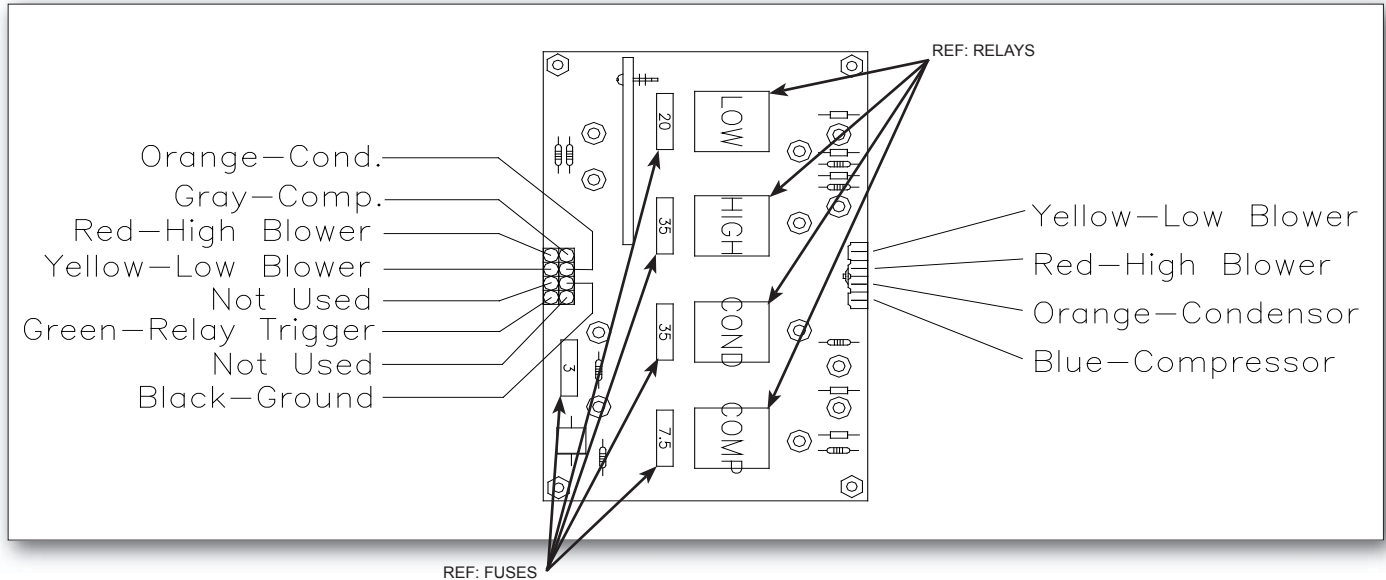

Detail of A/C Module wiring as shown in photos on pg. 104

E-450 & F-550 RELAY BUSS VER D

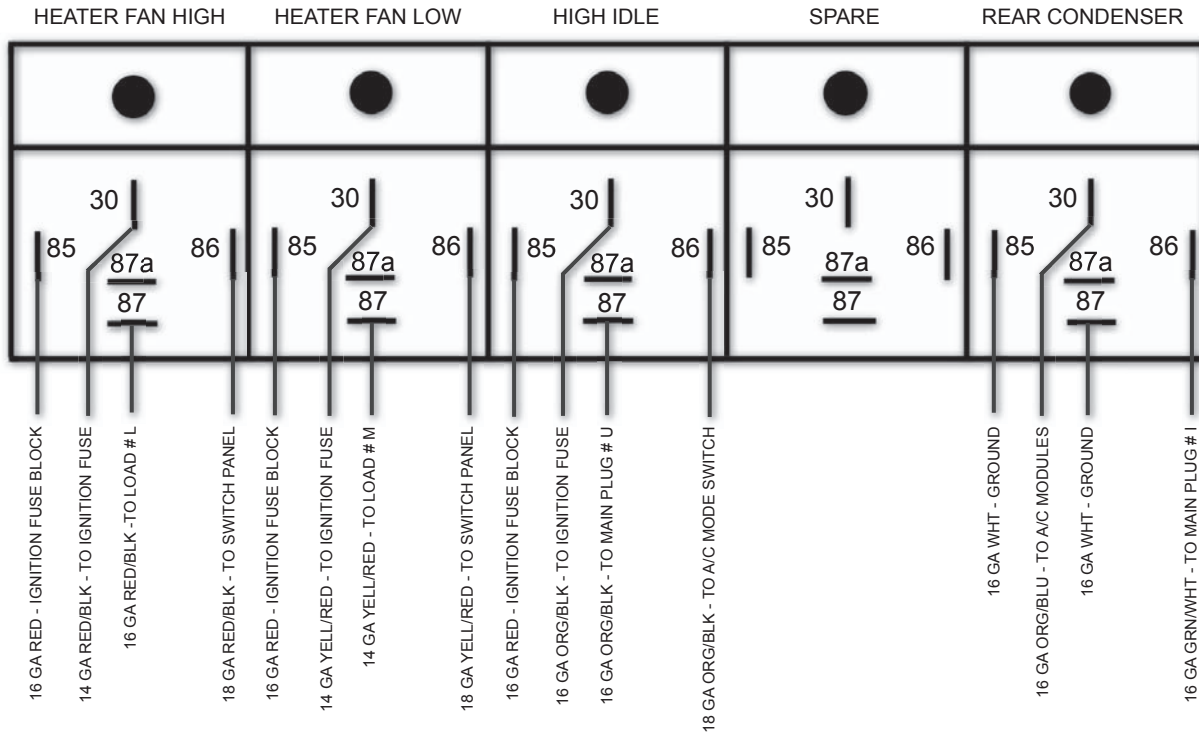

Krystal Enterprises

Air and Electrical Diagrams & Schematics

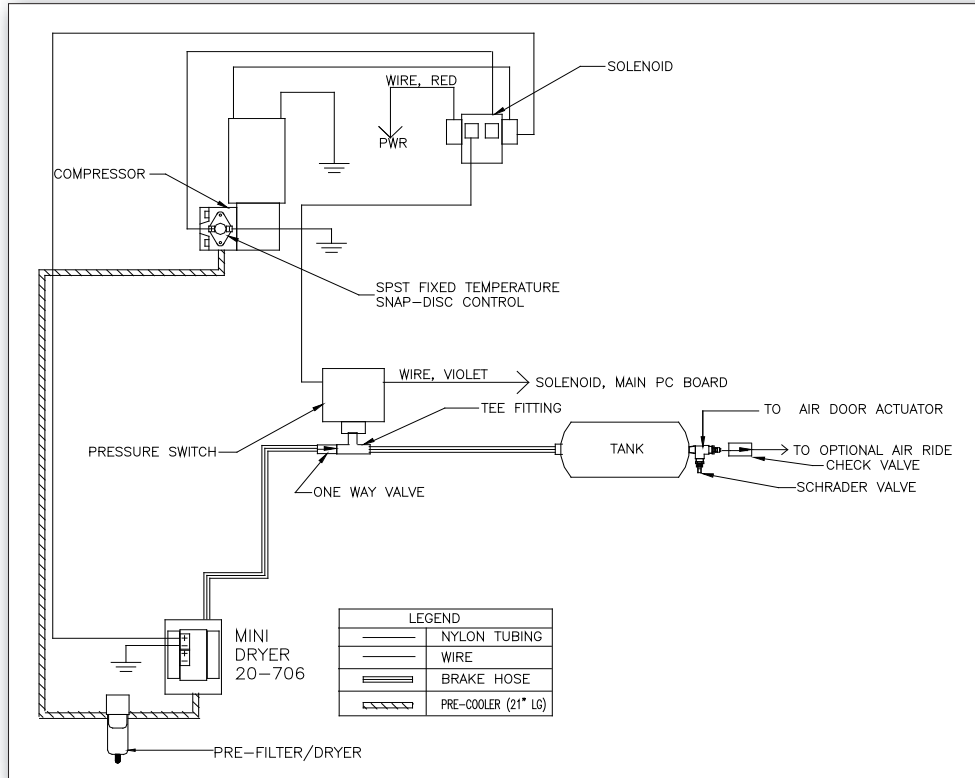

Double Plug Air Door Schematic (ref. pg 49)

Air and Electrical Diagrams & Schematics

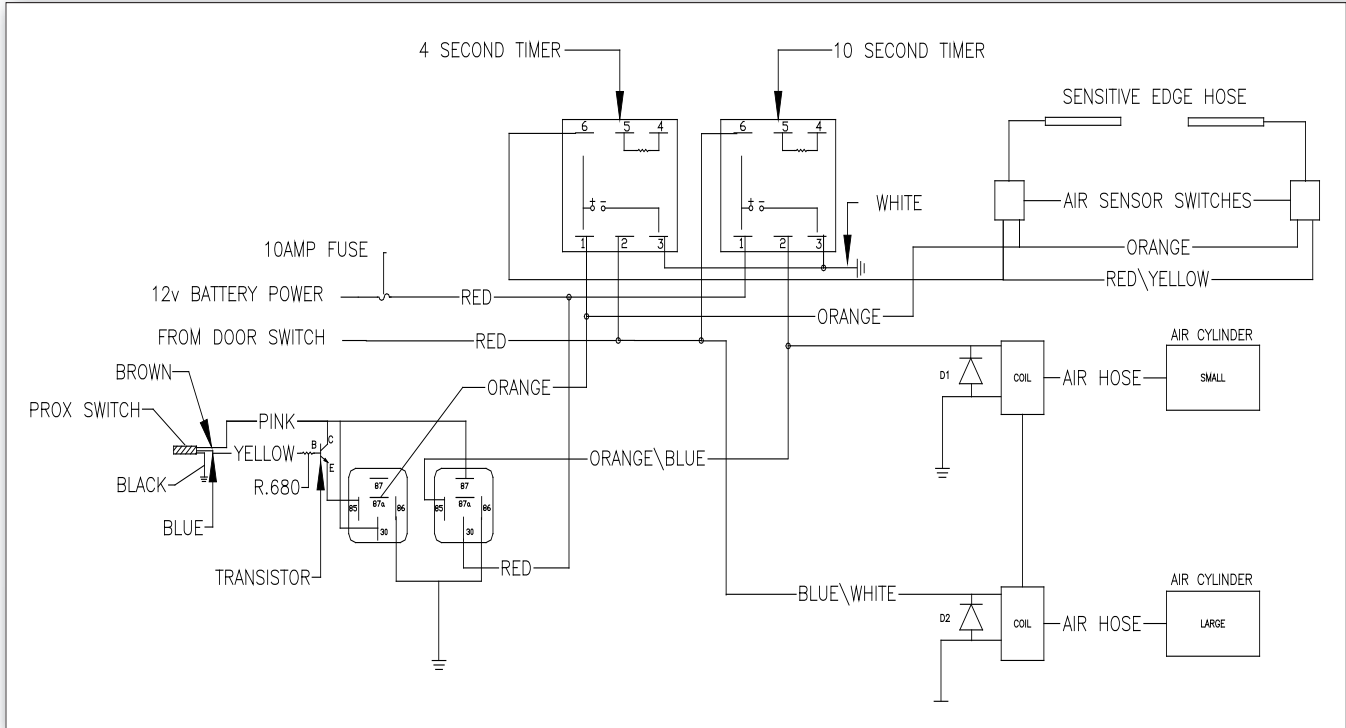

Electrical Schematic for Doors with Sensitive Edge (ref. pg. 57)

Air and Electrical Diagrams & Schematics

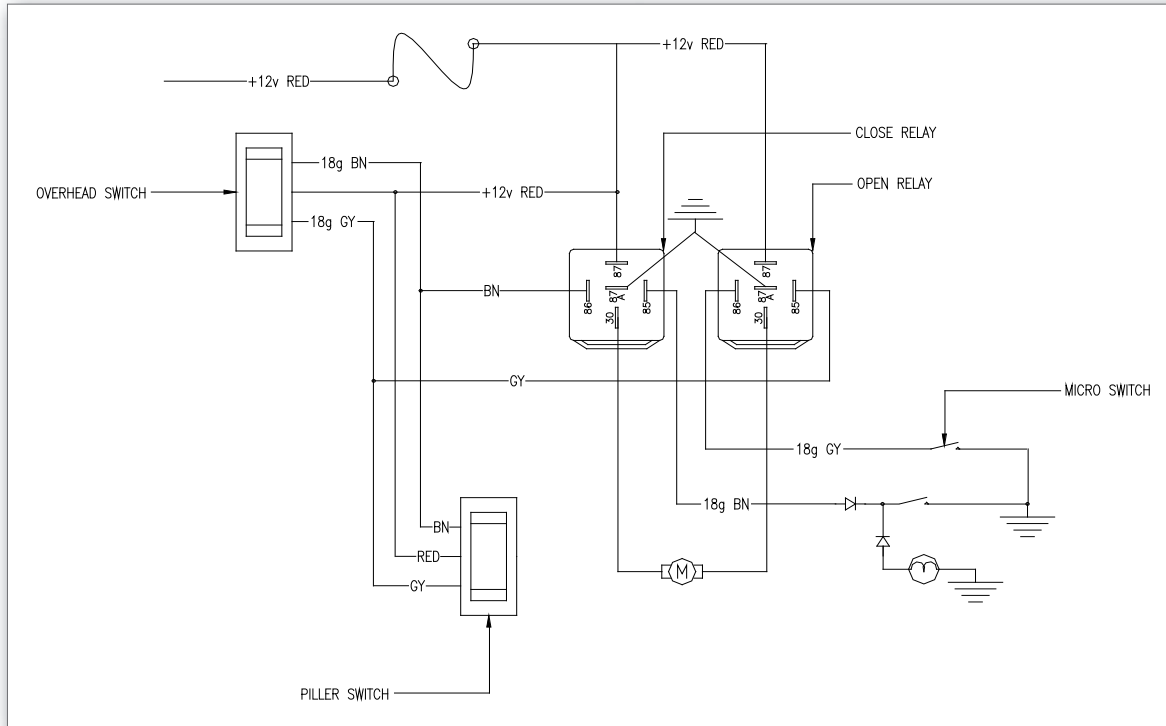

E-450 Electrical Schematic for Swing Doors System (ref. pg. 51)

Air and Electrical Diagrams & Schematics

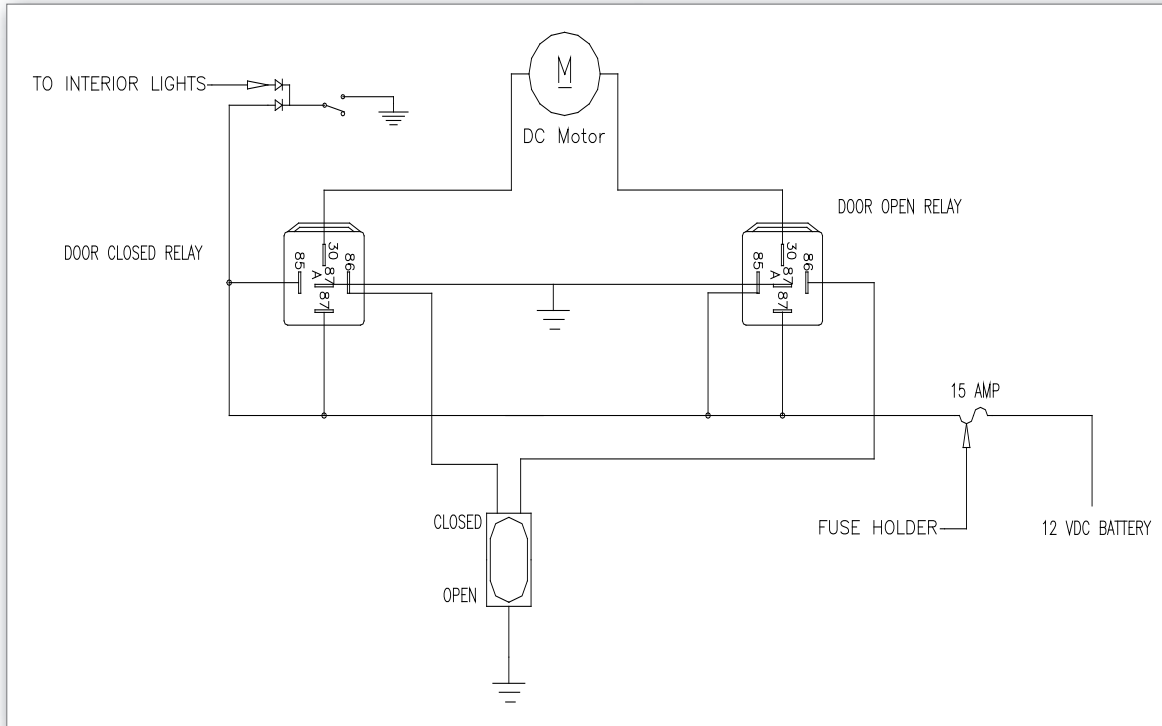

F-550 Electrical Schematic for Swing Door System (ref. pg 51)

PARTS - SERVICE - WARRANTY

OBTAINING PARTS

When parts are required for a warranty repair, all parts will be handled by the KRYSTAL Service Department.

All other Non-Warranty parts needs can be handled by contacting the KRYSTAL PARTS DEPARTMENT, directly at 1-800-845-4883. You may purchase parts directly over the counter, or have them shipped to you, usually within 24 hours. In order to expedite your parts order, please have your KRYSTAL ENTERPRISES serial number, which starts with K-#####, and is located on the drivers door jamb of all our vehicles.

UNDERSTANDING WARRANTY POLICY *(read the following sections carefully)*

Should your bus require service related to the converted areas of the vehicle, ***read this section first, before taking any action.*** By doing so, you will clearly understand the KRYSTAL SERVICE PROCESS, and avoid possible delays. NEVER initiate a warranty repair without prior approval of the KRYSTAL SERVICE DEPARTMENT. Not following this procedure could void your warranty reimbursement for that particular repair.

PARTS - SERVICE - WARRANTY

WHO SHOULD PERFORM WARRANTY SERVICE ON YOUR VEHICLE

If there is any doubt as to whether or not a repair is related to the KRYSTAL WARRANTY, call the KRYSTAL SERVICE DEPARTMENT at 1-800-845-4883, this may save you time wasted at a chassis dealer or another shop, for a problem appropriately solved by contacting KRYSTAL SERVICE DEPARTMENT.

If the problem is conversion related, then it can either be repaired at our Brea, California facility, or by a shop that we recommend in your area, or by a shop of your choice. This procedure is true of both warranty and non-warranty repairs. Depending on the nature of the problem, it may be necessary to have the warranty repair done at our Brea, California facility.

CAUTION ABOUT TOWING!

If it becomes necessary to tow your bus, a flat bed rig is preferred. UNDER NO CIRCUMSTANCES, should the bus be towed by lifting the rear end, serious frame damage can occur.

PARTS - SERVICE - WARRANTY

WARRANTY VERSUS NON-WARRANTY

Whether a particular problem is covered under the KRYSTAL WARRANTY depends, in some cases, on several factors. The KRYSTAL SERVICE DEPARTMENT, determines coverages ahead of time on a case-by-case basis, either over the phone or at our Brea, California facility.

HAVING NON-WARRANTY REPAIRS PERFORMED

If the service manager has determined that the repair is not covered, or you are sure that it is not covered, we would be happy to recommend a shop in your area, or schedule an appointment with the KRYSTAL SERVICE DEPARTMENT, whichever is more convenient.

HAVING WARRANTY REPAIRS PERFORMED

There are three (3) methods:

1. Repair is done at the KRYSTAL SERVICE DEPARTMENT, in Brea, California
2. Repair is done at a KRYSTAL authorized service facility near you.
3. Repair is done at a shop of your choice, with prior approval of the KRYSTAL SERVICE DEPARTMENT

PARTS - SERVICE - WARRANTY

HAVING WARRANTY REPAIRS PERFORMED (con't)

If either method 2 or 3 as described on the previous page are to be used, you must obtain pre-authorization and a KRYSTAL ENTERPRISES SERVICE DEPARTMENT repair authorization number (R.A.N), in advance of performing any repairs. Both requirements may be accomplished from a single phone call to the KRYSTAL SERVICE DEPARTMENT, at 1-800-845-4883.

If method 3 is used, simply pay for the work and mail a copy of the invoice with the repair authorization number, and your KRYSTAL vehicle ID number, which is found on the vehicle ID tag on the drivers door jamb) on the invoice, so your claim(s) can be processed without any problems. You will be reimbursed within 30 days.

Send all invoices to the service manager at:

KRYSTAL ENTERPRISES
Attn: Service Department Manager
2701 East Imperial Highway
Brea, California 92821

Krystal Enterprises

RETURN TO MENU

Vendor Reference Listing

Vendor	Warranty Period
AUTOMOTIVE CLIMATE CONTROL A/C 1-800-462-6322	2 Years, Unlimited Miles
AUDIOVOX TV & VCP 1-800-274-1886	1 Year, Unlimited Miles
CARRIER A/C 1-800-673-2431	2 Years, Unlimited Miles
FIRESTONE TIRES 1-800-356-4644	1 Year Replacement, No Charge
FORD HOTLINE 1-800-343-5338	3 Years, 36,000 Miles Bumper to Bumper 3 Years, 100,000 Miles on Diesel Engine
FORD ROADSIDE ASSISTANCE 1-800-241-3673 (24 HOUR HOTLINE)	See FORD Manual
FREEDMAN SEATING 1-713-929-6100	2 Years or 20,000 Miles, Whichever Comes First
PHOENIX USA 1-931-561-6128	3 Years
KRYSTAL SERVICE DEPT 1-800-579-7825	See Copy of Krystal Warranty
KWIKEE ELECTRIC STEPS 1-800-736-7366	1 Year or 12,000 Miles, Whichever Comes First
MICHELIN TIRES 1-800-847-8475	1 Year Replacement, No Charge
PENNTEx ALTERNATORS 1-800-590-2818	18 Months, or 75,000 Miles, Whichever Comes First
ROSEN 1-866-467-6736	1 Year, Unlimited Miles
PANASONIC 1-949-251-1851	1 Year, Unlimited Miles
SHURFLOW WATER PUMPS 1-800-854-3218	2 Years, Unlimited Miles
SONY STEREO 1-800-282-2848	1 Year, Unlimited Miles

Vendor Reference Listing

Vendor

Warranty Period

Vendor	Warranty Period
TRANSPEC WORLDWIDE 1-810-274-9400	1 Year, Unlimited Miles
VELVAC MIRRORS 1-800-783-8871	1 Year, Unlimited Miles
VOYAGER PA SYSTEM 1-800-274-1886	1 Year, Unlimited Miles
INTERMOTIVE VEHICLE CONTROLS 1-530-823-2332	2 Years or 24,000 Miles

INDEX

A

A/C Module-Frt & Rear 2004 104
Accessory Switches 21
Air and Electrical Diagrams & Schematics 108
Air Conditioning 37
Air Conditioning Charging Chart 67
Air Door Lock Pin 16
Air Schematic, Single & Double Plug Doors 47, 49
Audio/Video. PA Control 23

B

Back-Up Camera 31
Battery Location 28
Body Materials & Construction Measurements 66
Braun Rear Door Wheelchair Lift 52

C

Cargo Door Micro Switch 33
Caution!, Safety Alerts 10, 14, 16, 17, 46
Charge Protection 24, 25, 26, 27
Circuit Board Assembly, E-450 90
Circuit Board Assembly, F-550 Ver 1 & 2 96, 98

INDEX

Circuit Board Assembly Ver. 3 100

Compressed Air Supply & Schematic, single & double plug door 45, 47, 49

Construction Materials & Measurements 66

D

Dimensional Specifications, Body & Chassis 64

Double Plug Door System 48, 49

E

E-450 & F-550 Modular Circuit Board Assembly Ver. 3 100

E-450 Circuit Board Assembly 90

E-450 Shuttle Bus-Wiring Diagram 92

E-450 Shuttle Bus - Drivers Side Wiring Diagram 93

E-450 Shuttle Bus - Rear Wiring Diagram 94

Electrical Diagram, E-450, circuit board, relays, breakers 91

Electrical Diagrams & Schematics, misc, enlargements 107 - 111

Electrical Schematic, sensitive edge, swing door 49, 108, 109

Emergency Egress Window 18

Emergency Release Lever 11, 13

Emergency Release Valve 8, 11, 12, 48

Emergency Roof Hatch 19

INDEX

F

- F-550 Circuit Board Assembly Ver. 1 96
- F-550 Circuit Board Assembly Ver. 2 989
- F-550 Circuit Board Ver 1 - Electrical Diagram 97
- F-550 Circuit Board Ver 2 - Electrical Diagram 99
- F-550 Shuttle Bus -Wiring Diagram 107
- Foldaway Seating 34

G

- GENERAL VEHICLE SAFETY WARNINGS 10

H

- Heated Mirror Switch 29
- High Idle Controller 24, 25, 26
- Hour Meter 21

I

- Identification Label, Vehicle Manufacturers 68
- Idle Controller 24, 25, 26

L

- LCD Monitor, ref back-up camera 31
- Low Air warning light 21
- Low Battery Light 21

INDEX

M

Micro Switch 33

Mirror Control Switch 29

Mirror Switch 29

Movable Wall 40, 42

O

Obstruction Sensing System, Sensitive Edge 11

Occupant Restraint Systems, ADA 14

Overhead Control Panel 20, 22

Overhead Parcel Rack 17

P

PARTS 112, 113, 114, 115

Passenger Seating 35

PA Control, Audio/Video 23

Pre-Trip Inspection 8

PREVENTATIVE MAINTENANCE SCHEDULE 70

Processing Warranty Claims 114, 115

R

Rear Step 32

Ricon Rear Door Wheelchair Lift 54

INDEX

Ridewell Air Suspension Chart 69

S

Safety Check List, Vapor Air & Elect Door 11

Seating, Std. Passenger & Foldaway 34, 35

SERVICE, Warranty 112, 113, 114, 115, 116

Single Plug Door System 46, 47

Specification for E450, Std Chassis 58, 59

Specification for F550, Std Chassis 61, 62

Standard Equipment on E450 60

Standard Equipment on F550 63

Suspension Chart, Ridewell Airride 69

Swing Door System 50

Switches - mirror, micro, pressure, door, step 22, 29, 33, 45, 46, 48

T

TOWING 113

Troubleshooting Guide 86

V

Vapor Air & Electric Door Safety Alerts 11

VEHICLE SAFETY WARNINGS 10

Vendor Reference Listing 116

INDEX

Video Entertainment Center 30

W

WARNING DEVICE 22

Warning Lights, low air, low battery, door open 21

WARRANTY 112, 113, 114, 115

WARRANTY POLICY 112

WARRANTY REPAIRS 114, 115

WARRANTY SERVICE 113

Wheelchair Lift, Braun & Ricon 52, 53, 54, 55, 56, 57

Wheelchair Securement, ADA 14, 15

Wheel Liners, Stainless Steel 36

Wiring Diagram, E-450 92, 93, 94

Wiring Diagram, F-550 107



KRYSTAL ENTERPRISES LIMITED WARRANTY

Krystal Enterprises (hereinafter referred to as Krystal Enterprises and Krystal) is the final stage manufacturer of an incomplete vehicle, which is manufactured and separately warranted by the incomplete vehicle manufacturer. This limited Warranty thus does not extend to any part or portion of the incomplete vehicle except as specifically required by any applicable Federal law or regulation.

Krystal Enterprises warrants to the original purchaser of each new Krystal Enterprises bus, that all parts (except electronic parts which are warranted by their original manufacturer) installed by Krystal will be free from defects in material and workmanship under normal use and service for one (1) year, with unlimited mileage, from the date of purchase by the original retail customer.

Krystal Enterprises further warrants to the original purchaser of each new Krystal Enterprises bus, the body structure which is defined as the cage, skin, front and rear caps, and floor structure to be free from defects, in material and workmanship under normal use and service for five (5) years or 100,000 miles, whichever comes first, from the date of purchase by the original retail customer.

In the event of a Warranty claim, Krystal reserves the right to replace or repair the defective part. The original retail customer must return the bus to the original selling Authorized Dealer for the necessary authorization and parts. **THE DEALER MUST OBTAIN, PRIOR TO PERFORMING ANY WORK, A REPAIR AUTHORIZATION NUMBER (R.A.N) ON ANY KRISTAL ENTERPRISES BUS.** If the selling Dealer is unable to remedy the situation, the original retail customer should contact the Warranty Department of Krystal Enterprises. If the selling

Krystal Enterprises

[RETURN TO MENU](#)

KRYSTAL ENTERPRISES LIMITED WARRANTY



dealer does not perform repair work on premise, the Dealer must call the Krystal Warranty Department for instructions on proceeding with the repair via an authorized repair facility.

If the bus was not purchased from a Krystal Authorized Dealer, the original retail customer must contact the Krystal Warranty Department to receive information and prior authorization for any needed repair work.

Provided that prior authorization was obtained from the Warranty Department of Krystal Enterprises, all labor costs associated with the repair or replacement of defective parts will be paid by Krystal. Krystal reserves the right to make a physical inspection of the bus by authorized factory personnel following any complaint prior to any repair.

Krystal shall have no liability for any defect or damage caused by the original owner's use of parts or services which are not authorized by Krystal or for any parts or paint which have been subject to misuse, neglect or accident, or have been subject to external mechanical or chemical influences, especially stone chips, airborne rust or industrial fall-out. This Limited Warranty **DOES NOT** cover loss to time. Inconvenience, loss of use of any vehicle, cost of rented replacement vehicle, or lodging or mileage expense in connection with any warranty repairs.

NO PERSON IS AUTHORIZED TO ALTER OR CHANGE IN ANY WAY
THE TERMS AND CONDITIONS OF THE ABOVE STATED LIMITED WARRANTY

Krystal Enterprises

RETURN TO MENU



It is the policy of KRYSTAL ENTERPRISES, INC. to incorporate product improvements to our products whenever possible or practical to do so. We reserve the right to make changes and or improvements at any time without incurring any obligation to make such changes on previously sold products. Additionally, the information and specifications contained within this manual are current at time of printing. Subsequently all information contained in this manual is subject to change at any time, without notice.

Please note that this manual applies to all FORD models and explains standard equipment as well as many options, and may include equipment not presently installed on your vehicle.

KRYSTAL ENTERPRISES, INC.

Copyright © 2005
Rev-2

Krystal Enterprises