

## Contents

### Before driving

**Introduction** 2

**Instrumentation** 6

**Controls and features** 16

**Seating and safety restraints** 74

### Starting and driving

**Starting** 108

**Driving** 113

**Roadside emergencies** 130

### Servicing

**Maintenance and care** 148

**Capacities and specifications** 205

**Customer assistance** 212

**Reporting safety defects** 224

**Index** 225

All rights reserved. Reproduction by any means, electronic or mechanical including photocopying, recording or by any information storage and retrieval system or translation in whole or part is not permitted without written authorization from Ford Motor Company. Ford may change the contents without notice and without incurring obligation.

Copyright © 1999 Ford Motor Company

## Introduction

The following warning may be required by California law:

### **CALIFORNIA Proposition 65 Warning**



Engine exhaust, some of its constituents, and certain vehicle components contain or emit chemicals known to the State of California to cause cancer, or birth defects or other reproductive harm.

### **ICONS**

Indicates a safety alert. Read the following section on *Warnings*.



Indicates vehicle information related to recycling and other environmental concerns will follow.



Correct vehicle usage and the authorized disposal of waste cleaning and lubrication materials are significant steps towards protecting the environment.

Indicates a message regarding child safety restraints. Refer to *Seating and safety restraints* for more information.



Indicates that this Owner Guide contains information on this subject. Please refer to the Index to locate the appropriate section which will provide you more information.



### **WARNINGS**

Warnings provide information which may reduce the risk of personal injury and prevent possible damage to others, your vehicle and its equipment.

### **BREAKING-IN YOUR VEHICLE**

There are no particular breaking-in rules for your vehicle. During the first 1 600 km (1 000 miles) of driving, vary speeds frequently. This is necessary to give the moving parts a chance to break in.

### **INFORMATION ABOUT THIS GUIDE**

The information found in this guide was in effect at the time of printing. Ford may change the contents without notice and without incurring obligation.

## Introduction

These are some of the symbols you may see on your vehicle.

### Vehicle Symbol Glossary

Safety Alert		See Owner's Guide	
Fasten Safety Belt		Air Bag-Front	
Air Bag-Side		Child Seat	
Child Seat Installation Warning		Child Seat Tether Anchorage	
Brake System		Anti-Lock Brake System	
Brake Fluid - Non-Petroleum Based		Traction Control	
Master Lighting Switch		Hazard Warning Flasher	
Fog Lamps-Front		Fuse Compartment	
Fuel Pump Reset		Windshield Wash/Wipe	
Windshield Defrost/Demist		Rear Window Defrost/Demist	
Power Windows Front/Rear		Power Window Lockout	

## Vehicle Symbol Glossary

Child Safety Door Lock/Unlock		Interior Luggage Compartment Release Symbol	
Panic Alarm		Engine Oil	
Engine Coolant		Engine Coolant Temperature	
Do Not Open When Hot		Battery	
Avoid Smoking, Flames, or Sparks		Battery Acid	
Explosive Gas		Fan Warning	
Power Steering Fluid		Maintain Correct Fluid Level	
Emission System		Engine Air Filter	
Passenger Compartment Air Filter		Jack	

# Instrumentation

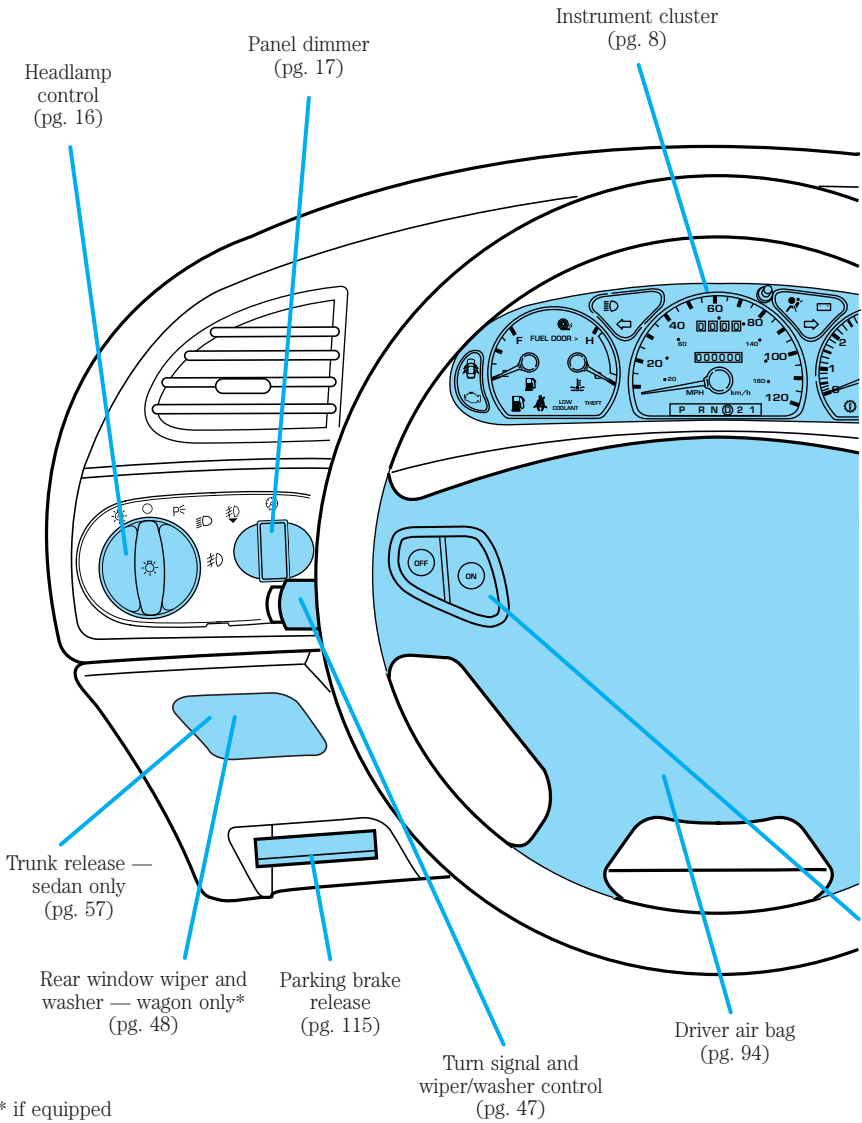

# Instrumentation

Electronic sound system  
(pg. 28)

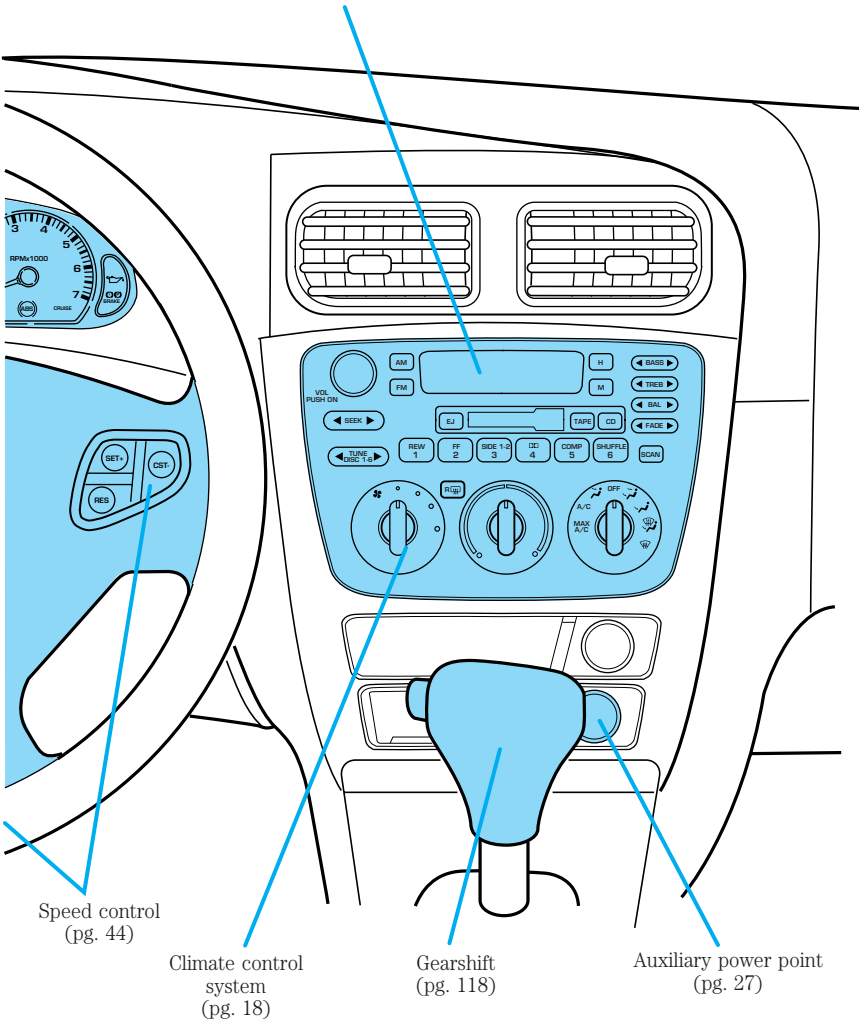

Speed control  
(pg. 44)

Climate control  
system  
(pg. 18)

Gearshift  
(pg. 118)

Auxiliary power point  
(pg. 27)

# Instrumentation

## WARNING LIGHTS AND CHIMES

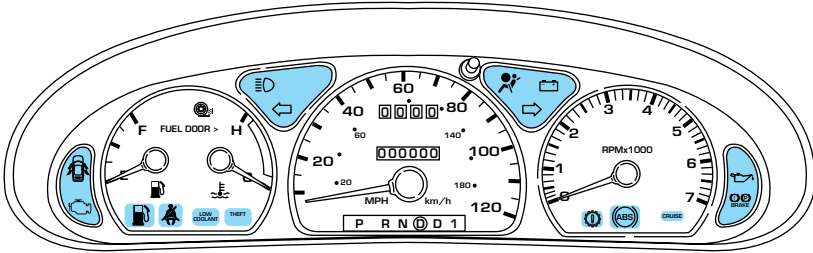

### Turn signal

Illuminates when the left or right turn signal or the hazard lights are turned on. If one or both of the indicators stay on continuously or flash faster, check for a burned-out turn signal bulb. Refer to *Exterior bulbs* in the *Maintenance and care* chapter.

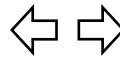

### High beams

Illuminates when the high beam headlamps are turned on.



### Traction Control™ active (if equipped)

Momentarily illuminates when the ignition is turned to ON. It also illuminates when the Traction Control™ system begins applying and releasing the brakes and



adjusting the engine characteristics to limit a wheelspin condition. It will be lit for the duration of the Traction Control™ event.

For more information, refer to the *Driving* chapter.



## Instrumentation

### Safety belt

Momentarily illuminates when the ignition is turned to the ON position to remind you to fasten your safety belts. For more information, refer to the *Seating and safety restraints* chapter.



### Door ajar

Illuminates when the ignition is in the ON or START position and any door is open.



### Service engine soon

Your vehicle is equipped with a computer that monitors the engine's emission control system. This system is commonly known as the On Board Diagnostics System (OBD II). The OBD II system protects the environment by ensuring that your vehicle continues to meet government emission standards. The OBD II system also assists the service technician in properly servicing your vehicle.

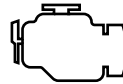

The  indicator light illuminates when the ignition is first turned to the ON position to check the bulb. If it comes on after the engine is started, one of the engine's emission control systems may be malfunctioning. The light may illuminate without a driveability concern being noted. The vehicle will usually be drivable and will not require towing.

**What you should do if the  light illuminates**

#### **Light turns on solid:**

This means that the OBD II system has detected a malfunction.

Temporary malfunctions may cause your  light to illuminate. Examples are:

1. The vehicle has run out of fuel. (The engine may misfire or run poorly.)
2. Poor fuel quality or water in the fuel.

## Instrumentation

3. The fuel cap may not have been properly installed and securely tightened.

These temporary malfunctions can be corrected by filling the fuel tank with high quality fuel of the recommended octane and/or properly installing and securely tightening the gas cap. After three driving cycles without these or any other temporary malfunctions present, the  light should turn off. (A driving cycle consists of a cold engine startup followed by mixed city/highway driving.) No additional vehicle service is required.

If the  light remains on, have your vehicle serviced at the first available opportunity.

### Light is blinking:

Engine misfire is occurring which could damage your catalytic converter. You should drive in a moderate fashion (avoid heavy acceleration and deceleration) and have your vehicle serviced at the first available opportunity.



Under engine misfire conditions, excessive exhaust temperatures could damage the catalytic converter, the fuel system, interior floor coverings or other vehicle components, possibly causing a fire.

### Low fuel

Illuminates as an early reminder of a low fuel condition indicated on the fuel gauge (refer to *Fuel gauge* in this chapter for more information).

When refueling, after the light

comes on, the amount of fuel that is added will be less than the advertised capacity since there is fuel still in the tank. The ignition must be in the ON position for this lamp to illuminate. The lamp will also illuminate for several seconds after the ignition is turned to the ON position regardless of the fuel level to ensure your bulb is working.



### Low coolant (if equipped)

This lamp will illuminate when the engine coolant inside the reservoir is low. This lamp will come on when the ignition is first turned on, but then should turn off. If the lamp

LOW  
COOLANT

## Instrumentation

stays on, you should check the coolant level inside the reservoir. For instructions on adding coolant, see *Engine coolant* in the *Maintenance and care* chapter.

### Anti-theft system (if equipped)

Refer to *Perimeter alarm system (if equipped)* and *SecuriLock™ passive anti-theft system* in the *Controls and features* chapter.

## THEFT

### Anti-lock brake system (ABS) (If equipped)

Momentarily illuminates when the ignition is turned to the ON position. If the light does not illuminate momentarily at start up, remains on or continues to flash, the ABS needs to be serviced. With the ABS light on, the anti-lock brake system is disabled and normal braking is still effective unless the brake warning light also remains illuminated with the parking brake released.



### Check transaxle

Illumination of this light indicates that a problem has been detected and shifting may be restricted. If this lamp remains on, have your vehicle serviced immediately.

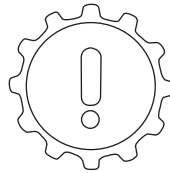

### Speed control (if equipped)

This light comes on when either the SET/ACCEL or RESUME controls are pressed. It turns off when the speed control OFF control is pressed, the brake is applied or the ignition is turned to the OFF position.

## CRUISE

## Instrumentation

### Brake system warning

Momentarily illuminates when the ignition is turned to the RUN position. Also illuminates if the parking brake is engaged. If the brake warning lamp does not illuminate at these times, or remains on after releasing the parking brake, seek service immediately.



One of the following conditions may exist:

- low brake fluid level in the reservoir.
- Brake force distribution system failure. The ABS light will also illuminate if this condition is present.

### Engine oil pressure

Momentarily illuminates when the ignition is turned to the ON position and the engine is off. Illuminates when the oil pressure falls below the normal range. Stop the vehicle as soon as safely possible and switch off the engine immediately. Check the oil level and add oil if needed. Refer to *Engine oil* in the *Maintenance and care* chapter.

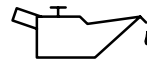

### Charging system

Illuminates when the ignition is turned to the ON position and the engine is off. The light also illuminates when the battery is not charging properly, requiring electrical system service.

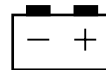

### Air bag readiness

Momentarily illuminates when the ignition is turned ON. If the light fails to illuminate, continues to flash or remains on, have the system serviced immediately.



## Instrumentation

### Safety belt warning chime

Sounds to remind you to fasten your safety belts.

For information on the safety belt warning chime, refer to the *Seating and safety restraints* chapter.

### Supplemental restraint system (SRS) warning chime

For information on the SRS warning chime, refer to the *Seating and safety restraints* chapter.

### Key-in-ignition warning chime

Sounds when the key is left in the ignition in the OFF/LOCK or ACC position and the driver's door is opened.

### Headlamps on warning chime

Sounds when the headlamps or parking lamps are on, the ignition is off (and the key is not in the ignition) and the driver's door is opened.

## GAUGES

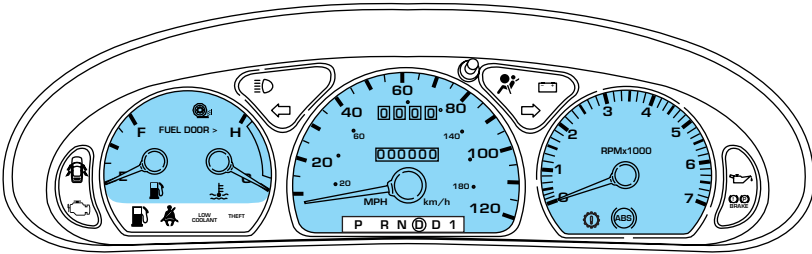

### Speedometer

Indicates the current vehicle speed.

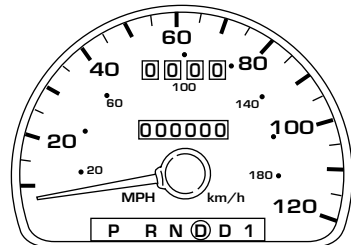

## Instrumentation

### Tachometer

Indicates the engine speed in revolutions per minute.

Driving with your tachometer pointer continuously at the top of the scale may damage the engine.

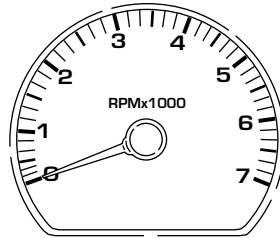

### Engine coolant temperature gauge

Indicates the temperature of the engine coolant. At normal operating temperature, the needle remains within the normal area (the area between the "H" and "C"). If it enters the red section, the engine is overheating. Stop the vehicle as soon as safely possible, switch off the engine immediately and let the engine cool. Refer to *Engine coolant* in the *Maintenance and care* chapter.

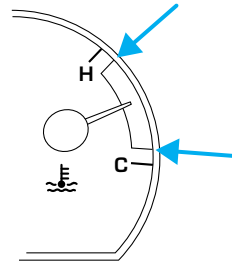

Never remove the coolant reservoir cap while the engine is running or hot.

This gauge indicates the temperature of the engine coolant, not the coolant level. If the coolant is not at its proper level the gauge indication will not be accurate.

## Instrumentation

### Odometer

Registers the total kilometers (miles) of the vehicle.

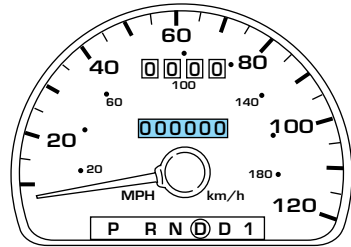

### Trip odometer

Registers the kilometers (miles) of individual journeys. To reset, depress the control.

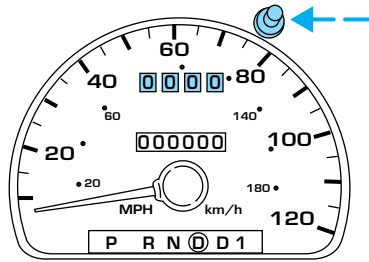

### Fuel gauge

Displays approximately how much fuel is in the fuel tank (when the key is in the ON position). The fuel gauge may vary slightly when the vehicle is in motion. The ignition should be in the OFF position while the vehicle is being refueled. When the gauge first indicates empty, there is a small amount of reserve fuel in the tank. When refueling the vehicle from an empty indication, the amount of fuel that can be added will be less than the advertised capacity due to the reserve fuel.

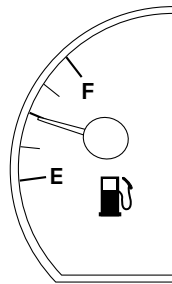

## Controls and features

### HEADLAMP CONTROL

Rotate the headlamp control to the first position to turn on the parking lamps. Rotate to the second position to also turn on the headlamps.

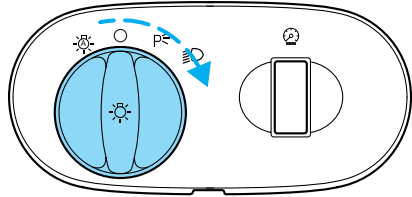

### Daytime running lamps (DRL) (if equipped)

Turns the headlamps on with a reduced output. To activate:

- the ignition must be in the ON position and
- the headlamp control is in the OFF or Parking lamps position.



Always remember to turn on your headlamps at dusk or during inclement weather. The Daytime Running Light (DRL) System does not activate your tail lamps and generally may not provide adequate lighting during these conditions. Failure to activate your headlamps under these conditions may result in a collision.

### High beams

Push forward to activate.

Pull toward you to deactivate.

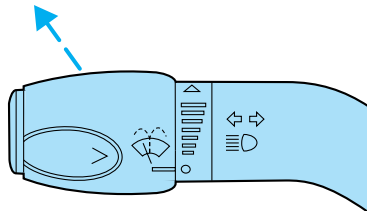

### Flash to pass

Pull toward you to activate and release to deactivate.

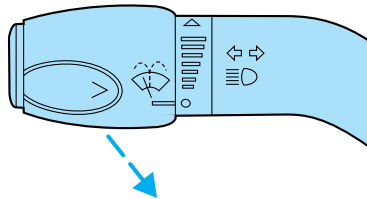



## Controls and features

### PANEL DIMMER CONTROL

Use to adjust the brightness of the instrument panel during headlamp and parklamp operation.

- Rotate up to brighten.
- Rotate down to dim.
- Rotate to full up position (past detent) to turn on interior lamps.

The dome lamp will not illuminate if the panel dimmer/dome lamp control is switched to OFF.

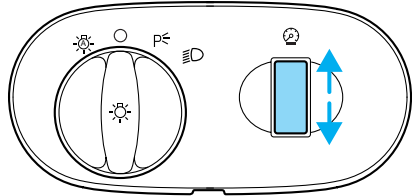

### AUTOLAMP CONTROL (IF EQUIPPED)

The autolamp system provides light sensitive automatic on-off control of the exterior lights normally controlled by the headlamp control.

The autolamp system also keeps the lights on for a fixed period of time after the ignition switch is turned to OFF.

- To turn autolamps on, rotate the control counterclockwise.
- To turn autolamps off, rotate the control clockwise to OFF.

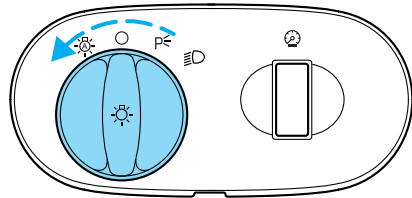

### REAR WINDOW DEFROSTER

The rear defroster control is located on the instrument panel.

Press the rear defroster control to clear the rear window of thin ice and fog.

- A small LED will illuminate when the rear defroster is activated.

The ignition must be in the ON position to operate the rear window defroster.

The defroster turns off automatically after 10 minutes or when the ignition is turned to the OFF position. To manually turn off the defroster before 10 minutes have passed, push the control again.

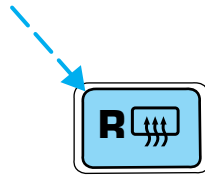

## Controls and features

Activating the rear window defroster will also activate the heated mirrors (if equipped). For more information refer to *Heated Outside Mirrors* in this section.

### CLIMATE CONTROL SYSTEM

#### Manual heating and air conditioning system (if equipped)

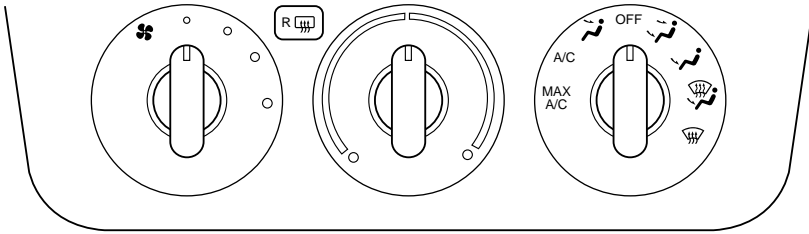

#### **Fan speed control**

Controls the volume of air circulated in the vehicle.

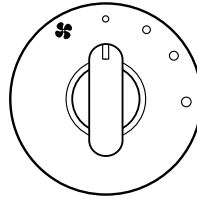

#### **Temperature control knob**

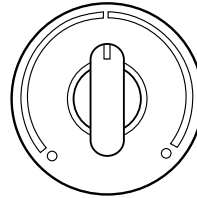

Controls the temperature of the airflow inside the vehicle.



## Controls and features



### **Mode selector control**

Controls the direction of the airflow to the inside of the vehicle.

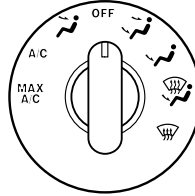

The air conditioning compressor will operate in all modes except (Panel)  and  (Floor). However, the air conditioning will only function if the outside temperature is about 10°C (50°F) or higher.



Since the air conditioner removes considerable moisture from the air during operation, it is normal if clear water drips on the ground under the air conditioner drain while the system is working and even after you have stopped the vehicle.

- **MAX A/C**-Uses recirculated air to cool the vehicle. MAX A/C is noisier than A/C but more economical and will cool the inside of the vehicle faster. Airflow will be from the instrument panel registers. This mode can also be used to prevent undesirable odors from entering the vehicle.
- **A/C**-Uses outside air to cool the vehicle. It is quieter than MAX A/C but not as economical. Airflow will be from the instrument panel registers.
-  (Panel)-Distributes outside air through the instrument panel registers. However, the air will not be cooled below the outside temperature because the air conditioning does not operate in this mode.
- **OFF**-Outside air is shut out and the fan will not operate. For short periods of time only, use this mode to prevent undesirable odors from entering the vehicle.
-  (Panel and floor)-Distributes outside air through the instrument panel registers and the floor ducts. Heating and air conditioning capabilities are provided in this mode. For added customer comfort, when the temperature control knob is anywhere in between the full hot and full cold positions, the air distributed through the floor ducts will be slightly warmer than the air sent to the instrument panel registers.

## Controls and features

-  (Floor)-Allows for maximum heating by distributing outside air through the floor ducts. However, the air will not be cooled below the outside temperature because the air conditioning does not operate in this mode.
-  (Floor and defrost)-Distributes outside air through the windshield defroster ducts and the floor ducts. Heating and air conditioning capabilities are provided in this mode. For added customer comfort, when the temperature control knob is anywhere in between the full hot and full cold positions, the air distributed through the floor ducts will be slightly warmer than the air sent to the windshield defrost ducts. If the temperature is about 10°C (50°F) or higher, the air conditioner will automatically dehumidify the air to reduce fogging.
-  (Defrost)-Distributes outside air through the windshield defroster ducts. It can be used to clear ice or fog from the windshield. If the temperature is about 10°C (50°F) or higher, the air conditioner will automatically dehumidify the air to reduce fogging.

### Operating tips

- In humid weather, select  before driving. This will reduce fogging on your windshield. After a few minutes, select any desired position.
- To reduce humidity buildup inside the vehicle, do not drive with the climate control system in the OFF or MAX A/C position.
- Do not put objects under the front seat that will interfere with the airflow to the rear seats.
- Remove any snow, ice or leaves from the air intake area (at the bottom of the windshield under the hood).

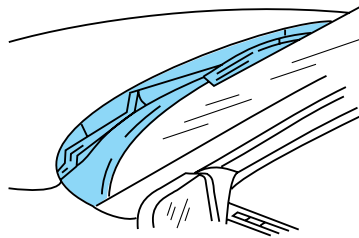

- If the air conditioner works well in MAX A/C, but not in A/C, this may indicate that the cabin air filter (if equipped) needs to be replaced.
- If your vehicle has been parked with the windows closed during hot weather, the air conditioner will do a much faster job of cooling if you

## Controls and features

drive for two or three minutes with the windows open. This will force most of the hot, stale air out of the vehicle. Then operate your air conditioner as you would normally.

- Do not place objects over the defroster outlets. These objects can block airflow and reduce your ability to see through your windshield. Also, avoid placing small objects on top of your instrument panel. These objects can fall down into the defroster outlets and block airflow and possibly damage your climate control system.



Do not place objects on top of the instrument panel, as these objects may become projectiles in a collision or sudden stop.



### Electronic Automatic Temperature Control (EATC) system (if equipped)

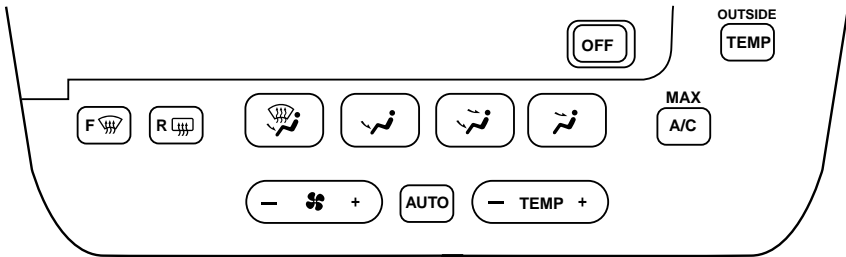

The EATC system will maintain a selected temperature and automatically control airflow. You can override automatic operation with any of the override controls or the fan speed control.

## Controls and features

### Turning the EATC on

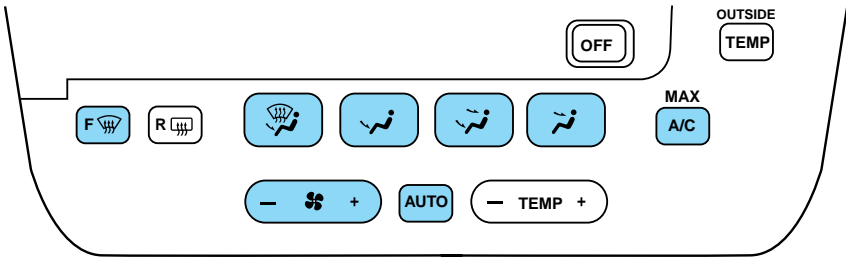

Press AUTO, any of the override controls or the fan speed control. The EATC will only operate when the vehicle is running.

### Turning the EATC off

Press OFF. The Outside Temperature function will continue to operate until the ignition is turned off.

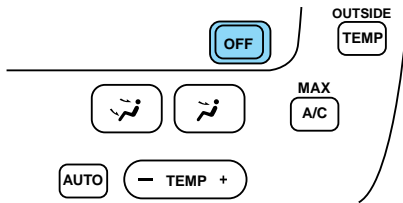

### Automatic operation

Press AUTO and select the desired temperature. The selected temperature and the word AUTO will appear in the display window. The EATC system will either heat or cool to achieve the selected temperature. The system will automatically determine fan speed, airflow location and if outside air or recirculated air is required. Fan speed remains automatic unless the fan speed control is pressed.

When in AUTO and weather conditions require heat, air will be sent to the floor. However, if the engine is not warm enough to provide heat, the fan will be at a low speed and the air will be directed to the windshield. In 3½ minutes or less, the fan speed will start to increase and the airflow location will change to the floor area.

If unusual conditions exist (i.e.-window fogging, etc.), the manual override controls allow you to select airflow locations and the fan control allows you to adjust fan speed as necessary.

## Controls and features

### Temperature selection

The display window indicates the selected temperature, function (AUTO or one of the override controls) and manual control of fan speed (  ) if automatic fan speed is not desired.

AUTO  
72 °F  
FAN  . . .

To control the temperature, select any temperature between 18°C (65°F) and 29°C (85°F) by pressing the temperature control.

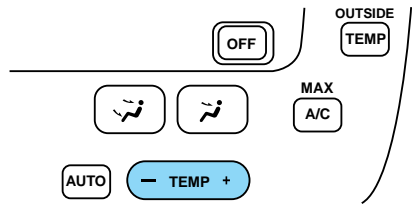

For continuous maximum cooling, push the temperature control until 16°C (60°F) is shown in the display window. The EATC will continue maximum cooling (disregarding the displayed temperature) until a warmer temperature is selected by pressing the temperature control.

For continuous maximum heating, push the temperature control until 32°C (90°F) is shown in the display window. The EATC will continue maximum heating (disregarding the displayed temperature) until a cooler temperature is selected by pressing the temperature control.

### Temperature conversion

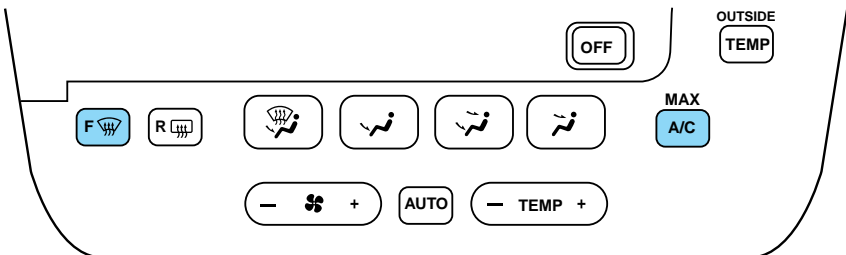

Press MAX A/C and F  at the same time (until the display changes) to switch between Fahrenheit and Celsius.

## Controls and features

### Fan speed ( )

When AUTO is pressed, fan speed is adjusted automatically for existing conditions. You can override fan speed at any time. To control fan speed manually, press the fan control to cancel automatic fan speed operation. Press the control up for higher fan speed or down for lower fan speed.

The display will show  and a bar graph to indicate manual fan operation and relative speed.

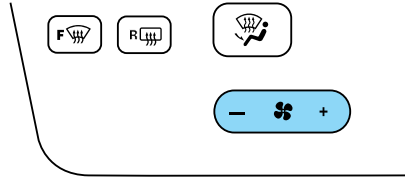

AUTO  
72 °F  
FAN  . . .

To return to automatic fan operation, press AUTO.

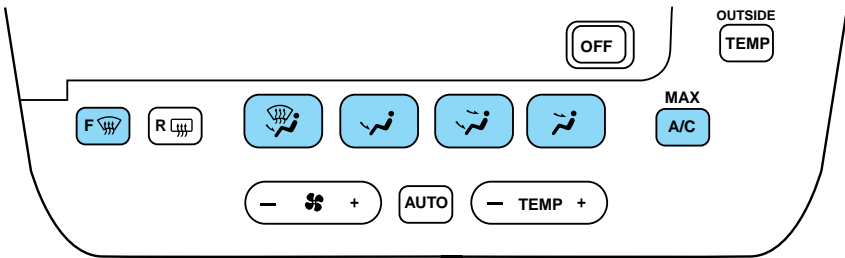

### Manual override controls



The override controls are located at the bottom of the EATC and allow you to determine where airflow is directed. To return to full automatic control, press AUTO.









## Controls and features

The air conditioning compressor can operate in all modes except  and . It will also operate only when required when AUTO has been selected. However, the air conditioning will only function if the outside temperature is about 10°C (50°F) or higher.

Since the air conditioner removes considerable moisture from the air during operation, it is normal if clear water drips on the ground under the air conditioner drain while the system is working and even after you have stopped the vehicle.

Under normal conditions, your vehicle's climate control system should be left in any position other than MAX A/C or OFF when the vehicle is parked. This allows the vehicle to “breathe” through the outside air inlet duct.

-  -Distributes outside air through the windshield defroster ducts. It can be used to clear ice or fog from the windshield. If the outside air temperature is about 10°C (50°F) or higher, the air conditioner will automatically dehumidify the air to reduce fogging.
-  (Rear Window Defroster) — Refer to *Rear Window Defroster*.
-  -Distributes outside air through the windshield defroster ducts and the floor ducts. Heating and air conditioning capabilities are provided in this mode. The air will be heated or cooled based on the temperature selection. For added customer comfort, the air distributed through the floor ducts will be slightly warmer than the air sent to the windshield defroster ducts. If the temperature is about 10°C (50°F) or higher, the air conditioner will automatically dehumidify the air to reduce fogging.
-  -Allows for maximum heating by distributing outside air through the floor ducts. However, the air cannot be cooled below the outside temperature because the air conditioning does not operate in this mode.
-  -Distributes outside air through the instrument panel registers and the floor ducts. Heating and air conditioning capabilities are provided in this mode. The air will be heated or cooled based on the temperature selection. For added customer comfort, the air distributed through the floor ducts will be slightly warmer than the air sent to the instrument panel registers.
-  -Distributes outside air through the instrument panel registers. However, the air cannot be cooled below the outside temperature because the air conditioning does not operate in this mode.

## Controls and features

- **MAX A/C**-Uses recirculated air to cool the vehicle. The temperature will remain unchanged and air will be cooled based on the selected temperature. To exit, press **AUTOMATIC** or any other override controls. **MAX A/C** is noisier than normal **A/C** but more economical and will cool the inside of the vehicle faster. Airflow is from the instrument panel registers. This mode can also be used to prevent undesirable odors from entering the vehicle.
- **OFF**-Outside air is shut out and the fan will not operate. For short periods of time only, use this mode to reduce undesirable odors from entering the vehicle.

### Displaying outside temperature

Press **OUTSIDE TEMP** to display the outside air temperature. It will be displayed until **OUTSIDE TEMP** is pressed again or until any other control is pressed. When the **EATC** system is off and **OUTSIDE TEMP** is pressed, the outside temperature will only be displayed for four seconds.

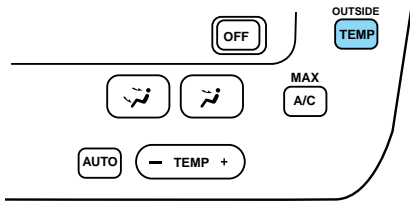

The outside temperature reading is most accurate when the vehicle is moving. Higher readings may be obtained when the vehicle is not moving. The readings that you get may not agree with temperatures given on the radio due to differences in vehicle and station locations.

### Operating tips

- In humid weather, select F  before driving. This will reduce fogging on your windshield. After a few minutes, select any desired position.
- To prevent humidity buildup inside the vehicle, don't drive with the climate control system in the **OFF** position.
- Don't put objects under the front seat that will interfere with the airflow to the back seats.

## Controls and features

- Remove any snow, ice or leaves from the air intake area (at the bottom of the windshield).

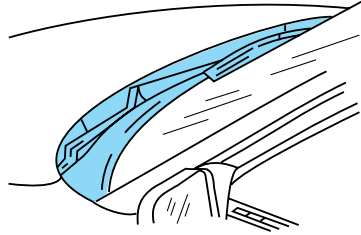

- If your vehicle has been parked with the windows closed during hot weather, the air conditioner will do a much faster job of cooling if you drive for two or three minutes with the windows open. This will force most of the hot, stale air out of the vehicle. Then operate the air conditioner as you would normally.
- If the air conditioner works well in MAX A/C but not in normal A/C, this may indicate that the cabin air filter (if equipped) needs to be replaced.
- Do not place objects over the defroster outlets. These objects can block airflow and reduce your ability to see through your windshield. Also, avoid placing small objects on top of your instrument panel. These objects can fall down into the defroster outlets and block airflow and possibly damage your climate control system.



Do not place objects on top of the instrument panel, as these objects may become projectiles in a collision or sudden stop.

### AUXILIARY POWER POINT 12V

The auxiliary power point is located on the instrument panel.

Do not plug optional electrical accessories into the cigarette lighter. Use the power point.

## Controls and features

### USING YOUR AUDIO SYSTEM

#### AM/FM Stereo

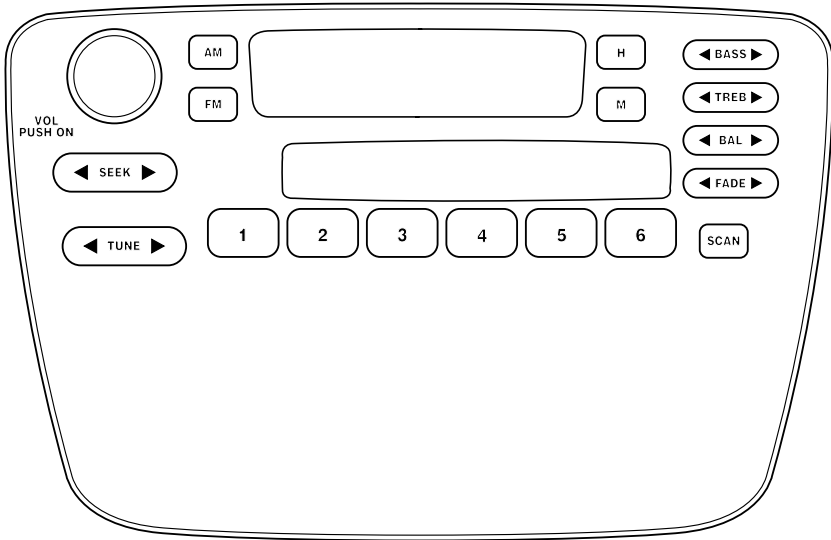

#### ***Volume/power control***

Press the control to turn the audio system on or off.

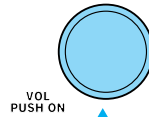

Turn control to raise or lower volume.

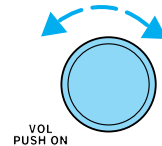

If the volume is set above a certain level and the ignition is turned off, the volume will come back on at a “nominal” listening level when the

## Controls and features

ignition switch is turned back on. If you wish to maintain your preset volume level, turn the audio system off with the power control before switching off the ignition.

### **AM/FM select**

The AM/FM select control works in radio mode. Press the AM or FM control to enter radio mode.

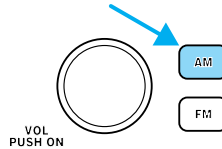

### **AM/FM select in radio mode**

This control allows you to select AM or FM frequency bands. Press the control to switch between AM, FM1 or FM2 memory preset stations.

Pressing the AM or FM controls when the ignition is turned on will also enable the radio.

### **Tune adjust**

The tune control works in radio mode.



### **Tune adjust in radio mode**

- Press the ◀ to move to the next frequency down the band (whether or not a listenable station is located there). Hold the control to move through the frequencies quickly.
- Press the right side of the control to move to the next frequency up the band (whether or not a listenable station is located there). Hold the control to move through the frequencies quickly.

### **Seek function**

The seek function control works in radio mode.



### **Seek function in radio mode**

- Press ◀ to find the next listenable station down the frequency band.
- Press ▶ to find the next listenable station up the frequency band.

## Controls and features

### Scan function

The scan function works in radio mode.



### Scan function in radio mode

Press the SCAN control to hear a brief sampling of all listenable stations on the frequency band. Press the control again to stop the scan mode.

### Radio station memory preset

The radio is equipped with six station memory preset controls. These controls can be used to select up to six preset AM stations and twelve FM stations (six in FM1 and six in FM2).

### Setting memory preset stations

1. Select the frequency band with the AM/FM select control.
2. Select a station. Refer to *Tune adjust* or *Seek function* for more information on selecting a station.

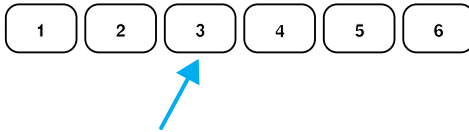
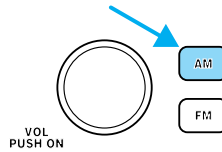

3. Press and hold a memory preset control until the sound returns, indicating the station is held in memory on the control you selected.

### Bass/treble adjust

- The bass adjust control allows you to increase or decrease the audio system's bass output.
- The treble adjust control allows you to increase or decrease the audio system's treble output.

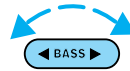

## Controls and features

### **Speaker balance/fade adjust**

- Speaker sound distribution can be adjusted between the right and left speakers.
- Speaker sound can be adjusted between the front and rear speakers.



### **Setting the clock**

To set the hour, press and hold the hour (H) control. When the desired hour appears, release the control.

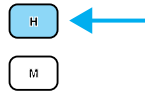

To set the minute, press and hold the minute (M) control. When the desired minute appears, release the control.

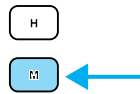

Your vehicle is equipped with a special feature that allows you to access clock mode when the vehicle is not running. Press the H or M control to engage the clock at this time.

# Controls and features

## MACH® Audio System with AM/FM Stereo/Cassette

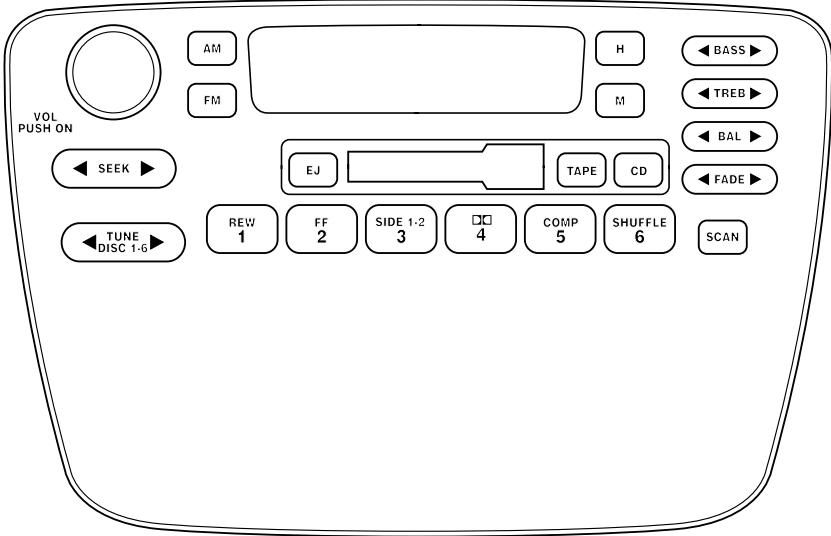

### ***Volume/power control***

Press the control to turn the audio system on or off.

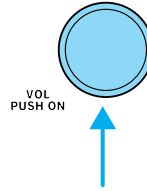

Turn control to raise or lower volume.

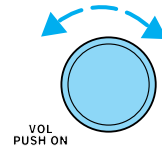

If the volume is set above a certain level and the ignition is turned off, the volume will come back on at a “nominal” listening level when the ignition switch is turned back on. If you wish to maintain your preset volume level, turn the audio system off with the power control before switching off the ignition.



## Controls and features

### **AM/FM select**

The AM/FM select control works in radio, tape and CD modes (if equipped). Press the AM or FM control to enter into radio mode.

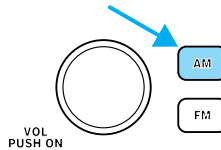

### **AM/FM select in radio mode**

This control allows you to select AM or FM frequency bands. Press the control to switch between AM, FM1 or FM2 memory preset stations.

Pressing the AM or FM controls when the ignition is turned on will also engage the radio.

### **AM/FM select in tape mode**

Press this control to stop tape play and begin radio play.

### **AM/FM select in CD mode**

Press this control to stop CD play and begin radio play.

You can switch from CD play to tape play by simply inserting a tape into the cassette deck.

### **Tune disc adjust**

The tune control works in radio or CD mode.



### **Tune adjust in radio mode**

- Press ◀ to move to the next frequency down the band (whether or not a listenable station is located there). Hold the control to move through the frequencies quickly.
- Press ▶ to move to the next frequency up the band (whether or not a listenable station is located there). Hold for quick movement.

### **Tune adjust for CD mode**

- Press the ◀ to select the previous disc in the CD changer. (Play will begin on the first track of the disc unless the CD changer is in shuffle mode. Refer to *Shuffle feature* for more information. Hold the control to continue reversing through the disc.

## Controls and features

- Press ► to select the next disc in the CD changer. Hold the control to fast-forward through the remaining discs.

### **Seek function**

The seek function control works in radio, tape or CD mode.



### **Seek function in radio mode**

- Press ◀ to find the next listenable station down the frequency band.
- Press ► to find the next listenable station up the frequency band.

### **Seek function in tape mode**

- Press ◀ to listen to the previous selection on the tape.
- Press ► to listen to the next selection on the tape.

### **Seek function in CD mode**

- Press ◀ to seek to the previous track of the current disc. If a selection has been playing for three seconds or more and you press ◀, the CD changer will replay that selection from the beginning.
- Press ► to seek forward to the next track of the current disc. After the last track has been completed, the first track of the current disc will automatically replay.

### **Scan function**

The scan function works in radio, tape or CD mode.



### **Scan function in radio mode**

Press the SCAN control to hear a brief sampling of all listenable stations on the frequency band. Press the control again to stop the scan mode.

### **Scan function in tape mode**

Press the SCAN control to hear a short sampling of all selections on the tape. (The tape scans in a forward direction. At the end of the tape's first side, direction automatically reverses to the opposite side of the tape.) To stop on a particular selection, press the control again.

## Controls and features

### Scan function in CD mode

Press the SCAN control to hear a short sampling of all selections on the CD. (The CD scans in a forward direction, wrapping back to the first track at the end of the CD.) To stop on a particular selection, press the control again.

### Radio station memory preset

The radio is equipped with six station memory preset controls. These controls can be used to select up to six preset AM stations and twelve FM stations (six in FM1 and six in FM2).

### Setting memory preset stations

1. Select the frequency band with the AM/FM select control.
2. Select a station. Refer to *Tune adjust* or *Seek function* for more information on selecting a station.

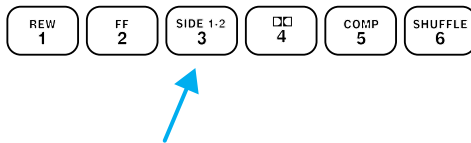
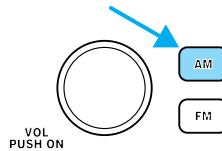

3. Press and hold a memory preset control until the sound returns, indicating the station is held in memory on the control you selected.

### Bass/treble adjust

- The bass adjust control allows you to increase or decrease the audio system's bass output.
- The treble adjust control allows you to increase or decrease the audio system's treble output.

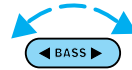

### Speaker balance/fade adjust

- Speaker sound distribution can be adjusted between the right and left speakers.



## Controls and features

- Speaker sound can be adjusted between the front and rear speakers.



### **Inserting a tape**

Push only slightly when inserting a cassette tape (with the open edge to the right). A cassette deck loading mechanism pulls the tape in the rest of the way.



You can switch from CD to tape play by inserting a tape into the cassette deck.

### **Tape/CD select**

- Pressing the TAPE or CD control when the ignition is on will engage the system if a tape or CD is present in the audio system.
- To begin tape play (with a tape loaded into the audio system) while in the radio or CD mode, press the TAPE control. Press the control during rewind or fast forward to stop the rewind or fast forward function.
- To begin CD play (if CDs are loaded in the CD changer), press the CD button. The first track of the first disc will begin playing. After that CD play will begin where it stopped last.



### **Rewind**

The rewind control works in tape and CD modes.

- In tape mode, radio play will continue until rewind is stopped (with the TAPE or REW control) or the beginning of the tape is reached.

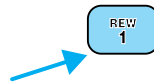

## Controls and features

- In CD mode, pressing the REW control for less than three seconds results in a slow reverse. Pressing the control for more than three seconds results in fast reverse.

### **Fast forward**

The fast forward control works in tape and CD modes.



- In the tape mode, tape direction will automatically reverse when the end of the tape is reached.
- In CD mode, pressing the control for less than three seconds results in slow forward action. Pressing the control for more than three seconds results in fast forward action.
- You can cancel the fast forward mode by pressing TAPE, or the FF control.

### **Tape direction select**

Press SIDE 1-2 to play the alternate side of a tape.

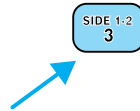

### **Dolby® noise reduction**

Dolby® noise reduction operates only in tape mode. Dolby® noise reduction reduces the amount of hiss and static during tape playback.



Press the  control to activate (and deactivate) Dolby® noise reduction.

Dolby® noise reduction system is manufactured under license from Dolby® Laboratories Licensing Corporation. “Dolby®” and the double-D symbol are trademarks of Dolby® Laboratories Licensing Corporation.

### **Compression adjust**

Compression adjust brings soft and loud CD passages together for a more consistent listening level.



Press the COMP control to activate and deactivate compression adjust.

## Controls and features

### **Shuffle feature**

The shuffle feature operates in CD mode and plays all tracks on the current disc in random order.

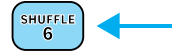

If equipped with the CD changer, the shuffle feature continues to the next disc after all tracks are played.

Press the SHUFFLE control to start this feature. Random order play will continue until the SHUFFLE control is pressed again.

### **Setting the clock**

To set the hour, press and hold the hour (H) control. When the desired hour appears, release the control.

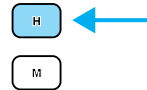

To set the minute, press and hold the minute (M) control. When the desired minute appears, release the control.

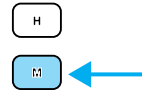

Your vehicle is equipped with a special feature that allows you to access clock mode when the vehicle is not running. Press the H or M control to engage the clock at this time.

### **CD changer (if equipped)**

Your CD changer is either located in the trunk, the console or the right side cargo area storage compartment.

1. Slide the door to access the CD changer magazine.

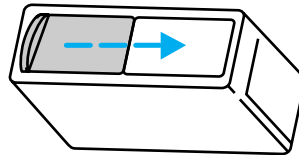

## Controls and features

2. Press ▲ to eject the magazine.

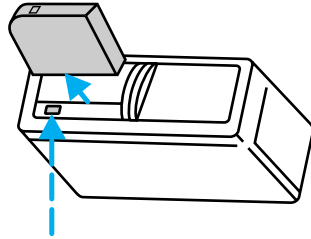

3. Turn the magazine (A) over.

4. Using the disc holder release knob (C), pull the disc holder (B) out of the magazine.

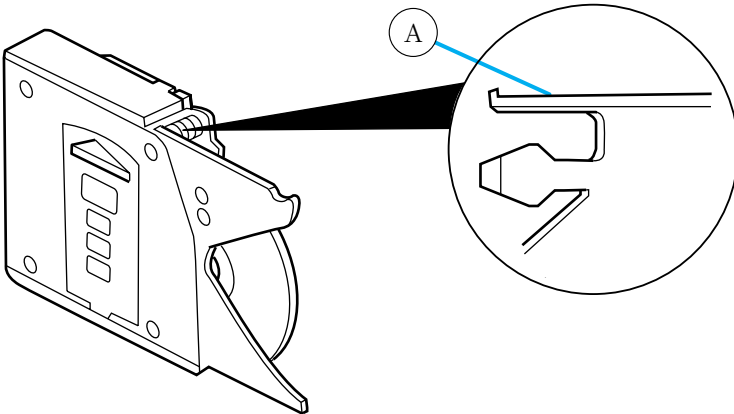
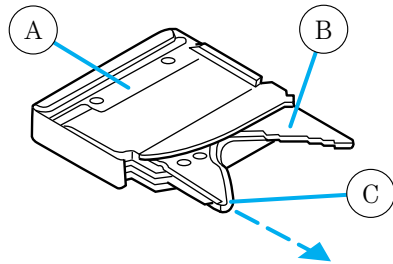

If you pull too hard on the disc holder, the disc holder may come completely out of the magazine. If this happens, reinsert the disc holder back into the magazine while pressing on the lever (A).

## Controls and features

5. Line up the CD with the groove of the disc holder. Ensure that the label on the CD faces downwards.

6. Press in on the disc holder until it locks securely into the magazine. If the disc holders are not fully locked into the magazine, the unit will not operate.

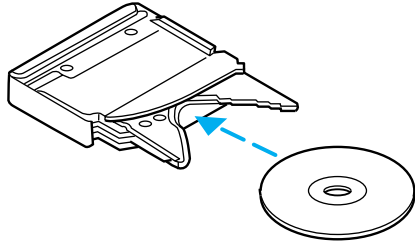

Ensure that the disc holder is evenly inserted and at the same level as the magazine (A). The unit will not operate if the disc holder is not inserted at the same level (B).

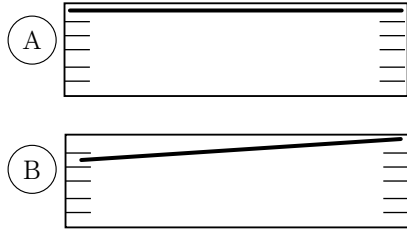

Radio power must be turned on to play the CDs in the changer. The magazine may be stored in the glove box when not being used.

The CD magazine may be inserted or ejected with the radio power off.

ONLY use the magazine supplied with the CD changer, other types will damage the unit.

Keep the CD changer door closed. Coins and foreign objects will damage the CD player and void your audio system warranty.

**Do not insert any promotional (odd shaped or sized) discs, or discs with removable labels into the CD changer as that jamming may occur.**

### Troubleshooting the CD changer (if equipped)



The laser beam used in the compact disc player is harmful to the eyes. Do not attempt to disassemble the case.

If sound skips:

- You may be traveling on a rough road, playing badly scratched discs or the disc may be dirty. Skipping will not scratch the discs or damage the player.



## Controls and features

If your changer does not work, it may be that:

- A disc is already loaded where you want to insert a disc.
- The disc is inserted with the label surface downward.
- The disc is dusty or defective.
- The player's internal temperature is above 60°C (140°F). Allow the player to cool down before operating.
- A disc with format and dimensions not within industry standards is inserted.

### **Cleaning compact discs**

Inspect all discs for contamination before playing. If necessary, clean discs only with an approved CD cleaner and wipe from the center out to the edge. Do not use circular motion.

### **CD and CD changer care**

- Handle discs by their edges only. Never touch the playing surface.
- Do not expose discs to direct sunlight or heat sources for extended periods of time.
- Do not insert more than one disc into each slot of the CD changer magazine.

### **Cleaning cassette player (if equipped)**

Clean the tape player head with a cassette cleaning cartridge after 10 to 12 hours of play in order to maintain the best sound and operation.

### **Cassette and cassette player care**

- Use only cassettes that are 90 minutes long or less.
- Do not expose tapes to direct sunlight, high humidity, extreme heat or extreme cold. Allow tapes that may have been exposed to extreme temperatures to reach a moderate temperature before playing.
- Tighten very loose tapes by inserting a finger or pencil into the hole and turning the hub.
- Remove loose labels before inserting tapes.
- Do not leave tapes in the cassette player for a long time when not being played.

## Controls and features

### Radio frequency information

The Federal Communications Commission (FCC) and the Canadian Radio and Telecommunications Commission (CRTC) establish the frequencies AM and FM stations may use for their broadcasts. Allowable frequencies are:

AM 530, 540–1600, 1610 kHz

FM 87.7, 87.9–107.7, 107.9 MHz

Not all frequencies are used in a given area.

### *Radio reception factors*

Three factors can affect radio reception:

- **Distance/strength.** The further an FM signal travels, the weaker it is. The listenable range of the average FM station is approximately 40 km (24 miles). This range can be affected by “signal modulation.” Signal modulation is a process radio stations use to increase their strength/volume relative to other stations.
- **Terrain.** Hills, mountains and tall buildings between your vehicle’s antenna and the radio station signal can cause FM reception problems. Static can be caused on AM stations by power lines, electric fences, traffic lights and thunderstorms. Moving away from an interfering structure (out of its “shadow”) returns your reception to normal.
- **Station overload.** Weak signals are sometimes captured by stronger signals when you pass a broadcast tower. A stronger signal may temporarily overtake a weaker signal and play while the weak station frequency is displayed.

The audio system automatically switches to single channel reception if it will improve the reception of a station normally received in stereo.

### **Audio system warranties and service**

Refer to the “Warranty Guide” for audio system warranty information.

If service is necessary, see your dealer or a qualified technician.

## Controls and features

### POWER ADJUSTABLE FOOT PEDALS (IF EQUIPPED)

Press and hold the rocker control (located on the side of the driver's seat) to adjust accelerator and brake pedal.

- press the rear side of the control to adjust the pedals toward you
- press the front side of the control to adjust the pedals away from you

The adjustment allows for approximately 76mm (3 inches) of maximum travel.

### PEDALS

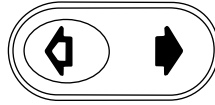

Never adjust the accelerator and brake pedal with feet on pedals or while the vehicle is moving.

### TRACTION CONTROL™ (IF EQUIPPED)

This control can be used to turn the Traction Control™ on or off. Refer to the *Traction Control™* section of the *Driving* chapter for more information.

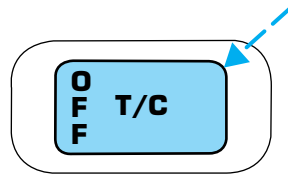

### POSITIONS OF THE IGNITION

1. ACCESSORY, allows the electrical accessories such as the radio to operate while the engine is not running.

2. LOCK, locks the steering wheel, automatic transmission gearshift lever and allows key removal.

3. OFF, shuts off the engine without locking the steering wheel.

4. ON, all electrical circuits operational. Warning lights illuminated with engine off. Key position when driving.

5. START, cranks the engine. Release the key as soon as the engine starts.

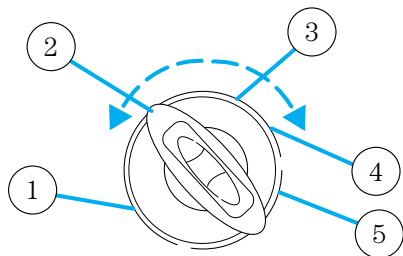

## Controls and features

### SPEED CONTROL (IF EQUIPPED)

#### To turn speed control on

- Press ON.

Vehicle speed cannot be controlled until the vehicle is traveling at or above 48 km/h (30 mph).

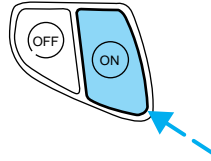

Do not use the speed control in heavy traffic or on roads that are winding, slippery, or unpaved.



Do not shift the gearshift lever into N (Neutral) with the speed control on.

#### To turn speed control off

- Press OFF or
- Turn off the vehicle ignition.

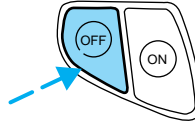

Once speed control is switched off, the previously programmed set speed will be erased.

#### To set a speed

- Press SET+. For speed control to operate, the speed control must be ON and the vehicle speed must be greater than 48 km/h (30 mph).

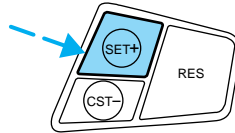

If you drive up or down a steep hill, your vehicle speed may vary momentarily slower or faster than the set speed. This is normal.

Speed control cannot reduce the vehicle speed if it increases above the set speed on a downhill. If your vehicle speed is faster than the set speed while driving on a downhill, you may want to shift to the next lower gear or apply the brakes to reduce your vehicle speed.

## Controls and features

If your vehicle slows down more than 16 km/h (10 mph) below your set speed on an uphill, your speed control will disengage. This is normal. Pressing RES/RSM/RESUME will re-engage it.



Do not use the speed control in heavy traffic or on roads that are winding, slippery, or unpaved.

### To set a higher set speed

- Press and hold SET +. Release the control when the desired vehicle speed is reached or
- Press and release SET +. Each press will increase the set speed by 1.6 km/h (1 mph) or
- Accelerate with your accelerator pedal. When the desired vehicle speed is reached, press and release SET +.

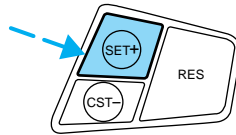

You can accelerate with the accelerator pedal at any time during speed control usage. Releasing the accelerator pedal will return your vehicle to the previously programmed set speed.

### To set a lower set speed

- Press and hold CST -. Release the control when the desired speed is reached or
- Press and release CST -. Each press will decrease the set speed by 1.6 km/h (1 mph) or
- Depress the brake pedal. When the desired vehicle speed is reached, press SET +.

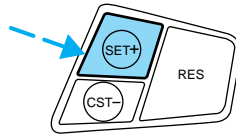
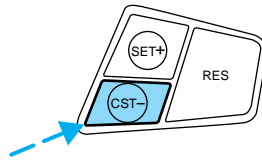

## Controls and features

### To disengage speed control

- Depress the brake pedal.

Disengaging the speed control will not erase the previously programmed set speed.

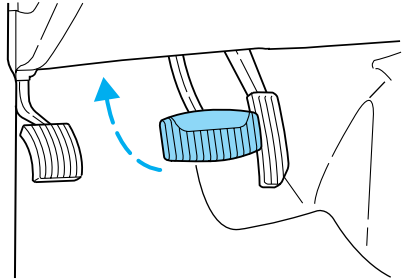

Pressing OFF will erase the previously programmed set speed.

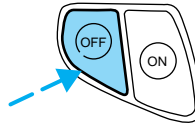

### To return to a previously set speed

- Press RES/RSM/RESUME. For RES/RSM/RESUME to operate, the vehicle speed must be faster than 48 km/h (30 mph).

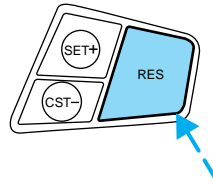

### Indicator light

This light comes on when either the SET ACC/SET ACCEL or RES/RSM/RESUME controls are pressed. It turns off when the speed control OFF control is pressed, the brake is applied or the ignition is turned to the OFF position.

**CRUISE**

## Controls and features

### TURN SIGNAL CONTROL ⇐⇒

- Push down to activate the left turn signal.
- Push up to activate the right turn signal.

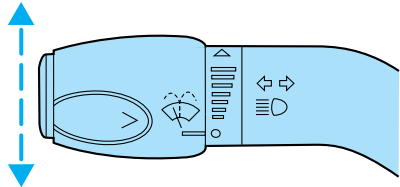

### WINDSHIELD WIPER/WASHER CONTROLS

Rotate the windshield wiper control to the desired interval, low or high speed position.

The bars of varying length are for intermittent wipers. When in this position rotate the control upward for fast intervals and downward for slow intervals.

Push the control on the end of the stalk to activate washer. Push and hold for a longer wash cycle. The washer will automatically shut off after ten seconds of continuous use.

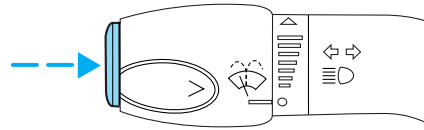
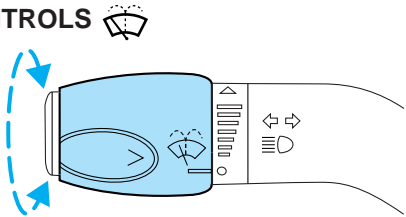

### Mist Function

To operate the Mist function of the windshield wipers, push and release the windshield washer control quickly. The wipers will cycle one or two times.

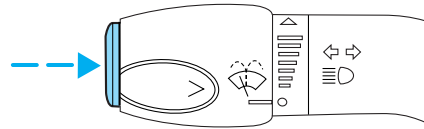

## Controls and features

### Rear window wiper and washer (wagon only)

The rear wiper control is located under the headlamp controls. Press the wiper control to activate the rear wiper. Press again to turn off the wiper.

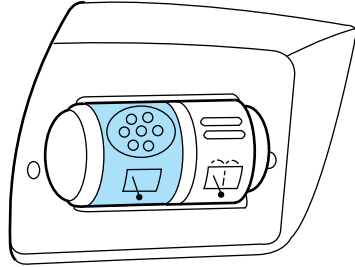

Press the washer control to activate the rear washer. The wiper will come on when the washer control is pressed, if it is not already on.

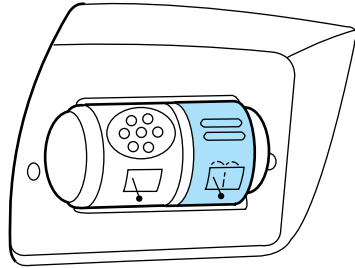

### HAZARD FLASHER

For information on the hazard flasher control, refer to *Hazard flasher* in the *Roadside emergencies* chapter.



## Controls and features

### TILT STEERING

Pull the tilt steering control toward you to move the steering wheel up or down. Hold the control while adjusting the wheel to the desired position, then release the control.

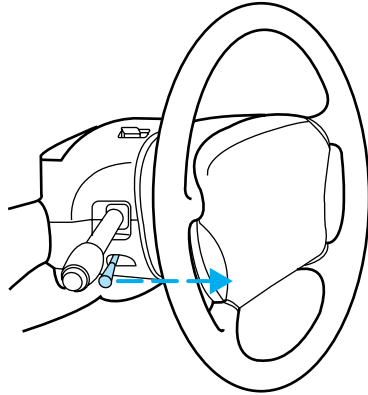

Never adjust the steering wheel when the vehicle is moving.

### DOMES LAMPS AND MAP LAMPS

The front dome lamp is located overhead between the driver and passenger seats. If the vehicle is equipped with a moon roof, the dome lamp is located behind the moon roof.

The dome lamp will stay on if the control is moved to the passenger side position. When the control is in the middle position, the lamp will only come on when a door is opened. If the control is moved to the driver's side position, the lamp will not come on at all.

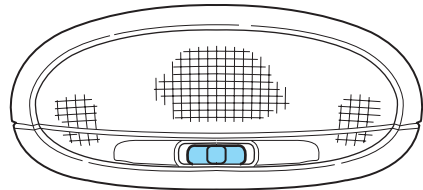

With the control in the middle position, the dome lamp will illuminate whenever a front door is opened. If either front door has been opened from the outside, the lamp will remain on for 25 seconds after the door is shut. If any other door has been opened from the inside, the lamp will shut off immediately after the door is closed.

## Controls and features

The map lamp controls (if equipped) are located on the dome lamp. Press the controls on either side of each lens on each map lamp to activate the lamps.

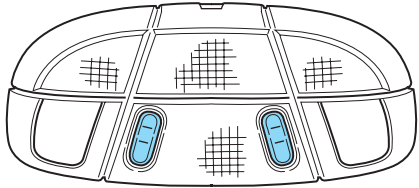

If equipped with a moon roof, the map lamps are located on the moon roof control panel. Press the controls on either side of each map lamp to activate the lamps.

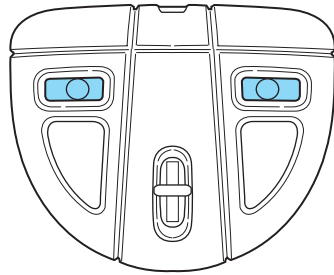

### REAR DOME LAMP (IF EQUIPPED)

The dome lamp lights when:

- any door is opened with the control in the middle position.
- the instrument panel dimmer switch is held up until the courtesy lamps come on.
- any of the remote entry controls are pressed and the ignition is OFF.
- the lamp control is moved to the passenger side position.

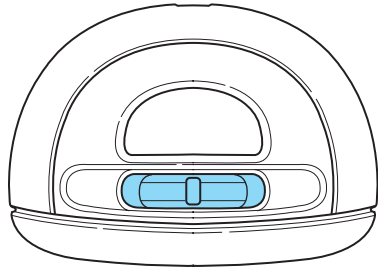

With the ignition key in the ACC or ON position, the rear dome lamp can be turned ON or OFF by sliding the control.

## Controls and features

### ILLUMINATED VISOR MIRROR (IF EQUIPPED)

To turn on the visor mirror lamps, lift the mirror cover. Adjust the amount of light by sliding the control.

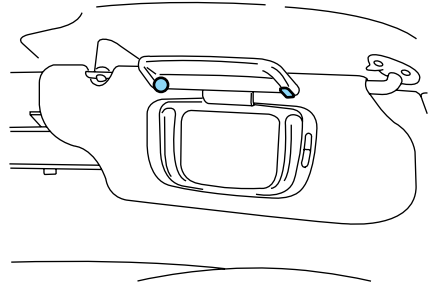

### MOON ROOF (IF EQUIPPED)

To open, press and hold the rear portion of the control. This will fully open the moon roof.

To close, press and hold the front portion of the control.

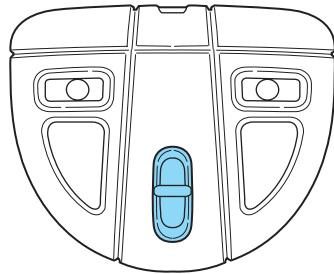

### WIRELESS INTERFACE MODULE (WIM) CELL PHONE SYSTEM (IF EQUIPPED)

The Wireless Interface Module (WIM) Cell Phone System allows for hands-free phone communication while in your car. With your cell phone plugged in the Phone Adapter System (PAS) in the center console, incoming calls will ring through the audio system speakers. The audio system does not have to be “ON” to place or receive a phone call. The WIM will turn on your audio system when you place or receive a phone call.

With this system you will hear and control the volume of the person you are talking to through your car's audio system. Your voice is picked up through the microphone mounted above the rear view mirror allowing you to talk on the phone. *Your volume setting in your phone will effect the volume through the audio system. You may have to reset the volume of your phone when using WIM system.*

## Controls and features

You will need a Phone Adapter System (PAS) that is compatible with your cell phone that you install into the center console. This system includes a Phone Adapter Module (PAM) with a Wiring Harness and a Hang-Up Cup. For more information, call 1-800-736-9450 to order the Phone Adapter System (PAS) for your specific phone.

To install the PAS, locate the four screw holes in the console. Install the PAM and the hang-up cup with four screws.

Remove the connector cover and plug the PAS wiring harness into the harness connector in the console.

Position the PAS harness in the opening on the inside corner of the connector cover and install the connector cover on the console.

To answer or end a call, press and release the control button on the microphone mounted above the rear view mirror or use the phone itself (refer to your phone's owner manual for more information).

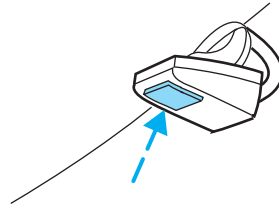
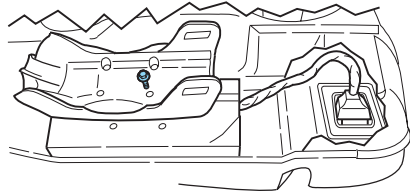

The radio will display the word “CALL” when you are on the phone.

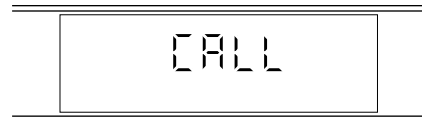

Check and obey the laws and regulations on the use of wireless telephones in the areas where you drive.

**Before driving, familiarize yourself with the operation and location of the WIM system.**



To avoid potential distraction and increased risk of injury or accident, Ford recommends you do not use the phone while driving.

Please pull off the road and park before making or answering a call

To prevent damage to the antenna or your car, remove the cellular phone antenna mast before using an automatic car wash.

## Controls and features

### POWER WINDOWS

Press and hold the rocker switches to open and close windows.

- Press the top portion of the rocker switch to close.

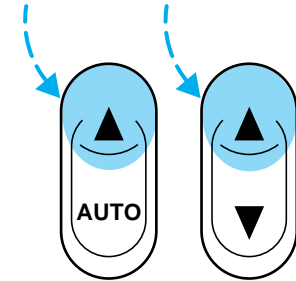

- Press the bottom portion of the rocker switch to open.

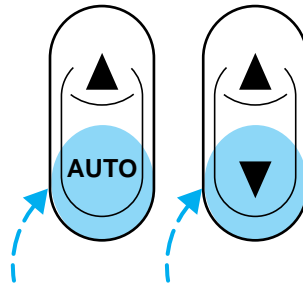

### One touch down

- Press AUTO completely down to the second detent. The driver's window will open fully. Depress up to stop window operation.

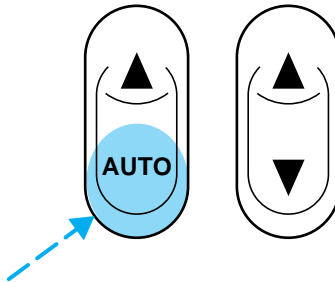

## Controls and features

### Window lock

The window lock feature allows only the driver to operate the power windows.

To lock out all the window controls except for the driver's press the left side of the control. Press the right side to restore the window controls.

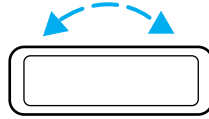

### Accessory delay (if equipped)

With accessory delay, the window switches may be used for up to ten minutes after the ignition switch is turned to the OFF position or until any door is opened.

### POWER DOOR LOCKS (IF EQUIPPED)

Press control to unlock or lock all doors.

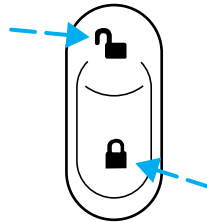

### CHILDPROOF DOOR LOCKS

When these locks are set, the rear doors cannot be opened from the inside. The rear doors can be opened from the outside when the doors are unlocked.

The childproof locks are located on rear edge of each rear door and must be set separately for each door. Setting the lock for one door will not automatically set the lock for both doors.

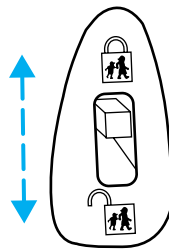



Move lock control up to engage the childproof lock. Move control down to disengage childproof locks.

## Controls and features

### POWER SIDE VIEW MIRRORS

To adjust your mirrors:

1. Select  to adjust the left mirror or  to adjust the right mirror.

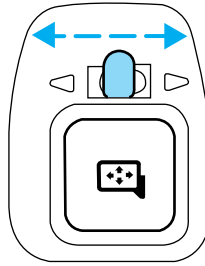

2. Move the control in the direction you wish to tilt the mirror.

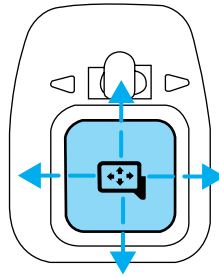

3. Return to the center position to disable adjust function.

### Heated outside mirrors (if equipped)

Both mirrors are heated automatically to remove ice, mist and fog when the rear window defrost is activated.

Do not remove ice from the mirrors with a scraper or attempt to readjust the mirror glass if it is frozen in place. These actions could cause damage to the glass and mirrors.

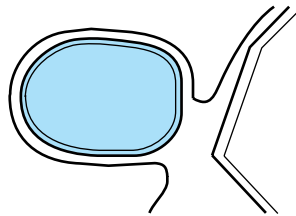

## Controls and features

### CENTER CONSOLE

Your vehicle may be equipped with a variety of console features. These include:

- Utility compartment
- Bin mat (snap-in)
- Cupholders (front and rear)
- Coin holder slots
- Compact disc changer (if equipped)
- Tissue holder
- Rear A/C vent
- Rear ashtray (see your Ford, Lincoln Mercury dealer to obtain rear ashtray)



Use only soft cups in the cupholder. Hard objects can injure you in a collision.

If your vehicle is equipped with the column shift and a bench seat, it has a center console in the center front seating position.

The center console has similar features as the full console. To open the storage compartment, raise the armrest and pull the strap on the seat up and toward the front of the vehicle. The rear seat area is provided with dual cupholders.

### POSITIVE RETENTION FLOOR MAT

Position the floor mat so that the eyelet is over the pointed end of the retention post and rotate forward to lock in. Make sure that the mat does not interfere with the operation of the accelerator or the brake pedal. To remove the floor mat, reverse the installation procedure.

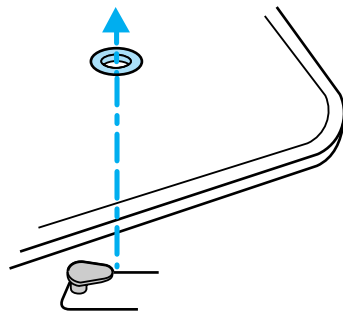



## Controls and features

### TRUNK REMOTE CONTROL

Press the remote trunk release control on the instrument panel to the left of the steering wheel.

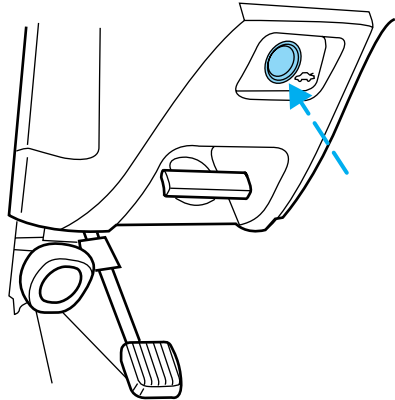

### LIFTGATE (WAGON ONLY)

You can open and close the liftgate and the liftgate window from outside the vehicle. It cannot be opened from inside the cargo area.

- To open the liftgate window, unlock the liftgate (with the key, the power door locks or the remote entry key fob) and push the key lock cylinder.
- To open the liftgate, unlock the liftgate and pull up on the handle under the license plate lamp shield.

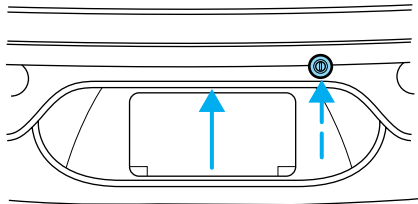

To lock the liftgate and the liftgate window, press the lock button down on the inside of the liftgate, use the key, the power door locks, or the remote entry key fob.

The liftgate and liftgate window should be closed before driving your vehicle. If not, possible damage may occur to the liftgate lift cylinders and attaching hardware.

## Controls and features

### CARGO AREA FEATURES

#### Storage compartment

Your vehicle comes equipped with a storage compartment in the floor of the cargo area. An additional compartment is in the rear trim panel on the right. Always put the load you are carrying as far forward as possible.

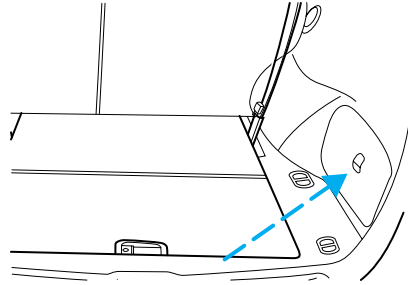

#### Cargo net (if equipped) (Wagon)

The cargo net secures lightweight objects in the cargo area. Attach the net to the anchors provided. Do not put more than 22 kg (50 lbs.) in the net. This net is not designed to restrain objects during a collision.

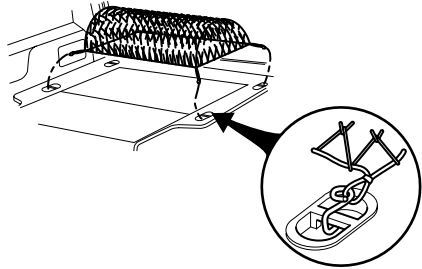

#### Cargo cover (if equipped)

Your vehicle may be equipped with a cargo area shade that covers the luggage compartment of your vehicle.

To install the shade:

1. Fasten the cover into the mounting brackets (make sure the cover is right side up).
2. Pull the end of the shade toward you and hook the sides into the notches (right side first) in the rear trim panels.

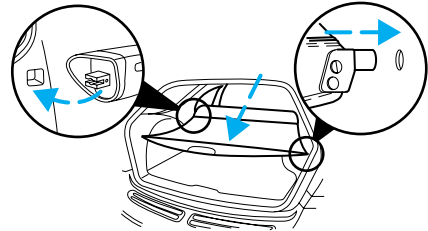

## Controls and features



To prevent the possibility of injuries, the fasteners for the cargo area cover must be properly attached to the mounting clips on the rear trim panels.



Do not place any objects on the cargo area cover. They may obstruct your vision or strike occupants of the vehicle in the case of a sudden stop or collision.

### Rewinding the shade

With extended use, the cargo shade may lose its spring tension. If this occurs, the shade must be manually rewound. This is a two-person operation.

1. Remove the shade from the vehicle and extend it with the smooth grain facing you.
2. Wrap the vinyl around the roller tube twice. Tuck the edges of the vinyl inside the end cap with each wrap.
3. Fold the edges of the vinyl towards the center, making sure that the edges clear the end cap slots. Use tape or a rubber band to hold the vinyl to the left side of the tube.
4. Push in the right end cap (marked RH) about  $\frac{1}{4}$  of the total length to disengage the clutch and hold the end cap in while turning the roller tube toward you 14 times.
5. Let go of the right end cap. The clutch will now engage and stop the shade from losing its spring tension.
6. Unfold the vinyl and place it into the end cap slots.

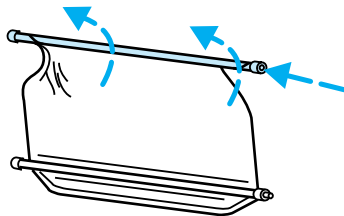
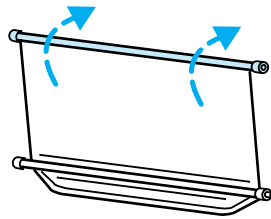

## Controls and features

7. Insert the shade into the side mounting brackets and check to make sure that it operates properly.



The cover may cause injury in a sudden stop or accident if it is not securely installed.

### Cargo utility hooks (Sedan)

The utility hooks located in side the trunk can be used to hang small items on. Do not hang more than 12 kg (20 lbs) on the hooks. The hooks are not designed to restrain objects during a collision.

### REMOTE ENTRY SYSTEM (IF EQUIPPED)

The remote entry system allows you to lock or unlock all vehicle doors, trunk and liftgate without a key.

The remote entry features only operate with the vehicle in P (Park) or N (Neutral) and the ignition in the, ACC, OFF or ON positions.

If there is any potential remote keyless entry problem with your vehicle, ensure **ALL key fobs** (remote entry transmitters) are brought to the dealership, to aid in troubleshooting.

### Unlocking the doors/liftgate

Press this control to unlock the driver's door. The interior lamps will illuminate with the ignition OFF.

Press the control a second time within three seconds to unlock all doors and liftgate (wagons).

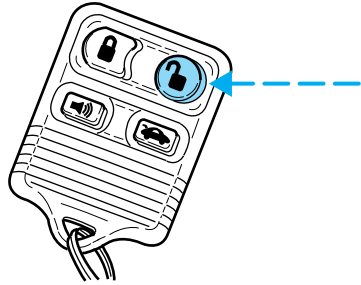

## Controls and features

### Locking the doors/liftgate

Press this control to lock all doors and liftgate (wagons).

To confirm all doors are closed and locked, press the control a second time within three seconds. The doors will lock again and the horn will chirp.

If any of the doors or liftgate are ajar, the horn will make two quick chirps, reminding you to properly close all doors.

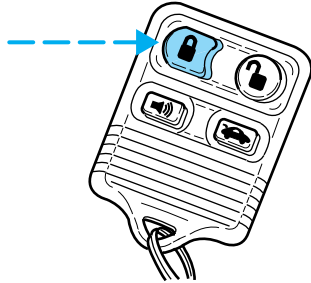

### Unlocking the liftgate/trunk

Press the control to unlock the liftgate/trunk.

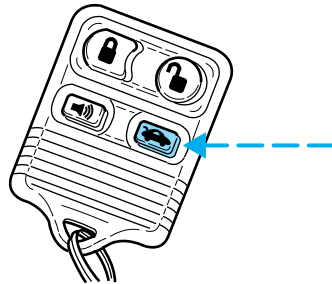

### Sounding a panic alarm

Press this control to activate the alarm.

To deactivate the alarm, press the control again or turn the ignition to ACC or ON.

This device complies with part 15 of the FCC rules and with RS-210 of Industry Canada. Operation is subject to the following two conditions: (1) This device may not cause harmful interference, and (2) This device must accept any interference received, including interference that may cause undesired operation.

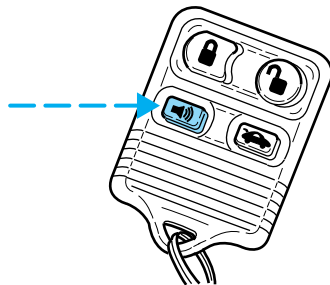

## Controls and features

**Changes or modifications not expressly approved by the party responsible for compliance could void the user's authority to operate the equipment.**

### Illuminated entry

The interior lamps illuminate when the remote entry system is used to unlock the door(s).

The system automatically turns off after 25 seconds or when the ignition is turned to the ON or ACC position. The dome lamp control (if equipped) must **not** be set to the OFF position for the illuminated entry system to operate.

The inside lights will not turn off if:

- they have been turned on with the dimmer control or
- any door is open.

The battery saver will shut off the interior lamps 10 minutes after the ignition has been turned to the OFF position.

### Replacing lost transmitters

If a remote transmitter has been lost and you would like to remove it from the vehicle's memory, or you would like to purchase additional remote transmitters and have them programmed to your vehicle:

- Take **all** your vehicle's transmitters to your dealer for programming, or
- Perform the programming procedure yourself

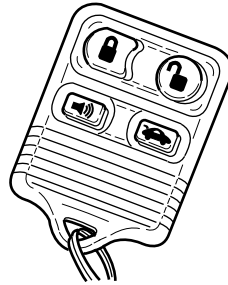

### Programming remote transmitters

It is necessary to have **all** (maximum of four — original and/or new) of your remote transmitters available prior to beginning this procedure.

## Controls and features

To program the transmitters yourself:

- Insert a key in the ignition and turn from 3 (OFF) to 4 (ON) eight times in rapid succession (within 10 seconds) with the eighth turn ending in the 4 (ON) position. The doors will lock/unlock to confirm that programming mode has been entered.
- Within 20 seconds, program a remote transmitter by pressing any button on a transmitter. The doors will lock/unlock to confirm that the remote transmitter has been programmed. (If more than 20 seconds pass before pressing a remote transmitter button, the programming mode will exit and the procedure will have to be repeated.)
- Repeat the previous step to program additional remote transmitters. The doors will lock/unlock to confirm that each remote transmitter has been programmed.
- When you have completed programming the remote transmitters, turn the ignition to 3 (OFF) or wait 20 seconds. Again the doors will lock/unlock to confirm programming has been completed.

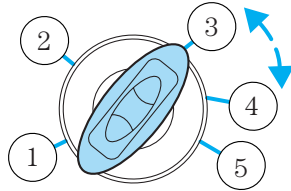

### Replacing the battery

The remote transmitter is powered by one coin type three-volt lithium battery CR2032 or equivalent. Typical operating range will allow you to be up to 10 meters (33 feet) away from your vehicle. A decrease in operating range can be caused by:

- weather conditions
- nearby radio towers
- structures around the vehicle
- other vehicles parked next to the vehicle

## Controls and features

To replace the battery:

1. Twist a thin coin between the two halves of the transmitter near the key ring. **DO NOT TAKE THE FRONT PART OF THE TRANSMITTER APART.**
2. Place the positive (+) side of new battery in the same orientation. Refer to the diagram inside the transmitter unit.
3. Snap the two halves back together.

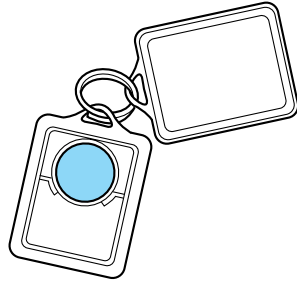

Replacement of the battery will **not** cause the remote transmitter to become deprogrammed from your vehicle. The remote transmitter should operate normally after battery replacement.

### PERIMETER ALARM SYSTEM (IF EQUIPPED)

The perimeter anti-theft system will help prevent your vehicle from unauthorized entry.

If there is any potential perimeter anti-theft problem with your vehicle, ensure **ALL key fobs** (remote entry transmitters) are brought to the dealership, to aid in troubleshooting.

### Arming the system

When armed, this system will help protect your vehicle from unauthorized entry. When unauthorized entry occurs, the system will flash the headlamps and/or parking lamps, and will chirp the horn.

The system is ready to arm whenever the ignition is turned OFF. Any of the following actions will prearm the alarm system:

- Press the remote entry lock control (doors opened or closed).

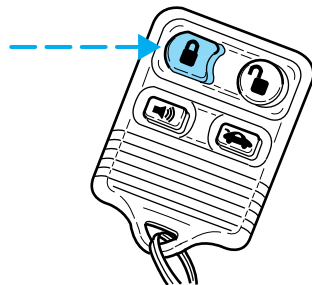



## Controls and features

- Press 7/8 and 9/0 controls on the keyless entry pad at the same time to lock the doors (doors opened or closed).

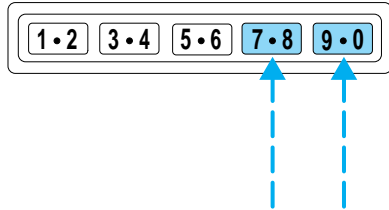

- Open a door and press the power door lock control to lock the doors. There is a 20 second countdown when any of the above actions occur before the vehicle becomes ARMED.

Each door/hood or liftgate (wagon) arm individually, and if any door/hood or liftgate (wagon) is open, then it must be closed for it to be armed.

When you press the lock control twice within three seconds on your remote entry transmitter, the horn will chirp once to let you know that all doors/hood and liftgate (wagon) are closed.

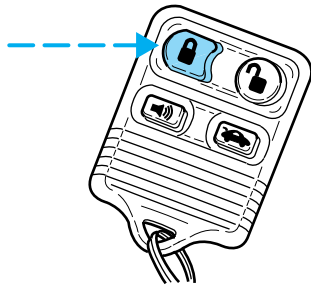

If the doors/hood or liftgate (wagon) are not closed and you press the remote entry transmitter twice to confirm the doors are locked, the horn will chirp twice to warn you that a door/hood or liftgate (wagon) is still open.

## Controls and features

### Disarming the system

You can disarm the system by any of the following actions:

- Unlock the doors by using your remote entry transmitter.

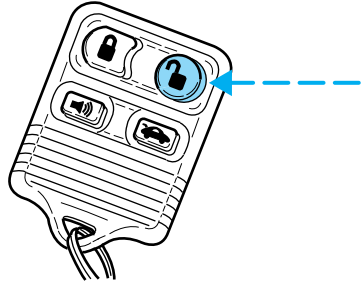

- Unlock the doors by using your keyless entry pad.

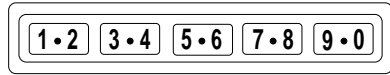

- Unlock the doors or liftgate with a key. Turn the key full travel (toward the front of the vehicle) to make sure the alarm disarms.
- Turn ignition to ON.
- Press the PANIC control on the remote entry transmitter. This will only shut the horn OFF when the alarm is sounding. The alarm system will still be armed.

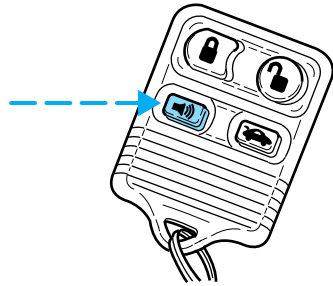

### Triggering the anti-theft system

The armed system will be triggered if:

- Any door, liftgate or hood is opened without using the door key or the remote entry transmitter.
- The trunk is forced opened.

## Controls and features

### KEYLESS ENTRY SYSTEM (IF EQUIPPED)

With the keyless entry keypad, you can:

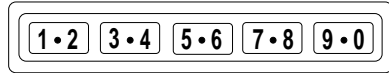

- lock or unlock the vehicle doors and liftgate (wagons) without using the key
- open the trunk
- arm and disarm the perimeter alarm system (if equipped)

See also *Remote entry system* and *Perimeter alarm system* in this chapter for more information.

Your vehicle has a factory-set 5–digit code that operates the keyless entry system. You can also program your own 5–digit personal entry code.

The factory-set code is located:

- on the owner’s wallet card in the glove compartment
- taped to the computer module

When pressing the controls on the keyless entry keypad, press the middle of the controls to ensure a good activation.

### Programming your own personal entry code

1. Enter the factory-set code (keypad will illuminate when pressed).
2. Press the 1/2 control within five seconds of step 1.
3. Enter your personal 5 digit code. Enter each digit within five seconds of the previous one.

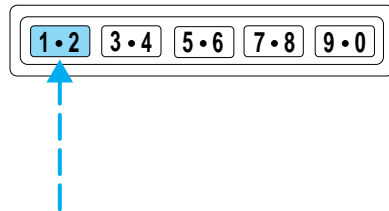

Do not set a code that includes three of the same number or presents them in sequential order. Thieves can easily figure out these types of codes.

Your personal code does not replace the permanent code that the dealership gave you. You can use either code to unlock your vehicle. If a second personal code is entered, the module will erase the first personal code in favor of the new code.

## Controls and features

To exit, press 7/8 and 9/0 simultaneously or allow more than 5 seconds to elapse since a button press occurred and the 5 digit keycode will be programmed.

If you wish to erase your personal code, use the following instructions:

### ***Erasing personal code***

1. Enter the factory-set code.
2. Press 1/2 within five seconds of step 1 and release.
3. Press the 1/2 control and hold for 2 seconds to erase the customer programmed keycode, within five seconds of step 2.

The system will now only respond to the factory-set code.

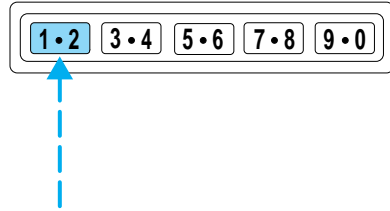

### **Unlocking the doors and releasing the trunk with the keyless entry system**

The driver's door must be unlocked before any other. If more than five seconds pass between pressing numbers, enter the code again. The system has shut down if the keypad light is out. If the keyless entry system does not work, use the key or remote entry transmitter(s).

1. To unlock the driver's door, enter one of the two codes. After pressing the fifth number, the driver's door unlocks.
2. To unlock the passenger's door(s) and liftgate (wagon), press the 3/4 control within five seconds of unlocking the driver's door.

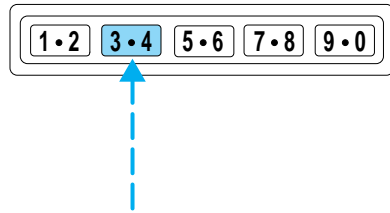

## Controls and features

3. To unlock the trunk or liftgate (wagon), enter the five-digit factory-set code, then press the 5/6 control within five seconds.

Locking the doors and liftgate (wagon), press the 7/8 and 9/0 controls at the same time. This can be done at any time.

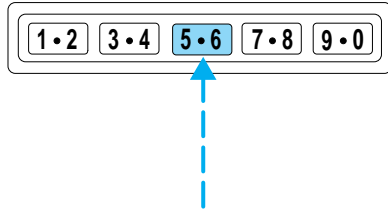

### Autolock

Autolock is a feature that will automatically lock all doors when all of the following occurs:

- all vehicle doors and liftgate are fully closed
- the ignition key is in the RUN position
- vehicle is not in P (Park) or N (Neutral)
- vehicle speed exceeds 5 kph (3 mph)

The autolock feature repeats when all of the above occur and:

- any door is opened and then closed

### Deactivating/activating autolock

There are 2 methods to enable/disable this feature. One through your dealer and the second with a door lock sequence using the following instructions:

1. Turn the ignition key to RUN, then press the door UNLOCK control button 3 times.
2. Turn the ignition key to OFF, then press the door UNLOCK control button 3 times.
3. Turn the ignition key to RUN, within five seconds press the door UNLOCK control button 1 time.

The user should receive a **horn chirp** to indicate the system has been altered.

Pressing the power door UNLOCK control button again will toggle the Autolock/Relock states.

- Turn ignition to OFF to exit.

## Controls and features

### *Deactivating/activating horn chirp*

There are 2 methods to enable/disable this feature. One through your dealer and the second with a door lock sequence using the following instructions:

1. Turn the ignition key to RUN, then press the door UNLOCK control button 3 times.
2. Turn the ignition key to OFF, then press the door UNLOCK control button 3 times.
3. Turn the ignition key to RUN, within five seconds press the door UNLOCK control button 2 times.

The user should receive two **horn chirps** to indicate the system had been altered.

Pressing the power door UNLOCK control button two times again will toggle the Autolock/Relock states.

- Turn ignition to OFF to exit.

### **SECURILOCK™ PASSIVE ANTI-THEFT SYSTEM**

The SecuriLock™ passive anti-theft system provides an advanced level of vehicle theft protection. Your vehicle's engine can only be started with the two special SecuriLock™ electronically coded keys provided with your vehicle. Each time you start your vehicle, the SecuriLock™ key is read by the SecuriLock™ passive anti-theft system. If the SecuriLock™ key identification code matches the code stored in the SecuriLock™ anti-theft system, the vehicle's engine is allowed to start. If the SecuriLock™ key identification code does not match the code stored in the system or if a SecuriLock™ key is not detected (vehicle theft situation), the vehicle's engine will not operate.

If there is any potential SecuriLock™ anti-theft problem with your vehicle, ensure **ALL SecuriLock™ keys** for that vehicle are brought to the dealership, to aid in troubleshooting.

The SecuriLock™ passive anti-theft system is not compatible with aftermarket remote start systems. Use of these systems may result in vehicle starting problems and a loss of security protection. Large metallic objects, a second key or electronic devices used to purchase gasoline or similar items on the same key ring as the PATS ignition key may cause vehicle starting problems. If present, you need to keep these objects from touching the PATS ignition key while starting the engine. These objects cannot damage the PATS ignition key, but can cause a

## Controls and features

momentary problem if they are too close to the key during engine start. If a problem occurs, turn the ignition OFF and restart the engine with all other objects on the key ring held away from the ignition key. Check to make sure the encoded ignition key is an approved Ford encoded ignition key.

Spare SecuriLock™ keys can be purchased from your dealership and programmed to your SecuriLock™ passive anti-theft system. Refer to *Programming spare SecuriLock™ keys* for more information.

If one or both of your SecuriLock™ keys are lost or stolen and you want to ensure the lost or stolen key will not operate your vehicle, bring your vehicle and all available SecuriLock™ keys to your dealership for reinitialization.

### Theft indicator

The theft indicator on the instrument cluster will operate as follows:

- When the ignition is OFF, the theft indicator will flash briefly every two seconds to indicate the SecuriLock™ system is protecting your vehicle.
- When the ignition is turned to ON or START, the theft indicator will light for three seconds and then go out. If the theft indicator stays on for an extended period of time or flashes rapidly, have the system serviced by your dealership or a qualified technician.

### Procedure to program spare SecuriLock™ keys to your vehicle

New SecuriLock™ keys must have the correct mechanical key cut for your vehicle.

Conventional (non-SecuriLock™) keys **cannot** be programmed to your vehicle.

The correct type of SecuriLock™ key for your vehicle is identifiable by the vehicle logo being on only **one side** of the key. If the vehicle logo is on both sides, it is not the right key for your vehicle.

You will need to have two previously programmed SecuriLock™ keys and the new unprogrammed SecuriLock™ key readily accessible for the procedure. Please read and understand the entire procedure before you begin.

1. Insert the first previously programmed SecuriLock™ key into the ignition and turn the ignition from OFF to ON (maintain ignition in ON for at least one second).

## Controls and features

2. Turn ignition to OFF and remove the first SecuriLock™ key from the ignition.
3. Within five seconds of turning the ignition to OFF, insert the second previously programmed SecuriLock™ key into the ignition and turn the ignition from OFF to ON (maintain ignition in ON for at least one second but no more than five seconds).
4. Turn the ignition to OFF and remove the second SecuriLock™ key from the ignition.
5. Within 10 seconds of turning the ignition to OFF, insert the unprogrammed SecuriLock™ key (new key/valet key) into the ignition and turn the ignition from OFF to ON (maintain ignition in ON for at least one second). This step will program your new SecuriLock™ key.
6. To program additional SecuriLock™ key(s), repeat this procedure from step 1.

If the programming procedure was successful, the new SecuriLock™ key(s) will start the vehicle's engine. The theft indicator (located on the instrument cluster) will light for three seconds and then go out.

If the programming procedure was not successful, the new SecuriLock™ key(s) will not operate the vehicle's engine. The theft indicator will flash on and off. Wait at least one minute and then repeat the procedure from step 1. If failure repeats, bring your vehicle to your dealership to have the spare SecuriLock™ key(s) programmed.

### **INTERIOR LUGGAGE COMPARTMENT RELEASE (IF EQUIPPED)**

Your vehicle is equipped with a mechanical interior luggage compartment release handle that provides a means of escape for children and adults in the event they become locked inside the luggage compartment.

Adults are advised to familiarize themselves with the operation and location of the release handle.



## Controls and features

To open the luggage compartment door (lid) from the inside, pull the illuminated “T” shaped handle and push up on the trunk lid. The material that the handle is made of will glow for hours in the darkness of the luggage compartment following brief exposure to ambient light.

The “T” shaped handle will be located either on the luggage compartment door (lid) or inside the luggage compartment near the tail lamps.



Keep vehicle doors and luggage compartment locked and keep keys out of a child's reach. Unsupervised children could lock themselves in an open trunk and risk injury. Children should be taught not to play in vehicles.

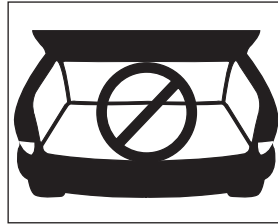

On hot days, the temperature in the trunk or vehicle interior can rise very quickly. Exposure of people or animals to these high temperatures for even a short time can cause death or serious heat-related injuries, including brain damage. Small children are particularly at risk.

## Seating and safety restraints

### SEATING

#### Adjustable head restraints

Your vehicle's seats are equipped with head restraints which are vertically adjustable. The purpose of these head restraints is to help limit head motion in the event of a rear collision. To properly adjust your head restraints, lift the head restraint so that it is located directly behind your head or as close to that position as possible. Refer to the following to raise and lower the head restraints.

The head restraints can be moved up and down.

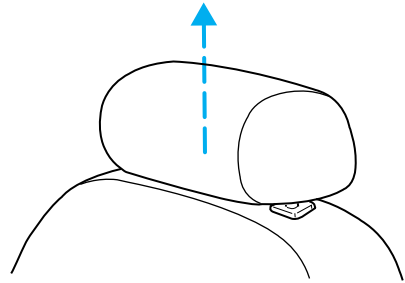

Push control to lower head restraint.

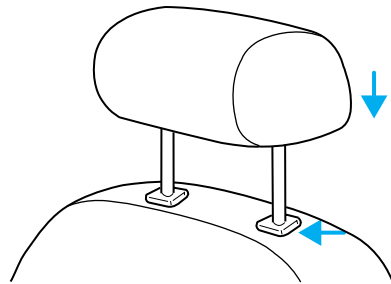

#### Adjusting the front manual seat



Never adjust the driver's seat or seatback when the vehicle is moving.



Do not pile cargo higher than the seatbacks to reduce the risk of injuring people in a collision or sudden stop.

## Seating and safety restraints



Always drive and ride with your seatback upright and the lap belt snug and low across the hips.



Reclining the seatback can reduce the effectiveness of the seat's safety belt in the event of a collision.

Lift handle to move seat forward or backward.

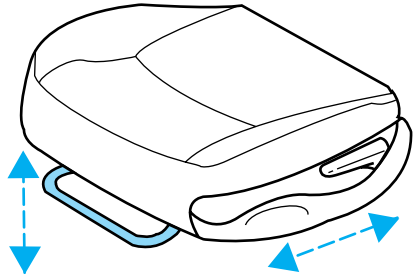

Pull lever up to adjust seatback.

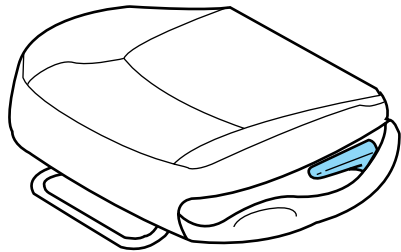

### Adjusting the front power seat (if equipped)



Never adjust the driver's seat or seatback when the vehicle is moving.



Do not pile cargo higher than the seatbacks to avoid injuring people in a collision or sudden stop.



Always drive and ride with your seatback upright and the lap belt snug and low across the hips.

## Seating and safety restraints



Reclining the seatback can reduce the effectiveness of the seat's safety belt in the event of a collision.

The control is located on the outboard side of the seat cushion.

Press front to raise or lower the front portion of the seat cushion.

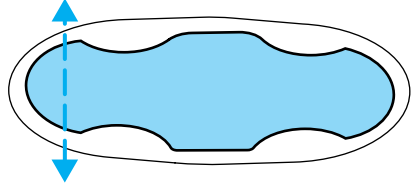

Press rear to raise or lower the rear portion of the seat cushion.

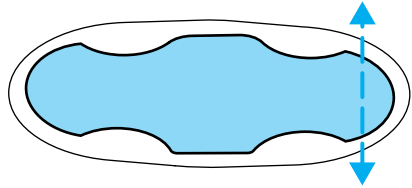

Press the control to move the seat forward, backward, up or down.

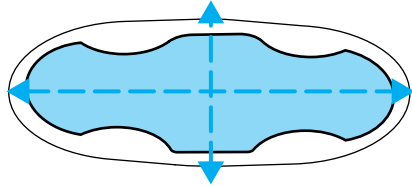

### Using the manual lumbar support (if equipped)

The lumbar control is located on the front of the seat cushion.

Turn to adjust lumbar support.

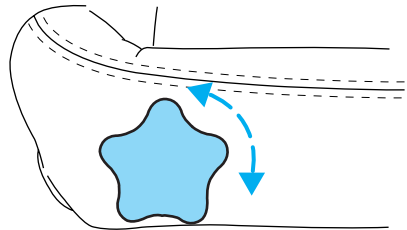

## Seating and safety restraints

### REAR SEATS

#### 2nd seat/Split-folding rear seat (if equipped)

One or both rear seatbacks can be folded down to provide additional cargo space.

To lower the seatback(s) from inside the vehicle, pull tab to release seat back and then fold seatback down.

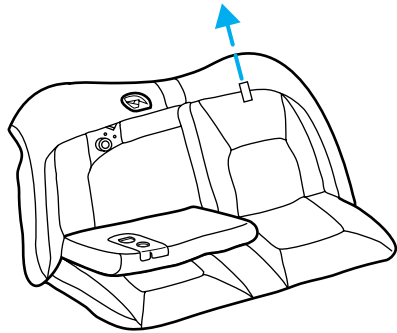

When raising the seatback(s), make sure you hear the seat latch into place.

#### 3rd seat (wagon only)

The third seat faces the rear of the vehicle. For height and weight limits, see the label on the seat cushion. When the seat is down, the back of your wagon has a flat surface for carrying cargo.

To open up the seat:

1. Unlock the floor panel with the key, then use the handle to fold the floor panel toward the front of the car.
2. Remove the cargo cover. The cargo cover must be removed or the seatback will not latch in the upright position.

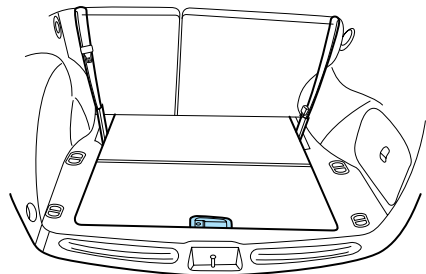

## Seating and safety restraints

3. Lift the remote latch release on the left side of the compartment and fold the remaining floor panel until it latches. Make sure the seatback is locked in the upright position.

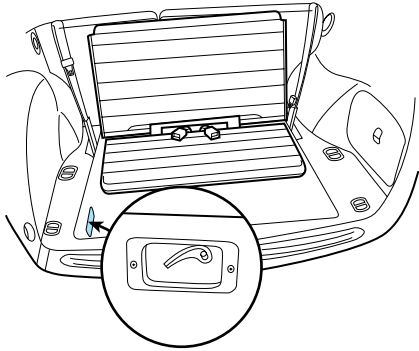

To close the seat, make sure the safety belts are properly stowed, then lift the remote latch release and push the seat down until it latches. Pull up on the handle and push the floor panel into place.

### SAFETY RESTRAINTS

#### Personal Safety System

The Personal Safety System provides an improved overall level of frontal crash protection to front seat occupants and is designed to help further reduce the risk of air bag-related injuries. The system is able to analyze different occupant conditions and crash severity before activating the appropriate safety devices to help better protect a range of occupants in a variety of frontal crash situations.

Your vehicle's Personal Safety System consists of:

- Driver and passenger dual-stage air bag supplemental restraints. Refer to the *Air bag supplemental restraints* section in this chapter.
- Front safety belts with pretensioners, energy management retractors, and safety belt usage sensors. Refer to the *Safety belts* section in this chapter.
- Driver's seat position sensor.
- Front crash severity sensor.
- Restraints Control Module (RCM) with impact and safing sensors.
- An indicator light and back-up tone.

## Seating and safety restraints

- The electrical wiring for the air bags, crash sensor(s), safety belt pretensioners, front safety belt usage sensors and driver's seat position sensor.

### ***How does the personal safety system work?***

The Personal Safety System uses a collection of sensors to gather information about the driver's seat position, driver and front outboard passenger's safety belt usage and accident severity. Then, dual-stage inflating air bags are combined with safety belt pretensioners and energy management retractors to help provide enhanced occupant protection in frontal crashes.

The driver's seat position sensor determines if the seat is fore or aft of a reference position. Similarly, the safety belt usage sensors determine if the driver and front outboard passenger safety belts are fastened. These sensors provide the ability to tailor the air bag deployment based upon how close the driver's seat is to the steering wheel and whether or not the safety belts are fastened.

The dual-stage air bags offer the ability to tailor the air bag inflation with two energy levels. A lower, less forceful energy level is provided for more common, moderate-severity impacts. A higher energy level is provided for the most severe impacts. Whether or not the air bag deploys at all can also be different for the driver versus the passenger based upon driver's seat position and safety belt usage allowing further tailoring of the system.

### ***Determining if the personal safety system is operational***

The Personal Safety System uses a warning indicator light in the instrument cluster or a back-up tone to indicate the condition of the system. Refer to the *Restraints Warning Indicator* section in the *Instrumentation* chapter. Routine maintenance of the Personal Safety System is not required.

The RCM (restraints control module) monitors its own internal circuits and the circuits for the air bag supplemental restraints, crash sensor(s), safety belt pretensioners, front safety belt usage sensors and driver's seat position sensor. In addition, the RCM also monitors the restraints warning indicator light in the instrument cluster. A difficulty with the system is indicated by one or more of the following:

- The indicator light will either flash or stay lit.



## Seating and safety restraints

- The indicator light will not illuminate immediately after ignition is turned on.
- A series of five beeps will be heard. The tone pattern will repeat periodically until the problem and indicator light are repaired.

If any of these things happen, even intermittently, have the Personal Safety System serviced at your dealership or by a qualified technician immediately. Unless serviced, the system may not function properly in the event of a collision.

### ***When are the front air bags and pretensioners deployed?***

Front air bags and pretensioners are designed to activate in frontal and near-frontal collisions, not rollover, side-impacts, or rear-impacts unless the collision causes sufficient longitudinal deceleration. The fact that the pretensioners or air bags did not activate in a collision does not mean that something is wrong with the system. Rather, it means the Personal Safety System determined the occupant conditions

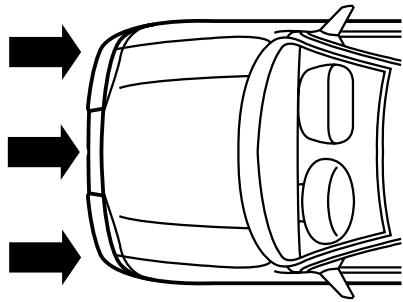

or crash severity were not appropriate to activate these safety devices.

### **Safety belt precautions**



Always drive and ride with your seatback upright and the lap belt snug and low across the hips.



To reduce the risk of injury, make sure children sit where they can be properly restrained.





Never let a passenger hold a child on his or her lap while the vehicle is moving. The passenger cannot protect the child from injury in a collision.





## Seating and safety restraints

 All occupants of the vehicle, including the driver, should always properly wear their safety belts, even when an air bag SRS is provided.

 It is extremely dangerous to ride in a cargo area, inside or outside of a vehicle. In a collision, people riding in these areas are more likely to be seriously injured or killed. Do not allow people to ride in any area of your vehicle that is not equipped with seats and safety belts. Be sure everyone in your vehicle is in a seat and using a safety belt properly.

 In a rollover crash, an unbelted person is significantly more likely to die than a person wearing a seat belt.

 Each seating position in your vehicle has a specific safety belt assembly which is made up of one buckle and one tongue that are designed to be used as a pair. 1) Use the shoulder belt on the outside shoulder only. Never wear the shoulder belt under the arm. 2) Never swing the safety belt around your neck over the inside shoulder. 3) Never use a single belt for more than one person.

 Always transport children 12 years old and under in the back seat and always properly use appropriate child restraints.

### Combination lap and shoulder belts

1. Insert the belt tongue into the proper buckle (the buckle closest to the direction the tongue is coming from) until you hear a snap and feel it latch. Make sure the tongue is securely fastened in the buckle.

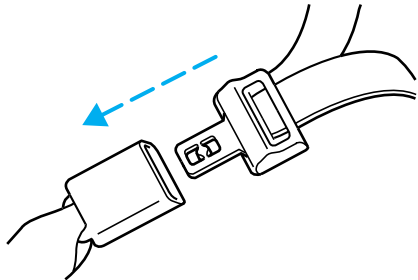

## Seating and safety restraints

2. To unfasten, push the release button and remove the tongue from the buckle.

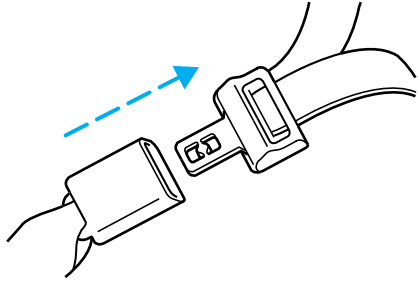

The front and rear outboard safety restraints in the vehicle are combination lap and shoulder belts. The front passenger and rear seat outboard safety belts have two types of locking modes described below:

### Energy management retractors

Your vehicle has a seat belt system equipped with energy management retractors at the driver and front outboard passenger seating positions.

An energy management retractor is a device which pays out webbing in a controlled manner. This feature is designed to help further reduce the risk of force-related injuries to the occupant.

Seat belt systems equipped with an energy management retractor must be replaced if they were in use during a frontal collision which resulted in deployment of the frontal air bags. Refer to the *Safety belt maintenance* section in this chapter.



In the event of a collision resulting in the deployment of the front air bags, the front safety belts must be replaced if they were in use.



After any vehicle collision, the seat belt system at all outboard seating positions (except driver, which has no “automatic locking retractor” feature) must be checked by a qualified technician to verify that the “automatic locking retractor” feature for child seats is still functioning properly. In addition, all seat belts should be checked for proper function.

## Seating and safety restraints



BELT AND RETRACTOR ASSEMBLY MUST BE REPLACED if the seat belt assembly “automatic locking retractor” feature or any other seat belt function is not operating properly when checked according to the procedures in Workshop Manual.



Failure to replace the Belt and Retractor assembly could increase the risk of injury in collisions.

### Vehicle sensitive mode

The vehicle sensitive mode is the normal retractor mode, allowing free shoulder belt length adjustment to your movements and locking in response to vehicle movement. For example, if the driver brakes suddenly or turns a corner sharply, or the vehicle receives an impact of approximately 8 km/h (5 mph) or more, the combination safety belts will lock to help reduce forward movement of the driver and passengers.

### Automatic locking mode

In this mode, the shoulder belt is automatically pre-locked. The belt will still retract to remove any slack in the shoulder belt.

The automatic locking mode is not available on the driver safety belt.

### When to use the automatic locking mode

- **Anytime** a child safety seat is installed in the vehicle. Children 12 years old and under should be properly restrained in the rear seat whenever possible. Refer to *Safety Restraints for Children* or *Safety Seats for Children* later in this chapter.

## Seating and safety restraints

### **How to use the automatic locking mode**

- Buckle the combination lap and shoulder belt.

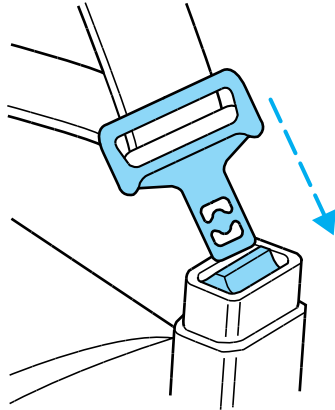

- Grasp the shoulder portion and pull downward until the entire belt is extracted.



- Allow the belt to retract. As the belt retracts, you will hear a clicking sound. This indicates the safety belt is now in the automatic locking mode.

### **How to disengage the automatic locking mode**

Disconnect the combination lap/shoulder belt and allow it to retract completely to disengage the automatic locking mode and activate the vehicle sensitive (emergency) locking mode.

## Seating and safety restraints



After any vehicle collision, the seat belt system at all outboard seating positions (except driver, which has no “automatic locking retractor” feature) must be checked by a qualified technician to verify that the “automatic locking retractor” feature for child seats is still functioning properly. In addition, all seat belts should be checked for proper function.



**BELT AND RETRACTOR ASSEMBLY MUST BE REPLACED** if the seat belt assembly “automatic locking retractor” feature or any other seat belt function is not operating properly when checked according to the procedures in Workshop Manual.



Failure to replace the Belt and Retractor assembly could increase the risk of injury in collisions.

### Safety belt pretensioner

Your vehicle is equipped with safety belt pretensioners at the driver and front outboard passenger seating positions.

The safety belt pretensioners are designed to activate only when the safety belts are fastened during certain frontal or near-frontal collisions with sufficient longitudinal deceleration. A safety belt pretensioner is a device which tightens the webbing of the lap and shoulder belts in such a way that they fit more snugly against the body.

The driver and front outboard passenger safety belt system (including retractors, buckles and height adjusters) must be replaced if the vehicle is involved in a collision that results in the activation of the safety belt pretensioners. Refer to the *Safety belt maintenance* section in this chapter.

### Safety belt usage sensors

The driver and front outboard passenger safety belt buckles are equipped with sensors that detect if the safety belts are fastened. The sensors provide information to the Personal Safety System which can then adapt the air bag deployment or safety belt pretensioner activation based upon safety belt usage.

## Seating and safety restraints

 The Personal Safety System provides the most benefit to belted occupants. The system monitors and tailors the air bag deployment based upon safety belt usage. Failure to properly wear your safety belt will increase your risk of injury.

### Front safety belt height adjustment

Your vehicle has safety belt height adjustments for the driver and front passenger. Adjust the height of the shoulder belt so the belt rests across the middle of your shoulder.

To lower the shoulder belt height, pull the control down and slide the height adjuster down. To raise the height of the shoulder belt, slide the height adjuster up. Pull down on the height adjuster to make sure it is locked in place.

 Position the shoulder belt height adjusters so that the belt rests across the middle of your shoulder. Failure to adjust the safety belt properly could reduce the effectiveness of the seat belt and increase the risk of injury in a collision.

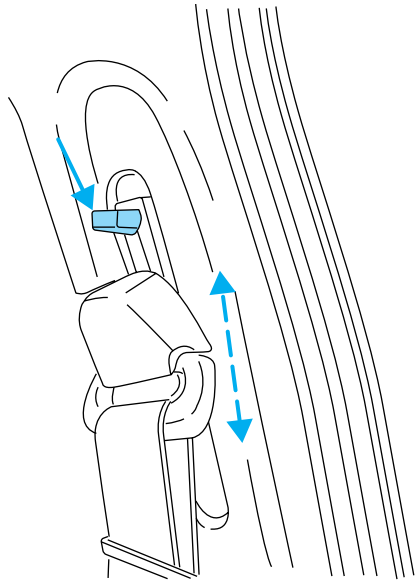

## Seating and safety restraints

### Lap belts

#### **Adjusting the lap belt**

The lap belt does not adjust automatically.



The lap belts should fit snugly and as low as possible around the hips, not around the waist.

Insert the tongue into the correct buckle (the buckle closest to the direction the tongue is coming from). To lengthen the belt, turn the tongue at a right angle to the belt and pull across your lap until it reaches the buckle. To tighten the belt, pull the loose end of the belt through the tongue until it fits snugly across the hips.

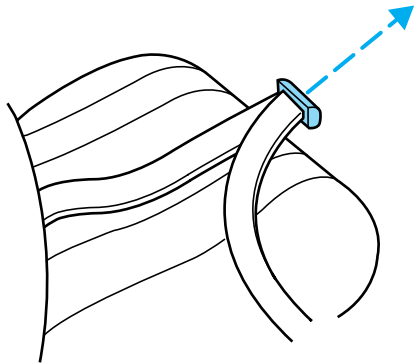

Shorten and fasten the belt when not in use.

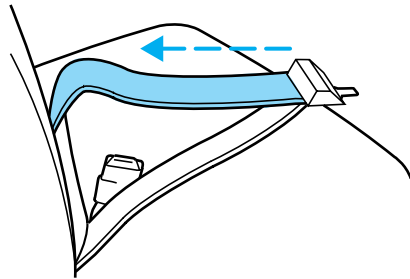

## Seating and safety restraints

### Safety belts for rear-facing occupants (wagon only)



Never use child safety seats in the third seat of a wagon.

Your vehicle is equipped with safety belts containing an adjust tongue at the rear-facing seating positions.

When the adjust tongue of the lap/shoulder combination seat belt is latched into the buckle, the tongue will allow the lap portion to become shorter, but locks the webbing in place to restrict it from becoming longer.

Before you reach and latch a combination lap and shoulder belt having an adjust tongue into the buckle, you may have to lengthen the lap belt portion of it. To lengthen the lap belt, pull some webbing out of the shoulder belt retractor. While holding the webbing below the tongue, grasp the tongue so that it is parallel to the webbing and slide the tongue upward. Provide enough length so that the tongue can reach the buckle.

To fasten the belt, pull the combination lap and shoulder belt from the retractor so that the shoulder belt portion of the safety belt crosses your shoulder and chest. Be sure the belt is not twisted. If the belt is twisted, remove the twist. Insert the tongue into the proper buckle for your seating position until you hear a snap and feel it latch. Make sure the tongue is securely fastened to the buckle by pulling on the tongue.



The lap belts should fit snugly and as low as possible around the hips, not around the waist.



Front and rear seat occupants, including pregnant women, should wear safety belts for optimum protection in an accident.



Each seating position in your vehicle has a specific safety belt assembly which is made up of one buckle and one tongue that are designed to be used as a pair. 1) Use the shoulder belt on the outside shoulder only. Never wear the shoulder belt under the arm. 2) Never swing the safety belt around your neck over the inside shoulder. 3) Never use a single belt for more than one person.

Due to folding rear seats, sometimes the buckles and tongues toward the center of the vehicle may be hidden by the rear edge of the seat cushion. Pull them out so they will be accessible.



## Seating and safety restraints

While you are fastened in the seat belt, the shoulder belt adjusts to your movement. However, if you brake hard, turn hard or your vehicle receives an impact of 8 km/h (5 mph) or more, the safety belt will become locked and help reduce your forward movement.

To unfasten the belt, push the red release button on the end of the buckle. This allows the tongue to unlatch from the buckle. While the belt retracts, guide the tongue to its original position to prevent it from striking you or the vehicle.

### Safety belt extension assembly

If the safety belt assembly is too short, even when fully extended, 20 cm (8 inches) can be added to the safety belt assembly by adding a safety belt extension assembly (part number 611C22). Safety belt extension assemblies can be obtained from your dealer at no cost.

Use only extensions manufactured by the same supplier as the safety belt. Manufacturer identification is located at the end of the webbing on the label. Also, use the safety belt extension only if the safety belt is too short for you when fully extended. Do not use extensions to change the fit of the shoulder belt across the torso.

### Safety belt warning light and indicator chime

The seat belt warning light illuminates in the instrument cluster and a chime sounds to remind the occupants to fasten their safety belts.

### Conditions of operation

If...	Then...
The driver's safety belt is not buckled before the ignition switch is turned to the ON position...	The safety belt warning light illuminates 1-2 minutes and the warning chime sounds 4-8 seconds.
The driver's safety belt is buckled while the indicator light is illuminated and the warning chime is sounding...	The safety belt warning light and warning chime turn off.
The driver's safety belt is buckled before the ignition switch is turned to the ON position...	The safety belt warning light and indicator chime remain off.

## Seating and safety restraints

### Belt minder (if equipped)

The Belt Minder feature is a supplemental warning to the safety belt warning function. This feature provides additional reminders to the driver that the driver's safety belt is unbuckled by intermittently sounding a chime and illuminating the safety belt warning lamp in the instrument cluster.

If...	Then...
The driver's safety belt is not buckled before the vehicle has reached at least 5 km/h (3 mph) and 1-2 minutes have elapsed since the ignition switch has been turned to ON...	The Belt Minder feature is activated - the safety belt warning light illuminates and the warning chime sounds for 6 seconds every 30 seconds, repeating for approximately 5 minutes or until safety belt is buckled.
The driver's safety belt is buckled while the safety belt indicator light is illuminated and the safety belt warning chime is sounding...	The Belt Minder feature will not activate.
The driver's safety belt is buckled before the ignition switch is turned to the ON position...	The Belt Minder feature will not activate.

The purpose of the Belt Minder is to remind occasional wearers to wear safety belts all of the time.

## Seating and safety restraints

The following are reasons most often given for not wearing safety belts:  
(All statistics based on U.S. data)

Reasons given...	Consider...
"Crashes are rare events"	<b>36 700 crashes occur every day.</b> The more we drive, the more we are exposed to "rare" events, even for good drivers. <i>1 in 4 of us will be seriously injured in a crash during our lifetime.</i>
"I'm not going far"	<b>3 of 4</b> fatal crashes occur within <b>25</b> miles of home.
"Belts are uncomfortable"	Ford designs its safety belts to enhance comfort. If you are uncomfortable - try different positions for the safety belt upper anchorage and seatback which should be as upright as possible; this can improve comfort.
"I was in a hurry"	<b>Prime time for an accident.</b> Belt Minder reminds us to take a few seconds to buckle up.
"Seat belts don't work"	<b>Safety belts</b> , when used properly, <b>reduce risk of death</b> to front seat occupants by <b>45% in cars</b> , and by <b>60% in light trucks</b> .
"Traffic is light"	<b>Nearly 1 of 2 deaths occur in single-vehicle crashes</b> , many when no other vehicles are around.
"Belts wrinkle my clothes"	Possibly, but a serious crash can do much more than wrinkle your clothes, particularly if you are unbelted.
"The people I'm with don't wear belts"	Set the example, teen deaths occur 4 times more often in vehicles with TWO or MORE people. Children and younger brothers/sisters imitate behavior they see.
"I have an air bag"	Air bags offer greater protection when used with safety belts. Frontal airbags are not designed to inflate in rear and side crashes or rollovers.
"I'd rather be thrown clear"	Not a good idea, <b>people</b> who are <b>ejected are 40 times more likely to DIE</b> . Safety belts help prevent ejection, WE CAN'T "PICK OUR CRASH".



Do not sit on top of a buckled safety belt to avoid the Belt Minder chime. Sitting on the safety belt will increase risk of injury in an accident. To disable (one-time) or deactivate the Belt Minder feature please follow the directions stated below.

## Seating and safety restraints

### **One time disable**

Anytime the safety belt is buckled and then unbuckled during an ignition ON cycle, Belt Minder will be disabled for that ignition cycle only. The safety belt needs to be latched for a minimum of 3 seconds before belt minder is disabled.

### **Deactivating/activating the belt minder feature**

*Read steps 1 - 9 thoroughly before proceeding with the deactivation/activation programming procedure.*

The Belt Minder feature can be deactivated/activated by performing the following procedure:

Before following the procedure, make sure that:

- the parking brake is set
- the gearshift is in P (Park) (automatic transmission).
- the ignition switch is in the OFF position
- all vehicle doors are closed
- the driver's safety belt is unbuckled
- the parklamps/headlamps are in OFF position (If vehicle is equipped with Autolamps, this will not affect the procedure.)



To reduce the risk of injury, do not deactivate/activate the Belt Minder feature while driving the vehicle.

1. Turn the ignition switch to the RUN (or ON) position. (DO NOT START THE ENGINE)
2. Wait until the safety belt warning light turns off. (Approximately 1–2 minutes)
  - Steps 3–5 must be completed within 60 seconds or the procedure will have to be repeated.
3. Buckle then unbuckle the safety belt three times, ending with the safety belt unbuckled. This can be done before or during Belt Minder warning activation.
4. Turn on the parklamps/headlamps, turn off the parklamps/headlamps.
5. Buckle then unbuckle the safety belt three times, ending with the safety belt unbuckled.

## Seating and safety restraints

- After step 5 the safety belt warning light will be turned on for three seconds.
- 6. Within seven seconds of the safety belt warning light turning off, buckle then unbuckle the safety belt.
  - This will disable Belt Minder if it is currently enabled, or enable Belt Minder if it is currently disabled.
- 7. Confirmation of disabling Belt Minder is provided by flashing the safety belt warning light four times per second for three seconds.
- 8. Confirmation of enabling Belt Minder is provided by flashing the safety belt warning light four times per second for three seconds, followed by three seconds with the safety belt warning light off, then followed by flashing the safety belt warning light four times per second for three seconds again.
- 9. After receiving confirmation, the deactivation/activation procedure is complete.

### Safety belt maintenance

Inspect the safety belt systems periodically to make sure they work properly and are not damaged. Inspect the safety belts to make sure there are no nicks, wears or cuts, replacing if necessary. All safety belt assemblies, including retractors, buckles, front seat belt buckle assemblies, buckle support assemblies (slide bar-if equipped), shoulder belt height adjusters (if equipped), shoulder belt guide on seatback (if equipped), child safety seat tether bracket assemblies (if equipped), and attaching hardware, should be inspected after a collision. Ford recommends that all safety belt assemblies used in vehicles involved in a collision be replaced. However, if the collision was minor and a qualified technician finds that the belts do not show damage and continue to operate properly, they do not need to be replaced. Safety belt assemblies not in use during a collision should also be inspected and replaced if either damage or improper operation is noted.



Failure to inspect and if necessary replace the safety belt assembly under the above conditions could result in severe personal injuries in the event of a collision.

Refer to *Cleaning and maintaining the safety belts* in the *Maintenance and care* section.

## Seating and safety restraints

### AIR BAG SUPPLEMENTAL RESTRAINT SYSTEM

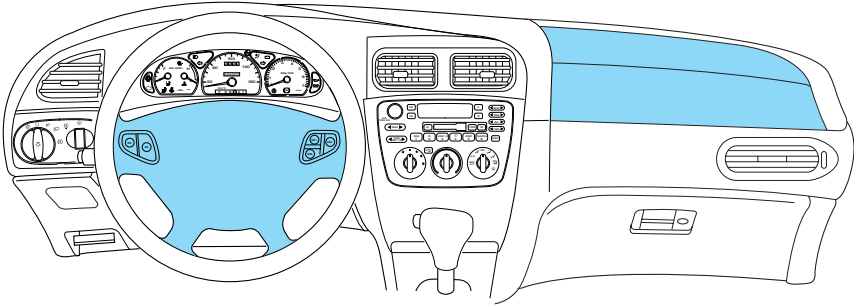

Your vehicle is equipped with a crash sensing and diagnostic module which records information about the air bag and sensor systems. In the event of a collision this module may save information related to the collision including information about the air bag system and impact severity. This information will assist Ford in the servicing of your vehicle and may help Ford better understand real world collisions and further improve the safety of future vehicles.

The air bag supplemental restraint system is designed to work in conjunction with the safety belts to help protect the driver and front outboard passenger from certain upper body injuries. The term “supplemental restraint” means the air bags are intended as a supplement to the safety belts. Air bags alone cannot protect as well as air bags plus safety belts in impacts for which the air bags are designed to deploy, and air bags do not offer any protection in crashes for which they do not deploy.

### HOW DO THE AIR BAG SUPPLEMENTAL RESTRAINTS WORK?

The air bag supplemental restraint system consists of:

- driver and passenger dual stage air bag modules (which include the inflators and air bags).
- side air bags (if equipped). Refer to *Side air bag system* later in this chapter.
- one or more impact and safing sensors.
- the same indicator light, RCM (restraints control module) and diagnostic unit used for the Personal safety system.

## Seating and safety restraints

The air bag supplemental restraints are an integral part of the Personal Safety System. They are designed to be deployed in cases where the Personal Safety System has determined the occupant conditions and crash severity are appropriate to activate these devices. Refer to the *Personal Safety System* section in this chapter.

### Important supplemental restraint system precautions

Air bags DO NOT inflate slowly or gently and the risk of injury from a deploying air bag is greatest close to the trim covering the air bag module.

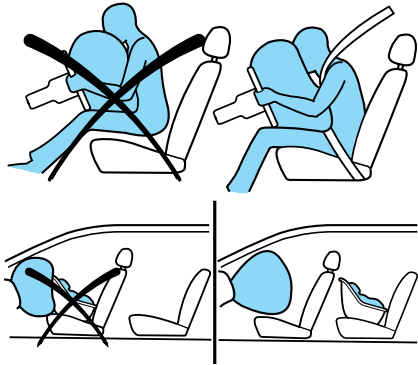

All occupants of the vehicle, including the driver, should always properly wear their safety belts, even when an air bag SRS is provided.



Always transport children 12 years old and under in the back seat and always properly use appropriate child restraints.



National Highway Traffic Safety Administration (NHTSA) recommends a minimum distance of at least 25 cm (10 inches) between an occupant's chest and the driver air bag module.



Never place your arm over the air bag module as a deploying air bag can result in serious arm fractures or other injuries.

Steps you can take to properly position yourself away from the airbag:

- Move your seat to the rear as far as you can while still reaching the pedals comfortably.

## Seating and safety restraints

- Recline the seat slightly (one or two degrees) from the upright position.

 Do not put anything on or over the air bag module. Placing objects on or over the air bag inflation area may cause those objects to be propelled by the air bag into your face and torso causing serious injury.

 Do not attempt to service, repair, or modify the Air Bag Supplemental Restraint System or its fuses. See your Ford or Lincoln-Mercury dealer.

 Modifications to the front end of the vehicle, including frame, bumper, front end body structure and tow hooks may effect the performance of the air bag sensors increasing the risk of injury. Do not modify the front end of the vehicle.

### Children and air bags

For additional important safety information, read all information on safety restraints in this guide.

Children must always be properly restrained. Accident statistics suggest that children are safer when properly restrained in the rear seating positions than in the front seating position. Failure to follow these instructions may increase the risk of injury in a collision.

 Air bags can kill or injure a child in a child seat. **NEVER** place a rear-facing child seat in front of an active air bag. If you must use a forward-facing child seat in the front seat, move the seat all the way back.

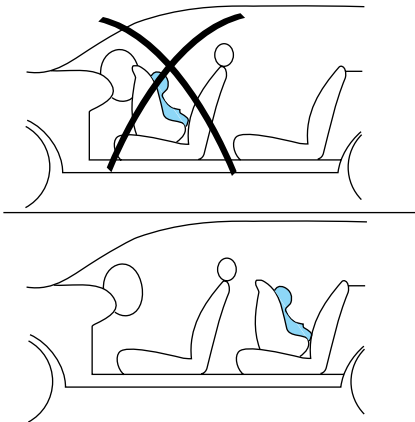



## Seating and safety restraints

### **Determining if the system is operational**

The supplemental restraint system uses a warning indicator in the instrument cluster or a back-up tone to indicate the condition of the system. Refer to the *Restraints Warning Indicator* section in the *Instrumentation* chapter. Routine maintenance of the air bag is not required.

A difficulty with the system is indicated by one or more of the following:

- The readiness light (same light for front and side air bag system) will either flash or stay lit.
- The readiness light will not illuminate immediately after ignition is turned on.
- A series of five beeps will be heard. The tone pattern will repeat periodically until the problem and light are repaired.



If any of these things happen, even intermittently, have the supplemental restraint system serviced at your dealership or by a qualified technician immediately. Unless serviced, the system may not function properly in the event of a collision.

### **How do the air bag supplemental restraints work?**

The air bags inflate and deflate rapidly upon activation. After air bag deployment, it is normal to notice a smoke-like, powdery residue or smell the burnt propellant. This may consist of cornstarch, talcum powder (to lubricate the bag) or sodium compounds (e.g., baking soda) that result from the combustion process that inflates the air bag. Small amounts of sodium hydroxide may be present which may irritate the skin and eyes, but none of the residue is toxic.



While the system is designed to help reduce serious injuries, contact with a deploying air bag may also cause abrasions, swelling or temporary hearing loss. Because air bags must inflate rapidly and with considerable force, there is the risk of death or serious injuries such as fractures,

## Seating and safety restraints

facial and eye injuries or internal injuries, particularly to occupants who are not properly restrained or are otherwise out of position at the time of air bag deployment. Thus, it is extremely important that occupants be properly restrained as far away from the air bag module as possible while maintaining vehicle control.



Several air bag system components get hot after inflation. Do not touch them after inflation.



If the air bag is deployed, **the air bag will not function again and must be replaced immediately.** If the air bag is not replaced, the unrepaired area will increase the risk of injury in a collision.

### Side air bag system (if equipped)



Do not place objects or mount equipment on or near the air bag cover on the side of the seatbacks of the front seats or in front seat areas that may come into contact with a deploying air bag. Failure to follow these instructions may increase the risk of personal injury in the event of a collision.



Do not use accessory seat covers. The use of accessory seat covers may prevent the deployment of the side air bags and increase the risk of injury in an accident.



Do not lean your head on the door. The side air bag could injure you as it deploys from the side of the seatback.



Do not attempt to service, repair, or modify the air bag Supplemental Restraint System, its fuses or the seat cover on a seat containing an air bag. See your Ford or Lincoln Mercury dealer.



All occupants of the vehicle including the driver should always wear their safety belts even when an air bag SRS is provided.

## Seating and safety restraints

### ***How does the side air bag system work?***

The side air bag system consists of the following:

- An inflatable nylon bag (air bag) with a gas generator concealed behind the outboard bolster of the driver and front passenger seatbacks.
- A special seat cover designed to allow airbag deployment.
- The same warning light, electronic control and diagnostic unit as used for the front air bags.
- Two crash sensors located under the outboard side of the front seats, attached to the floor.

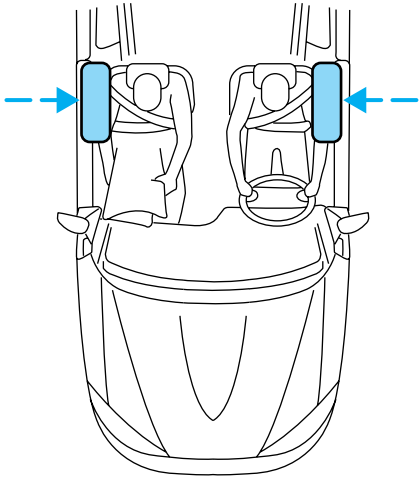

Side air bags, in combination with seat belts, can help reduce the risk of severe injuries in the event of a significant side impact collision.

The side air bags are fitted on the outboard side of the seatbacks of the front seats. In certain lateral collisions, the air bag on the side affected by the collision will be inflated, even if the respective seat is not occupied. The air bag was designed to inflate between the door panel and occupant to further enhance the protection provided occupants in side impact collisions.

The air bag SRS is designed to activate when the vehicle sustains lateral deceleration sufficient to cause the sensors to close an electrical circuit that initiates air bag inflation.

The fact that the air bags did not inflate in a collision does not mean that something is wrong with the system. Rather, it means the forces were not of the type sufficient to cause activation. Side air bags are designed to inflate in side-impact collisions, not roll-over, rear-impact, frontal or near-frontal collisions, unless the collision causes sufficient lateral deceleration.

## Seating and safety restraints

 Several air bag system components get hot after inflation. Do not touch them after inflation.

 If the side air bag has deployed, **the air bag will not function again. The side air bag system (including the seat) must be inspected and serviced by a qualified technician in accordance with the vehicle service manual.** If the air bag is not replaced, the unrepaired area will increase the risk of injury in a collision.

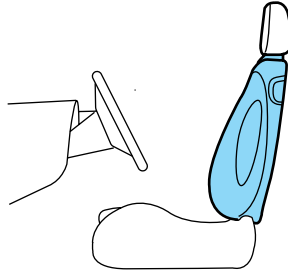

### Disposal of air bags and air bag equipped vehicles

For disposal of air bags or air bag equipped vehicles, see your local dealership or qualified technician. Air bags **MUST BE** disposed of by qualified personnel.

### SAFETY RESTRAINTS FOR CHILDREN

See the following sections for directions on how to properly use safety restraints for children. Also see *Air Bag Supplemental Restraint System (SRS)* in this chapter for special instructions about using air bags.

#### Important child restraint precautions

You are required by law to use safety restraints for children in the U.S. and Canada. If small children ride in your vehicle (generally children who are four years old or younger and who weigh 18 kg [40 lbs] or less), you must put them in safety seats made especially for children. Check your local and state or provincial laws for specific requirements regarding the safety of children in your vehicle.

## Seating and safety restraints



Never let a passenger hold a child on his or her lap while the vehicle is moving. The passenger cannot protect the child from injury in a collision.

Always follow the instructions and warnings that come with any infant or child restraint you might use.

When possible, always place children under age 12 in the rear seat of your vehicle. Accident statistics suggest that children are safer when properly restrained in the rear seating positions than in the front seating position.

### Children and safety belts

If the child is the proper size, restrain the child in a safety seat.

Children who are too large for child safety seats (as specified by your child safety seat manufacturer) should always wear safety belts.

Follow all the important safety restraint and air bag precautions that apply to adult passengers in your vehicle.

If the shoulder belt portion of a combination lap and shoulder belt can be positioned so it does not cross or rest in front of the child's face or neck, the child should wear the lap and shoulder belt. Moving the child closer to the center of the vehicle may help provide a good shoulder belt fit.



Do not leave children, unreliable adults, or pets unattended in your vehicle.

To improve the fit of lap and shoulder belts on children who have outgrown child safety seats, Ford recommends use of a belt-positioning booster seat that is labelled as conforming to all Federal motor vehicle safety standards. Belt-positioning booster seats raise the child and provide a shorter, firmer seating cushion that encourages safer seating posture and better fit of lap and shoulder belts on the child.

A belt-positioning booster should be used if the shoulder belt rests in front of the child's face or neck, or if the lap belt does not fit snugly on both thighs, or if the thighs are too short to let the child sit all the way back on the seat cushion when the lower legs hang over the edge of the seat cushion. You may wish to discuss the special needs of your child with your pediatrician.

## Seating and safety restraints

### SAFETY SEATS FOR CHILDREN



#### Child and infant or child safety seats

Use a safety seat that is recommended for the size and weight of the child. Carefully follow all of the manufacturer's instructions with the safety seat you put in your vehicle. If you do not install and use the safety seat properly, the child may be injured in a sudden stop or collision.

When installing a child safety seat:

- Review and follow the information presented in the *Air Bag Supplemental Restraint System* section in this chapter.
- Use the correct safety belt buckle for that seating position.
- Insert the belt tongue into the proper buckle until you hear a snap and feel it latch. Make sure the tongue is securely fastened in the buckle.
- Keep the buckle release button pointing up and away from the safety seat, with the tongue between the child seat and the release button, to prevent accidental unbuckling.
- Place seat back in upright position.
- Put the safety belt in the automatic locking mode. Refer to *Automatic locking mode*.

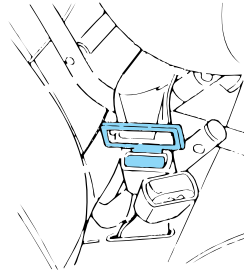

Ford recommends the use of a child safety seat having a top tether strap. Install the child safety seat in a seating position which is capable

## Seating and safety restraints

of providing a tether anchorage. For more information on top tether straps, refer to *Attaching safety seats with tether straps*.

 Carefully follow all of the manufacturer's instructions included with the safety seat you put in your vehicle. If you do not install and use the safety seat properly, the child may be injured in a sudden stop or collision.

### Installing child safety seats in combination lap and shoulder belt seating positions

 Air bags can kill or injure a child in a child seat. **NEVER** place a rear-facing child seat in front of an active air bag. If you must use a forward-facing child seat in the front seat, move the seat all the way back.

1. Position the child safety seat in a seat with a combination lap and shoulder belt.

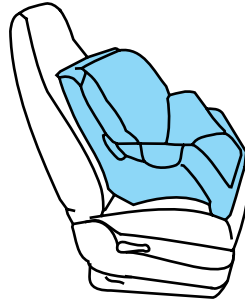

 Children 12 and under should be properly restrained in the rear seat whenever possible.

## Seating and safety restraints

2. Pull down on the shoulder belt and then grasp the shoulder belt and lap belt together.

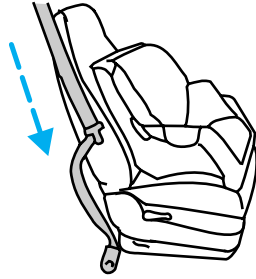

3. While holding the shoulder and lap belt portions together, route the tongue through the child seat according to the child seat manufacturer's instructions. Be sure the belt webbing is not twisted.

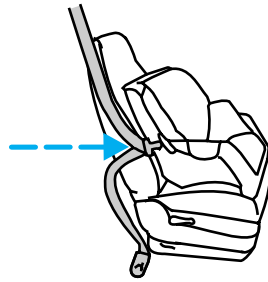

4. Insert the belt tongue into the proper buckle (the buckle closest to the direction the tongue is coming from) for that seating position until you hear a snap and feel the latch engage. Make sure the tongue is latched securely by pulling on it.

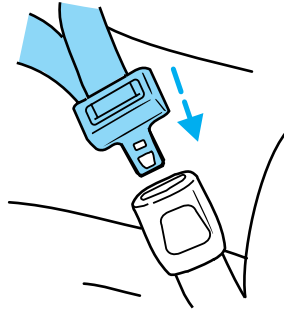



## Seating and safety restraints

5. To put the retractor in the automatic locking mode, grasp the shoulder portion of the belt and pull downward until all of the belt is extracted and a click is heard.

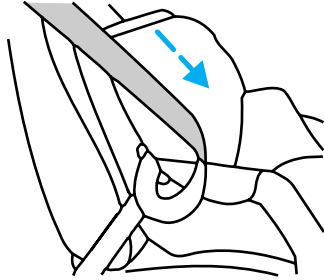

6. Allow the belt to retract. The belt will click as it retracts to indicate it is in the automatic locking mode.

7. Pull the lap belt portion across the child seat toward the buckle and pull up on the shoulder belt while pushing down with your knee on the child seat.

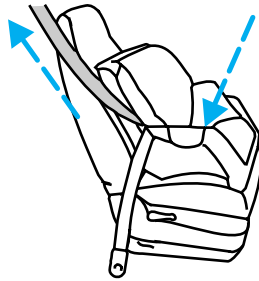

8. Allow the safety belt to retract to remove any slack in the belt.

9. Before placing the child in the seat, forcibly tilt the seat forward and back to make sure the seat is securely held in place.

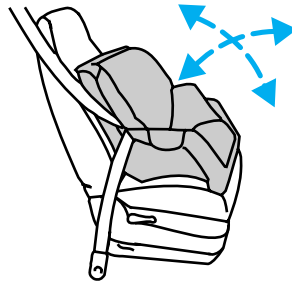

10. Try to pull the belt out of the retractor to make sure the retractor is in the automatic locking mode (you should not be able to pull more belt out). If the retractor is not locked, unbuckle the belt and repeat steps two through nine.

Check to make sure the child seat is properly secured before each use.

## Seating and safety restraints

### Installing child safety seats in the lap belt seating positions

1. Lengthen the lap belt. To lengthen the belt, hold the tongue so that its bottom is perpendicular to the direction of webbing while sliding the tongue up the webbing.
2. Place the child safety seat in the center seating position.
3. Route the tongue and webbing through the child seat according to the child seat manufacturer's instructions.
4. Insert the belt tongue into the proper buckle for the center seating position until you hear a snap and feel it latch. Make sure the tongue is securely fastened to the buckle by pulling on tongue.
5. Push down on the child seat while pulling on the loose end of the lap belt webbing to tighten the belt.
6. Before placing the child into the child seat, forcibly tilt the child seat from side to side and in forward direction to make sure that the seat is held securely in place. If the child seat moves excessively, repeat steps 5 through 6, or properly install the child seat in a different position.

### Attaching child safety seats with tether straps

Most new forward-facing child safety seats include a tether strap which goes over the back of the seat and hooks to an anchoring point. Tether straps are available as an accessory for many older safety seats. Contact the manufacturer of your child seat for information about ordering a tether strap.

The rear seats of your vehicle are equipped with built-in tether strap anchors located behind the seats as described below.

The tether anchors in your vehicle are either located under a cover marked with the tether anchor symbol (shown with title) or are recessed bars on the back side of the seatback.

The tether strap anchors in your vehicle are in the following positions (shown from top view):



Attach the tether strap only to the appropriate tether anchor as shown. The tether strap may not work properly if attached somewhere other than the correct tether anchor.

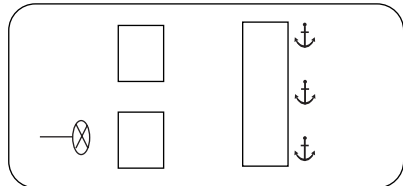

## Seating and safety restraints

1. Position the child safety seat on the passenger seat cushion.
2. Route the child safety seat tether strap over the back of the seat.

For vehicles with adjustable head restraints, route the tether strap under the head restraint and between the head restraint posts, otherwise route the tether strap over the top of the seatback.

3. Locate the correct anchor for the selected seating position.

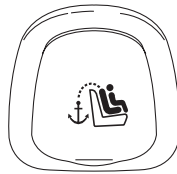

4. Open the tether anchor cover.

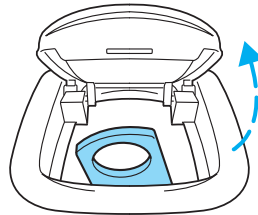

5. Clip the tether strap to the anchor as shown.



If the tether strap is clipped incorrectly, the child safety seat may not be retained properly in the event of a collision.

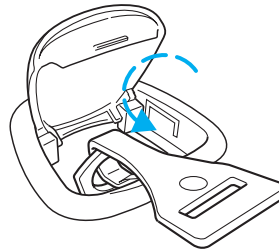

6. Refer to the *Installing child*

*safety seats in combination lap and shoulder belt seating positions* section of this chapter for further instructions to secure the child safety seat.

7. Tighten the child safety seat tether strap according to the manufacturer's instructions.



If the safety seat is not anchored properly, the risk of a child being injured in a collision greatly increases.

## Starting

### PREPARING TO START YOUR VEHICLE

Engine starting is controlled by the powertrain control system. This system meets all Canadian Interference-Causing Equipment standard requirements regulating the impulse electrical field strength of radio noise.

When starting a fuel-injected engine, avoid pressing the accelerator before or during starting. Only use the accelerator when you have difficulty starting the engine. For more information on starting the vehicle, refer to *Starting the engine* in this chapter.



Extended idling at high engine speeds can produce very high temperatures in the engine and exhaust system, creating the risk of fire or other damage.



Do not park, idle, or drive your vehicle in dry grass or other dry ground cover. The emission system heats up the engine compartment and exhaust system, which can start a fire.



Do not start your vehicle in a closed garage or in other enclosed areas. Exhaust fumes can be toxic. Always open the garage door before you start the engine. See *Guarding against exhaust fumes* in this chapter for more instructions.



If you smell exhaust fumes inside your vehicle, have your dealer inspect your vehicle immediately. Do not drive if you smell exhaust fumes.

### Important safety precautions

A computer system controls the engine's idle revolutions per minute (RPM). When the engine starts, the idle RPM runs faster to warm the engine. If the engine idle speed does not slow down automatically, have the vehicle checked. Do not allow the vehicle to idle for more than 10 minutes at the higher engine RPM.

Before starting the vehicle:

1. Make sure all vehicle occupants have buckled their safety belts. For more information on safety belts and their proper usage, refer to the *Seating and safety restraints* chapter.

## Starting

2. Make sure the headlamps and vehicle accessories are off.
3. Make sure the parking brake is set.

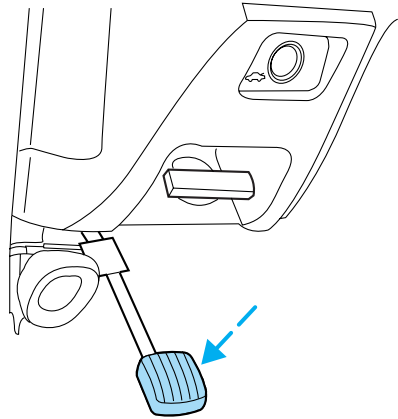

4. Make sure the gearshift is in P (Park).



5. Turn the key to 4 (ON) without turning the key to 5 (START).

If there is difficulty in turning the key, firmly rotate the steering wheel left and right until the key turns freely. This condition may occur when:

- front wheels are turned
- front wheel is against the curb
- steering wheel is turned when getting in or out of the vehicle

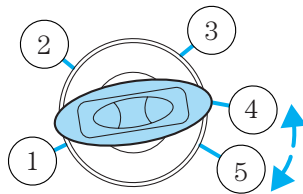

## Starting

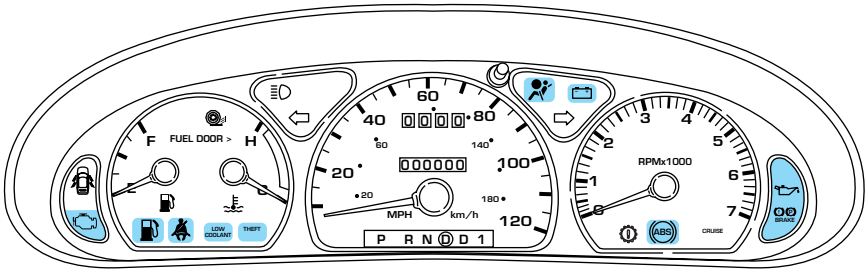

Make sure the corresponding lights illuminate briefly. If a light fails to illuminate, have the vehicle serviced.

- If the driver's safety belt is fastened, the  light may not illuminate.

### STARTING THE ENGINE

1. Turn the key to 5 (START) without pressing the accelerator pedal and release as soon as the engine starts. The key will return to 4 (ON).

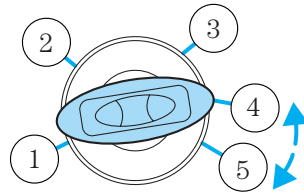

2. If the temperature is above  $-12^{\circ}\text{C}$  ( $10^{\circ}\text{F}$ ) and the engine does not start within five seconds on the first try, turn the key to OFF, wait 10 seconds and try again.

3. If the temperature is below  $-12^{\circ}\text{C}$  ( $10^{\circ}\text{F}$ ) and the engine does not start in 15 seconds on the first try, turn the key OFF and wait 10 seconds and try again. If the engine does not start in two attempts, Press the accelerator pedal all the way to floor and hold. Turn the key to START position.

4. When the engine starts, release the key, then release the accelerator pedal gradually as the engine speeds up.

5. After idling for a few seconds, apply the brake and release the parking brake.

### Cold weather starting (flexible fuel vehicles only)

As the outside temperature approaches freezing, ethanol fuel distributors should supply winter grade (E<sub>d</sub> 85) ethanol (same as with unleaded gasoline). If summer grade (E<sub>d</sub> 85) ethanol is used in cold weather conditions, you may experience increased cranking times, rough idle or hesitation until the engine has warmed up. Consult your fuel distributor for the availability of winter grade (E<sub>d</sub> 85) ethanol.

High-quality blends of winter grade (E<sub>d</sub> 85) ethanol will produce satisfactory cold weather starting and driving results. However, fuel composition varies, and sub-optimal winter grade blends could produce increased cranking times, rough idle or hesitation at temperatures below -18 degrees C (0 degrees F). If you experience this condition you may find that a different brand of winter grade (E<sub>d</sub> 85) (if available in your area) improves the performance of your vehicle.

Cold starting performance can also be improved with the use of an engine block heater. The engine block heater is available as a Ford option and can also be obtained from your Ford dealer. Consult the engine block heater section for proper use of the engine block heater.

If you should experience cold weather starting problems on (E<sub>d</sub> 85) ethanol, and neither an alternative brand of (E<sub>d</sub> 85) ethanol nor an engine block heater is available, the addition of unleaded gasoline to your tank will improve cold starting performance. Your vehicle is designed to operate on (E<sub>d</sub> 85) ethanol alone, unleaded gasoline alone, or any mixture of the two.

### ***If the engine fails to start using the preceding instructions***

1. Press the accelerator pedal 1/3 to 1/2 of the way to floor and hold.
2. Turn the key to START position.
3. When the engine starts, release the key, then release the accelerator pedal gradually as the engine speeds up.
4. If the engine still fails to start, repeat steps one through three.
5. After the engine starts, hold your foot on the brake pedal, put the gearshift lever in gear and release the parking brake. Slowly release the brake pedal and drive away in a normal manner.

### **Using the engine block heater (if equipped)**

An engine block heater warms the engine coolant, which improves starting, warms up the engine faster and allows the heater-defroster system to respond quickly. Use of an engine block heater is strongly recommended if you live in a region where temperatures reach -23°C (-10°F) or below.

For best results, plug the heater in at least three hours before starting the vehicle. Using the heater for longer than three hours will not harm the engine, so the heater can be plugged in the night before starting the vehicle.

## Starting



To prevent electrical shock, do not use your heater with ungrounded electrical systems or two-pronged (cheater) adapters.

### Guarding against exhaust fumes

Although odorless and colorless, carbon monoxide is present in exhaust fumes. Take precautions to avoid its dangerous effects.



If you ever smell exhaust fumes of any kind inside your vehicle, have your dealer inspect and fix your vehicle immediately. Do not drive if you smell exhaust fumes. These fumes are harmful and could kill you.

Have the exhaust and body ventilation systems checked whenever:

- the vehicle is raised for service.
- the sound of the exhaust system changes.
- the vehicle has been damaged in a collision.



Engine exhaust, some of its constituents, and certain vehicle components contain or emit chemicals known to the State of California to cause cancer, and birth defects or other reproductive harm.

### Important ventilating information

If the engine is idling while the vehicle is stopped in an open area for long periods of time, open the windows at least 2.5 cm (one inch).

Adjust the heating or air conditioning (if equipped) to bring in fresh air.

Improve vehicle ventilation by keeping all air inlet vents clear of snow, leaves and other debris.

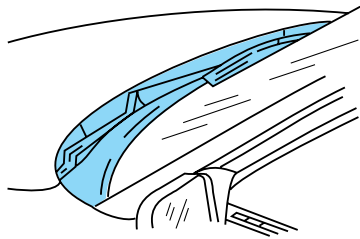



## BRAKES

Your service brakes are self-adjusting. Refer to the scheduled maintenance guide for scheduled maintenance.

Occasional brake noise is normal and often does not indicate a performance concern with the vehicle's brake system. In normal operation, automotive brake systems may emit occasional or intermittent squeal or groan noises when the brakes are applied. Such noises are usually heard during the first few brake applications in the morning; however, they may be heard at any time while braking and can be aggravated by environmental conditions such as cold, heat, moisture, road dust, salt or mud. If a "metal-to-metal," "continuous grinding" or "continuous squeal" sound is present while braking, the brake linings may be worn-out and should be inspected by a qualified service technician.

### Anti-lock brake system (ABS) (if equipped)

On vehicles equipped with an anti-lock braking system (ABS), a noise from the hydraulic pump motor and pulsation in the pedal may be observed during ABS braking events. Pedal pulsation coupled with noise while braking under panic conditions or on loose gravel, bumps, wet or snowy roads is normal and indicates proper functioning of the vehicle's anti-lock brake system. The ABS performs a self-check after you start the engine and begin to drive away. A brief mechanical noise may be heard during this test. This is normal. If a malfunction is found, the ABS warning light will come on. If the vehicle has continuous vibration or shudder in the steering wheel while braking, the vehicle should be inspected by a qualified service technician.

The ABS operates by detecting the onset of wheel lockup during brake applications and compensates for this tendency. The wheels are prevented from locking even when the brakes are firmly applied. The accompanying illustration depicts the advantage of an ABS equipped vehicle (on bottom) to a non-ABS equipped vehicle (on top) during hard braking with loss of front braking traction.

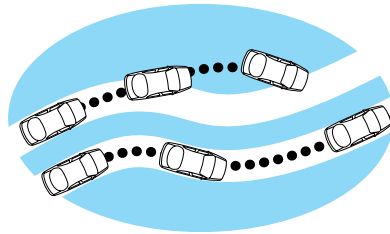

## Driving

### ABS warning lamp

The  warning lamp in the instrument cluster momentarily illuminates when the ignition is turned to the ON position. If the light does not illuminate momentarily at start up, remains on or continues to flash, the ABS needs to be serviced.

With the ABS light on, the anti-lock brake system is disabled and normal braking is still effective unless the brake warning light also remains illuminated with parking brake released. (If your brake warning lamp illuminates, have your vehicle serviced immediately.)



### Using ABS

- In an emergency or when maximum efficiency from the ABS is required, apply continuous force on the brake. The ABS will be activated immediately, thus allowing you to retain full steering control of your vehicle and, providing there is sufficient space, will enable you to avoid obstacles and bring the vehicle to a controlled stop.
- The Anti-Lock system does not decrease the time necessary to apply the brakes or always reduce stopping distance. Always leave enough room between your vehicle and the vehicle in front of you to stop.
- We recommend that you familiarize yourself with this braking technique. However, avoid taking any unnecessary risks.

### Parking brake (P)

Apply the parking brake whenever the vehicle is parked. To set the parking brake, press the parking brake pedal down until the pedal stops.

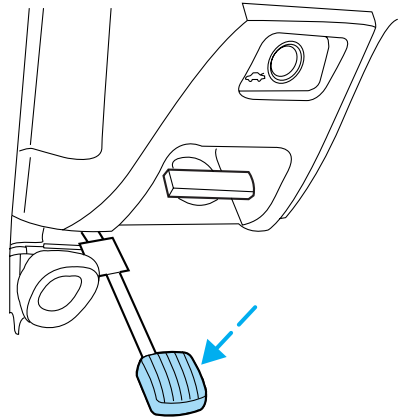

The BRAKE warning lamp in the instrument cluster illuminates and remains illuminated (when the ignition is turned ON) until the parking brake is released.



Always set the parking brake fully and make sure that the gearshift is securely latched in P (Park).

The parking brake is not recommended to stop a moving vehicle. However, if the normal brakes fail, the parking brake can be used to stop your vehicle in an emergency. Since the parking brake applies only the rear brakes, the vehicle's stopping distance will increase greatly and the handling of your vehicle will be adversely affected.

## Driving

Pull the release lever to release the brake. Driving with the parking brake on will cause the brakes to wear out quickly and reduce fuel economy.

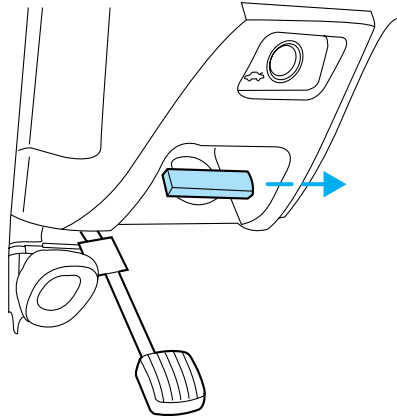

### TRACTION CONTROL™ (IF EQUIPPED)

Your vehicle may be equipped with the optional Traction Control™ system. This system helps you maintain the stability and steerability of your vehicle. It is especially useful on slippery and/or hilly road surfaces. The system operates by detecting and controlling wheel spin. The system borrows many of the electronic and mechanical elements already present in the anti-lock braking system (ABS).

Wheel-speed sensors allow excess front wheel spin to be detected by the Traction Control™ portion of the ABS computer. Any excessive wheel spin is controlled by automatically applying and releasing the front brakes in conjunction with engine torque reductions. Engine torque reduction is realized via the fully electronic spark and fuel injection systems. This process is very sensitive to driving conditions and very fast acting. The front wheels “search” for optimum traction several times a second and adjustments are made accordingly.

The Traction Control™ system will allow your vehicle to make better use of available traction on slippery surfaces. The system is a driver aid which makes your vehicle easier to handle primarily on snow, ice covered and gravel roads.

During Traction Control™ operation, the traction control active light will illuminate, you may hear an electric motor type of sound coming from

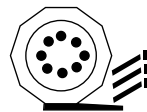

the engine compartment and the engine will not “rev-up” when you push further on the accelerator. This is normal system behavior.

The Traction Control™ on/off switch, located on the right side of the instrument cluster, illuminates OFF when the system is turned OFF. The Traction Control™ system will revert to the ON position every time the ignition is turned OFF and ON.

If you should become stuck in snow or ice or on a very slippery road surface, try switching the Traction Control™ system off. This may allow excess wheel spin to “dig” the vehicle out and enable a successful “rocking” maneuver.

If a system fault is detected the traction control active light will illuminate, the Traction Control™ on/off switch will not toggle on and off, and your vehicle should be serviced as soon as possible.

### STEERING

Your vehicle is equipped with power steering. Power steering uses energy from the engine to help steer the vehicle.

To prevent damage to the power steering pump:

- Never hold the steering wheel to the extreme right or the extreme left for more than a few seconds when the engine is running.
- Do not operate the vehicle with a low power steering pump fluid level (below the MIN mark on the reservoir).

If the power steering system breaks down (or if the engine is turned off), you can steer the vehicle manually, but it takes more effort.

If the steering wanders or pulls, the condition could be caused by any of the following:

- underinflated tire(s) on any wheel(s)
- high crown in center of road
- high crosswinds
- wheels out of alignment
- loose or worn components in steering linkage

## Driving

### AUTOMATIC TRANSAXLE OPERATION

#### Brake-shift interlock

This vehicle is equipped with a brake-shift interlock feature that prevents the gearshift lever from being moved from P (Park) when the ignition is in the ON position unless brake pedal is depressed.

If you cannot move the gearshift lever out of P (Park) with ignition in the ON position and the brake pedal depressed:

1. Apply the parking brake, turn ignition key to LOCK, then remove the key.
2. Insert the key and turn it to OFF. Apply the brake pedal and shift to N (Neutral).
3. Start the vehicle.

If it is necessary to use the above procedure to move the gearshift lever, it is possible that a fuse has blown or the vehicle's brakelamps are not operating properly. Refer to *Fuses and relays* in the *Roadside emergencies* chapter.



Do not drive your vehicle until you verify that the brakelamps are working.

If your vehicle gets stuck in mud or snow, it may be rocked out by shifting from forward and reverse gears while stopping between shifts, in a steady pattern. Press lightly on the accelerator in each gear. If necessary, try turning the Traction Control<sup>™</sup> system off. This will allow the wheels to spin, which may help to free your stuck vehicle. For more information, refer to *Traction Control<sup>™</sup> (if equipped)* in this chapter.

**Do not rock the vehicle if the engine is not at normal operating temperature or damage to the transaxle may occur.**

**Do not rock the vehicle for more than a few minutes or damage to the transaxle and tires may occur or the engine may overheat.**



Always set the parking brake fully and make sure the gearshift is latched in P (Park). Turn off the ignition whenever you leave your vehicle.

## Driving



If the parking brake is fully released, but the brake warning lamp remains illuminated, the brakes may not be working properly. See your dealer or a qualified service technician.

### Driving with an automatic overdrive transaxle

Your automatic transaxle electronically controls the shift feel by using an adaptive learning strategy. This feature is designed to optimize shift smoothness. It is normal for your transaxle to shift firmly during the first few hundred kilometers (miles) of operation until the adaptive strategy has been learned. The adaptive learning strategy is maintained by power from the battery. When the battery is disconnected or a new battery is installed, the transaxle must relearn its adaptive strategy. Optimal shifting will resume within a few hundred kilometers (miles) of operation.

Your automatic overdrive transaxle provides fully automatic operation in either **D** (Overdrive) or **D** (Drive). Driving with the shift selector in **D** (Overdrive) gives the best fuel economy for normal driving conditions. For manual control start in **1** (First) and then shift manually.

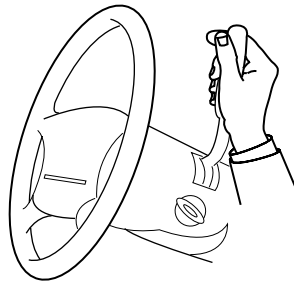

If your vehicle is equipped with a console mounted gearshift, you must press the thumb button on the side of the gearshift lever to move the gearshift lever from **P** (Park).

To put your vehicle in gear, start the engine, depress the brake pedal, then move the gearshift lever out of **P** (Park).

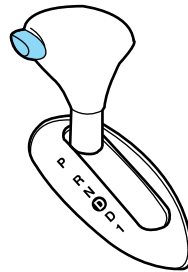

Hold the brake pedal down while you move the gearshift lever from **P** (Park) to another position. If you do not hold the brake pedal down, your vehicle may move unexpectedly and injure someone.

# Driving

## Understanding gearshift positions

### **P (Park)**

Always come to a complete stop before shifting into P (Park). Make sure the gearshift lever is securely latched in P (Park). This locks the transaxle and prevent the front wheels from rotating.

 Always set the parking brake fully and make sure the gearshift is latched in P (Park). Turn off the ignition whenever you leave your vehicle.

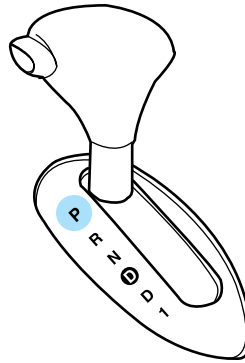

### **R (Reverse)**

With the gearshift lever in R (Reverse), the vehicle will move backward. You should always come to a complete stop before shifting into and out of R (Reverse).

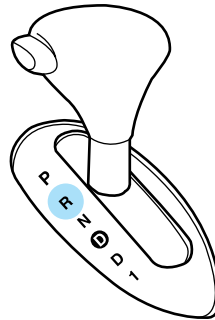



## **N (Neutral)**

With the gearshift lever in the N (Neutral) position, the vehicle can be started and is free to roll. Hold the brake pedal down while in this position.

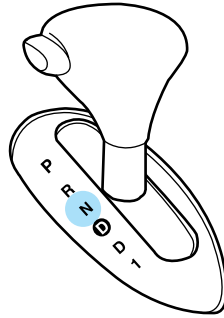

## **D (Overdrive)**

The **D** (Overdrive) position is the normal driving position for an automatic overdrive transaxle.

When in the **D** (Overdrive) position, the transaxle works the same way as when in D (Drive). However, when your vehicle cruises at a constant speed for any length of time, the transaxle shifts into a fourth gear (Overdrive) and allows the torque converter to lock-up.

Overdrive will increase your fuel economy when you travel at cruising speeds.

Overdrive may not be appropriate for certain terrains. If the transaxle shifts back and forth between third and fourth gears while you are driving on hilly roads, or if your vehicle requires additional power for climbing hills, shift into D (Drive).

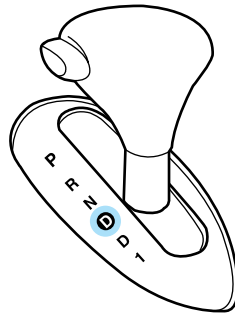

# Driving

## **When to use D (Drive)**

The D (Drive) position eliminates the needless shifting back and forth between third and fourth gears that your vehicle may do when driving on hilly terrain. It also gives more engine braking than overdrive to slow your vehicle on downgrades.

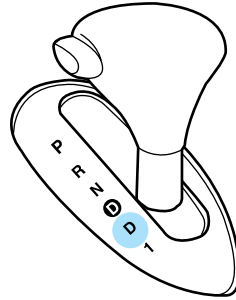

## **1 (First)**

Use 1 (First) for when added engine braking is desired when descending steep hills.

The automatic transaxle will shift to the proper gear to ascend any grade without any need to shift to 1 (First).

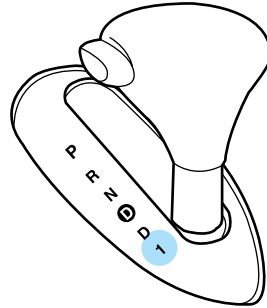

Do not go faster than 61 km/h (38 mph) when in this gear. You can upshift from 1 (First) to overdrive at any time.



When parking, do not use the gearshift in place of the parking brake. Always set the parking brake fully and make sure that the gearshift is securely latched in Park (P). Turn off the ignition whenever you leave your vehicle. Never leave your vehicle unattended while it is running. If you do not take these precautions, your vehicle may move unexpectedly and injure someone.

### VEHICLE LOADING

Before loading a vehicle, familiarize yourself with the following terms:

- **Base Curb Weight:** Weight of the vehicle including any standard equipment, fluids, lubricants, etc. It does not include passengers or aftermarket equipment.
- **Payload:** Combined maximum allowable weight of cargo, passengers and optional equipment. The payload equals the gross vehicle weight rating minus base curb weight.
- **GVW (Gross Vehicle Weight):** Base curb weight plus payload weight. The GVW is not a limit or a specification.
- **GVWR (Gross Vehicle Weight Rating):** Maximum total weight of the base vehicle, passengers, optional equipment and cargo. The GVWR is specific to each vehicle and is listed on the Safety Certification Label on the driver's door pillar.
- **GAWR (Gross Axle Weight Rating):** Carrying capacity for each axle system. The GAWR is specific to each vehicle and is listed on the Safety Certification Label on the driver's door pillar.
- **GCW (Gross Combined Weight):** The combined weight of the towing vehicle (including passengers and cargo) and the trailer.
- **GCWR (Gross Combined Weight Rating):** Maximum combined weight of towing vehicle (including passengers and cargo) and the trailer. The GCWR indicates the maximum loaded weight that the vehicle is designed to tow.
- **Maximum Trailer Weight Rating:** Maximum weight of a trailer the vehicle is permitted to tow. The maximum trailer weight rating is determined by subtracting the vehicle curb weight for each engine/transmission combination, any required option weight for trailer towing and the weight of the driver from the GCWR for the towing vehicle.

## Driving

- **Maximum Trailer Weight:** Maximum weight of a trailer the loaded vehicle (including passengers and cargo) is permitted to tow. It is determined by subtracting the weight of the loaded trailer towing vehicle from the GCWR for the towing vehicle.
- **Trailer Weight Range:** Specified weight range that the trailer must fall within that ranges from zero to the maximum trailer weight rating.

Remember to figure in the tongue load of your loaded trailer when figuring the total weight.



Do not exceed the GVWR or the GAWR specified on the certification label.

Do not use replacement tires with lower load carrying capacities than the originals because they may lower the vehicle's GVWR and GAWR limitations. Replacement tires with a higher limit than the originals do not increase the GVWR and GAWR limitations.

The Safety Certification Label, found on the driver's door pillar, lists several important vehicle weight rating limitations. Before adding any additional equipment, refer to these limitations. If you are adding weight to the front of your vehicle, (potentially including weight added to the cab), the weight added should not exceed the front axle reserve capacity (FARC). Additional frontal weight may be added to the front axle reserve capacity provided you limit your payload in other ways (i.e. restrict the number of passengers or amount of cargo carried).

You may add equipment throughout your vehicle if the total weight added is equal to or less than the total axle reserve capacity (TARC) weight. You should NEVER exceed the total axle reserve capacity.

Always ensure that the weight of passengers, cargo and equipment being carried is within the weight limitations that have been established for your vehicle including both gross vehicle weight and Front and rear gross axle weight rating limits. Under no circumstance should these limitations be exceeded. Exceeding any vehicle weight rating limitation could result in serious damage to the vehicle and/or personal injury.

### DRIVING THROUGH WATER

Do not drive quickly through standing water, especially if the depth is unknown. Traction or brake capability may be limited and if the ignition system gets wet, your engine may stall. Water may also enter your engine's air intake and severely damage your engine.

## Driving

If driving through deep or standing water is unavoidable, proceed very slowly. Never drive through water that is higher than the bottom of the hubs (for trucks) or the bottom of the wheel rims (for cars).

Once through the water, always try the brakes. Wet brakes do not stop the vehicle as effectively as dry brakes. Drying can be improved by moving your vehicle slowly while applying light pressure on the brake pedal.

**Driving through deep water where the transmission vent tube is submerged may allow water into the transmission and cause internal transmission damage.**

### TRAILER TOWING

Your vehicle is classified as a light duty towing vehicle. The amount of weight you can safely tow depends on the type of engine you have in your vehicle. Your vehicle does not come from the factory fully equipped to tow. No towing packages are available through Ford or Mercury/Lincoln dealers. Do not tow a trailer until your vehicle has been driven at least 800 km (500 miles). If towing with a station wagon, inflate the rear tires to 35 psi.

Towing a trailer places an additional load on your vehicle's engine, transaxle, brakes, tires and suspension. Inspect these components carefully after towing.

In order to identify your vehicle's engine, refer to *Identifying components in the engine compartment* in the Maintenance and Care chapter.

The amount of weight that you can tow depends on the type of engine in your vehicle. See the following charts:

<b>3.0L 2-Valve Vulcan Engine</b>			
<b>Model</b>	<b>Passenger Load - #/kg (lbs.)</b>	<b>Luggage Load - kg (lbs.)</b>	<b>Max Trailer Wt.- kg (lbs.)</b>
Sedan	5/340 (750)	0	365 (800)
	4/270 (600)	70 (150)	365 (800)
	2/135 (300)	70 (150)	500 (1 100)
	2/135 (300)	0	565 (1 250)
Wagon	4/270 (600)	0	365 (800)
	2/135 (300)	70 (150)	430 (950)
	2/135 (300)	0	500 (1 100)

The above chart is based on the specified vehicle at a maximum GCW (Vehicle weight + Trailer weight) equal to 2 245 kg (4 950 lbs.).

## Driving

3.0L 4-Valve Duratec Engine			
Model	Passenger Load - #/kg (lbs.)	Luggage Load - kg (lbs.)	Max Trailer Wt.- kg (lbs.)
Sedan	5/340 (750)	0	590 (1 300)
	2/135 (300)	70 (150)	725 (1 600)
	2/135 (300)	0	795 (1 750)
Wagon	5/340 (750)	70 (150)	455 (1 000)
	2/135 (300)	70 (150)	660 (1 450)
	2/135 (300)	0	725 (1 600)

The above chart is based on the specified vehicle at a maximum GCW (Vehicle weight + Trailer weight) equal to 2 470 kg (5 450 lbs.).



Do not exceed the GVWR or the GAWR specified on the certification label.



Towing trailers beyond the maximum recommended gross trailer weight exceeds the limit of the vehicle and could result in engine damage, transaxle damage, structural damage, loss of control, and personal injury.

### Preparing to tow

Use the proper equipment for towing a trailer, and make sure it is properly attached to your vehicle. See your dealer or a reliable trailer dealer if you require assistance.

### Hitches

Do not use hitches that clamp onto the vehicle bumper. Use a load carrying hitch. You must distribute the load in your trailer so that 10% of the total weight of the trailer is on the tongue.

### Safety chains

Always connect the trailer's safety chains to the frame or hook retainers of the vehicle. To connect the trailer's safety chains, cross the chains under the trailer tongue and allow slack for turning corners.

If you use a rental trailer, follow the instructions that the rental agency gives to you.

**Do not attach safety chains to the bumper.**

### **Trailer brakes**

Electric brakes and manual, automatic or surge-type trailer brakes are safe if installed properly and adjusted to the manufacturer's specifications. The trailer brakes must meet local and Federal regulations.



Do not connect a trailer's hydraulic brake system directly to your vehicle's brake system. Your vehicle may not have enough braking power and your chances of having a collision greatly increase.

The braking system of the tow vehicle is rated for operation at the GVWR not GCWR.

### **Trailer lamps**

Trailer lamps are required on most towed vehicles. Make sure your trailer lamps conform to local and Federal regulations. See your dealer or trailer rental agency for proper instructions and equipment for hooking up trailer lamps.

### **Driving while you tow**

When towing a trailer:

- Ensure that you turn off your speed control. The speed control may shut off automatically when you are towing on long, steep grades.
- Consult your local motor vehicle speed regulations for towing a trailer.
- Use D (Drive) or a lower gear when towing up or down steep hills. This will eliminate excessive downshifting and upshifting for optimum fuel economy and transaxle cooling.
- Anticipate stops and brake gradually.

### **Servicing after towing**

If you tow a trailer for long distances, your vehicle will require more frequent service intervals. Refer to your scheduled maintenance guide for more information.

### **Trailer towing tips**

- Practice turning, stopping and backing up in an area before starting on a trip to get the feel of the vehicle trailer combination. When turning, make wider turns so the trailer wheels will clear curbs and other obstacles.

## Driving

- Allow more distance for stopping with a trailer attached.
- The trailer tongue weight should be 10% of the loaded trailer weight.
- After you have traveled 80 km (50 miles), thoroughly check your hitch, electrical connections and trailer wheel lug nuts.
- When stopped in traffic for long periods of time in hot weather, place the gearshift in P (Park) and increase idle speed. This aids engine cooling and air conditioner efficiency.
- Vehicles with trailers should not be parked on a grade. If you must park on a grade, place wheel chocks under the trailer's wheels.

### Recreational towing

Follow these guidelines for your specific powertrain combination to tow your vehicle with all four wheels on the ground (such as behind a recreational vehicle).

These guidelines are designed to ensure that your transmission is not damaged due to insufficient lubrication.

#### ***All Front Wheel Drive (FWD) vehicles***

An example of recreational towing is towing your vehicle behind a Motorhome. The following recreational towing guidelines are designed to ensure that your transmission is not damaged. It is not recommended to tow front wheel drive vehicles with the front drive wheels on the ground. It is recommended to tow your vehicle with the drive wheels on a dolly or two wheel car hauling trailer.

In case of a roadside emergency with a disabled vehicle (without access to wheel dollies, car hauling trailer or flatbed transport vehicle) your vehicle can be flat towed (all wheels on the ground) under the following conditions:

- Place the transmission in N (Neutral).
- Maximum speed is 56 km/h (35 mph).
- Maximum distance is 80 km (50 miles).



### LUGGAGE RACK (IF EQUIPPED)

The rear crossbar can be adjusted to fit the item being carried. The front crossbar does not move. Do not load more than 44 kg (100 lbs.) on the luggage rack.

To adjust cross-bar position:

1. Loosen the thumbwheel at both ends of the cross-bar.
2. Slide the cross-bar to the desired location.
3. Tighten the thumbwheel at both ends of the cross-bar.

Use adjustable tie down loops to secure the load.

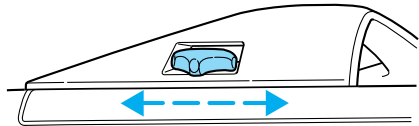

## Roadside emergencies

### GETTING ROADSIDE ASSISTANCE

To fully assist you should you have a vehicle concern, Ford offers a complimentary roadside assistance program. This program is separate from the New Vehicle Limited Warranty. The service is available:

- 24-hours, seven days a week
- for the Basic warranty period (Canada) or New Vehicle Limited Warranty period (U.S.) of three years or 60,000 km (36,000 miles), whichever comes first on Ford and Mercury vehicles, and four years or 80,000 km (50,000 miles) on Lincoln vehicles

Roadside assistance will cover:

- changing a flat tire
- jump-starts
- lock-out assistance
- fuel delivery
- towing of your disabled vehicle to the nearest Ford dealership, or your selling dealer if within 25 kms (15.5 miles) of the nearest Ford Dealership (one tow per disablement). Even non-warranty related tows, like accidents or getting stuck in the mud or snow, are covered (some exclusions apply, such as impound towing or repossession).

### Using roadside assistance

Complete the roadside assistance identification card and place it in your wallet for quick reference. In the United States, this card is found in the Owner Guide portfolio in the glove compartment in Ford vehicles and is mailed to you if you own a Mercury or Lincoln. In Canada, it is found in the Roadside Assistance book in the glove compartment.

To receive roadside assistance in the United States for Ford or Mercury vehicles, call 1-800-241-3673 or if you own a Lincoln vehicle, call 1-800-521-4140. In Canada call 1-800-665-2006.

Should you need to arrange roadside assistance for yourself, Ford will reimburse a reasonable amount. To obtain information about reimbursement, call 1-800-241-3673 in the United States for Ford or Mercury vehicles; or if you own a Lincoln vehicle, call 1-800-521-4140. Call 1-800-665-2006 in Canada.

## Roadside emergencies

### Roadside coverage beyond basic warranty

In the United States, you may purchase additional roadside assistance coverage beyond this period through the Ford Auto Club by contacting your Ford or Lincoln Mercury dealer.

Similarly in Canada, you may purchase additional coverage beyond the basic coverage period by consulting the Ford Roadside Assistance Club brochure or by calling 1-877-294-CLUB (1-877-894-2582).

### HAZARD FLASHER

Use only in an emergency to warn traffic of vehicle breakdown, approaching danger, etc. The hazard flashers can be operated when the ignition is off.

- The hazard lights control is located on top of the steering column.
- Depress hazard lights control to activate all hazard flashers simultaneously.
- Depress control again to turn the flashers off.

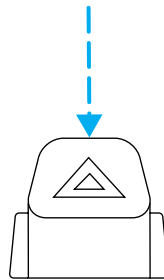

### RESETTING THE FUEL PUMP SHUT-OFF SWITCH

The fuel pump shut-off switch is a device intended to stop the electric fuel pump when your vehicle has been involved in a substantial jolt.

After a collision, if the engine cranks but does not start, the fuel pump shut-off switch may have been activated.

## Roadside emergencies

If your vehicle is a sedan, the fuel pump shut-off switch is located on the right side of the trunk behind the trunk liner.

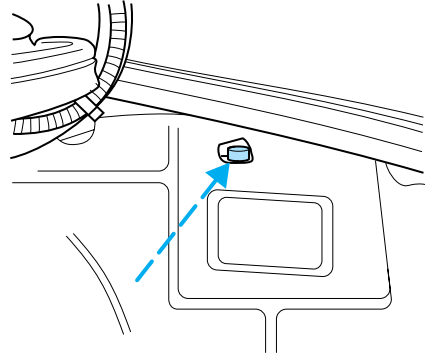

If your vehicle is a wagon, the fuel pump shut-off switch is located behind the service panel on the right side of the cargo area.

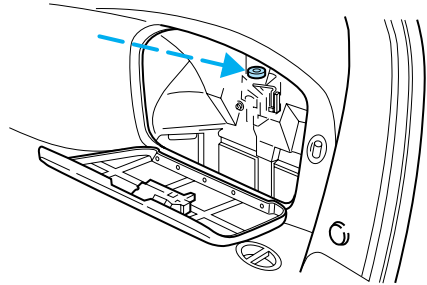

Use the following procedure to reset the fuel pump shut-off switch.

1. Turn the ignition to the OFF position.
2. Check the fuel system for leaks.
3. If no fuel leak is apparent, reset the fuel pump shut-off switch by pushing in on the reset button.
4. Turn the ignition to the ON position. Pause for a few seconds and return the key to the OFF position.
5. Make a further check for leaks in the fuel system.

## Roadside emergencies

### FUSES AND RELAYS

#### Fuses

If electrical components in the vehicle are not working, a fuse may have blown. Blown fuses are identified by a broken wire within the fuse. Check the appropriate fuses before replacing any electrical components.

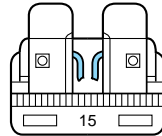

Always replace a fuse with one that has the specified amperage rating. Using a fuse with a higher amperage rating can cause severe wire damage and could start a fire.

#### Standard fuse amperage rating and color

COLOR					
Fuse Rating	Mini Fuses	Standard Fuses	Maxi Fuses	Cartridge Maxi Fuses	Fuse Link Cartridge
2A	Grey	Grey	—	—	—
3A	Violet	Violet	—	—	—
4A	Pink	Pink	—	—	—
5A	Tan	Tan	—	—	—
7.5A	Brown	Brown	—	—	—
10A	Red	Red	—	—	—
15A	Blue	Blue	—	—	—
20A	Yellow	Yellow	Yellow	Blue	Blue
25A	Natural	Natural	—	—	—
30A	Green	Green	Green	Pink	Pink
40A	—	—	Orange	Green	Green
50A	—	—	Red	Red	Red
60A	—	—	Blue	—	Yellow
70A	—	—	Tan	—	Brown
80A	—	—	Natural	—	Black

## Roadside emergencies

### Passenger compartment fuse panel

The fuse panel is located below and to the left of the steering wheel by the brake pedal. Remove the panel cover to access the fuses.

To remove a fuse use the fuse puller tool provided on the fuse panel cover.

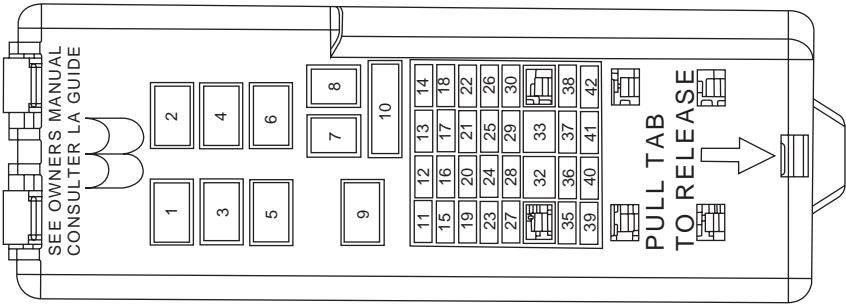

The fuses are coded as follows.

Fuse/Relay Location	Fuse Amp Rating	Passenger Compartment Fuse Panel Description
1	—	Accessory Delay Relay
2	—	Driver One Touch Down Relay
3	—	Blower Motor Relay
4	—	Flasher Relay
5	—	Not Used
6	—	Not Used
7	40A	Rear Defrost Grid Feed
8	40A	Blower Motor
9	—	Rear Defrost Relay
10	30A	Power Seats, Delayed Accessory, Adjustable Pedals
11	15A	Integrated Control Panel (ICP), Rear Washer Wiper Control, Front Washer, Cell Phone, Passenger Switch Illumination, GEM, Rear Wiper Motor
12	10A	Heated Mirrors, Rear Defrost Switch

## Roadside emergencies

<b>Fuse/Relay Location</b>	<b>Fuse Amp Rating</b>	<b>Passenger Compartment Fuse Panel Description</b>
13	20A	Cigar Lighter, Auxiliary Power Point
14	—	Not Used
15	30A	Front Wiper Motor
16	15A	Flasher and GEM Power, Integrated Control Panel (ICP) Power, RCC Memory, Cluster
17	15A	Stop Lamp, Speed Control Deactivating Switch
18	—	Not Used
19	—	Not Used
20	—	Not Used
21	—	Not Used
22	20A	Deck Lid Release Solenoid, Lock/Unlock Relays
23	10A	Air Bag Module, PATS Transceiver
24	15A	Transit Relay
25	2A	PCM Relay
26	10A	Mirrors, Power Antenna, Pulse Stretcher Module, Deck Lid Lamp, Battery Saver
27	10A	Gauges and Warning Lamps, Integrated Control Panel (ICP), FFV Sender, GEM
28	10A	Blower Motor Relay Coil, EATC Logic
29	15A	Autolamps, Headlamp Switch
30	15A	Horns and Horn Switch, OBD II Connector
31	—	Not Used
32	10A	ABS, DRL Relay Coil, Speed Control Actuator, Traction Control Switch, AC Heater Selector Switch, Blend Door Actuator, Brake Shift Interlock
33	—	Not Used
34	—	Not Used
35	—	Not Used
36	15A	Turn Signals, Back-up Lamps

## Roadside emergencies

Fuse/Relay Location	Fuse Amp Rating	Passenger Compartment Fuse Panel Description
37	15A	Transmission Position Switch
38	5A	GEM Park Neutral Switch
39	—	Not Used
40	—	Not Used
41	—	Not Used
42	—	Not Used

### Power distribution box

The power distribution box is located in the engine compartment. The power distribution box contains high-current fuses that protect your vehicle's main electrical systems from overloads.

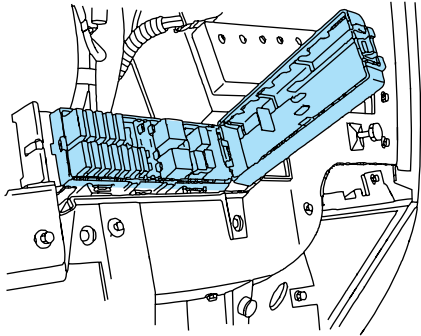

Always disconnect the battery before servicing high current fuses.



Always replace the cover to the Power Distribution Box before reconnecting the battery or refilling fluid reservoirs.

If the battery has been disconnected and reconnected, refer to the *Battery* section of the *Maintenance and care* chapter.



## Roadside emergencies

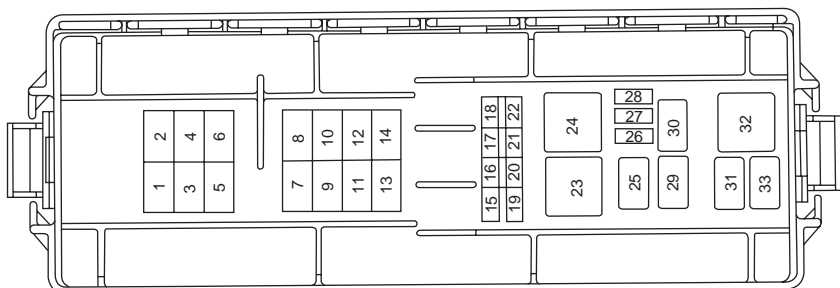

The high-current fuses are coded as follows.

Fuse/Relay Location	Fuse Amp Rating	Power Distribution Box Description
1	60A**	Fuse Junction Panel
2	30A**	PCM Relay
3	60A**	Fuse Junction Panel
4	—	Not Used
5	—	Not Used
6	—	Not Used
7	40A**	Starter Relay, Ignition Switch
8	20A**	Transit Relay (Export only)
9	40A**	Cooling Fan Relays
10	—	Not Used
11	20A**	Thermactor Relay (FFV only)
12	—	Not Used
13	40A**	Anti-Lock Brake Module Pump Feed
14	—	Not Used
15	20A*	Anti-Lock Brake Module Valve Solenoid
16	20A*	Fuel Pump Relay
17	20A*	Rear Control Unit, CD Changer, Cell Phone
18	—	Not Used
19	15A*	Right Headlamp
20	—	Not Used

## Roadside emergencies

Fuse/Relay Location	Fuse Amp Rating	Power Distribution Box Description
21	15A*	Left Headlamp
22	10A*	A/C Clutch Relay, PCM Keep Alive Power
23	—	Starter Motor Relay
24	—	Low Speed Fan Relay
25	—	Wiper Speed Relay
26	30A*	Generator
27	5A*	Rear Control Unit, Antenna
28	15A*	HEGO Sensor Transmission Shift Solenoid, Canister Vent, A/C Clutch Relay, Thermactor Bypass Solenoid
29	—	Wiper Park Relay
30	—	Fuel Pump Relay
31	—	PCM Power Relay
32	—	High Speed Fan Relay
33	—	A/C Clutch Relay
* Mini Fuses ** Maxi Fuses		

### Relays

Relays are located in the power distribution box and should be replaced by qualified technicians.

### CHANGING THE TIRES

If you get a flat tire while driving, do not apply the brake heavily. Instead, gradually decrease your speed. Hold the steering wheel firmly and slowly move to a safe place on the side of the road.

### Temporary spare tire information

The temporary spare tire for your vehicle is labeled as such. It is smaller than a regular tire and is designed for emergency use only.



If you use the temporary spare tire continuously or do not follow these precautions, the tire could fail, causing you to lose control of the vehicle, possibly injuring yourself or others.

## Roadside emergencies

When driving with the temporary spare tire **do not:**

- exceed 80 km/h (50 mph) under any circumstances
- load the vehicle beyond maximum vehicle load rating listed on the Safety Compliance Label
- tow a trailer
- use tire chains
- drive through an automatic car wash, because of the vehicle's reduced ground clearance
- try to repair the temporary spare tire or remove it from its wheel
- use the wheel for any other type of vehicle

### Tire change procedure

1. Park on a level surface, activate hazard flashers and set parking brake.



When one of the front wheels is off the ground, the transaxle alone will not prevent the vehicle from moving or slipping off the jack, even if the vehicle is in P (Park).



To prevent the vehicle from moving when you change a tire, be sure the parking brake is set, then block (in both directions) the wheel that is diagonally opposite (other side and end of the vehicle) to the tire being changed.



If the vehicle slips off the jack, you or someone else could be seriously injured.

2. Place gearshift lever in P (Park), turn engine OFF, block the diagonally opposite wheel, then remove the spare tire, jack and lug wrench.

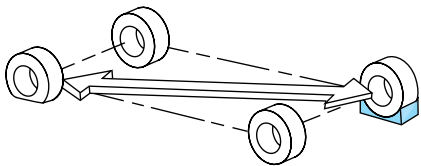

## Roadside emergencies

- In the sedan, these are located in the trunk cargo area storage compartment.

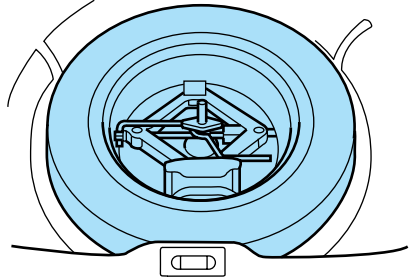

- In the wagon, they are stored in the left side rear trim panel for the temporary spare and in the floor cargo area storage compartment for the full size spare.

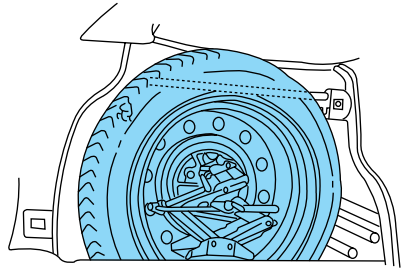

3. If equipped with a wheel cover that's bolted on, loosen the five plastic nuts with the lug nut wrench.

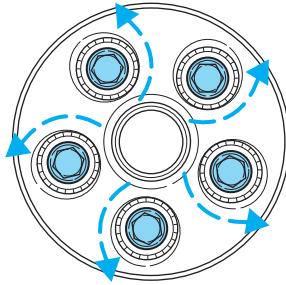

4. Remove the center ornament or wheel cover from the wheel with the tapered end of the wheel lug nut wrench that came with your vehicle. Insert and twist the handle, then pry against the wheel.

## Roadside emergencies

5. Loosen each wheel lug nut one-half turn counterclockwise but do not remove them until the wheel is raised off the ground.

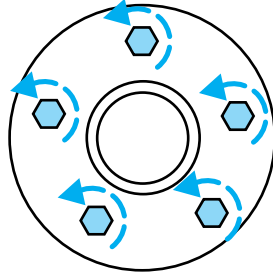

6. Put the jack in the jack notch next to the door of the tire you are changing. Turn the jack handle clockwise until the wheel is completely off the ground.

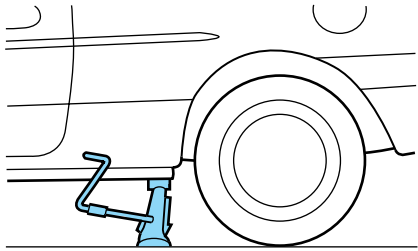

7. Remove the lug nuts with the lug nut wrench.

8. Replace the flat tire with the spare tire, making sure the valve stem is facing outward. Reinstall lug nuts until the wheel is snug against the hub. Do not fully tighten the lug nuts until the wheel has been lowered.

9. Lower the wheel by turning the jack handle counterclockwise.

10. Remove the jack and fully tighten the lug nuts in the order shown.

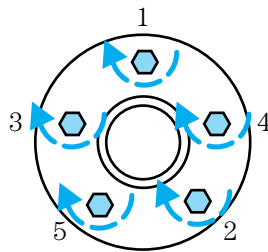

## Roadside emergencies

11. Return the flat tire, jack and lug wrench to their proper storage locations. Make sure the jack is fastened so it does not rattle when you drive.
12. Unblock the wheels.

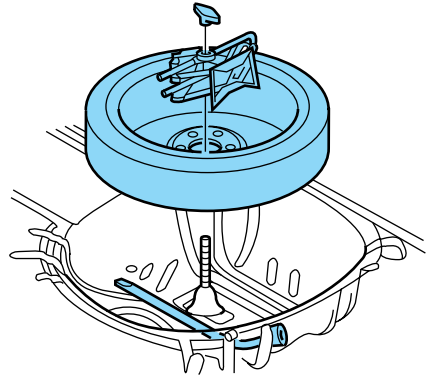

## JUMP STARTING YOUR VEHICLE



The gases around the battery can explode if exposed to flames, sparks, or lit cigarettes. An explosion could result in injury or vehicle damage.



Do not push start your vehicle. You could damage the catalytic converter.



Batteries contain sulfuric acid which can burn skin, eyes, and clothing, if contacted.

**Do not attempt to push start your vehicle. Automatic transmissions do not have push-start capability.**

### Preparing your vehicle

1. **Use only a 12-volt supply to start your vehicle.**
2. Do not disconnect the battery of the disabled vehicle as this could damage the vehicle's electrical system.
3. Park the booster vehicle close to the hood of the disabled vehicle making sure the two vehicles **do not** touch. Set the parking brake on both vehicles and stay clear of the engine cooling fan and other moving parts.

## Roadside emergencies

4. Check all battery terminals and remove any excessive corrosion before you attach the battery cables. Ensure that vent caps are tight and level.
5. Turn the heater fan on in both vehicles to protect any electrical surges. Turn all other accessories off.

### Connecting the jumper cables

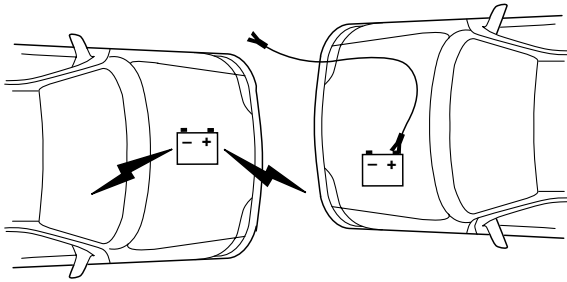

1. Connect the positive (+) booster cable to the positive (+) terminal of the discharged battery.

**Note:** In the illustrations, *lightning bolts* are used to designate the assisting (boosting) battery.

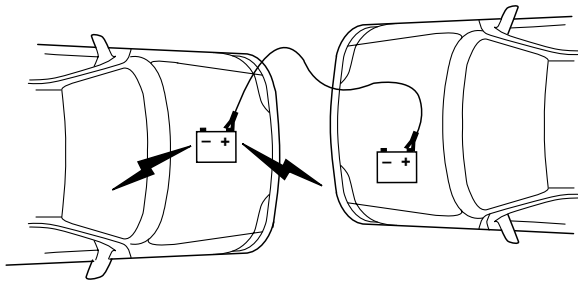

2. Connect the other end of the positive (+) cable to the positive (+) terminal of the assisting battery.

## Roadside emergencies

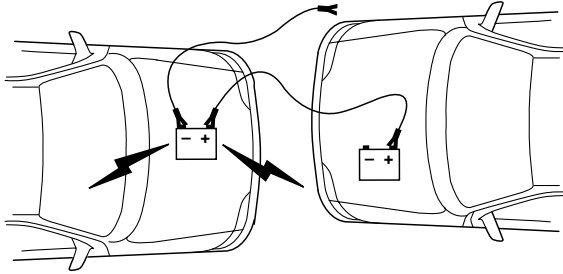

3. Connect the negative (-) cable to the negative (-) terminal of the assisting battery.

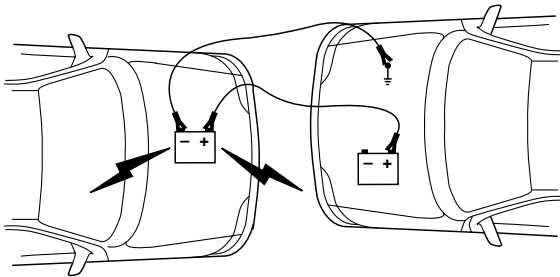

4. Make the final connection of the negative (-) cable. Make the connection to an exposed metal part of the stalled vehicle's engine, away from the battery and the carburetor/fuel injection system. **Do not** use fuel lines, engine rocker covers or the intake manifold as *grounding* points.



Do not connect the end of the second cable to the negative (-) terminal of the battery to be jumped. A spark may cause an explosion of the gases that surround the battery.

5. Ensure that the cables are clear of fan blades, belts, moving parts of both engines, or any fuel delivery system parts.



## Roadside emergencies

### Jump starting

1. Start the engine of the booster vehicle and run the engine at moderately increased speed.
2. Start the engine of the disabled vehicle.
3. Once the disabled vehicle has been started, run both engines for an additional three minutes before disconnecting the jumper cables.

### Removing the jumper cables

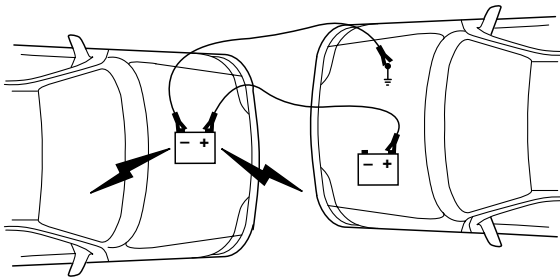

### Remove the jumper cables in the reverse order that they were connected.

1. Remove the jumper cable from the *ground* metal surface.

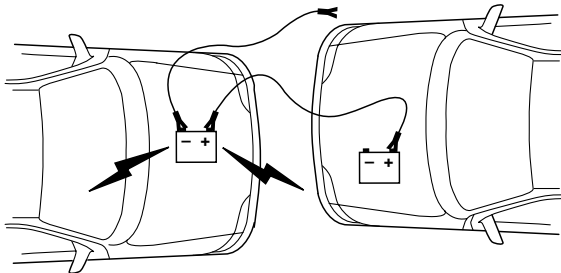

2. Remove the jumper cable on the negative (-) connection of the booster vehicle's battery.

## Roadside emergencies

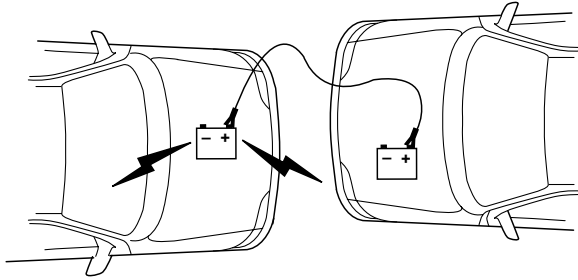

3. Remove the jumper cable from the positive (+) terminal of the booster vehicle's battery.

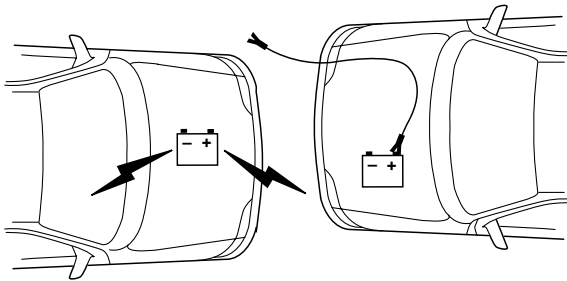

4. Remove the jumper cable from the positive (+) terminal of the disabled vehicle's battery.

After the disabled vehicle has been started and the jumper cables removed, allow it to idle for several minutes so the engine computer can *relearn* its idle conditions.

## Roadside emergencies

### WRECKER TOWING

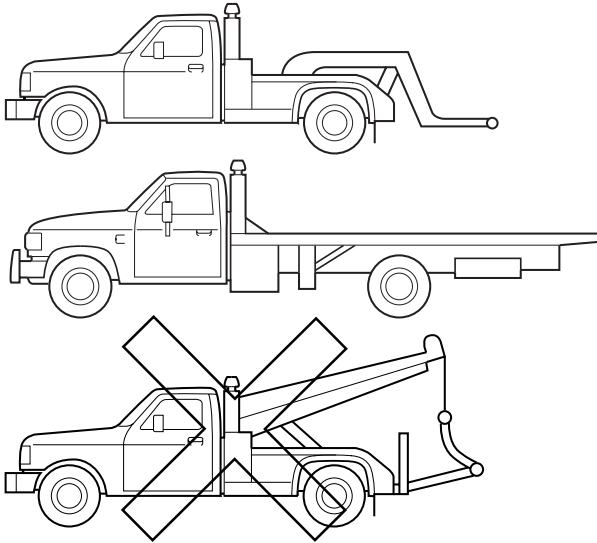

If you need to have your vehicle towed, contact a professional towing service or, if you are a member, your roadside assistance center.

It is recommended that your vehicle be towed with a wheel lift or flatbed equipment. Do not tow with a slingbelt. Ford Motor Company has not approved a slingbelt towing procedure.

If your vehicle is to be towed from the rear using wheel lift equipment, it is recommended that the front wheels (drive wheels) be placed on a dolly to prevent damage to the transaxle.

If your vehicle must be towed with the drive wheels on the ground:

- Place the transaxle in N (Neutral).
- DO NOT exceed the distance of 80 km (50 miles).
- DO NOT exceed the speed of 56 km/h (35 mph).

**If the vehicle is towed by other means or incorrectly, vehicle damage may occur.**

Ford Motor Company provides a towing manual for all authorized tow truck operators. Have your tow truck operator refer to this manual for proper hook-up and towing procedures for your vehicle.

## Maintenance and care

### SERVICE RECOMMENDATIONS

To help you service your vehicle:

- We highlight do-it-yourself items in the engine compartment for easy location.
- We provide a Scheduled Maintenance Guide which makes tracking routine service easy.

If your vehicle requires professional service, your dealership can provide necessary parts and service. Check your “Warranty Guide” to find out which parts and services are covered.

Use only recommended fuels, lubricants, fluids and service parts conforming to specifications. Motorcraft parts are designed and built to provide the best performance in your vehicle.

### PRECAUTIONS WHEN SERVICING YOUR VEHICLE

Be especially careful when inspecting or servicing your vehicle.

- Do not work on a hot engine.
- When the engine is running, keep loose clothing, jewelry or long hair away from moving parts.
- Do not work on a vehicle with the engine running in an enclosed space, unless you are sure you have enough ventilation.
- Keep all lit cigarettes, open flames and other lit material away from the battery and all fuel related parts.

If you disconnect the battery, the engine must “relearn” its idle conditions before your vehicle will drive properly, as explained in the *Battery* section in this chapter.

### Working with the engine off

1. Set the parking brake, and ensure the gearshift is securely latched in park.
2. Turn off the engine and remove the key.
3. Block the wheels to prevent the vehicle from moving unexpectedly.

### Working with the engine on

1. Set the parking brake and ensure the gearshift is securely latched in P (Park).
2. Block the wheels to prevent the vehicle from moving unexpectedly.

## Maintenance and care



Do not start your engine with the air cleaner removed and do not remove it while the engine is running.

### OPENING THE HOOD

1. Inside the vehicle, pull the hood release handle located under the bottom of the instrument panel.
2. Go to the front of the vehicle and release the auxiliary latch located in the center between the hood and the grille.
3. Lift the hood until the lift cylinders hold it open.

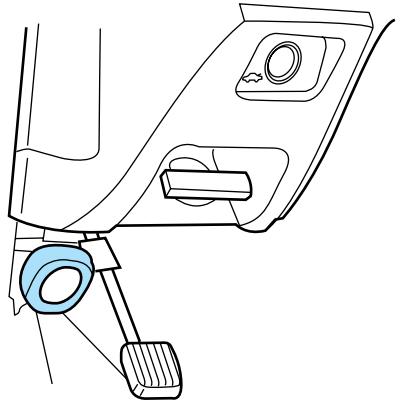

## Maintenance and care

### IDENTIFYING COMPONENTS IN THE ENGINE COMPARTMENT

#### 3.0L V6 Vulcan engine

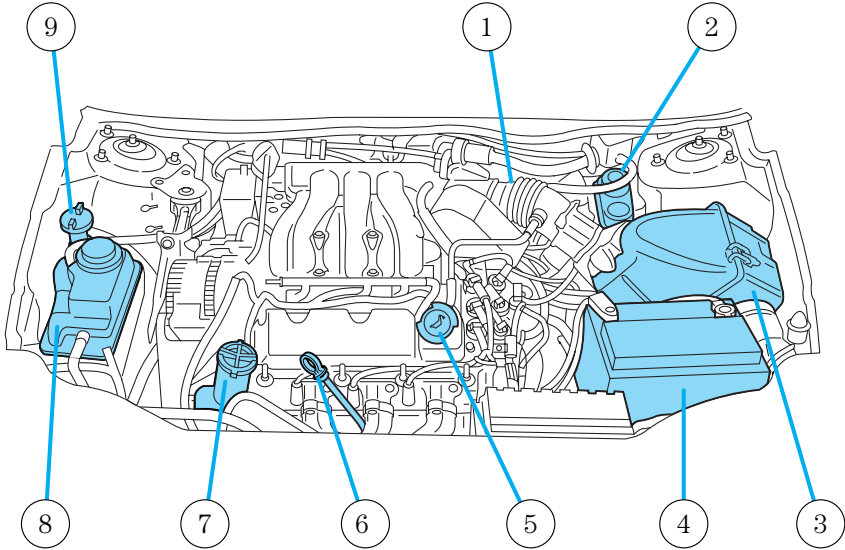

1. Automatic transmission fluid dipstick
2. Brake fluid reservoir
3. Air filter assembly
4. Battery
5. Engine oil filler cap
6. Engine oil dipstick
7. Power steering fluid reservoir
8. Engine coolant reservoir
9. Windshield washer fluid reservoir

## Maintenance and care

### 3.0L DOHC V6 Duratec engine

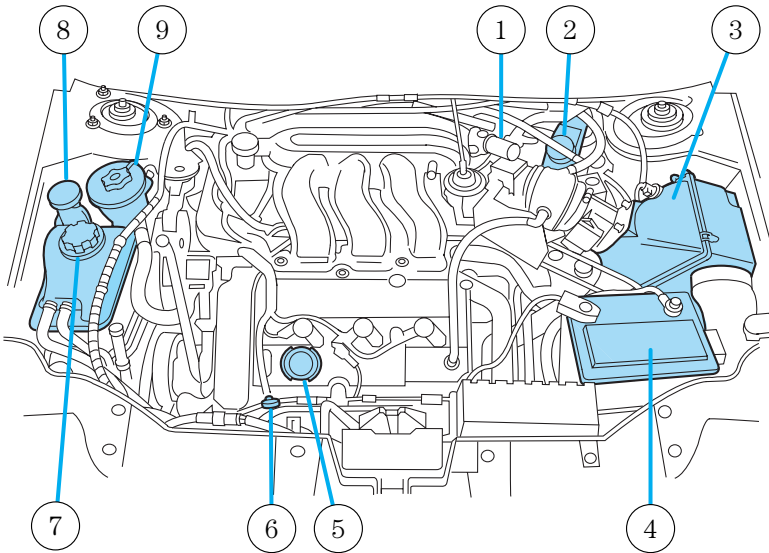

1. Automatic transmission fluid dipstick
2. Brake fluid reservoir
3. Air filter assembly
4. Battery
5. Engine oil filler cap
6. Engine oil dipstick
7. Engine coolant reservoir
8. Windshield washer fluid reservoir
9. Power steering fluid reservoir

## Maintenance and care

### ENGINE OIL

#### Checking the engine oil

Refer to the Scheduled Maintenance Guide for the appropriate intervals for checking the engine oil.

1. Make sure the vehicle is on level ground.
2. Turn the engine off and wait a few minutes for the oil to drain into the oil pan.
3. Set the parking brake and ensure the gearshift is securely latched in P.
4. Open the hood. Protect yourself from engine heat.
5. Locate and carefully remove the engine oil indicator (dipstick).

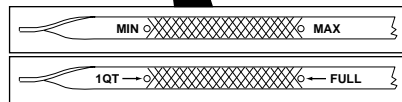
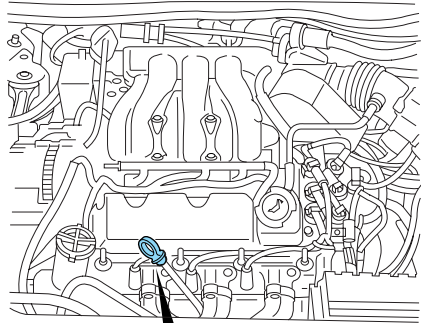

6. Wipe the indicator clean. Insert the indicator fully, then remove it again.

- If the oil level is **between the add 1QT and FULL marks or between the MIN and MAX marks (depending on application)**, the oil level is acceptable. **DO NOT ADD OIL.**



## Maintenance and care

- If the oil level is below the add 1QT or MIN mark, add enough oil to raise the level within the 1QT-FULL or the MIN-MAX range (depending on application).

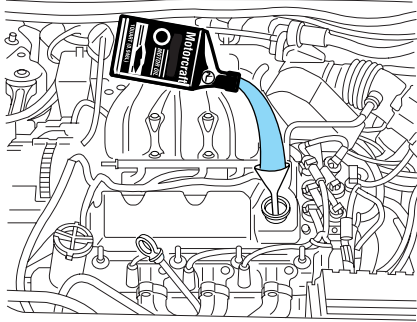

- Oil levels above the F in FULL or above the MAX mark, may cause engine damage. Some oil must be removed from the engine by a service technician.
7. Put the indicator back in and ensure it is fully seated.

### Adding engine oil

1. Check the engine oil. For instructions, refer to *Checking the engine oil* in this chapter.
2. If the engine oil level is not within the normal range, add only certified engine oil of the recommended viscosity. Remove the engine oil filler cap and use a funnel to pour the engine oil into the opening.
3. Recheck the engine oil level. Make sure the oil level is not above the MAX mark or the letter F in FULL on the engine oil level indicator (dipstick).
4. Install the indicator and ensure it is fully seated.
5. Fully install the engine oil filler cap by turning the filler cap clockwise until three clicks can be heard.

**To avoid possible oil loss, DO NOT operate the vehicle with the engine oil level indicator and/or the engine oil filler cap removed.**

## Maintenance and care

### Engine oil and filter recommendations

Look for this certification trademark.

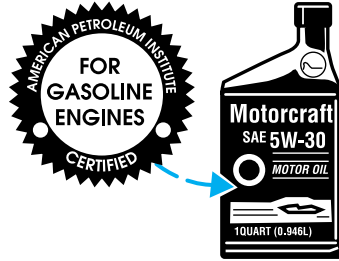

Use SAE 5W-30 motor oil certified for gasoline engines by the American Petroleum Institute (API).

Motor oil displaying the API certification trademark will meet all requirements for your vehicle's engine.

Ford oil specification is WSS-M2C153-G.

Do not use supplemental engine oil additives, oil treatments or engine treatments. They are unnecessary and could, under certain conditions, lead to engine damage which is not covered by your warranty.

Change your engine oil and filter according to the appropriate schedule listed in the Scheduled Maintenance Guide.

Ford production and aftermarket (Motorcraft) oil filters are designed for added engine protection and long life. If a replacement oil filter is used that does not meet Ford material and design specifications, start-up engine noises or knock may be experienced.

It is recommended you use the appropriate Motorcraft oil filter (or another brand meeting Ford specifications) for your engine application.

## Maintenance and care

### BRAKE FLUID (⚠)

#### Checking and adding brake fluid

Brake fluid should be checked and refilled as needed. Refer to the Scheduled Maintenance Guide for the service interval schedules.

1. Clean the reservoir cap before removal to prevent dirt or water from entering the reservoir.

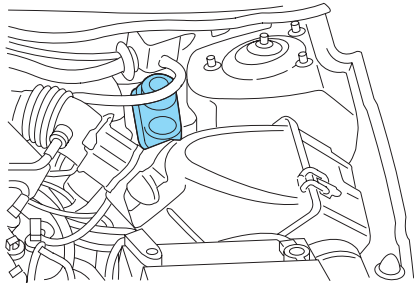

2. Visually inspect the fluid level.

3. If necessary, add brake fluid from a clean un-opened container until the level reaches MAX. Do not fill above this line.

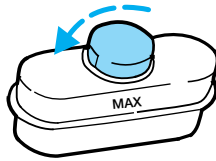

4. Use only a DOT 3 brake fluid certified to meet Ford specifications. Refer to *Lubricant specifications* in the *Capacities and specifications* chapter.



Brake fluid is toxic. If brake fluid contacts the eyes, flush eyes with running water for 15 minutes. Seek medical attention if irritation persists. If taken internally, drink water and induce vomiting. Seek medical attention immediately.



If you use a brake fluid that is not DOT 3, you will cause permanent damage to your brakes.



Do not let the reservoir for the master cylinder run dry. This may cause the brakes to fail.

## Maintenance and care

### WINDSHIELD WASHER FLUID

#### Checking and adding washer fluid

Check the washer fluid whenever you stop for fuel. The reservoir is highlighted with a  symbol.

If the level is low, add enough fluid to fill the reservoir. In very cold weather, do not fill the reservoir all the way.

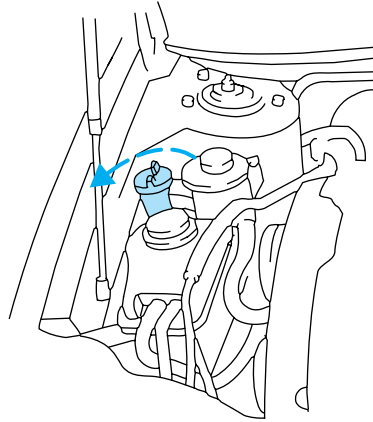

Only use a washer fluid that meets Ford specifications. Refer to *Lubricant specifications* in the *Capacities and specifications* chapter.

State or local regulations on volatile organic compounds may restrict the use of methanol, a common windshield washer antifreeze additive. Washer fluids containing non-methanol antifreeze agents should be used only if they provide cold weather protection without damaging the vehicle's paint finish, wiper blades or washer system.



Do not put washer fluid in the engine coolant reservoir. Washer fluid placed in the cooling system may harm engine and cooling system components.

## Maintenance and care

### Checking and adding washer fluid for the liftgate (if equipped)

The opening for the reservoir is located on the passenger side under the tail lamp. Refill this reservoir with the same fluid you use for your windshield.

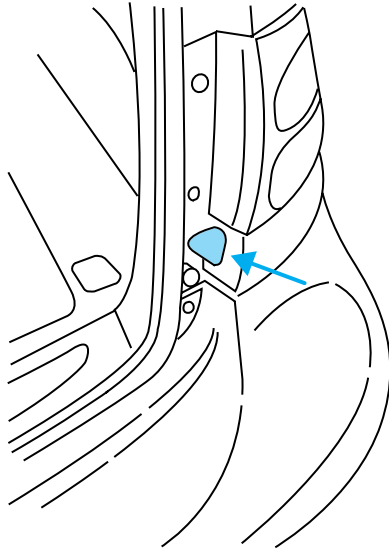

### ENGINE COOLANT

#### Checking engine coolant

Your engine's cooling system has been factory-filled with a 50/50 mixture of distilled water and Ford Premium Engine Coolant E2FZ-19549-AA (in Canada, Motorcraft CXC-10), or an equivalent premium engine coolant that meets Ford specification ESE-M97B44-A.

A **50/50 mixture** of distilled water and Ford Premium Engine Coolant provides:

- **maximum cooling system efficiency.**
- **freeze protection down to -36° C (-34° F).**
- **boiling protection up to 129° C (265° F).**
- **protection against rust and other forms of corrosion.**
- **an accurate temperature readout from the engine coolant gauge.**

## Maintenance and care

**The engine coolant must be maintained at the correct fluid level and concentration to work properly. If the engine coolant fluid level and concentration is not maintained correctly, damage to the engine and cooling system may result.**

When the engine is cold, check the level of the engine coolant in the reservoir.

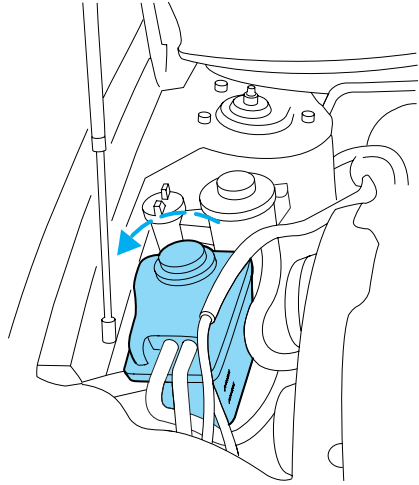

- The engine coolant should be at the “cold fill level” or within the “cold fill range” as listed on the engine coolant reservoir (depending upon application).
- Refer to the Scheduled Maintenance Guide for service interval schedules.
- Be sure to read and understand *Precautions when servicing your vehicle* in this chapter.

If the engine coolant has not been checked at the recommended interval, the engine coolant reservoir may become low or empty. If the reservoir is low or empty, add engine coolant to the reservoir. Refer to *Adding engine coolant* in this chapter.



Automotive fluids are not interchangeable; do not use engine coolant, antifreeze or windshield washer fluid outside of its specified function and vehicle location.

## Maintenance and care

### Adding engine coolant

Use only **Ford Premium Engine Coolant E2FZ-19549-AA** (in Canada, **Motorcraft CXC-8-B**) or a premium engine coolant that meets Ford specification **ESE-M97B44-A**.

- **DO NOT USE Ford Extended Life Engine Coolant F6AZ-19544-AA (orange in color).**
- **DO NOT USE a DEX-COOL® engine coolant or an equivalent engine coolant that meets Ford specification WSS-M97B44-D.**
- **DO NOT USE alcohol or methanol antifreeze or any engine coolants mixed with alcohol or methanol antifreeze.**
- **DO NOT USE supplemental coolant additives in your vehicle. These additives may harm your engine's cooling system.**
- **DO NOT MIX recycled coolant and conventional coolant together in your vehicle. Mixing of engine coolants may harm your engine's cooling system.**
- **The use of an improper coolant may harm engine and cooling system components and may void the warranty of your vehicle's engine cooling system. If you are unsure which type of coolant your vehicle requires, contact your local dealer.**



To avoid scalding hot steam or coolant from being released from the engine cooling system, never remove the pressure relief cap from the engine coolant reservoir while the engine is running or hot. Failure to follow this warning may result in damage to the engine's cooling system and possible severe personal injury.



Do not put engine coolant in the windshield washer fluid reservoir. If engine coolant is sprayed onto the windshield, it could make it difficult to see through the windshield.

When the engine is cool, add a **50/50 mixture** of engine coolant and distilled water to the engine coolant reservoir, until the coolant is at the “cold fill level” or within the “cold fill range” as listed in the engine coolant reservoir (depending upon application).

- **NEVER increase the coolant concentration above 60%.**
- **NEVER decrease the coolant concentration below 40%.**

## Maintenance and care

- **Engine coolant concentrations above 60% or below 40% will decrease the freeze protection characteristics of the engine coolant and may cause engine damage.**

Plain water may be added in an emergency, but you **must** replace it with a 50/50 mixture of engine coolant and distilled water as soon as possible.

Check the coolant level in the reservoir before you drive your vehicle the next few times (with the engine cool). If necessary, add a **50/50 mixture** of engine coolant and distilled water to the engine coolant reservoir until the coolant level is at the “cold fill level” or within the “cold fill range” as listed on the reservoir (depending upon application).

Have your dealer check the engine cooling system for leaks if you have to add more than 1.0 liter (1.0 quart) of engine coolant per month.



To avoid scalding hot steam or coolant from being released from the engine cooling system, never remove the pressure relief cap from the engine coolant reservoir while the engine is running or hot. Failure to follow this warning may result in damage to the engine's cooling system and possible severe personal injury.

If you must remove the pressure relief cap from the engine coolant reservoir, follow these steps to avoid personal injury:

1. Before you remove the cap, turn the engine off and let it cool.
2. When the engine is cool, wrap a thick cloth around the cap. Slowly turn cap counterclockwise until pressure begins to release.
3. Step back while the pressure releases.
4. When you are sure that all the pressure has been released, use the cloth to turn it counterclockwise and remove the cap.

### Recycled engine coolant

Ford Motor Company recommends the use of a recycled engine coolant produced by Ford-approved processes.

Not all coolant recycling processes produce coolant which meets Ford specification ESE-M97B44-A. Use of a recycled engine coolant which does not meet the Ford specification may harm engine and cooling system components.



## Maintenance and care



Always dispose of used automotive fluids in a responsible manner. Follow your community's regulations and standards for recycling and disposing of automotive fluids.

### Coolant refill capacity

To find out how much fluid your vehicle's cooling system can hold, refer to *Refill capacities* in the *Capacities and specifications* chapter.

Fill your engine coolant reservoir as outlined in *Adding engine coolant* in this chapter.

### Severe climates

If you drive in extremely cold climates (less than  $-36^{\circ}\text{C}$  [ $-34^{\circ}\text{F}$ ):

- **it may be necessary to increase the coolant concentration above 50%.**
- **NEVER increase the coolant concentration above 60%.**
- **increased engine coolant concentrations above 60% will decrease the overheat protection characteristics of the engine coolant and may cause engine damage.**
- **refer to the chart on the coolant container to ensure the coolant concentration in your vehicle will provide adequate freeze protection at the temperatures in which you drive in the winter months.**

If you drive in extremely hot climates:

- **it is still necessary to maintain the coolant concentration above 40%.**
- **NEVER decrease the coolant concentration below 40%.**
- **decreased engine coolant concentrations below 40% will decrease the corrosion protection characteristics of the engine coolant and may cause engine damage.**
- **decreased engine coolant concentrations below 40% will decrease the freeze protection characteristics of the engine coolant and may cause engine damage.**
- **refer to the chart on the coolant container to ensure the coolant concentration in your vehicle will provide adequate protection at the temperatures in which you drive.**

## Maintenance and care

Vehicles driven year-round in non-extreme climates should use a 50/50 mixture of engine coolant and distilled water for optimum cooling system and engine protection.

### CHECKING AND ADDING POWER STEERING FLUID

Check the power steering fluid.  
Refer to the Scheduled Maintenance Guide for the service interval schedules. If adding fluid is necessary, use only MERCON® ATF.

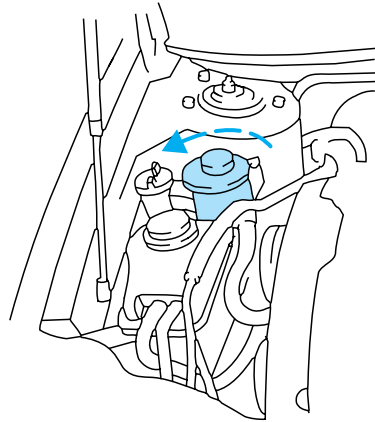

1. Start the engine and let it run until it reaches normal operating temperature (the engine coolant temperature gauge indicator will be near the center of the normal area between H and C).
2. While the engine idles, turn the steering wheel left and right several times.
3. Turn the engine off.

Perform steps 4 and 5 following the procedure for your engine.

## Maintenance and care

### 3.0L V6 Vulcan engine

4. Check the fluid level on the dipstick. It should be between the arrows in the FULL HOT range. Do not add fluid if the level is within this range.

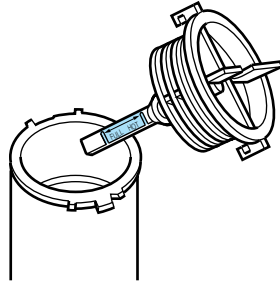

5. If the fluid is low, add fluid in small amounts, continuously checking the level until it reaches the FULL HOT range. Be sure to put the dipstick back in the reservoir.

### 3.0L DOHC V6 Duratec engine

4. Check the fluid level in the reservoir. It should be between the MIN and MAX lines. Do not add fluid if the level is within this range.

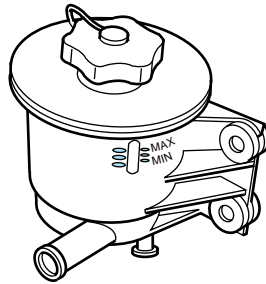

5. If the fluid is low, add fluid in small amounts, continuously checking the level until it reaches the range between the MIN and MAX lines. Be sure to put the cap back on the reservoir.

## TRANSMISSION FLUID

### Checking automatic transmission fluid

Refer to your Scheduled Maintenance Guide for scheduled intervals for fluid checks and changes. Your transaxle does not consume fluid. However, the fluid level should be checked if the transaxle is not working properly, i.e., if the transaxle slips or shifts slowly or if you notice some sign of fluid leakage.

## Maintenance and care

**Automatic transmission fluid expands when warmed. To obtain an accurate fluid check, drive the vehicle until it is warmed up (approximately 30 km [20 miles]). If your vehicle has been operated for an extended period at high speeds, in city traffic during hot weather or pulling a trailer, the vehicle should be turned off for about 30 minutes to allow fluid to cool before checking.**

1. Drive the vehicle 30 km (20 miles) or until it reaches normal operating temperature.
2. Park the vehicle on a level surface and engage the parking brake.
3. With the parking brake engaged and your foot on the brake pedal, start the engine and move the gearshift lever through all of the gear ranges. Allow sufficient time for each gear to engage.
4. Latch the gearshift lever in P (Park) and leave the engine running.
5. Remove the dipstick, wiping it clean with a clean, dry lint free rag. If necessary, refer to *Identifying components in the engine compartment* in this chapter for the location of the dipstick.
6. Install the dipstick making sure it is fully seated in the filler tube.
7. Remove the dipstick and inspect the fluid level. The fluid should be in the designated areas for normal operating temperature.

### **Low fluid level**

Do not drive the vehicle if the fluid level is at the bottom of the dipstick and the outside temperatures are above 10°C (50°F).



### **Correct fluid level**

The transmission fluid should be checked at normal operating temperatures 66°C-77°C (150°F-170°F) on a level surface. The normal operating temperature can be reached after approximately 30 km (20 miles) of driving.

The transmission fluid should be in this range if at normal operating temperature (66°C-77°C [150°F-170°F]).



## Maintenance and care

### **High fluid level**

Fluid levels above the safe range may result in transaxle failure. An overfill condition of transmission fluid may cause shift and/or engagement concerns and/or possible damage.

High fluid levels can be caused by an overheating condition.



### **Adjusting automatic transmission fluid levels**

Before adding any fluid, make sure the correct type is used. The type of fluid used is normally indicated on the dipstick and also in the *Lubricant specifications* section in the *Capacities and specifications* chapter.

**Use of a non-approved automatic transmission fluid may cause internal transaxle component damage.**

If necessary, add fluid in 250 mL (1/2 pint) increments through the filler tube until the level is correct.

If an overfill occurs, excess fluid should be removed by a qualified technician.



**An overfill condition of transmission fluid may cause shift and/or engagement concerns and/or possible damage.**

## Maintenance and care

### CABIN AIR FILTER (IF EQUIPPED)

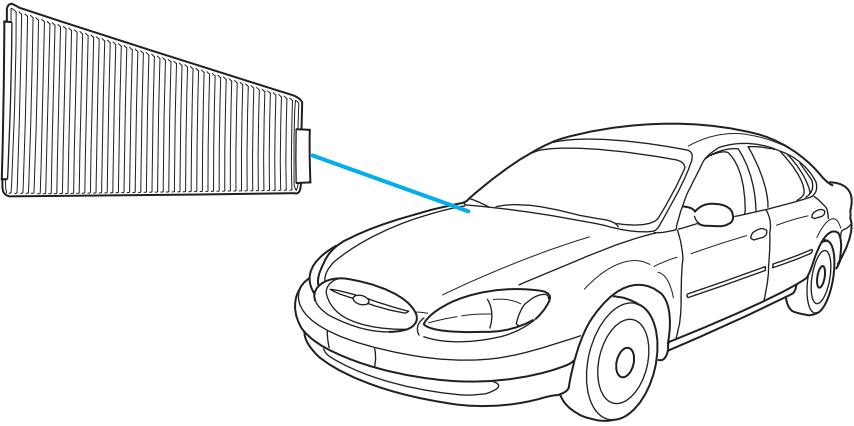

The particulate air filtration system is designed to reduce the concentration of airborne particles such as dust, spores and pollen in the air being supplied to the interior of the vehicle. The particulate filtration system gives the following benefits to customers:

- Improves the customer's driving comfort by reducing particle concentration
- Improves the interior compartment cleanliness
- Protects the climate control components from particle deposits

The filter is located just in front of the windshield under the cowl grille on the passenger side of the vehicle.

## Maintenance and care

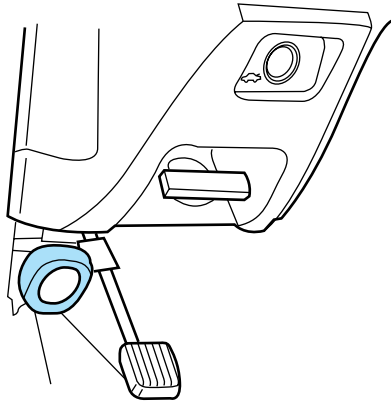

1. Release and open the hood.

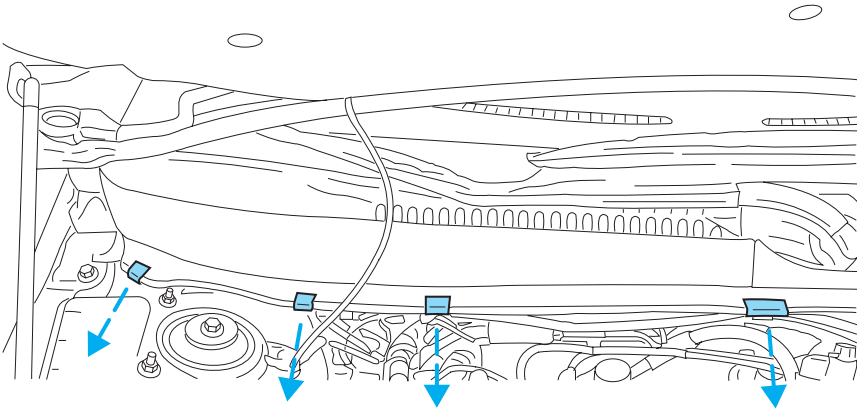

2. Remove the four clips located on the cowl vent screen.

## Maintenance and care

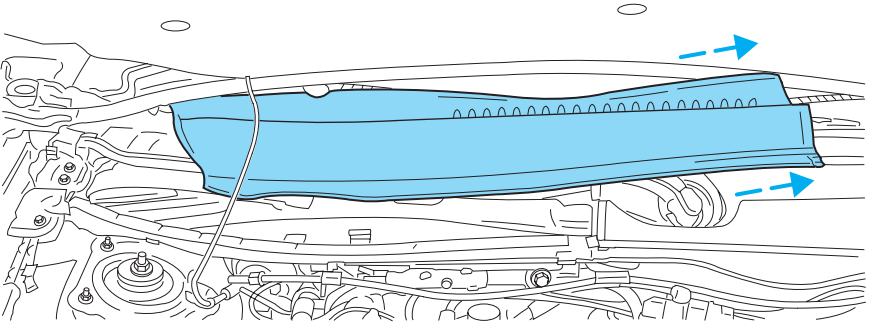

3. Remove the cowl vent screen.

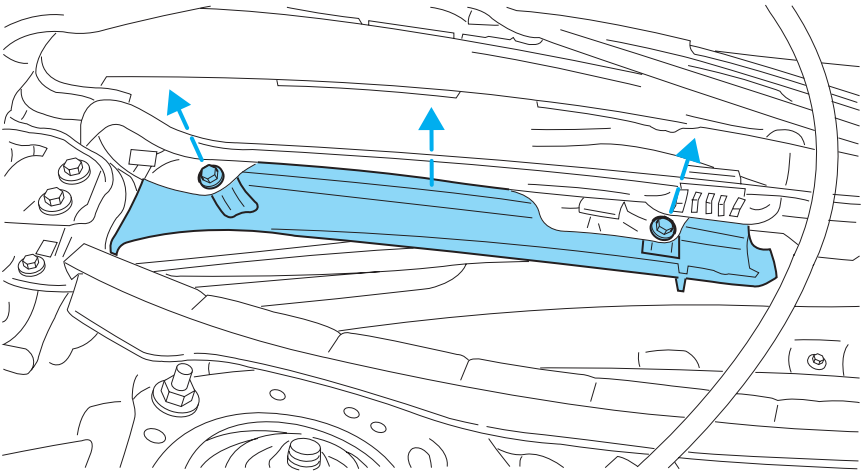

4. Remove the two screws retaining the cowl top inner panel shield.

5. Remove the inner panel shield.



## Maintenance and care

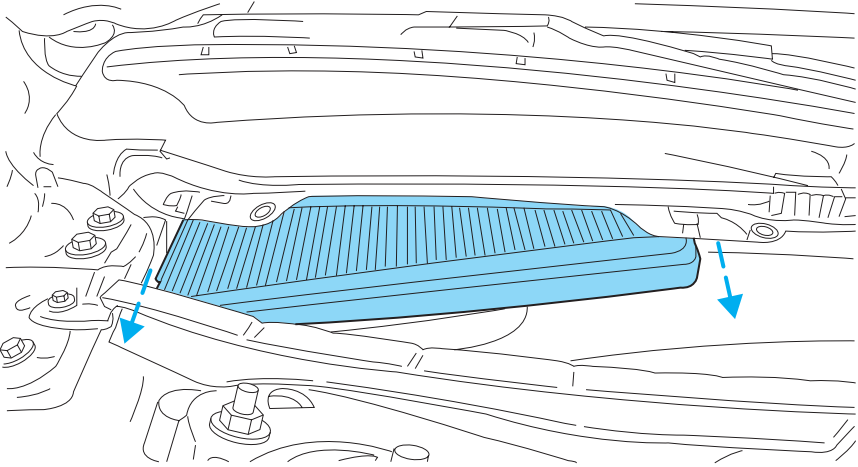

6. Remove the filter from the cabin air filter housing.

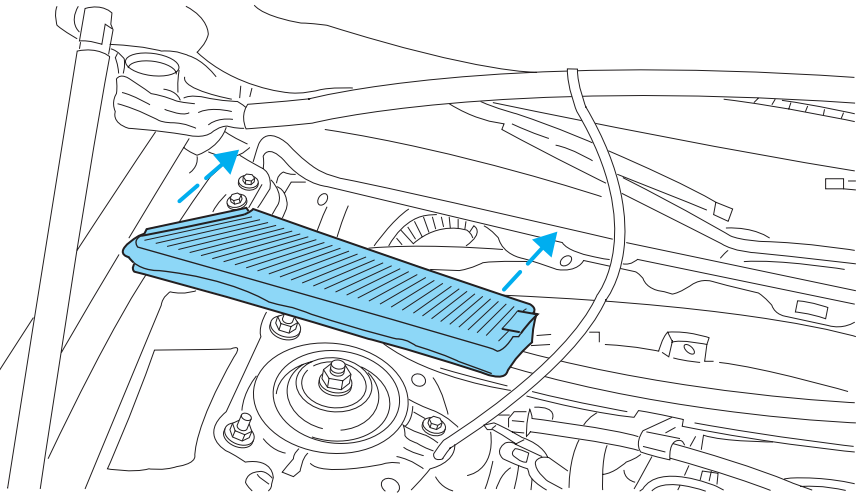

7. Install the new cabin air filter into the cabin air filter housing.

## Maintenance and care

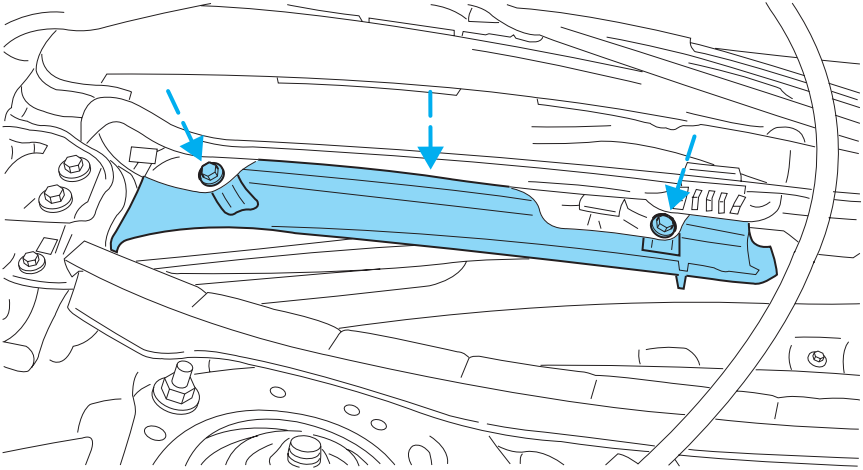

8. Replace the inner panel shield.
9. Replace the two screws retaining the cowl top inner panel shield.

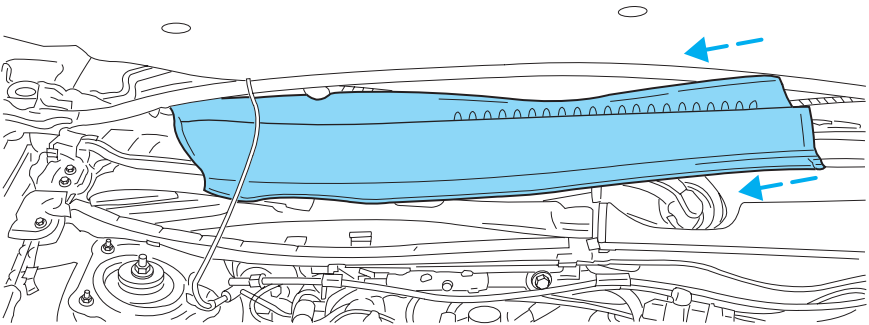

10. Replace the cowl vent screen.

## Maintenance and care

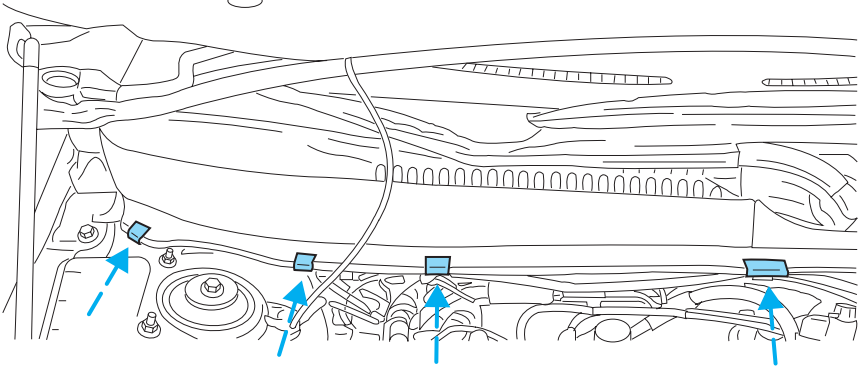

11. Replace the four clips located on the cowl vent screen.

### BATTERY

Your vehicle is equipped with a Motorcraft maintenance-free battery which normally does not require additional water during its life of service.

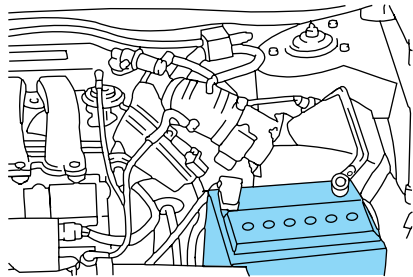

However, for severe usage or in high temperature climates, check the battery electrolyte level. Refer to the Scheduled Maintenance Guide for the service interval schedules.

**Keep the electrolyte level in each cell up to the “level indicator”. Do not overfill the battery cells.**

If the electrolyte level in the battery is low, you can add plain tap water to the battery, as long as you do not use hard water (water with a high mineral or alkali content). If possible, however, try to only fill the battery cells with distilled water. If the battery needs water often, have the charging system checked.

## Maintenance and care

### **If your battery has a cover/shield, make sure it is reinstalled after the battery has been cleaned or replaced.**

For longer, trouble-free operation, keep the top of the battery clean and dry. Also, make certain the battery cables are always tightly fastened to the battery terminals.

If you see any corrosion on the battery or terminals, remove the cables from the terminals and clean with a wire brush. You can neutralize the acid with a solution of baking soda and water.



Batteries normally produce explosive gases which can cause personal injury. Therefore, do not allow flames, sparks or lighted substances to come near the battery. When working near the battery, always shield your face and protect your eyes. Always provide proper ventilation.



When lifting a plastic-cased battery, excessive pressure on the end walls could cause acid to flow through the vent caps, resulting in personal injury and/or damage to the vehicle or battery. Lift the battery with a battery carrier or with your hands on opposite corners.



Keep batteries out of reach of children. Batteries contain sulfuric acid. Avoid contact with skin, eyes or clothing. Shield your eyes when working near the battery to protect against possible splashing of acid solution. In case of acid contact with skin or eyes, flush immediately with water for a minimum of 15 minutes and get prompt medical attention. If acid is swallowed, call a physician immediately.



Battery posts, terminals and related accessories contain lead and lead compounds. Wash hands after handling.

Because your vehicle's engine is electronically controlled by a computer, some control conditions are maintained by power from the battery. When the battery is disconnected or a new battery is installed, the engine must relearn its idle and fuel trim strategy for optimum driveability and performance. To begin this process:

1. With the vehicle at a complete stop, set the parking brake.

## Maintenance and care

2. Put the gearshift in P (Park), turn off all accessories and start the engine.
3. Run the engine until it reaches normal operating temperature.
4. Allow the engine to idle for at least one minute.
5. Turn the A/C on and allow the engine to idle for at least one minute.
6. With your foot on the brake pedal and with the A/C on, put the vehicle in D (Drive) and allow the engine to idle for at least one minute.
7. Drive the vehicle to complete the relearning process.
  - The vehicle may need to be driven 16 km (10 miles) or more to relearn the idle and fuel trim strategy.
  - **If you do not allow the engine to relearn its idle trim, the idle quality of your vehicle may be adversely affected until the idle trim is eventually relearned.**

If the battery has been disconnected or a new battery has been installed, the clock must be reset once the battery is reconnected.

- Always dispose of automotive batteries in a responsible manner. Follow your local authorized standards for disposal. Call your local authorized recycling center to find out more about recycling automotive batteries.

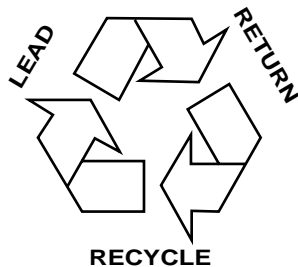

### WINDSHIELD WIPER BLADES

Check the wiper blades at least twice a year or when they seem less effective. Substances such as tree sap and some hot wax treatments used by commercial car washes reduce the effectiveness of wiper blades.

#### Checking the wiper blades

If the wiper blades do not wipe properly, clean both the windshield and wiper blades using undiluted windshield wiper solution or a mild detergent. Rinse thoroughly with clean water. To avoid damaging the blades, do not use fuel, kerosene, paint thinner or other solvents.

## Maintenance and care

### Changing the wiper blades

To replace the wiper blades:

1. Pull the wiper arm away from the windshield and lock into the service position.
2. Turn the blade at an angle from the wiper arm. Push the lock pin manually to release the blade and pull the wiper blade down toward the windshield to remove it from the arm.
3. Attach the new wiper to the wiper arm and press it into place until a click is heard.

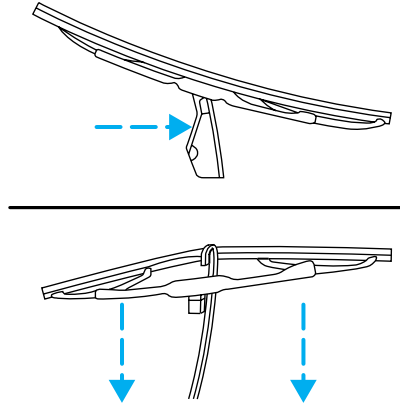

### REAR WINDOW WIPER BLADES

Refer to *Windshield Wiper Blades* in this section for more information on rear wiper blades.

### INFORMATION ABOUT UNIFORM TIRE QUALITY GRADING

New vehicles are fitted with tires that have a rating on them called Tire Quality Grades. The Quality grades can be found where applicable on the tire sidewall between tread shoulder and maximum section width. For example:

- **Treadwear 200 Traction AA Temperature A**

These Tire Quality Grades are determined by standards that the United States Department of Transportation has set.

Tire Quality Grades apply to new pneumatic tires for use on passenger cars. They do not apply to deep tread, winter-type snow tires, space-saver or temporary use spare tires, tires with nominal rim diameters of 10 to 12 inches or limited production tires as defined in Title 49 Code of Federal Regulations Part 575.104(c)(2).

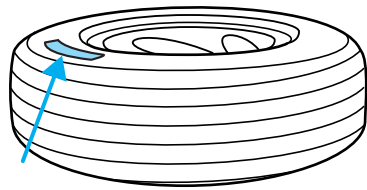

## Maintenance and care

**U.S. Department of Transportation-Tire quality grades:** The U.S. Department of Transportation requires Ford to give you the following information about tire grades exactly as the government has written it.

### Treadwear

The treadwear grade is a comparative rating based on the wear rate of the tire when tested under controlled conditions on a specified government test course. For example, a tire graded 150 would wear one and one-half (1 1/2) times as well on the government course as a tire graded 100. The relative performance of tires depends upon the actual conditions of their use, however, and may depart significantly from the norm due to variations in driving habits, service practices, and differences in road characteristics and climate.

### Traction AA A B C

The traction grades, from highest to lowest are AA, A, B, and C. Those grades represent the tire's ability to stop on wet pavement as measured under controlled conditions on specified government test surfaces of asphalt and concrete. A tire marked C may have poor traction performance.



The traction grade assigned to this tire is based on straight-ahead braking traction tests, and does not include acceleration, cornering, hydroplaning or peak traction characteristics.

### Temperature A B C

The temperature grades are A (the highest), B, and C, representing the tire's resistance to the generation of heat and its ability to dissipate heat when tested under controlled conditions on a specified indoor laboratory test wheel. Sustained high temperature can cause the material of the tire to degenerate and reduce tire life, and excessive temperature can lead to sudden tire failure. The grade C corresponds to a level of performance which all passenger car tires must meet under the Federal Motor Vehicle Safety Standard No. 109. Grades B and A represent higher levels of performance on the laboratory test wheel than the minimum required by law.

## Maintenance and care



The temperature grade for this tire is established for a tire that is properly inflated and not overloaded. Excessive speed, underinflation, or excessive loading, either separately or in combination, can cause heat buildup and possible tire failure.

### SERVICING YOUR TIRES

#### Checking the tire pressure

- Use an accurate tire pressure gauge.
- Check the tire pressure when tires are cold, after the vehicle has been parked for at least one hour or has been driven less than 5 km (3 miles).
- Adjust tire pressure to recommended specifications found on the Certification Label located on the driver's door panel.



Improperly inflated tires can affect vehicle handling and can fail suddenly, possibly resulting in loss of vehicle control.

#### Tire rotation

Because your vehicle's tires perform different jobs, they often wear differently. To make sure your tires wear evenly and last longer, rotate them as indicated in the Scheduled Maintenance Guide. If you notice that the tires wear unevenly, have them checked.

- Four tire rotation

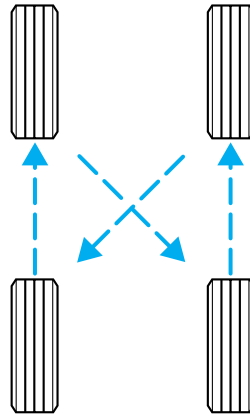





## Maintenance and care

### Replacing the tires

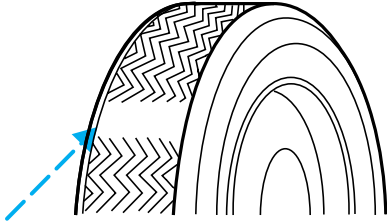
Replace the tires when the wear band is visible through the tire treads.



 When replacing full size tires, never mix radial bias-belted, or bias-type tires. Use only the tire sizes that are listed on the Certification Label. Make sure that all tires are the same size, speed rating, and load-carrying capacity. Use only the tire combinations recommended on the label. If you do not follow these precautions, your vehicle may not drive properly and safely.

 Make sure that all replacement tires are of the same size, type, load-carrying capacity and tread design (e.g., “All Terrain”, etc.), as originally offered by Ford.

 Failure to follow these precautions may adversely affect the handling of the vehicle and make it easier for the driver to lose control and roll over.

Tires that are larger or smaller than your vehicle’s original tires may also affect the accuracy of your speedometer.

### SNOW TIRES AND CHAINS

 Snow tires must be the same size and grade as the tires you currently have on your vehicle.

The tires on your vehicle have all weather treads to provide traction in rain and snow. However, in some climates, you may need to use snow tires and chains. If you need to use snow tires and chains, it is

## Maintenance and care

recommended that steel wheels are used of the same size and specifications as those originally installed.

Follow these guidelines when using snow tires and chains:

- Use only cable type chains offered by Ford as an accessory or equivalent. SAE class “S” or other conventional link type chains may cause damage to the vehicle’s wheel house and/or body.
- Install cable chains securely, verifying that the cables do not touch any wiring, brake lines or fuel lines.
- Drive cautiously. If you hear the cables rub or bang against your vehicle, stop and re-tighten the cables. If this does not work, remove the cables to prevent damage to your vehicle.
- If possible, avoid fully loading your vehicle.
- Remove the tire cables when they are no longer needed. Do not use tire cables on dry roads.
- The suspension insulation and bumpers will help prevent vehicle damage. Do not remove these components from your vehicle when using snow tires and cables.
- Do not exceed 48 km/h (30 mph) with tire cables on your vehicle.

## WHAT YOU SHOULD KNOW ABOUT AUTOMOTIVE FUELS

### Important safety precautions



Do not overfill the fuel tank. The pressure in an overfilled tank may cause leakage and lead to fuel spray and fire.



The fuel system may be under pressure. If the fuel filler cap is venting vapor or if you hear a hissing sound, wait until it stops before completely removing the fuel filler cap. Otherwise, fuel may spray out and injure you or others.



If you do not use the proper fuel filler cap, excessive pressure or vacuum in the fuel tank may damage the fuel system or cause the fuel system to work improperly in a collision, which may result in possible personal injury.

## Maintenance and care



Automotive fuels can cause serious injury or death if misused or mishandled.



Fuel ethanol and gasoline may contain benzene, which is a cancer-causing agent.

Observe the following guidelines when handling automotive fuel:

- Extinguish all smoking materials and any open flames before fueling your vehicle.
- Always turn off the vehicle before fueling.
- Automotive fuels can be harmful or fatal if swallowed. Fuels such as gasoline and ethanol are highly toxic and if swallowed can cause death or permanent injury. If fuel is swallowed, call a physician immediately, even if no symptoms are immediately apparent. The toxic effects of fuel may not be visible for hours.
- Avoid inhaling fuel vapors. Inhaling too much fuel vapor of any kind can lead to eye and respiratory tract irritation. In severe cases, excessive or prolonged breathing of fuel vapor can cause serious illness and permanent injury.
- Avoid getting fuel liquid in your eyes. If fuel is splashed in the eyes, remove contact lenses (if worn), flush with water for 15 minutes and seek medical attention. Failure to seek proper medical attention could lead to permanent injury.
- Fuels can also be harmful if absorbed through the skin. If fuel is splashed on the skin and/or clothing, promptly remove contaminated clothing and wash skin thoroughly with soap and water. Repeated or prolonged skin contact with fuel liquid or vapor causes skin irritation.
- Be particularly careful if you are taking “Antabuse” or other forms of disulfiram for the treatment of alcoholism. Breathing gasoline and/or ethanol vapors, or skin contact could cause an adverse reaction. In sensitive individuals, serious personal injury or sickness may result. If



## Maintenance and care

fuel is splashed on the skin, promptly wash skin thoroughly with soap and water. Consult a physician immediately if you experience an adverse reaction.

- FFV fuel tanks may contain zero to 85 percent or more of ethanol. Any fuel blends containing gasoline and ethanol should be treated the same as “Fuel Ethanol (E85)”.

Pure ethanol is the alcohol which is the intoxicating agent in liquor, beer and wine. It is distilled from the fermentation of plants such as field corn and sugar cane. When ethanol is used in the making of motor fuels, a small amount of a bad tasting chemical is added to discourage beverage use. The resulting fuel is called E<sub>d</sub> 100 meaning 100% pure ethanol diluted by 2% to 5% gasoline as the “denaturant.”

Fuel ethanol (E<sub>d</sub> 85) is then made by adding 15% more unleaded gasoline. The resulting fuel also has a higher octane rating than unleaded regular gasoline and other properties which allow engine designs with greater efficiency and power.

Winter blends may contain up to 30% unleaded gasoline (25% plus the denaturant) to enhance cold engine starts. Severely cold weather may require additional measures for reliable starting. Refer to *Cold Weather Starting* in the *Starting* chapter.

Ethanol is more chemically active than gasoline. It corrodes some metals and causes some plastic and rubber components to swell, break down or become brittle and crack, especially when mixed with gasoline. Special materials and procedures have been developed for flexible fuel vehicles and the dispensers used by ethanol fuel providers.



Flexible fuel components and standard unleaded gasoline fuel components are not interchangeable. If your vehicle is not serviced in accordance with flexible fuel vehicles procedures, damage may occur and your warranty may be invalidated.



When refueling always shut the engine off and never allow sparks or open flames near the filler neck. Never smoke while refueling. Fuel vapor is extremely hazardous under certain conditions. Care should be taken to avoid inhaling excess fumes.

## Maintenance and care



The flow of fuel through a fuel pump nozzle can produce static electricity, which can cause a fire if fuel is pumped into an ungrounded fuel container.

Use the following guidelines to avoid static build-up when filling an ungrounded fuel container:



- Place approved fuel container on the ground.
- DO NOT fill a fuel container while it is in the vehicle.
- Keep the fuel pump nozzle in contact with the fuel container while filling.
- DO NOT use a device that would hold the fuel pump handle in the fill position.

### Fuel Filler Cap

Your fuel tank filler cap has an indexed design with a 1/8 turn on/off feature.

When fueling your vehicle:

1. Turn the engine off.
2. Carefully turn the filler cap counterclockwise 1/8 of a turn until it stops.
3. Pull to remove the cap from the fuel filler pipe.
4. To install the cap, align the tabs on the cap with the notches on the filler pipe.
5. Turn the filler cap clockwise 1/8 of a turn until it stops.

After refueling, if the  indicator comes on and stays on when you start the engine, the fuel filler cap may not be properly installed. Turn off the engine, remove the fuel filler cap, align the cap properly and reinstall it securely. The  indicator should turn off after three driving cycles with the fuel filler cap properly installed. A driving cycle consists of a cold engine start-up followed by mixed city/highway driving.

**If you must replace the fuel filler cap, replace it with a fuel filler cap that is designed for your vehicle. The customer warranty may be void for any damage to the fuel tank or fuel system if the correct genuine Ford or Motorcraft fuel filler cap is not used.**

## Maintenance and care



The fuel system may be under pressure. If the fuel filler cap is venting vapor or if you hear a hissing sound, wait until it stops before completely removing the fuel filler cap. Otherwise, fuel may spray out and injure you or others.



If you do not use the proper fuel filler cap, excessive pressure or vacuum in the fuel tank may damage the fuel system or cause the fuel system to work improperly in a collision, which may result in possible personal injury.

### Choosing the right fuel

Use only UNLEADED FUEL. The use of leaded fuel is prohibited by law and could damage your vehicle.

If your vehicle is a flexible fuel vehicle (FFV), use only UNLEADED FUEL and ETHANOL (E85). The use of leaded fuel is prohibited by law and could damage your vehicle.

Do not use fuel containing methanol. It can damage critical fuel system components.

Your vehicle was not designed to use fuel or fuel additives with metallic compounds, including manganese-based compounds containing MMT.

Repairs to correct the effects of using a fuel for which your vehicle was not designed may not be covered by your warranty.

### Octane recommendations

Do not be concerned if your engine sometimes knocks lightly. However, if it knocks heavily under most driving conditions while you are using fuel with the recommended octane rating, see your dealer or a qualified service technician to prevent any engine damage.

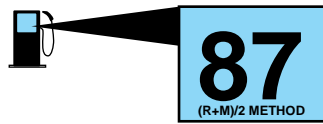

### Unleaded Gasoline engines

Your vehicle is designed to use “Regular” unleaded gasoline with an (R+M)/2 octane rating of 87. We do not recommend the use of gasolines labeled as “Regular” that are sold with octane ratings of 86 or lower in high altitude areas.

## Maintenance and care

### **FFV engine**

Your vehicle is designed to use Fuel Ethanol (E85), “Regular” unleaded gasoline or any percentage of the two fuels combined.

**U.S. government regulations require fuel ethanol dispensing pumps to have a small, square, orange and black label with the common abbreviation E85 or the appropriate percentage for that region. Use of other fuels such as Fuel Methanol may cause powertrain damage, a loss of vehicle performance, and your warranty may be invalidated.**

### **Fuel quality**

Many of the world’s automakers issued the World-wide Fuel Charter that recommends gasoline specifications to provide improved performance and emission control system protection for your vehicle. Gasolines that meet the World-wide Fuel Charter should be used when available. Ask your fuel supplier about gasolines that meet the World-wide Fuel Charter.

It should not be necessary to add any aftermarket products to your fuel tank if you continue to use high quality fuel of the recommended octane rating. Aftermarket products could cause damage to the fuel system. Repairs to correct the effects of using an aftermarket product in your fuel may not be covered by your warranty.

### **Unleaded Gasoline engines**

If you are experiencing starting, rough idle or hesitation driveability problems during a cold start, try a different brand of “Regular” unleaded gasoline. “Premium” unleaded gasoline is not recommended (particularly in the United States) because it may cause these problems to become more pronounced. If the problems persist, see your dealer or a qualified service technician.

### **FFV engine**

Your FFV will operate well on ordinary “Regular” unleaded gasoline, but only the highest quality fuel ethanol will provide the same level of protection and performance.

Standards for fuel ethanol have been developed to provide FFVs the best possible performance, safety and durability. To assist alcohol fuel providers in meeting these standards, guidelines have also been developed which prescribe “Ethanol Fuel Compatible” dispensing station equipment. These standards and guidelines can be obtained from Ford

## Maintenance and care

Motor Company. Fuel stations may apply to be certified as meeting these standards. However, not all stations meet these standards at this time. To ensure proper operation of your FFV on fuel ethanol, refuel at certified stations.

If you are experiencing a rough or rolling idle after start-up with the outside temperature above 27° C (80° F), the idle should improve within 10 to 30 seconds. If the problems persist below this temperature, see your dealer or a qualified service technician.

### Cleaner air

Ford approves the use of reformulated “cleaner-burning” gasolines to improve air quality. These gasolines may contain oxygenates up to 10% ethanol or 15% MTBE.

### Running out of fuel

Avoid running out of fuel because this situation may have an adverse affect on powertrain components.

If you have run out of fuel:

- You may need to cycle the ignition from OFF to ON several times after refueling, to allow the fuel system to pump the fuel from the tank to the engine.
- The  indicator may come on. For more information on the “Service Engine Soon” indicator, refer to the *Instrumentation* chapter.

### Fuel Filter

For fuel filter replacement, see your dealer or a qualified service technician. Refer to the Scheduled Maintenance Guide for the appropriate intervals for changing the fuel filter.

**Replace the fuel filter with an authorized Motorcraft part. The customer warranty may be void for any damage to the fuel system if an authorized Motorcraft fuel filter is not used.**

## ESSENTIALS OF GOOD FUEL ECONOMY

### Measuring techniques

Your best source of information about actual fuel economy is you, the driver. You must gather information as accurately and consistently as possible. Fuel expense, frequency of fillups or fuel gauge readings are



## Maintenance and care

NOT accurate as a measure of fuel economy. We do not recommend taking fuel economy measurements during the first 1 600 km (1 000 miles) of driving (engine break-in period). You will get a more accurate measurement after 3 000 km–5 000 km (2 000 miles–3 000 miles).

### Filling the tank

The advertised fuel capacity of the fuel tank on your vehicle is equal to the rated refill capacity of the fuel tank as listed in the *Refill Capacities* section of the *Capacities and specifications* chapter.

The advertised capacity is the amount of the indicated capacity and the empty reserve combined. Indicated capacity is the difference in the amount of fuel in a full tank and a tank when the fuel gauge indicates empty. Empty reserve is the small amount of usable fuel remaining in the fuel tank after the fuel gauge indicates empty.

**The amount of empty reserve varies and should not be relied upon to increase driving range. When refueling your vehicle after the fuel gauge indicates empty, you might not be able to refuel the full amount of the advertised capacity of the fuel tank due to the empty reserve still present in the tank.**

For consistent results when filling the fuel tank:

- Use the same filling rate setting (low — medium — high) each time the tank is filled.
- Allow three automatic click-offs when filling.
- Always use fuel with the recommended octane rating.
- Use a known quality gasoline, preferably a national brand.
- Use the same side of the same pump and have the vehicle facing the same direction each time you fill up.
- Have the vehicle loading and distribution the same every time.

Your results will be most accurate if your filling method is consistent.

### Calculating fuel economy

1. Fill the fuel tank completely and record the initial odometer reading (in kilometers or miles).
2. Each time you fill the tank, record the amount of fuel added (in liters or gallons).
3. After at least three to five tank fill-ups, fill the fuel tank and record the current odometer reading.

## Maintenance and care

4. Subtract your initial odometer reading from the current odometer reading.
5. Follow one of the simple calculations in order to determine fuel economy:

**Multiply liters used by 100, then divide by total kilometers traveled.**

**Divide total miles traveled by total gallons used.**

Keep a record for at least one month and record the type of driving (city or highway). This will provide an accurate estimate of the vehicle's fuel economy under current driving conditions. Additionally, keeping records during summer and winter will show how temperature impacts fuel economy. In general, lower temperatures give lower fuel economy.

### Driving style — good driving and fuel economy habits

Give consideration to the lists that follow and you may be able to change a number of variables and improve your fuel economy.

#### *Habits*

- Smooth, moderate operation can yield up to 10% savings in fuel.
- Steady speeds without stopping will usually give the best fuel economy.
- Idling for long periods of time (greater than one minute) may waste fuel.
- Anticipate stopping; slowing down may eliminate the need to stop.
- Sudden or hard accelerations may reduce fuel economy.
- Slow down gradually.
- Driving at reasonable speeds (traveling at 88 km/h [55 mph] uses 15% less fuel than traveling at 105 km/h [65 mph]).
- Revving the engine before turning it off may reduce fuel economy.
- Using the air conditioner or defroster may reduce fuel economy.
- You may want to turn off the speed control in hilly terrain if unnecessary shifting between third and fourth gear occurs. Unnecessary shifting of this type could result in reduced fuel economy.
- Warming up a vehicle on cold mornings is not required and may reduce fuel economy.

## Maintenance and care

- Resting your foot on the brake pedal while driving may reduce fuel economy.
- Combine errands and minimize stop-and-go driving.

### **Maintenance**

- Keep tires properly inflated and use only recommended size.
- Operating a vehicle with the wheels out of alignment will reduce fuel economy.
- Use recommended engine oil. Refer to *Lubricant Specifications*.
- Perform all regularly scheduled maintenance items. Follow the recommended maintenance schedule and owner maintenance checks found in your vehicle Scheduled Maintenance Guide.

### **Conditions**

- Heavily loading a vehicle or towing a trailer may reduce fuel economy at any speed.
- Carrying unnecessary weight may reduce fuel economy (approximately 0.4 km/L [1 mpg] is lost for every 180 kg [400 lb] of weight carried).
- Adding certain accessories to your vehicle (for example bug deflectors, rollbars/light bars, running boards, ski/luggage racks) may reduce fuel economy.
- Using fuel blended with alcohol may lower fuel economy.
- Fuel economy may decrease with lower temperatures during the first 12–16 km (8–10 miles) of driving.
- Driving on flat terrain offers improved fuel economy as compared to driving on hilly terrain.
- Transmissions give their best fuel economy when operated in the top cruise gear and with steady pressure on the gas pedal.
- Close windows for high speed driving.

### **EPA window sticker**

Every new vehicle should have the EPA window sticker. Contact your dealer if the window sticker is not supplied with your vehicle. The EPA window sticker should be your guide for the fuel economy comparisons with other vehicles.

It is important to note the box in the lower left corner of the window sticker. These numbers represent the Range of L/100 km (MPG)

## Maintenance and care

expected on the vehicle under optimum conditions. Your fuel economy may vary depending upon the method of operation and conditions.

### EMISSION CONTROL SYSTEM

Your vehicle is equipped with various emission control components and a catalytic converter which will enable your vehicle to comply with applicable exhaust emission standards. To make sure that the catalytic converter and other emission control components continue to work properly:

- Use only unleaded fuel (or E85, if equipped with the 3.0L FFV V6 engine).
- Avoid running out of fuel.
- Do not turn off the ignition while your vehicle is moving, especially at high speeds.
- Have the items listed in your Scheduled Maintenance Guide performed according to the specified schedule.

The scheduled maintenance items listed in the Scheduled Maintenance Guide are essential to the life and performance of your vehicle and to its emissions system.

If other than Ford, Motorcraft or Ford-authorized parts are used for maintenance replacements or for service of components affecting emission control, such non-Ford parts should be equivalent to genuine Ford Motor Company parts in performance and durability.



Do not park, idle, or drive your vehicle in dry grass or other dry ground cover. The emission system heats up the engine compartment and exhaust system, which can start a fire.

Illumination of the  indicator, charging system warning light or the temperature warning light, fluid leaks, strange odors, smoke or loss of engine power, could indicate that the emission control system is not working properly.



Exhaust leaks may result in entry of harmful and potentially lethal fumes into the passenger compartment.



Do not make any unauthorized changes to your vehicle or engine. By law, vehicle owners and anyone who manufactures, repairs, services, sells, leases, trades vehicles, or supervises a fleet of vehicles are not

## Maintenance and care

permitted to intentionally remove an emission control device or prevent it from working. Information about your vehicle's emission system is on the Vehicle Emission Control Information Decal located on or near the engine. This decal identifies engine displacement and gives some tune up specifications.

Please consult your “Warranty Guide” for complete emission warranty information.

### Readiness for Inspection/Maintenance (I/M) testing

In some localities, it may be a legal requirement to pass an I/M test of the on-board diagnostics system. If your  indicator is on, refer to the description in the *Warning Lights and Chimes* section of the *Instrumentation* chapter. Your vehicle may not pass the I/M test with the  indicator on.

If the vehicle's powertrain system or its battery has just been serviced, the on-board diagnostics system is reset to a “not ready for I/M test” condition. To ready the on-board diagnostics system for I/M testing, a minimum of 30 minutes of city and highway driving is necessary as described below:

- First, at least 10 minutes of driving on an expressway or highway.
- Next, at least 20 minutes driving in stop-and-go, city-type traffic with at least four idle periods.

Allow the vehicle to sit for at least eight hours without starting the engine. Then, start the engine and complete the above driving cycle. The engine must warm up to its normal operating temperature. Once started, do not turn off the engine until the above driving cycle is complete.

## BULBS

### Replacing exterior bulbs

Check the operation of the following lamps frequently:

- Headlamps
- Tail lamps
- Brakelamps
- High-mount brakelamp
- Turn signals
- Backup lamps

## Maintenance and care

- License plate lamp

Do not remove lamp bulbs unless they will be replaced immediately. If a bulb is removed for an extended period of time, contaminants may enter the lamp housings and affect performance.

### Replacing headlamp bulbs

To remove the headlamp bulb:

1. Make sure headlamp switch is in OFF position.
2. Remove the bolt from the headlamp housing.
3. At the back of the headlamp, pry up and remove the two retainer pins to release the headlamp assembly from the vehicle and pull headlamp forward.

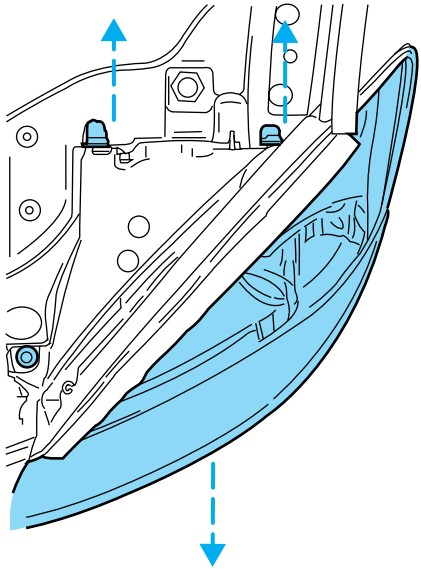

4. Remove the protective dust shield from the housing by turning the dust shield counterclockwise (when viewed from the rear).

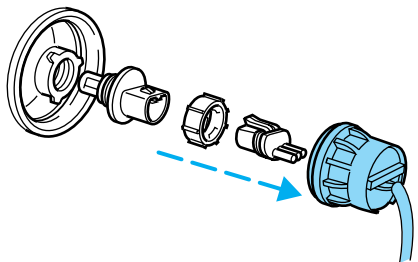

## Maintenance and care

5. Disconnect the electrical connector from the bulb by pulling rearward.

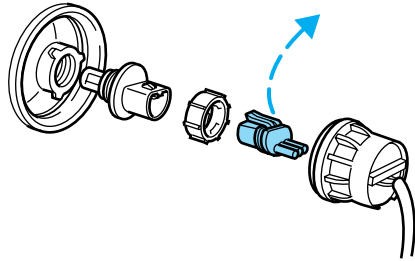

6. Remove the bulb retaining ring by rotating it counterclockwise.

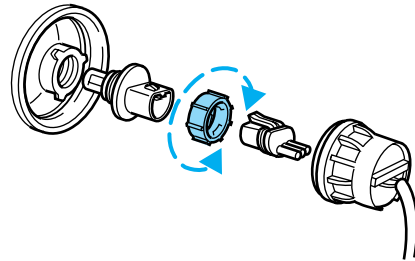

7. Remove the old bulb from the lamp assembly by pulling it straight out of the lamp assembly.

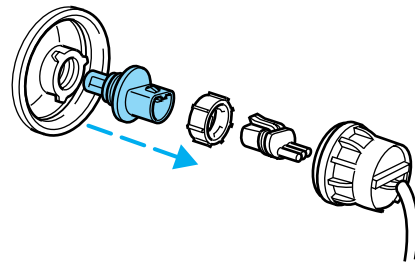

To install the new bulb:



Handle a halogen headlamp bulb carefully and keep out of children's reach. Grasp the bulb only by its plastic base and do not touch the glass. The oil from your hand could cause the bulb to break the next time the headlamps are operated.

1. Install the new bulb in lamp assembly by pushing straight in with the flat surface of the bulb's plastic base facing upward. You may need to turn the bulb slightly to align the grooves in the plastic base with the tabs in the lamp assembly.

## Maintenance and care

2. Install the bulb retaining ring over the plastic base and lock the ring by rotating clockwise until it snaps into place.
3. Connect the electrical connector to the bulb.
4. Install the protective dust shield and lock the shield by rotating it clockwise until it locks into position.
5. Carefully position the headlamp assembly onto the vehicle.
6. Hold the headlamp assembly snugly against the vehicle and install the retainer pins straight down to lock the lamp into place.
7. Before reinstalling the bolt, make sure the retainer pins are fully seated, and install bolt on headlamp housing.
8. Turn the headlamps on and make sure they work properly. If the headlamp was correctly aligned before you changed the bulb, you should not need to align it again.

### ***Replacing front parking lamp/turn signal/cornering lamp bulbs***

1. Make sure the headlamp control is in the OFF position.
2. Remove the bolt from the headlamp housing.
3. At the back of the headlamp, pry up and remove the two retainer pins to release the headlamp assembly from the vehicle and pull headlamp forward.
4. Rotate the bulb socket counterclockwise and remove it from the lamp assembly.

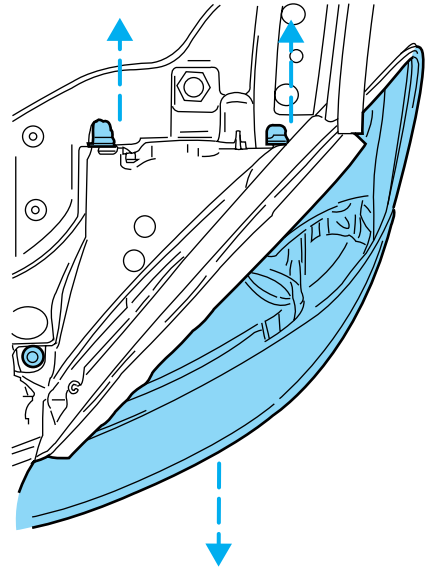



## Maintenance and care

5. Carefully pull bulb straight out of the socket and push in the new bulb.

6. Install the bulb socket into the lamp assembly by rotating it clockwise.

7. Carefully position the headlamp assembly onto the vehicle.

8. Hold the headlamp assembly snugly against the vehicle and install the retainer pins straight down to lock the lamp into place.

9. Before reinstalling the bolt, make sure the retainer pins are fully seated, and install bolt on headlamp housing.

10. Turn the headlamps on and make sure they work properly. If the headlamp was correctly aligned before you changed the bulb, you should not need to align it again.

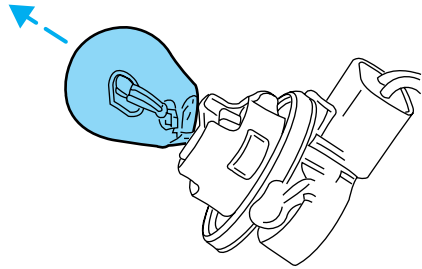

### **Replacing high-mount brakelamp bulbs**

The following procedure is for sedans only. For wagon, refer to a qualified technician.

1. Open trunk.

2. Inside trunk, locate access hole under the rear window.

3. Remove the bulb socket by rotating it counterclockwise and pulling it down from the lamp assembly.

4. Carefully pull bulb straight out of socket and push in new bulb.

5. To complete installation, follow the removal procedure in reverse order.

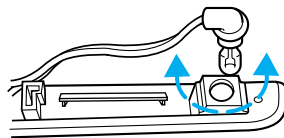
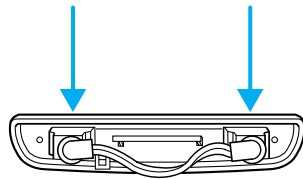

### **Replacing license plate lamp bulbs**

The following procedure is for wagons only. For sedans, refer to a qualified technician.

## Maintenance and care

1. Remove screw and the license plate lamp assembly from liftgate.
2. Remove bulb socket by turning counterclockwise.
3. Carefully pull the bulb out from the socket and push in the new bulb.
4. Install the lamp assembly on liftgate with screw.

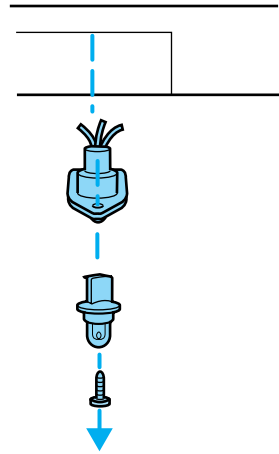

### **Replacing tail/brake/turn signal/backup lamp bulbs**

#### **Sedan**

The tail lamp, brake lamp, turn signal lamp and backup lamp bulbs are located in the same portion of the tail lamp assembly. Follow the same steps to replace either bulb.

1. Open trunk and remove two plastic mushroom nuts, five push pins and the plastic cover from inside the trunk to access the lamp assembly.
2. Carefully pull the carpet away to expose the lamp assembly hardware.
3. Remove three nut and washer assemblies and the lamp assembly from the vehicle.

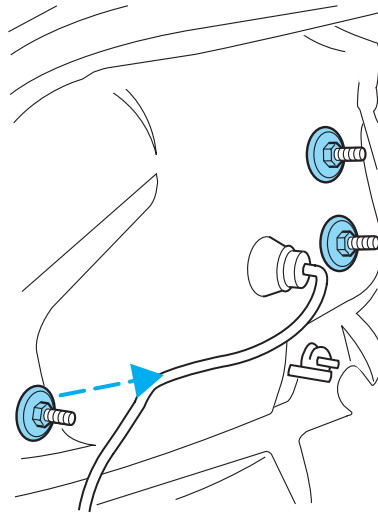

## Maintenance and care

4. Remove the bulb socket by rotating it counterclockwise, then pulling it out of the lamp assembly.

5. Pull the bulb from the socket and push in the new bulb.

6. Install the bulb socket into the lamp assembly by rotating it clockwise.

7. Install the lamp assembly on the vehicle with three nut and washer assemblies ensuring the washers on the nuts are flush with the body to prevent water from entering the trunk.

8. Carefully push the carpet back in to place and install the plastic cover inside the trunk with five push pins and two plastic mushroom nuts.

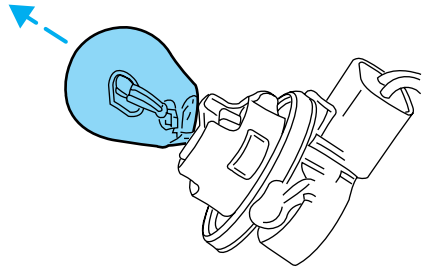

### Wagon

The tail lamp/turn lamp bulbs are located in the same portion of the tail lamp assembly, one just below the other. Follow the same steps to replace either bulb:

1. Open the liftgate to expose the lamp assemblies.

2. Remove the two bolts from the tail lamp assembly.

3. Carefully pull the lamp assembly from the tailgate.

4. Twist the bulb socket counterclockwise and remove from lamp assembly.

5. Pull the bulb straight out of the socket and push in the new bulb.

6. Install bulb socket in lamp assembly by turning clockwise.

7. Carefully install the tail lamp assembly on tailgate and secure with two bolts.

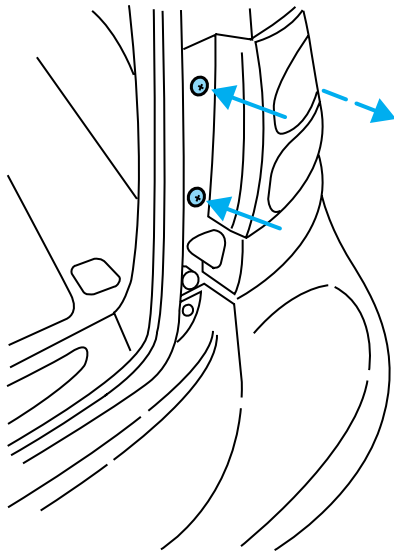

## Maintenance and care

### Using the right bulbs

Replacement bulbs are specified in the chart below. Headlamp bulbs must be marked with an authorized “D.O.T.” for North America and an “E” for Europe to assure lamp performance, light brightness and pattern and safe visibility. The correct bulbs will not damage the lamp assembly or void the lamp assembly warranty and will provide quality bulb burn time.

<b>Function</b>	<b>Number of bulbs</b>	<b>Trade Number</b>
Front park/turn lamp	2	3457 NAK (amber)
Headlamp	2	9007 QL (9007 LL optional)
Tail lamp/brake/turn lamp	2	3157
Tail lamp/brake lamp (wagon)	2	3157
Rear turn lamp (wagon)	2	3456K
Backup lamp	2	921
Backup lamp (wagon)	2	3156
License plate lamp	2	168
High-mount brake lamp	2	912
Rear side marker lamp (wagon)	2	168
Cargo lamp (wagon)	1	578
Dome lamp	1	578
Dome/map lamp	3	578
Dome lamp/moon roof	2	578
Visor vanity lamp (passenger/driver)	2	DE 3021
Floor console	2	194
Luggage compartment lamp	1	906
I/P ashtray lamp	1	194
All replacement bulbs are clear in color except where noted.		
To replace all instrument panel lights - see your dealer.		

## Maintenance and care

### AIMING THE HEADLAMPS

The headlamps on your vehicle are properly aimed at the assembly plant. If your vehicle has been in an accident the alignment of your headlamps should be checked by a qualified service technician.

#### Vertical aim adjustment

1. Park the vehicle on a level surface approximately 7.6 meters (25 feet) from a vertical wall or screen directly in front of it.

- (A) Eight feet
- (B) Center height of lamp to ground
- (C) Twenty five feet
- (D) Horizontal reference line

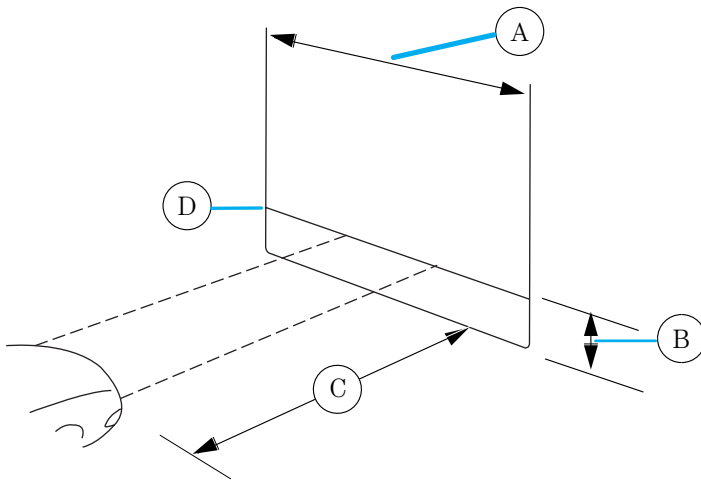

1. Measure the height of the headlamp bulb center from the ground and mark a 2.5 meter (8 foot) horizontal reference line on the vertical wall or screen at this height (a piece of masking tape works well).

2. Turn on the low beam headlamps to illuminate the wall or screen and open the hood.

## Maintenance and care

3. On the wall or screen you will observe an area of high intensity light. The top of the high intensity area should touch the horizontal reference line, if not, the beam will need to be adjusted.

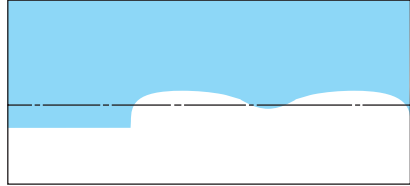

To see a clearer light pattern for adjusting, you may want to block the light from one headlamp while adjusting the other.

4. Locate the vertical adjuster on each headlamp. Using a 4 mm wrench, turn the adjuster either clockwise (to adjust down) or counterclockwise (to adjust up). The horizontal edge of the brighter light should touch the horizontal reference line.

5. HORIZONTAL AIM IS NOT REQUIRED FOR THIS VEHICLE AND IS NON-ADJUSTABLE.

6. Close the hood and turn off the lamps.

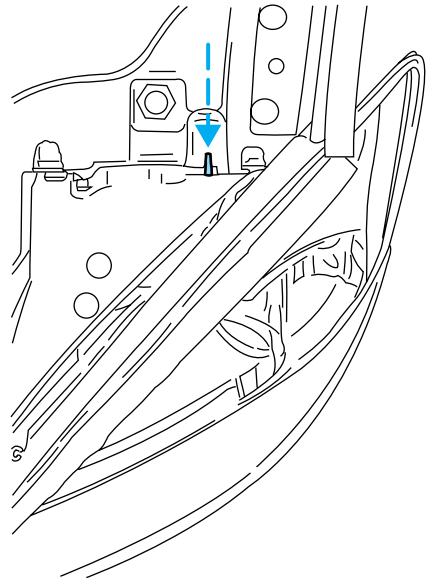

## CLEANING AND CARING FOR YOUR VEHICLE

Refer to the Customer Assistance chapter for a list of Ford-approved cleaners, polishes and waxes.

## Maintenance and care

### Washing your vehicle

Wash your vehicle regularly with cold or lukewarm water. Never use strong detergents or soap. If your vehicle is particularly dirty, use a quality car wash detergent. Always use a clean sponge, washing glove or similar device and plenty of water for best results. To avoid spots, avoid washing when the hood is still warm, immediately after or during exposure to strong sunlight.

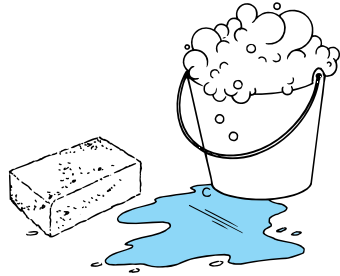

During winter months, it is especially important to wash the vehicle on a regular basis. Large quantities of dirt and road salt are difficult to remove and also cause damage to the vehicle.

Any gasoline spilled on the vehicle or deposits such as bird droppings should be washed and sponged off as soon as possible. Deposits not removed promptly can cause damage to the vehicle's paintwork.

Remove any exterior accessories, such as antennas, before entering a car wash. If you have wax applied to the vehicle at a commercial car wash, it is recommended that you clean the wiper blades and windshield as described in *Cleaning the wiper blades and windshield*.

After washing, apply the brakes several times to dry them.

### Waxing your vehicle

Waxing your vehicle on a regular basis will reduce minor scratches and paint damage.

Wax when water stops beading on the surface. This could be every three or four months, depending on operating conditions.

Use only carnauba or synthetic-based waxes. Use a cleaning fluid with a clean cloth to remove any bugs before waxing your vehicle. Use tar remover to remove any tar spots.

Avoid getting wax on the windshield, or on any surfaces which appear coarse or bumpy. If you have wax applied at a commercial car wash, it is recommended that you clean the wiper blades and windshield as described in *Cleaning the wiper blades and windshield*.

## Maintenance and care

### Repairing paint chips

Minor scratches or paint damage from road debris may be repaired with the Ultra Touch Prep and Finishing Kit (#F7AZ-19K507-BA), Lacquer Touch-up Paint (#ALBZ-19500-XXXXA), or Exterior Acrylic Spray Lacquer (#ALAZ-19500-XXXXA) from the Ford Car Care Chemicals line. Please note that the part numbers (shown as XXXX above) will vary with your vehicle's specific coloring. Observe the application instructions on the products.

Remove particles such as bird droppings, tree sap, insect remains, tar spots, road salt and industrial fallout immediately.

### Cleaning the wheels

Wash with the same detergent as the body of your vehicle. Do not use acid-based or alcohol-based wheel cleaners, steel wool, fuel or strong detergents. Never use abrasives that will damage the finish of special wheel surfaces. Use a tar remover to remove grease and tar.

The brushes used in some automatic car washes may damage the finish on your wheels. Before going to a car wash, find out if the brushes are abrasive.

### Cleaning non-painted plastic exterior parts

Use vinyl cleaner for routine cleaning. Clean with a tar remover if necessary. Do not clean plastic parts with thinners, solvents or petroleum-based cleaners.

### Underbody

Flush the complete underside of vehicle frequently. Keep body drain holes unplugged. Inspect for road damage.

### Cleaning mirrors

Do not clean your mirrors with a dry cloth or abrasive materials. Use a soft cloth and mild detergent and water. Be careful when removing ice from outside mirrors because you may damage the reflective surface.

### Cleaning the exterior lamps

Wash with the same detergent as the exterior of your vehicle. If necessary, use a tar remover such as Ford Extra Strength Tar and Road Oil Remover (B7A-19520-AA).



## Maintenance and care

To avoid scratching the lamps, do not use a dry paper towel, chemical solvents or abrasive cleaners.

### Cleaning the wiper blades, windshield and rear window

If the wiper blades do not wipe properly, clean the wiper blade rubber element with undiluted windshield washer solution or a mild detergent. To avoid damaging the blades, do not use fuel, kerosene, paint thinner or other solvents.

If the wiper still does not wipe properly, this could be caused by substances on the windshield or rear window such as tree sap and some hot wax treatments used by commercial car washes. Clean the outside of the windshield or rear window with a non-abrasive cleaner such as Ford Ultra-Clear Spray Glass Cleaner, (E4AZ-19C507-AA), available from your Ford Dealer. **Do not** use abrasive cleansers on glass as they may cause scratches. The windshield or rear window is clean if beads do not form when you rinse it with water. The windshield, rear window and wiper blades should be cleaned on a regular basis, and blades or rubber elements replaced when worn.

### Cleaning the engine

Engines are more efficient when they are clean because grease and dirt buildup keep the engine warmer than normal. When washing:

- Take care when using a power washer to clean the engine. The high pressure fluid could penetrate the sealed parts and cause damage.
- Do not spray a hot engine with cold water to avoid cracking the engine block or other engine components.
- Cover the highlighted areas to prevent water damage when cleaning the engine.

## Maintenance and care

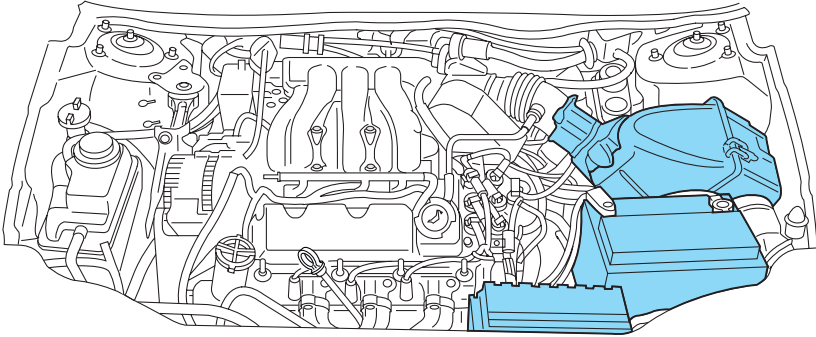

- 3.0L Vulcan engine

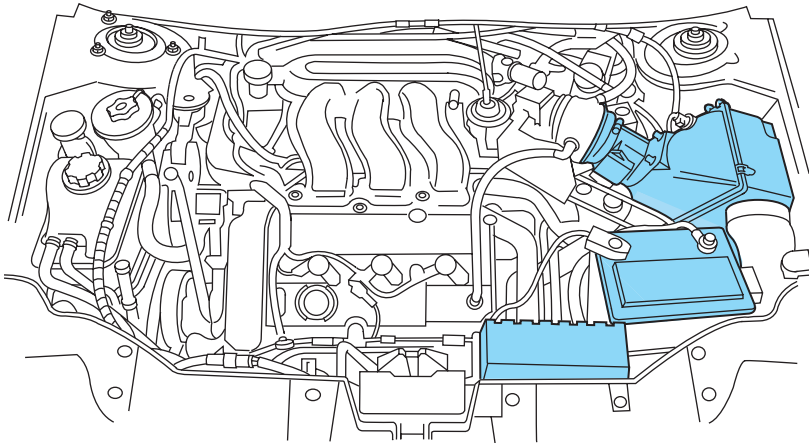

- 3.0L Duratec engine
- Never wash or rinse the engine while it is running; water in the running engine may cause internal damage.

## Maintenance and care

### Cleaning the instrument panel

Clean with a damp cloth, then dry with a dry cloth.

Avoid cleaner or polish that increases the gloss of the upper portion of the instrument panel. The dull finish in this area helps protect the driver from undesirable windshield reflection.



Do not use chemical solvents or strong detergents when cleaning the steering wheel or instrument panel to avoid contamination of the air bag system.

### Cleaning the instrument cluster lens

Clean with a damp cloth, then dry with a dry cloth.

Do not use household or glass cleaners as these may damage the lens.

### Cleaning seats equipped with side air bags

Remove dust and loose dirt with a whisk broom or a vacuum cleaner. Remove fresh spots immediately. Follow the directions that come with the cleaner. Do not saturate the seat cover with upholstery cleaner.



Do not use chemical solvents or strong detergents when cleaning the seat mounted side air bag. Such products could contaminate the side air bag system and affect performance of the side air bag in a collision.

### Woodtone trim

Wipe stains with a soft cloth and a multi-purpose cleaning solution.

### Inside windows

Use Ultra-Clear Spray Glass Cleaner (E4AZ-19C507-AA) for the inside windows if they become fogged.

### Cleaning and maintaining the safety belts

Clean the safety belts with a mild soap solution recommended for cleaning upholstery or carpets. Do not bleach or dye the belts, because these actions may weaken the belt webbing.

Check the safety belt system periodically to make sure there are no nicks, wear or cuts. If your vehicle has been involved in an accident,

## Maintenance and care

refer to the *Safety belt maintenance* section in the *Seating and safety restraints* chapter.

### **Cleaning leather seats (if equipped)**

To clean, simply use a soft cloth dampened with water and a mild soap. Wipe the leather again with a damp cloth to remove soap residue. Dry with a soft cloth. For tougher soiling concerns, Ford recommends using the Deluxe Leather Care Kit F8AZ-19G253-AA, which is available from your Ford Dealer. This mild cleaner and special pad, cleans the leather and maintains its natural beauty. Follow the instructions on the cleaner label. Regular cleaning of your leather upholstery helps maintain its resiliency and color.

**Do not use household cleaning products, alcohol solutions, solvents or cleaners intended for rubber, vinyl or plastics.**

### **Cleaning the interior fabric**

Remove dust and loose dirt with a whisk broom or a vacuum cleaner. Remove fresh spots immediately. Do not use household or glass cleaners. These agents can stain and discolor the fabric. Use a mild soap and water solution if necessary.

## Capacities and specifications

### MOTORCRAFT PART NUMBERS

<b>Component</b>	<b>3.0L V6 Vulcan engine</b>	<b>3.0L FFV V6 engine</b>	<b>3.0L DOHC V6 Duratec engine</b>
Air filter element <sup>1</sup>	FA-1683	FA-1683	FA-1683
Fuel filter	FG-1006	FG-1006	FG-1006
Battery (standard)	BXT-58R	BXT-58R	BXT-36R
Battery (optional)	BXT-36R	N/A	N/A
Oil filter	FL-400-S	FL-400-S	FL-820-S
PCV valve	EV-228	EV-130	EV-243
Spark plugs <sup>2</sup>	AWSF-32PP <sup>3</sup>	AGSF-22PP <sup>3</sup>	AGSF-32W

<sup>1</sup> Do not use oil-impregnated air filter elements. Failure to use the correct air filter element may result in severe engine damage. The customer warranty may be voided for any damage to the engine if the correct air filter element is not used.

<sup>2</sup> Refer to Vehicle Emissions Control Information (VECI) decal for spark plug gap information.

<sup>3</sup> If a spark plug is to be removed for inspection, it must be reinstalled in the same cylinder. If a spark plug needs to be replaced, use only spark plugs with the service part number suffix letter as shown on the engine decal.

## Capacities and specifications

### REFILL CAPACITIES

Fluid	Ford Part Name	Application	Capacity
Brake fluid	High Performance DOT 3 Motor Vehicle Brake Fluid	All	Fill to line on reservoir
Engine coolant <sup>1</sup>	Premium Engine Coolant	3.0L V6 Vulcan engine	11.0L (11.6 quarts)
		3.0L V6 Duratec engine	10.0L (10.6 quarts)
Engine oil (includes filter change)	Motorcraft SAE 5W-30 Super Premium Motor Oil	3.0L V6 Vulcan engine	4.25L (4.5 quarts)
		3.0L V6 Duratec engine	5.2L (5.5 quarts)
Fuel tank capacity	N/A	All vehicles	68.1L (18.0 gallons)
Power steering fluid	Motorcraft MERCON® ATF	3.0L V6 Vulcan engine	Keep in FULL range on dipstick
		3.0L V6 Duratec engine	Fill to line on reservoir
Automatic transaxle - AX4N	Motorcraft MERCON®V ATF	3.0L V6 Vulcan engine	12.8L (13.5 quarts)
		3.0L V6 Duratec engine	12.7L (13.4 quarts)
Automatic transaxle - AX4S	Motorcraft MERCON®V ATF	3.0L V6 Vulcan engine	11.6L (12.2 quarts)
Windshield washer fluid - Front	Ultra-Clear Windshield Washer Concentrate	All	2.8L (94.7 oz.)
Windshield washer fluid - Rear	Ultra-Clear Windshield Washer Concentrate	Wagon	1.8L (60.9 oz.)

<sup>1</sup> Use Ford Premium Engine Coolant (green in color). DO NOT USE Ford Extended Life Engine Coolant (orange in color). Refer to *Adding engine coolant*, in the *Maintenance and Care* chapter.

## Capacities and specifications

### LUBRICANT SPECIFICATIONS

<b>Items</b>	<b>Ford Part Name or equivalent</b>	<b>Ford Part Number</b>	<b>Ford Specification</b>
Brake fluid	High Performance DOT 3 Motor Vehicle Brake Fluid	C6AZ-19542-AB	ESA-M6C25-A and DOT 3
Door latch, hood latch, auxiliary hood latch, seat tracks, trunk and liftgate latches	Multi-Purpose Grease	DOAZ-19584-AA or F5AZ-19G209-AA	ESA-M1C93-B or ESR-M1C159-A
Lock cylinders	Penetrating and Lock Lubricant	E8AZ-19A501-B	none
Automatic transaxle (AX4S and AX4N)	Motorcraft MERCON®V ATF	XT-5-QM	MERCON®V
Engine oil	Motorcraft SAE 5W-30 Super Premium Motor Oil	XO-5W30-QSP	WSS-M2C153-G and API Certification Mark
Constant velocity joints	CV Joint Grease (High Temp.)	E43Z-19590-A	ESP-M1C207-A
Engine coolant	Ford Premium Engine Coolant	E2FZ-19549-AA (in Canada, Motorcraft CXC-8-B)	ESE-M97B44-A
Power steering fluid	Motorcraft MERCON® ATF	XT-2-QDX	MERCON®
Windshield washer fluid	Ultra-clear Windshield Washer Concentrate	C9AZ-19550-AC	ESR-M17P5-A

## Capacities and specifications

### ENGINE DATA

Engine	3.0L V6 Vulcan engine	3.0L FFV V6 engine	3.0L DOHC V6 Duratec engine
Cubic inches	182	182	181
Required fuel	87 octane	87 octane or Ethanol (E 85)	87 octane
Firing order	1-4-2-5-3-6	1-4-2-5-3-6	1-4-2-5-3-6
Spark plug gap	1.07-1.17 mm (0.042-0.046 inch)	1.07-1.17 mm (0.042-0.046 inch)	1.3-1.4 mm (0.052-0.056 inch)
Ignition system	EDIS	EDIS	Coil on plug
Compression ratio	9.3:1	9.14:1	10.0:1

### VEHICLE DIMENSIONS

Vehicle dimensions	Sedan mm (in)	Wagon mm (in)
(1) Overall length	5 016.5 (197.7)	5 069.8 (199.6)
(2) Overall width	1 854.2 (73.0)	1 854.2 (73.0)
(3) Overall height	1 399.5 (56.1)	1 472.0 (57.9)
(4) Wheelbase	2 755.9 (108.5)	2 755.9 (108.5)
(5) Track - Front	1 564.6 (61.6)	1 564.6 (61.6)
(5) Track - Rear	1 577.0 (62.1)	1 577.0 (62.1)



## Capacities and specifications

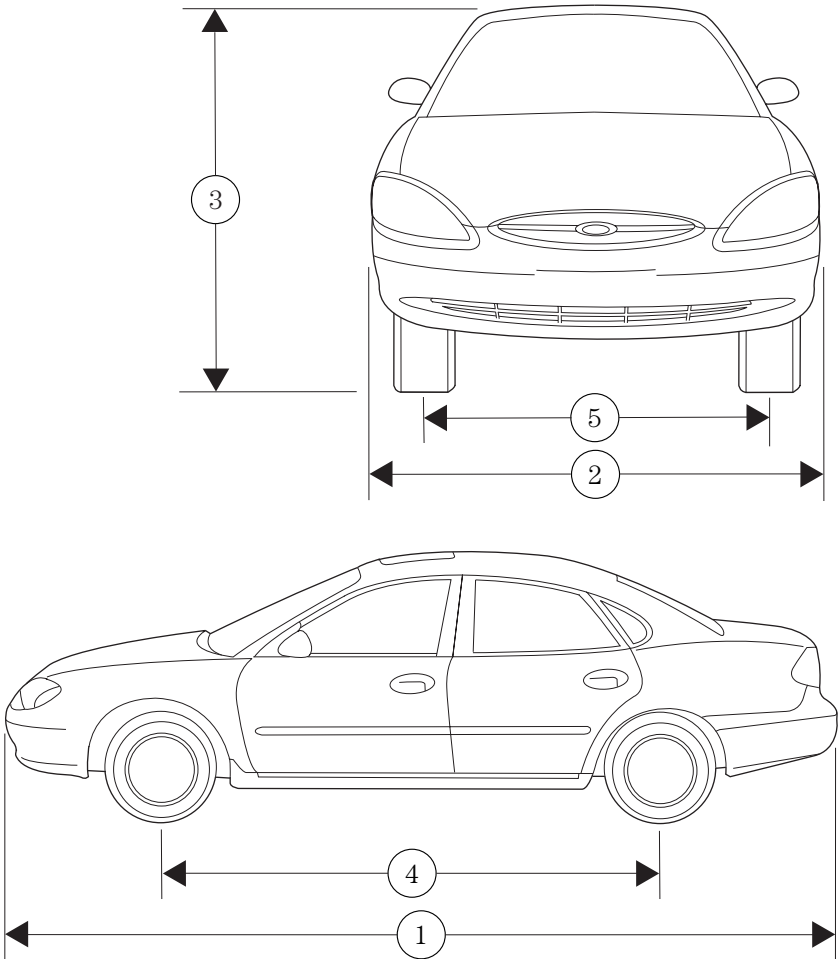

## Capacities and specifications

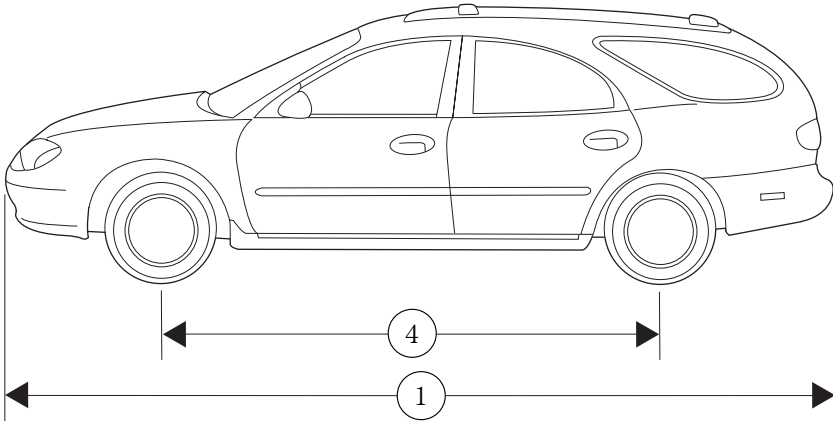

### IDENTIFYING YOUR VEHICLE

#### Certification label

The National Highway Traffic Safety Administration Regulations require that a Certification Label be affixed to a vehicle and prescribe where the Certification Label may be located. The Certification Label is located on the front door latch pillar on the driver's side.

<b>MFD. BY FORD MOTOR CO. IN U.S.A.</b>	
DATE: XXXXX	GVWR: XXXXX LB/ XXXXX KG
FGAWR: XXXXXX/XXXXXXXX	RGAWR: XXXXXX/XXXXXXXX
THIS VEHICLE CONFORMS TO ALL APPLICABLE FEDERAL MOTOR VEHICLE SAFETY STANDARDS IN EFFECT ON THE DATE OF MANUFACTURE SHOWN ABOVE.	
VIN: XXXXXXXXXXXXXXXXX	TYPE: XXXXXXXXXXXXXXXXX
MAXIMUM LOAD=OCCUPANTS + LUGGAGE=XXXKG/XXXLB	
OCCUPANTS: X TOTAL X FR X 2ND X RR	OCCUPANTS LUGGAGE
	XX XXXKG/XXXLB
	X XXXKG/XXXLB
TIRE: XXXX/XXXX XXX	
PRESSURE (FR) XXX kPa/33 PSI COLD	
PRESSURE (RR) XXX kPa/33 PSI COLD	
TRAILER TOWING - SEE OWNER GUIDE	
EXT PNT: XXXXXX XXXXXX	RC: XX   DSO: XXXX
BAR   INT TR   TP/PS   TR   AXLE   TR   SPR	F0000 T0000
X XX XXX X XX X XXX	
UTC VFOHT-15294A10-GA	

## Capacities and specifications

### Vehicle identification number

The vehicle identification number is attached to a metal tag and is located on the driver side instrument panel. (Please note that in the graphic XXXX is representative of your vehicle identification number.)

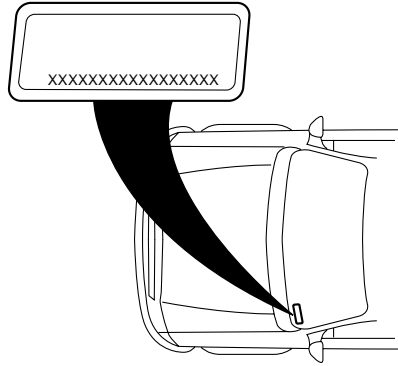

### Engine number

The engine number (the last eight numbers of the vehicle identification number) is stamped on the engine block, frame and transaxle.

## Customer assistance

### Ford Extended Service Plan

You can get more protection for your new car or light truck by purchasing Ford Extended Service Plan (Ford ESP) coverage. Ford ESP is an optional service contract which is backed by Ford Motor Company or Ford Motor Service Company (in the U.S.) and Ford of Canada (in Canada). It provides the following:

- benefits during the warranty period depending on the plan you purchase (such as: reimbursement for rentals; coverage for certain maintenance and wear items)
- protection against repair costs after your Bumper to Bumper Warranty expires

You may purchase Ford ESP from any participating Ford and Lincoln Mercury and Ford of Canada dealer. There are several plans available in various time, distance and deductible combinations which can be tailored to fit your own driving needs. Ford ESP also offers reimbursement benefits for towing and rental coverage. (In Hawaii, rules vary. See your dealer for details.)

When you buy Ford ESP, you receive Peace-of-Mind protection throughout the United States and Canada, provided by a network of more than 5,000 participating Ford or Lincoln Mercury and Ford of Canada dealers.

If you did not take advantage of the Ford Extended Service Plan at the time of purchasing your vehicle, you may still be eligible. Please contact your dealer for further information. Since this information is subject to change, please ask your dealer for complete details about Ford Extended Service Plan coverage options.

### Getting the service you need

#### At home

Ford Motor Company and Ford of Canada have authorized dealerships to service your vehicle. When you need warranty repairs your selling dealer would like you to return to it for that service, but you may also take your vehicle to another Ford Motor Company or Ford of Canada dealership authorized for warranty repairs. Certain warranty repairs require special training though, so not all dealers are authorized to perform all warranty repairs. That means that depending on the warranty repair needed, the vehicle may need to be taken to another dealer. If a particular dealership can not assist you, then contact the Customer Assistance Center.

## Customer assistance

If you have questions or concerns, or are unsatisfied with the service you are receiving, follow these steps:

1. Contact your Sales Representative or Service Advisor at your selling/servicing dealership.
2. If your inquiry or concern remains unresolved, contact the Sales Manager or Service Manager at the dealership.
3. If the inquiry or concern cannot be resolved at the dealership level, please contact the Ford Customer Assistance Center.

Ford Motor Company and Ford of Canada dealerships also carry quality parts and accessories, providing you with equipment reliability.

### Away from home

If you own a Ford or Mercury vehicle and are away from home when your vehicle needs service, or if you need more help than the dealership could provide, after following the steps described above, contact the Ford Customer Assistance Center to find an authorized dealership to help you. In the United States:

Ford Motor Company  
Customer Assistance Center  
16800 Executive Plaza Drive  
P.O. Box 6248  
Dearborn, Michigan 48121  
1-800-392-3673 (FORD)  
(TDD for the hearing impaired: 1-800-232-5952)

In Canada:  
Customer Assistance Centre  
Ford Motor Company of Canada, Limited  
P.O. Box 2000  
Oakville, Ontario L6J 5E4  
1-800-565-3673 (FORD)

## Customer assistance

If you own a Lincoln vehicle and are away from home when your vehicle needs service, or if you need more help than the dealership could provide, after following the steps described above, contact the Ford Customer Assistance Center to find an authorized dealership to help you. In the United States:

Ford Motor Company  
Customer Assistance Center  
16800 Executive Plaza Drive  
P.O. Box 6248  
Dearborn, Michigan 48121  
1-800-521-4140  
(TDD for the hearing impaired: 1-800-232-5952)

In Canada:  
Customer Assistance Centre  
Ford Motor Company of Canada, Limited  
P.O. Box 2000  
Oakville, Ontario L6J 5E4  
1-800-565-3673 (FORD)

In order to help you service your Ford or Lincoln Mercury vehicle, please have the following information available when contacting a Customer Assistance Center:

- Your telephone number (home and business)
- The name of the dealer and the city where the dealership is located
- The year and make of your vehicle
- The date of vehicle purchase
- The current odometer reading
- The vehicle identification number (VIN)

If you still have a complaint involving a warranty dispute, you may wish to contact the Dispute Settlement Board (U.S.) or the Canadian Motor Vehicle Arbitration Plan (CAMVAP), available in all of Canada (except Quebec).

In some states (in the U.S.) you must directly notify Ford in writing before pursuing remedies under your state's warranty laws. Ford is also allowed a final repair attempt in some states.

In the United States, a warranty dispute must be submitted to the Dispute Settlement Board before taking action under the Magnuson-Moss Warranty Act, or to the extent allowed by state law, before pursuing

## Customer assistance

replacement or repurchase remedies provided by certain state laws. This dispute handling procedure is not required prior to enforcing state created rights or other rights which are independent of the Magnuson-Moss Warranty Act or state replacement or repurchase laws.

### **THE DISPUTE SETTLEMENT BOARD (U.S. ONLY)**

The Dispute Settlement Board is:

- an independent, third-party arbitration program for warranty disputes
- available free to owners and lessees of qualifying Ford Motor Company vehicles

The Dispute Settlement Board may not be available in all states. Ford Motor Company reserves the right to change eligibility limitations, modify procedures and/or to discontinue this service without notice and without incurring obligations per applicable state law.

### **What kinds of cases does the Board review?**

Unresolved warranty repair concerns or vehicle performance as designed concerns on Ford and Lincoln Mercury cars and Ford and Lincoln Mercury light trucks which are within the terms of any applicable written new vehicle warranty are eligible for review, except those involving:

- a non-Ford product
- a non-Ford dealership
- sales disputes between customer and dealer except those associated with warranty repairs or concerns with the vehicle's performance as designed
- a request for reimbursement of consequential expenses unless a service or product concern is being reviewed
- items not covered by the New Vehicle Limited Warranty (including maintenance and wear items)
- alleged personal injury/property damage claims
- cases currently in litigation
- vehicles not used primarily for family, personal or household purposes (except in states where the Dispute Settlement Board is required to review commercial vehicles)
- vehicles with non-U.S. warranties

## Customer assistance

Concerns are ineligible for review if the New Vehicle Limited Warranty has expired at receipt of your application and, in certain states eligibility is dependent upon the customer's possession of the vehicle.

Eligibility may differ according to state law. For example, see the unique brochures for California, West Virginia, Georgia and Wisconsin purchasers/lessees.

### **Board membership**

The Board consists of:

- three consumer representatives
- a Ford or Lincoln Mercury dealership representative

Consumer candidates for Board membership are recruited and trained by an independent consulting firm. The dealership Board member is chosen from Ford and Lincoln Mercury dealership management, recognized for their business leadership qualities.

### ***What the Board needs***

To have your case reviewed you must complete the application in the DSB brochure and mail it to the address provided on the application form. Some states will require you to use certified mail, with return receipt requested.

Your application is reviewed and, if it is determined to be eligible, you will receive an acknowledgment indicating:

- the file number assigned to your application
- the toll-free phone number of the DSB's independent administrator

Your dealership and a Ford Motor Company representative will then be asked to submit statements.

To properly review your case, the Board needs the following information:

- legible copies of all documents and maintenance or repair orders relevant to the case
- the year, make, model, and Vehicle Identification Number (VIN) listed on your vehicle ownership license
- the date of repair(s) and mileage at the time of occurrence(s)
- the current mileage
- the name of the dealer(s) who sold or serviced the vehicle
- a brief description of your unresolved concern



## Customer assistance

- a brief summary of the action taken by the dealer(s) and Ford Motor Company
- the names (if known) of all the people you contacted at the dealership(s)
- a description of the action you expect to resolve your concern

You will receive a letter of explanation if your application does not qualify for Board review.

### ***Oral presentations***

If you would like to make an oral presentation, indicate YES to question #6 on the application. While it is your right to make an oral presentation before the Board, this is not a requirement and the Board will decide the case whether or not an oral presentation is made. Oral presentation may be requested by the Board as well.

### ***Making a decision***

Board members review all available information related to each complaint, including oral presentations, and arrive at a fair and impartial decision. Board review may be terminated at any time by either party.

Every effort is made to decide the case within 40 days of the date that all requested information is received by the Board. Since the Board generally meets once a month, it may take longer for the Board to consider some cases.

After a case is reviewed, the Board mails you a decision letter and a form on which to accept or reject the Board's decision. The decisions of the Board are binding on Ford (and, in some cases, on the dealer) but not on consumers who are free to pursue other remedies available to them under state or federal law.

### **To Request a DSB Brochure/Application**

For a brochure/application, speak to your dealer or write/call to the Board at the following address/phone number:

Dispute Settlement Board  
P.O. Box 5120  
Southfield, MI 48086-5120  
1-800-428-3718

## Customer assistance

You may also contact the North American Customer Assistance Center at 1-800-392-3673 (Ford), TDD for the hearing impaired: 1-800-232-5952 or by writing to the Center at the following address:

Ford Motor Company  
Customer Assistance Center  
16800 Executive Plaza Drive  
P.O. Box 6248  
Dearborn, Michigan 48121

### **UTILIZING THE MEDIATION/ARBITRATION PROGRAM (CANADA ONLY)**

In those cases where you continue to feel that the efforts by Ford and the dealer to resolve a factory-related vehicle service concern have been unsatisfactory, Ford of Canada participates in an impartial third party mediation/arbitration program administered by the Canadian Motor Vehicle Arbitration Plan (CAMVAP).

The CAMVAP program is a straight-forward and relatively speedy alternative to resolve a disagreement when all other efforts to produce a settlement have failed. This procedure is without cost to you and is designed to eliminate the need for lengthy and expensive legal proceedings.

In the CAMVAP program, impartial third-party arbitrators conduct hearings at mutually convenient times and places in an informal environment. These impartial arbitrators review the positions of the parties, make decisions and, when appropriate, render awards to resolve disputes. CAMVAP decisions are fast, fair, and final; the arbitrator's award is binding both to you and Ford of Canada.

CAMVAP services are available in all territories and provinces, except Quebec. For more information, without charge or obligation, call your CAMVAP Provincial Administrator directly at 1-800-207-0685.

### **GETTING ASSISTANCE OUTSIDE THE U.S. AND CANADA**

Before exporting your vehicle to a foreign country, contact the appropriate foreign embassy or consulate. These officials can inform you of local vehicle registration regulations and where to find unleaded fuel.

If you cannot find unleaded fuel or can only get fuel with an anti-knock index lower than is recommended for your vehicle, contact a district or owner relations/customer assistance office.

## Customer assistance

The use of leaded fuel in your vehicle without proper conversion may damage the effectiveness of your emission control system and may cause engine knocking or serious engine damage. Ford Motor Company/Ford of Canada is not responsible for any damage caused by use of improper fuel.

In the United States, using leaded fuel may also result in difficulty importing your vehicle back into the U.S.

If your vehicle must be serviced while you are traveling or living in Central or South America, the Caribbean, or the Middle East, contact the nearest Ford dealership. If the dealership cannot help you, write or call:

FORD MOTOR COMPANY  
WORLDWIDE DIRECT MARKET OPERATIONS  
1555 Fairlane Drive  
Fairlane Business Park #3  
Allen Park, Michigan 48101  
U.S.A.  
Telephone: (313) 594-4857  
FAX: (313) 390-0804

If you are in another foreign country, contact the nearest Ford dealership. If the dealership employees cannot help you, they can direct you to the nearest Ford affiliate office.

If you buy your vehicle in North America and then relocate outside of the U.S. or Canada, register your vehicle identification number (VIN) and new address with Ford Motor Company Worldwide Direct Market Operations.

### **FORD CAR CARE PRODUCTS FOR YOUR VEHICLE**

Ford has many quality products available from your dealer to clean your vehicle and protect its finishes. These quality products have been specifically engineered to fulfill your automotive needs; they are custom designed to complement the style and appearance of your vehicle. Each product is made from high quality materials and that meet or exceed Ford's rigid specifications. For best results, use the following or products of equivalent quality:

Ford Custom Clearcoat Polish\*

Ford Custom Silicone Gloss Polish

Ford Custom Vinyl Protectant\* (not available in Canada)

Motorcraft Vinyl Conditioner (Canada only)

## Customer assistance

Ford Deluxe Leather and Vinyl Cleaner (not available in Canada)

Motorcraft Vinyl Cleaner (Canada only)

Ford Extra Strength Tar and Road Oil Remover\* (not available in Canada)

Ford Extra Strength Upholstery Cleaner (Canada only)

Ford Extra Strength Upholstery Cleaner (not available in Canada)

Ford Metal Surface Cleaner

Ford Multi-Purpose Cleaner\*

Motorcraft Car Wash Concentrate

Motorcraft Carlite Glass Cleaner

Ford Spot and Stain Remover\*

Ford Super Premium Tire and Trim Dressing

Ford Triple Clean

Ford Ultra-Clear Spray Glass Cleaner (not available in Canada)

\* May be sold with the Motorcraft name

### **FORD ACCESSORIES FOR YOUR VEHICLE**

A wide selection of Ford accessories are available for your vehicle through your local authorized Ford, Lincoln Mercury or Ford of Canada dealer. These quality accessories have been specifically engineered to fulfill your automotive needs; they are custom designed to complement the style and aerodynamic appearance of your vehicle. In addition, each accessory is made from high quality materials and meets or exceeds Ford's rigid engineering and safety specifications. Ford accessories are warranted for up to 12 months or 20 000 km (12 000 miles) on all cars and light trucks and 12 months with unlimited distance on medium/heavy duty trucks unless the accessory is installed on a new vehicle, then the warranty becomes the balance of the new vehicle's warranty or the accessories warranty, whichever is greater. See your dealer for complete warranty information and availability.

**Not all accessories are available for all models.**

### **Vehicle Security**

Styled wheel protector locks

Vehicle security systems

## Customer assistance

### **Comfort and convenience**

Air conditioner  
Air filtration systems  
Cargo nets  
Cargo organizers  
Cargo shades  
Engine block heaters

### **Travel equipment**

Auto headlamps with DRL  
Daytime running lights (DRL)  
Electrochromic inside mirror with compass  
Electrochromic inside mirror with compass and temperature  
Factory luggage rack adaptors  
Framed luggage covers  
Heavy-duty battery  
Removable luggage rack  
Removable luggage rack adapters  
Soft luggage cover  
Speed control  
Track rider bars  
Trailer hitch wiring adaptor

### **Protection and appearance equipment**

Air bag anti-theft locks  
Car/truck covers  
Cargo liners, interior  
Carpet floor mats  
Cleaners, waxes and polishes  
Flat splash guards  
Front end covers (full)  
Lubricants and oils

## Customer assistance

Molded splash guards

Molded vinyl floor mats

Rear decklid spoilers

Touch-up paint

Universal floor mats

For maximum vehicle performance, keep the following information in mind when adding accessories or equipment to your vehicle:

- When adding accessories, equipment, passengers and luggage to your vehicle, do not exceed the total weight capacity of the vehicle or of the front or rear axle (GVWR or GAWR as indicated on the Safety compliance certification label). Consult your dealer for specific weight information.
- The Federal Communications Commission (FCC) and Canadian Radio Telecommunications Commission (CRTC) regulate the use of mobile communications systems - such as two-way radios, telephones and theft alarms - that are equipped with radio transmitters. Any such equipment installed in your vehicle should comply with FCC or CRTC regulations and should be installed only by a qualified service technician.
- Mobile communications systems may harm the operation of your vehicle, particularly if they are not properly designed for automotive use or are not properly installed. When operated, such systems may cause the engine to stumble or stall. In addition, such systems may be damaged or their performance may be affected by operating your vehicle. (Citizens band [CB] transceivers, garage door openers and other transmitters with outputs of five watts or less will not ordinarily affect your vehicle's operation.)
- Ford cannot assume responsibility for any adverse effects or damage that may result from the use of such equipment.

## Customer assistance

### **ORDERING ADDITIONAL OWNER'S LITERATURE**

To order the publications in this portfolio:

Make checks payable to:

HELM, INCORPORATED  
P.O. Box 07150  
Detroit, Michigan 48207

**For a free publication catalog, order toll free: 1-800-782-4356**

Monday-Friday 8:00 a.m. - 6:00 p.m. EST,  
for credit card holders only

### **Obtaining a French owner's guide**

French Owner's Guides can be obtained from your dealer or by writing to Ford Motor Company of Canada, Limited, Service Publications, P.O. Box 1580, Station B, Mississauga, Ontario L4Y 4G3.

## Reporting safety defects

### REPORTING SAFETY DEFECTS (U.S. ONLY)

If you believe that your vehicle has a defect that could cause a crash, or could cause injury or death, you should immediately inform the National Highway Traffic Safety Administration (NHTSA) in addition to notifying Ford Motor Company.



If NHTSA receives similar complaints, it may open an investigation, and if it finds that a safety defect exists in a group of vehicles, it may order a recall and remedy campaign. However, NHTSA cannot become involved in individual problems between you, your dealer or Ford Motor Company.

To contact NHTSA, you may either call the Auto Safety Hotline toll-free at 1-800-424-9393 (202-366-0123 in the Washington D.C. area) or write to:

NHTSA  
U.S. Department of Transportation  
400 Seventh Street  
Washington D.C. 20590

You can also obtain other information about motor vehicle safety from the Hotline.



## Index

- Accessory delay .....54
- Air bag supplemental  
restraint system .....94,95,98  
and child safety seats .....96  
description .....95,98  
disposal .....100  
driver air bag .....94,97,99  
indicator light .....12,97  
operation .....94,97,99  
passenger air bag .....94,97,99  
side air bag .....98
- Air cleaner filter .....205
- Air conditioning .....18  
automatic temperature  
control system .....21
- Air filter, cabin .....166
- Antifreeze  
(see Engine coolant) .....157
- Anti-lock brake system  
(see Brakes) .....113,114
- Anti-theft system .....64  
arming the system .....64  
disarming a triggered system ..66  
warning light .....11
- Audio system (see Radio) .....28
- Automatic transaxle .....118  
driving with .....120  
fluid, adding .....163  
fluid, checking .....163  
fluid, refill capacities .....206  
fluid, specification .....208
- Auxiliary power point .....27
- Axle  
lubricant specifications .....207
- Battery .....171  
acid, treating emergencies .....171  
charging system  
warning light .....12  
jumping a disabled battery ....142  
maintenance-free .....171  
replacement, specifications ...205  
servicing .....171
- Belt minder .....90
- Brakes .....113  
anti-lock .....113,114  
anti-lock brake system  
(ABS) warning light .....11,114  
brake warning light .....12  
fluid, checking and adding ....155  
fluid, refill capacities .....206  
fluid, specifications .....207,208  
lubricant specifications ...207,208  
parking .....115  
pedals (see Power  
adjustable foot pedals) .....43  
shift interlock .....118
- Break-in period .....3
- Capacities for refilling fluids ...206
- Cargo area shade .....59
- Cargo cover .....58
- Cargo net .....58
- CD changer .....38
- Cellular telephone  
Wireless Interface Module .....51
- Certification Label .....210
- Child safety restraints .....101  
child safety belts .....101
- Child safety seats .....102  
attaching with tether straps ..106  
in front seat .....103  
in rear seat .....103,106
- Cleaning your vehicle .....198  
engine compartment .....201  
exterior .....200  
exterior lamps .....200  
instrument panel .....203  
instrument panel lens .....203  
interior .....203,204  
mirrors .....200  
plastic parts .....200  
safety belts .....203  
washing .....199  
waxing .....199  
wheels .....200

## Index

- windows .....203
- wiper blades .....201
- woodtone trim .....203
- Climate control (see Air conditioning or Heating) .....18
- Clock .....31,38
- Console .....56
- Controls
  - power seat .....75
- Coolant
  - checking and adding .....157
  - refill capacities .....161,206
  - specifications .....207,208
- Cruise control (see Speed control) .....44
- Customer Assistance .....130
  - Ford accessories for your vehicle .....219
  - Ford Extended Service Plan .....212
  - Getting assistance outside the U.S. and Canada .....218
  - Getting roadside assistance ...130
  - Getting the service you need .....212
  - Ordering additional owner's literature .....223
  - The Dispute Settlement Board .....215
  - Utilizing the Mediation/ Arbitration Program .....218
- Daytime running lamps (see Lamps) .....16
- Defrost
  - rear window .....17
- Dipstick
  - automatic transmission fluid .....163
  - engine oil .....152
- Doors
  - door ajar warning .....9
  - lubricant specifications .....207
- Driving under special conditions
  - through water .....124
- Emergencies, roadside
  - jump-starting .....142
- Emission control system .....188
- Engine .....208
  - check engine/ service engine soon light .....9
  - cleaning .....201
  - coolant .....157
  - idle speed control .....171
  - lubrication specifications .....207,208
  - refill capacities .....206
  - service points .....150,151
  - starting after a collision .....131
- Engine block heater .....111
- Engine oil .....152
  - checking and adding .....152
  - dipstick .....152
  - filter, specifications .....154,205
  - recommendations .....154
  - refill capacities .....206
  - specifications .....207,208
- Exhaust fumes .....112
- Floor mats .....56
- Fluid capacities .....206
- Fuel .....178
  - calculating fuel economy .....184
  - cap .....181
  - capacity .....206
  - choosing the right fuel .....182
  - comparisons with EPA fuel economy estimates .....187
  - detergent in fuel .....184
  - filling your vehicle with fuel .....178,181,185
  - filter, specifications .....184,205
  - fuel pump shut-off switch ....131
  - gauge .....15
  - improving fuel economy .....184

## Index

- low fuel warning light .....10
- octane rating .....182,208
- quality .....183
- running out of fuel .....184
- safety information relating to
  - automotive fuels .....178
- Fuses .....133,134
- Gas cap (see Fuel cap) .....181
- Gas mileage  
(see Fuel economy) .....184
- Gauges .....13
  - engine coolant temperature gauge .....14
  - fuel gauge .....15
  - odometer .....15
  - speedometer .....13
  - tachometer .....14
  - trip odometer .....15
- GAWR  
(Gross Axle Weight Rating) .....123
  - definition .....123
  - driving with a heavy load .....123
  - location .....123
- GVWR (Gross Vehicle Weight Rating) .....123
  - calculating .....123
  - definition .....123
  - driving with a heavy load .....123
  - location .....123
- Hazard flashers .....131
- Head restraints .....74
- Headlamps .....16
  - aiming .....197
  - autolamp system .....17
  - bulb specifications .....196
  - daytime running lights .....16
  - flash to pass .....16
  - high beam .....8,16
  - replacing bulbs .....190
  - turning on and off .....16
  - warning chime .....13
- Heating .....18
  - heating and air conditioning system .....18
- Hood .....149
- Ignition .....43,208
- Infant seats  
(see Safety seats) .....102
- Inspection/  
maintenance (I/M) testing .....189
- Instrument panel
  - cleaning .....203
  - cluster .....8,203
  - lighting up
    - panel and interior .....17
    - location of components .....8
- Jump-starting your vehicle .....142
- Keyless entry system .....67
  - autolock .....69
  - keypad .....67
  - locking and unlocking doors ....68
  - programming entry code .....67
- Keys
  - key in ignition chime .....13
  - positions of the ignition .....43
- Lamps
  - autolamp system .....17
  - bulb replacement
    - specifications chart .....196
  - cargo lamps .....17
  - daytime running light .....16
  - headlamps .....16
  - headlamps, flash to pass .....16
  - instrument panel, dimming .....17
  - interior lamps .....49,50
  - replacing
    - bulbs .....189,190,192,193,194
- Lane change indicator  
(see Turn signal) .....47
- Liftgate .....57,61
- Lights, warning and indicator .....8
  - air bag .....12
  - anti-lock brakes (ABS) .....11,114
  - anti-theft .....11

## Index

- brake .....12
- charging system .....12
- check coolant .....11
- cruise indicator .....11
- door ajar .....9
- high beam .....8
- low coolant .....10
- low fuel .....10
- oil pressure .....12
- safety belt .....9
- service engine soon .....9
- speed control .....46
- traction control active .....8
- turn signal indicator .....8
- Load limits .....123
  - GAWR .....123
  - GVWR .....123
  - trailer towing .....123
- Locks
  - autolock .....69
  - childproof .....54
- Lubricant specifications ....207,208
- Lumbar support, seats .....76
- Mirrors .....51
  - cleaning .....200
  - heated .....55
  - side view mirrors (power) .....55
- Moon roof .....51
- Motorcraft parts .....184,205
- Octane rating .....182
- Odometer .....15
- Oil (see Engine oil) .....152
- Overdrive .....119
- Panic alarm feature, remote entry system .....61
- Parking brake .....115
- Parts (see Motorcraft parts) ....205
- Pedals (see Power adjustable foot pedals) .....43
- Power adjustable foot pedals ....43
- Power distribution box (see Fuses) .....136
- Power door locks .....54
- Power steering .....117
  - fluid, checking and adding ....162
  - fluid, refill capacity .....206
  - fluid, specifications .....207,208
- Radio .....28
- Relays .....133,138
- Remote entry system .....60,61
  - illuminated entry .....62
  - locking/unlocking doors ....60,61
  - opening the trunk .....61
  - panic alarm .....61
  - replacement/additional transmitters .....62
  - replacing the batteries .....63
- Roof rack .....129
- Safety belts (see Safety restraints) ....13,78,80,81,82,83,84,86
- Safety defects, reporting .....224
- Safety restraints ....78,80,81,82,83,84,85,86,88
  - belt minder .....90
  - cleaning the safety belts ...93,203
  - extension assembly .....89
  - for adults .....81,82,83,84
  - for children .....100,101
  - lap belt .....87
  - warning light and chime ..9,13,89
- Safety seats for children .....102
- Seat belts (see Safety restraints) .....78
- Seats .....74
  - child safety seats .....102
  - cleaning .....203,204
- SecuriLock passive anti-theft system .....70,71
- Servicing your vehicle .....148
- Spark plugs, specifications .....205,208
- Specification chart, lubricants .....207,208

## Index

- Speed control .....44
- Speedometer .....13
- Starting your vehicle .....108,110
  - jump starting .....142
- Steering wheel
  - tilting .....49
- Tachometer .....14
- Tires .....138,174,175,176
  - changing .....138,139
  - checking the pressure .....176
  - replacing .....177
  - rotating .....176
  - snow tires and chains .....177
  - tire grades .....175
  - treadwear .....175
- Towing .....125,176
  - recreational towing .....128
  - trailer towing .....125
  - wrecker .....147
- Traction control .....43,116
  - active light .....8
- Transaxle
  - automatic operation .....118
  - fluid, refill capacities .....206
  - lubricant specifications .....208
- Transmission
  - fluid, checking and adding  
(automatic) .....163
  - lubricant specifications .....207
- Trip odometer .....15
- Trunk .....58,60,61,72
  - remote release .....57
- Turn signal .....8,47
- Vehicle dimensions .....208
- Vehicle Identification Number  
(VIN) .....211
- Vehicle loading .....123
- Ventilating your vehicle .....112
- Warning chimes .....13
- Warning lights (see Lights) .....8
- Washer fluid .....156
- Water, Driving through .....124
- Windows
  - power .....53
  - rear wiper/washer .....48
- Windshield washer fluid and  
wipers
  - checking and adding fluid .....156
  - checking and cleaning .....173,174
  - liftgate reservoir .....157
  - operation .....47
  - replacing wiper blades .....174
- Wrecker towing .....147



## Filling station information

Item	Information
Required fuel	Refer to "Octane recommendations" in the <i>Maintenance and care</i> chapter.
Fuel tank capacity	68.1L (18 gallons)
Engine oil capacity (including filter change)-3.0L V6 Vulcan engine	4.25L (4.5 quarts). Use Motorcraft SAE 5W-20 Super Premium Motor Oil, Ford specification WSS-M2C153-H.
Engine oil capacity (including filter change)-3.0L DOHC V6 Duratec engine	5.2L (5.5 quarts). Use Motorcraft SAE 5W-30 Super Premium Motor Oil, Ford specification WSS-M2C153-H.
Tire size and pressure	Refer to Certification Label located on driver's side door panel. Inflate temporary spare to 414 kPa (60 psi).
Hood release	Pull handle under the left side of the instrument panel.
Coolant capacity (3.0L V6 Vulcan engine) <sup>1</sup>	11.0L (11.6 quarts)
Coolant capacity (3.0L DOHC V6 Duratec engine) <sup>1</sup>	10.0L (10.6 quarts)
Power steering fluid capacity-3.0L V6 Vulcan engine	Keep in FULL range on dipstick.
Power steering fluid capacity-3.0L DOHC V6 Duratec engine	Fill to line on reservoir.
Automatic transaxle capacity (AX4N)-3.0L V6 Vulcan engine <sup>2</sup>	12.8L (13.5 quarts). Use Motorcraft MERCON®V ATF.
Automatic transaxle capacity (AX4N)-3.0L DOHC V6 Duratec engine <sup>2</sup>	12.7L (13.4 quarts). Use Motorcraft MERCON®V ATF.
Automatic transaxle capacity (AX4S)-3.0L V6 Vulcan engine <sup>2</sup>	11.6L (12.2. quarts). Use Motorcraft MERCON®V ATF.

## Filling station information

<sup>1</sup> Use Ford Premium Engine Coolant (green in color). DO NOT USE Ford Extended Life Engine Coolant (orange in color). Refer to *Adding engine coolant*, in the *Maintenance and Care* chapter.

<sup>2</sup> Ensure the correct automatic transmission fluid is used. Transmission fluid requirements are indicated on the dipstick or on the dipstick handle. MERCON® and MERCON® V are not interchangeable. DO NOT mix MERCON® and MERCON® V. Refer to your Scheduled Maintenance Guide to determine the correct service interval.