

Table of Contents

Introduction	4
Congratulations	4
Safety and environment protection	5
Symbol glossary	8
Instrument Cluster	10
Warning and control lights	10
Gauges	16
Entertainment Systems	19
AM/FM stereo with CD	19
AM/FM stereo cassette with CD	26
Climate Controls	63
Heater only	63
Manual heating and air conditioning	65
Lights	69
Headlamps	69
Bulb replacement	74
Driver Controls	80
Steering wheel adjustment	83
Power windows	85
Mirrors	87
Locks and Security	105
Keys	105
Locks	105
Anti-theft system	106

Table of Contents

Seating and Safety Restraints 115

Seating	115
Safety restraints	127
Air bags	139
Child restraints	147

Driving 157

Starting	157
Brakes	161
Transmission operation	165
Vehicle loading	180
Trailer towing	183
Recreational towing	187

Roadside Emergencies 188

Hazard flasher switch	189
Fuses and relays	191
Changing tires	199
Jump starting	203
Wrecker towing	209

Customer Assistance 211

The dispute settlement board	214
Utilizing the mediation/arbitration	217
Getting assistance outside the U.S. and Canada	217
Ordering additional owner's literature	218
Reporting safety defects (U.S. only)	220

Cleaning 221

Cleaning your vehicle	221
Underbody preservation	227

Table of Contents

Maintenance and Specifications	229
Hood	230
Engine compartment	232
Engine oil	234
Battery	238
Fuel information	245
Air filter(s)	259
Part numbers	265
Refill capacities	265
Lubricant specifications	268
Engine data	270
Vehicle dimensions	270
Accessories	274
Index	277

All rights reserved. Reproduction by any means, electronic or mechanical including photocopying, recording or by any information storage and retrieval system or translation in whole or part is not permitted without written authorization from Ford Motor Company. Ford may change the contents without notice and without incurring obligation.

Copyright © 2001 Ford Motor Company

Introduction

The following warning may be required by California law:

CALIFORNIA Proposition 65 Warning



WARNING: Engine exhaust, some of its constituents, and certain vehicle components contain or emit chemicals known to the State of California to cause cancer and birth defects or other reproductive harm. In addition, certain fluids contained in vehicles and certain products of component wear contain or emit chemicals known to the State of California to cause cancer and birth defects or other reproductive harm.

CONGRATULATIONS

Congratulations on acquiring your new Ford. Please take the time to get well acquainted with your vehicle by reading this handbook. The more you know and understand about your vehicle the greater the safety and pleasure you will derive from driving it.

For more information on Ford Motor Company and its products visit the following website:

In the United States: www.ford.com

In Canada: www.ford.ca

In Australia: www.ford.com.au

In Mexico: www.ford.com.mx

Additional owner information is given in separate publications.



This Owner's Guide describes every option and model variant available and therefore some of the items covered may not apply to your particular vehicle. Furthermore, due to printing cycles it may describe options before they are generally available.



Remember to pass on the Owner's Guide when reselling the vehicle. It is an integral part of the vehicle.

Introduction



Fuel pump shut-off switch In the event of an accident the safety switch will automatically cut off the fuel supply to the engine. The switch can also be activated through sudden vibration (e.g. collision when parking). To reset the switch, refer to the *Fuel pump shut-off switch* in the *Roadside emergencies* chapter.

SAFETY AND ENVIRONMENT PROTECTION



Warning symbols in this guide

How can you reduce the risk of personal injury and prevent possible damage to others, your vehicle and its equipment? In this guide, answers to such questions are contained in comments highlighted by the warning triangle symbol. These comments should be read and observed.



Warning symbols on your vehicle

When you see this symbol, it is imperative that you consult the relevant section of this guide before touching or attempting adjustment of any kind.



Protecting the environment

We must all play our part in protecting the environment. Correct vehicle usage and the authorized disposal of waste cleaning and lubrication materials are significant steps towards this aim. Information in this respect is highlighted in this guide with the tree symbol.



BREAKING-IN YOUR VEHICLE

There are no particular guidelines for breaking-in your vehicle. During the first 1 600 km (1 000 miles) of driving, vary speeds frequently. This is recommended to give the moving parts a chance to break in.

Introduction

SPECIAL NOTICES

Emission warranty

The New Vehicle Limited Warranty includes Bumper-to-Bumper Coverage, Safety Restraint Coverage, Corrosion Coverage, and 7.3L Power Stroke Diesel Engine Coverage. In addition, your vehicle is eligible for Emissions Defect and Emissions Performance Warranties. For a detailed description of what is covered and what is not covered, refer to the *Warranty Guide* that is provided to you along with your Owner's Guide.

Special instructions

For your added safety, your vehicle is fitted with sophisticated electronic controls.



By operating other electronic equipment (e.g. mobile telephone without exterior aerial) electromagnetic fields can occur which can cause malfunctions of the vehicle electronics. Therefore you should observe the instructions of the equipment manufacturers.



Please read the section *Air bag* in the *Seating and safety restraints* chapter. Failure to follow the specific warnings and instructions could result in personal injury.



Front seat mounted rear facing child or baby seats should **NEVER** be used in front of a passenger side air bag unless the air bag can be and is turned OFF.

Notice to owners of pickup trucks and utility type vehicles



Utility vehicles have a significantly higher rollover rate than other types of vehicles.

Before you drive your vehicle, please read this Owner's Guide carefully. Your vehicle is not a passenger car. As with other vehicles of this type, failure to operate this vehicle correctly may result in loss of control or an accident.

Introduction

Using your vehicle with a snowplow



Do not use this vehicle for snowplowing.

Using your vehicle as an ambulance



Do not use this vehicle as an ambulance.

Your vehicle is not equipped with the Ford Ambulance Preparation Package.

Middle East/North Africa vehicle specific information

For your particular global region, your vehicle may be equipped with features and options that are different from the ones that are described in this Owner Guide; therefore, a supplement has been supplied that complements this book. By referring to the pages in the provided supplement, you can properly identify those features, recommendations and specifications that are unique to your vehicle. **Refer to this Owner Guide for all other required information and warnings.**





















Introduction

These are some of the symbols you may see on your vehicle.

Vehicle Symbol Glossary

Safety Alert		See Owner's Guide	
Fasten Safety Belt		Air Bag-Front	
Air Bag-Side		Child Seat	
Child Seat Installation Warning		Child Seat Tether Anchorage	
Brake System		Anti-Lock Brake System	
Brake Fluid - Non-Petroleum Based		Traction Control	
Master Lighting Switch		Hazard Warning Flasher	
Fog Lamps-Front		Fuse Compartment	
Fuel Pump Reset		Windshield Wash/Wipe	
Windshield Defrost/Demist		Rear Window Defrost/Demist	
Power Windows Front/Rear		Power Window Lockout	

Vehicle Symbol Glossary

Child Safety Door Lock/Unlock		Interior Luggage Compartment Release Symbol	
Panic Alarm		Engine Oil	
Engine Coolant		Engine Coolant Temperature	
Do Not Open When Hot		Battery	
Avoid Smoking, Flames, or Sparks		Battery Acid	
Explosive Gas		Fan Warning	
Power Steering Fluid		Maintain Correct Fluid Level	
Emission System		Engine Air Filter	
Passenger Compartment Air Filter		Jack	
Check fuel cap		Low tire warning	

Instrument Cluster

WARNING LIGHTS AND CHIMES

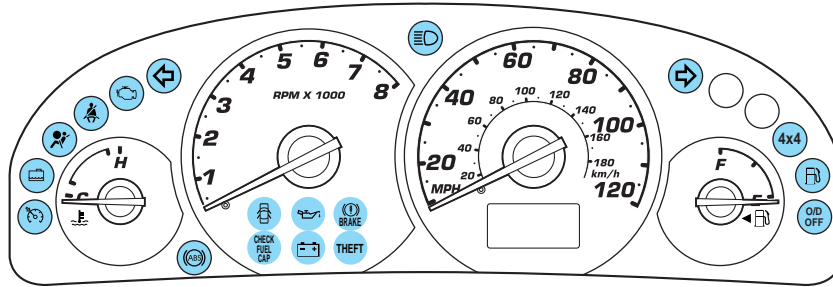

Warning lights and gauges can alert you to a vehicle condition that may become serious enough to cause expensive repairs. A warning light may illuminate when a problem exists with one of your vehicle's functions. Many lights will illuminate when you start your vehicle to make sure the bulb works. **If any light remains on after starting the vehicle, have the respective system inspected immediately.**

Service engine soon

Your vehicle is equipped with a computer that monitors the engine's emission control system. This system is commonly known as the

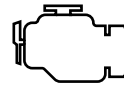

On Board Diagnostics System (OBD II). The OBD II system protects the environment by ensuring that your vehicle continues to meet government emission standards. The OBD II system also assists the service technician in properly servicing your vehicle.

The  indicator light illuminates when the ignition is first turned to the RUN position to check the bulb. If it comes on after the engine is started, one of the engine's emission control systems may be malfunctioning. The light may illuminate without a driveability concern being noted. The vehicle will usually be drivable and will not require towing.

What you should do if the light illuminates

Light turns on solid:

This means that the OBD II system has detected a malfunction.

Temporary malfunctions may cause your  light to illuminate.

Instrument Cluster

Examples are:

1. The vehicle has run out of fuel. (The engine may misfire or run poorly.)
2. Poor fuel quality or water in the fuel.
3. The fuel cap may not have been properly installed and securely tightened.

These temporary malfunctions can be corrected by filling the fuel tank with high quality fuel of the recommended octane and/or properly installing and securely tightening the fuel cap. After three driving cycles without these or any other temporary malfunctions present, the  light should turn off. (A driving cycle consists of a cold engine startup followed by mixed city/highway driving.) No additional vehicle service is required.

If the  light remains on, have your vehicle serviced at the first available opportunity.

Light is blinking:

Engine misfire is occurring which could damage your catalytic converter. You should drive in a moderate fashion (avoid heavy acceleration and deceleration) and have your vehicle serviced at the first available opportunity.



Under engine misfire conditions, excessive exhaust temperatures could damage the catalytic converter, the fuel system, interior floor coverings or other vehicle components, possibly causing a fire.

Brake system warning

To confirm the brake system warning light is functional, it will momentarily illuminate when the ignition is turned to the ON position (alternatively for some vehicles



when the ignition is moved from the ON position to START position, the light will momentarily illuminate prior to reaching the START position). It also illuminates if the parking brake is engaged. If the brake system warning light does not illuminate as described, seek service immediately. Illumination after the parking brake is released indicates low brake fluid level or a brake system malfunction and the brake system should be serviced immediately by a qualified technician. Refer to *Brakes* in the *Driving* chapter for more information.

Instrument Cluster

Anti-lock brake system (ABS) (if equipped)

To confirm the anti-lock brake system (ABS) warning light is functional it will momentarily illuminate when the ignition is turned to the ON position

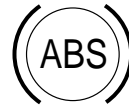

(alternatively for some vehicles when the ignition is moved from the ON position to the START position, the light will momentarily illuminate just prior to reaching the START position). If the light remains on, continues to flash or fails to illuminate, have the ABS serviced immediately. If the ABS light remains on, it means the anti-lock brake system has malfunctioned and is disabled, however, the normal brake system will still function unless the brake warning light also remains illuminated and parking brake is off. Refer to *Brakes* in the *Driving* chapter for more information.

Safety belt

Illuminates to remind you to fasten your safety belts. For more information, refer to the *Seating and safety restraints* chapter.



Air bag readiness

Illuminates to confirm that the air bags (front and side) are operational. If the light fails to illuminate, continues to flash or remains on, have the system serviced immediately.



Charging system

Illuminates when the battery is not charging properly.

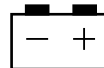

Instrument Cluster

Engine oil pressure

Illuminates when the oil pressure falls below the normal range. Check the oil level and add oil if needed. Refer to *Engine oil* in the *Maintenance and specifications* chapter.

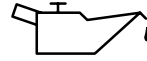

Low fuel

Illuminates when the fuel level in the fuel tank is at, or near, empty (refer to *Fuel gauge* in this chapter for more information).



Speed control

Illuminates when the speed control is activated.

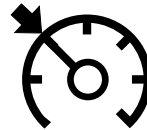

O/D off (if equipped)

Illuminates when the overdrive function has been turned OFF using the Transmission Control Switch (TCS) on end of gearshift. If the light does not come on or the light flashes steadily, have your vehicle serviced as soon as possible, damage to the transmission could occur.

O/D
OFF

Turn signals

Illuminates when the turn signals or the hazard lights are turned on. If the lights stay on continuously or flash faster, check for a burned-out bulb.

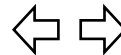

Instrument Cluster

High beams

Illuminates when the high beam headlamps are turned on.



Door ajar

Illuminates when any door, liftgate or liftgate window is open.



Anti-theft system

Refer to *SecuriLock[™] passive anti-theft system* in the *Locks and Security* chapter.

THEFT

Low coolant (if equipped)

Illuminates when the coolant level in the coolant reservoir is low and more needs to be added. For more information on adding engine coolant, refer to *Engine coolant* in the *Maintenance and specifications* chapter.



Instrument Cluster

Check fuel cap

Illuminates when the fuel cap is not installed correctly. Check the fuel cap for proper installation. When the fuel filler cap is properly re-installed, the light(s) will turn off after a period of normal driving. Continuing to operate the vehicle with the check fuel cap light on, can activate the *Service Engine Soon/Check Engine* warning light.

**CHECK
FUEL
CAP**

It may take a long period of time for the system to detect an improperly installed fuel filler cap.

For more information, refer to *Fuel filler cap* in the *Maintenance and specifications* chapter.

Four wheel drive indicator (if equipped)

Illuminates when the four-wheel drive is engaged. If the light continues to flash have the system serviced.

4x4

Safety belt warning chime

Sounds to remind you to fasten your safety belts.

BeltMinder chime

Sounds intermittently to remind you to fasten your safety belts.

Supplemental restraint system (SRS) warning chime

Sounds when a malfunction in the supplemental restraint system (front or side airbags) has been detected. Have the supplemental restraint system inspected immediately.

Key-in-ignition warning chime

Sounds when the key is left in the ignition and the door, liftgate or liftgate window is opened.

Headlamps on warning chime

Sounds when the headlamps or parking lamps are on, the key is removed from the ignition and the driver's door is opened.

Instrument Cluster

GAUGES

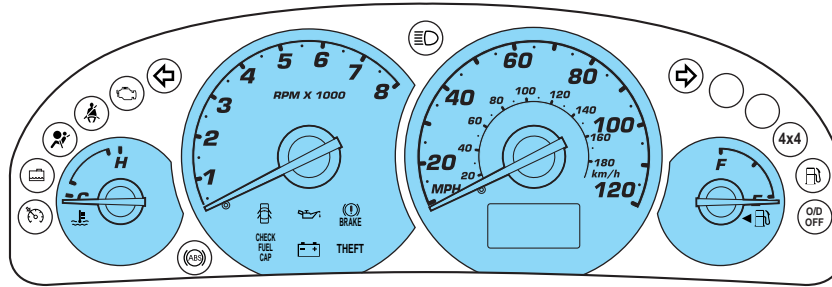

Engine coolant temperature gauge

Indicates the temperature of the engine coolant. At normal operating temperature, the needle remains within the normal area (the area between the “H” and “C”). If it enters the red section, the engine is overheating. Stop the vehicle as soon as safely possible, switch off the engine immediately and let the engine cool. Refer to *Engine coolant* in the *Maintenance and specifications* chapter.

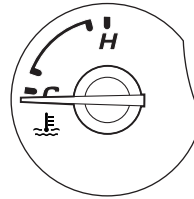

 Never remove the coolant reservoir cap while the engine is running or hot. Steam and scalding liquid from a hot cooling system can burn you badly.

This gauge indicates the temperature of the engine coolant, not the coolant level. If the coolant is not at its proper level the gauge indication will not be accurate.

Instrument Cluster

Fuel gauge

Displays approximately how much fuel is in the fuel tank. The fuel gauge may vary slightly when the vehicle is in motion or on a grade.

When refueling the vehicle from empty indication, the amount of fuel that can be added will be less than the advertised capacity due to the reserve fuel.

The arrow near the fuel pump icon indicates which side of the vehicle the fuel filler door is located.

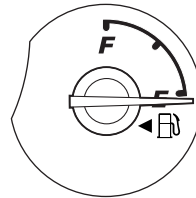

Speedometer

Indicates the current vehicle speed.

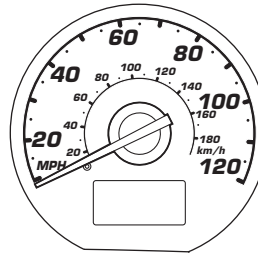

Odometer

Registers the total kilometers (miles) of the vehicle.



Instrument Cluster

Trip odometer

Registers the kilometers (miles) of individual journeys. Press and hold the button for 1 or more seconds to reset. Press and release the button in less than 1 second to toggle between odometer and trip odometer.



Tachometer

Indicates the engine speed in revolutions per minute.

Driving with your tachometer pointer continuously at the top of the scale may damage the engine.

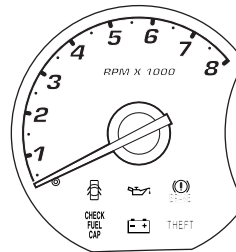

Entertainment Systems

AM/FM STEREO / SINGLE CD RADIO

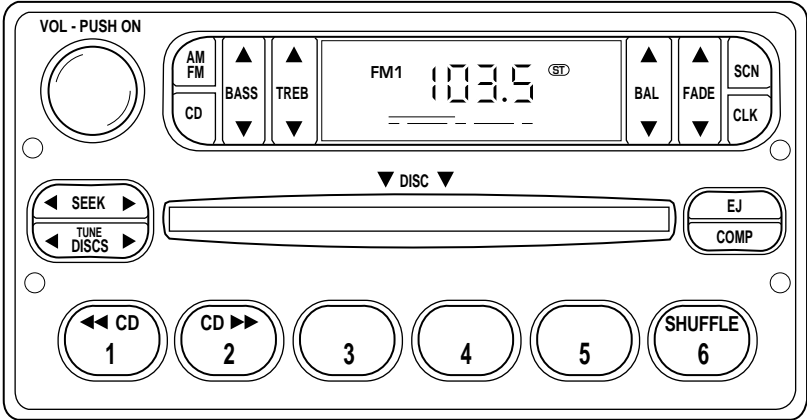

Volume/power control

Press the control to turn the audio system on or off.



Turn the control to raise or lower volume.



If the volume is set above a certain level and the ignition is turned off, the volume will come back on at a “nominal” listening level when the ignition switch is turned back on.

Entertainment Systems

AM/FM select

The AM/FM select control works in radio and CD modes.



AM/FM select in radio mode

The AM/FM control allows you to select AM or FM frequency bands. Press the control to switch between AM, FM1 or FM2 memory preset stations.

AM/FM select in CD or CD changer mode (if equipped)

The AM/FM control to stop CD play and begin radio play.

Tune adjust

The tune control works in radio mode.

Tune adjust in radio mode

- Press ◀ to move to the next frequency down the band (whether or not a listenable station is located there). Hold the control to move through the frequencies quickly.
- Press ▶ to move to the next frequency up the band (whether or not a listenable station is located there). Hold for quick movement.



Tune adjust in CD changer mode (if equipped)

- Press ◀ to move to the previous disc. Hold for quick movement.
- Press ▶ to move to the next disc. Hold for quick movement.



Seek function

The seek function control works in radio, CD or CD changer mode (if equipped).

Entertainment Systems

Seek function in radio mode

- Press ◀ to find the next listenable station down the frequency band.
- Press ▶ to find the next listenable station up the frequency band.



Seek function in CD or CD changer mode (if equipped)

- Press ▶ to listen to the next selection on the current disc.
- Press ◀ to listen to the previous selection on the current disc.



Scan function

The scan function works in radio or CD mode.



Scan function in radio mode

Press the SCN control to hear a brief sampling of all listenable stations on the frequency band. Press the SCN control again to stop the scan mode.

Scan function in CD or CD changer mode (if equipped)

Press the SCN control to hear a short sampling of all selections on the current CD. (The CD scans in a forward direction, wrapping back to the first track at the end of the CD.) To stop on a particular selection, press the control again.

Radio station memory preset

The radio is equipped with four or six station memory preset controls. These controls can be used to select up to four or six preset AM stations and eight or twelve FM stations (four to six in FM1 and four to six in FM2).

Setting memory preset stations

1. Select the frequency band with the AM/FM select control.
2. Select a station. Refer to *Tune adjust* or *Seek function* for more information on selecting a station.

Entertainment Systems

3. Press and hold a memory preset control until the sound returns, indicating the station is held in memory on the control you selected.

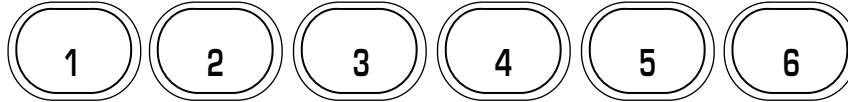

Autoset memory preset

Autoset allows you to set strong radio stations without losing your original manually set preset stations. This feature is helpful on trips when you travel between cities with different radio stations.

Starting autoset memory preset

1. Select a frequency using the AM/FM select controls.
2. Press the control.
3. When the first six strong stations are filled, the station stored in memory preset control 1 will start playing.

If there are less than six strong stations available on the frequency band, the remaining memory preset controls will all store the last strong station available.

To deactivate autoset and return to your audio system's manually set memory stations, press the control again.

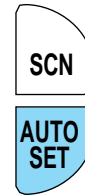

Bass adjust

The bass adjust control allows you to increase or decrease the audio system's bass output.

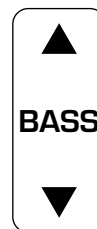

Entertainment Systems

Treble adjust

The treble adjust control allows you to increase or decrease the audio system's treble output.



Speaker balance adjust

Speaker sound distribution can be adjusted between the right and left speakers.

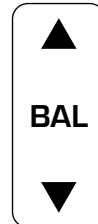

Speaker fade adjust

Speaker sound can be adjusted between the front and rear speakers.



CD select

To begin CD play (if CD[s] are loaded), press the CD control. The first track of the disc will begin playing. After that, CD play will begin where it stopped last. Press the control again to begin CD changer play (if equipped).



Entertainment Systems

Do not insert any promotional (odd shaped or sized) discs, or discs with removable labels into the CD player as jamming may occur.

Rewind

The rewind control works in CD and CD changer (if equipped) modes.

To rewind in CD mode press the CD control (preset 1).



Pressing the control for less than three seconds results in slow rewind. Pressing the control for more than three seconds results in fast rewind.

Fast forward

The fast forward control works in CD mode.

To fast forward in CD mode, press the CD control (preset 2).



Pressing the control for less than three seconds results in slow forward action. Pressing the control for more than three seconds results in fast forward action.

Eject function

Press the control to stop and eject a CD.



Compression feature

Compression adjust brings soft and loud CD passages together for a more consistent listening level.



Press the COMP control to activate and deactivate compression adjust.

Entertainment Systems

Shuffle feature

The shuffle feature operates in CD changer mode (if equipped) and plays all tracks on the current disc in random order.



Press the SHUFFLE control to start this feature. Random order play will continue until the SHUFFLE control is pressed again.

Setting the clock

Press CLK to toggle between listening frequencies and clock mode while in radio mode.

To set the hour, press and hold the CLK control.



Press the SEEK control:

- ◀ to decrease hours and
- ▶ to increase hours.

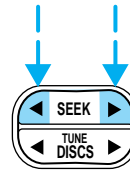

To set the minute, press and hold the CLK control.



Press the TUNE control:

- ◀ to decrease minutes and
- ▶ to increase minutes.



Entertainment Systems

PREMIUM AM/FM STEREO/CASSETTE/SINGLE CD

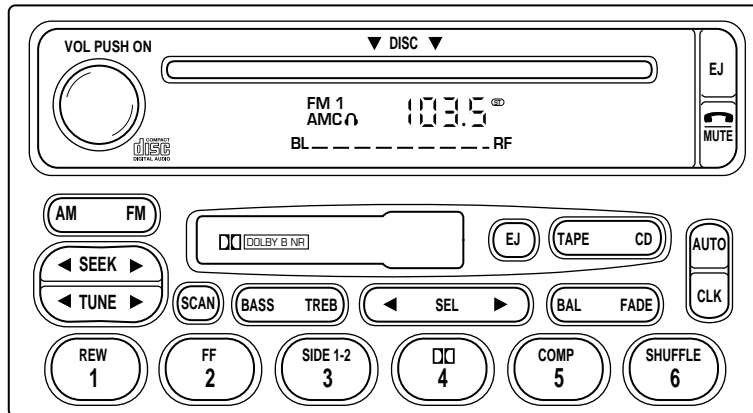

Volume/power control

Press the control to turn the audio system on or off.

Audio power can also be turned on by pressing the AM/FM select control or the TAPE/CD select control.

Turn control to raise or lower volume.



If the volume is set above a certain level and the ignition is turned off, the volume will come back on at a “nominal” listening level when the ignition switch is turned back on.

Entertainment Systems

AM/FM select

The AM/FM select control works in radio, tape and CD modes.



AM/FM select in radio mode

This control allows you to select AM or FM frequency bands. Press the control to switch between AM, FM1 or FM2 memory preset stations.

AM/FM select in tape mode

Press this control to stop tape play and begin radio play.

AM/FM select in CD or CD changer mode (if equipped)

Press this control to stop CD play and begin radio play.

Tune adjust

The tune control works in radio or CD changer mode.

Tune adjust in radio mode

- Press ◀ to move to the next frequency down the band (whether or not a listenable station is located there). Hold the control to move through the frequencies quickly.
- Press ▶ to move to the next frequency up the band (whether or not a listenable station is located there). Hold for quick movement.

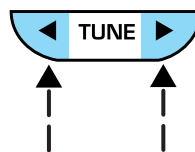

Tune adjust for CD changer (if equipped)

- Press ◀ to select the previous disc in the CD changer. (Play will begin on the first track of the disc unless the CD changer is in shuffle mode. Refer to *Shuffle feature* for more information. Hold the control to continue reversing through the remaining discs.
- Press ▶ to select the next disc in the CD changer. Hold the control to fast-forward through the remaining discs.

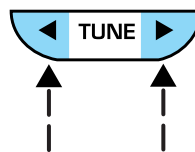

Entertainment Systems

Seek function

The seek function control works in radio, tape or CD mode.

Seek function in radio mode

- Press ◀ to find the next listenable station down the frequency band.
- Press ▶ to find the next listenable station up the frequency band.

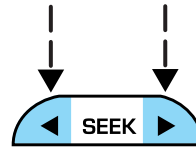

Seek function in tape mode

- Press ◀ to listen to the previous selection on the tape.
- Press ▶ to listen to the next selection on the tape.

Seek function for CD or CD changer (if equipped)

- Press ◀ to seek to the previous track of the current disc. If a selection has been playing for three seconds or more and you press ◀, the CD changer will replay that selection from the beginning.
- Press ▶ to seek forward to the next track of the current disc. After the last track has been completed, the first track of the current disc will automatically replay.

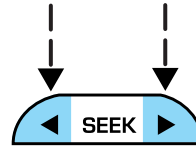

Scan function

The scan function works in radio, tape or CD mode.



Scan function in radio mode

Press the SCAN control to hear a brief sampling of all listenable stations on the frequency band. Press the control again to stop the scan mode.

Scan function in tape mode

Press the SCAN control to hear a short sampling of all selections on the tape. (The tape scans in a forward direction. At the end of the tape's first side, direction automatically reverses to the opposite side of the tape.) To stop on a particular selection, press the control again.

Entertainment Systems

Scan function in CD or CD changer mode (if equipped)

Press the SCAN control to hear a short sampling of all selections on the CD. (The CD scans in a forward direction, wrapping back to the first track at the end of the CD.) To stop on a particular selection, press the control again.

Radio station memory preset

The radio is equipped with six station memory preset controls. These controls can be used to select up to six preset AM stations and twelve FM stations (six in FM1 and six in FM2).

Setting memory preset stations

1. Select the frequency band with the AM/FM select control.
2. Select a station. Refer to *Tune adjust* or *Seek function* for more information on selecting a station.
3. Press and hold a memory preset control until the sound returns, indicating the station is held in memory on the control you selected.

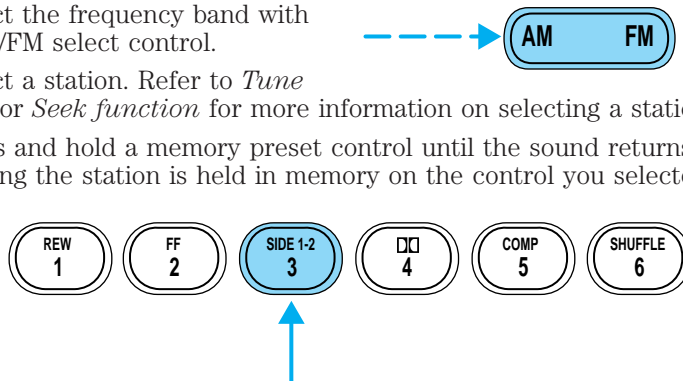

Autoset memory preset

Autoset allows you to set strong radio stations without losing your original manually set preset stations. This feature is helpful on trips when you travel between cities with different radio stations.

Entertainment Systems

Starting autoselect memory preset

1. Select a frequency using the AM/FM select controls.
2. Press the control.
3. When the first six strong stations are filled, the station stored in memory preset control 1 will start playing.

If there are less than six strong stations available on the frequency band, the remaining memory preset controls will all store the last strong station available.

These stations are temporarily stored in the memory preset controls (until deactivated) and are accessed in the same manner as your original presets.

To deactivate autoselect and return to your audio system's manually set memory stations, press the AUTO control again.

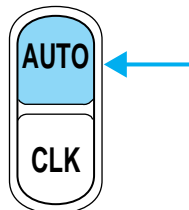

Bass adjust

The bass adjust control allows you to increase or decrease the audio system's bass output.

Press the BASS control then press:

- ◀ to decrease the bass output and
- ▶ to increase the bass output.

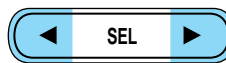
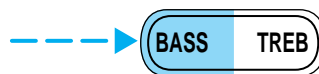

Treble adjust

The treble adjust control allows you to increase or decrease the audio system's treble output.



Entertainment Systems

Press the TREB control then press:

- ◀ to decrease the treble output and
- ▶ to increase the treble output.

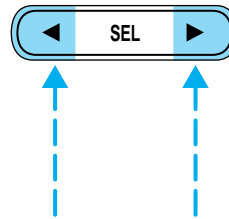

Speaker balance adjust

Speaker sound distribution can be adjusted between the right and left speakers.

Press the BAL control then press:

- ◀ to shift sound to the left and
- ▶ to shift sound to the right.

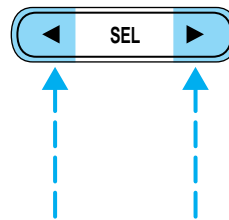

Speaker fade adjust

Speaker sound can be adjusted between the front and rear speakers.

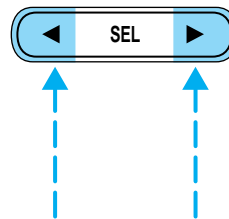

Press the FADE control then press:

- ▶ to shift the sound to the front and
- ◀ to shift the sound to the rear.



Entertainment Systems

Tape/CD select

- To begin tape play (with a tape loaded into the audio system) while in the radio or CD mode, press the TAPE control. Press again during rewind or fast forward to stop the rewind or fast forward function. 
- To begin CD play (if CD(s) are loaded), press the CD control. The first track of the disc will begin playing. If returning from radio or tape mode, CD play will begin where it stopped last. 

Press the CD control to toggle between single CD and CD changer play (if equipped).

Do not insert any promotional (odd shaped or sized) discs, or discs with removable labels into the CD player as jamming may occur.

Rewind

The rewind control works in tape and CD modes.

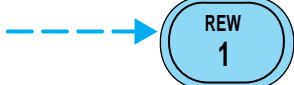
- In tape mode, radio play will continue until rewind is stopped (with the TAPE control) or the beginning of the tape is reached.
- In CD mode, pressing the REW control rewinds the CD within the current track. 

Fast forward

The fast forward control works in tape and CD modes.

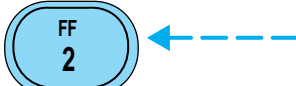
- In the tape mode, tape direction will automatically reverse when the end of the tape is reached.
- In CD mode, pressing the control fast forwards the CD within the current track. 

Entertainment Systems

Tape direction select

Press SIDE 1-2 to play the alternate side of a tape.

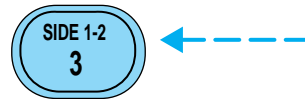

Eject function

Press the EJ control to stop and eject a tape.

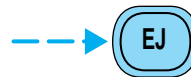

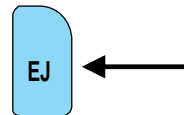

Press the EJ control to stop and eject a CD.

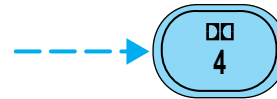

Dolby® noise reduction

Dolby® noise reduction operates in tape mode. Dolby® noise reduction reduces the amount of hiss and static during tape playback.



Press the  control to activate (and deactivate) the Dolby® noise reduction.

Dolby® noise reduction is manufactured under license from Dolby® Laboratories Licensing Corporation. “Dolby®” and the double-D symbol  are registered trademarks of Dolby® Laboratories Licensing Corporation.

Compression adjust

Compression adjust brings soft and loud CD passages together for a more consistent listening level.

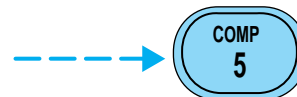

Press the COMP control to activate and deactivate compression adjust.

Entertainment Systems

Shuffle feature

The shuffle feature operates in CD mode (if equipped) and plays all tracks on the current disc in random order. If equipped with the CD changer, the shuffle feature continues to the next disc after all tracks on the current disc are played. Press the SHUFFLE control to start this feature. Random order play will continue until the SHUFFLE control is pressed again.

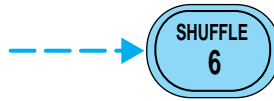

Setting the clock

To set the hour, press and hold the CLK control and press SEEK:

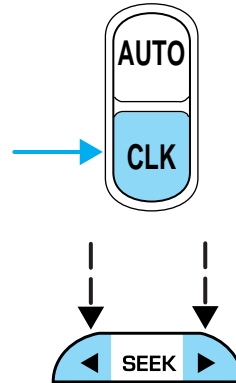

- ◀ to decrease hours and
- ▶ to increase hours.

To set the minute, press and hold the CLK control and press TUNE:

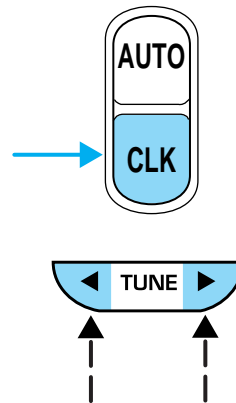

- ◀ to decrease minutes and
- ▶ to increase minutes.

If your vehicle has a separate clock, (other than the digital radio display), the CLK control will not function in the above manner.

Entertainment Systems

The CLK control will allow you to switch between media display mode (radio station, stereo information, etc.) and clock display mode (time). When in clock mode, the media information will display for 10 seconds, when the radio is turned on, and then revert to clock information. Any time that the media is changed, (new radio station, etc.), the media information will again display for 10 seconds before reverting back to the clock. In media mode, the media information will always be displayed.

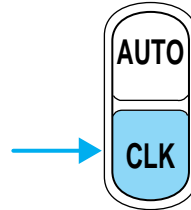

Mute mode

Press the MUTE control to mute the playing media. Press the MUTE control again to return to the playing media.

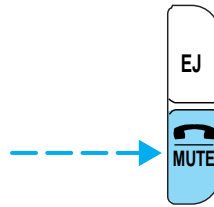

MACH® AUDIO SYSTEM WITH AM/FM STEREO/CASSETTE/SINGLE CD

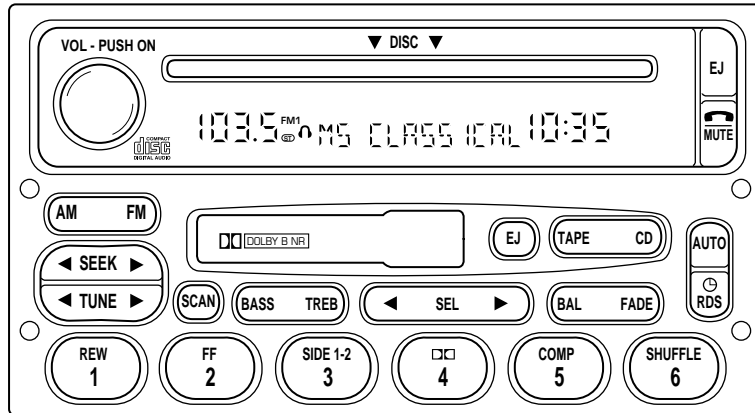

Entertainment Systems

Volume/power control

Press the control to turn the audio system on or off.



Turn control to raise or lower volume.



If the volume is set above a certain level and the ignition is turned off, the volume will come back on at a “nominal” listening level when the ignition switch is turned back on. If you wish to maintain your preset volume level, turn the audio system off with the power control before switching off the ignition.

AM/FM select

The AM/FM select control works in radio, tape and CD modes.



AM/FM select in radio mode

This control allows you to select AM or FM frequency bands. Press the control to switch between AM, FM1 or FM2 memory preset stations.

AM/FM select in tape mode

Press this control to stop tape play and begin radio play.

AM/FM select in CD mode

Press this control to stop CD play and begin radio play.

Entertainment Systems

Tune adjust

The tune control works in radio or CD mode.

Tune adjust in radio mode

- Press ◀ to move to the next frequency down the band (whether or not a listenable station is located there). Hold the control to move through the frequencies quickly.
- Press ▶ to move to the next frequency up the band (whether or not a listenable station is located there). Hold for quick movement.

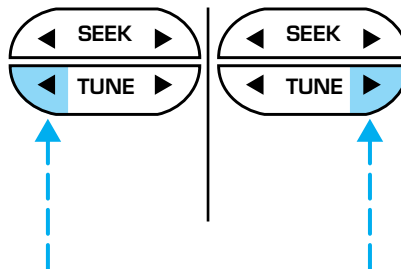

Tune adjust for CD changer (if equipped)

- Press ◀ to select the previous disc in the CD changer. (Play will begin on the first track of the disc unless the CD changer is in shuffle mode. Refer to *Shuffle feature* for more information. Hold the control to continue reversing through the disc.
- Press ▶ to select the next disc in the CD changer. Hold the control to fast-forward through the remaining discs.

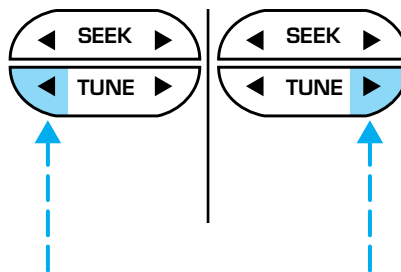

Seek function

The seek function control works in radio, tape or CD mode.

Seek function in radio mode

- Press ◀ to find the next listenable station down the frequency band.
- Press ▶ to find the next listenable station up the frequency band.

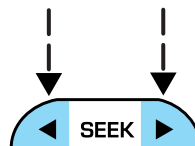

Entertainment Systems

Seek function in tape mode

- Press ◀ to listen to the previous selection on the tape.
- Press ▶ to listen to the next selection on the tape.

Seek function for CD changer (if equipped)

- Press ◀ to seek to the previous track of the current disc. If a selection has been playing for three seconds or more and you press ◀, the CD changer will replay that selection from the beginning.
- Press ▶ to seek forward to the next track of the current disc. After the last track has been completed, the first track of the current disc will automatically replay.

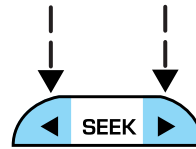

Scan function

The scan function works in radio, tape or CD mode.



Scan function in radio mode

Press the SCAN control to hear a brief sampling of all listenable stations on the frequency band. Press the control again to stop the scan mode.

Scan function in tape mode

Press the SCAN control to hear a short sampling of all selections on the tape. (The tape scans in a forward direction. At the end of the tape's first side, direction automatically reverses to the opposite side of the tape.) To stop on a particular selection, press the control again.

Scan function in CD mode

Press the SCAN control to hear a short sampling of all selections on the CD. (The CD scans in a forward direction, wrapping back to the first track at the end of the CD.) To stop on a particular selection, press the control again.

Entertainment Systems

Radio station memory preset

The radio is equipped with six station memory preset controls. These controls can be used to select up to six preset AM stations and twelve FM stations (six in FM1 and six in FM2).

Setting memory preset stations

1. Select the frequency band with the AM/FM select control.
2. Select a station. Refer to *Tune adjust* or *Seek function* for more information on selecting a station.
3. Press and hold a memory preset control until the sound returns, indicating the station is held in memory on the control you selected.

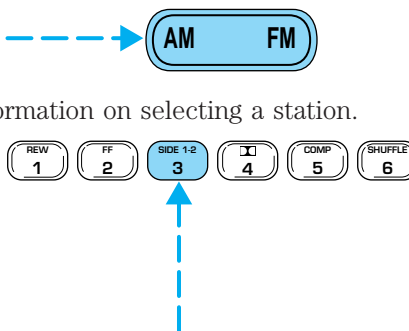

Autoset memory preset

Autoset allows you to set strong radio stations without losing your original manually set preset stations. This feature is helpful on trips when you travel between cities with different radio stations.

Starting autoset memory preset

1. Select a frequency using the AM/FM select controls.
2. Press the AUTO control.
3. When the first six strong stations are filled, the station stored in memory preset control 1 will start playing.

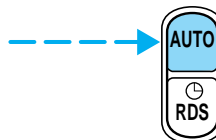

If there are less than six strong stations available on the frequency band, the remaining memory preset controls will all store the last strong station available.

To deactivate autoset and return to your audio system's manually set memory stations, press the AUTO control again.

Entertainment Systems

Bass adjust

The bass adjust control allows you to increase or decrease the audio system's bass output.

Press the BASS control then press:

- ◀ to decrease bass output and
- ▶ to increase bass output.

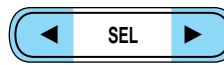
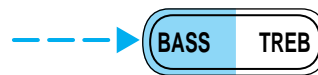

Treble adjust

The treble adjust control allows you to increase or decrease the audio system's treble output.

Press the TREB control then press:

- ◀ to decrease treble output and
- ▶ to increase treble output.

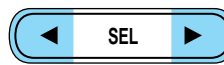

Speaker balance adjust

Speaker sound distribution can be adjusted between the right and left speakers.

Press the BAL control then press:

- ◀ to shift sound to the left and
- ▶ to shift sound to the right.

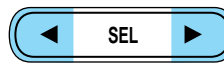



Entertainment Systems

Speaker fade adjust

Speaker sound can be adjusted between the front and rear speakers.

Press the FADE control then press:

-  to shift sound to the front and
-  to shift sound to the rear.

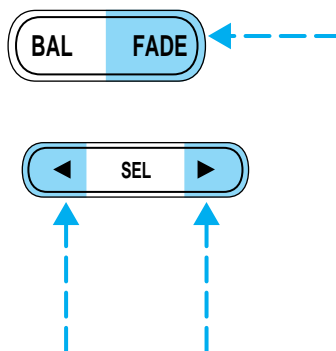

Tape/CD/CD changer (if equipped) select

- To begin tape play (with a tape loaded into the audio system) while in the radio or CD mode, press the TAPE control. Press the button during rewind or fast forward to stop the rewind or fast forward function.
- To begin CD play (if CD(s) are loaded), press the CD control. The first track of the disc will begin playing. After that CD play will begin where it stopped last.



If equipped with a CD changer, press the CD control to toggle between single CD and CD changer play.

Do not insert any promotional (odd shaped or sized) discs, or discs with removable labels into the CD player as jamming may occur.

Entertainment Systems

Rewind

The rewind control works in tape and CD modes.

- In tape mode, radio play will continue until rewind is stopped (with the TAPE control) or the beginning of the tape is reached.
- In CD mode, pressing the REW control for less than three seconds results in slow rewind. Pressing the control for more than three seconds results in fast rewind.

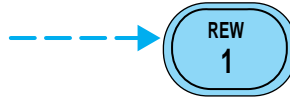

Fast forward

The fast forward control works in tape and CD modes.

- In the tape mode, tape direction will automatically reverse when the end of the tape is reached.
- In CD mode, pressing the control for less than three seconds results in slow forward action. Pressing the control for more than three seconds results in fast forward action.

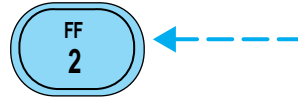

Tape direction select

Press SIDE 1-2 to play the alternate side of a tape.

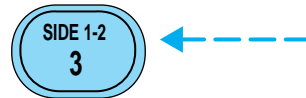

Eject function

Press the control to stop and eject a tape.

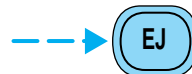

Press the control to stop and eject a CD.

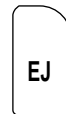

Entertainment Systems

Dolby® noise reduction

Dolby® noise reduction operates only in tape mode. Dolby® noise reduction reduces the amount of hiss and static during tape playback.

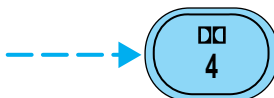

Press the  control to activate (and deactivate) Dolby® noise reduction.

The Dolby® noise reduction system is manufactured under license from Dolby Laboratories Licensing Corporation. Dolby® and the double-D symbol are registered trademarks of Dolby® Laboratories Licensing Corporation.

Compression adjust

Compression adjust brings soft and loud CD passages together for a more consistent listening level.

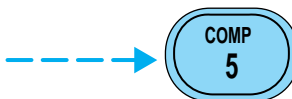

Press the COMP control to activate and deactivate compression adjust.

Shuffle feature

The shuffle feature operates in CD mode and plays all tracks on the current disc in random order. If equipped with the CD changer, the shuffle feature continues to the next disc after all tracks on the current disc are played.

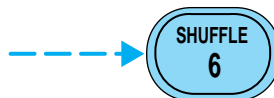

Press the SHUFFLE control to start this feature. Random order play will continue until the SHUFFLE control is pressed again.

Entertainment Systems

Setting the clock

Press the clock/RDS control until SELECT HOUR is displayed and press:

- ◀ to decrease hours and
- ▶ to increase hours.

To set the minute, press the clock/RDS control until SELECT MIN is displayed and press:

- ◀ to decrease minutes and
- ▶ to increase minutes.

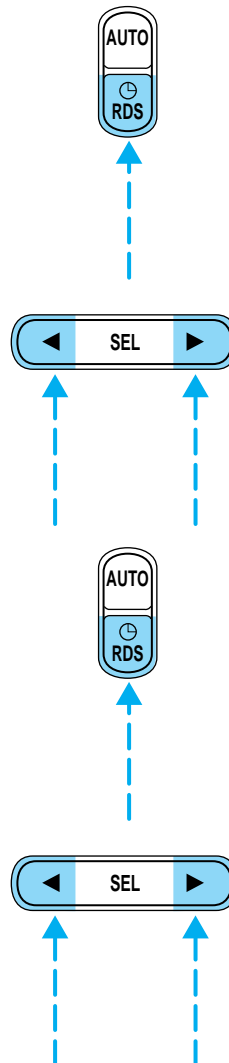

Entertainment Systems

Radio Data System (RDS) feature

This feature allows your audio system to receive text information from RDS-equipped FM radio stations.

Press and hold the control for three seconds to turn the feature on or off. Press the control to scroll through the following selections:



RDS traffic announcement

- Press the RDS control until TRAFFIC is displayed.
- Use the SELECT control to select ON or OFF. With the feature ON, use the SEEK or SCAN control to find a radio station broadcasting a traffic report (if it is broadcasting RDS data).

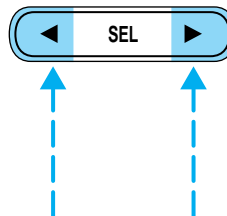

Entertainment Systems

RDS select program type

- Press the RDS control until FIND program type is displayed.



- Use the SEL control to select the program type. With the feature on, use the SEEK or AUTOSET or SCAN control to find the desired program type from the following selections:

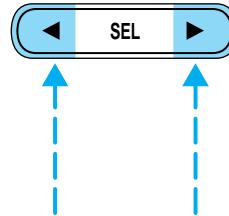

- Classic
- Country
- Info
- Jazz/R&B
- Religious
- Rock
- Soft
- Top 40

RDS show

- With the RDS menu enabled, press the RDS control until SHOW is displayed.



Entertainment Systems

- Use the SEL control to select TYPE, NAME, TEXT or NONE. When your radio is turned to a RDS station, RDS station TYPE, station NAME, or TEXT message will be displayed along with the frequency. Press SEL in order to scroll through the text messages.

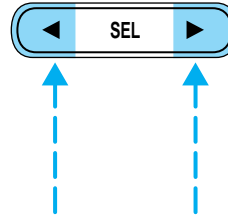

Mute mode

Press the control to mute the playing media. Press the control again to return to the playing media.

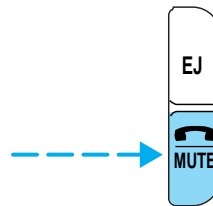

AUDIOPHILE AM/FM STEREO IN DASH SIX CD RADIO

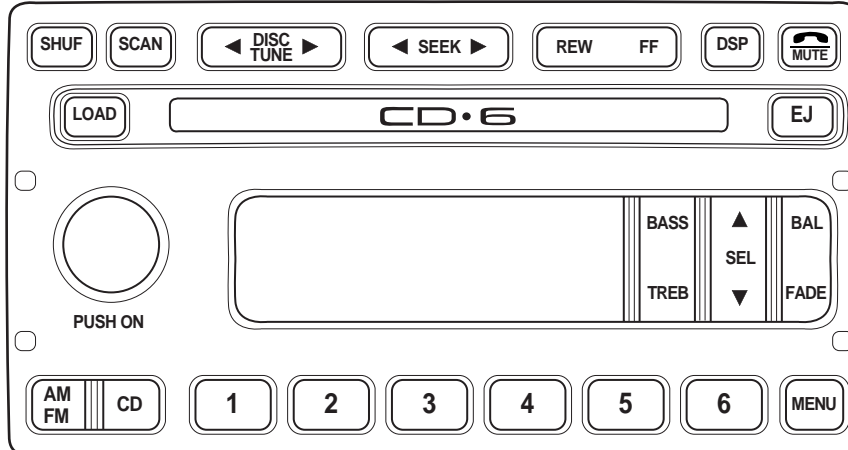

Entertainment Systems

Volume/power control

Press the control to turn the audio system on or off.

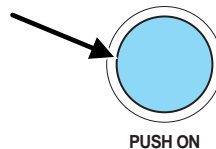

Turn the control to raise or lower volume.

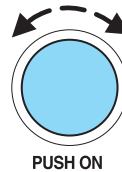

If the volume is set above a certain level and the ignition is turned off, the volume will come back on at a “nominal” listening level when the ignition switch is turned back on.

AM/FM select

The AM/FM select control works in radio and CD modes.

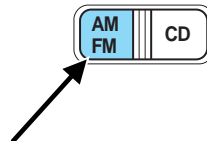

AM/FM select in radio mode

This control allows you to select AM or FM frequency bands. Press the control to switch between AM, FM1 or FM2 memory preset stations.

AM/FM select in CD mode

Press this control to stop CD play and begin radio play.

Tune adjust

The tune control works in radio or CD mode.

Entertainment Systems

Tune adjust in radio mode

- Press ◀ to move to the next frequency down the band (whether or not a listenable station is located there). Hold the control to move through the frequencies quickly.

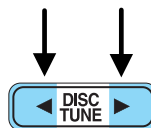

- Press ▶ to move to the next frequency up the band (whether or not a listenable station is located there). Hold for quick movement.

Tune adjust for CD mode

- Press ◀ to select the previous disc. (Play will begin on the first track of the disc unless shuffle mode is engaged.) Refer to *Shuffle feature* for more information. Hold the control to continue reversing through the discs.

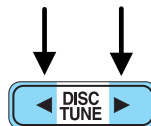

- Press ▶ to select the next disc. Hold the control to fast-forward through the remaining discs.

Seek function

The seek function works in radio or CD mode.

Seek function in radio mode

- Press ◀ to find the next listenable station down the frequency band. SEEK DOWN will display.



- Press ▶ to find the next listenable station up the frequency band. SEEK UP will display.

Entertainment Systems

Seek function in CD mode

- Press ◀ to seek to the previous track of the current disc. If the beginning of the disc is reached, the CD player seeks to the beginning of the last track on the current disc and begins playing.
- Press ▶ to seek forward to the next track of the current disc. After the last track has been completed, the first track of the current disc will automatically replay.



Scan function

The scan function works in radio or CD mode.

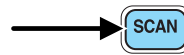

Scan function in radio mode

Press the SCAN control to hear a brief sampling of all listenable stations on the frequency band. Press the SCAN control again to stop the scan mode.

Scan function in CD mode

Press the SCAN control to hear a short sampling of all selections on the CD. (The CD scans in a forward direction, wrapping back to the first track at the end of the CD.) To stop on a particular selection, press the control again.

Radio station memory preset

The radio is equipped with six station memory preset controls. These controls can be used to select up to six preset AM stations and twelve FM stations (six in FM1 and six in FM2).

Setting memory preset stations

1. Select the frequency band with the AM/FM select control. Press the AM/FM control to toggle between AM, FM1, or FM2.
2. Press the SEEK control to access the next listenable station up or down the frequency band. Press the TUNE control to go up or down the listening band in individual increments.
3. Select a station. Refer to *Seek function* for more information on selecting a station.

Entertainment Systems

4. Press and hold a memory preset control. The playing media will mute momentarily. When the sound returns, the station is held in memory on the control you selected. The display will read **SAVED**.

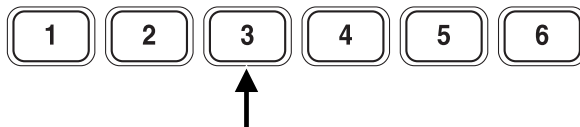

Autostore

Autostore allows you to set the strongest local radio stations without losing your original manually set preset stations. This feature is helpful on trips when you travel between cities with different radio stations.

Starting autostore

1. Press and momentarily hold the AM/FM control.
2. **AUTOSET** will flash in the display as the frequency band is scrolled through.
3. When the six strongest stations are filled, the station stored in memory preset control 1 will start playing.

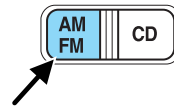

If there are less than six strong stations available on the frequency band, the remaining memory preset controls will all store the last strong station available.

To deactivate autostore and return to your audio system's manually set memory stations, press the AM/FM control again.

CD select

CD mode may be entered by pressing the CD control and the **LOAD** control. Load the CD into the audio system. The first track of the disc will begin playing. After that, CD play will begin where it stopped last.

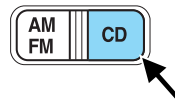

If an alternative CD is desired, press the corresponding preset control (1-6) of a loaded CD, or press the **TUNE** control to access the other loaded CDs.

Entertainment Systems

NO CD will display if the CD control is activated when there is not a CD present in the audio system.

NO CD will illuminate in the display if the CD control and a present number (that is currently empty) are pressed. The system will play the next available disc.

If your vehicle is equipped with a CD changer, pressing the CD control again will allow you to toggle between accessing the multi disc system and the CD changer. The display will read CD or CDDJ.

Do not insert any promotional (odd shaped or sized) discs, or discs with removable labels into the CD player as jamming may occur.

Display description

Six circles are always lit in the digital display. These signify the six CD slots in the audio system. When a disc is loaded into a particular slot (1–6), the number inside that specific circle lights. If the circle is empty, there is no CD in that particular slot.

Load

The load feature allows you to load single CDs into the player internal to the radio.



This six disc CD player is equipped with a CD door. Compact discs should only be inserted into the player after the door has been opened by the player. Do not attempt to force the door open. Compact discs should only be loaded by pressing the LOAD control.

Press the LOAD control. (You can choose which slot will be loaded by pressing the desired preset number. If you do not choose a slot, the system will choose the next available one.) Wait until the CD door opens. Load the CD into the player. LOADING CD# is displayed. When the CD has been loaded, the door will close and the CD will begin to play. For example, to load a CD into slot 2, press the LOAD control and then press preset 2.

Auto load

This feature allows you to autoloading up to 6 discs into the multi disc CD player internal to the radio.



Entertainment Systems

Press and hold the LOAD control until AUTOLOAD # is displayed. The CD door will open. Load the desired disc, one at a time. The CD is loaded into position and the audio system will display CD#. Each time the CD door opens, INSERT CD# is displayed. The door will close and the player will move to the next slot after each disc has been loaded. The process is repeated until all 6 slots are full. The audio system plays the last CD loaded and the display is updated. If some slots are already full and autoloading is activated, the system will fill all empty slots.

Eject

Press the EJ control to stop and eject a CD. You can choose which CD will be ejected by pressing the EJ control and the desired preset number (1–6). For example, to eject CD 2, press the EJ control and then press the preset 2 control. If you do not choose a specific CD, the player will eject the current CD.



If a CD is ejected and not removed from the door of the CD player, the player will automatically reload the CD. This feature may be used when the ignition is ON or OFF.

Auto eject

Press and momentarily hold the EJ control to engage auto eject. All CDs which are present in the player will be ejected one at a time. If a CD is ejected and not removed from the door of the CD player, the player will automatically reload the CD. This feature may be used when the ignition is ON or OFF.



Rewind

The rewind control works in CD modes.

Press and hold the REW control until the desired selection is reached. If the beginning of the disc is reached, the CD will begin play at the first track. Release the control to disengage rewind mode.

When in rewind mode, your audio system will automatically lower the volume level of the playing media.



Entertainment Systems

Fast forward

The fast forward control works in CD modes.

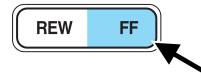

Press and hold the FF control until the desired selection is reached. If the end of the disc is reached, the CD will return to the first track. Release the control to disengage fast forward mode.

When in fast forward mode, your audio system will automatically lower the volume level of the playing media.

Shuffle feature

Press the SHUF control until the desired shuffle mode is displayed. The audio system will then engage the desired shuffle mode.



When engaged, the shuffle feature has two different modes: SHUFFLE DISC and SHUFFLE TRK.

SHUFFLE DISC randomly plays tracks from all the discs presently in the audio system.

SHUFFLE TRK plays all the tracks on the current disc in random order.

Compression feature

The compression feature operates in CD mode and brings soft and loud CD passages together for a more consistent listening level.

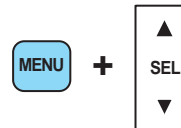

Press the MENU control until compression status is displayed. Press the SEL control to enable the compression feature when COMP OFF is displayed. Press the SEL control again to disable the feature when COMP ON is displayed.

Entertainment Systems

Bass adjust

The bass adjust control allows you to increase or decrease the audio system's bass output.

Press the BASS control. Use the SEL control to increase or decrease the amount of bass.



Treble adjust

The treble adjust control allows you to increase or decrease the audio system's treble output.

Press the TREB control. Use the SEL control to increase or decrease the amount of treble.



Speaker balance adjust

Speaker sound distribution can be adjusted between the right and left speakers.

Press the BAL control. Use the SEL control to adjust the sound between the speakers.

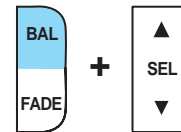

Speaker fade adjust

Speaker sound can be adjusted between the front and rear speakers.

Press the FADE control. Use the SEL control to adjust the sound between the front and rear speakers.



Entertainment Systems

Menu mode

The MENU control allows you to access many different features within your audio system. There are three sets of menus available depending upon which mode or feature is activated.

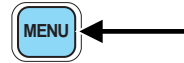

While in FM mode, two menus are available. **If RDS is turned OFF**, you can access the following:

- SELECT HOURS — Refer to *Setting the clock*.
- SELECT MINUTES — Refer to *Setting the clock*.
- RDS OFF — Refer to *Radio data system feature*.

If RDS is turned ON, you can access the following:

- TRAFFIC ON/OFF-Refer to *Traffic announcements*.
- FIND type-Refer to *Program type*.
- SHOW (NAME, TYPE, NONE)- Refer to *Radio data system feature*.
- RDS ON— Refer to *Radio data system feature*.
- SELECT HOURS — Refer to *Setting the clock*.
- SELECT MINUTES —Refer to *Setting the clock*.

When in CD mode, you can access: SELECT HOURS, SELECT MINUTES or COMP ON/OFF.

SELECT HOURS, SELECT MINUTES— Allows you to adjust the hours and minutes. Refer to *Setting the clock*.

TRAFFIC ON/OFF— Traffic announcements can be programmed as local or distant. Refer to *Traffic announcements*.

RDS ON/OFF— This feature allows your audio system to receive text information from RDS-equipped FM radio stations. Refer to *Radio Data System feature*.

FIND type — Allows you to select your desired FM program type and search for that selection.

SHOW — Allows you to select from NAME (displays the name of the radio station), TYPE (displays the RDS program type: rock, jazz, etc.), or NONE (deactivates the RDS display).

Entertainment Systems

Traffic announcements

This feature allows you to hear traffic announcements. When in this mode, traffic announcements will interrupt radio and CD play.

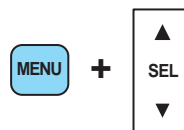

When in FM mode and RDS is activated, press the MENU until TRAFFIC OFF displays. Press the SEL control to engage the feature. The display will read TRAFFIC ON.

This feature also allows you to control the volume of traffic announcements. With the display reading TRAFFIC ON, adjust the volume using the volume control to the desired level. The volume level will show at the bottom of the display. Interrupting traffic announcements will be at the selected volume level.

To disengage the feature, press the MENU control until TRAFFIC ON displays. Press the SEL control. The display will read TRAFFIC OFF.

RDS traffic seek feature

When in traffic mode, you can use the SEEK feature to seek up or down the listenable traffic capable frequencies.

With the RDS activated, press MENU until TRAFFIC ON is displayed. Press and hold the SEEK control until the desired selection is reached. The feature disengages when the control is released.

RDS traffic scan feature

When in traffic mode, you can use the SCAN feature to scan up the frequency band for listenable traffic capable frequencies.

With the RDS activated, press the MENU control until TRAFFIC ON is displayed. Press the SCAN control. SCAN TRAFFIC will display. The audio system will scan to all traffic capable frequencies. If no valid stations are found after one pass, the scan function is cancelled and NOT FOUND displays.

Radio data system (RDS) feature

This feature allows your audio system to receive text information from RDS-equipped FM radio stations.

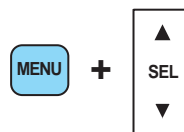

Entertainment Systems

To activate RDS:

- When in FM mode, press the MENU control until RDS OFF displays.
- Press the SEL control to engage this feature (RDS ON).

RDS features:

Once the RDS feature is on, press the MENU control to scroll through the following selections:

Traffic announcements

This feature allows you to hear traffic announcements while in CD mode. These announcements are broadcast by traffic capable RDS stations.

When in this mode, traffic announcements will interrupt radio and CD play.

- Press the MENU control until TRAFFIC is displayed.
- Press the SEL control to engage the feature. The display will read TRAFFIC ON.

This feature also allows you to control the volume of traffic announcements. With the display reading TRAFFIC ON, adjust the volume using the volume control to the desired level. The volume level will show at the bottom of the display. Interrupting traffic announcements will be at the selected volume level.

To disengage the feature, press the MENU control until TRAFFIC ON displays. Press the SEL control. The display will read TRAFFIC OFF.

Traffic announcements are not available in most U.S. markets.

Program type

This feature allows you to search for RDS stations selectively by their program type.

Press the MENU control until FIND program type is displayed.

Use the SEL control to select the program type. With the feature on, use the SEEK or SCAN control to

find the desired program type from the following selections:

- Classic
- Country
- Info

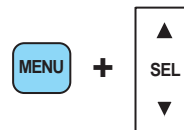

Entertainment Systems

- Jazz
- Oldies
- R & B
- Religious
- Rock
- Soft
- Top 40

Show

This feature allows you to select the type of RDS broadcast information the radio will regularly show in the display.

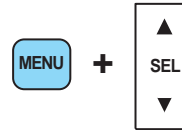

With RDS activated, press the MENU control until SHOW is displayed.

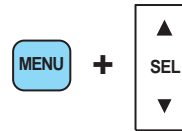

Use the SEL control to select TYPE (displays the RDS program type: rock, jazz, etc), NAME (displays the name of the radio station) or NONE (deactivates the RDS display).

Digital signal processing

The digital signal processing (DSP) feature allows you to change the signal mode to suit your listening tastes.

Press the DSP control to access the DSP menu. Press the SEL control to enter one of the following modes:



- DSP OFF
- SIGNAL MODE
- OCCUPANCY MODE

Entertainment Systems

Use the SEL control to select the desired signal mode (the selected mode will appear in the display). The following signal modes can be selected:



- DSP OFF—disengages the feature
- NEWS—"voice-only" type of sound with a limited audio band
- JAZZ CLUB—jazz club with clearly reflected sounds
- HALL—rectangular concert hall capacity of about 2 000
- CHURCH—church with a high vault
- STADIUM—outdoor stadium with a capacity of about 30 000

Press the DSP control again to access the Occupancy Modes. Use the SEL control to optimize the sound based upon the occupants in the vehicle. The following occupancy modes can be selected:

- ALL SEATS — Optimizes the acoustic sound for all seating locations. Rear seat performance may be compromised in the interest of the front seats.
- DRIVER SEAT — Optimizes the acoustic sound for the driver. Rear seat and passenger seat performance may be compromised in favor of the driver.
- REAR SEATS — Optimizes the acoustic sound for the rear seat passengers and reduces the audio level in the front speakers. This enables the front seat passengers to speak while the rear seat passengers listen to the audio system.

Mute mode

Press the control to mute the playing media. Press the control again to return to the playing media.



Setting the clock

Press the MENU control until SELECT HOUR or SELECT MINUTE is displayed. (The menu mode must be engaged to enable clock mode).

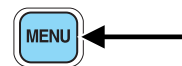

Entertainment Systems

Use the SEL control to manually set the time.

- Press ▲ to increase hours/minutes.
- Press ▼ to decrease hours/minutes.

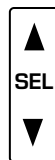

Press the MENU control again to disengage the clock mode.

TROUBLESHOOTING THE CD CHANGER (IF EQUIPPED)



The laser beam used in the compact disc player is harmful to the eyes. Do not attempt to disassemble the case.

If sound skips:

- You may be traveling on a rough road, playing badly scratched discs or the disc may be dirty. Skipping will not scratch the discs or damage the player.

If your changer does not work, it may be that:

- A disc is already loaded where you want to insert a disc.
- The disc is inserted with the label surface downward.
- The disc is dusty or defective.
- The player's internal temperature is above 60°C (140°F). Allow the player to cool down before operating.
- A disc with format and dimensions not within industry standards is inserted.

CLEANING COMPACT DISCS

Inspect all discs for contamination before playing. If necessary, clean discs only with an approved CD cleaner and wipe from the center out to the edge. Do not use circular motion.

CD AND CD CHANGER CARE

- Handle discs by their edges only. Never touch the playing surface.
- Do not expose discs to direct sunlight or heat sources for extended periods of time.
- Do not insert more than one disc into each slot of the CD changer magazine.

Entertainment Systems

Do not insert any promotional (odd shaped or sized) discs, or discs with removable labels into the CD player as jamming may occur.

RADIO FREQUENCY INFORMATION

The Federal Communications Commission (FCC) and the Canadian Radio and Telecommunications Commission (CRTC) establish the frequencies AM and FM stations may use for their broadcasts. Allowable frequencies are:

AM 530, 540–1600, 1610 kHz

FM 87.7, 87.9–107.7, 107.9 MHz

Not all frequencies are used in a given area.

RADIO RECEPTION FACTORS

Three factors can affect radio reception:

- **Distance/strength.** The further an FM signal travels, the weaker it is. The listenable range of the average FM station is approximately 40 km (24 miles). This range can be affected by “signal modulation.” Signal modulation is a process radio stations use to increase their strength/volume relative to other stations.
- **Terrain.** Hills, mountains and tall buildings between your vehicle’s antenna and the radio station signal can cause FM reception problems. Static can be caused on AM stations by power lines, electric fences, traffic lights and thunderstorms. Moving away from an interfering structure (out of its “shadow”) returns your reception to normal.
- **Station overload.** Weak signals are sometimes captured by stronger signals when you pass a broadcast tower. A stronger signal may temporarily overtake a weaker signal and play while the weak station frequency is displayed.

The audio system automatically switches to single channel reception if it will improve the reception of a station normally received in stereo.

AUDIO SYSTEM WARRANTIES AND SERVICE

Refer to the *Warranty Guide* for audio system warranty information.

If service is necessary, see your dealer or a qualified technician.

Climate Controls

HEATER ONLY SYSTEM (IF EQUIPPED)



Fan speed control

Controls the volume of air circulated in the vehicle.







Temperature control knob

Controls the temperature of the airflow inside the vehicle. On heater-only systems, the air cannot be cooled below the outside temperature.



Mode selector control

Controls the direction of the airflow to the inside of the vehicle.

-  (Panel) – Distributes outside air through the instrument panel registers.
-  (Panel and floor) – Distributes outside air through the instrument panel registers and the floor ducts.
- **O** (OFF) – Outside air is shut out and the fan will not operate. For short periods of time only, use this mode to prevent undesirable odors from entering the vehicle.
-  (Floor) – Allows for maximum heating. Distributes outside air through the floor ducts.
-  (Floor and defrost) – Distributes outside air through the floor ducts and the windshield defroster ducts.



Climate Controls

-  (Defrost) – Distributes outside air through the windshield defroster ducts. It can be used to clear ice or fog from the windshield.

Operating tips

- In humid weather, place the climate control system in DEF before driving. This will reduce fogging on your windshield. Once the windshield has been cleared, select any desired position.
- To reduce humidity buildup inside the vehicle, do not drive with the climate control system in the OFF position.
- Under normal weather conditions, your vehicle's climate control system should be left in any position other than OFF position when the vehicle is parked. This allows the vehicle to "breathe" through the outside air inlet duct.
- Under snowy or dirty weather conditions, your vehicle's climate control system should be left in the OFF position when the vehicle is parked. This allows the climate control system to be free from contamination of outside pollutants.
- Do not place objects under the front seat which may interfere with the airflow to the rear seats.
- Remove any snow, ice, or leaves from the air intake area (at the base of the windshield and underneath the hood).
- Do not place objects over the defroster outlets. These objects may block airflow and reduce your visibility through the windshield. Avoid placing small objects on top of the instrument panel. These objects can fall into the defroster outlets and block airflow, in addition to, damaging your climate control system.

Do not place objects on top of the instrument panel, as these objects may become projectiles in instances of sudden impact or a sudden stop.

Climate Controls

MANUAL HEATING AND AIR CONDITIONING SYSTEM



Fan speed control

Controls the volume of air circulated in the vehicle.



Temperature control knob



Controls the temperature of the airflow inside the vehicle.



Mode selector control

Controls the direction of the airflow to the inside of the vehicle.







The air conditioning compressor can operate in all modes except , , and . However, the air conditioning will only function if the outside temperature is about 6°C (43°F) or higher.

Since the air conditioner removes considerable moisture from the air during operation, it is normal if clear water drips on the ground under the air conditioner drain while the system is working and even after you have stopped the vehicle.

- MAX A/C- Uses recirculated air to cool the vehicle. MAX A/C is louder than A/C but more economical and will cool the inside of the vehicle faster. Airflow will be from the instrument panel registers. This mode can also be used to prevent undesirable odors from entering the vehicle.

Climate Controls

- A/C-Uses outside air to cool the vehicle. It is quieter than MAX A/C but not as economical. Airflow will be from the instrument panel registers.
-  (Panel)-Distributes outside air through the instrument panel registers. However, the air will not be cooled below the outside temperature because the air conditioning does not operate in this mode.
-  (Panel and floor)-Distributes outside air through the instrument panel registers and the floor ducts. Heating capabilities are provided in this mode. For added customer comfort, when the temperature control knob is anywhere in between the full hot and full cold positions, the air distributed through the floor ducts will be slightly warmer than the air sent to the instrument panel registers. However, the air will not be cooled below the outside temperature because the air conditioning does not operate in this mode.
- O (OFF)-Outside air is shut out and the fan will not operate. For short periods of time only, use this mode to prevent undesirable odors from entering the vehicle.
-  (Floor)-Allows for maximum heating by distributing outside air through the floor ducts. However, the air will not be cooled below the outside temperature because the air conditioning does not operate in this mode.
-  (Floor and defrost)-Distributes outside air through the windshield defroster ducts, the demister outlets, and the floor ducts. Heating and air conditioning capabilities are provided in this mode. For added customer comfort, when the temperature control knob is anywhere in between the full hot and full cold positions, the air distributed through the floor ducts will be slightly warmer than the air sent to the windshield defrost ducts. If the temperature is about 6°C (43°F) or higher, the air conditioner will automatically dehumidify the air to reduce fogging.
-  (Defrost)-Distributes outside air through the windshield defroster ducts and the demister outlets. It can be used to clear ice or fog from the windshield. If the temperature is about 6°C (43°F) or higher, the air conditioner will automatically dehumidify the air to reduce fogging.

Climate Controls

Operating tips

- In humid weather conditions, place the climate control system in Defrost mode before driving. This will reduce fogging on your windshield. Once the windshield has been cleared, operate the climate control system as desired.
- To reduce humidity buildup inside the vehicle in cold weather conditions, don't drive with the climate control system in the OFF or MAX A/C position.
- To reduce humidity buildup inside the vehicle in warm weather conditions, don't drive with the climate control system in the OFF position.
- Under normal weather conditions, your vehicle's climate control system should be left in any position other than the MAX A/C or OFF when the vehicle is parked. This allows the vehicle to "breathe" through the outside air inlet duct.
- Under snowy or dirty weather conditions, your vehicle's climate control system should be left in the OFF position when the vehicle is parked. This allows the climate control system to be free from contamination of outside pollutants.
- If your vehicle has been parked with the windows closed during warm weather conditions, the air conditioner will perform more efficiently in cooling the vehicle if driven for two or three minutes with the windows open. This will force most of the hot, stale air out of the vehicle. Once the vehicle has been "aired out", operate the climate control system as desired.
- Do not put objects under the front seat which may interfere with the airflow to the rear seats (if equipped).
- Remove any snow, ice or leaves from the air intake area (at the bottom of the windshield and underneath the hood).
- Do not place objects over the defroster outlets. These objects can block airflow and reduce visibility through your windshield. Avoid placing small objects on top of the instrument panel. These objects may fall down into the defroster outlets and block airflow, in addition to, damaging the climate control system.

Climate Controls

To aid in side window defogging/demisting in cold weather conditions:

1. Select the position that distributes air through the Panel and Floor.
2. Set the temperature control to full heat.
3. Set the fan speed to full fan.
4. Direct the outer panel vents towards the side windows.
5. To increase airflow to the outer panel vents, close the central panel vents.

Do not place objects on top of the instrument panel as these objects may become projectiles in a collision or sudden stop.

REAR WINDOW DEFROSTER

The rear defroster control is located on the instrument panel.

Press the rear defroster control to clear the rear window of thin ice and fog.

- The small LED will illuminate when the rear defroster is activated.

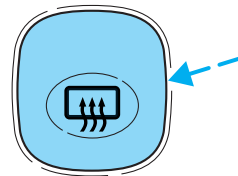

The ignition must be in the ON position to operate the rear window defroster.

The heated rear screen does not turn off automatically. Press the control to turn it off after the screen has been cleared. If the heated rear screen is still in operation when the ignition is switched off, the heating function will be reactivated when the ignition is switched on again.

Lights

HEADLAMP CONTROL ☼

Rotate the headlamp control to the first position to turn on the parking lamps. Rotate to the second position to also turn on the headlamps.

Your vehicle is equipped with a battery saver feature which, if you leave the headlamps on, automatically turns off the headlamps after 30 seconds when the ignition is in the OFF position.

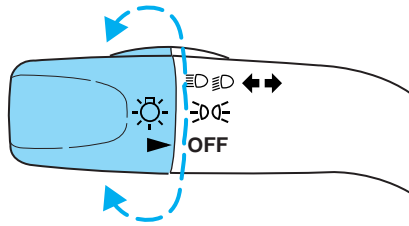

Foglamp control (if equipped) ⌘

Turn on the low-beam headlamps. Press the foglamp control, located on the instrument panel, to activate the foglamps. The foglamp LED will illuminate when the foglamps are on. When the highbeams are activated, the foglamps will not operate.

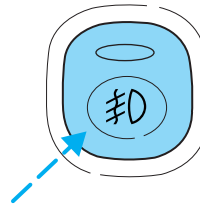

Press the foglamp control to deactivate the foglamps.

Daytime running lamps (DRL) (if equipped)

Turns the headlamps on with a reduced output. To activate:

- the ignition must be in the ON position and
- the headlamp control is in the OFF or Parking lamps position.

 Always remember to turn on your headlamps at dusk or during inclement weather. The Daytime Running Lamp (DRL) system does not activate with your tail lamps and generally may not provide adequate lighting during these conditions. Failure to activate your headlamps under these conditions may result in a collision.

Lights

High beams

- Push forward past detent to activate.
- Pull toward you past detent to deactivate.

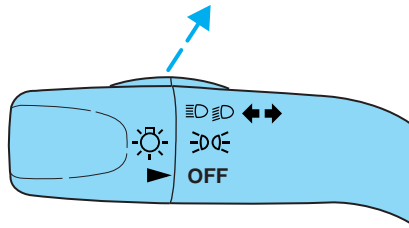

Flash to pass

Pull toward you slightly to activate and release to deactivate.

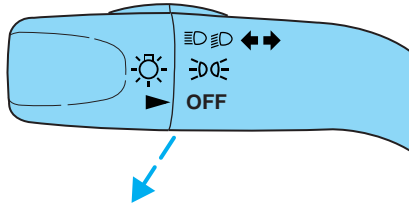

PANEL DIMMER CONTROL

Use to adjust the brightness of the instrument panel.

- Push and hold top of control to brighten.
- Push and hold bottom of control to dim.

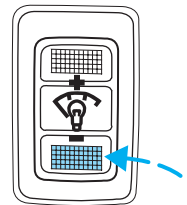
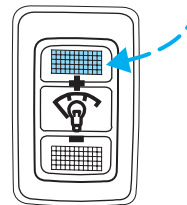

AIMING THE HEADLAMPS

The headlamps on your vehicle are properly aimed at the assembly plant. If your vehicle has been in an accident the alignment of your headlamps should be checked by a qualified service technician.

Vertical aim adjustment

1. Park the vehicle on a level surface approximately 7.6 meters (25 feet) from a vertical wall or screen directly in front of it.

- (A) Eight feet
- (B) Center height of lamp to ground
- (C) Twenty five feet
- (D) Horizontal reference line

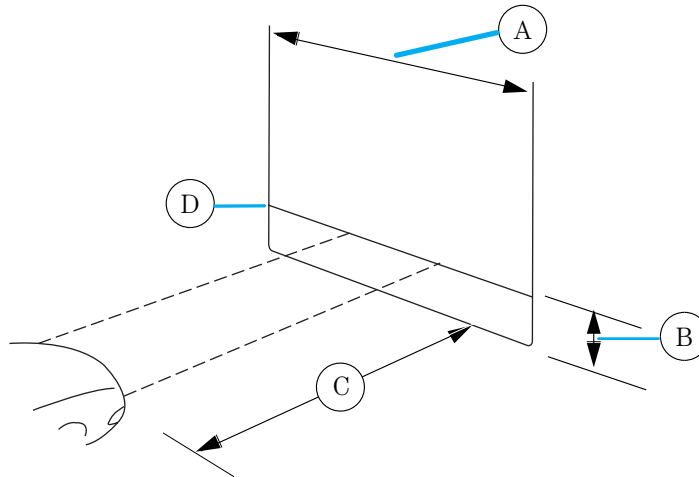

2. Measure the height from the center of your headlamp to the ground and mark a 2.4 meter (8 foot) horizontal reference line on the vertical wall or screen at this height (a piece of masking tape works well). The center of the lamp is marked by a 3.0 mm circle on the headlamp lens.

3. Turn on the low beam headlamps to illuminate the wall or screen and open the hood. Cover the left-hand headlamp with an opaque cloth.

Lights

4. On the wall or screen you will observe a light pattern with a distinct horizontal edge of high intensity light towards the right. If this edge is not at the horizontal reference line, the beam will need to be adjusted.

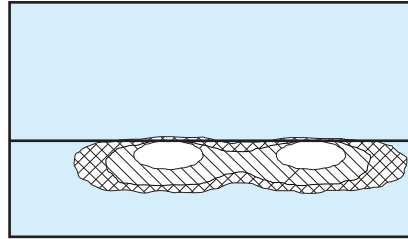

5. Locate the vertical adjuster on the headlamp, then use a 7 mm hex socket or T20 Torx driver to turn the adjuster either counterclockwise (to adjust down) or clockwise (to adjust up) aligning the upper edge of the light pattern to the horizontal line.

6. Move the opaque cloth to cover the right-hand headlamp and repeat steps 4 and 5 for the left-hand headlamp.

7. HORIZONTAL AIM IS NOT REQUIRED FOR THIS VEHICLE AND IS NON-ADJUSTABLE.

8. Close the hood and turn off the lamps.

TURN SIGNAL CONTROL ⇄

- Push down to activate the left turn signal.
- Push up to activate the right turn signal.

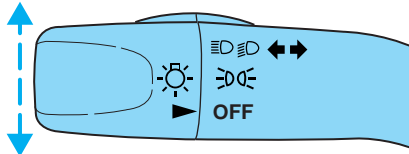

INTERIOR LAMPS

Dome lamps and map lamps

The front dome lamp is located overhead between the driver and passenger seats.

The dome lamp will stay on if the control is moved to the passenger side position. When the control is in the middle position, the lamp will only come on when a door is opened. If the control is moved to the driver's side position, the lamp will not come on at all.

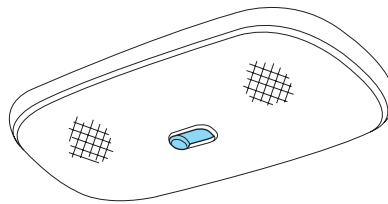

Lights

With the control in the middle position, the dome lamp will illuminate whenever any door is opened. If any door has been opened from the outside, the lamp will remain on for 15 seconds after the door is shut.

The map lamp controls (without moon roof) are located on the dome lamp. Press the controls on either side of each map lamp to activate the lamps.

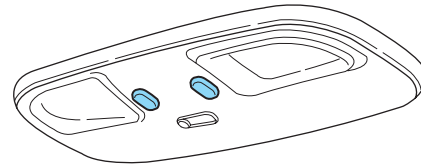

If equipped with a moon roof, the map lamps are located on the moon roof control panel. Press the controls on either side of each map lamp to activate the lamps.

This map lamp will illuminate whenever any door is opened. If any door has been opened from the outside, the lamp will remain on for 15 seconds after the door is closed.

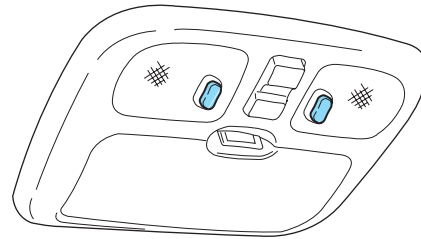

Cargo and dome lamp

Rear cargo lamp equipped with an ON/OFF/DOOR control will light when:

- the doors are closed and the control is in the ON position.
- the control is in the DOOR position and any door is open.
- the headlamp control is rotated fully counterclockwise.

When the control is in the OFF position, it will not illuminate when you open the doors or fully rotate the headlamp control.

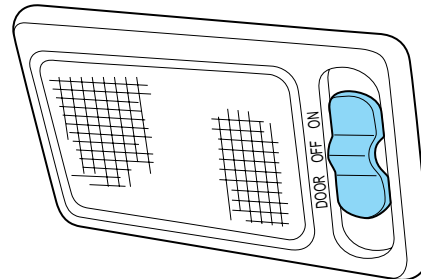

Lights

BULBS

Replacing exterior bulbs

Check the operation of the following lamps frequently:

- Headlamps
- Foglamps
- High-mount brakelamp
- Brakelamps
- Parking lamps
- Turn signal lamps
- License plate lamp
- Tail lamps
- Back-up lamps

Do not remove lamp bulbs unless they can be replaced immediately with new ones. If a bulb is removed for an extended period of time, contaminants may enter the lamp housings and affect lamp performance.

Using the right bulbs

Replacement bulbs are specified in the chart below. Headlamp bulbs must be marked with an authorized "D.O.T." for North America and an "E" for Europe to assure lamp performance, light brightness and pattern and safe visibility. The correct bulbs will not damage the lamp assembly or void the lamp assembly warranty and will provide quality bulb burn time.

Function	Number of bulbs	Trade number
Park/turn lamps (front)	2	3157 AK (amber)
Headlamps	2	HB2
Rear stop/tail/sidemarkers	2	3157K
Rear turn lamps	2	3156K
Backup lamp	2	3156K
Foglamp (front)	2	898

Lights

Function	Number of bulbs	Trade number
Center High-mount stop lamp	5	168
Rear license plate lamp	2	W5W
All replacement bulbs are clear in color except where noted.		
To replace all instrument panel lights - see your dealer.		

Replacing the interior bulbs

Check the operation of the following interior bulbs frequently:

- Interior overhead lamp
- Map lamp

For bulb replacement, see a dealer or qualified technician.

Replacing headlamp bulbs

1. Make sure that the headlamp control is in the OFF position.
2. Open the hood.
3. Press two tabs and disconnect the electrical connector from the bulb.

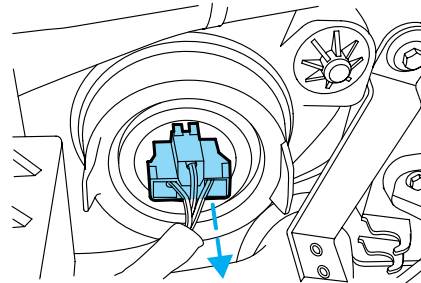

Lights

4. Remove the rubber boot from the lamp assembly by pulling on one of the tabs.

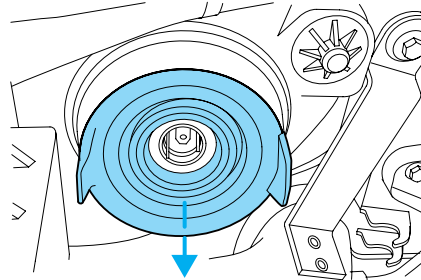

5. Press the retainer spring forward and spread the spring releasing it from bulb hooks and rotate it away from the bulb.

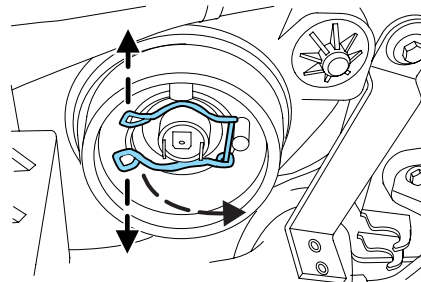

6. Without turning, carefully pull bulb out of headlamp assembly.

 Handle a halogen headlamp bulb carefully and keep out of children's reach. Grasp the bulb only by its metal base and do not touch the glass. The oil from your hand could cause the bulb to break the next time the headlamps are operated.

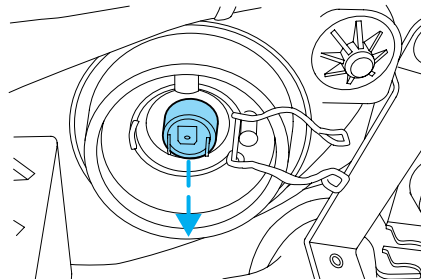

Note: The bulb's metal base gets very hot during headlamp operation. Be sure the bulb base is cool before handling.

If the bulb is accidentally touched, it should be cleaned with rubbing alcohol before being used.

Lights

7. Insert the glass end of the new bulb into the headlamp assembly. When the bulb's three metal tabs are aligned with the grooves in the plastic base, push the bulb into the lamp assembly until the bulb's metal base contacts the plastic base.
8. Rotate the retainer spring over the bulb metal base and secure it on the bulb hooks.
9. Install rubber boot on the lamp assembly. Be sure to press firmly around the perimeter of the boot and around the bulb to ensure the proper seal of the bulb.
10. Connect the electrical connector into the rear of the bulb until it "snaps."

Replacing brake/tail/turn/backup/rear fog lamp bulbs

The brake/tail/turn/backup/rear fog lamp bulbs are located in the tail lamp assembly, one just below the other. Follow the same steps to replace either bulb:

1. Open the liftgate to expose the lamp assemblies.
2. Remove the two screws from the lamp assembly.
3. Carefully remove the lamp assembly by pulling it rearward to disengage snap features on the outward side of the lamp.
4. Twist the bulb socket counterclockwise and remove from lamp assembly.

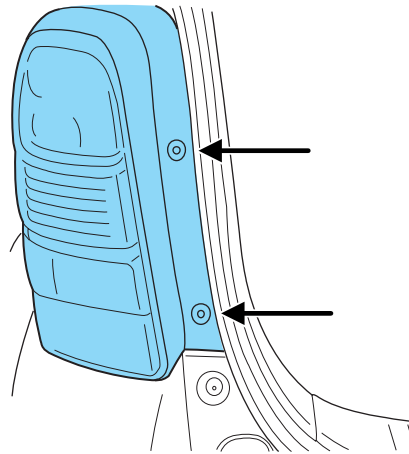

Lights

5. Pull the bulb straight out of the socket and push in the new bulb.
6. To complete installation, follow the removal procedure in reverse order.

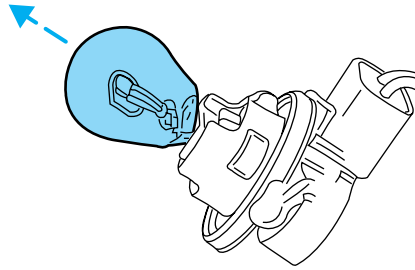

Replacing license plate lamp bulbs

1. Pry the license plate lamp assembly from the liftgate.
2. Remove bulb socket from lamp assembly by turning counterclockwise.
3. Pull the bulb out from the socket and push in the new bulb.
4. Install the bulb socket in lamp assembly turning it clockwise,
5. To install, press the lamp assembly in to liftgate.

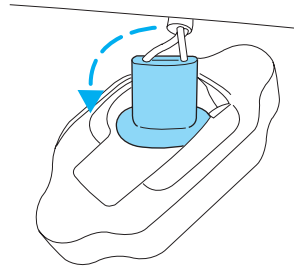

Lights

Replacing high-mount brake lamp bulbs

To remove the lamp assembly:

1. Remove the two screws and move the lamp assembly away from the liftgate.

2. Remove the bulb holder from the lamp assembly by depressing the snaps.

3. Pull the bulb straight out of the socket and push in the new bulb.

To complete installation, follow the removal procedure in reverse order.

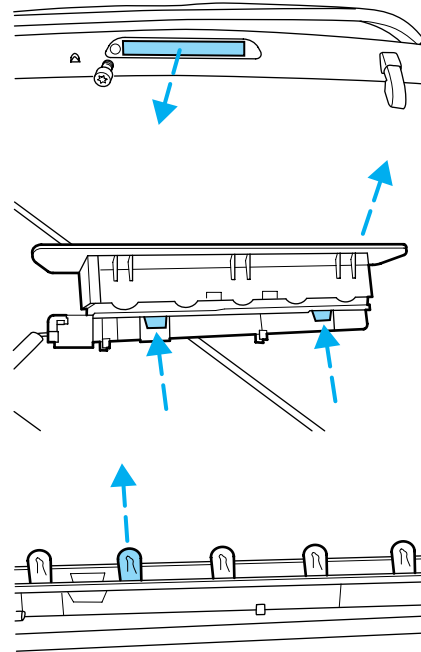

Replacing front parking lamp/turn signal bulbs

For bulb replacement, see a dealer or qualified technician.

Replacing foglamp bulbs

For bulb replacement, see a dealer or qualified technician.

Driver Controls

WINDSHIELD WIPER AND WASHER

For intermittent operation, move control down one position.

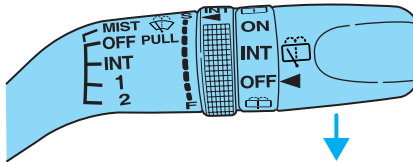

Adjust the rotary control to the desired speed setting.

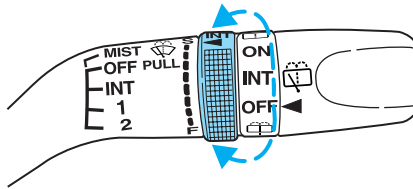

For normal or low speed wiper operation, move control down two positions from OFF.

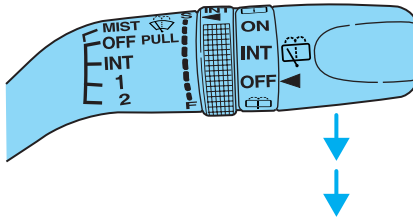

For high speed wiper operation, move control down three positions from OFF.

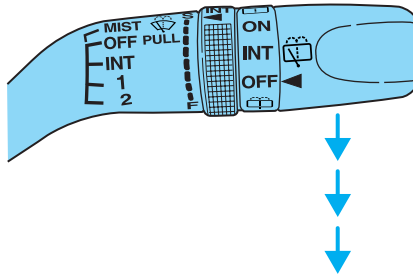

Driver Controls

To activate the windshield washer, pull control toward you. Release control to stop washer fluid spray.

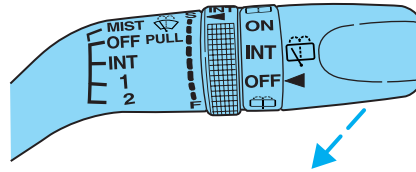

MIST FUNCTION

Move control up and release for one wipe.

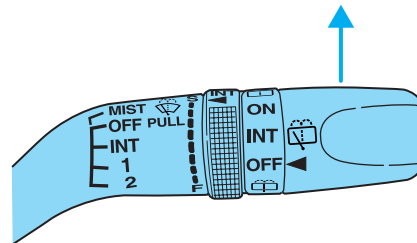

Checking the wiper blades

If the wiper blades do not wipe properly, clean both the windshield and wiper blades using undiluted windshield wiper solution or a mild detergent. Rinse thoroughly with clean water. To avoid damaging the blades, do not use fuel, kerosene, paint thinner or other solvents.

Windshield wiper blades

Check the wiper blades at least twice a year or when they seem less effective. Substances such as tree sap and some hot wax treatments used by commercial car washes reduce the effectiveness of wiper blades.

Driver Controls

Changing the wiper blades

To replace the wiper blades:

1. Pull the wiper arm away from the windshield and lock into the service position.
2. Turn the blade at an angle from the wiper arm. Push the lock pin manually to release the blade and pull the wiper blade down toward the windshield to remove it from the arm.
3. Attach the new wiper to the wiper arm and press it into place until a click is heard.

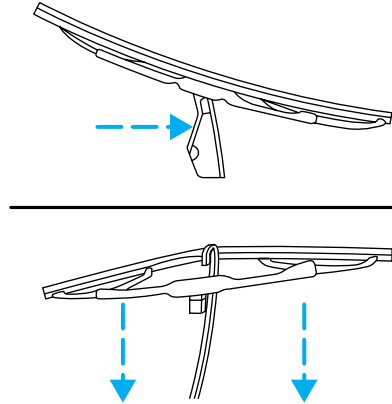

Rear window wiper/washer controls

For intermittent operation of rear wiper, rotate end of control upward to the INT position.

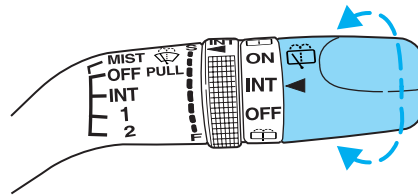

For normal speed rear wiper operation, rotate control upward to ON.

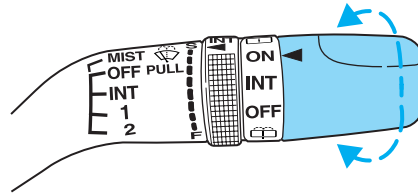

Driver Controls

To activate the rear washer, rotate the control to the  position and release.

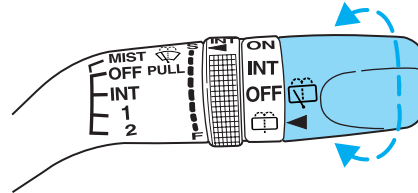

Rear window wiper blades

Refer to *Windshield wiper blades* in this section for more information on rear wiper blades.

MANUAL TILT STEERING COLUMN (IF EQUIPPED)

Push the tilt steering wheel lever downward to move the steering wheel up or down. Pull the control up into the original position to lock the steering wheel in position.

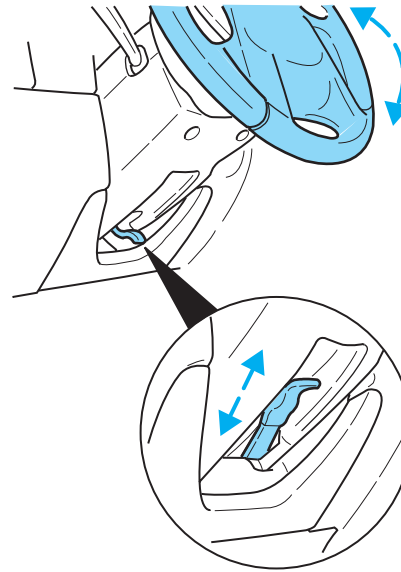

Never adjust the steering wheel when the vehicle is moving.

Driver Controls

OVERHEAD CONSOLE (IF EQUIPPED)

The appearance of your vehicle's overhead console will vary according to your option package.

Storage compartment (if equipped)

Press the OPEN control to open the storage compartment. The door will open slightly and can be moved to full open.

The storage compartment may be used to secure sunglasses or a similar object.

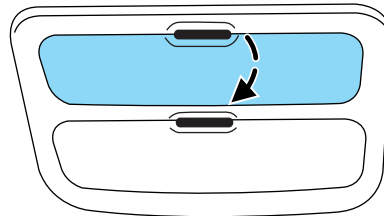

Installing a garage door opener (if equipped)

The storage compartment can be converted to accommodate a variety of aftermarket garage door openers:

- Remove the Velcro pad from the storage compartment door.
- Place Velcro on aftermarket transmitter opposite of actuator control.
- Install the transmitter on to storage compartment door aligning the actuator control with the rubber plunger.
- Close the door and press the storage compartment door to activate the transmitter.

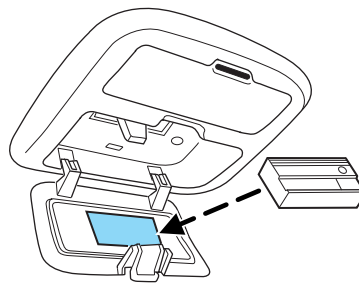

Driver Controls

AUXILIARY POWER POINT 12V

Power outlets are designed for accessory plugs only. Do not hang any type of accessory or accessory bracket from the plug. Improper use of the power outlet can cause damage not covered by your warranty.

The auxiliary power point is located on the instrument panel.

Do not plug optional electrical accessories into the cigarette lighter. Use the power point.

An additional auxiliary power point is located in the cargo area (if equipped).

Power outlets are designed for accessory plugs only. Do not hang any type of accessory or accessory bracket from the plug. Improper use of the power outlet can cause damage not covered by your warranty.

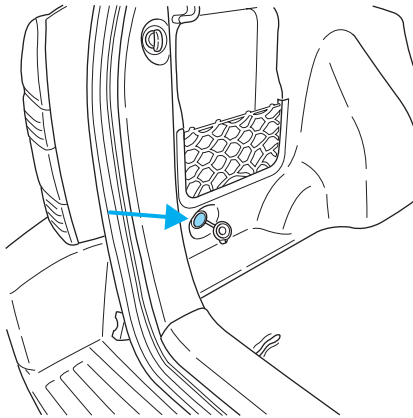
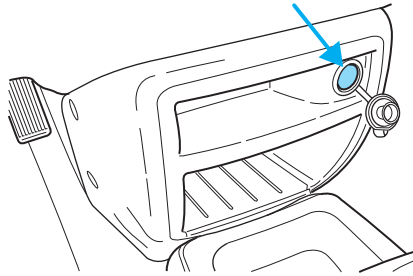

POWER WINDOWS (IF EQUIPPED)

Press and hold the rocker switches to open and close windows.

NOTE: The window switches will not illuminate when the window lock control is in the LOCKED position.

Driver Controls

- Press the top portion of the rocker switch to close.

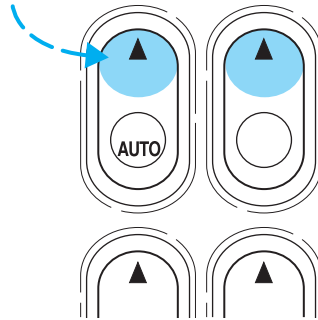

- Press the bottom portion of the rocker switch to open.

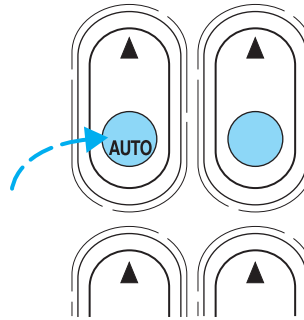

One touch down

- Press AUTO completely down to the second detent. The driver's window will open fully. Depress up to stop window operation.

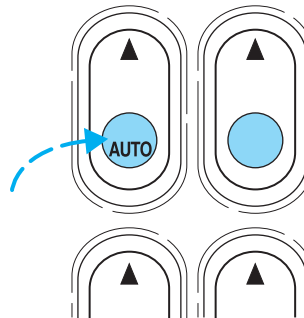

Driver Controls

Window lock (if equipped)

The window lock feature disables all the power windows except the drivers.

To lock out all the window controls except for the driver's press the right side of the control.

NOTE: The window switches will not illuminate when the window control is in the LOCKED position.

Press the left side to restore the window controls.

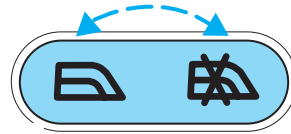

POWER SIDE VIEW MIRRORS (IF EQUIPPED)

The ignition must be in the ACC or ON position to adjust the power side view mirrors.

To adjust your mirrors:

1. Rotate the control clockwise to adjust the right mirror and rotate the control counterclockwise to adjust the left mirror.

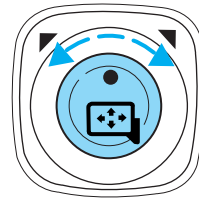

2. Move the control in the direction you wish to tilt the mirror.

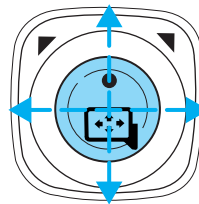

3. Return to the center position to lock mirrors in place.

Driver Controls

Fold-away mirrors

Pull the side mirrors in carefully when driving through a narrow space, like an automatic car wash.

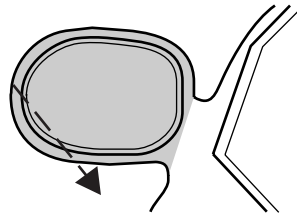

SPEED CONTROL (IF EQUIPPED)

To turn speed control on

- Press ON.

Vehicle speed cannot be controlled until the vehicle is traveling at or above 48 km/h (30 mph).

Do not shift the gearshift lever into N (Neutral) with the speed control on.

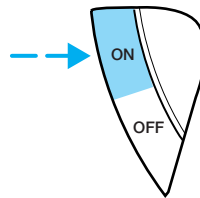

Do not use the speed control in heavy traffic or on roads that are winding, slippery, or unpaved.

To turn speed control off

- Press OFF or
- Turn off the vehicle ignition.

Once speed control is switched off, the previously programmed set speed will be erased.

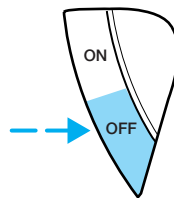

Driver Controls

To set a speed

- Press SET ACC. For speed control to operate, the speed control must be ON and the vehicle speed must be greater than 48 km/h (30 mph).

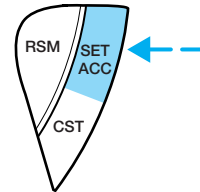

If you drive up or down a steep hill, your vehicle speed may vary momentarily slower or faster than the set speed. This is normal.

Speed control cannot reduce the vehicle speed if it increases above the set speed on a downhill. If your vehicle speed is faster than the set speed while driving on a downhill, you may want to shift to the next lower gear or apply the brakes to reduce your vehicle speed.

If your vehicle slows down more than 16 km/h (10 mph) below your set speed on an uphill, your speed control will disengage. This is normal. Pressing RSM will re-engage it.



Do not use the speed control in heavy traffic or on roads that are winding, slippery, or unpaved.

To set a higher set speed

- Press and hold SET ACC. Release the control when the desired vehicle speed is reached or
- Press and release SET ACC to operate the Tap-Up function. Each press will increase the set speed by 1.6 km/h (1 mph) or
- Accelerate with your accelerator pedal. When the desired vehicle speed is reached, press and release SET ACC.

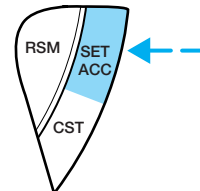

You can accelerate with the accelerator pedal at any time during speed control usage. Releasing the accelerator pedal will return your vehicle to the previously programmed set speed.

Driver Controls

To set a lower set speed

- Press and hold CST. Release the control when the desired speed is reached or
- Press and release CST to operate the Tap-Down function. Each press will decrease the set speed by 1.6 km/h (1 mph) or
- Depress the brake pedal. When the desired vehicle speed is reached, press SET ACC.

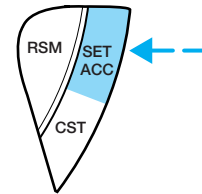
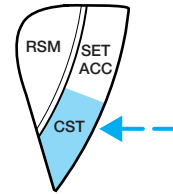

To disengage speed control

- Depress the brake pedal or

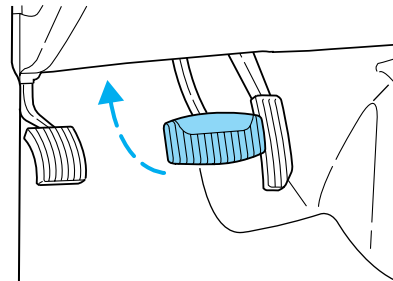

- Depress the clutch pedal (if equipped).

Disengaging the speed control will not erase the previously programmed set speed.

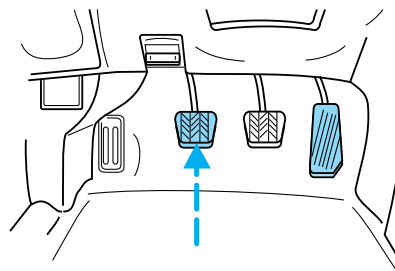

Driver Controls

Pressing OFF will erase the previously programmed set speed.

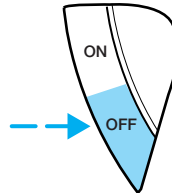

To return to a previously set speed

- Press RSM. For RSM to operate, the vehicle speed must be faster than 48 km/h (30 mph).

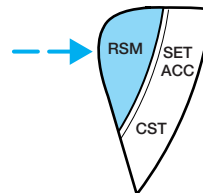

CENTER CONSOLE

Your vehicle may be equipped with a variety of console features. These include:

- Utility compartment
- Cupholders
- Ashcup



Use only soft cups in the cupholder. Hard objects can injure you in a collision.

MOON ROOF (IF EQUIPPED)

To operate the moon roof:

- The moon roof is equipped with an automatic, one-touch, express opening feature. Press and release the rear portion of the control. To stop motion at any time during the one-touch opening, press the control a second time.
- To close, press and hold the front portion of the control.

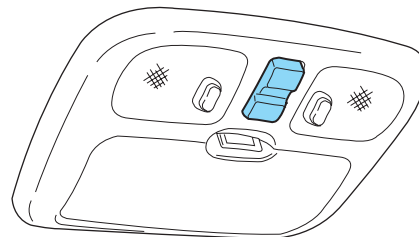

Driver Controls

To operate the moon roof vent position:

- To open, press and hold the front portion of the control. This will open the vent.
- To close, press and hold the rear portion of the control.

If the battery is disconnected, discharged, or a new battery is installed, the moon roof needs to be opened to the vent position to reset the moon roof positions.

If you open and close the moon roof repeatedly, the moon roof motor may overheat and shut down for 45 seconds while the motor cools.



Do not let children play with the moon roof. They may seriously injure themselves.

LIFTGATE

To open the rear window, pull the right side of the liftgate handle.

To open the liftgate, pull the left side of the liftgate handle.

- Do not open the liftgate or liftgate glass in a garage or other enclosed area with a low ceiling. If the liftgate glass is raised and the liftgate is also opened, both liftgate and glass could be damaged against a low ceiling.
- Do not leave the liftgate or liftgate glass open while driving. Doing so could cause serious damage to the liftgate and its components as well as allowing carbon monoxide to enter the vehicle.

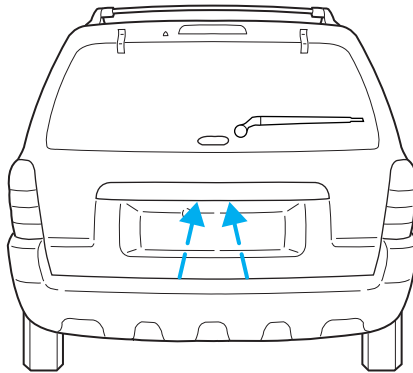

Make sure that the liftgate door and/or window are closed to prevent exhaust fumes from being drawn into the vehicle. This will also prevent passengers and cargo from falling out. If you must drive with the liftgate door or window open, keep the vents open so outside air comes into the vehicle.

Driver Controls

CARGO AREA FEATURES

Cargo cover (if equipped)

Your vehicle may be equipped with a cargo area shade that covers the luggage compartment of your vehicle.

To install the shade:

1. Fasten the cover into the mounting brackets (make sure the cover is right side up).
2. Pull the end of the shade toward you and hook the sides into the notches (right side first) in the rear trim panels.

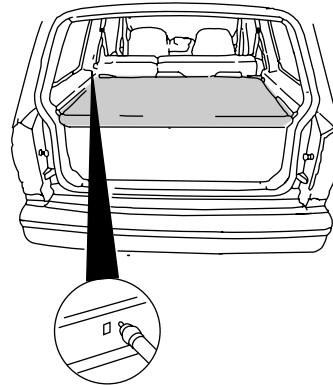

 To reduce the risk of injuries, the fasteners for cargo area cover must be properly attached to the mounting clips on the rear trim panels.

 Do not place any objects on the cargo area cover. They may obstruct your vision or strike occupants of the vehicle in the case of a sudden stop or collision.

 The cover may cause injury in a sudden stop or accident if it is not securely installed.

Cargo table (if equipped)

Your vehicle may be equipped with a cargo table that is located behind the rear seat of your vehicle which can be used to store and compartmentalize cargo and be used as a picnic table.

Driver Controls

To remove the cargo table:

1. Push the button in the center of the table to unlock it. Lift up either side of the table to disengage from the trim panels.
2. Fold the table in half and remove it from the cargo area.

To install the cargo table:

1. Set the table in the cargo area like a bi-fold table.
2. Insert both feet from one side of the table into the holes in the trim panel then repeat on the other side.
3. Check and make sure that all four feet are properly seated into the holes of the trim panel and the hinge is locked.

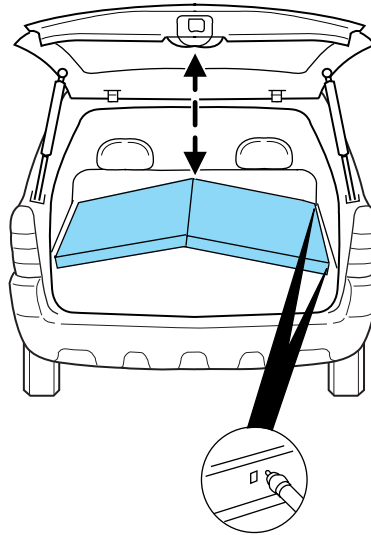

To use the cargo table:

- To store items under the table in the cargo area, unhook and lift the panels in the table.
- To use as a picnic table, remove the table from the cargo area, unfold it and extend the legs.

 To reduce the risk of injuries, all four feet must be properly seated in the notches on the rear trim panels and the hinge must be locked.

 Do not place any objects on the cargo table. They may obstruct your vision or strike occupants of the vehicle in the case of a sudden stop or collision.

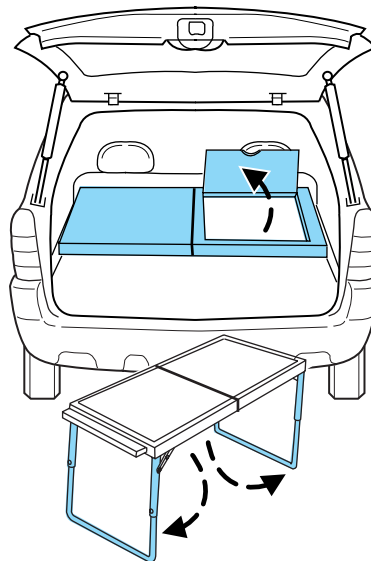

Driver Controls

LUGGAGE RACK

Your vehicle is equipped with a roof rack. The maximum load for the roof rack is 44 kg (100 lbs), evenly distributed on the crossbars. If it is not possible to evenly distribute the load, position it in the center or as far forward on the crossbars as possible. Always use the adjustable tie down loops to secure the load.

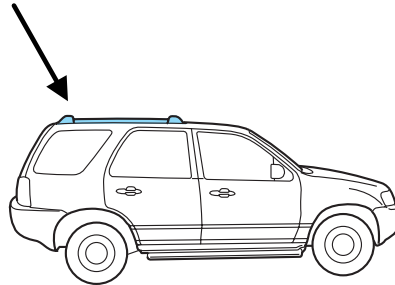

To adjust the cross-bar position:

1. Loosen the thumbwheel at both ends of the cross-bar (both cross-bars are adjustable).
2. Slide the cross-bar to the desired location.
3. Tighten the thumbwheel at both ends of the cross-bar.

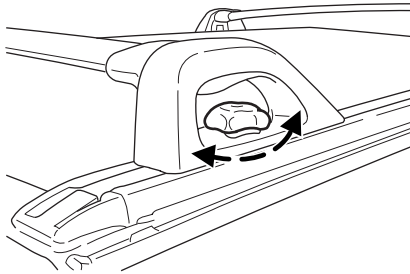

Driver Controls

To remove the cross-bar assembly from the roof rack side rails:

1. Loosen the thumbwheel at both ends of the cross-bar (both cross-bars are adjustable).

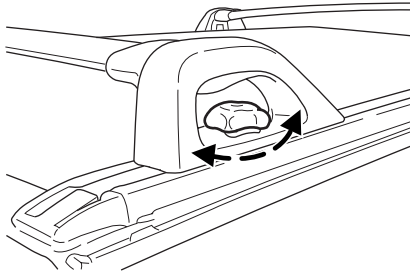

2. Slide the cross-bar to the end of the rail.

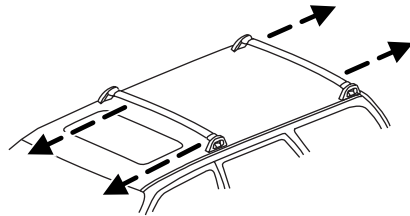

3. Use a long, flat object in order to depress the tongue in the endcaps on both sides of the cross-bar.

4. Slide the cross-bar assembly and the tie down loop off the end of the rail.

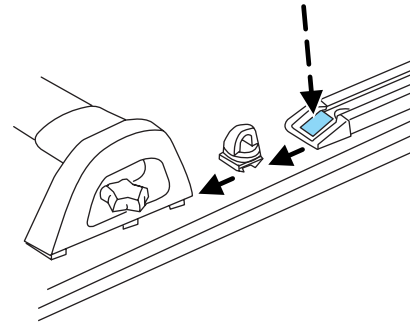

Driver Controls

To reinstall the cross-bar assembly to the roof rack side rails:

1. Ensure that both cross-bar assemblies are installed with the F (front) arrow facing towards the front of the vehicle.

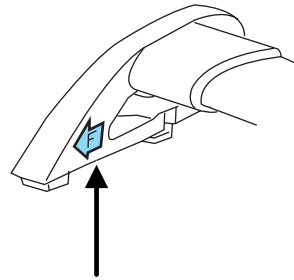

2. Use a long, flat object to depress the tongue in the endcaps on both sides of the cross-bar.

3. Slide the tie down loops and the cross-bar assemblies over the end cap tongue and into the side rails.

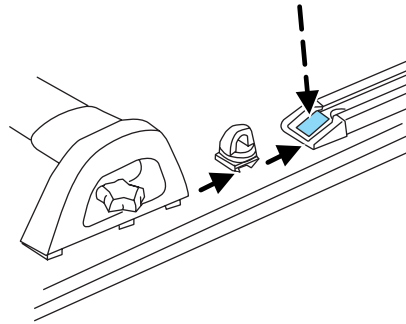

4. Tighten thumbwheel at both ends of the cross-bar.

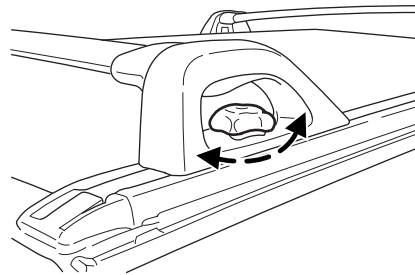

Driver Controls

No boundaries rack system (if equipped)

Your vehicle may be equipped with an optional roof rack. This unique feature allows you to carry cargo on an inner roof rack as well as on the conventional roof rack. The maximum load for the conventional roof rack is 45 kg (100 lbs). The inner rack can also hold 45 kg (100 lbs) if in the down and locked position. Distribute the loads as evenly as possible on both the roof and inner rack, when extended or stowed. Always secure the loads by using the tie down loops.

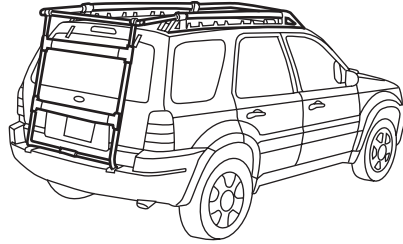

To extend the rack:

1. Press in the release control on the cross-bar and twist the handle.

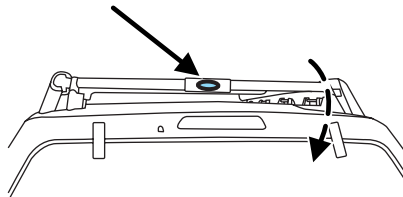

2. Lift the bar straight up (about two inches).

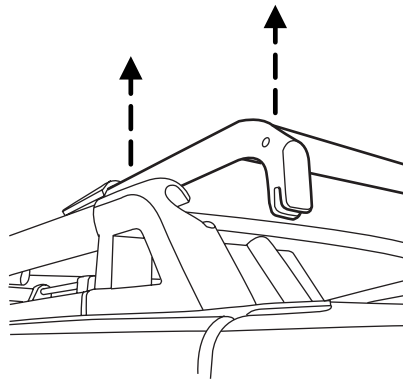

Driver Controls

3. Pull the inner rack toward you (1) until it is completely extended and stops, pivoting at the hinges (2).

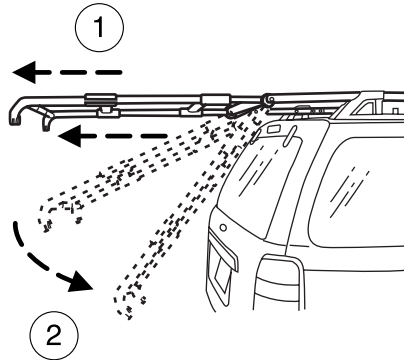

4. Lower the inner rack.

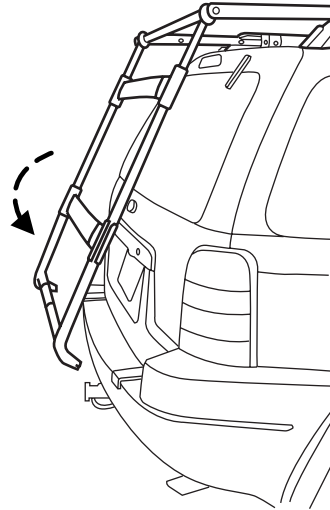

Driver Controls

5. Insert the feet into the receivers on the bumper.

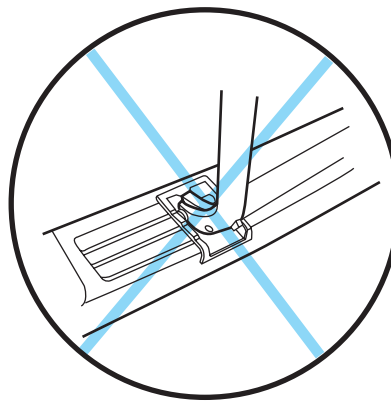
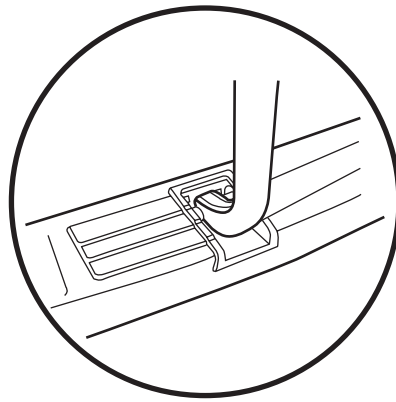
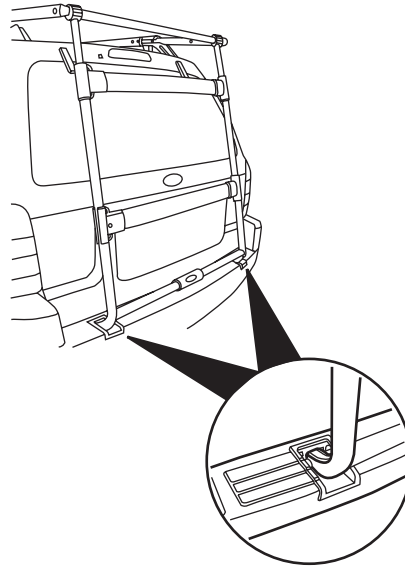

6. **Ensure that the rack clicks into place and is secure before attempting to load cargo.**

Driver Controls

 Do not drive the vehicle if the inner roof rack is extended and loaded with cargo but is not secured into the receivers. This can cause dangerous driving conditions.

 Do not attempt to move the inner rack when loaded. This can cause personal injury and damage to your vehicle that may not be covered by warranty.

 Do not use the inner rack as a ladder. This could result in personal injury and damage to your roof rack.

To stow the inner rack:

1. Push the release control on the bottom bar of the inner rack.
2. Twist the handle down.

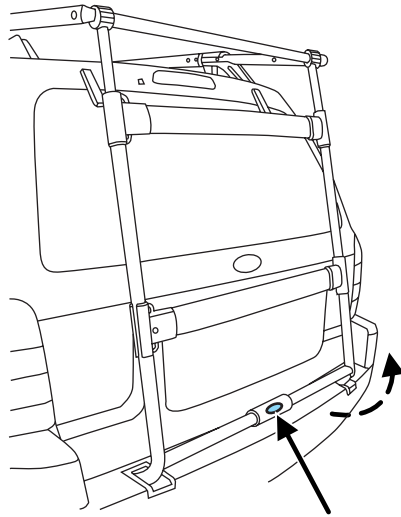

Driver Controls

3. Lift the inner rack (pivoting at the hinges).

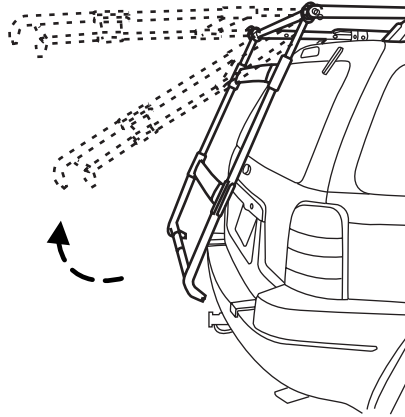

4. Continue lifting the inner rack until it is parallel with the roof (1).

5. Slide the rack forward onto the roof (2).

6. Lift the feet over the side rails and lock them into place.

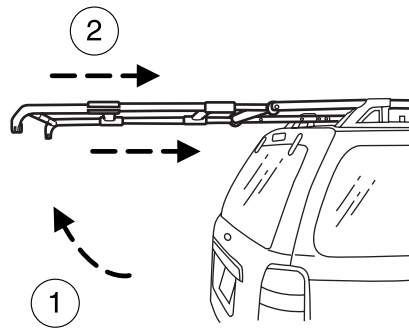

Driver Controls

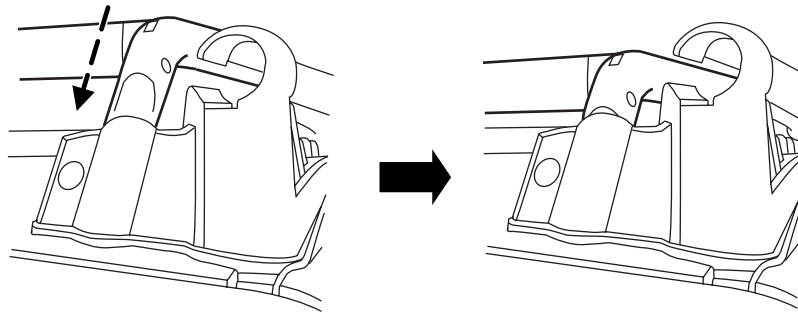

7. Ensure both feet are locked and secured into place.

 Do not attempt to stow the inner rack on the roof when cargo is loaded on the roof rack. The extended rack will not lock into place and could force cargo loose creating dangerous driving situations.

To adjust the cross-bar assembly on the inner rack:

1. Loosen the screws on the cross-bar with the supplied Torx driver.
2. Move the cross-bar to the desired location, keeping the cross-bar parallel with the upper bar.
3. Tighten the screws with the supplied Torx driver.
4. Ensure that the cross-bar is tightened and secured into place before attempting to load cargo.

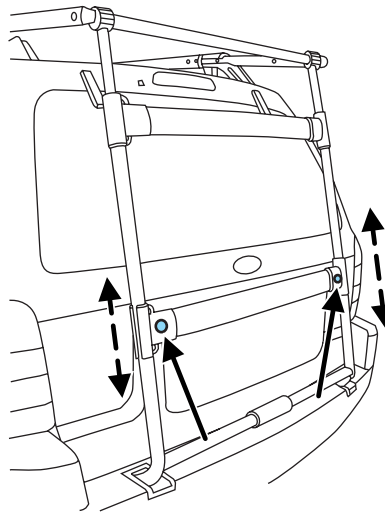

Driver Controls

Loading cargo:

Only load cargo in the approved area (1) shown above. Do not load cargo outside of the designated area (2). Distribute the load as evenly as possible. Always use tie downs to secure the load.

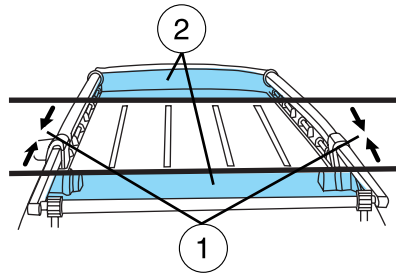

Always stow the inner rack on the roof when using an automated car wash.

Do not attempt to open the liftgate or rear window when the rack is in the down position. This may damage the rack of your vehicle.



Do not load large or bulky items (i.e., plywood, mattresses) on the rear of the vehicle so that they extend above the roof line. In addition to blocking your rear view, they can also cause dangerous driving situations and possibly cause damage to your vehicle. Use additional care when driving with reduced visibility.



Only load cargo in the designated area. Loading outside of the approved area could result in personal injury as well as vehicle damage that may not be covered by warranty.

Locks and Security

KEYS

The key operates all locks on your vehicle. In case of loss, replacement keys are available from your dealer.

You should always carry a second key with you in a safe place in case you require it in an emergency.

Refer to *SecuriLock™ Passive Anti-Theft System* for more information.

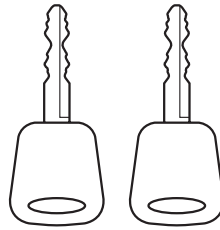

POWER DOOR LOCKS (IF EQUIPPED)

Press control to unlock all doors.

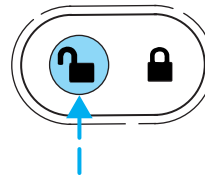

Press control to lock all doors.

NOTE: The power door switches will not illuminate when the window lock switch is in the LOCKED position.

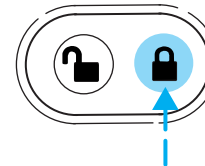

Two step unlocking (if equipped)

To unlock the driver door, turn the key in the door cylinder once toward the front of the vehicle. The turn signals will flash twice and the dome lamp (set in time delay) will illuminate. Turn the key a second time within three seconds of the first turn to unlock all passenger doors, liftgate and liftgate glass.

To lock all doors, liftgate and liftgate glass, turn the key toward the back of the vehicle once. The turn signals will flash once confirming all are closed and locked. If any door, liftgate or liftgate glass is open, the turn signals will not flash.

Locks and Security

Childproof door locks

When these locks are set, the rear doors cannot be opened from the inside. The rear doors can be opened from the outside when the doors are unlocked.

The childproof locks are located on rear edge of each rear door and must be set separately for each door. Setting the lock for one door will not automatically set the lock for both doors.

Rotate lock control in the direction of arrow to engage the lock. Rotate control in the opposite direction to disengage childproof locks.

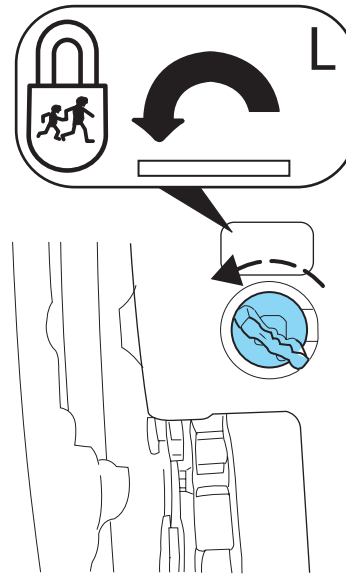

REMOTE ENTRY SYSTEM (IF EQUIPPED)

This device complies with part 15 of the FCC rules and with RS-210 of Industry Canada. Operation is subject to the following two conditions: (1) This device may not cause harmful interference, and (2) This device must accept any interference received, including interference that may cause undesired operation.

Changes or modifications not expressly approved by the party responsible for compliance could void the user's authority to operate the equipment.

The remote entry system allows you to lock or unlock all vehicle doors without a key.

The remote entry features only operate with the ignition in the LOCK position.

If there is any potential remote keyless entry problem with your vehicle, ensure **ALL key fobs** (remote entry transmitters) are brought to the dealership, to aid in troubleshooting.

Locks and Security

Unlocking the doors

Press this control to unlock the driver's door. The interior lamps will illuminate. The flashers will flash twice to confirm the vehicle is unlocked.

Press the control a second time within three seconds to unlock all doors.

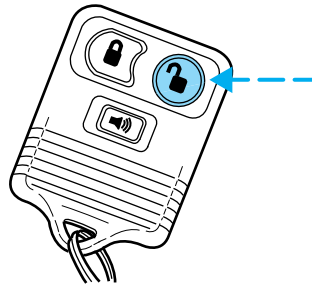

Locking the doors

Press this control to lock all doors. If all doors are closed, the flashers will flash once and the perimeter alarm (if equipped) will be armed.

If the control is pressed a second time within three seconds the doors will lock again and the horn will chirp.

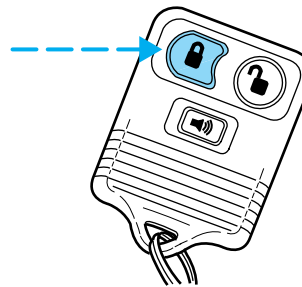

Sounding a panic alarm

Press this control to activate the alarm.

To deactivate the alarm, press the control again.

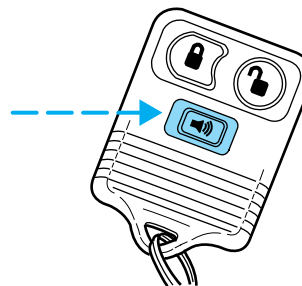

Locks and Security

Replacing the battery

The transmitter is powered by one coin type three-volt lithium battery CR2032 or equivalent. Typical operating range will allow you to be up to 10 meters (33 feet) away from your vehicle. A decrease in operating range can be caused by:

- weather conditions
- nearby radio towers
- structures around the vehicle
- other vehicles parked next to the vehicle

To replace the battery:

1. Twist a thin coin between the two halves of the transmitter near the key ring. **DO NOT TAKE THE FRONT PART OF THE TRANSMITTER APART.**
2. Place the positive (+) side of new battery in the same orientation. Refer to the diagram inside the transmitter unit.
3. Snap the two halves back together.

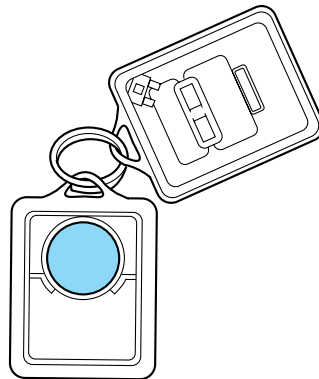

Replacing lost transmitters

If a remote transmitter has been lost and you would like to remove it from the vehicle's memory, or you would like to purchase additional remote transmitters and have them programmed to your vehicle:

- Take **all** your vehicle's transmitters to your dealer for programming, or
- Perform the programming procedure yourself

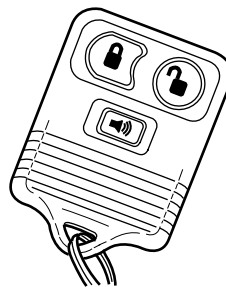

Locks and Security

Programming remote transmitters

It is necessary to have **all** (maximum of four — original and/or new) of your remote transmitters available prior to beginning this procedure.

To program the transmitters yourself:

- Insert a key in the ignition and turn from 1 (LOCK) to 3 (RUN) eight times in rapid succession (within 10 seconds) with the eighth turn ending in the 3 (RUN) position. The doors will lock/unlock to confirm that programming mode has been entered.
- Within 20 seconds, program a remote transmitter by pressing any button on a transmitter. The doors will lock/unlock to confirm that the remote transmitter has been programmed. (If more than 20 seconds pass before pressing a remote transmitter button, the programming mode will exit and the procedure will have to be repeated.)
- Repeat the previous step to program additional remote transmitters. The doors will lock/unlock to confirm that each remote transmitter has been programmed.
- When you have completed programming the remote transmitters, turn the ignition to 1 (LOCK) or wait 20 seconds. Again the doors will lock/unlock to confirm programming has been completed.

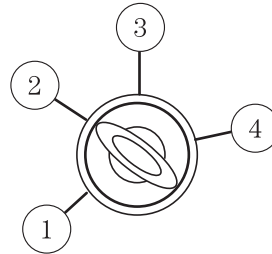

Illuminated entry

The interior lamps illuminate when the remote entry system is used to unlock the door(s).

The system automatically turns off after 30 seconds or when the ignition is turned to the RUN position. The dome lamp control (if equipped) must **not** be set to the OFF position for the illuminated entry system to operate.

The inside lights will not turn off if:

- they have been turned on in the dome lamp control or
- any door is open

Locks and Security

The battery saver will shut off the interior lamps 40 minutes after the ignition has been turned to the OFF position.

SECURILOCK™ PASSIVE ANTI-THEFT SYSTEM

SecuriLock™ passive anti-theft system is an engine immobilization system. This system prevents the engine from being started unless a **coded key programmed to your vehicle** is used.

The SecuriLock™ passive anti-theft system is not compatible with non-Ford aftermarket remote start systems. Use of these systems may result in vehicle starting problems and a loss of security protection.

Automatic arming

The vehicle is armed approximately 15 seconds after switching the ignition to the 2 (ACC) position. The **THEFT** light in the instrument cluster will flash every two seconds when the vehicle is armed.

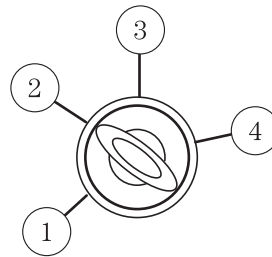

Automatic disarming

Switching the ignition to the 4 (ON) position with a **coded key** disarms the vehicle. The **THEFT** light will illuminate for three seconds and then go out. If the **THEFT** light stays on for an extended period of time or flashes rapidly, have the system serviced by your dealership or a qualified technician.

Key information

Your vehicle is supplied with **two coded keys**. Only a **coded key** will start your vehicle. Spare coded keys can be purchased from your dealership. Your dealership can program your key or you can “do it yourself”, refer to *Programming spare keys*.

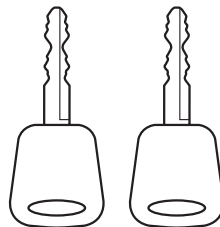

Locks and Security

Large metallic objects, electronic devices on the key chain that can be used to purchase gasoline or similar items, or a second key on the same key ring as the **coded key** may cause vehicle starting issues. If present, you need to keep these objects from touching the **coded key** while starting the engine. These objects and devices cannot damage the **coded key**, but can cause a momentary NO—START condition if they are too close to the key during engine start. If a problem occurs, turn ignition OFF and restart the engine with all other objects on the key ring held away from the ignition key. Check to make sure the **coded key** is an approved Ford **coded key**.

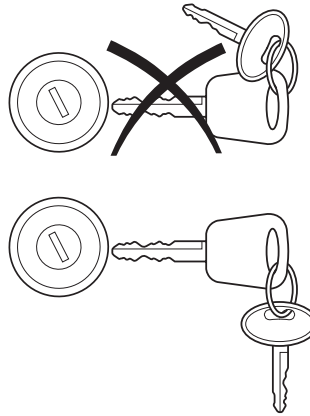

If your keys are lost or stolen you will need to do the following:

- Use your spare key to start the vehicle, or
- Have your vehicle towed to a dealership or a locksmith. The key codes will need to be erased from your vehicle and new key codes will need to be re-coded.

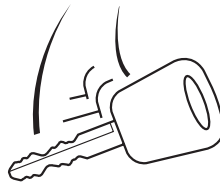

Replacing coded keys can be very costly and you may want to store an extra programmed key away from the vehicle in a safe place to prevent an unforeseen inconvenience.

The correct **coded key** must be used for your vehicle. The use of the wrong type of **coded key** may lead to a “NO-START” condition.

If an unprogrammed key is used in the ignition it will cause a “NO START” condition.

Locks and Security

Programming spare keys

A maximum of eight keys can be coded to your vehicle. Only SecuriLock[™] keys can be used. To program a **coded key** yourself, you will need two previously programmed **coded keys** (keys that already operate your vehicle's engine) and the new unprogrammed key(s) readily accessible for timely implementation of each step in the procedure.

If two previously programmed coded keys are not available, you must bring your vehicle to your dealership to have the spare coded key(s) programmed.

Please read and understand the entire procedure before you begin.

1. Insert the first previously programmed **coded key** into the ignition and turn the ignition from 2 (ACC) to 3 (RUN) (maintain ignition in 3 (RUN) for at least one second).

2. Turn ignition to 1 (LOCK) and remove the first **coded key** from the ignition.

3. Within ten seconds of turning the ignition to 2 (ACC), insert the second previously programmed **coded key** into the ignition and turn the ignition from 2 (ACC) to 3 (RUN) (maintain ignition in 3 (RUN) for at least one second but no more than ten seconds).

4. Turn the ignition to 1 (LOCK) and remove the second **coded key** from the ignition.

5. Within 20 seconds of turning the ignition to 2 (ACC), insert the new unprogrammed key (new key/valet key) into the ignition and turn the ignition from 2 (ACC) to 3 (RUN) (maintain ignition in 3 (RUN) for at least one second). This step will program your new key to a coded key.

6. To program additional new unprogrammed key(s), repeat this procedure from step 1.

If successful, the new coded key(s) will start the vehicle's engine and the theft indicator will illuminate for three seconds and then go out.

If not successful, the new coded key(s) will not start the vehicle's engine and the theft indicator will flash on and off and you may repeat steps 1 through 6. If failure repeats, bring your vehicle to your dealership to have the new spare key(s) programmed.

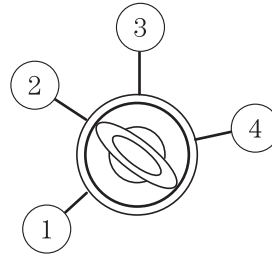

Locks and Security

PERIMETER ALARM SYSTEM (IF EQUIPPED)

The perimeter anti-theft system will help prevent your vehicle from unauthorized entry.

If there is any potential perimeter anti-theft problem with your vehicle, ensure **ALL key fobs** (remote entry transmitters) are brought to the dealership, to aid in troubleshooting.

Arming the system

When armed, this system will help protect your vehicle from unauthorized entry. When unauthorized entry occurs, the system will flash the headlamps, parking lamps and will sound the horn.

The system is ready to arm whenever the key is removed from the ignition. Either of the following actions will prearm the alarm system:

- Press the remote entry lock control.
- Lock the doors using the key.

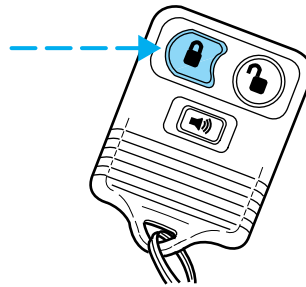

If a door is open, the system is not armed. The system will become prearmed when all doors are closed. When the system becomes prearmed the flashers will flash to confirm the prearming.

Once the system is prearmed, the system will arm in 20 seconds. If any door is opened during these 20 seconds, the arming will be canceled.

Locks and Security

Disarming the system

You can disarm the system by any of the following actions:

- Unlock the doors by using your remote entry transmitter.
- Unlock the doors with a key.
- Press the panic control on the remote entry transmitter. This will disarm the system only if the alarm is sounding.

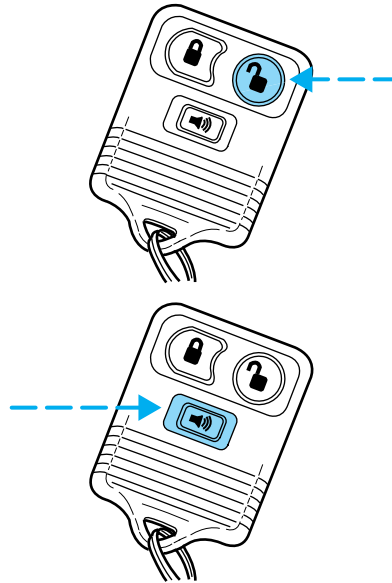

Seating and Safety Restraints

SEATING

Adjusting the front manual seat



Never adjust the driver's seat or seatback when the vehicle is moving.



Do not pile cargo higher than the seatbacks to reduce the risk of injuring people in a collision or sudden stop.



Always drive and ride with your seatback upright and the lap belt snug and low across the hips.



Reclining the seatback can reduce the effectiveness of the seat's safety belt in the event of a collision.

Lift handle to move seat forward or backward.

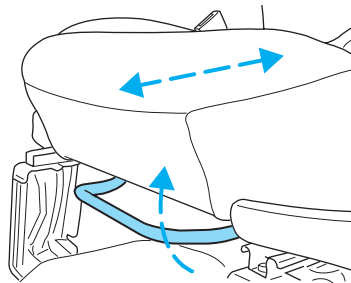

Seating and Safety Restraints

Pull lever up to adjust seatback.

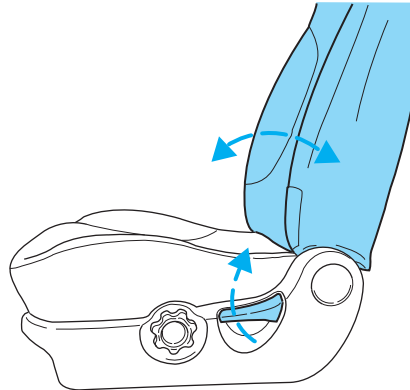

Adjusting the front power seat (if equipped)



Never adjust the driver's seat or seatback when the vehicle is moving.



Do not pile cargo higher than the seatbacks to avoid injuring people in a collision or sudden stop.



Always drive and ride with your seatback upright and the lap belt snug and low across the hips.



Reclining the seatback can reduce the effectiveness of the seat's safety belt in the event of a collision.

Seating and Safety Restraints

The control is located on the outboard side of the seat cushion.

Press to raise or lower the front portion of the seat cushion.

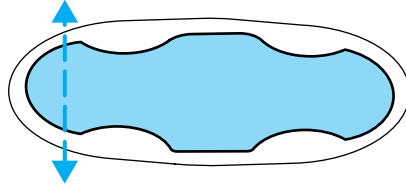

Press to raise or lower the rear portion of the seat cushion.

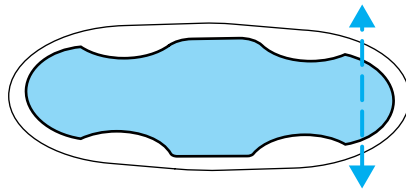

Press the control to move the seat forward, backward, up or down.

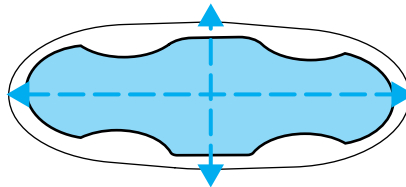

Using the manual lumbar support (if equipped)

The lumbar support control is located on the inboard side of the driver's seat.

Turn the lumbar support control clockwise to increase firmness.

Turn the lumbar support control counterclockwise to increase softness.

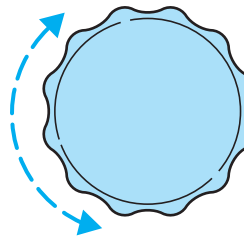

Seating and Safety Restraints

Rear seats

Head restraints

Your vehicle's seats may be equipped with head restraints which are vertically adjustable. The purpose of these head restraints is to help limit head motion in the event of a rear collision. To properly adjust your head restraints, lift the head restraint so that it is located directly behind your head or as close to that position as possible. Refer to the following to raise and lower the head restraints.

The head restraints can be moved up and down.

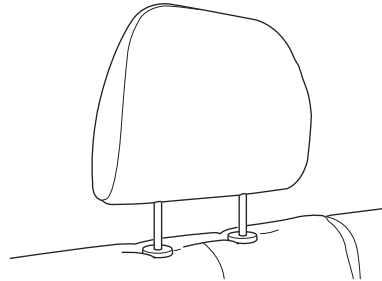

Push control to lower head restraint.

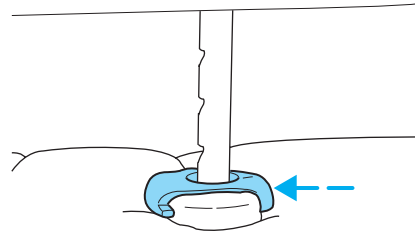

Folding down rear seats

1. Raise the rear seat head restraint and remove.

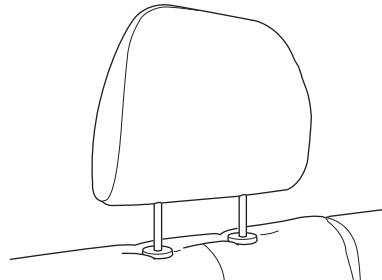

Seating and Safety Restraints

2. Place the head restraint under the front seat for storage.

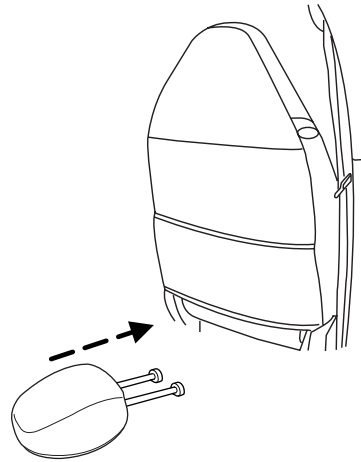

3. Pull the seat release control.

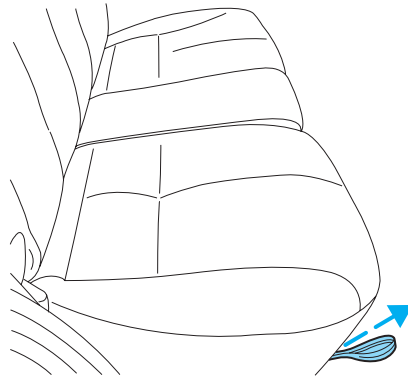

NOTE: Make sure the floor is clear of all objects before folding the seat.

Seating and Safety Restraints

4. Flip seat forward.

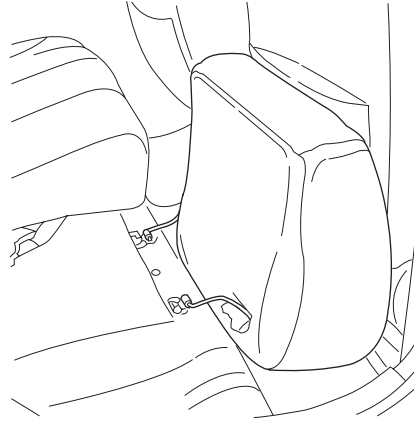

5. Pull the seatback release strap toward the front seat. Make sure the seat belt buckle heads are fully extended towards the front of the vehicle and are away from the seatback.

NOTE: When the seatback release strap is pulled use your other hand to guide the seatback.

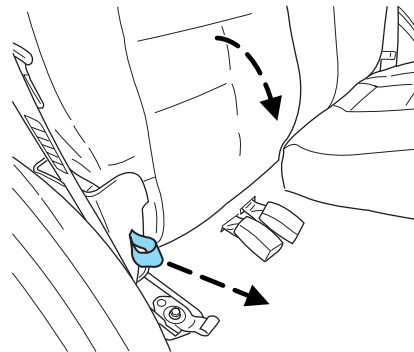

Seating and Safety Restraints

6. Rotate seatback down into load floor position.

 Make sure seat belt buckle heads are not trapped underneath the seatback and that the seat belt buckle heads are fully extended towards the front of the vehicle. Seat belt buckle heads may break if they are trapped underneath the seatback as the seatback is rotated down.

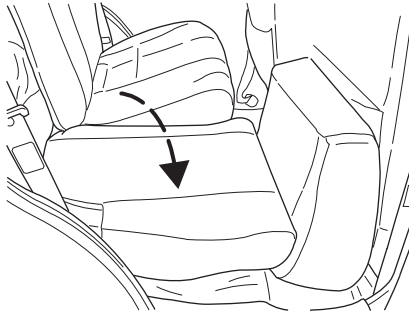

Returning the rear seats to upright position

1. Pull seatback up and into upright position making sure seatback locks into place. While holding the seatback, pull the release and push seatback backward into the desired position.

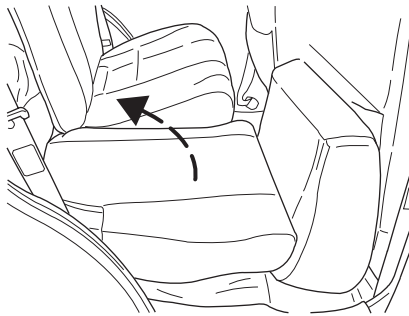

Seating and Safety Restraints

2. Rotate seat cushion down into the seating position making sure that the seat cushion is locked into place and that the seat belt buckles are exposed.

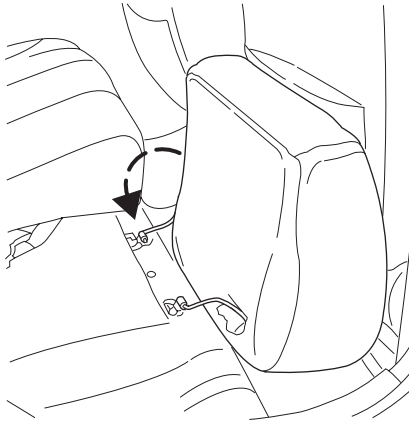

3. Remove the head restraint stored under the front seat and return it to the original position on the seat back.

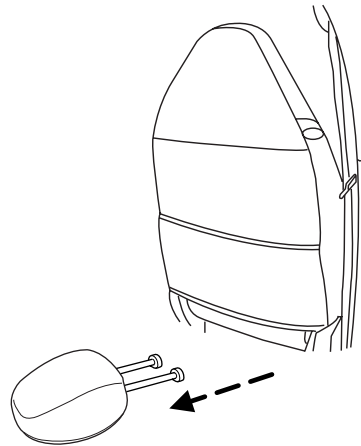

Seating and Safety Restraints

To remove the rear cushion

1. Pull the Yellow tab
2. Pull the cushion to the outboard side of the vehicle.

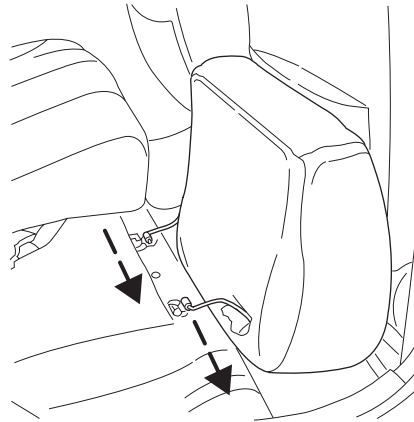

To install the rear cushion

1. Push the cushion to the inboard side of the vehicle.
2. Make sure that the hinges are locked into place.

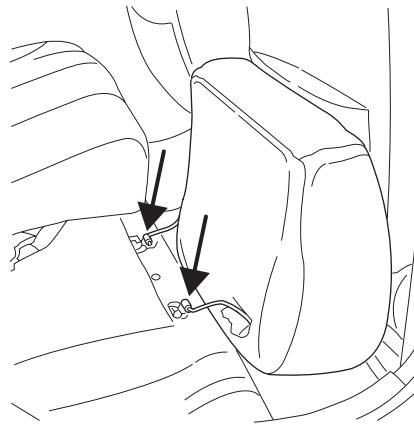

Seating and Safety Restraints

Folding down rear bench seats (if equipped)

1. Raise the rear seat head restraint and remove.

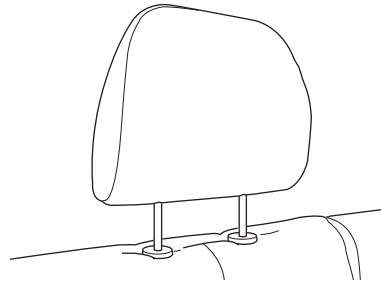

2. Place the head restraint under the front seat for storage.

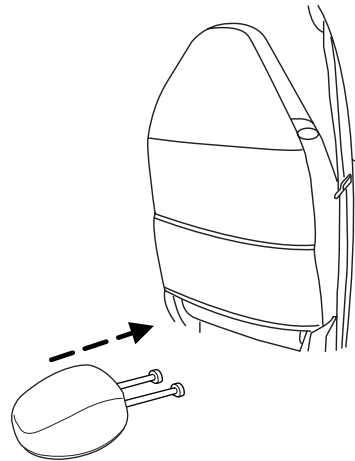

3. Pull the seat release control on each side of the seat to release the locks.

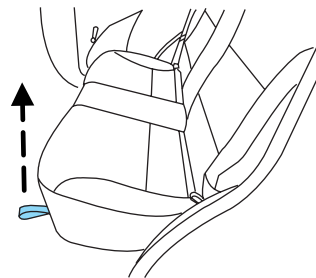

Seating and Safety Restraints

4. Flip the seat forward.

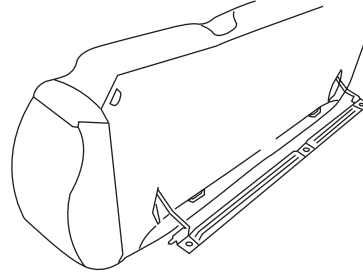

5. Pull the seatback release strap toward the front seat. Make sure the seat belt buckle heads are fully extended towards the front of the vehicle and are away from the seatback.

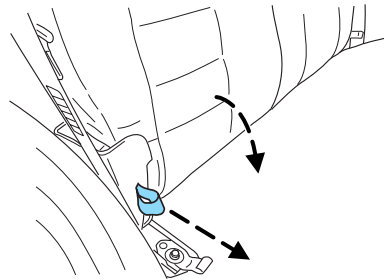

6. Rotate seatback down into load floor position.

NOTE:When the seatback release strap is pulled use your other hand to guide the seatback.

Returning the rear seats to upright position

1. Pull seatback up and into upright position making sure seatback locks into place. While holding the seatback, pull the release and push seatback backward into the desired position.

2. Rotate seat cushion down into the seating position making sure that the seat cushion is locked into place and that the seat belt buckles are exposed.

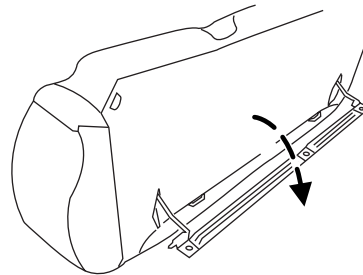

Seating and Safety Restraints

3. Remove the head restraint stored under the front seat and return it to the original position on the seat back.

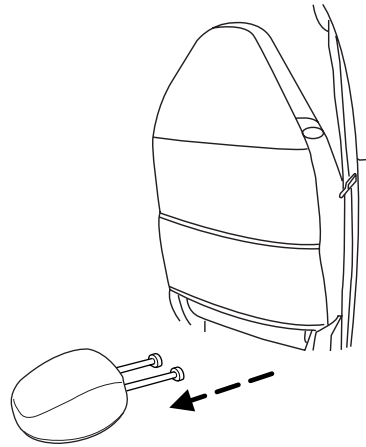

To remove the rear cushion

1. Pull the Yellow tab.
2. Pull the cushion so that the rods remove from the locking tabs.

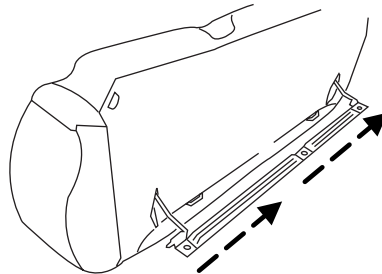

To install the rear cushion

1. Push the cushion so that the rods fit into the locking tabs.
2. Make sure that the hinges are locked into place.

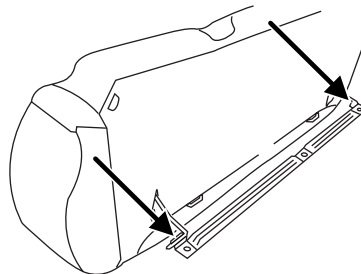

Seating and Safety Restraints

SAFETY RESTRAINTS

Safety restraints precautions



Always drive and ride with your seatback upright and the lap belt snug and low across the hips.



To reduce the risk of injury, make sure children sit where they can be properly restrained.



Never let a passenger hold a child on his or her lap while the vehicle is moving. The passenger cannot protect the child from injury in a collision.



All occupants of the vehicle, including the driver, should always properly wear their safety belts, even when an air bag (SRS) is provided.



It is extremely dangerous to ride in a cargo area, inside or outside of a vehicle. In a collision, people riding in these areas are more likely to be seriously injured or killed. Do not allow people to ride in any area of your vehicle that is not equipped with seats and safety belts. Be sure everyone in your vehicle is in a seat and using a safety belt properly.



In a rollover crash, an unbelted person is significantly more likely to die than a person wearing a safety belt.



Each seating position in your vehicle has a specific safety belt assembly which is made up of one buckle and one tongue that are designed to be used as a pair. 1) Use the shoulder belt on the outside shoulder only. Never wear the shoulder belt under the arm. 2) Never swing the safety belt around your neck over the inside shoulder. 3) Never use a single belt for more than one person.

Seating and Safety Restraints



Always transport children 12 years old and under in the back seat and always properly use appropriate child restraints.

Energy Management Feature

- This vehicle has a safety belt system with an energy management feature at the front seating positions to help further reduce the risk of injury in the event of a head-on collision.
- This safety belt system has a retractor assembly that is designed to pay out webbing in a controlled manner. This feature is designed to help reduce the belt force acting on the occupant's chest.



After any vehicle collision, the safety belt system at all outboard seating positions (except driver, which has no “automatic locking retractor” feature) must be checked by a qualified technician to verify that the “automatic locking retractor” feature for child seats is still functioning properly. In addition, all safety belts should be checked for proper function.



BELT AND RETRACTOR ASSEMBLY MUST BE REPLACED if the safety belt assembly “automatic locking retractor” feature or any other safety belt function is not operating properly when checked according to the procedures in Workshop Manual.



Failure to replace the Belt and Retractor assembly could increase the risk of injury in collisions.

Seating and Safety Restraints

Combination lap and shoulder belts

1. Insert the belt tongue into the proper buckle (the buckle closest to the direction the tongue is coming from) until you hear a snap and feel it latch. Make sure the tongue is securely fastened in the buckle.

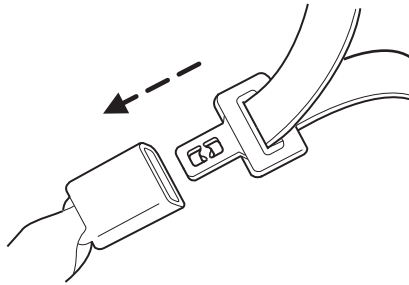

2. To unfasten, push the release button and remove the tongue from the buckle.

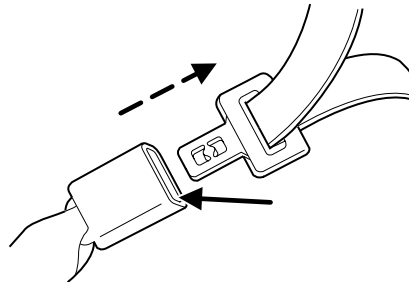

The front and rear outboard safety restraints in the vehicle are combination lap and shoulder belts. The front passenger and rear seat outboard safety belts have two types of locking modes described below:

Vehicle sensitive mode

The vehicle sensitive mode is the normal retractor mode, allowing free shoulder belt length adjustment to your movements and locking in response to vehicle movement. For example, if the driver brakes suddenly or turns a corner sharply, or the vehicle receives an impact of approximately 8 km/h (5 mph) or more, the combination safety belts will lock to help reduce forward movement of the driver and passengers.

Automatic locking mode

In this mode, the shoulder belt is automatically pre-locked. The belt will still retract to remove any slack in the shoulder belt.

The automatic locking mode is not available on the driver safety belt.

Seating and Safety Restraints

When to use the automatic locking mode

- **Any time** a child safety seat is installed in a passenger front or outboard rear seating position (if equipped). Children 12 years old and under should be properly restrained in the rear seat whenever possible. Refer to *Safety Restraints for Children* or *Safety Seats for Children* later in this chapter.

How to use the automatic locking mode

- Buckle the combination lap and shoulder belt.

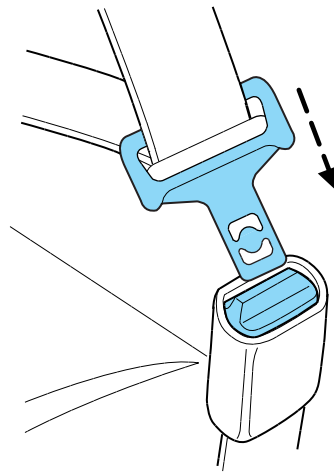

- Grasp the shoulder portion and pull downward until the entire belt is extracted.



- Allow the belt to retract. As the belt retracts, you will hear a clicking sound. This indicates the safety belt is now in the automatic locking mode.

Seating and Safety Restraints

How to disengage the automatic locking mode

Disconnect the combination lap/shoulder belt and allow it to retract completely to disengage the automatic locking mode and activate the vehicle sensitive (emergency) locking mode.



After any vehicle collision, the safety belt systems at all outboard seating positions (except driver, which has no automatic locking feature) must be checked by a qualified technician to verify that the “automatic locking retractor” feature for child seats is still functioning properly. In addition, all seat belts should be checked for proper function.



BELT AND RETRACTOR ASSEMBLY MUST BE REPLACED if the seat belt assembly “automatic locking retractor” feature or any other seat belt function is not operating properly when checked according to the procedures in Workshop Manual.



Failure to replace the Belt and Retractor assembly could increase the risk of injury in collisions.

Seating and Safety Restraints

Front safety belt height adjustment

Your vehicle has safety belt height adjustments for the driver and front passenger. Adjust the height of the shoulder belt so the belt rests across the middle of your shoulder.

To lower the shoulder belt height, push the button and slide the height adjuster down. To raise the height of the shoulder belt, slide the height adjuster up. Pull down on the height adjuster to make sure it is locked in place.

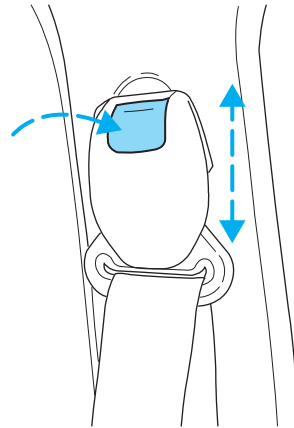

 Position the safety belt height adjusters so that the belt rests across the middle of your shoulder. Failure to adjust the safety belt properly could reduce the effectiveness of the seat belt and increase the risk of injury in a collision.

Safety belt pretensioner

Your vehicle is equipped with safety belt pretensioners at the driver and front passenger seating positions.

The safety belt pretensioners are designed to activate during certain frontal or near-frontal collisions with sufficient longitudinal deceleration. A safety belt pretensioner is a device which tightens the webbing of the lap and shoulder belts in such a way that they fit more snugly against the body.

The driver and front outboard passenger safety belt system (including retractors, buckles and height adjusters) must be replaced if the vehicle is involved in a collision that results in the activation of the safety belt pretensioners. Refer to the *Safety belt maintenance* section in this chapter.

Seating and Safety Restraints



Failure to replace the safety belt assembly under the above conditions could result in severe personal injuries in the event of a collision.

Lap belts

Adjusting the center lap belt

The lap belt does not adjust automatically.



The lap belt should fit snugly and as low as possible around the hips, not across the waist.

Insert the tongue into the correct buckle (the buckle closest to the direction the tongue is coming from). To lengthen the belt, turn the tongue at a right angle to the belt and pull across your lap until it reaches the buckle. To tighten the belt, pull the loose end of the belt through the tongue until it fits snugly across the hips.

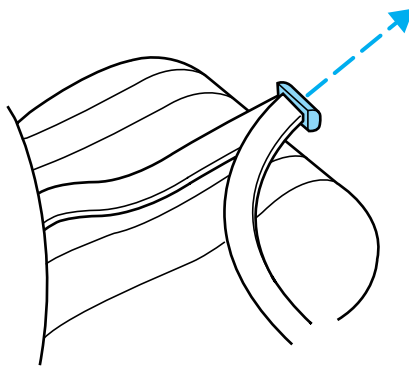

Shorten and fasten the belt when not in use.

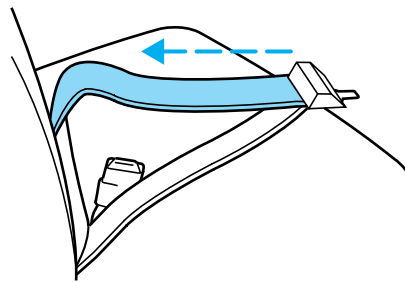

Seating and Safety Restraints

Safety belt extension assembly

If the safety belt is too short when fully extended, there is a 20 cm (8 inch) safety belt extension assembly that can be added (part number 611C22). This assembly can be obtained from your dealer at no cost.

Use only extensions manufactured by the same supplier as the safety belt. Manufacturer identification is located at the end of the webbing on the label. Also, use the safety belt extension only if the safety belt is too short for you when fully extended. Do not use extensions to change the fit of the shoulder belt across the torso.

Safety belt warning light and indicator chime

The seat belt warning light illuminates in the instrument cluster and a chime sounds to remind the occupants to fasten their safety belts.

Conditions of operation

If...	Then...
The driver's safety belt is not buckled before the ignition switch is turned to the ON position...	The safety belt warning light illuminates 1 minute and the warning chime sounds 6 seconds.
The driver's safety belt is buckled while the indicator light is illuminated and the warning chime is sounding...	The safety belt warning light and warning chime turn off.
The driver's safety belt is buckled before the ignition switch is turned to the ON position...	The safety belt warning light and indicator chime remain off.

BeltMinder

The BeltMinder feature is a supplemental warning to the safety belt warning function. This feature provides additional reminders to the driver that the driver's safety belt is unbuckled by intermittently sounding a chime and illuminating the safety belt warning lamp in the instrument cluster.

Seating and Safety Restraints

If...	Then...
The driver's safety belt is not buckled approximately 5 seconds after the safety belt warning light has turned off and vehicle speed exceeds 8 km/h (3 mph)...	The BeltMinder feature is activated - the safety belt warning light illuminates and the warning chime sounds for 6 seconds every 30 seconds, repeating for approximately 5 minutes or until safety belt is buckled.
The driver's safety belt is buckled while the safety belt indicator light is illuminated and the safety belt warning chime is sounding...	The BeltMinder feature will not activate.
The driver's safety belt is buckled before the ignition switch is turned to the ON position...	The BeltMinder feature will not activate.

The purpose of the BeltMinder is to remind occasional wearers to wear safety belts all of the time.

The following are reasons most often given for not wearing safety belts: (All statistics based on U.S. data)

Reasons given...	Consider...
"Crashes are rare events"	36 700 crashes occur every day. The more we drive, the more we are exposed to "rare" events, even for good drivers. <i>1 in 4 of us will be seriously injured in a crash during our lifetime.</i>
"I'm not going far"	3 of 4 fatal crashes occur within 25 miles of home.

Seating and Safety Restraints

Reasons given...	Consider...
"Belts are uncomfortable"	Ford designs its safety belts to enhance comfort. If you are uncomfortable - try different positions for the safety belt upper anchorage and seatback which should be as upright as possible; this can improve comfort.
"I was in a hurry"	Prime time for an accident. BeltMinder reminds us to take a few seconds to buckle up.
"Seat belts don't work"	Safety belts , when used properly, reduce risk of death to front seat occupants by 45% in cars , and by 60% in light trucks .
"Traffic is light"	Nearly 1 of 2 deaths occur in single-vehicle crashes , many when no other vehicles are around.
"Belts wrinkle my clothes"	Possibly, but a serious crash can do much more than wrinkle your clothes, particularly if you are unbelted.
"The people I'm with don't wear belts"	Set the example, teen deaths occur 4 times more often in vehicles with TWO or MORE people. Children and younger brothers/sisters imitate behavior they see.
"I have an air bag"	Air bags offer greater protection when used with safety belts. Frontal airbags are not designed to inflate in rear and side crashes or rollovers.
"I'd rather be thrown clear"	Not a good idea. People who are ejected are 40 times more likely to DIE . Safety belts help prevent ejection, WE CAN'T "PICK OUR CRASH".

Seating and Safety Restraints



Do not sit on top of a buckled safety belt to avoid the Belt Minder chime. Sitting on the safety belt will increase the risk of injury in an accident. To disable (one-time) or deactivate the Belt Minder feature please follow the directions stated below.

One time disable

Any time the safety belt is buckled and then unbuckled during an ignition ON cycle, BeltMinder will be disabled for that ignition cycle only.

Deactivating/activating the BeltMinderfeature

Read steps 1 - 9 thoroughly before proceeding with the deactivation/activation programming procedure.

The BeltMinderfeature can be deactivated/activated by performing the following procedure:

Before following the procedure, make sure that:

- the parking brake is set
- the gearshift is in P (Park) (automatic transmission) or the neutral position (manual transmission).
- the ignition switch is in the OFF position
- all vehicle doors are closed
- the driver's safety belt is unbuckled
- the parklamps/headlamps are in OFF position (If vehicle is equipped with Autolamps, this will not affect the procedure.)



To reduce the risk of injury, do not deactivate/activate the Belt Minder feature while driving the vehicle.

1. Turn the ignition switch to the RUN (or ON) position. (DO NOT START THE ENGINE)
2. Wait until the safety belt warning light turns off. (Approximately 1–2 minutes)
 - Steps 3–5 must be completed within 60 seconds or the procedure will have to be repeated.
3. Uncoil then retract the safety belt three times, ending with the safety belt retracted. This can be done before or during BeltMinderwarning activation.

Seating and Safety Restraints

4. Turn on the parklamps/headlamps, turn off the parklamps/headlamps.
5. Uncoil then retract the safety belt three times, ending with the safety belt retracted.
 - After step 5 the safety belt warning light will be turned on for three seconds.
6. Within seven seconds of the safety belt warning light turning off, uncoil then retract the safety belt.
 - This will disable BeltMinder if it is currently enabled, or enable BeltMinder if it is currently disabled.
7. Confirmation of disabling BeltMinder is provided by flashing the safety belt warning light four times per second for three seconds.
8. Confirmation of enabling BeltMinder is provided by flashing the safety belt warning light four times per second for three seconds, followed by three seconds with the safety belt warning light off, then followed by flashing the safety belt warning light four times per second for three seconds again.
9. After receiving confirmation, the deactivation/activation procedure is complete.

Safety belt maintenance

Inspect the safety belt systems periodically to make sure they work properly and are not damaged. Inspect the safety belts to make sure there are no nicks, tears or cuts. Replace if necessary. All safety belt assemblies, including retractors, buckles, front seat belt buckle assemblies, buckle support assemblies (slide bar-if equipped), shoulder belt height adjusters (if equipped), shoulder belt guide on seatback (if equipped), child safety seat tether bracket assemblies (if equipped), LATCH child seat tether anchors and lower anchors (if equipped), and attaching hardware, should be inspected after a collision. Ford Motor Company recommends that all safety belt assemblies used in vehicles involved in a collision be replaced. However, if the collision was minor and a qualified technician finds that the belts do not show damage and continue to operate properly, they do not need to be replaced. Safety belt assemblies not in use during a collision should also be inspected and replaced if either damage or improper operation is noted.

Seating and Safety Restraints

 Failure to inspect and if necessary replace the safety belt assembly under the above conditions could result in severe personal injuries in the event of a collision.

Refer to *Cleaning and maintaining the safety belts* in the *Cleaning* chapter.

AIR BAG SUPPLEMENTAL RESTRAINT SYSTEM (SRS)

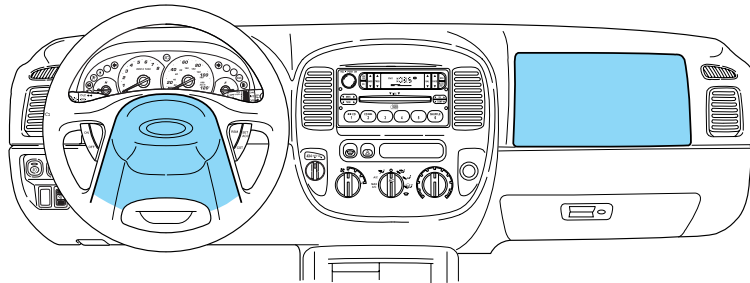

Your vehicle is equipped with a crash sensing and diagnostic module which records information about the air bag and sensor systems. In the event of a collision this module may save information related to the collision including information about the air bag system and impact severity. This information will assist Ford Motor Company in the servicing vehicle and helping to better understand real world collisions and further improve the safety of future vehicles.

 The front passenger air bag is not designed to offer protection to occupants in the center front seating position.

Seating and Safety Restraints

Important supplemental restraint system (SRS) precautions

The supplemental restraint system is designed to work with the safety belt to help protect the driver and right front passenger from certain upper body injuries.

Air bags DO NOT inflate slowly or gently and the risk of injury from a deploying air bag is greatest close to the trim covering the air bag module.

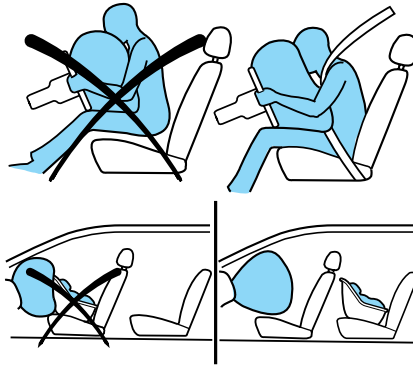

 All occupants of the vehicle, including the driver, should always properly wear their safety belts, even when an air bag (SRS) is provided.

 Always transport children 12 years old and under in the back seat and always properly use appropriate child restraints.

 National Highway Traffic Safety Administration (NHTSA) recommends a minimum distance of at least 25 cm (10 inches) between an occupant's chest and the driver air bag module.

 Never place your arm over the air bag module as a deploying air bag can result in serious arm fractures or other injuries.

Steps you can take to properly position yourself away from the air bag:

- Move your seat to the rear as far as you can while still reaching the pedals comfortably.
- Recline the seat slightly (one or two degrees) from the upright position.

Seating and Safety Restraints



Do not put anything on or over the air bag module. Placing objects on or over the air bag inflation area may cause those objects to be propelled by the air bag into your face and torso causing serious injury.



Do not attempt to service, repair, or modify the air bag supplemental restraint systems or its fuses. See your Ford or Lincoln Mercury dealer.



Modifications to the front end of the vehicle, including frame, bumper, front end body structure, tow hooks and B-pillar surrounding parts may affect the performance of the air bag sensors increasing the risk of injury. Do not modify the front end of the vehicle.



Additional equipment may affect the performance of the air bag sensors increasing the risk of injury. Please refer to the Body Builders Layout Book for instructions about the appropriate installation of additional equipment.

Seating and Safety Restraints

Children and air bags

For additional important safety information, read all information on safety restraints in this guide.

Children must always be properly restrained. Accident statistics suggest that children are safer when properly restrained in the rear seating positions than in the front seating position. Failure to follow these instructions may increase the risk of injury in a collision.



Air bags can kill or injure a child in a child seat.

NEVER place a rear-facing child seat in front of an active air bag. If you must use a forward-facing child seat in the front seat, move the seat all the way back.

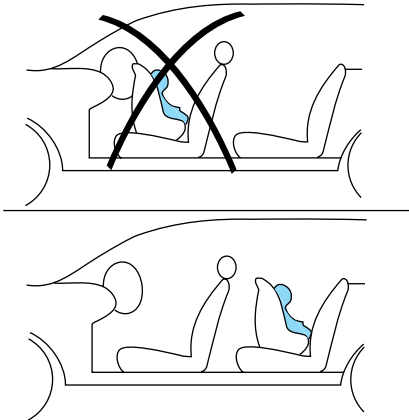

How does the air bag supplemental restraint system work?

The air bag SRS is designed to activate when the vehicle sustains longitudinal deceleration sufficient to cause the sensors to close an electrical circuit that initiates air bag inflation.

The fact that the air bags did not inflate in a collision does not mean that something is wrong with the system. Rather, it means the forces were not of the type sufficient to cause activation. Air bags are designed to inflate in frontal and near-frontal collisions, not rollover, side-impact, or rear-impacts unless the collision causes sufficient longitudinal deceleration.

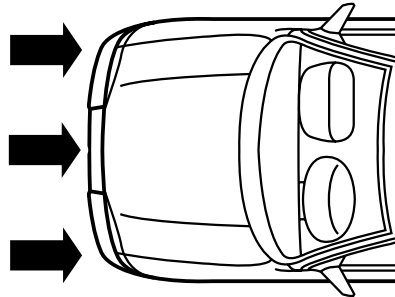

Seating and Safety Restraints

The air bags inflate and deflate rapidly upon activation. After air bag deployment, it is normal to notice a smoke-like, powdery residue or smell the burnt propellant. This may consist of cornstarch, talcum powder (to lubricate the bag) or sodium compounds (e.g., baking soda) that result from the combustion process that inflates the air bag. Small amounts of sodium hydroxide may be present which may irritate the skin and eyes, but none of the residue is toxic.



While the system is designed to help reduce serious injuries, contact with a deploying air bag may also cause abrasions, swelling or temporary hearing loss. Because air bags must inflate rapidly and with considerable force, there is the risk of death or serious injuries such as fractures, facial and eye injuries or internal injuries, particularly to occupants who are not properly restrained or are otherwise out of position at the time of air bag deployment. Thus, it is extremely important that occupants be properly restrained as far away from the air bag module as possible while maintaining vehicle control.

The SRS consists of:

- driver and passenger air bag modules (which include the inflators and air bags)
- one or more impact and safing sensors
- a readiness light and tone
- a diagnostic module
- and the electrical wiring which connects the components

The diagnostic module monitors its own internal circuits and the supplemental air bag electrical system warning (including the impact sensors), the system wiring, the air bag system readiness light, the air bag back up power and the air bag igniters.



Several air bag system components get hot after inflation. Do not touch them after inflation.

Seating and Safety Restraints

 If the air bag has deployed, **the air bag will not function again and must be replaced immediately.** If the air bag is not replaced, the unrepaired area will increase the risk of injury in a collision.

Determining if the system is operational

The SRS uses a readiness light in the instrument cluster or a tone to indicate the condition of the system. Refer to *Air bag readiness* section in the *Instrument cluster* chapter. Routine maintenance of the air bag is not required.

A difficulty with the system is indicated by one or more of the following:

- The readiness light will either flash or stay lit.
- The readiness light will not illuminate immediately after ignition is turned on.
- A series of five beeps will be heard. The tone pattern will repeat periodically until the problem and/or light are repaired.



If any of these things happen, even intermittently, have the SRS serviced at your dealership or by a qualified technician immediately. Unless serviced, the system may not function properly in the event of a collision.

Side air bag system (if equipped)

 Do not place objects or mount equipment on or near the air bag cover on the side of the seatbacks of the front seats or in front seat areas that may come into contact with a deploying air bag. Failure to follow these instructions may increase the risk of personal injury in the event of a collision.

 Do not use accessory seat covers. The use of accessory seat covers may prevent the deployment of the side air bags and increase the risk of injury in an accident.

Seating and Safety Restraints



Do not lean your head on the door. The side air bag could injure you as it deploys from the side of the seatback.



Do not attempt to service, repair, or modify the air bag supplemental restraint system, its fuses or the seat cover on a seat containing an air bag. See your Ford or Lincoln Mercury dealer.



All occupants of the vehicle including the driver should always wear their safety belts even when an air bag SRS is provided.

How does the side air bag system work?

The side air bag system consists of the following:

- An inflatable nylon bag (air bag) with a gas generator concealed behind the outboard bolster of the driver and front passenger seatbacks.
- A special seat cover designed to allow airbag deployment.
- The same warning light, electronic control and diagnostic unit as used for the front air bags.
- The two side sensors are located on the lower portion of the b-pillar.

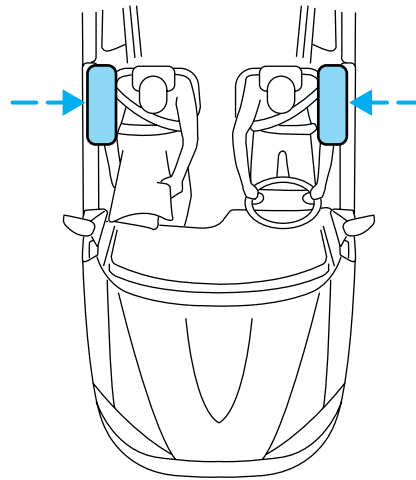

Side air bags, in combination with seat belts, can help reduce the risk of severe injuries in the event of a significant side impact collision.

The side air bags are fitted on the outboard side of the seatbacks of the front seats. In certain lateral collisions, the air bag on the side affected by the collision will be inflated, even if the respective seat is not occupied. The air bag was designed to inflate between the door panel and occupant to further enhance the protection provided occupants in side impact collisions.

Seating and Safety Restraints

The air bag SRS is designed to activate when the vehicle sustains lateral deceleration sufficient to cause the sensors to close an electrical circuit that initiates air bag inflation.

The fact that the air bags did not inflate in a collision does not mean that something is wrong with the system. Rather, it means the forces were not of the type sufficient to cause activation. Side air bags are designed to inflate in side-impact collisions, not roll-over, rear-impact, frontal or near-frontal collisions, unless the collision causes sufficient lateral deceleration.

 Several air bag system components get hot after inflation. Do not touch them after inflation.

 If the side air bag has deployed, **the air bag will not function again. The side air bag system (including the seat) must be inspected and serviced by a qualified technician in accordance with the vehicle service manual.** If the air bag is not replaced, the unrepaired area will increase the risk of injury in a collision.

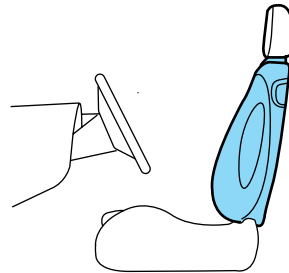

Determining if the system is operational

The SRS uses a readiness light in the instrument cluster or a tone to indicate the condition of the system. Refer to the *Air bag readiness* section in the *Instrumentation* chapter. Routine maintenance of the side air bag is not required.

A difficulty with the system is indicated by one or more of the following:

- The readiness light (same light as for front air bag system) will either flash or stay lit.

Seating and Safety Restraints

- The readiness light will not illuminate immediately after ignition is turned on.
- A series of five beeps will be heard. The tone pattern will repeat periodically until the problem and light are repaired.

If any of these things happen, even intermittently, have the SRS serviced at your dealership or by a qualified technician immediately. Unless serviced, the system may not function properly in the event of a collision.

Disposal of air bags and air bag equipped vehicles (including pretensioners)

For disposal of air bags or air bag equipped vehicles, see your local dealership or qualified technician. Air bags **MUST BE** disposed of by qualified personnel.

SAFETY RESTRAINTS FOR CHILDREN

See the following sections for directions on how to properly use safety restraints for children. Also see *Air bag supplemental restraint system (SRS)* in this chapter for special instructions about using air bags.

Important child restraint precautions

You are required by law to use safety restraints for children in the U.S. and Canada. If small children ride in your vehicle (generally children who are four years old or younger and who weigh 18 kg [40 lbs] or less), you must put them in safety seats made especially for children. Check your local and state or provincial laws for specific requirements regarding the safety of children in your vehicle.



Never let a passenger hold a child on his or her lap while the vehicle is moving. The passenger cannot protect the child from injury in a collision.

Always follow the instructions and warnings that come with any infant or child restraint you might use.

When possible, always place children under age 12 in the rear seat of your vehicle. Accident statistics suggest that children are safer when properly restrained in the rear seating positions than in the front seating position.

Seating and Safety Restraints

Children and safety belts

If the child is the proper size, restrain the child in a safety seat.

Children who are too large for child safety seats (as specified by your child safety seat manufacturer) should always wear safety belts.

Follow all the important safety restraint and air bag precautions that apply to adult passengers in your vehicle.

If the shoulder belt portion of a combination lap and shoulder belt can be positioned so it does not cross or rest in front of the child's face or neck, the child should wear the lap and shoulder belt. Moving the child closer to the center of the vehicle may help provide a good shoulder belt fit.



Do not leave children, unreliable adults, or pets unattended in your vehicle.

To improve the fit of lap and shoulder belts on children who have outgrown child safety seats, Ford recommends use of a belt-positioning booster seat that is labelled as conforming to all applicable Federal motor vehicle safety standards. Belt-positioning booster seats raise the child and provide a shorter, firmer seating cushion that encourages safer seating posture and better fit of lap and shoulder belts on the child.

A belt-positioning booster seat should be used if the shoulder belt rests in front of the child's face or neck, or if the lap belt does not fit snugly on both thighs, or if the thighs are too short to let the child sit all the way back on the seat cushion when the lower legs hang over the edge of the seat cushion. You may wish to discuss the special needs of your child with your pediatrician.

SAFETY SEATS FOR CHILDREN



Seating and Safety Restraints

Child and infant or child safety seats

Use a safety seat that is recommended for the size and weight of the child. Carefully follow all of the manufacturer's instructions with the safety seat you put in your vehicle. If you do not install and use the safety seat properly, the child may be injured in a sudden stop or collision.

When installing a child safety seat:

- Review and follow the information presented in the *Air Bag Supplemental Restraint System* (SRS) section in this chapter.
- Use the correct safety belt buckle for that seating position (the buckle closest to the direction the tongue is coming from).
- Insert the belt tongue into the proper buckle until you hear a snap and feel it latch. Make sure the tongue is securely fastened in the buckle.
- Keep the buckle release button pointing up and away from the safety seat, with the tongue between the child seat and the release button, to prevent accidental unbuckling.
- Place seat back in upright position.
- Put the safety belt in the automatic locking mode. Refer to *Automatic locking mode* (passenger side front and outboard rear seating positions) (if equipped) section in this chapter.

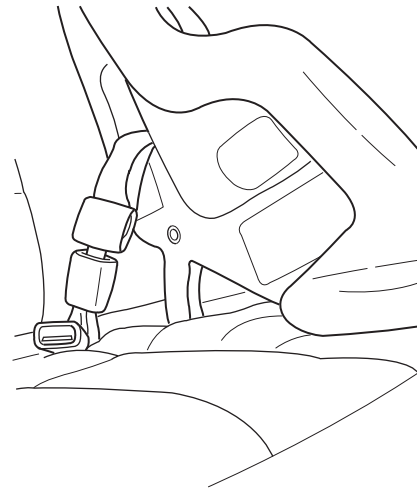

Ford recommends the use of a child safety seat having a top tether strap. Install the child safety seat in a seating position which is capable of providing a tether anchorage. For more information on top tether straps, refer to *Attaching child safety seats with tether straps*. in this chapter.

Seating and Safety Restraints

 Carefully follow all of the manufacturer's instructions included with the safety seat you put in your vehicle. If you do not install and use the safety seat properly, the child may be injured in a sudden stop or collision.

Installing child safety seats in combination lap and shoulder belt seating positions

The rear seat head restraints must be removed when using a child seat.

 Air bags can kill or injure a child in a child seat. **NEVER** place a rear-facing child seat in front of an active air bag. If you must use a forward-facing child seat in the front seat, move the seat all the way back.

1. Position the child safety seat in a seat with a combination lap and shoulder belt.

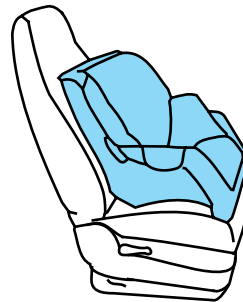

 Children 12 and under should be properly restrained in the rear seat whenever possible.

Seating and Safety Restraints

2. Pull down on the shoulder belt and then grasp the shoulder belt and lap belt together.

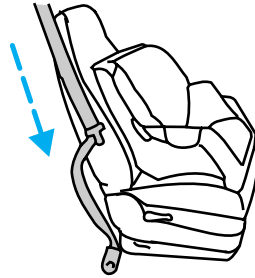

3. While holding the shoulder and lap belt portions together, route the tongue through the child seat according to the child seat manufacturer's instructions. Be sure the belt webbing is not twisted.

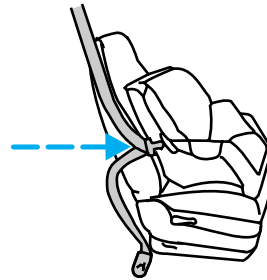

4. Insert the belt tongue into the proper buckle (the buckle closest to the direction the tongue is coming from) for that seating position until you hear a snap and feel the latch engage. Make sure the tongue is latched securely by pulling on it.

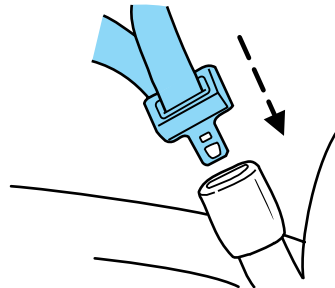

Seating and Safety Restraints

5. To put the retractor in the automatic locking mode, grasp the shoulder portion of the belt and pull downward until all of the belt is extracted and a click is heard.

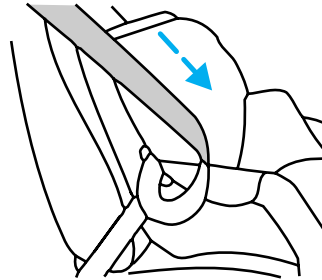

6. Allow the belt to retract. The belt will click as it retracts to indicate it is in the automatic locking mode.

7. Pull the lap belt portion across the child seat toward the buckle and pull up on the shoulder belt while pushing down with your knee on the child seat.

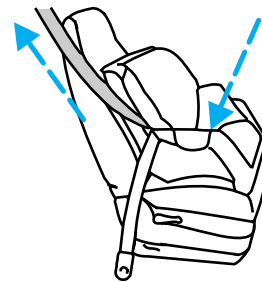

8. Allow the safety belt to retract to remove any slack in the belt.

9. Before placing the child in the seat, forcibly tilt the seat forward and back to make sure the seat is securely held in place. To check this, grab the seat at the belt path and attempt to move it side to side and forward and back. There should be no more than one inch of movement for proper installation.

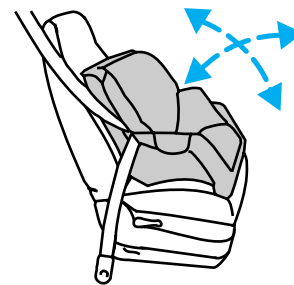

10. Try to pull the belt out of the retractor to make sure the retractor is in the automatic locking mode (you should not be able to pull more belt out). If the retractor is not locked, unbuckle the belt and repeat steps two through nine.

Check to make sure the child seat is properly secured before each use.

Seating and Safety Restraints

Attaching child safety seats with tether straps

Most new forward-facing child safety seats include a tether strap which goes over the back of the seat and hooks to an anchoring point. Tether straps are available as an accessory for many older safety seats. Contact the manufacturer of your child seat for information about ordering a tether strap.

The rear seating positions of your vehicle are equipped with built-in tether strap anchors located behind the seats on the roof panel in the cargo area.

The tether strap anchors in your vehicle are in the following positions:

 Attach the tether strap only to the appropriate tether anchor as shown. The tether strap may not work properly if attached somewhere other than the correct tether anchor.

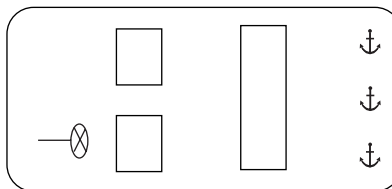

1. Position the child safety seat on the seat cushion.
2. Route the child safety seat tether strap over the back of the seat.

For vehicles with adjustable head restraints, remove the head restraints first, place under the front seat for storage, and then route the tether strap over the top of the seatback.

3. Locate the correct anchor for the selected seating position.

There are three tether anchors located on the headliner at the rear of the vehicle.

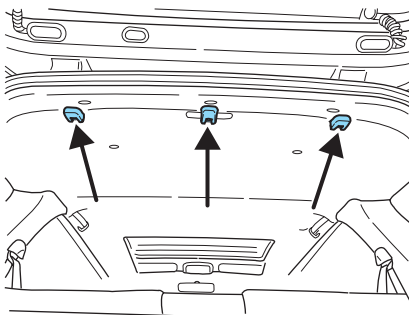

Seating and Safety Restraints

4. Clip the tether strap to the anchor as shown.

The arrow in the above graphic points toward the front of the vehicle.

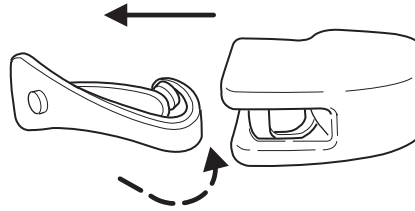

 If the tether strap is clipped incorrectly, the child safety seat may not be retained properly in the event of a collision.

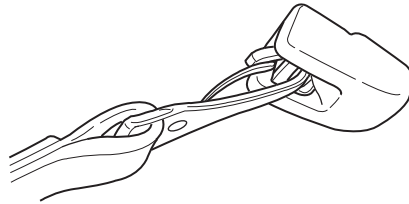

5. Refer to the *Installing child safety seats in combination lap and shoulder belt seating positions* section of this chapter for further instructions to secure the child safety seat.

6. Tighten the child safety seat tether strap according to the manufacturer's instructions.

 If the safety seat is not anchored properly, the risk of a child being injured in a collision greatly increases.

Attaching safety seats with LATCH (Lower Anchors and Tethers for Children) attachments for child seat anchors

Some child safety seats have two rigid or webbing mounted attachments that connect to two anchors at certain seating positions in your vehicle. This type of child seat eliminates the need to use seat belts to attach the child seat. For forward-facing child seats, the tether strap must also be attached to the proper tether anchor. See *Attaching safety seats with tether straps* in this chapter.

Seating and Safety Restraints

Your vehicle has LATCH anchors for child seat installation at the following locations:

The anchors on both sides of the center of the rear seat are provided primarily for child seats at the outboard seats, and are further apart than the pairs of lower anchors for child seat installation at other seats. A child seat with rigid LATCH attachments cannot be installed at the center rear seat. A child seat with LATCH attachments on belt webbing can be used at the center rear seat unless a child seat at an outboard rear seat is attached to one of these lower anchors. Install a child seat onto the lower anchors at the center rear seat **ONLY IF** the child restraint manufacturer recommends that the child seat can be installed to anchors that are spaced up to 500 mm (19 in) apart.

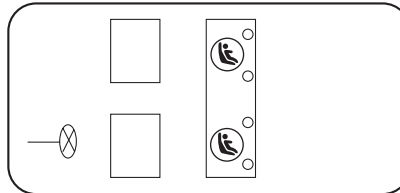

 Never attach two LATCH child safety seats to the same anchor. In a crash, one anchor may not be strong enough to hold two child safety seat attachments and may break, causing serious injury or death.

The lower anchors for child seat installation are located at the rear section of the rear seat between the cushion and seat back.

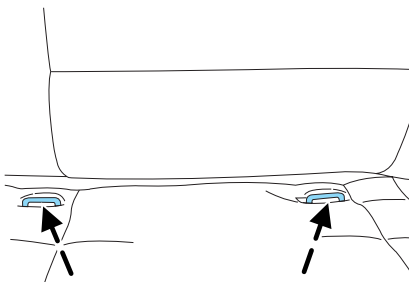

Follow the child seat manufacturer's instructions to properly install a child seat with LATCH attachments.

 Attach LATCH lower attachments of the child seat only to the anchors shown.

Seating and Safety Restraints

If you install a child seat with rigid LATCH attachments, do not tighten the tether strap enough to lift the child seat off the vehicle seat cushion when the child is seated in it. Keep the tether strap just snug without lifting the front of the child seat. Keeping the child seat just touching the vehicle seat gives the best protection in a severe crash.

Each time you use the safety seat, check that the seat is properly attached to the lower anchors and tether anchor. Try to tilt the child seat from side to side. Also try to tug the seat forward. Check to see if the anchors hold the seat in place.



If the safety seat is not anchored properly, the risk of a child being injured in a crash greatly increases.

STARTING

Positions of the ignition

1. LOCK, locks the gearshift lever and allows key removal.
2. ACCESSORY, allows the electrical accessories such as the radio to operate while the engine is not running.
3. RUN, all electrical circuits operational. Warning lights illuminated. Key position when driving.
4. START, cranks the engine. Release the key as soon as the engine starts.

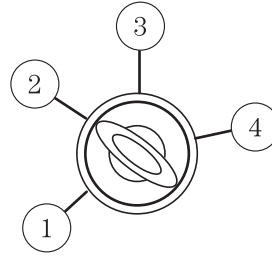

Preparing to start your vehicle

Engine starting is controlled by the powertrain control system. This system meets all Canadian Interference-Causing Equipment standard requirements regulating the impulse electrical field strength of radio noise.

When starting a fuel-injected engine, avoid pressing the accelerator before or during starting. Only use the accelerator when you have difficulty starting the engine. For more information on starting the vehicle, refer to *Starting the engine* in this chapter.





Extended idling at high engine speeds can produce very high temperatures in the engine and exhaust system, creating the risk of fire or other damage.



Do not park, idle, or drive your vehicle in dry grass or other dry ground cover. The emission system heats up the engine compartment and exhaust system, which can start a fire.

Driving

 Do not start your vehicle in a closed garage or in other enclosed areas. Exhaust fumes can be toxic. Always open the garage door before you start the engine. See *Guarding against exhaust fumes* in this chapter for more instructions.

 If you smell exhaust fumes inside your vehicle, have your dealer inspect your vehicle immediately. Do not drive if you smell exhaust fumes.

Important safety precautions

A computer system controls the engine's idle revolutions per minute (RPM). When the engine starts, the idle RPM runs faster to warm the engine. If the engine idle speed does not slow down automatically, have the vehicle checked.

Before starting the vehicle:

1. Make sure all vehicle occupants have buckled their safety belts. For more information on safety belts and their proper usage, refer to the *Seating and safety restraints* chapter.
2. Make sure the headlamps and vehicle accessories are off.

If starting a vehicle with an automatic transmission:

- Make sure the parking brake is set.
- Make sure the gearshift is in P (Park).

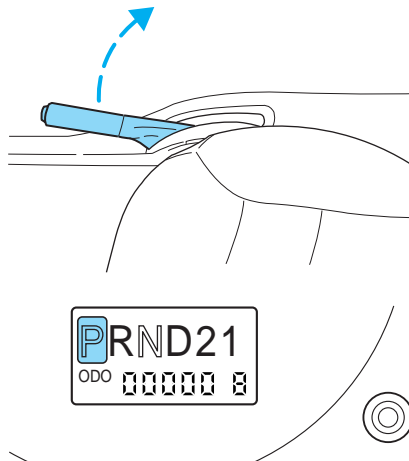

Driving

If starting a vehicle with a manual transmission:

- Make sure the parking brake is set.
- Push the clutch pedal to the floor.

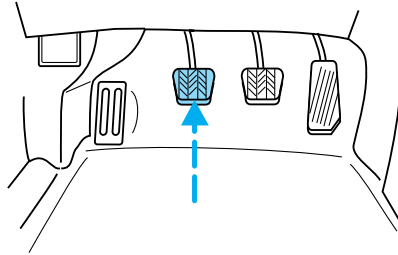

3. Turn the key to 3 (RUN) without turning the key to 4 (START).

If there is difficulty in turning the key, firmly rotate the steering wheel left and right until the key turns freely. This condition may occur when:

- front wheels are turned
- front wheel is against the curb
- steering wheel is turned when getting in or out of the vehicle

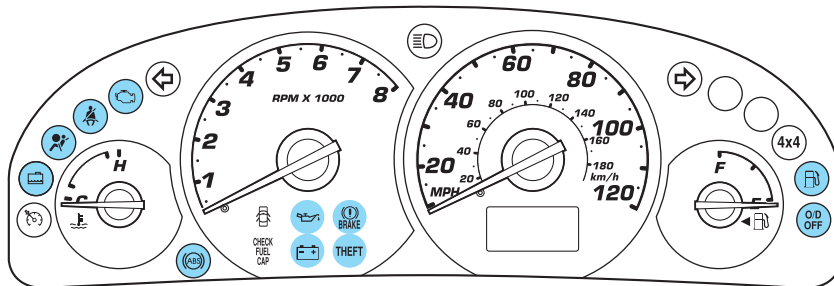
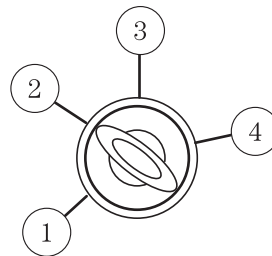

Make sure the corresponding lights illuminate or illuminate briefly. If a light fails to illuminate, have the vehicle serviced.

- If the driver's safety belt is fastened, the  light may not illuminate.

Driving

Starting the engine

Note: Whenever you start your vehicle, release the key as soon as the engine starts. Excessive cranking could damage the starter.

1. Turn the key to 4 (START) without pressing the accelerator pedal and release as soon as the engine starts. The key will return to 3 (RUN).

2. If the temperature is above -12°C (10°F) and the engine does not start within five seconds on the first try, turn the key to OFF, wait 10 seconds and try again.

3. If the temperature is below -12°C (10°F) and the engine does not start in 15 seconds on the first try, turn the key OFF and wait 10 seconds and try again. If the engine does not start in two attempts, Press the accelerator pedal all the way to floor and hold. Turn the key to START position.

4. When the engine starts, release the key, then release the accelerator pedal gradually as the engine speeds up.

5. After idling for a few seconds, apply the brake and release the parking brake.

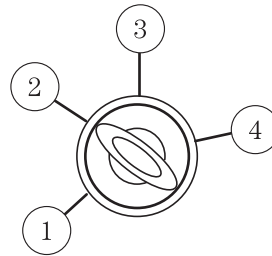

Using the engine block heater (if equipped)

An engine block heater warms the engine coolant, which improves starting, warms up the engine faster and allows the heater-defroster system to respond quickly. Use of an engine block heater is strongly recommended if you live in a region where temperatures reach -23°C (-10°F) or below.

For best results, plug the heater in at least three hours before starting the vehicle. Using the heater for longer than three hours will not harm the engine, so the heater can be plugged in the night before starting the vehicle.



To prevent electrical shock, do not use your heater with ungrounded electrical systems or two-pronged (cheater) adapters.

Guarding against exhaust fumes

Although odorless and colorless, carbon monoxide is present in exhaust fumes. Take precautions to avoid its dangerous effects.



If you ever smell exhaust fumes of any kind inside your vehicle, have your dealer inspect and fix your vehicle immediately. Do not drive if you smell exhaust fumes. These fumes are harmful and could kill you.

Have the exhaust and body ventilation systems checked whenever:

- the vehicle is raised for service
- the sound of the exhaust system changes
- the vehicle has been damaged in a collision



WARNING: Engine exhaust, some of its constituents, and certain vehicle components contain or emit chemicals known to the State of California to cause cancer and birth defects or other reproductive harm. In addition, certain fluids contained in vehicles and certain products of component wear contain or emit chemicals known to the State of California to cause cancer and birth defects or other reproductive harm.

Important ventilating information

If the engine is idling while the vehicle is stopped in an open area for long periods of time, open the windows at least 2.5 cm (one inch).

Adjust the heating or air conditioning (if equipped) to bring in fresh air.

Improve vehicle ventilation by keeping all air inlet vents clear of snow, leaves and other debris.

BRAKES

Your service brakes are self-adjusting. Refer to the scheduled maintenance guide for scheduled maintenance.

Occasional brake noise is normal and often does not indicate a performance concern with the vehicle's brake system. In normal operation, automotive brake systems may emit occasional or intermittent squeal or groan noises when the brakes are applied. Such noises are usually heard during the first few brake applications in the morning; however, they may be heard at any time while braking and can be

Driving

aggravated by environmental conditions such as cold, heat, moisture, road dust, salt or mud. If a “metal-to-metal,” “continuous grinding” or “continuous squeal” sound is present while braking, the brake linings may be worn-out and should be inspected by a qualified service technician.



If you are driving down a long or steep hill, shift to a lower gear. Do not apply your brakes continuously, as they may overheat and become less effective.

Four-wheel anti-lock brake system (ABS) (if equipped)

On vehicles equipped with a four-wheel anti-lock braking system (ABS), a noise from the hydraulic pump motor and pulsation in the pedal may be observed during ABS braking events. Pedal pulsation coupled with noise while braking under panic conditions or on loose gravel, bumps, wet or snowy roads is normal and indicates proper functioning of the vehicle’s anti-lock brake system. If the vehicle has continuous vibration or shudder in the steering wheel while braking, the vehicle should be inspected by a qualified service technician.

The ABS operates by detecting the onset of wheel lockup during brake applications and compensates for this tendency. The wheels are prevented from locking even when the brakes are firmly applied. The accompanying illustration depicts the advantage of an ABS equipped vehicle (on bottom) to a non-ABS equipped vehicle (on top) during hard braking with loss of front braking traction.

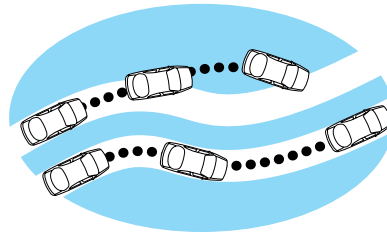

Using ABS

- In an emergency or when maximum efficiency from the four-wheel ABS is required, apply continuous force on the brake. The four wheel ABS will be activated immediately, thus allowing you to retain full steering control of your vehicle and, providing there is sufficient space, will enable you to avoid obstacles and bring the vehicle to a controlled stop.

Driving

- The anti-lock system does not decrease the time necessary to apply the brakes or always reduce stopping distance. Always leave enough room between your vehicle and the vehicle in front of you to stop.
- We recommend that you familiarize yourself with this braking technique. However, avoid taking any unnecessary risks.

ABS warning lamp (ABS)

The (ABS) warning lamp in the instrument cluster momentarily illuminates when the ignition is turned to the RUN position. If the light does not illuminate momentarily at start up, remains on or continues to flash, the ABS needs to be serviced.

With the ABS light on, the anti-lock brake system is disabled and normal braking is still effective unless the brake warning light also remains illuminated with parking brake released. (If your brake warning lamp illuminates, have your vehicle serviced immediately.)



Parking brake (P)

Apply the parking brake whenever the vehicle is parked. To set the parking brake, apply the brake pedal and pull the parking brake handle up as far as possible.

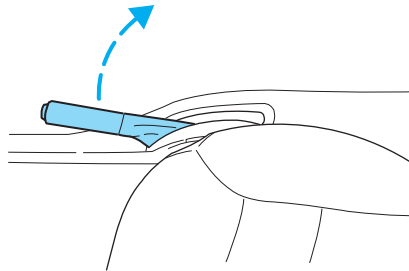

The BRAKE warning lamp in the instrument cluster illuminates and remains illuminated (when the ignition is turned ON) until the parking brake is released.



 Always set the parking brake fully and make sure that the gearshift is securely latched in P (Park) (automatic transmission) or in 1 (First Gear) (manual transmission).

Driving

The parking brake is not recommended to stop a moving vehicle. However, if the normal brakes fail, the parking brake can be used to stop your vehicle in an emergency. Since the parking brake applies only the rear brakes, the vehicle's stopping distance will increase greatly and the handling of your vehicle will be adversely affected.

To release the parking brake, the brake handle may need to be pulled up slightly to release pressure before pushing in the button.

Push the button on the end of the parking brake handle and push the handle down as far as possible. Driving with the parking brake applied will cause the brakes to wear out quickly and reduce fuel economy.

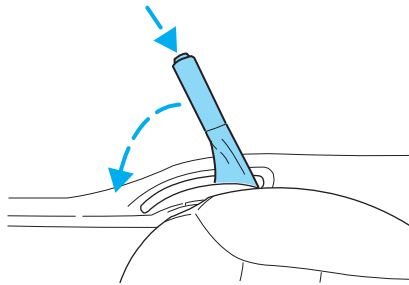

STEERING

Your vehicle is equipped with power steering. Power steering uses energy from the engine to help steer the vehicle.

To prevent damage to the power steering pump:

- Never hold the steering wheel to the extreme right or the extreme left for more than a few seconds when the engine is running.
- Do not operate the vehicle with a low power steering pump fluid level (below the MIN mark on the reservoir).

If the power steering system breaks down (or if the engine is turned off), you can steer the vehicle manually, but it takes more effort.

If the steering wanders or pulls, the condition could be caused by any of the following:

- underinflated tire(s) on any wheel(s)
- uneven vehicle loading
- high crown in center of road
- high crosswinds
- wheels out of alignment
- loose or worn suspension components

PREPARING TO DRIVE YOUR VEHICLE



Utility vehicles have a significantly higher rollover rate than other types of vehicles.



In a rollover crash, an unbelted person is significantly more likely to die than a person wearing a seat belt.

Your vehicle has special design and equipment features to make it capable of performing in a wide variety of circumstances. These special design features, such as larger tires and increased ground clearance, give the vehicle a higher center of gravity than a passenger car.



Vehicles with a higher center of gravity such as utility and four-wheel drive vehicles handle differently than vehicles with a lower center of gravity. Utility and four-wheel drive vehicles are **not** designed for cornering at speeds as high as passenger cars any more than low-slung sports cars are designed to perform satisfactorily under off-road conditions. Avoid sharp turns, excessive speed and abrupt maneuvers in these vehicles. Failure to drive cautiously could result in an increased risk of vehicle rollover, personal injury and death.



Loaded vehicles, with a higher center of gravity, may handle differently than unloaded vehicles. Extra precautions, such as slower speeds and increased stopping distance, should be taken when driving a heavily loaded vehicle.

Your vehicle has the capability to haul more cargo and people than most passenger cars. Depending upon the type and placement of the load, hauling people and cargo may raise the center of gravity of the vehicle.

Use extra caution while becoming familiar with your vehicle. Know the capabilities and limitations of both you as a driver and your vehicle.

AUTOMATIC TRANSAXLE OPERATION (IF EQUIPPED)

Brake-shift interlock

This vehicle is equipped with a brake-shift interlock feature that prevents the gearshift lever from being moved from P (Park) when the ignition is in the ON position unless brake pedal is depressed.

Driving

If you cannot move the gearshift lever out of P (Park) with ignition in the ON position and the brake pedal depressed:

1. Apply the parking brake, turn ignition key to LOCK, then remove the key.
2. Locate the access cover plate to the brake-shift interlock override. It is located on the top of the steering column.

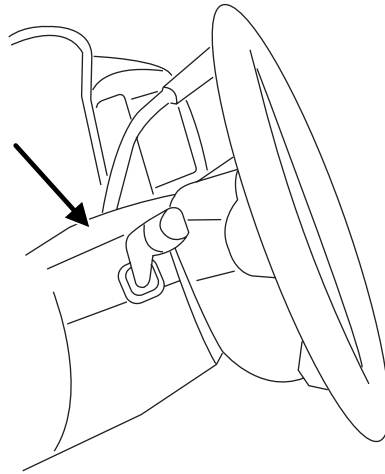

3. Insert a tool (or a screwdriver) into the right-hand side of the brake-shift interlock access cover and remove the cover.

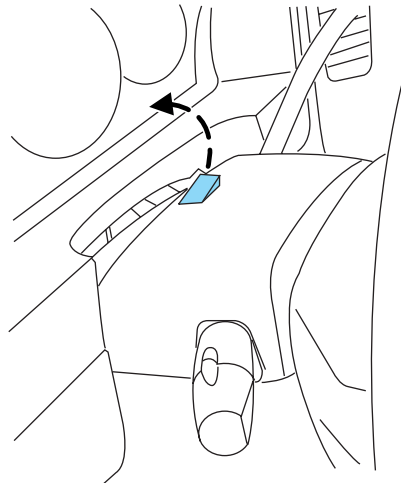

Driving

4. Insert a tool (or screw driver) into the access hole to override the brake-shift interlock. Apply the brake and shift into Neutral while holding down the override tab.

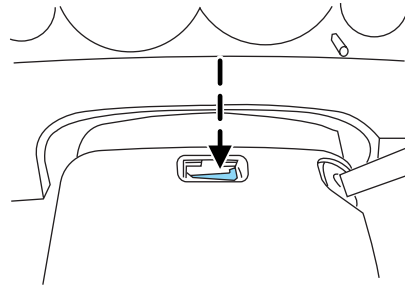

If it is necessary to use the above procedure to move the gearshift lever, it is possible that a fuse has blown or the vehicle's brakelamps are not operating properly. Refer to *Fuses and relays* in the *Roadside emergencies* chapter.



Do not drive your vehicle until you verify that the brakelamps are working.

If your vehicle gets stuck in mud or snow it may be rocked out by shifting between forward and reverse gears, stopping between shifts, in a steady pattern. Press lightly on the accelerator in each gear.

Do not rock the vehicle if the engine is not at normal operating temperature or damage to the transmission may occur.

Do not rock the vehicle for more than a few minutes or damage to the transmission and tires may occur or the engine may overheat.



Always set the parking brake fully and make sure the gearshift is latched in P (Park). Turn the ignition to the LOCK position and remove the key whenever you leave your vehicle.



If the parking brake is fully released, but the brake warning lamp remains illuminated, the brakes may not be working properly. See your dealer or a qualified service technician.

Driving

Driving with an automatic overdrive transaxle

Your automatic transaxle electronically controls the shift feel by using an adaptive learning strategy. This feature is designed to optimize shift smoothness. It is normal for your transaxle to shift firmly during the first few hundred kilometers (miles) of operation until the adaptive strategy has been learned. The adaptive learning strategy is maintained by power from the battery. When the battery is disconnected or a new battery is installed, the transaxle must relearn its adaptive strategy. Optimal shifting will resume within a few hundred kilometers (miles) of operation.

Your automatic overdrive transaxle provides fully automatic operation in either D (Overdrive) or with the O/D OFF switch depressed. Driving with the gearshift lever in D (Overdrive) gives the best fuel economy for normal driving conditions.



For manual control, start in 1 (First) and then shift manually.

To put your vehicle in gear, start the engine, depress the brake pedal, then move gearshift lever out of P (Park).



Understanding gearshift positions

P (Park)

Always come to a complete stop before shifting into P (Park). Make sure the gearshift lever is securely latched in P (Park). This locks the transaxle and prevents the front wheels from rotating.



Always set the parking brake fully and make sure the gearshift is latched in P (Park). Turn the ignition to the LOCK position and remove the key whenever you leave your vehicle.

R (Reverse)

With the gearshift lever in R (Reverse), the vehicle will move backward. You should always come to a complete stop before shifting into and out of R (Reverse).



N (Neutral)

With the gearshift lever in the N (Neutral) position, the vehicle can be started and is free to roll. Hold the brake pedal down while in this position.



Overdrive — column mounted gearshift with O/D off switch

The Overdrive position with the O/D OFF switch **not** depressed is the normal driving position for this automatic overdrive transaxle. When your vehicle cruises at a constant speed for any length of time, this fourth gear will increase your fuel economy.



Overdrive may not be appropriate for certain terrains. If the transaxle shifts back and forth between third and fourth gears while you are driving hilly roads or if your vehicle requires additional power for climbing hills, press the O/D OFF switch.



Each time the vehicle is started, the transaxle will automatically return to normal overdrive mode.

Driving

When to use D (Drive) or press the O/D OFF switch

You will notice that there is only one drive position on your gearshift indicator (instead of Drive and Overdrive). However, you will find a control labeled OVERDRIVE located on the gearshift lever. Push in the switch and the O/D OFF light in the instrument cluster will illuminate. With the O/D OFF light illuminated, the transaxle will operate in first, second and third gears and will not shift into fourth gear. Operating in D (O/D OFF) provides more engine braking than Overdrive for descending hills or city driving.

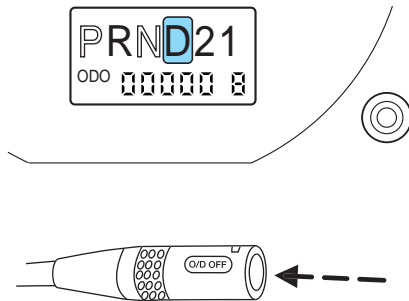

To return the transaxle to the normal Overdrive operation, press the O/D OFF control again. Use this control to select between Overdrive or D (O/D OFF) whenever you drive your vehicle.

If the O/D OFF indicator light is flashing on and off repeatedly when the vehicle is started or does not come on when the O/D OFF control is pressed, there may be a transaxle electronic system malfunction. You should contact your dealer as soon as possible or damage to the transaxle could occur.

2 (Second)

Use 2 (Second) for start-up on slippery roads or to give you more engine braking to slow your vehicle on downgrades.

Do not go faster than 108 km/h (68 mph) when in this gear. You can upshift from 2 (Second) to overdrive at any time.



Driving

1 (First)

Use 1 (First) for when added engine braking is desired when descending steep hills.

The automatic transaxle will shift to the proper gear to ascend any grade without any need to shift to 1 (First).

Do not go faster than 56 km/h (35 mph) when in this gear. You can upshift from 1 (First) to overdrive at any time.



 When parking, do not use the gearshift in place of the parking brake. Always set the parking brake fully and make sure that the gearshift is securely latched in Park (P). Turn off the ignition whenever you leave your vehicle. Never leave your vehicle unattended while it is running. If you do not take these precautions, your vehicle may move unexpectedly and injure someone.

FOUR WHEEL DRIVE (4X4) SYSTEM (IF EQUIPPED)

4x4 system general information

 For important information regarding safe operation of this type of vehicle, see **Preparing to drive your vehicle** in this chapter.

Your vehicle is equipped with a 4x4 system. This 4x4 system can use all four wheels to power the vehicle. This helps increase traction, enabling you to drive your vehicle over terrain and road conditions not normally traveled by two-wheel drive vehicles.

Power is always supplied to the front wheels and to the rear wheels through the transaxle and Rotary Blade Coupling (RBC) unit that allows you to select a four-wheel drive mode best suited for your current driving conditions.

For the lubricant specification and refill capacity of the Power Take-Off Unit and rear axle refer to the *Maintenance and specifications* chapter.

Driving

Operating modes of the 4x4 system

The 4x4 system functions in two modes:

- The 4x4 AUTO mode provides four-wheel drive with full power delivered to the front axle at all times, and to the rear axle as required for increased traction. This is appropriate for normal on-road operating conditions, such as dry road surfaces, wet pavement, snow and gravel.

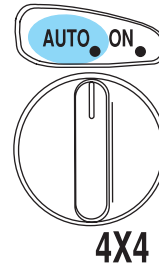

- The 4x4 ON mode provides four-wheel drive with full power to both axles at all times. It is only intended for severe or off-road driving conditions, such as deep snow and ice (where no dry or wet pavement remains uncovered) and shallow sand or mud.

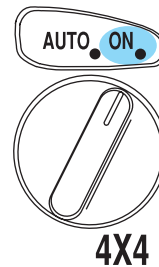

- **The vehicle should not be operated in the 4x4 ON mode on dry or merely wet pavement. Doing so will produce excessive noise, increase tire wear and may damage driveline components. The 4x4 ON mode is intended for use only on consistently slippery or loose surfaces.**
- **If your vehicle is equipped with this 4x4 system, a spare tire of a different diameter than the road tires should never be used. Such a tire could result in damage to driveline components and make the vehicle difficult to control.**



Utility and four-wheel drive vehicles are **not** designed for cornering at speeds as high as passenger cars any more than low-slung sports cars are designed to perform satisfactorily under off-road conditions. Avoid sharp turns or abrupt maneuvers in these vehicles.

4x4 system indicator lights

The 4x4 mode indicator light illuminates only under the following conditions. If the indicator light illuminates when driving in the 4x4 AUTO mode, contact your Ford dealer as soon as possible.

This light steadily illuminates when the 4x4 ON mode is engaged.

4x4

Shifting between 4x4 Auto and ON modes

Switch the four-wheel drive control to 4x4 ON to apply power to both axles. When you activate the control to 4x4 ON, the indicator light will illuminate in the instrument cluster.

When you switch the control back to 4x4 AUTO for normal on-road operating conditions, the indicator light is activated and will turn off.

Either shift can be done at a stop or while driving at any speed.

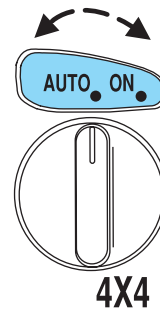

Driving off-road with truck and utility vehicles

4x4 vehicles are specially equipped for driving on sand, snow, mud and rough terrain and have operating characteristics that are somewhat different from conventional vehicles, both on and off the road.

How your vehicle differs from other vehicles

Truck and utility vehicles can differ from some other vehicles. Your vehicle may be higher to allow it to travel over rough terrain without getting hung up or damaging underbody components.

The differences that make your vehicle so versatile also make it handle differently than an ordinary passenger car.

Maintain steering wheel control at all times, especially in rough terrain. Since sudden changes in terrain can result in abrupt steering wheel motion, make sure you grip the steering wheel from the outside. Do not grip the spokes.

Driving

Drive cautiously to avoid vehicle damage from concealed objects such as rocks and stumps.

You should either know the terrain or examine maps of the area before driving. Map out your route before driving in the area. To maintain steering and braking control of your vehicle, you must have all four wheels on the ground and they must be rolling, not sliding or spinning.

Basic operating principles

- Drive slower in strong crosswinds which can affect the normal steering characteristics of your vehicle.
- Be extremely careful when driving on pavement made slippery by loose sand, water, gravel, snow or ice.

If your vehicle goes off the edge of the pavement

- If your vehicle goes off the edge of the pavement, slow down, but avoid severe brake application, ease the vehicle back onto the pavement only after reducing your speed. Do not turn the steering wheel too sharply while returning to the road surface.
- It may be safer to stay on the apron or shoulder of the road and slow down gradually before returning to the pavement. You may lose control if you do not slow down or if you turn the steering wheel too sharply or abruptly.
- It often may be less risky to strike small inanimate objects, such as highway reflectors, with minor damage to your vehicle rather than attempt a sudden return to the pavement which could cause the vehicle to slide sideways out of control or roll over. Remember, your safety and the safety of others should be your primary concern.

If your vehicle gets stuck

If the vehicle is stuck it may be rocked out by shifting from forward and reverse gears, stopping between shifts, in a steady pattern. Press lightly on the accelerator in each gear.

Do not rock the vehicle for more than a few minutes or damage to the transmission and tires may occur or the engine may overheat.



Do not spin the wheels at over 56 km/h (35 mph). The tires may fail and injure a passenger or bystander.

Emergency maneuvers

- In an unavoidable emergency situation where a sudden sharp turn must be made, remember to avoid “over-driving” your vehicle, i.e., turn the steering wheel only as rapidly and as far as required to avoid the emergency. Excessive steering will result in less vehicle control, not more. Additionally, smooth variations of the accelerator and/or brake pedal pressure should be utilized if changes in vehicle speed are called for. Avoid abrupt steering, acceleration or braking. Use all available road surface to return the vehicle to a safe direction of travel.
- In the event of an emergency stop, avoid skidding the tires and do not attempt any sharp steering wheel movements.
- If the vehicle goes from one type of surface to another (i.e., from concrete to gravel) there will be a change in the way the vehicle responds to a maneuver (steering, acceleration or braking). Again, avoid these abrupt inputs.

Sand

When driving over sand, try to keep all four wheels on the most solid area of the trail. Avoid reducing the tire pressures but shift to a lower gear and drive steadily through the terrain. Apply the accelerator slowly and avoid spinning the wheels.

If you must reduce the tire pressure for whatever reason in sand, make sure you re-inflate the tires as soon as possible.

Avoid excessive speed because vehicle momentum can work against you and cause the vehicle to become stuck to the point that assistance may be required from another vehicle. Remember, you may be able to back out the way you came if you proceed with caution.

Driving

Mud and water

If you must drive through high water, drive slowly. Traction or brake capability may be limited.

When driving through water, determine the depth; avoid water higher than the bottom of the hubs (if possible) and proceed slowly. If the ignition system gets wet, the vehicle may stall.

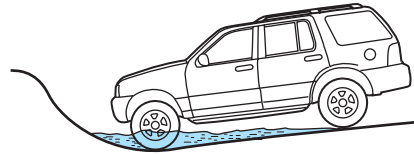

Once through water, always try the brakes. Wet brakes do not stop the vehicle as effectively as dry brakes. Drying can be improved by moving your vehicle slowly while applying light pressure on the brake pedal.

Be cautious of sudden changes in vehicle speed or direction when you are driving in mud. Even 4x4 vehicles can lose traction in slick mud. As when you are driving over sand, apply the accelerator slowly and avoid spinning your wheels. If the vehicle does slide, steer in the direction of the slide until you regain control of the vehicle.

If the transmission, transfer case or front axle are submerged in water, their fluids should be checked and changed, if necessary.

Water intrusion into the transmission may damage the transmission.

If the front or rear axle is submerged in water, the axle lubricant should be replaced.

After driving through mud, clean off residue stuck to rotating driveshafts and tires. Excess mud stuck on tires and rotating driveshafts causes an imbalance that could damage drive components.

“Tread Lightly” is an educational program designed to increase public awareness of land-use regulations and responsibilities in our nation's wilderness areas. Ford joins the U.S.

Forest Service and the Bureau of Land Management in encouraging you to help preserve our national forest and other public and private lands by “treading lightly.”



Driving on hilly or sloping terrain

Although natural obstacles may make it necessary to travel diagonally up or down a hill or steep incline, you should always try to drive straight up or straight down. **Avoid driving crosswise or turning on steep slopes or hills.** A danger lies in losing traction, slipping sideways and possibly rolling over. Whenever driving on a hill, determine beforehand the route you will use. Do not drive over the crest of a hill without seeing what conditions are on the other side. Do not drive in reverse over a hill without the aid of an observer.

When climbing a steep slope or hill, start in a lower gear rather than downshifting to a lower gear from a higher gear once the ascent has started. This reduces strain on the engine and the possibility of stalling.

If you do stall out, Do not try to turnaround because you might roll over. It is better to back down to a safe location.

Apply just enough power to the wheels to climb the hill. Too much power will cause the tires to slip, spin or lose traction, resulting in loss of vehicle control.

Descend a hill in the same gear you would use to climb up the hill to avoid excessive brake application and brake overheating. Do not descend in neutral, disengage overdrive or manually shift to a lower gear. When descending a steep hill, avoid sudden hard braking as you could lose control.

When you brake hard, the front wheels can't turn and if they aren't turning, you won't be able to steer.

The front wheels have to be turning in order to steer the vehicle. Rapid pumping of the brake pedal will help you slow the vehicle and still maintain steering control.

If your vehicle has anti-lock brakes, apply the brakes steadily. Do not "pump" the brakes.

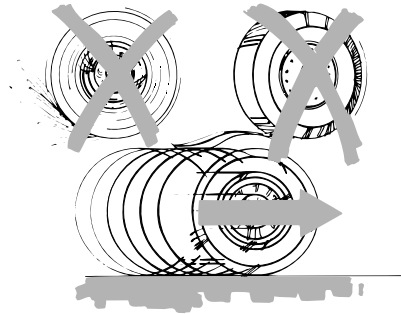
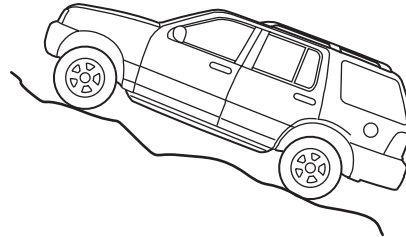

Driving

Driving on snow and ice

4x4 vehicles have advantages over 2WD vehicles in snow and ice but can skid like any other vehicle.

Should you start to slide while driving on snowy or icy roads, turn the steering wheel in the direction of the slide until you regain control.

Avoid sudden applications of power and quick changes of direction on snow and ice. Apply the accelerator slowly and steadily when starting from a full stop.

Avoid sudden braking as well. Although a 4x4 vehicle may accelerate better than a two-wheel drive vehicle in snow and ice, it won't stop any faster, because as in other vehicles, braking occurs at all four wheels. Do not become overconfident as to road conditions.

Make sure you allow sufficient distance between you and other vehicles for stopping as well as drive slower than usual and consider using one of the lower gears. In emergency stopping situations, avoid locking of the wheels. Use a "squeeze" technique, push on the brake pedal with a steadily increasing force which allows the wheels to brake yet continue to roll so that you may steer in the direction you want to travel. If you lock the wheels, release the brake pedal and repeat the squeeze technique. If your vehicle is equipped with a Four Wheel Anti-Lock Brake System (ABS), apply the brake steadily. Do not "pump" the brakes. Refer to the *Brakes* section of this chapter for additional information on the operation of the anti-lock brake system.

Never drive with chains on the front tires of 4x4 vehicles without also putting them on the rear tires. This could cause the rear to slide and swing around during braking.

Tires, Replacement Requirements

4x4 vehicles are equipped with tires designed to provide for safe ride and handling capability.

Do not use a size and type of tire and wheel other than that originally provided by Ford because it can affect the safety and performance of your vehicle, which could lead to loss of vehicle control or roll over and serious injury. Make sure all tires and wheels on the vehicle are of the same size, type, tread design, brand and load-carrying capacity. If you have questions regarding tire replacement, see an authorized Ford or Lincoln/Mercury dealer.

Driving

If you nevertheless decide to equip your 4x4 for off-road use with tires larger than what Ford recommends, you should not use these tires for highway driving.

If you use any tire/wheel combination not recommended by Ford, it may adversely affect vehicle handling and could cause steering, suspension, axle or transfer case failure.

Do not use "aftermarket lift kits" or other suspension modifications, whether or not they are used with larger tires and wheels.

These "aftermarket lift kits" could adversely affect the vehicle's handling characteristics, which could lead to loss of vehicle control or roll over and serious injury.

Tires can be damaged during off-road use. For your safety, tires that are damaged should not be used for highway driving because they are more likely to blow out or fail.

You should carefully observe the recommended tire inflation pressure found on the safety compliance certification label attached to the left front door lock facing or door latch post pillar. Failure to follow tire pressure recommendations can adversely affect the way your vehicle handles. Do not exceed the Ford recommended pressure even if it is less than the maximum pressure allowed for the tire.

Each day before you drive, check your tires. If one looks lower than the others, use a tire gauge to check pressure of all tires, and adjust if required. Check tire pressure with a tire gauge every few weeks (including spare). Safe operation requires tires that are neither underinflated nor overloaded.

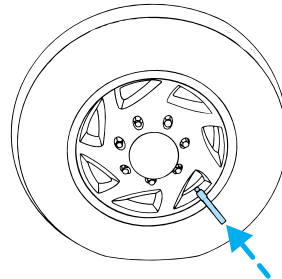

Periodically inspect the tire treads and remove stones, nails, glass or other objects that may be wedged in the tread grooves. Check for holes or cuts that may permit air leakage from the tire and make necessary repairs.

Inspect the tire side walls for cuts, bruises and other damage. If internal damage to the tire is suspected, have the tire demounted and inspected in case it needs to be repaired or replaced.

Driving

Maintenance and Modifications

The suspension and steering systems on your vehicle have been designed and tested to provide both reasonably safe, predictable performance whether loaded or empty and durable load carrying capability. For this reason, Ford strongly recommends that you do not make modifications such as adding or removing parts (such as lift kits or stabilizer bars) or by using replacement parts not equivalent to the original factory equipment.

Any modifications to a vehicle that raise the center of gravity can make it more likely the vehicle will roll over as a result of a loss of control. Ford recommends that caution be used with any vehicle equipped with a high load or device (such as ladder racks or pickup box cover).

Failure to maintain your vehicle properly may void the warranty, increase your repair cost, reduce vehicle performance and operational capabilities and adversely affect driver and passenger safety. Frequent inspection of vehicle chassis components is recommended if the vehicle is subjected to heavy off-road usage.

DRIVING THROUGH WATER

Do not drive quickly through standing water, especially if the depth is unknown. Traction or brake capability may be limited and if the ignition system gets wet, your engine may stall. Water may also enter your engine's air intake and severely damage your engine.

If driving through deep or standing water is unavoidable, proceed very slowly. Never drive through water that is higher than the bottom of the hubs.

Once through the water, always try the brakes. Wet brakes do not stop the vehicle as effectively as dry brakes. Drying can be improved by moving your vehicle slowly while applying light pressure on the brake pedal.

Driving through deep water where the transaxle is submerged may allow water into the transaxle and cause internal damage.

VEHICLE LOADING

Before loading a vehicle, familiarize yourself with the following terms:

- **Base Curb Weight:** Weight of the vehicle including any standard equipment, fluids, lubricants, etc. It does not include occupants or aftermarket equipment.

Driving

- **Payload:** Combined maximum allowable weight of cargo, occupants and optional equipment. The payload equals the gross vehicle weight rating minus base curb weight.
- **GVW (Gross Vehicle Weight):** Base curb weight plus payload weight. The GVW is not a limit or a specification.
- **GVWR (Gross Vehicle Weight Rating):** Maximum permissible total weight of the base vehicle, occupants, optional equipment and cargo. The GVWR is specific to each vehicle and is listed on the Safety Certification Label on the driver's door pillar.
- **GAWR (Gross Axle Weight Rating):** Carrying capacity for each axle system. The GAWR is specific to each vehicle and is listed on the Safety Certification Label on the driver's door pillar.
- **GCW (Gross Combined Weight):** The combined weight of the towing vehicle (including occupants and cargo) and the loaded trailer.
- **GCWR (Gross Combined Weight Rating):** Maximum permissible combined weight of towing vehicle (including occupants and cargo) and the loaded trailer
- **Maximum Trailer Weight Rating:** Maximum weight of a trailer the vehicle is permitted to tow. The maximum trailer weight rating is determined by subtracting the vehicle curb weight for each engine/transmission combination, any required option weight for trailer towing and the weight of the driver from the GCWR for the towing vehicle.
- **Maximum Trailer Weight:** Maximum weight of a trailer the loaded vehicle (including occupants and cargo) is permitted to tow. It is determined by subtracting the weight of the loaded trailer towing vehicle from the GCWR for the towing vehicle.
- **Trailer Weight Range:** Specified weight range that the trailer must fall within that ranges from zero to the maximum trailer weight rating.

Remember to figure in the tongue load of your loaded trailer when figuring the total weight.



Do not exceed the GVWR or the GAWR specified on the certification label.

Do not use replacement tires with lower load carrying capacities than the originals because they may lower the vehicle's GVWR and GAWR limitations. Replacement tires with a higher limit than the originals do not increase the GVWR and GAWR limitations.

Driving

The Safety Certification Label, found on the driver's door pillar, lists several important vehicle weight rating limitations. Before adding any additional equipment, refer to these limitations. If you are adding weight to the front of your vehicle, (potentially including weight added to the cab), the weight added should not exceed the front axle reserve capacity (FARC). Additional frontal weight may be added to the front axle reserve capacity provided you limit your payload in other ways (i.e. restrict the number of occupants or amount of cargo carried).

Always ensure that the weight of occupants, cargo and equipment being carried is within the weight limitations that have been established for your vehicle including both gross vehicle weight and front and rear gross axle weight rating limits. Under no circumstance should these limitations be exceeded.



Exceeding any vehicle weight rating limitation could result in serious damage to the vehicle and/or personal injury.

Special loading instructions for owners of pickup trucks and utility-type vehicles



For important information regarding safe operation of this type of vehicle, see the **Preparing to drive your vehicle** section in this chapter.



Loaded vehicles, with a higher center of gravity, may handle differently than unloaded vehicles. Extra precautions, such as slower speeds and increased stopping distance, should be taken when driving a heavily loaded vehicle.

Your vehicle has the capability to haul more cargo and people than most passenger cars. Depending upon the type and placement of the load, hauling cargo and people may raise the center of gravity of the vehicle.

Calculating the load your vehicle can carry/tow

1. Use the appropriate maximum gross combined weight rating (GCWR) chart to find the maximum GCWR for your type engine and rear axle ratio.
2. Weigh your vehicle as you customarily operate the vehicle without cargo. To obtain correct weights, try taking your vehicle to a shipping company or an inspection station for trucks.
3. Subtract your loaded vehicle weight from the maximum GCWR on the following charts. This is the maximum trailer weight your vehicle can tow and must fall below the maximum shown under maximum trailer weight on the chart.

TRAILER TOWING

Trailer towing with your vehicle may require the use of a trailer tow option package.

Trailer towing puts additional loads on your vehicle's engine, transaxle, axle, brakes, tires, and suspension. For your safety and to maximize vehicle performance, be sure to use the proper equipment while towing.

Follow these guidelines to ensure safe towing procedure:

- Stay within your vehicle's load limits.
- Thoroughly prepare your vehicle for towing. Refer to *Preparing to tow* in this chapter.
- Use extra caution when driving while trailer towing. Refer to *Driving while you tow* in this chapter.
- Service your vehicle more frequently if you tow a trailer. Refer to the severe duty schedule in the scheduled maintenance guide.
- Do not tow a trailer until your vehicle has been driven at least 800 km (500 miles).
- Refer to the instructions included with towing accessories for the proper installation and adjustment specifications.

Do not exceed the maximum loads listed on the Certification label. For load specification terms found on the label, refer to *Vehicle loading* in this chapter. Remember to figure in the tongue load of your loaded vehicle when figuring the total weight.

Driving

4x2			
GCWR (Gross Combined Weight Rating)/Trailer Weights			
Engine	Maximum GCWR - kg (lbs.)	Trailer Weight Range - kg (lbs.)	Maximum frontal area of trailer - m ² (ft) ²
2.0L w/manual transmission	1 886 (4 160)	453 (1 000)	2.2 (24)
3.0L w/automatic transmission	2 413 (5 320)	907 (2 000)	2.2 (24)
3.0L w/automatic transmission and towing package	3 111 (6 860)	1 587 (3 500)	2.8 (30)
4x4			
GCWR (Gross Combined Weight Rating)/Trailer Weights			
Engine	Maximum GCWR - kg (lbs.)	Trailer Weight Range - kg (lbs.)	Maximum frontal area of trailer - m ² (ft) ²
2.0L w/manual transmission	1 941 (4 280)	453 (1 000)	2.2 (24)
3.0L w/automatic transmission	2 485 (5 480)	907 (2 000)	2.2 (24)
3.0L w/automatic transmission and towing package	3 184 (7 020)	1 587 (3 500)	2.8 (30)
<p>Notes: For high altitude operation, reduce GCW by 2% per 300 meters (1000 ft.) elevation. For definitions of terms and instructions on calculating your vehicle's load, refer to <i>Vehicle Loading</i> in this chapter. Maximum trailer weights shown. The combined weight of the completed towing vehicle and the loaded trailer must not exceed the GCWR.</p>			



Do not exceed the GVWR or the GAWR specified on the certification label.

Driving



Towing trailers beyond the maximum recommended gross trailer weight exceeds the limit of the vehicle and could result in engine damage, transmission damage, structural damage, loss of control, and personal injury.

Preparing to tow

Use the proper equipment for towing a trailer, and make sure it is properly attached to your vehicle. See your dealer or a reliable trailer dealer if you require assistance.

Hitches

Do not use hitches that clamp onto the vehicle bumper. Use a load carrying hitch. You must distribute the load in your trailer so that 10% of the total weight of the trailer is on the tongue.

Safety chains

Always connect the trailer's safety chains to hook retainers on the vehicle. To connect the trailer's safety chains, cross the chains under the trailer tongue and allow slack for turning corners.

If you use a rental trailer, follow the instructions that the rental agency gives to you.

Do not attach safety chains to the bumper.

Trailer brakes

Electric brakes and manual, automatic or surge-type trailer brakes are safe if installed properly and adjusted to the manufacturer's specifications. The trailer brakes must meet local and Federal regulations.



Do not connect a trailer's hydraulic brake system directly to your vehicle's brake system. Your vehicle may not have enough braking power and your chances of having a collision greatly increase.

The braking system of the tow vehicle is rated for operation at the GVWR not GCWR.

Driving

Trailer lamps

Trailer lamps are required on most towed vehicles. Make sure your trailer lamps conform to local and Federal regulations. See your dealer or trailer rental agency for proper instructions and equipment for hooking up trailer lamps.

Driving while you tow

When towing a trailer:

- Ensure that you turn off your speed control. The speed control may shut off automatically when you are towing on long, steep grades.
- Consult your local motor vehicle speed regulations for towing a trailer.
- Use a lower gear when towing up or down steep hills. This will eliminate excessive downshifting and upshifting for optimum fuel economy and transmission cooling.
- Anticipate stops and brake gradually.

Exceeding the GCWR rating may cause internal transmission damage and void your warranty coverage.

Servicing after towing

If you tow a trailer for long distances, your vehicle will require more frequent service intervals. Refer to your scheduled maintenance guide for more information.

Trailer towing tips

- Practice turning, stopping and backing up before starting on a trip to get the feel of the vehicle trailer combination. When turning, make wider turns so the trailer wheels will clear curbs and other obstacles.
- Allow more distance for stopping with a trailer attached.
- The trailer tongue weight should be no more than 10–15% of the loaded trailer weight.
- After you have traveled 80 km (50 miles), thoroughly check your hitch, electrical connections and trailer wheel lug nuts.
- When stopped in traffic for long periods of time in hot weather, place the gearshift in P (Park) (automatic transmissions) or N (Neutral) (manual transmissions). This aids engine cooling and air conditioner efficiency.

- Vehicles with trailers should not be parked on a grade. If you must park on a grade, place wheel chocks under the trailer's wheels.

Launching or retrieving a boat

When backing down a ramp during boat launching or retrieval:

- do not allow the static water level to rise above the bottom edge of the rear bumper.
- do not allow waves to break higher than 15 cm (6 inches) above the bottom edge of the rear bumper.

Exceeding these limits may allow water to enter critical vehicle components, adversely affecting driveability, emissions, reliability and causing internal transmission damage.

Replace the rear axle lubricant any time the axle has been submerged in water. Rear axle lubricant quantities are not to be checked or changed unless a leak is suspected or repair required.

Disconnect the wiring to the trailer before backing the trailer into the water. Reconnect the wiring to the trailer after the trailer is removed from the water.

RECREATIONAL TOWING

An example of “recreational towing” is towing your vehicle behind a motorhome.

If your vehicle is automatic transmission equipped, with a 4x2 (front-wheel drive only) configured powertrain, “recreational towing” is permitted by trailering the vehicle with its front wheels on a dolly. This protects the transmission's internal mechanical components from potential lack of lubrication damage.

If your vehicle is automatic transmission equipped, with a 4x4 (all-wheel drive) configured powertrain, “recreational towing” is permitted only if the vehicle is trailered with all four (4) wheels off the ground. Otherwise, no “recreational towing” is permitted.

If your vehicle is manual transmission equipped, shifting the transmission into neutral permits “flat-towing” (all wheels on the ground) for pulling behind a motorhome. Your vehicle may be towed up to a speed of 120 km/h (75 mph) but you should always obey local speed limits.

For other towing requirements, refer to *Wrecker Towing* in the *Roadside emergencies* chapter.

Roadside Emergencies

GETTING ROADSIDE ASSISTANCE

To fully assist if you should have a vehicle concern, Ford Motor Company offers a complimentary roadside assistance program. This program is separate from the New Vehicle Limited Warranty. The service is available:

- 24-hours, seven days a week
- for the Basic warranty period (Canada) or New Vehicle Limited Warranty period (U.S.) of three years or 60 000 km (36 000 miles), whichever comes first on Ford and Mercury vehicles, and four years or 80 000 km (50 000 miles) on Lincoln vehicles

Roadside assistance will cover:

- changing a flat tire
- jump-starts
- lock-out assistance
- limited fuel delivery*
- towing of your disabled vehicle to the nearest Ford Motor Company dealership, or your selling dealer if within 25 kms (15.5 miles) of the nearest Ford Motor Company dealership (one tow per disablement). Even non-warranty related tows, like accidents or getting stuck in the mud or snow, are covered (some exclusions apply, such as impound towing or repossession).

* Canadian customers refer to your Owner Information Guide for exact fuel amounts.

USING ROADSIDE ASSISTANCE

Complete the roadside assistance identification card and place it in your wallet for quick reference. In the United States, this card is found in the Owner Guide portfolio in the glove compartment. In Canada, the card is found in the Roadside Assistance book in the glove compartment.

U.S. Mazda vehicle customers who require roadside assistance, call 1-800-241-3673.

Canadian customers who require roadside assistance, call 1-800-665-2006.

If you need to arrange roadside assistance for yourself, Mazda Corporation will reimburse a reasonable amount. To obtain reimbursement information, U.S. Mazda vehicle customers call 1-800-241-3673.

Canadian customers who need to obtain reimbursement information, call 1-800-665-2006.

Roadside Emergencies

ROADSIDE COVERAGE BEYOND BASIC WARRANTY

In the United States, you may purchase additional roadside assistance coverage beyond this period through the Mazda Auto Club by contacting your Mazda dealer.

Similarly in Canada, for uninterrupted Roadside Assistance coverage, you may purchase extended coverage prior to your Basic Warranty's Roadside Assistance expiring. For more information and enrollment, contact 1-877-294-2582 or visit our website at www.mazda.ca.

HAZARD FLASHER CONTROL

Use only in an emergency to warn traffic of vehicle breakdown, approaching danger, etc. The hazard flashers can be operated when the ignition is off.

- The hazard lights control is located on the instrument panel by the radio.
- Depress hazard lights control to activate all hazard flashers simultaneously.
- Depress control again to turn the flashers off.

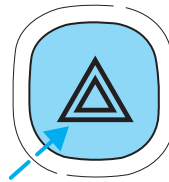

FUEL PUMP SHUT-OFF SWITCH FUEL RESET

The fuel pump shut-off switch is a device intended to stop the electric fuel pump when your vehicle has been involved in a substantial jolt.

After a collision, if the engine cranks but does not start, the fuel pump shut-off switch may have been activated.

Roadside Emergencies

The fuel pump shut-off switch is located in the front passenger's foot well, behind the kick panel. The reset button for the fuel pump shut-off switch is accessible through an opening in the kick panel.

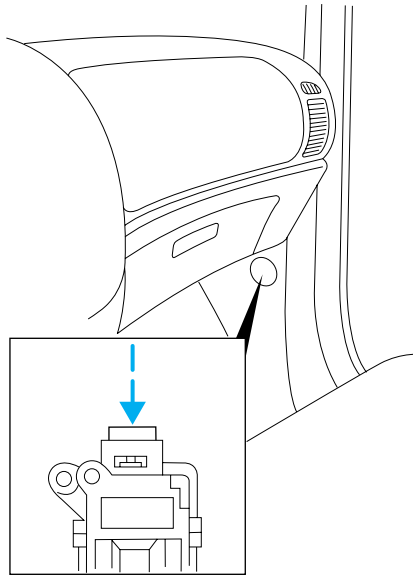

Use the following procedure to reset the fuel pump shut-off switch.

1. Turn the ignition to the OFF position.
2. Check the fuel system for leaks.
3. If no fuel leak is apparent, reset the fuel pump shut-off switch by pushing in, i.e. down on the reset button.
4. Turn the ignition to the ON position. Pause for a few seconds and return the key to the OFF position.
5. Make a further check for leaks in the fuel system.

Roadside Emergencies

FUSES AND RELAYS

Fuses

If electrical components in the vehicle are not working, a fuse may have blown. Blown fuses are identified by a broken wire within the fuse. Check the appropriate fuses before replacing any electrical components.

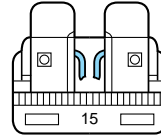

Note: Always replace a fuse with one that has the specified amperage rating. Using a fuse with a higher amperage rating can cause severe wire damage and could start a fire.

Standard fuse amperage rating and color

COLOR					
Fuse rating	Mini fuses	Standard fuses	Maxi fuses	Cartridge maxi fuses	Fuse link cartridge
2A	Grey	Grey	—	—	—
3A	Violet	Violet	—	—	—
4A	Pink	Pink	—	—	—
5A	Tan	Tan	—	—	—
7.5A	Brown	Brown	—	—	—
10A	Red	Red	—	—	—
15A	Blue	Blue	—	—	—
20A	Yellow	Yellow	Yellow	Blue	Blue
25A	Natural	Natural	—	—	—
30A	Green	Green	Green	Pink	Pink
40A	—	—	Orange	Green	Green
50A	—	—	Red	Red	Red
60A	—	—	Blue	—	Yellow
70A	—	—	Tan	—	Brown
80A	—	—	Natural	—	Black

Roadside Emergencies

Passenger compartment fuse panel

The fuse panel is located on the left hand side kick panel. Remove the panel cover to access the fuses.

To remove a fuse use the fuse puller tool provided on the fuse panel cover.

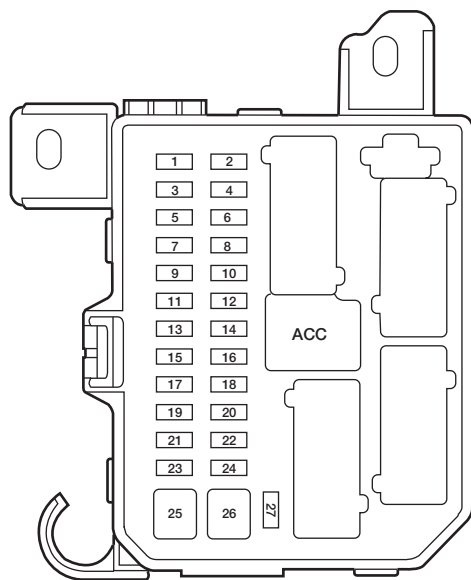

The fuses are coded as follows:

Fuse/Relay Location	Fuse Amp Rating	Passenger Compartment Fuse Panel Description
1	5A	Canister Vent Control Solenoid
2	5A	Blower Relay (coil), Rear Defrost Relay (coil), Pressure Switch to PCM
3	10A	Rear Wiper Motor, Rear Washer Motor, Rear Wiper Relay (coil)

Roadside Emergencies

Fuse/Relay Location	Fuse Amp Rating	Passenger Compartment Fuse Panel Description
4	10A	Four Wheel Drive Control Module, Cluster (Restraints Control Warning)
5	5A	ABS Unit (EVAC & FILL), ASC Unit, Restraints Control Module, ASC Main SW to ASC Unit
6	10A	Flasher Unit, Left reversing Lamp, Right Reversing Lamp
7	10A	Passive Anti-theft Transceiver (PATS), Restraints Control Module
8	10A	Cluster, Shift Lock Relay (coil), O/D signal to PCM
9	3A	PCM Relay (coil), Fan Relay 1, 2, 3 (coil), A/C Relay (coil)
10	20A	Front Wiper Motor, Front Washer Motor, INT Relay
11	10A	IGN Relay (coil), ACC Relay (coil), Starter Relay (coil), Key Interlock Solenoid, GEM
12	5A	Radio, Clock
13	—	Not Used
14	20A	Cigar Lighter
15	15A	Left Front Position Lamp, Right Front Position Lamp, Left License Lamp, Right License Lamp, Left Tail Lamp, Right Tail Lamp, Park Lamp Relay (coil), Trailer Fuse, Illumination Fuse
16	10A	Cluster, Power Mirror, GEM
17	15A	Sun Roof Motor

Roadside Emergencies

Fuse/Relay Location	Fuse Amp Rating	Passenger Compartment Fuse Panel Description
18	5A	Illumination for: Cluster, Heater Unit, Radio, Hazard Switch, Rear Defrost Switch, 4WD Switch, Front Fog Switch
19	10A	Subwoofer Amp
20	15A	Left/Right Turn Indicators, Left/Right Front Side Turn Lamps, Left/Right Front turn Lamps, Left/Right Rear Turn Lamps, Left/Right Trailer Turn, Flasher Unit
21	10A	Left /Right Trailer Position Lamps
22	15A	Not Used
23	20A	Left/Right Horn
24	15A	Left/Right Stoplamps, High Mounted Stoplamp, Left/Right Trailer Stoplamp, ABS Unit, ASC Unit (Brake Pedal Position Switch), PCM, Shift Solenoid
25	30A	Power Window Motor - Right Front, Left Front, Right Rear, Left Rear
26	30A	Power Door Lock Motor - Right Front, Left Front, Right Rear, Left Rear, GEM (Door Lock Relay Coil), Power Seat
27	10A	Audio, Cluster, Interior Lamp, Map Lamp Cargo Lamp
ACC	—	Accessory Relay

Roadside Emergencies

Power distribution box

The power distribution box is located in the engine compartment. The power distribution box contains high-current fuses that protect your vehicle's main electrical systems from overloads.

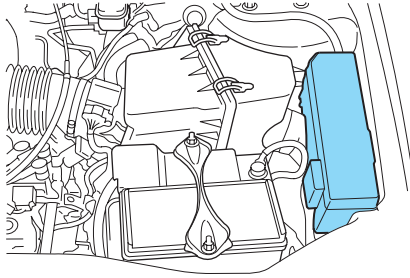

Always disconnect the battery before servicing high current fuses.



To reduce risk of electrical shock, always replace the cover to the Power Distribution Box before reconnecting the battery or refilling fluid reservoirs.

If the battery has been disconnected and reconnected, refer to the *Battery* section of the *Maintenance and specifications* chapter.

Roadside Emergencies

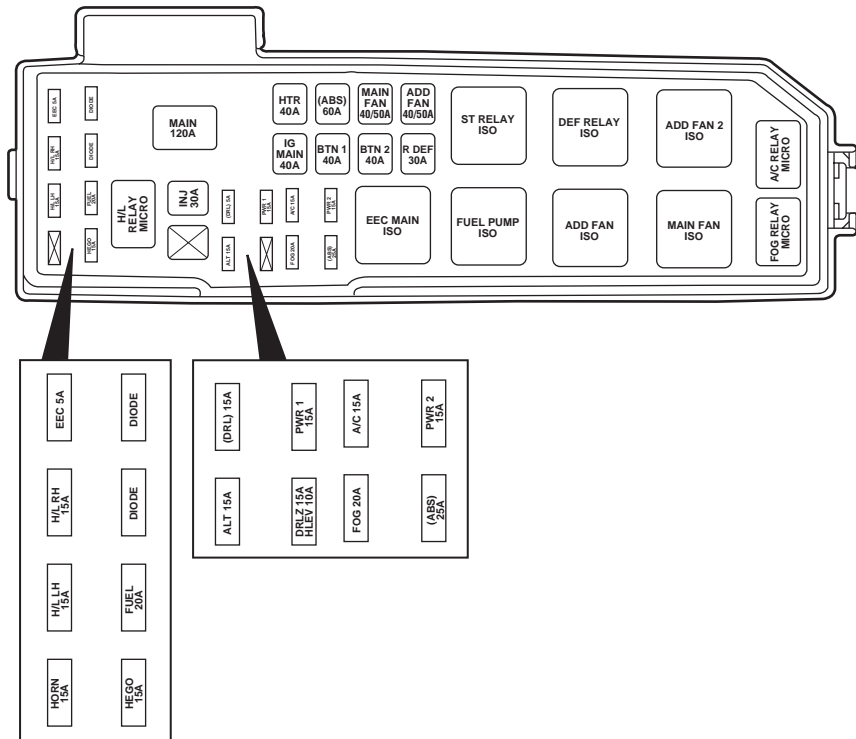

The high-current fuses are coded as follows.

Fuse/Relay Location	Fuse Amp Rating	Power Distribution Box Description
Horn	15A	Horn
H/L LH	15A*	Headlamp (High/Low Left, High Beams)
H/L RH	15A*	Headlamp (High/Low Right, High Beams)
EEC	5A*	EEC (KPWR)
HEGO	15A*	HEGO 1,2, CMS 1,2, VMV

Roadside Emergencies

Fuse/Relay Location	Fuse Amp Rating	Power Distribution Box Description
FUEL	20A*	Fuel Pump, EEC (FPM)
DIODE	—	—
DIODE	—	—
H/L RELAY MICRO	—	Headlamp (High/Low, Right/Left Relay)
—	—	—
INJ	30A**	EEC (VPWR), EVR, MAF, IAC, Bulkhead
MAIN	120A	Main
ALT	15A*	Alternator/ Regulator
(DRL)	15A*	DRL Unit (feed), DRL Relay
(DRLZ) (HLEV)	15A*(DRLZ) 10A(HLEV)	Daytime Running Lamps (DRL) Module, HLEV
PWR 1	15A*	Auxiliary Power Point
FOG	20A*	Fog lamps RH/LH, Foglamp Indicator
A/C	15A*	A/C Clutch
(ABS)	25A*	Anti-Lock Brake System SOL
PWR 2	15A*	Auxiliary Power Point
IG MAIN	40A**	Starter
HTR	40A**	Blower Motor, Blower Motor Relay
BTN 1	40A**	JB — Acc. Relay, Radio, Clock, Cigar Lighter, Cluster, Power Mirror, GEM
(ABS)	60A**	Anti-Lock Brake System Motor
BTN 2	40A**	JB — Radio, CD Changer, Cluster, Dome Lamps, Map Lamps, Cargo Lamps
MAIN FAN	40A** (2.0 L) 50A(3.0 L)	Main Fan
R DEF	30A**	Rear Defroster

Roadside Emergencies

Fuse/Relay Location	Fuse Amp Rating	Power Distribution Box Description
ADD FAN	40A**(2.0 L) 50A(3.0 L)	Add Fan
EEC MAIN ISO	—	EEC Relay
FUEL PUMP ISO	—	Fuel Pump Relay
MAIN FAN ISO	—	Low Speed Fan Control Relay (2.0L Engine) High Speed Fan Control Relay 1 (3.0L Engine)
ADD FAN ISO	—	High Speed Fan Control Relay 1 (2.0L Engine) Low Speed Fan Control Relay (3.0L Engine)
DEF RELAY ISO	—	Rear Defroster Relay
ST RELAY ISO	—	Starter Relay
ADD FAN 2 ISO	—	High Speed Fan Control Relay 2 (3.0L Engine) Medium Speed Fan Control Relay (2.0L Engine)
FOG RELAY MICRO	—	Foglamp Relay
A/C RELAY MICRO	—	A/C Clutch Relay

Roadside Emergencies

CHANGING THE TIRES

If you get a flat tire while driving, do not apply the brake heavily. Instead, gradually decrease your speed. Hold the steering wheel firmly and slowly move to a safe place on the side of the road.

Temporary spare tire information

The temporary spare tire for your vehicle is labeled as such. It is smaller than a regular tire and is designed for emergency use only.



If you use the temporary spare tire continuously or do not follow these precautions, the tire could fail, causing you to lose control of the vehicle, possibly injuring yourself or others.

When driving with the temporary spare tire **do not:**

- exceed 80 km/h (50 mph) under any circumstances
- load the vehicle beyond maximum vehicle load rating listed on the Safety Compliance Label
- tow a trailer
- use tire chains
- try to repair the temporary spare tire or remove it from its wheel
- use the wheel for any other type of vehicle

Tire change procedure



When one of the front wheels is off the ground, the transmission alone will not prevent the vehicle from moving or slipping off the jack, even if the vehicle is in P (Park) (automatic transaxle) or R (Reverse) (manual transaxle).



To prevent the vehicle from moving when you change a tire, be sure the parking brake is set, then block (in both directions) the wheel that is diagonally opposite (other side and end of the vehicle) to the tire being changed.



If the vehicle slips off the jack, you or someone else could be seriously injured.

Roadside Emergencies

1. Park on a level surface, activate hazard flashers and place gearshift lever in P (Park) (automatic transmission) or R (Reverse) (manual transmission).

2. Set the parking brake and turn engine OFF.

3. Block the diagonally opposite wheel.

4. Lift the cargo cover and remove the tool bag with jack handle, lug nut wrench and long spare tire rod and spare tire from the wheel well.

5. Loosen each wheel lug nut one-half turn counterclockwise but do not remove them until the wheel is raised off the ground.

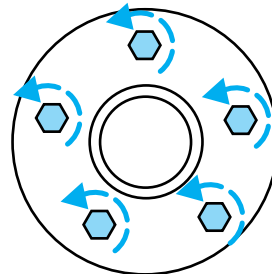
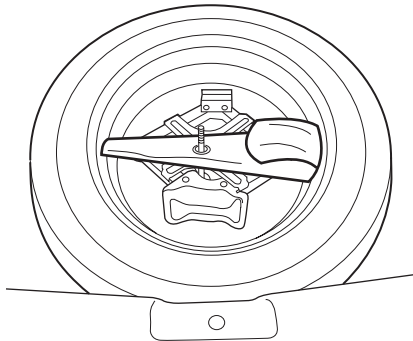
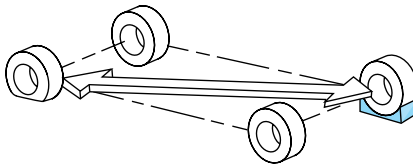
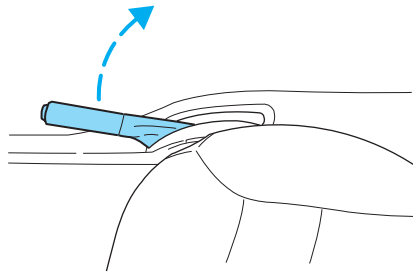

Roadside Emergencies

STOP Before placing the jack under the vehicle, NOTE the jack locations:

- **Front** jacking notches are located **under the front suspension arm.**

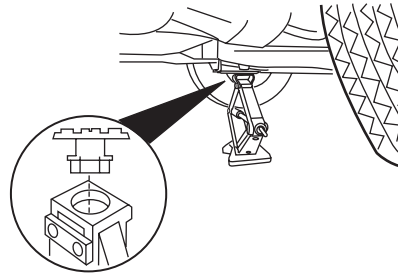

- **Rear** jacking notches are located **under the rear trailing arm.**

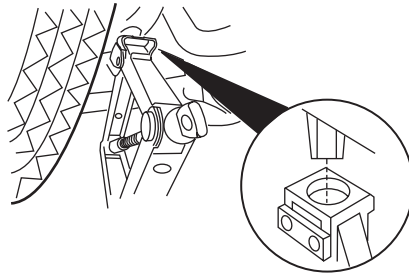

6. Position the jack according to the following guides and turn the jack handle clockwise until the tire is a maximum of 25 mm (1 inch) off the ground.

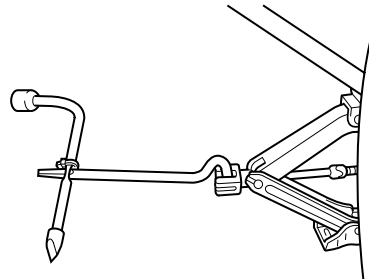

Roadside Emergencies

Never use the differentials as a jacking point.

 To lessen the risk of personal injury, do not put any part of your body under the vehicle while changing a tire. Do not start the engine when your vehicle is on the jack. The jack is only meant for changing the tire.

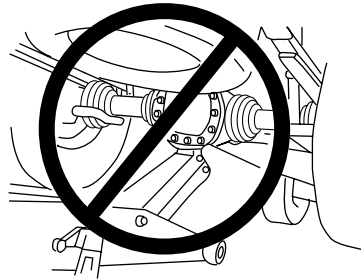

7. Remove the lug nuts with the lug nut wrench.
8. Replace the flat tire with the spare tire, making sure the valve stem is facing outward. Reinstall lug nuts until the wheel is snug against the hub. Do not fully tighten the lug nuts until the wheel has been lowered.
9. Lower the wheel by turning the jack handle counterclockwise.
10. Remove the jack and fully tighten the lug nuts in the order shown.

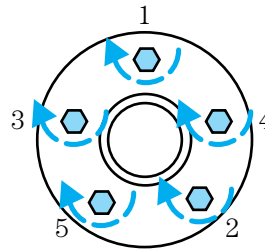

Roadside Emergencies

To stow the full size flat tire in the cargo floor, the long spare tire rod in the tool bag needs to be installed.

11. Using the lug wrench, remove the spare tire rod from the cargo floor and install the longer spare tire rod.

12. Put flat tire and tool bag with jack handle, lug nut wrench and spare tire rod away. Make sure jack is fastened so it does not rattle when you drive.

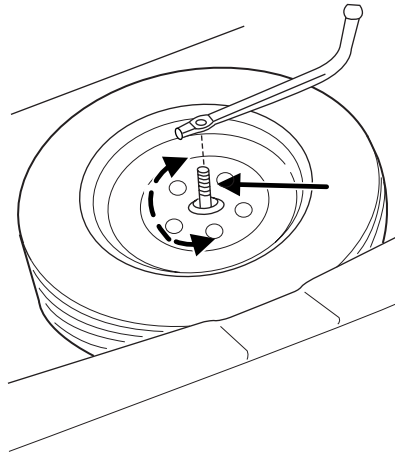

The cargo cover can not be reattached to the back seat clips when a full size tire is stowed.

13. Install cargo cover over the flat tire and secure with the plastic nut.

14. Unblock the wheels.

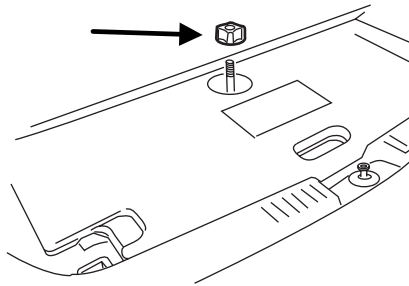

JUMP STARTING YOUR VEHICLE



The gases around the battery can explode if exposed to flames, sparks, or lit cigarettes. An explosion could result in injury or vehicle damage.



Batteries contain sulfuric acid which can burn skin, eyes, and clothing, if contacted.

Do not attempt to push-start your vehicle. Automatic transmissions do not have push-start capability; also, the catalytic converter may become damaged.

Roadside Emergencies

Preparing your vehicle

When the battery is disconnected or a new battery is installed, the transmission must relearn its adaptive strategy. As a result of this, the transmission may shift firmly. This operation is considered normal and will not affect function or durability of the transmission. Over time, the adaptive learning process will fully update transmission operation to its optimum shift feel.

1. **Use only a 12-volt supply to start your vehicle.**
2. Do not disconnect the battery of the disabled vehicle as this could damage the vehicle's electrical system.
3. Park the booster vehicle close to the hood of the disabled vehicle making sure the two vehicles **do not** touch. Set the parking brake on both vehicles and stay clear of the engine cooling fan and other moving parts.
4. Check all battery terminals and remove any excessive corrosion before you attach the battery cables. Ensure that vent caps are tight and level.
5. Turn the heater fan on in both vehicles to protect any electrical surges. Turn all other accessories off.

Connecting the jumper cables

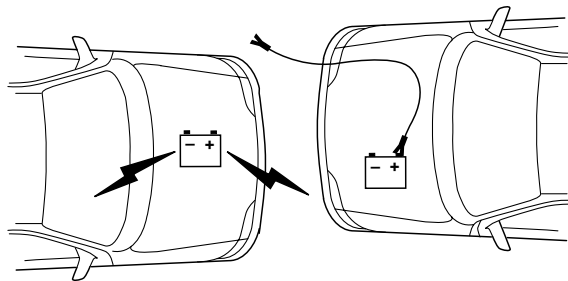

1. Connect the positive (+) booster cable to the positive (+) terminal of the discharged battery.

Note: In the illustrations, *lightning bolts* are used to designate the assisting (boosting) battery.

Roadside Emergencies

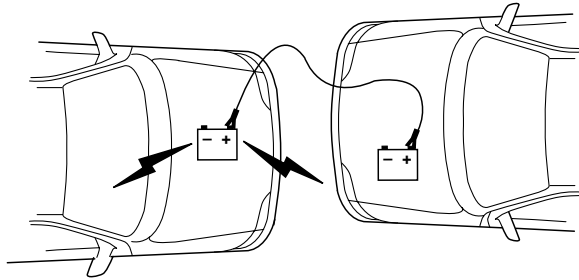

2. Connect the other end of the positive (+) cable to the positive (+) terminal of the assisting battery.

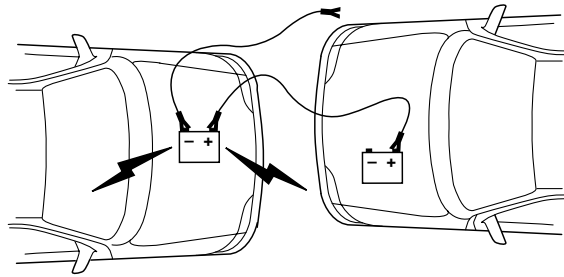

3. Connect the negative (-) cable to the negative (-) terminal of the assisting battery.

Roadside Emergencies

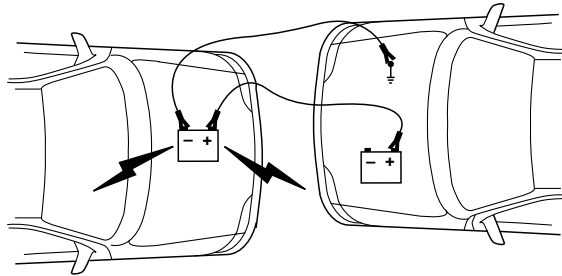

4. Make the final connection of the negative (-) cable to an exposed metal part of the stalled vehicle's engine, away from the battery and the carburetor/fuel injection system. **Do not** use fuel lines, engine rocker covers or the intake manifold as *grounding* points.



Do not connect the end of the second cable to the negative (-) terminal of the battery to be jumped. A spark may cause an explosion of the gases that surround the battery.

5. Ensure that the cables are clear of fan blades, belts, moving parts of both engines, or any fuel delivery system parts.

Jump starting

1. Start the engine of the booster vehicle and run the engine at moderately increased speed.
2. Start the engine of the disabled vehicle.
3. Once the disabled vehicle has been started, run both engines for an additional three minutes before disconnecting the jumper cables.

Roadside Emergencies

Removing the jumper cables

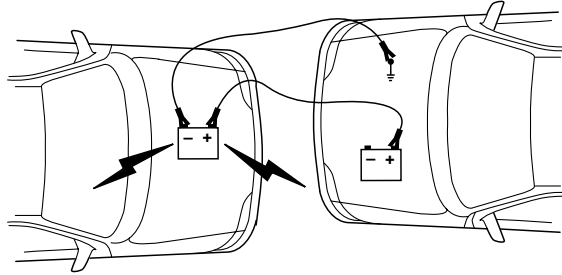

Remove the jumper cables in the reverse order that they were connected.

1. Remove the jumper cable from the *ground* metal surface.

Note: In the illustrations, *lightning bolts* are used to designate the assisting (boosting) battery.

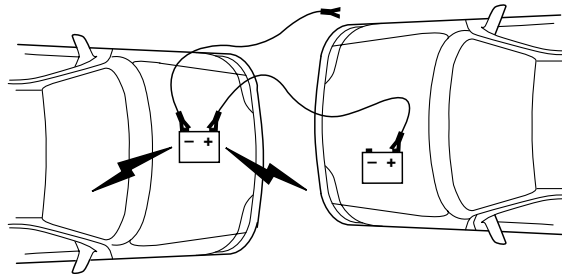

2. Remove the jumper cable on the negative (-) connection of the booster vehicle's battery.

Roadside Emergencies

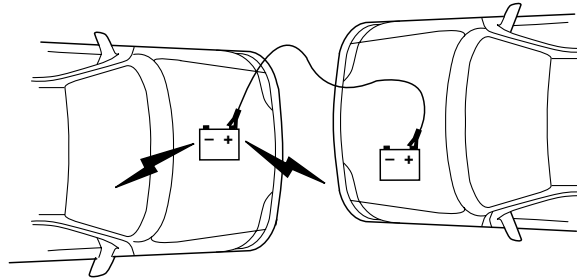

3. Remove the jumper cable from the positive (+) terminal of the booster vehicle's battery.

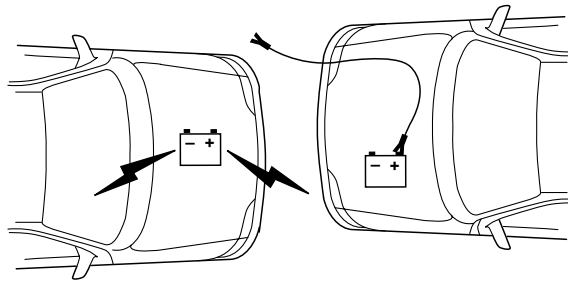

4. Remove the jumper cable from the positive (+) terminal of the disabled vehicle's battery.

After the disabled vehicle has been started and the jumper cables removed, allow it to idle for several minutes so the engine computer can *relearn* its idle conditions.

Roadside Emergencies

WRECKER TOWING

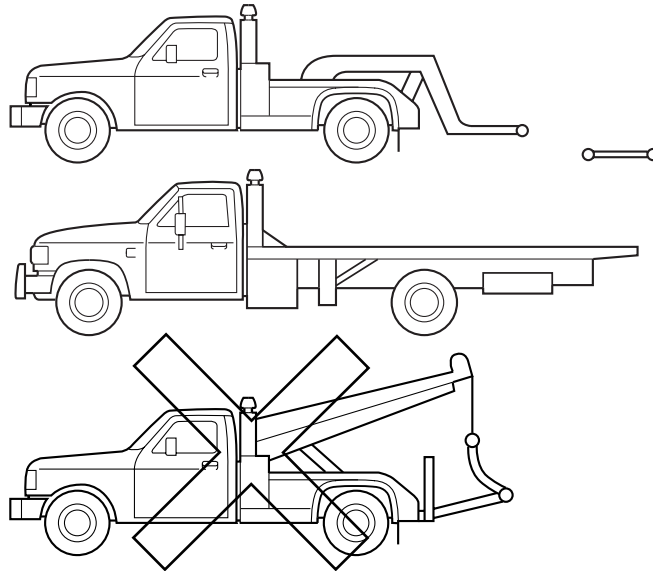

If you need to have your vehicle towed, contact a professional towing service or, if you are a member, your roadside assistance center.

It is recommended that your vehicle be towed with a wheel lift and dollies or flatbed equipment. Do not tow with a slingbelt. Ford Motor Company has not approved a slingbelt towing procedure.

If your vehicle is to be towed from the rear using wheel lift equipment, it is recommended that the front wheels (drive wheels) be placed on a dolly to prevent damage to the transaxle.

Roadside Emergencies

On 4x4 vehicles, it is **required** that your vehicle be towed with a wheel lift and dollies or flatbed equipment with all the wheels off the ground to prevent damage to the 4x4 system or vehicle.

If the vehicle is towed by other means or incorrectly, vehicle damage may occur.

In case of a roadside emergency with a disabled vehicle (without access to wheel dollies, car hauling trailer, or flatbed transport vehicle) your vehicle (regardless of transmission powertrain configuration) can be flat towed (all wheels in the ground) under the following conditions:

- Place the transmission in N (Neutral).
- Maximum speed is not to exceed 56 km/h (35 mph).
- Maximum distance is 80 km (50 miles).

Ford Motor Company provides a towing manual for all authorized tow truck operators. Have your tow truck operator refer to this manual for proper hook-up and towing procedures for your vehicle.

Customer Assistance

GETTING THE SERVICES YOU NEED

At home

Ford Motor Company and Ford of Canada have authorized dealerships to service your vehicle. It is preferred that you return to the Ford dealer where your vehicle was purchased when warranty repairs are needed. However, you may also take your vehicle to another Ford Motor Company or Ford of Canada dealership authorized for warranty repairs. Certain warranty repairs require special training though, so not all dealers are authorized to perform all warranty repairs. That means that depending on the warranty repair needed, the vehicle may need to be taken to another dealer. If a particular dealership can not assist you, then contact the Customer Relationship Center.

If you have questions or concerns, or are unsatisfied with the service you are receiving, follow these steps:

1. Contact your Sales Representative or Service Advisor at your selling/servicing dealership.
2. If your inquiry or concern remains unresolved, contact the Sales Manager or Service Manager at the dealership.
3. If the inquiry or concern cannot be resolved at the dealership level, please contact the Ford Customer Relationship Center.

Away from home

If you own a Ford or Mercury vehicle and are away from home when your vehicle needs service, or if you need more help than the dealership could provide, after following the steps described above, contact the Ford Customer Relationship Center to find an authorized dealership to help you.

In the United States:

Ford Motor Company
Customer Relationship Center
16800 Executive Plaza Drive
P.O. Box 6248
Dearborn, Michigan 48121
1-800-392-3673 (FORD)
(TDD for the hearing impaired: 1-800-232-5952)

Customer Assistance

In Canada:
Customer Relationship Centre
Ford Motor Company of Canada, Limited
P.O. Box 2000
Oakville, Ontario L6J 5E4
1-800-565-3673 (FORD)

If you own a Lincoln vehicle and are away from home when your vehicle needs service, or if you need more help than the dealership could provide, after following the steps described above, contact the Ford Customer Relationship Center to find an authorized dealership to help you.

In the United States:
Ford Motor Company
Customer Relationship Center
16800 Executive Plaza Drive
P.O. Box 6248
Dearborn, Michigan 48121
1-800-521-4140
(TDD for the hearing impaired: 1-800-232-5952)

In Canada:
Customer Relationship Centre
Ford Motor Company of Canada, Limited
P.O. Box 2000
Oakville, Ontario L6J 5E4
1-800-565-3673 (FORD)

In order to help you service your Ford or Lincoln Mercury vehicle, please have the following information available when contacting a Customer Relationship Center:

- Your telephone number (home and business).
- The name of the dealer and the city where the dealership is located.
- The year and make of your vehicle.
- The date of vehicle purchase.
- The current odometer reading.
- The vehicle identification number (VIN).

If you still have a complaint involving a warranty dispute, you may wish to contact the Dispute Settlement Board (U.S.).

Customer Assistance

In some states (in the U.S.) you must directly notify Ford in writing before pursuing remedies under your state's warranty laws. Ford is also allowed a final repair attempt in some states.

In the United States, a warranty dispute must be submitted to the Dispute Settlement Board before taking action under the Magnuson-Moss Warranty Act, or to the extent allowed by state law, before pursuing replacement or repurchase remedies provided by certain state laws. This dispute handling procedure is not required prior to enforcing state created rights or other rights which are independent of the Magnuson-Moss Warranty Act or state replacement or repurchase laws.

FORD EXTENDED SERVICE PLAN

You can get more protection for your new car or light truck by purchasing Ford Extended Service Plan (Ford ESP) coverage. Ford ESP is an optional service contract which is backed by Ford Motor Company or Ford Motor Service Company (in the U.S.) and Ford of Canada (in Canada). It provides the following:

- Benefits during the warranty period depending on the plan you purchase (such as: reimbursement for rentals; coverage for certain maintenance and wear items).
- Protection against covered repair costs after your Bumper-to-Bumper Warranty expires.

You may purchase Ford ESP from any participating Ford and Lincoln Mercury and Ford of Canada dealer. There are several plans available in various time, distance and deductible combinations which can be tailored to fit your own driving needs. Ford ESP also offers reimbursement benefits for towing and rental coverage.

When you buy Ford ESP, you receive Peace-of-Mind protection throughout the United States and Canada, provided by a network of more than 5,000 participating Ford or Lincoln Mercury and Ford of Canada dealers.

If you did not take advantage of the Ford Extended Service Plan at the time of purchasing your vehicle, you may still be eligible. Please contact your dealer for further information. Since this information is subject to change, please ask your dealer for complete details about Ford Extended Service Plan coverage options, or visit the Ford ESP website at www.ford-esp.com.

Customer Assistance

THE DISPUTE SETTLEMENT BOARD (U.S. ONLY)

The Dispute Settlement Board is:

- an independent, third-party arbitration program for warranty disputes
- available free to owners and lessees of qualifying Ford Motor Company vehicles

The Dispute Settlement Board may not be available in all states. Ford Motor Company reserves the right to change eligibility limitations, modify procedures and/or to discontinue this service without notice and without incurring obligations per applicable state law.

What kinds of cases does the Board review?

Unresolved warranty repair concerns or vehicle performance concerns as on Ford and Lincoln Mercury cars and Ford and Lincoln Mercury light trucks which are within the terms of any applicable written new vehicle warranty are eligible for review, except those involving:

- a non-Ford product
- a non-Ford dealership
- sales disputes between customer and dealer except those associated with warranty repairs or concerns with the vehicle's performance as designed
- a request for reimbursement of consequential expenses unless a service or product concern is being reviewed
- items not covered by the New Vehicle Limited Warranty (including maintenance and wear items)
- alleged personal injury/property damage claims
- cases currently in litigation
- vehicles not used primarily for family, personal or household purposes (except in states where the Dispute Settlement Board is required to review commercial vehicles)
- vehicles with non-U.S. warranties

Concerns are ineligible for review if the New Vehicle Limited Warranty has expired at receipt of your application and, in certain states eligibility is dependent upon the customer's possession of the vehicle.

Eligibility may differ according to state law. For example, see the unique brochures for California, West Virginia, Georgia and Wisconsin purchasers/lessees.

Customer Assistance

Board membership

The Board consists of:

- three consumer representatives
- a Ford or Lincoln Mercury dealership representative

Consumer candidates for Board membership are recruited and trained by an independent consulting firm. The dealership Board member is chosen from Ford and Lincoln Mercury dealership management, recognized for their business leadership qualities.

What the Board needs

To have your case reviewed you must complete the application in the DSB brochure and mail it to the address provided on the application form. Some states will require you to use certified mail, with return receipt requested.

Your application is reviewed and, if it is determined to be eligible, you will receive an acknowledgment indicating:

- The file number assigned to your application.
- The toll-free phone number of the DSB's independent administrator.

Your dealership and a Ford Motor Company representative will then be asked to submit statements.

To properly review your case, the Board needs the following information:

- Legible copies of all documents and maintenance or repair orders relevant to the case.
- The year, make, model, and Vehicle Identification Number (VIN) listed on your vehicle ownership license.
- The date of repair(s) and mileage at the time of occurrence(s).
- The current mileage.
- The name of the dealer(s) who sold or serviced the vehicle.
- A brief description of your unresolved concern.
- A brief summary of the action taken by the dealer(s) and Ford Motor Company.
- The names (if known) of all the people you contacted at the dealership(s).
- A description of the action you expect to resolve your concern.

Customer Assistance

You will receive a letter of explanation if your application does not qualify for Board review.

Oral presentations

If you would like to make an oral presentation, indicate YES to question 6 on the application. While it is your right to make an oral presentation before the Board, this is not a requirement and the Board will decide the case whether or not an oral presentation is made. An oral presentation may be requested by the Board as well.

Making a decision

Board members review all available information related to each complaint, including oral presentations, and arrive at a fair and impartial decision. Board review may be terminated at any time by either party.

Every effort is made to decide the case within 40 days of the date that all requested information is received by the Board. Since the Board generally meets once a month, it may take longer for the Board to consider some cases.

After a case is reviewed, the Board mails you a decision letter and a form on which to accept or reject the Board's decision. The decisions of the Board are binding on Ford (and, in some cases, on the dealer) but not on consumers who are free to pursue other remedies available to them under state or federal law.

To Request a DSB Brochure/Application

For a brochure/application, speak to your dealer or write/call to the Board at the following address/phone number:

Dispute Settlement Board
P.O. Box 5120
Southfield, MI 48086-5120
1-800-428-3718

You may also contact the North American Customer Relationship Center at 1-800-392-3673 (Ford), TDD for the hearing impaired: 1-800-232-5952 or by writing to the Center at the following address:

Ford Motor Company
Customer Relationship Center
16800 Executive Plaza Drive
P.O. Box 6248
Dearborn, Michigan 48121

Customer Assistance

UTILIZING THE MEDIATION/ARBITRATION PROGRAM (CANADA ONLY)

In those cases where you continue to feel that the efforts by Ford and the dealer to resolve a factory-related vehicle service concern have been unsatisfactory, Ford of Canada participates in an impartial third party mediation/arbitration program administered by the Canadian Motor Vehicle Arbitration Plan (CAMVAP).

The CAMVAP program is a straight-forward and relatively speedy alternative to resolve a disagreement when all other efforts to produce a settlement have failed. This procedure is without cost to you and is designed to eliminate the need for lengthy and expensive legal proceedings.

In the CAMVAP program, impartial third-party arbitrators conduct hearings at mutually convenient times and places in an informal environment. These impartial arbitrators review the positions of the parties, make decisions and, when appropriate, render awards to resolve disputes. CAMVAP decisions are fast, fair, and final; the arbitrator's award is binding both to you and Ford of Canada.

CAMVAP services are available in all territories and provinces. For more information, without charge or obligation, call your CAMVAP Provincial Administrator directly at 1-800-207-0685.

GETTING ASSISTANCE OUTSIDE THE U.S. AND CANADA

Before exporting your vehicle to a foreign country, contact the appropriate foreign embassy or consulate. These officials can inform you of local vehicle registration regulations and where to find unleaded fuel.

If you cannot find unleaded fuel or can only get fuel with an anti-knock index lower than is recommended for your vehicle, contact a district or owner relations/customer relationship office.

The use of leaded fuel in your vehicle without proper conversion may damage the effectiveness of your emission control system and may cause engine knocking or serious engine damage. Ford Motor Company/Ford of Canada is not responsible for any damage caused by use of improper fuel.

In the United States, using leaded fuel may also result in difficulty importing your vehicle back into the U.S.

Customer Assistance

If your vehicle must be serviced while you are traveling or living in Central or South America, the Caribbean, or the Middle East, contact the nearest Ford dealership. If the dealership cannot help you, write or call:

FORD MOTOR COMPANY
WORLDWIDE DIRECT MARKET OPERATIONS
1555 Fairlane Drive
Fairlane Business Park #3
Allen Park, Michigan 48101
U.S.A.
Telephone: (313) 594-4857
FAX: (313) 390-0804

If you are in another foreign country, contact the nearest Ford dealership. If the dealership employees cannot help you, they can direct you to the nearest Ford affiliate office.

If you buy your vehicle in North America and then relocate outside of the U.S. or Canada, register your vehicle identification number (VIN) and new address with Ford Motor Company Worldwide Direct Market Operations.

ORDERING ADDITIONAL OWNER'S LITERATURE

To order the publications in this portfolio, contact Helm, Incorporated at:
HELM, INCORPORATED
P.O. Box 07150
Detroit, Michigan 48207

Or call:

For a free publication catalog, order toll free: 1-800-782-4356

Monday-Friday 8:00 a.m. - 6:00 p.m. EST

(Items in this catalog may be purchased by credit card holders only.)

Obtaining a French owner's guide

French Owner's Guides can be obtained from your dealer or by writing to Ford Motor Company of Canada, Limited, Service Publications, P.O. Box 1580, Station B, Mississauga, Ontario L4Y 4G3.

Customer Assistance

IN CALIFORNIA (U.S. ONLY)

California Civil Code Section 1793.2(d) requires that, if a manufacturer or its representative is unable to repair a motor vehicle to conform to the vehicle's applicable express warranty after a reasonable number of attempts, the manufacturer shall be required to either replace the vehicle with one substantially identical or repurchase the vehicle and reimburse the buyer in an amount equal to the actual price paid or payable by the consumer (less a reasonable allowance for consumer use). The consumer has the right to choose whether to receive a refund or replacement vehicle.

California Civil Code Section 1793.22(b) presumes that the manufacturer has had a reasonable number of attempts to conform the vehicle to its applicable express warranties if, within the first 18 months of ownership of a new vehicle or the first 29 000 km (18 000 miles), whichever occurs first:

1. Two or more repair attempts are made on the same nonconformity likely to cause death or serious bodily injury OR
2. Four or more repair attempts are made on the same nonconformity (a defect or condition that substantially impairs the use, value or safety of the vehicle) OR
3. The vehicle is out of service for repair of nonconformities for a total of more than 30 calendar days (not necessarily all at one time)

In the case of 1 or 2 above, the consumer must also notify the manufacturer of the need for the repair of the nonconformity at the following address:

16800 Executive Plaza Drive
Mail Drop 3NE-B
Dearborn, MI 48126

Customer Assistance

REPORTING SAFETY DEFECTS (U.S. ONLY)

If you believe that your vehicle has a defect which could cause a crash or could cause injury or death, you should immediately inform the National Highway Traffic Safety Administration (NHTSA) in addition to notifying Ford Motor Company.

Ford Motor Company

If NHTSA receives similar complaints, it may open an investigation, and if it finds that a safety defect exists in a group of vehicles, it may order a recall and remedy campaign. However, NHTSA cannot become involved in individual problems between you, your dealer, or Ford Motor Company.

To contact NHTSA, you may either call the Auto Safety Hotline toll-free at 1-800-424-9393 (or 366-0123 in the Washington D.C. area) or write to:

NHTSA
U.S. Department of Transportation
Washington, D.C. 20590

You can also obtain other information about motor vehicle safety from the Hot-line.

WASHING THE EXTERIOR OF YOUR VEHICLE

Never wash a vehicle that is “hot to the touch” or during exposure to strong, direct sunlight. It is recommended that you wash your vehicle regularly with cool or lukewarm water and a neutral Ph shampoo, such as Detail Wash (ZC-3-A), which is available from your authorized Ford, Lincoln or Mercury dealer. Always use a clean sponge or carwash mitt with plenty of water for best results. Dry the vehicle with a chamois or soft terry cloth towel in order to eliminate water spotting.

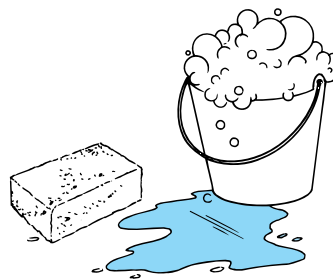

Never use strong household detergents or soap, such as dish washing or laundry liquid. These products can discolor and spot painted surfaces.

It is especially important to wash the vehicle regularly during winter months, as dirt and road salt are difficult to remove and do cause damage to the vehicle.

Items such as gasoline, diesel fuel, bird droppings and insect deposits should be washed and sponged off as soon as possible. Deposits not removed promptly can cause damage to the vehicle’s paintwork and trim over time.

Remove any exterior accessories, such as antennas, before entering a car wash.

PROTECTING THE PAINT FINISH OF YOUR VEHICLE

Applying a polymer paint sealant to your vehicle on a regular basis will assist in reducing minor scratches and paint damage.

A typical paint sealant lasts approximately six months to a year, depending on local weather conditions and the cleaning soap that is used in washing the vehicle.

Do not use a wax that beads excessively.

Do not allow paint sealant to come in contact with any non-body (low-gloss black) colored trim, such as grained door handles, roof racks, bumpers, side moldings, mirror housings or the windshield cowl area. The paint sealant will “gray” or stain the parts over time.

Cleaning

REPAIRING PAINT CHIPS

Remove particles such as bird droppings, tree sap, insect deposits, tar spots, road salt and industrial fallout before repairing paint chips.

Minor scratches or paint damage from road debris may be repaired using the Ultra Touch Prep and Finishing Kit (F7AZ-19K507-BA), which is available at your authorized Ford, Lincoln or Mercury dealer. This kit contains:

- Lacquer Touch-Up Paint (ALBZ-19500-XXXXA)
- Exterior Acrylic Spray Lacquer (ALAZ-19500-XXXXA)

Please note that the part numbers (shown as XXXX above) will vary with your vehicle's specific coloring. **Carefully observe the application instructions on the products.**

CLEANING THE WHEEL RIMS AND COVERS

Aluminum wheel rims or covers are coated with a clearcoat paint finish.

Some automatic car washes may cause damage to the finish on your wheel rims or covers. Chemical-strength cleaners, or cleaning chemicals, in combination with brush agitation to remove brake dust and dirt, could wear away the clearcoat finish over time.

Do not use hydrofluoric acid-based or high caustic-based wheel cleaners, steel wool, fuels or strong household detergents for soiled wheel rims and covers.

Never apply any cleaning chemical to hot or warm wheel rims or covers.

Clean wheel rims and covers with Detail Wash (ZC-3-A), which is available from your authorized Ford, Lincoln or Mercury dealer. Spray cleaner on cool wheel rims or covers and allow to set for 2–5 minutes. Agitate the area with a sponge and rinse off with plenty of water.

Use Extra Strength Tar and Road Oil Removal (B7A-19520-AA), available from your authorized Ford, Lincoln or Mercury dealer, in order to remove tar and grease from wheel rims and covers.

Cleaning

CLEANING THE ENGINE

Engines are more efficient when they are clean because grease and dirt buildup keep the engine warmer than normal. When washing:

- The engine must be cool to the touch before spraying with water.
- **Never spray a hot engine with cold water, as damage to the engine block or engine components may occur.**
- Use caution when using a self-serve power washer (1000 psi maximum pressure) to clean the engine, as the high-pressure fluid could penetrate the sealed parts and cause damage.
- **Never apply anything to any exposed belts in the engine compartment, including belt dressing.**

For general cleaning of the engine and engine compartment, spray Engine Shampoo and Degreaser (F4AZ-19A536-A) on all parts that require cleaning and pressure rinse the area with cool water.

- Cover the highlighted areas to prevent water damage when cleaning the engine.

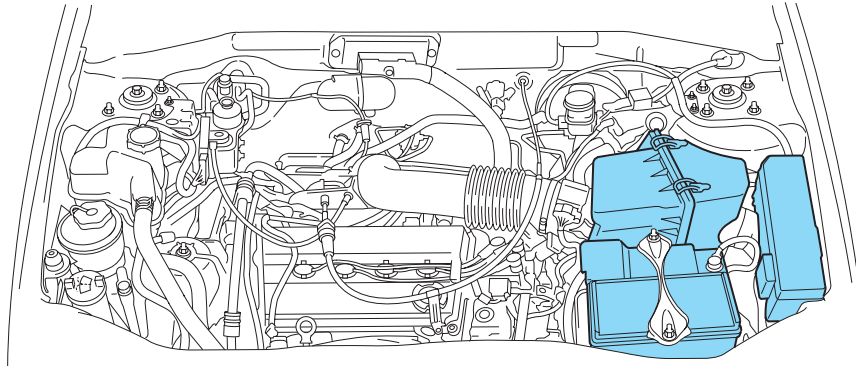

- **2.0L DOHC I4 — Zetec Engine**

Cleaning

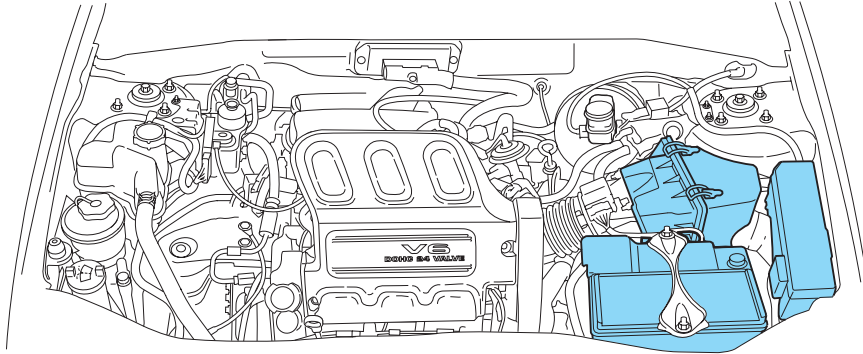

- **3.0L DOHC V6 — Duratec Engine**
- **Never wash or rinse the engine while it is running; water in the running engine may cause internal damage.**

WASHING NON-PAINTED PLASTIC EXTERIOR PARTS

Use Detail Wash (ZC-3-A) for routine cleaning.

If tar or grease spots are present, clean with Extra Strength Tar and Road Oil Removal (B7A-19520-AA).

Use only approved products to clean plastic parts. These products are available from your authorized Ford, Lincoln or Mercury dealer.

WASHING MIRRORS, MIRROR HOUSINGS AND REFLECTIVE SURFACES

Do not clean mirrors, mirror housings or reflective surfaces with abrasive materials or a dry cloth.

Use a soft cloth and Detail Wash (ZC-3-A) mixed with water in order to clean the mirror housing. Use Glass Cleaner (E4AZ-19C507-AA) in order to clean the reflective mirror surface.

Use care when removing ice from outside mirrors as you may damage the reflective surface.

WASHING THE EXTERIOR LAMPS

In order to avoid scratching the plastic lamps, do not use dry paper towels, non-approved chemical solvents or abrasive cleaners.

Use a soft cloth and a solution of Triple Clean (EOAZ-19526-AA), mixed properly with water, in order to remove bug residue. If tar or grease spots are present, clean with Extra Strength Tar and Road Oil Removal (B7A-19520-AA).

CLEANING THE WINDSHIELD, WIPER BLADES AND REAR WINDOW

If the wiper does not wipe properly, substances on the windshield, rear window or the wiper blades may be the cause. These may include hot wax treatments used by commercial car washes, tree sap, or other organic contamination.

Do not clean the windshield or rear window glass with abrasives, as they may cause scratches.

Do not use fuel, kerosene, or paint thinner to clean the windshield, rear window or the wiper blades as damage may occur.

Clean the outside of the windshield or rear window with a non-abrasive cleaner such as Ultra Clear Spray Glass Cleaner (E4AZ-19C507-AA), available from your authorized Ford, Lincoln or Mercury dealer. If after cleaning the glass surface, the water sheets from the glass (e.g., does not bead), then the window is clean.

The windshield, rear window and wiper blades should be cleaned regularly. Wiper blades can be cleaned with isopropyl (rubbing) alcohol or windshield washer solution. Be sure to replace wiper blades when they appear worn or do not function properly.

Cleaning

CLEANING THE INSTRUMENT PANEL

Clean the instrument panel with a damp cloth, then dry with a dry cloth.

Avoid cleaners or polish that increase the gloss of the upper portion of the instrument panel. The dull finish in this area helps protect the driver from undesirable windshield reflection.



Do not use chemical solvents or strong detergents when cleaning the steering wheel or instrument panel to avoid contamination of the air bag system.

CLEANING THE INSTRUMENT CLUSTER LENS

Wipe the cluster area with a soft, damp cotton towel. Dry the area with a clean, dry towel.

CLEANING WOOD-TONE TRIM

Wipe stains with a clean, soft cloth and Ultra Clear Spray Glass Cleaner (E4AZ-19C507-AA). Dry the area by wiping with a dry, soft, clean cloth.

CLEANING THE INSIDE WINDOWS

Use Ultra Clear Spray Glass Cleaner (E4AZ-19C507-AA) for the inside windows if they become fogged.

To clean, use two lint-free, soft towels, folded into a pad-shape. Mist the glass completely with cleaner, and use one of the towels to evenly agitate the surface. Use the other towel to remove the residue.

CLEANING THE INTERIOR FABRIC, CARPETS AND CLOTH SEATS

Remove dust and loose dirt with a vacuum cleaner. Remove light stains and soil with Extra Strength Upholstery Cleaner (E8AZ-19523-AA).

Never saturate the seat covers with cleaning solution.

Do not use household cleaning products or glass cleaners, which can stain and discolor the fabric and affect the flame retardant abilities of the seat materials.

If grease or tar is present on the material, spot-clean the area first with Spot and Stain Remover (F3AZ-19521-WA). Follow up by recleaning the area with Extra Strength Upholstery Cleaner (E8AZ-19523-AA).

Cleaning

CLEANING LEATHER SEATS (IF EQUIPPED)

All Ford, Lincoln and Mercury vehicles with leather seating surfaces have a clear, protective coating over the leather.

To clean the leather seats, simply use a soft cloth with Deluxe Leather and Vinyl Cleaner (F2AZ-19521-WA). Dry the area with a soft cloth.

It is recommended that you use the Deluxe Leather Care Kit (F8AZ-19G253-AA), available from your authorized Ford, Lincoln or Mercury dealer. The mild cleaner and special pad available in the kit cleans the leather and maintains its natural beauty. For best results, follow the instructions printed on the cleaner label. Regular cleaning of your leather upholstery helps maintain its resiliency and color.

Do not use household cleaning products, alcohol solutions, solvents or cleaners intended for rubber, vinyl and plastics, or oil/petroleum-based leather conditioners. These products may cause premature wearing of the clear, protective coating.

CLEANING SEATS EQUIPPED WITH SIDE AIR BAGS

Remove dust and loose dirt with a vacuum cleaner. In order to remove stains and soil, clean with Extra Strength Upholstery Cleaner (E8AZ-19523-AA).

Never saturate the seat covers with any cleaning solution.



Do not use chemical solvents or strong detergents when cleaning the seat where the side air bag is mounted. Such products could contaminate the side air bag system and affect performance of the side air bag in a collision. The air bag may not function correctly and not provide injury reduction benefits.

CLEANING AND MAINTAINING THE SAFETY BELTS

Clean the safety belts with Extra Strength Upholstery Cleaner (E8AZ-19523-AA), available from your authorized Ford, Lincoln or Mercury dealer.

Do not use bleach, dye or any other solvent to clean the belts, as these actions may weaken the belt webbing.

UNDERBODY

Flush the complete underside of your vehicle frequently. Keep body and door drain holes free from packed dirt.

Cleaning

FORD, LINCOLN AND MERCURY CAR CARE PRODUCTS

Your Ford, Lincoln or Mercury dealer has many quality products available to clean your vehicle and protect its finishes. These quality products have been specifically engineered to fulfill your automotive needs; they are custom designed to complement the style and appearance of your vehicle. Each product is made from high quality materials that meet or exceed rigid specifications. For best results, use the following or products of equivalent quality:

Ford Custom Clearcoat Polish*

Ford Custom Silicone Gloss Polish

Ford Custom Vinyl Protectant* (not available in Canada)

Motorcraft Vinyl Conditioner (Canada only)

Ford Deluxe Leather and Vinyl Cleaner (not available in Canada)

Motorcraft Vinyl Cleaner (Canada only)

Ford Extra Strength Tar and Road Oil Remover* (not available in Canada)

Ford Extra Strength Upholstery Cleaner (not available in Canada)

Ford Custom Bright Metal Cleaner

Motorcraft Premium Car Wash Concentrate

Motorcraft Carlite Glass Cleaner (Canada only)

Ford Spot and Stain Remover*

Ford Super Premium Tire and Trim Dressing

Ford Triple Clean

Ford Ultra-Clear Spray Glass Cleaner (not available in Canada)

Ford Engine Shampoo and Degreaser

* May be sold with the Motorcraft name

Maintenance and Specifications

SERVICE RECOMMENDATIONS

To help you service your vehicle:

- We highlight do-it-yourself items in the engine compartment for easy location.
- We provide a scheduled maintenance guide which makes tracking routine service easy.

If your vehicle requires professional service, your dealership can provide the necessary parts and service. Check your *Warranty Guide* to find out which parts and services are covered.

Use only recommended fuels, lubricants, fluids and service parts conforming to specifications. Motorcraft parts are designed and built to provide the best performance in your vehicle.

PRECAUTIONS WHEN SERVICING YOUR VEHICLE

Be especially careful when inspecting or servicing your vehicle.

- Do not work on a hot engine.
- When the engine is running, make sure that loose clothing, jewelry or long hair does not get caught up in moving parts.
- Do not work on a vehicle with the engine running in an enclosed space, unless you are sure you have enough ventilation.
- Keep all lit cigarettes, open flames and other lit material away from the battery and all fuel related parts.

If you disconnect the battery, the engine must “relearn” its idle conditions before your vehicle will drive properly, as explained in *Battery* in this chapter.

Working with the engine off

- Automatic transmission:
 1. Set the parking brake and ensure the gearshift is securely latched in P (Park).
 2. Turn off the engine and remove the key.
 3. Block the wheels to prevent the vehicle from moving unexpectedly.
- Manual transmission:
 1. Set the parking brake.
 2. Depress the clutch and place the gearshift in 1 (First).

Maintenance and Specifications

3. Turn off the engine and remove the key.
4. Block the wheels to prevent the vehicle from moving unexpectedly.

Working with the engine on

- Automatic transmission:

1. Set the parking brake and ensure the gearshift is securely latched in P (Park).
2. Block the wheels to prevent the vehicle from moving unexpectedly.

Note: Do not start your engine with the air cleaner removed and do not remove it while the engine is running.

- Manual transmission:

1. Set the parking brake, depress the clutch and place the gearshift in neutral.
2. Block the wheels to prevent the vehicle from moving unexpectedly.

Note: Do not start your engine with the air cleaner removed and do not remove it while the engine is running.



The cooling fan is automatic and may come on at any time. Always disconnect the negative terminal of the battery before working near the fan.

OPENING THE HOOD

1. Inside the vehicle, pull the hood release handle located under the bottom of the instrument panel.

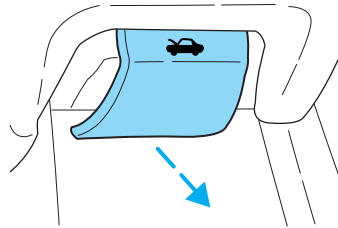

Maintenance and Specifications

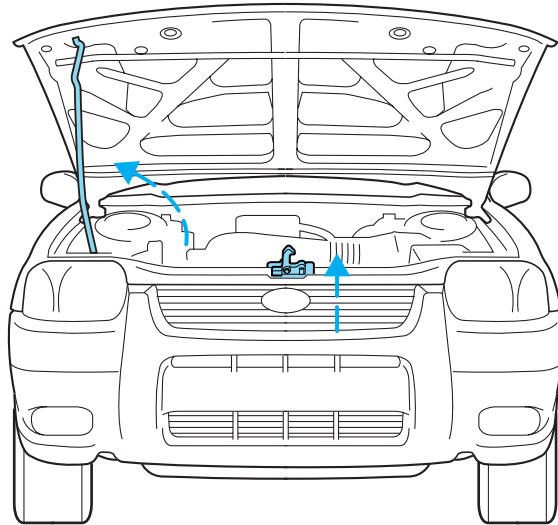

2. At the front of the vehicle, lift up on the auxiliary latch handle located in the center between the hood and the grille.
3. Lift the hood open and secure it with the prop rod.

Maintenance and Specifications

IDENTIFYING COMPONENTS IN THE ENGINE COMPARTMENT

2.0L DOHC I4 Zetec engine

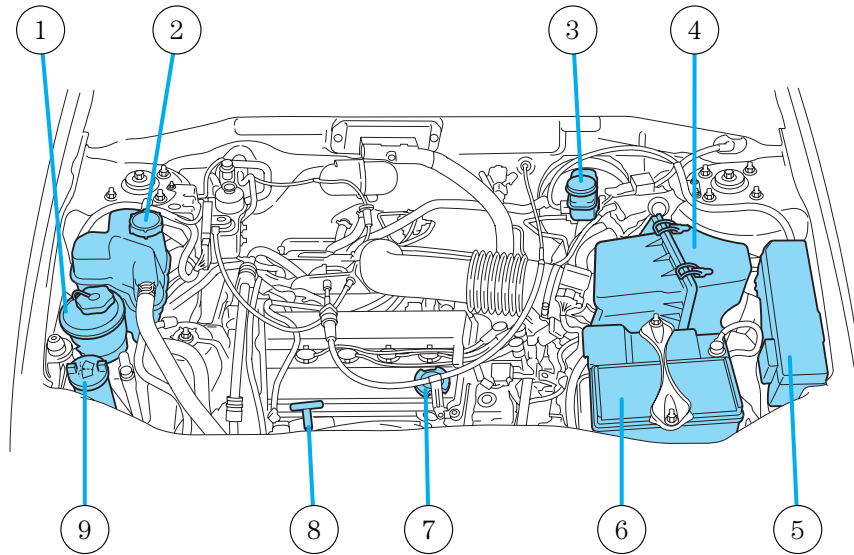

1. Power steering fluid reservoir
2. Engine coolant reservoir
3. Brake/Clutch fluid reservoir
4. Air filter assembly
5. Power distribution box
6. Battery
7. Engine oil filler cap
8. Engine oil dipstick
9. Windshield washer fluid reservoir

Maintenance and Specifications

3.0L DOHC V6 Duratec engine

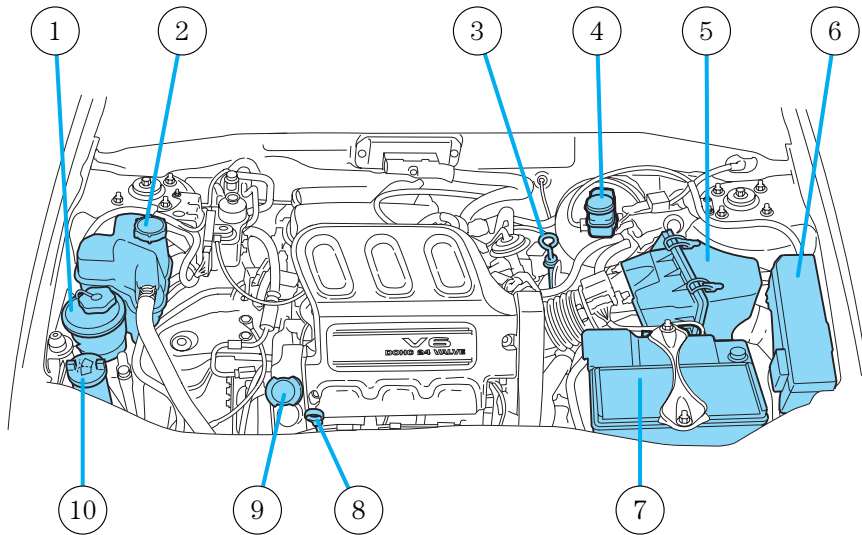

1. Power steering fluid reservoir
2. Engine coolant reservoir
3. Automatic transmission fluid dipstick
4. Brake fluid reservoir
5. Air filter assembly
6. Power distribution box
7. Battery
8. Engine oil dipstick
9. Engine oil filler cap
10. Windshield washer fluid reservoir

Maintenance and Specifications

WINDSHIELD WASHER FLUID

Checking and adding washer fluid

Check the washer fluid whenever you stop for fuel. The reservoir is highlighted with a  symbol.

If the level is low, add enough fluid to fill the reservoir. In very cold weather, do not fill the reservoir all the way.

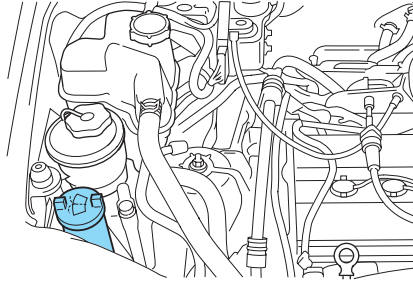

Only use a washer fluid that meets Ford specifications. Refer to *Lubricant specifications* in this chapter.

State or local regulations on volatile organic compounds may restrict the use of methanol, a common windshield washer antifreeze additive. Washer fluids containing non-methanol antifreeze agents should be used only if they provide cold weather protection without damaging the vehicle's paint finish, wiper blades or washer system.

Note: Do not put washer fluid in the engine coolant reservoir. Washer fluid placed in the cooling system may harm engine and cooling system components.

Checking and adding washer fluid for the liftgate

Washer fluid for the liftgate is supplied by the same reservoir as the windshield.

ENGINE OIL

Checking the engine oil

Refer to the scheduled maintenance guide for the appropriate intervals for checking the engine oil.

1. Make sure the vehicle is on level ground.
2. Turn the engine off and wait a few minutes for the oil to drain into the oil pan.
3. Set the parking brake and ensure the gearshift is securely latched in P (Park) (automatic transmissions) or 1 (First) (manual transmissions).

Maintenance and Specifications

4. Open the hood. Protect yourself from engine heat.
 5. Locate and carefully remove the engine oil level indicator (dipstick).
- 2.0L DOHC I4 Zetec engine

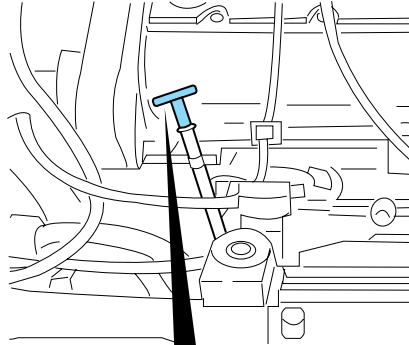

- 3.0L DOHC V6 Duratec engine

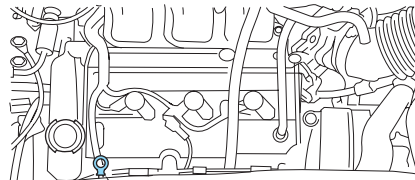

6. Wipe the indicator clean. Insert the indicator fully, then remove it again.
- If the oil level is **between the MIN—MAX marks**, the oil level is acceptable. **DO NOT ADD OIL.**

Maintenance and Specifications

- If the oil level is below the MIN mark, add enough oil to raise the level within the MIN—MAX range.
- 2.0L DOHC I4 Zetec engine

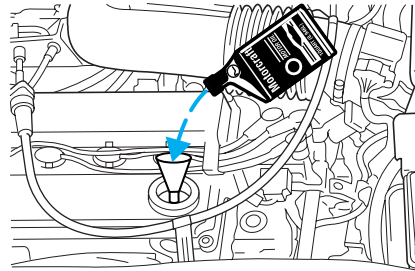

- 3.0L DOHC V6 Duratec engine

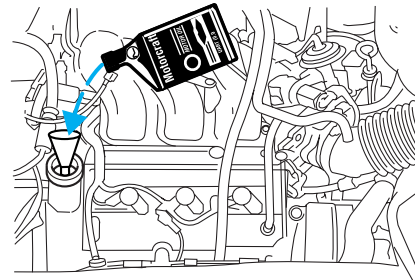

- Oil levels above the MAX mark may cause engine damage. Some oil must be removed from the engine by a service technician.
7. Put the indicator back in and ensure it is fully seated.

Adding engine oil

1. Check the engine oil. For instructions, refer to *Checking the engine oil* in this chapter.
2. If the engine oil level is not within the normal range, add only certified engine oil of the recommended viscosity. Remove the engine oil filler cap and use a funnel to pour the engine oil into the opening.
3. Recheck the engine oil level. Make sure the oil level is not above the MAX or FULL mark on the engine oil level indicator (dipstick).
4. Install the indicator and ensure it is fully seated.
5. Fully install the engine oil filler cap by turning the filler cap clockwise 1/4 of a turn until it is seated.

Maintenance and Specifications

To avoid possible oil loss, DO NOT operate the vehicle with the engine oil level indicator and/or the engine oil filler cap removed.

Engine oil and filter recommendations

Look for this certification trademark.

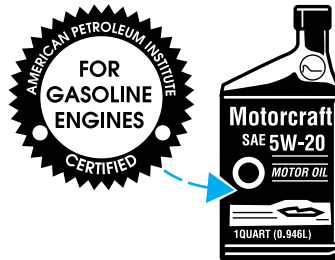

SAE 5W-20 engine oil is recommended.

Only use oils “Certified For Gasoline Engines” by the American Petroleum Institute (API). Use Motorcraft or an equivalent oil meeting Ford specification WSS-M2C153-H. **SAE 5W-20 oil provides optimum fuel economy and durability performance meeting all requirements for your vehicle’s engine.**

Do not use supplemental engine oil additives, oil treatments or engine treatments. They are unnecessary and could, under certain conditions, lead to engine damage which is not covered by your warranty.

Change your engine oil and filter according to the appropriate schedule listed in the scheduled maintenance guide.

Ford production and aftermarket (Motorcraft) oil filters are designed for added engine protection and long life. If a replacement oil filter is used that does not meet Ford material and design specifications, start-up engine noises or knock may be experienced.

It is recommended you use the appropriate Motorcraft oil filter (or another brand meeting Ford specifications) for your engine application.

Maintenance and Specifications

BATTERY

Your vehicle is equipped with a Motorcraft maintenance-free battery which normally does not require additional water during its life of service.

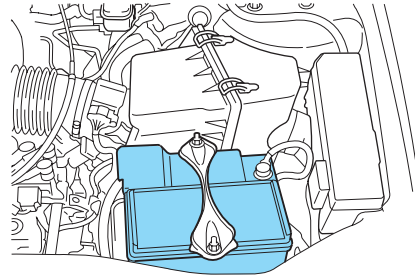

However, for severe usage or in high temperature climates, check the battery electrolyte level. Refer to the scheduled maintenance guide for the service interval schedules.

Keep the electrolyte level in each cell up to the “level indicator”. Do not overfill the battery cells.

If the electrolyte level in the battery is low, you can add plain tap water to the battery, as long as you do not use hard water (water with a high mineral or alkali content). If possible, however, try to only fill the battery cells with distilled water. If the battery needs water often, have the charging system checked.

If your battery has a cover/shield, make sure it is reinstalled after the battery has been cleaned or replaced.

For longer, trouble-free operation, keep the top of the battery clean and dry. Also, make certain the battery cables are always tightly fastened to the battery terminals.

If you see any corrosion on the battery or terminals, remove the cables from the terminals and clean with a wire brush. You can neutralize the acid with a solution of baking soda and water.



Batteries normally produce explosive gases which can cause personal injury. Therefore, do not allow flames, sparks or lighted substances to come near the battery. When working near the battery, always shield your face and protect your eyes. Always provide proper ventilation.

Maintenance and Specifications



When lifting a plastic-cased battery, excessive pressure on the end walls could cause acid to flow through the vent caps, resulting in personal injury and/or damage to the vehicle or battery. Lift the battery with a battery carrier or with your hands on opposite corners.



Keep batteries out of reach of children. Batteries contain sulfuric acid. Avoid contact with skin, eyes or clothing. Shield your eyes when working near the battery to protect against possible splashing of acid solution. In case of acid contact with skin or eyes, flush immediately with water for a minimum of 15 minutes and get prompt medical attention. If acid is swallowed, call a physician immediately.



Battery posts, terminals and related accessories contain lead and lead compounds. **Wash hands after handling.**

Because your vehicle's engine is electronically controlled by a computer, some control conditions are maintained by power from the battery. When the battery is disconnected or a new battery is installed, the engine must relearn its idle and fuel trim strategy for optimum driveability and performance. To begin this process:

1. With the vehicle at a complete stop, set the parking brake.
2. Put the gearshift in P (Park), turn off all accessories and start the engine.
3. Run the engine until it reaches normal operating temperature.
4. Allow the engine to idle for at least one minute.
5. Turn the A/C on and allow the engine to idle for at least one minute.
6. Drive the vehicle to complete the relearning process.
 - The vehicle may need to be driven 16 km (10 miles) or more to relearn the idle and fuel trim strategy.
 - **If you do not allow the engine to relearn its idle trim, the idle quality of your vehicle may be adversely affected until the idle trim is eventually relearned.**

When the battery is disconnected or a new battery installed, the transmission must relearn its adaptive strategy. As a result of this, the transmission may shift firmly. This operation is considered normal and

Maintenance and Specifications

will not affect function or durability of the transmission. Over time the adaptive learning process will fully update transmission operation to its optimum shift feel.

If the battery has been disconnected or a new battery has been installed, the clock and the preset radio stations must be reset once the battery is reconnected.

- Always dispose of automotive batteries in a responsible manner. Follow your local authorized standards for disposal. Call your local authorized recycling center to find out more about recycling automotive batteries.

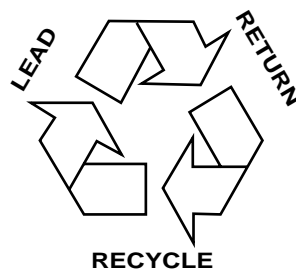

ENGINE COOLANT

Checking engine coolant

The concentration and level of engine coolant should be checked at the mileage intervals listed in the scheduled maintenance guide. The coolant concentration should be maintained at 50/50 coolant and water, which equates to a freeze point of -36°C (-34°F). Coolant concentration testing is possible with a hydrometer or antifreeze tester (such as the Rotunda Battery and Antifreeze Tester, 014-R1060). The level of coolant should be maintained at the “cold full” or “cold fill range” level in the coolant reservoir. If the level falls below, add coolant per the instructions in the *Adding Engine Coolant* section.

Your vehicle was factory-filled with a 50/50 engine coolant and water concentration. If the concentration of coolant falls below 40% or above 60%, the engine parts could become damaged or not work properly. **A 50–50 mixture of coolant and water provides the following:**

- **Freeze protection down to -36°C (-34°F).**
- **Boiling protection up to 129°C (265°F).**
- **Protection against rust and other forms of corrosion.**
- **Enables calibrated gauges to work properly.**

Maintenance and Specifications

When the engine is cold, check the level of the engine coolant in the reservoir.

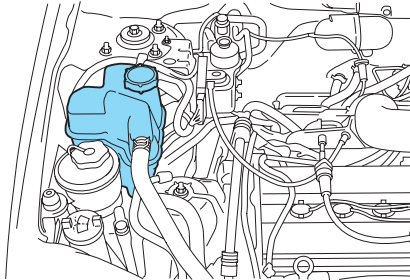

- The engine coolant should be at the “cold fill level” or within the “cold fill range” as listed on the engine coolant reservoir (depending upon application).
- Refer to the Scheduled Maintenance Guide for service interval schedules.
- Be sure to read and understand *Precautions when servicing your vehicle* in this chapter.

If the engine coolant has not been checked at the recommended interval, the engine coolant reservoir may become low or empty. If the reservoir is low or empty, add engine coolant to the reservoir. Refer to *Adding engine coolant* in this chapter.

Note: Automotive fluids are not interchangeable; do not use engine coolant, antifreeze or windshield washer fluid outside of its specified function and vehicle location.

Adding engine coolant

When adding coolant, make sure it is a 50/50 mixture of engine coolant and distilled water. Add the mixture to the coolant reservoir, **when the engine is cool**, until the appropriate fill level is obtained.



Do not add engine coolant when the engine is hot. Steam and scalding liquids released from a hot cooling system can burn you badly. Also, you can be burned if you spill coolant on hot engine parts.



Do not put engine coolant in the windshield washer fluid container. If sprayed on the windshield, engine coolant could make it difficult to see through the windshield.

Maintenance and Specifications

The cooling system in your vehicle is filled with either green-colored Motorcraft Premium Engine Coolant meeting Ford specification ESE-M97B44-A or yellow-colored Motorcraft Premium Gold Engine Coolant meeting Ford Specification WSS-M97B51-A1. To determine your vehicle's coolant type (color), check your coolant reservoir.

- **Add Motorcraft Premium Engine Coolant (green-colored), VC-4-A (U.S.) or CXC-10 (Canada) or Motorcraft Premium Gold Engine Coolant (yellow-colored), VC-7-A (VC-7-A in Oregon), depending on the type of coolant originally equipped in your vehicle.** If you are unsure which type of coolant your vehicle requires, check your coolant reservoir or contact your local dealer.

Note: Use of Motorcraft Cooling System Stop Leak Pellets, VC-6, darkens the color of Motorcraft Premium Gold Engine Coolant from yellow to golden tan.

- **Do not add/mix an orange-colored, extended life coolant such as Motorcraft Speciality Orange Engine Coolant, VC-2 (US) or CXC-209 (Canada), meeting Ford specification WSS-M97B44-D with the factory-filled coolant.** Mixing Motorcraft Speciality Orange Engine Coolant or any orange-colored extended life product with your factory filled coolant can result in degraded corrosion protection.
- A large amount of water without engine coolant may be added, in case of emergency, to reach a vehicle service location. In this instance, the cooling system must be drained and refilled with a 50/50 mixture of engine coolant and distilled water as soon as possible. Water alone (without engine coolant) can cause engine damage from corrosion, overheating or freezing.
- **Do not use alcohol, methanol or brine or any engine coolants mixed with alcohol or methanol antifreeze (coolant).** Alcohol and other liquids can cause engine damage from overheating or freezing.
- **Do not add extra inhibitors or additives to the coolant.** These can be harmful and compromise the corrosion protection of the engine coolant.
- **Do not mix with recycled coolant unless from a Ford-approved recycling process (see *Use of Recycled Engine Coolant* section).**

For vehicles with overflow coolant systems with a non-pressurized cap on the coolant recovery system, add coolant to the coolant recovery reservoir when the engine is cool. Add the proper mixture of coolant and water to the "cold full" level. For all other vehicles, which have a coolant

Maintenance and Specifications

degas system with a pressurized cap, or if it is necessary to remove the coolant pressure relief cap on the radiator of a vehicle with an overflow system, follow these steps to add engine coolant.



To avoid personal injury, make sure the engine is cool before unscrewing the coolant pressure relief cap. The cooling system is under pressure; steam and hot liquid can come out forcefully when the cap is loosened slightly.

1. Before you begin, turn the engine off and let it cool.
2. When the engine is cool, wrap a thick cloth around the coolant pressure relief cap on the coolant reservoir (an opaque plastic bottle). Slowly turn cap counterclockwise (left) until pressure begins to release.
3. Step back while the pressure releases.
4. When you are sure that all the pressure has been released, use the cloth to turn it counterclockwise and remove the cap.
5. Fill the coolant reservoir slowly with the proper coolant mixture (see above), to within the “cold fill range” or the “cold full” level on the reservoir. If you removed the radiator cap in an overflow system, fill the radiator until the coolant is visible and radiator is almost full.
6. Replace the cap. Turn until tightly installed. (Cap must be tightly installed to prevent coolant loss.)

After any coolant has been added, check the coolant concentration (see Checking Engine Coolant section). If the concentration is not 50/50 (protection to $-34^{\circ}\text{F}/-36^{\circ}\text{C}$), drain some coolant and adjust the concentration. It may take several drains and additions to obtain a 50/50 coolant concentration.

Whenever coolant has been added, the coolant level in the coolant reservoir should be checked the next few times you drive the vehicle. If necessary, add enough 50/50 concentration of engine coolant and distilled water to bring the liquid level to the proper level.

If you have to add more than 1.0 liter (1.0 quart) of engine coolant per month, have your dealer check the engine cooling system. Your cooling system may have a leak. Operating an engine with a low level of coolant can result in engine overheating and possible engine damage.

Maintenance and Specifications

Recycled engine coolant

Ford Motor Company recommends the use of a recycled engine coolant produced by Ford-approved processes in vehicles originally equipped with Motorcraft Premium Engine Coolant (green-colored). However, not all coolant recycling processes produce coolant that meets Ford specification ESE-M97B44-A. Use of such coolant may harm the engine and cooling system components.

Ford Motor Company does NOT recommend the use of recycled engine coolant in vehicles originally equipped with Motorcraft Premium Gold Engine Coolant since a Ford-approved recycling process is not yet available.



Used engine coolant should be disposed of in an appropriate manner. Follow your community's regulations and standards for recycling and disposing of automotive fluids.

Coolant refill capacity

To find out how much fluid your vehicle's cooling system can hold, refer to *Refill capacities* in this chapter.

Fill your engine coolant reservoir as outlined in *Adding engine coolant* in this chapter.

Severe climates

If you drive in extremely cold climates (less than -36°C [-34°F):

- **It may be necessary to increase the coolant concentration above 50%.**
- **NEVER increase the coolant concentration above 60%.**
- **Increased engine coolant concentrations above 60% will decrease the overheat protection characteristics of the engine coolant and may cause engine damage.**
- **Refer to the chart on the coolant container to ensure the coolant concentration in your vehicle will provide adequate freeze protection at the temperatures in which you drive in the winter months.**

If you drive in extremely hot climates:

- **It is still necessary to maintain the coolant concentration above 40%.**

Maintenance and Specifications

- **NEVER decrease the coolant concentration below 40%.**
- **Decreased engine coolant concentrations below 40% will decrease the corrosion protection characteristics of the engine coolant and may cause engine damage.**
- **Decreased engine coolant concentrations below 40% will decrease the freeze protection characteristics of the engine coolant and may cause engine damage.**
- **Refer to the chart on the coolant container to ensure the coolant concentration in your vehicle will provide adequate protection at the temperatures in which you drive.**

Vehicles driven year-round in non-extreme climates should use a 50/50 mixture of engine coolant and distilled water for optimum cooling system and engine protection.

WHAT YOU SHOULD KNOW ABOUT AUTOMOTIVE FUELS

Important safety precautions



Do not overfill the fuel tank. The pressure in an overfilled tank may cause leakage and lead to fuel spray and fire.



The fuel system may be under pressure. If the fuel filler cap is venting vapor or if you hear a hissing sound, wait until it stops before completely removing the fuel filler cap. Otherwise, fuel may spray out and injure you or others.



If you do not use the proper fuel filler cap, excessive pressure or vacuum in the fuel tank may damage the fuel system or cause the fuel cap to disengage in a collision, which may result in possible personal injury.



Automotive fuels can cause serious injury or death if misused or mishandled.



Gasoline may contain benzene, which is a cancer-causing agent.

Maintenance and Specifications

Observe the following guidelines when handling automotive fuel:

- Extinguish all smoking materials and any open flames before fueling your vehicle.
- Always turn off the vehicle before fueling.
- Automotive fuels can be harmful or fatal if swallowed. Fuel such as gasoline is highly toxic and if swallowed can cause death or permanent injury. If fuel is swallowed, call a physician immediately, even if no symptoms are immediately apparent. The toxic effects of fuel may not be visible for hours.
- Avoid inhaling fuel vapors. Inhaling too much fuel vapor of any kind can lead to eye and respiratory tract irritation. In severe cases, excessive or prolonged breathing of fuel vapor can cause serious illness and permanent injury.
- Avoid getting fuel liquid in your eyes. If fuel is splashed in the eyes, remove contact lenses (if worn), flush with water for 15 minutes and seek medical attention. Failure to seek proper medical attention could lead to permanent injury.
- Fuels can also be harmful if absorbed through the skin. If fuel is splashed on the skin and/or clothing, promptly remove contaminated clothing and wash skin thoroughly with soap and water. Repeated or prolonged skin contact with fuel liquid or vapor causes skin irritation.
- Be particularly careful if you are taking “Antabuse” or other forms of disulfiram for the treatment of alcoholism. Breathing gasoline vapors, or skin contact could cause an adverse reaction. In sensitive individuals, serious personal injury or sickness may result. If fuel is splashed on the skin, promptly wash skin thoroughly with soap and water. Consult a physician immediately if you experience an adverse reaction.



When refueling always shut the engine off and never allow sparks or open flames near the filler neck. Never smoke while refueling. Fuel vapor is extremely hazardous under certain conditions. Care should be taken to avoid inhaling excess fumes.

Maintenance and Specifications



The flow of fuel through a fuel pump nozzle can produce static electricity, which can cause a fire if fuel is pumped into an ungrounded fuel container.

Use the following guidelines to avoid static build-up when filling an ungrounded fuel container:



- Place approved fuel container on the ground.
- DO NOT fill a fuel container while it is in the vehicle (including the cargo area).
- Keep the fuel pump nozzle in contact with the fuel container while filling.
- DO NOT use a device that would hold the fuel pump handle in the fill position.

Fuel Filler Cap

Your fuel tank filler cap has an indexed design with a 1/8 turn on/off feature.

When fueling your vehicle:

1. Turn the engine off.
2. Carefully turn the filler cap counterclockwise 1/8 of a turn until it stops.
3. Pull to remove the cap from the fuel filler pipe.
4. To install the cap, align the tabs on the cap with the notches on the filler pipe.
5. Turn the filler cap clockwise 1/8 of a turn until it stops.

After refueling, if the “CHECK FUEL CAP”  indicator comes on and stays on when you start the engine, the fuel filler cap may not be properly installed. Turn off the engine, remove the fuel filler cap, align the cap properly and reinstall it securely. The  indicator should turn off after three driving cycles with the fuel filler cap properly installed. A driving cycle consists of a cold engine start-up followed by mixed city/highway driving.

If you must replace the fuel filler cap, replace it with a fuel filler cap that is designed for your vehicle. The customer warranty may be void for any damage to the fuel tank or fuel system if the correct genuine Ford or Motorcraft fuel filler cap is not used.

Maintenance and Specifications

 The fuel system may be under pressure. If the fuel filler cap is venting vapor or if you hear a hissing sound, wait until it stops before completely removing the fuel filler cap. Otherwise, fuel may spray out and injure you or others.

 If you do not use the proper fuel filler cap, excessive pressure or vacuum in the fuel tank may damage the fuel system or cause the fuel cap to disengage in a collision, which may result in possible personal injury.

Choosing the right fuel

Use only UNLEADED FUEL. The use of leaded fuel is prohibited by law and could damage your vehicle.

Do not use fuel containing methanol. It can damage critical fuel system components.

Your vehicle was not designed to use fuel or fuel additives with metallic compounds, including manganese-based compounds containing MMT.

Repairs to correct the effects of using a fuel for which your vehicle was not designed may not be covered by your warranty.

Octane recommendations

Your vehicle is designed to use “Regular” unleaded gasoline with pump (R+M)/2 octane rating of 87. We do not recommend the use of gasolines labeled as “Regular” that are sold with octane ratings of 86 or lower in high altitude areas.



Do not be concerned if your engine sometimes knocks lightly. However, if it knocks heavily under most driving conditions while you are using fuel with the recommended octane rating, see your dealer or a qualified service technician to prevent any engine damage.

Fuel quality

If you are experiencing starting, rough idle or hesitation driveability problems during a cold start, try a different brand of “Regular” unleaded gasoline. “Premium” unleaded gasoline is not recommended (particularly in the United States) because it may cause these problems to become

Maintenance and Specifications

more pronounced. If the problems persist, see your dealer or a qualified service technician.

It should not be necessary to add any aftermarket products to your fuel tank if you continue to use high quality fuel of the recommended octane rating. Aftermarket products could cause damage to the fuel system. Repairs to correct the effects of using an aftermarket product in your fuel may not be covered by your warranty.

Many of the world's automakers issued the World-wide Fuel Charter that recommends gasoline specifications to provide improved performance and emission control system protection for your vehicle. Gasolines that meet the World-wide Fuel Charter should be used when available. Ask your fuel supplier about gasolines that meet the World-wide Fuel Charter. In Canada, look for fuels that display the **Auto Makers' Choice**[™] logo.



Cleaner air

Ford endorses the use of reformulated “cleaner-burning” gasolines to improve air quality.

Running out of fuel

Avoid running out of fuel because this situation may have an adverse affect on powertrain components.

If you have run out of fuel:

- You may need to cycle the ignition from OFF to ON several times after refueling, to allow the fuel system to pump the fuel from the tank to the engine.
- The  indicator may come on. For more information on the “Check Engine” indicator, refer to the *Instrument Cluster* chapter.

Fuel Filter

For fuel filter replacement, see your dealer or a qualified service technician. Refer to the scheduled maintenance guide for the appropriate intervals for changing the fuel filter.

Maintenance and Specifications

Replace the fuel filter with an authorized Motorcraft part. The customer warranty may be void for any damage to the fuel system if an authorized Motorcraft fuel filter is not used.

ESSENTIALS OF GOOD FUEL ECONOMY

Measuring techniques

Your best source of information about actual fuel economy is you, the driver. You must gather information as accurately and consistently as possible. Fuel expense, frequency of fillups or fuel gauge readings are NOT accurate as a measure of fuel economy. We do not recommend taking fuel economy measurements during the first 1 600 km (1 000 miles) of driving (engine break-in period). You will get a more accurate measurement after 3 000 km–5 000 km (2 000 miles–3 000 miles).

Filling the tank

The advertised fuel capacity of the fuel tank on your vehicle is equal to the rated refill capacity of the fuel tank as listed in the *Refill capacities* section of this chapter.

The advertised capacity is the amount of the indicated capacity and the empty reserve combined. Indicated capacity is the difference in the amount of fuel in a full tank and a tank when the fuel gauge indicates empty. Empty reserve is the small amount of fuel remaining in the fuel tank after the fuel gauge indicates empty.

The amount of usable fuel in the empty reserve varies and should not be relied upon to increase driving range. When refueling your vehicle after the fuel gauge indicates empty, you might not be able to refuel the full amount of the advertised capacity of the fuel tank due to the empty reserve still present in the tank.

For consistent results when filling the fuel tank:

- Turn the engine/ignition switch to the off position prior to refueling, an error in the reading will result if the engine is left running.
- Use the same filling rate setting (low — medium — high) each time the tank is filled.
- Allow no more than 2 automatic click-offs when filling.
- Always use fuel with the recommended octane rating.
- Use a known quality gasoline, preferably a national brand.

Maintenance and Specifications

- Use the same side of the same pump and have the vehicle facing the same direction each time you fill up.
- Have the vehicle loading and distribution the same every time.

Your results will be most accurate if your filling method is consistent.

Calculating fuel economy

1. Fill the fuel tank completely and record the initial odometer reading (in kilometers or miles).
2. Each time you fill the tank, record the amount of fuel added (in liters or gallons).
3. After at least three to five tank fill-ups, fill the fuel tank and record the current odometer reading.
4. Subtract your initial odometer reading from the current odometer reading.
5. Follow one of the simple calculations in order to determine fuel economy:

Multiply liters used by 100, then divide by total kilometers traveled.

Divide total miles traveled by total gallons used.

Keep a record for at least one month and record the type of driving (city or highway). This will provide an accurate estimate of the vehicle's fuel economy under current driving conditions. Additionally, keeping records during summer and winter will show how temperature impacts fuel economy. In general, lower temperatures give lower fuel economy.

Driving style — good driving and fuel economy habits

Give consideration to the lists that follow and you may be able to change a number of variables and improve your fuel economy.

Habits

- Smooth, moderate operation can yield up to 10% savings in fuel.
- Steady speeds without stopping will usually give the best fuel economy.
- Idling for long periods of time (greater than one minute) may waste fuel.
- Anticipate stopping; slowing down may eliminate the need to stop.

Maintenance and Specifications

- Sudden or hard accelerations may reduce fuel economy.
- Slow down gradually.
- Driving at reasonable speeds (traveling at 88 km/h [55 mph] uses 15% less fuel than traveling at 105 km/h [65 mph]).
- Revving the engine before turning it off may reduce fuel economy.
- Using the air conditioner or defroster may reduce fuel economy.
- You may want to turn off the speed control in hilly terrain if unnecessary shifting between third and fourth gear occurs. Unnecessary shifting of this type could result in reduced fuel economy.
- Warming up a vehicle on cold mornings is not required and may reduce fuel economy.
- Resting your foot on the brake pedal while driving may reduce fuel economy.
- Combine errands and minimize stop-and-go driving.

Maintenance

- Keep tires properly inflated and use only recommended size.
- Operating a vehicle with the wheels out of alignment will reduce fuel economy.
- Use recommended engine oil. Refer to *Lubricant specifications* in this chapter.
- Perform all regularly scheduled maintenance items. Follow the recommended maintenance schedule and owner maintenance checks found in your vehicle scheduled maintenance guide.

Conditions

- Heavily loading a vehicle or towing a trailer may reduce fuel economy at any speed.
- Carrying unnecessary weight may reduce fuel economy (approximately 0.4 km/L [1 mpg] is lost for every 180 kg [400 lb] of weight carried).
- Adding certain accessories to your vehicle (for example bug deflectors, rollbars/light bars, running boards, ski/luggage racks) may reduce fuel economy.
- Using fuel blended with alcohol may lower fuel economy.

Maintenance and Specifications

- Fuel economy may decrease with lower temperatures during the first 12–16 km (8–10 miles) of driving.
- Driving on flat terrain offers improved fuel economy as compared to driving on hilly terrain.
- Transmissions give their best fuel economy when operated in the top cruise gear and with steady pressure on the gas pedal.
- Close windows for high speed driving.

EPA window sticker

Every new vehicle should have the EPA window sticker. Contact your dealer if the window sticker is not supplied with your vehicle. The EPA window sticker should be your guide for the fuel economy comparisons with other vehicles.

It is important to note the box in the lower left corner of the window sticker. These numbers represent the Range of L/100 km (MPG) expected on the vehicle under optimum conditions. Your fuel economy may vary depending upon the method of operation and conditions.

EMISSION CONTROL SYSTEM

Your vehicle is equipped with various emission control components and a catalytic converter which will enable your vehicle to comply with applicable exhaust emission standards. To make sure that the catalytic converter and other emission control components continue to work properly:

- Use only the specified fuel listed.
- Avoid running out of fuel.
- Do not turn off the ignition while your vehicle is moving, especially at high speeds.
- Have the items listed in your scheduled maintenance guide performed according to the specified schedule.

The scheduled maintenance items listed in the scheduled maintenance guide are essential to the life and performance of your vehicle and to its emissions system.

If other than Ford, Motorcraft or Ford-authorized parts are used for maintenance replacements or for service of components affecting emission control, such non-Ford parts should be equivalent to genuine Ford Motor Company parts in performance and durability.

Maintenance and Specifications



Do not park, idle, or drive your vehicle in dry grass or other dry ground cover. The emission system heats up the engine compartment and exhaust system, which can start a fire.

Illumination of the  indicator, charging system warning light or the temperature warning light, fluid leaks, strange odors, smoke or loss of engine power, could indicate that the emission control system is not working properly.





Exhaust leaks may result in entry of harmful and potentially lethal fumes into the passenger compartment.

Do not make any unauthorized changes to your vehicle or engine. By law, vehicle owners and anyone who manufactures, repairs, services, sells, leases, trades vehicles, or supervises a fleet of vehicles are not permitted to intentionally remove an emission control device or prevent it from working. Information about your vehicle's emission system is on the Vehicle Emission Control Information Decal located on or near the engine. This decal identifies engine displacement and gives some tune up specifications.

Please consult your *Warranty Guide* for complete emission warranty information.

Readiness for Inspection/Maintenance (I/M) testing

In some localities, it may be a legal requirement to pass an I/M test of the on-board diagnostics system. If your  indicator is on, refer to the description in the *Warning lights and chimes* section of the *Instrument Cluster* chapter. Your vehicle may not pass the I/M test with the  indicator on.

If the vehicle's powertrain system or its battery has just been serviced, the on-board diagnostics system is reset to a "not ready for I/M test" condition. To ready the on-board diagnostics system for I/M testing, a minimum of 30 minutes of city and highway driving is necessary as described below:

- First, at least 10 minutes of driving on an expressway or highway.
- Next, at least 20 minutes driving in stop-and-go, city-type traffic with at least four idle periods.

Allow the vehicle to sit for at least eight hours without starting the engine. Then, start the engine and complete the above driving cycle. The

Maintenance and Specifications

engine must warm up to its normal operating temperature. Once started, do not turn off the engine until the above driving cycle is complete.

CHECKING AND ADDING POWER STEERING FLUID

Check the power steering fluid. Refer to the scheduled maintenance guide for the service interval schedules. If adding fluid is necessary, use only MERCON® ATF.

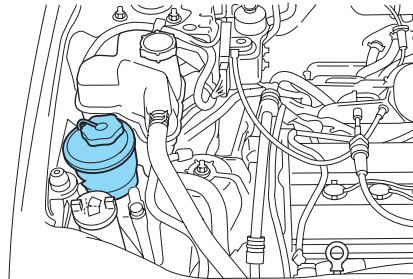

1. Start the engine and let it run until it reaches normal operating temperature (the engine coolant temperature gauge indicator will be near the center of the normal area between H and C).
2. While the engine idles, turn the steering wheel left and right several times.
3. Turn the engine off.
4. Check the fluid level in the reservoir. It should be between the MIN and MAX lines. Do not add fluid if the level is in this range.

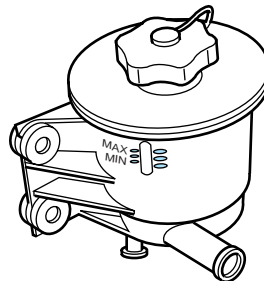

5. If the fluid is low, add fluid in small amounts, continuously checking the level until it reaches the range between the MIN and MAX lines. Be sure to put the cap back on the reservoir.

Maintenance and Specifications

BRAKE FLUID (⚠)

Checking and adding brake fluid

Brake fluid should be checked and refilled as needed. Refer to the scheduled maintenance guide for the service interval schedules.

1. Clean the reservoir cap before removal to prevent dirt or water from entering the reservoir.

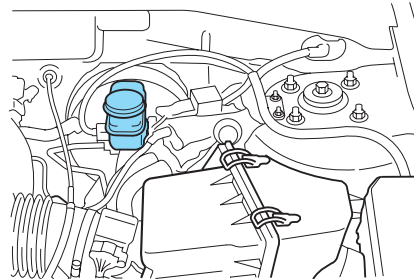

2. Visually inspect the fluid level.

3. If necessary, add brake fluid from a clean un-opened container until the level reaches MAX. Do not fill above this line.

4. Use only brake fluids certified to meet Ford specification ESA-M6C25-A. Refer to *Lubricant specifications* in this chapter.

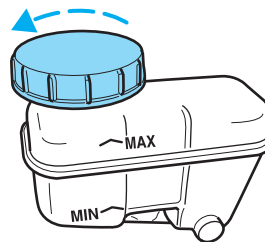

DOT 3 fluid is recommended. However, if DOT 3 is not available, DOT 4 fluid can be used.

 Brake fluid is toxic. If brake fluid contacts the eyes, flush eyes with running water for 15 minutes. Seek medical attention if irritation persists. If taken internally, drink water and induce vomiting. Seek medical attention immediately.

 If you use DOT 5 or any other brake fluid that is not DOT 3 or DOT 4, you will cause permanent damage to your brakes.

 Do not let the fluid level in the reservoir for the master cylinder fall below the MIN mark. If master cylinder runs dry, this may cause the brakes to fail.

Maintenance and Specifications

TRANSMISSION FLUID

Checking automatic transmission fluid (if equipped)

Refer to your scheduled maintenance guide for scheduled intervals for fluid checks and changes. Your transaxle does not consume fluid. However, the fluid level should be checked if the transaxle is not working properly, i.e., if the transaxle slips or shifts slowly or if you notice some sign of fluid leakage.

Automatic transmission fluid expands when warmed. To obtain an accurate fluid check, drive the vehicle until it is warmed up (approximately 30 km [20 miles]). If your vehicle has been operated for an extended period at high speeds, in city traffic during hot weather or pulling a trailer, the vehicle should be turned off for about 30 minutes to allow fluid to cool before checking.

1. Drive the vehicle 30 km (20 miles) or until it reaches normal operating temperature.
2. Park the vehicle on a level surface and engage the parking brake.
3. With the parking brake engaged and your foot on the brake pedal, start the engine and move the gearshift lever through all of the gear ranges. Allow sufficient time for each gear to engage.
4. Latch the gearshift lever in P (Park) and leave the engine running.
5. Remove the dipstick, wiping it clean with a clean, dry lint free rag. If necessary, refer to *Identifying components in the engine compartment* in this chapter for the location of the dipstick.
6. Install the dipstick making sure it is fully seated in the filler tube.
7. Remove the dipstick and inspect the fluid level. The fluid should be in the crosshatch zone for normal operating temperature.

Low fluid level

Do not drive the vehicle if the fluid level is at the bottom of the dipstick and the outside temperatures are above 10°C (50°F).

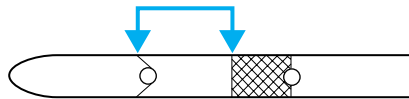

Maintenance and Specifications

Correct fluid level

The transmission fluid should be checked at normal operating temperatures 66°C-77°C (150°F-170°F) on a level surface. The normal operating temperature can be reached after approximately 30 km (20 miles) of driving.

The transmission fluid should be in the crosshatch zone if at normal operating temperature (66°C-77°C [150°F-170°F]).

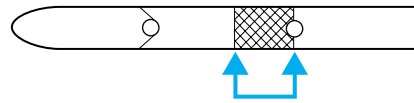

High fluid level

Fluid levels above the crosshatch zone may result in transaxle failure. An overfill condition of transmission fluid may cause shift and/or engagement concerns and/or possible damage.

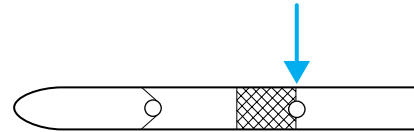

High fluid levels can be caused by an overheating condition.

Adjusting automatic transmission fluid levels

Before adding any fluid, make sure the correct type is used. The type of fluid used is normally indicated on the dipstick and also in the *Lubricant specifications* section in this chapter.

Use of a non-approved automatic transmission fluid may cause internal transaxle component damage.

If necessary, add fluid in 250 mL (1/2 pint) increments through the filler tube until the level is correct.

If an overfill occurs, excess fluid should be removed by a qualified technician.

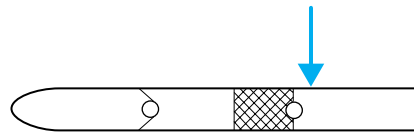

An overfill condition of transmission fluid may cause shift and/or engagement concerns and/or possible damage.

Maintenance and Specifications

Checking and adding manual transmission fluid (if equipped)

1. Clean the filler plug.
2. Remove the filler plug and inspect the fluid level.
3. Fluid level should be at bottom of the opening.

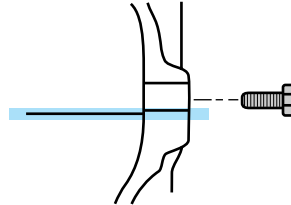

4. Add enough fluid through the filler opening so that the fluid level is at the bottom of the opening.
5. Install and tighten the fill plug securely.

Use only fluid that meets Ford specifications. Refer to the *Refill capacities* in this chapter.

CLUTCH FLUID (IF EQUIPPED)

The clutch master cylinder and brake master cylinder are part of the same system; both are refillable through the brake master cylinder with brake fluid. For more information on brake fluid maintenance, refer to *Brake fluid* in this chapter.

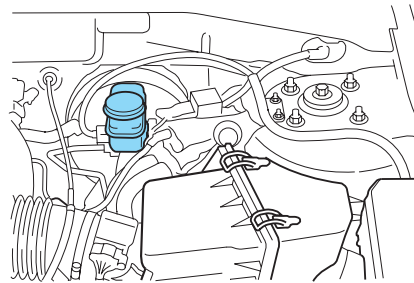

Brake fluid is toxic. If brake fluid contacts the eyes, flush eyes with running water for 15 minutes. Seek medical if irritation persists. If taken internally, drink water and induce vomiting. Seek medical attention immediately.

AIR FILTER MAINTENANCE

Refer to the scheduled maintenance guide for the appropriate intervals for changing the air filter element.

Maintenance and Specifications

When changing the air filter element, use only the Motorcraft air filter element listed. Refer to *Motorcraft Part Numbers*.

Note: Do not start your engine with the air cleaner removed and do not remove it while the engine is running.

Changing the air filter element

1. Loosen the clamp that secures the air inlet tube to the engine air filter cover and disconnect the tube from the cover.
2. Release the clamps that secure the air filter housing cover.
3. Carefully separate the two halves of the air filter housing.

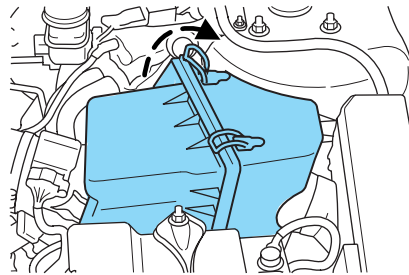

4. Remove the air filter element from the air filter housing.
5. Wipe the air filter housing and cover clean to remove any dirt or debris and to ensure good sealing.
6. Install a new air filter element. Be careful not to crimp the filter element edges between the air filter housing and cover. This could cause filter damage and allow unfiltered air to enter the engine if not properly seated.

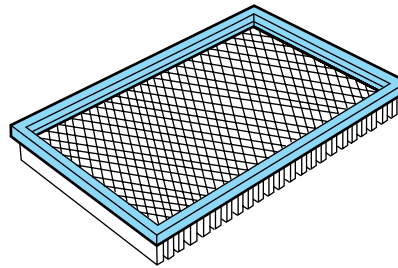

7. Replace the air filter housing cover and secure the clamps.
8. Replace the air inlet tube and secure the clamp.

Note: Failure to use the correct air filter element may result in severe engine damage. The customer warranty may be voided for any damage to the engine if the correct air filter element is not used.

Maintenance and Specifications

INFORMATION ABOUT UNIFORM TIRE QUALITY GRADING

New vehicles are fitted with tires that have a rating on them called Tire Quality Grades. The Quality grades can be found where applicable on the tire sidewall between tread shoulder and maximum section width. For example:

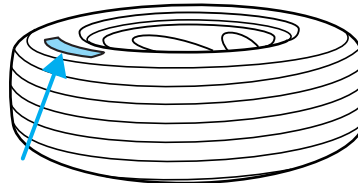

- **Treadwear 200 Traction AA Temperature A**

These Tire Quality Grades are determined by standards that the United States Department of Transportation has set.

Tire Quality Grades apply to new pneumatic tires for use on passenger cars. They do not apply to deep tread, winter-type snow tires, space-saver or temporary use spare tires, tires with nominal rim diameters of 10 to 12 inches or limited production tires as defined in Title 49 Code of Federal Regulations Part 575.104(c)(2).

U.S. Department of Transportation-Tire quality grades: The U.S. Department of Transportation requires Ford to give you the following information about tire grades exactly as the government has written it.

Treadwear

The treadwear grade is a comparative rating based on the wear rate of the tire when tested under controlled conditions on a specified government test course. For example, a tire graded 150 would wear one and one-half (1 1/2) times as well on the government course as a tire graded 100. The relative performance of tires depends upon the actual conditions of their use, however, and may depart significantly from the norm due to variations in driving habits, service practices, and differences in road characteristics and climate.

Traction AA A B C

The traction grades, from highest to lowest are AA, A, B, and C. The grades represent the tire's ability to stop on wet pavement as measured under controlled conditions on specified government test surfaces of asphalt and concrete. A tire marked C may have poor traction performance.

Maintenance and Specifications



The traction grade assigned to this tire is based on straight-ahead braking traction tests, and does not include acceleration, cornering, hydroplaning or peak traction characteristics.

Temperature A B C

The temperature grades are A (the highest), B, and C, representing the tire's resistance to the generation of heat and its ability to dissipate heat when tested under controlled conditions on a specified indoor laboratory test wheel. Sustained high temperature can cause the material of the tire to degenerate and reduce tire life, and excessive temperature can lead to sudden tire failure. The grade C corresponds to a level of performance which all passenger car tires must meet under the Federal Motor Vehicle Safety Standard No. 109. Grades B and A represent higher levels of performance on the laboratory test wheel than the minimum required by law.



The temperature grade for this tire is established for a tire that is properly inflated and not overloaded. Excessive speed, underinflation, or excessive loading, either separately or in combination, can cause heat buildup and possible tire failure.

SERVICING YOUR TIRES

Checking the tire pressure

- Use an accurate tire pressure gauge.
- Check the tire pressure when tires are cold, after the vehicle has been parked for at least one hour or has been driven less than 5 km (3 miles).
- Adjust tire pressure to recommended specifications found on the Certification Label. Tire pressure information can also be found on the Tire Information label located on the inside of the fuel filler door.



Improperly inflated tires can affect vehicle handling and can fail suddenly, possibly resulting in loss of vehicle control.

Maintenance and Specifications

Tire rotation

Because your vehicle's tires perform different jobs, they often wear differently. To make sure your tires wear evenly and last longer, rotate them as indicated in the scheduled maintenance guide. If you notice that the tires wear unevenly, have them checked.

- Four tire rotation

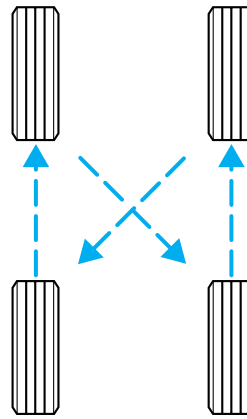

Replacing the tires

Replace the tires when the wear band is visible through the tire treads.

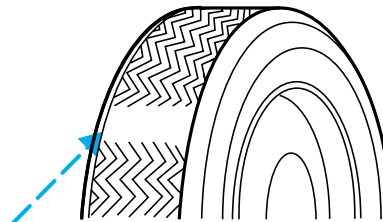

 When replacing full size tires, never mix radial bias-belted, or bias-type tires. Use only the tire sizes that are listed on the Certification Label. Make sure that all tires are the same size, speed rating, and load-carrying capacity. Use only the tire combinations recommended on the label. If you do not follow these precautions, your vehicle may not drive properly and safely.

 Make sure that all replacement tires are of the same size, type, load-carrying capacity and tread design (e.g., "All Terrain", etc.), as originally offered by Ford.

Maintenance and Specifications



Do not replace your tires with “high performance” tires or larger size tires.



Failure to follow these precautions may adversely affect the handling of the vehicle and make it easier for the driver to lose control and roll over.

Tires that are larger or smaller than your vehicle’s original tires may also affect the accuracy of your speedometer.

USING SNOW TIRES AND TRACTION DEVICES



Snow tires must be the same size and grade as the tires you currently have on your vehicle.

The tires on your vehicle have all-weather treads to provide traction in rain and snow. However, in some climates, using snow tires or traction devices may be necessary.

Follow these guidelines when using snow tires and traction devices:

- SAE class “S” cable should be used only on front axle for P235/70R16 tires. With P225/70R15 and P215/70R16 tires, SAE class “S” cables can be used on both the front and rear wheels.
- Install cables or chains securely, verifying that the cables or chains do not touch any wiring, brake lines or fuel lines.
- Drive cautiously. If you hear the cables or chains rub or bang against the vehicle, stop and retighten them. If this does not work, remove the cables or chains to prevent vehicle damage.
- Avoid overloading your vehicle.
- Remove the cables or chains when they are no longer needed.
- Do not use cables or chains on dry roads.
- Do not exceed 48 km/h (30 mph) with tire cables or chains on your vehicle.

Consult your dealer for information on other Ford approved methods of traction control.

Maintenance and Specifications

MOTORCRAFT PART NUMBERS

Component	2.0L DOHC I4 Zetec engine	3.0L DOHC V6 Duratec engine
Air filter element ¹	FA-1683	FA-1683
Fuel filter	FG-800-A	FG-800-A
Battery	BXT-96R	BXT-40R
Oil filter	FL-400S	FL-820-S
PCV valve	EV-224	EV-243
Spark plugs* ²	AZFS-32FE ³	AGSF-32W

¹Failure to use the correct air filter element may result in severe engine damage. The customer warranty may be voided for any damage to the engine if the correct air filter element is not used.

²Refer to Vehicle Emissions Control Information (VECI) decal for spark plug gap information.

³If a spark plug is to be removed for inspection, it must be reinstalled in the same cylinder. If a spark plug needs to be replaced, use only spark plugs with the service part number suffix letter as shown on the engine decal.

REFILL CAPACITIES

Fluid	Ford Part Name	Application	Capacity
Brake fluid	Motorcraft High Performance DOT 3 Motor Vehicle Brake Fluid	All	Fill to line on reservoir
Engine oil (including filter change)	Motorcraft SAE 5W-20 Super Premium Motor Oil	2.0L I4 Zetec engine	4.25L (4.5 quarts)
		3.0L V6 Duratec engine	5.2L (5.5 quarts)
Fuel tank	N/A	2.0L I4 Zetec engine	57L (15 gallons)
		3.0L V6 Duratec engine	61L (16 gallons)

Maintenance and Specifications

Fluid	Ford Part Name	Application	Capacity
Power steering fluid	Motorcraft MERCON® ATF	All	Fill to line on reservoir
Transmission fluid ¹	Motorcraft SAE 75W-90 API GL-4 Gear Oil	Manual transaxle (2WD)	2.7L (2.85 quarts) ²
		Manual transaxle (4X4)	2.2L (2.32 quarts) ²
	Motorcraft MERCON® ATF	2.0L engine with Automatic transaxle and oil cooler	8.5L (9.0 quarts)
		3.0L engine with Automatic transaxle and oil cooler	9.6L (10.2 quarts) ³
Power Take-off Unit	Motorcraft SAE 75W-140 High Performance Synthetic Rear Axle Lubricant	4X4 (Automatic)	0.35L (12 ounces)
	Motorcraft SAE 80W-90 Premium Rear Axle Lubricant	4X4 (Manual)	0.35L (12 ounces)

Maintenance and Specifications

Fluid	Ford Part Name	Application	Capacity
Engine coolant ⁴	Motorcraft Premium Engine Coolant (green colored) or	2.0L I4 Zetec engine with manual transaxle	5.0L (5.3 quarts)
	Motorcraft Premium Gold Engine Coolant (yellow-colored)	2.0L I4 Zetec engine with automatic transaxle	6.0L (6.3 quarts)
		3.0L V6 Duratec engine with automatic transaxle	10.0L (10.6 quarts)
Rear axle lubricant	Motorcraft SAE 80W-90 Premium Rear Axle Lubricant	4X4	1.4L (2.96 pints) ⁵
Windshield washer fluid	Ultra-Clear Windshield Washer Concentrate	All	2.6L (2.7 quarts)

¹Ensure the correct automatic transmission fluid is used. Transmission fluid requirements are indicated on the dipstick or on the dipstick handle. MERCON® and MERCON® V are not interchangeable. DO NOT mix MERCON® and MERCON® V. Refer to your scheduled maintenance guide to determine the correct service interval.

²Service refill capacity is determined by filling the transmission to the bottom of the filler hole with the vehicle on a level surface.

³Indicates only approximate dry-fill capacity. Some applications may vary based on cooler size and if equipped with an in-tank cooler. The amount of transmission fluid and fluid level should be set by the indication on the dipstick's normal operating range.

⁴Add the coolant type originally equipped in your vehicle.

⁵Fill to 6 mm to 14 mm (1/4 inch to 9/16 inch) below bottom of fill hole.

Maintenance and Specifications

LUBRICANT SPECIFICATIONS

Item	Ford Part Name or equivalent	Ford Part Number	Ford Specification
Body hinges, latches, door striker plates and rollers, seat tracks, fuel filler door hinge and spring, primary and auxiliary hood latches	Multi-Purpose Grease	XG-4 or F5AZ-19G209-AA	ESB-M1C93-B or ESR-M1C159-A
Hydraulic clutch fluid and brake fluid	Motorcraft High Performance DOT 3 Motor Vehicle Brake Fluid	PM-1	ESA-M6C25-A and DOT 3
Halfshaft CV joints	Motorcraft Premium Long Life Grease	XG-1-C or XG-1-T or XG-1-K	ESA-M1C75-B
Engine coolant ¹	Motorcraft Premium Engine Coolant (green-colored)	VC-4-A (US) or CXC-10 (Canada)	ESE-M97B44-A
	Motorcraft Premium Gold Engine Coolant (yellow-colored)	VC-7-A	WSS-M97B51-A1
Engine oil	Motorcraft SAE 5W-20 Super Premium Motor Oil	XO-5W20-QSP	WSS-M2C153-H with API Certification Mark
Manual transaxle ²	Motorcraft SAE 75W-90 Gear Oil	F32Z-19C547-MA	WSS-M2C203-A1
Automatic transaxle ²	Motorcraft MERCON® ATF	XT-2-QDX	MERCON®
Power steering fluid	Motorcraft MERCON® ATF	XT-2-QDX	MERCON®

Maintenance and Specifications

Item	Ford Part Name or equivalent	Ford Part Number	Ford Specification
Rear axle (4X4) ⁴	Motorcraft SAE 80W-90 Premium Rear Axle Lubricant	XY-80W90-QL	WSP-M2C197-A
Power Take-off(PTO) (4X4-Manual Transaxle)	Motorcraft SAE 80W-90 Premium Rear Axle Lubricant	XY-80W90-QL	WSP-M2C197-A
Power Take-off(PTO) ³ (4X4-Automatic Transaxle)	Motorcraft SAE 75W-140 Synthetic Rear Axle Lubricant	XY-75W140-QL	WSL-M2C192-A
Windshield washer fluid	Ultra-clear Windshield Washer Concentrate	C9AZ-19550-AC	ESR-M17P5-A

¹DO NOT USE Ford Extended Life Engine Coolant F6AZ-19544-AA, meeting Ford specification WSS-M97B44-D (orange in color) Refer to *Adding engine coolant*, in the *Maintenance and Care* chapter.

²Ensure the correct automatic transmission fluid is used. Transmission fluid requirements are indicated on the dipstick or on the dipstick handle. MERCON® and MERCON® V are not interchangeable. DO NOT mix MERCON® and MERCON® V. Refer to your scheduled maintenance guide to determine the correct service interval.

³The Power Take-off(PTO) is lubricated for life with synthetic lube. Lubricant levels are not to be checked or changed unless a leak is suspected or repair required. Replace Power Take-off(PTO) lubricant with specified synthetic lubricant anytime the unit is submerged in water. Never engage the 4X4 feature while on dry pavement.

⁴4X4 vehicles exposed for prolonged periods to temperatures less than -40° C (-40° F) should change out the rear axle fluid to Motorcraft SAE 75W-140 Synthetic Rear Axle Lubricant, Ford part number XY-75W140-QL meeting Ford specification WSL-M2C192-A.

Maintenance and Specifications

ENGINE DATA

Engine	2.0L DOHC I4 Zetec engine	3.0L DOHC V6 Duratec engine
Cubic inches	121	181
Required fuel	87 octane	87 octane
Firing order	1-3-4-2	1-4-2-5-3-6
Spark plug gap	1.22-1.32 mm (0.048-0.052 inch)	1.32-1.42 mm (0.052-0.056 inch)
Ignition system	DIS	Coil on plug
Compression ratio	9.6:1	10.0:1

VEHICLE DIMENSIONS

Dimensions	4 Door mm (in.)
(1) Vehicle height/ Maximum height*	1 755 (69.1)/1 774 (69.8)*
(2) Front track / rear	1 551 (61.1)/1 530 (60.2)
(3) Overall width (body)	1 780 (70.1)
(4) Wheelbase	2 620 (103.1)
(5) Overall length	4 393 (173.0)

* Denotes a 4x4 vehicle with optional 16" tires

Maintenance and Specifications

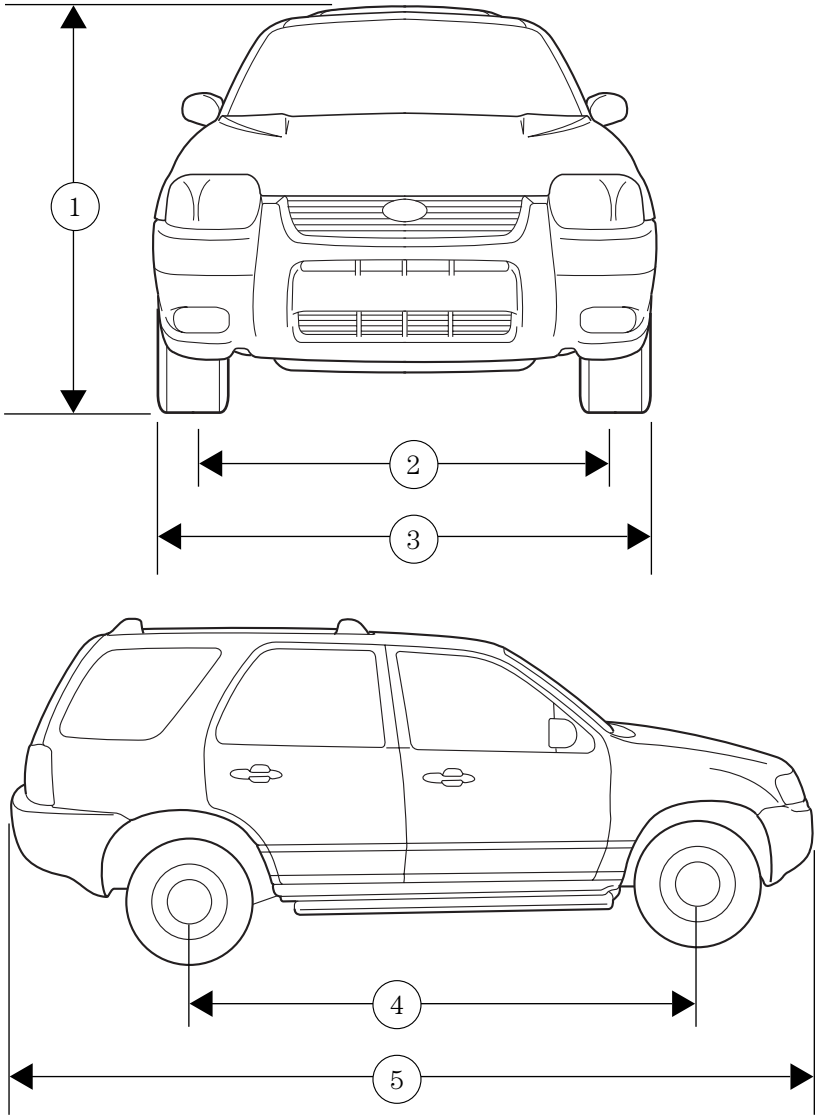

Maintenance and Specifications

IDENTIFYING YOUR VEHICLE

Certification label

The National Highway Traffic Safety Administration Regulations require that a Certification label be affixed to a vehicle and prescribe where the Certification label may be located. The Certification label is located on the front door latch pillar on the driver's side.

MFD. BY FORD MOTOR CO. IN U.S.A.	
DATE: XXXXX	GVWR: XXXXX LB/ XXXXX KG
FGAWR: XXXXX/XXXXXXXX	RGAWR: XXXXX/XXXXXXXX
THIS VEHICLE CONFORMS TO ALL APPLICABLE FEDERAL MOTOR VEHICLE SAFETY STANDARDS IN EFFECT ON THE DATE OF MANUFACTURE SHOWN ABOVE.	
VIN: XXXXXXXXXXXXXXXXX	TYPE: XXXXXXXXXXXXXXXXX
	
MAXIMUM LOAD=OCCUPANTS + LUGGAGE=XXXKG/XXXLB	
OCCUPANTS: X TOTAL X FR X 2ND X RR OCCUPANTS LUGGAGE	
	XX XXXKG/XXXLB
	X XXXKG/XXXLB
TIRE: XXXX/XXXXX XXX	X XXXKG/XXXLB
PRESSURE (FR) XXX kPa/ XX PSI COLD	
PRESSURE (RR) XXX kPa/ XX PSI COLD	
TRAILER TOWING - SEE OWNER GUIDE	
EXT PNT: XXXXX XXXXX	RC: XX DSO: XXXX F0000
BAR INT TR TP/PS R	AXLE TR SPR T0000
X XX XXX X XX X XXXX	
UTC VFOHT-15294A10-GA	

Vehicle identification number

The vehicle identification number is attached to a metal tag and is located on the driver side instrument panel. (Please note that in the graphic XXXX is representative of your vehicle identification number.)

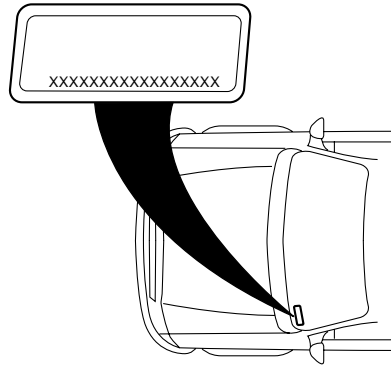

Maintenance and Specifications

1. World manufacturer identifier
2. Brake type and gross vehicle weight rating (GVWR)
3. Vehicle line, series, body type
4. Engine type
5. Check digit
6. Model year
7. Assembly plant
8. Production sequence number

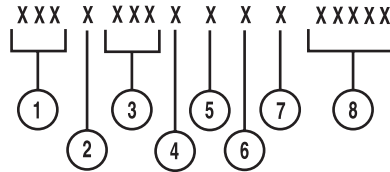

Engine number

The engine number (the last eight numbers of the vehicle identification number) is stamped on the engine block, transmission and frame.

Accessories

FORD ACCESSORIES FOR YOUR VEHICLE

A wide selection of genuine Ford accessories are available for your vehicle through your local authorized Ford, Lincoln Mercury or Ford of Canada dealer. These quality accessories have been specifically engineered to fulfill your automotive needs; they are custom designed to complement the style and aerodynamic appearance of your vehicle. In addition, each accessory is made from high quality materials and meets or exceeds Ford's rigorous engineering and safety specifications. Ford Motor Company will repair or replace any properly dealer-installed Ford accessory found to be defective in factory-supplied materials or workmanship during the warranty period, as well as any component damaged by the defective accessory. The accessory will be warranted for whichever provides you the greatest benefit:

- 12 months or 20 000 km (12 000 miles) (whichever occurs first), or
- The remainder of your new vehicle limited warranty.

This means that genuine Ford accessories purchased along with your new vehicle and installed by the dealer are covered for the full length of your New Vehicle's Limited Warranty — 3 years or 60 000 km (36 000 miles) (whichever occurs first). Contact your dealer for details and a copy of the warranty.

Not all accessories are available for all models.

Vehicle Security

Styled wheel protector locks
Vehicle security systems

Comfort and convenience

Cabin air filtration
Cargo organizers
Cargo shades
Cargo trays
Carpeted cargo mat
Celluar phone holder
Dash trim
Engine block heater
Floor cargo net
Tire step

Accessories

Travel equipment

Auto headlamps with DRL (Daytime Running Lights)
Console
Daytime running lights
Factory luggage rack adaptors
Hitch mounted bike rack
Mirror I/S electrochromic compass with and without temperature display
Pet guard
Removable luggage rack (Track riders)
Removable luggage rack adapters
Running boards and running bars
Soft luggage cover
Trailer hitch (Class II)
Trailer hitch bars and balls
Trailer hitch wiring adaptor

Protection and appearance equipment

Air bag anti-theft locks
Car/truck covers
Cargo liners, interior (soft and rigid)
Carpet floor mats
Door edge guards
Front end covers (full and mini)
Grill guard
Hood deflectors
Molded splash guards
Molded vinyl floor mats
Moonroof deflector
Rear air deflectors
Side window air deflectors
Step/sill plates
Universal floor mats

Accessories

For maximum vehicle performance, keep the following information in mind when adding accessories or equipment to your vehicle:

- When adding accessories, equipment, passengers and luggage to your vehicle, do not exceed the total weight capacity of the vehicle or of the front or rear axle (GVWR or GAWR as indicated on the Safety compliance certification label). Consult your dealer for specific weight information.
- The Federal Communications Commission (FCC) and Canadian Radio Telecommunications Commission (CRTC) regulate the use of mobile communications systems - such as two-way radios, telephones and theft alarms - that are equipped with radio transmitters. Any such equipment installed in your vehicle should comply with FCC or CRTC regulations and should be installed only by a qualified service technician.
- Mobile communications systems may harm the operation of your vehicle, particularly if they are not properly designed for automotive use or are not properly installed. When operated, such systems may cause the engine to stumble or stall or cause the transmission to be damaged or operate improperly. In addition, such systems may be damaged or their performance may be affected by operating your vehicle. If you intend on fitting a mobile radio such as a citizens band radio (CB), please refer to your local dealer for Ford recommended installation guidelines. Ask your dealer to reference the "Ford Mobile Radio Installation Guidelines." (Citizens band [CB] transceivers, garage door openers and other transmitters with outputs of five watts or less will not ordinarily affect your vehicle's operation.)
- Ford cannot assume responsibility for any adverse effects or damage that may result from the use of such equipment.

Index

A

ABS (see Brakes)162
Air bag supplemental
restraint system139–140, 144
and child safety seats142
description140, 144
disposal147
driver air bag142, 145
indicator light12, 144, 146
operation142, 145
passenger air bag142, 145
side air bag144
Air cleaner filter259–260, 265
Air conditioning
manual heating and air
conditioning system65
All Wheel Drive (AWD),
driving off road171
Ambulance packages7
Antifreeze
(see Engine coolant)240
Anti-lock brake system
(see Brakes)162
Anti-theft system113
arming the system113
disarming a triggered
system114
warning light14
Audio system (see Radio) ...26, 47
Automatic transaxle165
driving with168
fluid, adding257
fluid, checking257
Automatic transmission
fluid, refill capacities265
fluid, specification270

Auxiliary power point85

Axle

lubricant
specifications268, 270
refill capacities265

B

Battery238
acid, treating emergencies238
charging system warning
light12
jumping a disabled battery203
maintenance-free238
replacement, specifications ...265
servicing238
BeltMinder134
Brakes161
anti-lock162
anti-lock brake system
(ABS) warning light12, 163
brake warning light11
fluid, checking and adding256
fluid, refill capacities265
fluid, specifications268, 270
lubricant
specifications268, 270
parking163
shift interlock165
Break-in period5
Bulbs74

C

Capacities for refilling fluids265
Cargo cover93
Cargo net93
CD-single19

Index

- CD-single premium26
 - Certification Label272
 - Changing a tire199
 - Child safety restraints148
 - child safety belts148
 - Child safety seats148–149
 - attaching with tether straps153
 - in front seat150
 - in rear seat150
 - Cleaning your vehicle
 - engine compartment223
 - exterior227
 - instrument cluster lens226
 - instrument panel226
 - interior226–227
 - plastic parts224–225
 - safety belts227
 - washing221
 - waxing221
 - wheels222
 - windows226
 - wiper blades225
 - woodtone trim226
 - Climate control (see Air conditioning or Heating)63, 65
 - Clock25, 34, 44, 60
 - Clutch
 - fluid259
 - Console91
 - overhead84
 - Controls
 - power seat116
 - Coolant
 - checking and adding240
 - refill capacities244, 265
 - specifications268, 270
 - Cruise control (see Speed control)88
 - Customer Assistance188
 - Ford accessories for your vehicle228
 - Ford Extended Service Plan213
 - Getting assistance outside the U.S. and Canada217
 - Getting roadside assistance188
 - Getting the service you need211
 - Ordering additional owner's literature218
 - The Dispute Settlement Board214
 - Utilizing the Mediation/Arbitration Program217
- ## D
- Daytime running lamps (see Lamps)69
 - Defrost
 - rear window68
 - Dipstick
 - automatic transmission fluid257
 - engine oil234
 - Doors
 - central unlocking105
 - door ajar warning14
 - lubricant specifications268
 - Driving under special conditions174, 177
 - sand175
 - snow and ice178
 - through water176, 180

Index

E

Emergencies, roadside
 jump-starting203

Emission control system253

Engine270
 check engine/service engine
 soon light10
 cleaning223
 coolant240
 idle speed control238
 lubrication specifications268,
 270
 refill capacities265
 service points232–233
 starting after a collision189

Engine block heater160

Engine oil234
 checking and adding234
 dipstick234
 filter, specifications237, 265
 recommendations237
 refill capacities265
 specifications268, 270

Exhaust fumes161

F

Fluid capacities265

Foglamps69

Four-Wheel Drive vehicles
 description172
 driving off road173
 indicator light15, 173
 preparing to drive your
 vehicle165

Fuel245
 calculating fuel economy250
 cap15, 247

 capacity265
 choosing the right fuel248
 comparisons with EPA
 fuel economy estimates253
 detergent in fuel249
 filling your vehicle
 with fuel245, 247, 250
 filter, specifications249, 265
 fuel pump shut-off switch189
 gauge17
 improving fuel economy250
 low fuel warning light13
 octane rating248, 270
 quality248
 running out of fuel249
 safety information relating
 to automotive fuels245

Fuses191–192

G

Garage door opener84

Gas cap (see Fuel cap)15, 247

Gas mileage
(see Fuel economy)250

Gauges16
 engine coolant temperature
 gauge16
 fuel gauge17
 odometer17–18
 speedometer17
 tachometer18

GAWR (Gross Axle
Weight Rating)180
 calculating183
 definition180
 driving with a heavy load180
 location180

Index

- GVWR (Gross Vehicle Weight Rating)180
calculating180, 183
definition180
driving with a heavy load180
location180
- H**
- Hazard flashers189
Head restraints118
Headlamps69
aiming71
bulb specifications74
daytime running lights69
flash to pass70
high beam14, 70
replacing bulbs75
turning on and off69
warning chime15
Heating
heater only system63
heating and air conditioning
system65
Hood230
- I**
- Ignition157, 270
Infant seats
(see Safety seats)148–149
Inspection/maintenance
(I/M) testing254
Instrument panel
cleaning226
cluster10, 226
lighting up panel
and interior70
- J**
- Jack199
positioning199
storage199
Jump-starting your vehicle203
- K**
- Keys110, 112
key in ignition chime15
positions of the ignition157
- L**
- Lamps
bulb replacement
specifications chart74
cargo lamps70
daytime running light69
fog lamps69
headlamps69
headlamps, flash to pass70
instrument panel,
dimming70
interior lamps72–73, 75
replacing bulbs74–75, 77–79
Lane change indicator
(see Turn signal)72
Liftgate92
Lights, warning and indicator10
air bag12
anti-lock brakes (ABS)12, 163
anti-theft14
brake11
charging system12
cruise indicator13
door ajar14
fuel cap light15
high beam14

Index

- low coolant14
- low fuel13
- oil pressure13
- overdrive off13
- safety belt12
- service engine soon10
- turn signal indicator13
- Load limits180
 - GAWR180
 - GVWR180
 - trailer towing180
- Loading instructions182
- Locks
 - childproof106
- Lubricant specifications268, 270
- Lumbar support, seats117–118
- M**
- Manual transaxle
 - fluid, checking and adding259
- Manual transmission
 - fluid capacities265
 - lubricant specifications270
- Mirrors
 - fold away88
 - side view mirrors (power)87
- Moon roof91
- Motorcraft parts249, 265
- O**
- Octane rating248
- Odometer17–18
- Oil (see Engine oil)234
- Overdrive168
- P**
- Panic alarm feature, remote entry system107
- Parking brake163
- Parts (see Motorcraft parts)265
- Power distribution box (see Fuses)195
- Power door locks105
- Power mirrors87
- Power steering164
 - fluid, checking and adding255
 - fluid, refill capacity265
 - fluid, specifications268, 270
- Power Windows85
- Preparing to drive your vehicle165
- R**
- Radio26, 47
- Radio reception62
- Rear window defroster68
- Relays191
- Remote entry system106–107
 - illuminated entry109
 - locking/unlocking doors105, 107
 - panic alarm107
 - replacement/additional transmitters108
 - replacing the batteries108
- Roof rack95

Index

S

Safety belts (see
Safety restraints)15, 127–132
Safety defects, reporting220
Safety restraints127–132
 belt minder134
 cleaning the safety
 belts138, 227
 extension assembly134
 for adults128–131
 for children147–148
 lap belt133
 warning light and
 chime12, 15, 134
Safety seats for
 children148–149
Seat belts
 (see Safety restraints)127
Seats115
 child safety seats148–149
 cleaning227
SecuriLock passive
 anti-theft system110, 112
Servicing your vehicle229
Snowplowing7
Spare tire (see Changing
 the Tire)199
Spark plugs,
 specifications265, 270
Special notice
 ambulance conversions7
 utility-type vehicles6
Specification chart,
 lubricants268, 270
Speed control88

Speedometer17
Starting your
 vehicle157–158, 160
 jump starting203
Steering wheel
 controls88

T

Tachometer18
Temperature control
 (see Climate control)63
Tires199, 261–262
 changing199
 checking the pressure262
 replacing263
 rotating263
 snow tires and chains264
 tire grades262
 treadwear261
Towing183
 recreational towing187
 trailer towing183
 wrecker209
Transaxle
 automatic operation165
 fluid, checking and adding
 (manual)259
Transmission
 fluid, checking and adding
 (automatic)257
 fluid, refill capacities265
 lubricant
 specifications268, 270
Turn signal13, 72
V
Vehicle dimensions270

Index

Vehicle Identification Number (VIN)	272
Vehicle loading	180
Ventilating your vehicle	161
W	
Warning chimes	15
Warning lights (see Lights)	10
Washer fluid	234
Water, Driving through	180
Windows	
power	85
rear wiper/washer	82
Windshield washer fluid and wipers	
checking and adding fluid	234
checking and cleaning	81, 83
liftgate reservoir	234
operation	80
replacing wiper blades	82
Wrecker towing	209

