

Contents

Before driving

Introduction	2
---------------------	----------

Instrumentation	6
------------------------	----------

Controls and features	31
------------------------------	-----------

Seating and safety restraints	135
--------------------------------------	------------

Starting and driving

Starting	182
-----------------	------------

Driving	187
----------------	------------

Roadside emergencies	225
-----------------------------	------------

Servicing

Maintenance and care	251
-----------------------------	------------

Capacities and specifications	304
--------------------------------------	------------

Customer assistance	313
----------------------------	------------

Reporting safety defects	325
---------------------------------	------------

Index	326
--------------	------------

All rights reserved. Reproduction by any means, electronic or mechanical including photocopying, recording or by any information storage and retrieval system or translation in whole or part is not permitted without written authorization from Ford Motor Company. Ford may change the contents without notice and without incurring obligation.

Copyright © 2002 Ford Motor Company

Introduction

The following warning may be required by California law:

CALIFORNIA Proposition 65 Warning



WARNING: Engine exhaust, some of its constituents, and certain vehicle components contain or emit chemicals known to the State of California to cause cancer and birth defects or other reproductive harm. In addition, certain fluids contained in vehicles and certain products of component wear contain or emit chemicals known to the State of California to cause cancer and birth defects or other reproductive harm.

ICONS

Indicates a safety alert. Read the following section on *Warnings*.



Indicates vehicle information related to recycling and other environmental concerns will follow.



Correct vehicle usage and the authorized disposal of waste cleaning and lubrication materials are significant steps towards protecting the environment.

Indicates a message regarding child safety restraints. Refer to *Seating and safety restraints* for more information.



Indicates that this Owner Guide contains information on this subject. Please refer to the Index to locate the appropriate section which will provide you more information.



WARNINGS

Warnings provide information which may reduce the risk of personal injury and prevent possible damage to others, your vehicle and its equipment.

Introduction

BREAKING-IN YOUR VEHICLE

There are no particular guidelines for breaking-in your vehicle. During the first 1,600 km (1,000 miles) of driving, vary speeds frequently. This is recommended to give the moving parts a chance to break in.

INFORMATION ABOUT THIS GUIDE

The information found in this guide was in effect at the time of printing. Ford may change the contents without notice and without incurring obligation.

EMISSION WARRANTY

The New Vehicle Limited Warranty includes Bumper-to-Bumper Coverage, Safety Restraint Coverage, Corrosion Coverage, and 7.3L Power Stroke Diesel Engine Coverage. In addition, your vehicle is eligible for Emissions Defect and Emissions Performance Warranties. For a detailed description of what is covered and what is not covered, refer to the *Warranty Guide* that is provided to you along with your Owner's Guide.

SPECIAL NOTICES

Notice to owners of pickup trucks and utility type vehicles



Utility vehicles have a significantly higher rollover rate than other types of vehicles.

Before you drive your vehicle, please read this Owner's Guide carefully. Your vehicle is not a passenger car. As with other vehicles of this type, failure to operate this vehicle correctly may result in loss of control, vehicle rollover, personal injury or death.

Be sure to read *Driving off road* in the *Driving* chapter.

Using your vehicle with a snowplow



Do not use this vehicle for snowplowing.

Using your vehicle as an ambulance



Do not use this vehicle as an ambulance.

Your vehicle is not equipped with the Ford Ambulance Preparation Package.





















Introduction

These are some of the symbols you may see on your vehicle.

Vehicle Symbol Glossary

Safety Alert		See Owner's Guide	
Fasten Safety Belt		Air Bag-Front	
Air Bag-Side		Child Seat	
Child Seat Installation Warning		Child Seat Tether Anchorage	
Brake System		Anti-Lock Brake System	
Brake Fluid - Non-Petroleum Based		Traction Control	
AdvanceTrac		Master Lighting Switch	
Hazard Warning Flasher		Fog Lamps-Front	
Fuse Compartment		Fuel Pump Reset	
Windshield Wash/Wipe		Windshield Defrost/Demist	
Rear Window Defrost/Demist		Power Windows Front/Rear	

Vehicle Symbol Glossary

Power Window Lockout		Child Safety Door Lock/Unlock	
Interior Luggage Compartment Release Symbol		Panic Alarm	
Engine Oil		Engine Coolant	
Engine Coolant Temperature		Do Not Open When Hot	
Battery		Avoid Smoking, Flames, or Sparks	
Battery Acid		Explosive Gas	
Fan Warning		Power Steering Fluid	
Maintain Correct Fluid Level		Emission System	
Engine Air Filter		Passenger Compartment Air Filter	
Jack		Check fuel cap	
Low tire warning			

Instrumentation

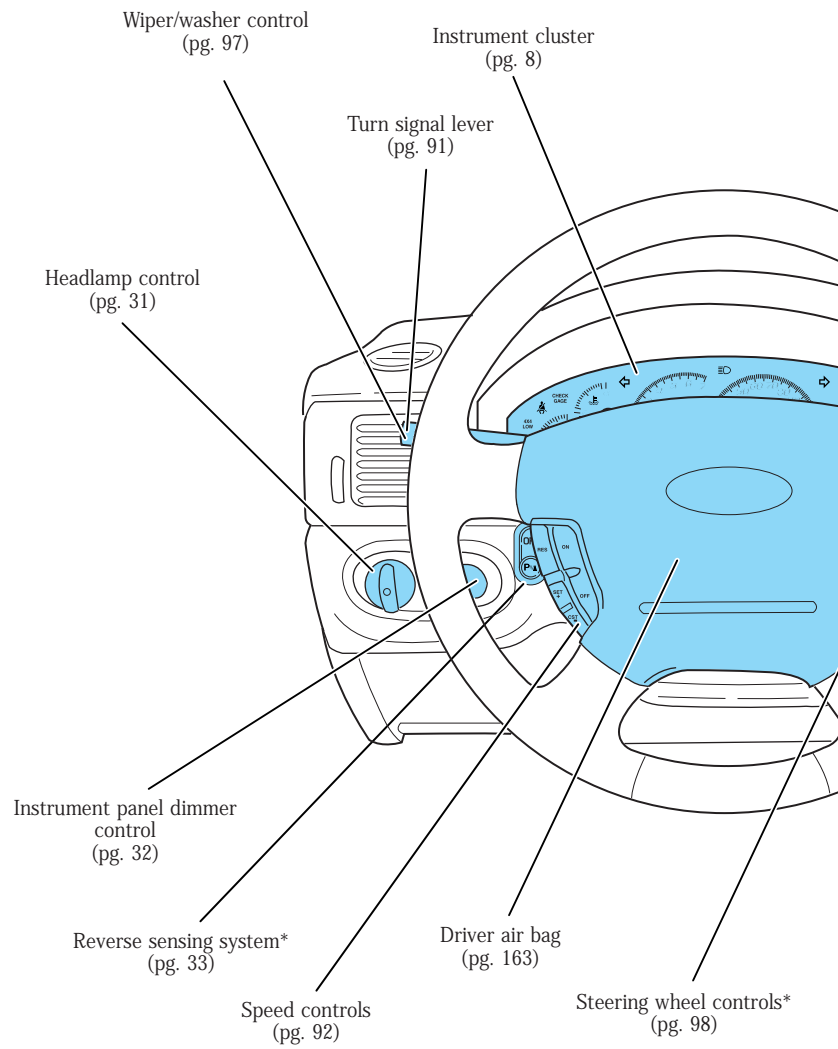

* if equipped

Instrumentation

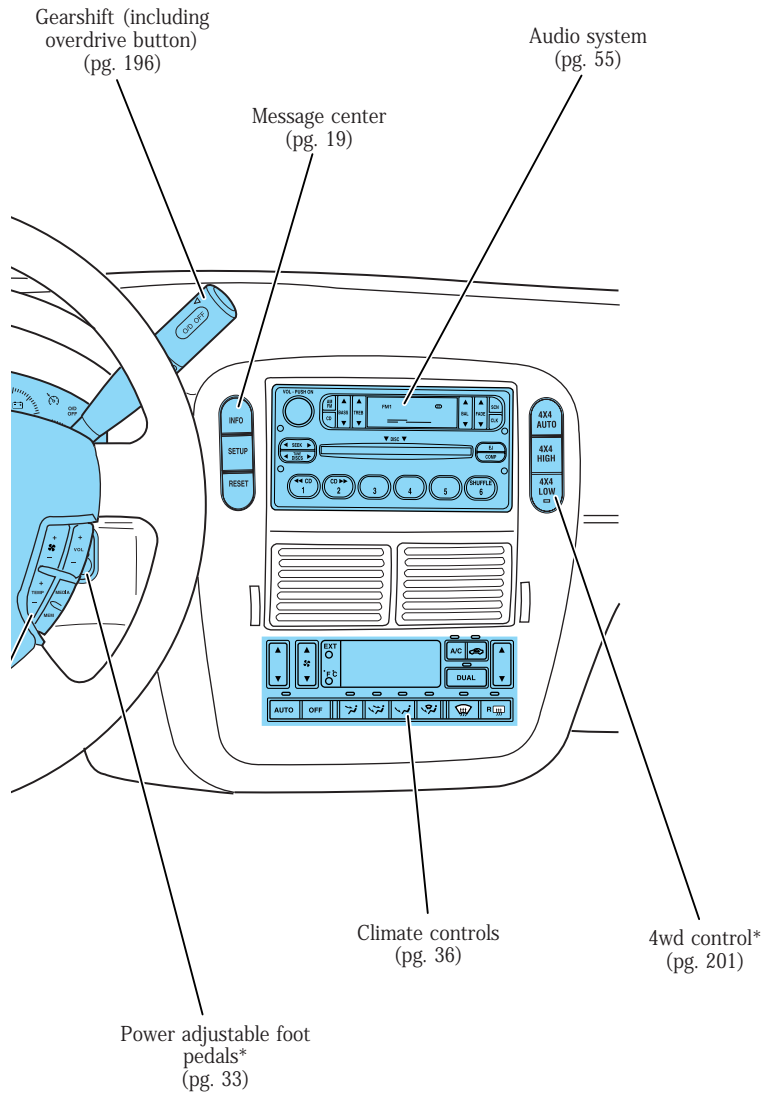

Instrumentation

WARNING LIGHTS AND CHIMES

Standard instrument cluster

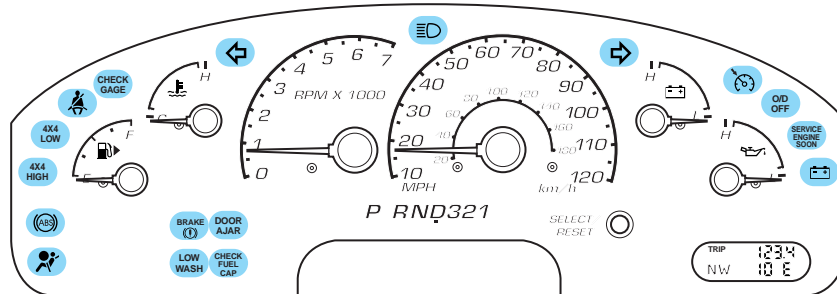

Optional instrument cluster

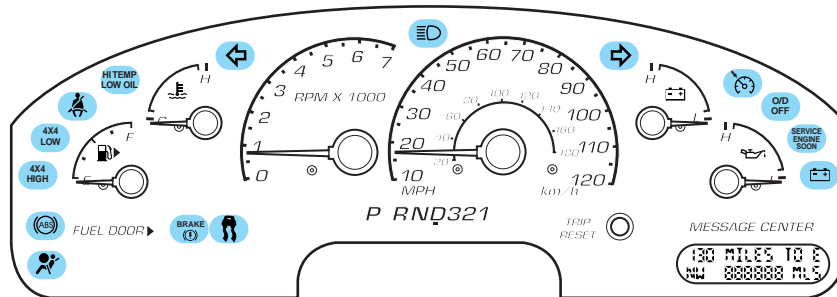

Service engine soon

Illuminates briefly to ensure the system is functional. If it comes on after the engine is started, one of the engine's emission control systems may be malfunctioning. The light may illuminate without a driveability concern being noted. The vehicle will usually be drivable and will not require towing.

Light turns on solid:

Temporary malfunctions may cause the light to illuminate. Examples are:

1. The vehicle has run out of fuel.
2. Poor fuel quality or water in the fuel.

SERVICE
ENGINE
SOON

Instrumentation

3. The fuel cap may not have been properly installed and securely tightened.

These temporary malfunctions can be corrected by filling the fuel tank with high quality fuel of the recommended octane and/or properly installing and securely tightening the fuel cap. After three driving cycles without these or any other temporary malfunctions present, the light should turn off. (A driving cycle consists of a cold engine startup followed by mixed city/highway driving.) No additional vehicle service is required.

If the light remains on, have your vehicle serviced at the first available opportunity.

Light is blinking:

Engine misfire is occurring which could damage your catalytic converter. You should drive in a moderate fashion (avoid heavy acceleration and deceleration) and have your vehicle serviced at the first available opportunity.



Under engine misfire conditions, excessive exhaust temperatures could damage the catalytic converter, the fuel system, interior floor coverings or other vehicle components, possibly causing a fire.

Check fuel cap (if equipped)

Illuminates when the fuel cap is not installed correctly. Check the fuel cap for proper installation. When the fuel filler cap is properly re-installed, the light(s) will turn off after a period of normal driving. Continuing to operate the vehicle with the fuel cap mis-installed can activate the *Service Engine Soon/Check Engine* warning light.

**CHECK
FUEL
CAP**

It may take a long period of time for the system to detect an improperly installed fuel filler cap.

For more information, refer to *Fuel filler cap* in the *Maintenance and care* chapter.

Instrumentation

Air bag readiness

Illuminates to confirm that the air bags (front or side) are operational. If the light fails to illuminate, continues to flash or remains on, have the system serviced immediately.



Safety belt

Illuminates to remind you to fasten your safety belts. For more information, refer to the *Seating and safety restraints* chapter.



Brake system warning

To confirm the brake system warning light is functional, it will momentarily illuminate when the ignition is turned to the ON position (alternatively for some vehicles when the ignition is moved from the ON position to START position, the light will momentarily illuminate prior to reaching the START position). It also illuminates if the parking brake is engaged. If the brake system warning light does not illuminate as described, seek service immediately. Illumination after the parking brake is released indicates low brake fluid level or a brake system malfunction and the brake system should be serviced immediately by a qualified technician. Refer to *Brakes* in the *Driving* chapter for more information.



Check gage (if equipped)

Illuminates when the engine coolant temperature is high, the engine oil pressure is low or the fuel gauge is at or near empty. Refer to *Engine coolant temperature gauge*, *Engine oil pressure gauge* or *Fuel gauge* in this chapter for more information.

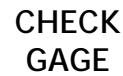

Instrumentation

Oil pressure/Engine coolant

Illuminates when the engine coolant temperature is above the normal range or the engine oil pressure is outside normal range. Check the engine oil and coolant level refer to *Adding engine oil* and *Adding coolant* in the *Maintenance and care* chapter.

**HITEMP
LOW OIL**

Anti-lock brake system (ABS)

To confirm the anti-lock brake system (ABS) warning light is functional it will momentarily illuminate when the ignition is turned to the ON position



(alternatively for some vehicles when the ignition is moved from the ON position to the START position, the light will momentarily illuminate just prior to reaching the START position). If the light remains on, continues to flash or fails to illuminate, have the ABS serviced immediately. If the ABS light remains on, it means the anti-lock brake system has malfunctioned and is disabled, however, the normal brake system will still function unless the brake warning light also remains illuminated and parking brake is off. Refer to *Brakes* in the *Driving* chapter for more information.

Turn signal

Illuminates when the turn signals or the hazard lights are turned on. If the lights stay on continuously or flash faster, check for a burned-out bulb.



High beams

Illuminates when the high beam headlamps are turned on.



Instrumentation

Low washer fluid (if equipped)

Illuminates when the windshield washer fluid is low.

LOW
WASH

Charging system

Illuminates when the battery is not charging properly.



AdvanceTrac™ (if equipped)

Flashes when the AdvanceTrac™ system is active. If the light remains on, have the system serviced immediately.

For more information, refer to the *Driving* chapter.



Four wheel drive low (if equipped)

Illuminates when four-wheel drive low is engaged. If the light continues to flash have the system serviced.

4x4
LOW

Four wheel drive high (if equipped)

Illuminates when four-wheel drive is put in high range. If the light continues to flash have the system serviced.

4x4
HIGH

Door ajar

Illuminates when any door is open (or not fully closed).

DOOR
AJAR

Instrumentation

O/D off (if equipped)

Illuminates when the overdrive function has been turned OFF using the Transmission Control Switch (TCS) on end of gearshift. If the

light does not come on or the light flashes steadily, have your vehicle serviced as soon as possible, as damage to the transmission could occur.

O/D
OFF

Speed control

Illuminates when the speed control is activated.

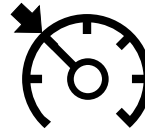

Seat belt warning chime

Sounds to remind you to fasten your seat belts.

BeltMinder™ chime

Sounds intermittently to remind you to fasten your safety belts.

Supplemental restraint system (SRS) warning chime

Sounds when a malfunction in the supplemental restraint system (front or side airbags) has been detected. Have the supplemental restraint system inspected immediately.

Key-in-ignition warning chime

Sounds when the key is left in the ignition and the driver's door is opened.

Headlamps on warning chime

Sounds when the headlamps or parking lamps are on, the key is removed from the ignition and the driver's door is opened.

Instrumentation

GAUGES

Standard instrument cluster gauges

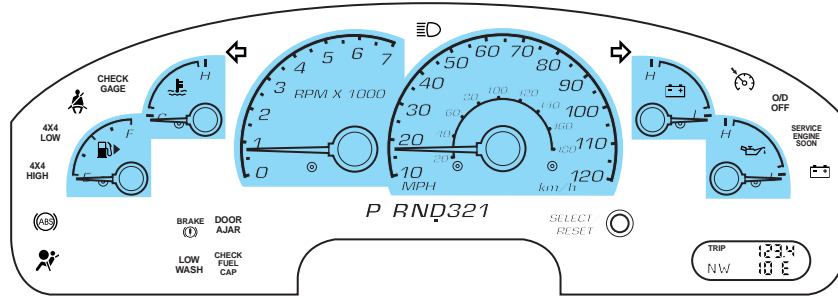

Optional instrument cluster gauges

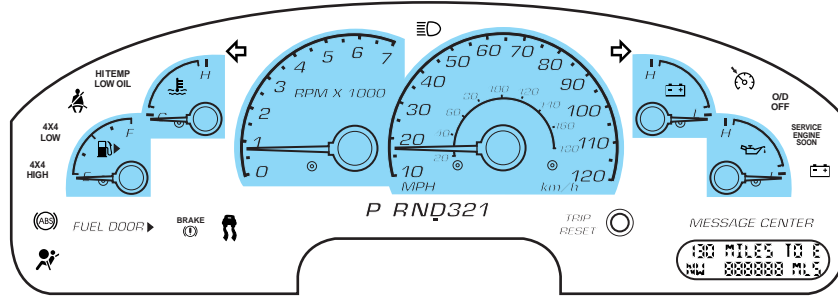

Speedometer

Indicates the current vehicle speed.

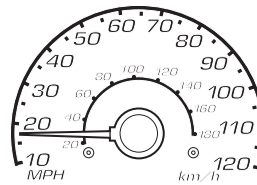

Instrumentation

Engine coolant temperature gauge

Indicates the temperature of the engine coolant. At normal operating temperature, the needle remains within the normal area (the indicated area between the “H” and “C”). If it enters the red section, the engine is overheating. Stop the vehicle as soon as safely possible, switch off the engine immediately and let the engine cool. Refer to *Engine coolant* in the *Maintenance and care* chapter.

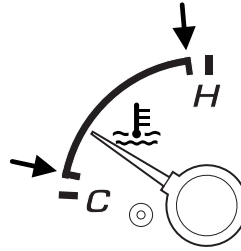

 Never remove the coolant reservoir cap while the engine is running or hot. Steam and scalding liquid from a hot cooling system can burn you badly.

This gauge indicates the temperature of the engine coolant, not the coolant level. If the coolant is not at its proper level the gauge indication will not be accurate.

Odometer

Registers the total kilometers (miles) of the vehicle.

- Standard instrument cluster

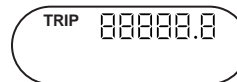

- Optional instrument cluster

MESSAGE CENTER

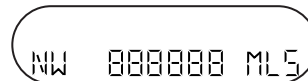

Refer to *Message Center* in this section for information on how to switch the display from metric to English measurements.

Instrumentation

Trip odometer

Registers the kilometers (miles) of individual journeys.

- Standard instrument cluster

Press and release the SELECT/RESET button to toggle between the odometer and trip odometer display. Press and hold the button to reset.



- Optional instrument cluster

Press and release the TRIP/RESET button to toggle between the odometer and trip odometer display. Press and hold the button to reset.



Tachometer

Indicates the engine speed in revolutions per minute.

Driving with your tachometer pointer in the red zone may damage the engine.

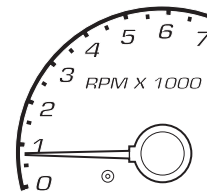

Battery voltage gauge

Indicates battery voltage. If the pointer moves and stays outside the normal operating range, have the vehicle's electrical system checked as soon as possible.

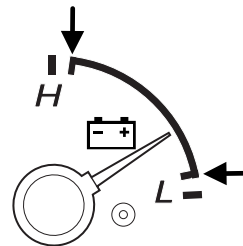

Instrumentation

Engine oil pressure gauge

Indicates engine oil pressure. At normal operating temperature, the needle will be in the normal range (the area between the “L” and “H”); if the needle goes below the normal range, stop the vehicle as soon as safely possible and switch off the engine immediately. Check the oil level. Add oil if needed (refer to *Engine oil* in the *Maintenance and care* chapter). If the oil level is correct, have your vehicle checked at your dealership or by a qualified technician.

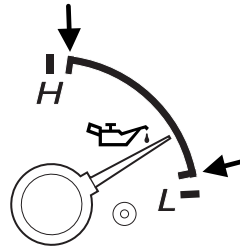

Fuel gauge

Displays approximately how much fuel is in the fuel tank. The fuel gauge may vary slightly when the vehicle is in motion or on a grade.

When refueling the vehicle from empty indication, the amount of fuel that can be added will be less than the advertised capacity due to the reserve fuel.

The FUEL DOOR icon and arrow indicates which side of the vehicle the fuel filler door is located.

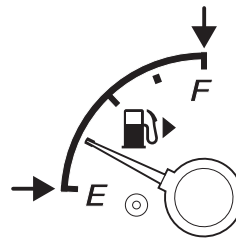

ELECTRONIC COMPASS/TEMPERATURE DISPLAY (IF EQUIPPED) OUTSIDE AIR TEMPERATURE

The outside temperature display is contained in the instrument cluster and displays all the time. If equipped with the DEATC climate control system, the outside temperature will be displayed there.



To turn the display off or change the display from English to metric see your dealer.

Compass

The compass reading may be affected when you drive near large buildings, bridges, power lines and powerful broadcast antennas. Magnetic or metallic objects placed in, on or near the vehicle may also affect compass accuracy.

Instrumentation

Usually, when something affects the compass readings, the compass will correct itself after a few days of operating your vehicle in normal conditions. If the compass still appears to be inaccurate, a manual calibration may be necessary. Refer to *Compass calibration adjustment*.

Most geographic areas (zones) have a magnetic north compass point that varies slightly from the northerly direction on maps. This variation is four degrees between adjacent zones and will become noticeable as the vehicle crosses multiple zones. A correct zone setting will eliminate this error. Refer to *Compass zone adjustment*.

Compass zone adjustment

1. Determine which magnetic zone you are in for your geographic location by referring to the zone map.
2. Turn ignition to the ON position.

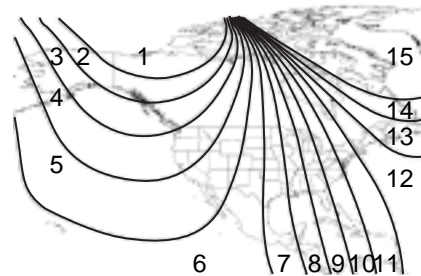

3. Locate compass sensor mounted at base of mirror.

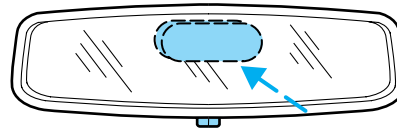

4. Insert a paperclip into the small hole on the bottom of the compass sensor or press the button on the top of the compass module until ZONE appears in the instrument cluster display.

5. Release pressure on the paperclip or button and then slowly press it down again.

6. Continue to press until ZONE appears in the instrument cluster display, then release. The display should show the current zone number.



7. Press until the desired zone number appears. The display will flash and then return to normal operation. The zone is now updated.

Instrumentation

Compass calibration adjustment

Perform this adjustment in an open area free from steel structures and high voltage lines:

For optimum calibration, turn off all electrical accessories (heater/air conditioning, wipers, etc.) and make sure all vehicle doors are shut.

1. Start the vehicle.
2. Locate compass sensor mounted at base of mirror.
3. Insert a paperclip into the small hole on the bottom of the compass sensor or press the button on the top of the compass module until ZONE appears in the instrument cluster display. Continue to hold down until ZONE disappears and CAL is displayed (approximately eight seconds) and release.
4. Drive the vehicle slowly (less than 5 km/h [3 mph]) in circles until CAL indicator turns off (4–5 complete circles).
5. The compass is now calibrated.



MESSAGE CENTER (IF EQUIPPED)

With the ignition in the ON position, the message center, located on your instrument cluster, displays important vehicle information

through a constant monitor of vehicle systems. You may select

display features on the message center for a display of status preceded by a brief indicator chime. The system will also notify you of potential vehicle problems with a display of system warnings followed by a long indicator chime.

MESSAGE CENTER

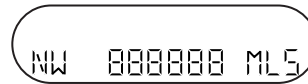

Instrumentation

Selectable features

Reset

Press this control to select and reset functions shown in the INFO menu and SETUP menu.

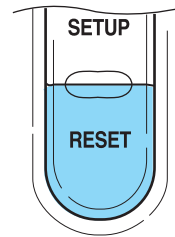

Info menu

This control displays the following control displays:

- Odometer/Compass
- Trip odometer/Odometer/Compass
- Average Fuel Economy
- Trip Elapsed Drive Time
- Distance to Empty

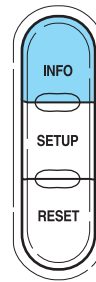

Odometer/Trip odometer

Refer to *Gauges* in this chapter.

Compass display

The compass reading may be affected when you drive near large buildings, bridges, power lines and powerful broadcast antenna. Magnetic or metallic objects placed in, on or near the vehicle may also affect compass accuracy.

Usually, when something affects the compass readings, the compass will correct itself after a few days of operating your vehicle in normal conditions. If the compass still appears to be inaccurate, a manual calibration may be necessary. Refer to *Compass zone/calibration adjustment*.

Most geographic areas (zones) have a magnetic north compass point that varies slightly from the northerly direction on maps. This variation is four

Instrumentation

degrees between adjacent zones and will become noticeable as the vehicle crosses multiple zones. A correct zone setting will eliminate this error. Refer to *Compass zone/calibration adjustment*.

Compass zone/calibration adjustment

Perform this adjustment in an open area free from steel structures and high voltage lines.

For optimum calibration, turn off all electrical accessories (heater/air conditioning, wipers, etc.) and make sure all vehicle doors are shut.

1. Turn ignition to the ON position.
2. Start the engine.
3. Determine your magnetic zone by referring to the zone map.
4. From Info menu, select the Compass/Odometer function. (Do not select Trip, DTE, or AFE. The top of the message center must be blank).

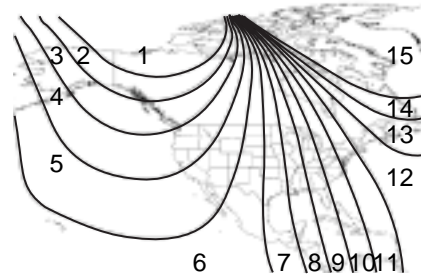

5. Press and hold the RESET and SETUP control until the message center display changes to show the current zone setting.

RESET FOR ZONE
INFO TO EXIT

6. Release the RESET AND SETUP control, then slowly press RESET down again.

SETUP ZONE XX
RESET IF DONE

7. Press the SETUP control repeatedly until the correct zone setting for your geographic location is displayed on the message center. To exit the zone setting mode press and release the RESET control.

8. Press the RESET control to start the compass calibration function.

RESET FOR CAL
INFO TO EXIT

Instrumentation

9. Slowly drive the vehicle in a circle (less than 5 km/h [3 mph]) until the CIRCLE SLOWLY TO CALIBRATE indicator changes to CALIBRATION COMPLETED. This will take up to three circles to complete calibration.

A rectangular box with rounded corners containing the text "CIRCLE SLOWLY TO CALIBRATE" in a bold, sans-serif font.

10. The compass is now calibrated.

Average fuel economy (AFE)

Select this function from the INFO menu to display your average fuel economy in liters/100 km or miles/U.S. gallon.

A rectangular box with rounded corners containing the text "X X .X MPG" in a bold, sans-serif font.

If you calculate your average fuel economy by dividing liters of fuel used by 100 kilometers traveled (miles traveled by gallons used), your figure may be different than displayed for the following reasons:

- Your vehicle was not perfectly level during fill-up
- Differences in the automatic shut-off points on the fuel pumps at service stations
- Variations in top-off procedure from one fill-up to another
- Rounding of the displayed values to the nearest 0.1 liter (gallon)

1. Drive the vehicle at least 8 km (5 miles) with the speed control system engaged to display a stabilized average.

2. Record the highway fuel economy for future reference.

It is important to press the RESET control after setting the speed control to get accurate highway fuel economy readings.

Average fuel economy for FFV-equipped vehicles

Upon refueling, your vehicle must determine the percentage of Ethanol in the fuel. For the first several minutes, or few miles of driving, the message CALCULATING FUEL will appear in the message center. The correct fuel economy will appear within approximately five miles of driving.

Instrumentation

Trip elapsed drive time

Select this function from the INFO menu to display a timer.

To operate the Trip Elapsed Drive Time perform the following:

1. Press and release RESET in order to start the timer.
2. Press and release RESET to pause the timer.
3. Press and hold RESET for 2 seconds in order to reset the timer.



Distance to empty (DTE)

Selecting this function from the INFO menu will give you an estimate of how far you can drive with the fuel remaining in your tank under normal driving conditions.

Remember to turn the ignition OFF when refueling your vehicle. Otherwise, the display will not show the addition of fuel for a few kilometers (miles).

The DTE function will display LOW FUEL LEVEL and sound a tone for 1 second when you have low fuel level indicated on the fuel gauge.



Setup menu

Press this control for the following displays:

- Autolock
- Easy Entry/Exit
- Autolamp Delay
- Language
- Units (English/Metric)
- System Check
- Oil Change

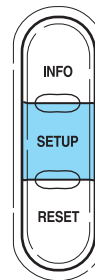

Instrumentation

Autolocks

1. Select this function from the SETUP control for the current display mode.
2. Press the RESET control to turn the autolocks ON or OFF.

AUTO LOCKS
< ON >OFF

Easy entry/exit

1. Select this function from the SETUP control for the current display mode.
2. Press the RESET control to turn the easy entry/exit feature ON or OFF. For more information refer to *Memory Seat* in the *Seating and Safety Restraints* chapter.

EASY ENTRY
< ON >OFF

Autolamp delay

1. Select this function from the SETUP control for the current display mode.
2. Press the RESET control to select the autolamp delay time.

AUTOLAMP
DELAY = XXX SEC

Language

1. Select this function from the SETUP menu for the current language to be displayed.
2. Pressing the RESET control cycles the message center through each of the language choices.
3. Press and hold the RESET control to set the language choice.

ENGLISH
RESET FOR NEW

FOR ENGLISH
HOLD RESET

SET TO
ENGLISH

Instrumentation

Units (English/Metric)

1. Select this function from the SETUP menu for the current units to be displayed.
2. Press the RESET control to change from English to Metric.



UNITS
< ENG > METRIC

System check

Selecting this function from the SETUP menu causes the message center to cycle through each of the systems being monitored. For each of the monitored systems, the message center will indicate either an OK message or a warning message for three seconds.

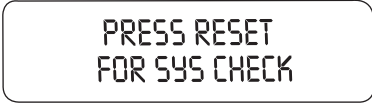

PRESS RESET
FOR SYS CHECK

Pressing the RESET control cycles the message center through each of the systems being monitored.

The sequence of the system check report and how it appears in the message center is as follows:

1. FUEL LEVEL
2. WASHER FLUID LEVEL
3. OIL LIFE IN XX%
4. ENGINE TEMP
5. OIL PRESSURE
6. TIRE PRESSURE SYSTEM (if equipped)
7. BRAKE FLUID LEVEL
8. CHARGING SYSTEM

System warnings

System warnings alert you to possible problems or malfunctions in your vehicle's operating systems.

In the event of a multiple warning situation, the message center will cycle the display to show all warnings by displaying each one for several seconds.

The message center will display the last selected feature if there are no more warning messages. This allows you to use the full functionality of the message center after you acknowledge the warning by pressing the RESET control and clearing the warning message.

Instrumentation

Warning messages that have been reset are divided into three categories:

- They will reappear on the display every minute from the reset.
- They will reappear on the display ten minutes from the reset.
- They will not reappear until an ignition OFF-ON cycle has been completed.

This acts as a reminder that these warning conditions still exist within the vehicle.

Warning display	Status
Warning-tire very low (if equipped)	Warning returns every minute
Check engine temperature	Warning returns after 10 minutes
Transmission overheated	
Check transmission	
Low fuel level	
Check fuel cap	
Check charging system	
Low brake fluid level	
Low oil pressure	
Check tire pressure (if equipped)	Warning returns after the ignition key is turned from OFF to ON.
Check spare tire pressure (if equipped)	
Tire pressure system fault (if equipped)	
Tire pressure sensor fault (if equipped)	
Check AdvanceTrac [®] (if equipped)	
Advtrac off t/c on (if equipped)	
Low washer fluid level	
Door ajar	
Change oil soon	
Oil change required	

Instrumentation

CHECK ENGINE TEMPERATURE. Displayed when the engine coolant is overheating. Stop the vehicle as soon as safely possible, turn off the engine and let it cool. Check the coolant and coolant level. Refer to *Engine coolant* in the *Maintenance and care* chapter. If the warning stays on or continues to come on, contact your dealer as soon as possible.

TRANSMISSION OVERHEATED. Indicates the transmission is overheating. This warning may appear when towing heavy loads or when driving in a low gear at a high speed for an extended period of time. Stop the vehicle as soon as safely possible, turn off the engine and let it cool. Refer to *Transmission fluid* in the *Maintenance and care* chapter. If the warning stays on or continues to come on, contact your dealer for transmission service as soon as possible.

CHECK TRANSMISSION. Indicates the transmission is not operating properly. If this warning stays on, contact your dealer as soon as possible.

LOW FUEL LEVEL. Displayed as an early reminder of a low fuel condition.

CHECK FUEL CAP. Displayed when the fuel filler cap is not properly installed. Check the fuel filler cap for proper installation. Refer to *Fuel filler cap* in the *Maintenance and care* chapter.

CHECK CHARGING SYSTEM. Displayed when the electrical system is not maintaining proper voltage. If you are operating electrical accessories when the engine is idling at a low speed, turn off as many of the electrical loads as possible. If the warning stays on or comes on when the engine is operating at normal speeds, have the electrical system checked as soon as possible.

LOW BRAKE FLUID LEVEL. Indicates the brake fluid level is low and the brake system should be inspected immediately. Refer to *Checking and adding brake fluid* in the *Maintenance and care* chapter.

LOW OIL PRESSURE. Displayed when the engine oil level is low. If this warning message is displayed, check the level of the engine oil. Refer to *Engine oil* in the *Maintenance and care* chapter for information about adding engine oil.

WARNING-TIRE VERY LOW (if equipped). Displayed when one or more tires have very low pressure. When this warning message is displayed, a warning chime will sound reminding you to stop the vehicle as soon as safely possible and check your tires for proper pressure, leaks and damage. Refer to *Servicing your tires* in the *Maintenance and care* chapter.

Instrumentation

CHECK TIRE PRESSURE (if equipped). Displayed when any of the tire pressures are high or low. Refer to *Checking the tire pressure* in the *Maintenance and care* chapter.

CHECK SPARE TIRE PRESSURE (if equipped). Displayed when the spare tire pressure is high or low. Refer to *Checking the tire pressure* in the *Maintenance and care* chapter.

TIRE PRESSURE SYSTEM FAULT (if equipped). Displayed when the Tire pressure monitoring system is malfunctioning. If the warning stays on or continues to come on, have the system checked by your dealer.

TIRE PRESSURE SENSOR FAULT (if equipped). Displayed when a Tire pressure sensor is malfunctioning. If the warning stays on or continues to come on, have the system checked by your dealer.

LOW WASHER FLUID LEVEL. Indicates the washer fluid reservoir is less than one quarter full. Check the washer fluid level. Refer to *Windshield washer fluid* in the *Maintenance and care* chapter.

CHECK ADVANCETRAC™ (if equipped). Displayed when the AdvanceTrac™ system is not operating properly. If this message is displayed on the message center the AdvanceTrac™ system will be partially operable. If this warning stays on while the engine is running, contact your dealer for service as soon as possible. For further information, refer to *AdvanceTrac™ stability enhancement system* in the *Driving* chapter.

ADVTRAC OFF T/C ON. Displayed on 4x4 vehicles only when 4x4 Low Range is selected. In this mode, the stability enhancement portion of the AdvanceTrac™ is disabled, but the traction enhancement feature remains enabled. For further information, refer to *AdvanceTrac™ stability enhancement system* in the *Driving* chapter.

DOOR AJAR. Displayed when a door or liftgate is not completely closed.

CHANGE OIL SOON/OIL CHANGE REQUIRED. Displayed when the engine oil life remaining is 5 percent or less. When oil life left is between 5% and 0%, the CHANGE OIL SOON message will be displayed. When oil life left reaches 0%, the OIL CHANGE REQUIRED message will be displayed.

An oil change is required whenever indicated by the message center.
USE ONLY RECOMMENDED ENGINE OILS.

Instrumentation

To reset the oil monitoring system to 100% after each oil change [approximately 8,000 km (5,000 miles) or 180 days] perform the following:

1. Press the SETUP control to access the System Check function.

PRESS RESET
FOR SYS CHECK

2. Press and release the RESET control to display "OIL LIFE XX% HOLD RESET NEW".

OIL LIFE XX%
HOLD RESET NEW

3. Press and hold the RESET control for 2 seconds to display "IF NEW OIL HOLD RESET".

IF NEW OIL
HOLD RESET

4. Press and hold the RESET control to display OIL LIFE SET TO 100%. Your oil life is now reset.

OIL LIFE SET
TO 100%

To reset the oil monitoring system to your personalized oil life %:

1. Press the SETUP control to access the System Check function.

PRESS RESET
FOR SYS CHECK

2. Press and release the RESET control to display "OIL LIFE XX% HOLD RESET NEW".

OIL LIFE XX%
HOLD RESET NEW

3. Press and hold the RESET control for 2 seconds to display "IF NEW OIL HOLD RESET".

IF NEW OIL
HOLD RESET

Instrumentation

4. Release the RESET control momentarily, then press RESET and SETUP controls at the same time to activate a service mode which will display OIL LIFE XX% RESET TO ALTER.



OIL LIFE XX%
RESET TO ALTER

5. Press RESET until you find your personalized OIL LIFE XX%.

6. With your personalized OIL LIFE XX% displayed, press SETUP to continue the system check.

TIRE PRESSURE SYSTEM OFF (if equipped). Displayed when the tire pressure monitoring system is turned off. Only your dealer can turn the system on or off. It is recommended that the tire pressure monitoring system is always turned ON.

DATA ERR. These messages indicate improper operation of the vehicle network communication between electronic modules.

- Fuel computer
- Oil life
- Charging system
- Door sensor
- Washer fluid
- Brake fluid
- Compass
- Outside temperature
- Engine sensor

Contact your dealer as soon as possible if these messages occur on a regular basis.

Controls and features

HEADLAMP CONTROL ☀

Rotate the headlamp control clockwise to the first position to turn on the parking lamps. Rotate clockwise to the second position to also turn on the headlamps.

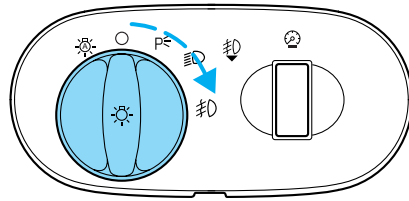

Foglamp control (if equipped) 𐄀

The headlamp control also operates the foglamps. The foglamps can be turned on only when the headlamp control is in the 𐄀, ☀ and P positions and the high beams are not turned on.

Pull headlamp control towards you to turn foglamps on. The foglamp indicator light 𐄀 will illuminate if the ignition is in the Run position.

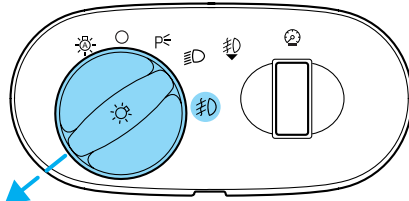

Daytime running lamps (DRL) (if equipped)

Turns the headlamps on with a reduced output. To activate:

- the ignition must be in the ON position and
- the headlamp control is in the OFF or Parking lamps position
- the parking brake must be disengaged.

 Always remember to turn on your headlamps at dusk or during inclement weather. The Daytime Running Light (DRL) System does not activate your tail lamps and generally may not provide adequate lighting during these conditions. Failure to activate your headlamps under these conditions may result in a collision.

Controls and features

High beams

Push the lever toward the instrument panel to activate. Pull the lever towards you to deactivate.

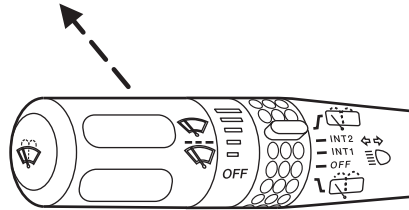

Flash to pass

Pull toward you slightly to activate and release to deactivate.

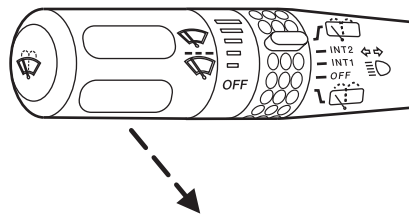

PANEL DIMMER CONTROL

Use to adjust the brightness of the instrument panel during headlamp parklamp operation.

- Rotate up to brighten.
- Rotate down to dim.
- Rotate to full up position (past detent/dome defeat) to turn on interior lamps.
- Rotate to full down position (past detent/dome defeat) to turn off the interior lamps, approach lamps, and will also disable the illuminated entry feature.

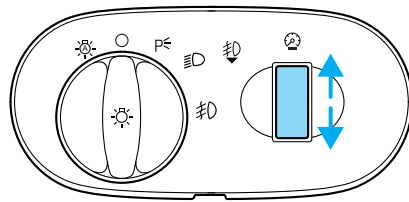

Controls and features

AUTOLAMP CONTROL

The autolamp system provides light sensitive automatic on-off control of the exterior lights normally controlled by the headlamp control.

The autolamp system also keeps the lights on for approximately 20 seconds or a programmed time delay after the ignition switch is turned to the OFF position.

- To turn autolamps on, rotate the control counterclockwise.
- To turn autolamps off, rotate the control clockwise to the OFF position.

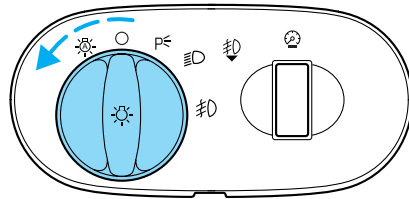

POWER ADJUSTABLE FOOT PEDALS (IF EQUIPPED)

The accelerator and brake pedal should only be adjusted when the vehicle is stopped and the gearshift lever is in the P (Park) position.

Press and hold the rocker control to adjust accelerator and brake pedal toward you or away from you.

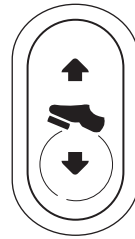

The adjustment allows for approximately 76 mm (3 inches) of maximum travel.



Never adjust the accelerator and brake pedal with feet on pedals or while the vehicle is moving.

REVERSE SENSING SYSTEM (IF EQUIPPED)

The Reverse Sensing System (RSS) sounds a tone to warn the driver of obstacles near the rear bumper when R (Reverse) is selected. The RSS will assist the driver in detecting certain objects while:

- the vehicle is moving toward a stationary object at a speed of 5 km/h (3 mph) or less.
- the vehicle is in R (Reverse) but not moving backward (the brake pedal is depressed or the parking brake is applied), and a moving object is approaching the rear of the vehicle at a speed of 5 km/h (3 mph) or less.

Controls and features

- the vehicle is moving in reverse at a speed of less than 5 km/h (3 mph) and a moving object is approaching the rear of the vehicle at a speed of less than 5 km/h (3 mph)

The RSS is not effective at speeds greater than 5 km/h (3 mph) and may not detect certain angular or moving objects.

 To help avoid personal injury, please read and understand the limitations of the reverse sensing system as contained in this section. Reverse sensing is only an aid for some (generally large and fixed) objects when moving in reverse on a flat surface at “parking speeds”. Inclement weather may also affect the function of the RSS; this may include reduced performance or a false activation.

 To help avoid personal injury, always use caution when in R (Reverse) and when using the RSS.

 This system is not designed to prevent contact with small or moving objects. The system is designed to provide a warning to assist the driver in detecting large stationary objects to avoid damaging the vehicle. The system may not detect smaller objects, particularly those close to the ground.

Controls and features

The RSS detects obstacles within approximately 1.8 meters (5.9 ft.) of the rear bumper with a decreased coverage area at the outer corners of the bumper, (refer to the figures for approximate zone coverage areas). As you move closer to the obstacle, the rate of the tone increases. When the distance to the obstacle is less than 25.0 cm (10 in.), the tone will sound continuously. If the system detects a stationary or receding object further than 25.0 cm (10 in.) from the side of the vehicle, the tone will sound for only three seconds. Once the system detects an object approaching, the tone will sound again.

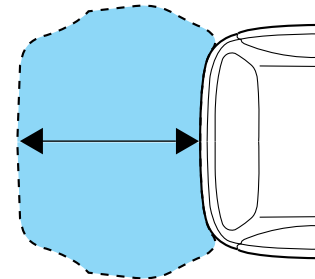
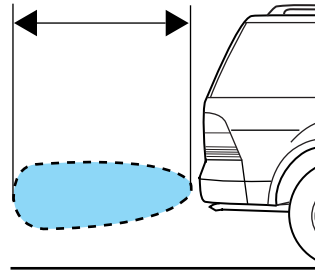

The RSS is automatically enabled when the gear selector is placed in R (Reverse) and the ignition is ON. The RSS control allows the driver to disable the RSS only when the ignition is ON, and the gear selector is in R (Reverse).

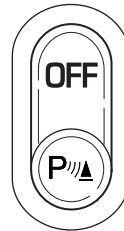

The OFF indicator remains illuminated when the system is disabled. The system defaults to ON every time R (Reverse) is selected. Press the control to disable or enable the system.

The indicator will remain illuminated to indicate a failure of the RSS.

Always keep the sensors (located on the rear bumper/fascia) free from snow, ice and large accumulations of dirt (do not clean the sensors with sharp objects). These elements may cause the system to operate inaccurately.

If the vehicle sustains damage to the rear bumper/fascia, leaving it misaligned or bent, the sensing zone may be altered causing inaccurate measurement of obstacles or false alarms.

Controls and features

CLIMATE CONTROL SYSTEM

Manual heating and air conditioning system (if equipped)

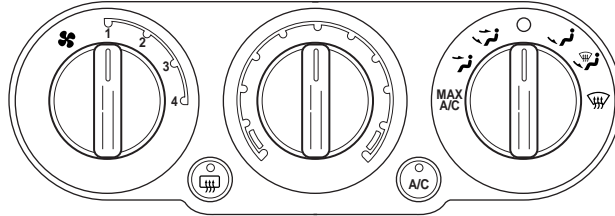

Fan speed control

Controls the volume of air circulated in the vehicle.

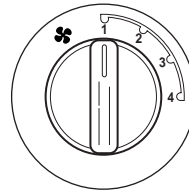

Temperature control knob

Controls the temperature of the airflow inside the vehicle.

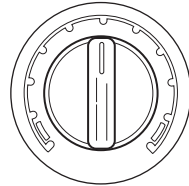

Mode selector control



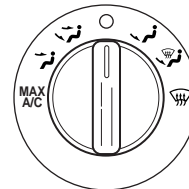

Controls the direction of the airflow to the inside of the vehicle.



The air conditioning can operate in all modes. However, the air conditioning will only function if the outside temperature is about 6°C (43°F) or higher.

Controls and features

Since the air conditioner removes considerable moisture from the air during operation, it is normal if clear water drips on the ground under the air conditioner drain while the system is working and even after you have stopped the vehicle.

- MAX A/C-Uses recirculated air to cool the vehicle. MAX A/C is noisier than A/C but more economical and will cool the inside of the vehicle faster. Airflow will be restricted to instrument panel registers. This mode can also be used to prevent undesirable odors from entering the vehicle. When placed in MAX A/C, the A/C indicator will be illuminated and cannot be manually disabled.
-  (Panel)-Distributes outside air through the instrument panel registers. Heating and air conditioning capabilities are provided in this mode. Push the A/C control in order to cool the vehicle below the outside temperature. For added customer comfort, the system will allow some airflow through the floor ducts in this mode.
- OFF (0)-Outside air is shut out and the fan will not operate. For short periods of time only, use this mode to prevent undesirable odors from entering the vehicle.
-  (Panel and floor)-Distributes outside air through the instrument panel registers and the floor ducts. Heating and air conditioning capabilities are provided in this mode. Push the A/C control in order to cool the vehicle below the outside temperature. For added customer comfort, when the temperature control knob is anywhere in between the full hot and full cold positions, the air distributed through the floor ducts will be slightly warmer than the air sent to the instrument panel registers.
-  (Floor)-Distributes outside air through the floor ducts. Heating and air conditioning capabilities are provided in this mode. Push the A/C control in order to cool the vehicle below the outside temperature.
-  (Floor and defrost)-Distributes outside air through the windshield defroster ducts and the floor ducts. Heating and air conditioning capabilities are provided in this mode. For added customer comfort, when the temperature control knob is anywhere in between the full hot and full cold positions, the air distributed through the floor ducts will be slightly warmer than the air sent to the windshield defrost ducts. If the outside temperature is about 6°C (43°F) or higher, the air conditioner will automatically dehumidify the air to reduce fogging. (Note that the A/C indicator does not illuminate when this mode is selected.)





Controls and features

-  (Defrost)-Distributes outside air through the windshield defroster ducts. It can be used to clear ice or fog from the windshield. If the outside temperature is about 6°C (43°F) or higher, the air conditioner will automatically dehumidify the air to reduce fogging. (Note that the A/C indicator does not illuminate when this mode is selected.) For added customer comfort, the system will allow some airflow through the floor ducts in this mode.

Cooling your vehicle with outside air

Cooling your vehicle with air conditioned outside air is quieter but less economical than using recirculated air. It also has less cooling capacity.



In order to cool your vehicle using outside air:

1. Turn the mode selector to ,  or .
2. Press . (The indicator light will illuminate.)
3. Turn the temperature control knob to the left.
4. Turn the fan speed control to the position of your choice.



During periods of high humidity, vapor may be emitted from the air outlets when using the A/C system with outside air. This can be corrected by using MAX A/C to cool the vehicle.



• **A/C control**

This control is used to manually enable or disable the operation of the air conditioning in all modes except ,  and MAX A/C.

When manual A/C is selected (ON) the indicator will be lit. When manual A/C is selected (OFF) the indicator will not be lit.

In  and , if the outside temperature is about 6°C (43°F) or higher, the air conditioner will automatically dehumidify the air to reduce fogging. However, the A/C indicator will not illuminate.



When placed in MAX A/C, the A/C indicator will illuminate automatically and cannot be manually disabled.

• **Defrost control**



Refer to *Rear window defroster*.

Controls and features

Operating tips

- In humid weather conditions, place the climate control system in  before driving. This will reduce fogging on your windshield. Once the windshield has been cleared, operate the climate control system as desired.
- To reduce humidity buildup inside the vehicle in cold weather conditions, don't drive with the climate control system in the OFF or MAX A/C position.
- To reduce humidity buildup inside the vehicle in warm weather conditions, don't drive with the climate control system in the OFF position.
- Under normal weather conditions, your vehicle's climate control system should be left in any position other than MAX A/C or OFF when the vehicle is parked. This allows the vehicle to "breathe" through the outside air inlet duct.
- Under snowy or dirty weather conditions, your vehicle's climate control system should be left in the OFF position when the vehicle is parked. This allows the climate control system to be free from contamination of outside pollutants.
- If your vehicle has been parked with the windows closed during warm weather conditions, the air conditioner will perform more efficiently in cooling the vehicle if driven for two or three minutes with the windows open. This will force most of the hot, stale air out of the vehicle. Once the vehicle has been "aired out", operate the climate control system as desired.
- Do not place objects under the front seat that will interfere with the airflow to the rear seats.
- Remove any snow, ice or leaves from the air intake area at the base of the windshield.
- Do not place objects over the defroster outlets. These objects can block airflow and reduce your ability to see through your windshield. Avoid placing small objects on top of the instrument panel. These objects may fall down into the defroster outlets and block airflow, in addition to damaging the climate control system.

To aid in side window defogging/demisting in cold weather conditions:

1. Select 
2. Set the temperature control to full heat
3. Select 

Controls and features

4. Set the fan speed to High
5. Direct the outer panel vents towards the side windows
6. To increase airflow to the outer panel vents, close the central panel vents.



Do not place objects on top of the instrument panel, as these objects may become projectiles in a collision or sudden stop.

Dual Electronic Automatic Temperature Control (DEATC) system (if equipped)

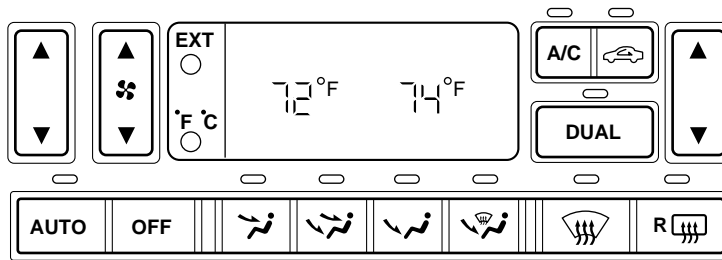

The Dual Electronic Automatic Temperature Control (DEATC) system will maintain a selected temperature and automatically control air flow.

You can override the automatic operation with any of the override controls.

The dual temperature zone feature allows the driver and front passenger to set their own independent temperature set points for individual comfort. The system uses common controls for air distribution and fan speed for both driver and passenger.

Controls and features

Turning the DEATC system on

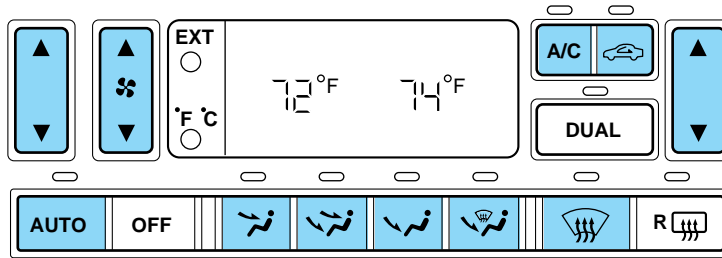

Press AUTO, any of the override controls, the fan speed control, or either of the temperature selection controls. The DEATC system will only operate when the ignition is in the ON position.

Turning the DEATC system off

Press OFF. The outside temperature (EXT) function (if selected) will continue to operate until the ignition is turned off.

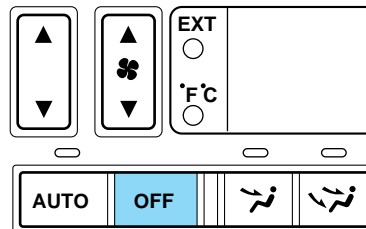

Controls and features

DEATC automatic operation

Press AUTO and select the desired temperature. The selected temperature will appear in the display window, and an indicator above the AUTO control will light. The DEATC system will either heat or cool the vehicle to achieve the selected temperature. The system will automatically determine the fan speed, airflow location and whether outside or recirculated air is required.

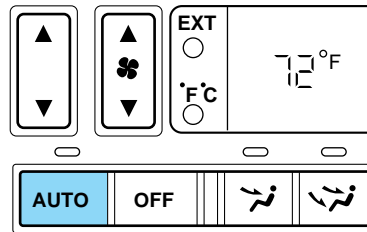

When in AUTO mode and the weather is cool, the DEATC directs the majority of the airflow to the floor area. The system will allow some airflow out the windshield defroster ducts and the demister outlets to reduce window fogging. Additionally, if the engine is not warm enough to provide heat, the fan will operate at a low speed and the airflow will be directed to the windshield or to the floor. The fan speed will start to increase and the airflow location will change to the floor area.

If unusual conditions exist (window fogging, etc.), the manual override controls allow you to select airflow locations as necessary. To return to full automatic control, press the AUTO control.

Controls and features

Single/dual electronic temperature zone

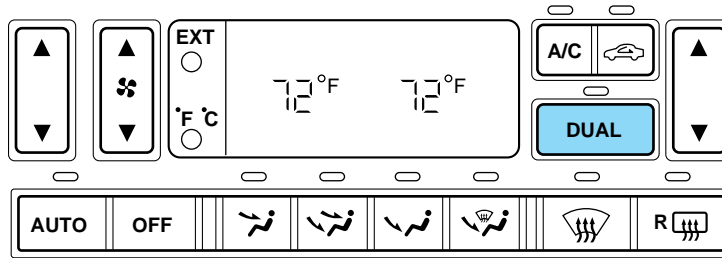

Press DUAL to enable or disable the dual zone temperature feature. When DUAL is pressed, the display window indicates the current temperature setting for the driver and the last temperature setting that was selected for the passenger. In addition to the DUAL control, the passenger may engage the dual temperature zone feature by pressing the passenger side temperature control.

The DUAL indicator will be lit when the dual temperature zone feature is selected.

Driver side temperature selection

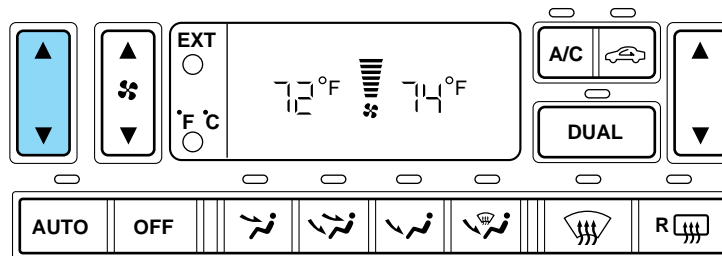

The display window indicates the selected temperature and manual control of fan speed () if automatic fan speed is not desired.

To control the temperature, select any temperature between 16°C (60°F) and 32°C (90°F) by pressing the temperature control on the driver side of the system.

Controls and features

Passenger side temperature selection

To control the temperature, select any temperature between 16°C (60°F) and 32°C (90°F) by pressing the temperature control on the passenger side of the system.

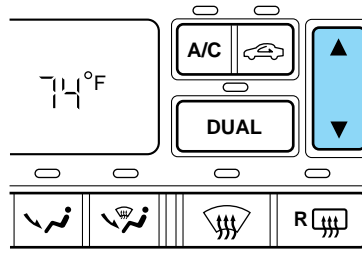

Temperature conversion

Press the Fahrenheit/Celsius (°F °C) control to switch between Fahrenheit and Celsius temperature on the DEATC display only. The temperature in Celsius will be displayed in half-degree increments.

The English/Metric control on the trip computer and message center (if equipped) will not change the DEATC temperature display. Refer to *Message Center* in the *Instrumentation* chapter.

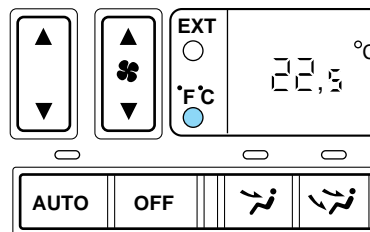

Controls and features

Fan speed ()

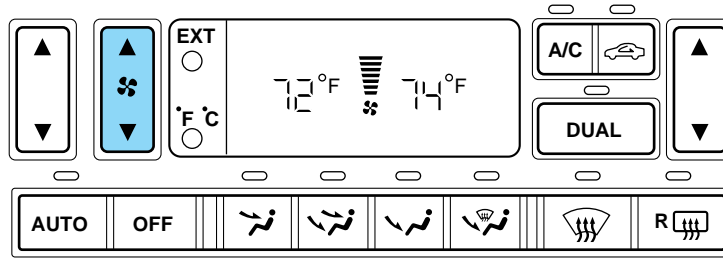



When AUTO is pressed, fan speed is adjusted automatically for existing conditions. You can override fan speed at any time. To control fan speed manually, press the fan control to cancel the automatic fan speed operation. Press the control up for higher fan speed or down for lower fan speed. The display will show  and a bar graph to indicate manual fan operation and relative speed.

When the fan is adjusted in the AUTO mode, the AUTO indicator will remain lit and the system will remain in auto operation.

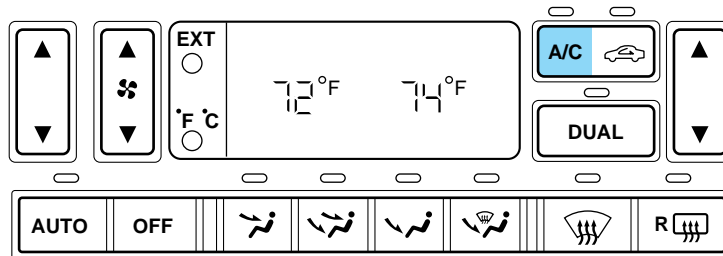

To return to automatic fan operation, press AUTO. The fan icon and bars will disappear from the display, and the DEATC system will return to full automatic operation.



• A/C control

 (air conditioning) — Used to manually enable or disable the operation of the air conditioning in all modes except  and . In all modes, the air conditioning will only function if the outside temperature is about 6°C (43°F) or higher. When manual A/C is selected (ON) the indicator will be lit. When manual A/C is selected (OFF) the indicator will not be lit.

Controls and features

In  and  , if the outside temperature is about 6°C (43°F) or higher, the air conditioner will automatically dehumidify the air to reduce fogging. However, the A/C indicator will be off and the A/C override control cannot be selected.

The air conditioning compressor can operate in all modes except OFF. However, the air conditioning will only function if the outside temperature is about 6°C (43°F) or higher.



Since the air conditioner removes considerable moisture from the air during operation, it is normal if clear water drips on the ground under the air conditioner drain while the system is working and even after you have stopped the vehicle.

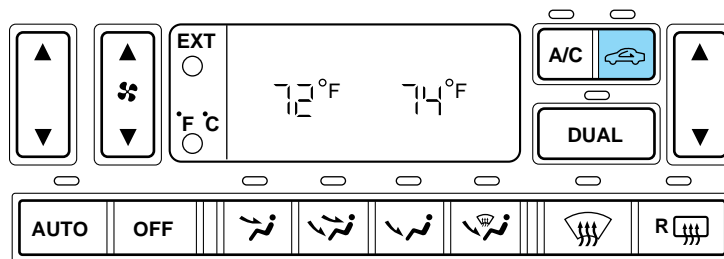

When AUTO is selected, the A/C operates automatically for existing conditions. However, the A/C indicator will not be lit. If A/C is selected when in AUTO operation, the DEATC system will be disabled and you will return to manual operation with the A/C indicator lit.

To return to automatic A/C operation, press AUTO.



• Recirculation control

 (air recirculation) — Used to manually enable or disable recirculated air operation in all modes except  and  . The use of recirculated air when the air conditioning is operating helps to reduce the amount of time to cool down the interior of the vehicle in very hot conditions. Recirculated air may also help to keep undesired outside odors from reaching the vehicle interior. It is recommended to allow the DEATC system to automatically control the selection of outside or recirculated air.

The recirculation control cannot be selected in  or  , as interior fogging may occur.

When AUTO is selected, the recirculated air feature operates automatically for existing conditions. However, the air recirculation

Controls and features

indicator will not be lit. If the recirculated air is selected while in AUTO operation, the DEATC system will be disabled and you will return to manual operation with the recirculated air indicator lit and with the A/C operating.

To return to automatic recirculated air operation, press AUTO.

Do not leave the DEATC system in recirculated air operation for extended periods of time while the system is in a heating mode or in cold/damp conditions as this may cause interior fogging of the front, side and rear windows.

Manual override controls

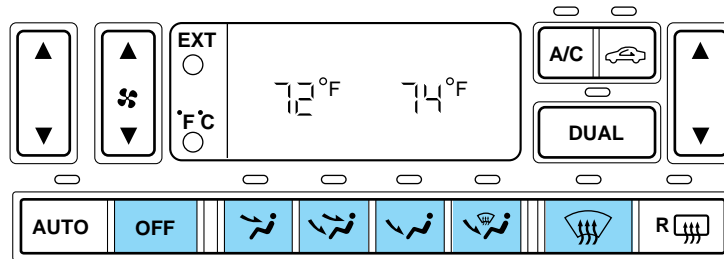



The manual override controls allow you to manually determine where airflow is directed. To return to fully automatic control, press AUTO.

When a manual airflow override control is selected, the DEATC system will turn off the AUTO indicator and display the indicators of all operating override controls. More than one override control indicator may turn on when an override control is selected.

• Airflow direction control

 (panel) — Distributes air through the instrument panel registers.

 (panel/floor) — Distributes air through the instrument panel registers and the front seat floor ducts. For added customer comfort, the air distributed through the floor ducts may be slightly warmer than the air sent to the instrument panel registers.

 (floor) — Distributes air through the front seat floor ducts. The system will allow some airflow out the window defroster ducts and the demister outlets.

 (floor/defrost) — Distributes outside air through the windshield defroster ducts, the demister outlets and the front and rear seat floor

Controls and features

ducts. If the temperature is about 6°C (43°F) or higher, the air conditioner will automatically dehumidify the air to reduce fogging. (Note that the A/C indicator does not illuminate when this mode is selected.) Recirculation and A/C override controls cannot be selected. For added customer comfort, the air distributed through the floor ducts may be slightly warmer than the air sent to the windshield defroster ducts.

 (defrost) — Distributes outside air through the windshield defroster ducts and the demister outlets. It can be used to clear ice or fog from the windshield. If the outside air temperature is about 6°C (43°F) or higher, the air conditioner will automatically dehumidify the air to reduce fogging. (Note that the A/C indicator does not illuminate when this mode is selected.) Recirculation and A/C override controls cannot be selected. For added customer comfort, the system will allow some airflow through the floor ducts in this mode.

- **Turn DEATC off**

OFF—Outside air is shut out. The fan, heating and air conditioning will not operate. The outside temperature will still display when selected with the ignition in the ON position.

 (rear window defroster) — Refer to *Rear window defroster*.

Displaying outside temperature

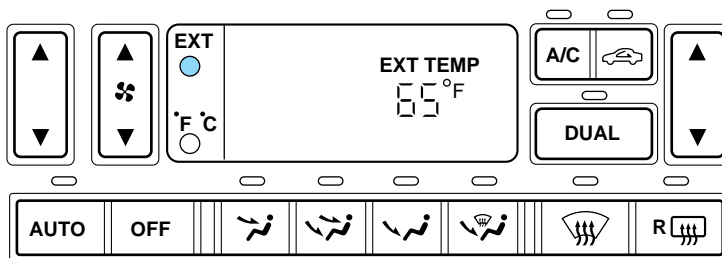

Press EXT to display the outside air temperature. It will remain selected until the EXT control is pressed again.





If the driver or passenger temperature or the fan speed is changed, or the AUTO or  modes are selected while the outside temperature is displayed, the driver and passenger temperature display will be displayed for 4 seconds. Following this, the outside temperature display will return to the window.

Controls and features

If the outside temperature is displayed while the DEATC system is in the OFF mode and the DEATC is turned on, the driver and passenger temperatures will be displayed for 4 seconds. Following this, the outside temperature display will return to the window.

The outside temperature reading is most accurate when the vehicle is moving. Higher readings may be obtained when the vehicle is not moving. The readings that you get may not agree with temperatures given on the radio due to differences in vehicle and station locations.

Operating tips

- In humid weather conditions, place the climate control system in  or  before driving. This will reduce fogging on your windshield. Once the windshield has been cleared, operate the climate control system as desired.
- To reduce humidity buildup inside the vehicle in cold weather conditions, don't drive with the climate control system in the OFF position or .
- To reduce humidity buildup inside the vehicle in warm weather conditions, don't drive with the climate control system in the OFF position.
- Under normal weather conditions, your vehicle's climate control system should be left in any position other than OFF or  when the vehicle is parked. This allows the vehicle to "breathe" through the outside air inlet duct.
- Under snowy or dirty weather conditions, your vehicle's climate control system should be left in the OFF position when the vehicle is parked. This allows the climate control system to be free from contamination of outside pollutants.
- If your vehicle has been parked with the windows closed during warm weather conditions, the air conditioner will perform more efficiently in cooling the vehicle if driven for two or three minutes with the windows open. This will force most of the hot, stale air out of the vehicle. Once the vehicle has been "aired out", operate the climate control system as desired.
- Remove any snow, ice or leaves from the air intake area at the base of the windshield.
- Do not place objects over the defroster outlets. These objects can block airflow and reduce your ability to see through your windshield. Avoid placing small objects on top of the instrument panel. These

Controls and features

objects may fall down into the defroster outlets and block airflow, in addition to damaging the climate control system.

To aide in side window defogging/demisting in cold weather conditions:

1. Select 
2. Set the temperature control to full heat
3. Select A/C
4. Set the fan speed to High
5. Direct the outer panel vents towards the side windows

In order to increase the airflow to the outer panel vents, close the central panel vents.



Do not place objects on top of the instrument panel, as these objects may become projectiles in a collision or sudden stop.

Auxiliary climate controls (if equipped)

Your vehicle may be equipped with auxiliary climate controls which are located in the overhead console of the first row and in the headliner for second row seating. The auxiliary climate control feature provides increased capacity to quickly heat or cool your vehicle.

If your vehicle is equipped with a manual heating and air conditioning system, the auxiliary climate controls are dependent on the main climate control system. If the main climate control system is in the OFF position, the auxiliary climate controls will not work.

If your vehicle is equipped with a DEATC system, the auxiliary climate controls are independent of the main climate control system. If the main climate control system is in the OFF position, the auxiliary climate controls will still work. However, the A/C function will not operate unless the A/C control has been selected on the main climate control system.

Front auxiliary control

For the rear auxiliary climate controls to function, the front auxiliary climate control must be set to REAR.

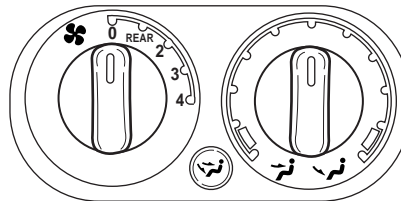

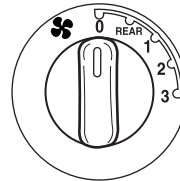

Controls and features

To control the auxiliary climate control system from the front controls, turn the fan speed control knob to the desired speed.

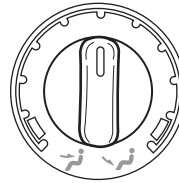

Turn the temperature control to regulate the air temperature.



Press the mode selector once to select air distribution through the overhead vents. The  icon will illuminate on the temperature selector.

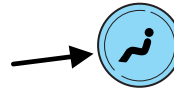

Press the mode selector again to select air distribution through the floor vents. The  icon will illuminate on the temperature selector. Only the auxiliary control head (front or rear) that is active will have the indicator lights functioning.

Rear auxiliary climate controls (if equipped)

The rear auxiliary climate controls are located in the headliner of the second row seating.

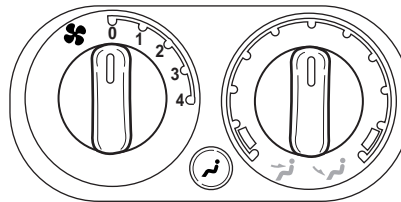

Controls and features

Ensure that the front auxiliary control is turned to REAR to enable the rear climate controls.

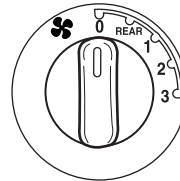

Turn the fan speed control to the desired fan speed.

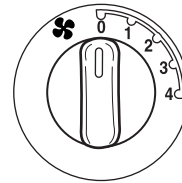

Turn the temperature control to regulate the air temperature.

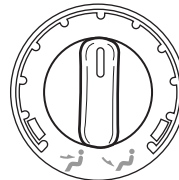

Press the mode selector once to select air distribution through the overhead vents. The  icon will illuminate on the temperature selector.

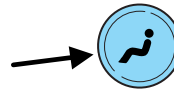

Press the mode selector again to select air distribution through the floor vents. The  icon will illuminate on the temperature selector. Only the auxiliary control head (front or rear) that is active will have the indicator lights functioning.

Controls and features

Floor console climate controls (if equipped)

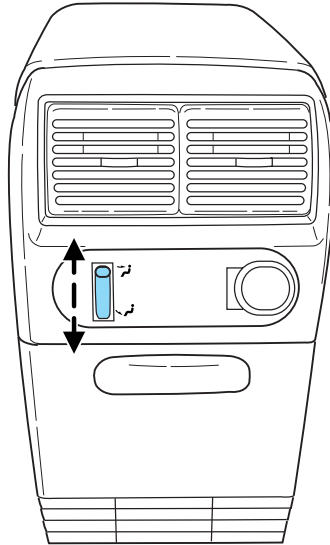

Depending on the equipment package, your vehicle may be equipped with floor console climate control capabilities.

The floor console climate control system allows the rear passengers to select a mode of airflow distribution through the floor console. However, air temperature and fan speed are controlled by the main climate control system.

Mode selector control

Controls the direction of the airflow to the rear of the vehicle.

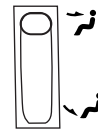

To select air flow from the panel registers of the console, slide the control to **ن**. To select airflow from the registers of the floor console, slide the control to **ف**.

To stop the air from flowing through the floor console:

1. slide the mode selector control to **ن**.
2. manually close the registers (rotate down).

Controls and features

REAR WINDOW DEFROSTER

The rear defroster control is located on the instrument panel.

Press the rear defroster control to clear the rear window of thin ice and fog.

- A small LED will illuminate when the rear defroster is activated.

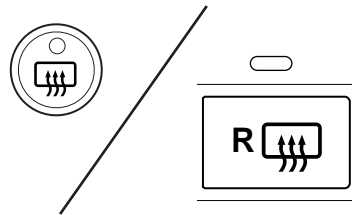

The ignition must be in the ON position to operate the rear window defroster.

The defroster turns off automatically after 10 minutes or when the ignition is turned to the OFF position. To manually turn off the defroster before 10 minutes have passed, push the control again.

4WD CONTROL

This control operates the 4WD. Refer to the *Driving* chapter for more information.



Controls and features

USING YOUR AUDIO SYSTEM

AM/FM stereo cassette

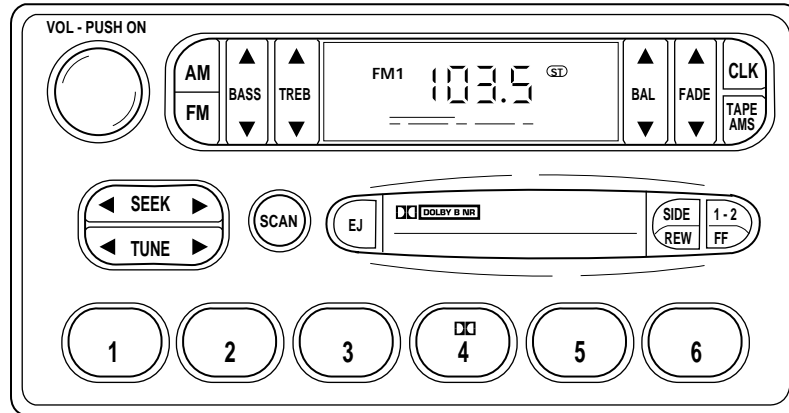

Volume/power control

Press the control to turn the audio system on or off.

Turn the control to raise or lower volume.



If the volume is set above a certain level and the ignition is turned off, the volume will come back on at a “nominal” listening level when the ignition switch is turned back on.

Controls and features

AM/FM select

The AM/FM select control works in radio and tape modes.

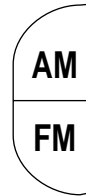

AM/FM select in radio mode

This control allows you to select AM or FM frequency bands. Press the AM control to select from AM selections, and press the FM control to select from FM1 or FM2 memory preset stations.

AM/FM select in tape mode

Press this control to stop tape play and begin radio play.

Tune adjust

The tune control works in radio mode.

Tune adjust in radio mode

- Press ◀ to move to the next frequency down the band (whether or not a listenable station is located there). Hold the control to move through the frequencies quickly.
- Press ▶ to move to the next frequency up the band (whether or not a listenable station is located there). Hold for quick movement.

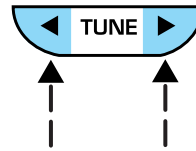

Seek function

The seek function control works in radio mode.

Seek function in radio mode

- Press ◀ to find the next listenable station down the frequency band.
- Press ▶ to find the next listenable station up the frequency band.

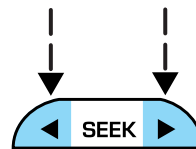

Controls and features

Scan function

The scan function works in radio mode.



Scan function in radio mode

Press the SCAN control to hear a brief sampling of all listenable stations on the frequency band. Press the SCAN control again to stop the scan mode.

Radio station memory preset

The radio is equipped with six station memory preset controls. These controls can be used to select up to six preset AM stations and twelve FM stations (six in FM1 and six in FM2).

Setting memory preset stations

1. Select the frequency band with the AM or the FM select control.
2. Select a station. Refer to *Tune adjust* or *Seek function* for more information on selecting a station.
3. Press and hold a memory preset control until the sound returns, indicating the station is held in memory on the control you selected.

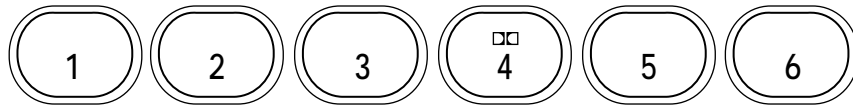

Bass adjust

The bass adjust control allows you to increase or decrease the audio system's bass output.

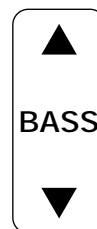

Controls and features

Treble adjust

The treble adjust control allows you to increase or decrease the audio system's treble output.

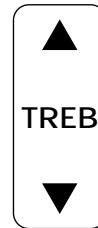

Speaker balance adjust

Speaker sound distribution can be adjusted between the right and left speakers.

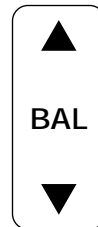

Speaker fade adjust

Speaker sound can be adjusted between the front and rear speakers.



Tape select

- To enter tape mode while in radio mode, press the TAPE AMS control.



Controls and features

Automatic Music Search

The Automatic Music Search feature allows you to quickly locate the beginning of the tape selection being played or to skip to the next selection.

To activate the feature, momentarily depress the TAPE AMS button. Then, press either REW (for the beginning of the current selection) or FF (to advance to the next selection). The tape deck stops and returns to play mode when the AMS circuit senses a blank section on the tape.

In order to ensure proper operation of the AMS feature, the tape **MUST** have a blank section of at least four seconds duration between programs.



Rewind

The rewind control works in tape mode.

To rewind in tape mode, press the REW control.

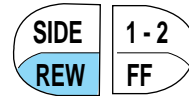

Fast forward

The fast forward control works in tape mode.

To fast forward in tape mode, press the FF control.

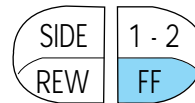

In the tape mode, tape direction will automatically reverse when the end of the tape is reached.

Tape direction select

Press SIDE and 1-2 at the same time to play the alternate side of a tape.



Controls and features

Eject function

Press the control to stop and eject a tape.

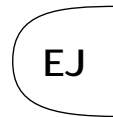

Dolby® noise reduction

Dolby® noise reduction operates only in tape mode. Dolby® noise reduction reduces the amount of hiss and static during tape playback.

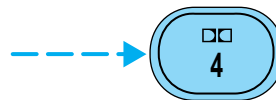



Press the  control to activate (and deactivate) Dolby® noise reduction.

Dolby® noise reduction is manufactured under license from Dolby® Laboratories Licensing Corporation. “Dolby®” and the double-D symbol are registered trademarks of Dolby Laboratories Licensing Corporation.

Setting the clock

Press CLK to toggle between listening frequencies and clock mode while in radio mode.

To set the hour, press and hold the CLK control and press the SEEK control:

-  to decrease hours and
-  to increase hours.

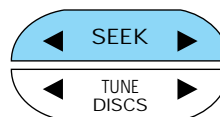

To set the minute, press and hold the CLK control and press the TUNE control:



Controls and features

- ◀ to decrease minutes and
- ▶ to increase minutes.



The CLK control will allow you to switch between media display mode (radio station, stereo information, etc.) and clock display mode (time). When in clock mode, the media information will display for 10 seconds, when the radio is turned on, and then revert to clock information. Any time that the media is changed, (new radio station, etc.), the media information will again display for 10 seconds before reverting back to the clock. In media mode, the media information will always be displayed.

AM/FM Stereo / Single CD Radio

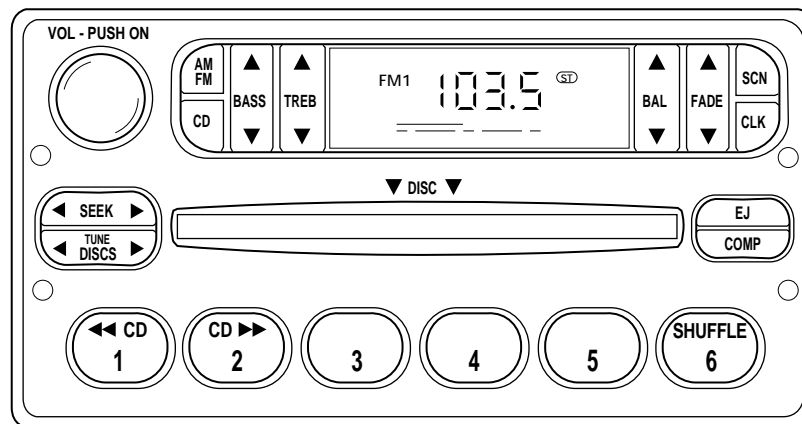

Volume/power control

Press the control to turn the audio system on or off.

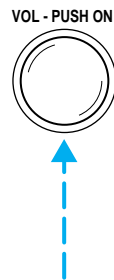

Controls and features

Turn the control to raise or lower volume.



If the volume is set above a certain level and the ignition is turned off, the volume will come back on at a “nominal” listening level when the ignition switch is turned back on.

AM/FM select

The AM/FM select control works in radio and CD modes.



AM/FM select in radio mode

This control allows you to select AM or FM frequency bands. Press the control to switch between AM, FM1 or FM2 memory preset stations.

AM/FM select in CD mode

Press this control to stop CD play and begin radio play.

Tune adjust

The tune control works in radio mode.

Tune adjust in radio mode

- Press ◀ to move to the next frequency down the band (whether or not a listenable station is located there). Hold the control to move through the frequencies quickly.
- Press ▶ to move to the next frequency up the band (whether or not a listenable station is located there). Hold for quick movement.



Seek function

The seek function control works in radio or CD mode.

Controls and features

Seek function in radio mode

- Press ◀ to find the next listenable station down the frequency band.
- Press ▶ to find the next listenable station up the frequency band.



Seek function in CD mode

- Press ▶ to listen to the next selection.
- Press ◀ to listen to the previous selection.



Scan function

The scan function works in radio or CD mode.



Scan function in radio mode

Press SCN to hear a brief sampling of all listenable stations on the frequency band. Press SCN again to stop the scan mode.

Scan function in CD mode

Press SCN to hear a short sampling of all selections on the CD. (The CD scans in a forward direction, wrapping back to the first track at the end of the CD.) To stop on a particular selection, press the control again.

Bass adjust

The bass adjust control allows you to increase or decrease the audio system's bass output.

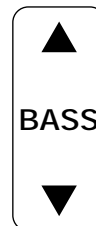

Controls and features

Treble adjust

The treble adjust control allows you to increase or decrease the audio system's treble output.

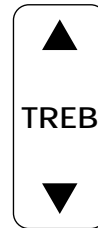

Speaker balance adjust

Speaker sound distribution can be adjusted between the right and left speakers.

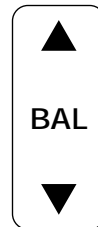

Speaker fade adjust

Speaker sound can be adjusted between the front and rear speakers.



CD select

- To begin CD play (if CD[s] are loaded), press the CD control. The first track of the disc will begin playing. After that, CD play will begin where it stopped last.



Controls and features

Do not insert any promotional (odd shaped or sized) discs, or discs with removable labels into the CD player as jamming may occur.

Rewind

The rewind control works in CD mode.

To rewind in CD mode, press the CD control (preset 1).

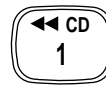

Press the control again to deactivate rewind mode.

Fast forward

The fast forward control works in CD mode.

To fast forward in CD changer mode, press the CD control (preset 2).



Press the control again to deactivate fast forward mode.

Eject function

Press the control to stop and eject a CD.



Compression feature

Compression adjust brings soft and loud CD passages together for a more consistent listening level.



Press the COMP control to activate and deactivate compression adjust.

Shuffle feature

The shuffle feature operates in CD mode and plays all tracks on the current disc in random order.



Press the SHUFFLE control to start this feature. Random order play will continue until the SHUFFLE control is pressed again.

Controls and features

Setting the clock

Press CLK to toggle between listening frequencies and clock mode while in radio mode.

To set the hour, press and hold the CLK control.

Press the SEEK control:

- ◀ to decrease hours and
- ▶ to increase hours.

To set the minute, press and hold the CLK control.

Press the TUNE control:

- ◀ to decrease minutes and
- ▶ to increase minutes.

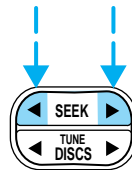

Controls and features

Premium AM/FM Stereo/Cassette/Single CD

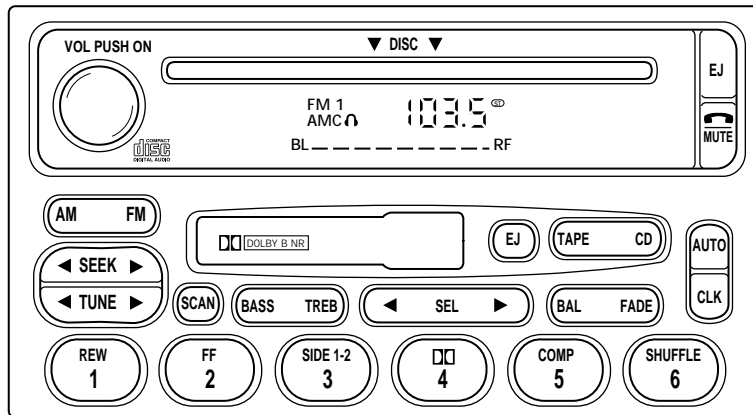

Volume/power control

Press the control to turn the audio system on or off.

Audio power can also be turned on by pressing the AM/FM select control or the TAPE/CD select control.

VOL - PUSH ON

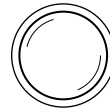

Turn control to raise or lower volume.

VOL - PUSH ON

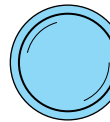

If the volume is set above a certain level and the ignition is turned off, the volume will come back on at a “nominal” listening level when the ignition switch is turned back on.

Controls and features

AM/FM select

The AM/FM select control works in radio, tape and CD modes.



AM/FM select in radio mode

This control allows you to select AM or FM frequency bands. Press the control to switch between AM, FM1 or FM2 memory preset stations.

AM/FM select in tape mode

Press this control to stop tape play and begin radio play.

AM/FM select in CD mode

Press this control to stop CD play and begin radio play.

Tune adjust

The tune control works in radio mode.

Tune adjust in radio mode

- Press ◀ to move to the next frequency down the band (whether or not a listenable station is located there). Hold the control to move through the frequencies quickly.
- Press ▶ to move to the next frequency up the band (whether or not a listenable station is located there). Hold for quick movement.



Seek function

The seek function control works in radio, tape or CD mode.

Seek function in radio mode

- Press ◀ to find the next listenable station down the frequency band.
- Press ▶ to find the next listenable station up the frequency band.



Seek function in tape mode

- Press ◀ to listen to the previous selection on the tape.
- Press ▶ to listen to the next selection on the tape.

Controls and features

Seek function in CD mode

- Press ◀ to seek to the previous track of the disc. If a selection has been playing for three seconds or more and you press ◀, the CD will replay that selection from the beginning.
- Press ▶ to seek forward to the next track of the disc. After the last track has been completed, the first track of the current disc will automatically replay.



Scan function

The scan function works in radio, tape or CD mode.



Scan function in radio mode

Press the SCAN control to hear a brief sampling of all listenable stations on the frequency band. Press the control again to stop the scan mode.

Scan function in tape mode

Press the SCAN control to hear a short sampling of all selections on the tape. (The tape scans in a forward direction. At the end of the tape's first side, direction automatically reverses to the opposite side of the tape.) To stop on a particular selection, press the control again.

Scan function in CD mode

Press the SCAN control to hear a short sampling of all selections on the CD. (The CD scans in a forward direction, wrapping back to the first track at the end of the CD.) To stop on a particular selection, press the control again.

Radio station memory preset

The radio is equipped with six station memory preset controls. These controls can be used to select up to six preset AM stations and twelve FM stations (six in FM1 and six in FM2).

Setting memory preset stations

1. Select the frequency band with the AM/FM select control.
2. Select a station. Refer to *Tune adjust* or *Seek function* for more information on selecting a station.



Controls and features

3. Press and hold a memory preset control until the sound returns, indicating the station is held in memory on the control you selected.

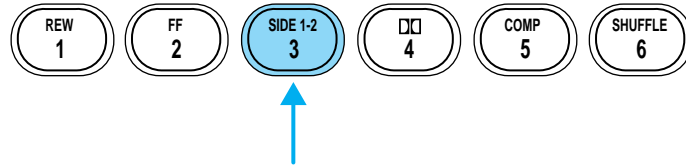

Autoset memory preset

Autoset allows you to set strong radio stations without losing your original manually set preset stations. This feature is helpful on trips when you travel between cities with different radio stations.

Starting autoset memory preset

1. Select a frequency using the AM/FM select controls.
2. Press the control.
3. When the first six strong stations are filled, the station stored in memory preset control 1 will start playing.

If there are less than six strong stations available on the frequency band, the remaining memory preset controls will all store the last strong station available.

These stations are temporarily stored in the memory preset controls (until deactivated) and are accessed in the same manner as your original presets.

To deactivate autoset and return to your audio system's manually set memory stations, press the AUTO control again.

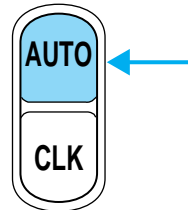

Bass adjust

The bass adjust control allows you to increase or decrease the audio system's bass output.

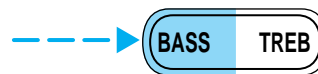

Controls and features

Press the BASS control then press:

- ◀ to decrease the bass output and
- ▶ to increase the bass output.

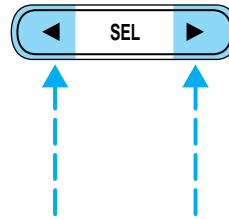

Treble adjust

The treble adjust control allows you to increase or decrease the audio system's treble output.

Press the TREB control then press:

- ◀ to decrease the treble output and
- ▶ to increase the treble output.

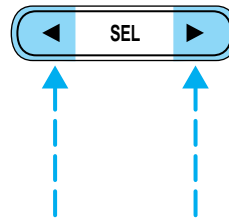

Speaker balance adjust

Speaker sound distribution can be adjusted between the right and left speakers.

Press the BAL control then press:

- ◀ to shift sound to the left and
- ▶ to shift sound to the right.

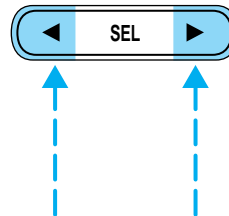



Controls and features

Speaker fade adjust

Speaker sound can be adjusted between the front and rear speakers.

Press the FADE control then press:

-  to shift the sound to the front and
-  to shift the sound to the rear.

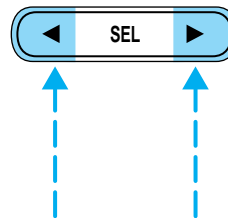

Tape/CD select

- To begin tape play (with a tape loaded into the audio system) while in the radio or CD mode, press the TAPE control. Press again during rewind or fast forward to stop the rewind or fast forward function.
- To begin CD play (if CD(s) are loaded), press the CD control. The first track of the disc will begin playing. If returning from radio or tape mode, CD play will begin where it stopped last.



Press the CD control to toggle between single CD and CD changer play (if equipped).

Do not insert any promotional (odd shaped or sized) discs, or discs with removable labels into the CD player as jamming may occur.

Rewind

The rewind control works in tape and CD modes.

- In tape mode, radio play will continue until rewind is stopped (with the TAPE control) or the beginning of the tape is reached.
- In CD mode, pressing the REW control rewinds the CD within the current track.

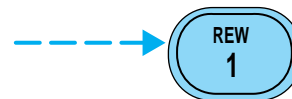

Controls and features

Fast forward

The fast forward control works in tape and CD modes.

- In the tape mode, tape direction will automatically reverse when the end of the tape is reached.
- In CD mode, pressing the control fast forwards the CD within the current track.

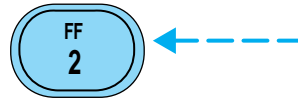

Tape direction select

Press SIDE 1-2 to play the alternate side of a tape.

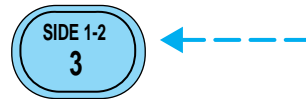

Eject function

Press the EJ control to stop and eject a tape.

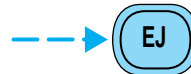

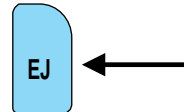

Press the EJ control to stop and eject a CD.

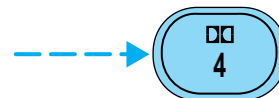

Dolby® noise reduction

Dolby® noise reduction operates in tape mode. Dolby® noise reduction reduces the amount of hiss and static during tape playback.



Press the  control to activate (and deactivate) the Dolby® noise reduction.

Dolby® noise reduction is manufactured under license from Dolby® Laboratories Licensing Corporation. "Dolby®" and the double-D symbol  are registered trademarks of Dolby® Laboratories Licensing Corporation.

Controls and features

Compression adjust

Compression adjust brings soft and loud CD passages together for a more consistent listening level.

Press the COMP control to activate and deactivate compression adjust.

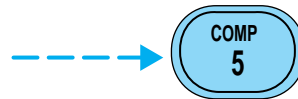

Shuffle feature

The shuffle feature operates in CD mode and plays all tracks in random order.

Press the SHUFFLE control to start this feature. Random order play will continue until the SHUFFLE control is pressed again.

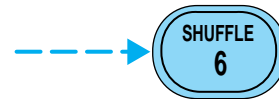

Setting the clock

To set the hour, press and hold the CLK control and press SEEK:

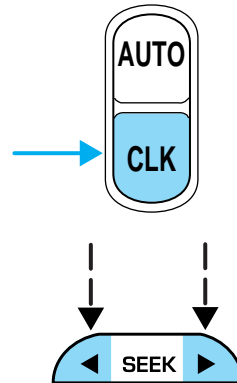

- ◀ to decrease hours and
- ▶ to increase hours.

To set the minute, press and hold the CLK control and press TUNE:

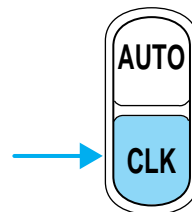

Controls and features

- ◀ to decrease minutes and
- ▶ to increase minutes.

If your vehicle has a separate clock, (other than the digital radio display), the CLK control will not function in the above manner.

The CLK control will allow you to switch between media display mode (radio station, stereo information, etc.) and clock display mode (time).

When in clock mode, the media information will display for 10 seconds, when the radio is turned on, and then revert to clock information. Any time that the media is changed, (new radio station, etc.), the media information will again display for 10 seconds before reverting back to the clock. In media mode, the media information will always be displayed.

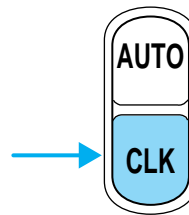
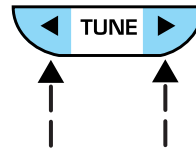

Mute mode

Press the MUTE control to mute the playing media. Press the MUTE control again to return to the playing media.

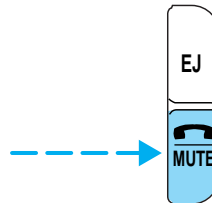

Controls and features

Audiophile AM/FM Stereo In Dash Six CD Radio

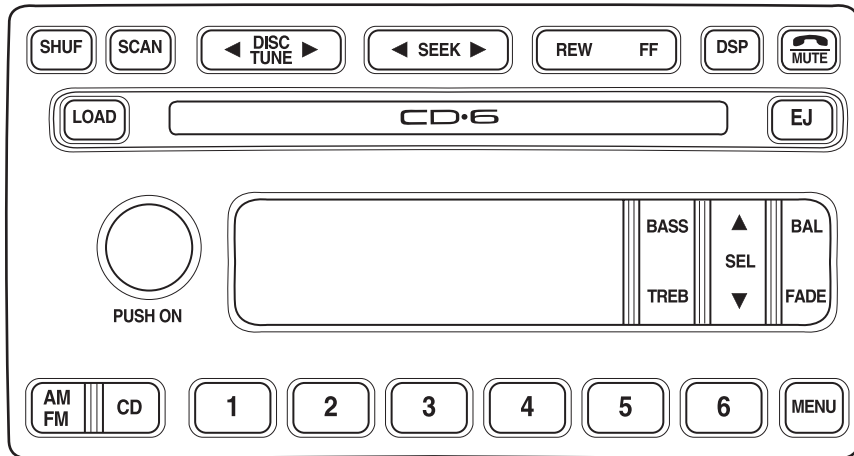

Premium AM/FM Stereo In Dash Six CD Radio

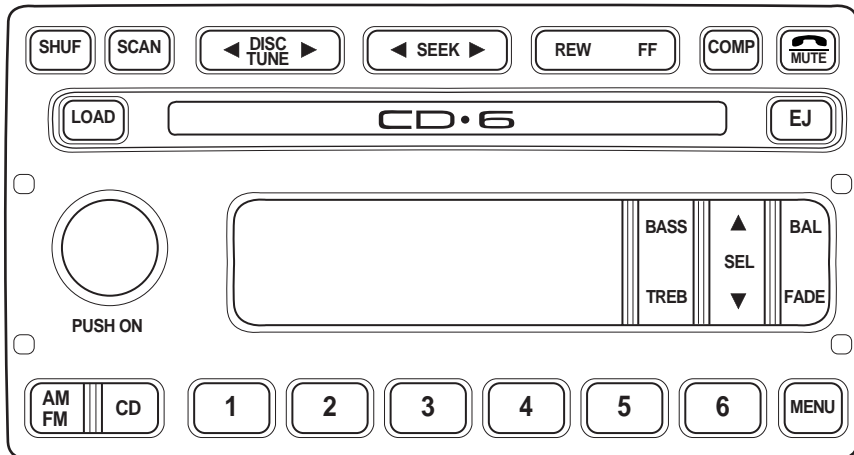

Controls and features

Volume/power control

Press the control to turn the audio system on or off. Turn the control to raise or lower volume.

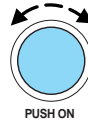

If the volume is set above a certain level and the ignition is turned off, the volume will come back on at a "nominal" listening level when the ignition switch is turned back on.

Speed sensitive volume

With this feature, radio volume changes automatically and slightly with vehicle speed to compensate for road and wind noise.

The recommended level for speed sensitive volume is from level 1 through level 3. Level 0 turns the speed sensitive volume off and level 7 is the maximum setting.

To engage the speed sensitive volume feature, press and hold the volume control for five seconds (with the radio on), then press:



- ▲ to increase volume compensation.
- ▼ to decrease or shut off the volume compensation.

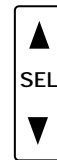

The selected level will appear in the display.

AM/FM select

The AM/FM select control works in radio and CD modes.



AM/FM select in radio mode

This control allows you to select AM or FM frequency bands. Press the control to switch between AM, FM1 or FM2 memory preset stations.

AM/FM select in CD mode

Press this control to stop CD play and begin radio play.

Controls and features

Tune/disc adjust

The tune control works in radio or CD mode.

Tune adjust in radio mode

- Press ◀ to move to the next frequency down the band (whether or not a listenable station is located there). Hold the control to move through the frequencies quickly.
- Press ▶ to move to the next frequency up the band (whether or not a listenable station is located there). Hold for quick movement.



Disc adjust for CD mode

- Press ◀ to select the previous disc. (Play will begin on the first track of the disc unless shuffle mode is engaged.) Refer to *Shuffle feature* for more information. Hold the control to continue reversing through the discs.
- Press ▶ to select the next disc. Hold the control to fast-forward through the remaining discs.



Seek function

The seek function works in radio or CD mode.

Seek function in radio mode

- Press ◀ to find the next listenable station down the frequency band. SEEK DOWN will display.
- Press ▶ to find the next listenable station up the frequency band. SEEK UP will display.



Controls and features

Seek function in CD mode

- Press ◀ to seek to the previous track of the current disc. If the beginning of the disc is reached, the CD player seeks to the beginning of the last track on the current disc and begins playing.
- Press ▶ to seek forward to the next track of the current disc. After the last track has been completed, the first track of the current disc will automatically replay.



Scan function

The scan function works in radio or CD mode.

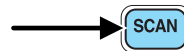

Scan function in radio mode

Press the SCAN control to hear a brief sampling of all listenable stations on the frequency band. Press the SCAN control again to stop the scan mode.

Scan function in CD mode

Press the SCAN control to hear a short sampling of all selections on the CD. (The CD scans in a forward direction, wrapping back to the first track at the end of the CD.) To stop on a particular selection, press the control again.

Radio station memory preset

The radio is equipped with six station memory preset controls. These controls can be used to select up to six preset AM stations and twelve FM stations (six in FM1 and six in FM2).

Setting memory preset stations

1. Select the frequency band with the AM/FM select control. Press the AM/FM control to toggle between AM, FM1, or FM2.
2. Press the SEEK control to access the next listenable station up or down the frequency band. Press the TUNE control to go up or down the listening band in individual increments.
3. Select a station. Refer to *Seek function* for more information on selecting a station.

Controls and features

4. Press and hold a memory preset control. The playing media will mute momentarily. When the sound returns, the station is held in memory on the control you selected. The display will read **SAVED**.

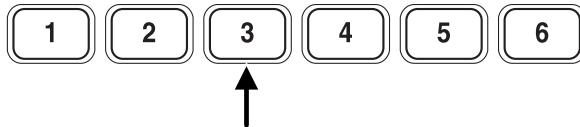

Autostore

Autostore allows you to set the strongest local radio stations without losing your original manually set preset stations. This feature is helpful on trips when you travel between cities with different radio stations.

Starting autostore

1. Press and momentarily hold the AM/FM control.

2. **AUTOSET** will flash in the display as the frequency band is scrolled through.



3. When the six strongest stations are filled, the station stored in memory preset control 1 will start playing.

If there are fewer than six strong stations available on the frequency band, the remaining memory preset controls will all store the last strong station available.

To deactivate autostore and return to your audio system's manually set memory stations, press the AM/FM control again.

Controls and features

CD select

CD mode may be entered by pressing the CD control and the LOAD control. Load the CD into the audio system. The first track of the disc will begin playing. After that, CD play will begin where it stopped last.



If an alternative CD is desired, press the corresponding preset control (1-6) of a loaded CD, or press the TUNE control to access the other loaded CDs.

NO CD will display if the CD control is activated when there is not a CD present in the audio system.

NO CD will illuminate in the display if the CD control and a present number (that is currently empty) are pressed. The system will play the next available disc.

CD units are designed to play commercially pressed 12 cm (4.75 in) audio compact discs only. Due to technical incompatibility, certain recordable and re-recordable compact discs may not function correctly when used in Ford CD players. Irregular shaped CDs, CDs with a scratch protection film attached, and CDs with homemade paper (adhesive) labels should not be inserted into the CD player. The label may peel and cause the CD to become jammed. It is recommended that homemade CDs be identified with permanent felt tip marker rather than adhesive labels. Ball point pens may damage CDs. Please contact your dealer for further information.

Display description

Six circles are always lit in the digital display. These signify the six CD slots in the audio system. When a disc is loaded into a particular slot (1-6), the number inside that specific circle lights. If the circle is empty, there is no CD in that particular slot.

Load

The load feature allows you to load single CDs into the player internal to the radio.



This six disc CD player is equipped with a CD door. Compact discs should only be inserted into the player after the CD door has been opened by the player. Do not attempt to force the door open. Compact discs should only be loaded by pressing the LOAD control.

Controls and features

Press the LOAD control. (You can choose which slot will be loaded by pressing the desired preset number. If you do not choose a slot, the system will choose the next available one.) Wait until the CD door opens. Load the CD into the player. LOADING CD# is displayed. When the CD has been loaded, the door will close and the CD will begin to play. For example, to load a CD into slot 2, press the LOAD control and then press preset 2.

Auto load

This feature allows you to autoload up to 6 discs into the multi disc CD player internal to the radio.



Press and hold the LOAD control until AUTOLOAD # is displayed. The CD door will open. Load the desired discs, one at a time. The CD is loaded into position and the audio system will display CD#. Each time the CD door opens, INSERT CD# is displayed. The door will close and the player will move to the next slot after each disc has been loaded. The process is repeated until all 6 slots are full. The audio system plays the last CD loaded and the display is updated. If some slots are already full and autoload is activated, the system will fill all empty slots.

Eject

Press the EJ control to stop and eject a CD. You can choose which CD will be ejected by pressing the



EJ control and the desired preset number (1-6). For example, to eject CD 2, press the EJ control and then press the preset 2 control. If you do not choose a specific CD, the player will eject the current CD.

If a CD is ejected and not removed from the door of the CD player, the player will automatically reload the CD. This feature may be used when the ignition is ON or OFF.

Auto eject

Press and momentarily hold the EJ control to engage auto eject. All CDs which are present in the player will



be ejected one at a time. If a CD is ejected and not removed from the door of the CD player, the player will automatically reload the CD. This feature may be used when the ignition is ON or OFF.

Controls and features

Rewind

The rewind control works in CD modes.



Press and hold the REW control until the desired selection is reached. If the beginning of the disc is reached, the CD will begin play at the first track. Release the control to disengage rewind mode.

When in rewind mode, your audio system will automatically lower the volume level of the playing media.

Fast forward

The fast forward control works in CD modes.



Press and hold the FF control until the desired selection is reached. If the end of the disc is reached, the CD will return to the first track. Release the control to disengage fast forward mode.

When in fast forward mode, your audio system will automatically lower the volume level of the playing media.

Shuffle feature

Press the SHUF control until the desired shuffle mode is displayed. The audio system will then engage the desired shuffle mode.



When engaged, the shuffle feature has two different modes: SHUFFLE DISC and SHUFFLE TRK.

SHUFFLE DISC randomly plays tracks from all the discs presently in the audio system.

SHUFFLE TRK plays all the tracks on the current disc in random order.

Compression feature (if equipped)

The compression feature operates in CD mode and brings soft and loud CD passages together for a more consistent listening level.

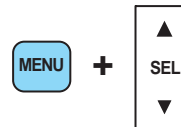

On Audiophile audios, press the MENU control until compression status is displayed. Press the SEL control to enable the compression feature

Controls and features

when COMP OFF is displayed. Press the SEL control again to disable the feature when COMP ON is displayed.

On Premium audios, press the COMP control until COMP ON is displayed.



Bass adjust

The bass adjust control allows you to increase or decrease the audio system's bass output.

Press the BASS control. Use the SEL control to increase or decrease the amount of bass.



Treble adjust

The treble adjust control allows you to increase or decrease the audio system's treble output.

Press the TREB control. Use the SEL control to increase or decrease the amount of treble.



Speaker balance adjust

Speaker sound distribution can be adjusted between the right and left speakers.

Press the BAL control. Use the SEL control to adjust the sound between the left and right speakers.

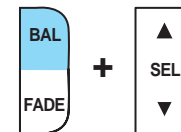

Speaker fade adjust

Speaker sound can be adjusted between the front and rear speakers.

Press the FADE control. Use the SEL control to adjust the sound between the front and rear speakers.



Controls and features

Menu mode

The MENU control allows you to access many different features within your audio system. There are three sets of menus available depending upon which mode or feature is activated.

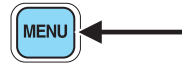

While in FM mode, two menus are available. **If RDS is turned OFF**, you can access the following:

- SELECT HOURS — Refer to *Setting the clock*.
- SELECT MINUTES — Refer to *Setting the clock*.
- RDS OFF — Refer to *Radio data system feature*.

If RDS is turned ON, you can access the following:

- TRAFFIC ON/OFF-Refer to *Traffic announcements*.
- FIND type-Refer to *Program type*.
- SHOW (NAME, TYPE, NONE)- Refer to *Radio data system feature*.
- RDS ON— Refer to *Radio data system feature*.
- SELECT HOURS — Refer to *Setting the clock*.
- SELECT MINUTES —Refer to *Setting the clock*.

When in CD mode, you can access: SELECT HOURS, SELECT MINUTES or COMP ON/OFF.

SELECT HOURS, SELECT MINUTES— Allows you to adjust the hours and minutes. Refer to *Setting the clock*.

TRAFFIC ON/OFF— Traffic announcements can be programmed as local or distant. Refer to *Traffic announcements*.

RDS ON/OFF— This feature allows your audio system to receive text information from RDS-equipped FM radio stations. Refer to *Radio Data System feature*.

FIND type — Allows you to select your desired FM program type and search for that selection.

SHOW — Allows you to select from NAME (displays the name of the radio station), TYPE (displays the RDS program type: rock, jazz, etc.), or NONE (deactivates the RDS display).

Controls and features

Radio data system (RDS) feature

This feature allows your audio system to receive text information from RDS-equipped FM radio stations.

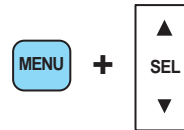

To activate RDS:

- When in FM mode, press the MENU control until RDS OFF displays.
- Press the SEL control to engage this feature (RDS ON).

RDS features:

Once the RDS feature is on, press the MENU control to scroll through the following selections:

Traffic announcements

This feature allows you to hear traffic announcements while in CD mode. These announcements are broadcast by traffic capable RDS stations.

When in this mode, traffic announcements will interrupt radio and CD play.

- Press the MENU control until TRAFFIC is displayed.
- Press the SEL control to engage the feature. The display will read TRAFFIC ON.

This feature also allows you to control the volume of traffic announcements. With the display reading TRAFFIC ON, adjust the volume using the volume control to the desired level. The volume level will show at the bottom of the display. Interrupting traffic announcements will be at the selected volume level.

To disengage the feature, press the MENU control until TRAFFIC ON displays. Press the SEL control. The display will read TRAFFIC OFF.

Traffic announcements are not available in most U.S. markets.

Program type

This feature allows you to search for RDS stations selectively by their program type.

Controls and features

Press the MENU control until FIND program type is displayed.

Use the SEL control to select the program type. With the feature on, use the SEEK or SCAN control to find the desired program type from the following selections:

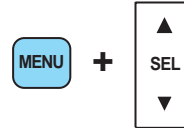

- Classic
- Country
- Info
- Jazz
- Oldies
- R & B
- Religious
- Rock
- Soft
- Top 40

Show

This feature allows you to select the type of RDS broadcast information the radio will regularly show in the display.

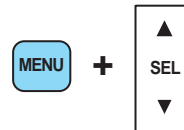

With RDS activated, press the MENU control until SHOW is displayed.

Use the SEL control to select TYPE (displays the RDS program type: rock, jazz, etc), NAME (displays the name of the radio station) or NONE (deactivates the RDS display).



Digital signal processing (if equipped)

The digital signal processing (DSP) feature allows you to change the signal mode to suit your listening tastes.

Controls and features

Press the DSP control to access one of the following modes:

- DSP OFF
- SIGNAL MODE
- OCCUPANCY MODE



Use the SEL control to select the



desired signal mode (the selected mode will appear in the display). The following signal modes can be selected:

- DSP OFF—disengages the feature
- NEWS—“voice-only” type of sound with a limited audio band
- JAZZ CLUB—jazz club with clearly reflected sounds
- HALL—rectangular concert hall capacity of about 2 000
- CHURCH—church with a high vault
- STADIUM—outdoor stadium with a capacity of about 30 000

Press the DSP control again to access the occupancy modes. Use the SEL control to optimize the sound based upon the occupants in the vehicle. The following occupancy modes can be selected:

- ALL SEATS
- DRIVER SEAT
- REAR SEATS

Mute mode

Press the control to mute the playing media. Press the control again to return to the playing media.



Setting the clock

Press the MENU control until SELECT HOUR or SELECT MINUTE is displayed. (The menu mode must be engaged to enable clock mode).

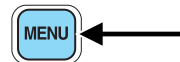

Controls and features

Use the SEL control to manually set the time.

- Press ▲ to increase hours/minutes.
- Press ▼ to decrease hours/minutes.

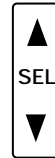

Press the MENU control again to disengage the clock mode.

Troubleshooting the CD changer (if equipped)



The laser beam used in the compact disc player is harmful to the eyes. Do not attempt to disassemble the case.

If sound skips:

- You may be traveling on a rough road, playing badly scratched discs or the disc may be dirty. Skipping will not scratch the discs or damage the player.

If your changer does not work, it may be that:

- A disc is already loaded where you want to insert a disc.
- The disc is inserted with the label surface downward.
- The disc is dusty or defective.
- The player's internal temperature is above 60°C (140°F). Allow the player to cool down before operating.
- A disc with format and dimensions not within industry standards is inserted.

Cleaning compact discs

Inspect all discs for contamination before playing. If necessary, clean discs only with an approved CD cleaner and wipe from the center out to the edge. Do not use circular motion.

CD and CD changer care

- Handle discs by their edges only. Never touch the playing surface.
- Do not expose discs to direct sunlight or heat sources for extended periods of time.
- Do not insert more than one disc into each slot of the CD changer magazine.

Controls and features

CD units are designed to play commercially pressed 12 cm (4.75 in) audio compact discs only. Due to technical incompatibility, certain recordable and re-recordable compact discs may not function correctly when used in Ford CD players. Irregular shaped CDs, CDs with a scratch protection film attached, and CDs with homemade paper (adhesive) labels should not be inserted into the CD player. The label may peel and cause the CD to become jammed. It is recommended that homemade CDs be identified with permanent felt tip marker rather than adhesive labels. Ball point pens may damage CDs. Please contact your dealer for further information.

Cleaning cassette player (if equipped)

Clean the tape player head with a cassette cleaning cartridge after 10 to 12 hours of play in order to maintain the best sound and operation.

Cassette and cassette player care

- Use only cassettes that are 90 minutes long or less.
- Do not expose tapes to direct sunlight, high humidity, extreme heat or extreme cold. Allow tapes that may have been exposed to extreme temperatures to reach a moderate temperature before playing.
- Tighten very loose tapes by inserting a finger or pencil into the hole and turning the hub.
- Remove loose labels before inserting tapes.
- Do not leave tapes in the cassette player for a long time when not being played.

Radio frequency information

The Federal Communications Commission (FCC) and the Canadian Radio and Telecommunications Commission (CRTC) establish the frequencies AM and FM stations may use for their broadcasts. Allowable frequencies are:

AM 530, 540–1600, 1610 kHz

FM 87.7, 87.9–107.7, 107.9 MHz

Not all frequencies are used in a given area.

Radio reception factors

Three factors can affect radio reception:

- **Distance/strength.** The further an FM signal travels, the weaker it is. The listenable range of the average FM station is approximately 40 km

Controls and features

(24 miles). This range can be affected by “signal modulation.” Signal modulation is a process radio stations use to increase their strength/volume relative to other stations.

- **Terrain.** Hills, mountains and tall buildings between your vehicle’s antenna and the radio station signal can cause FM reception problems. Static can be caused on AM stations by power lines, electric fences, traffic lights and thunderstorms. Moving away from an interfering structure (out of its “shadow”) returns your reception to normal.
- **Station overload.** Weak signals are sometimes captured by stronger signals when you pass a broadcast tower. A stronger signal may temporarily overtake a weaker signal and play while the weak station frequency is displayed.

The audio system automatically switches to single channel reception if it will improve the reception of a station normally received in stereo.

Audio system warranties and service

Refer to the *Warranty Guide* for audio system warranty information.

If service is necessary, see your dealer or a qualified technician.

TURN SIGNAL CONTROL ⇐⇒

- Push down to activate the left turn signal.
- Push up to activate the right turn signal.

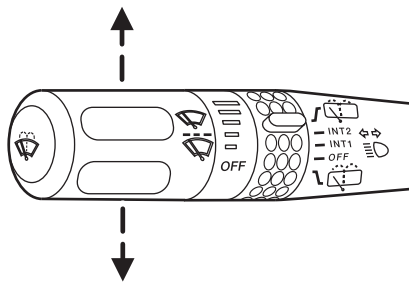

Controls and features

POSITIONS OF THE IGNITION

1. OFF/LOCK, shuts off the engine and all accessories/locks the steering wheel, gearshift lever and allows key removal.
2. ACC, allows the electrical accessories such as the radio to operate while the engine is not running.
3. ON, all electrical circuits operational. Warning lights illuminated. Key position when driving.
4. START, cranks the engine. Release the key as soon as the engine starts.

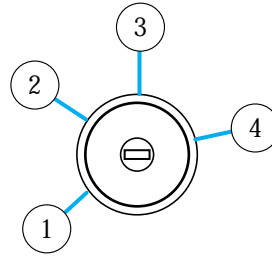

SPEED CONTROL

To turn speed control on

- Press ON.

Vehicle speed cannot be controlled until the vehicle is traveling at or above 48 km/h (30 mph).

Do not shift the gearshift lever into N (Neutral) with the speed control on.



Do not use the speed control in heavy traffic or on roads that are winding, slippery, or unpaved.

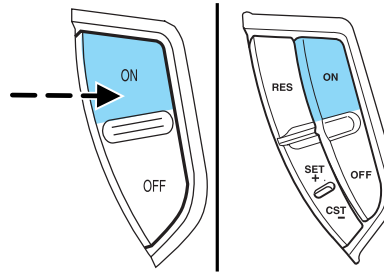

Controls and features

To turn speed control off

- Press OFF
- Speed control automatically defaults to OFF when the ignition is turn off.

Once speed control is switched off, the previously programmed set speed will be erased.

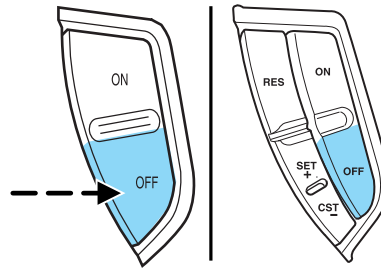

To set a speed

- Press SET+. For speed control to operate, the speed control must be ON and the vehicle speed must be greater than 48 km/h (30 mph).

If you drive up or down a steep hill, your vehicle speed may vary momentarily slower or faster than the set speed. This is normal.

Speed control cannot reduce the vehicle speed if it increases above the set speed going downhill. If your vehicle speed is faster than the set speed while driving downhill, you may want to shift to the next lower gear or apply the brakes to reduce your vehicle speed.

If your vehicle slows down more than 16 km/h (10 mph) below your set speed on an uphill, your speed control will disengage. This is normal. Pressing RES will re-engage it.

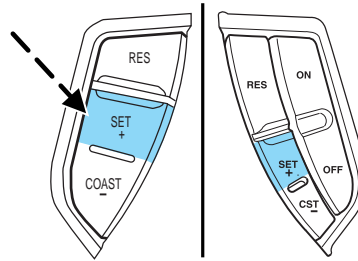

Do not use the speed control in heavy traffic or on roads that are winding, slippery, or unpaved.

Controls and features

To set a higher set speed

- Press and hold SET +. Release the control when the desired vehicle speed is reached or
- Press and release SET + to operate the Tap-Up function. Each press will increase the set speed by 1.6 km/h (1 mph) or
- Accelerate with your accelerator pedal. When the desired vehicle speed is reached, press and release SET +.

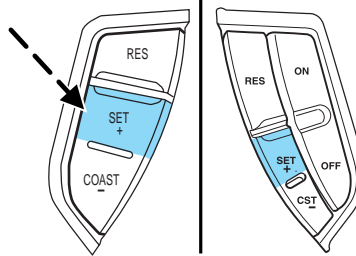

You can accelerate with the accelerator pedal at any time during speed control usage. Releasing the accelerator pedal will return your vehicle to the previously programmed set speed.

To set a lower set speed

- Press and hold COAST/CST -. Release the control when the desired speed is reached or
- Press and release COAST/CST - to operate the Tap-Down function. Each press will decrease the set speed by 1.6 km/h (1 mph) or

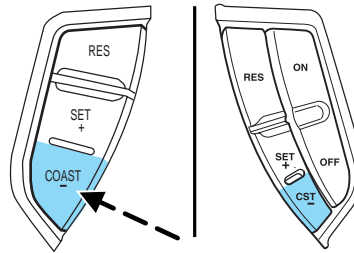

- Depress the brake pedal. When the desired vehicle speed is reached, press SET +.

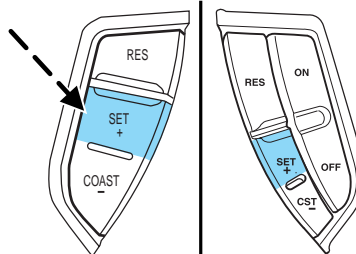

Controls and features

To disengage speed control

- Depress the brake pedal or

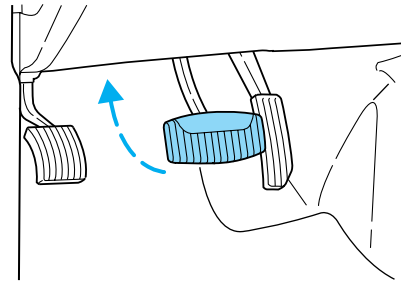

- Depress the clutch pedal (if equipped).

Disengaging the speed control will not erase the previously programmed set speed.

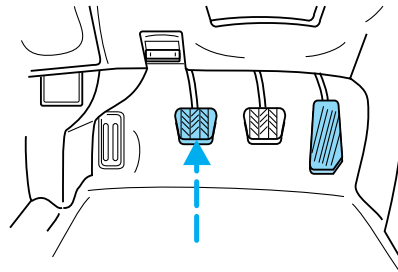

Pressing OFF will erase the previously programmed set speed.

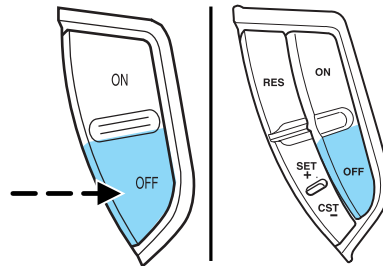

Controls and features

To return to a previously set speed

- Press RES. For RES to operate, the vehicle speed must be faster than 48 km/h (30 mph).

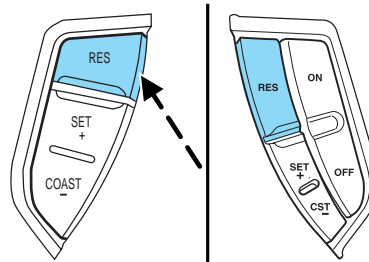

Indicator light

This light comes on when the vehicle speed control is engaged and actively controlling vehicle speed.

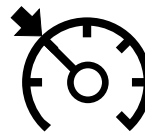

TILT/TELESCOPE STEERING COLUMN (IF EQUIPPED)

Pull the lever down to unlock the tilt/telescope steering column. While the lever is in the down position, tilt and telescope the steering column to the desired orientation.

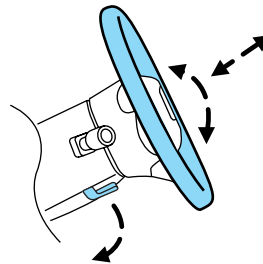

Controls and features

If your vehicle has the tilt-only steering column, pull the lever down to unlock the steering column. While the lever is in the down position, tilt the steering column to its desired orientation.

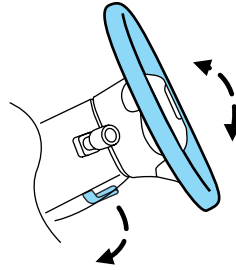

Lift the lever back to its original position to lock the steering column.

 Never adjust the steering column when the vehicle is moving.

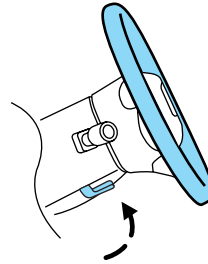

HAZARD FLASHER

For information on the hazard flasher control, refer to *Hazard flasher* in the *Roadside emergencies* chapter.

WINDSHIELD WIPER/WASHER CONTROLS

Rotate the windshield wiper control to the desired interval, low or high speed position.

The bars of varying length are for intermittent wipers. When in this position rotate the control upward for fast intervals and downward for slow intervals.

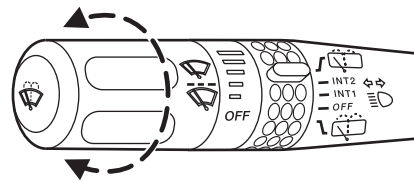

Controls and features

Push (tap) the end of the stalk briefly for a single swipe (no wash). Push and hold for three swipes with wash. Push and hold for a longer wash (up to ten seconds).



Speed dependent wipers

When the windshield wiper control is set on the intermittent settings, speed-sensitive front wipers automatically adjust as the vehicle's speed changes.

Rear window wiper/washer controls

For rear wiper operation, rotate the rear window wiper and washer control to the desired position. Select:

INT 1 — 3-4 second interval rear wiper.

INT 2 — 8-10 second interval rear wiper.

OFF — Rear wiper and washer off.

For rear wash cycle, rotate (and hold as desired) the rear wiper/washer control to either  position.

From either position, the control will automatically return to the INT 2 or OFF position.

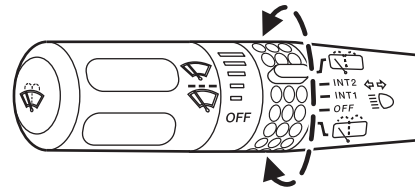

STEERING WHEEL CONTROLS (IF EQUIPPED)

These controls allow you to operate some radio and climate control features.

Controls and features

Audio control features

Press  to select:

- AM, FM1, FM2,
- TAPE (if equipped),
- CD (if equipped), or
- DVD (if equipped).

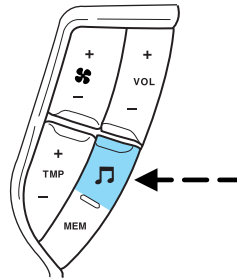

In AM, FM1, or FM2 mode:

- Press MEM to select preset stations within the selected radio band.

In Tape mode:

- Press MEM to select the next selection on the tape.

In CD mode:

- Press MEM to select the next selection on the CD.

In any mode:

- Press VOL + or - to adjust volume.

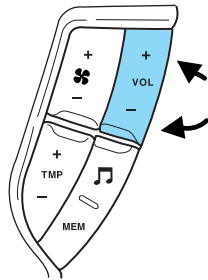
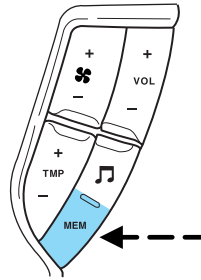

Controls and features

Climate control features

Press TMP + or - to adjust temperature.

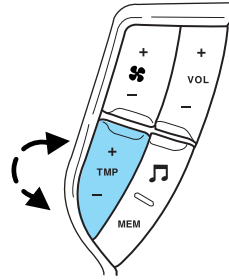

Press  + or - to adjust fan speed.

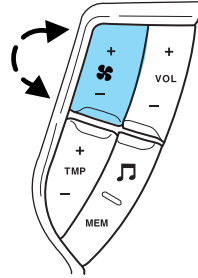

OVERHEAD CONSOLE (IF EQUIPPED)

The appearance of your vehicle's overhead console will vary according to your option package.

Controls and features

Storage compartment

Press the latch to open the storage compartment.

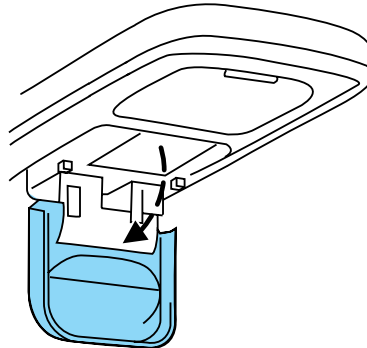

Installing a garage door opener (if equipped)

The storage compartment can be converted to accommodate a variety of aftermarket garage door openers:

- Place the Velcro hook onto the side of the aftermarket transmitter opposite of the button.
- Place the transmitter into storage compartment, button down.

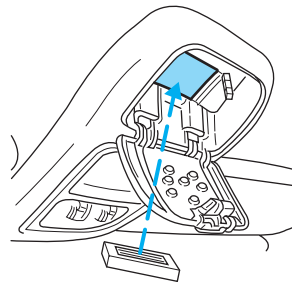

- Place the provided height adaptors onto the back of the door as needed.
- Close the door.
- Press the depression in the door to activate the transmitter.

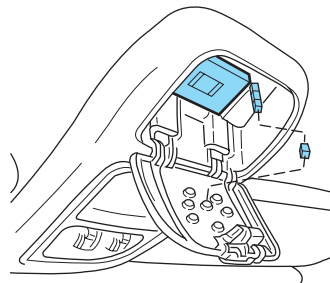

Controls and features

Moon roof (if equipped)

You can move the glass panel of the moon roof back to open or tilt up to ventilate the vehicle.

To open the moon roof:

The moon roof is equipped with an automatic, one-touch, express opening feature. Press and momentarily hold the rear portion of the control. To stop motion at any time during the one-touch opening, press the control a second time.

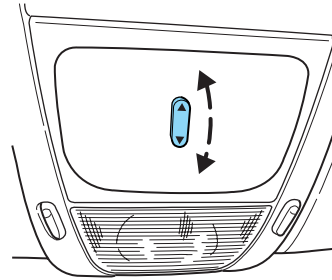

To close the moon roof:

Press and hold the front portion of the control until the glass panel stops moving. Once fully closed, the rear of the glass panel will appear higher than the front edge.

To vent:

To tilt the moon roof into the vent position (when the glass panel is closed), press and hold the front portion of the control. To close the moon roof from the vent position, press and hold the rear portion of the control until the glass panel stops moving.

If the battery is disconnected, discharged, or a new battery is installed, the moon roof needs to be opened to the vent position to reset the moon roof positions.

The moon roof has a sliding shade that can be opened or closed when the glass panel is shut. To close the shade, pull it toward the front of the vehicle.



Do not let children play with the moon roof. They may seriously hurt themselves.

Interior Lamps

Dome lamps and map lamps

The front map/dome lamp is located overhead between the driver and the passenger seats. If the vehicle is equipped with a moon roof or large overhead console, the map/dome lamp is located above the second row seat.

Controls and features

The map lamp controls are located on the dome lamp. Press the controls on either side of each lens on each map lamp to activate the lamps.

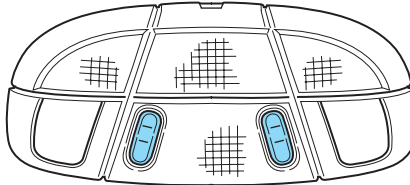

All vehicles are equipped with a cargo lamp, which is located overhead in the rear cargo area and above the third row seat (if equipped). The cargo lamp will stay on if the control is moved to the passenger side position. When the control is in the middle position, the lamp will only come on when a door is opened. If the control is moved to the driver's side position, the lamp will not come on at all.

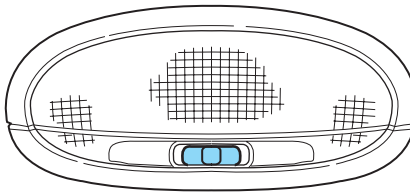

With the control in the middle position, the dome lamp will illuminate whenever a front door is opened. If either front door has been opened from the outside, the lamp will remain on for 25 seconds after the door is shut. If any other door has been opened from the inside, the lamp will shut off immediately after the door is closed.

The front map lamps are located on the control panel (if equipped). First row map lamps may also be located in the overhead console (if equipped). Press the controls on either side of each map lamp to activate the lamps.

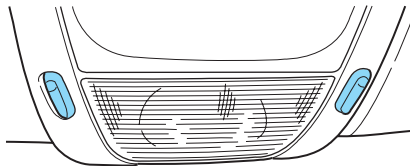

HOMELINK® UNIVERSAL TRANSCEIVER (IF EQUIPPED)

The HomeLink® Universal Transceiver, located on the overhead console, provides a convenient way to replace up to three hand-held transmitters with a single built-in device. This feature will learn the radio frequency codes of most current transmitters to operate garage doors, entry gate operators, security systems, entry door locks, and home or office lighting.



When programming your HomeLink® Universal Transceiver to a garage door or gate, be sure that people and objects are out of the way to prevent potential harm or damage.

Controls and features

Do not use the HomeLink® Universal Transceiver with any garage door opener that lacks safety stop and reverse features as required by U.S. federal safety standards (this includes any garage door opener model manufactured before April 1, 1982). A garage door which cannot detect an object, signaling the door to stop and reverse, does not meet current U.S. federal safety standards. For more information, contact HomeLink® at: **www.homelink.com** or **1-800-355-3515**.

Retain the original transmitter for use in other vehicles as well as for future programming procedures (i.e. new HomeLink® equipped vehicle purchase). It is also suggested that upon the sale of the vehicle, the programmed Homelink® Universal Transceiver buttons be erased for security purposes, refer to *Programming* in this section.

Programming

Do not program the HomeLink® Universal Transceiver with the vehicle parked in the garage.

Note: Some vehicles may require the ignition switch to be turned to the second (or “ACC”) position for programming and/or operation of the HomeLink®. It is also recommended that a new battery be placed in the hand-held transmitter of the device being programmed to HomeLink® for quicker training and accurate transmission of the radio-frequency signal.

1. Press and hold the two outside buttons releasing only when the red light begins to flash after 20 seconds. **Do not** repeat step one to program additional hand-held transmitters to the remaining two HomeLink® buttons. This will erase previously programmed hand-held transmitter signals into HomeLink®.

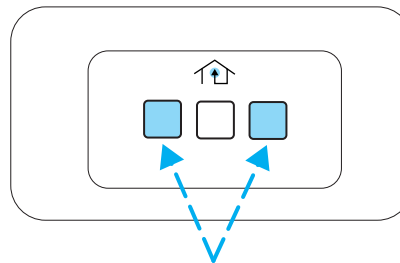

2. Position the end of your hand-held transmitter 2-8 cm (1-3 inches) away from the HomeLink® Universal Transceiver surface (located on your overhead console) while keeping the red light in view.

Controls and features

3. Simultaneously press and hold both the HomeLink® and hand-held transmitter button. **Do not release the buttons until step 4 has been completed.**

Some entry gates and garage door openers may require you to replace step 3 with procedures noted in the “Gate Operator and Canadian Programming” section for Canadian residents.

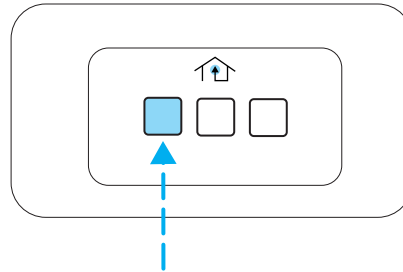

4. The red light will flash slowly and then rapidly. Release both buttons when the red light flashes rapidly. (The rapid flashing light indicates acceptance of the hand-held transmitters’ radio frequency signals.)

5. Press and hold the just-trained HomeLink® button and observe the red light. If the light is a constant red, programming is complete and your device should activate when the HomeLink® button is pressed and released. **Note:** To program the remaining two HomeLink® buttons, begin with step 2 in the “Programming” section — **do not** repeat step 1. If the red light blinks rapidly for two seconds and then turns to a continuous red, proceed with steps 6 through 8 to complete programming of a rolling code equipped device.

6. At the garage door opener receiver (motor-head unit) in the garage, locate the “learn” or “smart” button (usually near where the hanging antenna wire is attached to the unit).

7. Press and release the “learn” or “smart” button. (The name and color of the button may vary by manufacturer.)

Note: There are 30 seconds in which to initiate step eight.

8. Return to the vehicle and firmly press, hold for two seconds and release the HomeLink® button. Repeat the press/hold/release sequence again, and, depending on the brand of the garage door opener (or other rolling code equipped device), repeat this sequence a third time to complete the programming.

HomeLink® should now activate your rolling code equipped device. To program additional HomeLink® buttons begin with step 2 in the “Programming” section. For questions or comments, please contact HomeLink at **www.homelink.com** or **1-800-355-3515**.

Controls and features

Gate Operator & Canadian Programming

During programming, your hand-held transmitter may automatically stop transmitting — not allowing enough time for HomeLink® to accept the signal from the hand-held transmitter.

After completing steps 1 and 2 outlined in the “Programming” section, replace step 3 with the following:

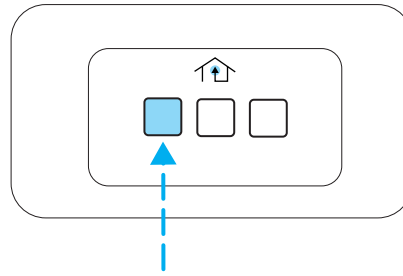

Note: If programming a garage door opener or gate operator, it is advised to unplug the device during the “cycling” process to prevent overheating.

- Continue to press and hold the HomeLink® button (note step 3 in the “Programming” section) while you press and release — **every two seconds** (“cycle”) your hand-held transmitter until the frequency signal has been accepted by the HomeLink®. The red indicator light will flash slowly and then rapidly after HomeLink® accepts the radio frequency signal.
- Proceed with step 4 in the “Programming” section.

Operating the HomeLink® Universal Transceiver

To operate, simply press and release the appropriate HomeLink® button. Activation will now occur for the trained product (garage door, gate operator, security system, entry door lock, or home or office lighting etc.). For convenience, the hand-held transmitter of the device may also be used at any time. In the event that there are still programming difficulties, contact Homelink® at www.homelink.com or **1-800-355-3515**.

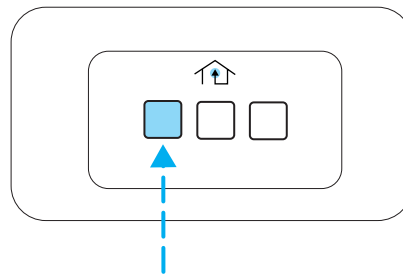

Controls and features

Erasing HomeLink® buttons

To erase the three programmed buttons (individual buttons cannot be erased):

- Press and hold the two outer HomeLink® buttons until the red indicator light begins to flash-after 20 seconds. Release both buttons. Do not hold for longer than 30 seconds.

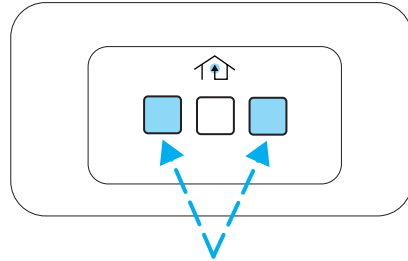

HomeLink® is now in the train (or learning) mode and can be programmed at any time beginning with step 2 in the “Programming” section.

Reprogramming a single HomeLink® button

To program a device to HomeLink® using a HomeLink® button previously trained, follow these steps:

1. Press and hold the desired HomeLink® button. **Do NOT** release the button.
2. The red indicator light will begin to flash after 20 seconds. Without releasing the HomeLink® button, follow step 2 in the “Programming” section.

For questions or comments, contact HomeLink® at www.homelink.com or **1-800-355-3515**.

AUTOMATIC DIMMING REAR VIEW MIRROR

The autolamp/automatic dimming mirror is equipped with an automatic dimming feature. This feature will change from the normal state to the non-glare “active” state when bright lights (glare) reach the mirror. When the mirror detects bright light from front or behind, it will adjust automatically to minimize glare.

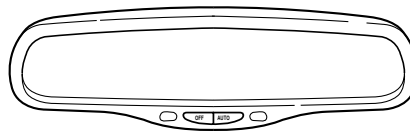

The mirror will automatically return to the normal position whenever the vehicle is placed in R (Reverse) (when the mirror is in the ON position). This helps to ensure a bright clear view in the mirror when backing up.

Controls and features

ILLUMINATED VISOR MIRROR (IF EQUIPPED)

To turn on the visor mirror lamps, lift the mirror cover.

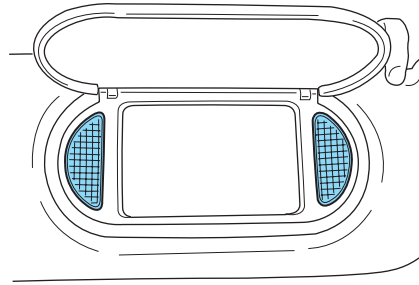

POWER WINDOWS

Press and hold the rocker switches to open and close windows.

- Press the top portion of the rocker switch to close.

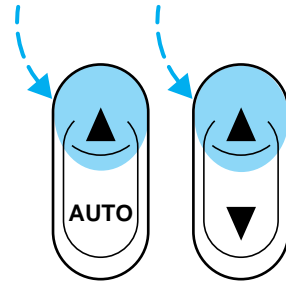

- Press the bottom portion of the rocker switch to open.

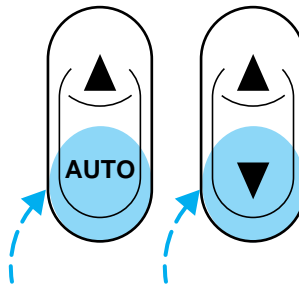

Controls and features

One touch down

- Press AUTO completely down and release quickly. The driver's window will open fully.

One touch down can be deactivated during operation by pushing down on the top part of the driver power window control.

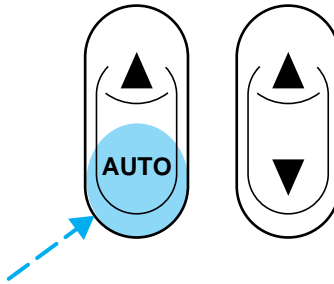

Window lock

The window lock feature allows only the driver to operate the power windows.

To lock out all the window controls except for the driver's press the left side of the control. Press the right side to restore the window controls.

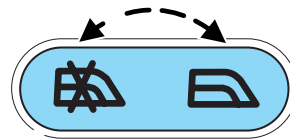

Accessory delay

With accessory delay, the window switches and audio system may be used for up to ten minutes after the ignition switch is turned to the OFF position or until any door is opened.

MANUAL DOOR LOCKS

The manual door lock knob is located above the inside door release handle for all four doors.

- Push the knob forward to lock the door.
- Pull back on the knob to unlock the door.

Controls and features

POWER DOOR LOCKS

Press control to unlock all doors.

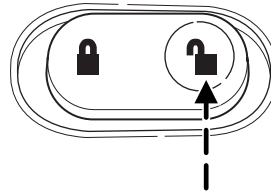

Press control to lock all doors.

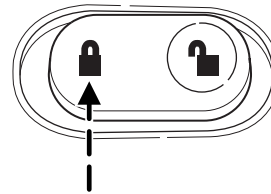

POWER DOOR LOCK/UNLOCK INHIBIT

If the interior trim switch does not operate, see the *Perimeter alarm system* in this section for more details.

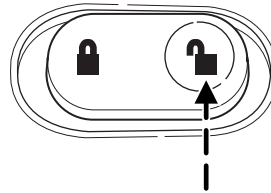

LIFTGATE

An additional power door lock can be accessed by opening the liftgate. The button is located either on the top of the left-hand quarter trim panel underneath the rear window, or on the bottom of the left-hand quarter trim panel. Press this button to lock or unlock all the doors.

Controls and features

CHILDPROOF DOOR LOCKS

When these locks are set, the rear doors cannot be opened from the inside. The rear doors can be opened from the outside when the doors are unlocked.

The childproof locks are located on rear edge of each rear door and must be set separately for each door. Setting the lock for one door will not automatically set the lock for both doors.

Move lock control up to engage the childproof lock. Move control down to disengage childproof locks.

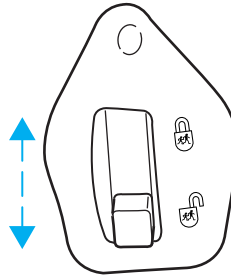

POWER SIDE VIEW MIRRORS

The ignition must be in the ACC or ON position to adjust the power side view mirrors.

To adjust your mirrors:

1. Rotate the control clockwise to adjust the right mirror and rotate the control counterclockwise to adjust the left mirror.

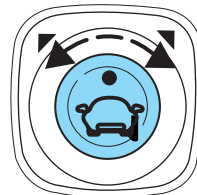

2. Move the control in the direction you wish to tilt the mirror.

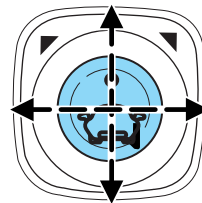

3. Return to the center position to lock mirrors in place.

Controls and features

Heated outside mirrors (if equipped)

Both mirrors are heated automatically to remove ice, mist and fog when the rear window defrost is activated.

Do not remove ice from the mirrors with a scraper or attempt to readjust the mirror glass if it is frozen in place.

These actions could cause damage to the glass and mirrors.

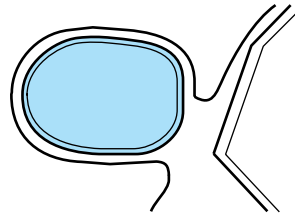

Fold-away mirrors

Pull the side mirrors in carefully when driving through a narrow space, like an automatic car wash.

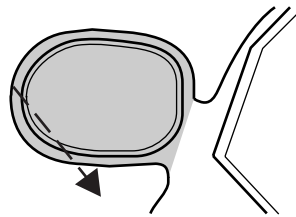

CENTER CONSOLE

Your vehicle may be equipped with a variety of console features. These include:

- Utility compartment with cassette/compact disc storage
- Auxiliary power point
- Cupholders
- Tissue box holder



Use only soft cups in the cupholder. Hard objects can injure you in a collision.

Controls and features

Auxiliary power point 12V

Power outlets are designed for accessory plugs only. Do not hang any type of accessory or accessory bracket from the plug. Improper use of the power outlet can cause damage not covered by your warranty.

The power point is an additional power source for electrical accessories.

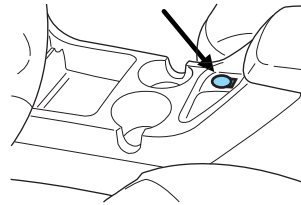

Rear auxiliary power point (if equipped)

A second auxiliary power point is located on the rear side of the console. It is accessible from the rear seats.

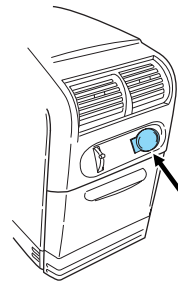

Rear console features

The rear console may incorporate the following features:

- air vents
- cupholders (will pull up with break away feature)
- rear power point

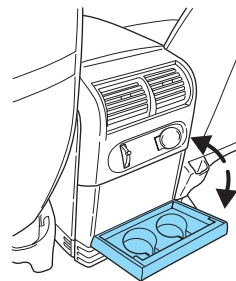

Controls and features

POSITIVE RETENTION FLOOR MAT

Position the driver floor mat so that the eyelet is over the pointed end of the retention post and rotate forward to lock in. Make sure that the mat does not interfere with the operation of the accelerator or the brake pedal. To remove the floor mat, reverse the installation procedure.

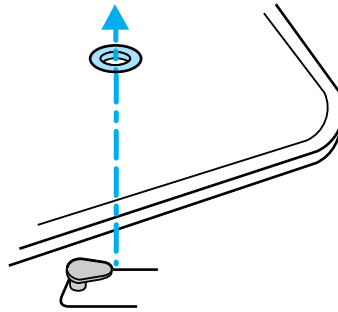

REAR LIFTGATE

The liftgate area is only intended for cargo, not passengers. You can open and close the liftgate from outside the vehicle. It cannot be opened from inside the cargo area.

- To open the liftgate window, press the control on the remote entry key fob or, with the liftgate unlocked, push the control button on the **right side** under the license plate lamp shield.
- To open the liftgate, unlock the liftgate (with the power door locks, the remote entry or the keyless entry pad) and pull the **middle** lever under the license plate lamp shield.

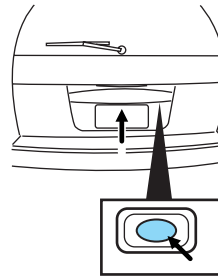

To lock the liftgate and the liftgate window, use the power door locks or press the door lock switch on the left side of the cargo area. To manually lock or unlock the liftgate, move the button located below the window down or up.

The liftgate door and window should be closed before driving. If not, possible damage may occur to your vehicle.

Always close liftgate window before opening liftgate. Liftgate glass and liftgate should never be open at the same time. Failure to observe this warning may result in personal injury or damage to your vehicle.

Controls and features

 Make sure the liftgate door and/or window are closed to prevent exhaust fumes from being drawn into the vehicle. This will also prevent passengers and cargo from falling out.

CARGO COVER (IF EQUIPPED)

Your vehicle may be equipped with a cargo area cover that covers the luggage compartment of your vehicle.

To install the cover:

Push both ends of the cover into the depressions (right side first) in the trim panels behind the second row seat.

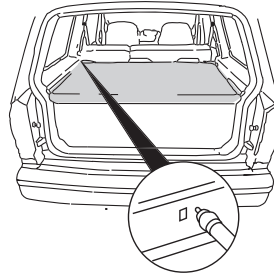

 To reduce the risk of injuries, the cargo area cover must be properly installed on the rear trim panels.

 Do not place any objects on the cargo area cover. They may obstruct your vision or strike occupants of the vehicle in the case of a sudden stop or collision.

 The cover may cause injury in a sudden stop or accident if it is not securely installed.

Cargo management system

The cargo management system consists of storage compartments located in the floor of the rear cargo area.

Controls and features

7 passenger stowage:

1. To open, lift the release handle and the lid.
2. To close, lower the lid, lift the release handle and press down on the lid.

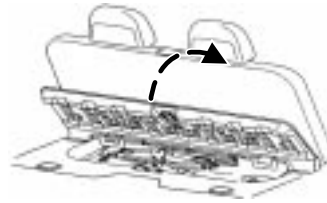

5 passenger stowage:

When the lid is open, it will stand up on its own. The lid can be detached from the vehicle and used as a knee pad (carpet side up) for changing a tire.

1. To open, lift the release handle and the lid.
2. To close, lower the lid, lift the release handle and press down on the lid.

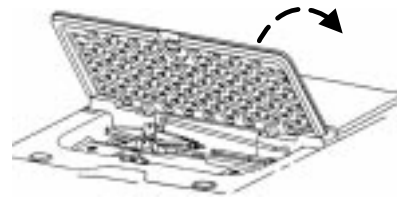

REMOTE ENTRY SYSTEM

This device complies with part 15 of the FCC rules and with RS-210 of Industry Canada. Operation is subject to the following two conditions: (1) This device may not cause harmful interference, and (2) This device must accept any interference received, including interference that may cause undesired operation.

Changes or modifications not expressly approved by the party responsible for compliance could void the user's authority to operate the equipment.

The remote entry system allows you to lock or unlock all vehicle doors and liftgate and open the liftgate window without a key.

The remote entry lock/unlock feature operates in any ignition position. The liftgate glass features operate as long as the vehicle's speed is less than 5 km/h (3 mph). The panic feature operates with the key in the OFF or ACC position.

If there is any potential remote keyless entry problem with your vehicle, ensure **ALL** remote entry transmitters are brought to the dealership, to aid in troubleshooting.

Controls and features

Unlocking the doors/liftgate

Press this control to unlock the driver's door. The interior lamps will illuminate with the ignition OFF.

Press the control a second time within three seconds to unlock all doors and liftgate.

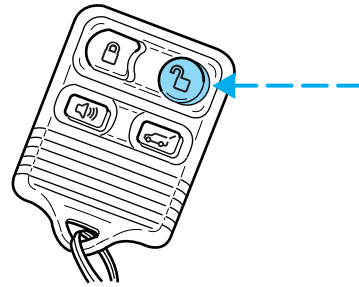

Locking the doors/liftgate

Press this control to lock all doors and liftgate. The doors and liftgate will lock and the lamps will flash once as long as all doors, liftgate, liftgate glass are closed (also includes hood on vehicles equipped with perimeter anti-theft). If any of these are ajar, the lamps will not flash.

To confirm all doors are closed and locked, press the control a second time within three seconds. The doors will lock again, the lamps will flash once and the horn will chirp.

If any of the doors or liftgate are ajar, the horn will make two quick chirps, reminding you to properly close all doors.

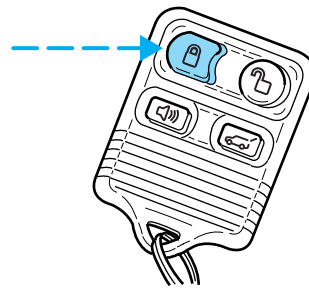

Controls and features

Opening the liftgate window

Press the control to unlatch the liftgate window.

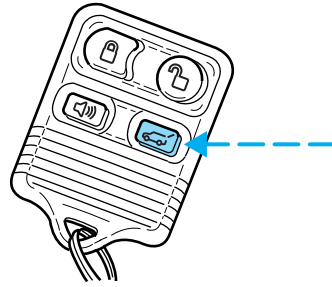

Sounding a panic alarm

Press this control to activate the alarm.

The personal panic alarm will cycle the horn and turn signals on/off, plus illuminate the interior lights.

To deactivate the alarm, press the control again or turn the ignition to ACC or ON.

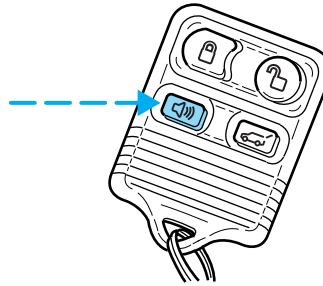

Memory seat feature (if equipped)

The remote entry system can also control the memory seat feature.

Press the control once to unlock the driver's door. Pressing the control will automatically move the seat to the desired memory position (the seat position corresponds to the transmitter being used).

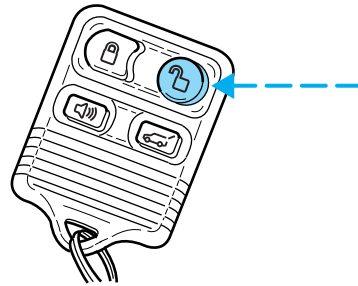

Controls and features

Activating the memory seat feature

To activate this feature:

1. Position the seat to the position you desire.
2. Press the SET control on the driver's door panel.
3. Within 5 five seconds, press one control on the remote transmitter and then press the 1 or 2 control on the driver's door panel to which you would like to associate with the seat and Driver 1 or Driver 2 positions.
4. Repeat this procedure for another remote transmitter if desired.

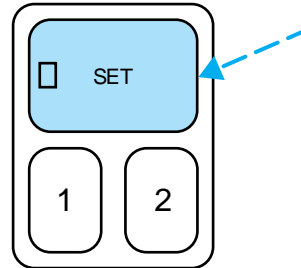

Deactivating the memory seat feature

To deactivate this feature:

1. Press the SET control on the driver's door panel.
2. Within 5 five seconds, press any control on the remote transmitter which you would like to deactivate and then press the SET control on the driver's door panel.
3. Repeat this procedure for another remote transmitter if desired.

Replacing the battery

The remote transmitter is powered by one coin type three-volt lithium battery CR2032 or equivalent. Typical operating range will allow you to be up to 10 meters (33 feet) away from your vehicle. A decrease in operating range can be caused by the following factors:

- Weather conditions
- Nearby radio towers
- Structures around the vehicle
- Other vehicles parked next to the vehicle

Controls and features

To replace the battery:

1. Twist a thin coin between the two halves of the transmitter near the key ring. **DO NOT TAKE THE FRONT PART OF THE TRANSMITTER APART.**

2. Place the positive (+) side of new battery in the same orientation. Refer to the diagram inside the transmitter unit.

3. Snap the two halves back together.

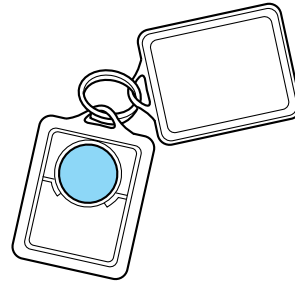

Replacement of the battery will **not** cause the remote transmitter to become deprogrammed from your vehicle. The remote transmitter should operate normally after battery replacement.

Replacing lost transmitters

If a remote transmitter has been lost and you would like to remove it from the vehicle's memory, or you would like to purchase additional remote transmitters and have them programmed to your vehicle:

- Take **all** your vehicle's transmitters to your dealer for programming, or
- Perform the programming procedure yourself.

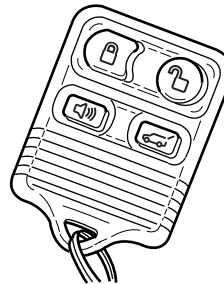

Programming remote transmitters

It is necessary to have **all** (maximum of four — original and/or new) of your remote transmitters available prior to beginning this procedure.

Controls and features

To program the transmitters yourself:

- Insert a key in the ignition and turn from 1 (LOCK) to 3 (ON) and cycle between 1 (LOCK) and 3 (ON) eight times in rapid succession (within 10 seconds) with the eighth turn ending in the 3 (ON) position. The doors will lock/unlock to confirm that programming mode has been entered.
- Within 20 seconds, program a remote transmitter by pressing any button on a transmitter. The doors will lock/unlock to confirm that the remote transmitter has been programmed. (If more than 20 seconds pass before pressing a remote transmitter button, the programming mode will exit and the procedure will have to be repeated.)
- Repeat the previous step to program additional remote transmitters. The doors will lock/unlock to confirm that each remote transmitter has been programmed.
- When you have completed programming the remote transmitters, turn the ignition to 1 (LOCK) or wait 20 seconds. Again the doors will lock/unlock to confirm programming has been completed.

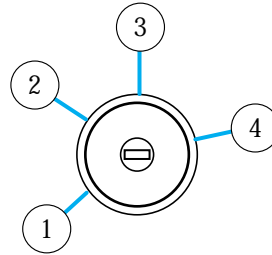

Illuminated entry

The interior lamps illuminate when the remote entry system is used to unlock the door(s).

The system automatically turns off after 25 seconds or when the ignition is turned to the ON or ACC position. The dome lamp control (if equipped) must **not** be set to the OFF position for the illuminated entry system to operate.

The inside lights will not turn off if:

- they have been turned on with the dimmer control, or
- any door is open.

The battery saver will shut off the interior lamps 10 minutes after the ignition has been turned to the OFF position.

Controls and features

KEYLESS ENTRY SYSTEM (IF EQUIPPED)

With the keyless entry keypad, you can:

- lock or unlock the vehicle doors and liftgate without using the key.
- open the liftgate window.
- disable/enable autolock.
- arm and disarm the perimeter alarm system (if equipped).

See also *Remote entry system* and *Perimeter alarm system* in this chapter for more information.

Your vehicle has a factory-set 5-digit code that operates the keyless entry system. You can also program your own 5-digit personal entry code.

The factory-set code is located:

- On the owner's wallet card in the glove compartment,
- Taped to the computer module, or
- At your dealer.

When using the keyless entry keypad, press the middle of each button in order to ensure a good activation.

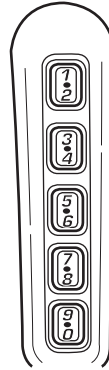

Controls and features

Programming your own personal entry code

1. Enter the factory-set code (keypad will illuminate when pressed).
2. Press the 1/2 control within five seconds of step 1.
3. Enter your personal 5 digit code. Enter each digit within five seconds of the previous one.

Do not set a code that includes three of the same number or presents them in sequential order; these types of codes are easier to figure out.

Your personal code does not replace the permanent code that the dealership gave you. You can use either code to unlock your vehicle.

If a second personal code is entered, the module will erase the first personal code in favor of the new code.

To exit, press 7/8 and 9/0 simultaneously or allow more than 5 seconds to elapse since a button press occurred and the 5 digit keycode will be programmed.

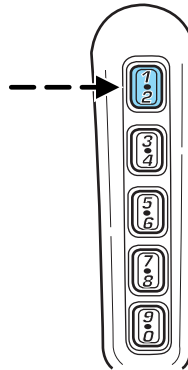

Controls and features

If you wish to erase your personal code, use the following instructions:

Erasing personal code

1. Enter the factory-set code.
2. Press 1/2 within five seconds of step 1 and release.
3. Press the 1/2 control and hold for 2 seconds to erase the customer programmed keycode, within five seconds of step 2.

The system will now only respond to the factory-set code.

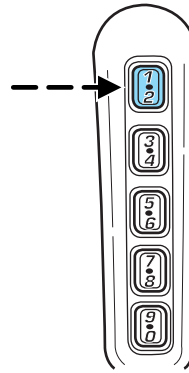

Anti-scan feature

The anti-scan feature prevents repeated attempts at arriving at a valid key code.

The system will ignore keypad presses for one minute if the user has pressed it 35 consecutive times without entering a valid code. This feature is to prevent unauthorized entry.

During the anti-scan operation the keypad lamp will flash.

Anti-scan will be turned off after:

- one minute of keypad inactivity
- the remote entry transmitter UNLOCK button is pressed.
- the ignition is turned to the ON position
- a key turned to the UNLOCK position on the driver's door (if the vehicle is equipped with Perimeter Anti-Theft)

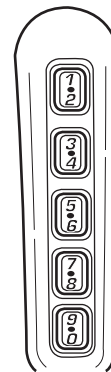

Controls and features

Unlocking the doors and liftgate or the liftgate window with the keyless entry system

The driver's door must be unlocked before any other. If more than five seconds pass between pressing numbers, enter the code again. The system has shut down if the keypad light is out. If the keyless entry system does not work, use the key or remote entry transmitter(s).

1. To unlock the driver's door, enter one of the two codes. After pressing the fifth number, the driver's door unlocks.
2. To unlock all the other door(s) and liftgate, press the 3/4 control within five seconds of unlocking the driver's door.

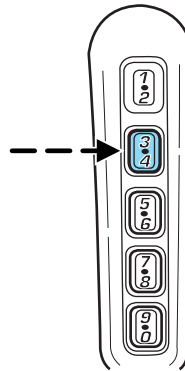

3. To open the liftgate window, enter the five-digit factory-set code, then press the 5/6 control within five seconds.

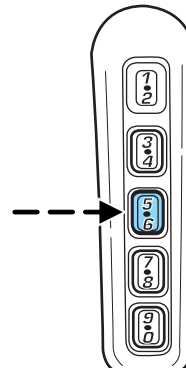

Controls and features

Locking the doors and liftgate, press the 7/8 and 9/0 controls at the same time. This can be done only when the driver's door is closed.

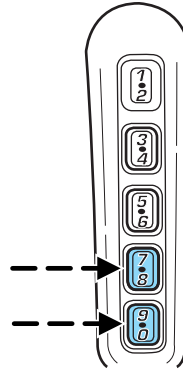

Autolock

The autolock feature will lock all of the vehicle doors when:

- all doors are closed
- the engine is running and
- you shift into any gear putting the vehicle in motion

The autolock feature repeats when:

- any door, liftgate or liftgate window is opened then closed while the engine is running, the brake pedal is released, and
- you put the vehicle in motion

Deactivating/activating autolock

There are 3 methods to enable/disable this feature. One through your dealer, the second with a power door unlock/lock sequence and the third with the keypad.

Before following the activation or deactivation procedures, make sure that the anti-theft system is not armed, ignition is off, and all vehicle doors, liftgate and liftgate window are closed.

Controls and features

Power door unlock/lock procedure

You must complete steps 1-5 within 30 seconds or the procedure will have to be repeated. If the procedure needs to be repeated, you must wait 30 seconds.

1. Turn the ignition key to ON.
2. Press the power door unlock control three times.
3. Turn the ignition key from ON to OFF.
4. Press the power door unlock control three times.
5. Turn the ignition back to ON. The horn will chirp.
6. Press the unlock control, then press the lock control. The horn will chirp once if autolock was deactivated or twice (one short and one long chirp) if autolock was activated.
7. Turn the ignition to OFF. The horn will chirp once to confirm the procedure is complete.

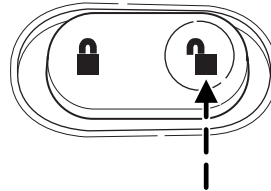

Keyless entry key pad procedure

1. Enter 5 digit entry code
2. Press and hold 7/8 control
3. Press and release 3/4 control
4. Release 7/8 control.

The user should receive a **horn chirp** to indicate the system has been disabled or a chirp followed by a honk to indicate the system has been enabled.

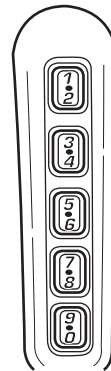

Smart unlock

This feature prevents the driver's door from locking while the key is in the ignition. This feature will unlock only the driver's door if the key is in the ignition cylinder, the driver's door is ajar and all doors are locked using the interior trim switch. If these conditions are met, the entire vehicle will lock and the driver's door will unlock within 1 second.

Controls and features

PERIMETER ALARM SYSTEM

The perimeter anti-theft system will help prevent your vehicle from unauthorized entry.

If there is any potential perimeter anti-theft problem with your vehicle, ensure **ALL remote entry transmitters** are brought to the dealership, to aid in troubleshooting.

PERIMETER ALARM SYSTEM (IF EQUIPPED)

The perimeter anti-theft system will help prevent your vehicle from unauthorized entry.

If there is any potential perimeter anti-theft problem with your vehicle, ensure **ALL remote entry transmitters** are brought to the dealership, to aid in troubleshooting.

Power door lock disable feature

This feature will help protect your vehicle from unauthorized entry.

This feature disables the power door locks and liftgate power door lock control if all doors are closed and the perimeter alarm becomes armed.

Once the locks are disabled, they only become active when the perimeter alarm is disarmed or a door, liftgate, liftgate window or hood is open.

Deactivating/activating power door lock disable feature

1. Verify that the alarm is not armed, the ignition is in the OFF position and all doors and windows are closed.
2. Turn the ignition key to ON, then press the UNLOCK button 3 times.
3. Turn the ignition key to OFF, then press the UNLOCK button 3 times.
4. Turn the ignition key to RUN; the horn will chirp once to confirm programming mode is entered.
5. Press the UNLOCK button and then the LOCK button. The horn will chirp once to verify that the autolock feature has been disabled, or chirp twice to indicate the system has been enabled.
6. Turn ignition to OFF to exit programming. A horn chirp will follow if the state has been changed.

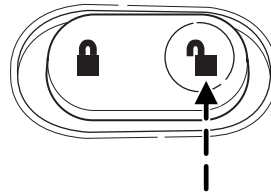

Controls and features

Arming the system

When armed, this system will help protect your vehicle from unauthorized entry. When unauthorized entry occurs, the system will flash the headlamps and/or parking lamps, and will chirp the horn.

The system is ready to arm whenever the key is removed from the ignition. Any of the following actions will prearm the alarm system:

- Open any door, liftgate or liftgate window and press the power door lock control to lock the doors.
- Press the remote entry lock control (doors opened or closed).

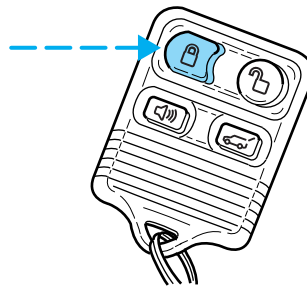

When you press the lock control twice within three seconds on your remote entry transmitter, the horn will chirp once to let you know that all doors/hood/liftgate and liftgate window are closed. If any of these are not closed, the horn will chirp twice to warn you that a door/hood/liftgate or liftgate window is still open.

- Press 7/8 and 9/0 controls on the keyless entry pad at the same time to lock the doors (driver's door must be closed).

There is a 20 second countdown when any of the above actions occur before the vehicle becomes ARMED.

Each door/hood/liftgate or liftgate window is armed individually, and if any are open, they must be closed for the system to enter the 20 second countdown.

The parking lamps will flash once when all doors/hood/liftgate and liftgate window are closed indicating the vehicle is locked and entering the 20 second countdown.

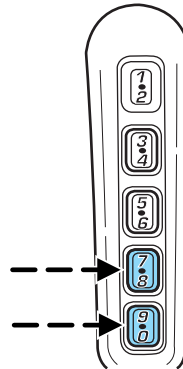

Controls and features

Disarming the system

You can disarm the system by any of the following actions:

- Unlock the doors by using your remote entry transmitter.

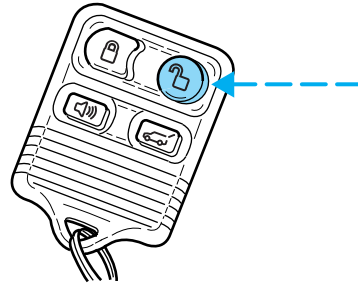

- Unlock the doors by using your keyless entry pad.

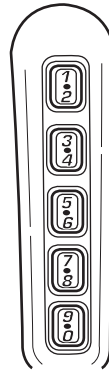

- Unlock the driver's door with a key. Turn the key full travel (toward the front of the vehicle) to make sure the alarm disarms.
- Turn ignition to ON.

Controls and features

- Press the PANIC control on the remote entry transmitter. This will only shut off the horn and parking lamps when the alarm is sounding. The alarm system will still be armed.

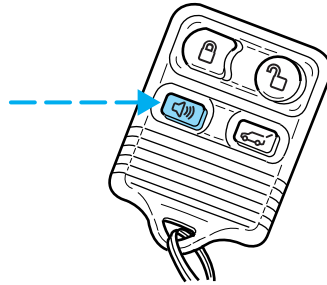

- Press the liftgate window control on the remote entry transmitter. The liftgate and liftgate window are no longer armed, but the doors and hood are still armed. To disarm the doors and hood, press the liftgate power door lock control.

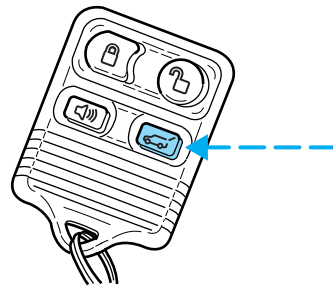

Pressing the power door UNLOCK trim switch within the 20 second prearmed mode will return the vehicle to a disarmed state.

Triggering the anti-theft system

The armed system will be triggered if:

- Any door, liftgate, liftgate window or hood is opened without using the door key, keypad or the remote entry transmitter.

SECURILOCK™ PASSIVE ANTI-THEFT SYSTEM

SecuriLock™ passive anti-theft system is an engine immobilization system. This system is designed to prevent the engine from being started unless a **coded key programmed to your vehicle** is used.

The SecuriLock™ passive anti-theft system is not compatible with non-Ford aftermarket remote start systems. Use of these systems may result in vehicle starting problems and a loss of security protection.

THEFT INDICATOR

The theft indicator is the flashing red indicator located on top of the instrument panel.

Controls and features

- When the ignition is in the OFF position, the indicator will flash once every 2 seconds to indicate the SecuriLock[™] system is functioning as a theft deterrent.
- When the ignition is in the ON position, the indicator will glow for 3 seconds to indicate normal system functionality.

If a problem occurs with the SecuriLock[™] system, the indicator will flash rapidly or glow steadily when the ignition is in the ON position. If this occurs, the vehicle should be taken to an authorized dealer for service.

Automatic arming

The vehicle is armed approximately 15 seconds after switching the ignition to the 2 (ACC) position. The THEFT indicator on top of the instrument panel will flash every two seconds when the vehicle is armed.

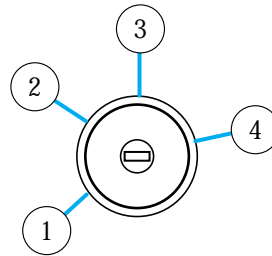

Automatic disarming

Switching the ignition to the 3 (ON) position with a **coded key** disarms the vehicle. The theft indicator will illuminate for three seconds and then go out. If the theft indicator stays on for an extended period of time or flashes rapidly, have the system serviced by your dealership or a qualified technician.

Key information

Your vehicle is supplied with **two coded keys**. Only a **coded key** will start your vehicle. Spare coded keys can be purchased from your dealership. Your dealership can program your key or you can “do it yourself.” Refer to *Programming spare keys*.

The following items may prevent the vehicle from starting:

- Large metallic objects
- Electronic devices on the key chain that can be used to purchase gasoline or similar items
- A second key on the same key ring as the **coded key**

Controls and features

If any of these items are present, you need to keep these objects from touching the **coded key** while starting the engine. These objects and devices cannot damage the **coded key**, but can cause a momentary “no start” condition if they are too close to the key during engine start. If a problem occurs, turn ignition OFF and restart the engine with all other objects on the key ring held away from the ignition key. Check to make sure the **coded key** is an approved Ford **coded key**.

If your keys are lost or stolen you will need to do the following:

- Use your spare key to start the vehicle, or
- Have your vehicle towed to a dealership or a locksmith. The key codes will need to be erased from your vehicle and new key codes will need to be re-coded.

Replacing coded keys can be very costly and you may want to store an extra programmed key away from the vehicle in a safe place to prevent an unforeseen inconvenience.

The correct **coded key** must be used for your vehicle. The use of the wrong type of **coded key** may lead to a “no start” condition.

If an unprogrammed key is used in the ignition it will cause a “no start” condition.

Programming spare keys

A maximum of eight keys can be coded to your vehicle. Only SecuriLock[™] keys can be used. To program a **coded key** yourself, you will need two previously programmed **coded keys** (keys that already operate your vehicle’s engine) and the new unprogrammed key(s) readily accessible for timely implementation of each step in the procedure.

If two previously programmed coded keys are not available, you must bring your vehicle to your dealership to have the spare coded key(s) programmed.

Please read and understand the entire procedure before you begin.

Controls and features

1. Insert the first previously programmed **coded key** into the ignition and turn the ignition from 2 (ACC) to 3 (ON) (maintain ignition in 3 (ON) for at least one second).

2. Turn ignition to 1 (LOCK) and remove the first **coded key** from the ignition.

3. Within ten seconds of turning the ignition to 2 (ACC), insert the second previously programmed **coded key** into the ignition and turn the ignition from 2 (ACC) to 3 (ON) (maintain ignition in 3 (ON) for at least one second but no more than ten seconds).

4. Turn the ignition to 1 (LOCK) and remove the second **coded key** from the ignition.

5. Within 20 seconds of turning the ignition to 2 (ACC), insert the new unprogrammed key (new key/valet key) into the ignition and turn the ignition from 2 (ACC) to 3 (ON) (maintain ignition in 3 (ON) for at least one second). This step will program your new key to a coded key.

6. To program additional new unprogrammed key(s), repeat this procedure from step 1.

If successful, the new coded key(s) will start the vehicle's engine and the theft indicator will illuminate for three seconds and then go out.

If not successful, the new coded key(s) will not start the vehicle's engine and the theft indicator will flash on and off and you may repeat steps 1 through 6. If failure repeats, bring your vehicle to your dealership to have the new spare key(s) programmed.

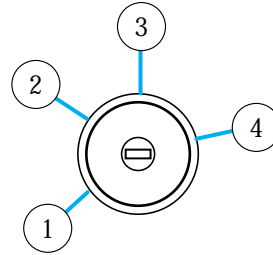

Seating and safety restraints

SEATING

Front seat Adjustable head restraints (if equipped)

Your vehicle's front seats are equipped with head restraints which are vertically adjustable. The purpose of these head restraints is to help limit head motion in the event of a rear collision. To properly adjust your head restraints, lift the head restraint so that it is located directly behind your head or as close to that position as possible. Refer to the following to raise and lower the head restraints.

The head restraints can be moved up and down.

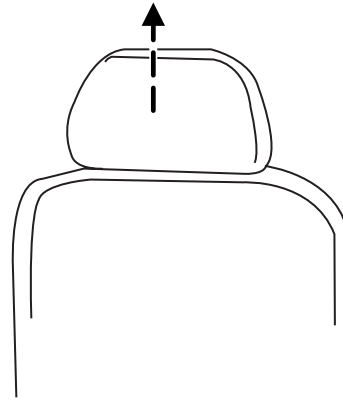

Push control to lower head restraint.

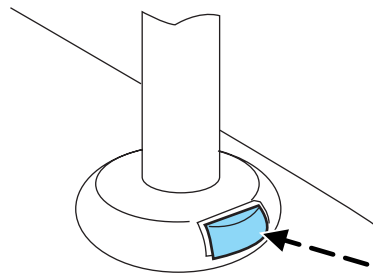



Adjusting the front manual seat



Never adjust the driver's seat or seatback when the vehicle is moving.

Seating and safety restraints

 Do not pile cargo higher than the seatbacks to reduce the risk of injuring people in a collision or sudden stop.

 Always drive and ride with your seatback upright and the lap belt snug and low across the hips.

 Reclining the seatback can cause an occupant to slide under the seat's safety belt, resulting in severe personal injuries in the event of a collision.

Lift handle to move seat forward or backward.

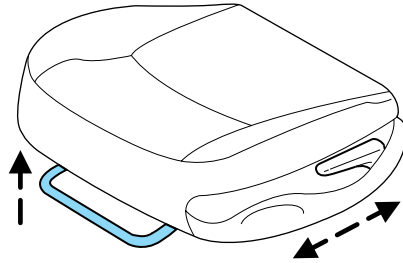

Pull lever up to adjust seatback.

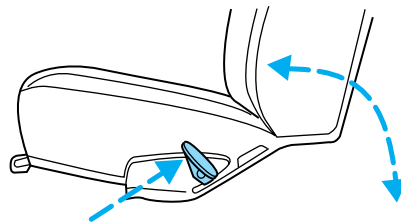



Adjusting the front power seat (if equipped)

 Never adjust the driver's seat or seatback when the vehicle is moving.

 Do not pile cargo higher than the seatbacks to avoid injuring people in a collision or sudden stop.

Seating and safety restraints

 Always drive and ride with your seatback upright and the lap belt snug and low across the hips.

 Reclining the seatback can cause an occupant to slide under the seat's safety belt, resulting in severe personal injuries in the event of a collision.

The control is located on the outboard side of the seat cushion.

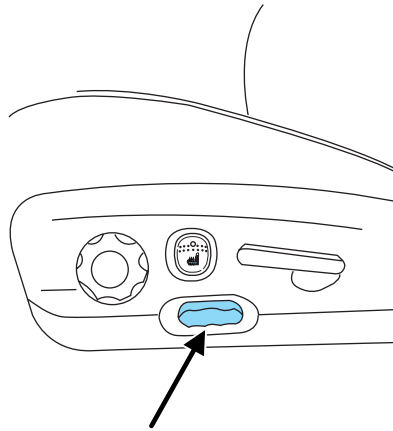

Press front to raise or lower the front portion of the seat cushion.

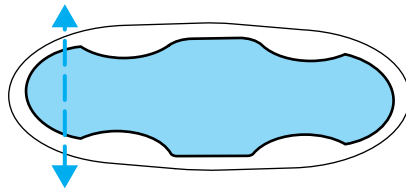

Press rear to raise or lower the rear portion of the seat cushion.

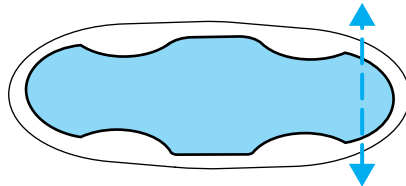

Seating and safety restraints

Press the control to move the seat forward, backward, up or down.

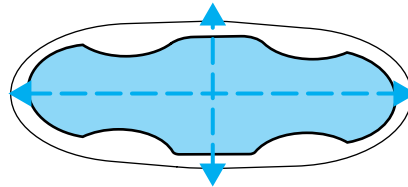

Memory seat/easy entry/exit feature (if equipped)

This system allows automatic positioning of the driver seat to three programmable positions.

The memory seat control is located on the driver door.

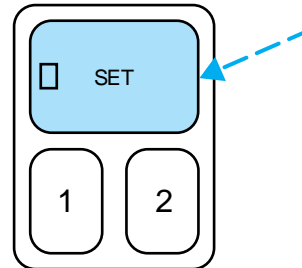

- To program position one, move the driver seat to the desired position using the seat controls. Press the SET control. The SET control indicator light will briefly illuminate. While the light is illuminated, press control 1.
- To program position two, repeat the previous procedure using control 2.
- To program position three, repeat the previous procedure but press controls 1 and 2 simultaneously.

A position can only be set or recalled when the transmission gearshift is in Park or Neutral. A memory seat position may be programmed at any time.

The memory seat positions are also recalled when you press your remote entry transmitter UNLOCK control.

To program the memory seat to remote entry transmitter, refer to *Remote entry system* in the *Controls and features* chapter.

The easy entry/exit feature automatically moves the drivers seat backwards slightly (if room is available) when the key is removed from the ignition. It will automatically move the seat forward to the original position when the key is inserted into the ignition.

Seating and safety restraints

Using the manual lumbar support

Turn the lumbar support control toward the front of vehicle to move the lumbar support forward for more direct support.

Turn the lumbar support control toward the rear of vehicle to move the lumbar support back for less direct support.

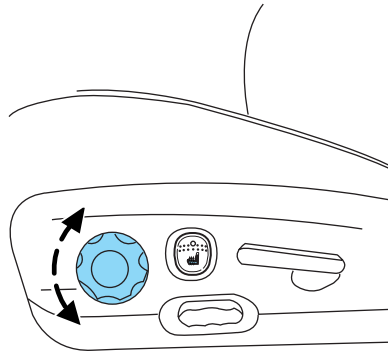

Heated seats (if equipped)

To operate the heated seats:

- Push control located on the seat to activate.
- Push again to deactivate.

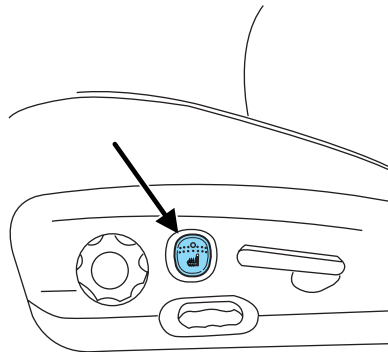

The heated seat icon in the dual electronic automatic temperature control (DEATC) will illuminate when activated.

Seating and safety restraints

REAR SEATS

Adjustable head restraints

Your vehicle's rear seats may be equipped with head restraints which are vertically adjustable. The purpose of these head restraints is to help limit head motion in the event of a rear collision. To properly adjust your head restraints, lift the head restraint so that it is located directly behind your head or as close to that position as possible. Refer to the following to raise and lower the head restraints.

Push or pull the head rests to the desired position.

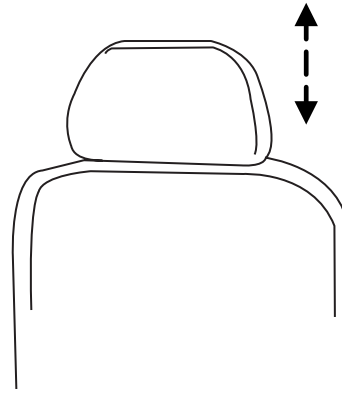

Folding down the 60/40 rear seats (if equipped)

If the rear seat is equipped with adjustable head restraints, they should be placed in the full down position before folding the seat back down.

Seating and safety restraints

1. Press the lower release control downward to unlatch the seatback.
2. Rotate the seatback downward into the load floor position.
3. Press down on the top outboard area of the seatback until a click is heard. The seat is now latched in the floor position.

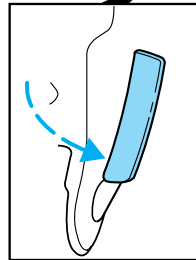
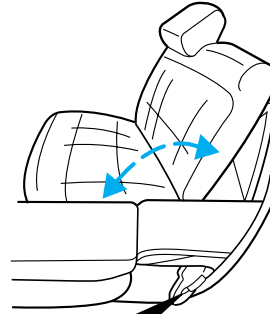

To return the seat to the upright position:

- Press downward on the upper corner of the seatback and hold.
- Pull the release handle upward to unlatch the seat.
- Rotate the seatback upward until the seatback latches in the upright position. The seatback will click when it is locked into position.

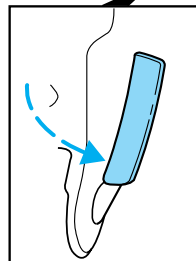
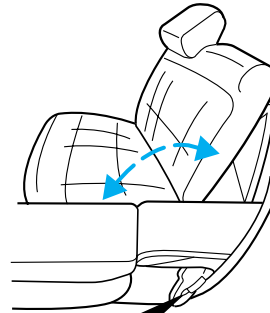

Seating and safety restraints

To return the seat to the upright position:

- Press downward on the upper corner of the seatback and hold.
- Pull the release handle upward to unlatch the seat.
- Rotate the seatback upward until the seatback latches in the upright position. The seatback will click when it is locked into position.

Folding down the 40/20/40 rear seats

Ensure that the headrest is in the down position and no objects such as books, purses or briefcases are on the floor in front of the second row seats before folding them down.

Move front passenger seat forward so that the second row seat headrest clears the front seat.

For assistance, refer to the label located on the lower position of the opening.

1. Locate handle on the side of the seat cushion by the door.
2. Pull the handle down and push the seatback toward the front of the vehicle.
3. Press down on the top outboard area of the seatback until a click is heard.

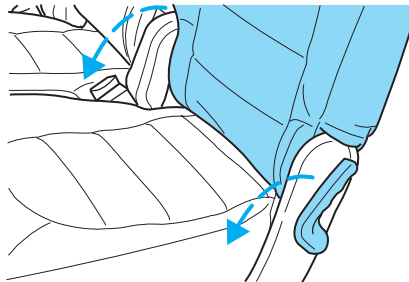

Seating and safety restraints

To return the seat to the upright position:

1. Pull the handle down and lift the seatback toward the rear of the vehicle.
2. Rotate the seatback until you hear a click, locking it in the upright position.

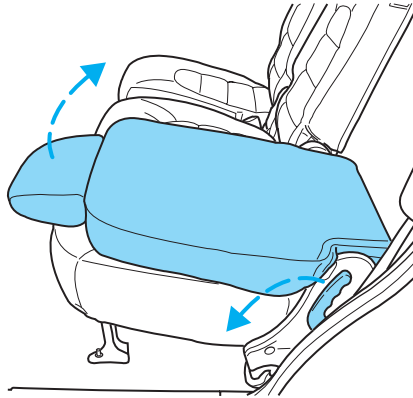

Adjusting the 2nd row seat for E-Z Entry (if equipped)

The E-Z Entry seat allows for easier entry and exit to and from the 3rd row seat.

To enter the 3rd row seat:

1. Fold down the 2nd row seat.
2. Pull the handle all the way down until the seat releases from the floor and folds away.

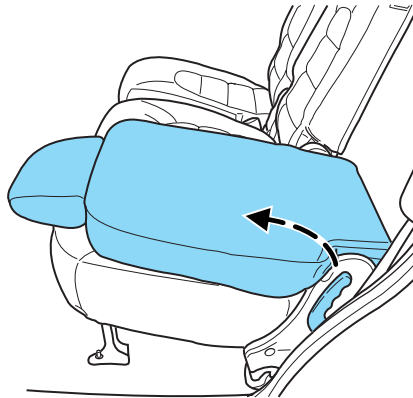

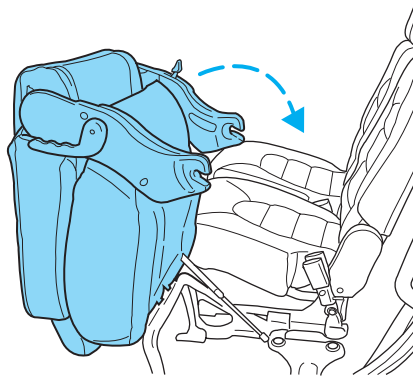

Seating and safety restraints

3. To return the seat to a seating position, flip the seat into the upright position.
4. Make sure the seat is latched to the floor.

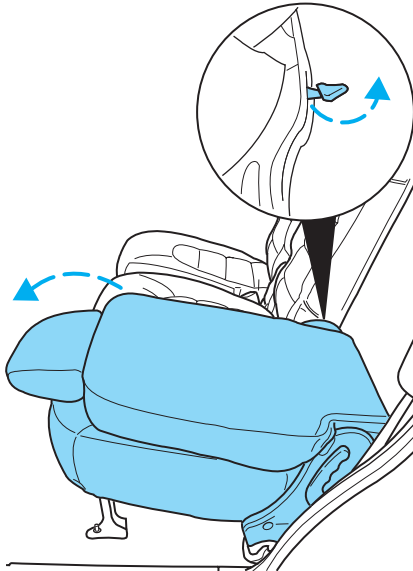

To exit the 3rd row seat, pull the red access control lever up releasing the seat from the floor and rotate the seat up towards the front seat.



 Always latch the vehicle seat to the floor, whether the seat is occupied or empty. If not latched, the seat may cause injury during a sudden stop.

Seating and safety restraints

Folding the middle 2nd row seat (If equipped)

1. Locate the lever on the side of the seatback.
2. Pull the lever up and push the seatback toward the front of the vehicle.
3. Press down on the top outboard area of the seatback until a click is heard.

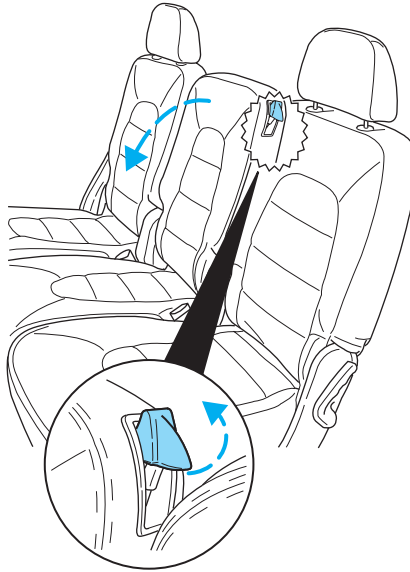

To return the seatback to the upright position:

1. Pull the lever and lift the seatback toward the rear of the vehicle.
2. Rotate the seatback until you hear a click, locking it in the upright position.

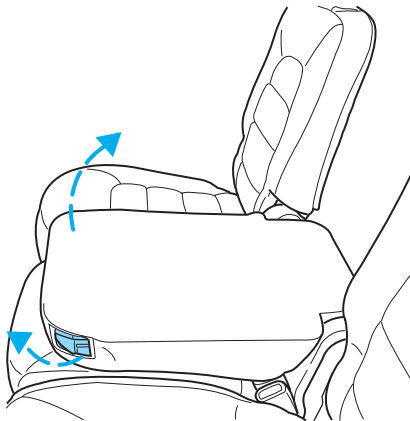

Seating and safety restraints

Third row seat (if equipped)

3rd row stow feature

The 3rd row seat has a tip/stow feature to increase cargo space without removing the seat from the vehicle.

To put seat in stowed position:

1. Pull the seat release lever located on top of the seatback while pushing the seatback down onto the seat cushion.
2. The seatback will latch into place.

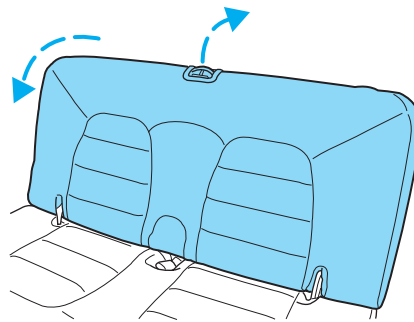

3. Push the closeout panel forward over the space between the seats.

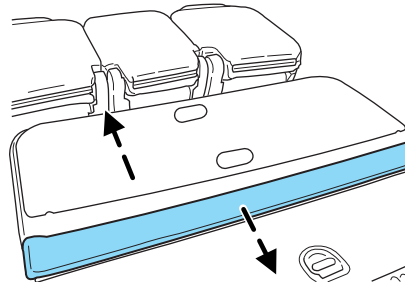

To put seat in upright position:

1. Pull back the slider panel on the seatback to release the closeout panel.

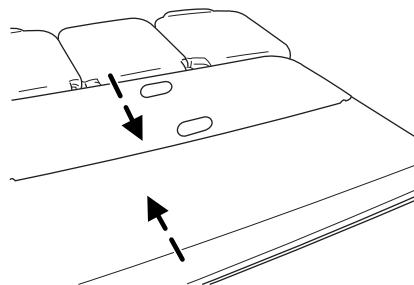

Seating and safety restraints

2. Pull the seat release lever located on top of the seatback while lifting the seatback into the upright position.
3. The seatback will latch into place.

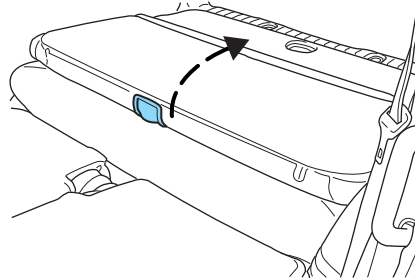

The third row seat is equipped with combination lap and shoulder belts in both seating positions. For information on the proper operation of the safety restraints, refer to *Safety Restraints* in this chapter.

SAFETY RESTRAINTS

Personal Safety System

The Personal Safety System provides an improved overall level of frontal crash protection to front seat occupants and is designed to help further reduce the risk of air bag-related injuries. The system is able to analyze different occupant conditions and crash severity before activating the appropriate safety devices to help better protect a range of occupants in a variety of frontal crash situations.

Your vehicle's Personal Safety System consists of:

- Driver and passenger dual-stage air bag supplemental restraints.
- Front safety belts with pretensioners, energy management retractors, and safety belt usage sensors.
- Driver's seat position sensor.
- Front crash severity sensor.
- Restraints Control Module (RCM) with impact and safing sensors.
- Restraint system warning light and back-up tone.
- The electrical wiring for the air bags, crash sensor(s), safety belt pretensioners, front safety belt usage sensors, driver seat position sensor, and indicator lights.

How does the personal safety system work?

The Personal Safety System can adapt the deployment strategy of your vehicle's safety devices according to crash severity and occupant conditions. A collection of crash and occupant sensors provides

Seating and safety restraints

information to the Restraints Control Module (RCM). During a crash, the RCM activates the safety belt pretensioners and/or either one or both stages of the dual-stage air bag supplemental restraints based on crash severity and occupant conditions.

The fact that the pretensioners or air bags did not activate for both front seat occupants in a collision does not mean that something is wrong with the system. Rather, it means the Personal Safety System determined the accident conditions (crash severity, belt usage, etc.) were not appropriate to activate these safety devices. Front air bags are designed to activate only in frontal and near-frontal collisions, not rollovers, side-impacts, or rear-impacts unless the collision causes sufficient longitudinal deceleration.

Driver and passenger dual-stage air bag supplemental restraints

The dual-stage air bags offer the capability to tailor the level of air bag inflation energy. A lower, less forceful energy level is provided for more common, moderate-severity impacts. A higher energy level is used for the most severe impacts. Refer to *Air bag Supplemental Restraints* section in this chapter.

Front crash severity sensor

The front crash severity sensor enhances the ability to detect the severity of an impact. Positioned up front, it provides valuable information early in the crash event on the severity of the impact. This allows your Personal Safety System to distinguish between different levels of crash severity and modify the deployment strategy of the dual-stage air bags and safety belt pretensioners.

Driver's seat position sensor

The driver's seat position sensor allows your Personal Safety System to tailor the deployment level of the driver dual-stage air bag based on seat position. The system is designed to help protect smaller drivers sitting close to the driver air bag by providing a lower air bag output level.

Front safety belt usage sensors

The front safety belt usage sensors detect whether or not the driver and front outboard passenger safety belts are fastened. This information allows your Personal Safety System to tailor the air bag deployment and safety belt pretensioner activation depending upon safety belt usage. Refer to *Safety Belt* section in this chapter.

Seating and safety restraints

Front safety belt pretensioners

The safety belt pretensioners are designed to tighten the safety belts firmly against the occupant's body during a collision. This maximizes the effectiveness of the safety belts and helps properly position the occupant relative to the air bag to improve protection. The safety belt pretensioners can be either activated alone or, if the collision is of sufficient severity, together with the air bags.

Front safety belt energy management retractors

The front safety belt energy management retractors allow webbing to be pulled out of the retractor in a gradual and controlled manner in response to the occupant's forward momentum. This helps reduce the risk of force-related injuries to the occupant's chest by limiting the load on the occupant. Refer to *Safety Belt* section in this chapter.

Determining if the Personal Safety System is operational

The Personal Safety System uses a warning light in the instrument cluster or a back-up tone to indicate the condition of the system. Refer to the *Warning Light* section in the *Instrument Cluster* chapter. Routine maintenance of the Personal Safety System is not required.

The Restraints Control Module (RCM) monitors its own internal circuits and the circuits for the air bag supplemental restraints, crash sensor(s), safety belt pretensioners, front safety belt buckle sensors, and the driver seat position sensor. In addition, the RCM also monitors the restraints warning light in the instrument cluster. A difficulty with the system is indicated by one or more of the following:

- The warning light will either flash or stay lit.
- The warning light will not illuminate immediately after the ignition is turned on.
- A series of five beeps will be heard. The tone pattern will repeat periodically until the problem and warning light are repaired.

If any of these things happen, even intermittently, have the Personal Safety System serviced at your dealership or by a qualified technician immediately. Unless serviced, the system may not function properly in the event of a collision.

Safety restraints precautions



Always drive and ride with your seatback upright and the lap belt snug and low across the hips.

Seating and safety restraints



To reduce the risk of injury, make sure children sit where they can be properly restrained.



Never let a passenger hold a child on his or her lap while the vehicle is moving. The passenger cannot protect the child from injury in a collision.



All occupants of the vehicle, including the driver, should always properly wear their safety belts, even when an air bag (SRS) is provided.



It is extremely dangerous to ride in a cargo area, inside or outside of a vehicle. In a collision, people riding in these areas are more likely to be seriously injured or killed. Do not allow people to ride in any area of your vehicle that is not equipped with seats and safety belts. Be sure everyone in your vehicle is in a seat and using a safety belt properly.



In a rollover crash, an unbelted person is significantly more likely to die than a person wearing a safety belt.



Each seating position in your vehicle has a specific safety belt assembly which is made up of one buckle and one tongue that are designed to be used as a pair. 1) Use the shoulder belt on the outside shoulder only. Never wear the shoulder belt under the arm. 2) Never swing the safety belt around your neck over the inside shoulder. 3) Never use a single belt for more than one person.



Always transport children 12 years old and under in the back seat and always properly use appropriate child restraints.





Safety belts and seats can become hot in a vehicle that has been closed up in sunny weather; they could burn a small child. Check seat covers and buckles before you place a child anywhere near them.

Seating and safety restraints

Energy management feature

- This vehicle has a seat belt system with an energy management feature at the front outboard seating positions to help further reduce the risk of injury in the event of a head-on collision.
- This seat belt system has a retractor assembly that is designed to pay out webbing in a controlled manner. This feature is designed to help reduce the belt force acting on the occupant's chest.

 After any vehicle collision, the seat belt system at all passenger seating positions must be checked by a qualified technician to verify that the “automatic locking retractor” feature for child seats is still functioning properly. In addition, all seat belts should be checked for proper function.

 Failure to replace the belt and retractor assembly could increase the risk of injury in collisions.

Combination lap and shoulder belts

1. Insert the belt tongue into the proper buckle (the buckle closest to the direction the tongue is coming from) until you hear a snap and feel it latch. Make sure the tongue is securely fastened in the buckle.

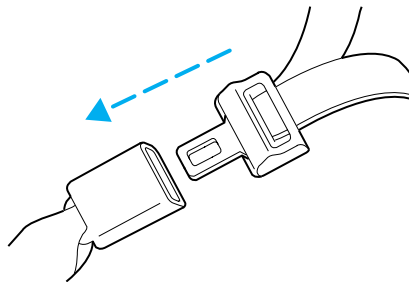

2. To unfasten, push the release button and remove the tongue from the buckle.

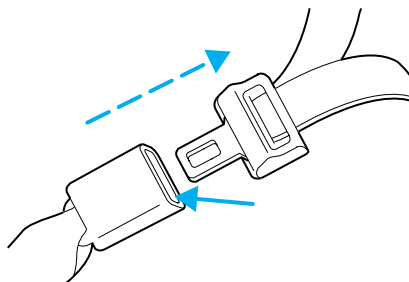

Seating and safety restraints

The front and rear outboard safety restraints in the vehicle are combination lap and shoulder belts. The front passenger and rear seat outboard safety belts have two types of locking modes described below:

Vehicle sensitive mode

The vehicle sensitive mode is the normal retractor mode, allowing free shoulder belt length adjustment to your movements and locking in response to vehicle movement. For example, if the driver brakes suddenly or turns a corner sharply, or the vehicle receives an impact of approximately 8 km/h (5 mph) or more, the combination safety belts will lock to help reduce forward movement of the driver and passengers.

Vehicle sensitive mode

The vehicle sensitive mode is the normal retractor mode, allowing free shoulder belt length adjustment to your movements and locking in response to vehicle movement. For example, if the driver brakes suddenly or turns a corner sharply, or the vehicle receives an impact of approximately 8 km/h or more, the combination safety belts (where fitted) will lock to help reduce forward movement of the driver and passengers.

Automatic locking mode

In this mode, the shoulder belt is automatically pre-locked. The belt will still retract to remove any slack in the shoulder belt.

The automatic locking mode is not available on the driver safety belt.

When to use the automatic locking mode

- **Any time** a child safety seat is installed in a passenger front or outboard rear seating position (if equipped). Children 12 years old and under should be properly restrained in the rear seat whenever possible. Refer to *Safety Restraints for Children* or *Safety Seats for Children* later in this chapter.

Seating and safety restraints

How to use the automatic locking mode

- Buckle the combination lap and shoulder belt.

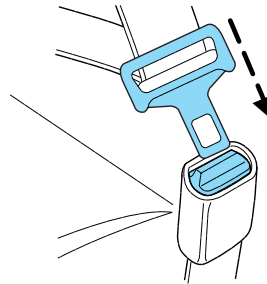

- Grasp the shoulder portion and pull downward until the entire belt is extracted.



- Allow the belt to retract. As the belt retracts, you will hear a clicking sound. This indicates the safety belt is now in the automatic locking mode.

How to disengage the automatic locking mode

Disconnect the combination lap/shoulder belt and allow it to retract completely to disengage the automatic locking mode and activate the vehicle sensitive (emergency) locking mode.



After any vehicle collision, all passenger seat belt systems must be checked by a qualified technician to verify that the “automatic locking retractor” feature for child seats is still functioning properly. In addition, all seat belts should be checked for proper function.

Seating and safety restraints

 BELT AND RETRACTOR ASSEMBLY MUST BE REPLACED if the seat belt assembly “automatic locking retractor” feature or any other seat belt function is not operating properly when checked according to the procedures in Workshop Manual.

 Failure to replace the belt and retractor assembly could increase the risk of injury in collisions.

Lap belts

Adjusting the lap belt

 The lap belt should fit snugly and as low as possible around the hips, not across the waist.

- **2nd row center seating position — 60/40**

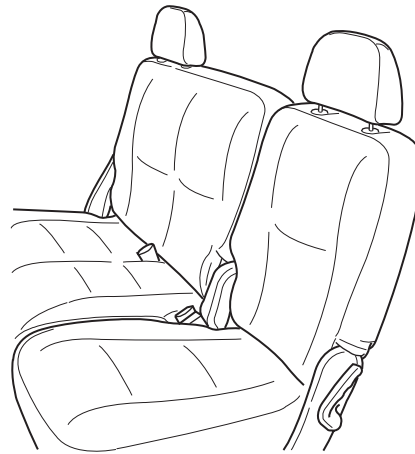

The lap belt does not adjust automatically.

Seating and safety restraints

Insert the tongue into the correct buckle (the buckle closest to the direction the tongue is coming from). To lengthen the belt, turn the tongue at a right angle to the belt and pull across your lap until it reaches the buckle. To tighten the belt, pull the loose end of the belt through the tongue until it fits snugly across the hips.

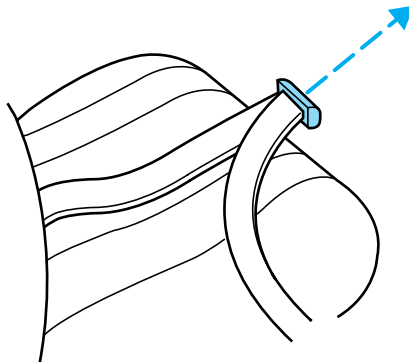

Shorten and fasten the belt when not in use.

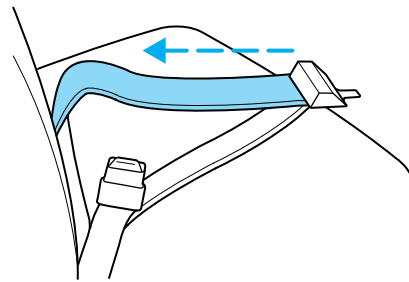

- **2nd row center seating position — 40/20/40**

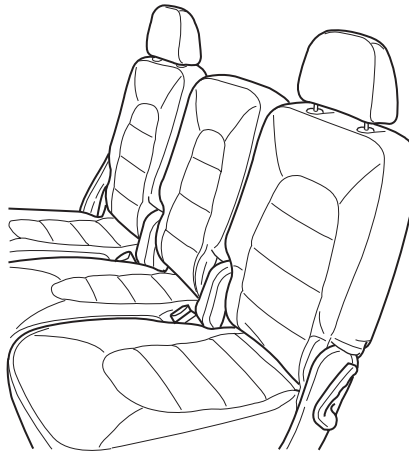

Seating and safety restraints

The lap belt will adjust automatically. To fasten, grasp the tongue, and with a continuous motion, pull out enough webbing to buckle the tongue into the correct buckle. If you did not pull out enough webbing to reach the buckle, allow the tongue to retract fully before trying to pull it out again.

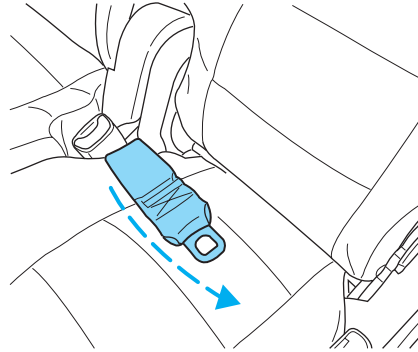

Safety belt pretensioner

Your vehicle is equipped with safety belt pretensioners at the driver and right front passenger seating positions.

The safety belt pretensioner is a device which removes excess webbing from the safety belt system. The safety belt pretensioner uses the same crash sensor system as the front air bag supplemental restraint system (SRS). When the safety belt pretensioner deploys, webbing from the lap and shoulder belt is tightened.

When the safety canopy system and the front airbags are activated, the safety belt pretensioners for the driver and right front passenger seating positions will be activated when the respective seatbelt is properly buckled.



The driver and the right front passenger seat belt system (including retractors, buckles and height adjusters) must be replaced if the vehicle is involved in a collision that results in deployment of front air bags and safety belt pretensioners.

Refer to the *Safety belt maintenance* section in this chapter.

Seating and safety restraints

Safety belt height adjustment

Your vehicle has safety belt height adjustments for the front and second row outboard seating positions. Adjust the height of the shoulder belt so the belt rests across the middle of your shoulder.

To lower the shoulder belt height, squeeze the button and slide the height adjuster down. To raise the height of the shoulder belt, slide the height adjuster up. Pull down on the height adjuster to make sure it is locked in place.

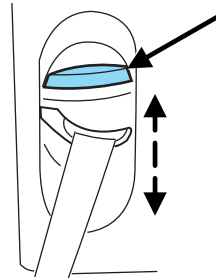

Position the safety belt height adjusters so that the belt rests across the middle of your shoulder. Failure to adjust the safety belt properly could reduce the effectiveness of the seat belt and increase the risk of injury in a collision.

Safety belt extension assembly

If the safety belt is too short when fully extended, there is a 20 cm (8 inch) safety belt extension assembly that can be added (part number 611C22). This assembly can be obtained from your dealer at no cost.

Use only extensions manufactured by the same supplier as the safety belt. Manufacturer identification is located at the end of the webbing on the label. Also, use the safety belt extension only if the safety belt is too short for you when fully extended.

Do not use extensions to change the fit of the shoulder belt across the torso.

Safety belt warning light and indicator chime

The seat belt warning light illuminates in the instrument cluster and a chime sounds to remind the occupants to fasten their safety belts.

Seating and safety restraints

Conditions of operation

If...	Then...
The driver's safety belt is not buckled before the ignition switch is turned to the ON position...	The safety belt warning light illuminates 1-2 minutes and the warning chime sounds 4-8 seconds.
The driver's safety belt is buckled while the indicator light is illuminated and the warning chime is sounding...	The safety belt warning light and warning chime turn off.
The driver's safety belt is buckled before the ignition switch is turned to the ON position...	The safety belt warning light and indicator chime remain off.

BeltMinder

The BeltMinder feature is a supplemental warning to the safety belt warning function. This feature provides additional reminders to the driver that the driver's safety belt is unbuckled by intermittently sounding a chime and illuminating the safety belt warning lamp in the instrument cluster.

If...	Then...
The driver's safety belt is not buckled before the vehicle has reached at least 5 km/h (3 mph) and 1-2 minutes have elapsed since the ignition switch has been turned to ON...	The BeltMinder feature is activated - the safety belt warning light illuminates and the warning chime sounds for 6 seconds every 30 seconds, repeating for approximately 5 minutes or until safety belt is buckled.
The driver's safety belt is buckled while the safety belt indicator light is illuminated and the safety belt warning chime is sounding...	The BeltMinder feature will not activate.

Seating and safety restraints

If...	Then...
The driver's safety belt is buckled before the ignition switch is turned to the ON position...	The BeltMinder feature will not activate.

The BeltMinder feature is a supplemental warning to the seat belt warning function. This feature provides additional reminders to the driver that the driver's seat belt is unbuckled by intermittently sounding a chime and illuminating the seat belt warning lamp in the instrument cluster.

If...	Then...
The driver's seat belt is not buckled before the vehicle has reached at least 5 km/h (3 mph) and 1-2 minutes have elapsed since the ignition switch has been turned to ON...	The BeltMinder feature is activated - the seat belt warning light illuminates and the warning chime sounds for 6 seconds every 30 seconds, repeating for approximately 5 minutes or until seat belt is buckled.
The driver's seat belt is buckled while the seat belt indicator light is illuminated and the seat belt warning chime is sounding...	The BeltMinder feature will not activate.
The driver's seat belt is buckled before the ignition switch is turned to the ON position...	The BeltMinder feature will not activate.

The purpose of the BeltMinder is to remind occasional wearers to wear safety belts all of the time.

The following are reasons most often given for not wearing safety belts: (All statistics based on U.S. data)

Reasons given...	Consider...
"Crashes are rare events"	36700 crashes occur every day. The more we drive, the more we are exposed to "rare" events, even for good drivers. <i>1 in 4 of us will be seriously injured in a crash during our lifetime.</i>
"I'm not going far"	3 of 4 fatal crashes occur within 25 miles of home.

Seating and safety restraints

Reasons given...	Consider...
"Belts are uncomfortable"	We design our safety belts to enhance comfort. If you are uncomfortable - try different positions for the safety belt upper anchorage and seatback which should be as upright as possible; this can improve comfort.
"I was in a hurry"	Prime time for an accident. BeltMinder reminds us to take a few seconds to buckle up.
"Seat belts don't work"	Safety belts , when used properly, reduce risk of death to front seat occupants by 45% in cars , and by 60% in light trucks .
"Traffic is light"	Nearly 1 of 2 deaths occur in single-vehicle crashes , many when no other vehicles are around.
"Belts wrinkle my clothes"	Possibly, but a serious crash can do much more than wrinkle your clothes, particularly if you are unbelted.
"The people I'm with don't wear belts"	Set the example, teen deaths occur 4 times more often in vehicles with TWO or MORE people. Children and younger brothers/sisters imitate behavior they see.
"I have an air bag"	Air bags offer greater protection when used with safety belts. Frontal airbags are not designed to inflate in rear and side crashes or rollovers.
"I'd rather be thrown clear"	Not a good idea. People who are ejected are 40 times more likely to DIE . Safety belts help prevent ejection, WE CAN'T "PICK OUR CRASH".



Do not sit on top of a buckled safety belt to avoid the Belt Minder chime. Sitting on the safety belt will increase the risk of injury in an accident. To disable (one-time) or deactivate the Belt Minder feature please follow the directions stated below.

Seating and safety restraints

One time disable

Any time the safety belt is buckled and then unbuckled during an ignition ON cycle, BeltMinder will be disabled for that ignition cycle only.

Deactivating/activating the BeltMinder feature

Read steps 1 - 9 thoroughly before proceeding with the deactivation/activation programming procedure.

The BeltMinder feature can be deactivated/activated by performing the following procedure:

Before following the procedure, make sure that:

- the parking brake is set
- the gearshift is in P (Park) (automatic transmission) or the neutral position (manual transmission).
- the ignition switch is in the OFF position
- all vehicle doors are closed
- the driver's safety belt is unbuckled
- the parklamps/headlamps are in OFF position (If vehicle is equipped with Autolamps, the Autolamps feature **MUST** be turned off.)



To reduce the risk of injury, do not deactivate/activate the Belt Minder feature while driving the vehicle.

1. Turn the ignition switch to the RUN (or ON) position. (DO NOT START THE ENGINE)
2. Wait until the safety belt warning light turns off. (Approximately 1-2 minutes)
 - Steps 3-5 must be completed within 60 seconds or the procedure will have to be repeated.
3. Buckle then unbuckle the safety belt three times, ending with the safety belt unbuckled. This can be done before or during BeltMinder warning activation.
4. Turn on the parklamps/headlamps, turn off the parklamps/headlamps.
5. Buckle then unbuckle the safety belt three times, ending with the safety belt unbuckled.
 - After step 5 the safety belt warning light will be turned on for three seconds.
6. Within seven seconds of the safety belt warning light turning off, buckle then unbuckle the safety belt.

Seating and safety restraints

- This will disable BeltMinder if it is currently enabled, or enable BeltMinder if it is currently disabled.
7. Confirmation of disabling BeltMinder is provided by flashing the safety belt warning light four times per second for three seconds.
 8. Confirmation of enabling BeltMinder is provided by flashing the safety belt warning light four times per second for three seconds, followed by three seconds with the safety belt warning light off, then followed by flashing the safety belt warning light four times per second for three seconds again.
 9. After receiving confirmation, the deactivation/activation procedure is complete.

Safety belt maintenance

Inspect the safety belt systems periodically to make sure they work properly and are not damaged. Inspect the safety belts to make sure there are no nicks, tears or cuts. Replace if necessary. All safety belt assemblies, including retractors, buckles, front seat belt buckle assemblies, buckle support assemblies (slide bar-if equipped), shoulder belt height adjusters (if equipped), shoulder belt guide on seatback (if equipped), child safety seat tether bracket assemblies (if equipped), LATCH child seat tether anchors and lower anchors (if equipped), and attaching hardware, should be inspected after a collision. Ford Motor Company recommends that all safety belt assemblies used in vehicles involved in a collision be replaced. However, if the collision was minor and a qualified technician finds that the belts do not show damage and continue to operate properly, they do not need to be replaced. Safety belt assemblies not in use during a collision should also be inspected and replaced if either damage or improper operation is noted.



Failure to inspect and if necessary replace the safety belt assembly under the above conditions could result in severe personal injuries in the event of a collision.

Refer to *Cleaning and maintaining the safety belts* in the *Cleaning* chapter.

Seating and safety restraints

AIR BAG SUPPLEMENTAL RESTRAINT SYSTEM (SRS)

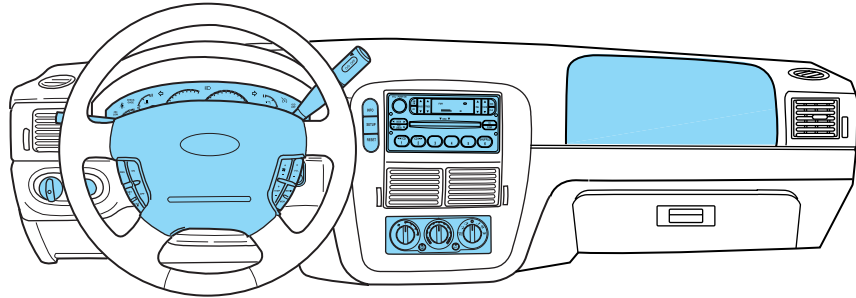



Your vehicle is equipped with a crash sensing and diagnostic module which records information about the air bag and sensor systems. In the event of a collision this module may save information related to the collision including information about the air bag system and impact severity. This information will assist Ford Motor Company in servicing the vehicle and in helping to better understand real world collisions and further improve the safety of future vehicles.

Important supplemental restraint system (SRS) precautions

The supplemental restraint system is designed to work with the safety belt to help protect the driver and right front passenger from certain upper body injuries.

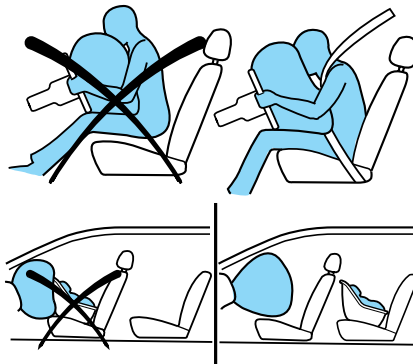
Air bags DO NOT inflate slowly or gently and the risk of injury from a deploying air bag is greatest close to the trim covering the air bag module.



 All occupants of the vehicle, including the driver, should always properly wear their safety belts, even when an air bag (SRS) is provided.

Seating and safety restraints



Always transport children 12 years old and under in the back seat and always properly use appropriate child restraints.



National Highway Traffic Safety Administration (NHTSA) recommends a minimum distance of at least 25 cm (10 inches) between an occupant's chest and the driver air bag module.



Never place your arm over the air bag module as a deploying air bag can result in serious arm fractures or other injuries.

Steps you can take to properly position yourself away from the air bag:

- Move your seat to the rear as far as you can while still reaching the pedals comfortably.
- Recline the seat slightly (one or two degrees) from the upright position.



Do not put anything on or over the air bag module. Placing objects on or over the air bag inflation area may cause those objects to be propelled by the air bag into your face and torso causing serious injury.



Do not attempt to service, repair, or modify the air bag supplemental restraint systems or its fuses. See your Ford or Lincoln Mercury dealer.



Modifications to the front end of the vehicle, including frame, bumper, front end body structure and non-Ford tow hooks may effect the performance of the air bag sensors increasing the risk of injury. Do not modify the front end of the vehicle.



Additional equipment may affect the performance of the air bag sensors increasing the risk of injury. Please refer to the Body Builders Layout Book for instructions about the appropriate installation of additional equipment.

Seating and safety restraints

Children and air bags

For additional important safety information, read all information on safety restraints in this guide.

Children must always be properly restrained. Accident statistics suggest that children are safer when properly restrained in the rear seating positions than in the front seating position. Failure to follow these instructions may increase the risk of injury in a collision.



Air bags can kill or injure a child in a child seat.

NEVER place a rear-facing child seat in front of an active air bag. If you must use a forward-facing child seat in the front seat, move the seat all the way back.

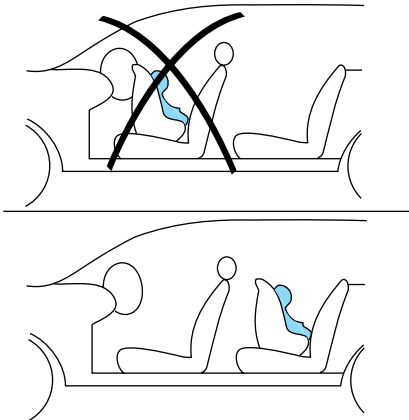

How does the air bag supplemental restraint system work?

The air bag SRS is designed to activate when the vehicle sustains longitudinal deceleration sufficient to cause the sensors to close an electrical circuit that initiates air bag inflation.

The fact that the air bags did not inflate in a collision does not mean that something is wrong with the system. Rather, it means the forces were not of the type sufficient to cause activation. Front air bags are designed to inflate in frontal and near-frontal collisions, not rollover, side-impact, or rear-impacts unless the collision causes sufficient longitudinal deceleration.

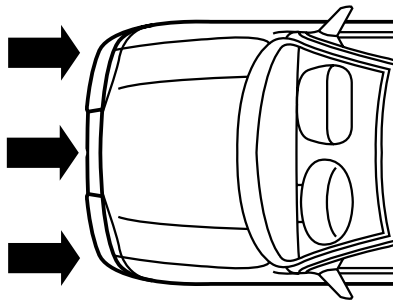

Seating and safety restraints

The air bags inflate and deflate rapidly upon activation. After air bag deployment, it is normal to notice a smoke-like, powdery residue or smell the burnt propellant. This may consist of cornstarch, talcum powder (to lubricate the bag) or sodium compounds (e.g., baking soda) that result from the combustion process that inflates the air bag. Small amounts of sodium hydroxide may be present which may irritate the skin and eyes, but none of the residue is toxic.



While the system is designed to help reduce serious injuries, contact with a deploying air bag may also cause abrasions, swelling or temporary hearing loss. Because air bags must inflate rapidly and with considerable force, there is the risk of death or serious injuries such as fractures, facial and eye injuries or internal injuries, particularly to occupants who are not properly restrained or are otherwise out of position at the time of air bag deployment. Thus, it is extremely important that occupants be properly restrained as far away from the air bag module as possible while maintaining vehicle control.



Several air bag system components get hot after inflation. Do not touch them after inflation.



If the air bag has deployed, **the air bag will not function again and must be replaced immediately.** If the air bag is not replaced, the unrepaired area will increase the risk of injury in a collision.

Seating and safety restraints

The SRS consists of:

- driver and passenger air bag modules (which include the inflators and air bags).
- side air curtains (if equipped). Refer to *Side air curtain system* later in this chapter.
- one or more impact and safing sensors.
- a readiness light and tone.
- diagnostic module.
- and the electrical wiring which connects the components.

The diagnostic module monitors its own internal circuits and the supplemental air bag electrical system warning (including the impact sensors), the system wiring, the air bag system readiness light, the air bag back up power and the air bag ignitors.

Determining if the system is operational

The SRS uses a readiness light in the instrument cluster or a tone to indicate the condition of the system. Refer to *Air bag readiness* section in the *Instrument cluster* chapter. Routine maintenance of the air bag is not required.

A difficulty with the system is indicated by one or more of the following:

- The readiness light will either flash or stay lit.
- The readiness light will not illuminate immediately after ignition is turned on.
- A series of five beeps will be heard. The tone pattern will repeat periodically until the problem and/or light are repaired.





If any of these things happen, even intermittently, have the SRS serviced at your dealership or by a qualified technician immediately. Unless serviced, the system may not function properly in the event of a collision.

Seating and safety restraints

Safety Canopy™ system (if equipped)

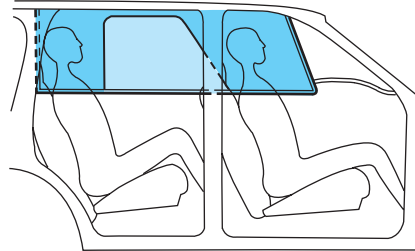
 Do not place objects or mount equipment on or near the headliner at the siderail that may come into contact with a deploying Safety Canopy™. Failure to follow these instructions may increase the risk of personal injury in the event of a collision.



 Do not lean your head on the door. The Safety Canopy™ could injure you as it deploys from the headliner.

 Do not attempt to service, repair, or modify the Safety Canopy™ system, its fuses, the A, B, or C pillar trim, or the headliner on a vehicle containing a Safety Canopy™. See your Ford or Lincoln Mercury dealer.

 All occupants of the vehicle including the driver should always wear their safety belts even when an air bag SRS and Safety Canopy™ system is provided.

 To reduce risk of injury, do not obstruct or place objects in the deployment path of the inflatable Safety Canopy™.

Seating and safety restraints

How does the Safety Canopy™ system work?

The design and development of the Safety Canopy™ system included recommended testing procedures that were developed by a group of automotive safety experts known as the Side Airbag Technical Working Group. These recommended testing procedures help reduce the risk of injuries related to the deployment of side airbags (including the Safety Canopy™).

The Safety Canopy™ system consists of the following:

- An inflatable nylon curtain with a gas generator concealed behind the headliner and above the doors (one each side of the vehicle).
- The headliner will flex to open above the side doors to allow Safety Canopy™ deployment.
- The same warning light, electronic control and diagnostic unit as used for the front airbags.
- Two side crash sensors mounted at the base of the B-pillar (one on each side).
- Two side crash sensors located at the c-pillar behind the rear doors (one on each side).
- Roll over sensor in the restraints control module (RCM).

The Safety Canopy™ system, in combination with seat belts, can help reduce the risk of severe injuries in the event of a significant side impact collision or rollover event.

Children 12 years old and under should always be properly restrained in the second or third row seats (if equipped). The Safety Canopy™ will not interfere with children restrained using a properly installed child or booster seat because it is designed to inflate downward from the headliner above the doors along the side window openings.

The Safety Canopy™ system is designed to activate when the vehicle sustains lateral deceleration sufficient to cause the side crash sensor to

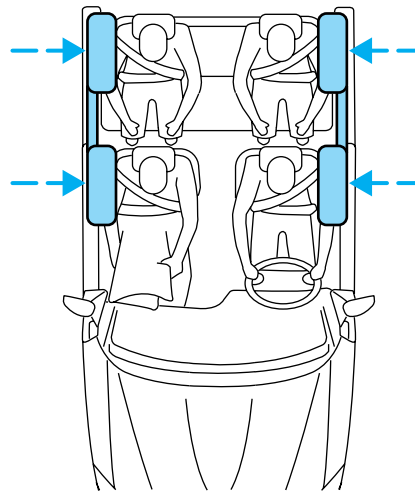



Seating and safety restraints

close an electrical circuit that initiates Safety Canopy™ inflation or when a certain likelihood of a rollover event is detected by the rollover sensor.

The Safety Canopy™ is mounted to the roof side-rail sheet metal, behind the headliner, above the first and second row seats. In certain lateral collisions or rollover events, the Safety Canopy™ system will be activated, regardless of which seats are occupied. The Safety Canopy™ is designed to inflate between the side window area and occupants to further enhance protection provided in side impact collisions and rollover events.

The fact that the Safety Canopy™ system did not activate in a collision does not mean that something is wrong with the system. Rather, it means the forces were not of the type sufficient to cause activation. The Safety Canopy™ is designed to inflate in certain side impact collisions or rollover events, not in rear impact, frontal or near-frontal collisions, unless the collision causes sufficient lateral deceleration or rollover likelihood.

 Several Safety Canopy™ system components get hot after inflation. Do not touch them after inflation.

 If the Safety Canopy™ system has deployed, **the Safety Canopy™ will not function again. The Safety Canopy™ system (including the A, B and C pillar trim) must be inspected and serviced by a qualified technician in accordance with the vehicle service manual.** If the Safety Canopy™ is not replaced, the unrepaired area will increase the risk of injury in a collision.

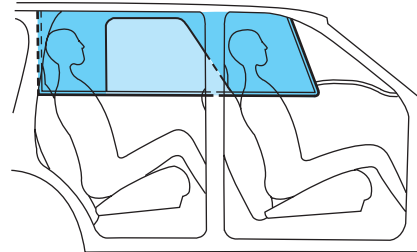

Seating and safety restraints

Determining if the system is operational

The SRS uses a readiness light in the instrument cluster or a tone to indicate the condition of the system. Refer to the *Air bag readiness* section in the *Instrumentation* chapter. Routine maintenance of the air bag is not required.

A difficulty with the system is indicated by one or more of the following:

- The readiness light (same light as for front air bag system) will either flash or stay lit.
- The readiness light will not illuminate immediately after ignition is turned on.
- A series of five beeps will be heard. The tone pattern will repeat periodically until the problem and light are repaired.

If any of these things happen, even intermittently, have the SRS serviced at your dealership or by a qualified technician immediately. Unless serviced, the system may not function properly in the event of a collision or rollover event.

Disposal of air bags and air bag equipped vehicles (including pretensioners)

For disposal of air bags or air bag equipped vehicles, see your local dealership or qualified technician. Air bags **MUST BE** disposed of by qualified personnel.

SAFETY RESTRAINTS FOR CHILDREN

See the following sections for directions on how to properly use safety restraints for children. Also see *Air bag supplemental restraint system (SRS)* in this chapter for special instructions about using air bags.

Important child restraint precautions

You are required by law to use safety restraints for children in the U.S. and Canada. If small children ride in your vehicle (generally children who are four years old or younger and who weigh 18 kg [40 lbs] or less), you must put them in safety seats made especially for children. Check your local and state or provincial laws for specific requirements regarding the safety of children in your vehicle.



Never let a passenger hold a child on his or her lap while the vehicle is moving. The passenger cannot protect the child from injury in a collision.

Seating and safety restraints

Always follow the instructions and warnings that come with any infant or child restraint you might use.

When possible, always place children under age 12 in the rear seat of your vehicle. Accident statistics suggest that children are safer when properly restrained in the rear seating positions than in the front seating positions.

Children and safety belts

If the child is the proper size, restrain the child in a safety seat. Children who are too large for child safety seats (as specified by your child safety seat manufacturer) should always wear safety belts.

Follow all the important safety restraint and air bag precautions that apply to adult passengers in your vehicle.

If the shoulder belt portion of a combination lap and shoulder belt can be positioned so it does not cross or rest in front of the child's face or neck, the child should wear the lap and shoulder belt. Moving the child closer to the center of the vehicle may help provide a good shoulder belt fit.



Do not leave children, unreliable adults, or pets unattended in your vehicle.

Child booster seats

Children outgrow a typical convertible or toddler seat when they weigh 40 pounds and are around 4 years of age. Although the lap/shoulder belt will provide some protection, these children are still too small for lap/shoulder belts to fit properly, which could increase the risk of serious injury.

To improve the fit of both the lap and shoulder belt on children who have outgrown child safety seats, Ford Motor Company recommends use of a belt-positioning booster.

Booster seats position a child so that safety belts fit better. They lift the child up so that the lap belt rests low across the hips and the knees bend comfortably. Booster seats also make the shoulder belt fit better and more comfortably for growing children.

When children should use booster seats

Children need to use booster seats from the time they outgrow the toddler seat until they are big enough for the vehicle seat and lap/shoulder belt to fit properly. Generally this is when they weigh about 80 lbs (about 8 to 12 years old).

Seating and safety restraints

Booster seats should be used until you can answer YES to ALL of these questions:

- Can the child sit all the way back against the vehicle seat back with knees bent comfortably at the edge of the seat without slouching?

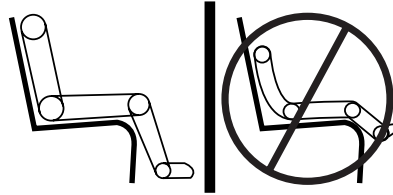

- Does the lap belt rest low across the hips?
- Is the shoulder belt centered on the shoulder and chest?
- Can the child stay seated like this for the whole trip?

Types of booster seats

There are two types of belt-positioning booster seats:

- Those that are backless.

If your backless booster seat has a removable shield, remove the shield and use the lap/shoulder belt. If a seating position has a low seat back and no head restraint, a backless booster seat may place your child's head (top of ear level) above the top of the seat. In this case, move the backless booster to another seating position with a higher seat back and lap/shoulder belts.

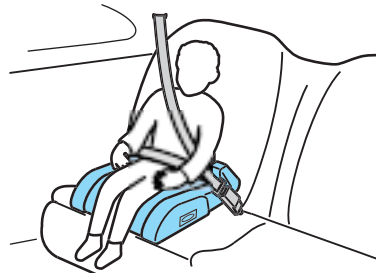

- Those with a high back.

If, with a backless booster seat, you cannot find a seating position that adequately supports your child's head, a high back booster seat would be a better choice.

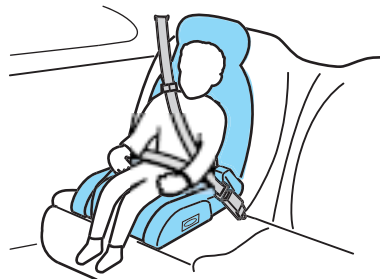

Both can be used in any vehicle in a seating position equipped with lap/shoulder belts if your child is over 40 lbs.

Seating and safety restraints

The shoulder belt should cross the chest, resting snugly on the center of the shoulder. The lap belt should rest low and snug across the hips, never up high across the stomach.

If the booster seat slides on the vehicle seat, placing a rubberized mesh sold as shelf or carpet liner under the booster seat may improve this condition.

The importance of shoulder belts

Using a booster without a shoulder belt increases the risk of a child's head hitting a hard surface in a collision. For this reason, you should never use a booster seat with a lap belt only. It is best to use a booster seat with lap/shoulder belts in the back seat- the safest place for children to ride.



Follow all instructions provided by the manufacturer of the booster seat.



Never put the shoulder belt under a child's arm or behind the back because it eliminates the protection for the upper part of the body and may increase the risk of injury or death in a collision.



Never use pillows, books, or towels to boost a child. They can slide around and increase the likelihood of injury or death in a collision.

SAFETY SEATS FOR CHILDREN



Child and infant or child safety seats

Use a safety seat that is recommended for the size and weight of the child. Carefully follow all of the manufacturer's instructions with the

Seating and safety restraints

safety seat you put in your vehicle. If you do not install and use the safety seat properly, the child may be injured in a sudden stop or collision.

When installing a child safety seat:

- Review and follow the information presented in the *Air bag supplemental restraint system (SRS)* section in this chapter.
- Use the correct safety belt buckle for that seating position (the buckle closest to the direction the tongue is coming from).
- Insert the belt tongue into the proper buckle until you hear a snap and feel it latch. Make sure the tongue is securely fastened in the buckle.
- Keep the buckle release button pointing up and away from the safety seat, with the tongue between the child seat and the release button, to prevent accidental unbuckling.
- Place seat back in upright position.
- Put the safety belt in the automatic locking mode. Refer to *Automatic locking mode* (passenger side front and outboard rear seating positions) (if equipped) section in this chapter.

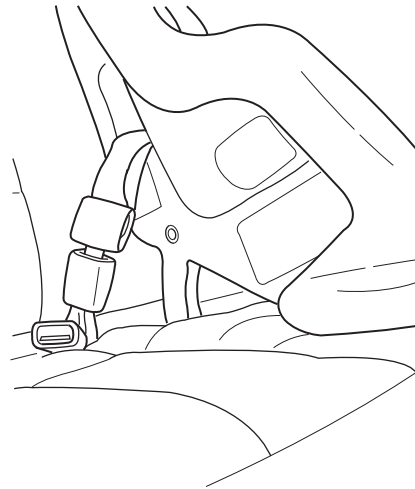

Ford recommends the use of a child safety seat having a top tether strap. Install the child safety seat in a seating position which is capable of providing a tether anchorage. For more information on top tether straps, refer to *Attaching child safety seats with tether straps*, in this chapter.



Carefully follow all of the manufacturer's instructions included with the safety seat you put in your vehicle. If you do not install and use the safety seat properly, the child may be injured in a sudden stop or collision.

Seating and safety restraints

Installing child safety seats in combination lap and shoulder belt seating positions

 Air bags can kill or injure a child in a child seat. **NEVER** place a rear-facing child seat in front of an active air bag. If you must use a forward-facing child seat in the front seat, move the seat all the way back.

 Children 12 and under should be properly restrained in the rear seat whenever possible.

1. Position the child safety seat in a seat with a combination lap and shoulder belt.



2. Pull down on the shoulder belt and then grasp the shoulder belt and lap belt together.

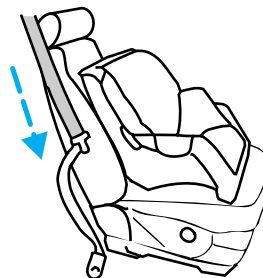

Seating and safety restraints

3. While holding the shoulder and lap belt portions together, route the tongue through the child seat according to the child seat manufacturer's instructions. Be sure the belt webbing is not twisted.

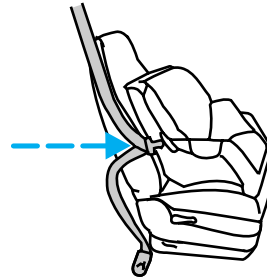

4. Insert the belt tongue into the proper buckle (the buckle closest to the direction the tongue is coming from) for that seating position until you hear a snap and feel the latch engage. Make sure the tongue is latched securely by pulling on it.

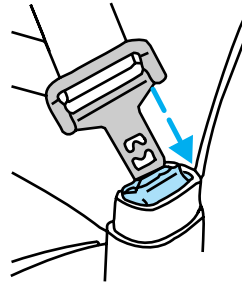

5. To put the retractor in the automatic locking mode, grasp the shoulder portion of the belt and pull downward until all of the belt is pulled out and a click is heard.

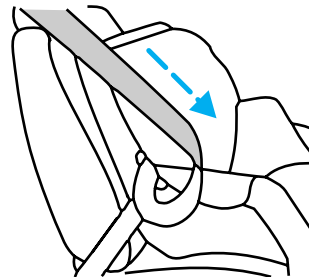

6. Allow the belt to retract. The belt will click as it retracts to indicate it is in the automatic locking mode.

Seating and safety restraints

7. Pull the lap belt portion across the child seat toward the buckle and pull up on the shoulder belt while pushing down with your knee on the child seat.

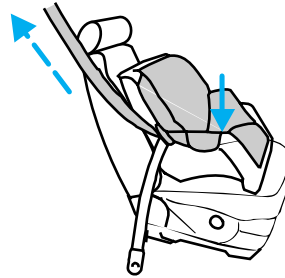

8. Allow the safety belt to retract to remove any slack in the belt.

9. Before placing the child in the seat, forcibly tilt the seat forward and back to make sure the seat is securely held in place. To check this, grab the seat at the belt path and attempt to move it side to side and forward and back. There should be no more than one inch of movement for proper installation.

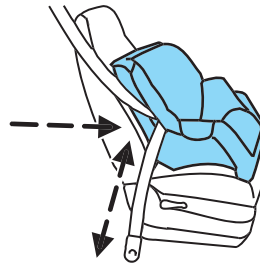

10. Try to pull the belt out of the retractor to make sure the retractor is in the automatic locking mode (you should not be able to pull more belt out). If the retractor is not locked, unbuckle the belt and repeat steps two through nine.

Check to make sure the child seat is properly secured before each use.

Installing child safety seat in the second row center seating position with an automatic locking retractor

1. Place the child safety seat in the center seating position.
2. In a continuous motion, pull out enough webbing from the retractor to route the tongue through the child seat.
3. While holding the webbing to prevent it from retracting, route the webbing through the child seat according to the child seat manufacturer's instructions. Be sure the belt webbing is not twisted.
4. Insert the tongue into the correct buckle for that seating position until you hear and feel the buckle engage. Make sure the buckle is latched securely by pulling on the webbing.

Seating and safety restraints

5. If you have not pulled out enough webbing to reach, allow the webbing to fully retract before attempting to pull it out again and repeat steps 2 through 4.
6. Pull the webbing through the child seat toward the retractor while pushing down with your knee on the child seat.
7. Allow the safety belt to retract to remove any slack in the belt. It will make a clicking noise while doing this.
8. Before placing the child in the seat, forcibly move the seat forward and side-to-side to make sure the seat is securely held in place.
9. Check to make sure the child seat is properly secured before each use.

Attaching child safety seats with tether straps

Most new forward-facing child safety seats include a tether strap which goes over the back of the seat and hooks to an anchoring point. Tether straps are available as an accessory for many older safety seats. Contact the manufacturer of your child seat for information about ordering a tether strap.

The rear seats of your vehicle are equipped with built-in tether strap anchors located behind the seats as shown below.

The tether strap anchors in your vehicle are in the following positions (shown from top view):

- 5 passenger vehicle

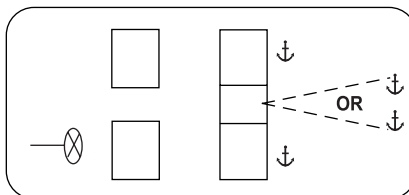

- 7 passenger vehicle

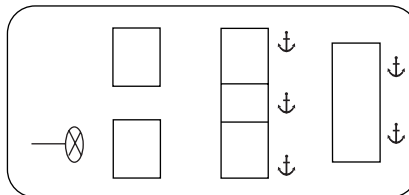

Seating and safety restraints



Attach the tether strap only to the appropriate tether anchor as shown. The tether strap may not work properly if attached somewhere other than the correct tether anchor.

1. Position the child safety seat on the rear seat cushion.
2. Route the tether strap under the head restraint and between the head restraint posts.
3. Locate the correct anchor for the selected rear seating position.

When placing a child safety seat in the 2nd row center seating position of the 5 passenger vehicle, the tether straps may be attached to either of the tether anchors located at the rear of the cargo area.

- Behind 2nd row seat

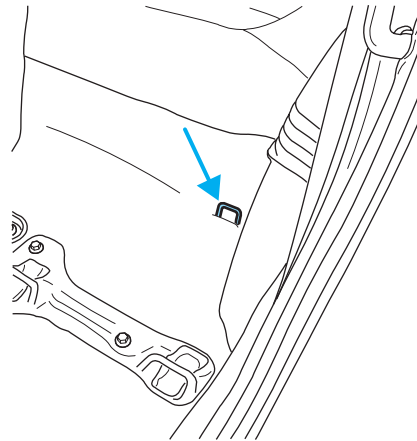

Seating and safety restraints

- At the rear of the cargo area

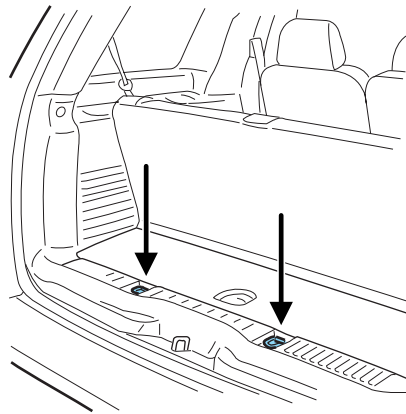

4. Clip the tether strap to the anchor.

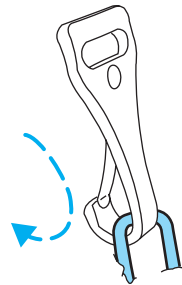

If the tether strap is clipped incorrectly, the child safety seat may not be retained properly in the event of a collision.

5. Refer to the *Installing child safety seats in combination lap and shoulder belt seating positions* section of this chapter for further instructions to secure the child safety seat.

6. Tighten the child safety seat tether strap according to the manufacturer's instructions.



If the safety seat is not anchored properly, the risk of a child being injured in a collision greatly increases.

Starting

PREPARING TO START YOUR VEHICLE

Engine starting is controlled by the powertrain control system. This system meets all Canadian Interference-Causing Equipment standard requirements regulating the impulse electrical field strength of radio noise.

When starting a fuel-injected engine, avoid pressing the accelerator before or during starting. Only use the accelerator when you have difficulty starting the engine. For more information on starting the vehicle, refer to *Starting the engine* in this chapter.



Extended idling at high engine speeds can produce very high temperatures in the engine and exhaust system, creating the risk of fire or other damage.



Do not park, idle, or drive your vehicle in dry grass or other dry ground cover. The emission system heats up the engine compartment and exhaust system, which can start a fire.



Do not start your vehicle in a closed garage or in other enclosed areas. Exhaust fumes can be toxic. Always open the garage door before you start the engine. See *Guarding against exhaust fumes* in this chapter for more instructions.



If you smell exhaust fumes inside your vehicle, have your dealer inspect your vehicle immediately. Do not drive if you smell exhaust fumes.

Important safety precautions

A computer system controls the engine's idle revolutions per minute (RPM). When the engine starts, the idle RPM runs higher than normal in order to warm the engine. If the engine idle speed does not slow down automatically, have the vehicle checked.

Before starting the vehicle:

1. Make sure all vehicle occupants have buckled their safety belts. For more information on safety belts and their proper usage, refer to the *Seating and safety restraints* chapter.
2. Make sure the headlamps and vehicle accessories are off.

Starting

- Make sure the parking brake is set.

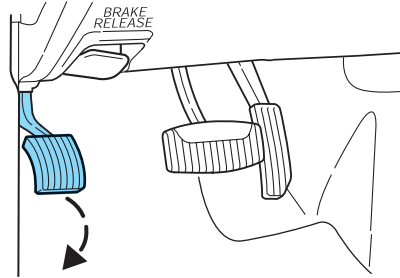

- Make sure the gearshift is in P (Park).

P RND321

3. Turn the key to 3 (ON) without turning the key to 4 (START).

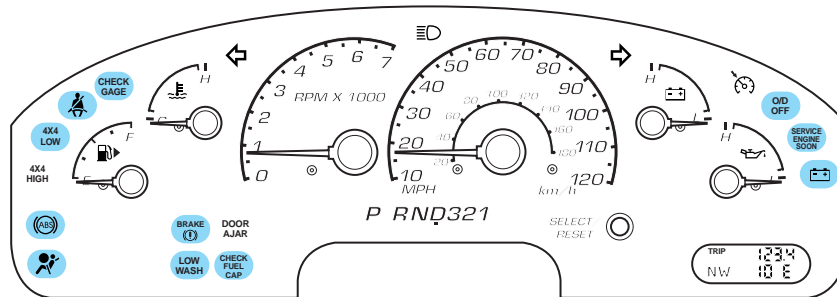
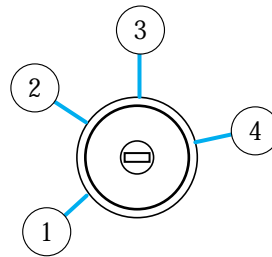

Starting

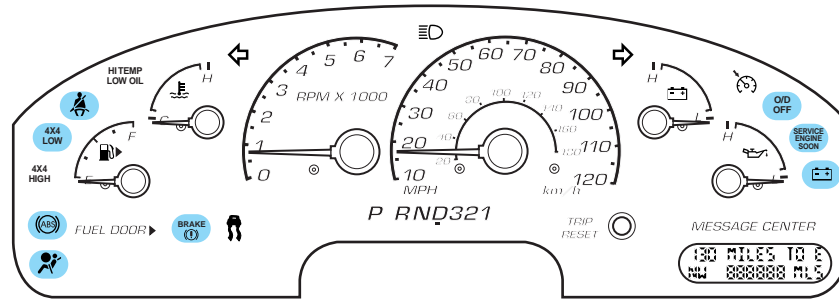

Make sure the corresponding lights illuminate or illuminate briefly. If a light fails to illuminate, have the vehicle serviced.

- If the driver's safety belt is fastened, the  light may not illuminate.

STARTING THE ENGINE

Note: Whenever you start your vehicle, release the key as soon as the engine starts. Excessive cranking could damage the starter.

1. Turn the key to 4 (START) without pressing the accelerator pedal and release as soon as the engine starts. The key will return to 3 (ON).

2. If the temperature is above -12°C (10°F) and the engine does not start within five seconds on the first try, turn the key to OFF, wait 10 seconds and try again.

3. If the temperature is below -12°C (10°F) and the engine does not start in 15 seconds on the first try, turn the key OFF and wait 10 seconds and try again. If the engine does not start in two attempts, press the accelerator pedal all the way to floor and hold. Turn the key to START position.

4. When the engine starts, release the key, then release the accelerator pedal gradually as the engine speeds up.

5. After idling for a few seconds, apply the brake, shift into gear and drive.

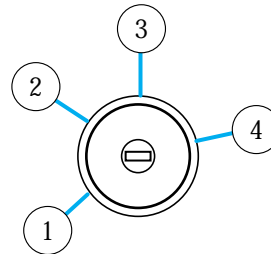

Cold weather starting (flexible fuel vehicles only)

As the outside temperature approaches freezing, ethanol fuel distributors should supply winter grade ethanol (same as with unleaded gasoline). If summer grade ethanol is used in cold weather conditions, you may experience increased cranking times, rough idle or hesitation until the engine has warmed up. Consult your fuel distributor for the availability of winter grade ethanol.

Do not crank the engine for more than 30 seconds at a time as starter damage may occur. If the engine fails to start, turn the key to OFF and wait 30 seconds before trying again.

Do not use starting fluid such as ether in the air intake system (see Air Cleaner decal). Such fluid could cause immediate explosive damage to the engine and possible personal injury.

If you should experience cold weather starting problems on E₈₅ ethanol, and neither an alternative brand of E₈₅ ethanol nor an engine block heater is available, the addition of unleaded gasoline to your tank will improve cold starting performance. Your vehicle is designed to operate on E₈₅ ethanol alone, unleaded gasoline alone, or any mixture of the two.

See *Choosing the right fuel* in the *Maintenance and care* chapter for more information on ethanol.

If the engine fails to start using the preceding instructions

1. Press the accelerator pedal 1/3 to 1/2 way to floor and hold.
2. Turn the key to START position.
3. When the engine starts, release the key, then release the accelerator pedal gradually as the engine speeds up.
4. If the engine still fails to start, repeat steps one through three.
5. After the engine starts, hold your foot on the brake pedal, put the gearshift lever in gear and release the parking brake. Slowly release the brake pedal and drive away in a normal manner.

Using the engine block heater (if equipped)

An engine block heater warms the engine coolant, which improves starting, warms up the engine faster and allows the heater-defroster system to respond quickly. Use of an engine block heater is strongly recommended if you live in a region where temperatures reach -23° C (-10° F) or below.

For best results, plug the heater in at least three hours before starting the vehicle. Using the heater for longer than three hours will not harm the engine, so the heater can be plugged in the night before starting the vehicle.

Starting



To prevent electrical shock, do not use your heater with ungrounded electrical systems or two-pronged (cheater) adapters.

Guarding against exhaust fumes

Although odorless and colorless, carbon monoxide is present in exhaust fumes. Take precautions to avoid its dangerous effects.



If you ever smell exhaust fumes of any kind inside your vehicle, have your dealer inspect and fix your vehicle immediately. Do not drive if you smell exhaust fumes. These fumes are harmful and could kill you.

Have the exhaust and body ventilation systems checked whenever:

- the vehicle is raised for service.
- the sound of the exhaust system changes.
- the vehicle has been damaged in a collision.



WARNING: Engine exhaust, some of its constituents, and certain vehicle components contain or emit chemicals known to the State of California to cause cancer and birth defects or other reproductive harm. In addition, certain fluids contained in vehicles and certain products of component wear contain or emit chemicals known to the State of California to cause cancer and birth defects or other reproductive harm.

Important ventilating information

If the engine is idling while the vehicle is stopped in an open area for long periods of time, open the windows at least 2.5 cm (one inch).

Adjust the heating or air conditioning (if equipped) to bring in fresh air.

Improve vehicle ventilation by keeping all air inlet vents clear of snow, leaves and other debris.

BRAKES

Your service brakes are self-adjusting. Refer to the scheduled maintenance guide for scheduled maintenance.

Occasional brake noise is normal and often does not indicate a performance concern with the vehicle's brake system. In normal operation, automotive brake systems may emit occasional or intermittent squeal or groan noises when the brakes are applied. Such noises are usually heard during the first few brake applications in the morning; however, they may be heard at any time while braking and can be aggravated by environmental conditions such as cold, heat, moisture, road dust, salt or mud. If a "metal-to-metal," "continuous grinding" or "continuous squeal" sound is present while braking, the brake linings may be worn-out and should be inspected by a qualified service technician.



If you are driving down a long or steep hill, shift to a lower gear. Do not apply your brakes continuously, as they may overheat and become less effective.

Anti-lock brake system (ABS)

On vehicles equipped with an anti-lock braking system (ABS), a noise from the hydraulic pump motor and pulsation in the pedal may be observed during ABS braking events. Pedal pulsation coupled with noise while braking under panic conditions or on loose gravel, bumps, wet or snowy roads is normal and indicates proper functioning of the vehicle's anti-lock brake system. The ABS performs a self-check after you start the engine and begin to drive away. A brief mechanical noise may be heard during this test. This is normal. If a malfunction is found, the ABS warning light will come on. If the vehicle has continuous vibration or shudder in the steering wheel while braking, the vehicle should be inspected by a qualified service technician.

Driving

The ABS operates by detecting the onset of wheel lockup during brake applications and compensates for this tendency. The wheels are prevented from locking even when the brakes are firmly applied. The accompanying illustration depicts the advantage of an ABS equipped vehicle (on bottom) to a non-ABS equipped vehicle (on top) during hard braking with loss of front braking traction.

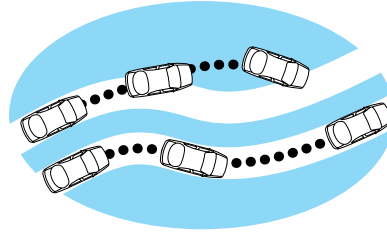

ABS warning lamp

The  warning lamp in the instrument cluster momentarily illuminates when the ignition is turned to the ON position. If the light does not illuminate momentarily at start up, remains on or continues to flash, the ABS needs to be serviced.

With the ABS light on, the anti-lock brake system is disabled and normal braking is still effective unless the brake warning light also remains illuminated with parking brake released. (If your brake warning lamp illuminates, have your vehicle serviced immediately.)

BRAKE

Using ABS

- In an emergency or when maximum efficiency from the four-wheel ABS is required, apply continuous force on the brake. The four wheel ABS will be activated immediately, thus allowing you to retain full steering control of your vehicle and, providing there is sufficient space, will enable you to avoid obstacles and bring the vehicle to a controlled stop.
- The anti-lock system does not reduce stopping distance. Always leave enough room between your vehicle and the vehicle in front of you to stop.
- We recommend that you familiarize yourself with this braking technique. However, avoid taking any unnecessary risks.

Brake Assist (if equipped as part of the AdvanceTrac™ system)

The Brake Assist system provides full braking force during panic braking situations. It detects a rapid application of the brake pedal and maximizes the amount of brake booster assist, helping the driver to achieve maximum braking pressure. Once a panic brake application is detected, the system will remain activated as long as the brake pedal is depressed. The system is deactivated by releasing the brake pedal.

When the system activates, the brake pedal will travel with very little effort; this is normal.

Parking brake (P)

Apply the parking brake whenever the vehicle is parked. To set the parking brake, press the parking brake pedal down until the pedal stops.

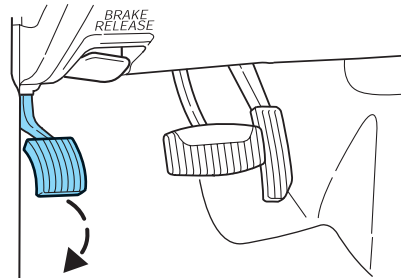

The BRAKE warning lamp in the instrument cluster illuminates and remains illuminated (when the ignition is turned ON) until the parking brake is released.

BRAKE
(!)

 Always set the parking brake fully and make sure that the gearshift is securely latched in P (Park) (automatic transmission) or in 1 (First) (manual transmission).

The parking brake is not recommended to stop a moving vehicle. However, if the normal brakes fail, the parking brake can be used to stop your vehicle in an emergency. Since the parking brake applies only the rear brakes, the vehicle's stopping distance will increase greatly and the handling of your vehicle will be adversely affected.

Driving

Pull the release lever to release the brake. Driving with the parking brake on will cause the brakes to wear out quickly and reduce fuel economy.

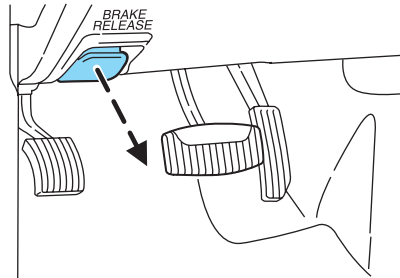

ADVANCETRAC STABILITY ENHANCEMENT SYSTEM (IF EQUIPPED)

The AdvanceTrac™ system provides a stability enhancement feature as well as a traction enhancement feature. It helps your vehicle maintain traction, when driving on slippery and/or hilly road surfaces, by detecting and controlling wheel spin. Excessive wheel spin is controlled by momentarily reducing engine power and rapidly applying the anti-lock brakes. The system is a driver aid which makes your vehicle easier to handle primarily on snow and ice-covered roads.

If your vehicle should become stuck in deep snow or mud, try switching the AdvanceTrac™ system off by pressing the AdvanceTrac™ button. This will allow your tires to “dig” for traction.

If the AdvanceTrac™ system is activated excessively in a short period of time, the brake portion of the system will shut down to allow the brakes to cool down. A limited AdvanceTrac™ function using only engine power reduction will still help control the wheels from over-spinning. When the brakes have cooled down, the system will again function normally. Anti-lock braking is not affected by this condition and will function normally during the cool-down period.

AdvanceTrac™ enhances your vehicle's stability during maneuvers that require all available tire traction, like in wet/snowy/icy road conditions and/or when performing emergency maneuvers. In an emergency lane-change, the driver will experience better overall vehicle traction, and have better control of the vehicle.

The AdvanceTrac™ system helps the driver maintain steering control if the vehicle begins to slide excessively left or right or spin out. AdvanceTrac™ will attempt to correct the sliding motion by applying brake force at individual tires and, if necessary, by reducing engine power.

Driving conditions which may activate AdvanceTrac™ include:

- Taking a turn too fast
- Maneuvering quickly to avoid an accident, pedestrian or obstacle
- Hitting a patch of ice
- Changing lanes on a snow-rutted road
- Entering a snow-free road from a snow-covered side street, or vice versa
- Entering a paved road from a gravel road, or vice versa
- Hitting a curb while turning
- Driving on slick surfaces
- Cornering while towing a heavily loaded trailer (refer to *Trailer Towing* in this chapter)

The AdvanceTrac™ system automatically turns on when the engine is started. However, the system does not function when the vehicle is traveling in R (Reverse) or, if equipped with four-wheel drive, in 4L (4X4 LOW). In R (Reverse) or in 4L (4X4 LOW), ABS and the traction enhancement feature will continue to function.

The AdvanceTrac™ button allows the driver to control the availability of the AdvanceTrac™ system.

AdvanceTrac™ system status is indicated by a warning indicator light with a “sliding car” icon in the instrument cluster that will flash when the system is active and an indicator light in the control button that will illuminate when the system is turned off. In vehicles with a message center, the message “ADVANCETRAC OFF” will be displayed.



If a failure is detected in the AdvanceTrac™ system, the warning indicator light in the instrument cluster will stay on. If the warning indicator light in the instrument cluster remains on while the engine is running, have the system serviced immediately.

Pressing the control once will disable the AdvanceTrac™ stability enhancement and the engine power reduction portion of the traction enhancement feature; the brake portion of the traction enhancement feature will still function normally. Pressing and holding the control for more than five seconds will disable the AdvanceTrac™ stability enhancement **and** traction enhancement feature. If the vehicle is stuck in snow or mud or when driving in deep sand, switching off the AdvanceTrac™ system may be beneficial so the wheels are allowed to

Driving

spin. If your vehicle seems to lose engine power while driving in deep sand or very deep snow, switching off the AdvanceTrac™ stability enhancement feature will restore full engine power and will enhance momentum through the obstacle.

Some drivers may notice a slight movement of the brake pedal when the AdvanceTrac™ performs a system self-check. During AdvanceTrac™ operation you may experience the following:

- A rumble or grinding noise
- A slight deceleration of the vehicle
- The AdvanceTrac™ indicator light will flash
- If your foot is on the brake pedal, you will feel a vibration in the pedal.
- If the driving condition is severe and your foot is not on the brake, the brake pedal will move to apply higher brake forces. You may also hear a whoosh of air from under the instrument panel during this severe condition.

All these conditions are normal during AdvanceTrac™ operation.

Do not alter or modify your vehicle's suspension or steering; the resulting changes to the vehicle's handling can adversely affect the AdvanceTrac™ system. Also, do not install a stereo loudspeaker near the rear console or either rear seat. The speaker vibrations can adversely affect the AdvanceTrac™ sensors located in this area.

 Aggressive driving in any road conditions can cause you to lose control of your vehicle increasing the risk of severe personal injury or property damage. The occurrence of an AdvanceTrac™ event is an indication that at least some of the tires have exceeded their ability to grip the road and that you may lose control of the vehicle. If you experience a severe road event, SLOW DOWN.

 If you find yourself regularly experiencing AdvanceTrac™ events, you are driving too fast for conditions, you should reduce your speed, and drive less aggressively. It is always possible to lose control of a vehicle due to inappropriate driving habits under severe conditions. The occurrence of an AdvanceTrac™ event is an indication that at least some of the tires have exceeded their ability to grip the road; this may cause you to lose control of the vehicle increasing the risk of severe personal injury or property damage.

STEERING

Your vehicle is equipped with power steering. Power steering uses energy from the engine to decrease the driver's effort in steering the vehicle.

To prevent damage to the power steering pump:

- Never hold the steering wheel to the extreme right or the extreme left for more than a few seconds when the engine is running.
- Do not operate the vehicle with the power steering pump fluid level below the MIN mark on the reservoir.

If the power steering system breaks down (or if the engine is turned off), you can steer the vehicle manually, but it takes more effort.

If the steering wanders or pulls, the condition could be caused by any of the following:

- Underinflated tire(s) on any wheel(s)
- Uneven vehicle loading
- High crown in center of road
- High crosswinds
- Wheels out of alignment
- Loose or worn suspension components

PREPARING TO DRIVE YOUR VEHICLE



Utility vehicles have a significantly higher rollover rate than other types of vehicles.



In a rollover crash, an unbelted person is significantly more likely to die than a person wearing a seat belt.

Your vehicle has special design and equipment features to make it capable of performing in a wide variety of circumstances. These special design features, such as larger tires and increased ground clearance, give the vehicle a higher center of gravity than a passenger car.



Vehicles with a higher center of gravity such as utility and four-wheel drive vehicles handle differently than vehicles with a lower center of gravity. Utility and four-wheel drive vehicles are **not** designed for cornering at speeds as high as passenger cars any more than low-slung sports cars are designed to perform satisfactorily under off-road conditions. Avoid sharp turns, excessive speed and abrupt maneuvers in these vehicles. Failure to drive cautiously could result in an increased risk of vehicle rollover, personal injury and death.

Driving



Loaded vehicles, with a higher center of gravity, may handle differently than unloaded vehicles. Extra precautions, such as slower speeds and increased stopping distance, should be taken when driving a heavily loaded vehicle.

Your vehicle has the capability to haul more cargo and people than most passenger cars. Depending upon the type and placement of the load, hauling people and cargo may raise the center of gravity of the vehicle.

Use extra caution while becoming familiar with your vehicle. Know the capabilities and limitations of both you as a driver and your vehicle.

AUTOMATIC TRANSMISSION OPERATION (IF EQUIPPED)

Brake-shift interlock

This vehicle is equipped with a brake-shift interlock feature that prevents the gearshift lever from being moved from P (Park) when the ignition is in the ON position unless brake pedal is depressed.

If you cannot move the gearshift lever out of P (Park) with ignition in the ON position and the brake pedal depressed:

1. Apply the parking brake, turn ignition key to LOCK, then remove the key.
2. Locate the access cover plate to the brake-shift interlock override. It is located on the underside of the steering column.

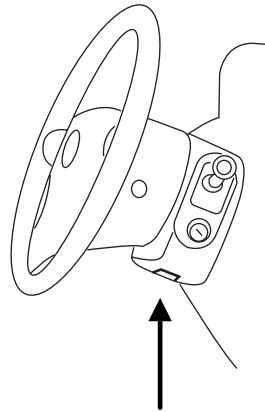

Driving

3. Rotate the access panel (counterclockwise) with a flat head screw driver until it is lined up to the access hole in the open position.

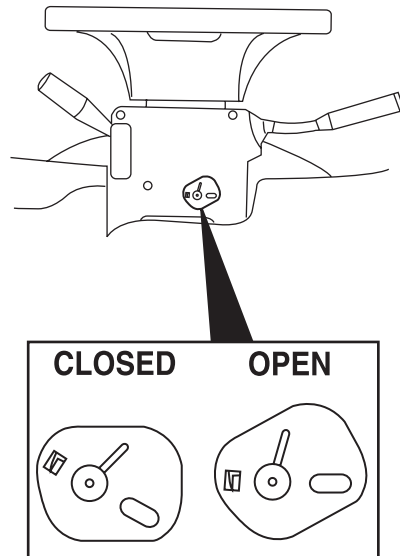

4. Insert a tool (or screw driver) into the access hole to override the brake-shift interlock. Apply the brake and shift into Neutral.

5. Return the cover plate (rotate clockwise) to the closed position. Start the vehicle.

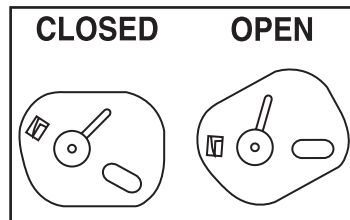

If it is necessary to use the above procedure to move the gearshift lever, it is possible that a fuse has blown or the vehicle's brakelamps are not operating properly. Refer to *Fuses and relays* in the *Roadside emergencies* chapter.



Do not drive your vehicle until you verify that the brakelamps are working.

Driving

If your vehicle gets stuck in mud or snow it may be rocked out by shifting between forward and reverse gears, stopping between shifts, in a steady pattern. Press lightly on the accelerator in each gear.

Do not rock the vehicle if the engine is not at normal operating temperature or damage to the transmission may occur.

Do not rock the vehicle for more than a few minutes or damage to the transmission and tires may occur or the engine may overheat.



Always set the parking brake fully and make sure the gearshift is latched in P (Park). Turn the ignition to the LOCK position and remove the key whenever you leave your vehicle.



If the parking brake is fully released, but the brake warning lamp remains illuminated, the brakes may not be working properly. See your dealer or a qualified service technician.

Driving with a 5-speed automatic transmission

Your automatic transmission electronically controls the shift feel by using an adaptive learning strategy. This feature is designed to increase durability, and provide consistent shift feel over the life of the vehicle. It is normal for a new transmission to shift firmly. This operation is considered normal and will not affect function or durability of the transmission. Once the vehicle is at operating temperature it may take several shifts at the same operating condition for the transmission to properly adapt. Over time the adaptive learning process will fully update transmission operation. The more varied the driving habits, speed and torque, the longer it may take to adapt but the more complete the process will be.

When the battery is disconnected or a new battery installed, the transmission must relearn its adaptive strategy. As a result of this, the transmission may shift firmly. This operation is considered normal and will fully update transmission operation to its optimum shift feel.

Understanding gearshift lever positions



Hold the brake pedal down while you move the gearshift lever from P (Park) to another position. If you do not hold the brake pedal down, your vehicle may move unexpectedly and injure someone.

P (Park)

To put your vehicle in gear, start the engine, depress the brake pedal, then move gearshift lever out of P (Park).

Always come to a complete stop before shifting into P (Park). Make sure the gearshift lever is securely latched in P (Park). This position locks the transmission and prevents the rear wheels from turning.



Always set the parking brake fully and make sure the gearshift is latched in P (Park). Turn the ignition to the LOCK position and remove the key whenever you leave your vehicle.

R (Reverse)

With the gearshift lever in R (Reverse), the vehicle will move backward. Always come to a complete stop before shifting into and out of R (Reverse).



N (Neutral)

With the gearshift lever in N (Neutral), the vehicle can be started and is free to roll. Hold the brake pedal down while in this position.



D (Overdrive)

The normal driving position for the best fuel economy. Transmission operates in gears one through five. D (Overdrive) can be deactivated by pressing the transmission control switch on the end of the gearshift lever.

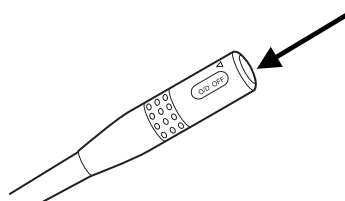

The transmission control indicator light (TCIL) will illuminate on the instrument cluster.

O/D
OFF

Driving

Drive (overdrive deactivated)

Activate by pressing the transmission control switch on the end of the gearshift lever with the gearshift lever in the D(Drive) position. The transmission with overdrive off operates in gears one through four, providing more engine braking than D(Drive) with Overdrive ON and is useful whenever driving conditions (i.e., city traffic, hilly terrain, etc.) cause the transmission to excessively shift between D (Overdrive) and other gears. Deactivate D (Overdrive) when:

- driving with a heavy load.
- towing a trailer up or down steep hills.
- additional engine braking is desired. If towing a trailer, refer to *Driving while you tow* in the *Trailer Towing* chapter.

To return to D (Overdrive) mode, press the transmission control switch at the end of the gear shift lever. The TCIL will no longer be illuminated.

Each time the vehicle is started, the transmission will automatically return to normal D (Overdrive) mode.

3 (Third)

Transmission operates in third gear only.

Used for improved traction on slippery roads. Selecting 3 (Third) provides engine braking.

2 (Second)

Use 2 (Second) to start-up on slippery roads or to provide additional engine braking on downgrades.

1 (First)

Use 1 (First) to provide maximum engine braking on steep downgrades. Upshifts can be made by shifting to 2 (Second) or to (Overdrive). Selecting 1 (Low) at higher speeds causes the transmission to shift to a lower gear and will shift to 1 (First) after the vehicle decelerates to the proper vehicle speed.

P RND321

P RND321

P RND321

P RND321

Forced Downshifts

To gain acceleration in (Overdrive) or Drive (O/D OFF) when passing another vehicle, push the accelerator to the floor. The transmission will downshift to the appropriate gear: fourth, third, second or first gear.

Manual transmission operation (if equipped)

Using the clutch

Vehicles equipped with a manual transmission have a starter interlock that prevents starting the engine unless the clutch pedal is fully depressed.

When starting a vehicle with a manual transmission:

1. Hold down the brake pedal.
2. Put the gearshift lever in N (Neutral).
3. Depress the clutch pedal.
4. Start the engine and let it idle for a few seconds.
 - Put the gearshift lever in 1 (First) or R (Reverse).
5. Move foot from brake to accelerator and begin to release the clutch slowly while gradually pressing down on the accelerator.
 - Do not drive with your foot resting on the clutch pedal. Do not use the clutch to hold your vehicle at a standstill while waiting on a hill. These actions may reduce clutch life.

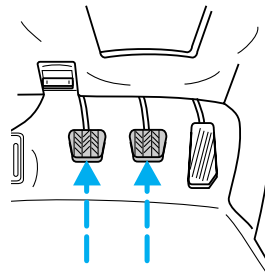

Parking

1. Apply the brake and shift into N (Neutral).

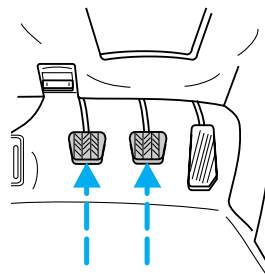

Driving

- Engage the parking brake.

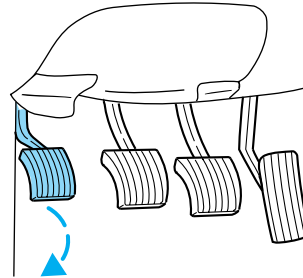

- Shift into 1 (First).
- Turn the ignition to Off.



Do not park your vehicle in Neutral, it may move unexpectedly and injure someone. Use 1 (First) gear and set the parking brake fully.

Recommended shift speeds

Upshifts when accelerating (recommended for best fuel economy)		
Shift from:	Transfer case position (if equipped)	
	AUTO or HIGH	LOW
1 - 2	14 km/h (9 mph)	5 km/h (3 mph)
2 - 3	32 km/h (20 mph)	11 km/h (7 mph)
3 - 4	50 km/h (31 mph)	19 km/h (12 mph)
4 - 5 (Overdrive)	71 km/h (44 mph)	27 km/h (17 mph)

Upshifts when cruising (recommended for best fuel economy)		
Shift from:	Transfer case position (if equipped)	
	AUTO or HIGH	LOW
1 - 2	16 km/h (10 mph)	6 km/h (4 mph)
2 - 3	26 km/h (16 mph)	10 km/h (6 mph)
3 - 4	43 km/h (27 mph)	16 km/h (10 mph)
4 - 5 (Overdrive)	68 km/h (42 mph)	26 km/h (16 mph)

Driving

Maximum downshift speeds		
Shift from:	Transfer case position (if equipped)	
	AUTO or HIGH	LOW
5 (Overdrive) - 4	88 km/h (55 mph)	34 km/h (21 mph)
4 - 3	72 km/h (45 mph)	27 km/h (17 mph)
3 - 2	56 km/h (35 mph)	21 km/h (13 mph)
2 - 1	32 km/h (20 mph)	11 km/h (7 mph)

Reverse

Ensure that the vehicle is at a complete stop before shifting into R (Reverse). Failure to do so may damage the transmission.

Put the gearshift lever into N and wait at least several seconds before shifting into R.

You can shift into R (Reverse) only by moving the gearshift lever from left of 3 (Third) and 4 (Fourth) gears before you shift into R (Reverse). This is a special lockout feature that protects you from accidentally shifting into R (Reverse) when you downshift from 5 (Overdrive).

FOUR-WHEEL DRIVE (4WD) OPERATION (IF EQUIPPED)



For important information regarding safe operation of this type of vehicle, see **Preparing to drive your vehicle** in this chapter.

When Four-wheel drive (4WD) is engaged, power is supplied to all four wheels through a transfer case. 4WD power can be selected when additional driving power is desired.

If equipped with the Electronic Shift 4WD System, and the 4x4 Low button is pressed while the vehicle is moving, the system will not engage and no damage will occur to the 4WD system.

4x4 High and 4x4 Low operation is not recommended on dry pavement. Doing so could result in difficult disengagement of the transfer case, increased tire wear and decreased fuel economy.

Control-Trac automatic four-wheel drive system

The 4WD system uses all four wheels to power the vehicle. This increases traction, enabling you to drive your 4x4 over terrain and road conditions not normally traveled by two-wheel drive vehicles.

Power is supplied to all four wheels through a transfer case that allows you to select a four-wheel drive mode best suited for your current driving conditions.

Driving

Positions of the Control-Trac system

The Control-Trac system functions in three modes:

- The 4x4 Auto mode provides four-wheel drive with full power delivered to the rear axle, and to the front axle as required for increased traction. This is appropriate for normal on-road operating conditions, such as dry road surfaces, wet pavement, snow and gravel.
- The 4x4 High mode provides four-wheel drive with full power to both axles. It is only intended for severe winter or off-road conditions, such as deep snow and ice (where no dry or wet pavement remains uncovered), and shallow sand.

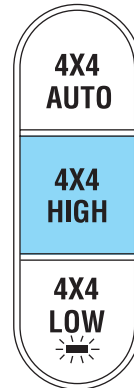

Driving

- The 4x4 Low mode supplies four-wheel drive with full power to both axles and includes a lower gear ratio for low-speed. It is only intended for off-road applications that require extra power including deep sand, steep grades and pulling a boat and trailer out of the water.



The vehicle should not be operated in 4x4 High and 4x4 Low on dry or merely wet pavement. Doing so will produce excessive noise, increase tire wear and may damage driveline components. These modes are intended for use only on consistently slippery or loose surfaces.



If your vehicle is equipped with 4WD, a spare tire of a different size than the road tires should never be used. Such a tire could make the vehicle difficult to control and as well as result in damage to driveline components.



Vehicles with a higher center of gravity such as utility and four-wheel drive vehicles handle differently than vehicles with a lower center of gravity. Utility and four-wheel drive vehicles are **not** designed for cornering at speeds as high as passenger cars any more than low-slung sports cars are designed to perform satisfactorily under off-road conditions. Avoid sharp turns, excessive speed and abrupt maneuvers in these vehicles. Failure to drive cautiously could result in an increased risk of vehicle rollover, personal injury and death.

Driving

Using the Control Trac 4WD system



4X4 AUTO - Power to all four wheels; used for normal street and highway driving.

4X4 HIGH (4WD High) - Used for extra traction such as in snow or icy roads or in off-road situations. Not intended for use on dry pavement.

4X4 LOW (4WD Low) - Uses extra gearing to provide maximum power to all four wheels. Intended only for off-road applications such as deep sand, steep grades or pulling heavy objects. 4X4 LOW (4WD Low) will not engage while the vehicle is moving; this is normal and should be no reason for concern. Refer to *Shifting to/from 4X4 LOW (4WD Low)* for proper operation.

Using the Control Trac system

Shifting between 4x4 Auto and 4x4 High

When you press the 4x4 High button, the indicator light will illuminate in the instrument cluster. When you press the 4x4 Auto button, the indicator light will turn off.

Either shift can be done at a stop or while driving at any speed.

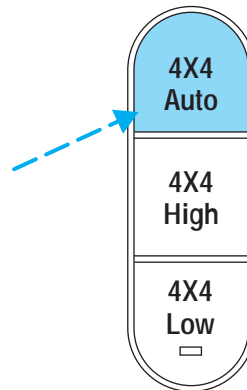

Shifting from 4x4 Auto or 4x4 High to 4x4 Low

1. Bring the vehicle to a stop.
2. Depress the brake.
3. Place the gearshift in N (Neutral) (automatic transmission) or depress the clutch (manual transmission).
4. Press the 4x4 Low button. When engaged the 4x4 Low instrument cluster light and the 4x4 Low button will illuminate.

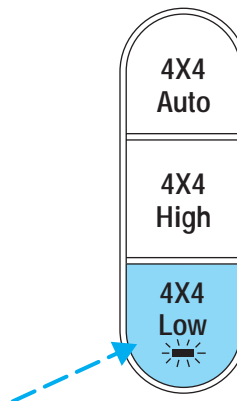

The 4X4 LOW button will flash if:

1. The system is waiting for driver input (brake and/or neutral gear). OR
2. There is a 4X4 low shift in progress.

If the driver inputs are not engaged, the button selection will time-out and the 4X4 system will remain in its current mode.

Driving

Shifting from 4x4 Low to 4x4 Auto or 4x4 High

1. Bring the vehicle to a stop.
2. Depress the brake.
3. Place the gearshift in N (Neutral) (automatic transmission) or depress the clutch (manual transmission).
4. Press the 4x4 Auto or the 4x4 High button. When 4x4 Auto is engaged NO indicator lights will illuminate. When 4x4 High is engaged the 4x4 High instrument cluster light will illuminate.

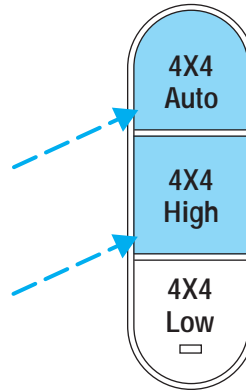

The 4X4 LOW button will flash if:

1. The system is waiting for driver input (brake and/or neutral gear). OR
2. There is a 4X4 low shift in progress.

If the driver inputs are not engaged, the button selection will time-out and the 4X4 system will remain in its current mode.

Driving off-road with truck and utility vehicles

4WD vehicles are specially equipped for driving on sand, snow, mud and rough terrain and have operating characteristics that are somewhat different from conventional vehicles, both on and off the road.

How your vehicle differs from other vehicles

Truck and utility vehicles can differ from some other vehicles. Your vehicle may be higher to allow it to travel over rough terrain without getting hung up or damaging underbody components.

The differences that make your vehicle so versatile also make it handle differently than an ordinary passenger car.

Maintain steering wheel control at all times, especially in rough terrain. Since sudden changes in terrain can result in abrupt steering wheel motion, make sure you grip the steering wheel from the outside. Do not grip the spokes.

Drive cautiously to avoid vehicle damage from concealed objects such as rocks and stumps.

You should either know the terrain or examine maps of the area before driving. Map out your route before driving in the area. To maintain

Driving

steering and braking control of your vehicle, you must have all four wheels on the ground and they must be rolling, not sliding or spinning.

Basic operating principles

- Do not use 4WD on dry, hard surfaced roads. Doing so will produce excessive noise, increase tire wear and may damage drive components. 4WD modes are only intended for consistently slippery or loose surfaces.
- Drive slower in strong crosswinds which can affect the normal steering characteristics of your vehicle.
- Be extremely careful when driving on pavement made slippery by loose sand, water, gravel, snow or ice.

If your vehicle goes off the edge of the pavement

- If your vehicle goes off the edge of the pavement, slow down, but avoid severe brake application, Ease the vehicle back onto the pavement only after reducing your speed. Do not turn the steering wheel too sharply while returning to the road surface.
- It may be safer to stay on the apron or shoulder of the road and slow down gradually before returning to the pavement. You may lose control if you do not slow down or if you turn the steering wheel too sharply or abruptly.



Vehicles with a higher center of gravity such as utility and four-wheel drive vehicles handle differently than vehicles with a lower center of gravity. Utility and four-wheel drive vehicles are **not** designed for cornering at speeds as high as passenger cars any more than low-slung sports cars are designed to perform satisfactorily under off-road conditions. Avoid sharp turns, excessive speed and abrupt maneuvers in these vehicles. Failure to drive cautiously could result in an increased risk of vehicle rollover, personal injury and death.

If your vehicle gets stuck

If your vehicle gets stuck in mud or snow it may be rocked out by shifting between forward and reverse gears, stopping between shifts, in a steady pattern. Press lightly on the accelerator in each gear.

Do not rock the vehicle if the engine is not at normal operating temperature or damage to the transmission may occur.

Do not rock the vehicle for more than a few minutes or damage to the transmission and tires may occur or the engine may overheat.

Driving

 Always set the parking brake fully and make sure the gearshift is latched in P (Park). Turn the ignition to the LOCK position and remove the key whenever you leave your vehicle.

 If the parking brake is fully released, but the brake warning lamp remains illuminated, the brakes may not be working properly. See your dealer or a qualified service technician.

 Do not spin the wheels at over 56 km/h (35 mph). The tires may fail and injure a passenger or bystander.

Emergency maneuvers

- In an unavoidable emergency situation where a sudden sharp turn must be made, remember to avoid “over-driving” your vehicle, i.e., turn the steering wheel only as rapidly and as far as required to avoid the emergency. Excessive steering will result in less vehicle control, not more. Additionally, smooth variations of the accelerator and/or brake pedal pressure should be utilized if changes in vehicle speed are called for. Avoid abrupt steering, acceleration or braking. Use all available road surface to return the vehicle to a safe direction of travel.
- In the event of an emergency stop, avoid skidding the tires and do not attempt any sharp steering wheel movements.

 Vehicles with a higher center of gravity such as utility and four-wheel drive vehicles handle differently than vehicles with a lower center of gravity. Utility and four-wheel drive vehicles are **not** designed for cornering at speeds as high as passenger cars any more than low-slung sports cars are designed to perform satisfactorily under off-road conditions. Avoid sharp turns, excessive speed and abrupt maneuvers in these vehicles. Failure to drive cautiously could result in an increased risk of vehicle rollover, personal injury and death.

- If the vehicle goes from one type of surface to another (i.e., from concrete to gravel) there will be a change in the way the vehicle responds to a maneuver (steering, acceleration or braking). Again, avoid these abrupt inputs.

Parking

On some 4WD vehicles, when the transfer case is in the N (Neutral) position, the engine and transmission are disconnected from the rest of

the driveline. Therefore, the vehicle is free to roll even if the automatic transmission is in P (Park) or the manual transmission is in gear. Do not leave the vehicle unattended with the transfer case in N (Neutral) position. Always set the parking brake fully and turn off the ignition when leaving the vehicle.

4WD Systems

4WD (when you select a 4WD mode) uses all four wheels to power the vehicle. This increases traction, enabling you to drive over terrain and road conditions that a conventional two-wheel drive vehicle can't.

Power is supplied to all four wheels through a transfer case. On 4WD vehicles, the transfer case allows you to select 4WD when necessary. Information on transfer case operation and shifting procedures can be found in the *Driving* chapter. Information on transfer case maintenance can be found in the *Maintenance and specifications* chapter. You should become thoroughly familiar with this information before you operate your vehicle.

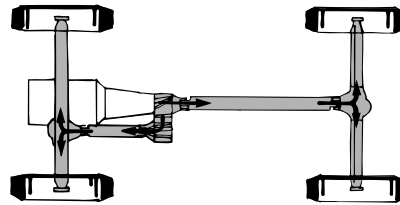

Normal characteristics

On some 4WD models, the initial shift from two-wheel drive to 4x4 while the vehicle is moving can cause some momentary clunk and ratcheting sounds. This is the front drivetrain coming up to speed and the automatic locking hubs engaging and is not cause for concern.

Sand

When driving over sand, try to keep all four wheels on the most solid area of the trail. Avoid reducing the tire pressures but shift to a lower gear and drive steadily through the terrain. Apply the accelerator slowly and avoid spinning the wheels.

If you must reduce the tire pressure for whatever reason in sand, make sure you re-inflate the tires as soon as possible.

Avoid excessive speed because vehicle momentum can work against you and cause the vehicle to become stuck to the point that assistance may be required from another vehicle. Remember, you may be able to back out the way you came if you proceed with caution.

Driving

Mud and water

If you must drive through high water, drive slowly. Traction or brake capability may be limited.

When driving through water, determine the depth; avoid water higher than the bottom of the hubs (if possible) and proceed slowly. If the ignition system gets wet, the vehicle may stall.

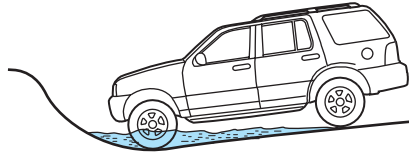

Once through water, always try the brakes. Wet brakes do not stop the vehicle as effectively as dry brakes. Drying can be improved by moving your vehicle slowly while applying light pressure on the brake pedal.

Be cautious of sudden changes in vehicle speed or direction when you are driving in mud. Even 4WD vehicles can lose traction in slick mud. As when you are driving over sand, apply the accelerator slowly and avoid spinning your wheels. If the vehicle does slide, steer in the direction of the slide until you regain control of the vehicle.

If the transmission, transfer case or front axle are submerged in water, their fluids should be checked and changed, if necessary.

Driving through deep water may damage the transmission.

If the front or rear axle is submerged in water, the axle lubricant should be replaced.

After driving through mud, clean off residue stuck to rotating driveshafts and tires. Excess mud stuck on tires and rotating driveshafts causes an imbalance that could damage drive components.

“Tread Lightly” is an educational program designed to increase public awareness of land-use regulations and responsibilities in our nation's wilderness areas. Ford Motor



Company joins the U.S. Forest Service and the Bureau of Land Management in encouraging you to help preserve our national forest and other public and private lands by “treading lightly.”

Driving on hilly or sloping terrain

Although natural obstacles may make it necessary to travel diagonally up or down a hill or steep incline, you should always try to drive straight up or straight down. **Avoid driving crosswise or turning on steep slopes or hills.** A danger lies in losing traction, slipping sideways and

Driving

possibly rolling over. Whenever driving on a hill, determine beforehand the route you will use. Do not drive over the crest of a hill without seeing what conditions are on the other side. Do not drive in reverse over a hill without the aid of an observer.

When climbing a steep slope or hill, start in a lower gear rather than downshifting to a lower gear from a higher gear once the ascent has started. This reduces strain on the engine and the possibility of stalling.

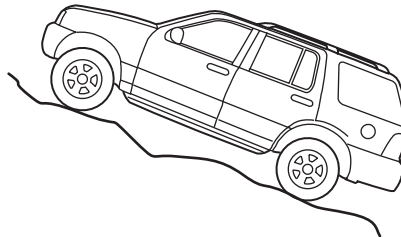

If you do stall out, do not try to turn around because you might roll over. It is better to back down to a safe location.

Apply just enough power to the wheels to climb the hill. Too much power will cause the tires to slip, spin or lose traction, resulting in loss of vehicle control.

Descend a hill in the same gear you would use to climb up the hill to avoid excessive brake application and brake overheating. Do not descend in neutral, disengage overdrive or manually shift to a lower gear. When descending a steep hill, avoid sudden hard braking as you could lose control. When you brake hard, the front wheels can't turn and if they aren't turning, you won't be able to steer.

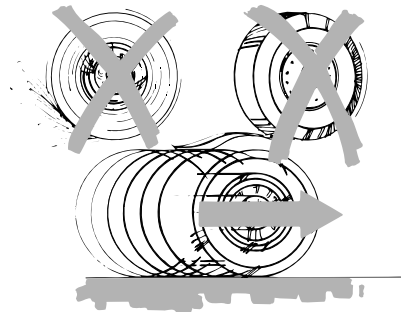

The front wheels have to be turning in order to steer the vehicle. Rapid pumping of the brake pedal will help you slow the vehicle and still maintain steering control.

If your vehicle has anti-lock brakes, apply the brakes steadily. Do not "pump" the brakes.

Driving on snow and ice

4WD vehicles have advantages over 2WD vehicles in snow and ice but can skid like any other vehicle.

Should you start to slide while driving on snowy or icy roads, turn the steering wheel in the direction of the slide until you regain control.

Driving

Avoid sudden applications of power and quick changes of direction on snow and ice. Apply the accelerator slowly and steadily when starting from a full stop.

Avoid sudden braking as well. Although a 4WD vehicle may accelerate better than a two-wheel drive vehicle in snow and ice, it won't stop any faster, because as in other vehicles, braking occurs at all four wheels. Do not become overconfident as to road conditions.

Make sure you allow sufficient distance between you and other vehicles for stopping as well as drive slower than usual and consider using one of the lower gears. In emergency stopping situations, avoid locking of the wheels. Use a "squeeze" technique, push on the brake pedal with a steadily increasing force which allows the wheels to brake yet continue to roll so that you may steer in the direction you want to travel. If you lock the wheels, release the brake pedal and repeat the squeeze technique. If your vehicle is equipped with a Four Wheel Anti-Lock Brake System (ABS), apply the brake steadily. Do not "pump" the brakes. Refer to the *Brakes* section of this chapter for additional information on the operation of the anti-lock brake system.

Never drive with chains on the front tires of 4WD vehicles without also putting them on the rear tires. This could cause the rear to slide and swing around during braking.

Tires, Replacement Requirements



Do not use a size and type of tire and wheel other than that originally provided by Ford Motor Company because it can affect the safety and performance of your vehicle, which could result in an increased risk of loss of vehicle control, vehicle rollover, personal injury or death.

Make sure all tires and wheels on the vehicle are of the same size, type, tread design, brand and load-carrying capacity. If you have questions regarding tire replacement, see an authorized Ford or Lincoln/Mercury dealer.

If you nevertheless decide to equip your 4WD for off-road use with tires larger than what Ford Motor Company recommends, you should not use these tires for highway driving.

If you use any tire/wheel combination not recommended by Ford Motor Company, it may adversely affect vehicle handling and could cause steering, suspension, axle or transfer case failure.

Do not use "aftermarket lift kits" or other suspension modifications, whether or not they are used with larger tires and wheels.

Driving

These “aftermarket lift kits” could adversely affect the vehicle’s handling characteristics, which could lead to loss of vehicle control or roll over and serious injury.

Tires can be damaged during off-road use. For your safety, tires that are damaged should not be used for highway driving because they are more likely to blow out or fail.

You should carefully observe the recommended tire inflation pressure found on the safety compliance certification label attached to the left front door lock facing or door latch post pillar. Failure to follow tire pressure recommendations can adversely affect the way your vehicle handles. Do not exceed the Ford Motor Company recommended pressure even if it is less than the maximum pressure allowed for the tire.

Each day before you drive, check your tires. If one looks lower than the others, use a tire gauge to check pressure of all tires, and adjust if required. Check tire pressure with a tire gauge every few weeks (including spare). Safe operation requires tires that are neither underinflated nor overloaded.

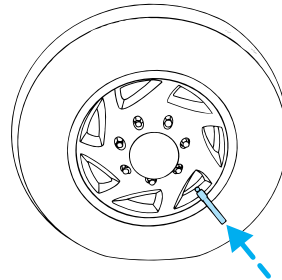

Periodically inspect the tire treads and remove stones, nails, glass or other objects that may be wedged in the tread grooves. Check for holes or cuts that may permit air leakage from the tire and make necessary repairs.

Inspect the tire side walls for cuts, bruises and other damage. If internal damage to the tire is suspected, have the tire demounted and inspected in case it needs to be repaired or replaced.

Maintenance and Modifications

The suspension and steering systems on your vehicle have been designed and tested to provide both reliable and reasonably predictable performance whether loaded or empty and durable load carrying capability. For this reason, Ford Motor Company strongly recommends that you do not make modifications such as adding or removing parts (such as lift kits or stabilizer bars) or by using replacement parts not equivalent to the original factory equipment.

Any modifications to a vehicle that raise the center of gravity can make it more likely the vehicle will roll over as a result of a loss of control.

Driving

Ford Motor Company recommends that caution be used with any vehicle equipped with a high load or device (such as ladder racks or pickup box cover).

Failure to maintain your vehicle properly may void the warranty, increase your repair cost, reduce vehicle performance and operational capabilities and adversely affect driver and passenger safety. Frequent inspection of vehicle chassis components is recommended if the vehicle is subjected to heavy off-road usage.

LIMITED-SLIP AXLE (IF EQUIPPED)

This axle provides added traction on slippery surfaces, particularly when one wheel is on a poor traction surface. Under normal conditions, the limited slip axle functions like a standard rear axle.

Extended use of other than the manufacturer's specified size tires on a limited slip rear axle could result in a permanent reduction in effectiveness. This loss of effectiveness does not affect normal driving and should not be noticeable to the driver.



To reduce the risk of injury, never run the engine with one wheel off the ground, such as when changing a tire.

VEHICLE LOADING

Before loading a vehicle, familiarize yourself with the following terms:

- **Base Curb Weight:** Weight of the vehicle including any standard equipment, fluids, lubricants, etc. It does not include occupants or aftermarket equipment.
- **Payload:** Combined maximum allowable weight of cargo, occupants and optional equipment. The payload equals the gross vehicle weight rating minus the weight of your vehicle.
- **GVW (Gross Vehicle Weight):** Base curb weight plus payload weight. The GVW is not a limit or a specification.
- **GVWR (Gross Vehicle Weight Rating):** Maximum permissible total weight of the base vehicle, occupants, optional equipment and cargo. The GVWR is specific to each vehicle and is listed on the Safety Certification Label on the driver's door pillar.
- **GAWR (Gross Axle Weight Rating):** Carrying capacity for each axle system. The GAWR is specific to each vehicle and is listed on the Safety Certification Label on the driver's door pillar.
- **GCW (Gross Combined Weight):** The combined weight of the towing vehicle (including occupants and cargo) and the loaded trailer.

Driving

- **GCWR (Gross Combined Weight Rating):** Maximum permissible combined weight of towing vehicle (including occupants and cargo) and the loaded trailer.
- **Maximum Trailer Weight Rating:** Maximum weight of a trailer the vehicle is permitted to tow. The maximum trailer weight rating is determined by subtracting the vehicle curb weight for each engine/transmission combination, any required option weight for trailer towing and the weight of the driver from the GCWR for the towing vehicle.
- **Maximum Trailer Weight:** Maximum weight of a trailer the loaded vehicle (including occupants and cargo) is permitted to tow. It is determined by subtracting the weight of the loaded trailer towing vehicle from the GCWR for the towing vehicle.
- **Trailer Weight Range:** Specified weight range that the trailer must fall within that ranges from zero to the maximum trailer weight rating.

Remember to figure in the tongue load of your loaded trailer when figuring the total weight.



Do not exceed the GVWR or the GAWR specified on the certification label.

Do not use replacement tires with lower load carrying capacities than the originals because they may lower the vehicle's GVWR and GAWR limitations. Replacement tires with a higher limit than the originals do not increase the GVWR and GAWR limitations.

The Safety Certification Label, found on the driver's door pillar, lists several important vehicle weight rating limitations. Before adding any additional equipment, refer to these limitations. If you are adding weight to the front of your vehicle, (potentially including weight added to the cab), the weight added should not exceed the front gross axle weight rating (FGAWR). Additional frontal weight may be added to the front axle reserve capacity provided you limit your payload in other ways (i.e. restrict the number of occupants or amount of cargo carried).

Always ensure that the weight of occupants, cargo and equipment being carried is within the weight limitations that have been established for your vehicle including both gross vehicle weight and front and rear gross axle weight rating limits. Under no circumstance should these limitations be exceeded.

Driving



Exceeding any vehicle weight rating limitation could result in serious damage to the vehicle and/or personal injury.

Special loading instructions for owners of pickup trucks and utility-type vehicles



For important information regarding safe operation of this type of vehicle, see the *Preparing to drive your vehicle* section in this chapter.



Loaded vehicles, with a higher center of gravity, may handle differently than unloaded vehicles. Extra precautions, such as slower speeds and increased stopping distance, should be taken when driving a heavily loaded vehicle.

Your vehicle has the capability to haul more cargo and people than most passenger cars. Depending upon the type and placement of the load, hauling cargo and people may raise the center of gravity of the vehicle.

Calculating the load your vehicle can carry/tow

1. Use the appropriate maximum gross combined weight rating (GCWR) chart (in the *Trailer Towing* section) to find the maximum GCWR for your type engine and rear axle ratio.
2. Weigh your vehicle as you customarily operate the vehicle without cargo. To obtain correct weights, try taking your vehicle to a shipping company or an inspection station for trucks.
3. Subtract your loaded vehicle weight from the maximum GCWR on the following charts. This is the maximum trailer weight your vehicle can tow and must fall below the maximum shown under maximum trailer weight on the chart.

DRIVING THROUGH WATER

Do not drive quickly through standing water, especially if the depth is unknown. Traction or brake capability may be limited and if the ignition system gets wet, your engine may stall. Water may also enter your engine's air intake and severely damage your engine.

If driving through deep or standing water is unavoidable, proceed very slowly. Never drive through water that is higher than the bottom of the hubs (for trucks) or the bottom of the wheel rims (for cars).

Once through the water, always try the brakes. Wet brakes do not stop the vehicle as effectively as dry brakes. Drying can be improved by moving your vehicle slowly while applying light pressure on the brake pedal.

Driving through deep water where the transmission vent tube is submerged may allow water into the transmission and cause internal transmission damage. Have the fluid checked and, if water is found, replace the fluid.

TRAILER TOWING

Trailer towing with your vehicle may require the use of a trailer tow option package.

Trailer towing puts additional loads on your vehicle's engine, transmission, axle, brakes, tires, and suspension. For your safety and to maximize vehicle performance, be sure to use the proper equipment while towing.

Follow these guidelines to ensure safe towing procedure:

- Stay within your vehicle's load limits.
- Thoroughly prepare your vehicle for towing. Refer to *Preparing to tow* in this chapter.
- Use extra caution when driving while trailer towing. Refer to *Driving while you tow* in this chapter.
- Service your vehicle more frequently if you tow a trailer. Refer to the severe duty schedule in the scheduled maintenance guide.
- Do not tow a trailer until your vehicle has been driven at least 800 km (500 miles).
- Refer to the instructions included with towing accessories for the proper installation and adjustment specifications.

Do not exceed the maximum loads listed on the Safety Compliance Certification label. For load specification terms found on the label, refer to *Vehicle loading* in this chapter. Remember to figure in the tongue load of your loaded vehicle when figuring the total weight.

Your vehicle is equipped with a standard Class II integrated hitch and requires only a draw bar and ball with a 19 mm (3/4 inch) shank diameter. An optional Class III/Class IV hitch is also available.

Note: Do not exceed the GVWR or the GAWR specified on the certification label.

Driving

 Towing trailers beyond the maximum recommended gross trailer weight exceeds the limit of the vehicle and could result in engine damage, transmission damage, structural damage, loss of vehicle control, vehicle rollover, personal injury or death.

Trailer towing table (4x2 w/manual transmission)			
GCWR (Gross Combined Weight Rating)/Trailer weights			
Engine	Rear axle ratio	Maximum GCWR-kg (lbs.)	Trailer weight range-kg (lbs.) (0-Maximum)
4.0L SOHC	3.73 LS	3175 (7000)	0-1179 (0-2600)
<p>Notes: - For high altitude operation, reduce GCW by 2% per 300 meters (1000 ft) elevation. For definitions of terms used in this table and instructions on how to calculate your vehicle load, refer to <i>Vehicle loading</i> in this chapter. Maximum trailer weights shown. The combined weight of the completed towing vehicle and the loaded trailer must not exceed the GCWR.</p> <p>Towing a trailer over 1588 kg (3500 lbs.) requires a weight distributing hitch.</p>			
4x2 w/automatic transmission			
GCWR (Gross Combined Weight Rating)/Trailer Weight			
Engine	Rear axle ratio	Maximum GCWR-kg (lbs.)	Trailer weight range-kg (lbs.) (0-Maximum)
4.0L SOHC/4.6L	3.55	3493 (7700)	0-1497 (0-3300)
4.0L SOHC	3.73 LS	4645 (10240)	0-2640 (0-5820)
4.6L*	3.73 LS	5262 (11600)	0-3257 (0-7180)
<p>Notes: - For high altitude operation, reduce GCW by 2% per 300 meters (1000 ft) elevation. For definitions of terms used in this table and instructions on how to calculate your vehicle load, refer to <i>Vehicle loading</i> in this chapter. Maximum trailer weights shown. The combined weight of the completed towing vehicle and the loaded trailer must not exceed the GCWR.</p>			

Driving

4x2 w/automatic transmission			
GCWR (Gross Combined Weight Rating)/Trailer Weight			
*-When towing maximum loads under high outside temperatures and on steep grades, the A/C system may cycle on and off to protect the engine from overheating. This may result in a temporary increase of interior temperatures.			
Towing a trailer over 1588 kg (3500 lbs.) requires a weight distributing hitch.			
Trailer towing table (4x4 w/manual transmission)			
GCWR (Gross Combined Weight Rating)/Trailer weights			
Engine	Rear axle ratio	Maximum GCWR-kg (lbs.)	Trailer weight range-kg (lbs.) (0-Maximum)
4.0L SOHC	3.73 LS	3175 (7000)	0- 1089 (0-2400)
Notes: - For high altitude operation, reduce GCW by 2% per 300 meters (1000 ft) elevation. For definitions of terms used in this table and instructions on how to calculate your vehicle load, refer to <i>Vehicle loading</i> in this chapter. Maximum trailer weights shown. The combined weight of the completed towing vehicle and the loaded trailer must not exceed the GCWR.			
Towing a trailer over 1588 kg (3500 lbs.) requires a weight distributing hitch.			
4x4 w/automatic transmission			
GCWR (Gross Combined Weight Rating)/Trailer Weight			
Engine	Rear axle ratio	Maximum GCWR-kg (lbs.)	Trailer weight range-kg (lbs.) (0-Maximum)
4.0L SOHC/4.6L	3.55	3629 (8000)	0-1542 (0-3400)
4.0L SOHC	3.73 LS	4536 (10000)	0-2440 (0-5380)
4.6L*	3.73 LS	5262 (11600)	0-3166 (0-6980)

Driving

4x4 w/automatic transmission			
GCWR (Gross Combined Weight Rating)/Trailer Weight			
Engine	Rear axle ratio	Maximum GCWR-kg (lbs.)	Trailer weight range-kg (lbs.) (0-Maximum)
<p>Notes: - For high altitude operation, reduce GCW by 2% per 300 meters (1000 ft) elevation. For definitions of terms used in this table and instructions on how to calculate your vehicle load, refer to <i>Vehicle loading</i> in this chapter. Maximum trailer weights shown. The combined weight of the completed towing vehicle and the loaded trailer must not exceed the GCWR.</p> <p>*-When towing maximum loads under high outside temperatures and/or on steep grades, the A/C system may cycle on and off to protect the engine from overheating. This may result in a temporary increase of interior temperatures.</p> <p>Towing a trailer over 1588 kg (3500 lbs.) requires a weight distributing hitch.</p>			
Trailer towing table (4x4 w/manual transmission)			
GCWR (Gross Combined Weight Rating)/Trailer weights			
Engine	Rear axle ratio	Maximum GCWR-kg (lbs.)	Trailer weight range-kg (lbs.) (0-Maximum)
4.0L SOHC	3.73	3175 (7000)	0- 1089 (0-2400)
<p>Notes: - For high altitude operation, reduce GCW by 2% per 300 meters (1000 ft) elevation. For definitions of terms used in this table and instructions on how to calculate your vehicle load, refer to <i>Vehicle loading</i> in this chapter. Maximum trailer weights shown. The combined weight of the completed towing vehicle and the loaded trailer must not exceed the GCWR.</p>			

Preparing to tow

Use the proper equipment for towing a trailer, and make sure it is properly attached to your vehicle. See your dealer or a reliable trailer dealer if you require assistance.

Hitches

Do not use hitches that clamp onto the vehicle bumper. Use a load carrying hitch. You must distribute the load in your trailer so that 10–15% of the total weight of the trailer is on the tongue.

Safety chains

Always connect the trailer's safety chains to the frame or hook retainers of the vehicle hitch. To connect the trailer's safety chains, cross the chains under the trailer tongue and allow slack for turning corners.

If you use a rental trailer, follow the instructions that the rental agency gives to you.

Do not attach safety chains to the bumper.

Trailer brakes

Electric brakes and manual, automatic or surge-type trailer brakes are safe if installed properly and adjusted to the manufacturer's specifications. The trailer brakes must meet local and Federal regulations.



Do not connect a trailer's hydraulic brake system directly to your vehicle's brake system. Your vehicle may not have enough braking power and your chances of having a collision greatly increase.

The braking system of the tow vehicle is rated for operation at the GVWR not GCWR.

Trailer lamps

Trailer lamps are required on most towed vehicles. Make sure your trailer lamps conform to local and Federal regulations. See your dealer or trailer rental agency for proper instructions and equipment for hooking up trailer lamps.



Never connect any trailer lighting to the vehicle's taillamp circuits, because it may damage the electrical system resulting in fire. Contact your local Ford dealership for assistance in proper trailer tow wiring installation. Additional electrical equipment may be required.

Driving while you tow

When towing a trailer:

- Turn off the speed control. The speed control may shut off automatically when you are towing on long, steep grades.

Driving

- Consult your local motor vehicle speed regulations for towing a trailer.
- To eliminate excessive shifting, use a lower gear. This will also assist in transmission cooling. (For additional information, refer to the *Driving with a 4-speed automatic transmission* section in this chapter.
- Anticipate stops and brake gradually.
- Do not exceed the GCWR rating or transmission damage may occur.

Servicing after towing

If you tow a trailer for long distances, your vehicle will require more frequent service intervals. Refer to your scheduled maintenance guide for more information.

Trailer towing tips

- Practice turning, stopping and backing up before starting on a trip to get the feel of the vehicle trailer combination. When turning, make wider turns so the trailer wheels will clear curbs and other obstacles.
- Allow more distance for stopping with a trailer attached.
- The trailer tongue weight should be 10–15% of the loaded trailer weight.
- After you have traveled 80 km (50 miles), thoroughly check your hitch, electrical connections and trailer wheel lug nuts.
- To aid in engine/transmission cooling and A/C efficiency during hot weather while stopped in traffic, place the gearshift lever in P (Park) (automatic transmission) or N (Neutral) (manual transmissions).
- Vehicles with trailers should not be parked on a grade. If you must park on a grade, place wheel chocks under the trailer's wheels.

Launching or retrieving a boat

Disconnect the wiring to the trailer before backing the trailer into the water. Reconnect the wiring to the trailer after the trailer is removed from the water.

When backing down a ramp during boat launching or retrieval:

- do not allow the static water level to rise above the bottom edge of the rear bumper.
- do not allow waves to break higher than 15 cm (6 inches) above the bottom edge of the rear bumper.

Exceeding these limits may allow water to enter vehicle components:

- causing internal damage to the components.
- affecting driveability, emissions and reliability.

Replace the rear axle lubricant any time the axle has been submerged in water. Rear axle lubricant quantities are not to be checked or changed unless a leak is suspected or repair required.

Recreational towing (all wheels on the ground)

Follow these guidelines for your specific powertrain combination to tow your vehicle with all four wheels on the ground (such as behind a recreational vehicle).

These guidelines are designed to ensure that your transmission is not damaged due to insufficient lubrication.

Rear Wheel Drive (RWD) 4x2 vehicles:

This applies to all 4x2 trucks/sport utilities with rear wheel drive capability.

An example of recreational towing is towing your vehicle behind a motorhome. The following recreational towing guidelines are designed to ensure that your transmission is not damaged.

- Place the transmission in N (Neutral).
- Maximum speed is 56 km/h (35 mph).
- Maximum distance is 80 km (50 miles).

If a distance of 80 km (50 miles) or a speed of 56 km/h (35 mph) must be exceeded, you must disconnect the driveshaft. Ford recommends the driveshaft be removed/installed only by a qualified technician. See your local dealer for driveshaft removal/installation.

Improper removal/installation of the driveshaft can cause transmission fluid loss, damage to the driveshaft and internal transmission components.

4x4 vehicles with electronic shift transfer case (Neutral tow kit accessory):

On vehicles equipped with 4WD, an accessory is available that allows you to tow your vehicle, behind another vehicle, with all the wheels on the ground. Contact your dealer for more details. Do not tow your vehicle with all wheels on the ground unless you install the neutral tow kit as vehicle damage may occur.

Driving

LUGGAGE RACK

Your vehicle is equipped with a roof rack. The maximum recommended load is 90 kg (200 lbs), evenly distributed. If it is not possible to distribute the load, position it as far rearward as possible. Use the tie down loops on the thumbwheels (if equipped) to secure the load.

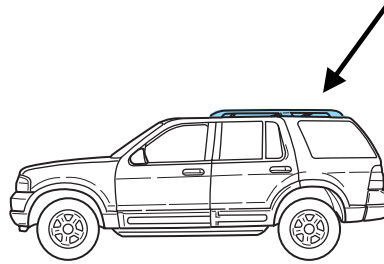

To adjust cross-bar position (if equipped):

1. Loosen the thumbwheel at both ends of the cross-bar (both cross-bars are adjustable).
2. Slide the cross-bar to the desired location.
3. Tighten the thumbwheel at both ends of the cross-bar.

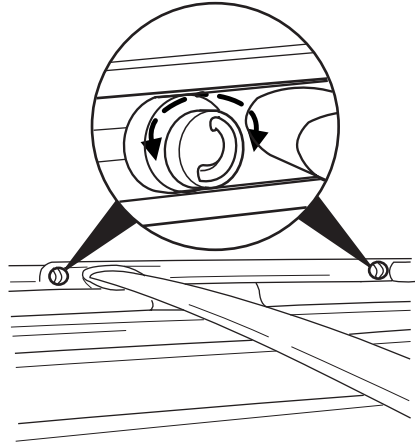

 Vehicles with a higher center of gravity such as utility and four-wheel drive vehicles handle differently than vehicles with a lower center of gravity. Utility and four-wheel drive vehicles are not designed for cornering at speeds as high as passenger cars any more that low-slung sport cars are designed to perform satisfactorily under off-road conditions. Avoid sharp turns, excessive speed and abrupt maneuvers in these vehicles. Failure to drive cautiously could result in an increase risk of vehicles rollover, personal injury and death.

Roadside emergencies

Getting roadside assistance

To fully assist you should you have a vehicle concern, Ford Motor Company offers a complimentary roadside assistance program. This program is separate from the New Vehicle Limited Warranty. The service is available:

- 24-hours, seven days a week
- for the New Vehicle Limited Warranty period of three years or 60,000 km (36,000 miles), whichever occurs first on Ford and Mercury vehicles, and four years or 80,000 km (50,000 miles) on Lincoln vehicles.

Roadside assistance will cover:

- changing a flat tire
- jump-starts
- lock-out assistance
- limited fuel delivery
- towing of your disabled vehicle to the nearest Ford Motor Company dealership, or your selling dealer if within 56.3 km (35 miles) of the nearest Ford Motor Company dealership (one tow per disablement). Even non-warranty related tows, like accidents or getting stuck in the mud or snow, are covered (some exclusions apply, such as impound towing or repossession).

Canadian customers refer to your Owner Information Guide for information on:

- Coverage period
- Exact fuel amounts
- Towing of your disabled vehicle
- Emergency travel expense reimbursement
- Travel planning benefits

Using roadside assistance

Complete the roadside assistance identification card and place it in your wallet for quick reference. In the United States, this card is found in the Owner Guide portfolio in the glove compartment in Ford vehicles and is mailed to you if you own a Mercury or Lincoln. In Canada, the card is found in the Owner Information Guide in the glove compartment.

U.S. Ford or Mercury vehicle customers who require roadside assistance, call 1-800-241-3673; Lincoln vehicle customers call 1-800-521-4140.

Roadside emergencies

Canadian customers who require roadside assistance, call 1-800-665-2006.

If you need to arrange roadside assistance for yourself, Ford Motor Company will reimburse a reasonable amount. To obtain reimbursement information, U.S. Ford or Mercury vehicles customers call 1-800-241-3673; Lincoln vehicle customers call 1-800-521-4140.

Canadian customers who need to obtain reimbursement information, call 1-800-665-2006.

Roadside coverage beyond basic warranty

In the United States, you may purchase additional roadside assistance coverage beyond this period through the Ford Auto Club by contacting your Ford or Lincoln Mercury dealer.

Similarly in Canada, for uninterrupted Roadside Assistance coverage, you may purchase extended coverage prior to your Basic Warranty's Roadside Assistance expiring. For more information and enrollment, contact 1-877-294-2582 or visit our website at www.ford.ca.

HAZARD FLASHER

Use only in an emergency to warn traffic of vehicle breakdown, approaching danger, etc. The hazard flashers can be operated when the ignition is off.

- The hazard lights control is located on top of the steering column.
- Depress hazard lights control to activate all hazard flashers simultaneously.
- Depress control again to turn the flashers off.

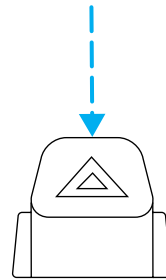

FUEL PUMP SHUT-OFF SWITCH FUEL RESET

The fuel pump shut-off switch is a device intended to stop the electric fuel pump when your vehicle has been involved in a substantial jolt.

After a collision, if the engine cranks but does not start, the fuel pump shut-off switch may have been activated.

Roadside emergencies

The fuel pump shut-off switch is located in the passenger's foot well, by the kick panel.

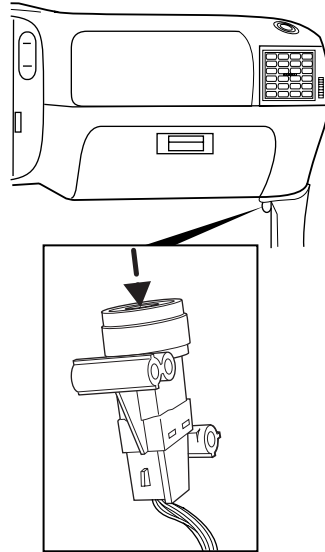

Use the following procedure to reset the fuel pump shut-off switch.

1. Turn the ignition to the OFF position.
2. Check the fuel system for leaks.
3. If no fuel leak is apparent, reset the fuel pump shut-off switch by pushing in on the reset button.
4. Turn the ignition to the ON position. Pause for a few seconds and return the key to the OFF position.
5. Make a further check for leaks in the fuel system.

FUSES AND RELAYS

Fuses

If electrical components in the vehicle are not working, a fuse may have blown. Blown fuses are identified by a broken wire within the fuse. Check the appropriate fuses before replacing any electrical components.

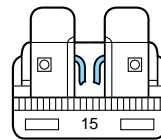

Roadside emergencies

Note: Always replace a fuse with one that has the specified amperage rating. Using a fuse with a higher amperage rating can cause severe wire damage and could start a fire.

Standard fuse amperage rating and color

COLOR					
Fuse rating	Mini fuses	Standard fuses	Maxi fuses	Cartridge maxi fuses	Fuse link cartridge
2A	Grey	Grey	—	—	—
3A	Violet	Violet	—	—	—
4A	Pink	Pink	—	—	—
5A	Tan	Tan	—	—	—
7.5A	Brown	Brown	—	—	—
10A	Red	Red	—	—	—
15A	Blue	Blue	—	—	—
20A	Yellow	Yellow	Yellow	Blue	Blue
25A	Natural	Natural	—	—	—
30A	Green	Green	Green	Pink	Pink
40A	—	—	Orange	Green	Green
50A	—	—	Red	Red	Red
60A	—	—	Blue	—	Yellow
70A	—	—	Tan	—	Brown
80A	—	—	Natural	—	Black

Roadside emergencies

Passenger compartment fuse panel

The fuse panel is located below the instrument panel on the driver's side.

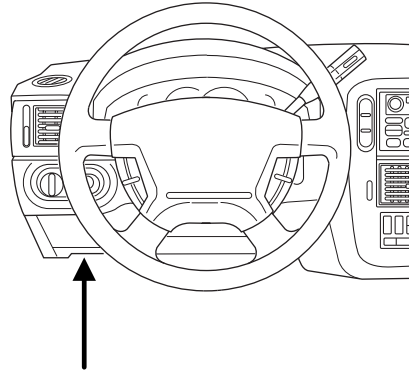

To remove a fuse use the fuse puller tool provided on the fuse panel box.

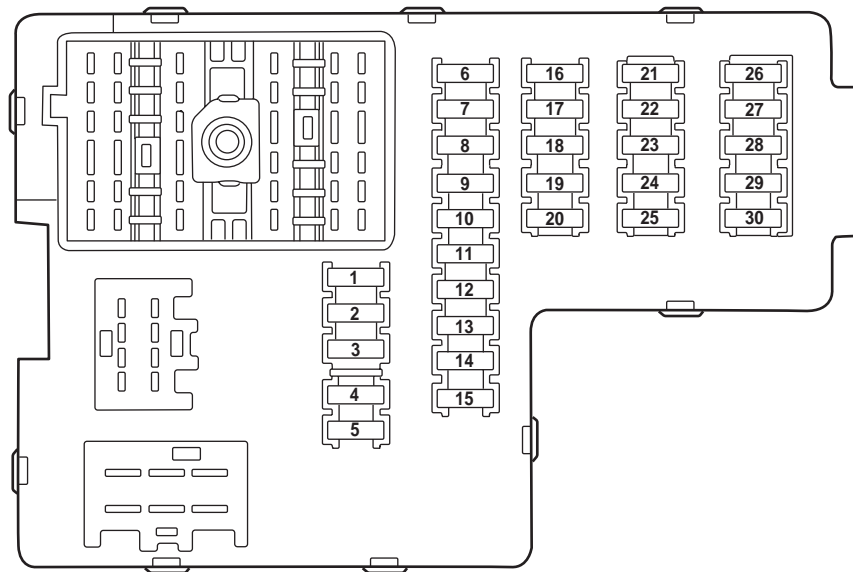

Roadside emergencies

The fuses are coded as follows:

Fuse/Relay Location	Fuse Amp Rating	Passenger Compartment Fuse Panel Description
1	30A	Memory seat module
2	20A	Heated seats, Moonroof
3	20A	Radio, Amplifier, Power antenna, DVD
4	5A	Front wiper module
5	15A	Flasher relay (Turn, hazards)
6	10A	Right horn
7	15A	Heated mirrors
8	-	Not used (spare)
9	-	Not used (spare)
10	10A	Heated backlight relay coil, Heated seat module, Temp blend actuator, A/C clutch contact
11	—	Not used (spare)
12	5A	Foglamp switch, 4x4 module
13	5A	Overdrive cancel switch, Flex fuel sender
14	5A	PATS module
15	5A	Rear wiper module, Cluster, TPMS
16	5A	Power mirror, Manual climate control, TPMS
17	15A	Delayed acc. coil, Battery saver, Interior lamps (front and rear), Glove compartment lamp
18	10A	Left horn
19	10A	RCM, PAD indicator
20	5A	PATS, Driver seat switch, Memory switch, Driver seat module, BSM, Sunload sensor
21	5A	Instrument cluster, Compass, Flasher coil

Roadside emergencies

Fuse/Relay Location	Fuse Amp Rating	Passenger Compartment Fuse Panel Description
22	10A	ABS, IVD Controller
23	15A	Brake pedal position switch, Driver brake applied relay, Redundant cruise deactivate switch
24	15A	Cigar lighter, OBD II
25	5A	Mode-Temperature actuator for auxiliary climate control, Trailer tow battery charge coil
26	7.5A	Park aid, Brake shift interlock, Approach lamp relay coil, IVD switch
27	7.5A	Electrochromatic mirror, Digital transmission range sensor - backup lamps
28	5A	Radio (Start)/DVD (Start)
29	10A	Digital transmission range sensor, PWR feed to fuse #28 (Start feed)
30	5A	Daytime Running Lamps (DRL), Remote solenoid, DEATC climate controller

Roadside emergencies

Passenger compartment fuse panel (top side)

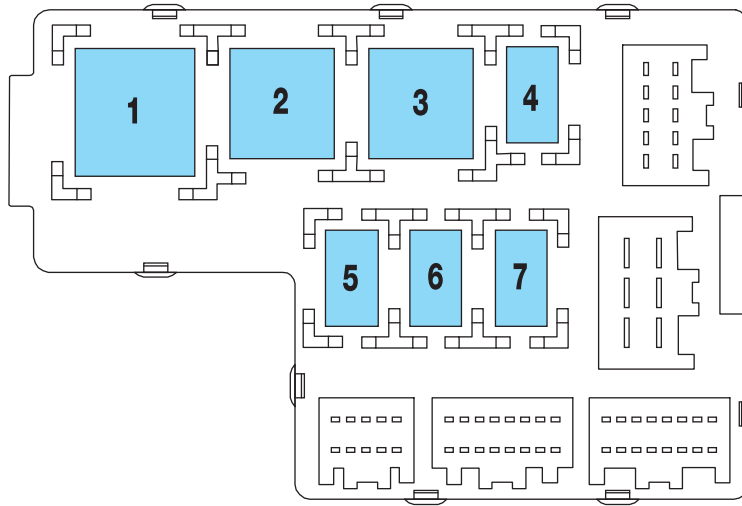

These relays are located on the reverse side of the passenger compartment fuse panel. To access the relays you must remove the passenger compartment fuse panel.

Fuse/Relay Location	Description
Relay 1	Flasher relay
Relay 2	Rear defrost
Relay 3	Delayed accessory relay
Relay 4	Open
Relay 5	Battery saver
Relay 6	Open
Relay 7	Open

Roadside emergencies

Power distribution box

The power distribution box is located in the engine compartment. The power distribution box contains high-current fuses that protect your vehicle's main electrical systems from overloads.

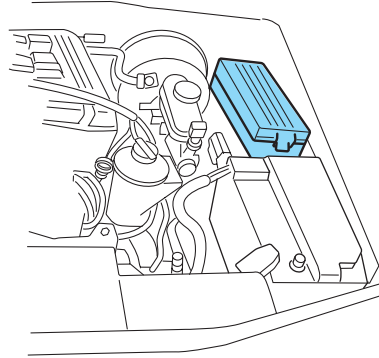

Always disconnect the battery before servicing high current fuses.



To reduce risk of electrical shock, always replace the cover to the Power Distribution Box before reconnecting the battery or refilling fluid reservoirs.

If the battery has been disconnected and reconnected, refer to the *Battery* section of the *Maintenance and specifications* chapter.

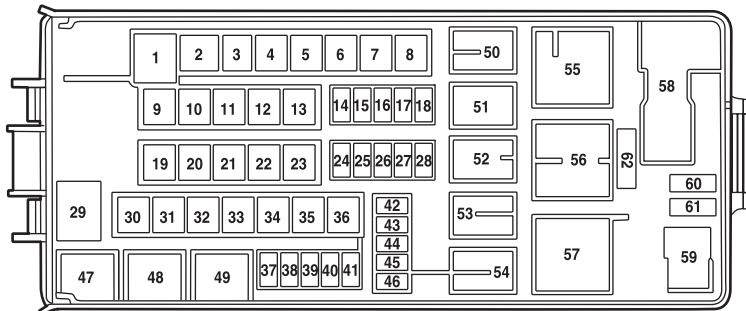

Roadside emergencies

The high-current fuses are coded as follows:

Fuse/Relay Location	Fuse Amp Rating	Power Distribution Box Description
1	60A**	PJB
2	30A**	BSM
3	20A**	GCC pusher fan (export only)
4	30A**	Rear defrost
5	40A**	Anti-lock Brake System (ABS) pump
6	60A**	Delayed accessory circuit breaker
7	20A**	Power point #2
8	—	Not used
9	20A**	Power point #1
10	30A**	ABS module (valves)
11	40A**	PTEC
12	50A**	Ignition relay/Starter relay
13	40A**	Trailer tow battery, Trailer tow turn signals
14	10A*	Daytime Running Lamps (DRL) (Canada)/Fog lamps (export only)
15	15A*	Memory (KAPWR)
16	15A*	Headlamp switch
17	20A*	4x4 (v-batt 2)
18	20A*	4x4 (v-batt 1)
19	20A**	High beam relay
20	30A**	Electric brake
21	30A**	Front wiper motor
22	20A**	Autolamp; Low beam
23	30A**	Ignition switch
24	20A*	Rear fog lamps (Export only)
25	—	Not used
26	15A*	Fuel pump
27	20A*	Trailer tow lamps

Roadside emergencies

Fuse/Relay Location	Fuse Amp Rating	Power Distribution Box Description
28	20A*	Horn relay
29	60A**	PJB
30	20A**	Rear wiper motor
31	—	Not used
32	—	Not used
33	30A**	Auxiliary blower motor
34	30A**	Power seats, Adjustable pedals
35	20A**	Rear power point
36	40A**	Blower motor
37	15A*	A/C clutch relay/Transmission
38	15A*	Coil on plug
39	15A*	Injectors/Fuel pump relay
40	15A*	PTEC power
41	15A*	HEGO, VMV, CMS, PTEC
42	10A*	Right low beam
43	10A*	Left low beam
44	15A*	Front foglamps
45	5A*	Brake pressure switch
46	20A*	High beams
47	—	Horn relay
48	—	Fuel pump relay
49	—	High beam relay
50	—	Fog lamp relay
51	—	Police IVD relay
52	—	A/C clutch relay
53	—	Trailer tow right turn
54	—	Trailer tow left turn
55	—	Blower motor relay
56	—	Starter relay
57	—	PTEC relay
58	—	Ignition relay

Roadside emergencies

Fuse/Relay Location	Fuse Amp Rating	Power Distribution Box Description
59	—	Driver brake applied or DRL relay (Canada only)
60	—	PCM diode
61	—	A/C clutch diode
62	30A CB	Delayed accessory

* Mini Fuses ** Maxi Cartridge Fuses

Rear Relay Box

The relay box is located on the rear passenger side quarter trim panel. To access this box you must remove the trim panel.

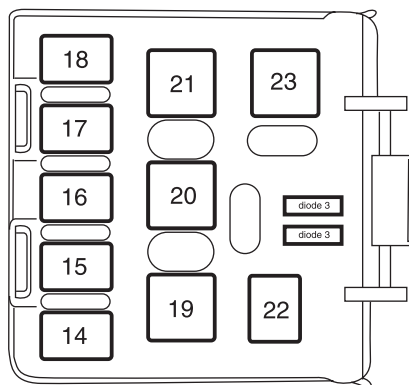

The relays are coded as follows:

Fuse/Relay Location	Description
Relay 14	Not used
Relay 15	Trailer tow back- up lamps
Relay 16	Not used
Relay 17	Not used
Relay 18	Not used
Relay 19	Trailer tow park lamps
Relay 20	Trailer tow battery charge

Roadside emergencies

Fuse/Relay Location	Description
Relay 21	Not used
Relay 22	Approach lamps
Relay 23	Not used
Diode 3	Not used
Diode 4	Not used

Auxiliary relay box (Canadian vehicles equipped with AdvanceTrac™ only)

The relay box is located on the front right fender well underneath the speed control module.

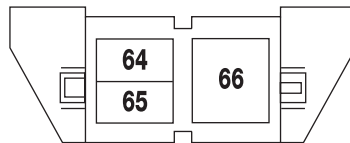
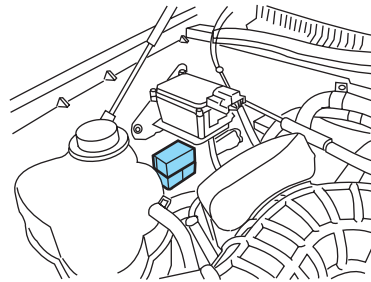

The relays are coded as follows:

Fuse/Relay Location	Description
Relay 64	Police vehicles equipped with AdvanceTrac™
Relay 65	Open
Relay 66	Open

CHANGING THE TIRES

If you get a flat tire while driving, do not apply the brake heavily. Instead, gradually decrease your speed. Hold the steering wheel firmly and slowly move to a safe place on the side of the road.

Roadside emergencies

 The use of tire sealants is not recommended and may compromise the integrity of your tires. The use of tire sealants may also affect your tire pressure monitoring system (if equipped).

 If your vehicle is equipped with a tire pressure monitoring system, refer to Tire Pressure Monitoring System (if equipped) in the *Maintenance and care* section for important information. If the tire pressure monitor sensor becomes damaged, it will no longer function.

Spare tire information

The spare tire can be used as a spare or a regular tire. The spare is identical to the other tires on your vehicle, although the wheel will not match.

 If your vehicle is equipped with 4WD or AWD, a spare tire of a different size than the road tires should not be used. Use of such a tire could result in damage to driveline components and an increased risk of loss of vehicle control, vehicle rollover, personal injury or death.

Location of the spare tire and tools

The spare tire and tools for your vehicle are stowed in the following locations:

Tool	Location
Spare tire	Under the vehicle, just in front of the rear bumper. The spare tire winch drive nut is located at the rear center of the cargo area under a lid.
Jack, lug nut wrench, jack handle	Behind the rear seat under the carpeted floor lid in the cargo floor.

Roadside emergencies

Removing the jack

1. Open liftgate and remove the carpeted floor lid and jack cover.
2. Turn jack screw eyelet counterclockwise and remove the jack from the bracket.
3. Remove the lug wrench from the bag and rotate the wrench socket out from the handle.

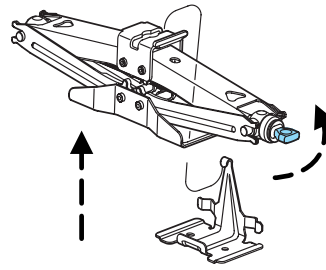

Removing the spare tire

Do not use an impact wrench on the winch drive nut. This will damage the spare tire winch.

1. Open the cover from the carpeting on cargo floor to expose the winch drive nut.
 2. Insert the lug wrench on the winch drive nut.
- The wrench will stop moving and forward resistance to turning will be felt when properly engaged.

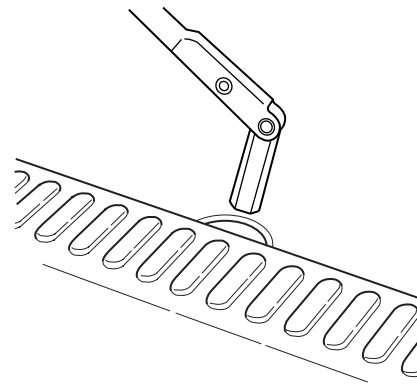

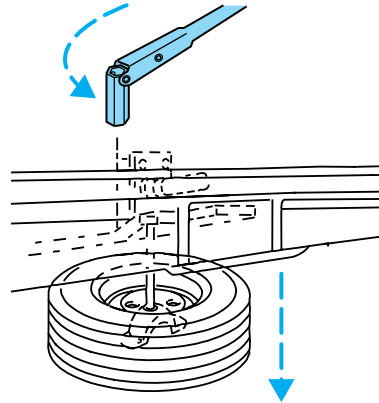

Roadside emergencies

3. Turn the wrench counterclockwise until tire is lowered to the ground making sure the other end of the wrench does not scuff kick plate, the tire can be slid rearward and the cable is slightly slack.
4. Lift tire on one side and remove the retainer from the spare tire.



Tire change procedure

 To prevent the vehicle from moving when you change a tire, be sure the parking brake is set, then block (in both directions) the wheel that is diagonally opposite (other side and end of the vehicle) to the tire being changed.

 If the vehicle slips off the jack, you or someone else could be seriously injured.

Refer to the tire changing instruction sheet for detailed tire change instructions.

Roadside emergencies

1. Park on a level surface, activate hazard flashers and set the parking brake.
2. Place gearshift lever in P (Park) or in the reverse gear (manual transmission) and turn engine OFF.

 When one of the rear wheels is off the ground, the transmission alone will not prevent the vehicle from moving or slipping off the jack, even if the transmission is in P (Park) (automatic transmission) or reverse (manual transmission).

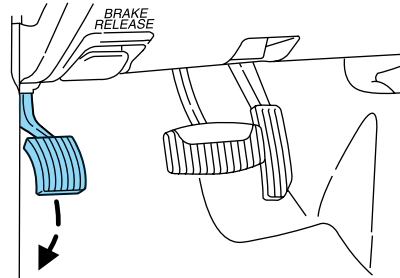

3. Block the diagonally opposite wheel.
4. Use the tip of the lug wrench to remove any beauty cap by twisting the tip under the cap. The carpeted floor lid can be used as a kneeling pad.
5. Loosen each wheel lug nut by half a turn, but do not remove them until the wheel is raised off the ground.

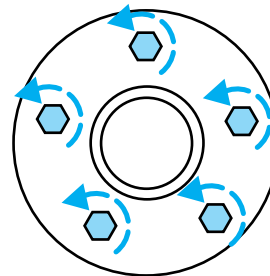
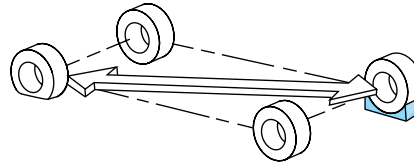

Roadside emergencies

6. Assemble the jack handle extension on the lug nut wrench by sliding the square end of the jack handle through the plastic grommet on the lug nut wrench and into the square hole on the other side.

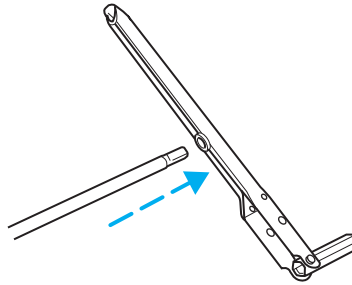

7. Position the jack on the frame under the diamond shaped hole and turn the jack handle clockwise until the tire is a maximum of 25 mm (1 inch) off the ground.

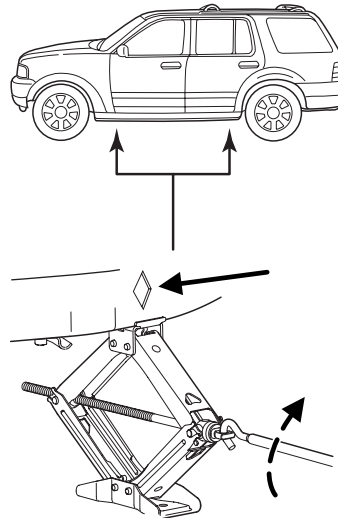

Roadside emergencies

 To lessen the risk of personal injury, do not put any part of your body under the vehicle while changing a tire. Do not start the engine when your vehicle is on the jack. The jack is only meant for changing the tire.

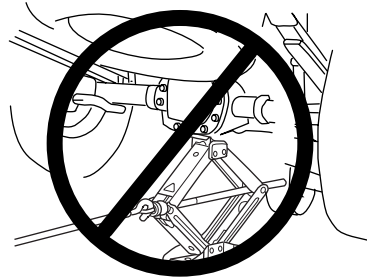

- **Never use the front or rear differential as a jacking point.**

8. Remove the lug nuts with the lug wrench.
9. Replace the flat tire with the spare tire, making sure the valve stem is facing outward. Reinstall the lug nuts, cone side in, until the wheel is snug against the hub. Do not fully tighten the lug nuts until the wheel has been lowered.
10. Lower the wheel by turning the jack handle counterclockwise.
11. Remove the jack and fully tighten the lug nuts in the order shown.
12. Replace beauty cap, stow the jack and tools in their respective locations, making sure they are fully secured so they do not rattle when you drive.
13. Unblock the wheels.

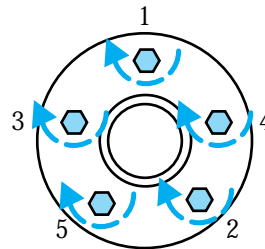

Stowing the spare tire

1. Lay the tire on the ground with the valve stem facing in the direction specified on the Tire Changing Instructions located with the jack hardware.

Roadside emergencies

- Slide the wheel under the vehicle and install the retainer through the wheel center.
- Turn the lug wrench clockwise until the tire is raised to its original position underneath the vehicle. The lug wrench will click when the tire is raised to the stowed position. It will not allow you to overtighten.

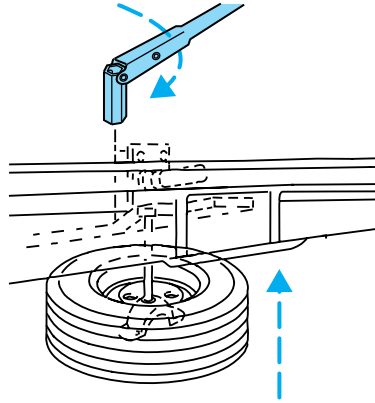

JUMP STARTING YOUR VEHICLE

 The gases around the battery can explode if exposed to flames, sparks, or lit cigarettes. An explosion could result in injury or vehicle damage.

 Batteries contain sulfuric acid which can burn skin, eyes and clothing, if contacted.

Do not attempt to push-start your vehicle. Automatic transmissions do not have push-start capability; also, the catalytic converter may become damaged.

Preparing your vehicle

When the battery is disconnected or a new battery is installed, the transmission must relearn its shift strategy. As a result, the transmission may have firm and/or soft shifts. This operation is considered normal and will not affect function or durability of the transmission. Over time, the adaptive learning process will fully update transmission operation.

- Use only a 12-volt supply to start your vehicle.**
- Do not disconnect the battery of the disabled vehicle as this could damage the vehicle's electrical system.
- Park the booster vehicle close to the hood of the disabled vehicle making sure the two vehicles **do not** touch. Set the parking brake on both vehicles and stay clear of the engine cooling fan and other moving parts.

Roadside emergencies

4. Check all battery terminals and remove any excessive corrosion before you attach the battery cables. Ensure that vent caps are tight and level.
5. Turn the heater fan on in both vehicles to protect any electrical surges. Turn all other accessories off.

Connecting the jumper cables

1. Connect the positive (+) booster cable to the positive (+) terminal of the discharged battery.

Note: In the illustrations, *lightning bolts* are used to designate the assisting (boosting) battery.

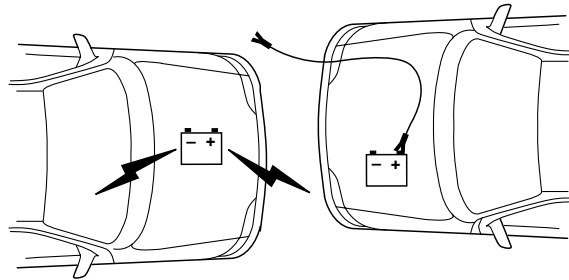

2. Connect the other end of the positive (+) cable to the positive (+) terminal of the assisting battery.

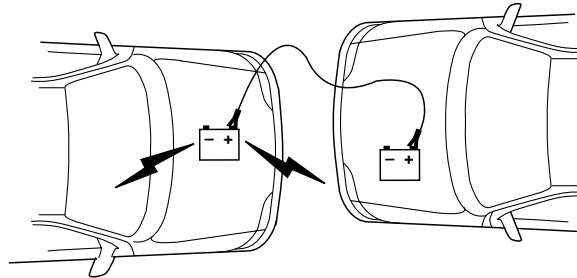

Roadside emergencies

3. Connect the negative (-) cable to the negative (-) terminal of the assisting battery.

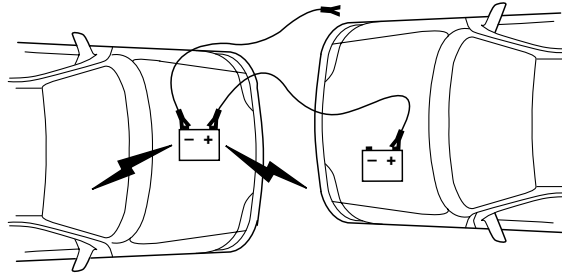

4. Make the final connection of the negative (-) cable to the provided jumpstarting bolt **ONLY**. Connecting to any other exposed component may cause an explosion.

Do not use fuel lines, engine rocker covers or the intake manifold as *grounding* points.



Do not connect the end of the second cable to the negative (-) terminal of the battery to be jumped. A spark may cause an explosion of the gases that surround the battery.

Roadside emergencies

4.0L Engine

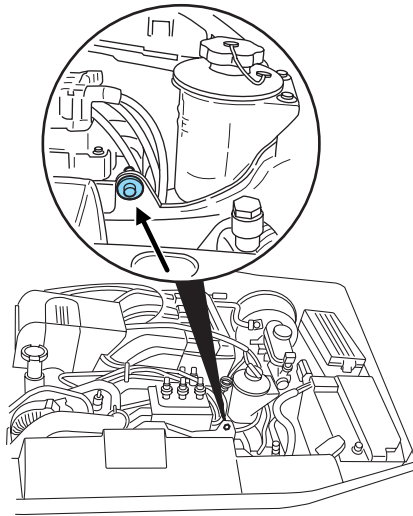

4.6L Engine

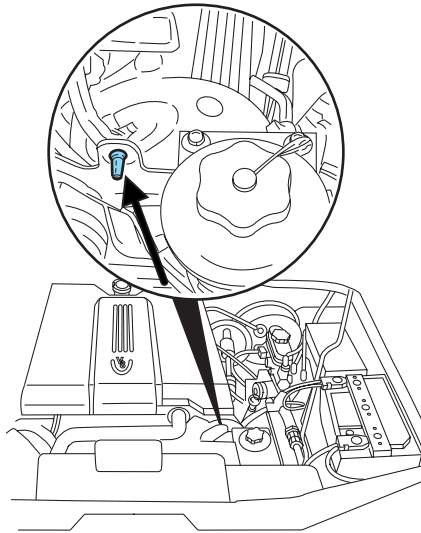

Roadside emergencies

5. Ensure that the cables are clear of fan blades, belts, moving parts of both engines, or any fuel delivery system parts.

Jump starting

1. Start the engine of the booster vehicle and run the engine at moderately increased speed.
2. Start the engine of the disabled vehicle.
3. Once the disabled vehicle has been started, run both engines for an additional three minutes before disconnecting the jumper cables.

Removing the jumper cables

Remove the jumper cables in the reverse order that they were connected.

1. Remove the jumper cable from the *ground* metal surface.

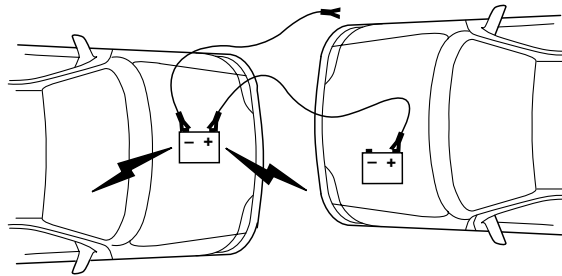

2. Remove the jumper cable on the negative (-) connection of the booster vehicle's battery.

Roadside emergencies

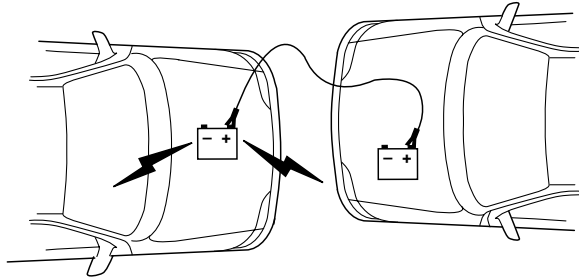

3. Remove the jumper cable from the positive (+) terminal of the booster vehicle's battery.

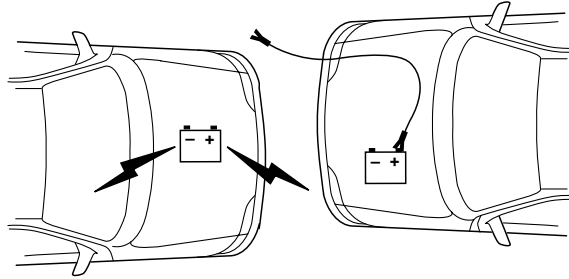

4. Remove the jumper cable from the positive (+) terminal of the disabled vehicle's battery.

After the disabled vehicle has been started and the jumper cables removed, allow it to idle for several minutes so the engine computer can relearn its idle conditions.

Roadside emergencies

WRECKER TOWING

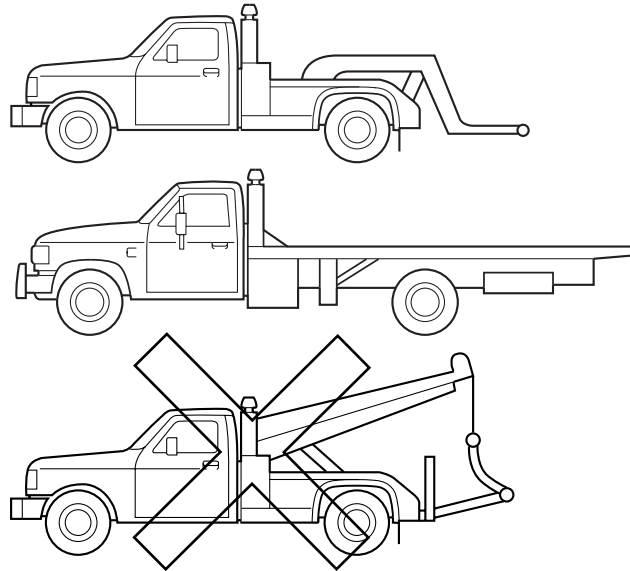

If you need to have your vehicle towed, contact a professional towing service or, if you are a member, your roadside assistance center.

It is recommended that your vehicle be towed with a wheel lift or flatbed equipment. Do not tow with a slingbelt. Ford Motor Company has not approved a slingbelt towing procedure.

On 4x2 vehicles, it is acceptable to tow the vehicle with the front wheels on the ground (without dollies) and the rear wheels off the ground.

On 4x4 vehicles, it is recommended that your vehicle be towed with a wheel lift and dollies or flatbed equipment with all the wheels off the ground.

If the vehicle is towed by other means or incorrectly, vehicle damage may occur.

Ford Motor Company produces a towing manual for all authorized tow truck operators. Have your tow truck operator refer to this manual for proper hook-up and towing procedures for your vehicle.

Maintenance and care

SERVICE RECOMMENDATIONS

To help you service your vehicle:

- We highlight do-it-yourself items in the engine compartment for easy location.
- We provide a scheduled maintenance guide which makes tracking routine service easy.

If your vehicle requires professional service, your dealership can provide the necessary parts and service. Check your *Warranty Guide/Owner Information Guide* to find out which parts and services are covered.

Use only recommended fuels, lubricants, fluids and service parts conforming to specifications. Motorcraft parts are designed and built to provide the best performance in your vehicle.

PRECAUTIONS WHEN SERVICING YOUR VEHICLE

Be especially careful when inspecting or servicing your vehicle.

- Do not work on a hot engine.
- When the engine is running, make sure that loose clothing, jewelry or long hair does not get caught up in moving parts.
- Do not work on a vehicle with the engine running in an enclosed space, unless you are sure you have enough ventilation.
- Keep all lit cigarettes, open flames and other lit material away from the battery and all fuel related parts.

If you disconnect the battery, the engine must “relearn” its idle conditions before your vehicle will drive properly, as explained in the *Battery* section of this chapter.

Working with the engine off

- Automatic transmission:
 1. Set the parking brake and ensure the gearshift is securely latched in P (Park).
 2. Turn off the engine and remove the key.
 3. Block the wheels to prevent the vehicle from moving unexpectedly.
- Manual transmission:
 1. Set the parking brake.
 2. Depress the clutch and place the gearshift in 1 (First).
 3. Turn off the engine and remove the key.
 4. Block the wheels to prevent the vehicle from moving unexpectedly.

Maintenance and care

Working with the engine on

- Automatic transmission:

1. Set the parking brake and ensure the gearshift is securely latched in P (Park).
2. Block the wheels to prevent the vehicle from moving unexpectedly.

Note: Do not start your engine with the air cleaner removed and do not remove it while the engine is running.

- Manual transmission:

1. Set the parking brake, depress the clutch and place the gearshift in neutral.
2. Block the wheels to prevent the vehicle from moving unexpectedly.

Note: Do not start your engine with the air cleaner removed and do not remove it while the engine is running.

 The cooling fan is automatic and may come on at any time. Always disconnect the negative terminal of the battery before working near the fan.

OPENING THE HOOD

1. Inside the vehicle, pull the hood (rearward) release handle located under the bottom left corner of the instrument panel.

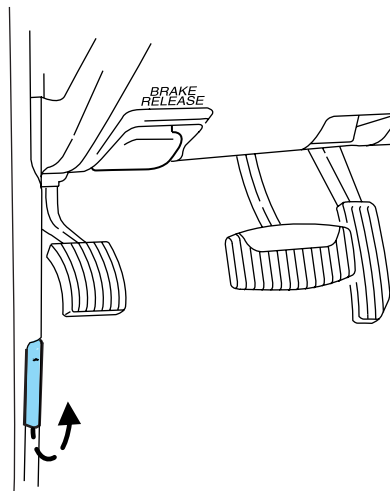

Maintenance and care

2. Go to the front of the vehicle and release the auxiliary latch that is located under the front center of the hood.

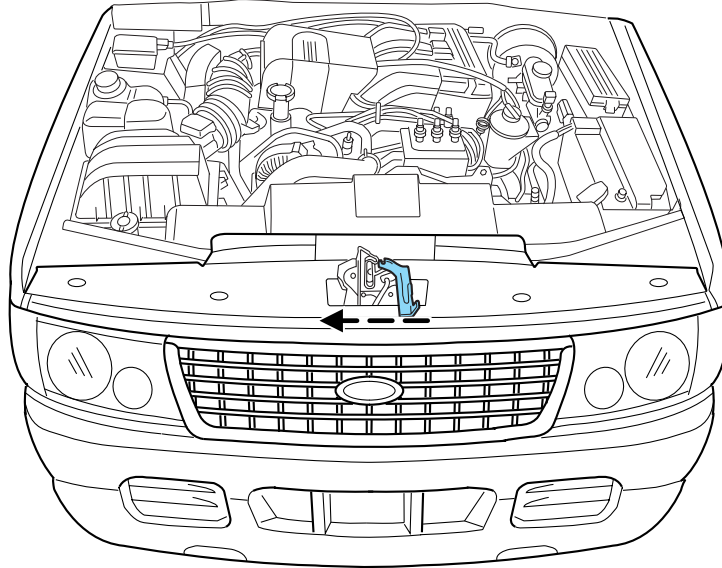

3. Lift the hood.

Maintenance and care

IDENTIFYING COMPONENTS IN THE ENGINE COMPARTMENT

4.0L SOHC V6 engine

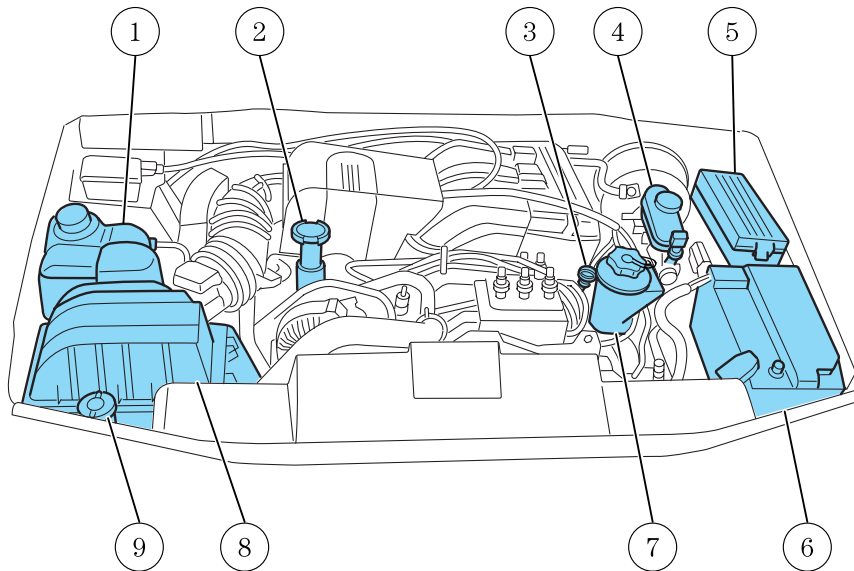

1. Engine coolant reservoir
2. Engine oil filler cap
3. Engine oil dipstick
4. Brake fluid reservoir
5. Power distribution box
6. Battery
7. Power steering fluid reservoir
8. Air filter assembly
9. Windshield washer fluid reservoir

Maintenance and care

4.6L V8 engine

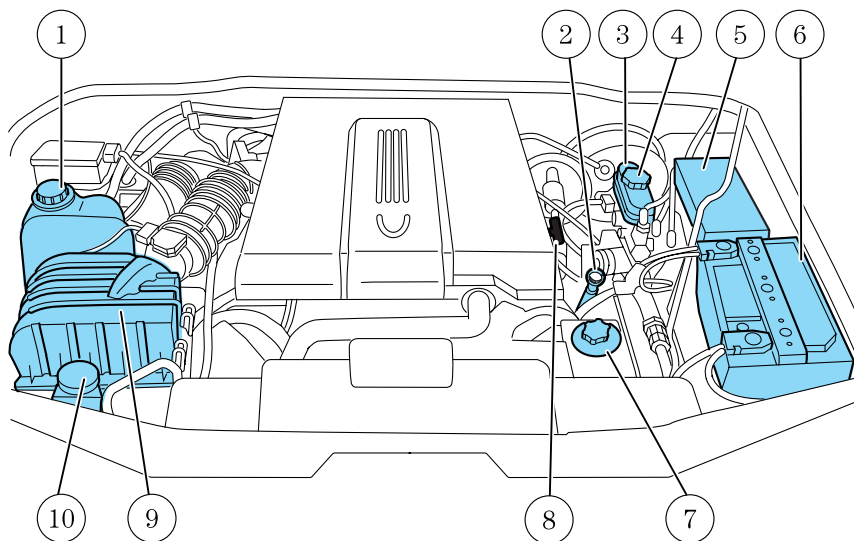

1. Engine coolant reservoir
2. Engine oil dipstick
3. Clutch fluid reservoir (if equipped)
4. Brake fluid reservoir
5. Power distribution box
6. Battery
7. Power steering fluid reservoir
8. Engine oil filler cap
9. Air filter assembly
10. Windshield washer fluid reservoir

Maintenance and care

ENGINE OIL

Checking the engine oil

Refer to the scheduled maintenance guide for the appropriate intervals for checking the engine oil.

1. Make sure the vehicle is on level ground.
 2. Turn the engine off and wait a few minutes for the oil to drain into the oil pan.
 3. Set the parking brake and ensure the gearshift is securely latched in P (Park).
 4. Open the hood. Protect yourself from engine heat.
 5. Locate and carefully remove the engine oil level indicator (dipstick).
- 4.0L V6 engine

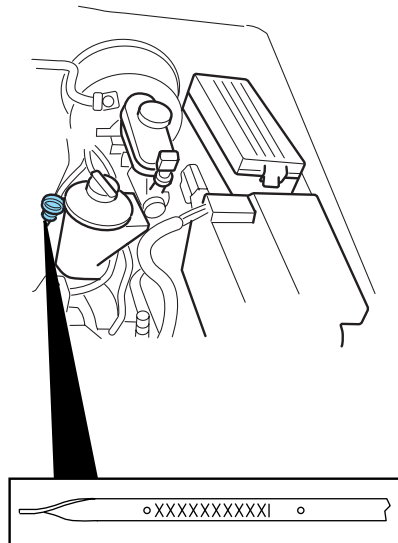

Maintenance and care

- 4.6L V8 engine

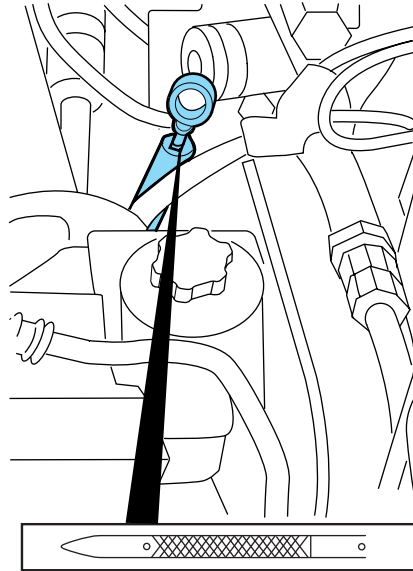

6. Wipe the indicator clean. Insert the indicator fully, then remove it again.
- If the oil level is **between the MIN and MAX marks**, the oil level is acceptable, **DO NOT ADD OIL**.
 - If the oil level is below the MIN mark, add enough oil to raise the level within the MIN-MAX range .

Maintenance and care

- 4.0L SOHC V6 engine

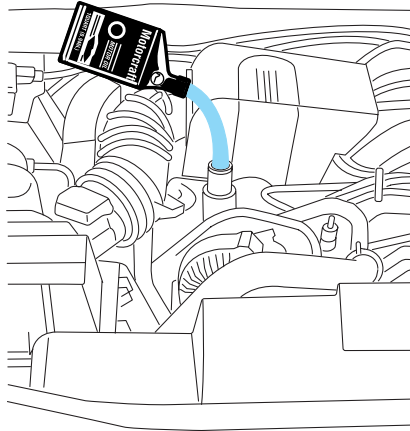

- 4.6L V8 engine

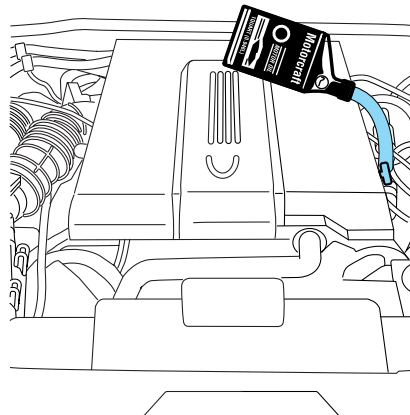

- Oil levels above the MAX mark may cause engine damage. Some oil must be removed from the engine by a service technician.

7. Put the indicator back in and ensure it is fully seated.

Adding engine oil

1. Check the engine oil. For instructions, refer to *Checking the engine oil* in this chapter.
2. If the engine oil level is not within the normal range, add only certified engine oil of the recommended viscosity. Remove the engine oil filler cap and use a funnel to pour the engine oil into the opening.

Maintenance and care

3. Recheck the engine oil level. Make sure the oil level is not above the MAX hole on the engine oil level indicator (dipstick).
4. Install the indicator and ensure it is fully seated.
5. Fully install the engine oil filler cap by turning the filler cap clockwise 1/4 of a turn or until three clicks can be heard.

To avoid possible oil loss, DO NOT operate the vehicle with the engine oil level indicator and/or the engine oil filler cap removed.

Engine Oil Recommendations

4.6L Engine

Look for this certification trademark.

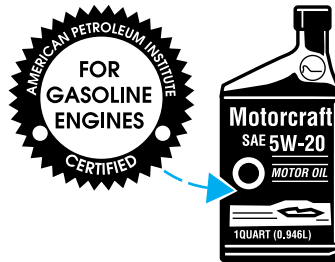

SAE 5W-20 engine oil is recommended.

Only use oils “Certified For Gasoline Engines” by the American Petroleum Institute (API). Use Motorcraft or an equivalent oil meeting Ford Specification WSS-M2C153-H. **SAE 5W-20 oil provides optimum fuel economy and durability performance meeting all requirements for your vehicle’s engine.**

Change your engine oil and filter according to the appropriate schedule listed in the scheduled maintenance guide.

Do not use supplemental engine oil additives, oil treatments or engine treatments. They are unnecessary and could, under certain conditions, lead to engine damage which is not covered by your warranty.

Maintenance and care

4.0L Engine

Look for this certification trademark.

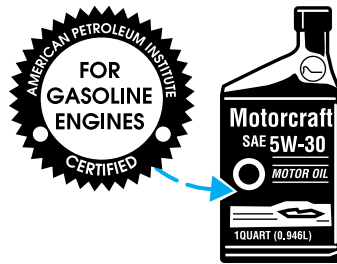

SAE 5W-30 engine oil is recommended.

Only use oils “Certified For Gasoline Engines” by the American Petroleum Institute (API). Use Motorcraft or an equivalent oil meeting Ford Specification WSS-M2C205-H.

Do not use supplemental engine oil additives, oil treatments or engine treatments. They are unnecessary and could, under certain conditions, lead to engine damage which is not covered by your warranty.

Change your engine oil according to the appropriate schedule listed in the scheduled maintenance guide.

Engine Oil Filter Recommendation

Change your engine oil filter according to the appropriate schedule listed in the scheduled maintenance guide. Ford production and aftermarket (Motorcraft) oil filters are designed for added engine protection and long life. If a replacement oil filter is used that does not meet Ford Material and design specifications, start-up engine noises or knock may be experienced.

It is recommended you use the appropriate Motorcraft oil filter (or another brand meeting Ford specifications) for your engine.

Maintenance and care

BRAKE FLUID AND CLUTCH FLUID

Checking and adding brake fluid/clutch fluid

When equipped with a manual transmission, your vehicle uses the same reservoir for brake and clutch fluid.

Brake/clutch fluid should be checked and refilled as needed. Refer to the scheduled maintenance guide for the service interval schedules.

1. Clean the reservoir cap before removal to prevent dirt or water from entering the reservoir.
2. Visually inspect the fluid level.
3. If necessary, add brake/clutch fluid from a clean un-opened container until the level reaches MAX. Do not fill above this line.
4. Use only a DOT 3 brake fluid certified to meet Ford specifications. Refer to *Lubricant specifications* in the *Capacities and specifications* chapter.

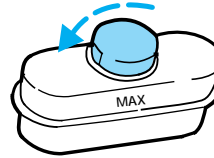
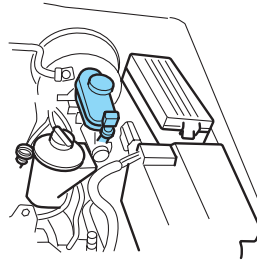

 Brake fluid/clutch fluid is toxic. If brake/clutch fluid contacts the eyes, flush eyes with running water for 15 minutes. Seek medical attention if irritation persists. If taken internally, drink water and induce vomiting. Seek medical attention immediately.

 If you use a brake fluid that is not DOT 3, you will cause permanent damage to your brakes.

 Do not let the reservoir for the master cylinder run dry. This may cause the brakes to fail.

Maintenance and care

WINDSHIELD WASHER FLUID

Windshield washer fluid

Check the washer fluid whenever you stop for fuel. The reservoir is highlighted with a  symbol.

Add fluid to fill the reservoir if the level is low. In very cold weather, do not fill the reservoir completely.

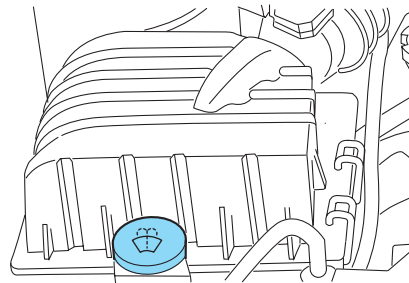

Only use a washer fluid that meets Ford specification WSB-M8B16-A2. Refer to *Lubricant specifications* in the *Capacities and specifications* chapter.

State or local regulations on volatile organic compounds may restrict the use of methanol, a common windshield washer antifreeze additive. Washer fluids containing non-methanol antifreeze agents should be used only if they provide cold weather protection without damaging the vehicle's paint finish, wiper blades or washer system.

Do not put washer fluid in the engine coolant reservoir. Washer fluid placed in the cooling system may harm engine and cooling system components.

Checking and adding washer fluid for the liftgate

Washer fluid for the liftgate is supplied by the same reservoir as the windshield.

ENGINE COOLANT

Checking engine coolant

The concentration and level of engine coolant should be checked at the mileage intervals listed in the scheduled maintenance guide. The coolant concentration should be maintained at 50/50 coolant and distilled water, which equates to a freeze point of -36° C (-34° F). Coolant concentration testing is possible with a hydrometer or antifreeze tester (such as the Rotunda Battery and Antifreeze Tester, 014-R1060). The level of coolant should be maintained at the "cold full" or "cold fill range" level in the coolant reservoir. If the level falls below, add coolant per the instructions in the *Adding engine coolant* section.

Maintenance and care

Your vehicle was factory-filled with a 50/50 engine coolant and water concentration. If the concentration of coolant falls below 40% or above 60%, the engine parts could become damaged or not work properly. **A 50–50 mixture of coolant and water provides the following:**

- **Freeze protection down to -36° C (-34° F).**
- **Boiling protection up to 129° C (265° F).**
- **Protection against rust and other forms of corrosion.**
- **Enables calibrated gauges to work properly.**

When the engine is cold, check the level of the engine coolant in the reservoir.

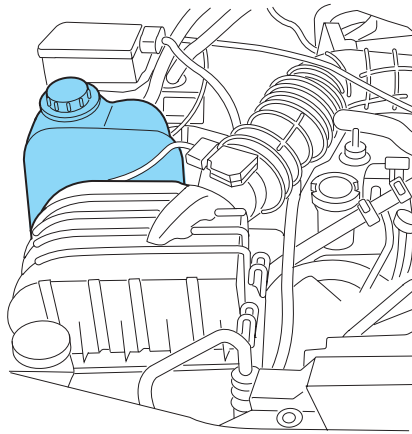

- The engine coolant should be at the “cold fill level” or within the “cold fill range” as listed on the engine coolant reservoir (depending upon application).
- Refer to the Scheduled Maintenance Guide for service interval schedules.
- Be sure to read and understand *Precautions when servicing your vehicle* in this chapter.

If the engine coolant has not been checked at the recommended interval, the engine coolant reservoir may become low or empty. If the reservoir is low or empty, add engine coolant to the reservoir. Refer to *Adding engine coolant* in this chapter.

Note: Automotive fluids are not interchangeable; do not use engine coolant, antifreeze or windshield washer fluid outside of its specified function and vehicle location.

Maintenance and care

Adding engine coolant

When adding coolant, make sure it is a 50/50 mixture of engine coolant and distilled water. Add the mixture to the coolant reservoir, **when the engine is cool**, until the appropriate fill level is obtained.



Do not add engine coolant when the engine is hot. Steam and scalding liquids released from a hot cooling system can burn you badly. Also, you can be burned if you spill coolant on hot engine parts.



Do not put engine coolant in the windshield washer fluid container. If sprayed on the windshield, engine coolant could make it difficult to see through the windshield.

The cooling system in your vehicle is filled with either green-colored Motorcraft Premium Engine Coolant meeting Ford specification ESE-M97B44-A or yellow-colored Motorcraft Premium Gold Engine Coolant meeting Ford Specification WSS-M97B51-A1. To determine your vehicle's coolant type (color), check your coolant reservoir.

- **Add Motorcraft Premium Engine Coolant (green-colored), VC-4-A (U.S.) or CXC-10 (Canada) or Motorcraft Premium Gold Engine Coolant (yellow-colored), VC-7-A (VC-7-B in Oregon), depending on the type of coolant originally equipped in your vehicle.** If you are unsure which type of coolant your vehicle requires, check your coolant reservoir or contact your local dealer.

Note: Use of Motorcraft Cooling System Stop Leak Pellets, VC-6, darkens the color of Motorcraft Premium Gold Engine Coolant from yellow to golden tan.

- **Do not add/mix an orange-colored, extended life coolant such as Motorcraft Speciality Orange Engine Coolant, VC-2 (US) or CXC-209 (Canada), meeting Ford specification WSS-M97B44-D with the factory-filled coolant.** Mixing Motorcraft Speciality Orange Engine Coolant or any orange-colored extended life product with your factory filled coolant can result in degraded corrosion protection.
- A large amount of water without engine coolant may be added, in case of emergency, to reach a vehicle service location. In this instance, the cooling system must be drained and refilled with a 50/50 mixture of engine coolant and distilled water as soon as possible. Water alone (without engine coolant) can cause engine damage from corrosion, overheating or freezing.

Maintenance and care

- **Do not use alcohol, methanol, brine or any engine coolants mixed with alcohol or methanol antifreeze (coolant).** Alcohol and other liquids can cause engine damage from overheating or freezing.
- **Do not add extra inhibitors or additives to the coolant.** These can be harmful and compromise the corrosion protection of the engine coolant.
- **Do not mix with recycled coolant unless from a Ford-approved recycling process (see *Use of Recycled engine coolant* section).**

For vehicles with overflow coolant systems with a non-pressurized cap on the coolant recovery system, add coolant to the coolant recovery reservoir when the engine is cool. Add the proper mixture of coolant and water to the “cold full” level. For all other vehicles, which have a coolant degas system with a pressurized cap, or if it is necessary to remove the coolant pressure relief cap on the radiator of a vehicle with an overflow system, follow these steps to add engine coolant.



To reduce the risk of personal injury, make sure the engine is cool before unscrewing the coolant pressure relief cap. The cooling system is under pressure; steam and hot liquid can come out forcefully when the cap is loosened slightly.

1. Before you begin, turn the engine off and let it cool.
2. When the engine is cool, wrap a thick cloth around the coolant pressure relief cap on the coolant reservoir (an opaque plastic bottle). Slowly turn cap counterclockwise (left) until pressure begins to release.
3. Step back while the pressure releases.
4. When you are sure that all the pressure has been released, use the cloth to turn it counterclockwise and remove the cap.
5. Fill the coolant reservoir slowly with the proper coolant mixture (see above), to within the “cold fill range” or the “cold full” level on the reservoir. If you removed the radiator cap in an overflow system, fill the radiator until the coolant is visible and radiator is almost full.
6. Replace the cap. Turn until tightly installed. (Cap must be tightly installed to prevent coolant loss.)

After any coolant has been added, check the coolant concentration, refer to *Checking Engine Coolant* section. If the concentration is not 50/50 (protection to $-34^{\circ}\text{F}/-36^{\circ}\text{C}$), drain some coolant and adjust the concentration. It may take several drains and additions to obtain a 50/50 coolant concentration.

Maintenance and care

Whenever coolant has been added, the coolant level in the coolant reservoir should be checked the next few times you drive the vehicle. If necessary, add enough 50/50 concentration of engine coolant and distilled water to bring the liquid level to the proper level.

If you have to add more than 1.0 liter (1.0 quart) of engine coolant per month, have your dealer check the engine cooling system. Your cooling system may have a leak. Operating an engine with a low level of coolant can result in engine overheating and possible engine damage.

Recycled engine coolant

Ford Motor Company recommends the use of a recycled engine coolant produced by Ford-approved processes in vehicles originally equipped with Motorcraft Premium Engine Coolant (green-colored). However, not all coolant recycling processes produce coolant that meets Ford specification ESE-M97B44-A. Use of such coolant may harm the engine and cooling system components.

Ford Motor Company does NOT recommend the use of recycled engine coolant in vehicles originally equipped with Motorcraft Premium Gold Engine Coolant since a Ford-approved recycling process is not yet available.



Used engine coolant should be disposed of in an appropriate manner. Follow your community's regulations and standards for recycling and disposing of automotive fluids.

Coolant refill capacity

To find out how much fluid your vehicle's cooling system can hold, refer to *Refill capacities* in the *Capacities and specifications* chapter.

Fill your engine coolant reservoir as outlined in *Adding engine coolant* in this chapter.

Severe climates

If you drive in extremely cold climates (less than -36°C [-34°F]), it may be necessary to increase the coolant concentration above 50%. Refer to the chart on the coolant container to ensure the coolant concentration in your vehicle will provide adequate freeze protection.

Never increase the engine coolant concentration above 60% (protection to -60°F). At a level over 60%, your engine could overheat and become damaged.

If you drive in extremely hot climates, it is still necessary to maintain the coolant concentration at 50/50 coolant and water. **Do not allow the coolant concentration to fall below 40% coolant.** At a concentration

Maintenance and care



less than 40%, the corrosion protection to your engine and cooling components may be compromised and permanent damage may result.

What you should know about fail-safe cooling (4.6L V8 engine only)

If the engine coolant supply is depleted, this feature allows the vehicle to be driven temporarily before incremental component damage is incurred. The “fail-safe” distance depends on ambient temperatures, vehicle load and terrain.

How fail-safe cooling works

If the engine begins to overheat:

- The engine coolant temperature gauge will move to the red (hot) area.
- The  and the  symbol will illuminate.
- The “Service Engine Soon” indicator light will illuminate.

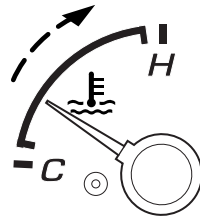

If the engine reaches a preset over-temperature condition, the engine will automatically switch to alternating cylinder operation. Each disabled cylinder acts as an air pump and cools the engine.

When this occurs the vehicle will still operate. However:

- The engine power will be limited.
- The air conditioning system will be disabled.

Continued operation will increase the engine temperature:

- The engine will completely shut down.
- Steering and braking effort will increase.

Once the engine temperature cools, the engine can be re-started. Take your vehicle to a service facility as soon as possible to minimize engine damage.

When fail-safe mode is activated

You have limited engine power when in the fail-safe mode, so drive the vehicle with caution. The vehicle will not be able to maintain high speed operation and the engine will run rough. Remember that the engine is capable of completely shutting down automatically to prevent engine damage, therefore:

1. Pull off the road as soon as safely possible and turn off the engine.

Maintenance and care

2. Arrange for the vehicle to be taken to a service facility.
3. If this is not possible, wait a short period for the engine to cool.
4. Check the coolant level and replenish if low.



Never remove the coolant reservoir cap while the engine is running or hot.

5. Restart the engine and take your vehicle to a service facility.

Driving the vehicle without repairing the engine problem increases the chance of engine damage. Take your vehicle to a service facility as soon as possible.

CHECKING AND ADDING POWER STEERING FLUID

Check the power steering fluid. Refer to the scheduled maintenance guide for the service interval schedules. If adding fluid is necessary, use only MERCON® ATF.

- 4.0L SOHC V6 engine

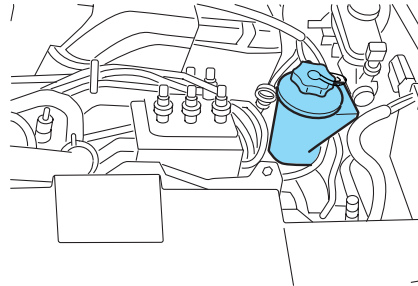

- 4.6L V8 engine

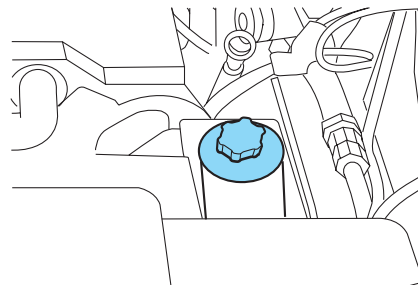

1. Start the engine and let it run until it reaches normal operating temperature (the engine coolant temperature gauge indicator will be near the center of the normal area between H and C).

Maintenance and care

2. While the engine idles, turn the steering wheel left and right several times.
3. Turn the engine off.
4. Check the fluid level in the reservoir.
5. The fluid level should be between the MIN and MAX lines. Do not add fluid if the level is in this range.
6. If the fluid is low, add fluid in small amounts, continuously checking the level until it reaches the correct operating range. Be sure to put the cap back on the reservoir.

TRANSMISSION FLUID

Checking automatic transmission fluid (if equipped)

The automatic transmission does not have a transmission fluid dipstick.

Refer to your scheduled maintenance guide for scheduled intervals for fluid checks and changes. Your transmission does not consume fluid. However, the fluid level should be checked if the transmission is not working properly, i.e., if the transmission slips or shifts slowly or if you notice some sign of fluid leakage.

Transmission fluid should be checked and, if required, fluid should be added by a qualified technician.

Do not use supplemental transmission fluid additives, treatments or cleaning agents. The use of these materials may affect transmission operation and result in damage to internal transmission components.

Maintenance and care

Checking and adding manual transmission fluid (if equipped)

1. Make sure the vehicle is on a level surface or level hoist.
2. Clean the filler plug or dirt and debris.
3. Remove the filler plug and inspect the fluid level.

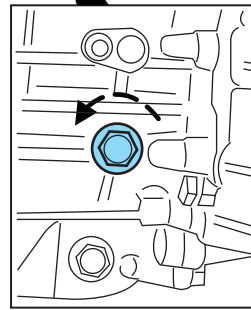
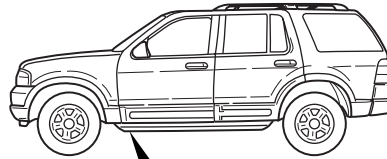

4. Fluid level should be at bottom of the opening.
5. Add enough fluid through the filler opening so that the fluid level is at the bottom of the opening.
6. Install and tighten the fill plug securely.

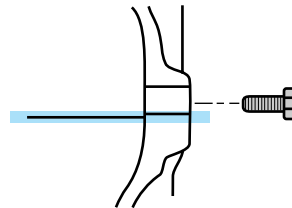

Use only fluid that meets Ford specifications. Refer to the *Lubricant Specifications* in this chapter.

Maintenance and care

CHECKING AND ADDING TRANSFER CASE FLUID (IF EQUIPPED)

1. Clean the filler plug.
2. Remove the filler plug and inspect the fluid level.

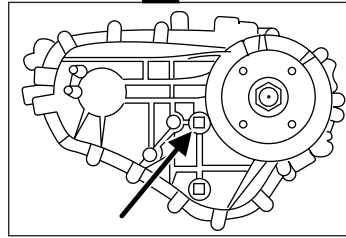
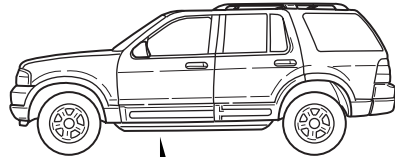

3. Add only enough fluid through the filler opening so that the fluid level is at the bottom of the opening.

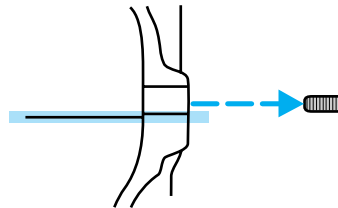

Use only fluid that meets Ford specifications. Refer to *Lubricant Specifications* in the *Capacities and specifications* chapter.

DRIVELINE UNIVERSAL JOINT AND SLIP YOKE

Your vehicle may be equipped with universal joints that require lubrication. Refer to the scheduled maintenance guide for maintenance intervals. If the original universal joints are replaced with universal joints equipped with grease fittings, lubrication will also be necessary.

Maintenance and care

BATTERY

Your vehicle is equipped with a Motorcraft maintenance-free battery which normally does not require additional water during its life of service.

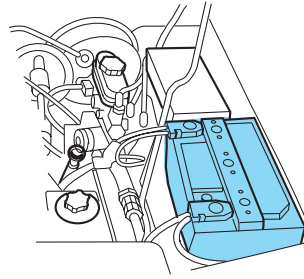

However, for severe usage or in high temperature climates, check the battery electrolyte level. Refer to the scheduled maintenance guide for the service interval schedules.

Keep the electrolyte level in each cell up to the “level indicator”. Do not overfill the battery cells.

If the electrolyte level in the battery is low, you can add plain tap water to the battery, as long as you do not use hard water (water with a high mineral or alkali content). If possible, however, try to only fill the battery cells with distilled water. If the battery needs water often, have the charging system checked.

If your battery has a cover/shield, make sure it is reinstalled after the battery has been cleaned or replaced.

For longer, trouble-free operation, keep the top of the battery clean and dry. Also, make certain the battery cables are always tightly fastened to the battery terminals.

If you see any corrosion on the battery or terminals, remove the cables from the terminals and clean with a wire brush. You can neutralize the acid with a solution of baking soda and water.



Batteries normally produce explosive gases which can cause personal injury. Therefore, do not allow flames, sparks or lighted substances to come near the battery. When working near the battery, always shield your face and protect your eyes. Always provide proper ventilation.

Maintenance and care

 When lifting a plastic-cased battery, excessive pressure on the end walls could cause acid to flow through the vent caps, resulting in personal injury and/or damage to the vehicle or battery. Lift the battery with a battery carrier or with your hands on opposite corners.

 Keep batteries out of reach of children. Batteries contain sulfuric acid. Avoid contact with skin, eyes or clothing. Shield your eyes when working near the battery to protect against possible splashing of acid solution. In case of acid contact with skin or eyes, flush immediately with water for a minimum of 15 minutes and get prompt medical attention. If acid is swallowed, call a physician immediately.

 Battery posts, terminals and related accessories contain lead and lead compounds. **Wash hands after handling.**

Because your vehicle's engine is electronically controlled by a computer, some control conditions are maintained by power from the battery. When the battery is disconnected or a new battery is installed, the engine must relearn its idle and fuel trim strategy for optimum driveability and performance. To begin this process:

1. With the vehicle at a complete stop, set the parking brake.
 2. Put the gearshift lever in P (Park), turn off all accessories and start the engine.
 3. Run the engine until it reaches normal operating temperature.
 4. Allow the engine to idle for at least one minute.
 5. Turn the A/C on and allow the engine to idle for at least one minute.
 6. Drive the vehicle to complete the relearning process.
- The vehicle may need to be driven to relearn the idle and fuel trim strategy.
 - **If you do not allow the engine to relearn its idle trim, the idle quality of your vehicle may be adversely affected until the idle trim is eventually relearned.**

When the battery is disconnected or a new battery installed, the transmission must relearn its adaptive strategy. As a result of this, the transmission may shift firmly. This operation is considered normal and will not affect function or durability of the transmission. Over time the adaptive learning process will fully update transmission operation to its optimum shift feel.

Maintenance and care

If the battery has been disconnected or a new battery has been installed, the clock and the preset radio stations must be reset once the battery is reconnected.

- Always dispose of automotive batteries in a responsible manner. Follow your local authorized standards for disposal. Call your local authorized recycling center to find out more about recycling automotive batteries.

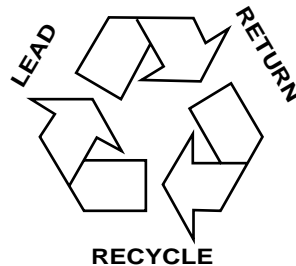

WINDSHIELD WIPER BLADES

Check the wiper blades for wear at least twice a year or when they seem less effective. Substances such as tree sap and some hot wax treatments used by commercial car washes reduce the effectiveness of wiper blades.

Checking the wiper blades

If the wiper blades do not wipe properly, clean both the windshield and wiper blades using undiluted windshield wiper solution or a mild detergent. Rinse thoroughly with clean water. To avoid damaging the blades, do not use fuel, kerosene, paint thinner or other solvents.

Changing the wiper blades

To replace the wiper blades:

1. Pull the wiper arm away from the windshield and lock into the service position.
2. Turn the blade at an angle from the wiper arm. Push the lock pin manually to release the blade and pull the wiper blade down toward the windshield to remove it from the arm.
3. Attach the new wiper to the wiper arm and press it into place until a click is heard.

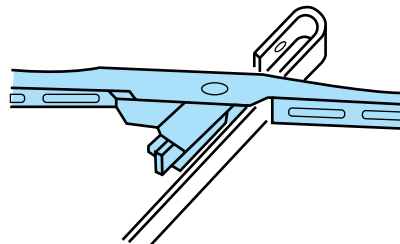

REAR WINDOW WIPER BLADE

Refer to *Windshield wiper blades* in this section for more information on rear wiper blades.

Maintenance and care

INFORMATION ABOUT UNIFORM TIRE QUALITY GRADING

New vehicles are fitted with tires that have a rating on them called Tire Quality Grades. The Quality grades can be found where applicable on the tire sidewall between tread shoulder and maximum section width. For example:

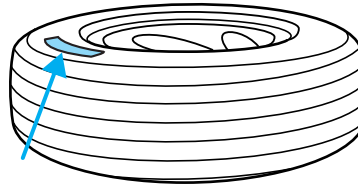

- **Treadwear 200 Traction AA Temperature A**

These Tire Quality Grades are determined by standards that the United States Department of Transportation has set.

Tire Quality Grades apply to new pneumatic tires for use on passenger cars. They do not apply to deep tread, winter-type snow tires, space-saver or temporary use spare tires, tires with nominal rim diameters of 10 to 12 inches or limited production tires as defined in Title 49 Code of Federal Regulations Part 575.104(c) (2).

U.S. Department of Transportation-Tire quality grades: The U.S. Department of Transportation requires Ford to give you the following information about tire grades exactly as the government has written it.

Treadwear

The treadwear grade is a comparative rating based on the wear rate of the tire when tested under controlled conditions on a specified government test course. For example, a tire graded 150 would wear one and one-half (1 1/2) times as well on the government course as a tire graded 100. The relative performance of tires depends upon the actual conditions of their use, however, and may depart significantly from the norm due to variations in driving habits, service practices, and differences in road characteristics and climates.

Traction AA A B C

The traction grades, from highest to lowest are AA, A, B, and C. The grades represent the tire's ability to stop on wet pavement as measured under controlled conditions on specified government test surfaces of asphalt and concrete. A tire marked C may have poor traction performance.

Maintenance and care



The traction grade assigned to this tire is based on straight-ahead braking traction tests, and does not include acceleration, cornering, hydroplaning or peak traction characteristics.

Temperature A B C

The temperature grades are A (the highest), B and C, representing the tire's resistance to the generation of heat and its ability to dissipate heat when tested under controlled conditions on a specified indoor laboratory test wheel. Sustained high temperature can cause the material of the tire to degenerate and reduce tire life, and excessive temperature can lead to sudden tire failure. The grade C corresponds to a level of performance which all passenger car tires must meet under the Federal Motor Vehicle Safety Standard No. 109. Grades A and B represent higher levels of performance on the laboratory test wheel than the minimum required by law.



The temperature grade for this tire is established for a tire that is properly inflated and not overloaded. Excessive speed, underinflation, or excessive loading, either separately or in combination, can cause heat buildup and possible tire failure.

SERVICING YOUR TIRES

Checking the tire pressure

- Use an accurate tire pressure gauge.
- Check the tire pressure when tires are **cold**, after the vehicle has been parked for at least 3 hours or has been driven less than 5 km (3 miles). As you drive, the temperature in the tire warms up, increasing the tire pressure.
- Adjust tire pressure to recommended specifications found on the Certification Label. Tire pressure information can also be found on the Tire Information label located on the inside of the fuel filler door.
- Check tires for proper air pressure monthly. Check spare tire for proper air pressure every six months.



Improperly inflated tires can affect vehicle handling and can fail suddenly, possibly resulting in loss of vehicle control.

Maintenance and care

Tire rotation

Because your vehicle's tires perform different jobs, they often wear differently. To make sure your tires wear evenly and last longer, rotate them as indicated in the scheduled maintenance guide. If you notice that the tires wear unevenly, have them checked.

- Four tire rotation

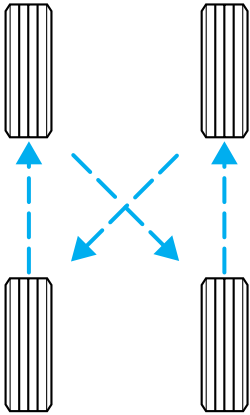

- Five tire rotation

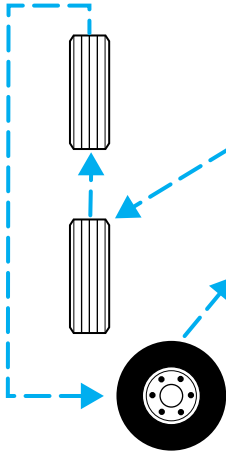



Maintenance and care

Replacing the tires

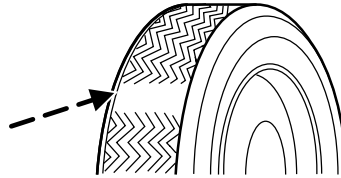
Replace the tires when the wear band is visible through the tire treads.



 When replacing full size tires, never mix radial bias-belted, or bias-type tires. Use only the tire sizes that are listed on the Certification Label. Make sure that all tires are the same size, speed rating, and load-carrying capacity. Use only the tire combinations recommended on the label. If you do not follow these precautions, your vehicle may not drive properly and safely.

 Make sure that all replacement tires are of the same size, type, load-carrying capacity and tread design (e.g., “All Terrain”, “Touring”, etc.), as originally offered by Ford.

 Do not replace your tires with “high performance” tires or larger size tires.

 Failure to follow these precautions may adversely affect the handling of the vehicle and make it easier for the driver to lose control and roll over.

Tires that are larger or smaller than your vehicle’s original tires may also affect the accuracy of your speedometer.

Tire pressure monitoring system (TPMS) (if equipped)

The tire pressure monitoring system provides the driver with a warning message indicating when tire pressure is severely low or high. This system is a supplement to normal tire maintenance including regular manual inspections. The device will inform the operator of severe low or high inflation pressures, but may not illuminate for less severe discrepancies in inflation pressure.

The system uses radio-frequency pressure sensors to monitor the tire pressure on all tires including the spare. The sensors transmit the tire

Maintenance and care

pressure readings to the receiver module located in the vehicle. The receiver module then transmits the status to the message center. For more tire warning information, refer to the *Message Center* in the *Driver controls* chapter.

This device complies with part 15 of the FCC rules and with RS-210 of Industry Canada. Operation is subject to the following two conditions: (1) This device may not cause harmful interference, and (2) This device must accept any interference received, including interference that may cause undesired operation.

 The tire pressure monitoring system is NOT a substitute for checking tire pressure. The tire pressure should be checked periodically (at least monthly) using a tire gauge, see *Checking the tire pressure* in this chapter. Failure to properly maintain your tire pressure could increase the risk of tire failure and the potential for personal injury.

Changing tires with TPMS

It is recommended that you always have your tires serviced by a dealer or qualified technician. **Each tire is equipped with a tire pressure sensor mounted on the wheel inside the tire behind the valve stem. The tire pressure sensor**

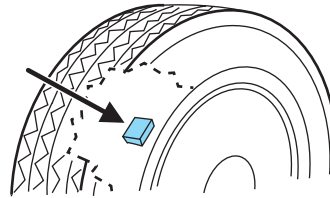

must be unbolted from the wheel prior to tire removal. The sensor can be removed by loosening the nut at the valve stem. Failure to remove the sensor may damage it. The rubber grommet (washer) between the wheel and the tire pressure sensor needs to be replaced when any tire is changed to minimize air leaks.

The tire pressure should be checked periodically (at least monthly) using a tire gauge, refer to *Checking the tire pressure* in this chapter.

USING SNOW TIRES AND TRACTION DEVICES

 Snow tires must be the same size and grade as the tires you currently have on your vehicle.

The tires on your vehicle have all-weather treads to provide traction in rain and snow. However, in some climates, using snow tires or traction devices may be necessary. Ford offers tire cables as a Ford approved

Maintenance and care

accessory and recommends use of these or SAE class “S”. See your dealer or qualified service technician for more information on tire cables for your vehicle.

Follow these guidelines when using snow tires and traction devices:

- Cables or chains should only be used on the rear wheels.
- Install cables or chains securely, verifying that the cables or chains do not touch any wiring, brake lines or fuel lines.
- Drive cautiously. If you hear the cables or chains rub or bang against the vehicle, stop and retighten them. If this does not work, remove the cables or chains to prevent vehicle damage.
- Avoid overloading your vehicle.
- Remove the cables or chains when they are no longer needed.
- Do not use cables or chains on dry roads.
- Do not exceed 48 km/h (30 mph) with tire cables or chains on your vehicle.

Consult your dealer for information on other Ford approved methods of traction control.

WHAT YOU SHOULD KNOW ABOUT AUTOMOTIVE FUELS

Important safety precautions



Do not overfill the fuel tank. The pressure in an overfilled tank may cause leakage and lead to fuel spray and fire.



The fuel system may be under pressure. If the fuel filler cap is venting vapor or if you hear a hissing sound, wait until it stops before completely removing the fuel filler cap. Otherwise, fuel may spray out and injure you or others.



If you do not use the proper fuel filler cap, excessive pressure or vacuum in the fuel tank may damage the fuel system or cause the fuel cap to disengage in a collision, which may result in possible personal injury.



Automotive fuels can cause serious injury or death if misused or mishandled.

Maintenance and care



Fuel ethanol and gasoline may contain benzene, which is a cancer-causing agent.

Observe the following guidelines when handling automotive fuel:

- Extinguish all smoking materials and any open flames before fueling your vehicle.
- Always turn off the vehicle before fueling.
- Automotive fuels can be harmful or fatal if swallowed. Fuels such as gasoline and ethanol are highly toxic and if swallowed can cause death or permanent injury. If fuel is swallowed, call a physician immediately, even if no symptoms are immediately apparent. The toxic effects of fuel may not be visible for hours.
- Avoid inhaling fuel vapors. Inhaling too much fuel vapor of any kind can lead to eye and respiratory tract irritation. In severe cases, excessive or prolonged breathing of fuel vapor can cause serious illness and permanent injury.
- Avoid getting fuel liquid in your eyes. If fuel is splashed in the eyes, remove contact lenses (if worn), flush with water for 15 minutes and seek medical attention. Failure to seek proper medical attention could lead to permanent injury.
- Fuels can also be harmful if absorbed through the skin. If fuel is splashed on the skin and/or clothing, promptly remove contaminated clothing and wash skin thoroughly with soap and water. Repeated or prolonged skin contact with fuel liquid or vapor causes skin irritation.
- Be particularly careful if you are taking “Antabuse” or other forms of disulfiram for the treatment of alcoholism. Breathing gasoline and/or ethanol vapors, or skin contact could cause an adverse reaction. In sensitive individuals, serious personal injury or sickness may result. If fuel is splashed on the skin, promptly wash skin thoroughly with soap and water. Consult a physician immediately if you experience an adverse reaction.
- FFV fuel tanks may contain zero to 85 percent ethanol. Any fuel blends containing gasoline and ethanol should be treated the same as “Fuel Ethanol”. To identify if your vehicle is an FFV, check your VIN or the label on the inside of your fuel filler door. When checking the VIN look for the engine type identifier (8th character). If your vehicle is an FFV, then the character will be labeled as a “K.”



Maintenance and care

Pure ethanol is the alcohol which is the intoxicating agent in liquor, beer and wine. It is distilled from the fermentation of plants such as field corn and sugar cane. When ethanol is used in the making of motor fuels, a small amount of a bad tasting chemical is added to discourage beverage use. The resulting fuel is called E_d100 meaning 100% pure ethanol diluted by 2% to 5% gasoline as the “denaturant.”

Fuel ethanol (summer blend_d) is then made by adding 15% more unleaded gasoline. The resulting fuel also has a higher octane rating than unleaded regular gasoline and other properties which allow engine designs with greater efficiency and power.

Winter blends may contain up to 30% (E70) unleaded gasoline (25% plus the denaturant) to enhance cold engine starts. Severely cold weather may require additional measures for reliable starting. Refer to *Cold Weather Starting* in the *Driving* chapter.

Ethanol is more chemically active than gasoline. It corrodes some metals and causes some plastic and rubber components to swell, break down or become brittle and crack, especially when mixed with gasoline. Special materials and procedures have been developed for flexible fuel vehicles and the dispensers used by ethanol fuel providers.



Flexible fuel components and standard unleaded gasoline fuel components are not interchangeable. If your vehicle is not serviced in accordance with flexible fuel vehicles procedures, damage may occur and your warranty may be invalidated.



When refueling always shut the engine off and never allow sparks or open flames near the filler neck. Never smoke while refueling. Fuel vapor is extremely hazardous under certain conditions. Care should be taken to avoid inhaling excess fumes.



The flow of fuel through a fuel pump nozzle can produce static electricity, which can cause a fire if fuel is pumped into an ungrounded fuel container.

Use the following guidelines to avoid static build-up when filling an ungrounded fuel container:

- Place approved fuel container on the ground.
- DO NOT fill a fuel container while it is in the vehicle (including the cargo area).

Maintenance and care

- Keep the fuel pump nozzle in contact with the fuel container while filling.
- DO NOT use a device that would hold the fuel pump handle in the fill position.

Choosing the right fuel

Use only UNLEADED FUEL. The use of leaded fuel is prohibited by law and could damage your vehicle.

If your vehicle is a flexible fuel vehicle (FFV), use only UNLEADED FUEL and (E85) ETHANOL. The use of leaded fuel is prohibited by law and could damage your vehicle.

Do not use fuel containing methanol. It can damage critical fuel system components.

Your vehicle was not designed to use fuel or fuel additives with metallic compounds, including manganese-based compounds containing MMT.

Repairs to correct the effects of using a fuel for which your vehicle was not designed may not be covered by your warranty.

Octane recommendations

Do not be concerned if your engine sometimes knocks lightly. However, if it knocks heavily under most driving conditions while you are using fuel with the recommended octane rating, see your dealer or a qualified service technician to prevent any engine damage.

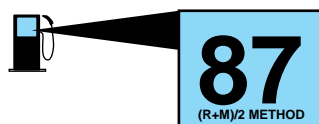

Unleaded Gasoline engines

Your vehicle is designed to use “Regular” unleaded gasoline with an (R+M)/2 octane rating of 87. We do not recommend the use of gasolines labeled as “Regular” that are sold with octane ratings of 86 or lower in high altitude areas.

FFV engine (if equipped)

Your vehicle is designed to use (E85) Fuel Ethanol, “Regular” unleaded gasoline or any percentage of the two fuels combined.

U.S. government regulations require fuel ethanol dispensing pumps to have a small, square, orange and black label with the common abbreviation or the appropriate percentage for that region. Use of other fuels such as Fuel Methanol may cause powertrain damage, a loss of vehicle performance, and your warranty may be invalidated.

Maintenance and care

Fuel quality

Many of the world's automakers issued the World-wide Fuel Charter that recommends gasoline specifications to provide improved performance and emission control system protection for your vehicle. Gasolines that meet the World-wide Fuel Charter should be used when available. Ask your fuel supplier about gasolines that meet the World-wide Fuel Charter. In Canada, look for fuels that display the **Auto Makers' Choice**[™] logo.



It should not be necessary to add any aftermarket products to your fuel tank if you continue to use high quality fuel of the recommended octane rating. Aftermarket products could cause damage to the fuel system. Repairs to correct the effects of using an aftermarket product in your fuel may not be covered by your warranty.

Unleaded Gasoline engines

If you are experiencing starting, rough idle or hesitation driveability problems during a cold start, try a different brand of "Regular" unleaded gasoline. "Premium" unleaded gasoline is not recommended (particularly in the United States) because it may cause these problems to become more pronounced. If the problems persist, see your dealer or a qualified service technician.

FFV engine (if equipped)

Your FFV will operate well on ordinary "Regular" unleaded gasoline, but only the highest quality fuel ethanol will provide the same level of protection and performance. To identify if your vehicle is an FFV, check your VIN or the label on the inside of your fuel filler door. When checking the VIN, look for the engine type identifier (8th character). If your vehicle is an FFV, then the character will be labeled as a "K."

If you operate your vehicle 50% or more of the time on ethanol, you should follow a different maintenance schedule. See the *Scheduled Maintenance Guide* for more information.

If you are experiencing a rough or rolling idle after start-up with the outside temperature above 27° C (80° F), the idle should improve within 10 to 30 seconds. If the problems persist below this temperature, see your dealer or a qualified service technician.

Maintenance and care

Cleaner air

Ford endorses the use of reformulated “cleaner-burning” gasolines to improve air quality.

Running out of fuel

Avoid running out of fuel because this situation may have an adverse affect on powertrain components.

If you have run out of fuel:

- You may need to cycle the ignition from OFF to ON several times after refueling, to allow the fuel system to pump the fuel from the tank to the engine.

Fuel Filler Cap

Your fuel tank filler cap has an indexed design with a 1/8 turn on/off feature.

When fueling your vehicle:

1. Turn the engine off.
2. Carefully turn the filler cap counterclockwise 1/8 of a turn until it stops.
3. Pull to remove the cap from the fuel filler pipe.
4. To install the cap, align the tabs on the cap with the notches on the filler pipe.
5. Turn the filler cap clockwise 1/8 of a turn until it stops.

If the “Check Fuel Cap” indicator comes on and stays on after you start the engine, the fuel filler cap may not be properly installed. Turn off the engine, remove the fuel filler cap, align the cap properly and reinstall it.

If you must replace the fuel filler cap, replace it with a fuel filler cap that is designed for your vehicle. The customer warranty may be void for any damage to the fuel tank or fuel system if the correct genuine Ford or Motorcraft fuel filler cap is not used.



The fuel system may be under pressure. If the fuel filler cap is venting vapor or if you hear a hissing sound, wait until it stops before completely removing the fuel filler cap. Otherwise, fuel may spray out and injure you or others.

Maintenance and care



If you do not use the proper fuel filler cap, excessive pressure or vacuum in the fuel tank may damage the fuel system or cause the fuel cap to disengage in a collision, which may result in possible personal injury.

Fuel Filter

For fuel filter replacement, see your dealer or a qualified service technician. Refer to the scheduled maintenance guide for the appropriate intervals for changing the fuel filter.

Replace the fuel filter with an authorized Motorcraft part. The customer warranty may be void for any damage to the fuel system if an authorized Motorcraft fuel filter is not used.

ESSENTIALS OF GOOD FUEL ECONOMY

Measuring techniques

Your best source of information about actual fuel economy is you, the driver. You must gather information as accurately and consistently as possible. Fuel expense, frequency of fill-ups or fuel gauge readings are NOT accurate as a measure of fuel economy. We do not recommend taking fuel economy measurements during the first 1,600 km (1,000 miles) of driving (engine break-in period). You will get a more accurate measurement after 3,000 km–5,000 km (2,000 miles–3,000 miles).

Filling the tank

The advertised fuel capacity of the fuel tank on your vehicle is equal to the rated refill capacity of the fuel tank as listed in the *Refill capacities* section of this chapter.

The advertised capacity is the amount of the indicated capacity and the empty reserve combined. Indicated capacity is the difference in the amount of fuel in a full tank and a tank when the fuel gauge indicates empty. Empty reserve is the small amount of fuel remaining in the fuel tank after the fuel gauge indicates empty.

The amount of usable fuel in the empty reserve varies and should not be relied upon to increase driving range. When refueling your vehicle after the fuel gauge indicates empty, you might not be able to refuel the full amount of the advertised capacity of the fuel tank due to the empty reserve still present in the tank.

Maintenance and care

For consistent results when filling the fuel tank:

- Turn the engine/ignition switch to the off position prior to refueling, an error in the reading will result if the engine is left running.
- Use the same filling rate setting (low — medium — high) each time the tank is filled.
- Allow no more than 2 automatic click-offs when filling.
- Always use fuel with the recommended octane rating.
- Use a known quality gasoline, preferably a national brand.
- Use the same side of the same pump and have the vehicle facing the same direction each time you fill up.
- Have the vehicle loading and distribution the same every time.

Your results will be most accurate if your filling method is consistent.

Filling the tank for FFV equipped vehicles

Your vehicle will operate on both unleaded gasoline with an octane rating of 87, or E-85 fuel, or any mixture of these two. For best results it is recommended that you do not add less than 5 gallons of fuel when refueling. Observing this precaution will avoid possible hard starting and/or deterioration in drivability during warm up.

Calculating fuel economy

1. Fill the fuel tank completely and record the initial odometer reading (in kilometers or miles).
2. Each time you fill the tank, record the amount of fuel added (in liters or gallons).
3. After at least three to five tank fill-ups, fill the fuel tank and record the current odometer reading.
4. Subtract your initial odometer reading from the current odometer reading.
5. Follow one of the simple calculations in order to determine fuel economy:

Multiply liters used by 100, then divide by total kilometers traveled.

Divide total miles traveled by total gallons used.

Keep a record for at least one month and record the type of driving (city or highway). This will provide an accurate estimate of the vehicle's fuel economy under current driving conditions. Additionally, keeping records during summer and winter will show how temperature impacts fuel economy. In general, lower temperatures give lower fuel economy.

Maintenance and care

Driving style — good driving and fuel economy habits

Give consideration to the lists that follow and you may be able to change a number of variables and improve your fuel economy.

Habits

- Smooth, moderate operation can yield up to 10% savings in fuel.
- Steady speeds without stopping will usually give the best fuel economy.
- Idling for long periods of time (greater than one minute) may waste fuel.
- Anticipate stopping; slowing down may eliminate the need to stop.
- Sudden or hard accelerations may reduce fuel economy.
- Slow down gradually.
- Driving at reasonable speeds (traveling at 88 km/h [55 mph] uses 15% less fuel than traveling at 105 km/h [65 mph]).
- Revving the engine before turning it off may reduce fuel economy.
- Using the air conditioner or defroster may reduce fuel economy.
- You may want to turn off the speed control in hilly terrain if unnecessary shifting between third and fourth gear occurs. Unnecessary shifting of this type could result in reduced fuel economy.
- Warming up a vehicle on cold mornings is not required and may reduce fuel economy.
- Resting your foot on the brake pedal while driving may reduce fuel economy.
- Combine errands and minimize stop-and-go driving.

Maintenance

- Keep tires properly inflated and use only recommended size.
- Operating a vehicle with the wheels out of alignment will reduce fuel economy.
- Use recommended engine oil. Refer to *Lubricant specifications* in the *Maintenance and Specifications* chapter.
- Perform all regularly scheduled maintenance items. Follow the recommended maintenance schedule and owner maintenance checks found in your vehicle scheduled maintenance guide.

Conditions

- Heavily loading a vehicle or towing a trailer may reduce fuel economy at any speed.

Maintenance and care

- Carrying unnecessary weight may reduce fuel economy (approximately 0.4 km/L [1 mpg] is lost for every 180 kg [400 lb] of weight carried).
- Adding certain accessories to your vehicle (for example bug deflectors, rollbars/light bars, running boards, ski/luggage racks) may reduce fuel economy.
- Fuel economy may decrease with lower temperatures during the first 12–16 km (8–10 miles) of driving.
- Driving on flat terrain offers improved fuel economy as compared to driving on hilly terrain.
- Transmissions give their best fuel economy when operated in the top cruise gear and with steady pressure on the gas pedal.
- Four-wheel-drive operation (if equipped) is less fuel efficient than two-wheel-drive operation.
- Close windows for high speed driving.

Flex fuel (E-85) cruising range

Because E-85 fuel contains less energy per gallon than gasoline, you will experience an increase in fuel consumption. You can expect your Miles Per Gallon (MPG) and your driving range to decrease by about 30% compared to gasoline operation.

EPA window sticker

Every new vehicle should have the EPA window sticker. Contact your dealer if the window sticker is not supplied with your vehicle. The EPA window sticker should be your guide for the fuel economy comparisons with other vehicles.

It is important to note the box in the lower left corner of the window sticker. These numbers represent the Range of L/100 km (MPG) expected on the vehicle under optimum conditions. Your fuel economy may vary depending upon the method of operation and conditions.

EMISSION CONTROL SYSTEM

Your vehicle is equipped with various emission control components and a catalytic converter which will enable your vehicle to comply with applicable exhaust emission standards. To make sure that the catalytic converter and other emission control components continue to work properly:

- Use only the specified fuel listed.
- Avoid running out of fuel.

Maintenance and care

- Do not turn off the ignition while your vehicle is moving, especially at high speeds.
- Have the items listed in your scheduled maintenance guide performed according to the specified schedule.

The scheduled maintenance items listed in the scheduled maintenance guide are essential to the life and performance of your vehicle and to its emissions system.

If other than Ford, Motorcraft or Ford-authorized parts are used for maintenance replacements or for service of components affecting emission control, such non-Ford parts should be equivalent to genuine Ford Motor Company parts in performance and durability.



Do not park, idle, or drive your vehicle in dry grass or other dry ground cover. The emission system heats up the engine compartment and exhaust system, which can start a fire.

Illumination of the “Check Engine” light, charging system warning light or the temperature warning light, fluid leaks, strange odors, smoke or loss of engine power, could indicate that the emission control system is not working properly.



Exhaust leaks may result in entry of harmful and potentially lethal fumes into the passenger compartment.

Do not make any unauthorized changes to your vehicle or engine. By law, vehicle owners and anyone who manufactures, repairs, services, sells, leases, trades vehicles, or supervises a fleet of vehicles are not permitted to intentionally remove an emission control device or prevent it from working. Information about your vehicle’s emission system is on the Vehicle Emission Control Information Decal located on or near the engine. This decal identifies engine displacement and gives some tune up specifications.

Please consult your *Warranty Guide* for complete emission warranty information.

Readiness for Inspection/Maintenance (I/M) testing

In some localities, it may be a legal requirement to pass an I/M test of the on-board diagnostics system. If your “Check Engine/Service Engine Soon” light is on, refer to the description in the *Warning lights and chimes* section of the *Instrumentation* chapter. Your vehicle may not pass the I/M test with the “Check Engine/Service Engine Soon” light on.

Maintenance and care

If the vehicle's powertrain system or its battery has just been serviced, the on-board diagnostics system is reset to a "not ready for I/M test" condition. To ready the on-board diagnostics system for I/M testing, a minimum of 30 minutes of city and highway driving is necessary as described below:

- First, at least 10 minutes of driving on an expressway or highway.
- Next, at least 20 minutes driving in stop-and-go, city-type traffic with at least four idle periods.

Allow the vehicle to sit for at least eight hours without starting the engine. Then, start the engine and complete the above driving cycle. The engine must warm up to its normal operating temperature. Once started, do not turn off the engine until the above driving cycle is complete.

BULBS

Replacing exterior bulbs

Check the operation of the following lamps frequently:

- Headlamps
- Foglamps
- High-mount brakelamp
- Brakelamps
- Parking lamps
- Turn signal lamps
- License plate lamp
- Tail lamps
- Back-up lamps

Do not remove lamp bulbs unless they can be replaced immediately with new ones. If a bulb is removed for an extended period of time, contaminants may enter the lamp housings and affect lamp performance.

Maintenance and care

Replacing headlamp bulbs

The high beam and low beam bulbs are located in the headlamp assembly. Follow the same steps to replace either bulb:

To remove the headlamp bulb:

1. Make sure headlamp switch is in OFF position, then open the hood.
2. At the back of the headlamp, pry up the two retainer pins until they stop to release the headlamp assembly from the vehicle and pull headlamp forward.

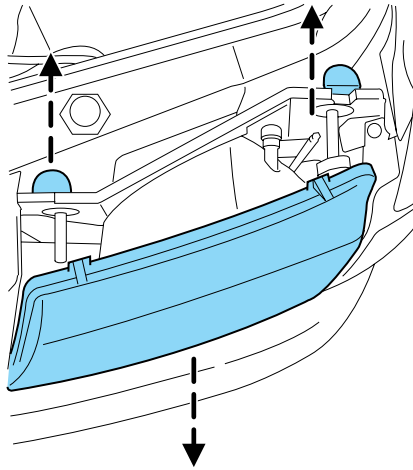

3. Disconnect the electrical connector from the bulb by pushing the center tab and pulling downward.
4. Remove the old bulb from the lamp assembly by turning counter clockwise to unlock and pulling it straight out of the lamp assembly.

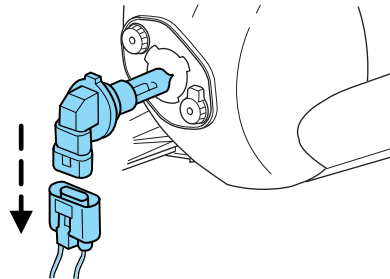

To install the new bulb:

 Handle a halogen headlamp bulb carefully and keep out of children's reach. Grasp the bulb only by its plastic base and do not touch the glass. The oil from your hand could cause the bulb to break the next time the headlamps are operated.

If the bulb is accidentally touched, it should be cleaned with rubbing alcohol before being used.

Maintenance and care

1. Install the new bulb in lamp assembly by pushing straight in and turning to lock in position. You may need to turn the bulb slightly to align the grooves in the plastic base with the tabs in the lamp assembly.
2. Connect the electrical connector to the bulb.
3. Install the headlamp on the vehicle by aligning the lamp on the vehicle, push rearward to fully seat the lamp assembly then push the two retainer pins down.
4. Turn the headlamps on and make sure they work properly. If the headlamp was correctly aimed before you changed the bulb, you should not need to aim it again.

Replacing front parking lamp/turn signal/sidemarker bulbs

1. Make sure headlamp switch is in OFF position, then open the hood.
2. Remove screw from the lamp assembly.
3. Disengage lamp assembly by pulling forward.

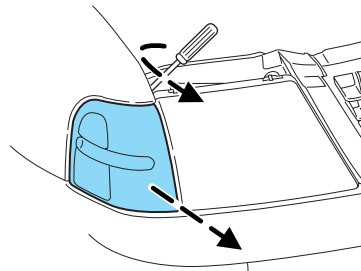

4. Rotate bulb socket counterclockwise and remove from lamp assembly.
5. Carefully pull bulb straight out of socket and push in the new bulb.
6. Install bulb socket in lamp assembly by turning clockwise.
7. Align the parking lamp studs with the plastic grommets on the vehicle and push rearward to snap in place.
8. Install screw on lamp assembly.

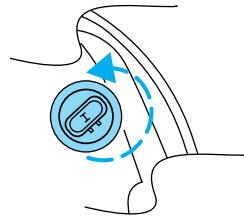

Maintenance and care

Replacing tail/brake/turn/backup lamp bulbs

The tail/brake/turn/backup bulbs are located in the tail lamp assembly, one just below the other. Follow the same steps to replace either bulb:

1. Make sure headlamp switch is in OFF position, then open the liftgate to expose the lamp assembly screws.
2. Remove the two screws from the lamp assembly.
3. Pull the lamp assembly towards the rear and side of the vehicle at an angle carefully removing it from the vehicle.
4. Rotate the bulb socket counterclockwise and remove from lamp assembly.
5. Pull the bulb straight out of the socket and push in the new bulb.
6. To complete installation, follow the removal procedure in reverse order.

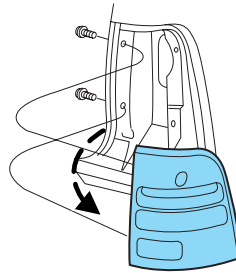

Replacing foglamp bulbs

1. Make sure headlamp switch is in OFF position, then reach under the front bumper and remove the bulb socket from the foglamp by turning counterclockwise.
2. Disconnect the electrical connector from the foglamp bulb.
3. Connect the electrical connector to the new foglamp bulb.
4. Install the bulb socket in the foglamp turning clockwise.

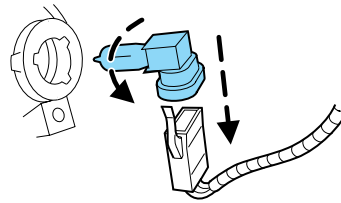

Maintenance and care

Replacing license plate lamp bulbs

1. Make sure headlamp switch is in OFF position, then remove two screws and the license plate lamp assembly from the liftgate.
2. Rotate bulb socket counterclockwise and remove from lamp assembly.
3. Carefully pull the bulb from the socket and push in the new bulb.
4. Install the lamp assembly on liftgate with two screws.

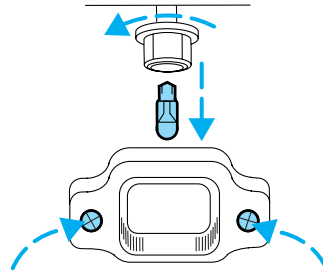

Replacing high-mount brake lamp bulbs

1. Make sure headlamp switch is in OFF position, then remove the two screws and move the lamp assembly away from the liftgate.

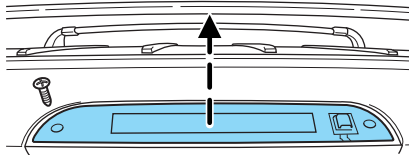

2. Remove the bulb holder from the lamp assembly by depressing the snaps.

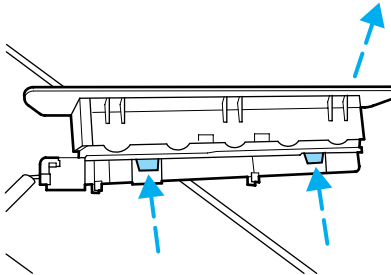

3. Pull the bulb straight out of the socket and push in the new bulb.
- To complete installation, follow the removal procedure in reverse order.

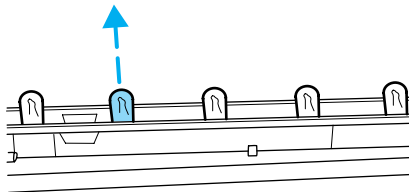

Maintenance and care

USING THE RIGHT BULBS

Replacement bulbs are specified in the chart below. Headlamp bulbs must be marked with an authorized "D.O.T." for North America and an "E" for Europe to assure lamp performance, light brightness and pattern and safe visibility. The correct bulbs will not damage the lamp assembly or void the lamp assembly warranty and will provide quality bulb burn time.

Function	Number of bulbs	Trade number
Park/turn lamps (front)	2	3157 AK (amber)
Headlamp high beam	2	9005
Headlamp low beam	2	9006
Rear stop/turn/tail lamps	2	3157K
Rear license plate lamps	2	168
Backup lamp	2	3156K
High-mount stop lamps	5	W5W
Fog lamp	2	9145
Cargo lamp	1	211-2
Interior overhead lamp	1	912 (906)
Front door courtesy lamp	1	168
Map lamps	2	168 (T10)
Ashtray lamp	1	161
All replacement bulbs are clear in color except where noted.		
To replace all instrument panel lights - see your dealer.		

Maintenance and care

VERTICAL AIM ADJUSTMENT

1. Park the vehicle on a level surface approximately 7.6 meters (25 feet) from a vertical wall or screen directly in front of it.

- (1) Eight feet
- (2) Center height of lamp to ground
- (3) Twenty-five feet
- (4) Horizontal reference line

2. Measure the height from the center of your headlamp to the ground and mark a 2.4 meter (8 foot) horizontal reference line on the vertical wall or screen at this height (a piece of masking tape works well). The center of the lamp is marked by a 3.0 mm circle on the headlamp lens.

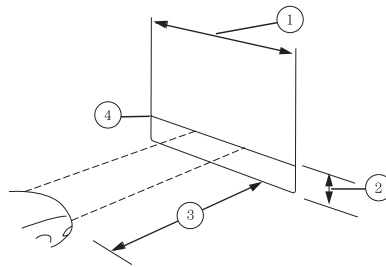

3. Turn on the low beam headlamps to illuminate the wall or screen and open the hood.

4. On the wall or screen you will observe a light pattern with a distinct horizontal edge of high intensity light with a slight angle towards the right. If this edge is not at the horizontal reference line, the beam will need to be adjusted.

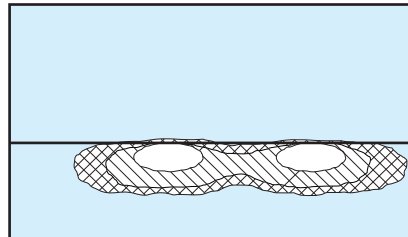

5. Locate the vertical adjuster on each headlamp, then use a 4 mm socket/wrench to turn the adjuster either counterclockwise (to adjust down) or clockwise (to adjust up) aligning the upper edge of the light pattern up to the horizontal line.

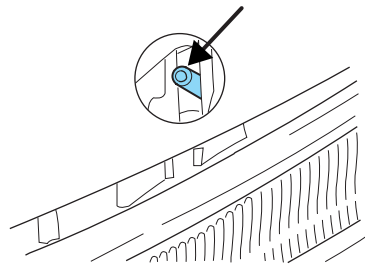

6. HORIZONTAL AIM IS NOT REQUIRED FOR THIS VEHICLE AND IS NON-ADJUSTABLE.

7. Close the hood and turn off the lamps.

Maintenance and care

CLEANING AND CARING FOR YOUR VEHICLE

Refer to the Accessories chapter for a list of Ford-approved cleaners, polishes and sealants.

Washing the exterior

Wash your vehicle regularly with cool or lukewarm water and a neutral Ph shampoo, such as Detail Wash (ZC-3-A), which is available from your dealer.

- Never use strong household detergents or soap, such as dish washing or laundry liquid. These products can discolor and spot painted surfaces.
- Never wash a vehicle that is “hot to the touch” or during exposure to strong, direct sunlight.
- Always use a clean sponge or carwash mitt with plenty of water for best results.
- Dry the vehicle with a chamois or soft terry cloth towel in order to eliminate water spotting.
- It is especially important to wash the vehicle regularly during the winter months, as dirt and road salt are difficult to remove and cause damage to the vehicle.
- Immediately remove items such as gasoline, diesel fuel, bird droppings and insect deposits because they can cause damage to the vehicle’s paintwork and trim over time.
- Remove any exterior accessories, such as antennas, before entering a car wash.
- **Suntan lotions and insect repellents can damage any painted surface; if these substances come in contact with your vehicle, wash off as soon as possible.**

Waxing

Applying a polymer paint sealant to your vehicle every six months will assist in reducing minor scratches and paint damage.

- Wash the vehicle first.
- Do not use waxes that contain abrasives.
- Do not allow paint sealant to come in contact with any non-body (low-gloss black) colored trim, such as grained door handles, roof racks, bumpers, side moldings, mirror housings or the windshield cowl area. The paint sealant will “gray” or stain the parts over time.

Maintenance and care

Paint chips

Your dealer has touch-up paint and sprays to match your vehicle's color. Take your color code (printed on a sticker in the driver's door jam) to your dealer to ensure you get the correct color.

- Remove particles such as bird droppings, tree sap, insect deposits, tar spots, road salt and industrial fallout before repairing paint chips.
- Always read the instructions before using the products.

Aluminum wheels and covers

Aluminum wheel rims or covers are coated with a clearcoat paint finish. In order to maintain their shine:

- Clean with Motorcraft Wheel and Tire Cleaner (ZC-37-A), which is available from your dealer.
- Never apply any cleaning chemical to hot or warm wheel rims or covers.
- Some automatic car washes may cause damage to the finish on your wheel rims or covers. Chemical-strength cleaners, or cleaning chemicals, in combination with brush agitation to remove brake dust and dirt, could wear away the clearcoat finish over time.
- Do not use hydrofluoric acid-based or high caustic-based wheel cleaners, steel wool, fuels or strong household detergent.
- To remove tar and grease, use Ford Extra Strength Tar and Road Oil Removal (B7A-19520-AA), available from your dealer.

Engine

Engines are more efficient when they are clean because grease and dirt buildup keep the engine warmer than normal. When washing:

- Take care when using a power washer to clean the engine. The high pressure fluid could penetrate the sealed parts and cause damage.
- Do not spray a hot engine with cold water to avoid cracking the engine block or other engine components.
- Spray Motorcraft Engine Shampoo and Degreaser (ZC-20) on all parts that require cleaning and pressure rinse clean.

Maintenance and care

- Cover the highlighted areas to prevent water damage when cleaning the engine.

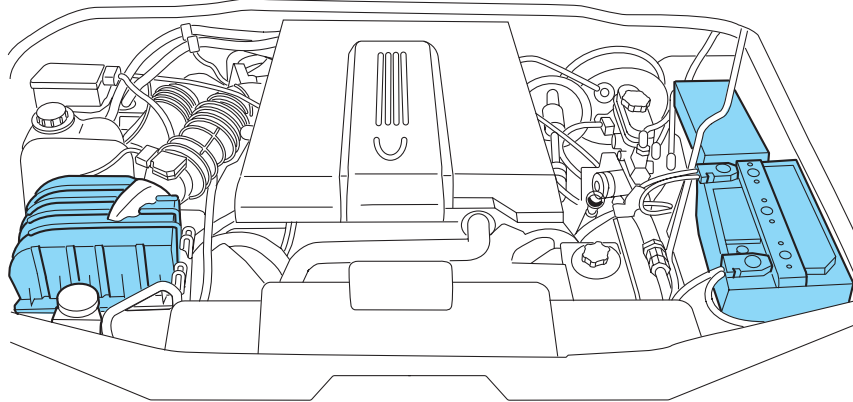

4.6L V8 Engine

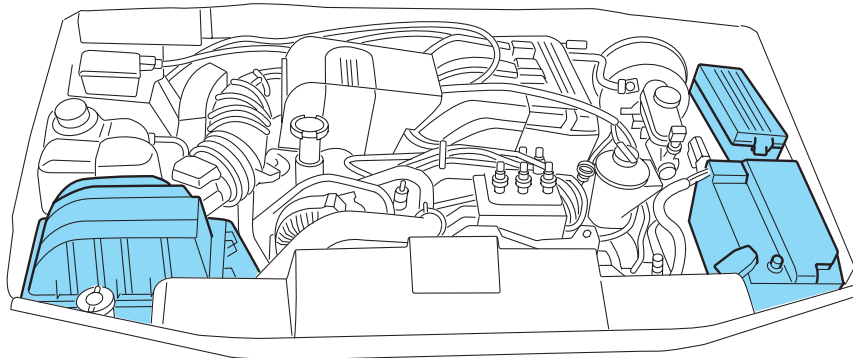

4.0L SOHC V6 Engine

- Never wash or rinse the engine while it is running; water in the running engine may cause internal damage.

Maintenance and care

Plastic (non-painted) exterior parts

Use only approved products to clean plastic parts. These products are available from your dealer.

- For routine cleaning, use Detail Wash (ZC-3-A).
- If tar or grease spots are present, use Ford Extra Strength Tar and Road Oil Removal (B7A-19520-AA).

Windows and wiper blades

The windshield, rear window and wiper blades should be cleaned regularly. If the wiper does not wipe properly, substances on the windshield, rear window or the wiper blades may be the cause. These may include hot wax treatments used by commercial car washes, tree sap, or other organic contamination. To clean these items, please follow these tips:

- The windshield or rear window may be cleaned with a non-abrasive cleaner such as Motorcraft Ultra Clear Spray Glass Cleaner (ZC-23), available from your dealer.
- Do not use abrasives, as they may cause scratches.
- Do not use fuel, kerosene, or paint thinner to clean any parts.
- Wiper blades can be cleaned with isopropyl (rubbing) alcohol or windshield washer solution. Be sure to replace wiper blades when they appear worn or do not function properly.

Instrument panel and cluster lens

Clean the instrument panel with a damp cloth, then dry with a dry cloth.

- Avoid cleaners or polish that increase the gloss of the upper portion of the instrument panel. The dull finish in this area helps protect the driver from undesirable windshield reflection.



Do not use chemical solvents or strong detergents when cleaning the steering wheel or instrument panel to avoid contamination of the air bag system.

- Be certain to wash or wipe your hands clean if you have been in contact with certain products such as insect repellent and suntan lotion in order to avoid possible damage to the painted surfaces.

Maintenance and care

Wood-tone trim

- Clean the area with a damp cloth, then dry by wiping with a dry, soft, clean cloth.
- Do not use household or glass cleaners as these may damage the finish.

Interior

For fabric, carpets, cloth seats and safety belts:

- Remove dust and loose dirt with a vacuum cleaner.
- Remove light stains and soil with Ford Extra Strength Upholstery Cleaner (E8AZ-19523-AA).
- If grease or tar is present on the material, spot-clean the area first with Motorcraft Spot and Stain Remover (ZC-14).
- Never saturate the seat covers with cleaning solution.
- Do not use household cleaning products or glass cleaners, which can stain and discolor the fabric and affect the flame retardant abilities of the seat materials.



Do not use cleaning solvents, bleach or dye on the vehicle's seatbelts, as these actions may weaken the belt webbing.

Leather seats (if equipped)

Your leather seating surfaces have a clear, protective coating over the leather.

- To clean, use a soft cloth with Motorcraft Deluxe Leather and Vinyl Cleaner (ZC-11-A). Dry the area with a soft cloth.
- To help maintain its resiliency and color, use the Motorcraft Deluxe Leather Care Kit (ZC-11-D), available from your authorized dealer.
- Do not use household cleaning products, alcohol solutions, solvents or cleaners intended for rubber, vinyl and plastics, or oil/petroleum-based leather conditioners. These products may cause premature wearing of the clear, protective coating.

Underbody

Flush the complete underside of your vehicle frequently. Keep body and door drain holes free from packed dirt.

Maintenance and care

Ford, Lincoln and Mercury car care products

Your Ford, Lincoln or Mercury dealer has many quality products available to clean your vehicle and protect its finishes. These quality products have been specifically engineered to fulfill your automotive needs; they are custom designed to complement the style and appearance of your vehicle. Each product is made from high quality materials that meet or exceed rigid specifications. For best results, use the following products or products of equivalent quality:

Motorcraft Custom Clearcoat Polish (ZC-8-A)

Ford Custom Vinyl Protectant* (not available in Canada)
(F2AZ-19530-A)

Motorcraft Vinyl Cleaner (Canada only) (CXC-93)

Motorcraft Vinyl Conditioner (Canada only) (CXC-94)

Motorcraft Deluxe Leather and Vinyl Cleaner (not available in Canada)
(ZC-11-A)

Ford Extra Strength Tar and Road Oil Remover* (not available in Canada)
(B7A-19520-AA)

Ford Extra Strength Upholstery Cleaner (not available in Canada)
(E8AZ-19523-AA)

Motorcraft Custom Bright Metal Cleaner (ZC-15)

Motorcraft Wheel and Tire Cleaner (ZC-37-A)

Motorcraft Dash and Vinyl Cleaner (ZC-38-A)

Motorcraft Car Care Kit (ZC-26)

Ford Premium Car Wash Concentrate (F2SZ-19523-WC)

Motorcraft Carlite Glass Cleaner (Canada only) (CXC-100)

Motorcraft Spot and Stain Remover (ZC-14)

Motorcraft Tire Detailer (ZC-28)

Motorcraft Triple Clean (ZC-13)

Motorcraft Ultra-Clear Spray Glass Cleaner (not available in Canada)
(ZC-23)

Motorcraft Engine Shampoo and Degreaser (ZC-20)

* May be sold with the Motorcraft name

Capacities and specifications

MOTORCRAFT PART NUMBERS

Component	4.0L SOHC V6 engine	4.6L V8 engine
Air filter element	FA-1695	FA-1695
Fuel filter	FG-986B	FG-986B
Battery	BXT-65-650	BXT-65-650
Oil filter	FL-820S	FL-820S
PCV valve	EV-243	F6ZE-6C324-CA
Spark plugs*	AGSF-22PP **	AWSF-32P

* Refer to Vehicle Emissions Control Information (VECI) decal for spark plug gap information.

** If a spark plug is removed for inspection, it must be reinstalled in the same cylinder. If a spark plug needs to be replaced, use only spark plugs with the service number suffix letter as shown on the engine decal.

REFILL CAPACITIES

Fluid	Ford Part Name	Application	Capacity
Brake fluid and Clutch fluid (if equipped)	Motorcraft High Performance DOT 3 Motor Vehicle Brake Fluid	All	Fill to line on reservoir
Engine oil (including filter change)	Motorcraft SAE 5W-30 Super Premium Motor Oil	4.0L	4.7L (5.0 quarts)
	Motorcraft SAE 5W-20 Premium Synthetic Blend Motor Oil	4.6L	5.7L (6.0 quarts)
Fuel tank	N/A	All	85.2L (22.5 gallons)

Capacities and specifications

Fluid	Ford Part Name	Application	Capacity
Power steering fluid	Motorcraft MERCON® ATF	All	Fill between the MIN and MAX lines on reservoir
Transmission fluid ¹	Motorcraft MERCON® ATF	5-speed manual	2.4L (5.1 pints) ²
	Motorcraft MERCON®V ATF	Automatic transmissions only.	12.0L (12.7 quarts) ³
Transfer case	Motorcraft MERCON® ATF	4WD	1.4L (1.5 quarts)
Engine coolant ⁴	Motorcraft Premium Engine Coolant (green-colored) or Motorcraft Premium Gold Engine Coolant (yellow-colored)	4.0L SOHC V6 engine without auxiliary climate control	15.4L (16.3 quarts)
		4.0L SOHC V6 engine with auxiliary climate control	17.2L (18.2 quarts)
		4.6L V8 engine without auxiliary climate control	17.6L (18.6 quarts)
		4.6L V8 engine with auxiliary climate control	19.0L (20.1 quarts)
Front axle lubricant	Motorcraft SAE 80W-90 Premium Rear Axle Lubricant	4x4 vehicles	1.7L (1.8 quarts)

Capacities and specifications

Fluid	Ford Part Name	Application	Capacity
Rear axle lubricant ⁵	Motorcraft SAE 75W-140 High Performance Synthetic Rear Axle Lubricant	Conventional Axle	1.7L (3.5 pints)
		Limited slip axle ⁶	1.5L (3.25 pints)
Windshield washer fluid	Motorcraft Premium Windshield Washer Concentrate	All	4.0L (4.2 quarts)

¹Ensure the correct automatic transmission fluid is used. MERCON® and MERCON® V are not interchangeable. DO NOT mix MERCON® and MERCON® V. Refer to your scheduled maintenance guide to determine the correct service interval.

²Service refill capacity is determined by filling the transmission to the bottom of the filler hole with the vehicle on a level surface.

³Indicates only approximate dry-fill capacity. Some applications may vary based on cooler size and if equipped with an in-tank cooler. The amount of transmission fluid and fluid level should be checked by a qualified technician.

⁴Add the coolant type originally equipped in your vehicle.

⁵All rear axles are filled with Motorcraft SAE 75W-140 High Performance Synthetic Rear Axle Lubricant, part number XY—75W140—QL or equivalent meeting Ford Specification WSL-M2C192-A.

⁶ Limited Slip differentials must add 118ml (4 oz) of Additive Friction Modifier XL—3 or equivalent meeting Ford Specification EST-M2C118-A to the rear axle whenever the axle has been serviced.

Capacities and specifications

LUBRICANT SPECIFICATIONS

Item	Ford Part Name or equivalent	Ford Part Number	Ford Specification
Body hinges, latches, door striker plates and rotors, seat tracks, fuel filler door hinge and spring, hood latch, auxiliary latch, seat tracks	Multi-Purpose Grease or Multi-Purpose Grease Spray	XG-4 or XL-5	ESR-M1C159-A or ESB-M1C93-B
Hydraulic brake fluid and Clutch Fluid (if equipped)	Motorcraft High Performance DOT 3 Motor Vehicle Brake Fluid	PM-1	ESA-M6C25-A, DOT 3
Driveshaft, slip spline, universal joints	Premium Long Life Grease	XG-1-C or XG-1-K	ESA-M1C75-B
Engine coolant	Motorcraft Premium Engine Coolant (green-colored)	VC-4-A (US) or CXC-10 (Canada)	ESE-M97B44-A
	Motorcraft Premium Gold Engine Coolant (yellow-colored)	VC-7-A	WSS-M97B51-A1
4.0L Engine oil	Motorcraft SAE 5W30 Super Premium Motor Oil	XO-5W30-QSP	WSS-M2C205-A with API Certification Mark
4.6L Engine oil	Motorcraft SAE 5W20 Premium Synthetic Blend Motor Oil	XO -5W20-QSP	WSS-M2C153-H with API Certification Mark

Capacities and specifications

Item	Ford Part Name or equivalent	Ford Part Number	Ford Specification
Automatic transmission ¹	Motorcraft MERCON®V ATF	XT-5-QM	MERCON®V
Power steering fluid	Motorcraft MERCON® Multi-Purpose ATF	XT-2-QDX	MERCON®
Ford conventional and Traction-Lok rear axles	75W-140 High Performance Synthetic Rear Axle Lubricant ²	XY-75W140-QL	WSL-M2C192_A
Front axle (4X4)	Motorcraft SAE 80W-90 Premium Rear Axle Lubricant	XY-80W90-QL	WSP-M2C197-A
Transfer case (4X4)	Motorcraft MERCON® Multi-Purpose ATF	XT-2-QDX	MERCON®
5-speed manual transmission	Motorcraft MERCON® Multi-Purpose ATF	XT-2-QDX	MERCON®
Transfer case Front Output Slip Shaft	Premium Long-Life Grease	XG-1-C or XG-1-K	ESA-M1C75-B
Windshield washer fluid	Motorcraft Premium Windshield Washer Concentrate	ZC—32-A	WSB-M8B16-A2

¹Ensure the correct automatic transmission fluid is used. MERCON® and MERCON® V are not interchangeable. DO NOT mix MERCON® and MERCON® V. Refer to your scheduled maintenance guide to determine the correct service interval.

Capacities and specifications

²Limited slip differentials must add 118 ml (4 oz) of Additive Friction Modifier XL—3 or equivalent meeting Ford specification EST-M2C118-A to the rear axle whenever the axle has been serviced.

ENGINE DATA

Engine	4.0L SOHC V6 engine	4.6L V8 engine
Cubic inches	245	281
Required fuel	87 octane	87 octane
Firing order	1-4-2-5-3-6	1-3-7-2-6-5-4-8
Spark plug gap	1.3-1.4 mm (0.052-0.056 inch)	1.3-1.4 mm (0.052-0.056 inch)
Ignition system	EDIS	EDIS
Compression ratio	9.7:1	9.4:1

VEHICLE DIMENSIONS

Dimensions	4-Door 4x2 or 4x4 XLT Model mm (in.)
(1) Overall length	4812 (189.5)
(2) Overall width	1832 (72.1)
(3) Maximum height*	1828 (71.9)
(4) Wheelbase	2889 (113.7)
(5) Track width, front	1547 (60.9)
(5) Track width, rear	1554 (61.2)

* Height includes roof rack and P255/70R16 tire

Capacities and specifications

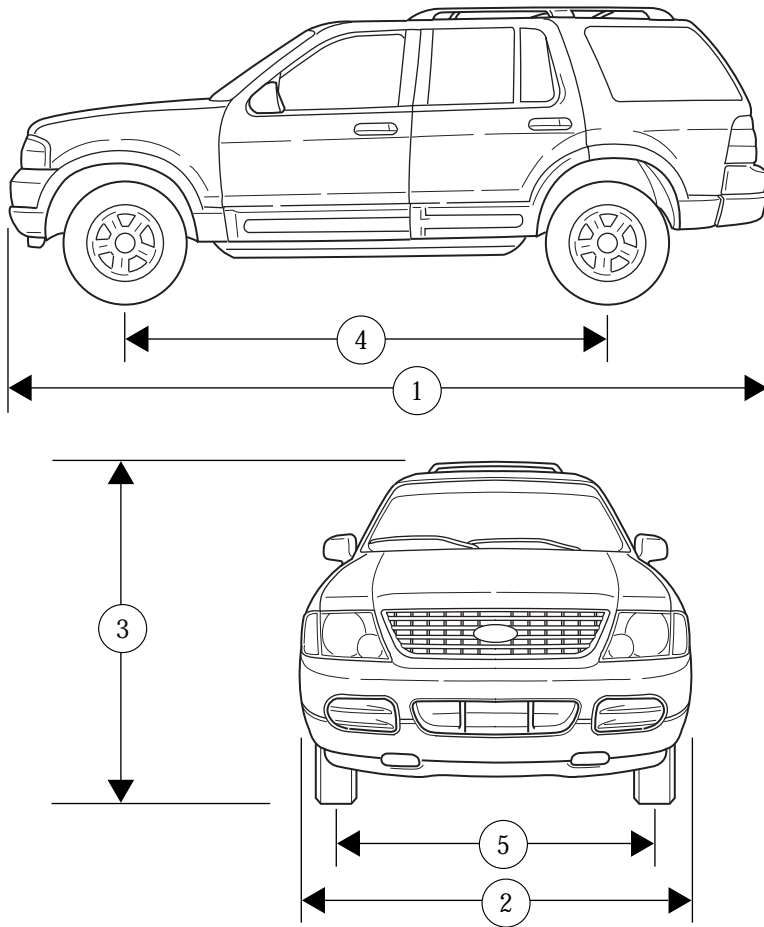

Capacities and specifications

IDENTIFYING YOUR VEHICLE

Certification label

The National Highway Traffic Safety Administration Regulations require that a Certification label be affixed to a vehicle and prescribe where the Certification label may be located. The Certification label is located on the front door latch pillar on the driver's side.

MFD. BY FORD MOTOR CO. IN U.S.A.			
DATE: XXXXX	GVWR: XXXXX LB/ XXXXX KG		
FGAWR: XXXXXX/XXXXXXXX	RGAWR: XXXXXX/XXXXXXXX		
THIS VEHICLE CONFORMS TO ALL APPLICABLE FEDERAL MOTOR VEHICLE SAFETY STANDARDS IN EFFECT ON THE DATE OF MANUFACTURE SHOWN ABOVE.			
VIN: XXXXXXXXXXXXXXXXX	TYPE: XXXXXXXXXXXXXXXXX		
MAXIMUM LOAD=OCCUPANTS + LUGGAGE=XXXKG/XXXLB			
OCCUPANTS: X TOTAL X FR X 2ND X RR OCCUPANTS LUGGAGE			
		XX	XXXKG/XXXLB
		X	XXXKG/XXXLB
TIRE: XXXX/XXXXX XXX			
PRESSURE (FR) XXX kPa/ XX PSI COLD			
PRESSURE (RR) XXX kPa/ XX PSI COLD			
TRAILER TOWING - SEE OWNER GUIDE			
EXT PNT: XXXXXX XXXXX	RC: XX	DSQ: XXXX	F0000
BAR INT TR TP/PS R	AXLE TR SPR	T0000	
X XX XXX X	XX X XXXX		
UTC VF0HT-15294A10-GA			

Vehicle identification number

The vehicle identification number (VIN) is a 17 digit combination of letters and numbers. The VIN is attached to a metal tag and is located on the driver side instrument panel. The VIN number is also found on the Certification label. (Please note that in the graphic XXXX is representative of your vehicle identification number.)

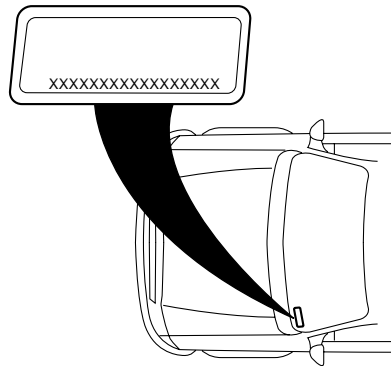

Capacities and specifications

1. World manufacturer identifier
2. Brake type and gross vehicle weight rating (GVWR)
3. Vehicle line, series, body type
4. Engine type
5. Check digit
6. Model year
7. Assembly plant
8. Production sequence number

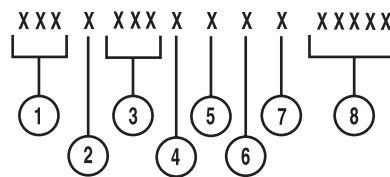

Engine number

The engine number (the last eight numbers of the vehicle identification number) is stamped on the engine block, transmission, frame and transfer case (if equipped).

Customer assistance

Ford Extended Service Plan

You can get more protection for your new car or light truck by purchasing Ford Extended Service Plan (Ford ESP) coverage. Ford ESP is an optional service contract which is backed by Ford Motor Company or Ford Motor Service Company (in the U.S.) and Ford of Canada (in Canada). It provides the following:

- Benefits during the warranty period depending on the plan you purchase (such as: reimbursement for rentals; coverage for certain maintenance and wear items).
- Protection against covered repair costs after your Bumper-to-Bumper Warranty expires.

You may purchase Ford ESP from any participating Ford and Lincoln Mercury and Ford of Canada dealer. There are several plans available in various time, distance and deductible combinations which can be tailored to fit your own driving needs. Ford ESP also offers reimbursement benefits for towing and rental coverage.

When you buy Ford ESP, you receive Peace-of-Mind protection throughout the United States and Canada, provided by a network of more than 5,000 participating Ford or Lincoln Mercury and Ford of Canada dealers.

If you did not take advantage of the Ford Extended Service Plan at the time of purchasing your vehicle, you may still be eligible. Please contact your dealer for further information. Since this information is subject to change, please ask your dealer for complete details about Ford Extended Service Plan coverage options, or visit the Ford ESP website at www.ford-esp.com.

GETTING THE SERVICES YOU NEED

At home

Ford Motor Company and Ford of Canada have authorized dealerships to service your vehicle. It is preferred that you return to the authorized dealer where your vehicle was purchased when warranty repairs are needed. However, you may also take your vehicle to another Ford Motor Company or Ford of Canada dealership authorized for warranty repairs. Certain warranty repairs require special training though, so not all dealers are authorized to perform all warranty repairs. That means that depending on the warranty repair needed, the vehicle may need to be taken to another dealer. If a particular dealership cannot assist you, then contact the Customer Relationship Center.

Customer assistance

If you have questions or concerns, or are unsatisfied with the service you are receiving, follow these steps:

1. Contact your Sales Representative or Service Advisor at your selling/servicing dealership.
2. If your inquiry or concern remains unresolved, contact the Sales Manager or Service Manager at the dealership.
3. If the inquiry or concern cannot be resolved at the dealership level, please contact the Ford Customer Relationship Center.

Away from home

If you own a Ford or Mercury vehicle and are away from home when your vehicle needs service, or if you need more help than the dealership could provide, after following the steps described above, contact the Ford Customer Relationship Center to find an authorized dealership to help you.

In the United States:

Ford Motor Company
Customer Relationship Center
16800 Executive Plaza Drive
P.O. Box 6248
Dearborn, Michigan 48121
1-800-392-3673 (FORD)
(TDD for the hearing impaired: 1-800-232-5952)
www.ford.com

In Canada:

Customer Relationship Centre
Ford Motor Company of Canada, Limited
P.O. Box 2000
Oakville, Ontario L6J 5E4
1-800-565-3673 (FORD)
www.ford.ca

If you own a Lincoln vehicle and are away from home when your vehicle needs service, or if you need more help than the dealership could provide, after following the steps described above, contact the Ford Customer Relationship Center to find an authorized dealership to help you.

Customer assistance

In the United States:

Ford Motor Company
Customer Relationship Center
16800 Executive Plaza Drive
P.O. Box 6248
Dearborn, Michigan 48121
1-800-521-4140
(TDD for the hearing impaired: 1-800-232-5952)
www.ford.com

In Canada:

Customer Relationship Centre
Ford Motor Company of Canada, Limited
P.O. Box 2000
Oakville, Ontario L6J 5E4
1-800-565-3673 (FORD)
www.ford.ca

In order to help you service your Ford or Lincoln Mercury vehicle, please have the following information available when contacting a Customer Relationship Center:

- Your telephone number (home and business)
- The name of the dealer and the city where the dealership is located
- The year and make of your vehicle
- The date of vehicle purchase
- The current odometer reading
- The vehicle identification number (VIN)

If you still have a complaint involving a warranty dispute, you may wish to contact the Dispute Settlement Board (U.S.).

In some states (in the U.S.) you must directly notify Ford in writing before pursuing remedies under your state's warranty laws. Ford is also allowed a final repair attempt in some states.

In the United States, a warranty dispute must be submitted to the Dispute Settlement Board before taking action under the Magnuson-Moss Warranty Act, or to the extent allowed by state law, before pursuing replacement or repurchase remedies provided by certain state laws. This dispute handling procedure is not required prior to enforcing state created rights or other rights which are independent of the Magnuson-Moss Warranty Act or state replacement or repurchase laws.

Customer assistance

THE DISPUTE SETTLEMENT BOARD (U.S. only)

The Dispute Settlement Board is:

- an independent, third-party arbitration program for warranty disputes.
- available free to owners and lessees of qualifying Ford Motor Company vehicles.

The Dispute Settlement Board may not be available in all states. Ford Motor Company reserves the right to change eligibility limitations, modify procedures and/or to discontinue this service without notice and without incurring obligations per applicable state law.

What kinds of cases does the Board review?

Unresolved warranty repair concerns or vehicle performance concerns as on Ford and Lincoln Mercury cars and Ford and Lincoln Mercury light trucks which are within the terms of any applicable written new vehicle warranty are eligible for review, except those involving:

- a non-Ford product
- a non-Ford dealership
- sales disputes between customer and dealer except those associated with warranty repairs or concerns with the vehicle's performance as designed
- a request for reimbursement of consequential expenses unless a service or product concern is being reviewed
- items not covered by the New Vehicle Limited Warranty (including maintenance and wear items)
- alleged personal injury/property damage claims
- cases currently in litigation
- vehicles not used primarily for family, personal or household purposes (except in states where the Dispute Settlement Board is required to review commercial vehicles)
- vehicles with non-U.S. warranties

Concerns are ineligible for review if the New Vehicle Limited Warranty has expired at receipt of your application and, in certain states eligibility is dependent upon the customer's possession of the vehicle.

Eligibility may differ according to state law. For example, see the unique brochures for California, West Virginia, Georgia and Wisconsin purchasers/lessees.

Customer assistance

Board membership

The Board consists of:

- Three consumer representatives
- A Ford or Lincoln Mercury dealership representative

Consumer candidates for Board membership are recruited and trained by an independent consulting firm. The dealership Board member is chosen from Ford and Lincoln Mercury dealership management, recognized for their business leadership qualities.

What the Board needs

To have your case reviewed you must complete the application in the DSB brochure and mail it to the address provided on the application form. Some states will require you to use certified mail, with return receipt requested.

Your application is reviewed and, if it is determined to be eligible, you will receive an acknowledgment indicating:

- The file number assigned to your application.
- The toll-free phone number of the DSB's independent administrator.

Your dealership and a Ford Motor Company representative will then be asked to submit statements.

To properly review your case, the Board needs the following information:

- Legible copies of all documents and maintenance or repair orders relevant to the case.
- The year, make, model, and Vehicle Identification Number (VIN) listed on your vehicle ownership license.
- The date of repair(s) and mileage at the time of occurrence(s).
- The current mileage.
- The name of the dealer(s) who sold or serviced the vehicle.
- A brief description of your unresolved concern.
- A brief summary of the action taken by the dealer(s) and Ford Motor Company.
- The names (if known) of all the people you contacted at the dealership(s).
- A description of the action you expect to resolve your concern.

You will receive a letter of explanation if your application does not qualify for Board review.

Customer assistance

Oral presentations

If you would like to make an oral presentation, indicate YES to question 6 on the application. While it is your right to make an oral presentation before the Board, this is not a requirement and the Board will decide the case whether or not an oral presentation is made. An oral presentation may be requested by the Board as well.

Making a decision

Board members review all available information related to each complaint, including oral presentations, and arrive at a fair and impartial decision. Board review may be terminated at any time by either party.

Every effort is made to decide the case within 40 days of the date that all requested information is received by the Board. Since the Board generally meets once a month, it may take longer for the Board to consider some cases.

After a case is reviewed, the Board mails you a decision letter and a form on which to accept or reject the Board's decision. The decisions of the Board are binding on Ford (and, in some cases, on the dealer) but not on consumers who are free to pursue other remedies available to them under state or federal law.

To request a DSB Brochure/Application

For a brochure/application, speak to your dealer or write/call to the Board at the following address/phone number:

Dispute Settlement Board
P.O. Box 5120
Southfield, MI 48086-5120
1-800-428-3718

You may also contact the North American Customer Relationship Center at 1-800-392-3673 (Ford), TDD for the hearing impaired: 1-800-232-5952 or by writing to the Center at the following address:

Ford Motor Company
Customer Relationship Center
16800 Executive Plaza Drive
P.O. Box 6248
Dearborn, Michigan 48121

Customer assistance

UTILIZING THE MEDIATION/ARBITRATION PROGRAM (CANADA ONLY)

In those cases where you continue to feel that the efforts by Ford and the dealer to resolve a factory-related vehicle service concern have been unsatisfactory, Ford of Canada participates in an impartial third party mediation/arbitration program administered by the Canadian Motor Vehicle Arbitration Plan (CAMVAP).

The CAMVAP program is a straight-forward and relatively speedy alternative to resolve a disagreement when all other efforts to produce a settlement have failed. This procedure is without cost to you and is designed to eliminate the need for lengthy and expensive legal proceedings.

In the CAMVAP program, impartial third-party arbitrators conduct hearings at mutually convenient times and places in an informal environment. These impartial arbitrators review the positions of the parties, make decisions and, when appropriate, render awards to resolve disputes. CAMVAP decisions are fast, fair, and final; the arbitrator's award is binding both to you and Ford of Canada.

CAMVAP services are available in all territories and provinces. For more information, without charge or obligation, call your CAMVAP Provincial Administrator directly at 1-800-207-0685.

GETTING ASSISTANCE OUTSIDE THE U.S. AND CANADA

Before exporting your vehicle to a foreign country, contact the appropriate foreign embassy or consulate. These officials can inform you of local vehicle registration regulations and where to find unleaded fuel.

If you cannot find unleaded fuel or can only get fuel with an anti-knock index lower than is recommended for your vehicle, contact a district or owner relations/customer relationship office.

The use of leaded fuel in your vehicle without proper conversion may damage the effectiveness of your emission control system and may cause engine knocking or serious engine damage. Ford Motor Company/Ford of Canada is not responsible for any damage caused by use of improper fuel.

In the United States, using leaded fuel may also result in difficulty importing your vehicle back into the U.S.

If your vehicle must be serviced while you are traveling or living in Central or South America, the Caribbean, or the Middle East, contact the nearest Ford dealership. If the dealership cannot help you, write or call:

Customer assistance

FORD MOTOR COMPANY
WORLDWIDE DIRECT MARKET OPERATIONS
1555 Fairlane Drive
Fairlane Business Park #3
Allen Park, Michigan 48101
U.S.A.
Telephone: (313) 594-4857
FAX: (313) 390-0804

If you are in another foreign country, contact the nearest Ford dealership. If the dealership employees cannot help you, they can direct you to the nearest Ford affiliate office.

If you buy your vehicle in North America and then relocate outside of the U.S. or Canada, register your vehicle identification number (VIN) and new address with Ford Motor Company Worldwide Direct Market Operations.

Ford accessories for your vehicle

A wide selection of genuine Ford accessories are available for your vehicle through your local authorized Ford, Lincoln Mercury or Ford of Canada dealer. These quality accessories have been specifically engineered to fulfill your automotive needs; they are custom designed to complement the style and aerodynamic appearance of your vehicle. In addition, each accessory is made from high quality materials and meets or exceeds Ford's rigorous engineering and safety specifications. Ford Motor Company will repair or replace any properly dealer-installed Ford accessory found to be defective in factory-supplied materials or workmanship during the warranty period, as well as any component damaged by the defective accessory. The accessory will be warranted for whichever provides you the greatest benefit:

- 12 months or 20 000 km (12 000 miles) (whichever occurs first), or
- The remainder of your new vehicle limited warranty.

This means that genuine Ford accessories purchased along with your new vehicle and installed by the dealer are covered for the full length of your New Vehicle's Limited Warranty — 3 years or 60 000 km (36 000 miles) (whichever occurs first). Contact your dealer for details and a copy of the warranty.

Not all accessories are available for all models.

Customer assistance

Vehicle Security

Styled wheel locks
Vehicle security systems

Comfort and convenience

Cargo net
Cargo organizers
Cargo shade
Cargo tray
Engine block heaters
Tire step

Travel equipment

Ash cup
Automatic headlamps with daytime running lights (DRL)
Cargo Organizer
Cellular phone holder
Cellular phone hands free system with voice recognition
Daytime running lights (DRL)
Dog guard
Factory luggage rack adaptors (bike and ski)
First aid kit
Fog lamps
Full vehicle cover
Highway safety kit
Inside mirror, electrochromic compass (with and without temperature display)
Luggage/Cargo basket
Luggage basket light bracket
Luggage divider
Luggage rack cross bars
Navigation system
Neutral towing transfer case kit

Customer assistance

Remote start system
Removable luggage rack adapters (bike and ski)
Running boards/bars
Seatback storage
Scuff plates
Smoker's package
Soft luggage cover
Track rider bars (for luggage rack)
Trailer hitch (Class III)
Trailer hitch (Class IV)
Trailer hitch bars and balls
Trailer hitch mount bike carrier
Trailer hitch receiver cover
Trailer hitch wiring adaptor
Trailgate table and adaptor

Protection and appearance equipment

Air bag anti-theft locks
All-weather floor mats
Cargo liners, interior
Carpet floor mats
Door edge guards
Front end covers (full and sport)
Front hood deflectors
Locking gas cap
Molded splash guards
Rear air deflector
Side window air deflectors
Skid plate
Tow hooks
Universal floor mats

Customer assistance

For maximum vehicle performance, keep the following information in mind when adding accessories or equipment to your vehicle:

- When adding accessories, equipment, passengers and luggage to your vehicle, do not exceed the total weight capacity of the vehicle or of the front or rear axle (GVWR or GAWR as indicated on the Safety compliance certification label). Consult your dealer for specific weight information.
- The Federal Communications Commission (FCC) and Canadian Radio Telecommunications Commission (CRTC) regulate the use of mobile communications systems - such as two-way radios, telephones and theft alarms - that are equipped with radio transmitters. Any such equipment installed in your vehicle should comply with FCC or CRTC regulations and should be installed only by a qualified service technician.
- Mobile communications systems may harm the operation of your vehicle, particularly if they are not properly designed for automotive use or are not properly installed. When operated, such systems may cause the engine to stumble or stall or cause the transmission to be damaged or operate improperly. In addition, such systems may be damaged or their performance may be affected by operating your vehicle. (Citizens band [CB] transceivers, garage door openers and other transmitters with outputs of five watts or less will not ordinarily affect your vehicle's operation.)
- Ford cannot assume responsibility for any adverse effects or damage that may result from the use of such equipment.

ORDERING ADDITIONAL OWNER'S LITERATURE

To order the publications in this portfolio, contact Helm, Incorporated at:

HELM, INCORPORATED
P.O. Box 07150
Detroit, Michigan 48207

Or call:

For a free publication catalog, order toll free: 1-800-782-4356

Monday-Friday 8:00 a.m. - 6:00 p.m. EST

Helm, Incorporated can also be reached by their website:
www.helminc.com.

(Items in this catalog may be purchased by credit card, check or money order.)

Customer assistance

Obtaining a French owner's guide

French Owner's Guides can be obtained from your dealer or by writing to Ford Motor Company of Canada, Limited, Service Publications, P.O. Box 1580, Station B, Mississauga, Ontario L4Y 4G3.

IN CALIFORNIA (U.S. ONLY)

California Civil Code Section 1793.2(d) requires that, if a manufacturer or its representative is unable to repair a motor vehicle to conform to the vehicle's applicable express warranty after a reasonable number of attempts, the manufacturer shall be required to either replace the vehicle with one substantially identical or repurchase the vehicle and reimburse the buyer in an amount equal to the actual price paid or payable by the consumer (less a reasonable allowance for consumer use). The consumer has the right to choose whether to receive a refund or replacement vehicle.

California Civil Code Section 1793.22(b) presumes that the manufacturer has had a reasonable number of attempts to conform the vehicle to its applicable express warranties if, within the first 18 months of ownership of a new vehicle or the first 29,000 km (18,000 miles), whichever occurs first:

1. Two or more repair attempts are made on the same nonconformity likely to cause death or serious bodily injury OR
2. Four or more repair attempts are made on the same nonconformity (a defect or condition that substantially impairs the use, value or safety of the vehicle) OR
3. The vehicle is out of service for repair of nonconformities for a total of more than 30 calendar days (not necessarily all at one time)

In the case of 1 or 2 above, the consumer must also notify the manufacturer of the need for the repair of the nonconformity at the following address:

Ford Motor Company
16800 Executive Plaza Drive
Mail Drop 3NE-B
Dearborn, MI 48126

Reporting safety defects

REPORTING SAFETY DEFECTS (U.S. ONLY)

If you believe that your vehicle has a defect which could cause a crash or could cause injury or death, you should immediately inform the National Highway Traffic Safety Administration (NHTSA) in addition to notifying Ford Motor Company.

Ford Motor Company

If NHTSA receives similar complaints, it may open an investigation, and if it finds that a safety defect exists in a group of vehicles, it may order a recall and remedy campaign. However, NHTSA cannot become involved in individual problems between you, your dealer, or Ford Motor Company.

To contact NHTSA, you may either call the Auto Safety Hotline toll-free at 1-800-424-9393 (or 366-0123 in the Washington D.C. area) or write to:

NHTSA
U.S. Department of Transportation
Washington, D.C. 20590

You can also obtain other information about motor vehicle safety from the Hotline.

Index

A

- ABS (see Brakes)187
- Accessory delay109
- Air bag supplemental restraint system163, 168
 - and child safety seats165
 - description163, 168
 - disposal171
 - driver air bag165, 169
 - indicator light10, 167, 171
 - operation165, 169
 - passenger air bag165, 169
- Air cleaner filter304
- Air conditioning36
 - automatic temperature control system40
 - auxiliary heater and air conditioner50
 - rear seat controls51
- Ambulance packages3
- Antifreeze (see Engine coolant)262
- Anti-lock brake system (see Brakes)187–189
- Anti-theft system128
 - arming the system129
 - disarming a triggered system130
- Audio system (see Radio)55, 67, 76
- Automatic transmission
 - driving an automatic overdrive196
 - fluid, adding269
 - fluid, checking269
 - fluid, refill capacities304
 - fluid, specification309
- Auxiliary power point113

Axle

- lubricant specifications ..307, 309
- refill capacities304

B

- Battery272
 - acid, treating emergencies272
 - charging system warning light12
 - jumping a disabled battery244
 - maintenance-free272
 - replacement, specifications ...304
 - servicing272
 - voltage gauge16
- BeltMinder158
- Brakes187
 - anti-lock187–189
 - anti-lock brake system (ABS) warning light11, 188
 - brake warning light10
 - fluid, checking and adding261
 - fluid, refill capacities304
 - fluid, specifications307, 309
 - lubricant specifications ..307, 309
 - parking189
 - pedals (see Power adjustable foot pedals)33
 - shift interlock194
- Break-in period3
- Bulbs291

C

- Capacities for refilling fluids304
- Cargo cover115
- CD-6 disc76
- CD-single61
- CD-single premium67
- Certification Label311

Index

- Changing a tire237
- Child safety restraints172
child safety belts172
- Child safety seats174
attaching with tether straps ..179
in front seat176
in rear seat176, 178
- Cleaning your vehicle298
engine compartment299
instrument panel301
interior302
plastic parts301
washing298
waxing298
wheels299
wiper blades301
woodtone trim302
- Climate control (see Air conditioning or Heating)36
- Clock60, 66, 74, 88
- Clutch
operation while driving199
recommended shift speeds200
- Compass, electronic17
calibration19
set zone adjustment18, 21
- Console112
overhead100–101
rear113
- Controls
power seat136
steering column98
- Coolant
checking and adding262
refill capacities266, 304
specifications307, 309
- Cruise control
(see Speed control)92
- Customer Assistance225
Ford accessories for your vehicle303, 320
Ford Extended Service Plan313
Getting assistance outside the U.S. and Canada319
Getting roadside assistance ...225
Getting the service you need313
Ordering additional owner's literature323
The Dispute Settlement Board316
Utilizing the Mediation/Arbitration Program319
- D**
- Daytime running lamps
(see Lamps)31
- Defrost
rear window54
- Dipstick
automatic transmission
fluid269
engine oil256
- Doors
door ajar warning12
lubricant specifications307
- Driveline universal joint and slip yoke271
- Driving under special conditions207, 210
sand209
snow and ice211
through water210, 216
- E**
- Electronic message center19

Index

- Emergencies, roadside
 jump-starting244
- Emission control system289
- Engine309
 check engine/service engine
 soon light8
 cleaning299
 coolant262
 fail-safe coolant267
 idle speed control272
 lubrication
 specifications307, 309
 refill capacities304
 service points254–255
 starting after a collision226
- Engine block heater185
- Engine oil256
 checking and adding256
 dipstick256
 filter, specifications259, 304
 recommendations259
 refill capacities304
 specifications307, 309
- Exhaust fumes186
- F**
- Fail safe cooling267
- Flexible Fuel Vehicle (FFV)280
- Floor mats114
- Fluid capacities304
- Foglamps31
- Four-Wheel Drive
vehicles12, 201
 control trac54, 201
 description202, 205
 driving off road206
 electronic shift54
 preparing to drive your
 vehicle193
- Fuel280
 calculating fuel
 economy22, 286
 cap9, 285
 capacity304
 choosing the right fuel283
 comparisons with EPA fuel
 economy estimates289
 detergent in fuel285
 filling your vehicle with
 fuel280, 285–286
 filter, specifications286, 304
 fuel pump shut-off switch226
 gauge17
 improving fuel economy286
 octane rating283, 309
 quality284
 running out of fuel285
 safety information relating to
 automotive fuels280
- Fuel - flex fuel vehicle
(FFV)280, 283
- Fuses227, 229
- G**
- Garage door opener101, 103
- Gas cap (see Fuel cap)9, 285
- Gas mileage (see Fuel
economy)286
- Gauges14
 battery voltage gauge16
 engine coolant temperature
 gauge15
 engine oil pressure gauge17
 fuel gauge17
 odometer15
 speedometer14

Index

- tachometer16
- trip odometer16
- GAWR (Gross Axle Weight Rating)214
 - calculating216
 - definition214
 - driving with a heavy load214
 - location214
- GVWR (Gross Vehicle Weight Rating)214
 - calculating214, 216
 - definition214
 - driving with a heavy load214
 - location214
- H**
- Hazard flashers226
- Head restraints135, 140
- Headlamps31
 - aiming297
 - autolamp system33
 - bulb specifications296
 - daytime running lights31
 - flash to pass32
 - high beam11, 32
 - replacing bulbs292
 - turning on and off31
 - warning chime13
- Heating36
 - heating and air conditioning system36
 - rear seat controls51
- HomeLink universal transceiver (see Garage door opener)103–104, 106–107
- Hood252
- I**
- Ignition92, 309
- Infant seats (see Safety seats)174
- Inspection/maintenance (I/M) testing290
- Instrument panel
 - cleaning301
 - cluster8
 - lighting up panel and interior32
 - location of components8
- J**
- Jack237, 239
 - positioning237, 240
 - storage237–238, 243
- Jump-starting your vehicle244
- K**
- Keyless entry system122
 - autolock126
 - keypad122
 - locking and unlocking doors125
 - programming entry code123
- Keys131–133
 - key in ignition chime13
 - positions of the ignition92
- L**
- Lamps
 - autolamp system33
 - bulb replacement specifications chart296
 - cargo lamps32
 - daytime running light31
 - fog lamps31
 - headlamps31
 - headlamps, flash to pass32
 - instrument panel, dimming32

Index

- interior lamps102
- replacing bulbs291–295
- Lane change indicator
(see Turn signal)91
- Liftgate114, 118
- Lights, warning and indicator8
 - AdvanceTrac12
 - air bag10
 - anti-lock brakes (ABS)11, 188
 - brake10
 - charging system12
 - check coolant10–11
 - cruise indicator13
 - door ajar12
 - engine oil pressure11
 - fuel cap light9
 - high beam11
 - low washer fluid12
 - overdrive off13
 - safety belt10
 - service engine soon8
 - speed control96
 - turn signal indicator11
- Limited-slip axle214
- Load limits214
 - GAWR214
 - GVWR214
 - trailer towing214
- Loading instructions216
- Locks
 - autolock126
 - childproof111
 - doors110
- Lubricant specifications ...307, 309
- Lumbar support, seats139
- M**
- Manual transmission199
- fluid capacities304
- lubricant specifications309
- reverse201
- Message center19–20
 - english/metric button25
 - system check button25
 - warning messages25
- Mirrors108
 - automatic dimming rearview
mirror107
 - fold away112
 - heated112
 - side view mirrors (power)111
- Moon roof102
- Motorcraft parts286, 304
- O**
- Octane rating283
- Odometer15
- Oil (see Engine oil)256
- P**
- Panic alarm feature, remote
entry system118
- Parking brake189
- Parts (see Motorcraft parts) ...304
- Pedals (see Power adjustable
foot pedals)33
- Power distribution box
(see Fuses)233
- Power door locks110
- Power mirrors111
- Power point113
- Power steering193
 - fluid, checking and adding268

Index

- fluid, refill capacity304
- fluid, specifications307, 309
- Power Windows108
- Preparing to drive your vehicle193
- R**
- Radio55, 67, 76
- Radio reception90
- Rear window defroster54
- Relays227, 236
- Remote entry system116, 118
 - illuminated entry121
 - locking/unlocking doors117, 128
 - opening the trunk118
 - panic alarm118
 - replacement/additional transmitters120
 - replacing the batteries119
- Reverse sensing system33
- Roadside assistance225
- Roof rack224
- S**
- Safety belts (see Safety restraints) ... 13, 147, 149, 151-153, 157
- Safety Canopy168-169
- Safety defects, reporting325
- Safety restraints .. 147, 149, 151-153, 156-157
 - belt minder158
 - cleaning the safety belts162
 - extension assembly157
 - for adults151-153
 - for children171-172
 - lap belt154
 - warning light and chime10, 13, 157-158
- Safety seats for children174
- Seat belts (see Safety restraints)147
- Seats135
 - child safety seats174
 - heated139
 - memory seat118, 138
- SecuriLock passive anti-theft system131-133
- Servicing your vehicle251
- Snowplowing3
- Spark plugs, specifications304, 309
- Special notice3
 - ambulance conversions3
 - utility-type vehicles3
- Specification chart, lubricants307, 309
- Speed control92
- Speedometer14
- Starting your vehicle182, 184-185
 - jump starting244
- Steering wheel
 - controls92, 96, 98
 - tilting96
- T**
- Tachometer16
- Tire warning278
- Tires237, 275-276, 278

Index

- changing237-238, 240
- checking the pressure276
- replacing239-240, 278
- rotating277
- snow tires and chains279
- tire grades276
- treadwear275
- Towing217
 - recreational towing223
 - trailer towing217
 - wrecker250
- Traction control190
 - active light12
- Transfer case
 - fluid checking271
- Transmission194
 - fluid, checking and adding
 - (automatic)269
 - (manual)270
 - fluid, refill capacities304
 - lubricant
 - specifications307, 309
 - manual operation199
- Trip odometer16
- Trunk118
- Turn signal11, 91
- V**
 - Vehicle dimensions309
 - Vehicle Identification Number (VIN)311
 - Vehicle loading214
 - Ventilating your vehicle186
- W**
 - Warning chimes13
 - Warning lights (see Lights)8
 - Washer fluid262
 - Water, Driving through216
 - Windows
 - power108
 - rear wiper/washer98
 - Windshield washer fluid and wipers
 - checking and adding fluid262
 - checking and cleaning274
 - liftgate reservoir262
 - operation97
 - replacing wiper blades274
 - Wrecker towing250

Filling station information

Item	Information
Required fuel	Unleaded fuel only - 87 octane
Fuel tank capacity	85.2L (22.5 gallons)
4.0L Engine oil capacity (includes filter change)	4.7L (5.0 quarts). Use Motorcraft SAE 5W-30 Super Premium Motor Oil, Ford specification WSS-M2C153-G.
4.6L Engine oil capacity (includes filter change)	5.7L (6.0 quarts). Use Motorcraft SAE 5W-20 Super Premium Motor Oil, Ford specification WSS-M2C153-H.
Tire size and pressure	Refer to the Certification Label on inside of driver's door.
Hood release	Pull handle under the instrument panel.
Coolant capacity-(4.0L SOHC V6 engine without auxiliary climate control) ¹	15.4L (16.3 quarts)
Coolant capacity-(4.0L SOHC V6 engine with auxiliary climate control) ¹	17.2L (18.2 quarts)
Coolant capacity (4.6L V8 engine without auxiliary climate control) ¹	17.6L (18.6 quarts)
Coolant capacity (4.6L V8 engine with auxiliary climate control) ¹	19.0L (20.1 quarts)
Power steering fluid capacity	Fill to line on reservoir. Use Motorcraft MERCON® ATF.
Manual transmission fluid capacity ²	2.4L (5.1 pints). Use Motorcraft MERCON® ATF.
Automatic transmission fluid capacity (5R55W transmission) ²	12.0L (12.7 quarts). Use Motorcraft MERCON® V ATF. ³

¹Use either green-colored Motorcraft Premium Engine Coolant or yellow-colored Motorcraft Premium Gold Engine Coolant. DO NOT USE Ford Extended Life Engine Coolant (orange in color). Refer to *Adding engine coolant, in the Maintenance and Care chapter*.

²Ensure the correct automatic transmission fluid is used. MERCON® and MERCON® V are not interchangeable. DO NOT mix MERCON® and MERCON® V. Refer to your scheduled maintenance guide to determine the correct service interval.

³Indicates only approximate dry-fill capacity. The amount of transmission fluid and fluid level should be checked by a qualified technician.